

## *Introduction*

This owner's manual has been compiled for you as the new owner of a Terhi ABS boat. We thank you for your choice, and we hope that your boat will meet with your expectations. This 12-page manual has been prepared to assist you in the safe and problem-free use of your boat. It contains information on the use and care of your boat. We urge you to read the manual carefully and fully acquaint yourself with your boat before you start to use it.

If this is your first boat, or you are changing to a type of boat that is not as familiar to you as your previous one, begin by acquiring handling and operating experience in conditions that are as safe as possible, before launching and taking responsibility for passengers.

KEEP THIS MANUAL IN A SAFE PLACE, AND GIVE IT TO THE NEXT OWNER IF YOU SELL THE BOAT.

# Contents

<b>Introduction</b> .....	1	<b>3 Electrical system</b> .....	7
<b>Contents</b> .....	2	3.1 Main switch .....	7
<b>Before you set out</b> .....	3	3.2 Battery hook-up and placement .....	7
Prevailing weather conditions and weather forecast .....	3	3.3 Control panel .....	8
Bailing .....	3	3.4 Wiring diagrams .....	8
Drain plugs .....	3	3.5 Fuses .....	9
Load Capacity .....	3	3.6 Navigation lights .....	9
Fuel .....	3	<b>4 Maintenance and winter storage</b> .....	9
Engine and other equipment .....	3	4.1 Washing and cleaning .....	9
The minimum onboard equipment .....	3	4.2 Winter storage .....	10
Securing of gear .....	3	4.3 Engine and other equipment .....	10
Charts .....	3	4.4 Anti-fouling .....	10
Setting out .....	3	4.5 Care and maintenance .....	10
<b>1 General</b> .....	4	4.6 Repairs .....	11
1.1 Certification .....	4	<b>5 Transport</b> .....	11
1.2 Construction of a Terhi boat .....	4	5.1 Trailer transport .....	11
1.3 Basic information about ABS plastic .....	4	5.2 Using your boat for towing .....	12
1.4 Warranty .....	4	5.3 Launching & Recovery .....	12
1.5 Insurance .....	4	<b>6 Technical specifications</b> .....	12
1.6 Registration .....	5	6.1 General set-up, dimensions and capacities, design categories .....	12
<b>2 Using the boat</b> .....	5	Design categories: .....	12
2.1 Mooring and anchoring .....	5	<b>Declaration of conformity</b> .....	14
2.2 On-shore storage .....	5		
2.3 Installation of steering console and rails .....	5		
2.4 Fire extinguisher .....	5		
2.5 Driving .....	6		
2.6 Engine .....	6		
2.7 Emergency switch .....	6		
2.8 Refuelling .....	6		
2.9 A Bilge pump .....	6		
2.10 Retro-fitting .....	7		

# Before you set out

Read through this manual. Tell your family and/or friends where you are going. Also let them know if you change your plans! Before setting out, always check the following:

## **Prevailing weather conditions and weather forecast**

Take wind, waves and visibility into account. Is the boat size, its equipment and your level of skill sufficient for the body of water onto which you are heading?

## **Bailing**

If necessary, bail out the boat with a bailer or a hand pump, not by tipping the water out. Tipping causes unnecessary strain on the boat's gunwales. If the boat is ashore, open the drain plug.

## **Drain plugs**

Before you set out, remember to check that the drain plugs are fitted and secure.

The Terhi 475 differs from other Terhi boats as it is equipped with a bilge drain plug, located under the plastic cover beneath the fuel tank. Bilge water can be drained out through here, when the boat is in dry dock. Always keep this plug closed when the boat is in the water.

## **Load Capacity**

Observe the recommendations on the manufacturer's plate: do not overload the boat, distribute loads evenly, and ensure that all passengers are wearing life jackets. Always remain seated in the boat!

## **Fuel**

Check that the boat has sufficient fuel for the anticipated trip. Take reserve fuel for adverse weather conditions or other unforeseeable circumstances.

## **Engine and other equipment**

Check the operation of the steering and electrical equipment and make a daily inspection of the engine. Further instructions can be found in the separate engine manual. Check the boat's seaworthiness, ensuring that there are no faults such as fuel- or water leaks.

## **The minimum onboard equipment should include:**

- life jacket for each passenger
- bailing device: pump or bailer
- oars or a paddle
- anchor and rope
- navigation lights for night boating
- for registered boats, equipment required by registration such as a fire extinguisher.

## **Securing of gear**

Check that all objects on board are stowed in such a way that they remain secure even in rough seas and high wind. Keep your boat in good order.

## **Charts**

Unless you are boating in a very familiar area, check that you are carrying charts covering the entire area into which you are heading.

## **Setting out**

Before departure, inform each crew member of their specific task. Check that the mooring rope and other lines do not get tangled in the propeller during departure or mooring.

# 1 General

The warnings and notes contained in this manual are specified as follows:

**WARNING!** Must be observed to avoid personal injury.

**NOTE!** Must be observed to avoid damage to the boat or its parts. Terhi boats conform to the standards set in sections 1 and 2 of the Finnish Boating Regulations 152/69.

## 1.1 Certification

Terhi boats are inspected and certified according to the EU Recreational Craft Directive 94/25/EC. The CE mark is printed on the manufacturer's plate, attached to the side of the engine well. All Terhi boats are certified for either for Category C or D (see chapter 6.1 Design Categories).

**WARNING!** Always consider your own driving skill, your speed and direction, if you have to set off into conditions exceeding the design specifications of your boat.

## 1.2 Construction of a Terhi boat

The durability and safety of a Terhi boat is based on an extremely rigid and strong sandwich construction. The shells are moulded from ABS plastic sheets. The space between the shells is filled with closed-cell, water-resistant polyurethane foam. The foam firmly adheres to both shells in a foam press with a pressure of over 30,000 kg/m<sup>2</sup>. Thanks to its construction, it is impossible to sink a Terhi boat, even by cutting it into pieces.

## 1.3 Basic information about ABS plastic

ABS is an acronym for acrylonitrine, butadiene and styrene, its three constituents. The most suitable and durable ABS qualities, and the special plastics used as coatings, have been selected on the basis of research carried out in co-operation with the Technical Research Centre of Finland. These plastics are characterised by their high impact strength. Thanks to this strength, ABS plastic is flexible and will not easily fracture in such as situations as running aground. The ABS plastic used is also UV-protected.

ABS does not absorb water, so there is no need to worry about scratches made by stones on the shore. Osmosis damage (blistering) cannot occur on an ABS boat. The properties of all thermoplastics vary to some degree depending on the ambient temperature. The high impact resistance of ABS may be adversely affected by severe frost, but it is unlikely that you would set to sea in such conditions. This fact must, however, be remembered if you are intending to move your boat in winter.

Another notable feature of thermoplastics is that their shape might become deformed under prolonged pressure on a small area. If, for example, you leave your boat in the sun, in such a way that most of its weight is resting on a small stone, an indentation may appear at that point after a few weeks. This fact must be borne in mind if you are storing your boat on a shore cart, trailer or winter storage trestles and when you are transporting it. A half-metre long piece of board is sufficient to distribute the point loads.

**NOTE!** The use of floor mats as anti-slip or floor protection is forbidden, as they can damage the sandwich construction of the boat when they warm up in the sun.

## 1.4 Warranty

A four-year warranty, effective from the date of sale is valid for raw material and manufacturing defects on Terhi boats. The warranty conditions approved by the manufacturer can be found on the warranty certificate delivered with this manual. Read these conditions carefully. A condition of the warranty is that the warranty certificate is returned filled out in accordance with the manufacturer's warranty conditions. Keep the purchaser's part of the warranty certificate in a safe place. Please consult your dealer in any possible matters related to warranty.

## 1.5 Insurance

Boat insurance may compensate for damage caused in the water, when transporting or storing. In some countries under certain circumstances, small boats may be covered by home insurance.

More detailed information about different insurance options is available from insurance companies.

### 1.6 Registration

In accordance with boating regulations in many countries, boats powered by an outboard motor exceeding 15kW (20 hp) may need to be registered before use. Registration can normally be

done by post. Detailed instructions on registration and its requirements can be obtained from your local administrative court. Often a registered boat may only be driven by persons over the age of 15.

In some countries, it is mandatory for even small boats to be registered. Check with the local authorities in your country of residence for the statutory regulations concerning boat registration.

## 2 Using the boat

### 2.1 Mooring and anchoring

Always moor your boat with care even in sheltered anchorages, as weather conditions can change rapidly. The cockpit of an unloaded Terhi boat is designed to drain rainwater. So, when unloaded, the boat can be left to float without its drain plug fitted, allowing rainwater to flow out.

**NOTE!** Remember to replace the drain plug when you step into the boat or load it. Ensure that the drain plug hole is free from foreign objects such as leaves. Depending on the weight of the engine and any other equipment in the boat, water may not necessarily completely drain out of the boat when the plug is open. If water has remained in the boat for a long period, it is advisable to clean the surfaces immediately after draining (see section 4.1).

**NOTE!** Where necessary, use sufficiently large fenders to prevent scratching the sides of the boat.

### 2.2 On-shore storage

If the boat is stored on a stony beach, we recommend the use of a roller slipway or hose slipway, as shown in figure 1.

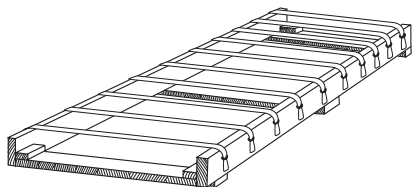

Figure 1

If the shore is soft sandy or muddy soil, you can simply pull your boat directly onto the land. Remember to lock the engine in the 'up' position before bringing the boat ashore.

**WARNING!** Do not try to stop the boat by hand. Do not put your hands or feet between the boat and the quay, the shore or another boat. First practice berthing in good weather conditions. Use prudent but purposeful engine throttle.

**NOTE!** The water run-off channels around the boat's hatches do not function as designed if the boat is stored at a steep angle, either lengthways or sideways, for example, when pulled to the shore. If the angle is too steep, water can collect in the boat's storage spaces or electrical equipment.

### 2.3 Installation of steering console and rails

Installation instructions for the steering console and rails are included in each package. By observing these instructions, you will achieve the best results. The steering wheel and system must be CE-certified. This can only be guaranteed if original Terhi parts are used. Always consult your dealer if you are inexperienced in installing items.

### 2.4 Fire extinguisher

Boats with a maximum allowable engine power of 26 kW (35 hp) or more must be equipped with a fire extinguisher. For Terhi boats, this applies to the Terhi 475 models where the fire extinguisher is mounted on the side of the steering console. Fire extinguishers fitted on boats must be serviced

annually. Read the user and maintenance instructions that are supplied with the device.

## 2.5 Driving

The trim angle of a boat has a significant effect on driving characteristics and fuel consumption. The trim angle can be adjusted by load re-distribution and adjusting engine trim angle.

A correct trim angle in conjunction with a suitable speed makes driving enjoyable and safe, even in a swell.

**WARNING!** High speed and sudden steering movements, especially in high seas, may result in loss of control of the boat and excessive heeling angles. Always consider your own driving skill, your speed and direction, if you have to set off into conditions exceeding the design specifications of your boat.

**WARNING!** Observe the recommendations on the manufacturer's plate concerning the maximum permitted number of passengers and maximum load.

**WARNING!** At high speeds, adjust the engine trim angle with care, as it will greatly change the behaviour of the boat. Do not drive with the bow too low, otherwise the boat might turn unexpectedly.

Water will drain from all planing Terhi models, when the drain plug is opened during planing.

**WARNING!** Close the plug as soon as the boat is empty of water, otherwise water will flow back into the boat when you reduce speed. In the boat, be careful when moving on surfaces not covered with anti-slip tapes.

## 2.6 Engine

If your boat is equipped with an engine, familiarise yourself with its operation by reading the engine manual. When installing the engine, please observe the instructions supplied by the engine manufacturer and your Terhi dealer. If your boat is to be left idle for a longer period of time, switch off the power from the main switch, if your boat has one.

**WARNING!** Observe the recommendations on the manufacturer's plate concerning the maximum motor power and weight.

**NOTE!** Do not use the main switch to cut the electric current when the engine is running, as this may damage the charger.

## 2.7 Emergency switch

All the newest models of outboard motor have an emergency switch. Check the location of the emergency switch and read the user instructions in the engine manual. The switch is usually used with a cotter-type coupler and a lanyard. Carefully attach one end of the lanyard to your wrist or clothing, and the other end to the engine's emergency switch.

**WARNING!** A spinning propeller can be fatal for a man overboard or swimmer. Stop the engine whenever a swimmer or water-skier is getting into the boat. When you are boating alone, it is especially important that the boat will stop if you fall overboard or trip over in the boat. Under such circumstances, use the emergency switch if your engine has one.

## 2.8 Refuelling

It is best to refuel at the quay or on shore to prevent fuel from spilling into the boat. Fuel and oil splashes must be wiped immediately from the surfaces of the boat. Hazardous materials and objects (e.g. sparking devices or flares) must not be stored in the tank storage compartment.

**WARNING!** Before you start refuelling, stop the engine.

## 2.9 Bilge pump

The bilge pump is fitted as standard on Terhi 475 and Nordic 6020 C Models. In Terhi 475 the pump is located in the bilge under the rear seat and in Terhi Nordic 6020 C in the draining well in front of the rear seat. The switch is on the control panel of the steering console.

**NOTE!** Check the operation of the bilge pump at regular intervals. Clean the pump's suction holes of foreign objects.

**WARNING!** The bilge pump is not designed to cope with leaks caused by running aground or other accidents.

### 2.10 Retro-fitting

In order to attach Terhi's own accessories, the sandwich construction comprises plywood support pieces under the shell in the attachment points. If you wish to fit other accessories, please observe the following instructions: Drill a hole in the shell (e.g. an Ø2mm hole for an Ø4.8mm screw) and wipe the surfaces. Add MS Polymer sealing adhesive on the piece and fasten it with acid proof screws. Do not over-tighten.

**NOTE!** The method described above is only suitable for attaching light-weight components, such as a log or depth finder.

In order to facilitate the drawing of the cables from the engine to the steering console, there are two drawstrings in the installation tube.

## 3 Electrical system

### 3.1 Main switch

A main electrical isolator switch is standard on Terhi 4110, Terhi Nordic 6020 C (with steering console) and Terhi 475 models. On the 475 the main switch is located under the rear seat. The Terhi 4110 and Terhi Nordic 6020 C boats have their main switch on the steering console.

The electrical system of Terhi boats is switched on when the key is turned in a clockwise direction and locked in position. The key is then in an upright position.

When leaving your boat idle for a longer period, use the main switch to cut the electric current. Also switch off the current when carrying out electrical work.

If the main switch is retro-fitted, it should be placed in an accessible location as close to the battery as is practically possible.

Do not modify the boat's electrical system or its drawings. Modifications and servicing should be left to a skilled professional in boat electrical systems.

**WARNING!** Never use the main switch to cut the current when the engine is running.

### 3.2 Battery hook-up and placement

Battery placement on Terhi boats are as follows: Terhi Sea Fun and Terhi 400:

- Under rear seat (in battery housing or fitted with terminal protectors)

Terhi 4110, Terhi Nordic 6020 C and Terhi 475:

- Inside the steering console
- Under the rear seat in a space reserved for the battery

The battery must be mounted securely in the boat. This is best achieved using a fastening strap, which is fixed by screws or pop rivets to the base of the battery space. If the battery is located in the same space as the fuel tank, it must be fitted either with battery housing or terminal protectors. Ensure that no electrically conductive items come into contact with the battery's positive terminal. The mountings of the cable lugs must not be dependent on spring tension.

**WARNING!** Charge the battery only using the engine or a battery charger. Charging at an excessive current causes a risk of explosion.

### 3.3 Control panel

The Terhi 4110, Terhi Nordic 6020 C and Terhi 475 are all equipped with a control panel as standard (figures 2,3 and 4).



Figure 2.  
4110 control panel



Figure 3. Nordic 6020 C and 475  
Open CC/FC control panel



Figure 4. 475 Twin C  
control panel

### 3.4 Wiring diagrams

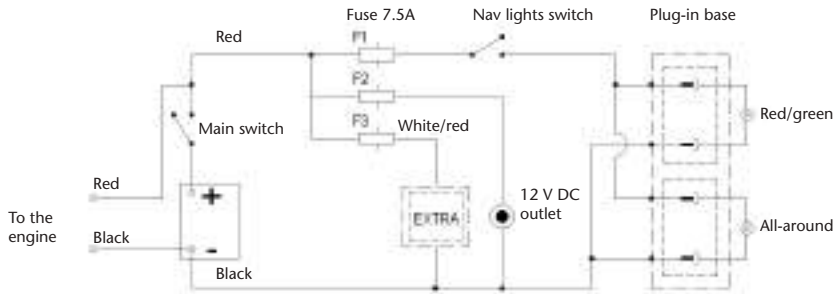

Figure 5. Terhi 4110 wiring diagram

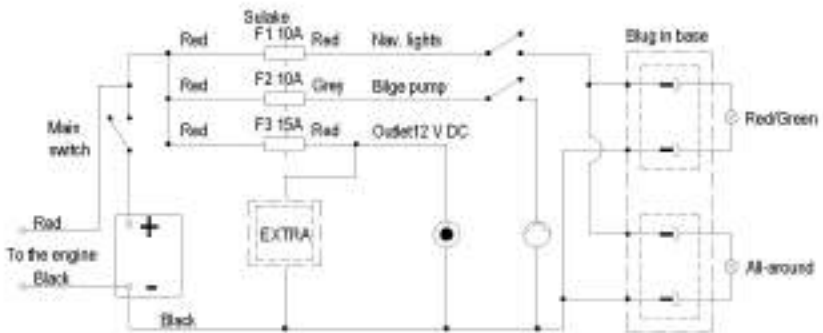

Figure 6. Terhi 475 wiring diagram

English



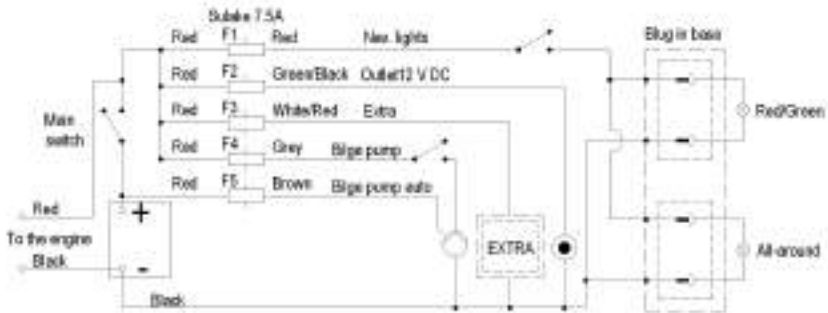

Figure 7. Terhi Nordic 6020 C wiring diagram

### 3.5 Fuses

In the following models the fuses of the electrical system are located inside the steering console: 4110 and Nordic 6020 C. In Terhi 475 the fuses are located under the rear seat. The above mentioned models have 7,5 A flat fuses with the exception of Terhi 475, where automatic fuses of 10A and 15A are used. When changing fuses, do not install one for a higher current or put components into the electrical system with a nominal ampere reading exceeding that of the electrical circuit.

### 3.6 Navigation lights

The following Terhi boats have a readiness for navigation lights (sockets pre-installed): Terhi Sea Fun, Terhi 4110, Terhi Nordic 6020 and Terhi 475.

**NOTE!** In boats not equipped with a separate switch for navigation lights (Sea Fun, 400 and Nordic 6020), a fuse and switch should be installed before starting to use the system. Power should be turned off whenever the lights are not in use. The set of navigation lights, available as an accessory, is CE-compliant.

## 4 Maintenance and winter storage

Take your Terhi boat out of the water in good time before there is any chance that the water will freeze. Your boat is not designed for use in ice-covered waters.

### 4.1 Washing and cleaning

Keep your boat clean and tidy. This enhances

comfort and safety and increases the boats re-sale value. The fuel consumption of a motor boat is significantly affected by the cleanliness of the hull and engine parts beneath the surface of the water. Usually the use of ordinary household detergents and boat-wax is sufficient for taking care of the

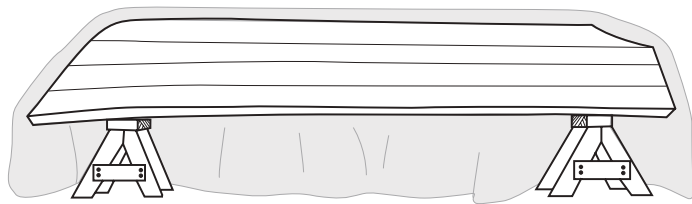

Figure 8.

inner shell and sides of an ABS boat. The removal of abrasions and difficult stains can be done using a fine polish. If the boat has been kept in the water, wash the hull as soon as it has been lifted out. Algae and slime are more easily removed if they are not allowed to dry. You can use a brush or wooden or plastic scraper to ease the work, but avoid the use of a scratching metal scraper.

**NOTE!** Do not clean with acetone, thinner, petrol, ketone or other strong solvents, as they may damage the plastic surface.

#### 4.2 Winter storage

The best place to store a Terhi boat in winter is in a shed or under a roof. The best storage position for a rowing boat is upside-down, resting on trestles (figure 8).

For planing and console boats stored on trestles or a trailer, ensure that the boat's weight is evenly distributed on its supports. Support surfaces must be wide – for example a board lying flat is well-suited to the purpose. When storing the boat on a trailer, the fastening straps must be loosened. If the engine is still mounted, its weight must be supported. During the period of storage, heavy loose items such as the battery and fuel tank should be removed.

The Terhi 475 is also equipped with a bilge-water drain plug, located under the plastic cover beneath the tank. Bilge water can be drained out here when the boat is dry-docked. Leave the plug open during storage, so that any condensation water can drain away. Always keep this plug closed when the boat is in the water.

If stored outdoors, cover the boat with a non-transparent tarpaulin. Ensure, however, that the boat has sufficient ventilation. When storing outdoors, make sure that an excessive amount of snow cannot accumulate on top of it. Storing a Terhi boat on its side is not recommended.

**NOTE!** The tarpaulin and its fastening ropes will chafe the surface of the boat if they flap and move in the wind, so fasten them with care.

#### 4.3 Engine and other equipment

Study the engine manual for instructions on winter storage and servicing and the spring overhaul. Have them done by a qualified service engineer or, if you do it yourself, take the utmost care over the task. Other equipment requiring regular servicing includes:

- steering and engine control equipment
- navigation lights
- covers
- battery

Remove the batteries during winter storage, store them in a cool dry place and charge them at least twice during the winter. Spray electrical connections with suitable anti-moisture and anti-corrosion substances. Carry out servicing on other equipment according to their manuals and instructions.

#### 4.4 Anti-fouling

In sea water, you can prevent vegetation and barnacles from getting attached to the hull by applying anti-fouling paint. All light-coloured, hard types of paint are suitable for Terhi boats. Carefully observe the instructions provided by the manufacturer. You can find water-line measurements for anti-fouling paint at TerhiTec Oy's website ([www.terhi.fi](http://www.terhi.fi)).

#### 4.5 Care and maintenance

Repair, or have repaired, any possible scratches or dents, according to section 4.6. Small surface scratches can be ignored as they do not adversely affect the integrity of the boat. Washing and waxing, as described in section 4.1 will help to keep the boat clean and neat throughout the boating season.

Soiling of the hull and, in particular, the propeller significantly increases fuel consumption, so it also pays to keep them clean throughout the boating season.

#### 4.6 Repairs

For repairs covered by warranty, please see instructions in section 1.4. For faults in the engine or other equipment, refer to the respective suppliers. The ABS shells of Terhi boats can withstand hard knocks. If, however, your boat suffers damage, it can easily be repaired with Terhi Fix repair compound, which is available from your Terhi dealer. Instructions for use of the compound are provided in the packet. Instructions for repair can also be found at TerhiTec Oy's website ([www.terhi.fi](http://www.terhi.fi)).

**NOTE!** If incorrectly done, retro-fitting and modification work can cause damage to the structure of the boat or endanger safety. Contact the manufacturer or dealer before commencing any significant modification work, such as drainings or larger surface fastenings.

**NOTE!** Always check the condition of your boat immediately after a collision. If the inner or outer shell of your boat has incurred damage that has penetrated the plastic layer, it must be dealt with immediately. Water penetrating through the inner or outer shell can damage the structure of the boat.

## 5 Transport

Smaller Terhi boats can be transported by car on a sturdy roof rack. Larger models should be transported on a purpose-built boat trailer.

### 5.1 Trailer transport

You can easily transport your Terhi boat on a trailer. Make sure, however, that the trailer is compatible with your boat. Check that the load capacity of the trailer is sufficient for your boat, its engine and other equipment. Terhi boats are very light for their length so ensure that your trailer is sufficiently long to accommodate your boat. It should have an adequate number of keel supports, and load bearing supports and all these supporting points must have a sufficiently large surface area, so that point loads do not become excessive. This is especially important on small roller trailers where there are few rollers as standard.

During transportation, the engine must be in the lower "trimmed down" running position.

Ensure, however, that there is sufficient ground clearance below the bottom of the outboard skeg. Check that the seat hatches are locked with their security clips in place. Do not leave loose items or excessive loads in the boat during transportation.

Fasten the boat securely to the trailer, before commencing the actual journey but take care not to over-tighten the fastening straps. The bow strap should point forwards and downwards (the winch strap on its own is insufficient for securing) and swaying of the stern can be prevented by tying a strap across the boat. To prevent the straps from marking the boat use a soft material between the strap and the hull. Adjust the trailer side supports or bunks, so that the boat cannot move sideways. Clean all the supports of sand and dirt, to prevent them scratching the hull.

Finally, check that the trailer is properly locked to the trailer hook! Always loosen the fastening strap immediately after transportation and when leaving the boat stored on the trailer.



Figure 9.

**NOTE!** The trailer's centre of gravity must be toward the front. Make sure that the boat is securely attached to the trailer. A swaying boat may strike a single support point, damaging the hull. **IMPORTANT:** The trailer's keel supports should carry most of the weight of the boat.

### 5.2 Using your boat for towing

When towing another boat, a buoyant rope of sufficient strength should be used. Start the tow carefully and avoid jerking movements. Do not overload the engine. When towing a rowing boat, remember that it is designed for slow speeds only. It is not suitable for fast towing, as it will not plane.

**WARNING!** The towing rope is highly tensioned when towing. If it breaks, the end of the rope can reach dangerously high speeds. Always use a thick enough rope, and avoid being in the vicinity of the end of the rope.

### 5.3 Launching & Recovery

When launching and recovering your Terhi boat on to its trailer ensure that the boat is empty of water and luggage. Winch it carefully on to the trailer avoiding excessive strain on the bow eye. Make sure the trailers rollers and supports do not hit the angled scupper plate that covers the drain hole as the boat is winched on. Always release the tension on the winch strap once the bow is resting on the rubber bump stop. Never winch your boat on to the trailer with people in the boat.

## 6 Technical specifications

Terhi boats have consecutive serial numbers, a CIN (Craft Identification Number) code etched into the right side of the stern under the fender list. You will need this number when you insure, register or sell the boat. Referring to this serial number helps with the delivery of correct spare parts and accessories. Check that the serial number on the warranty certificate corresponds to that on the boat. Fill in the boat and motor details in the boxes below for future reference.

### 6.1 General set-up, dimensions and capacities, design categories

Boat model:

Boat serial number (CIN code):

Engine model:















Engine serial number:

#### Design categories:

**Category C** This boat is designed for use in conditions, in which the wind speed does not exceed 6 on the Beaufort scale (approx. 14 m/s) and the swell is in proportion to that (significant wave height does not exceed 2m, see note below). Such conditions can be found in open lakes, river estuaries and coastal waters in moderate weather conditions.

**Category D:** This boat is designed for use in conditions, in which the wind speed does not exceed 4 on the Beaufort scale (approx. 8 m/s) and the swell is in proportion to that (meaning a wave height of max. 0.3 m, with occasional waves reaching a height of 0.5m). Such conditions can be found in sheltered inland waters and coastal waters in good weather conditions.

Significant wave height is the average height (trough to crest) of the highest 33% of waves over an indicated 12 hour period, which roughly corresponds to the height estimated by an experienced observer. Some individual waves can be twice as high as this.

Model	Baby Fun	Sunny	385	400	400 C	440	Saiman	Saiman Sunwind	Sea Fun	Sea Fun C	4110	Nordic 6020	Nordic 6020 C	475 Open CC (FC)	475 Twin C
General set-up and seats based on the greatest passenger load															
Length (cm)	235	310	380	401	401	440	478	478	406	406	410	462	462	475	475
Width (cm)	130	147	150	150	150	175	148	148	167	167	172	187	187	185	185
Weight without engine (kg)	55	75	98	120	130	150	105	105	140	165	200	225	255	345 (355)	370
Passengers	2	3	4	4	4	5	4	4	4	4	4	5	5	5	5
Max. load (kg) (people + fuel)	175	240	315	315	315	405	315	315	330	330	330	405	405	405	405
Draft without load (m)	0,12	0,15	0,18	0,18	0,18	0,21	0,18	0,2	0,15	0,17	0,18	0,15	0,16	0,28	0,28
Freeboard without load (mm)	0,35	0,34	0,39	0,27	0,27	0,34	0,31	0,29	0,32	0,3	0,46	0,62	0,61	0,55	0,55
Max kW/hp	2,3/3	3,7/5	4,5/6	7,4/10	7,4/10	7,3/9,9	2,9/4	Sähkö	11/15	15/20	22/30	22/30	22/30	45/60	45/60
Recommended engine power (hp)	2	4	4-6	6-10	6-10	4-6	2-4	2-4	8-10	10-15	20-30	10-15	20-30	50	50
Max. recommended engine weight (kg)	25	25	27	42	42	37	25	25	52	52	80	80	80	115	115
Max. speed with 2 persons (hp/Kn)	2/4	5/12	2/4 4/6	6/9,3 10/13,5	6/9,3 10/13,5	4/7 6/9	4 Kn	4 Kn	8/15 15/21	8/15 15/21	20/23 30/27	15/15 20/21	20/21 30/25	40/27 60/32	40/27 60/32
Shaft length	short	short	short	short	short	short	short	short	short	short	long	long	long	long	long
Length of steering cable (m)				2,7	2,7				2,7	2,7	3,3	3,6	3,6	3,9 (4,9)	2,75
Length of remote control cable (ft)				7	7				*	*	7	12	12	14 (17)	10
Navigation light readiness									*	*	*	*	*	*	*
Oars (ft)	std. 6,5	std. 7,5	std. 8	std. 8,5	std. 8,5	std. 9	std. 8,5	std. 8,5	opt. 8	opt. 8	opt. 8	opt. 9	opt. 9	opt. 9	opt. 9
CE design category	D	D	D	D	D	D	D	D	D	D	C	C	C	C	C
Certificate number	TER003	TER003	TER002	TER017	TER017	TER009	TER010	TER010	TER001	TER001	TER007	TER005	TER005	TER005	TER008
Type of craft	motor-boat	motor-boat	motor-boat	motor-boat	motor-boat	motor-boat	motor-boat	motor-boat	motor-boat	motor-boat	motor-boat	motor-boat	motor-boat	motor-boat	motor-boat
Type of hull	monohull	monohull	monohull	monohull	monohull	monohull	monohull	monohull	monohull	monohull	monohull	monohull	monohull	monohull	monohull
Construction material	plastic	plastic	plastic	plastic	plastic	plastic	plastic	plastic	plastic	plastic	plastic	plastic	plastic	plastic	plastic
Type of main propulsion	petrol-engine	petrol-engine	petrol-engine	petrol-engine	petrol-engine	petrol-engine	petrol-engine	electric-engine	petrol-engine	petrol-engine	petrol-engine	petrol-engine	petrol-engine	petrol-engine	petrol-engine
Type of engine	outboard	outboard	outboard	outboard	outboard	outboard	outboard	outboard	outboard	outboard	outboard	outboard	outboard	outboard	outboard
Rainwater draining	*	*	*	*	*	*	*	*	*	*	*	*	*	*	*

# Declaration of conformity

Manufacturer: TerhiTec Oy, 21140 Rymättylä, Finland

We declare that the below mentioned boats have been manufactured in conformance with mentioned standards and the RSG Guidelines to meet the requirements of the European Union Directive 94/25/EC as amended by Directive 2003/44/EC.

Boat model / Certificate number	CE category
TERHI SEA FUN / TER001	D
TERHI 385 / TER002	D
TERHI SUNNY / TER003	D
TERHI NORDIC 6020 / TER005	C
TERHI 4110 / TER007	C
TERHI 475 / BTER014	C
TERHI 440 / TER009	D
TERHI SAIMAN /BTER010	D
TERHI 400 / BTER17	D
Essential requirements	ISO-Standards, Other normative document/ methods
Craft Identification Number – CIN	ISO 10087:2006
Builder's Plate	ISO 14945:2004
Protection from falling overboard and means of reboarding	ISO 15085:2003
Visibility from the main steering position	ISO 11591:2011
Owner's manual	ISO 10240:2004
Structure	NBS 1990, RSG-guidelines
Stability and freeboard	ISO 12217-3:2002 + A1:2009
Buoyancy and floatation	ISO 12217-3:2002 + A1:2009
Openings in hull, deck and superstructure	ISO 9093-2:2002, ISO 12216:2002
Flooding	ISO 11812:2001, ISO 12216:2002, ISO12217-3:2002
Manufacturer's maximum recommended load	ISO 12217-3:2002, ISO 14946:2001
Anchoring, mooring and towing	ISO 15084:2003
Handling characteristics	ISO 11592:2001
Electrical systems	ISO 10133:2000
Steering systems	ISO 8848:1993, ISO 9775:1994
Fire protection	ISO 9094-1:2002

The stability, freeboard and buoyancy have been tested in accordance to certification module Aa.

Notified body number 0609: International Marine Certification Institute  
 Address: Rue Abbé Cuypress 3  
 B-1040 Brussels, Belgium

Rymättylä 1.10.2013

TerhiTec Oy



Jarmo Sundin, Managing Director

CIN:

FI-TRH