



HEWES[®]
LIGHT TACKLE BOATS

18 Redfisher Owner's Manual

Revised March 2020

Welcome to the Hewes Family!

Thank you for choosing a Hewes boat to transport you to your angling dreams. We believe the Hewes 18 Redfisher is the best backcountry boat on the market, and we're sure that you'll be completely satisfied with the unmatched performance, quality and fishability of your new boat.

We value your input, not just at the time of the sale, but throughout the entire boat ownership period, and we've taken steps to allow you to share that information. Over the next year or so, you will receive at least two questionnaires to fill out and return.

Be sure to visit our website www.hewes.com to find information on company events like our Owner's Tournaments and Corporate Calendar. You'll find a wealth of information on our Forum, where you can ask questions, get answers and join other Hewes owners to discuss all applications of your boat. We're proud to have you as a member of the Hewes family!

Tight lines and screaming drags!

Scott Deal

President and CEO



Maverick Boat Group

3207 Industrial 29th St. • Fort Pierce, Florida 34946
(772)-465-0631 • Hewesboats.com



Table of Contents

18 Redfisher Specifications..... 4

Pre-Operation Checklist..... 5

Maintenance & Cleaning 6

Engine Break-In Period 7

Switch Panel..... 8

Fuel-Water Separator & Drain..... 9

Bilge..... 10

Systems 11

Backing Plates & Trolling Motor Wiring..... 12

Battery Switch and Breaker Panel 14

Props & Trim Tabs 15

Fuel System 16

Self-Bailing Cockpit & Livewell..... 17

Wiring 19

Optional Features..... 20

18 Redfisher Fuel System 22

Upholstery Care & Cleaning Guide 23

Warranty..... 24

18 Redfisher Specifications

L.O.A.....	18' 10"
BEAM.....	7' 11"
DRAFT.....	10"
WEIGHT W/ ENGINE.....	1,900 LBS.
FUEL CAPACITY.....	31 GAL.
DEADRISE @ TRANSOM.....	13 DEG.
MAXIMUM H.P.....	150
MAX CAPACITIES.....	4 PERSONS OR 550 LBS.

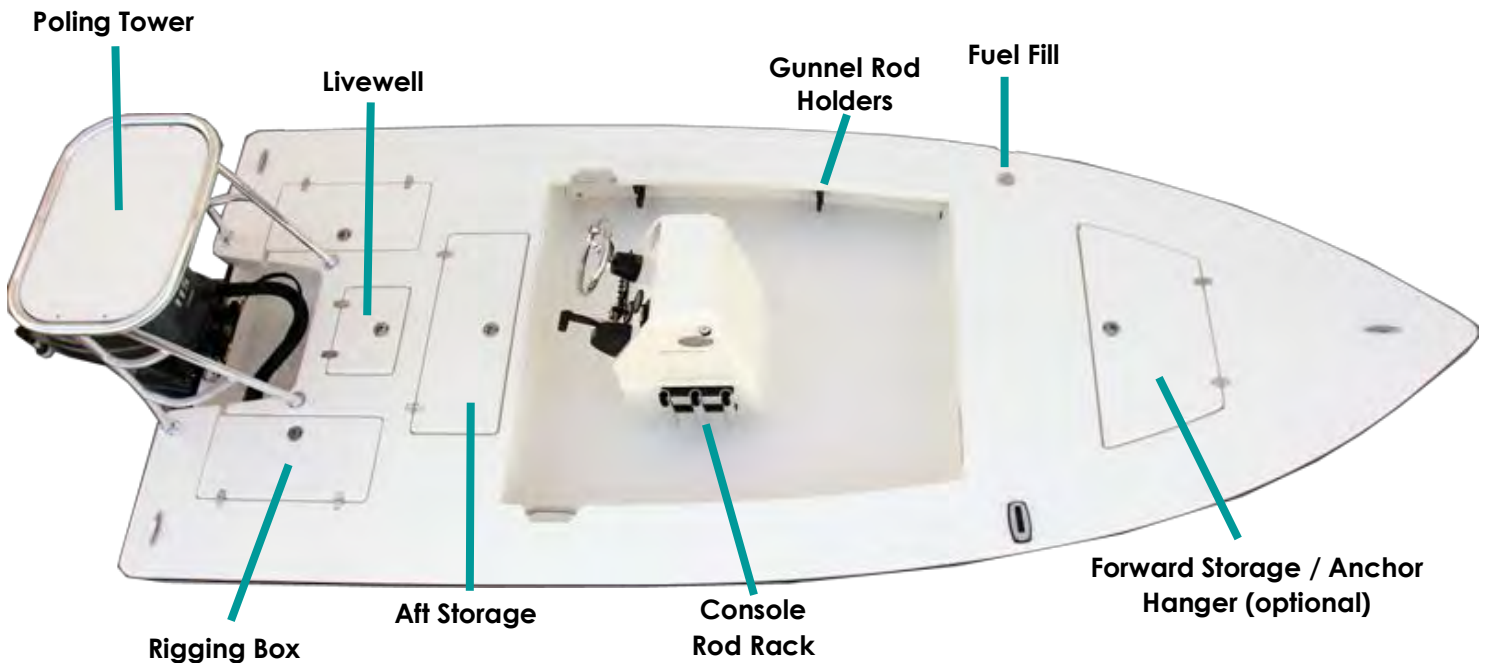

Pre-Operation Checklist

We recommend you print this document and store it at the helm station.

<h2 style="text-align: center;">Boating Safety Checklist</h2> <p style="text-align: center;">MUST HAVE ITEMS As Required By Regulation</p> <p>Personal Flotation Devices (Life Jackets)</p> <p><input type="checkbox"/> Type I, II, or V for each person onboard (Wearable)</p> <p><input type="checkbox"/> One Type IV (Throwable) <small>Not Required on Non-Powered boats under 30'</small></p> <p>Fire Extinguishers:</p> <table border="1"> <thead> <tr> <th>Boats w/out Fixed System</th> <th>Boats w/ Fixed System</th> </tr> </thead> <tbody> <tr> <td><input type="checkbox"/> Boats < 26' - 1 Size BI - OR -</td> <td><input type="checkbox"/> Fixed System</td> </tr> <tr> <td><input type="checkbox"/> Boats 26 - <40' - 2 Size BI* - OR -</td> <td><input type="checkbox"/> Fixed System + 1 Size BI</td> </tr> <tr> <td><input type="checkbox"/> Boats 40 - 65' - 3 Size BI* - OR -</td> <td><input type="checkbox"/> Fixed system + 2 Size BI*</td> </tr> </tbody> </table> <p><small>* One Size BI may be substituted for Two Size BI Extinguishers</small></p> <p>Visual Distress Signals (VDS)</p> <p>Choose One</p> <p><input type="checkbox"/> Combination Day/Night VDS (Flares or Flare Gun)</p> <p><input type="checkbox"/> Daytime VDS (Flags, Smoke Signal) AND Nighttime VDS (Automated SOS Light)</p> <p>Sound Signals:</p> <p><input type="checkbox"/> Horn or Whistle</p> <p><input type="checkbox"/> Bell (Not required for vessels under 12m)</p> <p>Ventilation (Boats with Gasoline Systems)</p> <p><input type="checkbox"/> Natural Ventilation</p> <p><input type="checkbox"/> Powered Ventilation</p> <p>Backfire Flame Control</p> <p><input type="checkbox"/> Backfire Flame Arrestor (Gasoline Engines except outboards)</p>	Boats w/out Fixed System	Boats w/ Fixed System	<input type="checkbox"/> Boats < 26' - 1 Size BI - OR -	<input type="checkbox"/> Fixed System	<input type="checkbox"/> Boats 26 - <40' - 2 Size BI* - OR -	<input type="checkbox"/> Fixed System + 1 Size BI	<input type="checkbox"/> Boats 40 - 65' - 3 Size BI* - OR -	<input type="checkbox"/> Fixed system + 2 Size BI*	<h2 style="text-align: center;">Boating Safety Checklist</h2> <p style="text-align: center;">Recommended Items</p> <p style="text-align: center;"><small>Items in Red May be Required in Some States</small></p> <p>Boats on Inland Waters Everything on Required List PLUS:</p> <p><input type="checkbox"/> First Aid Kit</p> <p><input type="checkbox"/> Boating Safety Education/Certificate</p> <p><input type="checkbox"/> Anchor with Sufficient Line</p> <p><input type="checkbox"/> Watersports Flag (Skier Down/Diver Down Flag)</p> <p><input type="checkbox"/> Bailing Device</p> <p><input type="checkbox"/> Sun Protection</p> <p><input type="checkbox"/> Alternate Propulsion (Paddles, Oars)</p> <p>Boats on Nearshore Waters Everything Above PLUS:</p> <p><input type="checkbox"/> Extra Food & Water</p> <p><input type="checkbox"/> GPS/Chartplotter</p> <p><input type="checkbox"/> Float Plan</p> <p><input type="checkbox"/> Depth Finder</p> <p><input type="checkbox"/> Compass</p> <p><input type="checkbox"/> VHF Radiop</p> <p>Boats on Offshore Waters Everything Above PLUS:</p> <p><input type="checkbox"/> EPIRB</p> <p><input type="checkbox"/> Life Raft</p> <p><input type="checkbox"/> Searchlight</p> <p><input type="checkbox"/> List of CPR Instruction</p> <p><input type="checkbox"/> Radar</p> <p><input type="checkbox"/> Radar Reflector</p> <p><input type="checkbox"/> Shore Landing Craft (Tender)</p> <p><input type="checkbox"/> Man-Overboard Recovery Gear</p> <p><input type="checkbox"/> AIS</p> <p><input type="checkbox"/> Sea Drogue</p> <p><input type="checkbox"/> Safety Knife</p> <p><input type="checkbox"/> Weather Information System</p> <p><input type="checkbox"/> Radio Direction Finder</p> <p><input type="checkbox"/> Long Range Communications Gear</p> <p>Boats on River Waters Everything on Required List Plus:</p> <p><input type="checkbox"/> Throw Bag</p> <p><input type="checkbox"/> Helmet</p> <p>Miscellaneous Items Other Items That May be Recommended:</p> <p><input type="checkbox"/> Heaving Line</p> <p><input type="checkbox"/> Spare Keys</p> <p><input type="checkbox"/> Boat Hook/Pole</p> <p><input type="checkbox"/> Spare Propeller</p> <p><input type="checkbox"/> Extra Engine Oil</p> <p><input type="checkbox"/> Handheld Lead-line</p> <p><input type="checkbox"/> Strobe Light</p> <p><input type="checkbox"/> Carbon Monoxide Detector</p> <p><input type="checkbox"/> Extra Clothing</p> <p><input type="checkbox"/> Marine Hardware</p> <p><input type="checkbox"/> Masks & Fins (For Clearing Props)</p> <p><input type="checkbox"/> Storm Sails</p>
Boats w/out Fixed System	Boats w/ Fixed System								
<input type="checkbox"/> Boats < 26' - 1 Size BI - OR -	<input type="checkbox"/> Fixed System								
<input type="checkbox"/> Boats 26 - <40' - 2 Size BI* - OR -	<input type="checkbox"/> Fixed System + 1 Size BI								
<input type="checkbox"/> Boats 40 - 65' - 3 Size BI* - OR -	<input type="checkbox"/> Fixed system + 2 Size BI*								



Maverick Boat Group
3207 Industrial 29th St. • Fort Pierce, Florida 34946
(772)-465-0631 • Hewesboats.com



Boating Safety. Built for you.



Boating Safety. Built for you.

Scan here to download the ABYC Boating Safety Checklist App abyc.org/mobileapps



Maintenance & Cleaning

Maintenance

Hewes advises owners that maintenance and repairs should be performed at an authorized Hewes Dealer. The following information is general in nature and should not be considered a repair manual or guidelines set forth by Maverick Boat Group.

Cleaning

Each Hewes boat is constructed using the finest materials and components available. However, no material is immune to the ravages of the saltwater environment. After each use, your boat should be rinsed thoroughly with fresh water. Refer to page 23 for upholstery care and cleaning instructions. A light coat of lubricant on metal railing, screws and electrical connections will help prevent electrolysis. The same holds true for your trailer. To improve the longevity of your gel coat, it is recommended that you wax your boat once a year using an approved fiberglass wax.



Engine Break-In Period

Engine Break-In Period

New engines require a period of break-in to allow the surfaces of the moving parts to mate evenly. Different engines require different break-in periods and methods. For instructions on break-in methods, refer to your Yamaha Engine Owner's Manual for the correct break-in procedures and times for your model engine.

Engine Stop Switch

If activated, the spring-loaded engine stop switch will automatically shut down the engine during emergency situations to prevent uncontrolled or unattended operation. Certain emergency conditions (e.g., turbulent water, wakes, unanticipated movement) may impair a person's ability to operate the craft safely. The switch, located on the helm, must have the safety lanyard attached at its base. This activates the protective shutdown circuitry.



Engine Stop Switch

Securely attach the other end of the lanyard to the operator of the boat. If the operator moves, falls or is at an unsafe distance from the steering wheel, tension on the lanyard will pull it from the switch. When the lanyard is removed, the engine stop switch is released and automatic engine shutdown occurs.



DANGER:

An engine stop switch system that is not used or does not function properly can cause death or serious injury. **DO NOT** operate the boat if the engine stop switch system does not function properly. Go to a Hewes Dealer to have this resolved immediately.

The lanyard should be securely attached to the boat operator at all times that the engine is on.

Switch Panel

Switch Panel

The dual activation switches are set in a standard grid. These switches can be flipped either up or down to control different accessories. The accessories located directly above a switch are activated when the switch is in the “Up” position and the accessories located directly below the switch are activated when the switch is flipped into the “Down” position. The bilge switch is an on-demand switch to run your bilge pump and is used as a backup in case the float indicator in your bilge pump becomes clogged. It is located on the far right.



Switch Panel

Command Link Gauges

Command Link gauges are standard on the 18 Redfisher. These gauges allow access to more information. Displays are user-selectable so you can choose the functions displayed on each gauge and what order. Speed data can be displayed from a pitot tube, Triducer, or NMEA protocol GPS unit. To learn the gauge’s full functionality, refer to your Yamaha engine owner’s manual located in the Hewes Duffel Bag.



Yamaha Command Link Gauges

Hewes Duffel Bag

Along with your boat, you received a Duffel Bag with your new Hewes. Inside the Duffel Bag are the following items:

- Large Livewell Standpipe
- Short Livewell Standpipe
- 1.5” Livewell Pacifier Plug
- 2 ignition Keys and Emergency Kill Cord /Engine Stop Lanyard
- Engine Start Cord
- 1 Garboard Drain Plug
- 1 Gas Fill Key
- 2 Glove Box Keys
- Various Accessories Manuals

Fuel-Water Separator & Drain

Fuel-Water Separator

Each Hewes is equipped with a fuel water separator to ensure maximum performance and protect the outboard engine from contaminated gasoline. The fuel separator is a metal, cylindrical unit secured to the transom section of your starboard aft rigging box.

The fuel separator can be checked by removing it from the mounting bracket in the rigging locker and dumping it into an approved waste collection device. If there appears to be an excessive amount of water, the filter component should be changed. See your authorized Hewes dealer for replacement parts.



Fuel-Water Separator



Maintenance Note: Yamaha recommends replacing the 10-micron fuel filter on new boats after the first 10 hours or 1 month of operation and every 50 hours or every 6 months thereafter. In areas of high humidity where water in fuel supplies is a problem or extensive engine operation occurs, more frequent replacement may be necessary.

Garboard Drain Plug

The garboard drain plug is the small metal plug located at the lowest point on the hull, at the bottom of the transom right above the keel. The drain has been designed so that it can be loosened by hand while the hull is out of the water for draining. This allows the plug to stay in contact with the surrounding frame so you'll never misplace or lose it. You can completely remove the insert by pulling back and continue turning in a counter-clockwise motion. It is manufactured with a rubber seal in place to ensure your bilge is watertight. Always make sure before putting the boat in the water that this plug is hand tightened firmly. Excess water in the bilge may be an indication of a problem with this plug or the automatic bilge pump.



Drain Plug

Bilge

Bilge

The bilge of your Hewes should always be checked before and after a launch. While checking the bilge, note that a small amount of water in the bilge is normal. However, a large amount of water or any signs of fuel or oil requires immediate attention. **If such a situation exists, the boat should be taken to a certified marine technician immediately. Never pump fuel or oil overboard while your boat is in the water.**

Large quantities of water in the bilge may be an indication of a leak or that your bilge pump is jammed, broken or has blown a 6 -amp fuse. First, check that your bilge pump is running. Turn the switch on and listen for the bilge pump to turn on. If the bilge pump does not come on, check your fuse box to make sure the pump hasn't blown a fuse. If the fuse is damaged, replace it and turn the switch on again, listening for the bilge pump to come on.

If the fuse is in working order, make sure the pump is turned off, then unhook the bilge pump from its cradle by squeezing the blue tabs on the sides of the pump and lifting. The entire bilge pump and wiring should release from the cradle. Check the underside and impeller areas for miscellaneous items that might clog the pump.

Items such as monofilament, plastic, rocks and small clumps of debris can easily clog the impeller and prevent the bilge pump from operating correctly. Should you find a clog, remove the item and turn the pump switch to the "on" position. If the pump runs, turn the switch "off" and return the pump to its cradle.

If the fuse is working and the impeller is not clogged, the bilge pump is probably bad and needs to be replaced. See your local Hewes dealer for bilge pump replacement.

If the bilge pump is working and pumping water, but the water level in the bilge does not go down, you likely have a leak which requires immediate attention. Remove your boat from the water and see your local Hewes dealer to have the bilge area inspected for possible leaks.

Fuel leaks also require immediate attention. Be sure to check for fuel leaks frequently and repair any problems immediately. Any replacement of parts or repairs to the fuel system should be performed by a trained marine mechanic. See your authorized Hewes dealer for parts and repair.



Maverick Boat Group

3207 Industrial 29th St. • Fort Pierce, Florida 34946
(772)-465-0631 • Hewesboats.com

Use bilge cleaner products to remove any obvious stains. Consult your authorized Hewes dealer for recommended types of bilge cleaners.

Systems

Ball Valves

Ball valves can be used to serve several purposes. They allow seawater to enter the boat, in the case of livewells, and they also act as a safeguard to stop water from entering. To tell which position a ball valve is in, open or closed, look at the valve and determine the direction of flow. When the ball valve handle is in the same position as the direction of flow, the valve is in the “OPEN” position. When the ball valve handle appears to cross the direction of flow, the valve is in the “CLOSED” position.

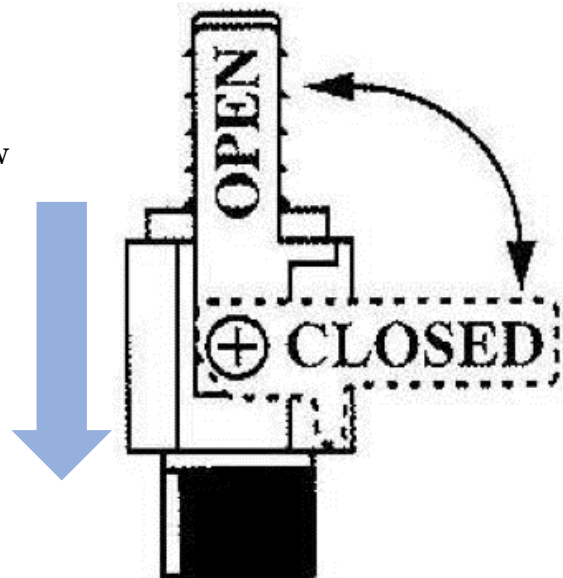

Livewell Pump Assembly in the “OPEN” Position

18 Redfisher Livewell Pump Assembly

The livewell pump assembly is composed of a scoop strainer mounted to the bottom of the hull, a thru hull fitting, ball valve assembly, and the pump. As you can see, the ball valve assembly is in the “OPEN” position. This is the correct position for the operation of the livewell.

Backing Plates & Trolling Motor Wiring

Backing Plates

The diagram below shows all the screw-retention backing plates (trolling motor, T-Top, Leaning Post) originally placed in the deck of a Hewes during the construction process.

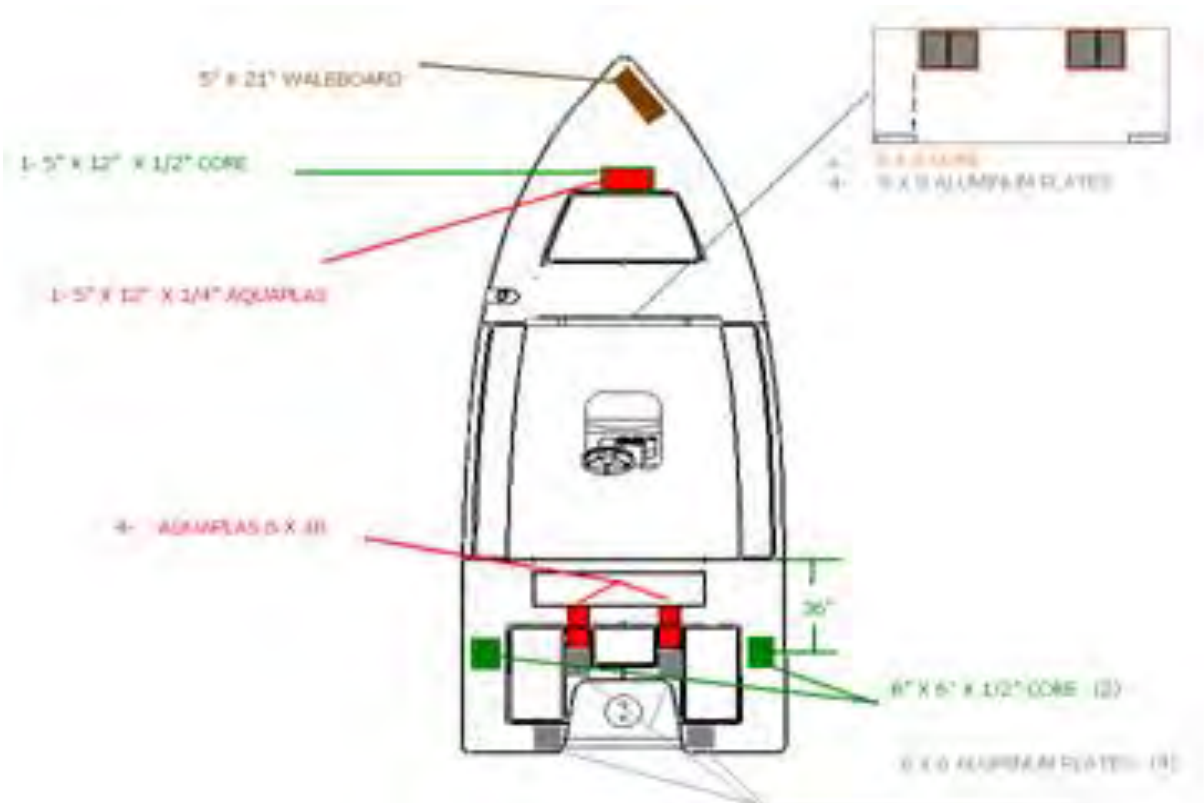

Trolling Motor/Wiring System

Your Hewes 18 Redfisher comes standard with a 24V trolling motor wiring system. A trolling motor mounting plate was built into the bow of your Hewes during the manufacturing process. To attach a trolling motor, please go to your nearest Hewes dealer. All trolling motors should be attached by drilling through the mounting plate with a 13/64" drill bit and 1/4" tap and using 1/4" #20 machine screws. The plate is designed to accommodate the mounting patterns of all trolling motor brands on the market currently. See below for optional trolling motor system with battery charger and wire routing.

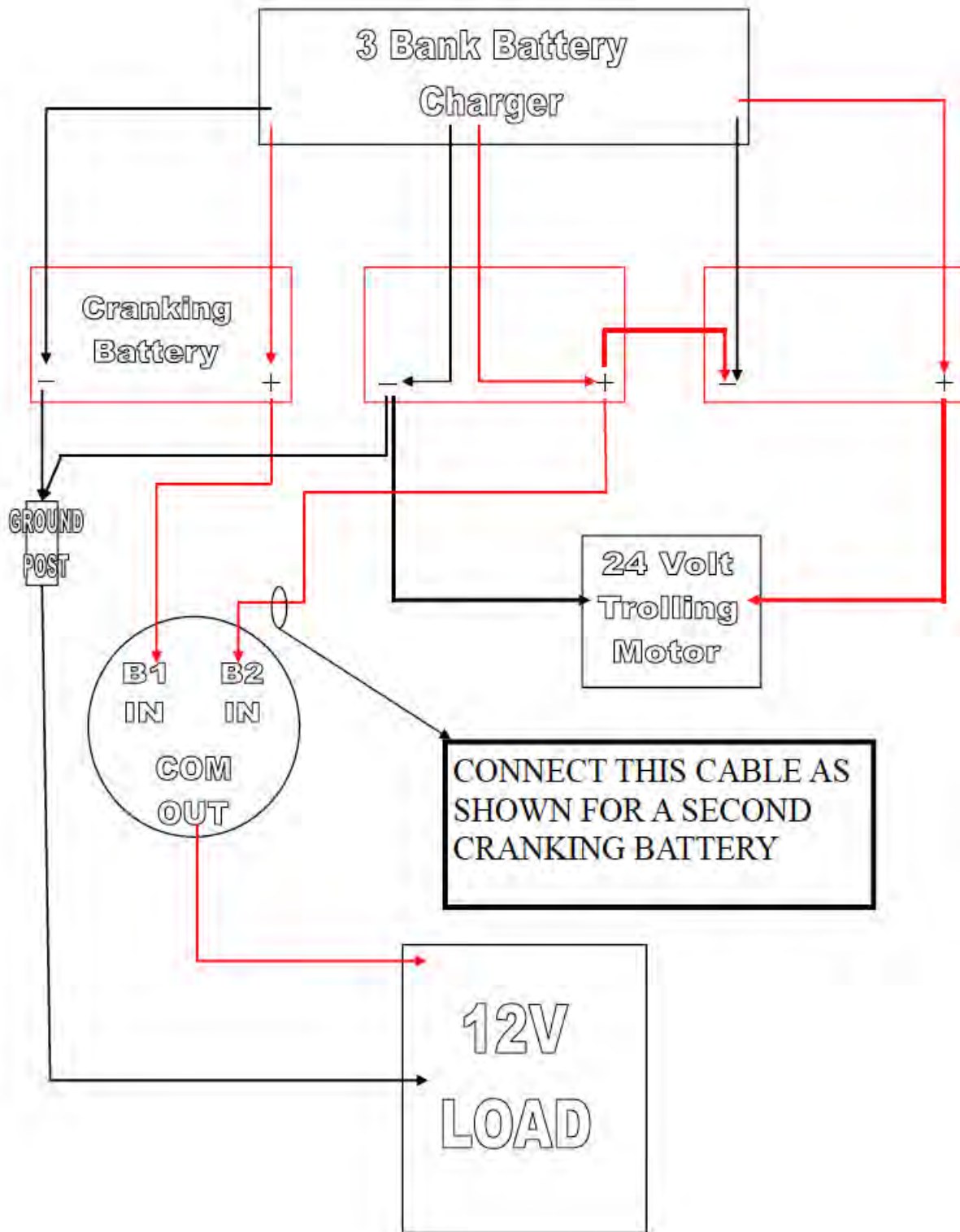

Battery Switch and Breaker Panel

Battery Switch and Breaker Panel

The battery switch panel comes as standard equipment on the 18 Redfisher. Power from the battery to the battery switch is protected with a 30-amp inline fuse.

On a single battery system, the battery is wired to the number 1 side of the switch. A dealer installed option would be a Dual Battery Setup. On the dual battery setup, one battery is wired to the number one position while the second battery is wired to the number 2 side of the switch. The operator can choose which battery to utilize by the selection on the switch. The only time the switch should be in the “1 & 2” position is if one battery will not start the engine. Then, switch to “1 & 2” and have two batteries to start the engine. Once the engine is started turn the switch back to the number one battery so that the engine alternator is once again charging that battery.



Battery Switch, Shown in the “Off” Position

Props & Trim Tabs

Props

Prop selection on your Redfisher is determined by your local Hewes dealer but based on recommendations made by Maverick Boat Group and Yamaha Marine to give your boat the maximum overall performance. Different prop designs may improve performance or can be tailored to enhance specifics of boat and motor performance.

For instance, a prop with a smaller pitch will increase speed out of the hole (jumping onto plane) but will produce a decreased overall speed compared to a prop with a larger pitch. Four bladed props may increase overall speed or allow the boat to run shallower, and some props can decrease cavitation at high speeds. Your individual prop needs will determine the prop design and size that best fits your performance requirements.

Always inspect the engine and prop prior to launching your boat. Key prop issues include tangled fishing line or other types of debris, cracked blades or fluid leaking out of the seal. Look for fishing line tangled around the prop or lower unit seal while the engine is off. **Consult your Yamaha Owner's Manual to address these issues.**



Engine Prop

Trim Tabs

Bennett trim tabs are standard on the Hewes Redfisher. Because the tabs are electric, there is no hydraulic trim tab pump, thus eliminating the possibility for fluid leaks as with other trim tab manufacturers.

Trim tabs allow the boat operator to get the maximum performance from the boat and are also great for balancing weight in the boat and for lifting or lowering the hull to accommodate for different running situations.



Trim Tab

Your port trim tab switch affects the port side of the boat, and the starboard switch will affect the starboard side, although they are operating tabs on the opposite sides. For instance, lowering the port trim tab creates stern lift on the port side, thus lowering the starboard bow. Raising the starboard trim tab lowers the stern on the starboard side and lifts the port bow. Use the tabs to adjust the attitude of the boat so that it sits evenly and to raise or lower the bow to control running performance.

Lightly tap the tabs with your fingers to allow the boat to adjust in response to the tabs without a dramatic change. Once the bow has been lowered or raised to the point that the ride has been adjusted for comfort and safety, tapping individual tabs can even improve the overall effects.

Pushing on the top of the switch (Down) will lower the trim tab and force the bow down, which is important for running through heavy seas or a stiff chop. In most instances, both tabs should be lowered for an even bow down ride.

Pushing the bottom of the switch (Up) will raise the tabs and lift the bow out of the water for better running performance. To achieve the best running performance with your Hewes, use the engine trim in conjunction with your trim tabs to find the perfect amount of lift and a safe, comfortable ride.

In cases of severe weather or high winds, it is possible to use your trim tabs to lift the windward side of the boat to avoid spray blowing back onto the passengers. Do this in conjunction with lowering the bow to improve the overall ride.

Fuel System

Fuel System

Your Redfisher comes with a 31-gallon, forward stationed, aluminum fuel cell. The fuel fill receptacle is on the port gunwale forward of the console. There's also a recessed fuel overflow vent on the port side of the boat just below the fuel receptacle.



Fuel Fill Receptacle

We regularly pressure test each fuel system when it is initially received at the factory and until it leaves the factory as a component on a new boat. Should you experience any fuel related problems or suspect problems with the fuel system, immediately take your boat to your local Hewes dealer.



DANGER:

Do not smoke while filling the tank. Be sure to turn off the engines and all electrical equipment when fueling the boat to prevent accidental discharges of static electricity. Use only the recommended gasoline (see Yamaha Owner's Manual). Do not use fuels with alcohol or alcohol related derivatives that can cause marine fuel system hoses to deteriorate.

Self-Bailing Cockpit & Livewell

Self-Bailing Cockpit

The cockpit on the 18 Redfisher is designed to be self-bailing, meaning that all the water that comes into the cockpit will be directly drained overboard. This keeps the boat from acquiring standing water and allows the boat to drain at all times, including while the boat is docked.

Water drains out of the cockpit through the side cockpit drains located at the junction of your aft casting deck and the gunwales. The drain runs water out the sides of the boat and clears the cockpit of all water whether the boat is running, anchored or tied off to a dock.

The bilge is designed to drain any water entering the inside of the hull. Livewell and cockpit drains are closed systems that flush water out the drain scuppers in the stern. All hoses are sealed and double clamped during construction. Continuous or periodic running of the automatic bilge pump may be an indication of a hose leak or break in a seal and should be investigated by your local Hewes dealer immediately.

Livewell System

The new and improved livewell system on the 18 Redfisher keeps bait alive longer than any other system on the market. It has a dual inflow system and a unique drain system that prevents dead zones and quickly expels any harmful chemicals (such as ammonia)

from the water. The livewell system takes water through our exclusive Sea Chest system. With this system, water enters the Sea Chest through a grate located at the bottom of the boat.

The boat is shipped with the shut-off valve turned to the “off” position (at a 90-degree angle). To start using your livewell, turn the shut-off valve counterclockwise so that it is in line with the pipe to open the system to water flow. This shut-off valve is also in place in case of the unlikely event of a leak while out on the water.

Your Redfisher comes with two standpipes and a pacifier-style drain plug to control water levels inside the livewell. The smaller standpipe is for use with crustaceans like shrimp and crabs that prefer a lower water level. The taller standpipe is for baitfish, and the drain plug is to hold water or seal the compartment. The standpipes should be placed in the hole located in the starboard aft section of the livewell. Make sure that the standpipe is firmly secured before covering the area with the plexiglass cover. Make sure that the bigger holes in the plexiglass cover are at the bottom before it is secured. Secure the cover by twisting the tabs located on both sides.

On rare occasions, the livewell will not pump water even though the switch is turned on, the system is open and the livewell pump is running. If that occurs shift the throttle into reverse and back the boat several feet to purge a possible air pocket in the system. If there appears to be a clog in the drain, remove the grate and clear the top of the standpipe of any detritus.

Your boat might come with an optional recirculation system. This is a closed system that recycles the water already within the well. This system is also controlled by a switch on the switch panel and allows the boat operator to operate the livewell without an outside feed. This is ideal if you are transporting bait from different water extremes.



Note: Be sure to turn the shut-off valve to the 90-degree off position BEFORE doing any work on the livewell pump or plumbing that could potentially allow the inflow of water. Failure to do so will result in outside water entering the bilge area.

Wiring

A wiring diagram of your Hewes has been included to help troubleshoot any electrical problems or to add additional electronics or electrical connections. We recommend you use a trained marine electrician for all electrical issues.

Inside the console on the starboard side is the ground terminal and the breaker panel is located in the glove box. All the grounds lead to the ground terminal and then to the battery via a large diameter black wire.

Hewes Main Harness

To Console

Pin #	Function	Wire Color	AWG	
1.	Nav Lts (Instrumentation)	Grey	16	
2.	Nav Lts	Grey	16	
3.	Anc Lt (Console)	Grey/White	16	
4.	Anc Lt (T-TOP)	Grey/White	16	Pin C T-Top Recept
5.	Horn	Orange/White	16	
6.	Spreader Lt	Blue/Black	16	Pin A T-Top Recept
7.	Overhead Lts	Blue/Green	16	Pin B T-Top Recept
8.	PANEL GROUND	Black	16	Console Ground



To Accessories

Pin #	Function	Main Harness Wire Color	AWG
1.	Bilge	Brown	14
2.	L/W-1	Brown/White	14
3.	RECIRC-1	Red/White	14
4.	L/W-2	Brown/Yellow	14
5.	RELEASE WELL	Brown/Orange	14
6.	RECIRC-2	Red/Yellow	14
7.	BUBBLER	Red/Orange	14
8.	SALT WATER	Brown/Green	14
9.	FRESH WATER	Brown/Black	14
10.	LIVEWELL LTS	Blue/White	16
11.	COCKPIT LTS	Blue/Red	16
12.	COMPARTMENT LTS	Blue/Black	16



8 PIN Plug

Pin #	Function
1	ACC-1
2	ACC-2
3	ACC-3
4	ACC-4
5	ACC-5

Always use the recommended breaker/fuse amp sizes. Oversizing or using larger breakers/fuses than required can lead to electrical shorting and possible damage or destruction of the entire electrical system.

There are open slots on both the ground block and the breaker panel for additional electrical hook-ups. The accessory switches should be used for any additional hook-ups to protect the entire electrical system. All additional electrical hook-ups should be performed by a qualified marine electrician.

As a standard practice, we run pull cords forward and aft for any additional wiring needs. For your convenience and ease we have included a nylon rigging string that runs through the rigging tubes and terminates in the bow. The nylon string will allow you to easily run any additional wiring through the rigging tubes, thus protecting them from outside elements. We also run a string aft to the rigging box.

Optional Features

Power Poles

Power Poles come as an option with the Hewes Redfisher and give the boat operator the ability to quickly and quietly stop the boat while in shallow water. Whether you want to enjoy a view, or you've stumbled upon a group of tailing redfish, the power pole will stop the boat quickly and easily. Please refer to the Power Pole owner's manual for operational and mechanical information. The Redfisher comes with an 8" aluminum backing plate on the transom of the boat which is built into the boat at the factory and allow for the secure installation of a power pole. The backing plate is equidistant from the outboard trim pocket and the hull side with the top just reaching the manufacturing number plate. Refer to the diagram below for aluminum plate locations. If you want to install a Power Pole after your boat has left the factory, please take your boat to your nearest Hewes dealer.

Aluminum Plate



18 Redfisher Fuel System

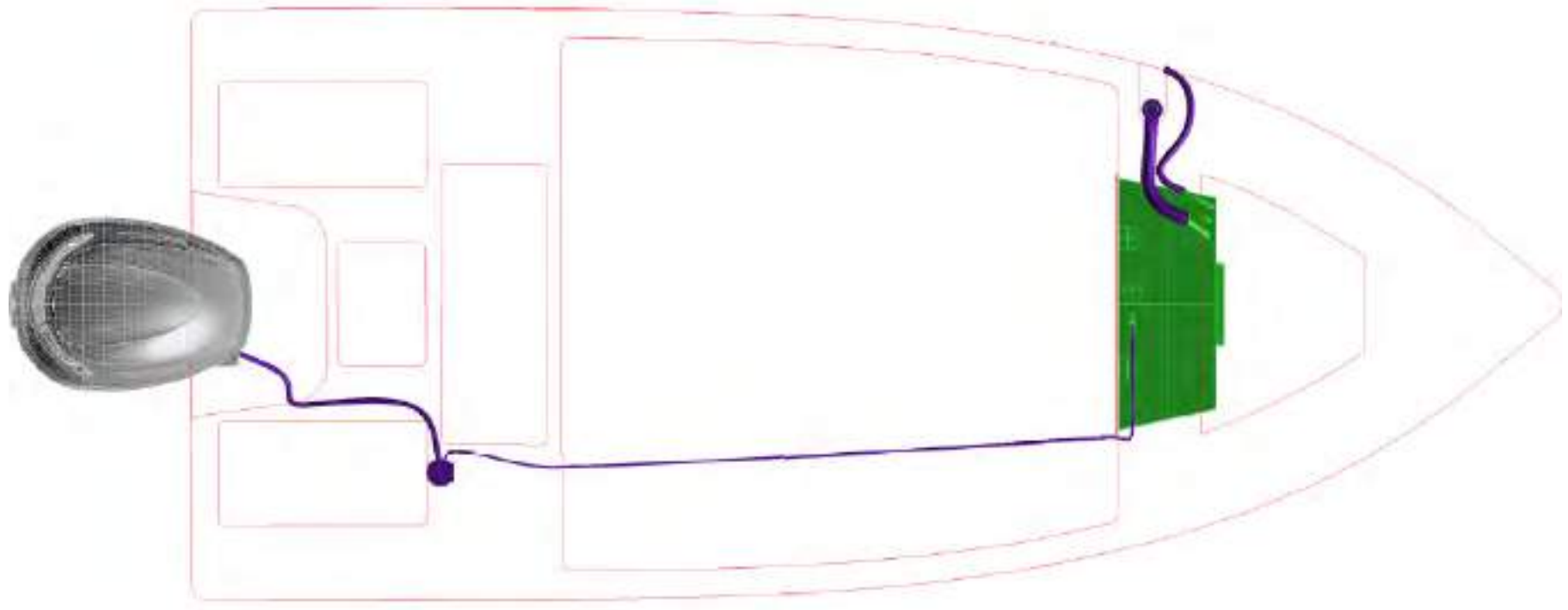



PERMAGUARD®
SUPERIOR STAIN RESISTANCE



PERMAGUARD® is a newly developed topcoat protective finish that permits frequent cleaning of Spradling's coated fabrics for upholstery. Spradling's proprietary barrier coating makes maintenance easy. Not only do stains disappear in seconds, but **PERMAGUARD** provides unequaled resistance to scratches, scuffs, and abrasion. No other marine vinyl surpasses **PERMAGUARD's** stain resistance and long-term, trouble-free performance.

Care & Cleaning Guide

For use on the white or the primary seating vinyls only!
For cleaning and care of accents and colors, please refer the back of this card.

Remove most stains with one of the following steps:

Step 1	baby oil, ketchup, chocolate, motor oil, olive oil, tea, coffee
Steps 2 & 3	eye shadow, crayon, grease, permanent felt tip marker, mustard, lipstick, ball point pen

Step 1: If cleaned immediately, use a clean dry cotton fabric. Wipe once, careful to remove most of the stain without spreading to surrounding area. Wipe more vigorously a second time if residue remains and proceed to step 2.

Step 2: If residue remains use a straight application of the following concentrated cleaners:

- Formula 409®
- Fantastik®

Wipe with a clean cloth, rinse with water and dry. If residue remains, proceed to step 3.

Step 3: More stubborn soiling may be eliminated using a cotton fabric soaked in 91% isopropyl (rubbing) alcohol. Wipe without spreading stain to surrounding area. A second application should be applied with vigorous rubbing in a circular motion. For highly textured material, a soft toothbrush is recommended to clean valleys and crevices. Wipe with a clean cloth, rinse with water and dry.

Certain clothing and accessory dyes (such as those used on denim jeans) may migrate to lighter colors. This phenomenon is increased by humidity and temperature and is irreversible.

Please check compatibility when using this product in combination with painted or varnished

Always remove stains immediately. Upholstery must be kept CLEAN!

Certain household cleaners, powdered abrasives, steel wool, and industrial cleaners can cause damage and discoloration and are not recommended. Dry cleaning fluids and lacquer solvents should not be used as they will remove printed pattern and gloss. Waxes should be used with caution as many contain dyes or solvents that can permanently damage the protective coating.

Suntan lotion, tree pollen, wet leaves, and some other products can contain dyes that stain permanently.

Do not clean with power washers, as they can generate 3500 PSI and could damage the surface of your interior. Do not use kerosene, gasoline, or acetone, as they will remove the protective marine top coat. Do not use any silicone-based protectants. They will extract the plasticizer, leaving vinyl hard and brittle, and eventually cracking will occur.

Failure to care for your vinyl properly, or use of improper cleaners, may void your warranty & damage your vinyl!

The information published in this care guide refers to the performance of **PERMAGUARD®** products in specific tests conducted under laboratory conditions. Results may vary under actual conditions.

This information is not a guarantee and does not relieve the user from the responsibility of the proper and safe use of the product and all cleaning agents. The use of certain agents can be harmful to the surface appearance and lifespan of vinyl. Spradling, its agents, and assigns assume no responsibility resulting from the use of such cleaning agents to the vinyl. Spradling's coated fabrics treated with **PERMAGUARD®** protective finish are resistant to most common stains. However existing dyes and pigments in some staining agents have the ability to create a permanent stain if not treated properly.

PERMAGUARD® is a trademark of Spradling International, Inc.

©2013 Spradling International, Inc.®

Find more vinyl cleaning & care information at:
www.spradlingvinyl.com/sim or call the cleaning hotline at 1-800-247-9901

Side A

America's leading source for vinyl-coated fabrics

Vinyl Coated Fabrics (Acrylic or Napa Topcoat)

Cleaning and Care: Colors and Accent Vinyls

Step 1: For light soiling, a solution of 10% household liquid dish soap in warm water, applied with a soft damp cloth. Rub gently and rinse with a water-dampened cloth.

Step 2: For heavy soiling, dampen a soft white cloth with a one-to-one (1:1) solution of *Formula 409® and water or *Fantastik® and water. Rub gently and rinse with a water-dampened cloth.

Step 3: For more difficult stains, dampen a soft white cloth with a solution of household bleach (10% bleach and 90% water). Rub gently and rinse with a water-dampened cloth to remove bleach concentration.

Do not use with alcohol-based cleaning agents!

All cleaning methods must be followed by a thorough rinse with clean warm water.

Failure to care for your vinyl properly, or use of improper cleaners, may void your warranty & damage your vinyl!

Certain household cleaners, powdered abrasives, steel wool, and industrial cleaners can cause damage and discoloration and are not recommended. Dry cleaning fluids and lacquer solvents should not be used as they will remove printed pattern and gloss. Waxes should be used with caution as many contain dyes or solvents that can permanently damage the protective coating.

Suntan lotion, tree pollen, wet leaves, and some other products can contain dyes that stain permanently.

Do not clean with power washers, as they can generate 3500 PSI and could damage the surface of your interior. Do not use kerosene, gasoline, or acetone, as they will remove the protective marine top coat. Do not use any silicone-based protectants. They will extract the plasticizer, leaving vinyl hard and brittle, and eventually cracking will occur.

Always remove stains immediately. Upholstery must be kept CLEAN!

Please contact our cleaning hotline at 1-800-247-9901 or online at www.spradlingvinyl.com/sim.

The information published in this care guide refers to the performance of Spradling International Marine products in specific tests conducted under laboratory conditions. Results may vary under actual conditions.

This information is not a guarantee and does not relieve the user from the responsibility of the proper and safe use of the product and all cleaning agents. The use of certain agents can be harmful to the surface appearance and lifespan of vinyl. Spradling, its agents, and assigns assume no responsibility resulting from the use of such cleaning agents to the vinyl. Spradling's coated fabrics treated with **PERMAGUARD®** protective finish are resistant to most common stains. However existing dyes and pigments in some staining agents have the ability to create a permanent stain if not treated properly.

Formula 409® is a registered trademark of the Clorox Company.®

Fantastik® is a trademark of DowBrands, Inc.® Trademark of the Dow Chemical Co.®

*Fantastik & Formula 409 are safe to use if cleaner is diluted (1:1), then thoroughly rinsed and used following manufacturers' instructions.

©1997 Spradling International, Inc.®

Please check compatibility when using this product in combination with painted or varnished surfaces.



Find more vinyl cleaning & care information at:
www.spradlingvinyl.com/sim or call the cleaning hotline at 1-800-247-9901

Side B

3/1/2014



Warranty

Your relationship with your local Hewes dealer should never end with the delivery of your new boat. Your local Hewes dealership is where you will take your boat for service and repair, as well as to address any warranty issues. Hewes is fortunate to have an outstanding dealer network selling and servicing our boats. Our dealers are knowledgeable in service and repairs for all our boat models and have extensive expertise troubleshooting a wide range of boat related issues.

All warranty claims and repair issues should be addressed to your local Hewes dealer. Through our dealer network, we should be able to address and fix repair issues and have you back on the water in a timely manner. A continued relationship with your local Hewes dealer will assure the best service and parts available and will create a direct link from the boat owner to the factory.



Maverick Boat Group

3207 Industrial 29th St. • Fort Pierce, Florida 34946
(772)-465-0631 • Hewesboats.com