

**KDI 1903 - TCR - TCRE5 – TC  
KDI 2504 - TCR - TCRE5**

**OWNER MANUAL**



**KOHLER**  
IN POWER. SINCE 1920.

<b>1</b>	<b>General Information .....</b>	<b>4</b>
1.1	<i>Manual's Purpose .....</i>	4
1.2	<i>Glossary and Definitions .....</i>	4
1.3	<i>Emission-Related Installation Instructions.....</i>	5
1.4	<i>Service request .....</i>	5
1.5	<i>Engine component identification.....</i>	6
1.6	<i>ATS (After Treatment System) .....</i>	7
1.7	<i>Manufacturer and motor identification data .....</i>	8
1.8	<i>Homologation labels.....</i>	9
<b>2</b>	<b>Technical information.....</b>	<b>12</b>
2.1	<i>General description of the engine .....</i>	12
2.2	<i>Engine specifications .....</i>	12
2.3	<i>Engine dimensions (mm) .....</i>	12
2.4	<i>Oil .....</i>	13
2.5	<i>Fuel.....</i>	14
2.6	<i>Coolant recommendation .....</i>	17
2.7	<i>Battery recommendation.....</i>	17
2.8	<i>Control panel.....</i>	18
<b>3</b>	<b>Safety information .....</b>	<b>19</b>
3.1	<i>Safety information .....</i>	19
3.2	<i>General remarks .....</i>	20
3.3	<i>Safety signal description .....</i>	22
3.4	<i>Information and safety signals.....</i>	24
3.5	<i>Safety and environmental impact.....</i>	26
3.6	<i>Location of safety labels on engine.....</i>	26
<b>4</b>	<b>Information about use .....</b>	<b>27</b>
4.1	<i>Pre-start check .....</i>	27
4.2	<i>Running-in period.....</i>	27
4.3	<i>Starting and turning off .....</i>	27
4.4	<i>Refuelling.....</i>	28
4.5	<i>Oil filling.....</i>	29
4.6	<i>Coolant filling .....</i>	30
4.7	<i>ATS regeneration strategy (only for Stage V configurations).....</i>	32
<b>5</b>	<b>Information about maintenance .....</b>	<b>34</b>
5.1	<i>Useful information about maintenance .....</i>	34
5.2	<i>Periodic maintenance .....</i>	35
5.3	<i>Oil level check .....</i>	37
5.4	<i>Oil dipstick on cylinder head .....</i>	37

5.5	<i>Air filter check</i> .....	38
5.6	<i>Check of the radiator heat - exchanger surface</i> .....	38
5.7	<i>Rubber hoses check</i> .....	39
5.8	<i>Check coolant level</i> .....	40
5.9	<i>Check and setting alternator standard belt tension</i> .....	41
5.10	<i>Check Poly-V alternator belt</i> .....	42
5.11	<i>Filter cartridge and fuel pre-filter check</i> .....	43
5.12	<i>Product preservation</i> .....	43
5.13	<i>Engine storage up to 6 months</i> .....	43
5.14	<i>Engine storage over 6 months</i> .....	44
5.15	<i>Engine starting after storage</i> .....	45
5.16	<i>Unused machine</i> .....	46
<b>6</b>	<b>Information about replacements</b> .....	<b>47</b>
6.1	<i>Engine oil replacement</i> .....	47
6.2	<i>Oil filter cartridge replacement</i> .....	48
6.3	<i>Remote oil filter cartridge replacement (optional)</i> .....	49
6.4	<i>Filter cartridge and fuel pre-filter replacement</i> .....	50
6.5	<i>Air filter cartridge replacement</i> .....	51
6.6	<i>Disposal and scrapping</i> .....	51
<b>7</b>	<b>Information about failures</b> .....	<b>52</b>
7.1	<i>Useful information about failures</i> .....	52
<b>8</b>	<b>Information about warranty</b> .....	<b>54</b>
8.1	<i>Warranty terms</i> .....	54
<b>9</b>	<b>Glossary</b> .....	<b>59</b>
9.1	<i>Glossary</i> .....	59

# 1 GENERAL INFORMATION

## 1.1 *Manual's Purpose*

- This manual contains the instructions needed to carry out proper use and maintenance of the engine, therefore it must always be available, for future reference when required.
- This manual is an integral part of the engine, in the event of transfer or sale, it must be attached to it.
- Safety pictograms can be found on the engine and it is the operator's responsibility to keep them in a perfectly visible place and replace them when they are no longer legible.
- Information, description and pictures in this manual reflect the state of the art at the time of the marketing of engine.
- However, development on the engines is continuous. Therefore, the information within this manual is subject to change without notice and without obligation.
- **KOHLER** reserves the right to make, at any time, changes in the engines for technical or commercial reasons.
- These changes do not require **KOHLER** to intervene on the marketed production up to that time and not to consider this manual as inappropriate.
- Any additional section that **KOHLER** will deem necessary to supply some time after the main text shall be kept together with the manual and considered as an integral part of it.
- The information contained within this manual is the sole property of **KOHLER**. As such, no reproduction or replication in whole or part is allowed without the express written permission of **KOHLER**.

## 1.2 *Glossary and Definitions*

The paragraphs, tables and figure are divided into chapter with their progressive numbers.

Es: **Par. 2.3** - chapter 2 paragraph 3.

**Tab. 3.4** - chapter 3 paragraph 4.

**Fig. 5.5** - chapter 5 paragraph 5.

The references of the objects described in the text and in figure and number are indicated by letters, which are always and only related to the paragraph you are reading unless there are specific references to other figures or paragraphs.

**NOTE:** All data, measurements and relevant symbols are shown in the glossary section.

### 1.3 Emission-Related Installation Instructions

Failing to follow the instructions in the applications guidebook when installing a certified engine in a piece of nonroad equipment violates federal law (40 CFR 1068.105(b)), subject to fines or other penalties as described in the Clean Air Act. OEM must apply a separate label with the following statement: "ULTRA LOW SULFUR FUEL ONLY" near the fuel inlet.

Ensure you are installing an engine appropriately certified for your application. Constant speed engines may only be installed on constant speed equipment for constant speed operation.

If you install the engine in a way that makes the engine's emission control information label hard to read during normal engine maintenance, you must place a duplicate label on the equipment, as described in 40 CFR 1068.105.

### 1.4 Service request

- The complete and updated list of authorized **Kohler Co.** service centers can be found on websites:  
[www.kohlerengines.com](http://www.kohlerengines.com) & [dealers.kohlerpower.it](http://dealers.kohlerpower.it) .
- If you have any questions regarding your warranty rights and responsibilities or the location of the nearest **Kohler Co.** authorized service location, you should contact **Kohler Co.** at 1-800-544-2444 or access our website at [www.kohlerengines.com](http://www.kohlerengines.com) (USA and North American).

### 1.5 Engine component identification

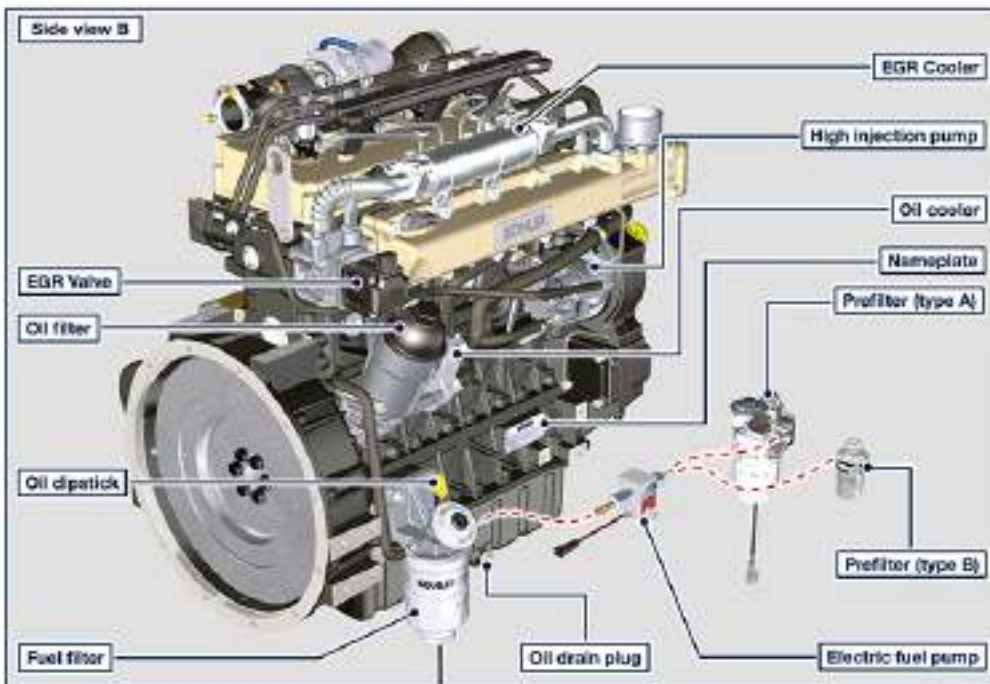
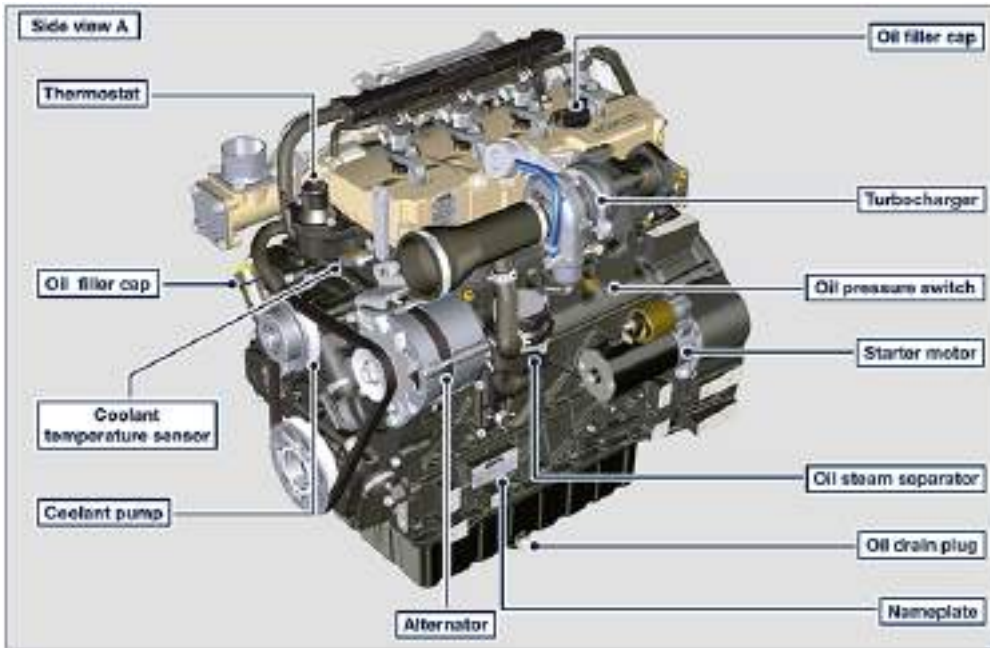

**1.6 ATS (After Treatment System)**

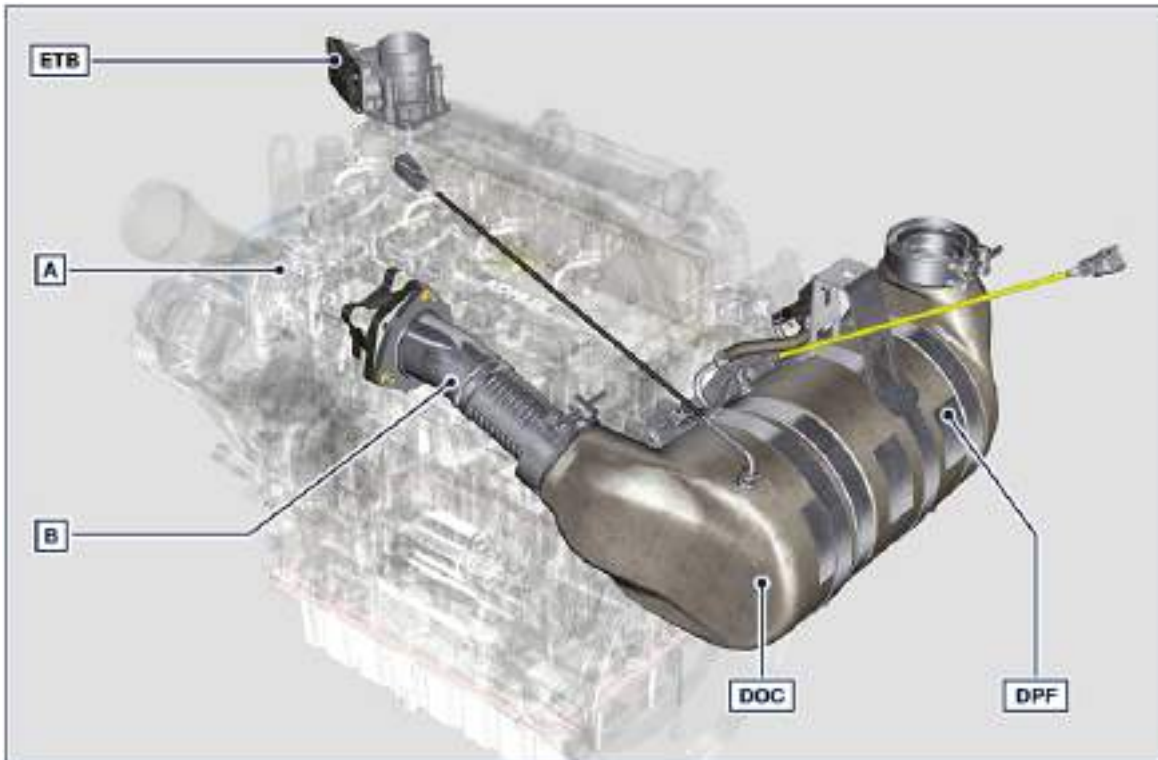

A: Turbocharger  
 B: Turbine exhaust pipe

**NOTE:** The ATS system is only present for versions that conform to "Stage V" emission regulations. The ATS system can be mounted differently than the figure.

- The ATS system reduces emissions because the DPF eliminates the particulates generated by the combustion of the diesel. The system starts automatic regeneration cycles of the DPF based on the level of clogging. The smell of the gases emitted by the exhaust line is different from that of traditional gases of diesel engines. Also, during the regeneration phases, the exhaust gases could be temporarily white.
- The minimum engine speed increases during the forced regeneration phases.
- See Par. 4.7 for the regeneration strategies of the DPF.

### 1.7 Manufacturer and motor identification data

The nameplate motor identification is find side **A** or side **B**.

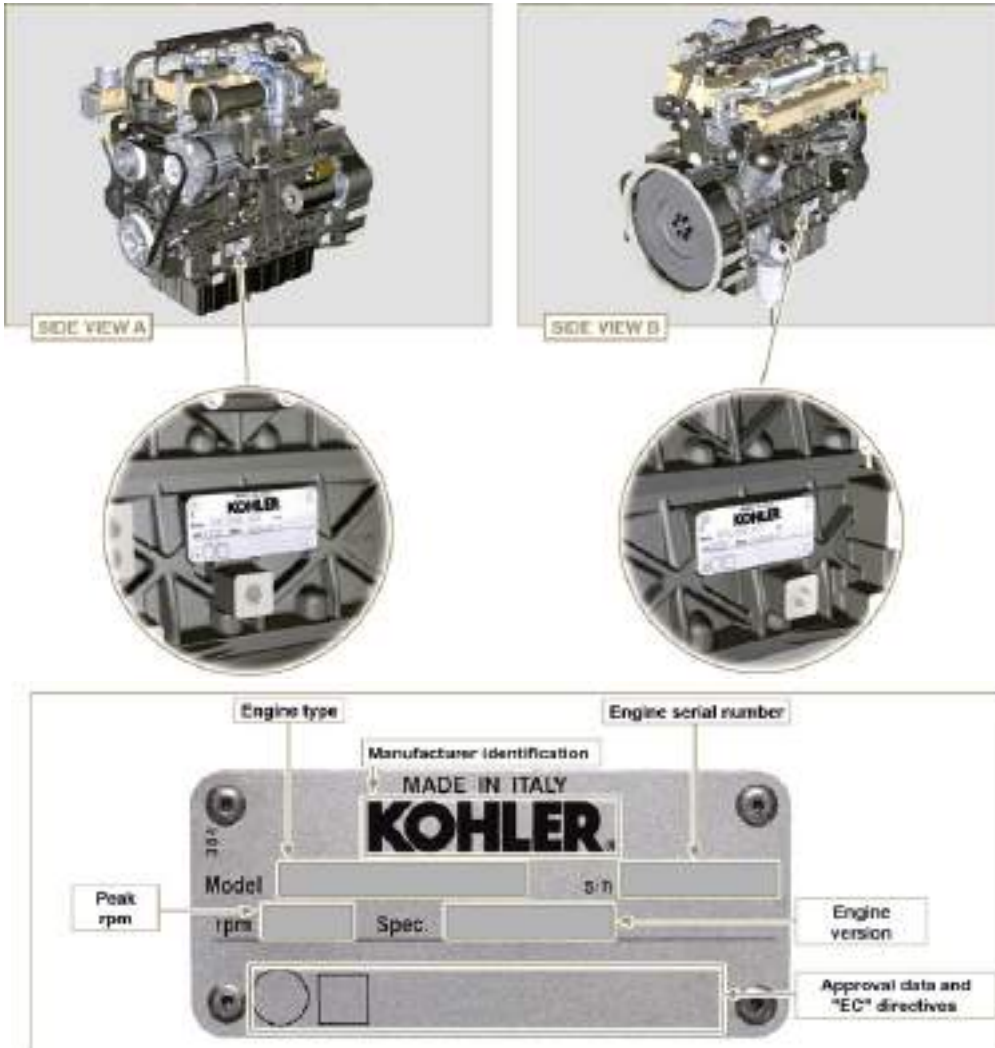



**1.8 Homologation labels**

**Label for EPA rules (compilation example)**

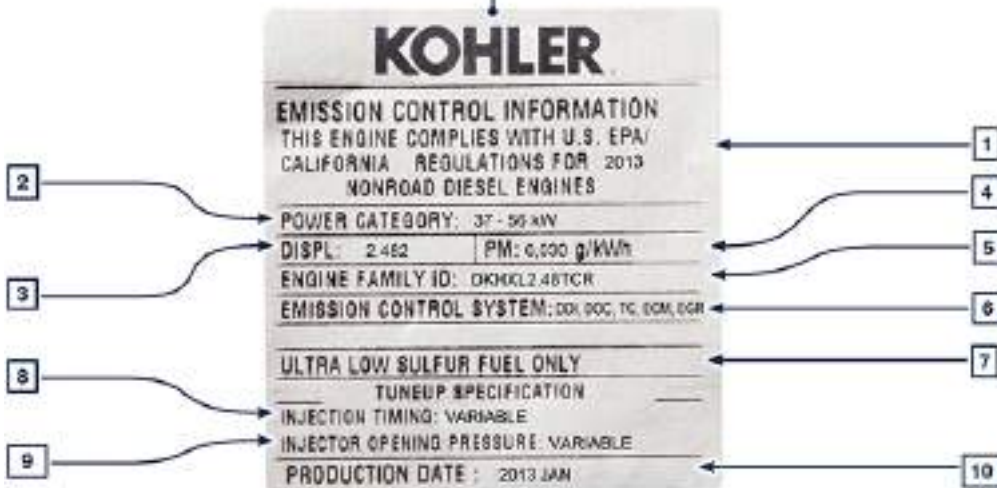

**Tab 1.1**

POS.	DESCRIPTION
1	Model year in compliance with the rules
2	Power category (kW)
3	Engine displacement (L)
4	Particulate emission limit (g/kWh)
5	Engine family ID
6	Emission Control System = ECS
7	Fuel with low sulphur content
8	Injection timing
9	Electronic injector opening pressure (bar)
10	Production date (example: 2013.JAN)

**Label for China Standards (compilation example)**

<b>KOHLER</b>				
此款发动机符合中国非道路移动机械用柴油机油标准 This engine complies with Stage 3 of China Off-road Mobile Machinery Standard GB30853-2014.				
1	制造商 \ Manufacturer <b>Lombardini srl</b>	2	机型 \ Engine model	
3	生产日期 \ Manufacturing date		4	证书编号 \ Information Disclosure No. CNF IC 03 00 0052000003 000000
5	额定功率范围 \ Power Range <b>75kW — 100kW</b>	6	排放阶段 \ Emission Level <b>国3</b>	
7	额定功率 \ Rated Power <b>100.0kW/2200rpm</b>	8	后处理系统 \ Aftertreat system <b>干滤器</b>	

**Tab 1.2**

POS	DESCRIPTION
1	Manufacturer
2	Engine model
3	Manufacturing date
4	Certificate N°
5	Power range (kW)
6	Emission level
7	Rated power
8	Aftertreat system

Label for Korea Standards (compilation example)



Tab 1.3

POS	DESCRIPTION
1	Tier 4 Final
2	Engine model
3	Manufacturing date and manufacturer code
4	N° Korea emission certificate



## 2 TECHNICAL INFORMATION

### 2.1 General description of the engine

- 4-stroke, in-line cylinders Diesel engine;
- Liquid-cooling system;
- 4 valves per cylinder with hydraulic tappets;
- Turbocharger with Waste-gate valve;
- Common rail - Direct injection.

### 2.2 Engine specifications

Tab. 2.1

TECHNICAL DATA		UNIT OF MEASURE		
Engine type			KDI 1903 TCR	KDI 2504 TCR
Cylinders		n.	3	4
Bore		mm	88	88
Stroke		mm	102	102
Displacement		cm <sup>3</sup>	1861	2482
MAX INCLINATION DURING OPERATION (even in combined)		α	30° max. 30 minutes	
		α	35° max. 1 minute	
OIL CAPACITY (MAX level.) including oil filter	standard version	lt.	8.9	11.5
	with balancer device	lt.	-	9
DRY WEIGHT		Kg	233	267

### 2.3 Engine dimensions (mm)

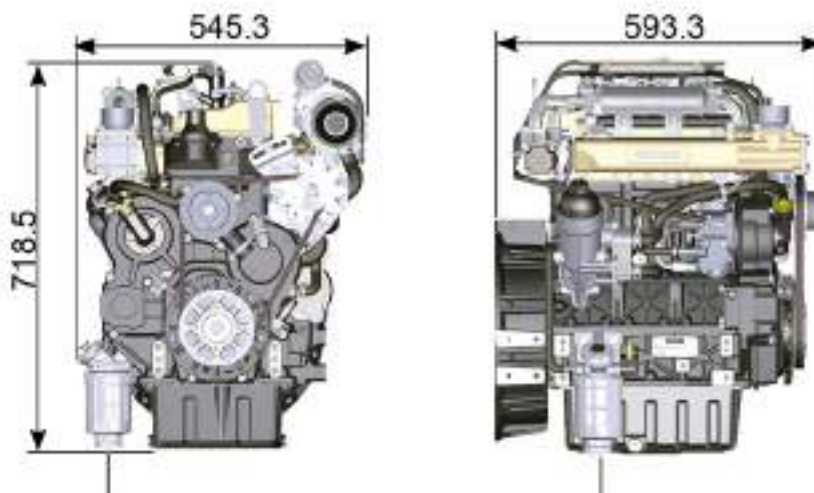

**2.4 Oil**



**Important**

- The engine may be damaged if operated with improper oil level.
- Do not exceed the **MAX** level because a sudden increase in engine rpm could be caused by its combustion.
- Use only the recommended oil to ensure adequate protection, efficiency and service life of the engine.
- The use of lubricants other than recommended may shorten the engine life.
- Viscosity must be appropriate to the ambient temperature to which the engine is to be exposed.



**Danger**

- Prolonged skin contact with the exhausted engine oil can cause cancer of the skin.
- If contact with oil cannot be avoided, thoroughly wash your hands with soap and water as soon as possible.
- For the exhausted oil disposal, refer to the **Par. DISPOSAL and SCRAPPING**.

**2.4.1 SAE oil classification**

- In the SAE classification, oils are identified according to viscosity without considering any other qualitative characteristic.
- The code is composed of two numbers, which indicate, and must correspond to, the ambient temperature in which the engine operates, the first number refers to the viscosity when cold, for use during winter (" **W** "), while the second number is for viscosity at high temperatures.

**2.2**

RECCOMENDED OIL		
<b>VISCOSITY</b>	<b>SAE</b>	10w-30 (-25°C ÷ +40°C)
		10w-40 (-25°C ÷ +50°C)
		5w-30 (-30°C ÷ +40°C)
		0w-40 (-40°C ÷ +50°C)

		<b>TCR STAGE-V (*1) (*2)</b>	<b>TCR TIER IV FINAL (*1)</b>	<b>TCR/D TIER III or UNCERTIFIED (*3)</b>
<b>WITH SPECIFICATIONS</b>	<b>API</b>	CJ-4 Low S.A.P.S	CJ-4 Low S.A.P.S	CI-4 Plus
				CI-4
				CH-4
	<b>ACEA</b>	E6 Low S.A.P.S.	E6 Low S.A.P.S.	E7
			E5	

- Low S.A.P.S. technology (oil with low Sulfated Ash, Phosphorus, Sulfur content) keeps catalyst in good working conditions. The presence of sulfated ash, phosphorus and sulfur causes with time the catalyst clogging and its consequent inefficiency.

- For Mid S.A.P.S oil sequence the sulfated ash level is the same as API CJ-4  $\leq 1.0\%$  but as per ACEA standardization those oils are referenced as mid SAPS.
- Filtration of oils is critical to proper operation and lubrication; always change filters regularly as specified in this manual.

(\*1) **NOTA** : Do NOT use fuel with sulphur content above 15ppm.

(\*2) - **On all engines compliant with Stage-V emission regulation (engines with DPF device), the oil to use must comply with the specification API CJ-4 Low S.A.P.S or ACEA E6 Low S.A.P.S.**

(\*3) - **NOTE** : Do NOT use fuel with sulphur content above 500ppm.

(\*3) - **NOTE** : Low S.A.P.S. oils, sulfate ashes  $<1\%$  may not be used with fuels with a sulfur content  $>50\text{ppm}$ .

## 2.5 Fuel



### Important

- Use of other types of fuel could damage the engine. Do not use dirty diesel fuel or mixtures of diesel fuel and water since this will cause serious engine faults.
- **Any failures resulting from the use of fuels other than recommended will not be warranted.**



### Warning

- Clean fuel prevents the fuel injectors from clogging. Immediately clean up any spillage during refuelling.
- Never store diesel fuel in galvanized containers (i.e. coated with zinc). Diesel fuel and the galvanized coating react chemically to each other, producing flaking that quickly clogs filters or causes fuel pump and/or injector failure.

2.3

### FUEL COMPATIBILITY

EN 590 (biodiesel content max. 7% (V/V))

ASTM D 975 Grade 1-D S15

ASTM D 975 Grade 2-D S15

NATO F-54, equivalent to diesel fuel in accordance with EN 590

EN 590 or ASTM D 975 Grade 1, 2 -D S15 Arctic Diesel

JIS K 2204 No. 1, No. 2

**NOTE** : In a warranty case the customer must prove by a certificate from the fuel supplier that an allowed fuel was used.

### **KDI Electronic Injection Tier 4 final – Stage IIIB – Stage IV- Stage V certified Engines**

- Those engines are designed for fuels in accordance with EN 590 and ASTM D975 for a cetane number of at least 45. Since those engines are equipped with exhaust gas after-treatment such as Diesel Oxidation Catalyst (DOC), Diesel Particulate Filter (DPF), Selective Catalytic Reduction (SCR), they may only be operated with sulfur-free diesel fuels (EN 590, DIN 5168, ASTM D975 Grade 2-D S15, ASTM D975 Grade 1-D S15). Otherwise, compliance with the emission requirements and durability are not guaranteed.

Insufficient lubricating capacity can lead to serious wear problems above all in common rail injection systems. Too low a lubricating capacity is particularly a problem in fuels with a low sulfur content (and in this respect sulfur contents <500 mg/kg can already be considered low). An adequate lubricating capacity is guaranteed by the appropriate additives in low-sulfur (<50 mg/kg) or sulfur-free (<10 mg/kg or <15 mg/kg) diesel fuels according to EN 590 and ASTM D 975. In low-sulfur and sulfur-free diesel fuels which do not comply with this standard, the lubricating capacity may have to be guaranteed by additives. The parameter for sufficient lubricating capacity is a maximum wear spot of 460 micrometers in the HFRR test (EN ISO 12156-1).

***KDI Electronic Injection Tier 3 – Stage IIIA emission equivalent certified Engines (EGR engines)***

- Those engines are designed for fuels in accordance with EN 590 and ASTM D975 for a cetane number of at least 45. Since those engines are not equipped with exhaust gas after-treatment, they can be operated with diesel fuels with sulfur content up to 500 mg/kg (ppm). Compliance with the emission requirements is guaranteed only with sulfur content up to 350 mg/kg (ppm). Fuels with a sulfur content > 50 mg/kg demand a shorter lubricating oil change interval. This is set at 250hrs. However, the engine oil must be changed when the Total Base Number TBN is reduced to 6.0 mgKOH/g test method ASTM D4739. Do not use low SAPS engine oils.

***KDI Electronic Injection uncertified Engines (no EGR engines)***

- Those engines are designed for fuels in accordance with EN 590 and ASTM D975 for a cetane number of at least 45. Since those engines are not equipped with exhaust gas after-treatment, they can be operated with diesel fuels with sulfur content up to 2000 mg/kg (ppm). Fuels with a sulfur content > 15 mg/kg demand a shorter lubricating oil change interval. This is set at 250hrs. However, the engine oil must be changed when the Total Base Number TBN is reduced to 6.0 mgKOH/g test method ASTM D4739.

**2.5.1 Fuel for low temperatures**

- When operating the engine in ambient temperatures lower than 0 degrees C, use suitable low temperature fuel normally available from fuel distributors and corresponding to the specifications of **Tab. 2.3**.
- These fuels reduce the formation of paraffin in diesel at low temperatures.
- When paraffin forms in the diesel, the fuel filter becomes blocked interrupting the flow of fuel.

**2.5.2 Biodiesel fuel**

- Fuels containing 10% methyl ester or B10, are suitable for use in this engine provided that they meet the specifications listed in the Tab. 2.3.
- **DO NOT USE** vegetable oil as a biofuel for this engine.

2.4

**BIODIESEL COMPATIBILITY**

Biodiesel according to EN 14214 (only permissible for mixture with diesel fuel at max. 10% (V/V))

US biodiesel according to ASTM D6751 – 09a (B100) (only permissible for mixtures with diesel fuel at 10% (V/V))

**2.5.3 Synthetic fuels: GTL, CTL, BTL, HV**

It is a well-known fact that engines which are operated for longer periods with conventional diesel fuel and then converted to synthetic fuels suffer shrinkage of polymer seals in the injection system and thus fuel leaks. The reason for this behavior is that the aromatic-free synthetic fuels can lead to a change in the sealing behavior of polymer seals.

Therefore, conversion from diesel fuel to synthetic fuel may only be done after changing the critical seals. The problem of shrinkage does not occur when an engine was operated with synthetic fuel from the start.

### 2.5.4 Non-Road Fuels

Only for KDI De- Contented Electronic Injection Tier 3 – Stage IIIA emission equivalent certified Engines (EGR engines) and KDI De- Contented Electronic Injection Uncertified Engines (no EGR engines).

Other non-road fuels may be used if they comply with all the limit values of EN 590 except for the fuel density, the cetane number and the sulfur content.

The following limits apply for these parameters:

2.5

FUEL PARAMETER	UNIT	LIMIT VALUE
Cetane number		Min. 49
Fuel density at 15°C	Kg/m <sup>3</sup>	820 - 860
Sulfur content	mg/kg or ppm	max. 500

### 2.5.5 Jet Fuels

Only for KDI De- Contented Electronic Injection Uncertified Engines (no EGR engines).

The following jet fuels can be used but only adopting an additional fuel filter with lubricity doser:

2.6

FUEL	
F-34/F-35 (kerosene, NATO designation)	JP-8 (kerosene, US military designation)
F-44 (kerosene, NATO designation)	JP-5 (kerosene, US military designation)
F-63 (kerosene, NATO designation, equivalent to F-34/F-35 with additives)	Jet A (kerosene for civil aviation)
F-65 (kerosene, NATO designation, 1:1 mixture of F-54 and F-34/F-35)	Jet A1 (kerosene for civil aviation)

**2.5.6 Emission-Related Installation Instructions** Failing to follow the instructions in the applications guidebook when installing a certified engine in a piece of nonroad equipment violates federal law (40 CFR 1068.105(b)), subject to fines or other penalties as described in the Clean Air Act.

OEM must apply a separate label with the following statement: “ULTRA LOW SULFUR FUEL ONLY” near the fuel inlet.

Ensure you are installing an engine appropriately certified for your application. Constant speed engines may only be installed on constant speed equipment for constant speed operation.

If you install the engine in a way that makes the engine's emission control information label hard to read during normal engine maintenance, you must place a duplicate label on the equipment, as described in 40 CFR 1068.105.



## 2.6 Coolant recommendation

A mixture of 50% demineralized water and 50% low silicate ethylene glycol based coolant liquid must be used. Use a Long Life or Extended Life Heavy Duty OAT coolant free of: silicates, phosphates, borates, nitrites and amines.

The following ethylene-glycol based engine coolant for all models within KDI engine family may be used:

- OAT (Organic Acid Technology) Low Silicate: **ASTM D-3306 D-6210**
- HOAT (Hybrid Organic Acid Technology) Low Silicate: **ASTM D-3306 D-6210**

The above coolants in concentrated formulation must be mixed with distilled, deionized, or demineralized water. A pre-mixed formulation (40-60% or 50-50%) can be used directly when available.



### Important

- Do not mix ethylene glycol and propylene glycol based coolants. Do not mix OAT and HOAT based coolant. OAT performance life can be drastically reduced if contaminated with nitrite-containing coolants.
- Never use automotive-type coolants. These coolants do not contain the correct additives to protect heavy – duty diesel engines.

OAT coolants are maintenance free up to 6 years or 6000hrs of operation , provided that the cooling system is topped up using the same type of coolant. Do not mix different coolant types. Test the coolant condition annually with coolant test strips.

HOAT are not all maintenance free and it is recommended to have SCA (Supplemental Coolant Additives) added at the first maintenance interval.

## 2.7 Battery recommendation

**Battery not supplied by Kohler**

Tab. 2.7

RECOMMENDED BATTERIES	
AMBIENT TEMPERATURE	BATTERY TYPE
≥ - 15°C	100 Ah - 800 CCA/SAE
< -15°C	120 Ah - 1000 CCA/SAE

## 2.8 Control panel

**Tab. 2.8** shows the control panel components.

**Tab 2.8**

POS.	DESCRIPTION
<b>A</b>	Switch key to start the panel and motor
<b>B</b>	Engine data or errors display
<b>C</b>	Top navigation menu arrow push button
<b>D</b>	Bottom navigation menu arrow push button
<b>E</b>	Data selection or entry push button
<b>F</b>	Engine operating status (green = no problem detected)

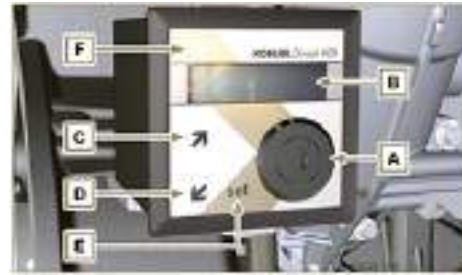

**Fig 2.1**

**NOTE** : if LED **F** is red, contact authorised KOHLER workshops to know what type of problem it is. Certain problems automatically switch off the engine.

**Tab. 2.9** shows data that can be consulted on display **B** by pressing push buttons **C** or **D** .

**NOTE** : data described in **Tab. 2.9** can differ, therefore, consult the machine's manual.

**Tab 2.9**

DESCRIPTION
Operating hours
Hours left for maintenance
Engine rpm
Engine oil pressure
Coolant temperature
Torque used @ rpm (% used)

## 3 SAFETY INFORMATION

### 3.1 *Safety information*

- The intended use of the engine is in conformity with the machine on which it is mounted.
- Any use of the machine other than that described cannot be considered as complying with its intended purpose as specified by **KOHLER**.
- **KOHLER** declines all responsibility for any change to the engine not described in this manual made by unauthorized **KOHLER** personnel.
- A proper use of the engine, a strict observance of the rules listed below and the rigorous application of all these precautions will avoid the risk of accidents or injuries.
- Those who carry out the use and maintenance on the engine must wear the safety equipment and the accident-prevention guards.
- **KOHLER** declines all direct and indirect liability for failure to comply with the standards of conduct contained in this manual.
- **KOHLER** cannot consider every reasonably unforeseeable misuse that may cause a potential danger.

## 3.2 General remarks

### 3.2.1 Note for OEM

- When installing the KDI engines, always bear in mind that any variation to the functional systems may result in serious failures to the engine.
- Any improvement must be verified at **KOHLER** testing laboratories before application of the engine.
- In case the approval to a modification is not granted, **KOHLER** shall not be deemed responsible for any consequential failures or damages to the engine.
- Those who carry out the use and maintenance on the engine must wear the safety equipment and the accident-prevention guards.
- **KOHLER** declines all direct and indirect liability for failure to comply with the standards of conduct contained in this manual.
- **KOHLER** cannot consider every reasonably unforeseeable misuse that may cause a potential danger.

### 3.2.2 Note for end user

- The following indications are dedicated to the user of the machine in order to reduce or eliminate risks concerning engine operation and the relative routine maintenance work.
- The user must read these instructions carefully. Failure to do this could lead to serious danger for his personal safety and health and that of any persons who may be in the vicinity of the machine.
- On starting, make sure that the engine is as horizontal as possible, unless the machine specifications differ.
- Make sure that the machine is stable to prevent the risk of overturning.
- The engine must not operate in places containing inflammable materials, in explosive atmospheres, where there is dust that can easily catch fire unless specific, adequate and clearly indicated precautions have been taken and have been certified for the machine.
- To prevent fire hazards, always keep the machine at least one meter from buildings or from other machinery.
- Children and animals must be kept at a due distance from operating machines in order to prevent hazards deriving from their operation.
- Thoroughly wash and clean all the external parts of the engine before performing any operation, in order to avoid the accidental introduction of impurities/foreign bodies. Use only water and/or appropriate products to clean the engine. If cleaning engine with a pressure washer or steam cleaner, it is important to maintain a minimum distance of at least 200mm between the surface to be washed and the nozzle. Avoid directing the nozzle on electrical components, cable connections and sealed rings (oil seals etc). Thoroughly wash and clean the area surrounding the engine following the instructions provided by machine manufacturer.
- Fuel and oil are inflammable. The tank must only be filled when the engine is off. Before starting, dry any spilt fuel.
- Make sure that no soundproofing panels and the ground or floor on which the machine is standing have not soaked up any fuel.
- Fuel vapour is highly toxic. Only refuel outdoors or in a well ventilated place
- Do not smoke or use open flames when refuelling.
- During operation, the surface of the engine can become dangerously hot. Avoid touching the exhaust system in particular.
- Before proceeding with any operation on the engine, stop it and allow it to cool.
- Always open the radiator plug or expansion chamber with the utmost caution, wearing protective garments and goggles.
- The coolant fluid is under pressure. Never carry out any inspections until the engine has cooled.
- If there is an electric fan, do not approach the engine when it is still hot as the fan could also start operating when the engine is at a standstill.
- The oil must be drained whilst the engine is hot. Particular care is required to prevent burns. Do not allow oil to come into contact with the skin because of the health hazards involved. It is recommended to use an oil intake pump.
- During operations that involve access to moving parts of the engine and/or removal of rotating guards, disconnect and insulate the negative wire (-) of the battery to prevent accidental short-circuits and to stop the starter motor from being energized.

- Check belt tension only when the engine is off.
- Fully tighten the tank cap each time after refuelling. Do not fill the tank right to the top but leave an adequate space for the fuel to expand.
- To start the engine follow the specific instructions provided in the engine and/or machine operating manual. Do not use auxiliary starting devices not originally installed on the machine (e.g. Startpilot).
- Before starting, remove any tools that were used to service the engine and/or machine. Make sure that all guards have been refitted.
- Do not mix fuel with elements such as oil or kerosene. Failure to comply with this prohibition will cause the non-operation of the catalyst and non-observance of the emissions declared by **KOHLER**.
- Pay attention to the temperature of the oil filter when the filter itself is replaced.
- Only check, top up and change the coolant fluid when the engine is off and reached the ambient temperature. Coolant fluid is polluting, it must therefore be disposed of in the correct way.
- Do not use air and water jets at high pressures on cables, connectors and injectors.



**Important**

- Only use the eyebolts **A** installed by **KOHLER** to move the engine (**Fig. 3.1**).
- The angle between each lifting chain and the eyebolts shall not exceed 15° inwards.
- The correct tightening of the lifting screws is 25Nm.
- Do not interpose spacers or washers between the eyebolts and engine head.
- Engines equipped with an ATS device require regeneration to be inhibited if the engine is used in environments at risk of fire (e.g. forest areas, areas with flammable materials, areas with flammable gases or liquids and any type of combustible material - if the function is available).

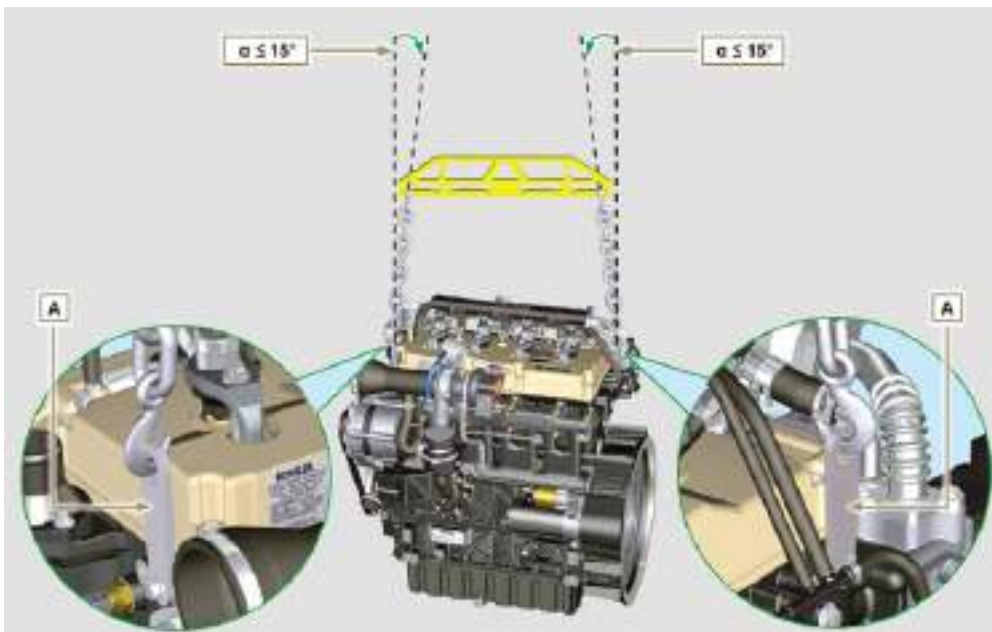





**Fig 3.1**





### 3.3 Safety signal description

- To ensure safe operation please read the following statements and understand their meaning.
- Also refer to your equipment manufacturer's manual for other important safety information.
- This manual contains safety precautions which are explained below.
- Please read them carefully.









#### Adhesive safety plates







The following is a list of the adhesive safety plates that may be found on the engine, which indicate potential points of danger to the operator.

	Read the Operation and Maintenance handbook before performing any operation on the engine.
	Hot Parts. Danger of burns.
	Presence of rotating parts. Danger of jamming or cutting.
	Presence of explosive fuel. Danger of fire or explosion.
	Presence of steam and pressurized coolant. Danger of burns.
<p><b>Warnings</b> Hereunder is a list of safety warnings that may be found in the manual, which advise you to pay attention when carrying out particular procedures that may be potentially dangerous to the operator or things.</p>	
	<p><b>Danger</b> This indicates situations of grave danger which, if ignored, may seriously threaten the health and safety of individuals.</p>



	<p><b>Important</b>                  This indicates particularly important technical information that should not be ignored.</p>
	<p><b>Warning</b>                  This indicates that failure to comply with it can cause minor damage or injury.</p>
<p><b>Safety guards</b> Hereunder is a list of safety guards that must be worn prior to carrying out any type of operation and to avoid potential harm to the operator.</p>	
	<p>Use suitable protective gloves before carrying out any type of operation.</p>
	<p>Use protective goggles before carrying out any type of operation.</p>
	<p>Use earmuffs before carrying out any type of operation.</p>

### 3.4 Information and safety signals

 <b>ACCIDENTAL START</b>	
  	<p><b>Accidental Starts can cause severe injury or death.</b></p>
<p>Before working on the engine or equipment, disconnect the battery negative (-) wire.</p>	
 <b>HOT PARTS</b>	
	<p><b>Hot Parts can cause severe burns.</b></p>
<p>Engine components can get extremely hot from operation. Do not touch engine while operating or just after stopping.</p> <p>Never operate the engine with heat shields or guards removed.</p>	
 <b>ROTATING PARTS</b>	
	<p><b>Rotating Parts can cause severe injury.</b></p>
<p>Stay away while engine is in operation. Keep hands, feet, hair, and clothing away from all moving parts to prevent injury.</p> <p>Never operate the engine with covers, shrouds, or guards removed.</p>	
 <b>LETHAL EXHAUST GASES</b>	

 <b>HIGH PRESSURE FLUID RISK OF PUNCTURE</b>	
	<p><b>High Pressure Fluids can puncture skin and cause severe injury or death.</b></p>
<p>Do not work on fuel system without proper training or safety equipment. Fluid puncture injuries are highly toxic and hazardous.</p> <p><b>If an injury occurs, seek immediate medical attention.</b></p>	
 <b>EXPLOSIVE FUEL</b>	
	<p><b>Explosive fuel can cause fires and severe burns.</b></p>
<p>Fuel is flammable and its vapours can ignite. Store fuel only in approved containers, in well ventilated, unoccupied buildings. Do not fill the fuel tank while the engine is hot or running, since spilled fuel could ignite if it comes in contact with hot parts or sparks from ignition.</p> <p>Do not start the engine near spilled fuel.</p> <p>Never use fuel as a cleaning agent.</p>	
 <b>EXPLOSIVE GAS</b>	
	<p><b>Explosive Gas can cause fires and severe acid burns.</b></p>
<p>Charge battery only in a well ventilated area. Keep sparks, open flames, and other sources of ignition away from the battery at all times. Batteries produce explosive hydrogen gas while being charged.</p> <p>Keep batteries out of the reach of children.</p> <p>Remove all jewelry when servicing batteries. Before disconnecting the negative (-) ground cable, make sure all switches are OFF.</p>	



	<p><b>Carbon Monoxide can cause severe nausea, fainting or death.</b></p>
<p>Avoid inhaling exhaust fumes and never run the engine in a closed building or confined area. Carbon monoxide is toxic, odorless, colorless, and can cause death if inhaled.</p>	
<p style="text-align: center;">   <b>ELECTRICAL SHOCK</b> </p>	
	<p><b>Electrical Shock can cause injury.</b></p>
<p>Do not touch wires while engine is running.</p>	

If ON, a spark will occur at the ground cable terminal which could cause an explosion.



**CALIFORNIA WARNING - DECLARATION 65**

Engine exhaust from this product contains chemicals known to the State of California to cause cancer, birth defects, or other reproductive harm.

### 3.5 Safety and environmental impact

Every organisation has a duty to implement procedures to identify, assess and monitor the influence of its own activities (products, services, etc.) on the environment. Procedures for identifying the extent of the impact on the environment must consider the following factors:

- Liquid waste.
- Waste management.
- Soil contamination.
- Atmospheric emission.
- Use of raw materials and natural resources.
- Regulations and directives regarding environmental impact.

In order to minimise the impact on the environment, **KOHLER** now provides a number of indications to be followed by all persons handling the engine, for any reason, during its expected lifetime. - All components and fluids must be disposed of in accordance with the laws of the country in which disposal is taking place.

- Keep the fuel and engine control systems and the exhaust pipes in efficient working order to limit environmental and noise pollution.

- When discontinuing use of the engine, select all components according to their chemical characteristics and dispose of them separately.

### 3.6 Location of safety labels on engine

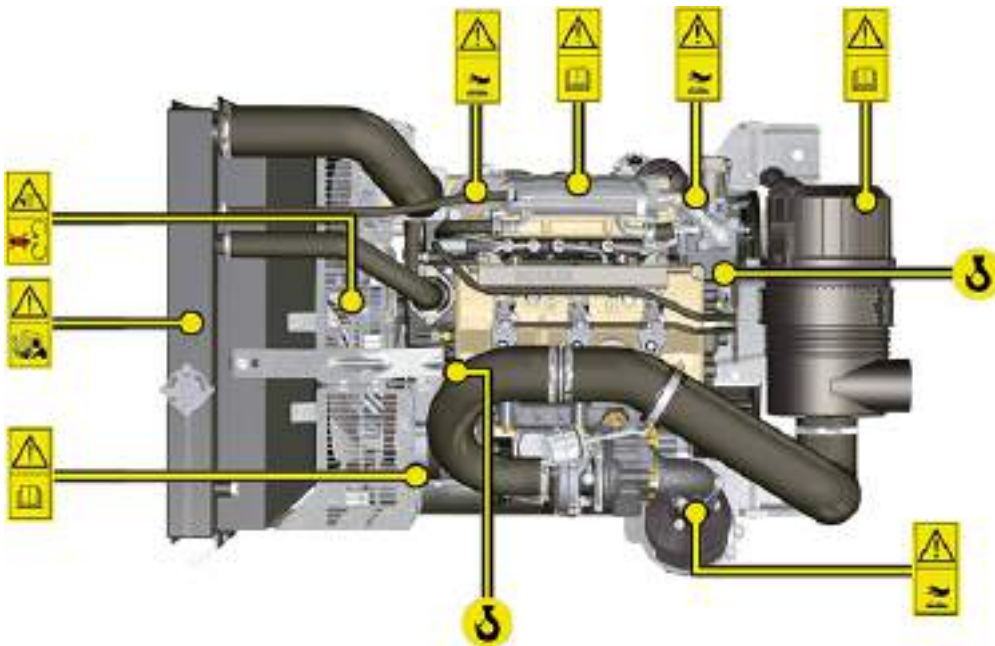

## 4 INFORMATION ABOUT USE

### 4.1 Pre-start check

- Read carefully the following pages and carry out the operations described below in accordance with the instructions specified.



#### Important

- Non compliance with the operations described in the following pages involves the risk of damages to the engine and vehicle on which it is installed as well as personal and/or property damage.
- Increase the frequency of maintenance operations in heavy working conditions (engine starts but stops, very dusty and hot environments, etc..).

### 4.2 Running-in period

**NOTE:** For the first 50 hours of engine operation, it is advisable not to exceed 75% of the maximum power supplied.

### 4.3 Starting and turning off

#### 4.3.1 Starting

1. Check the level of the engine oil, fuel and coolant and fill if necessary ( [Par. 4.5](#) e [Par. 4.6](#) ).
2. Put the ignition key in the ignition switch (if supplied).
3. Turn the key to **ON** position.
4. Turn the key beyond the **ON** position and release it when the engine starts (the key will return into ON position automatically).



#### Important

- At the first fuelling or if the tank was empty filling the fuel system ( [Par. 6.4 point 8](#) ).
- Do not actuate the starter for more than 15 seconds at a time. If the engine does not start, wait for one minute before repeating attempt.
- If engine does not start after two attempts see [Tab. 7.1 and Tab. 7.2](#) to found the cause.

#### 4.3.2 After starting



#### Warning

- Make sure that all the warning lights on the control panel are off when the engine is running.
- Run at minimum speed for a few minutes according to table (except constant speed engine).

**NOTE:** To avoid damaging the engine do not use it mostly at idle for a long time ( **MAX 30min.** ).

AMBIENT TEMPERATURE	TIME
≤ -20°C	2 minutes
from -20°C a -10°C	1 minutes
from -10°C a -5°C	30 seconds
from -5°C a 5°C	20 seconds
≥ 5°C	15 seconds

#### 4.3.3 Turning off

1. Do not turn off the engine when it is running at the maximum rotation speed (except constant speed engine).
2. Before turning it off, keep it idle at minimum speed for about 1 minute.
3. Turn the key to **OFF** position.

## 4.4 Refuelling



### Important

- Before proceeding with operation, read [Par. 3.2.2](#) .



### Danger

- Fill the engine off.
- The only approved fuels are those listed in [Tab. 2.3](#) .
- In those countries where fuel has a high sulphur content, its is advisable to lubricate the engine with a high alkaline oil or alternatively to replace the lubricating oil recommended by **KOHLER** more frequently.
- To avoid explosions or fire outbreaks, do not smoke or use open flames during the operations.
- Fuel vapours are highly toxic. Only carry out the operations outdoors or in a well ventilated place.
- Keep your face well away from the fuel fill to prevent harmful vapours from being inhaled.
- Dispose of fuel in the correct way and do not litter as it is highly polluting.
- When refuelling, it is advisable to use a funnel to prevent fuel from spilling out. The fuel should also be filtered to prevent dust or dirt from entering the tank.
- Do not overfill the fuel tank. Leave room for the fuel to expand.

**NOTE:** At the first fuelling or if the tank was empty filling the fuel system ( [Par. 6.4 point 8](#) ).

## 4.5 Oil filling



### Important

- For safety precautions see [Par. 2.4](#) .
- Before proceeding with operation, read [Par. 3.2.2](#) .
- Do not use the engine with the oil level below the minimum.

1. Loosen the oil filler cap **A** or the oil filler cap **C** if the cap **A** is not accessible.
2. Add the oil of type recommended ( [Tab. 2.1](#) and [Tab. 2.2](#) ).

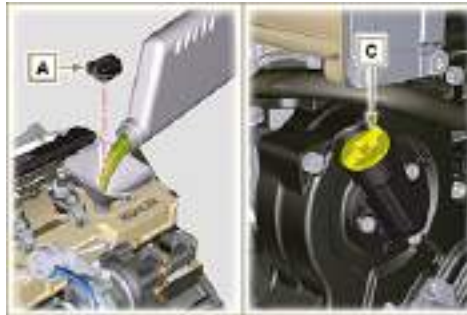

Fig 4.1

1. Before checking oil engine needs to be level.
2. Remove the oil dipstick **B** and check that the level is up to but does not exceed the **MAX** .
3. If level is not at the **MAX** . level, add additional oil.
4. Re-tighten the cap **A** or **C** .

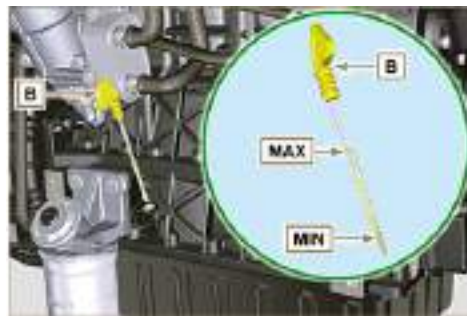

Fig 4.2

**NOTE** : Click on the right to play the procedure.

[https://www.youtube.com/embed/cVpoy\\_m253A?rel=0](https://www.youtube.com/embed/cVpoy_m253A?rel=0)

## 4.6 Coolant filling



### Important

- Before proceeding with operation, read [Par. 3.2.2](#) .



### Warning

- An anti-freeze protection liquid (ANTIFREEZE) - mixed with decalcified water - must be used.
- The freezing point of the refrigerant mixture depends on the amount concentration in water.
- As well as lowering the freezing point, the antifreeze also raises the boiling point.
- A 50% mixture is recommended to ensure a general level at protection prevents the formation of rust, galvanic currents and calcium deposits.

**NOTE:** Before proceeding with any operation on the engine, stop it and allow it to cool.



### Warning

- Presence of steam pressurized coolant danger of burns.
1. Loosen the cap **A** and fill the radiator with coolant composed of: 50% ANTIFREEZE and 50% decalcified water.
  2. Top liquid up until the pipes inside the radiator are covered by about 5 mm. Do not overfill the radiator, but leave room for the coolant to expand.
  3. For engines equipped with expansion tank, pour in fluid until reaching the max level mark.
  4. Loosen the screw **C**, release any air and tighten the screw **C** (Tightening torque of **8 Nm** - **Fig. 4.6** ).
  5. Re-tighten the cap **A** .
  6. After a few hours of operator, stop the engine and allow the liquid to cool returns to a ambient temperature and check the coolant level again.



Fig. 4.3



Fig. 4.4



Fig. 4.5 - Fig. 4.6

**NOTE** : Click on the right to play the procedure.

<https://www.youtube.com/embed/S79xPhTZMps?rel=0>



#### 4.7 ATS regeneration strategy (only for Stage V configurations)

Only for Stage V configurations [\(see Par. ATS\)](#)

You can intervene on the machine control panel for the DPF regeneration operations "only if requested by means of specific warning lights or messages on the control panel".

Tab. 4.11 describes the level of particulate accumulation, the relationship with the warning lights that will light up on the panel, the performance limitations of the engine and the operator's options intervention. Forced regeneration must be executed in accordance with the machine instructions.

##### 4.11

SOOT LEVEL	WARNING LAMPS *1	ENGINE DE-RATE	OPERATOR POSSIBLE ACTIONS	OPERATING CONDITIONS
Level 0				
Level 1				<ul style="list-style-type: none"> <li>No condition</li> </ul>
Level 2				
Level 3	 Fixed		Forced Regeneration is Necessary.	<ul style="list-style-type: none"> <li>Coolant temperature at 60 °C</li> <li>Do not switch the engine off</li> <li>Stationary vehicle</li> <li>No load applied to the engine *2</li> </ul>
Level 4	 Flashing	Engine de-rate.	Forced Regeneration is Necessary.	<ul style="list-style-type: none"> <li>Coolant temperature at 60 °C</li> <li>Do not switch the engine off</li> <li>Stationary vehicle</li> <li>No load applied to the engine *2</li> </ul>
Level 5	 Flashing	Strong Engine de-rate.	Contact an authorized KOHLER workshop. Service Regeneration Required	REGENERATION via Kohler software

\*1: The warning lights be different – consult the machine manual.

\*2: Unless stated otherwise in the machine manual.



**Warning**

- Forced regenerations must only be executed if required by the ECU when the "HIGH SOOT" warning light goes on (due to a Level 3 - 5 particulate accumulation).
- Do NOT execute the forced regenerations if not required by the ECU (due to a Level 0 - 2 particulate accumulation).
- Repeated forced regenerations cause significant engine oil contamination by the fuel.
- The operations described in Par. 5.3 or 5.4 must be executed after every forced regeneration.
- If the regeneration inhibition function is misused, the particulate accumulation level will increase within a short time.
- The engine oil filter and oil must be changed after a Service Regeneration is completed via KOHLER software
- (Level 5 Particulate accumulation).
- Fuel contamination allowed in the engine oil is 3% MAX.
- Any engine load must be eliminated during forced regeneration so as to prevent damaging the ATS \*2 system.
- Do not switch the engine off during level 3, 4 and 5 regeneration so as to prevent damaging the ATS system.

## 5 INFORMATION ABOUT MAINTENANCE

### 5.1 Useful information about maintenance

- This chapter shows all operations described in the [Tab. 5.1 and Tab. 5.2](#) . if you have the skills appropriate may be directly carried out by the user.
- Periodic inspection and maintenance operations must be carried out as indicated in this manual and are the responsibility of the user.
- Failure to comply with these service and maintenance intervals increases the risk of technical damage to the engine. Any non compliance makes the warranty become null and void.
- In order to prevent personal and property damage read carefully the instructions listed below before proceeding with any operation of the engine.



#### Warning

- Inspections must be made when the engine is off and cold.
- Place engine on level surface to ensure accurate measurement of oil level.
- Before starting, to avoid spillages of oil make sure that: - the oil dipstick is inserted correctly;

- also check that: oil drain plug and oil filler cap are tightened firmly.



#### Important

- Before proceeding with operation, read [Par. 3.2.2](#) .



#### Danger

- For safety precautions see [Chap. 3](#) .

## 5.2 Periodic maintenance

The intervals of preventive maintenance in **Tab. 5.1**, **Tab. 5.2**, **Tab. 5.3** and **Tab. 5.4** refer to the engine operating under normal operating conditions with fuel and oil meeting the recommended specifications.

### 5.1

CLEANING AND CHECKING				
OPERATION DESCRIPTION	PERIOD (HOURS)			
	100	250	500	5000
<a href="#">Engine oil level</a> <sup>-(4) (8)</sup>				
<a href="#">Coolant level</a> <sup>(8) (9)</sup>				
<a href="#">Cartridge dry-type air filter</a> <sup>(2)</sup>				
<a href="#">Radiator heat-exchange surface and Intercooler</a> <sup>(2) (8)</sup>				
<a href="#">Standard alternator belt</a> <sup>(8)</sup>				
<a href="#">Poly-V alternator belt</a> <sup>(8)</sup>				
<a href="#">Rubber hose</a> (intake air / coolant)				
Fuel hose				
Starter Motor <sup>(6)</sup>				
Alternator <sup>(6)</sup>				

### 5.2

REPLACEMENT				
OPERATION DESCRIPTION		PERIOD (HOURS)		
		500	2000	5000
<a href="#">Cartridge dry-type air filter</a> <sup>(2)</sup>				
Intake manifold hose (air filter - intake manifold) <sup>(6) (7)</sup>				
Coolant hoses <sup>(6) (7)</sup>				
Fuel line hose <sup>(6) (7)</sup>				
Alternator belt	Standard alternator belt (trapezoidal) <sup>(3) (6)</sup>			
	Poly-V belt heavy environmental condition <sup>(6)</sup>			
	Poly-V belt standard condition <sup>(6)</sup>			
Coolant	OAT <sup>(6)</sup>			
	HOAT <sup>(6)(10)</sup>			
<a href="#">ATS</a> <sup>(6)</sup>		ECU request (message or warning light activation) refer to the machine documentation		

## 5.3

ENGINE OIL AND OIL FILTER CARTRIDGE REPLACEMENT		
ENGINE VERSION	PERIOD (HOURS) - 6.1 - 6.2 - 6.3	
	250	500
KDI TCR Tier 4 final – Stage IIIB – Stage IV- Stage V <sup>(1)</sup>		
KDI TCR/D Tier 3 – Stage IIIA <sup>(1)(11)</sup>		
KDI TCR/D uncertified <sup>(1)</sup>		

## 5.4

FUEL FILTER AND PREFILTER CARTRIDGE REPLACEMENT		
ENGINE VERSION	PERIOD (HOURS) - 6.4	
	250	500
KDI TCR Tier 4 final – Stage IIIB – Stage IV- Stage V <sup>(1)</sup>		
KDI TCR/D Tier 3 – Stage IIIA <sup>(1)</sup>		
KDI TCR/D uncertified <sup>(1)</sup>		

(1) - In case of low use: 12 months.

(2) - The period of time that must elapse before checking the filter element depends on the environment in which the engine operates. The air filter must be cleaned and replaced more frequently under very dusty conditions.

(3) - In case of low use: 36 months.

(4) - The inspection must be carried out every 50 hours or every week in engines with an ATS system ( [see Par. 1.6](#) ).

(6) - Contact authorized **KOHLER** workshops.

(7) - The replacement interval is only an indication, it strongly depends from environmental condition and hose status detected during regular visual inspection.

(8) - The first check must be done after 10 hours.

(9) - Test the coolant condition annually with coolant test strips.

(10) - It is recommended to have SCA (Supplemental Coolant Additives) added at the first maintenance interval.

(11) - Read Cap. 2.5, "KDI De- Contented Electronic Injection Tier 3 – Stage IIIA emission equivalent certified Engines (EGR engines)" and "KDI De- Contented Electronic Injection Uncertified Engines (no EGR engines)".

### 5.3 Oil level check



**Important**

- Before proceeding with operation, read [Par. 3.2.2](#) .
- Do not use the engine with the oil level below the minimum.
- Change the oil and oil filter if the level exceeds the MAX.
- Do not use the engine with the level of oil over MAX.

1. Loosen the oil filler cap **A** .  
Remove the oil dipstick **B** and check that the level is up to **MAX** .
2. Pour in recommended oil until reaching the **MAX** level mark.
3. Reinstall the oil dipstick **B** completely..
4. Re-tighten the cap **A** and/or **C** (**Fig. 5.2**) .

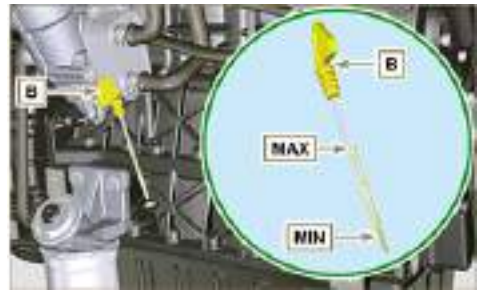

**Fig. 5.1**



**Fig. 5.2**

### 5.4 Oil dipstick on cylinder head



**Important**

- Before proceeding with operation, read [Par. 3.2.2](#) .

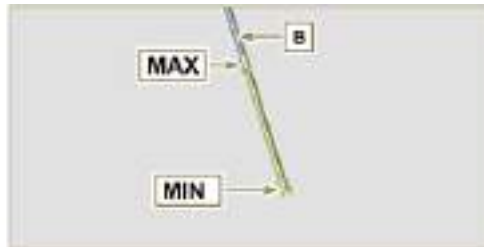

**Fig 5.3 - Fig. 5.4**

### 5.5 Air filter check



#### Important

- Before proceeding with operation, read [Par. 3.2.2](#) .
- When the cartridge **G** is dirty, do not clean it but replace cartridges **B** and **G**.

**NOTE:** Components not necessarily supplied by **KOHLER** .

1. Release the two clasps **F** of the cover **A** .
2. Remove the cartridges **B** and **G** .
3. Clean the inside components **A** and **D** with a damp cloth.
4. **Do not use compressed air** , repeatedly tap the front side **E** on a flat surface.
5. Reinstall:
  - cartridges **G** and **B**.
  - the cover **A** checking the right tightness of clasps **F** .

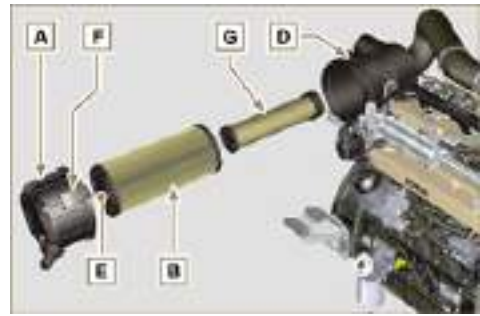

Fig 5.5

### 5.6 Check of the radiator heat - exchanger surface



#### Danger

- For safety precautions see [Chap. 3](#) .

**NOTE:** Component not necessarily supplied by **KOHLER** .



#### Important

- Before proceeding with operation, read [Par. 3.2.2](#) .
- Wear safety goggles when using compressed air.
- The radiator heat-exchange surface must be cleaned on both.

1. Check the radiator heat-exchange surface **D** .
2. Clean the surface with a brush soaked in special detergent if it is clogged.



Fig 5.6

## 5.7 Rubber hoses check



### Danger

- For safety precautions see [Chap. 3](#) .

The check is carried out by exerting a slight deflection or bending along the pipe and near the hose clamps. Components must be replaced if they have clear signs of cracks, tears, cuts, leaks and do not retain a certain degree of elasticity.



**Fig 5.7**



### Important

- Before proceeding with operation, read [Par. 3.2.2](#) .
- If hoses are damaged contact an authorized **KOHLER** workshop.

1. Check that the:

- Fuel system hoses **A** are intact.
- Cooling circuit hoses **B** .
- Vent system pipes **C** .
- Air system ducts **D** .
- Oil return circuit hose **E** .



**Fig 5.8**

## 5.8 Check coolant level



### Important

- Before proceeding with operation, read [Par. 3.2.2](#) .



### Danger

- For safety precautions see [Chap. 3](#) .

**NOTE** : Before proceeding with any operation on the engine, stop it and allow it to cool.



### Warning

- Presence of steam pressurized coolant danger of burn.

**NOTE** : Component not necessarily supplied by **KOHLER** .

1. Start the engine without the radiator cap **A** .
2. Top liquid up until the pipes inside the radiator are covered by about 5 mm.
3. **Top up if necessary.**
4. Do not overfill the radiator, but leave room for the coolant to expand.
5. Reinstall radiator cap **A**
6. For engines equipped with expansion tank (**B**) , check that the fluid is until reaching the **max** level mark

**NOTE** : For coolant filling see [Par. 4.6](#) .



### Warning

- Before starting make sure that the radiator cap and cap, if present, are installed correctly to avoid spillage of liquid or vapour at high temperatures.



Fig 5.9



Fig 5.10



## 5.9 Check and setting alternator standard belt tension



### Warning

- For safety precautions see **Chap. 3** .

#### 5.9.1 Check

1. Check the belt **A** condition, if worn out or deteriorated, replace it.
2. Check by the appropriate tool that at point **p** the tension value is between **80 and 85 Hz** .

Using the tool **F** (DENSO BTG-2 or a similar one) shown in the picture, it is possible to check the corresponding value in Newtons, which should be between **350 and 450 N**.

Should the correct tool not be available, the belt tension can be checked by applying a force in the direction of arrow **G** of approx' 10kg on the point **p**. When correctly tensioned the belt must show a movement of less than 10 mm. If not adjust it.

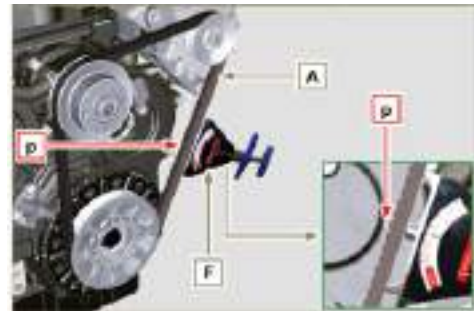

**Fig 5.11**



**Fig 5.12**

#### 5.9.2 Adjustment

1. Loosen the fastening bolts **B e C** .
2. Pull the alternator outwards (in direction of the arrow **D** ), to tension the belt.
3. Tension the belt tightening the bolts **B e C** .
4. Tighten bolts **B** (tightening torque of **25 Nm** ) and **C** (tightening torque of **69 Nm** ) in sequence with a torque wrench **E** .
5. Check by the appropriate tool that at point **p** the tension value is between **80 and 85 Hz** .

Using the tool **F** (DENSO BTG-2 or a similar one) shown in the picture, it is possible to check the corresponding value in Newtons, which should be between **350 and N.450**.

Should the correct tool not be available, the belt tension can be checked by applying a force in the direction of arrow **G** of approx' 10kg on the point **p**. When correctly tensioned the belt must show a movement of less than 10mm.

Let the engine run for some minutes, then let it cool down at ambient temperature and repeat the operations **2, 3, 4 and 5** in case the belt tension results out of the above mentioned values.

**NOTE:** Contact **KOHLER** authorised workshops for replacement.



**Fig 5.13**

### 5.10 Check Poly-V alternator belt



#### Important

- Before proceeding with operation, read [Par. 3.2.2](#) .



#### Danger

- For safety precautions see [Chap. 3](#) .

**NOTE** : The poly-v belt is not adjustable.

1. Check the belt **A** condition, if worn out or deteriorated, **replace it**.

**NOTE** : Make sure that the ribs of the belt **A** are inserted correctly into the grooves of the pulleys **B** (as shown in [Fig. 5.14](#) and [Fig. 5.15](#) ).

2. Start the engine and run it for some minutes, then turn off it, and let it cool down at ambient temperature.  
Check by the appropriate tool that at point **p** the tension value is between **149 and 196 Hz** .

**NOTE** : If the poly-v belt tension results out of the above mentioned values contact **KOHLER** authorised workshops for replacement.



Fig 5.14

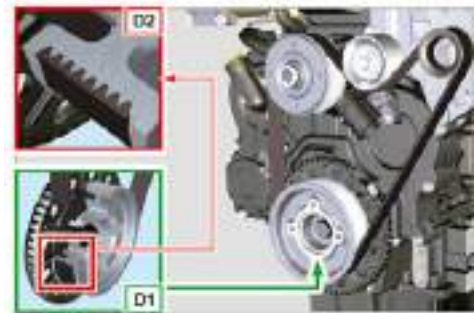

Fig 5.15

### 5.11 Filter cartridge and fuel pre-filter check



**Important**

- Before proceeding with operation, read [Par. 3.2.2](#) .



**Warning**

- For safety precautions see [Chap. 3](#) .



**Fig 5.16**

When turn on lights on control water filter cartridge fuel:

1. Gently loosen the wing screw **A** without removing it.
2. Drain the water if present.
3. Re-tighten the wing screw **A** as soon as the fuel begins to flow.

### 5.12 Product preservation



**Important**

- If the engines are not to be used for 6 months, they must be protected by carrying out the operations described in Engine storage (up to 6 months) ([Par. 5.13](#)) .
- If the engine is still not in use after the first 6 months, it is necessary to carry out a further operation to extend the protection period (more than 6 months) ([Par. 5.14](#)) .
- If the engine is not to be used for an extended period, the protective treatment procedure must be repeated within 24 months of the previous one.

### 5.13 Engine storage up to 6 months

**Before storing the engine check that:**

- The environments are not humid or exposed to bad weather. Cover the engine with a proper protective sheet against dampness and atmospheric contaminants.
- The place is not near electric panel.
- Avoid storing the engine in direct contact with the ground.

### 5.14 Engine storage over 6 months

Follow the steps described in **Par. 5.13** .

1. Engine oil replacement (**Par. 6.1**) .
2. Refuel with fuel additives for long storage. The following additives are recommended:

DEFA Fluid Plus (Pakelo Lubricants),

Diesel Treatment (Green Star),

Top Diesel (Bardhal),

STP<sup>®</sup> Diesel Fuel Injector Treatment.

3. With expansion tank:  
make sure that the coolant is up to the maximum level.
4. Without expansion tank: Top liquid up until the pipes inside the radiator are covered by about 5 mm.

Do not overfill the radiator, but leave room for the fuel to expand.

5. Start the engine and keep it idle at minimum speed for 2 minutes.
6. Bring the engine to 3/4 of the maximum speed for 5÷10 minutes.
7. Turn off the engine.
8. Completely empty the fuel tank.
9. Spray SAE 10W-40 on the exhaust and intake manifolds.
10. Seal the exhaust and intake ducts to prevent foreign bodies from entering.
11. When cleaning the engine, if using a pressure washer or steam cleaning device, avoid directing the nozzle on electrical components, cable connections and sealed rings (oil seals etc).  
If cleaning engine with a pressure washer or steam cleaner, it is important to maintain a minimum distance of at least 200mm between the surface to be washed and the nozzle - avoiding absolutely electrical components such as alternators, starter motors and engine control units (ECU).
12. Treat non-painted parts with protective products.

If the engine protection is performed according to the suggestions indicated no corrosion damage should occur.

### 5.15 Engine starting after storage

1. Remove the protective sheet.
2. Use a cloth soaked in degreasing product to remove the protective treatment from the external parts.
3. Inject lubricating oil (no more than 2 cm<sup>3</sup>) into the intake ducts.
4. Refill the tank with fresh fuel.
5. Make sure that the oil and the coolant are up to the **maximum** level.
6. Start the engine and keep it idle at minimum speed for a two about minutes.
7. Bring the engine to 75% of maximum rated speed for 5 to 10 minutes.
8. Stop the engine while the oil is still hot (**Par. 6.1**), discharge the protective oil in a suitable container.



#### **Warning**

- Over time, lubricants and filters lose their properties, so it is important consider whether they need replacing, also based on the criteria described in **Par. 5.2**.
9. Replace the filters (air, oil, fuel) with original spare parts.
  10. Pour new oil (**Par. 4.5**) up to the **maximum** level.
  11. Empty the cooling circuit completely and pour in the new coolant up to the **maximum** level (**Par. 4.6**).

## 5.16 Unused machine

If the machine is not used for a certain amount of time, follow the operations below:

### 5.16.1 Operations for the engine

POINT	OPERATION	
1	Unused machine up to 2 months	<ul style="list-style-type: none"> <li>• The place must be dry and fresh throughout the period in which the machine is not used.</li> <li>• Consult the machine's manual to disconnect the battery (before disconnecting the battery, wait for minimum 5 mins after turning off the engine).</li> <li>• Make sure the engine is not exposed to direct sunlight.</li> <li>• Make sure the engine is not near any heat sources.</li> </ul>
	Starting	<ul style="list-style-type: none"> <li>• Before starting the engine, check Par. 5.2 for maintenance operations.</li> <li>• Consult the machine's manual to connect the battery and start the engine.</li> </ul>
2	Unused machine from 2 to 9 months	<ul style="list-style-type: none"> <li>• Perform the operations related to unused machine described in point 1.</li> <li>• Perform the operations described in Par. 5.6.</li> <li>• Start the engine at least every 4 months as per operations described in point 1: Avoid sudden accelerations for the first few minutes.</li> </ul> <p>Bring the engine to the working temperature by pressing the accelerator 3/4 from MAX.</p> <p>Leave the engine running at minimum speed for a few minutes and turning off the engine.</p>
	Starting	<ul style="list-style-type: none"> <li>• Before starting the engine, check Par. 5.2 for maintenance operations.</li> <li>• Consult the machine's manual to connect the battery and start the engine.</li> <li>• Avoid sudden accelerations for the first few minutes.</li> </ul>
3	Unused machine over 9 months	<ul style="list-style-type: none"> <li>• Perform the operations related to unused machine described in point 1 and 2.</li> </ul>
	Starting	<ul style="list-style-type: none"> <li>• Before starting the engine, check Par. 5.2 for maintenance operations.</li> <li>• Check the quality of coolant from the relative testing strips.</li> <li>• Consult the machine's manual to connect the battery and start the engine.</li> <li>• Avoid sudden accelerations for the first few minutes.</li> </ul>

## 6 INFORMATION ABOUT REPLACEMENTS

### 6.1 Engine oil replacement



#### Danger

- Disconnect the negative wire (-) from the battery to avoid accidental engine starting.



#### Important

- Before proceeding with operation, read [Par. 3.2.2](#)
- Place engine on level surface to ensure accurate measurement of oil level.
- Before proceeding, perform the operation described in [Par. 6.2](#) - Point 1.

**NOTE :** Perform this operation with warm engine, to get a better fluidity of the oil and get a full discharge of oil and impurities contained in it.

1. Loosen the oil filler cap **A** (Fig. 6.1) .
2. Remove the oil dipstick **B** .
3. Remove the oil drain plug **D** and the gasket **E** (the oil drain plug is on both sides of the oil sump).
4. Drain oil in an appropriate container.  
(For the exhausted oil disposal, refer to [Par. 6.6 DISPOSAL and SCRAPPING](#) ).
5. Replace gasket **E** .
6. Tighten the drain oil plug **D** (tightening torque at **35 Nm** ).
7. Perform the operation described in [Par. 6.2](#) - point 2 to 5.  
<https://iservice.lombardini.it/jsp/Template2/manuale.jsp?id=84&parent=962>
8. Add the type of oil recommended ( [Tab. 2.1](#) and [Tab. 2.2](#) ).
9. If the plug **A** is not accessible, use the oil filler cap **C** .



#### Important

- Do not exceed the **MAX** level on the dipstick.
1. Fit and remove the oil dipstick **B** to check the level.  
Pour in fluid until reaching the **MAX** level mark.
  2. Upon completion, reinstall the oil dipstick **B** completely.
  3. Tighten the cap **A** or **C** .



Fig. 6.1



Fig. 6.2

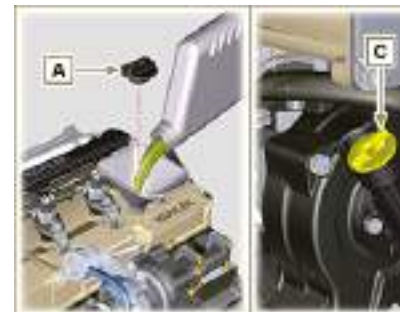

Fig. 6.3

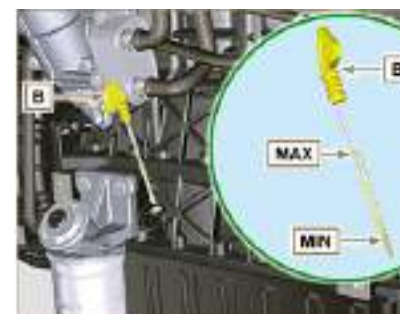

Fig. 6.4

**NOTE :** Click on the right to play the procedure.

<https://www.youtube.com/embed/IBL-IEYm16U?rel=0>

## 6.2 Oil filter cartridge replacement



### Important

- Before proceeding with operation, read [Par. 3.2.2](#)



### Warning

- Electric/pneumatic screwdrivers are forbidden.
  - In case of low use replace it 12 months.
  - For disposal of oil filter cartridge and fuel filter refer to [Par. 6.6 DISPOSAL and SCRAPPING](#).
1. Unscrew cartridge holder cover **A** by performing three complete turns and wait 1 minute..

**NOTE** : this operation allows to oil contained in the support **F** to flow into the oil sump in the correct way.

1. Unscrew cartridge holder cover **A** and check that the oil in the lub. oil filter support **F** has flowed towards the oil sump.
2. Remove the cap **A** as well as the oil cartridge **B** from the oil filter support.

1. Remove and replace the oil cartridge **B** with a new one.  
Remove and replace the gaskets **C**, **D** and **E** with new ones.

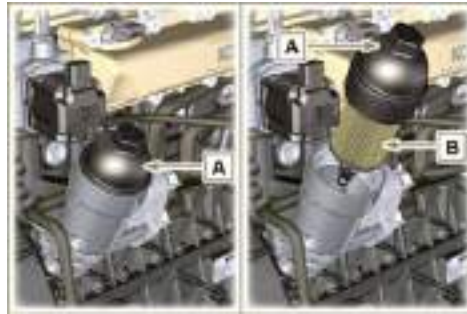

Fig 6.5

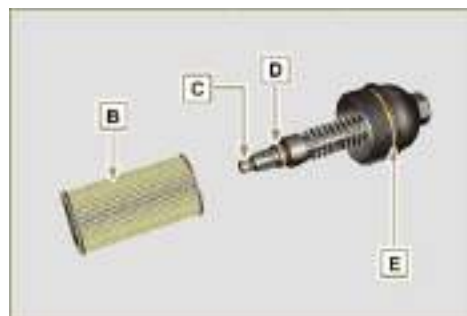

Fig 6.6



1. Fit and tighten the cover **A** on the oil filter support **F**, tightening it with a torque wrench **G** (tightening torque of **25 Nm**).



**Fig 6.7**

**NOTE :** Click on the right to play the procedure.

<https://www.youtube.com/embed/jr0sXe8Cdro?rel=0>

### 6.3 Remote oil filter cartridge replacement (optional)



**Important**

- Before proceeding with operation, read [Par. 3.2.2](#).
1. Unscrew and remove the cartridge **A** using the appropriate wrench.
  2. Lubricate the gasket and screw on the new cartridge **A** using the appropriate wrench.

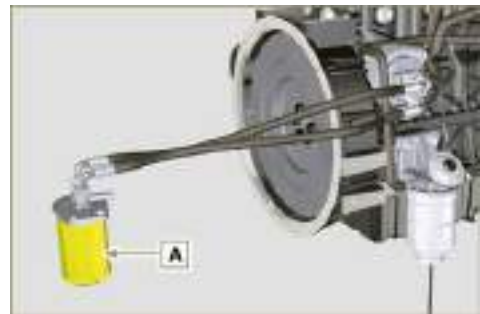

**Fig 6.8**

## 6.4 Filter cartridge and fuel pre-filter replacement



### Important

- Before proceeding with operation, read [Par. 3.2.2](#)



### Warning

- In case of low use replace it 12 months.
  - For disposal of oil filter cartridge and fuel filter refer to [Par. 6.6 DISPOSAL and SCRAPPING](#)
1. Disconnect the cable **A** of the water presence sensor **C**.
  2. Remove the water presence sensor **C** from its cartridge **B**.
  3. Loosen the cartridge **B** using the appropriate wrench **F** ([Fig. 6.10](#)).
  4. Lubricate the gasket **D** of the new cartridge **B**.

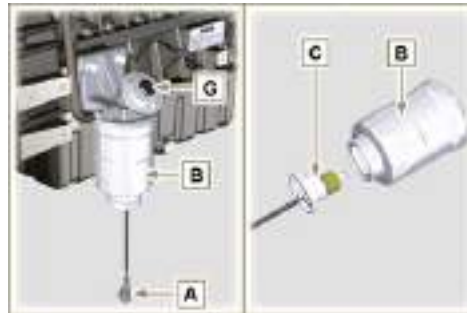

Fig 6.9



### Important

- Do not fill the new cartridge **B** with fuel.
5. Tighten the new cartridge **B** ([Fig. 6.10](#)) on the diesel fuel filter support **E** using the special wrench **F** (tightening torque of **17 Nm**).
  6. Tighten the water presence sensor **C** on the new cartridge **B** (tightening torque of **5 Nm**).
  7. Reconnect the cable **A** of the water presence sensor **C**.
  8. Push repeatedly the button **G** in order to fill the circuit.



Fig 6.10

**NOTE** : Click on the right to play the procedure.

<https://www.youtube.com/embed/MXs9IUimUi4?rel=0>

## 6.5 Air filter cartridge replacement



### Important

- Before proceeding with operation, read [Par. 3.2.2.](#)

**NOTE** : Component not necessarily supplied by **KOHLER** .

1. Release the two fastenings **F** of the cover **A** .
2. Remove the cartridges **B** and **G**.
3. Reinstall:
  - the new cartridges **B** and **G** .
  - the cover **A** checking the right tightness of fastenings **F** .

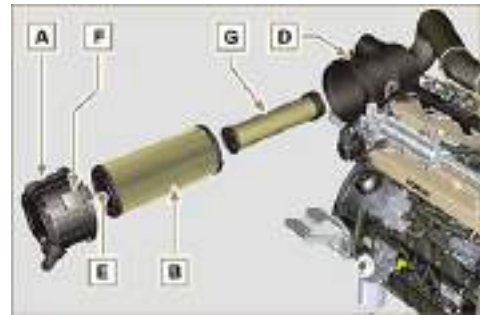

Fig. 6.11

## 6.6 Disposal and scrapping

- In case of scrapping, the engine shall be disposed of in appropriate locations, in conformity with the law in force.
- Before scrapping, it is necessary to separate the rubber or plastic parts from the rest of the components.
- The parts only composed of plastic material, aluminium and steel can be recycled if collected by the appropriate centers.
- Waste oil must properly be recycled and disposed of in the correct way to safeguard the environment. According to the laws in force, it is classified as hazardous waste, therefore it must be collected by the appropriate centers.

## 7 INFORMATION ABOUT FAILURES

### 7.1 Useful information about failures

- This chapter contains information about the problems that may appear during engine operation with its causes and trouble shooting **Tab. 7.2** .
- In some cases, you shall turn off the engine immediately to avoid further damage **Tab. 7.1** .

**Tab 7.1**

THE ENGINE MUST BE IMMEDIATELY TURNED OFF WHEN	
1	Warning RED light turn on
2	The oil pressure indicator light turns on while running
3	The engine rpms suddenly increase and decrease
4	A sudden and/or unusual noise is heard
5	Colour the exhaust fumes suddenly darkens

**Tab 7.2**

TROUBLES	POSSIBLE CAUSE	SOLUTION	PAR.
Warning YELLOW light turn on	Engine ECU has detect a malfunctions	Contact <b>KOHLER</b> authorised workshops	--
The engine does not start	Sulphated battery terminals corroded	Clean the battery terminals	--
	Battery voltage too low	Recharge the battery or replace it	--
	Low fuel level	Refuel	<a href="#">4.4</a>
	Frozen fuel	Contact <b>KOHLER</b> authorised workshops	--
	Clogged fuel filter	Replace with a new filter	<a href="#">6.4</a>
	Air suction in fuel system	Contact <b>KOHLER</b> authorised workshops	--
	Clogged air filter	Replace with a new filter	<a href="#">6.5</a>
	Clogged pipes	Contact <b>KOHLER</b> authorised workshops	--
	Intake or exhaust system clogged	Replace with a new fuse; if the problem persists, Contact <b>KOHLER</b> authorised workshops	--
	Intake or exhaust system clogged	Contact <b>KOHLER</b> authorised workshops	--
Engine starts but stops	Inefficient electrical connections	Clean the electrical contacts; if the problem persists, Contact <b>KOHLER</b> authorised workshops	--
	Sulphated battery terminals	Clean the battery terminals	--
	Clogged fuel filter	Replace with a new filter and clean the tank	--
	Clogged fuel pipes	Contact <b>KOHLER</b> authorised workshops	--
Engine doesn't rev up	Safety protocol in starting	Wait some seconds	--

	Throttle to MAX in starting	Release the throttle and wait some seconds	--
RPM instability at idle speed	Clogged fuel pipes	Contact <b>KOHLER</b> authorised workshops	--
Numero dei giri al minimo basso	Clogged fuel pipes	Contact <b>KOHLER</b> authorised workshops	--
	Poor quality fuel	Clean the tank and refuel with quality fuel	<a href="#">2.5</a>
Blue smoke	High oil sump level	Replace the engine oil; if the problem persists, Contact <b>KOHLER</b> authorised workshops	--
	Clogged air filter	Replace with a new filter	<a href="#">6.5</a>
Excessive fuel consumption	Clogged air filter	Replace with a new filter	<a href="#">6.5</a>
	High oil sump level	Replace the engine oil; if the problem persists, Contact <b>KOHLER</b> authorised workshops	--
Engine lost its initial performance	Clogged air filter	Replace with a new filter	<a href="#">6.5</a>
	Clogged fuel pipes	Contact <b>KOHLER</b> authorised workshops	--
	Cheap fuel	Clean the tank and refuel with quality fuel	
	High oil sump level	Replace the engine oil; if the problem persists, Contact <b>KOHLER</b> authorised workshops	--
Slow acceleration	Clogged fuel filter	Replace the fuel filter	<a href="#">6.4</a>
Engine jerking	Clogged fuel pipes	Contact <b>KOHLER</b> authorised workshops	
Engine overheats	Insufficient coolant level	Fill up to the level	<a href="#">4.6</a>
	High oil sump level	Replace the engine oil; if the problem persists, Contact <b>KOHLER</b> authorised workshops	--
	Clogged radiator	Clean the radiator; if the problem persists, contact <b>KOHLER</b> authorised workshops	--

In the event that the solutions proposed in **Tab. 7.2** do not eliminate the trouble, contact a **KOHLER** authorized workshop

## 8 INFORMATION ABOUT WARRANTY

### 8.1 Warranty terms

#### KOHLER DIESEL ENGINES GLOBAL WARRANTY TERMS

##### 1. WARRANTY PERIOD

Kohler Co. warrants to the End User that each Diesel engine will be free from manufacturing defects in materials or workmanship in normal service for the applicable coverage period or operating hours (whichever comes first) set forth below, provided the engine is operated and maintained in accordance with Kohler Co.'s instructions and manuals.

ENGINE SERIES	WARRANTY PERIOD	OPERATING HOURS	WARRANTY COVERAGE
KOHLER Diesel (non KDI)	3 Years	0 – 2.000	100% Parts & Labor
KOHLER KDI	3 Years	0 – 2.000	100% Parts & Labor
		2.001 – 6.000	Major Components Only *
Lombardini Diesel	2 Years	0 – 2.000	100% Parts & Labor

\* Major component defects are failures related to crankcase casting, cylinder head casting, crankshaft, crankshaft pulley, camshaft, connecting rod, flywheel, oil pump.

For the Warranty Period stated above, the period begins on the date of purchase of the finished equipment on which the engine is installed. If no hour meter is installed on the application, the Operating Hours will be calculated as 4 hours of use per day for 5 days per week beginning on the date of purchase.

Kohler Co.'s obligation under this warranty is expressly limited, at its option, to an appropriate adjustment, repair or replacement of such part or parts as found to be defective following an inspection by Kohler Co. or an authorized service facility designated by Kohler Co.

SPARE PARTS	WARRANTY PERIOD	OPERATING HOURS	WARRANTY COVERAGE
KOHLER and Lombardini Diesel Parts	2 Years	0 – 2.000	100% Parts & Labor

Parts/components that are scheduled to be replaced as part of the required maintenance schedule will be covered under Kohler Co.'s warranty from date of purchase of the part up to the first scheduled replacement point for the subject parts/ components.

All other Spare Parts items are covered by the above warranty provided that the repairs have been executed by Kohler Co or by an Authorized Kohler Service Dealer.

## **2. EXCLUSIONS**

The following items are not covered by this warranty.

- Damage caused by: (i) an accident or casualty; (ii) unreasonable use or neglect; (iii) normal wear; (iv) premature wear from improper maintenance; (v) improper storage; (vi) old or contaminated fuel left within the fuel system, which includes but is not limited to tanks, fuel lines, or fuel injection components; (vii) unapproved modifications.
- Failures caused by: (i) faulty repairs made by any party other than Kohler Co. or an authorized service facility designated by Kohler Co.; (ii) use of non-Kohler replacement service parts; or (iii) additional damages caused by a lack of prescribed actions as a result of an alarm light activation, either caused by fault or negligence or un-attended use of the engine; (iv) an act beyond the control of Kohler Co., which includes but is not limited to theft, vandalism, fire, lightning, earthquake, windstorm, hail, volcanic eruption, flood or tornado.
- Transportation charges or travel expenses in connection with the repair or replacement of defective parts on the engine.
- Engine accessories such as fuel tanks, clutches, transmissions, power drive assemblies, and batteries, unless supplied or installed by Kohler Co.
- Engines installed in an application not formally reviewed by Kohler.
- Rental of other equipment during performance of warranty repairs All items subject to wear and to periodical maintenance such as listed in the Use & Maintenance Manual (such as air, oil or fuel filters, belts etc.) are warranted for a period equal to the prescribed interval of replacement as listed in the Manual.
- Fuel, lubricating oil, coolant/antifreeze.

IMPLIED OR STATUTORY WARRANTIES, INCLUDING THOSE OF MERCHANTABILITY AND FITNESS FOR A PARTICULAR PURPOSE, ARE EXPRESSLY LIMITED TO THE DURATION OF THIS WRITTEN WARRANTY. KOHLER CO. MAKES NO OTHER EXPRESS WARRANTY, NOR IS ANYONE AUTHORIZED TO MAKE ANY ON KOHLER CO.'S BEHALF. KOHLER CO. AND/OR THE SELLER SHALL NOT BE LIABLE FOR SPECIAL, INDIRECT, INCIDENTAL, OR CONSEQUENTIAL DAMAGES OF ANY KIND.

## **3. TO OBTAIN WARRANTY SERVICE**

The repair shall be executed by a KOHLER Authorized Service Dealer designated by Kohler.

*USA & CANADA:*

List of Authorized dealers can be found by visiting [www.kohlerengines.com](http://www.kohlerengines.com) or telephone 1-800-544-2444 (U.S.A. and Canada) ENGINE DIVISION, Kohler Co., Kohler Wisconsin

#### *EUROPE, MIDDLE EAST, AND ASIA*

List of Authorized dealers can be found by visiting [dealers.kohlerpower.it](http://dealers.kohlerpower.it) .

#### *CENTRAL AND SOUTH AMERICA*

List of Authorized dealers can be found by visiting [dealers.kohlerpower.it](http://dealers.kohlerpower.it) .

#### *CHINA AND ASIA PACIFIC*

List of Authorized dealers can be found by visiting [dealers.kohlerpower.it](http://dealers.kohlerpower.it) .

#### *INDIA*

List of Authorized dealers can be found by visiting [dealers.kohlerpower.it](http://dealers.kohlerpower.it) .

**Note: Specific Warranty Terms and conditions do apply to engines directly sold in India.**

## **4. OWNER'S WARRANTY RESPONSIBILITIES**

1. As the off-road engine owner, you are responsible for the performance of the required maintenance listed in your Use & Maintenance Manual. Kohler Co. recommends that you retain all receipts covering maintenance on your off-road & marine engine, but Kohler Co. cannot deny warranty solely for the lack of receipts or for your failure to ensure the performance of all scheduled maintenance.
2. As the off-road & marine engine owner, you should however be aware that Kohler Co. may deny you warranty coverage if your off-road & marine engine or a part shows signs of malfunction or failed due to abuse, neglect, improper maintenance or unapproved modifications.
3. Your engine is designed to operate on diesel fuel only. Diesel fuel and all other fluids used shall comply with the recommendation listed in the Use & Maintenance Manual. Use of any other fuel or fluids may result in your engine breakage, premature wear or no longer operating in compliance with the California & US EPA emissions requirements.
4. You are responsible for initiating the warranty process. The ARB & US EPA suggests that you present your off-road & Marine engine to a Kohler Co. dealer as soon as a problem exists. The warranty repairs should be completed by the dealer as expeditiously as possible.

## **5. COVERAGE**

Kohler Co. will repair or replace emission control system parts, components and sub-assemblies found to be defective with respect to materials or workmanship at no cost to you including engine exhaust system related diagnosis, labor and parts, provided that no un-authorized modification of any kind has been executed on the engine, and its parts, components and sub-assemblies.



The choice and responsibility of the decision to repair or replace an emission control system defect will be solely that of Kohler Co. Emission control system parts/ components covered by the Federal and California Emission Control Systems Limited Warranty are listed below  
 engine is defective, the part will be repaired or replaced by Kohler Co.

Fuel injector(s)	Electronic control unit (ECU) if equipped
Injection pump(s)	Sensors associated with ECU operation
Exhaust manifold	Emission control information labels
Intake manifold	Turbocharger (if equipped)
Exhaust gas recirculation (EGR) tube	Fuel limiting device
Crankcase ventilation valve	Aftertreatment Systems if equipped and other components when present

Parts/components that are scheduled to be replaced as part of the required maintenance schedule will be covered under the warranty provisions for a period of time up to the first scheduled replacement point for the subject parts/ components. Subsequent damage to other engine components as a direct result of a warrantable failure an exhaust emission part/ component will be covered under the warranty provisions described herein.

**6. MAINTENANCE AND REPAIR REQUIREMENTS**

The owner is responsible for the proper use and maintenance of the engine. Kohler Co. recommends that all receipts and records covering the performance of regular maintenance be retained in case questions arise. If the engine is resold during the warranty period, the maintenance records should be transferred to each subsequent owner. Kohler Co. may not deny warranty repairs solely because of the lack of repair, maintenance or failure to keep maintenance records.

Normal maintenance, replacement or repair of emission control devices and systems may be performed by any repair establishment or individual; however, warranty repairs must be performed by a Kohler authorized service center.

**7. CALIFORNIA AND FEDERAL EMISSION CONTROL WARRANTY STATEMENT, OFF-ROAD & MARINE DIESEL ENGINES (USA ONLY)**

The California air resources board (carb), U.S. environmental protection agency (EPA), and Kohler Co. are pleased to explain the emission control system warranty on your [current model year – {2+ current model year}] off-road compression ignition and marine (diesel) engine. In California (“the state”) and US EPA regulated region, new heavy-duty off-road & marine engines must be designed, built and equipped to meet the state’s and US EPA anti-smog standards. The warranty period shall begin on the date the engine or equipment is delivered to an ultimate purchaser. Kohler Co. must warrant the emission control

system on your engine for the periods of time listed in the section below, provided there has been no abuse, neglect or improper maintenance of your engine.

Your emission control system may include parts such as the fuel injection system and the air-induction system. Also included maybe hoses, belts, connectors and other emission related assemblies.

When a warrantable condition exists, Kohler Co. will repair your heavy-duty off-road & marine engine at no cost to you including diagnosis, parts and labor.

The owner shall not be charged for diagnostic labor that leads to the determination that a warranted part is in fact defective, provided that such diagnostic work is performed at a warranty station.

#### MANUFACTURER'S WARRANTY COVERAGE

The [current model year – {2+ current model year}] heavy-duty off-road & marine engines are warranted for the periods listed below. If any emission-related part on your engine is defective, the part will be repaired or replaced by Kohler Co.

VARIABLE SPEED OR CONSTANT SPEED	KW <19	ANY SPEED	1,500 HOURS OR TWO YEARS, WHICHEVER COMES FIRST
Constant speed	$19 \leq kW < 37$	3,000 rpm or higher	1,500 hours or two years, whichever comes first
Constant speed	$19 \leq kW < 37$	Less than 3,000 rpm	3,000 hours or five years, whichever comes first
Constant speed	$19 \leq kW < 37$	Any speed	3,000 hours or five years, whichever comes first
Variable speed or constant speed	$kW \geq 37$	Any speed	3,000 hours or five years, whichever comes first

#### MARINE DIESEL ENGINE

ENGINE POWER	WARRANTY PERIOD
$kW < 19$	1,500 hours or 2.5 years, whichever comes first
$19 \leq kW < 37$	2,500 hours or 3.5 years, whichever comes first
$37 \leq kW < 75$	5,000 hours or 5 years, whichever comes first

## 9 GLOSSARY

### 9.1 Glossary

#### A

Alternator                      A component that transforms mechanical energy into AC electrical energy.

Authorised workshop              Kohler authorised service centre.

ATS                                  After Treatment System - Post-treatment system, referred to the exhaust gases produced by the engine.

#### B

Bore                                Internal diameter of the cylinder in combustion engines.

#### C

Catalyst                          A device in charge of filtering exhausted gas.

Combustion                      Chemical reaction of a mixture composed of fuel and fuel (air) inside a combustion chamber.

Common Rail                      A high-pressure "Common Duct" that produces a constant supply of fuel directly to the injectors.

#### D

DOC                                Diesel Oxidation Catalyst - Catalyst for diesel engines that reduces harmful exhaust gas emissions produced by the engine.

DPF                                 Diesel Particulate Filter - A filter that captures particles of carbonaceous origin emitted by diesel engines.

#### E

EC                                  "European Community".

ECS                                 "Emission Control System"

ECU                                 "Electronic Control Unit"; an electronic device in charge of electronically detecting and controlling other electronic control devices.

EGR                                 Exhaust Gas Recirculation, in internal combustion engines; a system that enables recirculation of combusted gas by means of taking it in once again, which enables it to break down a part of the pollutants present in the exhaust gas.

EGR Cooler                      Recirculated exhaust gas cooling; a system that is able to cool recirculated gas (EGR) from the exhaust. This enables the temperature to remain constant inside the intake manifold, thus improving combustion inside the cylinders and breaking down pollutants further.

Electronic injector              An electronically activated component able to inject jets of atomised fuel inside the cylinders.

EPA	"Environmental Protection Agency - The United States' authority that safeguards the environment" ; its duty is to govern and control polluting emissions.
ETB	Electronic Throttle Body - This is controlled by the ECU upon request of the accelerator pedal, and its function is crucial for the correct regeneration of the ATS system.
<b>F</b>	
Fig.	Figure.
<b>G</b>	
Galvanised	Material that has undergone surface protection treatment.
<b>H</b>	
Heavy conditions	Type of extreme condition referred to the work environment in which the engine is used (very dusty - dirty area, or in a contaminated environment due to various types of gas).
<b>I</b>	
Intercooler	Air-cooling element under pressure from the turbo situated between the turbine and intake manifold.
<b>K</b>	
KDI	"Kohler Direct Injection"
<b>M</b>	
Maintenance - periodic	A group of maintenance actions that have the sole objective to control and replace elements on their expiry, without modifying or improving the functions carried out by the system, neither increasing the value nor improving performance.
Max.	"Maximum".
Methyl ester	It is a mixture of products by means of a chemical conversion of oils and animal and/or vegetable fat, which is used to produce Biofuel.
Min	"Minutes".
Min.	"Minimum".
Model	"Model", engine identification plate, which indicates the engine's model.
<b>O</b>	
Oil Cooler	Small radiator used to cool the oil.
<b>P</b>	
Par.	Paragraph.
Paraffin	Fatty and solid substance that may form inside the diesel.
Poly-V	"Poly-V", the name associated with a service belt, which derives from the profile of its section that is constructed with joined Vs.

**R**

Ref. Reference.

**S**

s/n "Serial number" (engine identification name plate) indicating the engine identification series/chassis number.

Spec. "Specification", (engine identification name plate) indicating the engine version.

**T**

Tab. Table.

T-MAP "T-MAP" (sensor), measures the temperature and absolute pressure inside the intake collector.

TCR "Turbo Common Rail"

Tightening torque A term indicated for installation of threaded components and which is determined by means of a unit of measurement Nm.

Turbocharger Device that compresses air intake by sending it to the intake manifold by means of a turbine.

**U**

Used oil Oil altered by operation or time, which is no longer compliant for correct lubrication of the components.

**W**

Waste-Gate valve A device, which is directly or automatically controlled, used to limit the pressure of exhaust gas inside the turbine.

SYMBOLS AND UNITS OF MEASUREMENT			
SYMBOL	UNIT OF MEASUREMENT	DESCRIPTION	EXAMPLE
$\alpha$	degree	Rotation/inclination angle	1°
cm <sup>2</sup>	square centimetre	Area	1 cm <sup>2</sup>
Ø	millimetre	Circumference	Ø 1 mm
Nm	newton-metre	Torque	1 Nm
mm	millimetre	Length	1 mm
µm	1/1000 of a millimetre (micron)		1 µm
H	hour		Time
g/kW	grammes per kilowatt per hour	Specific consumption	1 g/kWh
kg/h	kilogramme per hour	Max. flow rate	1 kg/h
Lt./min.	litres per minute	Flow rate	1 Lt./min.
Lt./h	litres per hour		1 Lt./h
ppm	parts per million	Percentage	1 ppm
N	newton	Force	1 N
A	Ampere	Intensity of electrical current	1 A
gr.	gramme	Weight	1 gr.
kg	kilogramme		1 kg
W	Watt	Power	1 W.
kW	kiloWatt		1 kW
pa	pascal	Pressure	1 pa
KPa	Kilopascal		1 KPa
bar	barometric pressure		1 bar
mbar (1/1000 bar)	barometric pressure		1 mbar
R	Resistance	Resistance to electrical current (referred to a component)	1 Ω
Ω	ohm	Resistance of electrical current	1 Ω
Rpm	revs per minute	Rotation of an axis	1 Rpm
Ra	average roughness expressed in microns	Roughness	1 Ra
°C	degree centigrade	Temperature	1°C
V	Volt	Electrical voltage	1 V
•	millimetre	Hex-head capscrew	• 1 mm
cm <sup>3</sup>	cubic centimetre	Volume	1 cm <sup>3</sup>
Lt.	litre		1 Lt.



## **KOHLER.** IN POWER. SINCE 1920.

Lombardini S.p.A. is a part of Kohler Group. Lombardini has manufacturing facilities in Italy, Slovakia and India and sales subsidiaries in France, Germany, UK, Spain and Singapore. Kohler/Lombardini reserves the right to make modifications without any notice.  
[www.lombardini.it](http://www.lombardini.it)

**DEUTSCHLAND**  
Lombardini Motoren GmbH  
Ritz-Kofler-Str. 6, Bäresgäßchen 2  
D - 65933 Frankfurt  
Hessen, DEUTSCHLAND  
T. +49-(0)69-9506180  
F. +49-(0)69-95061630

**EUROPE**  
Lombardini Srl  
Via Cav. del lavoro  
A. Lombardini n° 2  
42124 Reggio Emilia (ITALY)  
T. +39-(0)522-389-1  
F. +39-(0)522-389-503

**UK**  
Lombardini U.K. Ltd  
1, Rochester Barn - Synham Road  
OX2 9NH  
Oxford, UK  
T. +44-(0)1865-863869  
F. +44-(0)1865-861754

**USA & CANADA**  
Kohler Co.  
444 Highland Drive,  
Kohler - Waukesha (53094), US  
T. +1 920-857-4441  
F. +1 920-459-1570

**ESPAÑA**  
Lombardini ESPAÑA, S.L.  
Pl. Cova Solera 1-9  
08101 - Rubí (Barcelona)  
ESPAÑA  
T. +34-(0)9398-62111  
F. +34-(0)9398-71613

**FRANCE**  
Lombardini France S.a.s.  
47 Allée de Florier,  
69400 Linais, FRANCE  
T. +33-(0)474-626900  
F. +33-(0)474-623940

**CHINA & ROAPAC**  
Kohler China INVESTMENT Co. Ltd  
no.158, Jiang Chang San Road,  
200436, Zhubei, Shanghai  
CHINA  
Tel. +86 400-0120-645  
Fax: +86 21 61078804