

# MARINE

High speed propulsion engines



MAN Engines





# Contents

## MAN Marine Engines

Customer Benefits . . . . .	4
Light, medium and heavy duty operation . . . . .	4
MAN Service: Competent and motivated . . . . .	5
MAN Environmental Awareness: Future-oriented and ecofriendly . . . . .	5
MAN Warranty: Relaxing and calculable. . . . .	5
Two years' warranty on MAN service and parts: Higher quality, more time . . . . .	5

## Description of engines – Light duty

D2676 . . . . .	8
D2868 . . . . .	11
D2862 . . . . .	15

## Description of engines – Medium duty

D2676 . . . . .	24
D2868 . . . . .	28
D2862 . . . . .	32

## Description of engines – Heavy duty

D2676 . . . . .	44
D2868 . . . . .	51
D2862 . . . . .	55

Exhaust aftertreatment . . . . .	62
----------------------------------	----

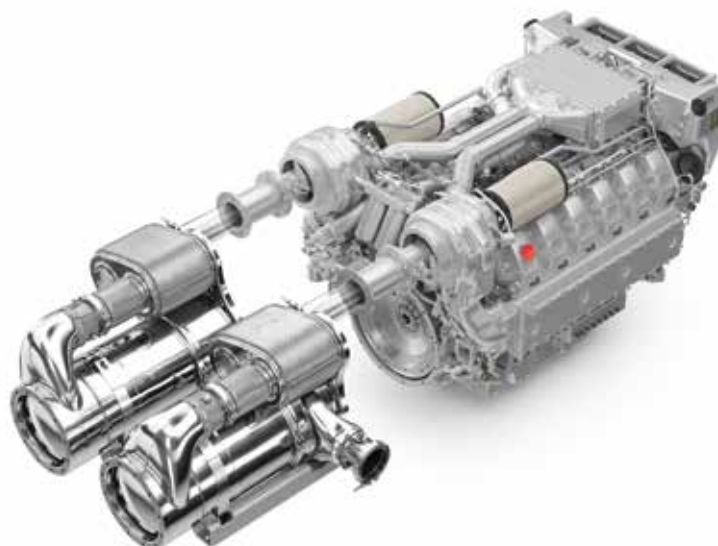

# MAN Marine Engines

## A reliable driving force

At sea, ships and boats have to contend with elemental forces, while harbours require them to navigate precisely through the narrowest of corridors.

### Customer Benefits

- Maximum torque at the most fuel efficient point of operation
- Maximum torque across a large range of engine speed for a powerful and steady acceleration
- Class-leading compactness for a space-saving design
- Best fuel consumption values and long service intervals minimizing the TCO
- Low acoustics and low vibrations
- World-wide service network with rapid spare parts supply

### Light duty operation

In light duty operation (730–1,900 hp), MAN Engines offer exceptional dynamics accompanied by maximum economic efficiency. And by the way: their pathbreaking technology for adhering to emission guidelines means that they easily take up a leading position on patrol boats, sea-rescue boats and coastguard boats.



### Medium duty operation

In medium duty operation (560–1,400 hp), the fuel-saving MAN engines ensure maximum efficiency on accompanying boats, pilot boats and deep-sea patrol boats, on fishing boats, ferries and on passenger ships. A long service life with low lifecycle costs and also quick supply of spare parts through the world-wide servicing network make the MAN engines profit earners in professional navigation.



### Heavy duty operation

MAN Engines offer a perfectly coordinated power spectrum for heavy duty (200–1,000 hp) operation with powerful acceleration and high tractive force. They are the ultimate in terms of reliability and efficiency in freight and passenger shipping as well as in trawlers, tugs and push boats.



### **MAN Service** **Competent and motivated**

MAN is there for you from the outset. Where qualified guidance is needed for the installation, our experts are at your side with advice and practical assistance. Of course you can always rely on our worldwide service.

Qualified service centres provide you with fast and skilled servicing and repairs. Worldwide partners ensure a service network for marine engines. As you can see we are there whenever and wherever you need us.

### **MAN Environmental Awareness** **Future-oriented and eco-friendly**

At MAN, we attach very great importance indeed to eco-friendliness. Every day, our engineers do their utmost to develop eco-friendly engines which comply with current emission standards worldwide.

With their particularly low fuel consumption, MAN engines not only ensure high economy, but also protect our environment. And your ears: this means that the quiet yet very powerful engine makes every trip a unique experience. Real recreation – both for the customer and the environment.

### **MAN Warranty** **Relaxing and calculable**

With MAN engines for work boats you are on the safe side since MAN Engines goes one step further. With the **“Work Plus”** Warranty you do not only extend the warranty for your engine, but it also gives you the certainty and peace of mind that you have made the right decision. In practice this means an additional year of safety for you and your engine plus attractive pricing which makes this offer even more appealing.

### **Two years' warranty on MAN service and parts:** **Higher quality, more time**

We know that MAN Genuine Parts are characterised by their quality and precise fit. Combined with the qualified and professional work at MAN service centres, they ensure reliability: reduced downtimes and a longer service life. We are now passing this security on to you. Instead of the one year we offer now the two years' warranty on MAN Genuine Parts and MAN Genuine Parts ecoline. That means double the security for you.

The MAN Truck & Bus AG two-year warranty is valid for all repairs carried out at MAN service centres<sup>1)</sup> from 2017<sup>2)</sup> onwards, including repairs where MAN Genuine Parts and MAN Genuine Parts ecoline are fitted. The scope of service is identical to the previously valid one-year warranty. Please refer to our General Terms & Conditions for more information.

We cover the following costs as part of a warranty case:

- Costs for work time and spare parts directly related to the repair of the defect or to the exchange of faulty parts.
- Installation and removal costs are covered if the original scope of delivery also included the installation of the part<sup>3)</sup>.
- Certain additional costs are covered after inspection, night time/weekend charges, on-site repairs, courier costs.

### **Our genuine engines deserve MAN Genuine Parts – now with two years' warranty.**

1) MAN-owned service outlets and participating partners

2) See validity of the General Terms & Conditions

3) Installation and removal costs are not covered in the case of counter sales



# Light duty operation

## Characteristics

- Annual operating hours:  $\leq 1,000$
- Percentage of time at full load:  $\leq 20\%$
- Average load application:  $\leq 50\%$

## Typical applications

- Season fishing
- Escort boats and patrol boats
- Ambulance boats
- Police boats





# D2676

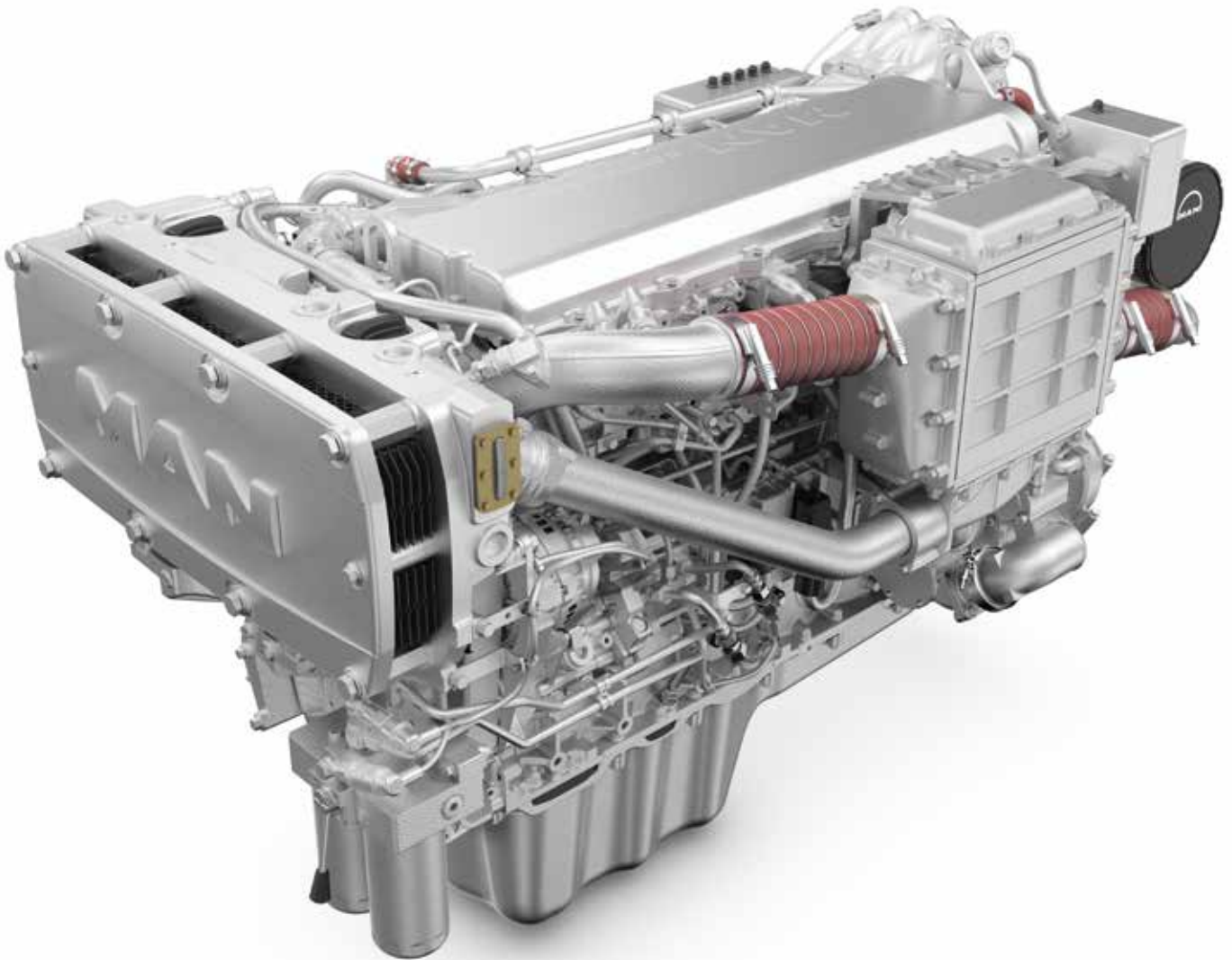

## Characteristics

- Cylinders and arrangement: 6 cylinders in-line
- Operation mode: 4-stroke diesel engine, watercooled
- Turbocharging: Turbocharger with charge air intercooler and waste gate
- Number of valves: 4 valves per cylinder
- Fuel system: Common Rail direct fuel injection with electronic control
- Engine lubrication: Closed system with forced feeding, oil cooling and filtering
- Type of cooling: Heat exchanger with engine and seawater circuit
- Engine control: Electronic injection control (EDC)  
Electronic engine monitoring including diagnostic unit
- Fuel: DIN EN 590



## Technical features

Type designation		LE 443	LE 423
Displacement	l	12.42	12.42
Maximum output to DIN ISO 3046-1	kW (hp)	537 (730)	588 (800)
Rated speed	rpm	2,300	2,300
Maximum torque	Nm	2,450	2,674
at speed	rpm	1,300–2,100	1,400–2,000
Lowest specific fuel consumption <sup>1)</sup>	g/kWh	199	213
Classifiable		✓	–
Exhaust gas aftertreatment		–	–
Exhaust gas status		IMO Tier II, EPA Tier 3 RCD 2013/53/EC, 97/68/EC	IMO Tier II, EPA Tier 3 <sup>2)</sup> , RCD 2013/53/EC, 97/68/EC

1) Tolerance +5% according to DIN ISO 3046-1

2) For private use only

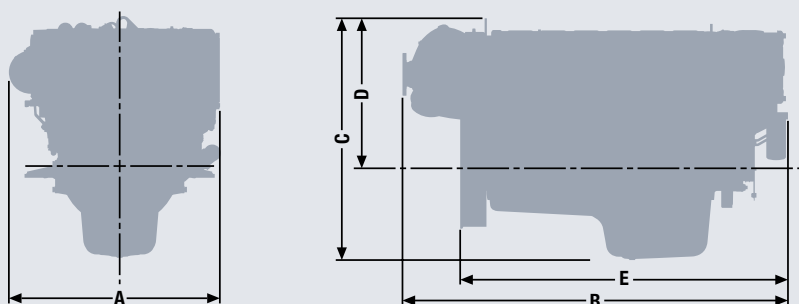

## Dimensions

Type designation		LE 443/423
A-Overall width	mm	986
B-Overall length	mm	1,795
C-Overall height – standard oil pan	mm	1,096
D-Top of engine to crankshaft centre	mm	674
E-Length of engine from front end to edge of flywheel housing	mm	1,527
Average weight of engine ready for installation (dry)	kg	1,215

For detailed examinations of installation dimensions, please order drawings from our factory.

# D2676

LE 443

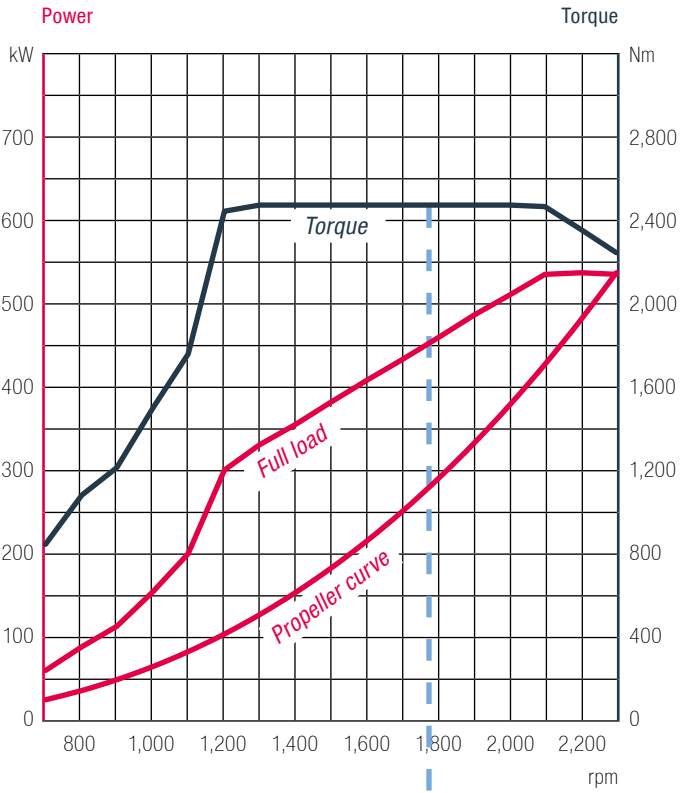

LE 423

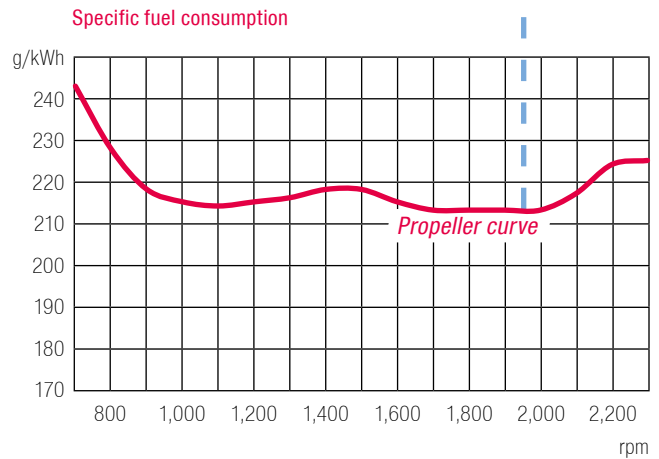
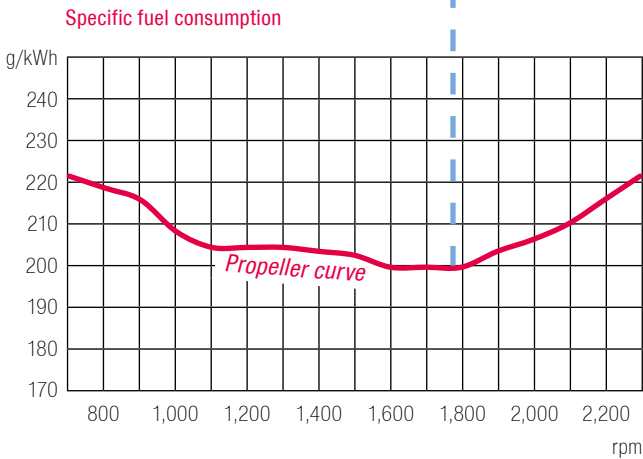
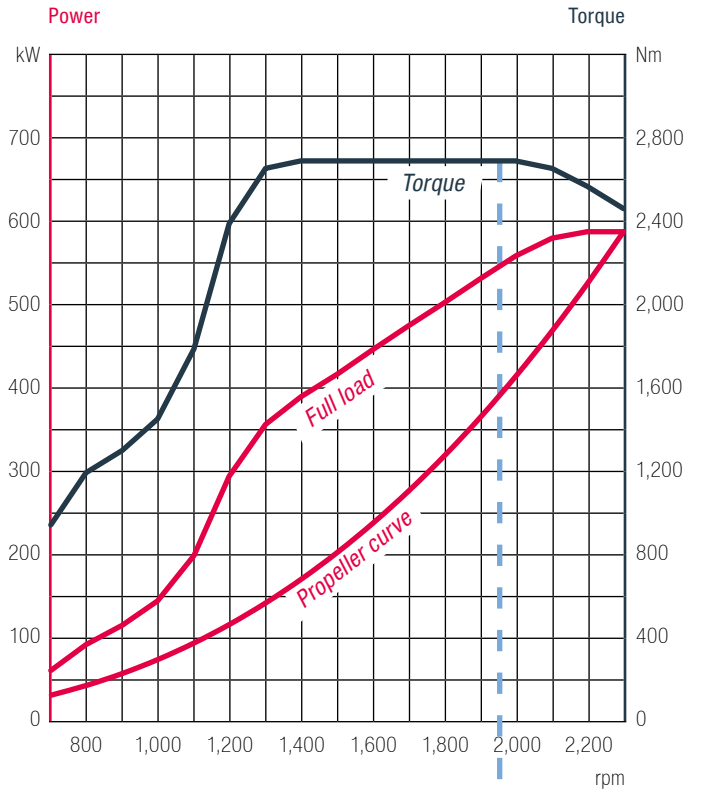

--- Maximum torque at most fuel efficient operating point

# D2868

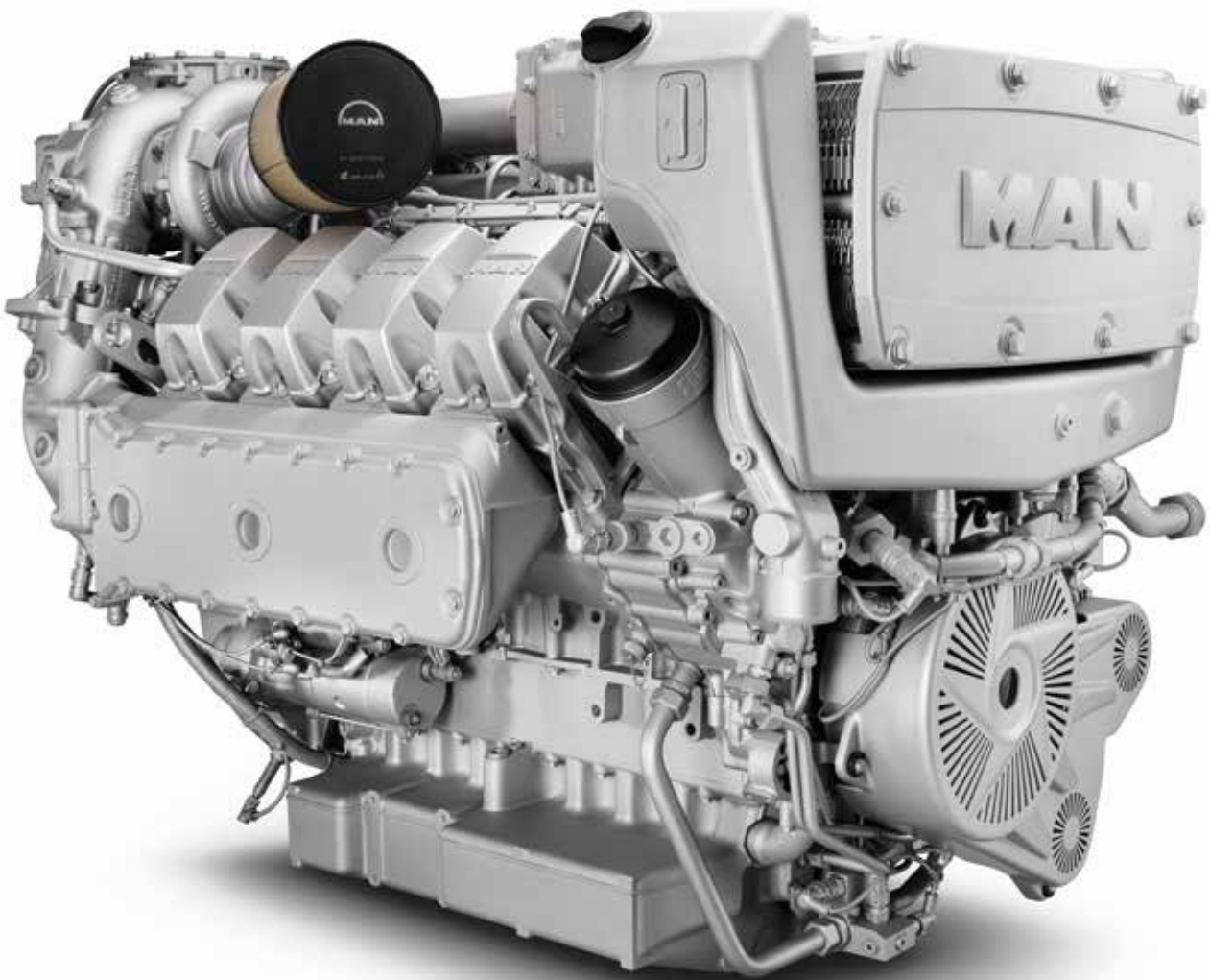

## Characteristics

- Cylinders and arrangement: 8 cylinders in 90° V arrangement
- Operation mode: 4-stroke diesel engine, watercooled
- Turbocharging: Turbocharger with charge air intercooler and waste gate (1-stage: D2686 LE 426, 2-stage: D2868 LE 436)
- Number of valves: 4 valves per cylinder
- Fuel system: Common Rail direct fuel injection with electronic control
- Engine lubrication: Closed system with forced feeding, oil cooling and filtering
- Type of cooling: Plate heat exchanger, seawater cooled
- Engine control: Electronic injection control (EDC)  
Electronic engine monitoring including diagnostic unit
- Fuel: DIN EN 590

# D2868

## Technical features

Type designation		LE 426	LE 453	LE 436
Displacement	l	16.16	16.16	16.16
Maximum output to DIN ISO 3046-1	kW (hp)	735 (1,000)	824 (1,121)	882 (1,200)
Rated speed	rpm	2,300	2,300	2,300
Maximum torque	Nm	3,340	3,745	4,010
at speed	rpm	1,300–2,100	1,200–2,100	1,200–2,100
Lowest specific fuel consumption <sup>1)</sup>	g/kWh	209	206	205
Classifiable		-	✓	-
Exhaust gas aftertreatment		-	-	-
Exhaust gas status		IMO Tier II, EPA Tier 3 <sup>2)</sup> , RCD 2013/53/EC, 97/68/EC	IMO Tier II, 97/68/EC	IMO Tier II, EPA Tier 3 <sup>2)</sup> , RCD 2013/53/EC, 97/68/EC

1) Tolerance +5% according to DIN ISO 3046-1

2) For private use only

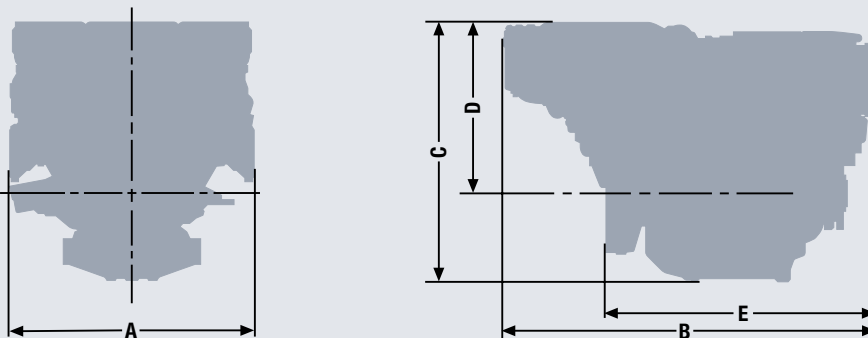

## Dimensions

Type designation		LE 426	LE 453	LE 436
A-Overall width	mm	1,153	1,153	1,153
B-Overall length	mm	1,745	1,736	1,745
C-Overall height	mm	1,177	1,222	1,222
D-Top of engine to crankshaft centre	mm	765	811	811
E-Length of engine from front end to edge of flywheel housing	mm	1,243	1,262	1,262
Average weight of engine ready for installation (dry)	kg	1,780	1,880	1,880

For detailed examinations of installation dimensions, please order drawings from our factory.

**LE 426**

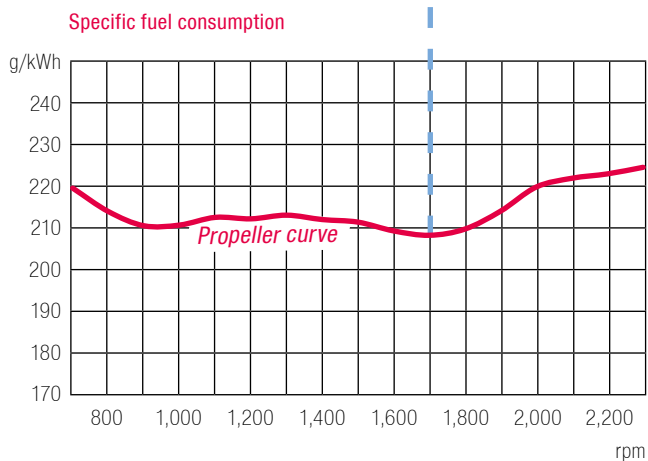
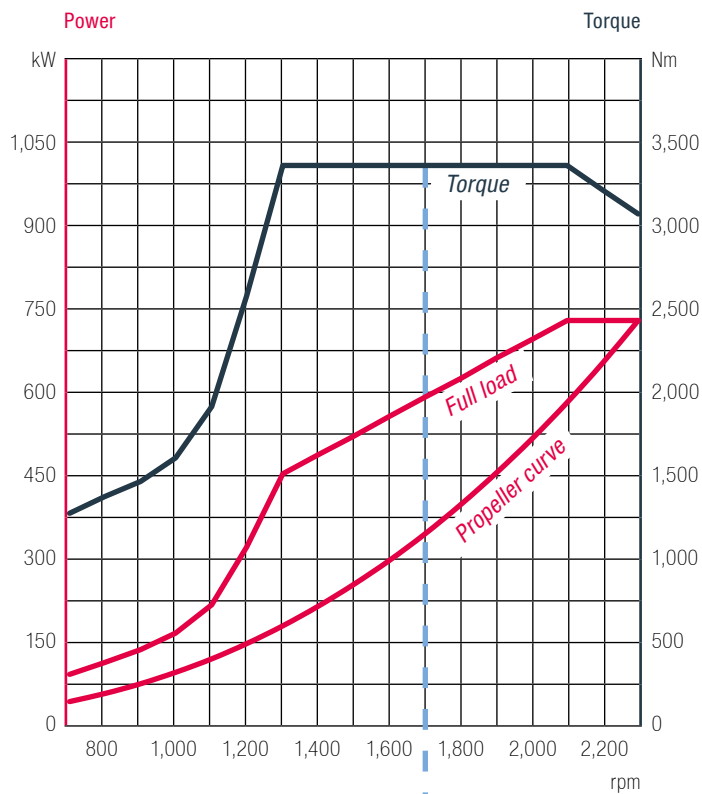

**LE 453**

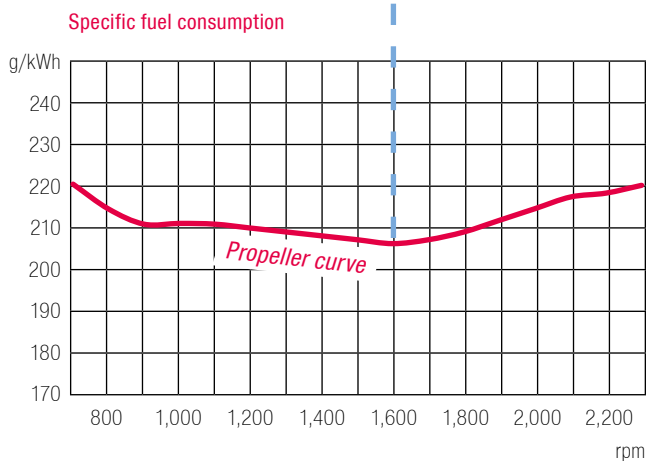
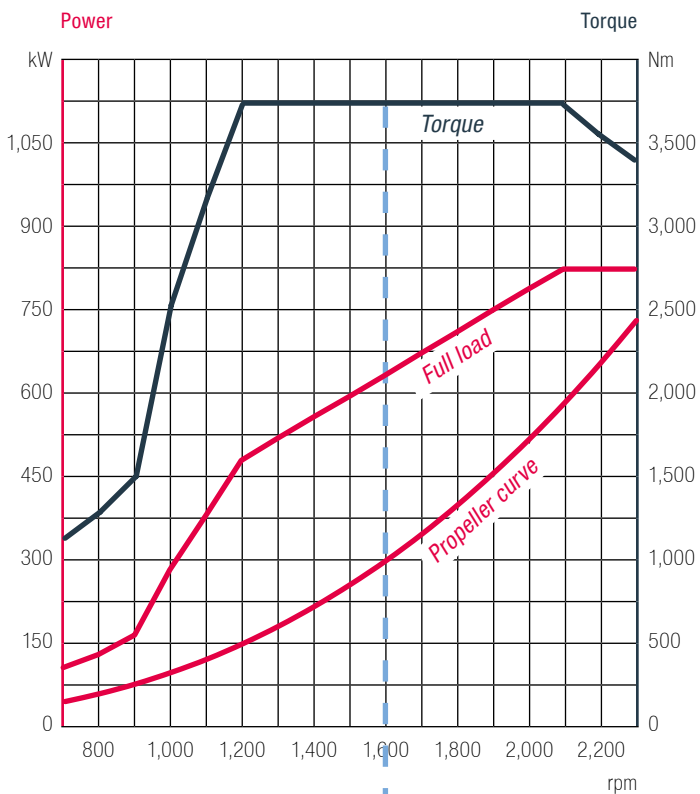

--- Maximum torque at most fuel efficient operating point

# D2868

LE 436

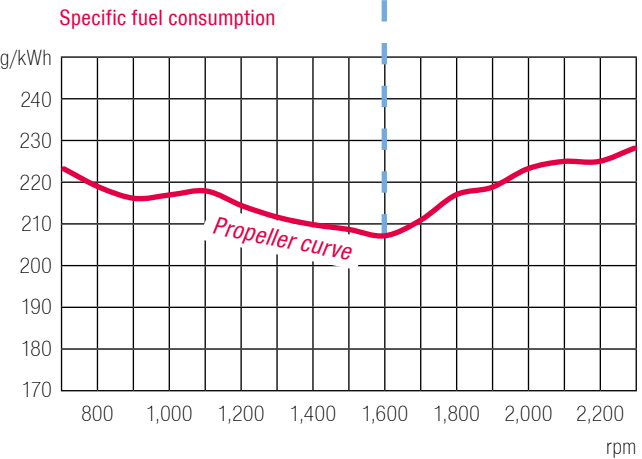
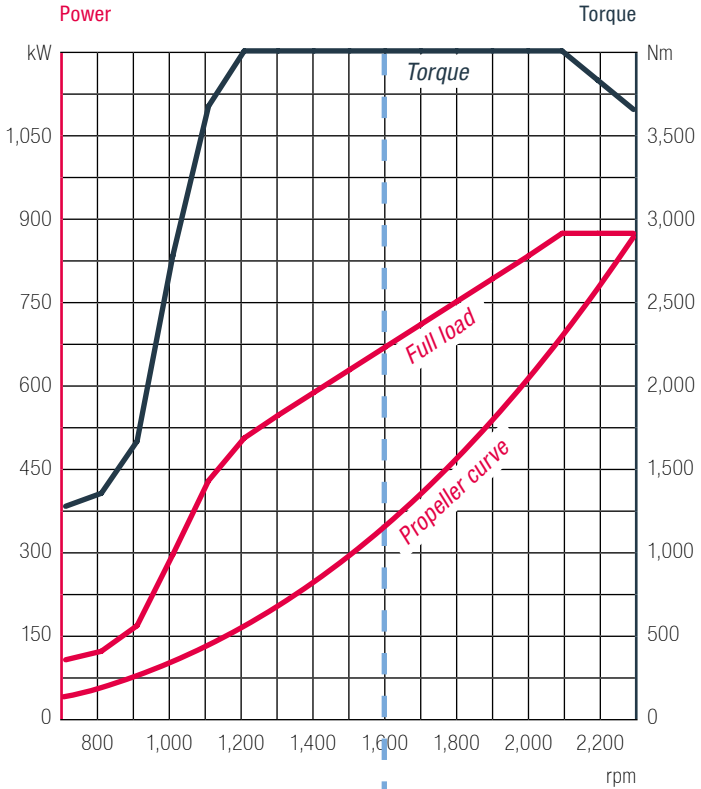

--- Maximum torque at most fuel efficient operating point

# D2862



## Characteristics

- Cylinders and arrangement: 12 cylinders in 90° V arrangement
- Operation mode: 4-stroke diesel engine, watercooled
- Turbocharging: Turbocharger with charge air intercooler and waste gate (1-stage: D2862 LE 446/426, 2-stage: D2862 LE 456/436/476)
- Number of valves: 4 valves per cylinder
- Fuel system: Common Rail direct fuel injection with electronic control
- Engine lubrication: Closed system with forced feeding, oil cooling and filtering
- Type of cooling: Plate heat exchanger, seawater cooled
- Engine control: Electronic injection control (EDC)  
Electronic engine monitoring including diagnostic unit
- Fuel: DIN EN 590

# D2862

## Technical features

Type designation	LE 446	LE 426	LE 456
Displacement l	24.24	24.24	24.24
Maximum output to DIN ISO 3046-1 kW (hp)	1,029 (1,400)	1,140 (1,550)	1,213 (1,650)
Rated speed rpm	2,300	2,300	2,300
Maximum torque Nm	4,680	5,180	5,510
at speed rpm	1,200–2,100	1,200–2,100	1,200–2,100
Lowest specific fuel consumption <sup>1)</sup> g/kWh	203	203	195
Classifiable	✓	-	✓
Exhaust gas aftertreatment	-	-	-
Exhaust gas status	IMO Tier II, EPA Tier 3 <sup>2)</sup> , RCD 2013/53/EC, 97/68/EC	IMO Tier II, EPA Tier 3 <sup>2)</sup> , RCD 2013/53/EC, 97/68/EC	IMO Tier II, EPA Tier 3 <sup>2)</sup> , RCD 2013/53/EC, 97/68/EC

1) Tolerance +5% according to DIN ISO 3046-1

2) For private use only

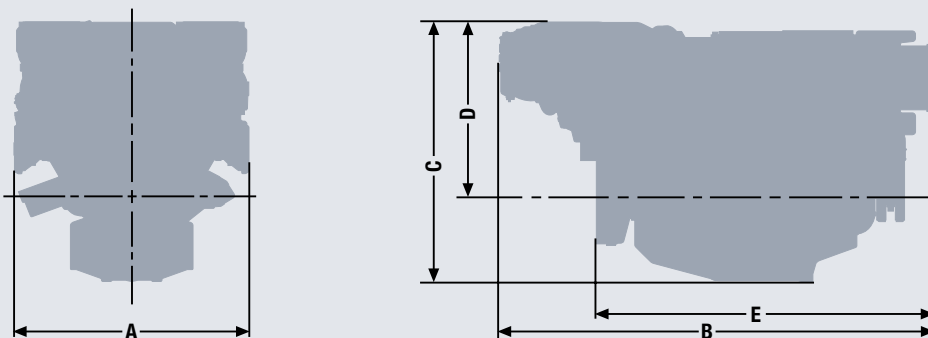

## Dimensions

Type designation		LE 446/426	LE 456/459
A-Overall width	mm	1,153	1,153
B-Overall length	mm	2,130	2,139
C-Overall height	mm	1,230	1,272
D-Top of engine to crankshaft centre	mm	765	808
E-Length of engine from front end to edge of flywheel housing	mm	1,630	1,658
Average weight of engine ready for installation (dry)	kg	2,270	2,380

For detailed examinations of installation dimensions, please order drawings from our factory.



LE 446

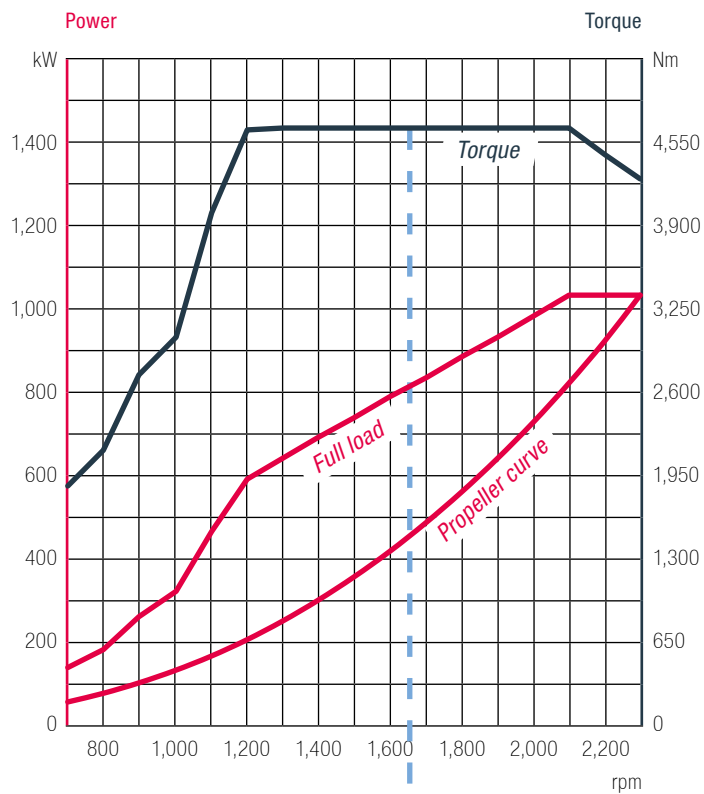

LE 426

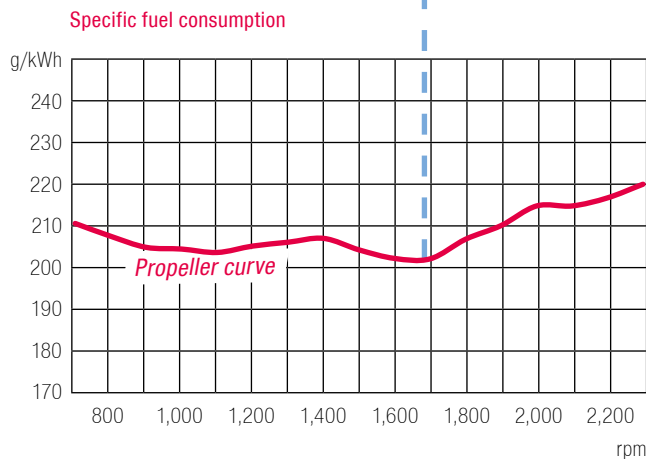
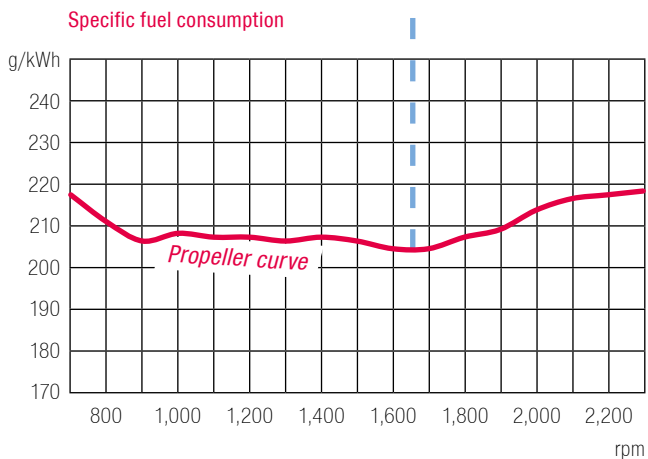
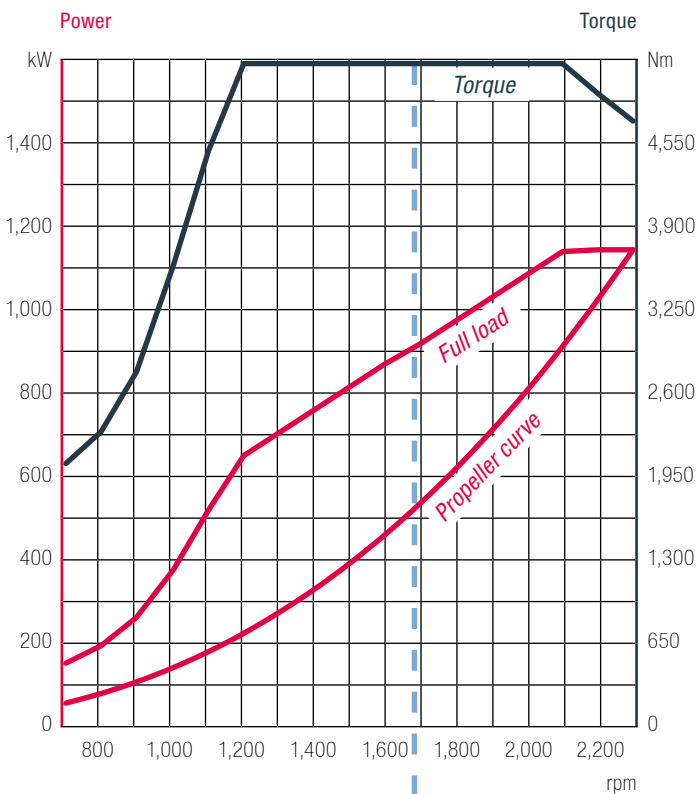

--- Maximum torque at most fuel efficient operating point

# D2862

## LE 456

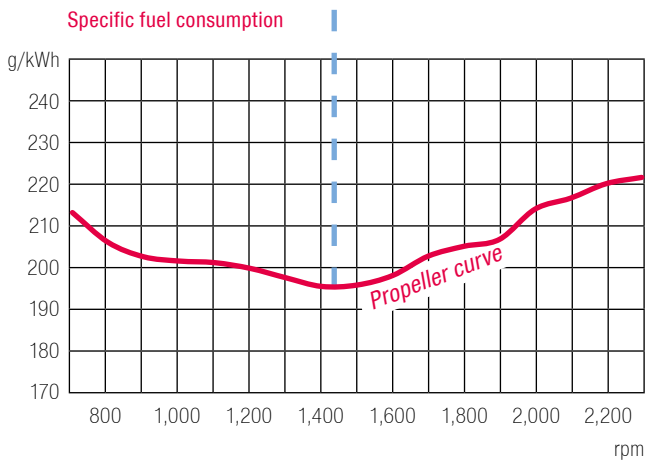
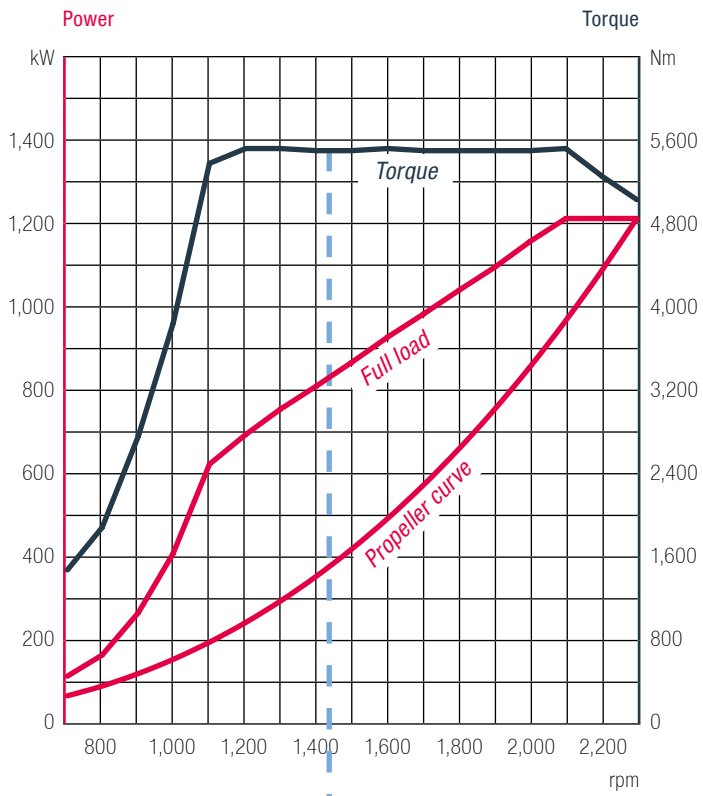

--- Maximum torque at most fuel efficient operating point

## Technical features

Type designation		LE 436	LE 476
Displacement	l	24.24	24.24
Maximum output to DIN ISO 3046-1	kW (hp)	1,324 (1,800)	1,397 (1,900)
Rated speed	rpm	2,300	2,300
Maximum torque	Nm	6,010	6,220
at speed	rpm	1,200–2,100	1,200–2,100
Lowest specific fuel consumption <sup>1)</sup>	g/kWh	200	199
Classifiable		-	-
Exhaust gas aftertreatment		-	-
Exhaust gas status		IMO Tier II, EPA Tier 3 <sup>2)</sup> , RCD 2013/53/EC, 97/68/EC	IMO Tier II, EPA Tier 3 <sup>2)</sup> , RCD 2013/53/EC, 97/68/EC

1) Tolerance +5% according to DIN ISO 3046-1

2) For private use only

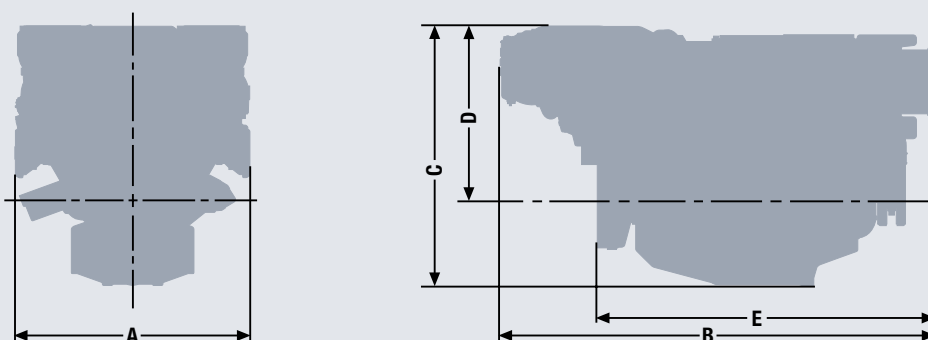

## Dimensions

Type designation		LE 436/476
A-Overall width	mm	1,153
B-Overall length	mm	2,139
C-Overall height	mm	1,272
D-Top of engine to crankshaft centre	mm	808
E-Length of engine from front end to edge of flywheel housing	mm	1,658
Average weight of engine ready for installation (dry)	kg	2,380

For detailed examinations of installation dimensions, please order drawings from our factory.

# D2862

LE 436

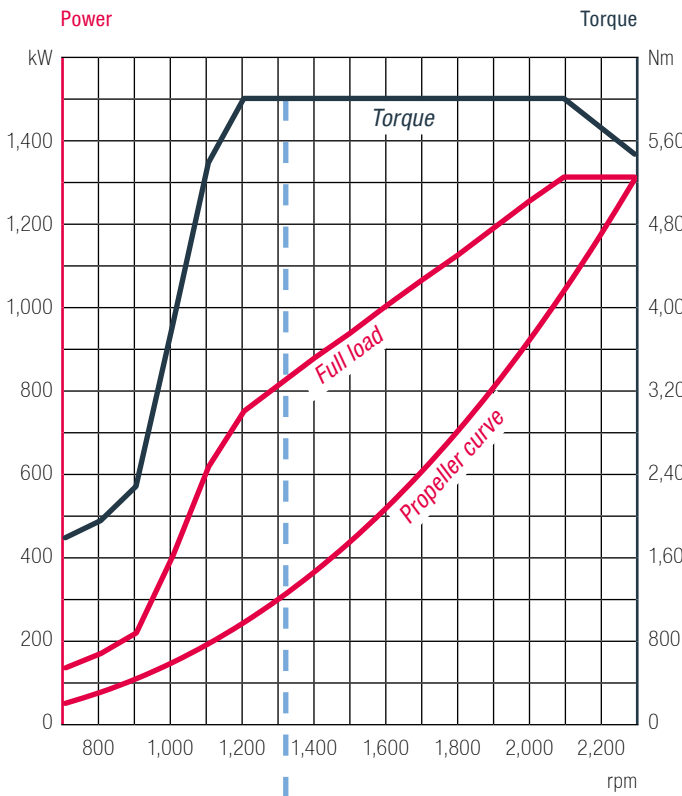

LE 476

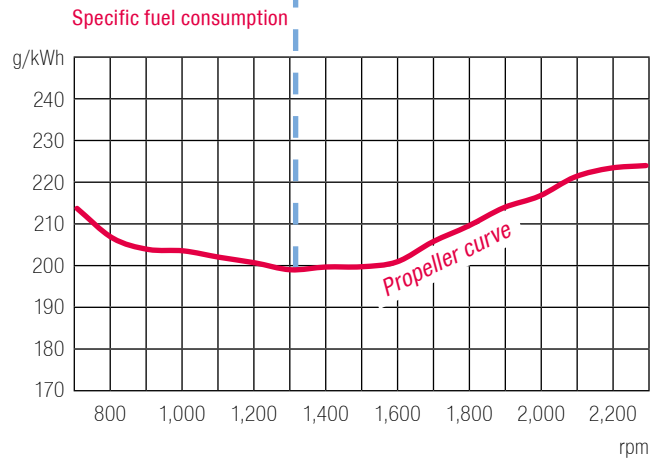
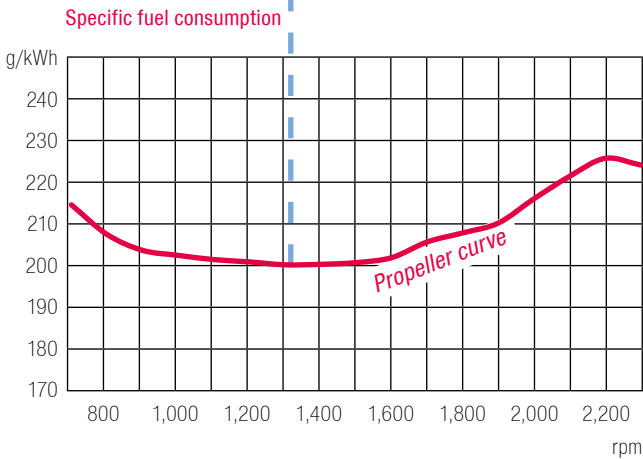
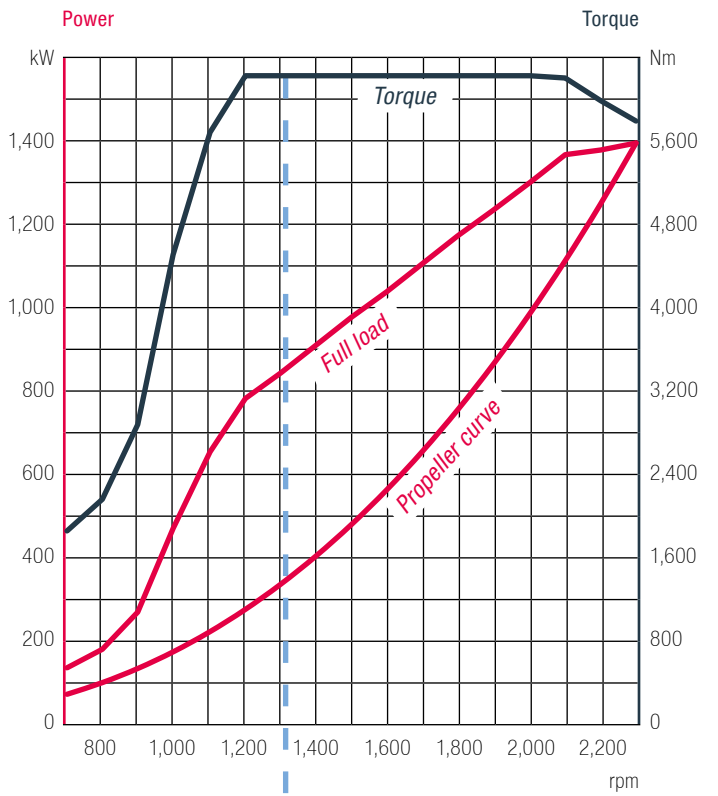

--- Maximum torque at most fuel efficient operating point

# Notes

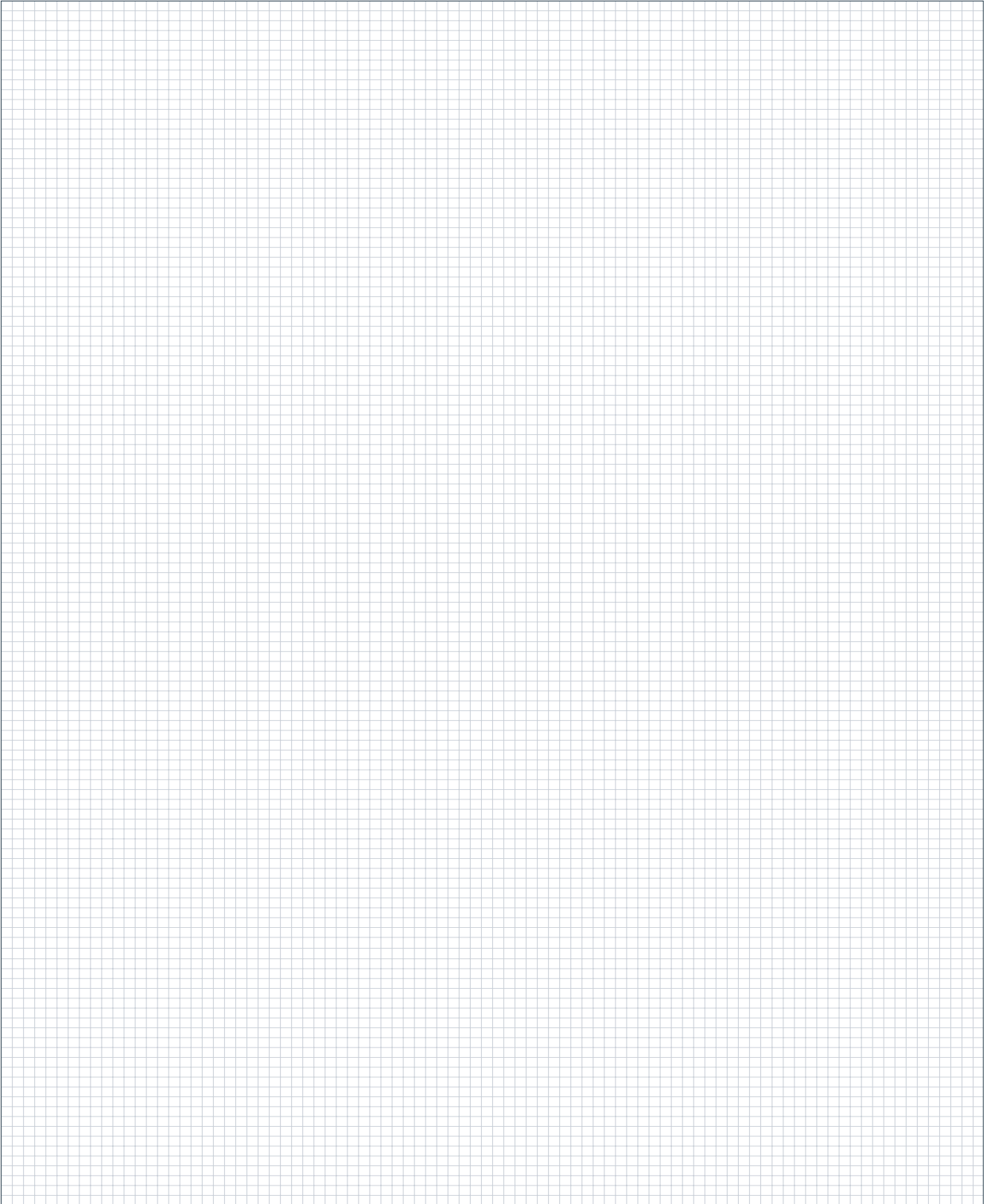

# Medium duty operation

## Characteristics

	Annual operating hours	Percentage of time at full load	Average load application
<b>D2676</b> LE 422/LE 425 LE 432/LE 435	≤ 3,000	≤ 50 %	≤ 70 %
<b>D2862</b> LE 463/LE 466 LE 483/LE 489	≤ 3,000	≤ 20 %	≤ 50 %
<b>D2862</b> LE 422/LE 425 LE 432/LE 435 LE 438/LE 428	≤ 4,000		≤ 60 %
<b>D2868</b> LE 422/LE 425 LE 443			

## Typical applications

- Escort boats and pilot boats
- Fishing boats
- Passenger boats and ferries
- Cruising vessels
- Seagoing patrol boats





# D2676



## Characteristics

- Cylinders and arrangement: 6 cylinders in-line
- Operation mode: 4-stroke diesel engine, watercooled
- Turbocharging: Turbocharger with charge air intercooler and wastegate
- Number of valves: 4 valves per cylinder
- Fuel system: Common rail injection with high pressure pump
- Engine block: High-strength casting with integrated oil and water ducts and replaceable cylinder liners
- Engine lubrication: Force-feed lubrication, lubrication oil cooler in cooling water circuit of the engine
- Type of cooling: Seawater cooled charge air cooler, plate heat exchanger by rubber impeller pump
- Engine control: Electronic injection control, electronic engine monitoring including diagnostic unit
- Fuel: DIN EN 590



## Technical features

Type designation		LE 432	LE 435	LE 422	LE 425
Displacement	l	12.42	12.42	12.42	12.42
Nominal rating <sup>1)</sup>	kW (hp)	412 (560)	412 (560)	478 (650)	478 (650)
Rated speed	rpm	2,100	2,100	2,100	2,100
Torque at rated speed	Nm	1,869	1,869	2,174	2,174
Maximum torque	Nm	2,065	2,065	2,402	2,402
at speed	rpm	1,200–1,900	1,200–1,900	1,200–1,900	1,200–1,900
Lowest specific fuel consumption	g/kWh	196	204	197	205
Classifiable		✓	✓	✓	✓
Exhaust gas aftertreatment		-	-	-	-
Exhaust gas status		IMO Tier II, 97/68/EC	IMO Tier II, EPA Tier 3, RCD 2013/53/EC, 97/68/EC	IMO Tier II, 97/68/EC	IMO Tier II, EPA Tier 3, RCD 2013/53/EC, 97/68/EC

1) Rating according to DIN 3046-1

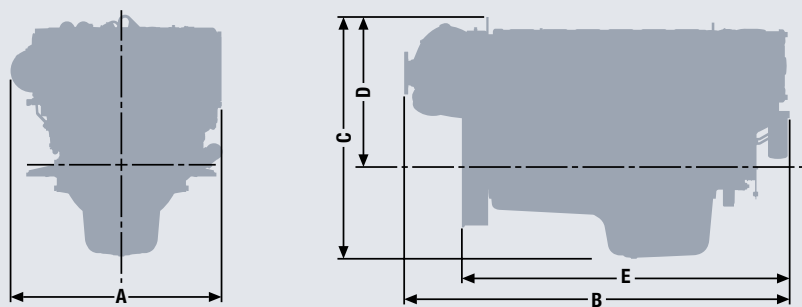

## Dimensions

Type designation		LE 432/435/422/425
A-Overall width	mm	986
B-Overall length	mm	1,795
C-Overall height	mm	1,096
D-Top of engine to crankshaft centre	mm	674
E-Length of engine from front end to edge of flywheel housing	mm	1,527
Average weight of engine ready for installation (dry)	kg	1,215

For detailed examinations of installation dimensions, please order drawings from our factory.

# D2676

LE 432

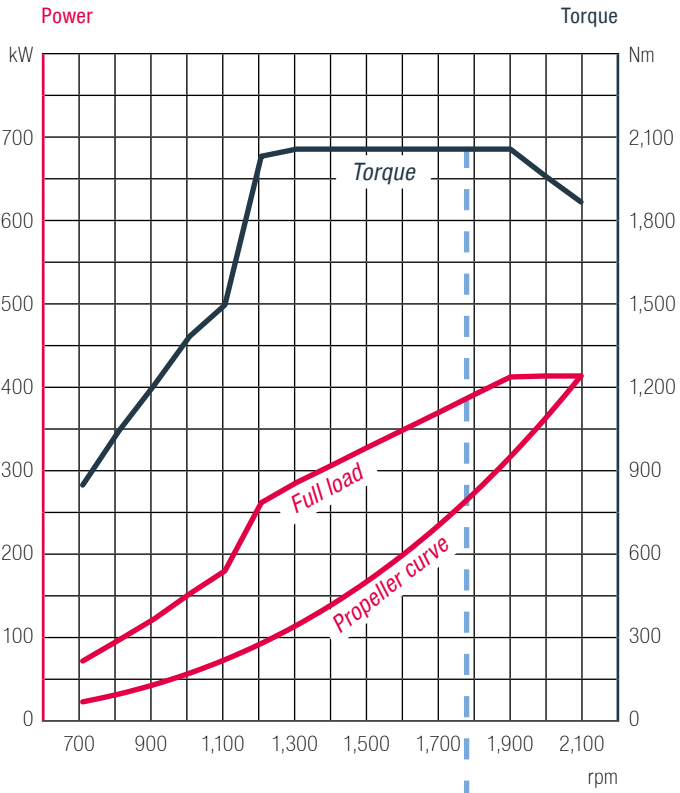

LE 435

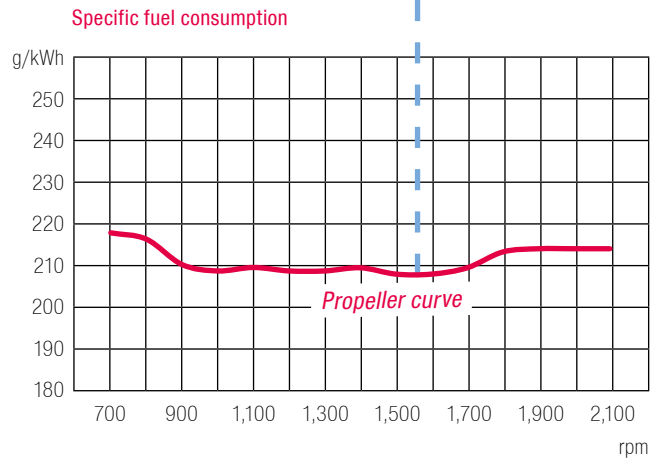
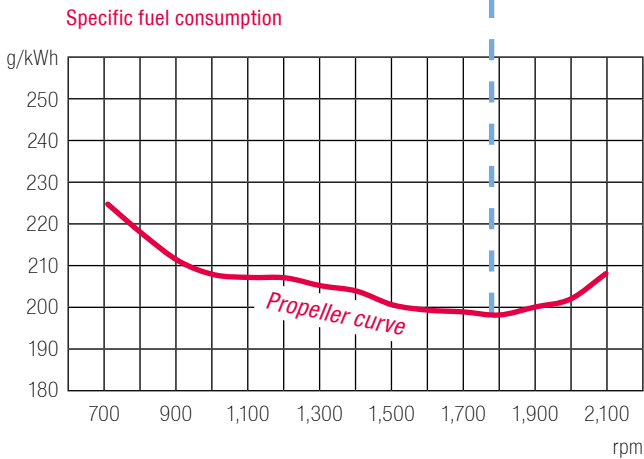
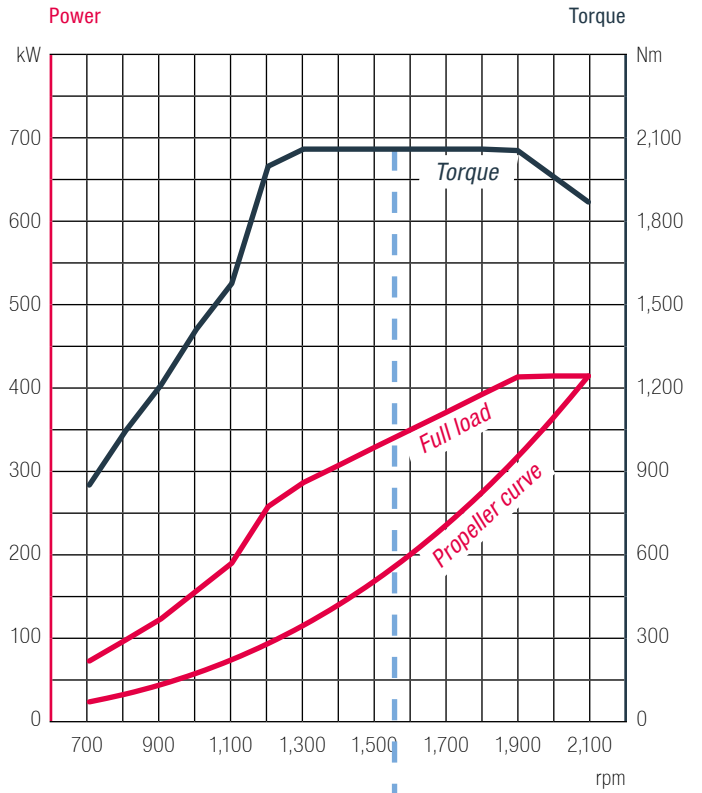

--- Maximum torque at most fuel efficient operating point

LE 422

LE 425

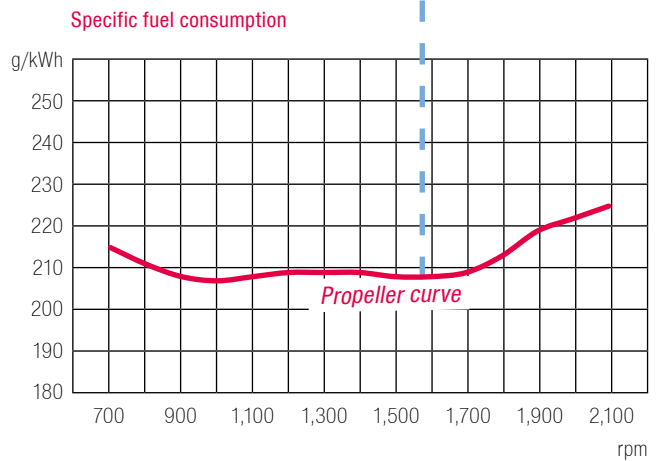
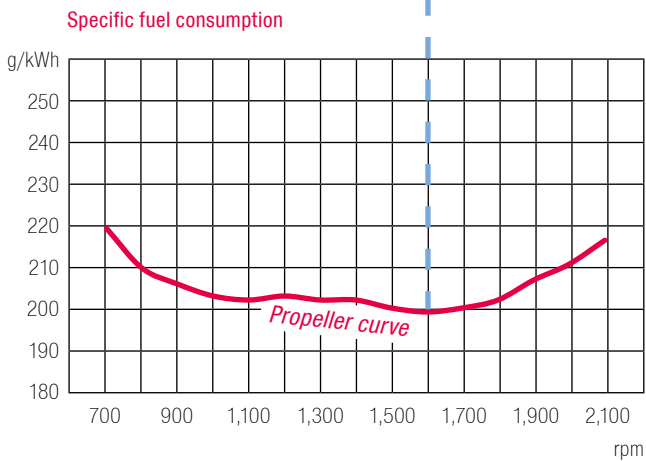
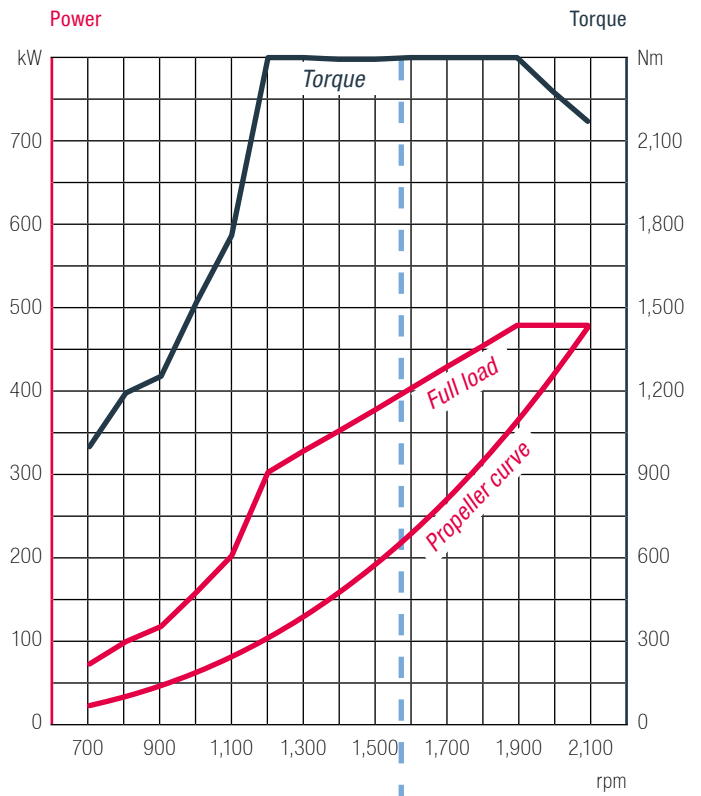
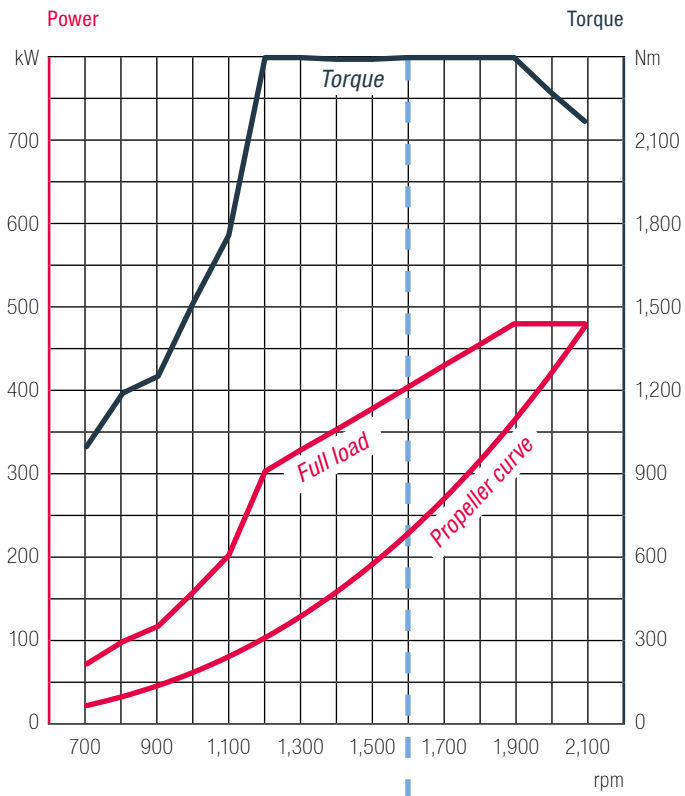

--- Maximum torque at most fuel efficient operating point

# D2868

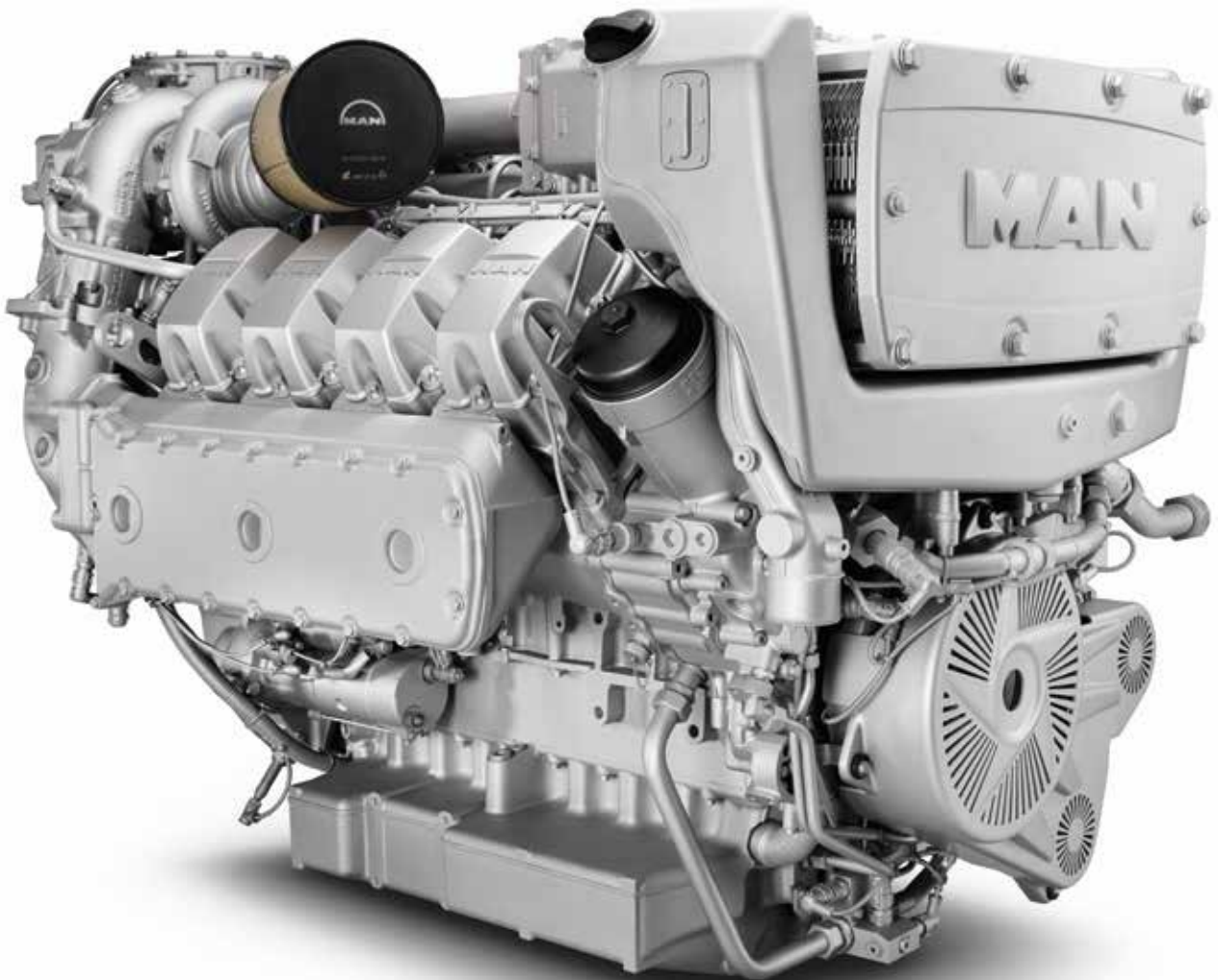

## Characteristics

- Cylinders and arrangement: 8 cylinders in V arrangement
- Operation mode: 4-stroke diesel engine, watercooled
- Turbocharging: Turbocharger with charge air intercooler and wastegate
- Number of valves: 4 valves per cylinder
- Fuel system: Common Rail direct fuel injection
- Engine block: High-strength casting with integrated oil and water ducts and replaceable cylinder liners
- Engine Lubrication: Closed system with forced feeding, oil cooling and filtering
- Type of cooling: Plate heat exchanger, seawater cooled
- Engine control: Electronic injection control, Electronic engine monitoring including diagnostic unit
- Fuel: DIN EN 590

## Technical features

Type designation		LE 422	LE 425	LE 443
Displacement	l	16.16	16.16	16.16
Maximum output <sup>1)</sup>	kW (hp)	588 (800)	588 (800)	662 (900)
Rated speed	rpm	2,100	2,100	2,100
Torque at rated speed	Nm	2,674	2,674	3,010
Maximum torque	Nm	2,950	2,980	3,325
at speed	rpm	1,300–1,900	1,400–1,900	1,400–1,900
Lowest specific fuel consumption	g/kWh	198	209	207
Classifiable		✓	✓	-
Exhaust gas aftertreatment		-	-	-
Exhaust gas status		IMO Tier II, 97/68/EC	IMO Tier II, EPA Tier 3, RCD 2013/53/EC, 97/68/EC	IMO Tier II, 97/68/EC

1) Rating according to DIN 3046-1

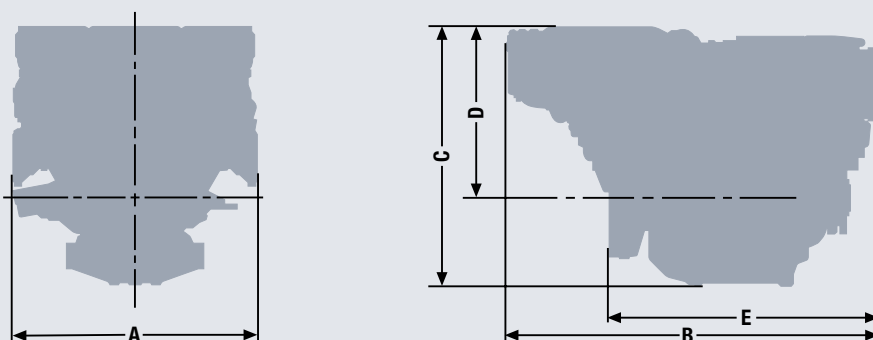

## Dimensions

Type designation		LE 422/425/443
A-Overall width	mm	1,153
B-Overall length	mm	1,745
C-Overall height	mm	1,243
D-Top of engine to crankshaft centre	mm	765
E-Length of engine from front end to edge of flywheel housing	mm	1,177
Average weight of engine ready for installation (dry)	kg	1,780

For detailed examinations of installation dimensions, please order drawings from our factory.

# D2868

LE 422

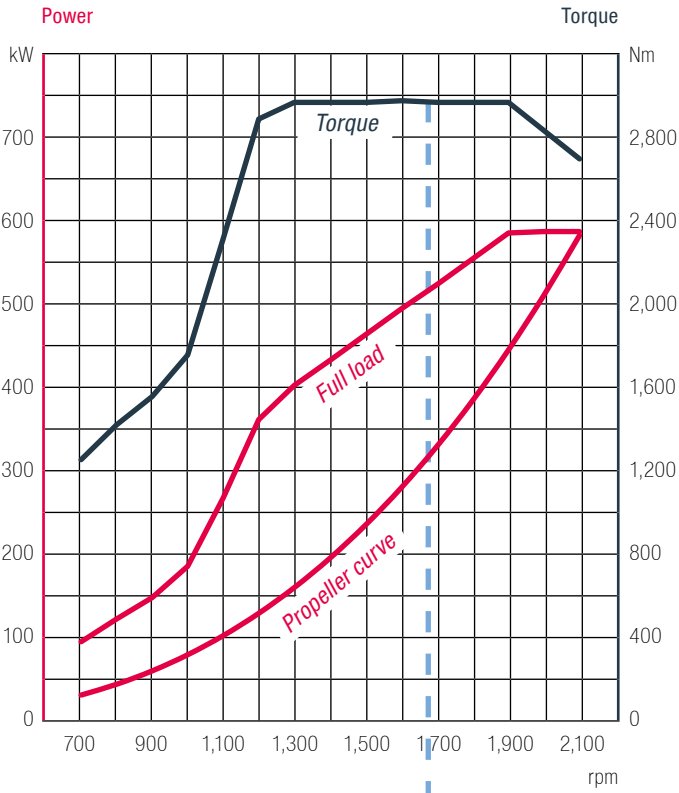

LE 425

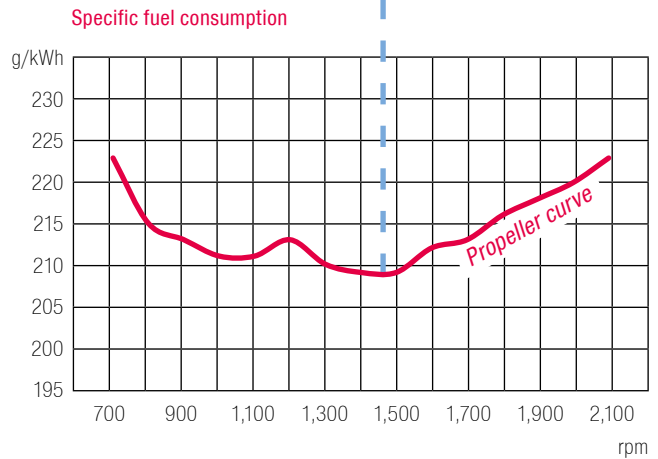
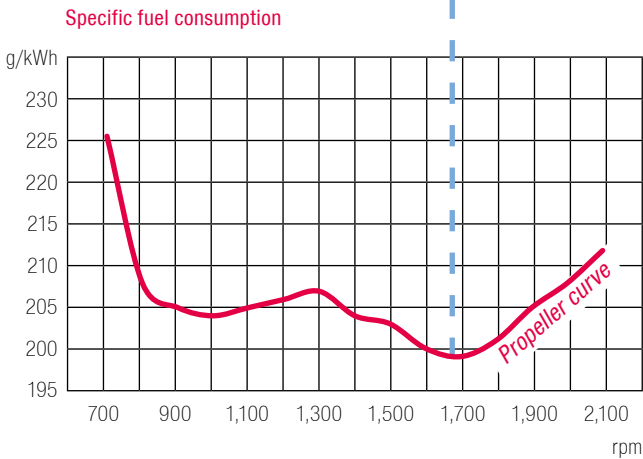
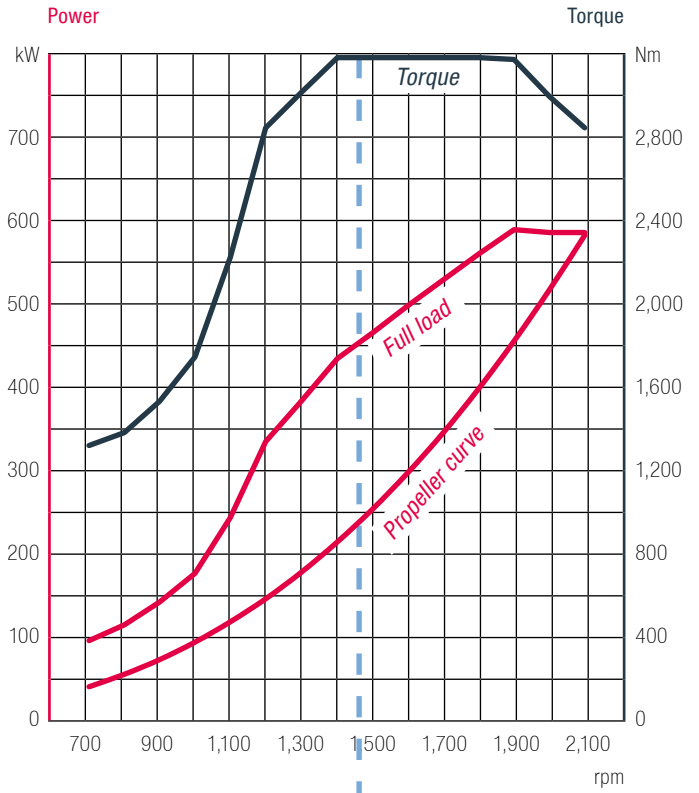

--- Maximum torque at most fuel efficient operating point

LE 443

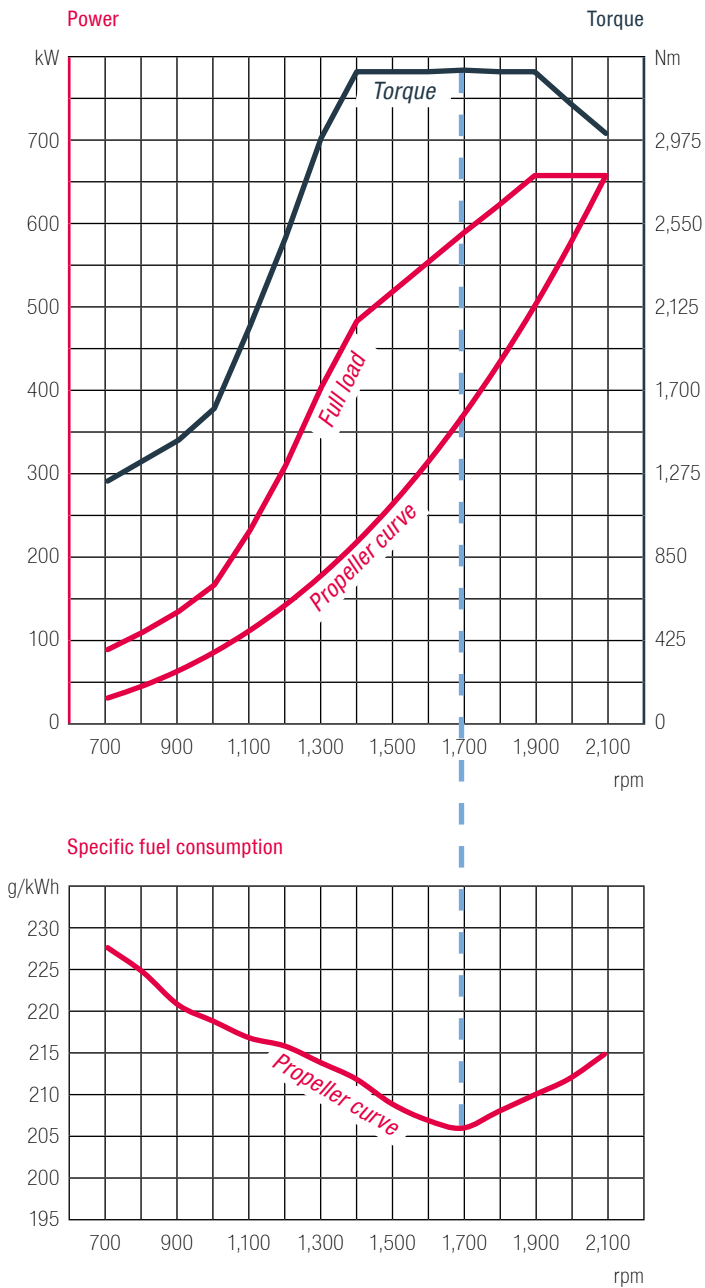

--- Maximum torque at most fuel efficient operating point

# D2862

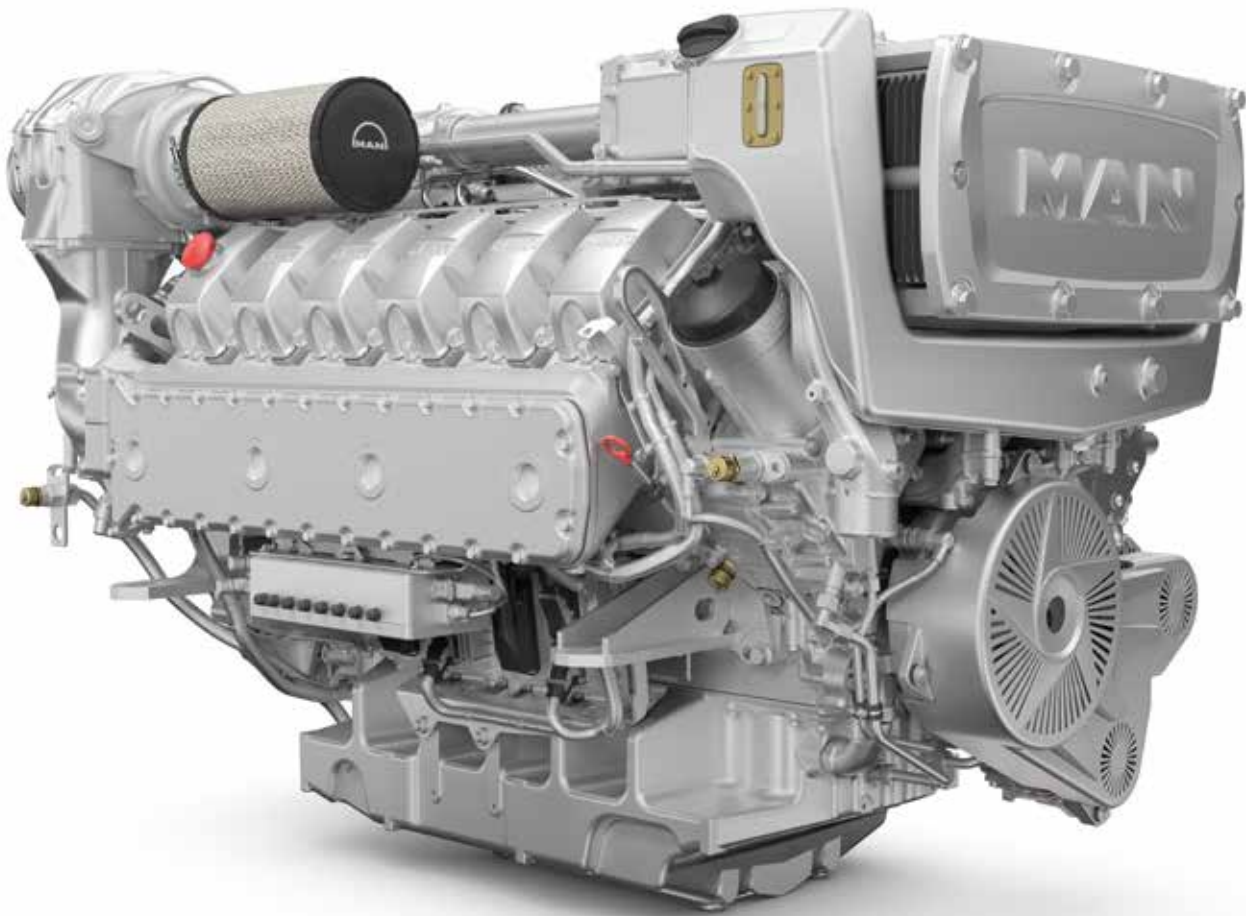

## Characteristics

- Cylinders and arrangement: 12 cylinders in V arrangement
- Operation mode: 4-stroke diesel engine, watercooled
- Turbocharging: Turbocharger with charge air intercooler and wastegate (2-stage: D2862 LE489)
- Number of valves: 4 valves per cylinder
- Fuel system: Common Rail direct fuel injection with electronic control
- Engine block: High-strength casting with integrated oil and water ducts and replaceable cylinder liners
- Engine lubrication: Closed system with forced feeding, oil cooling and filtering
- Type of cooling: Plate heat exchanger seawater cooled
- Engine control: Electronic injection control (EDC)  
Electronic engine monitoring including diagnostic unit
- Fuel: DIN EN 590



## Technical features

Type designation		LE 422	LE 428
Displacement	l	24.24	24.24
Nominal rating <sup>1)</sup>	kW (hp)	749 (1,019)	749 (1,019)
Rated speed	rpm	2,100	2,100
Torque at rated speed	Nm	3,406	3,406
Maximum torque	Nm	3,780	3,740
at speed	rpm	1,300–1,900	1,300–1,900
Lowest specific fuel consumption	g/kWh	207	199
Classifiable		✓	✓
Exhaust gas aftertreatment		-	✓
Exhaust gas status		IMO Tier II, 97/68/EC	IMO Tier III, EPA Tier 4 <sup>2)</sup>

1) Rating according to DIN 3046-1

2) on request

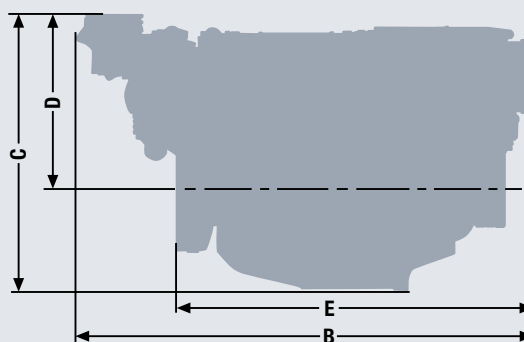
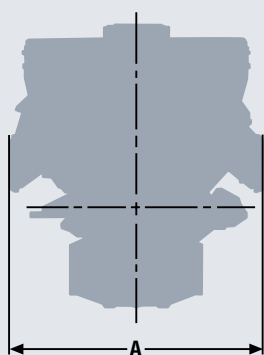

## Dimensions

Type designation		LE 422/428
A-Overall width	mm	1,153
B-Overall length	mm	2,130
C-Overall height	mm	1,230
D-Top of engine to crankshaft centre	mm	765
E-Length of engine from front end to edge of flywheel housing	mm	1,630
Average weight of engine ready for installation (dry)	kg	2,270

For detailed examinations of installation dimensions, please order drawings from our factory.

# D2862

LE 422

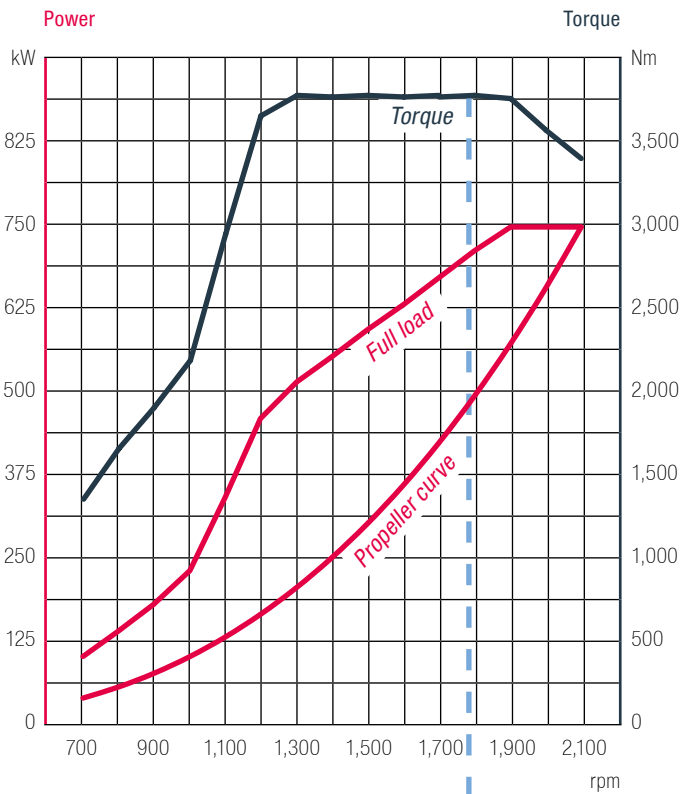

LE 428

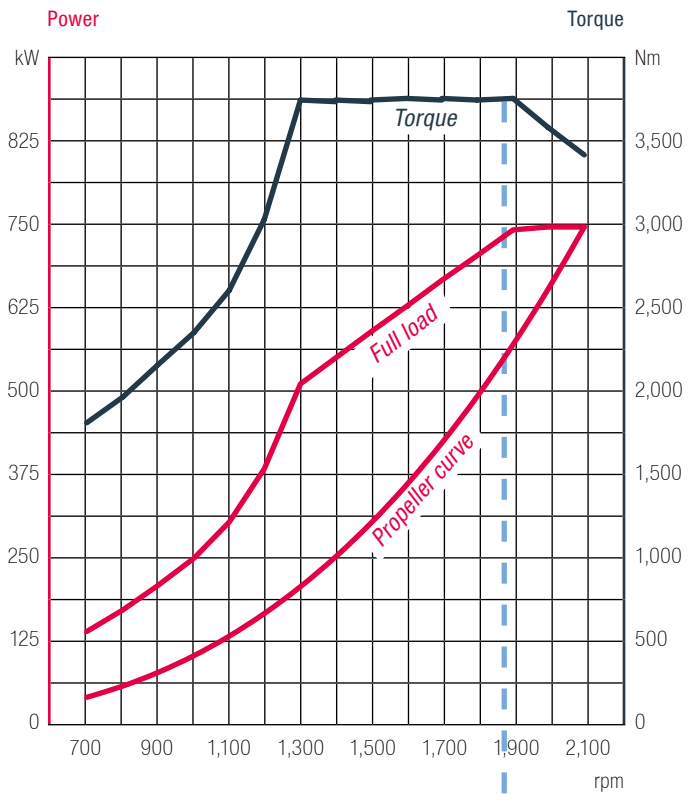

Specific fuel consumption

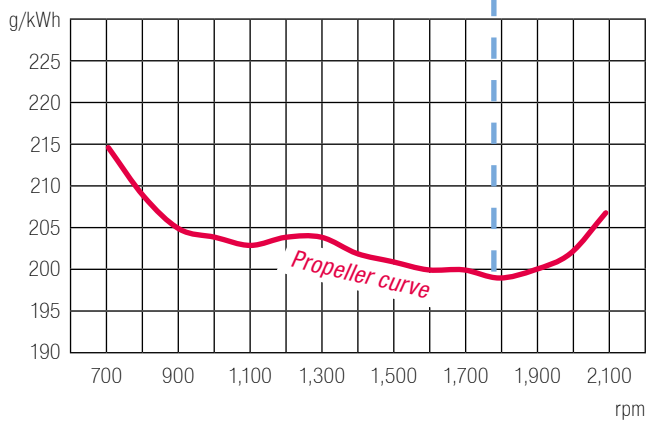

Specific fuel consumption

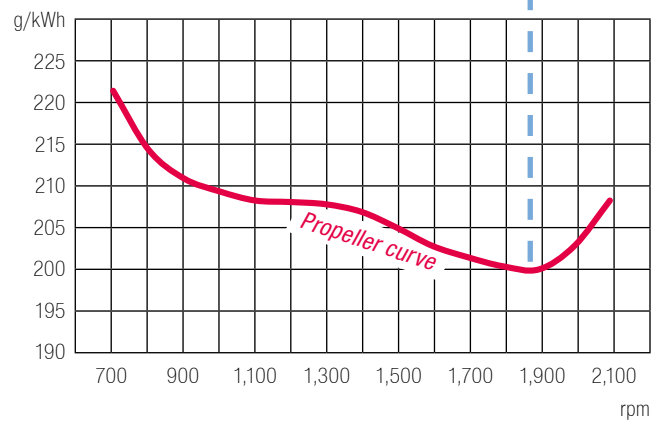

--- Maximum torque at most fuel efficient operating point

## Technical features

Type designation		LE 432	LE 435	LE 438	LE 463
Displacement	l	24.24	24.24	24.24	24.24
Nominal rating <sup>1)</sup>	kW (hp)	882 (1,200)	882 (1,200)	882 (1,200)	1,029 (1,400)
Rated speed	rpm	2,100	2,100	2,100	2,100
Torque at rated speed	Nm	4,010	4,010	4,010	4,680
Maximum torque	Nm	4,450	4,450	4,440	5,120
at speed	rpm	1,300–1,900	1,400–1,900	1,400–1,900	1,300–1,900
Lowest specific fuel consumption	g/kWh	198	203	197	200
Classifiable		✓	✓	✓	✓
Exhaust gas aftertreatment		-	-	✓	-
Exhaust gas status		IMO Tier II, 97/68/EC	IMO Tier II, RCD 2013/53/EC, 97/68/EC	IMO Tier III, EPA Tier 4 <sup>2)</sup>	IMO Tier II, 97/68/EC

1) Rating according to DIN 3046-1

2) on request

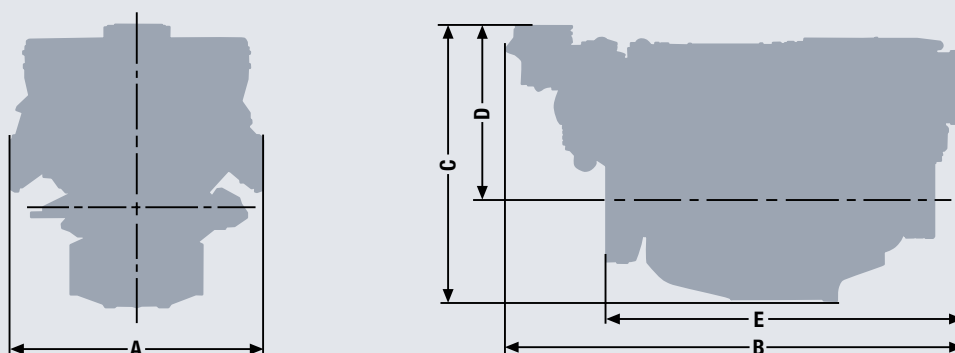

## Dimensions

Type designation		LE 432/435/438/463
A-Overall width	mm	1,153
B-Overall length	mm	2,130
C-Overall height	mm	1,230
D-Top of engine to crankshaft centre	mm	765
E-Length of engine from front end to edge of flywheel housing	mm	1,630
Average weight of engine ready for installation (dry)	kg	2,270

For detailed examinations of installation dimensions, please order drawings from our factory.

# D2862

LE 432

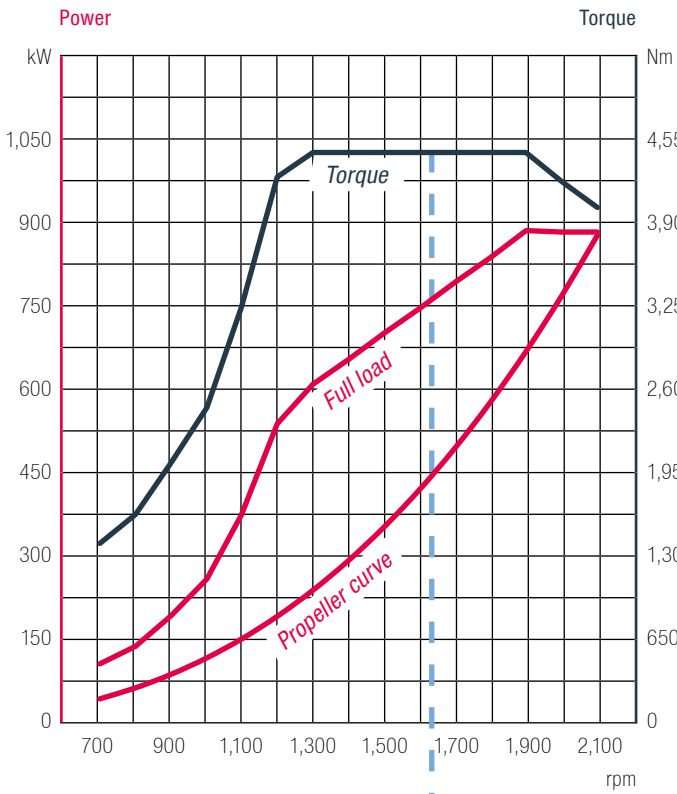

LE 435

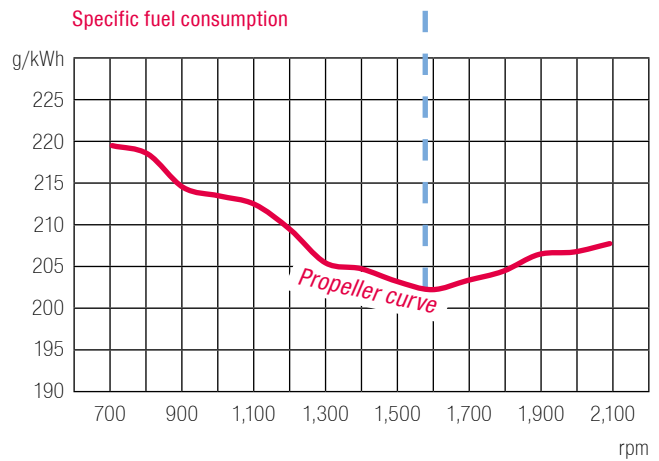
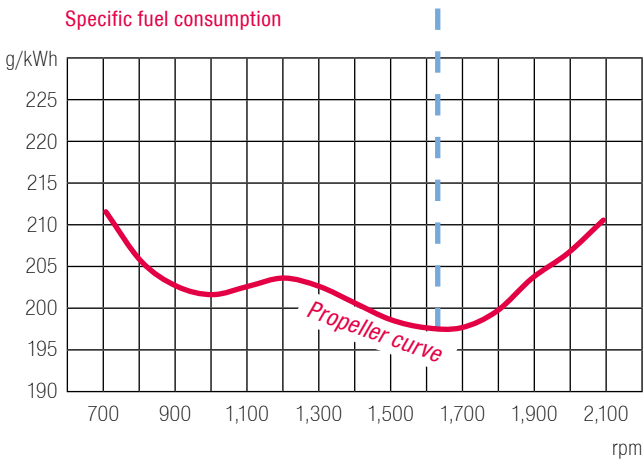
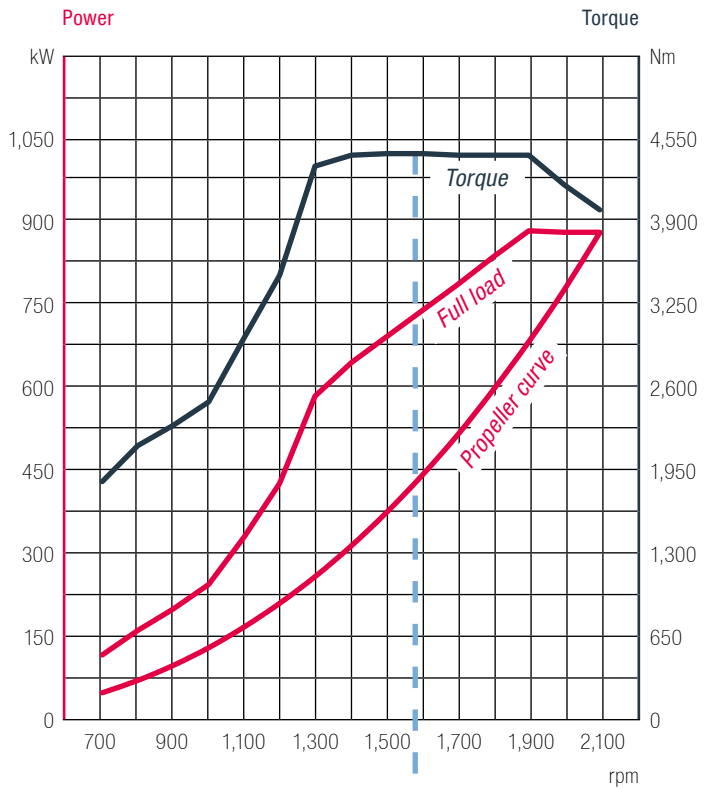

--- Maximum torque at most fuel efficient operating point

LE 438

LE 463

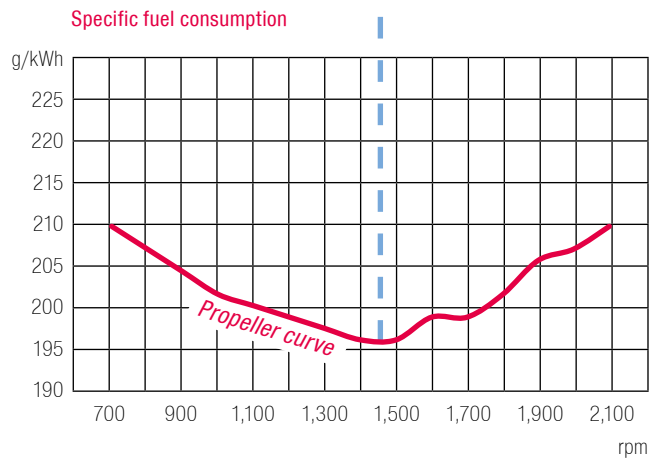
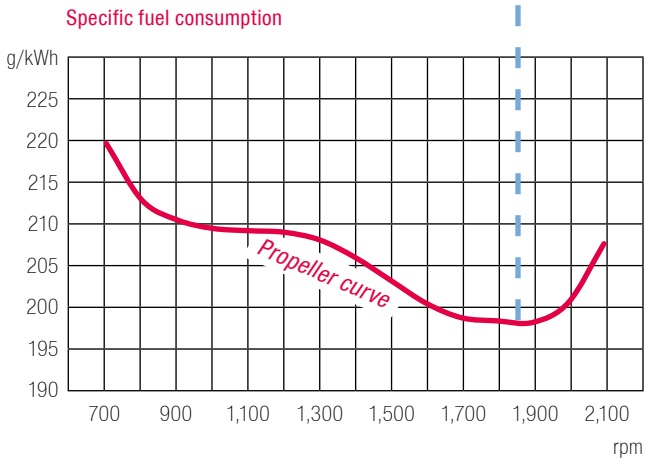
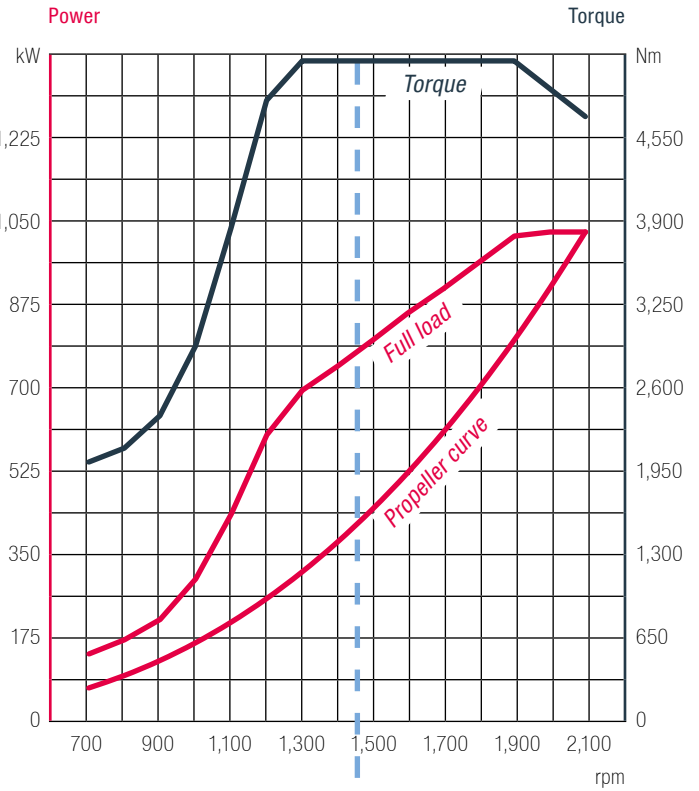
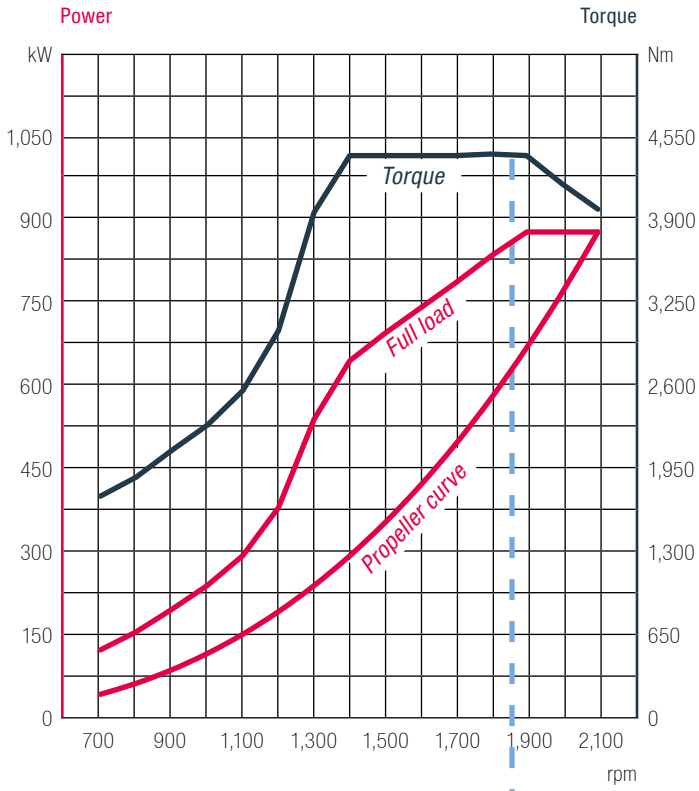

--- Maximum torque at most fuel efficient operating point

# D2862

## Technical features

Type designation		LE 466	LE 483	LE 489
Displacement	l	24.24	24.24	24.24
Nominal rating <sup>1)</sup>	kW (hp)	1,029 (1,400)	1,066 (1,450)	1,066 (1,450)
Rated speed	rpm	2,100	2,100	2,100
Torque at rated speed	Nm	4,680	4,847	4,847
Maximum torque	Nm	5,180	5,355	5,340
at speed	rpm	1,300–1,900	1,100–1,900	1,200–1,900
Lowest specific fuel consumption	g/kWh	203	209	196
Classifiable		✓	✓	✓
Exhaust gas aftertreatment		-	-	✓
Exhaust gas status		IMO Tier II, 97/68/EC	IMO Tier II, 97/68/EC	IMO Tier III, EPA Tier 4 <sup>2)</sup>

1) Rating according to DIN 3046-1

2) on request

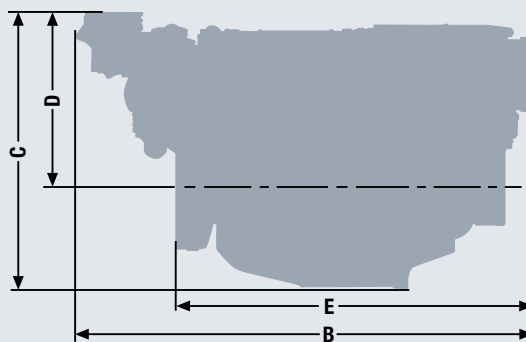
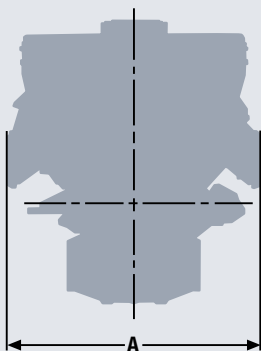

## Dimensions

Type designation		LE 466	LE 483/489
A-Overall width	mm	1,153	1,153
B-Overall length	mm	2,130	2,139
C-Overall height	mm	1,230	1,272
D-Top of engine to crankshaft centre	mm	765	808
E-Length of engine from front end to edge of flywheel housing	mm	1,630	1,658
Average weight of engine ready for installation (dry)	kg	2,270	2,365

For detailed examinations of installation dimensions, please order drawings from our factory.

LE 466

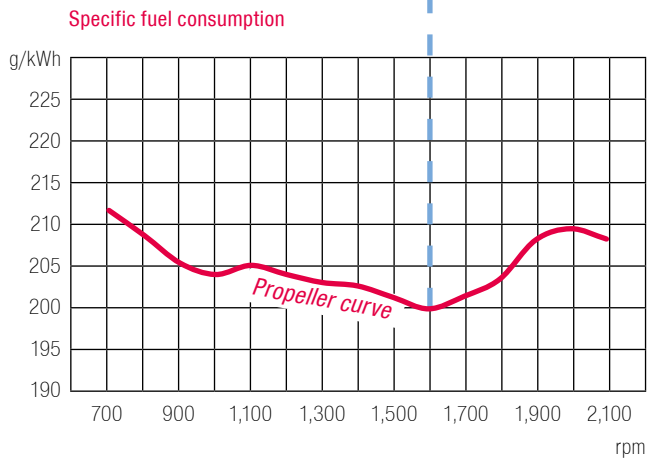
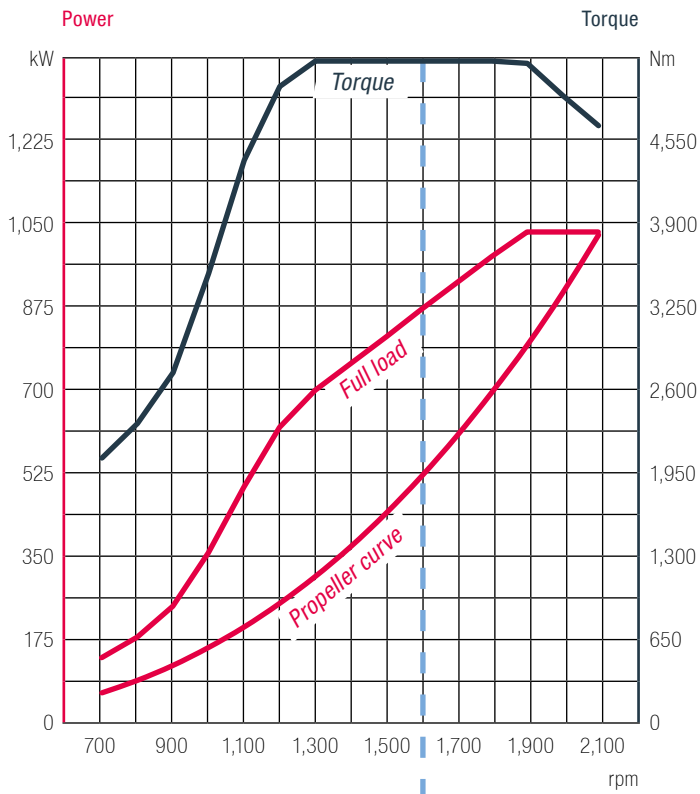

LE 483

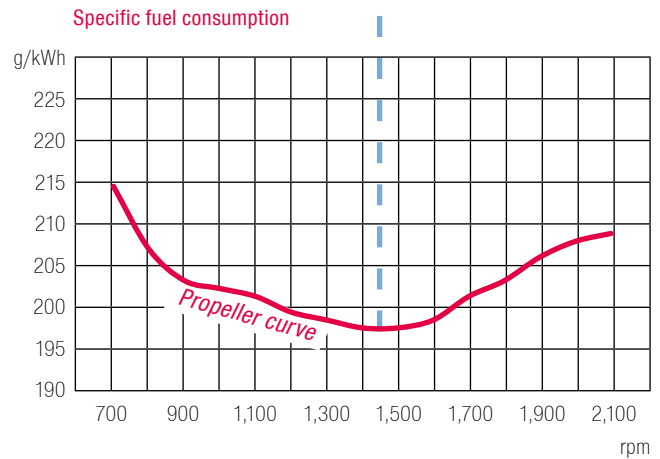
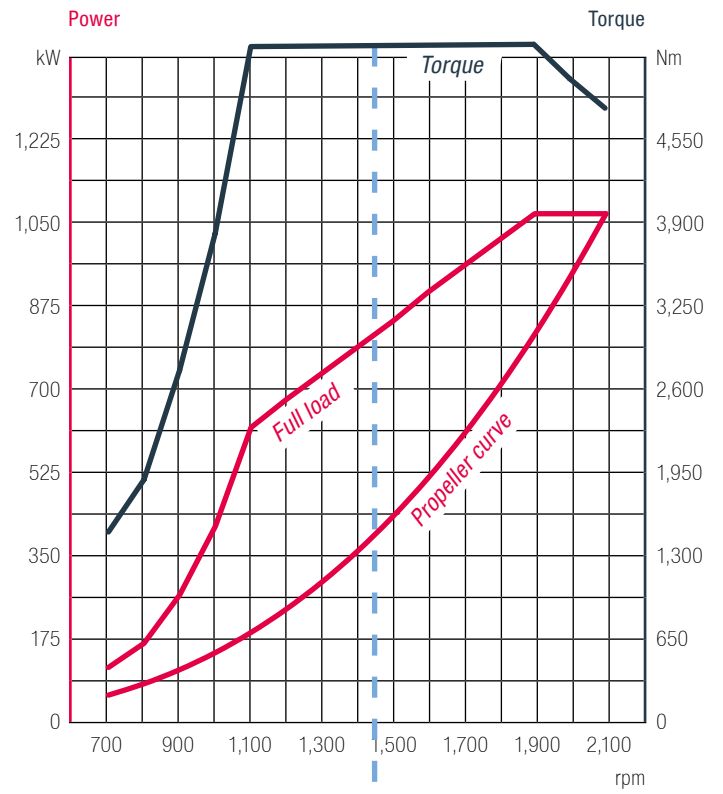

--- Maximum torque at most fuel efficient operating point

# D2862

LE 489

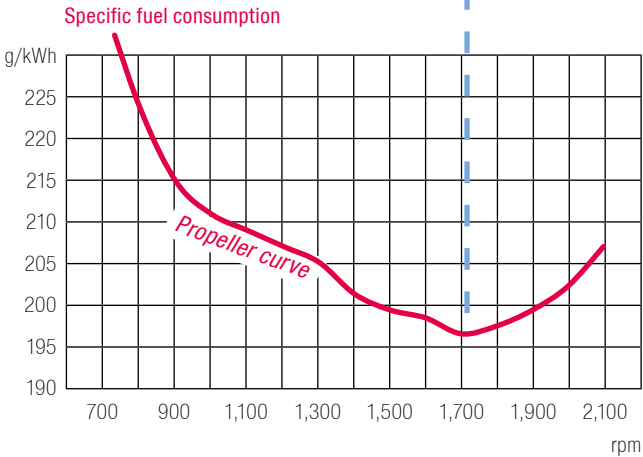
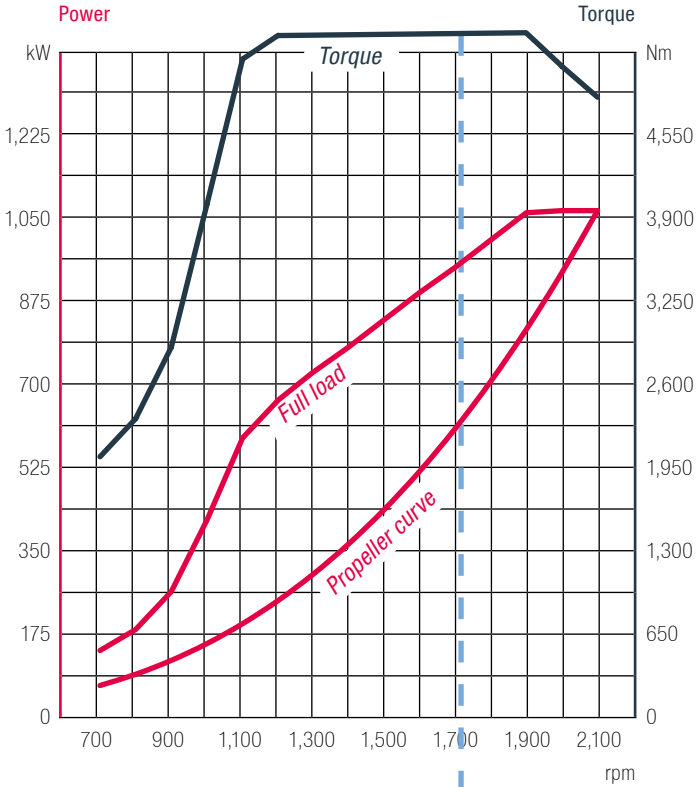

--- Maximum torque at most fuel efficient operating point



# Notes

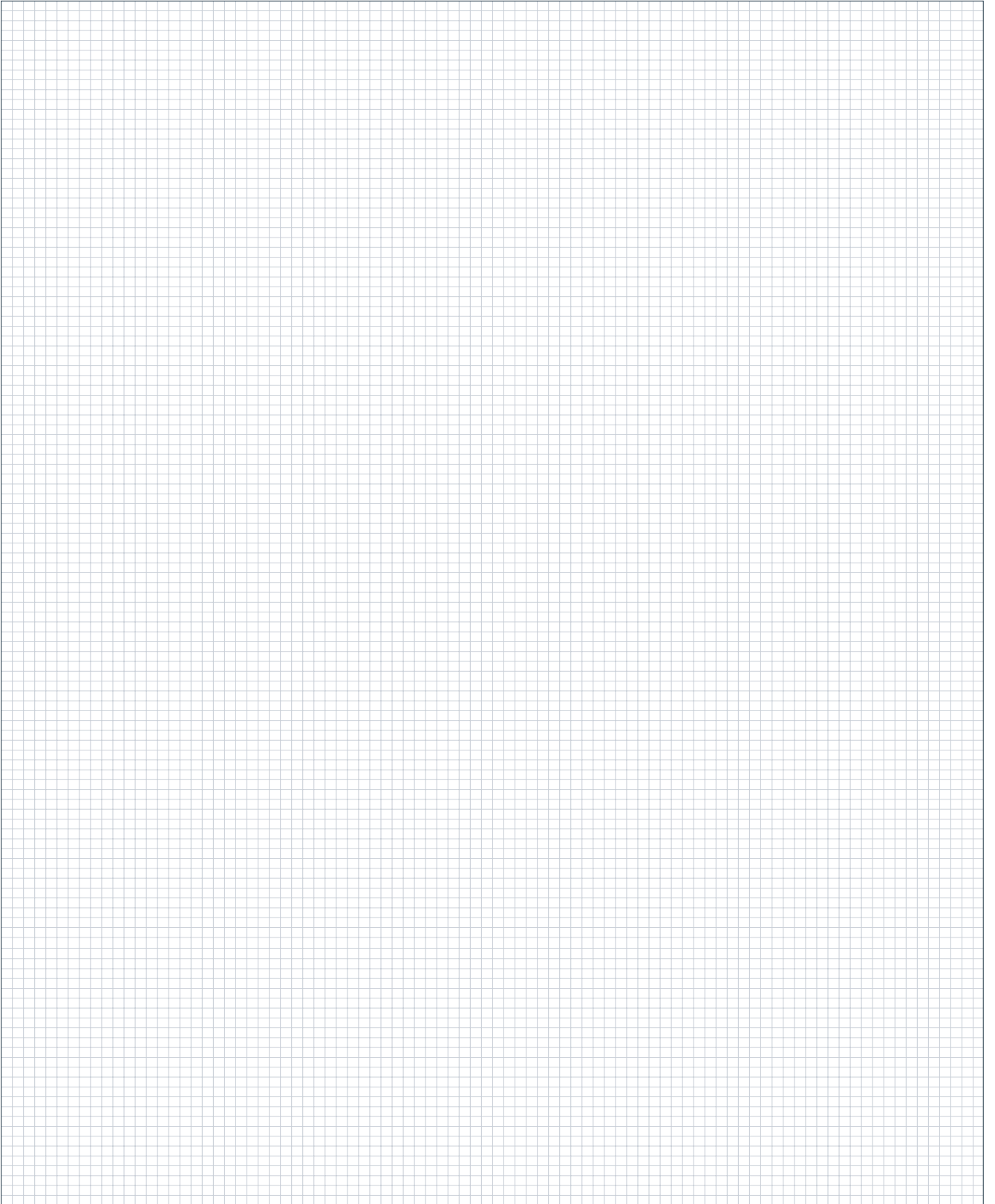

# Heavy duty operation

## Characteristics

- Annual operating hours: unlimited
- Percentage of time at full load:  $\leq 100\%$
- Average load application:  $\leq 100\%$

## Typical applications

- Trawlers
- Tugs and pushboats
- Freight barges and freighters
- Ferries
- Dredgers





# D2676



## Characteristics

- Cylinders and arrangement: 6 cylinders in-line
- Operation mode: 4-stroke diesel engine, watercooled
- Turbocharging: Turbocharger with charge air intercooler and wastegate
- Number of valves: 4 valves per cylinder
- Fuel system: Common rail injection with high pressure pump
- Engine block: High-strength casting with integrated oil and water ducts and replaceable cylinder liners
- Engine lubrication: Force-feed lubrication, lubrication oil cooler in cooling water circuit of the engine
- Type of cooling: Seawater cooled charge air cooler, plate heat exchanger by rubber impeller pump
- Engine control: Electronic injection control, electronic engine monitoring including diagnostic unit
- Fuel: DIN EN 590

## Technical features

Type designation		LE 461	LE 451	LE 441
Displacement	l	12.42	12.42	12.42
Nominal rating <sup>1)</sup>	kW (hp)	147 (200)	210 (286)	270 (367)
Rated speed	rpm	1,800	1,800	1,800
Torque at rated speed	Nm	780	1,114	1,432
Maximum torque	Nm	900	1,260	1,616
at speed	rpm	700–1,600	1,000–1,600	1,000–1,600
Lowest specific fuel consumption	g/kWh	218	209	204
Classifiable		✓	✓	✓
Exhaust gas aftertreatment		-	-	-
Exhaust gas status		IMO Tier II, 97/68/EC	IMO Tier II, 97/68/EC	IMO Tier II, 97/68/EC

1) The rating is according to DIN 3046/1

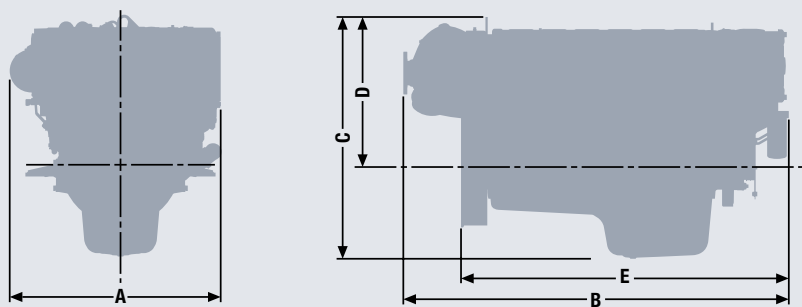

## Dimensions

Type designation		LE 461/451/441
A-Overall width	mm	986
B-Overall length	mm	1,795
C-Overall height	mm	1,096
D-Top of engine to crankshaft centre	mm	674
E-Length of engine from front end to edge of flywheel housing	mm	1,527
Average weight of engine ready for installation (dry)	kg	1,215

For detailed examinations of installation dimensions, please order drawings from our factory.

# D2676

LE 461

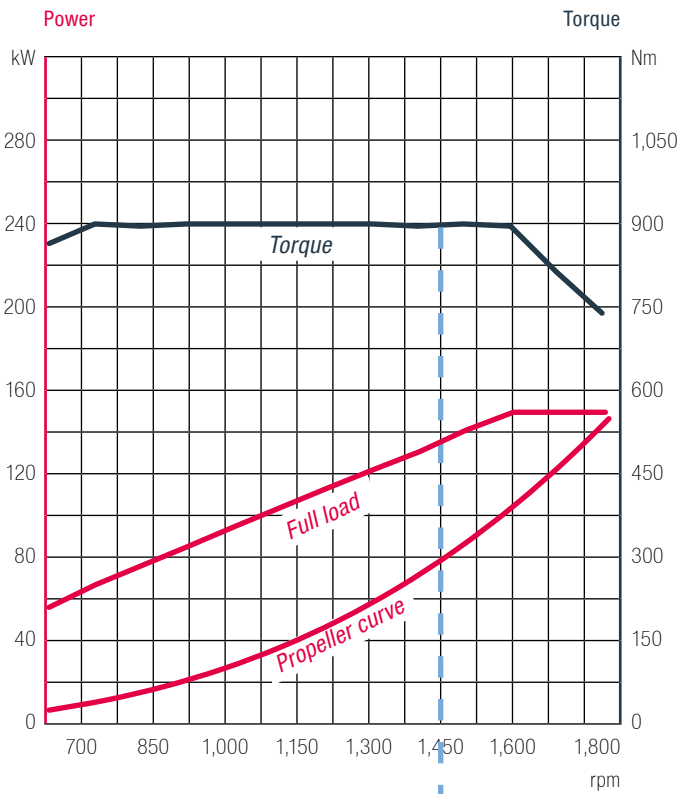

LE 451

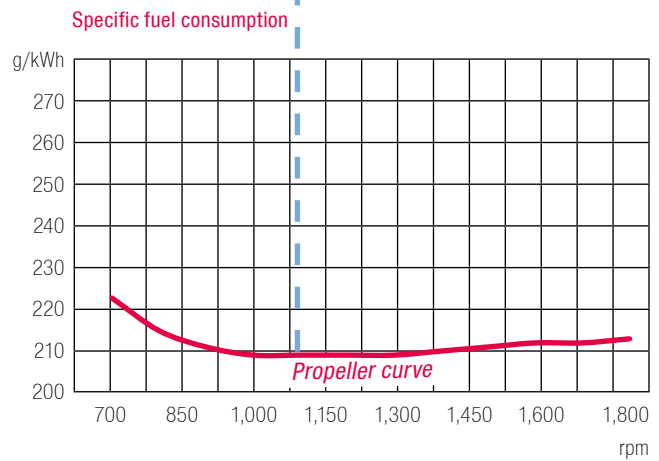
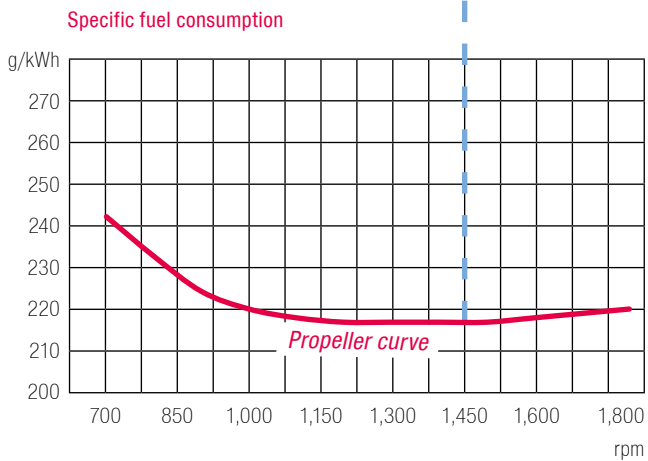
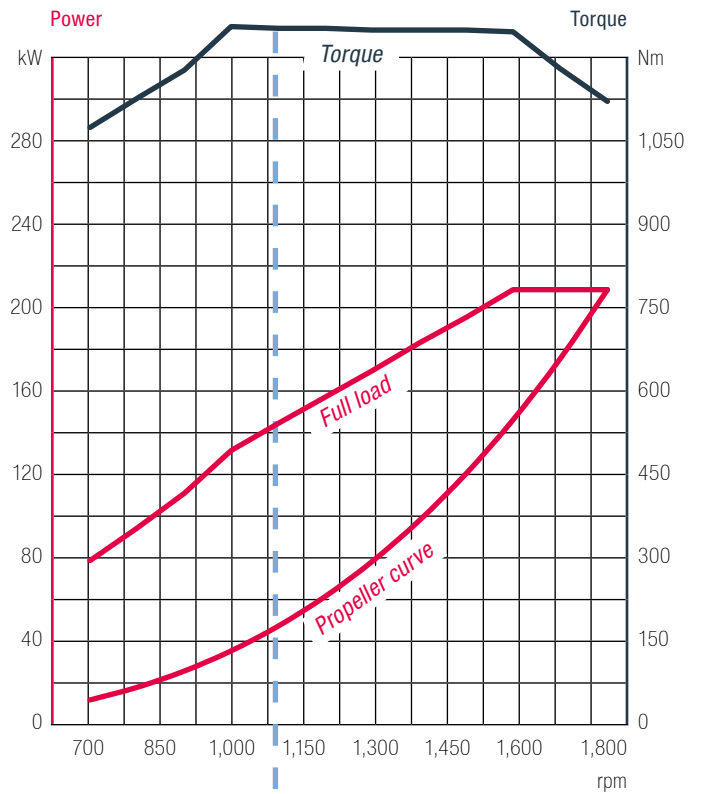

--- Maximum torque at most fuel efficient operating point

LE 441

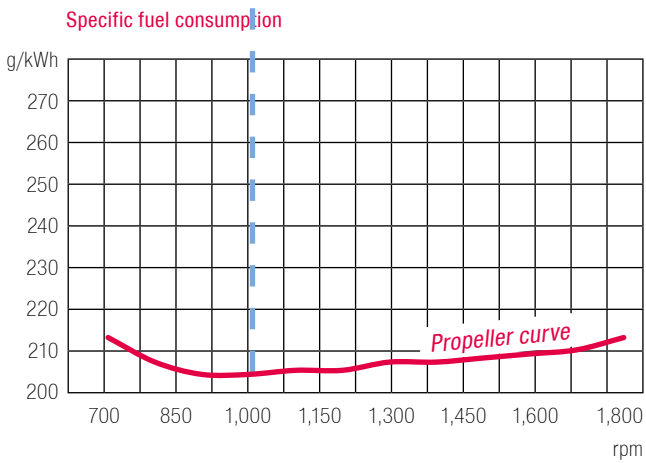
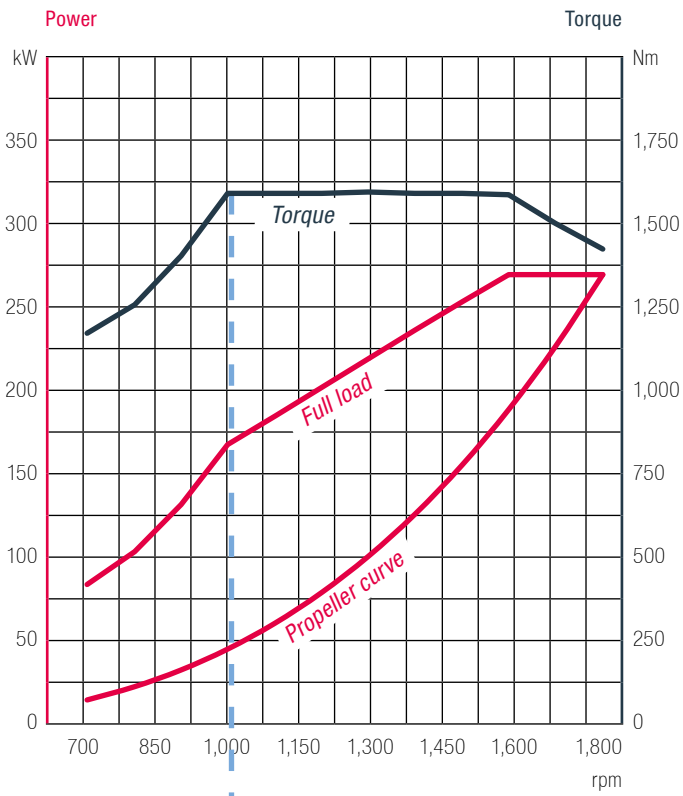

--- Maximum torque at most fuel efficient operating point

# D2676

## Technical features

Type designation		LE 431	LE 434	LE 421	LE 424
Displacement	l	12.42	12.42	12.42	12.42
Nominal rating <sup>1)</sup>	kW (hp)	324 (440)	324 (440)	382 (520)	382 (520)
Rated speed	rpm	1,800	1,800	1,800	1,800
Torque at rated speed	Nm	1,719	1,719	2,027	2,027
Maximum torque	Nm	1,925	1,925	2,275	2,270
at speed	rpm	1,100–1,600	1,100–1,600	1,200–1,600	1,200–1,600
Lowest specific fuel consumption <sup>2)</sup>	g/kWh	205	210	207	212
Classifiable		✓	✓	✓	✓
Exhaust gas aftertreatment		-	-	-	-
Exhaust gas status		IMO Tier II, 97/68/EC	IMO Tier II, EPA Tier 3, 97/68/EC	IMO Tier II, 97/68/EC	IMO Tier II, EPA Tier 3, RCD 2013/53/EC, 97/68/EC

1) The rating is according to DIN 3046/1

2) Consumption at rated power

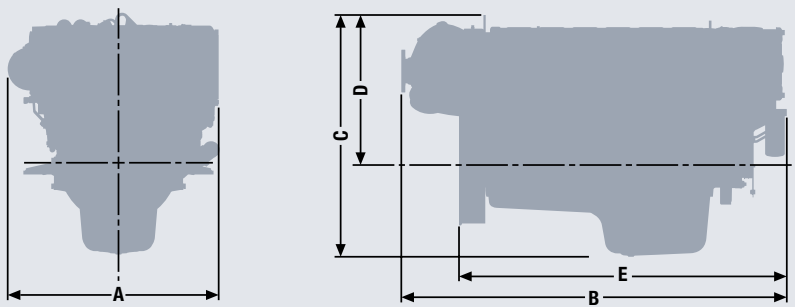

## Dimensions

Type designation		LE 431/434/421/424
A-Overall width	mm	986
B-Overall length	mm	1,795
C-Overall height	mm	1,096
D-Top of engine to crankshaft centre	mm	674
E-Length of engine from front end to edge of flywheel housing	mm	1,527
Average weight of engine ready for installation (dry)	kg	1,215

For detailed examinations of installation dimensions, please order drawings from our factory.



LE 431

LE 434

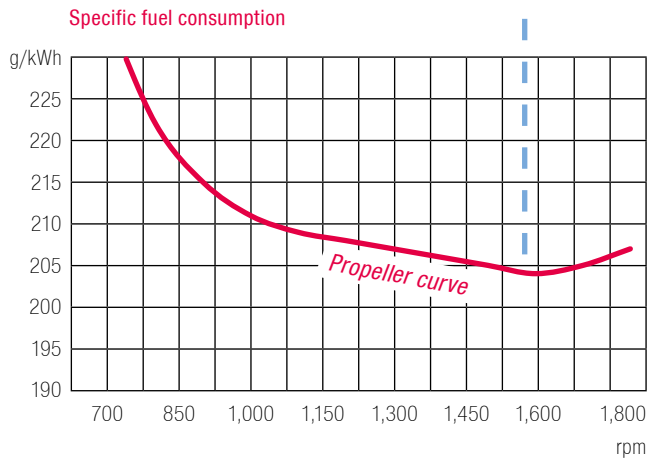
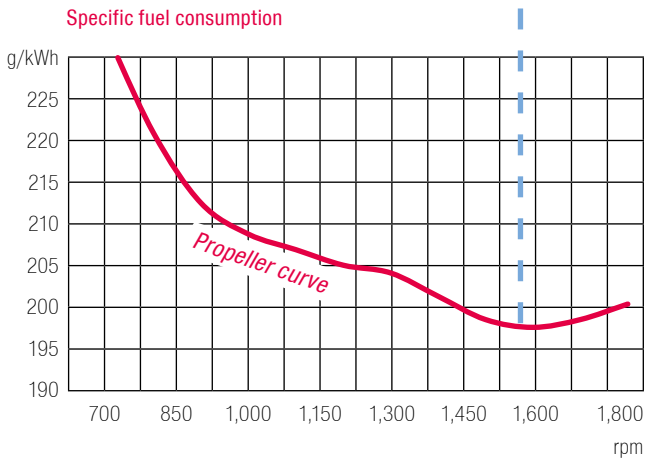
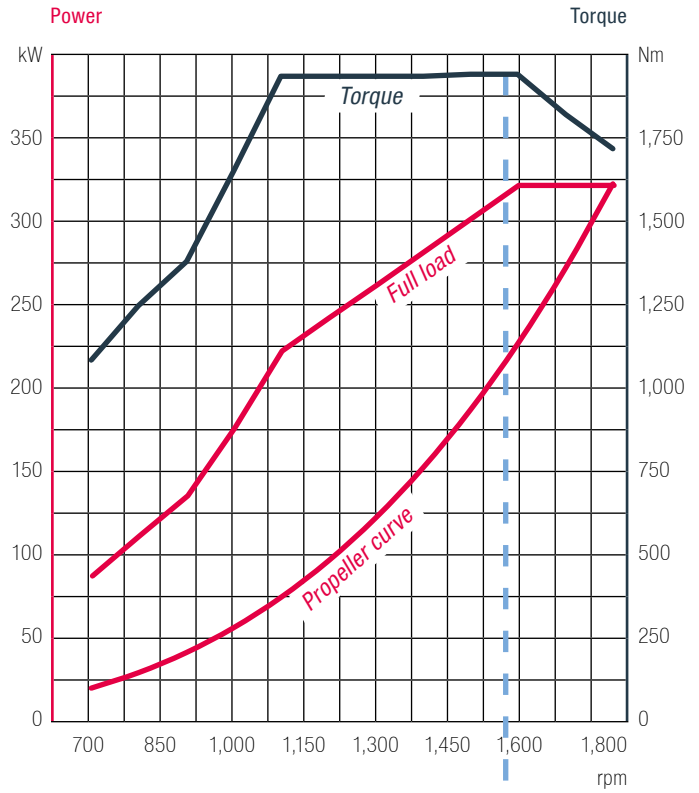
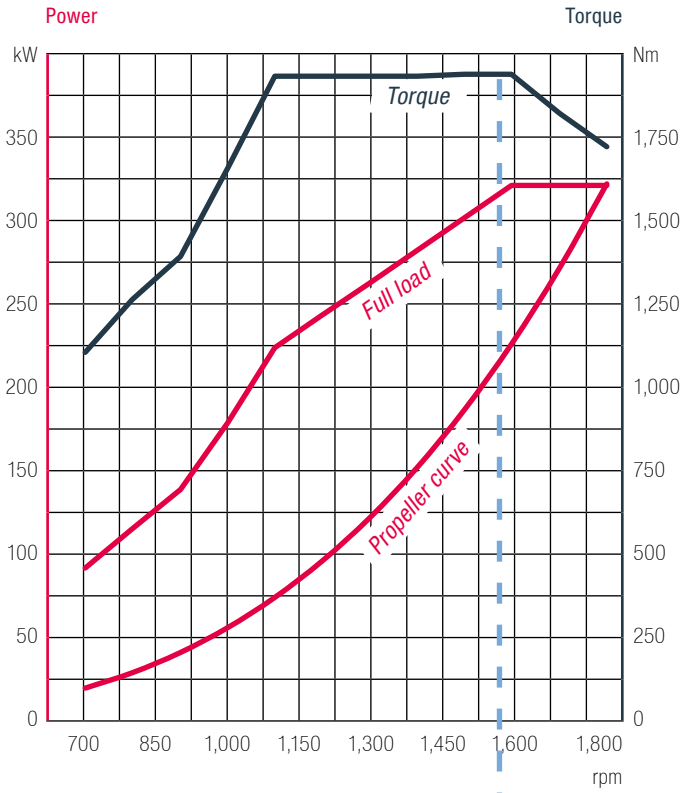

--- Maximum torque at most fuel efficient operating point

# D2676

LE 421

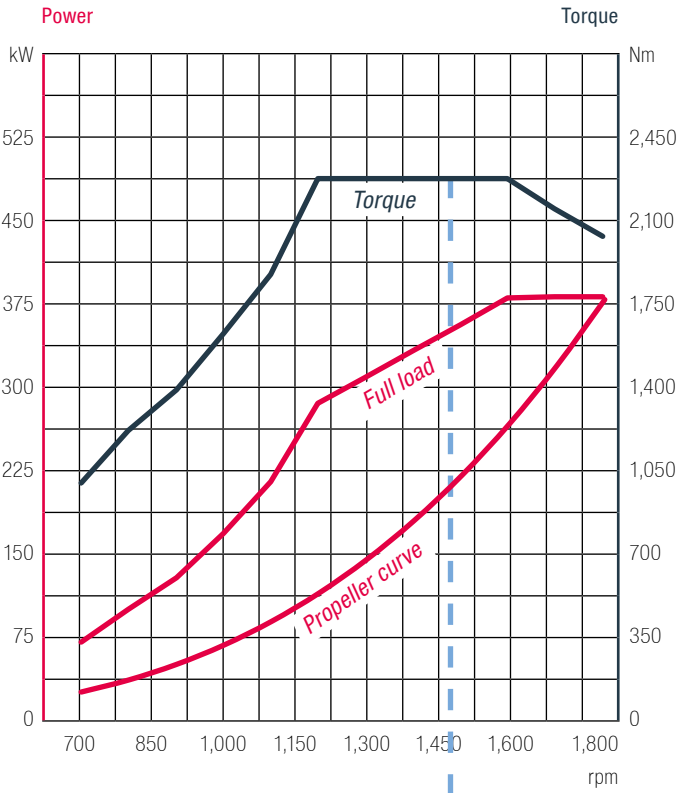

LE 424

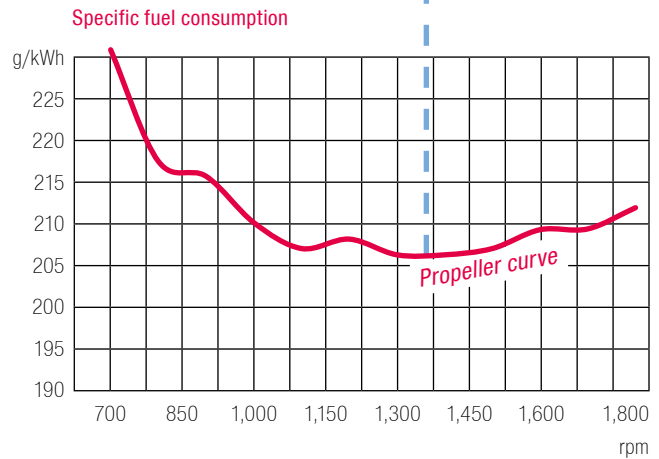
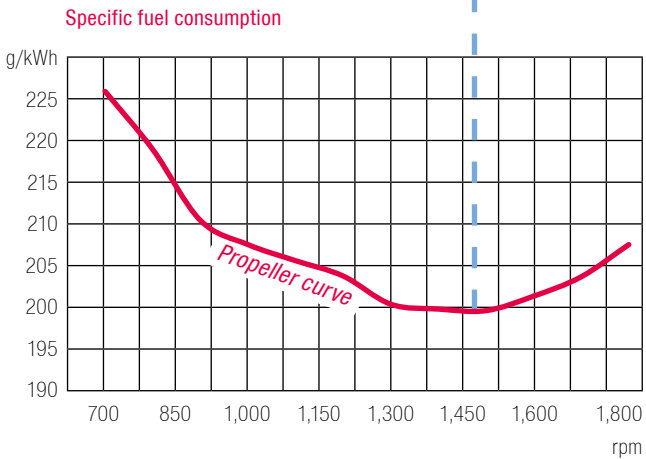
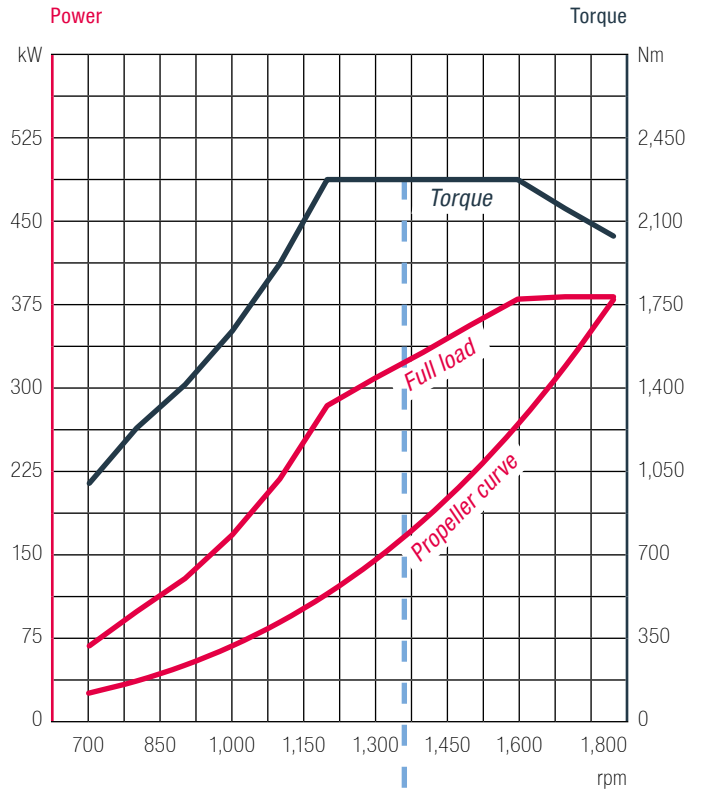

--- Maximum torque at most fuel efficient operating point

# D2868

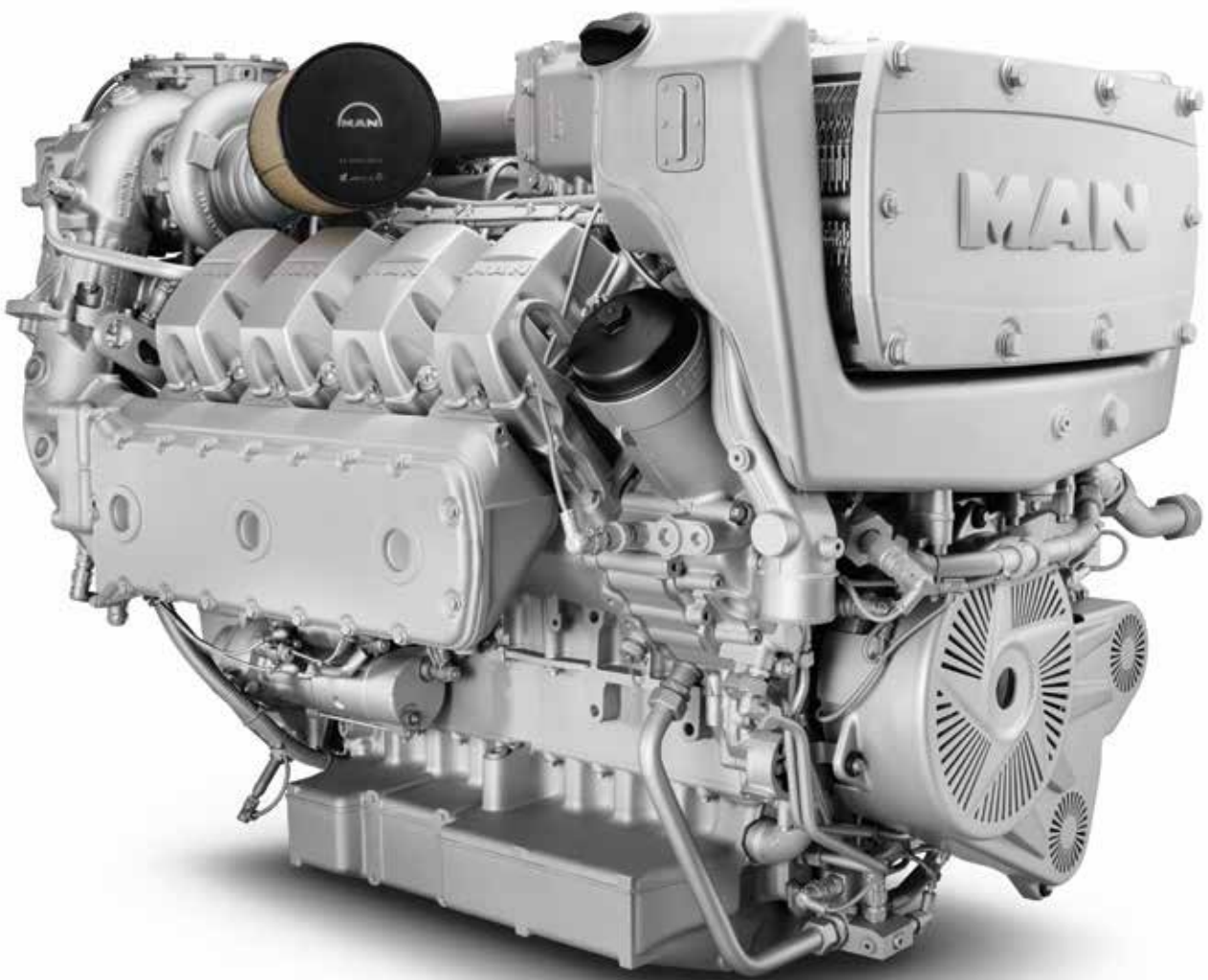

heavy duty

## Characteristics

- Cylinders and arrangement: 8 cylinders in V arrangement
- Operation mode: 4-stroke diesel engine, watercooled
- Turbocharging: Turbocharger with charge air intercooler and waste gate
- Number of valves: 4 valves per cylinder
- Fuel system: Common Rail direct fuel injection
- Engine block: High-strength casting with integrated oil and water ducts and replaceable cylinder liners
- Engine Lubrication: Closed system with forced feeding, oil cooling and filtering
- Type of cooling: Plate heat exchanger, seawater cooled
- Engine control: Electronic injection control  
Electronic engine monitoring including diagnostic unit
- Fuel: DIN EN 590

# D2868

## Technical features

Type designation		LE 421	LE 424	LE 431
Displacement	l	16.16	16.16	16.16
Nominal rating <sup>1)</sup>	kW (hp)	441 (600)	441 (600)	500 (680)
Rated speed	rpm	1,800	1,800	1,800
Torque at rated speed	Nm	2,340	2,340	2,653
Maximum torque	Nm	2,630	2,630	2,985
at speed	rpm	1,100–1,600	1,100–1,600	1,100–1,600
Lowest specific fuel consumption	g/kWh	197	206	199
Classifiable		✓	✓	✓
Exhaust gas aftertreatment		-	-	-
Exhaust gas status		IMO Tier II, 97/68/EC	IMO Tier II, EPA Tier 3, RCD 2013/53/EC, 97/68/EC	IMO Tier II, 97/68/EC

1) The rating is according to DIN 3046/1

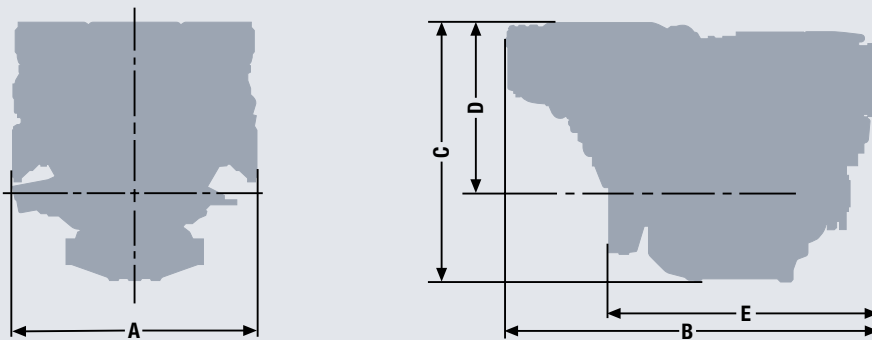

## Dimensions

Type designation		LE 421/424/431
A-Overall width	mm	1,153
B-Overall length	mm	1,745
C-Overall height	mm	1,243
D-Top of engine to crankshaft centre	mm	765
E-Length of engine from front end to edge of flywheel housing	mm	1,243
Average weight of engine ready for installation (dry)	kg	1,780

For detailed examinations of installation dimensions, please order drawings from our factory.

LE 421

LE 424

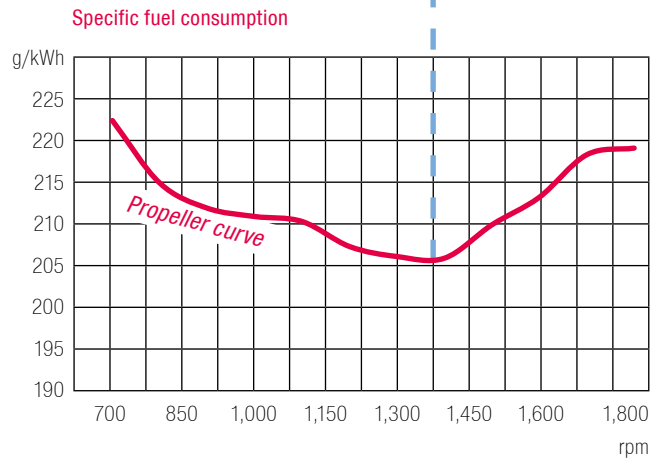
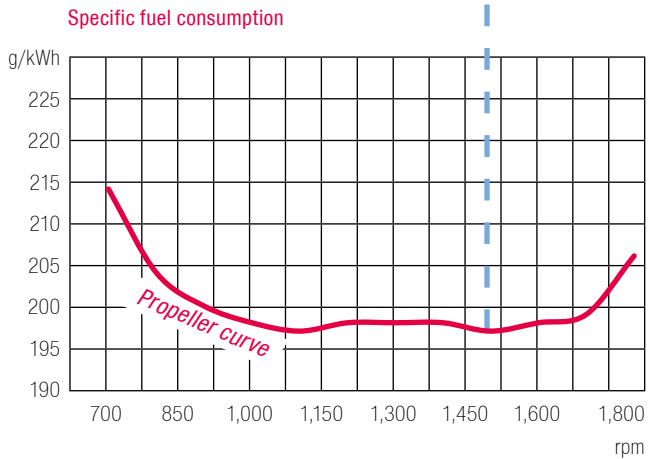
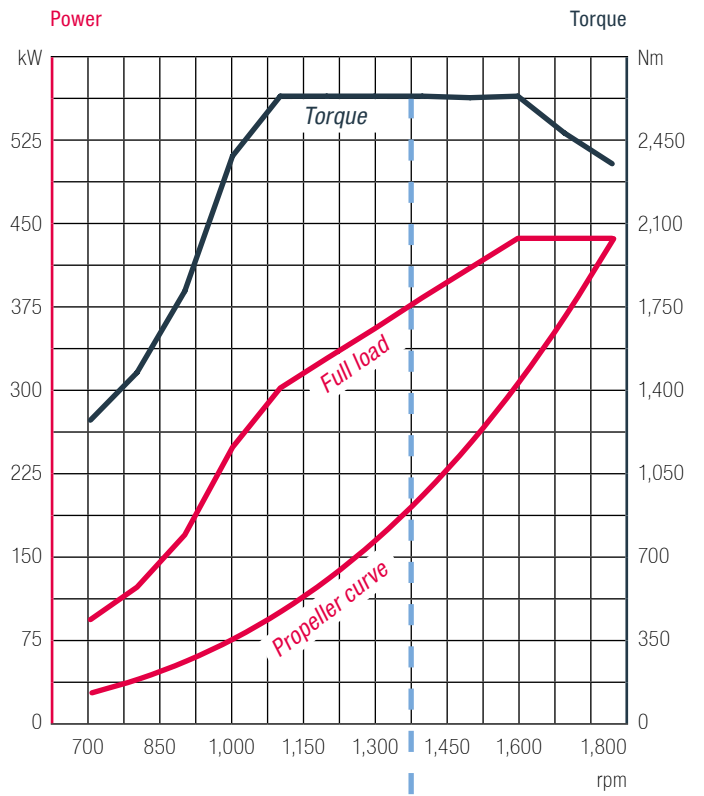
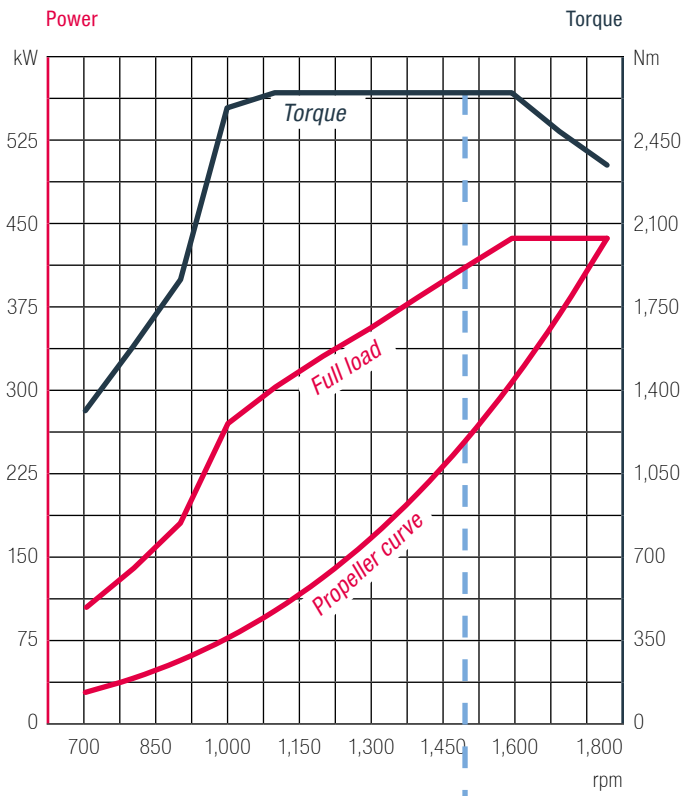

--- Maximum torque at most fuel efficient operating point

# D2868

LE 431

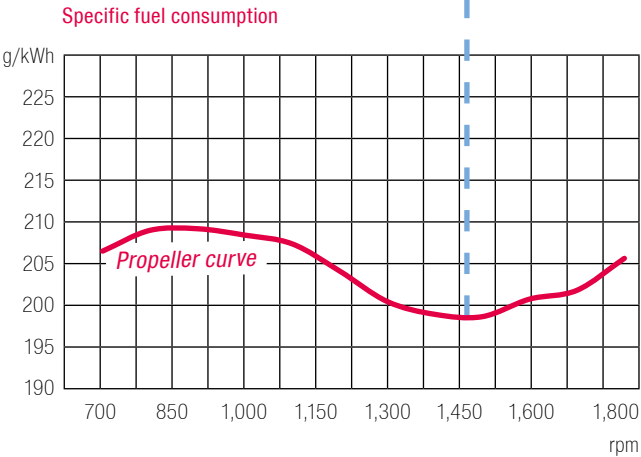
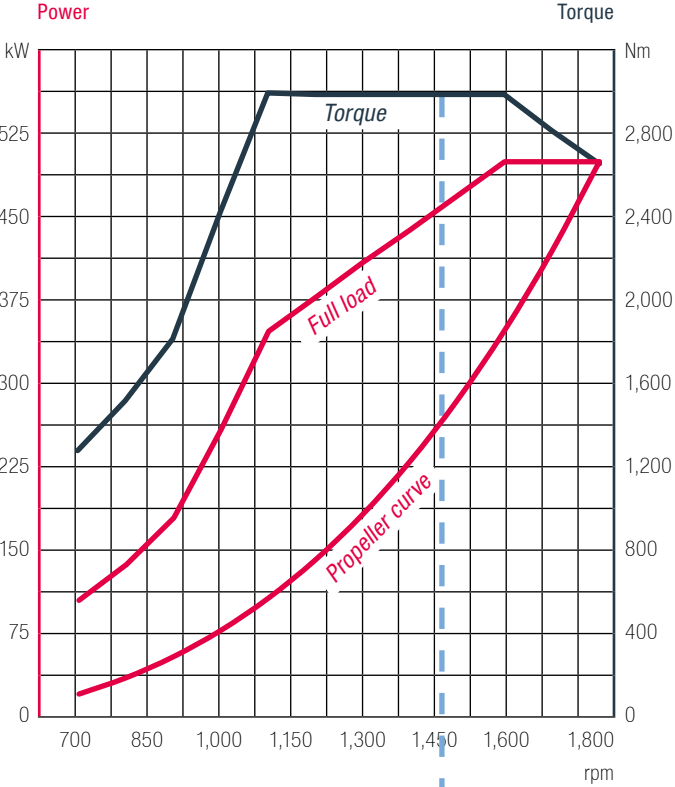

--- Maximum torque at most fuel efficient operating point

# D2862



heavy duty

## Characteristics

- Cylinders and arrangement: 12 cylinders in V arrangement
- Operation mode: 4-stroke diesel engine, watercooled
- Turbocharging: Turbocharger charge air intercooler and waste gate
- Number of valves: 4 valves per cylinder
- Fuel system: Common Rail direct fuel injection with electronic control
- Engine block: High-strength casting with integrated oil and water ducts and replaceable cylinder liners
- Engine lubrication: Closed system with forced feeding, oil cooling and filtering
- Type of cooling: Plate heat exchanger seawater cooled
- Engine control: Electronic injection control (EDC)  
Electronic engine monitoring including diagnostic unit
- Fuel: DIN EN 590

# D2862

## Technical features

Type designation		LE 431	LE 434	LE 437	LE 421
Displacement	l	24.24	24.24	24.24	24.24
Nominal rating <sup>1)</sup>	kW (hp)	551 (749)	551 (749)	551 (749)	662 (900)
Rated speed	rpm	1,800	1,800	1,800	1,800
Torque at rated speed	Nm	2,923	2,923	2,923	3,512
Maximum torque	Nm	3,305	3,305	3,295	3,955
at speed	rpm	1,000–1,600	1,000–1,600	1,000–1,600	1,100–1,600
Lowest specific fuel consumption	g/kWh	198	202	196	195
Classifiable		✓	✓	✓	✓
Exhaust gas aftertreatment		-	-	✓	-
Exhaust gas status		IMO Tier II, 97/68/EC	IMO Tier II, EPA Tier 3, RCD 2013/53/EC, 97/68/EC	IMO Tier III, EPA Tier 4 <sup>2)</sup>	IMO Tier II, 97/68/EC

1) The rating is according to DIN 3046/1

2) on request

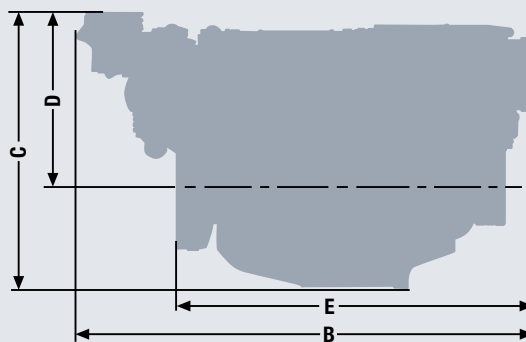
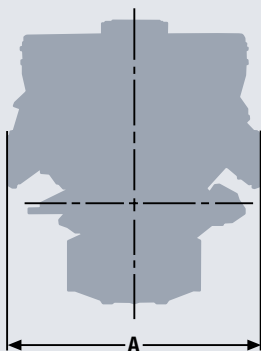

## Dimensions

Type designation		LE 431/434/437/421
A-Overall width	mm	1,153
B-Overall length	mm	2,130
C-Overall height	mm	1,230
D-Top of engine to crankshaft centre	mm	765
E-Length of engine from front end to edge of flywheel housing	mm	1,630
Average weight of engine ready for installation (dry)	kg	2,270

For detailed examinations of installation dimensions, please order drawings from our factory.



LE 431

LE 434

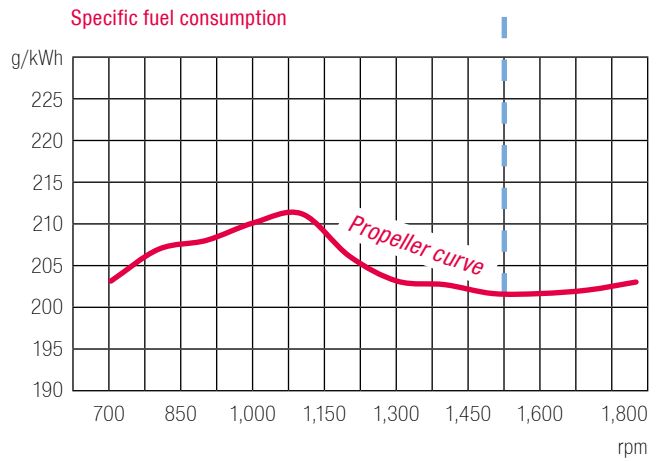
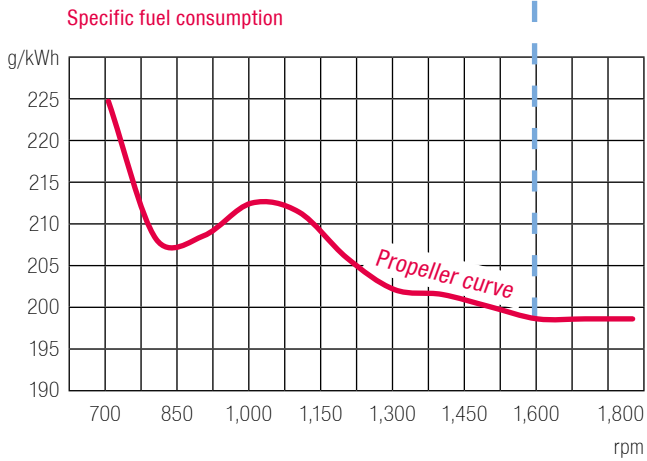
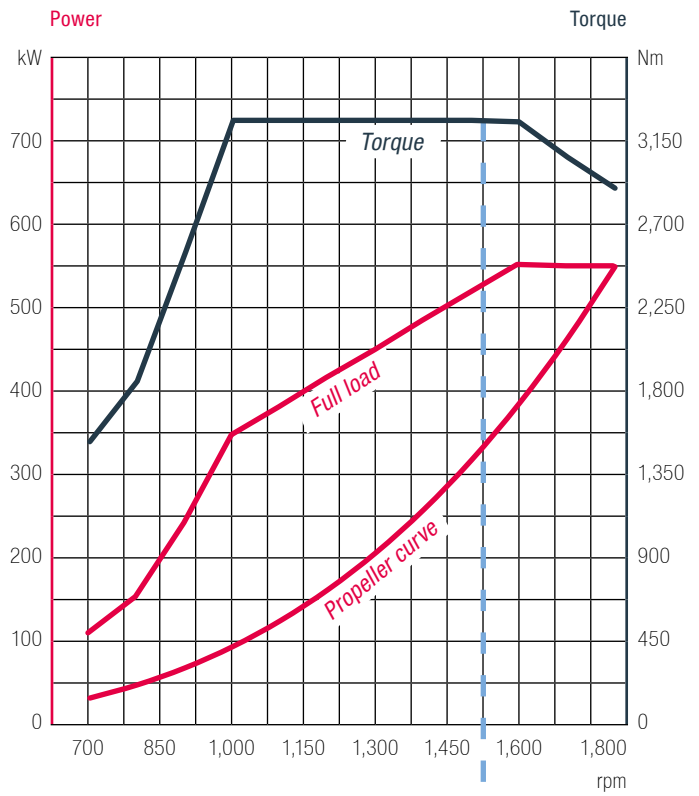
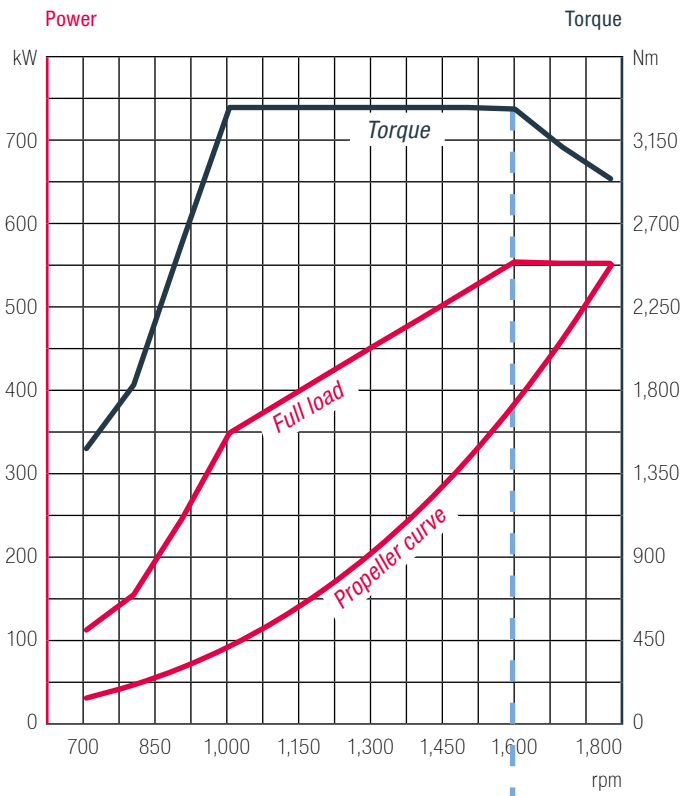

--- Maximum torque at most fuel efficient operating point

# D2862

LE 437

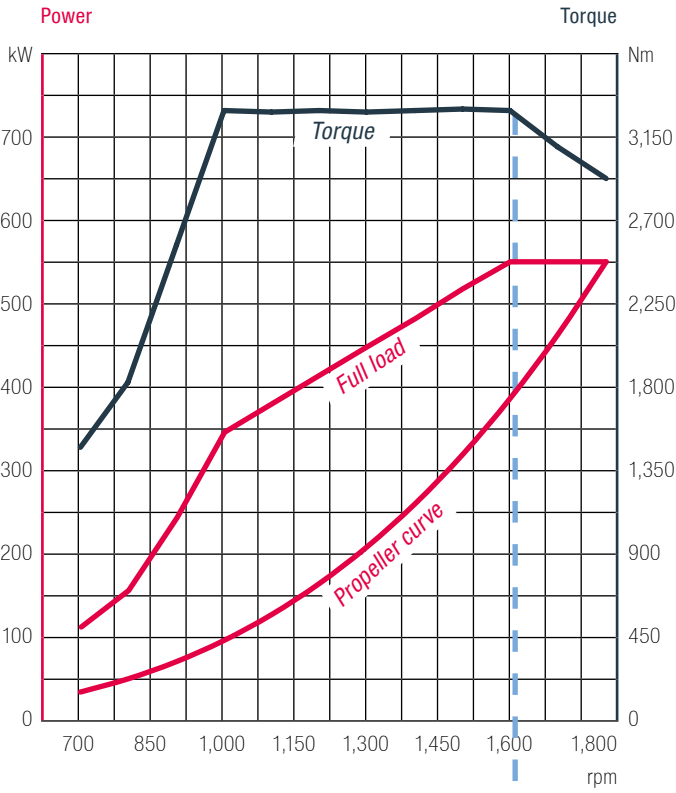

LE 421

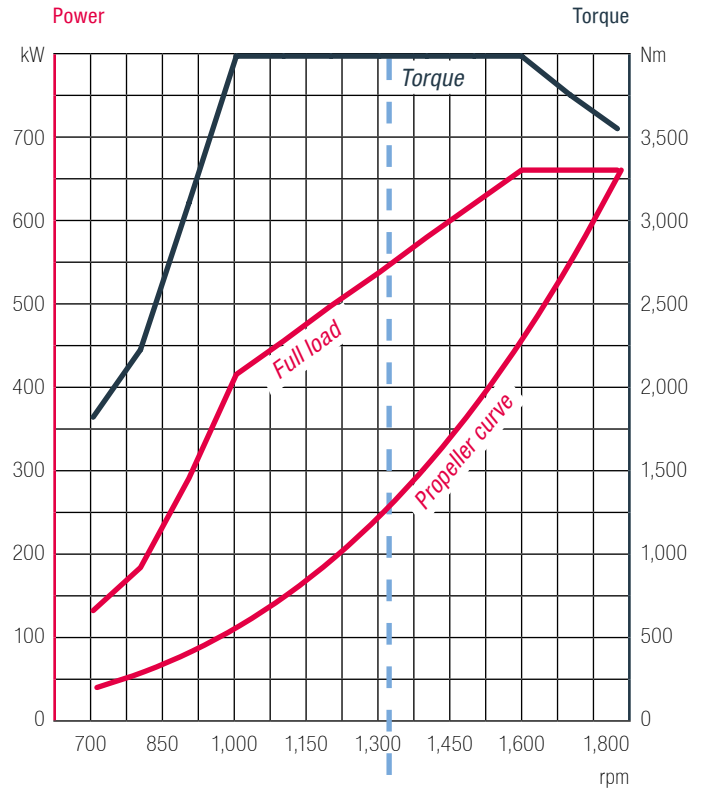

Specific fuel consumption

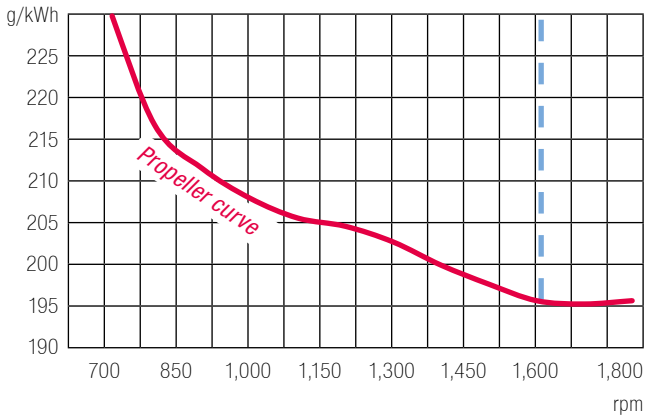

Specific fuel consumption

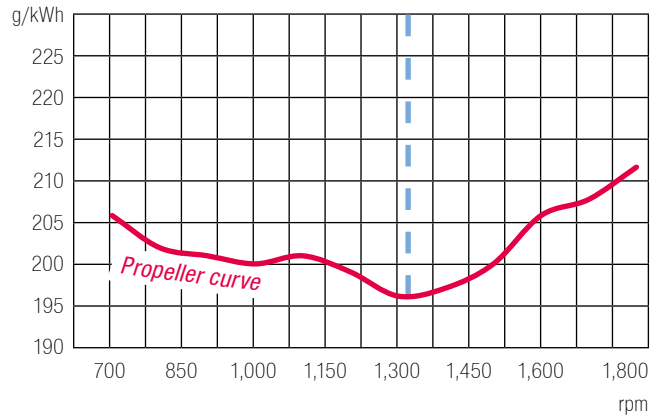

--- Maximum torque at most fuel efficient operating point

## Technical features

Type designation		LE 427	LE 441	LE 444	LE 447
Displacement	l	24.24	24.24	24.24	24.24
Nominal rating <sup>1)</sup>	kW (hp)	662 (900)	735 (1,000)	735 (1,000)	735 (1,000)
Rated speed	rpm	1,800	1,800	1,800	1,800
Torque at rated speed	Nm	3,512	3,900	3,900	3,900
Maximum torque	Nm	3,910	4,380	4,380	4,330
at speed	rpm	1,100–1,600	1,100–1,600	1,100–1,600	1,100–1,600
Lowest specific fuel consumption	g/kWh	196	193	193	193
Classifiable		✓	✓	✓	✓
Exhaust gas aftertreatment		✓	-	-	✓
Exhaust gas status		IMO Tier III, EPA Tier 4 <sup>2)</sup>	IMO Tier II	IMO Tier II, RCD 2013/53/EC, 97/68/EC	IMO Tier III, EPA Tier 4 <sup>2)</sup>

1) The rating is according to DIN 3046/1

2) on request

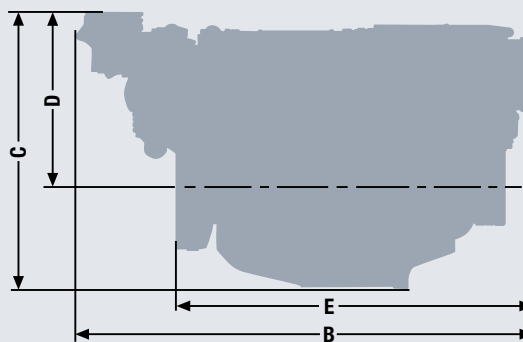
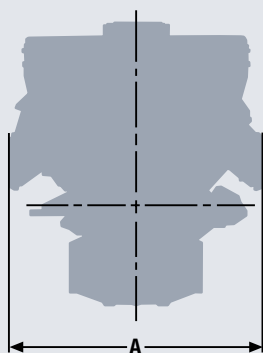

## Dimensions

Type designation		LE 427/441/444/447
A-Overall width	mm	1,153
B-Overall length	mm	2,130
C-Overall height	mm	1,230
D-Top of engine to crankshaft centre	mm	765
E-Length of engine from front end to edge of flywheel housing	mm	1,630
Average weight of engine ready for installation (dry)	kg	2,270

For detailed examinations of installation dimensions, please order drawings from our factory.

# D2862

LE 427

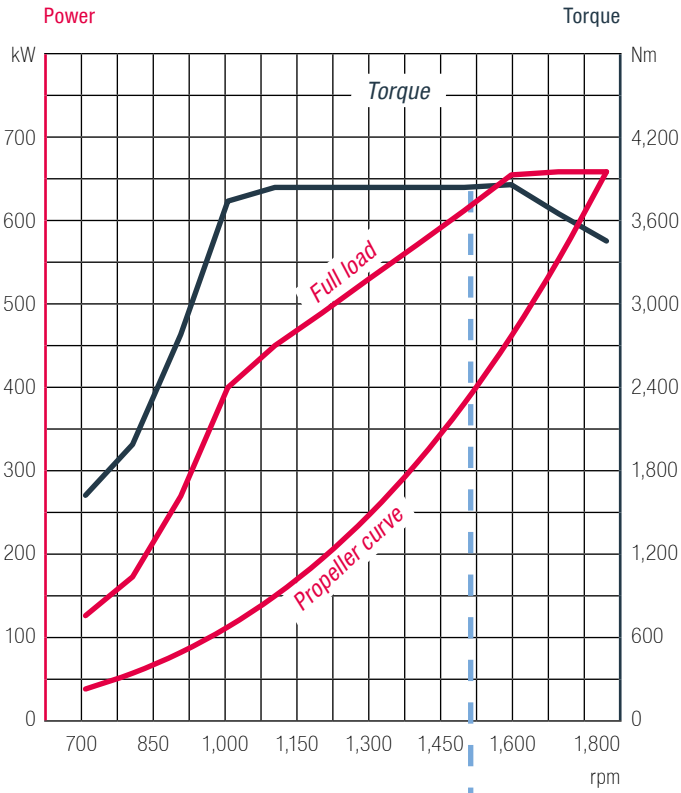

LE 441

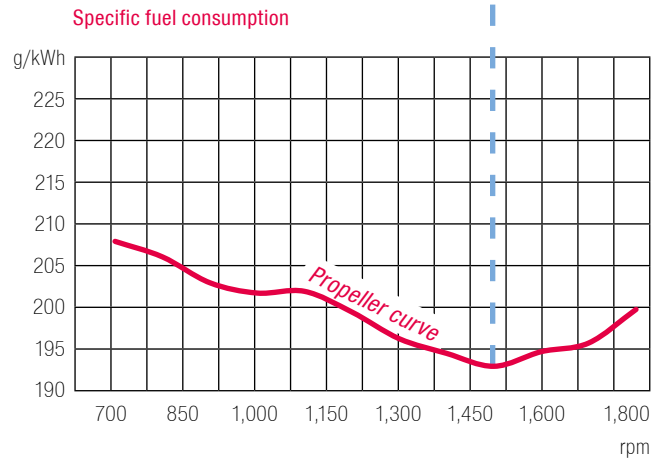
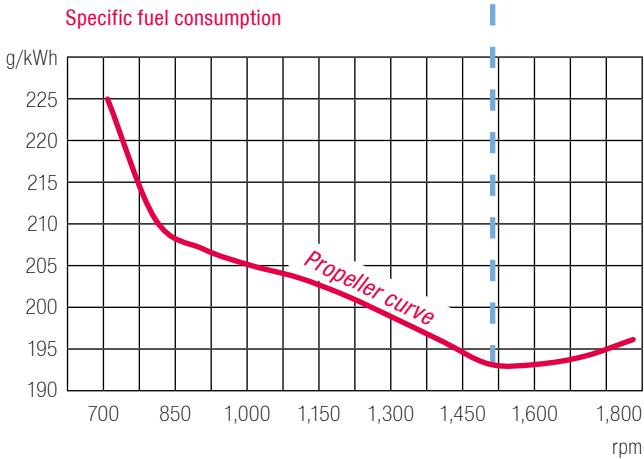
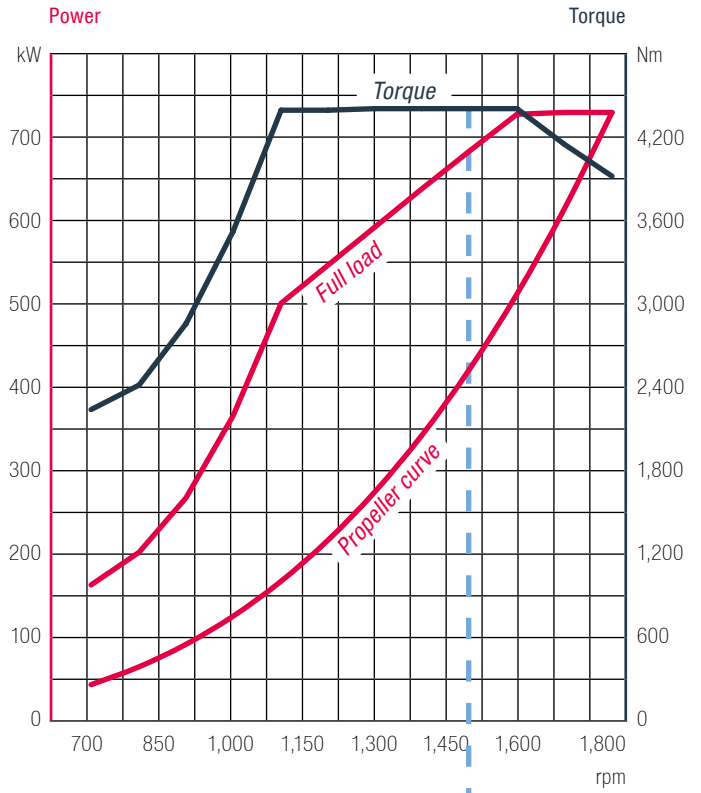

--- Maximum torque at most fuel efficient operating point

LE 444

LE 447

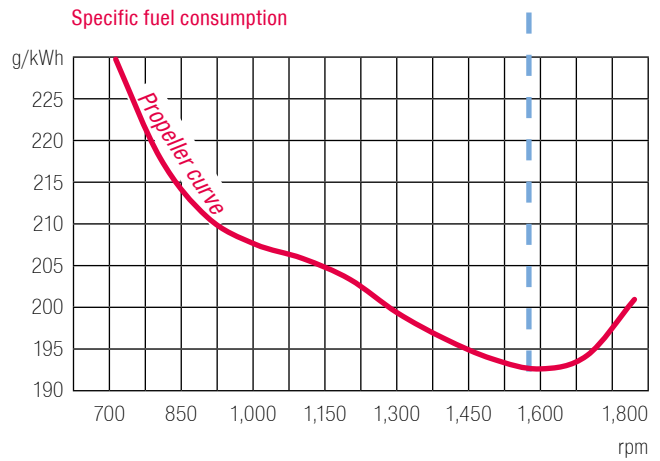
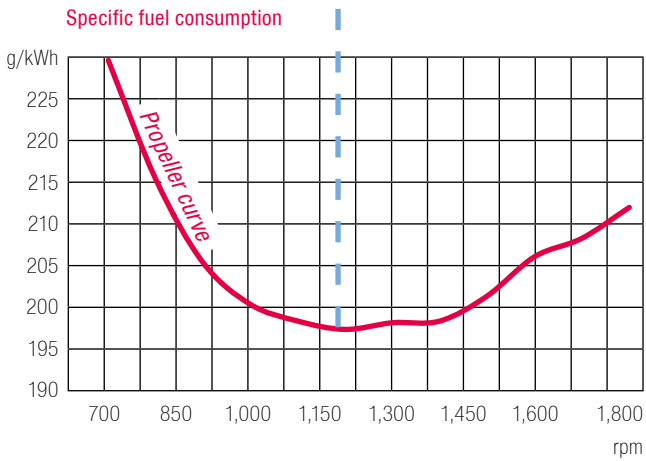
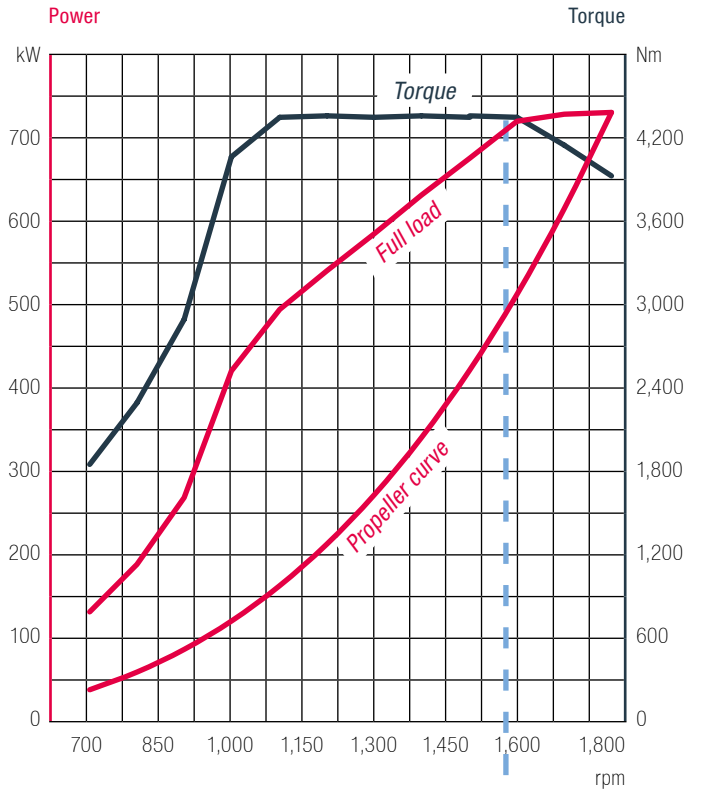
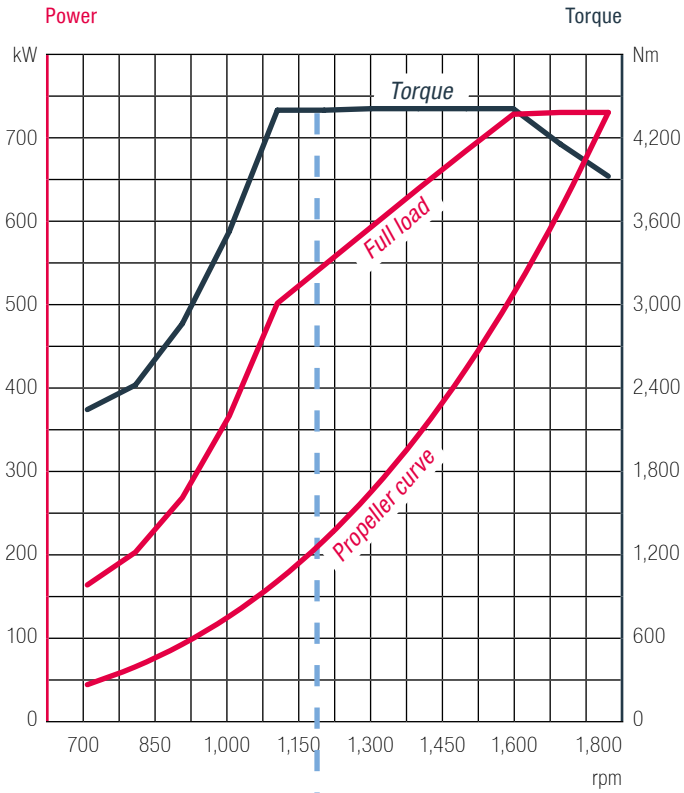

--- Maximum torque at most fuel efficient operating point

# Exhaust aftertreatment

Flexibility makes use of free space – also when it comes to exhaust gas aftertreatment: Individual components of the modular EGA kit from MAN Engines, which can be positioned variably, enable a wide range of installation variants as well as maximum design freedom when installed in machinery and vehicles. Alternatively, pre-defined complete systems offer practical, space-saving solutions.

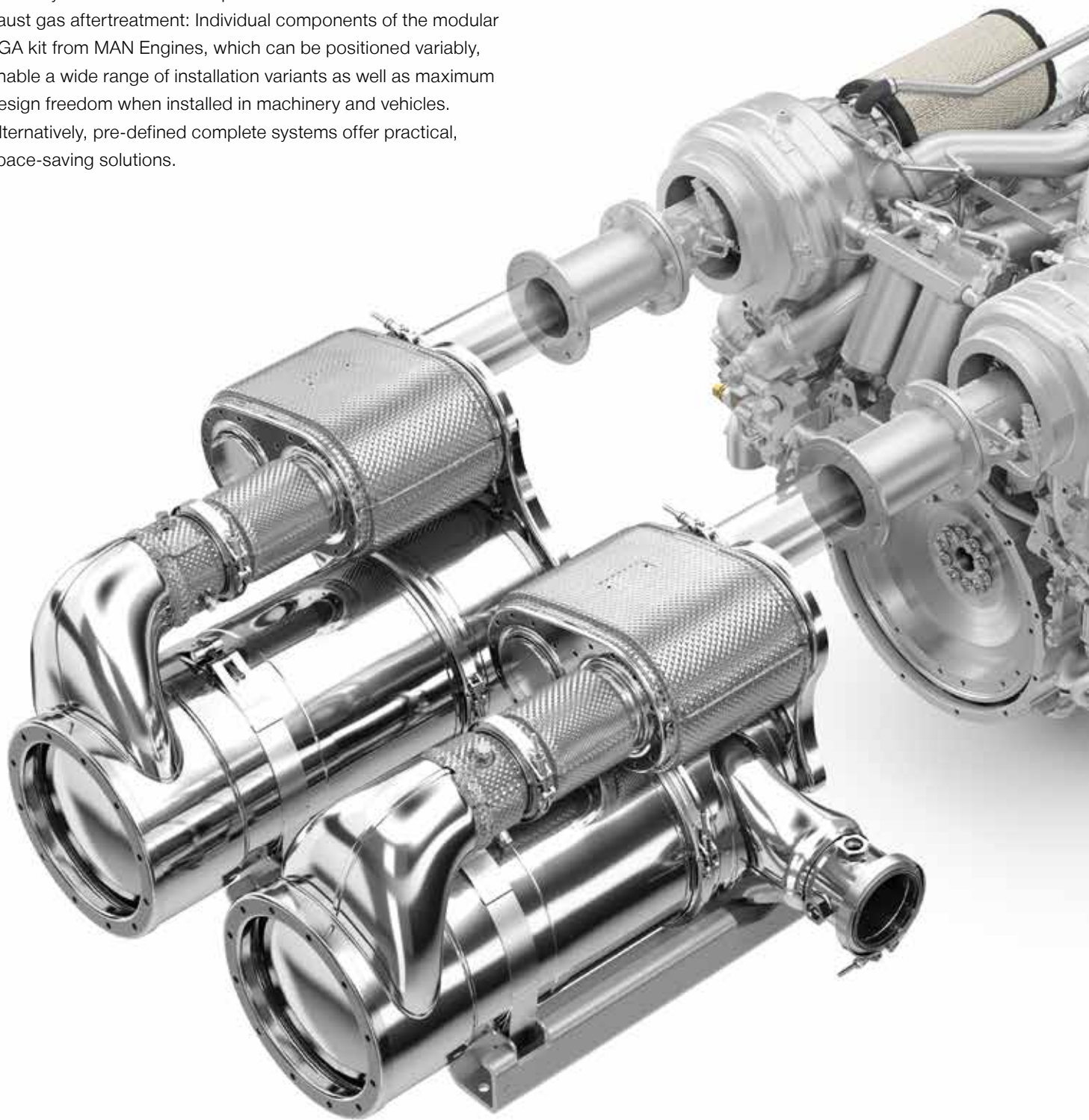

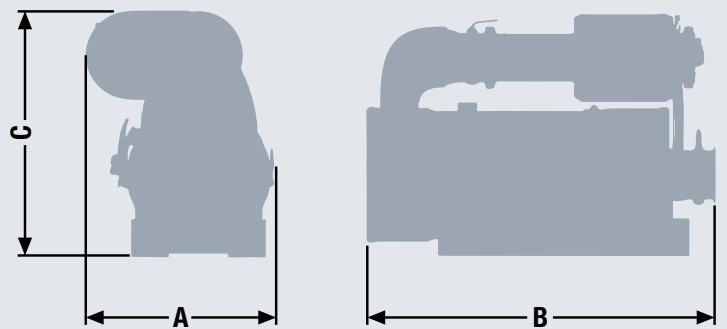

### Dimensions

Type designation		SCR system
A-Overall width	mm	475
B-Overall length	mm	950
C-Overall height	mm	420
Average weight of SCR system with exhaust silencer	kg	115

For detailed examinations of installation dimensions, please order drawings from our factory.

# Exhaust aftertreatment

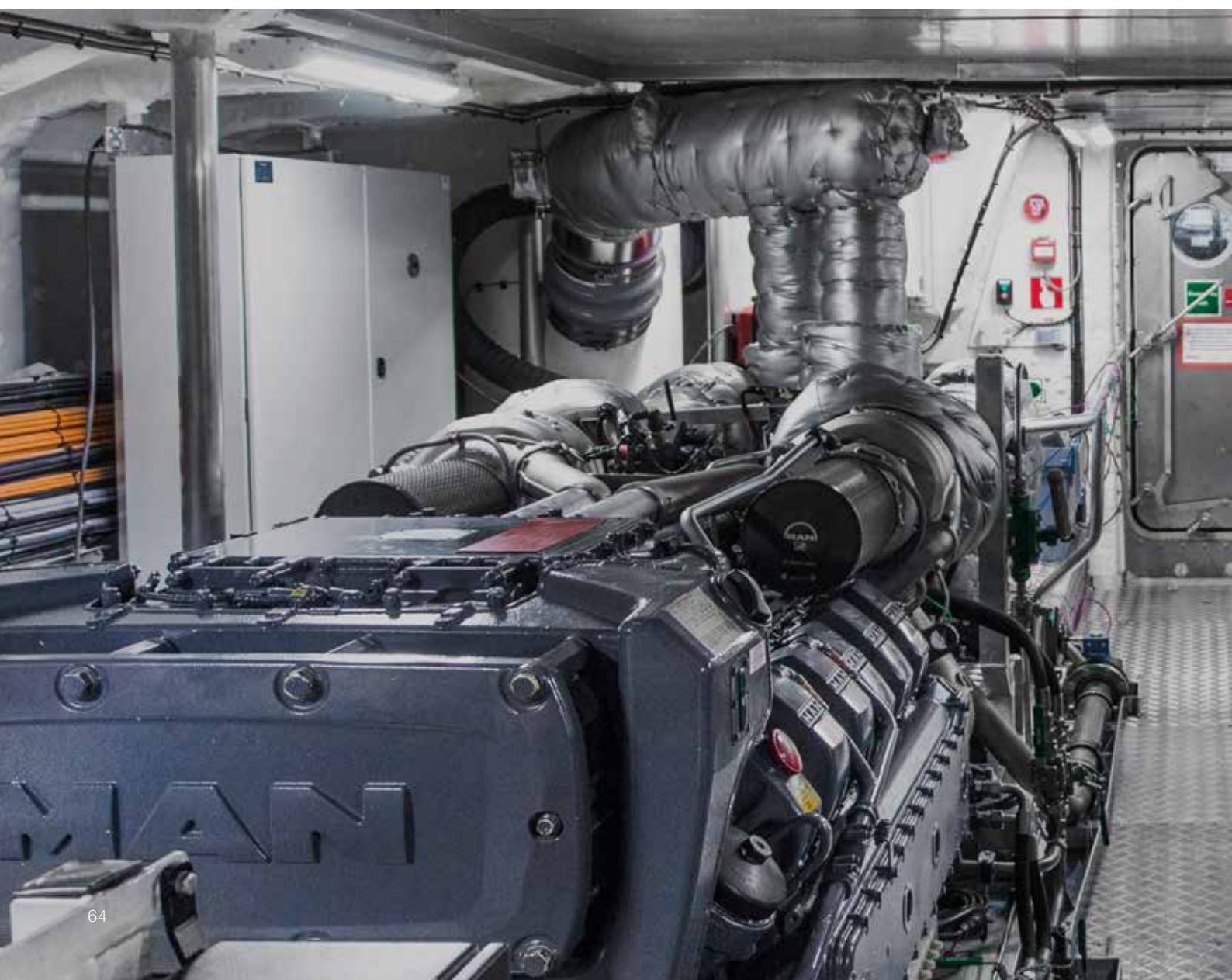





# Notes

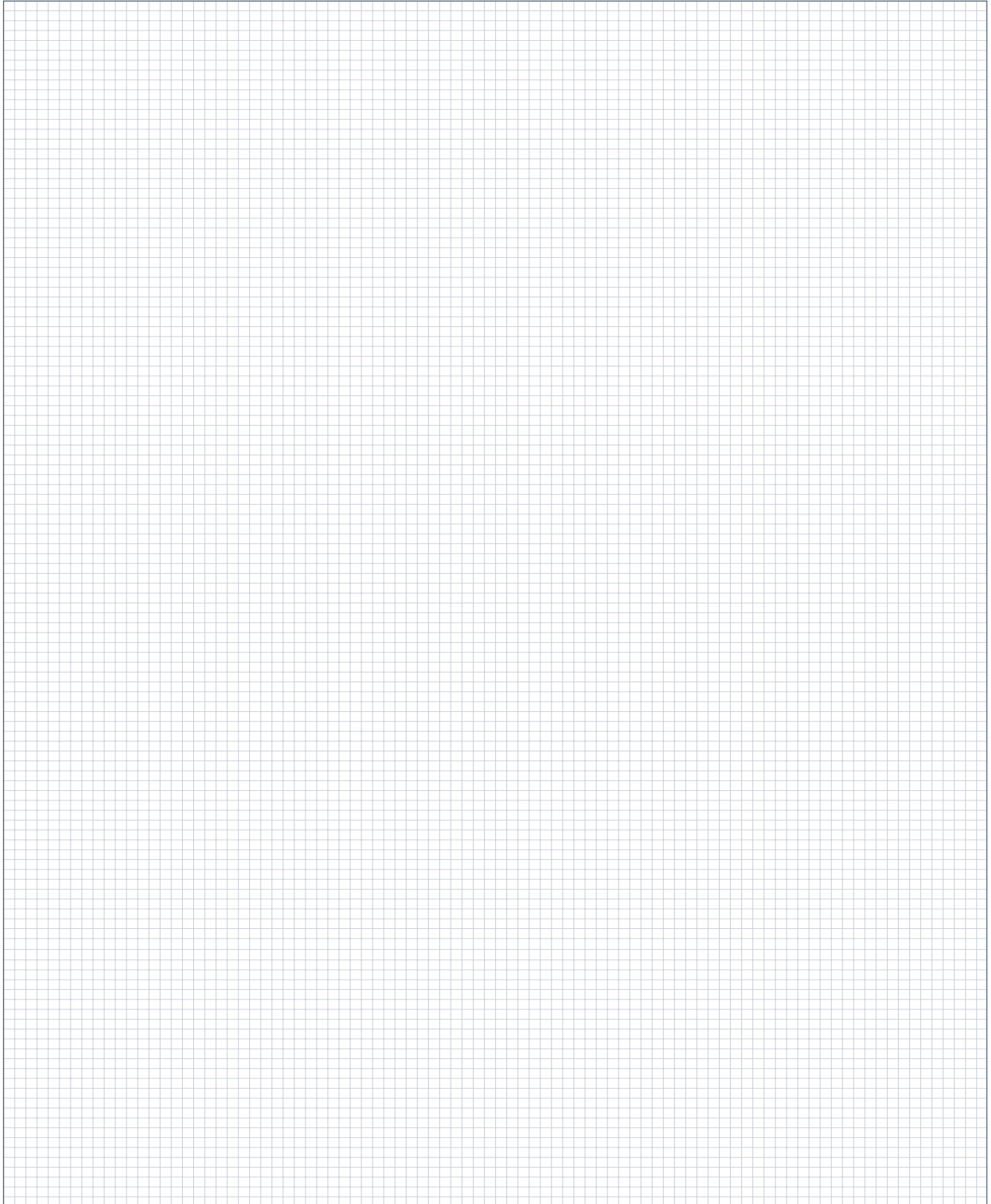

# Engine range

## Light duty

### 6 inline and V8 engines

Characteristics	Unit	D2676		D2868		
		LE 443	LE 423	LE 426	LE 453	LE 436
Type designation						
Arrangement and number of cylinders		R6	R6	V8	V8	V8
Nominal rating	hp	730	800	1,000	1,121	1,200
Maximum torque	Nm	2,450	2,674	3,340	4,345	4,010
Engine classifiable		✓	-	-	✓	-
Rated speed	rpm	2,300	2,300	2,300	2,300	2,300
Lowest specific fuel consumption	g/kWh	199	213	209	206	205
Bore/Stroke	mm	126/166	126/166	128/157	128/157	128/157
Displacement	l	12.42	12.42	16.16	16.16	16.16
Length of engine from front end to edge of flywheel housing	mm	1,527	1,527	1,243	1,262	1,262
Width	mm	986	986	1,153	1,153	1,153
Height	mm	1,096	1,096	1,177	1,222	1,222
Dry weight	kg	1,215	1,215	1,780	1,880	1,880
Exhaust gas aftertreatment		-	-	-	-	-
Exhaust gas status		A	B	A	C	B

Please turn the page for  
V12 engines

- A IMO Tier II, EPA Tier 3, RCD 2013/53/EC, 97/68/EC
- B IMO Tier II, EPA Tier 3 for private use only, RCD 2013/53/EC, 97/68/EC
- C IMO Tier II, 97/68/EC

# Engine range

## Light duty

### V12 engines

Characteristics	Unit	D2862				
		LE 446	LE 426	LE 456	LE 436	LE 476
Type designation		LE 446	LE 426	LE 456	LE 436	LE 476
Arrangement and number of cylinders		V12	V12	V12	V12	V12
Nominal rating	hp	1,400	1,550	1,650	1,800	1,900
Maximum torque	Nm	4,680	5,180	5,510	6,010	6,220
Engine classifiable		✓	-	✓	-	-
Rated speed	rpm	2,300	2,300	2,300	2,300	2,300
Lowest specific fuel consumption	g/kWh	203	203	195	200	199
Bore/Stroke	mm	128/157	128/157	128/157	128/157	128/157
Displacement	l	24.24	24.24	24.24	24.24	24.24
Length of engine from front end to edge of flywheel housing	mm	1,630	1,630	1,658	1,658	1,658
Width	mm	1,153	1,153	1,153	1,153	1,153
Height	mm	1,230	1,230	1,272	1,272	1,272
Dry weight	kg	2,270	2,270	2,380	2,380	2,380
Exhaust gas aftertreatment		-	-	-	-	-
Exhaust gas status		B	B	B	B	B

B IMO Tier II, EPA Tier 3 for private use only, RCD 2013/53/EC, 97/68/EC

# Engine range

## Medium duty

### 6 inline and V8 engines

Characteristics	Unit	D2676				D2868		
		LE 432	LE 435	LE 422	LE 425	LE422	LE425	LE443
Type designation								
Arrangement and number of cylinders		R6	R6	R6	R6	V8	V8	V8
Nominal rating	hp	560	560	650	650	800	800	900
Maximum torque	Nm	2,065	2,065	2,402	2,402	2,950	2,980	3,325
Engine classifiable		✓	✓	✓	✓	✓	✓	–
Rated speed	rpm	2,100	2,100	2,100	2,100	2,100	2,100	2,100
Lowest specific fuel consumption	g/kWh	196	204	197	205	198	209	207
Bore/Stroke	mm	126/166	126/166	126/166	126/166	128/157	128/157	128/157
Displacement	l	12.42	12.42	12.42	12.42	16.16	16.16	16.16
Length of engine from front end to edge of flywheel housing	mm	1,527	1,527	1,527	1,527	1,177	1,177	1,177
Width	mm	986	986	986	986	1,153	1,153	1,153
Height	mm	1,096	1,096	1,096	1,096	1,243	1,243	1,243
Dry weight	kg	1,215	1,215	1,215	1,215	1,780	1,780	1,780
Exhaust gas aftertreatment		–	–	–	–	–	–	–
Exhaust gas status		B	A	B	A	B	A	B

Please turn the page for  
V12 engines

# Engine range

## Medium duty

### V12 engines

Characteristics	Unit	D2862						
		LE 422	LE 428	LE 432	LE 435	LE 438	LE 463	LE 466
Type designation								
Arrangement and number of cylinders		V12	V12	V12	V12	V12	V12	V12
Nominal rating	hp	1,019	1,019	1,200	1,200	1,200	1,400	1,400
Maximum torque	Nm	3,780	3,740	4,450	4,450	4,440	5,120	5,180
Engine classifiable		✓	✓	✓	✓	✓	✓	✓
Rated speed	rpm	2,100	2,100	2,100	2,100	2,100	2,100	2,100
Lowest specific fuel consumption	g/kWh	207	199	198	203	197	200	203
Bore/Stroke	mm	128/157	128/157	128/157	128/157	128/157	128/157	128/157
Displacement	l	24.24	24.24	24.24	24.24	24.24	24.24	24.24
Length of engine from front end to edge of flywheel housing	mm	1,630	1,630	1,630	1,630	1,630	1,630	1,630
Width	mm	1,153	1,153	1,153	1,153	1,153	1,153	1,153
Height	mm	1,230	1,230	1,230	1,230	1,230	1,230	1,230
Dry weight	kg	2,270	2,270	2,270	2,270	2,270	2,270	2,270
Exhaust gas aftertreatment		-	✓	-	-	✓	-	-
Exhaust gas status		B	D	B	C	D	B	B

### V12 engines

Characteristics	Unit	D2862	
		LE 483	LE 489
Type designation			
Arrangement and number of cylinders		V12	V12
Nominal rating	hp	1,450	1,450
Maximum torque	Nm	5,355	5,340
Engine classifiable		✓	✓
Rated speed	rpm	2,100	2,100
Lowest specific fuel consumption	g/kWh	209	196
Bore/Stroke	mm	128/157	128/157
Displacement	l	24.24	24.24
Length of engine from front end to edge of flywheel housing	mm	1,658	1,658
Width	mm	1,153	1,153
Height	mm	1,272	1,272
Dry weight	kg	2,365	2,365
Exhaust gas aftertreatment		-	✓
Exhaust gas status		B	D

B IMO Tier II, 97/68/EC  
 C IMO Tier II, EPA Tier 3, 97/68/EC  
 D IMO Tier III, EPA Tier 4<sup>1)</sup>  
 1) on request

# Engine range

## Heavy duty

### 6 inline engines

Characteristics	Unit	D2676						
		LE 461	LE 451	LE 441	LE 431	LE 434	LE 421	LE 424
Type designation								
Arrangement and number of cylinders		R6	R6	R6	R6	R6	R6	R6
Nominal rating	hp	200	286	367	440	440	520	520
Maximum torque	Nm	900	1,260	1,616	1,925	1,925	2,275	2,270
Engine classifiable		✓	✓	✓	✓	✓	✓	✓
Rated speed	rpm	1,800	1,800	1,800	1,800	1,800	1,800	1,800
Lowest specific fuel consumption	g/kWh	218	209	204	198	204	197	204
Bore/Stroke	mm	126/166	126/166	126/166	126/166	126/166	126/166	126/166
Displacement	l	12.42	12.42	12.42	12.42	12.42	12.42	12.42
Length of engine from front end to edge of flywheel housing	mm	1,527	1,527	1,527	1,527	1,527	1,527	1,527
Width	mm	986	986	986	986	986	986	986
Height	mm	1,096	1,096	1,096	1,096	1,096	1,096	1,096
Dry weight	kg	1,215	1,215	1,215	1,215	1,215	1,215	1,215
Exhaust gas aftertreatment		-	-	-	-	-	-	-
Exhaust gas status		A	A	A	A	B	A	B

Please turn the page for  
V8 and V12 engines

# Engine range

## Heavy duty

### V8 and V12 engines

Characteristics	Unit	D2868				D2862		
		LE 421	LE 424	LE 431	LE 431	LE 434	LE 437	LE 421
Type designation								
Arrangement and number of cylinders		V8	V8	V8	V12	V12	V12	V12
Nominal rating	hp	600	600	680	749	749	749	900
Maximum torque	Nm	2,630	2,630	2,985	3,305	3,305	3,295	3,955
Engine classifiable		✓	✓	✓	✓	✓	✓	✓
Rated speed	rpm	1,800	1,800	1,800	1,800	1,800	1,800	1,800
Lowest specific fuel consumption	g/kWh	197	206	199	198	202	195	195
Bore/Stroke	mm	128/157	128/157	128/157	128/157	128/157	128/157	128/157
Displacement	l	16.16	16.16	16.16	24.24	24.24	24.24	24.24
Length of engine from front end to edge of flywheel housing	mm	1,243	1,243	1,243	1,630	1,630	1,630	1,630
Width	mm	1,153	1,153	1,153	1,153	1,153	1,153	1,153
Height	mm	1,243	1,243	1,243	1,230	1,230	1,230	1,230
Dry weight	kg	1,780	1,780	1,780	2,270	2,270	2,270	2,270
Exhaust gas aftertreatment		-	-	-	-	-	✓	-
Exhaust gas status		A	B	A	A	B	E	A

### V12 engines

Characteristics	Unit	D2862			
		LE 427	LE 441	LE 444	LE 447
Type designation					
Arrangement and number of cylinders		V12	V12	V12	V12
Nominal rating	hp	900	1,000	1,000	1,000
Maximum torque	Nm	3,910	4,380	4,380	4,330
Engine classifiable		✓	✓	✓	✓
Rated speed	rpm	1,800	1,800	1,800	1,800
Lowest specific fuel consumption	g/kWh	196	193	212	193
Bore/Stroke	mm	128/157	128/157	128/157	128/157
Displacement	l	24.24	24.24	24.24	24.24
Length of engine from front end to edge of flywheel housing	mm	1,630	1,630	1,630	1,630
Width	mm	1,153	1,153	1,153	1,153
Height	mm	1,230	1,230	1,230	1,230
Dry weight	kg	2,270	2,270	2,270	2,270
Exhaust gas aftertreatment		✓	-	-	✓
Exhaust gas status		E	C	D	E

- A IMO Tier II, 97/68/EC
  - B IMO Tier II, EPA Tier 3, RCD 2013/53/EC, 97/68/EC
  - C IMO Tier II
  - D IMO Tier II, RCD 2013/53/EC, 97/68/EC
  - E IMO Tier III, EPA Tier 4<sup>1)</sup>
- 1) on request





**MAN Truck & Bus AG**

Vogelweiherstraße 33

90441 Nuremberg

[www.man-engines.com](http://www.man-engines.com)

D 114.615 - bs 06185 - Printed in Germany

All data provided in this document is non-binding and not guaranteed in any aspect. The relevant data may be subject to changes and will be assessed and determined individually for each project depending specific site and operational conditions.