

42-C

OWNERS MANUAL





SILVERTON

MARINE CORPORATION AN EMPLOYEE OWNERSHIP COMPANY

Thank you!!
from your
Silverton Team!

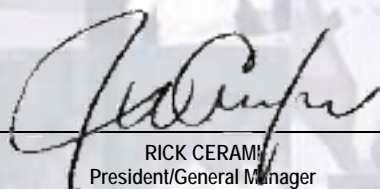

RICK CERAMI
President/General Manager

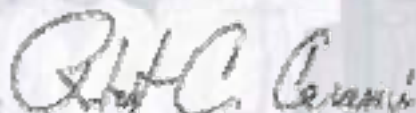

BOB CERAMI
Vice President of Operations

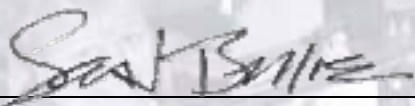

SEAN BERRIE
Director of Design & Engineering



WALT SHARP
Chief Engineer

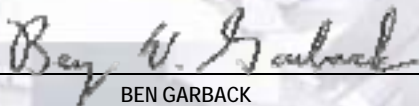

BEN GARBACK
Comptroller



JENNEY PETERSEN
Accounting Manager

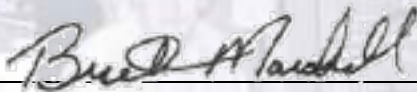

BRETT MARSHALL
Director of Sales

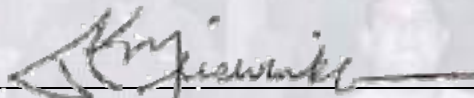

BOB MEISWINKLE
Regional Sales Manager

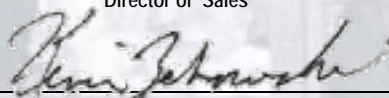

KEN ZEBROWSKI
Customer Service Manager

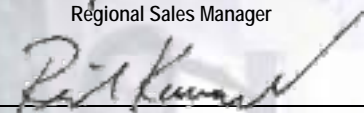

RICH KARRASCH
Quality Assurance Manager

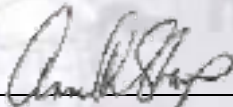

ANNE SHARP
Human Resources Manager

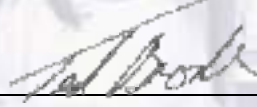

TED BRODE
Purchasing Manager

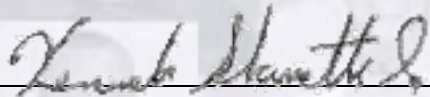

KEN SHARRETTS
Production Manager

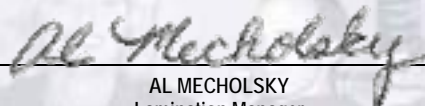

AL MECHOLSKY
Lamination Manager

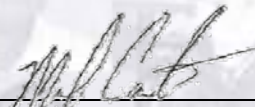

MIKE CARTER
Mill Manager



TABLE OF CONTENTS

Introduction

Letter from the President.....	5
The Silverton Story.....	7
Introduction to your Owner's Manual.....	9
Warranty Information.....	13
Recommended Reading.....	19
Record Keeping.....	19
Accident Reporting.....	19

Getting Familiar

Hull.....	1
Deck.....	5
Bridge.....	9
Interior.....	13
Engine Compartment.....	19

Boating Safety

Boating Safety.....	1
Safety Equipment.....	1
Fire Equipment.....	2
Navigation Rules of the Road.....	5
Basic Rules of Safe Boating.....	7
Carbon Monoxide Safety.....	8
Fuel Safety.....	13
Emergency Situations.....	14
Hazardous Weather Conditions.....	15
Fire Safety.....	16

Systems Operation

Air Conditioning/Heating System.....	1
Anchor System.....	3
Bilge Pump System.....	7
Bilge Ventilation System.....	9
Bonding System.....	11
Carbon Monoxide (CO) Detector System.....	13
Electrical System.....	15
Entertainment System.....	27
Fire Extinguisher System.....	29
Fresh Water System.....	33
Fuel System.....	37
Generator System.....	47
Hot Water System.....	51
Propulsion System.....	53
Marine Sanitation System.....	57
Shower Sump Pump System.....	61
Steering System.....	63
Shift/Throttle Control System.....	65
Trim Tab System.....	67
Icemaker Unit (Optional).....	69
LPG System (Optional).....	71
Oil X-changer System (Optional).....	73
Spotlight (Optional).....	75
SeaKey.....	77

Cleaning and Maintenance

Interior.....	1
Exterior.....	2
Canvas Enclosure (Optional).....	4
Winterization and Storage.....	6

Operating your Yacht

Engine Startup Preparation.....	1
Engine Startup.....	3
Shakedown Cruise.....	4
Getting Underway.....	5
Daily Engine Shutdown.....	5
16 Ways to Reduce Fuel Costs.....	7

Glossary

Warning Labels.....	5
Identification Labels.....	7
Maintenance Log.....	9
Maintenance Schedule.....	11
Boat Record.....	13
Boating Accident Report.....	15
Float Plan.....	19

SYSTEM SCHEMATICS.....

SPECIFICATIONS

42 CONVERTIBLE

Overall Length - 44' - 6"

Length at Waterline - 43'-10.5"

Beam - 14' - 10.5"

Beam - Waterline - 12' - 4"

Draft (Maximum) - 3' - 7"

Displacement (dry) - 26,300 lbs.

Displacement (full fluids) - 26,904 lbs.

Transom Deadrise - 17 degrees

Fuel Capacity - 524 Gal.

Fresh Water Capacity - 200 Gal.

Waste Water Capacity - 40 Gal.

Water Heater Capacity - 10.5 Gal.

Average Headroom - 6' - 5"

Maximum Recommended Number of Persons - 12

Maximum Recommended Load - 2,732 lbs

INTRODUCTION

Thank You!
From the President

Dear Silverton Owner,

Congratulations and welcome to the Silverton Family! As a Silverton owner, you will enjoy the quality and the attention to detail for which our Silverton yachts are renowned. Silverton and your dealer are committed to your service and total satisfaction.

This Owner's Manual will acquaint you with the proper operation and maintenance of your new Silverton yacht, as well as boating safety; which is our primary concern, whether docked or at sea.

Please mail in all manufacturers' registration and warranty cards to ensure that your Silverton and Original Equipment Manufacturer (O.E.M.) warranties are valid. The individual warranty cards are contained in the Owner's Packet along with all of the O.E.M. Manuals. Please remember that all

information contained in the O.E.M. Manuals supersedes the information contained in this Owner's Manual.

Finally, if you are new to boating, be certain to learn the proper rules of seamanship to ensure your safety and the safety of your passengers. Refer to Chapman's Piloting, Seamanship, and Small Boat Handling Manual for important and useful information concerning this aspect of boating. Attend a safe boating course offered by the United States Coast Guard Auxiliary, United States Power Squadron, or any enterprise experienced in conducting safe boating courses.

Thank you for choosing a Silverton. I am confident your new yacht will provide you and your family with years of enjoyable cruising.



Richard Cerami, President
Silverton Marine Division

THE SILVERTON STORY

SILVERTON YACHT OWNERS AND FOUNDERS

WARREN LUHRS & JOHN LUHRS

Hailing from East Orange, New Jersey, John and Warren Luhrs' ancestry goes back to their great-grandfather, Henry, who helped pioneer the development of railroading and clipper ships in America, and to their great-uncle, John, who helped build the famous St. Petersburg-to-Moscow Railroad for Russian Czar Alexander II.

Henry Luhrs owned shares in twenty-two different ocean-going vessels - barques, brigs, and schooners - and was the principal owner of the barque, Sophia R. Luhrs, named after his wife. He was also a partner with Albert Sprout, who managed a shipyard in Melbridge, Maine, where the Sophia R. Luhrs was built.

The Luhrs' family sea tradition was carried on during the Great Depression by John and Warren Luhrs' father, Henry, who worked at a small boat manufacturer in Morgan, New Jersey, and later started his own company. When war broke out in Europe, the United States Coast Guard asked Henry Luhrs to repair their boats and install ice sheathing on their bows.

After World War II, Henry built 27-foot fishing boats and, in 1948, he began to construct custom-built pleasure craft. He then turned to skiffs and, in 1952, incorporated as "Henry Luhrs Sea Skiffs". He constructed lap strake sea skiffs using assembly-line techniques. Henry personally "shook down" his prototypes with family trips up the Hudson River to Lake Champlain.

Henry Luhrs' basic philosophy was to emulate the late Henry Ford in building an inexpensive boat for the average man, thus enabling him to enjoy the luxury of boating. He was both designer and engineer, creating innovative and progressive new models. He designed the change in the line of the bow from straight to curved at a time when all boats were being built with the straight, square effect. It is believed he was also the first designer-builder to popularize a small boat with a flybridge.

In 1960, Henry Luhrs acquired the Ulrichsen Boat Company, located in Marlboro, New Jersey. It was here, too, that the Luhrs Alura Fiberglass Division was located. In 1965, Henry sold his company to Bangor Arrostock Railroad, which was to become the recreational conglomerate, Bangor-Punta. It was also during this period that the Silverton Company in Toms River, New Jersey, was purchased by his sons, John and Warren Luhrs.

Today, John and Warren own Silverton Marine Corporation, Hunter Marine Corporation, Mainship Motor Yachts Corporation, and Luhrs Fishing Boats Corporation, known as the "Luhrs Marine Group."

In January 1996, John and Warren transferred a portion of the Luhrs Marine Group to its employees through an Employee Stock Ownership Program, ensuring a personal interest in the construction of your Silverton yacht.

INTRODUCTION TO YOUR YACHT

OWNER'S MANUAL

We appreciate your selection of the Silverton yacht. We have designed and manufactured this yacht to bring you a strong, safe, and attractive yacht that will provide you with many years of pleasure and pride in ownership.

All Silverton yachts are built in compliance with applicable United States Coast Guard regulations and recommendations. In addition, our yachts meet or exceed all standards developed by the National Marine Manufacturer's Association for its "Yacht Certification Program".

This Owner's Manual includes general information concerning the operation, handling, and maintenance of your yacht. In addition, the various systems, both standard and optional, and factory installed equipment are described.

Please note that the information contained in this Owner's Manual summarizes the detailed information contained in the Original Equipment Manufacturer's (O.E.M.) Manuals contained in the Owner's Packet and is only intended to be a convenient reference for your daily use. Refer to the appropriate O.E.M. Manual for detailed information concerning the operation and maintenance of its respective piece of equipment.

Maintain your Owner's Manual and the Owner's Packet together in a safe, convenient location that is easily accessible for readily available reference.

General information designed to assist you in understanding the contents of your Owner's Manual is as follows:

HAZARD COMMUNICATION

This Owner's Manual contains certain signal graphics designed to call your attention to important and specific information. These graphics are shown as follows:



DANGER calls attention to immediate hazards that WILL result in severe personal injury or death.



WARNING identifies hazards or unsafe practices that COULD result in severe personal injury or death.



CAUTION indicates hazards or unsafe practices that COULD result in minor personal injury, product, or property damage.

OWNER ADVISORY STATEMENTS

This Owner's Manual contains certain advisory statements designed to alert you to conditions affecting equipment operation and maintenance practices and they are as follows:

Important: *This is an advisory statement or procedure intended to prevent damage to equipment or its associated components.*

Note: *This is a general advisory statement relating to equipment and maintenance procedures intended to call your attention to important information that is not contained within the normal text describing the specific issue.*

SUMMARY OF OWNER'S MANUAL CONTENTS

Brief summaries of each section of this Owner's Manual are as follows:

Introduction

This section includes general information about your yacht, warranty information, your responsibilities as the owner and/or operator, laws and regulations, logs and records.

Getting Familiar

This section is like a tour; showing you the various accessories and appliances, both standard and optional, that are found on your yacht. In addition, the Hull, Deck, Interior, and Engine Compartment will be described.

Boating Safety

This section discusses potential hazards associated with boating, safety recommendations, safety information, and safety practices. It also discusses safety equipment necessary to provide a reasonably safe operating environment.

Note: *For your safety, this Owner's Manual has specific safety warnings and comments where appropriate. Be certain to read and have an understanding of the entire manual.*

Systems Operation

This section explains the various systems found on your yacht and their operation and maintenance procedures.

Cleaning / Maintenance

Preventive maintenance is the key to trouble-free operation and helps to protect your investment. This section explains what you should do to maintain your yacht and how to make basic adjustments and repairs. A Maintenance Chart summarizes maintenance tasks by frequency. Included are procedures for winterizing and storing your yacht.

Operation of Your YACHT

This section explains what procedures you should follow before, during and after your boating excursion to make it an enjoyable and safe experience.

Glossary of Terms

The Glossary defines common nautical terms associated with your yacht.

Systems Schematics

This section displays schematic drawings, such as the Mechanical Layout, Electrical Schematic, and Fresh Water Schematic that may be useful to you in understanding the general layout of the systems described.

ORIGINAL EQUIPMENT MANUFACTURER'S MANUALS

Silverton purchased various items of equipment from other manufacturers and installed them on your yacht while it was being built. Examples of this equipment include, but are not limited to, the engines, generator (if so equipped), and appliances. The Original Equipment Manufacturers (O.E.M.) have provided operation and maintenance manuals describing their specific piece of equipment. **Although this Owner's Manual summarizes the information contained in the O.E.M. Manuals, it does not replace them. In the event of a conflict between the information contained in this manual and the information contained in the O.E.M. Manual, the O.E.M. Manual takes precedence.** Maintain all O.E.M. Manuals with this Owner's Manual in a safe, convenient location and be certain to pass them on to the new owner in the event you sell or trade your yacht.

WARRANTY INFORMATION

Silverton Yacht Dealers

Your Silverton yacht dealer is a trained professional with facilities and resources available to serve you to your complete satisfaction. Your dealer can assist you in all phases of yacht service and you should bring to his attention any problems you may not be able to correct. All warranty claims and subsequent service must be approved through your Silverton Dealer. The Silverton warranty is reproduced in its entirety at the end of this section.

Pre-Delivery Service Record

Your Silverton yacht was thoroughly inspected before it was shipped from the factory. Your dealer also inspected it during the pre-delivery service inspection. Please take time to discuss these inspections, the Silverton warranty, component warranties, and operation of your yacht with your dealer.

Your Silverton Dealer completes a Pre-Delivery Service Record before you take delivery of your yacht. It is the dealer's responsibility to both you and to Silverton to give your yacht a final inspection. The purpose of this inspection is to assure the proper adjustment and operation of all components installed on your yacht. Your dealer should provide you with the Pre-Delivery Service Record at the time of delivery. After you and your dealer have signed the form, the original copy and your warranty card is forwarded to Silverton.

Silverton will not pay warranty costs for items that should have been corrected during the pre-delivery service inspection and recorded on the Pre-Delivery Service Record.

Warranty Registration

All Silverton yachts are shipped to the dealer with a warranty registration form for the yacht. The warranty card should be completed and returned to Silverton, together with signed copies of the Pre-Delivery Service Record, within ten (10) days of delivery. **Failure to do so may void the warranty.**

Warranty Conditions

To avoid any misunderstanding of Silverton's warranty policy, we suggest that you discuss the following with your Silverton yacht dealer:

- All customer warranty claims and subsequent repairs must be approved through your Silverton Dealer.
- Your yacht must be returned to your selling dealer for warranty repairs unless other arrangements between the dealer and the customer have been made before delivery. Silverton will not pay travel time or mileage for warranty claims.
- Silverton allows a set hourly rate for labor. If you use any service facility other than a Silverton Dealer for warranty repairs, either the owner or the dealer must absorb any difference between what Silverton allows and what the "service contractor" may charge.
- Silverton will not assume any responsibility or liability for parts replaced or labor completed by anyone other than an authorized Silverton Dealer without prior authorization from Silverton.
- Silverton will not warrant items that should have been covered during the pre-delivery service inspection.
- Silverton will not be responsible for any problems or inconveniences that may be caused as a result of a defect.
- Silverton will not be responsible for any losses caused as a result of a defect for any reason.

Second Owner's Warranty

Some Silverton yacht owners trade up to a newer or larger yacht before the warranty on their current yacht has expired. Silverton will transfer the remaining warranty on your new yacht to its new owner. Conditions of the warranty transfer are stated in their entirety at the end of this section.

Owner's Responsibilities

Silverton service and support does not end after you purchase your yacht. Our dealers are committed to your total satisfaction with your yacht. They cannot accomplish this objective without your assistance. You are responsible for:

- Obtaining state registration or federal documentation.
- Providing and maintaining all safety equipment required by the United States Coast Guard.
- Completing and forwarding all Original Equipment Manufacturer's warranty registrations.
- Performing and completing required OEM maintenance.

LIMITED WARRANTY

According to the U.S. Public Law No. 93-637, effective July 4, 1975, the following limited warranties apply to all 2002 and newer Model Year boats produced by SILVERTON MARINE CORPORATION.

LIMITED TWO-YEAR WARRANTY

Silverton Marine Corporation ("Silverton") warrants to the first-use purchaser and any subsequent registered owner during the warranty period, that any part manufactured by Silverton in its 2007 Model Silverton Yacht purchased from an authorized Silverton Dealer will be free of defects caused by faulty workmanship or materials for a period of twenty-four (24) months from the date of delivery to the first-use purchaser, provided the part is properly used and maintained and subject to the following exclusions, limitations, and conditions. As the sole and exclusive remedy, Silverton's obligation under this warranty is limited to repair or replace any such defective part.

LIMITED FIVE-YEAR BOTTOM BLISTER WARRANTY

Silverton warrants to the first-use purchaser and any subsequent owner during the warranty period that the boat will be free from gelcoat blistering on underwater, exterior gelcoat surfaces of the hull, for a period of five (5) years from the date of delivery to the first-use purchaser, provided the hull has been properly used and maintained and subject to the following exclusions, limitations, and conditions. During this period, Silverton will supply or reimburse an authorized Silverton Dealer the parts and labor required to repair a blistered underwater surface of the hull. It is recommended that the blister repair be done during a seasonal haul out for service or storage.

Silverton's obligation for the cost reimbursement pursuant to this warranty is based on the prorated schedule described hereafter during the five-year period. During the first two (2) years of the first-use purchaser's ownership, Silverton will pay for 100% of the repair cost. During the third year of the first-use purchaser's ownership, Silverton will pay for 75% of the repair cost. During the fourth year of the

first-use purchaser's ownership, Silverton will pay for 50% of the repair cost. During the fifth year of the first-use purchaser's ownership, Silverton will pay for 25% of the repair cost.

The following will void this bottom blister limited warranty:

1. If the hull gelcoat has been sanded, sandblasted, and subjected to abrasion, impact or damage and/or such conditions being repaired.
2. If Silverton's required bottom preparation procedures described in the Silverton Owner's Manual are not followed.
3. If the hull gelcoat has been altered in any way by repairs or coatings other than the proper application of anti-fouling bottom paint.

LIMITED HULL AND DECK STRUCTURE FIBERGLASS WARRANTIES

Lifetime Limited Warranty Coverage to First-Use Purchaser (Non-Transferable): Silverton warrants to the first-use purchaser, who is not a corporation, limited liability entity, partnership or business entity, that the hull and deck of each boat will be free from structural defects in fiberglass materials and workmanship for the lifetime of the hull beginning with the date of delivery.

Five Year Limited Warranty Coverage (Transferable to Subsequent Registered Owner): Silverton warrants to the first-use purchaser and any subsequent registered owner during the warranty period the hull and deck of each boat shall be free from structural defects in fiberglass materials and workmanship for a period of five (5) years from the date of delivery to the first-use purchaser and subsequent registered owner under normal use and service.

These limited warranties apply only to the structural integrity of the deck and hull and the supporting pan/grid or stringer system. Hulls, pan/grid, or stringers modified in any way, or powered by engines other than the type and size installed or specified by Silverton, are not covered by these limited warranties. As the sole and exclusive remedy, Silverton's obligations under these limited warranties are limited to the repair or replacement of any such structurally defective part.

CONDITIONS ON THE APPLICABILITY OF LIMITED WARRANTY COVERAGE

The limited warranties contained herein apply only to covered defects first arising and reported in writing to Silverton or its authorized dealer within the applicable warranty coverage. If the Silverton Yacht is used for commercial, rental, charter or any other non-consumer, individual or recreational services, then the above warranty periods are limited to sixty (60) days from the date of purchase. These limited warranties shall not be effective unless the Silverton warranty registration form and pre-delivery service record are duly completed and signed by the first-use purchaser within ten (10) days of the date of delivery of a Silverton Yacht. The warranty registration form and the pre-delivery service record must be returned to Silverton, and they must be appropriately completed and signed by both the authorized Silverton Dealer and owner. Warranty coverage shall not be initiated until the completed form is received at Silverton. The Silverton Dealer is responsible for submitting the warranty registration form and pre-delivery service record to Silverton.

The Silverton Dealer is to be used by the Silverton Yacht owner for reporting, claiming, and receiving any warranty service from Silverton. All repairs covered by these limited warranties must be pre-approved by Silverton. Normally, all repair requests and approvals are to be communicated through an authorized Silverton Dealer. To obtain warranty service for your Silverton Yacht, including any allegedly defective part, you, as owner, must make a specific and detailed claim in writing to an authorized Silverton Dealer within the applicable warranty period. Warranty repairs may be performed at the authorized Silverton Dealers servicing location or at an otherwise Silverton approved servicing facility at Silverton's discretion. The owner is responsible for all expenses associated with transporting the Silverton Yacht and/or the defective part to and from the Silverton selected service location. Silverton may also, at its option, choose to conduct any repairs or replacements at the Silverton plant. If repairs or replacements are determined to be performed at the Silverton plant, then the transportation costs to and from the Silverton plant are the obligation of the owner.

The Silverton Yacht owner shall report to Silverton any Silverton Dealer failures in the performance of warranty repairs.

The sole and exclusive remedy under this warranty, including any applicable implied warranty, is the repair or replacement as determined by Silverton at its option of defects in materials and workmanship covered by the limited warranties. The labor cost reimbursement will be based on the Labor Allowance Schedule established by Silverton from time to time. Repairs are not to be performed by a non-Silverton Dealer and the repair cost MUST be authorized by Silverton in advance and be based on a reasonable number of hours as determined by Silverton. Transportation, hauling, launching, bottom paint, storage, dockage, cradling rental, rigging and de-rigging, or other similar costs are not part of Silverton's obligation under the limited warranties and shall not be paid for by Silverton.

LIMITED WARRANTY EXCLUSIONS

- * Silverton does not provide any warranty coverage nor shall it have any liability or responsibility for any defects, costs, expenses or damages related to the following:
- * Any yacht purchased from any party who is not an authorized Silverton Dealer.
- * Damage or deterioration of the gelcoat surface finishes, including cracking, fading or oxidation of gelcoat.
- * The cost to remove, disassemble, or reinstall any part not installed by Silverton which is needed to be removed before any warranty work approved by Silverton may be conducted.
- * Engines, transmissions, or generator(s).
- * Any component covered by its own specific warranty (such as, appliances or furniture not manufactured by Silverton).
- * Any glass breakage.
- * Speeds, fuel consumption, range or handling, or performance characteristics.
- * Exterior fabrics, carpet, upholstery, canvas, and enclosures.
- * Any parts or components not installed by Silverton.

* Any damage caused by collision, grounding, act of nature, accident, or abuse.

* Any loss of use, loss of time, maintenance cost, travel expenses, towing, transportation, survey expenses or other items not specifically covered within this document.

* Any Silverton that has been used for charter, rental or commercial, racing or military purpose (See 60-day limitation specified herein).

* Any Silverton that has been misused, used for commercial purpose, operated without required maintenance or operated contrary to instructions in the Silverton owner's manual, modified or altered from factory specifications or subject to improper maintenance.

* Damage, deterioration, and failure to maintain interior fabrics and finishes.

* Any Silverton product identified by Silverton to an authorized dealer as too damaged to be warranted.

* Paint, gelcoat, upholstery damage, plastic finishes, engines, engine parts, bilge pumps, stoves, blowers, pressure water pumps, propellers, shafts, rudders, controls, instruments.

* Problems caused by improper operation and maintenance, storage, cradling, blocking, normal wear and tear, misuse, neglect, accident, corrosion, electrolysis, or improper operation.

LIMITATION/EXCLUSION OF ANY APPLICABLE IMPLIED WARRANTIES

These limited warranties from Silverton are your sole and exclusive remedies and are expressly in lieu of any and all other remedies, including tort/negligence theories and warranties of merchantability and fitness for a particular purpose. Whether arising by law, custom, conduct, or usage of trade. Some states do not allow limitations on an implied warranty, so the above limitation may not apply to you. In the event that implied warranties are found to exist under the law of a particular state, notwithstanding the exclusion contained herein, the duration of any such implied warranty shall be limited to one year from the date of purchase by the first-use purchaser.

All implied warranties, if any, including merchantability and fitness for a particular purpose, are excluded and disclaimed in their entirety after one year from the date of purchase by the first-use purchaser. No other warranties from Silverton Marine extend beyond the description of the warranties contained herein. Please note that some states do not allow limitations on the applicable time period for implied warranties, so the one-year time limitation which is contained here may not apply to you. Your specific legal rights will vary from state to state.

The purchaser acknowledges that no other representations were made to him or her with respect to the quality or function of the boat. Any oral statement or printed material advertising the boat which speaks to any performance characteristics of the boat or any of its components shall be considered and construed as an estimated description only and should not be relied upon as an express warranty or as the basis of the bargain for the boat or any of its components.

Any consequential, indirect, or incidental damages which may be incurred are excluded and purchaser(s) remedy is limited to repairs or replacement of any defective part(s). Some states do not allow the exclusion of limitation of incidental or consequential or indirect damages, so the above limitation or exclusion may not apply to you. This warranty gives you specific legal rights, and you may also have other rights which vary from state to state.

TRANSFER OF LIMITED TWO-YEAR AND FIVE-YEAR BOTTOM BLISTER WARRANTIES

The unexpired portions of the two-year limited warranty and the limited five-year bottom blister warranty and the limited five-year hull and deck structure fiberglass warranty may be transferred to a second owner upon purchase of the Silverton Yacht from an authorized Silverton Dealer. An inspection report from an accredited marine surveyor and written request to transfer these warranties must be made within fifteen (15) days from date of resale. A non-refundable recording fee of \$250.00 must accompany any transfer request. Silverton reserves the right to reject any warranty transfer request for a Silverton Yacht that has been damaged

or neglected. Silverton will confirm all warranty transfers in writing to the Silverton dealer and the second owner. The limited lifetime hull and deck structure fiberglass warranty is not transferable to any owner subsequent to the first use purchaser.

OWNER'S PROBLEM WITH WARRANTY SERVICE

In the event the first-use purchaser or registered subsequent owner has any problems or questions regarding the Silverton warranty or the Silverton warranty service being provided by an authorized Silverton Dealer, please forward that question or problem directly to the authorized Silverton Dealer in writing explaining your problem and asking for their assistance in resolving the problem. Generally speaking, the owner of the authorized dealership, which is an independent contractor of Silverton, is in the very best position to assist you because of their familiarity with the warranty work that was performed on your behalf. In addition, Silverton expects its dealers to be concerned with your continued satisfaction and, as a result, should be given an opportunity to provide that assistance.

If, after contacting the dealer in writing and you, as the first-use purchaser or registered subsequent owner, are unhappy with the dealer's response or if you feel that you require any further assistance, please write to the address below. In communicating to Silverton, please provide Silverton with a copy of the warranty claim which is the subject of your need for assistance, and any correspondence which you exchanged with the dealer. Please be certain that the forwarded information includes your hull identification number and name as well as the hours of usage on your engines. If at all possible, provide a chronological description of the problems which you confronted as well as the repair attempts. Include the dealer name and dealer personnel consulted. It is much appreciated if you would concisely describe your problem or question and any comments that you might have regarding the dealer's efforts to conduct the repair. Upon receipt of your correspondence, Silverton will begin its analysis and investigation into the circumstances. Silverton may contact you directly and the dealer if any further information is necessary. Silverton will also contact the dealership so as to assist both the dealer and you in resolving the question or concern.

The above limitation or exclusion may not apply to you. This warranty gives you specific legal rights, and you may also have other rights which vary from state to state.

WARRANTY REGISTRATION

These limited warranties shall not be effective unless the SILVERTON Warranty Registration Form and Pre-Delivery Service Record; which are furnished with each new boat, are filled out completely and returned to SILVERTON within ten (10) days of delivery.

The return to SILVERTON of the fully signed Warranty Registration Form is critical. Warranty coverage cannot be initiated until the completed form is received at SILVERTON.

All repairs and/or replacements will be made by an authorized SILVERTON Dealer, or at the option of SILVERTON, at the SILVERTON plant. If the repairs are of such a nature that the warranty work must be performed at the SILVERTON plant, transportation costs to and from the SILVERTON plant shall be paid by the owner. The labor cost reimbursement will be based on the Labor Allowance Schedule established by SILVERTON and, where not applicable, on a reasonable number of hours as determined by SILVERTON. Any repairs and replacements must be approved in advance by an authorized SILVERTON Service Representative.

TRANSFER OF LIMITED WARRANTIES

Effective with 2007 model year boats, these limited warranties will be transferred to a subsequent purchaser of the boat if:

1. Purchased from a Silverton Dealer.
2. A notice of the transfer of ownership of the boat is given by the subsequent purchase in writing to SILVERTON within thirty (30) days of the transfer.
3. The notice shall include the name, address, and telephone number of the subsequent purchaser, the date of purchase, the hull number, and the name of the seller of the boat.

4. A non-refundable recording fee of \$250.00.
5. An inspection report by an accredited marine surveyor.

SILVERTON will mail to the subsequent purchaser notice of the expiration dates of the limited warranties (See sample). The transfer of the ownership of the boat will not extend the expiration dates of the limited warranties.

BOOKS AND PUBLICATIONS

Silverton recommends you purchase and read the following publications:

*Piloting, Seamanship and
Small Boat Handling*

By Chapman
(Included with this manual; compliments
of Silverton Marine Corporation)

Boatman's Handbook

By Tom Bottomly
Motorboat and Sailing
P.O. Box 2319, FDR Station
New York, New York 10002

*The Complete Book of Maintenance
and Repair*

By Dave Kendall
Doubleday and Company
Garden City, New York 11530

Pleasure Boating and Seamanship

United States Coast Guard Auxiliary
306 Wilson Road Oaklands
Newark, Delaware 19711

RECORD KEEPING

Boat Record

Use the **Boat Record** (included at the end of the Glossary Section of this manual) to record all important information concerning your yacht and its equipment. After your dealer has recorded all the information, remove the record from your Owner's Manual and store in a safe, convenient location. **Do not** keep this form aboard your yacht.

Float Plan

The **Float Plan** (included at the end of the Glossary Section of this manual) provides a record of your destination, departure and return times, yacht description, passenger list and other information about the trip you have planned. At the bottom of the form is a space for listing emergency telephone numbers in case your return is delayed past the expected time. It also has space for indicating information about the person filing this report. Leave a copy of the completed form ashore with a responsible person. Carry the original form with you on your cruise and if you deviate from your original plan, be certain to notify the person with whom you left the copy of your change in plans. Silverton recommends you make several copies of this form each yachting season to ensure you have an adequate supply.

Maintenance Log

The **Maintenance Log** (included at the end of the Glossary Section of this manual) provides the means to keep maintenance records in one location. Using this log will allow you to track maintenance work completed. Your Silverton Dealer will also find this information helpful if you decide to sell or trade your yacht. The maintenance record will make your yacht a more desirable purchase because it tells prospective buyers that you have maintained the proper care of the vessel on a regular basis.

Accident Reporting

No one likes to think about having a boating accident, but unfortunately, they do occur. You must file an **Accident Report** after a boating accident just as you would after an automobile accident. A copy of the United States Coast Guard Accident Report is included with this Owner's Manual. You can obtain more copies of the report by calling the

United States Coast Guard Boating Safety Hotline at 1-800-368-5647.

You are required to file an accident report with the United States Coast Guard within forty-eight (48) hours after the occurrence of an accident resulting in any one of the following:

- Loss of life.
- A person disappears from a vessel under circumstances that indicate the possibility of death or injury.
- Personal injury requiring medical treatment beyond first aid.
- Damage to the vessel or damage to property.*
- Complete loss of the vessel.

** State statutes determine whether you must file an accident report in this case. An accident report must be filed if the damage exceeds a threshold dollar value as established by the state in which the accident occurred. In most states, the threshold is \$2,000.00. Contact the United States Coast Guard Boating Safety Hotline to verify the threshold for a particular state.*

Note: *State and local agencies may also have accident reporting requirements. Check with local enforcement agencies or with your local Silverton Dealer regarding local requirements.*

GETTING FAMILIAR with your 42 CONVERTIBLE

This section of your Owner's Manual will give you a virtual tour of your new 42C.

The following areas will be described:

Hull, Deck, Interior, Bridge and Engine Compartment.

HULL

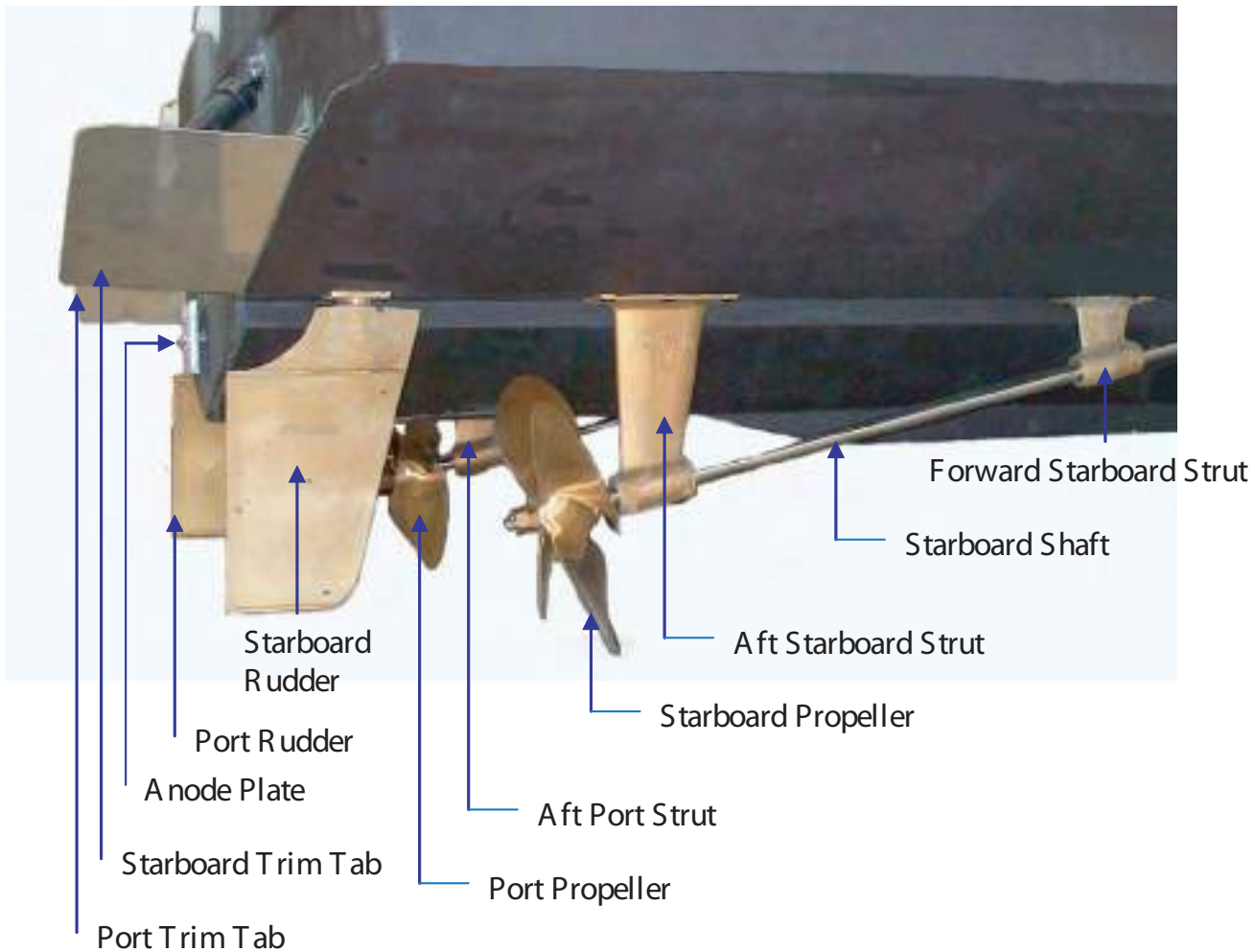

The Shaft is connected to the engine transmission with a coupling and extends through the bottom of the hull. The Propeller is attached to the end of the shaft. The shaft is supported forward of the propeller by two Struts. The struts support and stabilize the shafts. The rotation

of the Propellers will propel the yacht in the selected direction; controlled from the helm station. The Rudders provide steering for the yacht to port or starboard, depending on the direction they are turned by the operator from the helm station steering wheel.

The Zinc Anodes are dealer installed on the trim tabs, shafts, rudders, and transom for the purpose of preventing electrolysis and galvanic corrosion, which is discussed in the Winterization and Storage pages in the Cleaning and Maintenance section of this manual.

ENGINE SEAWATER PICKUP

The photograph below displays the Engine Seawater Pickup as shown on the starboard side. The Engine Seawater Pickups are located on the bottom exterior of the hull forward of the engines and are used for “scooping” water for the engine cooling system.



TRANSOM ANODE PLATE

The photograph below displays the Transom Anode Plate, which is a sacrificial zinc anode that is bolted to the transom and connected to the electrical bonding system. Its purpose is to help in reducing the effects of electrolysis and galvanic corrosion of the underwater components in your yacht, which is discussed in the Bonding System pages in the Systems Operation section of this Owner’s Manual.



TRIM TABS

The photograph below displays the Port Trim Tab, which is factory installed on the lower edge of the transom. The starboard trim tab is located in the same location on the starboard side of the transom. The purpose of the trim tabs is to assist you in controlling the angle, both longitudinally and athwartships, that your yacht rides in the water during forward movement. The control panel for the Trim Tabs is located at the helm station.



PROPELLERS

The photographs below display the propeller rotation for the Port and Starboard sides.

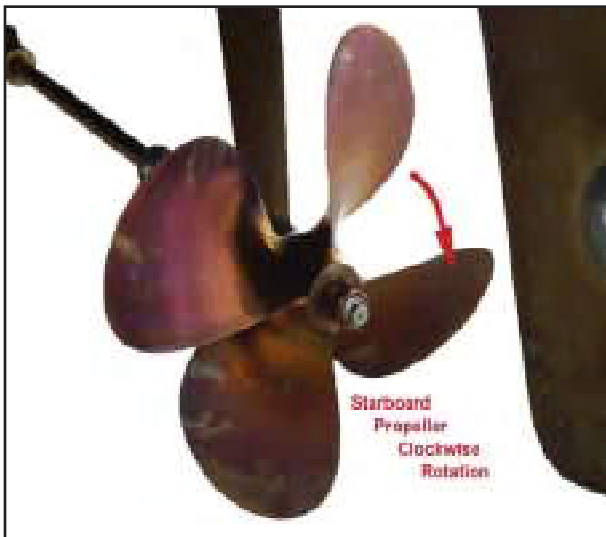
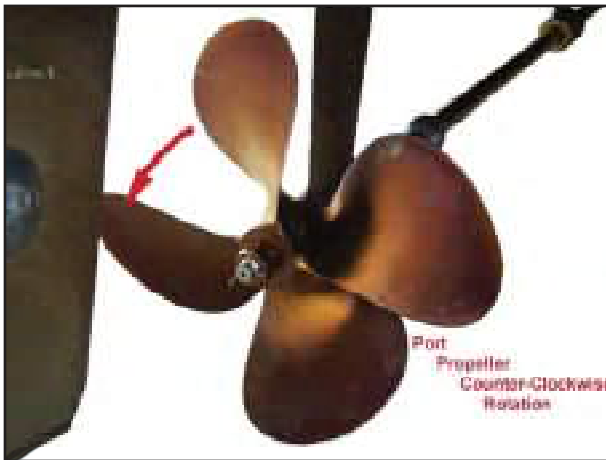

ENGINE EXHAUST PORTS



There are two Engine Exhaust Ports; one for each engine. The Port Engine Exhaust Port is located on the Port side of the hull forward of the transom and the Starboard Engine Exhaust Port is located on the Starboard side of the hull forward of the transom. The photograph above displays the Starboard Engine Exhaust Port. The Port Engine Exhaust Port is in the identical location on the port side of the yacht.

GENERATOR EXHAUST PORT

The photograph below displays the Generator Exhaust Port. It is located on the port side of the transom, outboard of the port trim tab.



DISCHARGE PORTS

The various Discharge Ports (also known as thru-hull ports) are located on the starboard and port sides of the hull. Refer to the Thru-Hull Schematic Drawings in the SCHEMATICS SECTION of this manual.

FUEL TANK VENTS

The photograph below displays the Port Fuel Tank Vent as shown on the port side of the hull. The Starboard Fuel Tank Vent is located in the identical location on the starboard side of the hull.

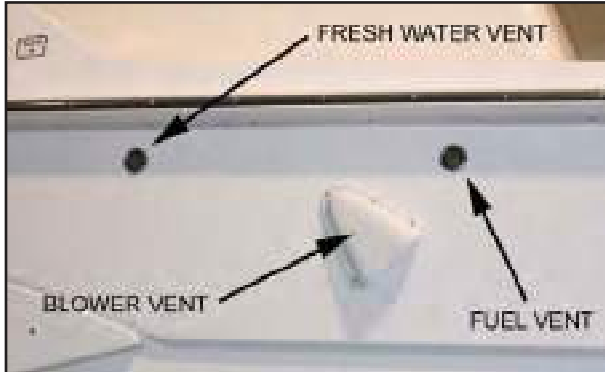

Note: Please refer to the Thru-Hull Location Schematics in the SCHEMATICS SECTION of this Owner's Manual.

BILGE VENTS

Your 42C has ventilation vents from the Engine Room. The amount of venting and the location depends upon the engine configuration of your 42C. There are large vents located on both sides of the hull. The photo below shows the Port Engine Room Vent.



This is an always open vent that has no fan attached to it.

The Bilge Ventilation System Pages in the Operations Systems Section of this manual discusses the ventilation system (Be certain to read and have a thorough understanding of this section. It contains important information concerning the SAFE operation of your yacht). The photograph below displays the engine room blower vent on the starboard side of your yacht. There is also a vent on the port side of the boat.

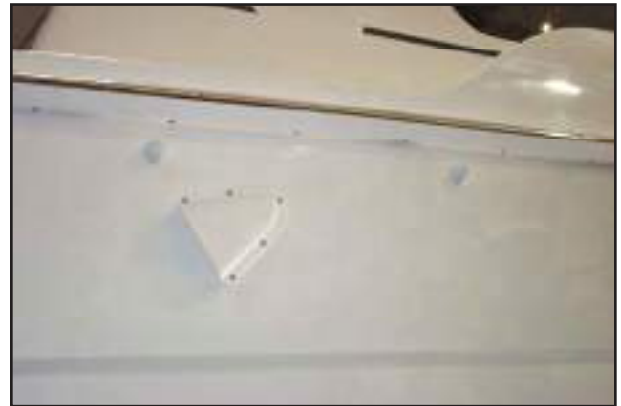

DECK

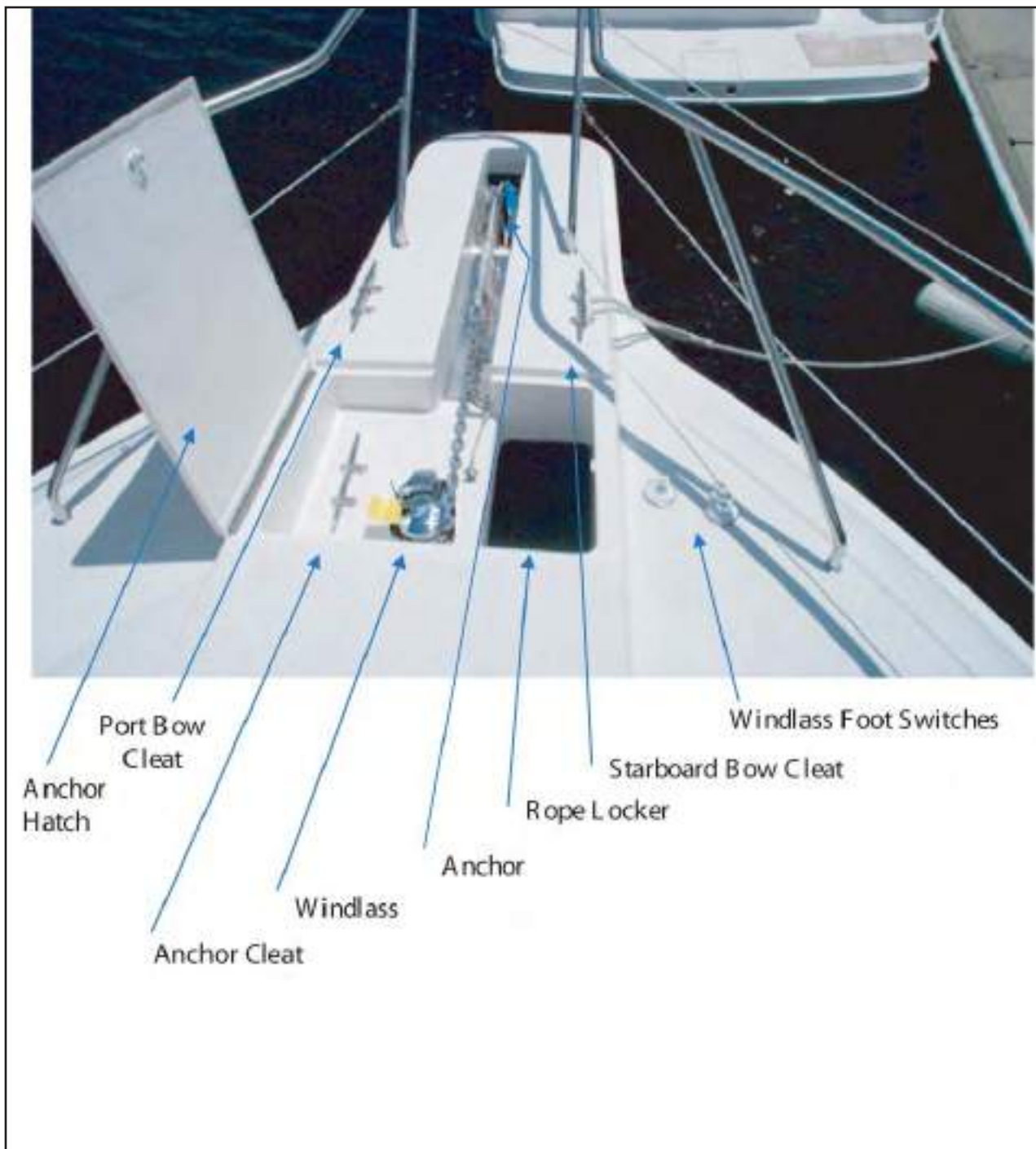

ANCHOR SYSTEM

The photograph below displays the location of the Anchor, which is located in its bracket under the pulpit.



The photograph below displays the optional Anchor Windlass and controls, which are located on the forward section of the deck immediately aft of the pulpit.



WARNING

Be certain to keep hands and feet away from any moving parts while operating the Anchor System. Becoming entangled in the anchor line may result in serious injury or death.

The photo below shows the Windlass Anchor Wench Control located at the helm.



SEARCH LIGHT

The 42C may be equipped with an optional Search Light, which is mounted on the forward portion of the pulpit. The photograph below displays the Search Light.



The actual control switch for the Search Light is an omni-positional switch. It controls the kind of light that comes out of your search light. It can be either spot (S) or flood (F). The photo below shows the control, which is located at the Helm.



DECK DRAIN

The photograph below displays the Deck Drain, located on the starboard side of the cockpit. There is an identical drain on the port side in the same location.

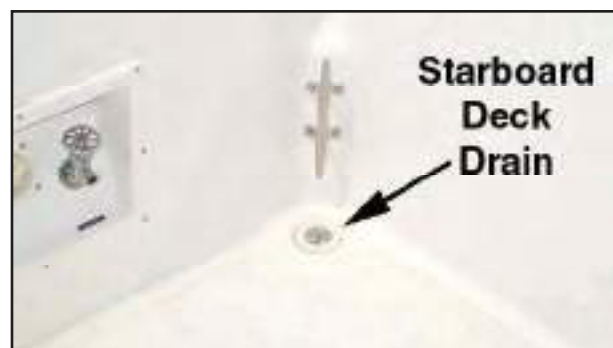

BRIDGE

HELM

The Helm, located on the Bridge of your 42C, is where your yacht is piloted.



STARBOARD BRIDGE LOUNGE

Located on the starboard side of the bridge is the Starboard Bridge Lounge. The lounge seat back is removable and gives you access to the Helm. The seat portions are removable and have storage underneath.



PORT BRIDGE LOUNGE

On the port side of the Bridge you will find the Port Bridge Lounge. The seat portion is removable and there is storage underneath.

The photo below shows the Port Bridge Lounge.



CAPTAIN'S CHAIRS

Aft of the Helm is the Captain's Chairs. These chairs are adjustable and swivel.



AIR HORNS

The factory installed Air Horns are mounted on the forward section of the bridge.



The button for the Air Horns is located at the Helm. The photo below shows the location of the button that sounds the Air Horns.



The Starboard Navigation Light is GREEN.

NAVIGATION LIGHTS

The photographs below display the location of the Port, Starboard, and the Transom Navigation Lights and the combination Masthead/Anchor Light.



The Transom Light is WHITE.



The Port Navigation Light is RED.



The Masthead/Anchor Light is also WHITE.

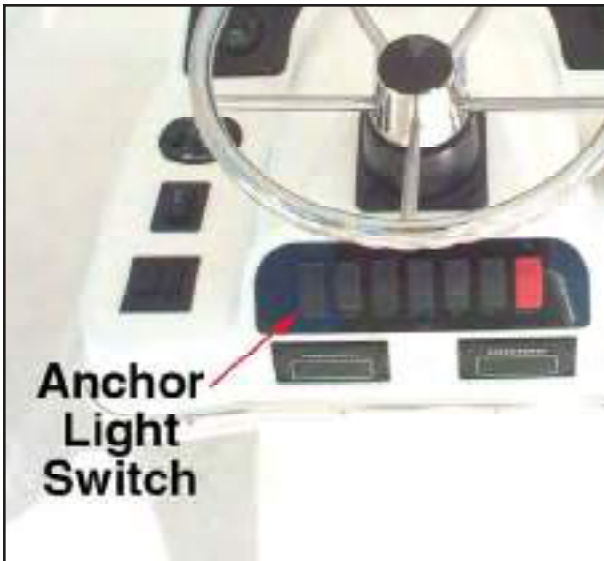

The Navigation/Anchor Light switch is located at the helm station.

ACCESS STEPS

On both the starboard and port sides of your 42C you have access steps from the Aft Deck to the Bow. There are also access steps from the Aft Deck to the Bridge. The photograph below displays the Aft Deck to Bridge Access Steps and outboard of those steps are the port side Aft Deck to Bow Access Steps.



FISH BOX

The photo below displays the Fish Box, which is located beneath the Aft Access Hatch in the Cockpit. This Fish Box has a drain in the bottom, and can be lifted out of the way for access to the Aft Bilge.



The Fish Box Drain is operated from the switch located by the Cockpit Wet Bar. The photo below shows the switch.



INTERIOR

This section will show you the various interior compartments of your 42C, starting with your entry into the Salon.

SALON ACCESS DOOR

The photograph below displays the **Salon Access Door**, located on the forward section of the Cockpit. This is a double sliding door that allows access to the salon area of your 42C.



SALON



Standing at the Access Door, and looking to the port side, you have a switch about waist high. This switch is for your lights. One switch is for the overhead lights and one switch is for the courtesy lights. To the right of the light switch is the Entertain-

ment Center. The photo below shows the Entertainment Center.



The Entertainment Center includes a JVC Receiver and a 5 disk CD player. Available as an option is the 20" TV and a VCR, which also fits in this space. Also available as an option is the BOSE Surround Sound System. Above the Entertainment Center on the outer bulkhead is a 12 Volt Outlet, 120 Volt Outlet, Telephone Hook-up and a CO Monitor. To the right of the Entertainment Center are two large doors. Inside you will find the AC/DC Electrical Panels, the Battery Management Center, and the Dual Water/Waste Monitor, which you can see in the photo below.



The Dual Water/Waste Monitor, which is below the Electrical Panel, will show you the level of the fresh water tanks and the level of the waste tank (both tanks will always have the same amount of water).

DINETTE

Next we have the Dinette. The photo below shows the Dinette.



The Dinette has a table in the center, and seats all the way around the table. If you look at the seats on the starboard side of the table you will notice an opening right below the seat cushion. This is the vent for the refrigerator. Do not block this vent. To the right and down from where you are standing is the Central Vacuum Outlet and a 120 Volt Outlet. In the corner facing forward is a Storage Closet. On the bottom of this cabinet is an access panel. Under this panel is the Central Vacuum System, or it can be used for storage. Above this closet is the AC vent.

Next on the bulkhead is the A/C Control Unit. Then you have the lounge. Behind the lounge is a vent. This vent is the inlet vent for the AC unit. It is important not to block this vent. Forward of the couch is a table with storage underneath. Inside the storage cabinet you will find the storage area for wine and liquor. Above the cabinet is another 120 Volt Outlet. If you look above the Salon, you will find a Fishing Pole Storage Cabinet.

PASSAGEWAY / GALLEY



On the starboard side of the Salon, you have steps going down into the Passage-way/Galley. If you are standing on those steps and looking forward, on the right is the Galley. Above the counter and to the right is the microwave. Then a large two door cabinet, and two smaller storage cabinets. Under the two door cabinet is a 120 Volt Outlet. A little forward of that outlet is another 120 Volt Outlet. In the corner, under the cabinet, is the Coffeemaker. Above the microwave and the storage cabinets are three smaller storage cabinets. These doors are kept open with a spring hinge. If you open the door all the way, the spring straightens out and holds the door open. To close the door, lightly tap the center of the spring, do not pull, and the spring will collapse. Also in with these three cabinets is an AC Vent. To your right, but lower, we have a set of switches. One switch is for the exhaust fan, and the other two switches control the lights. Next on the counter, is the range. Behind the door, under the counter is a refrigerator. Under the refrigerator is a swing out storage unit. Next is a bank of four sliding drawers. Next is a large storage Cabinet with a sliding drawer above it. Next, on top of the counter, is your sink. Below the sink is a storage cabinet.

To your lower left is the Refrigerator/ Freezer Unit. Above that is a 120 Volt Outlet. Going forward is 4 sliding drawers. Above the drawers is a pantry cabinet. At the end of the passageway are three doors. The port door is access to mid-stateroom. The center door is access to the forward stateroom. The starboard door is access to the head.

HEAD



Standing in the Passageway, looking through the doorway into the head, to the right is the toilet paper roll holder. On the same wall and a little higher is the towel rack. Further on the bulkhead, toward the outside bulkhead is the exhaust vent. Looking down you will see your toilet. On the outside bulkhead is the porthole. Forward of the porthole is a cabinet with a mirrored door. Below the shelf and the cabinet is a wide storage cabinet with two sliding doors. On the counter forward is the sink. Forward of the sink on the bulkhead is a 120 Volt Outlet. Under the counter you have a large storage cabinet with 2 doors. To the left of the cabinet are the switches for the exhaust fan and the lights. On the forward bulkhead is a towel rack and the A/C Outlet Vent. The door to your left is access to the Forward Stateroom. There is a clothes hook on the door.

FORWARD STATEROOM



Standing in the doorway of the Forward Stateroom, on the bulkhead to your right is a light switch. The switch controls the upper and lower courtesy lights. To the right of this switch you have the door to the Head then a large closet. This closet is lined with cedar and there is another closet identical to this on the other side of the boat. To the right of the closet is the A/C Vent. Around the corner from the closet on the bulkhead is the CO monitor, 120 Volt Outlet, and the A/C Control Unit. If you look all the way forward you see two lights. These lights are reading lights and are controlled independent of each other. There is a mirror in between the lights. Coming further counter-clockwise is another cedar lined closet below the shelf. On the shelf above the closet is a 120 Volt Outlet and a cable TV Outlet. The door to your left is the access door for entry into the shower. Looking straight ahead you see the bed unit. Under the mattress is two access panels. The forward access panel is for storage and the middle access panel is for maintenance for A/C Unit and storage. Looking down under the bed mattress are three large drawers. On the starboard side under the mattress is the A/C Intake Vent. Do not block this

vent. Fresh air must be allowed to enter this vent. On the port side under the mattress is another vent for the A/C Unit. On the floor in front of you is an access panel. This panel is for storage. It also could serve as access to the optional Bow Thruster. Looking above, you will see the escape Hatch.

SHOWER



Standing outside the shower unit at the doorway entering the shower from the forward stateroom. Looking straight to the back is a porthole. Above the porthole is a storage cabinet. This cabinet has a spring hinge. Open the door all the way and the spring snaps in the locked position. To close the door gently push, NOT PULL,

on the center of this spring. To the left under the closet is the exhaust vent. Right above the exhaust fan is the switch panel for the exhaust fan vent and the lights. To the left of the vent is the shower control unit. Then you have the door into the mid-stateroom. On your immediate left is the shower unit.

corner from the closet is a light switch for the two reading lights above the bed, a CO monitor and a 120 Volt Outlet. Above the reading lights is a storage closet. Under the mattress is three access panels with storage underneath. Looking down below the mattress in the front of the bed frame is a sliding drawer.

MID-STATEROOM



Standing in the passageway entrance doorway, into the mid stateroom, on the right hand side is the door to the shower. Going counter-clockwise you have a light switch which controls the cabin and courtesy lights. Above the switch is a A/C Vent. There is a large cedar lined storage closet to the left of the switch. Around the

ENGINE COMPARTMENT

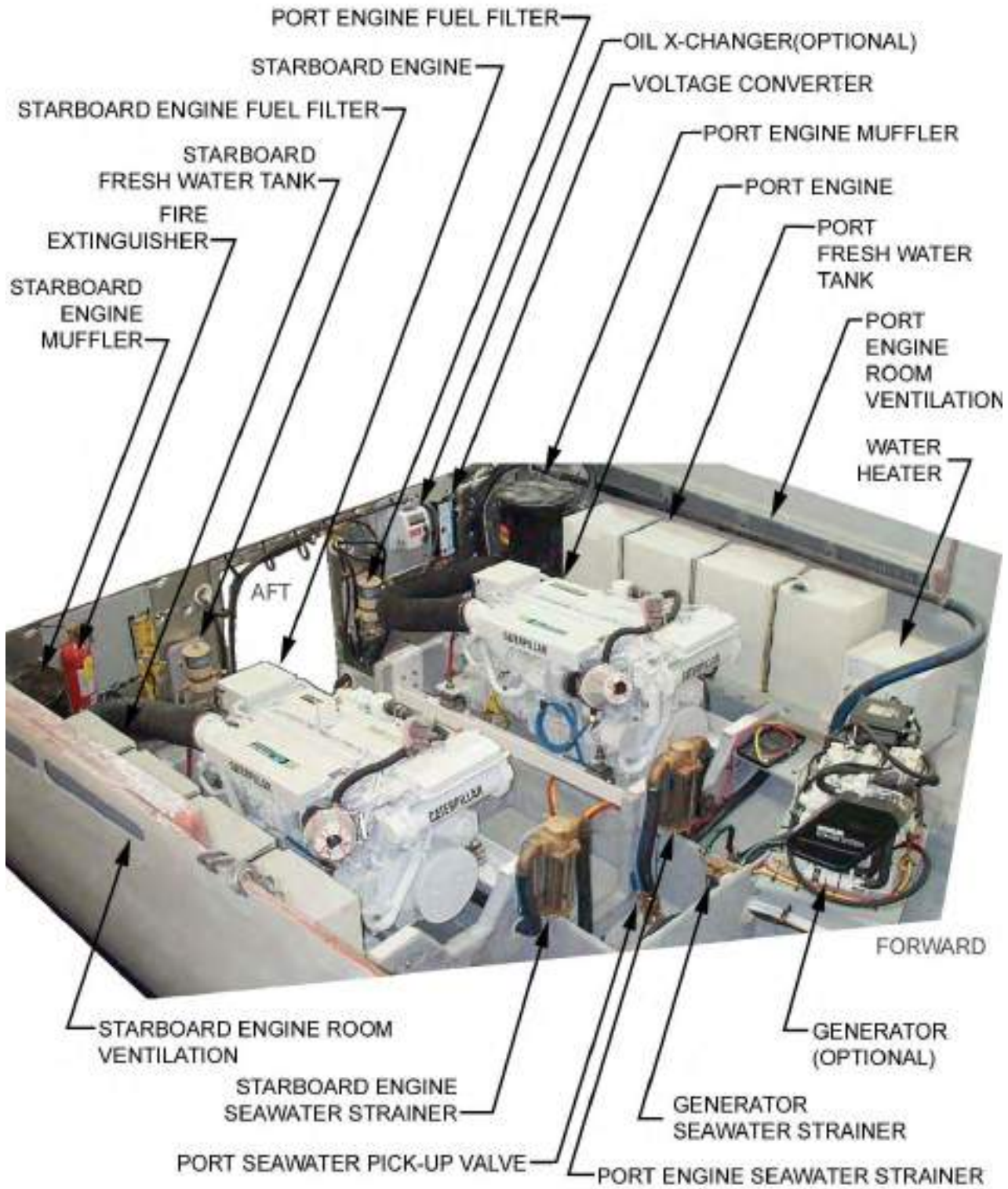

The Engine Compartment is accessed through the hatch located in the cockpit. The photo below shows the Engine Room Access Hatch.



BOATING SAFETY

Silverton believes your safety aboard your yacht, whether cruising or moored at your dock, is extremely important. A yacht operated in a safe manner will provide you, your passengers and other boaters many pleasurable hours of cruising and peace of mind. This section discusses the potential hazards that may be associated with boating for your awareness so they may be avoided, if possible. Be certain to read and have a thorough understanding of this section.

Silverton recommends completing a safe boating course if you are new to boating. Even if you are an experienced boater, you should consider enrolling in one of these courses as they will provide you with updated information that will prove to be valuable and enhance your cruising pleasure. Your local United States Coast Guard Auxiliary and United States Power Squadrons offer comprehensive safe boating classes several times a year. You may contact them for a course schedule in your area or the Boat/U.S. Foundation at 1-800-336-BOAT, or in Virginia, at 1-800-245-BOAT.

Safety Equipment

Important: Federal Law requires you provide and maintain certain safety equipment on your yacht. As the yacht owner, you are responsible for providing all required safety equipment. Consult the United States Coast Guard and your state and local regulations to ensure your yacht is in complete compliance with all requirements concerning safety equipment on board. Additional safety equipment may be recommended for your safety and the safety of your passengers. Be aware of its availability and specific use.

Minimum Recommended Safety Equipment

- ✘ Required life saving equipment, including personal flotation and throwing devices.
- ✘ Required fire-extinguishing equipment.
- ✘ Required visual distress signal devices.
- ✘ First aid kit.
- ✘ Emergency position indicating radio beam (EPIRB).
- ✘ Manual bailing device.
- ✘ Anchor with sufficient line/chain.
- ✘ Flashlight with fully charged batteries.
- ✘ Binoculars.
- ✘ Whistle.
- ✘ VHF Radio.
- ✘ Navigational charts for your cruising areas.
- ✘ Fog Bell (boats over 39.4 feet).

If you need assistance, please feel free to contact our Customer Service Hotline at 1-800-882-9266.

Personal Flotation Devices (PFD's)

United States Coast Guard regulations require you to have at least one (1) approved Type I, Type II, or Type III Personal Flotation Device (PFD) for each person on board. The PFD's must be of suitable size for each person aboard and must be maintained in serviceable condition and readily accessible. A minimum of three (3) PFD's (two wearable and one throwable) are required, regardless of the number of persons on board. Each of these Personal Flotation devices, commonly

known as “Life Jackets”, are described as follows:

TYPE I (Wearable): This off-shore PFD has the greatest buoyancy. It is most effective for all waters where rescue may be delayed. Its design allows for turning most unconscious persons in the water from a face down position to a face up position, assisting in the prevention of drowning.

Type II (Wearable): This near-shore PFD provides less buoyancy than a Type I PFD. It is intended for use in calm, inland waters or waters where there is a greater chance of a quick rescue. It turns its wearer to a face up position as does the Type I PFD, but the turning action is not as pronounced. A Type II PFD may not turn as many persons to a face up position under the same conditions as would a Type I PFD.

Type III (Wearable): Classified as a flotation aid, the Type III PFD permits the wearer to place himself in a vertical or face up position, but it will not do it automatically as would a Type I or Type II PFD. The Type III PFD has the same minimum buoyancy as a Type II PFD, but it has little, or no, turning ability. It is intended for use in calm, inland waters where immediate rescue is probable. The Type III PFD is used most often by people participating in water sports, as it is generally the most comfortable type for continuous wear.

Type IV (Throwable): United States Coast Guard regulations require at least one (1) throwable Type IV PFD to be on board, regardless of the number of passengers. The Type IV PFD is not intended to be worn; it is intended to be thrown to a person who has fallen overboard and is conscious. The Type IV PFD is held by the user until rescued. The most common examples of Type IV PFD's

are buoyant cushions or ring buoys and they are required to be immediately available for use and in serviceable condition.

Note: *United States Coast Guard regulations for the number and type of PFD's are the minimum required. Silverton recommends exceeding the minimum requirements for your safety and the safety of your passengers.*

Fire Extinguishing Equipment

As a yacht owner, you are responsible to maintain a minimum number and type of portable fire extinguishers on board. All fire extinguishers must be approved by the United States Coast Guard and be readily accessible and in serviceable condition. United States Coast Guard classification includes foam, carbon dioxide, and chemical fire extinguishing materials, which are described in detail in the **Portable Fire Extinguisher System Section** of this Owner's Manual. Be certain to read and have a thorough understanding of the portable fire extinguishing equipment. United States Coast Guard minimum requirements for portable fire extinguishers maintained aboard your yacht are as follows:

*** Yachts longer than 26 feet and shorter than 40 feet:** Two (2) Type B-I or at least one (1) Type B-II portable, hand-held fire extinguisher. If your yacht has a fixed fire extinguishing system approved by the United States Coast Guard, one (1) Type B-I portable fire extinguisher is required.

*** Yachts longer than 40 feet and shorter than 65 feet:** Three (3) Type B-I or one (1) Type B-I and one (1) Type B-II portable, hand held fire extinguishers. If your yacht has a fixed fire extinguishing system ap-

proved by the United States Coast Guard, two (2) type B-I or one (1) Type B-II portable fire extinguisher is required.

Note: United States Coast Guard regulations are the minimum requirements. Silverton recommends exceeding the minimum requirements for your safety.

Fire Safety

Fire safety is something that everyone who owns or operates a boat should practice. Each year, boating fires and explosions injure hundreds of boaters and cause millions of dollars in property damage. While there is a greater chance of a fire or explosion on a boat than on land, most of these accidents can be prevented. With a little effort on your part, fire prevention and fire safety are very attainable goals.

As owner of your yacht, it is your responsibility to:

- ✓ Have fire-fighting equipment inspected at regular intervals.
 - ✓ Replace fire-fighting equipment, if expired or discharged, with devices of equal or greater fire-fighting capacity.
 - ✓ Inform members of the crew and guests about:
 - the location and operation of fire-fighting equipment.
 - the location and operation of escape hatches.
 - ✓ Ensure that fire-fighting equipment is readily accessible.
 - ✓ Keep passageways to exits and escape hatches clear of obstructions.
- ✓ Never allow the use of gas lights on board.
 - ✓ Never leave the boat unattended when cooking or heating appliances are in use.
 - ✓ Never modify any of the boat's systems (especially electrical, fuel, and ventilation).
 - ✓ Never handle fuel of any type when machinery is running or when cooking or heating appliances are in use.
 - ✓ Follow proper fueling procedures (discussed in the fuel safety section of this publication).
 - ✓ Never smoke while handling fuel.
 - ✓ Keep machinery and bilge areas clean and free of debris.
 - ✓ Always sniff for fuel vapors before starting engines or generator.

If you need assistance, please feel free to contact our Customer Service Hotline at 1-800-882-9266.

Other good ways to prevent fire aboard your yacht is to keep the bilge areas clean and to check for fuel and gas vapors at regular intervals, and not to fit free hanging curtains or other fabrics in the vicinity of, or above, cookers or other open flame devices. Also combustible material should not be stored in the engine compartment. If non-combustible materials are stowed in the engine space they shall be secured against falling into machinery and shall cause no obstruction to access in or from the space.



Fire prevention is something that you as the yacht owner are responsible for. Too much fire prevention is not possible. This is an area that is unfortunately often overlooked by boat owners. However, as long as this area is an important part of your boating safety preparation, you can help to make your journeys safer for not only for you, but your crew and family as well.

VISUAL DISTRESS SIGNAL DEVICES

The United States Coast Guard requires all boats operating on the coastal waters of the United States to maintain visual distress signal equipment (flares) on board. Coastal waters are defined as all waters, except rivers, streams and inland lakes. The Great Lakes and any river mouth greater than two (2) miles wide are considered coastal waters. All boats owned in the United States and operating on the high seas are required to carry visual distress signal equipment on board.

All visual distress signal devices are required to be maintained in serviceable condition and stowed in a readily accessible location. Equipment displaying a useful service life date must be within the specified usage date shown. Both pyrotechnic and non-pyrotechnic equipment must be United States Coast Guard approved.

Pyrotechnic visual distress signal devices and their associated equipment include the following:

- ☆ Red Flares - Hand held or aerial.

- ☆ Orange Smoke - Hand held or floating.

- ☆ Launchers for aerial red meteors or parachute flares.

Non-pyrotechnic visual distress signal devices include the following:

- ☆ Orange Distress Flag.
- ☆ Dye Markers.
- ☆ Electric Flashing Distress Light.

No single visual distress signal device is perfect for all conditions or purposes. Silverton recommends carrying various types of devices as described above. Careful selection and the proper stowage of visual distress signal equipment is extremely important. If young children are frequently aboard, you should select devices with packaging which children, but not adults, will find difficult to open.

Sound Signaling Devices

The United States Coast Guard requires all boats over 16 feet in length to have a device that is capable of producing a sound signal when conditions require. Boats greater than 26 feet and less than 39 feet 4 inches, must have a sound signaling device that is capable of producing a four (4) second blast, which can be heard at least one-half mile away. The device may be either hand held or power operated. Boats greater than 39 feet 4 inches must have in addition to the above sound signaling device, a whistle and a bell, which must meet or exceed the requirements of the Inland Navigational Rules Act of 1980.

Refer to the United States Coast Guard publication *“Navigational Rules, Interna-*

tional-Inland” for specific requirements of sound signaling devices.

Navigation Lights

The United States Coast Guard requires all boats that are operated during the hours of darkness or when visibility is impaired, be equipped with navigation lights that are illuminated. Observe all rules of navigation when meeting or passing another vessel. **DO NOT** operate your yacht at high speeds during night operation or when visibility is impaired. A good rule to follow is to **NEVER** operate your yacht at a greater speed than that which would prevent you from stopping within the distance of your visibility.

Always use common sense and good judgement when operating your yacht at night or during restricted visibility.

Refer to the United States Coast Guard publication *“Navigational Rules, International-Inland”* for specific navigational lighting requirements.

Additional Safety Equipment

You should consider having additional equipment on board your yacht to help make your cruising experience safer and more enjoyable. Some examples of this additional equipment are as follows:

- ✓ Anchor with chain and/or line.
- ✓ Boat hook.
- ✓ Bucket and sponge.
- ✓ Commonly used spare parts, such as hose clamps, spark plugs, etc.
- ✓ Compass.

- ✓ Docking lines.
- ✓ Engine and accessory manuals.
- ✓ Extra keys.
- ✓ Extra V-belts.
- ✓ Fenders.
- ✓ First aid kit.
- ✓ Flashlight with extra batteries.
- ✓ Manually operated bilge pump.
- ✓ Navigational charts for your cruising area.
- ✓ Owner’s Manual.
- ✓ Replacement light bulbs.
- ✓ Ship-to-Shore radio.
- ✓ Spare fuel and oil filters.
- ✓ Spare propeller with fastening hardware.
- ✓ Tool kit.

Navigation Rules of the Road

Navigating your yacht is much the same as driving an automobile. Operating either one responsibly means complying with a set of rules intended to prevent accidents. Just as you assume other automobile drivers know the rules of the road and expect them to abide by them, other boaters assume the same of you. As a responsible yachtsman, you must comply with the **“Rules of the Road”**; the marine traffic laws enforced by the United States Coast Guard. There are two (2) sets of rules: The **United States Inland Navigational Rules** and the **Inter-**

national Rules. The United States Inland Navigational rules apply to all vessels operated within the demarcation lines separating inland and international waters. The United States Coast Guard publishes the “**Rules of the Road**” in its publication “*Navigational Rules, International-Inland*”. You can obtain a copy of this publication from your local United States Coast Guard Unit or the United States Coast Guard Headquarters, 1300 “E” Street NW, Washington, D.C. 20226.

Other helpful publications available from the United States Coast Guard include, “*Aids to Navigation*” (Pamphlet #123), which explains the significance of various lights and buoys; “*Boating Safety Training Manual*”; “*Federal Requirements For Recreational Boats*”. Be certain to check with your local United States Coast Guard station, your Silverton Dealer or a local marina concerning navigational aids unique to your yachting area.

It is impossible to establish rules for every type of yachting situation. Therefore, it is extremely important to use common sense and good judgement when operating your yacht. Some of the basic rules to follow are:

- ✘ Always adhere to navigational rules to avoid collisions.
- ✘ Less maneuverable boats generally have the right-of-way. Always steer clear of the Stand-on vessel (boat having the right-of-way) and pass to its stern in a crossing situation.
- ✘ If a collision appears unavoidable, **BOTH** vessels must act **IMMEDIATELY**. Prudence **ALWAYS** takes precedence over the right-of-way rules if a collision is imminent.
- ✘ **NEVER** send a “**MAYDAY**” message unless there is a serious emergency and you

are in need of immediate assistance.

Be certain you understand important terminology distinctions:

Power Driven Vessel

A boat propelled by an engine, including a sailboat propelled by an engine and sails.

Sailing Vessel

A boat propelled by sail only, with no engine in operation.

Vessel Engaged In Fishing

A commercial fishing boat with apparatus that restricts its maneuverability (does not include trolling lines or other apparatus that does not restrict its maneuverability).

Vessel With Restricted Maneuverability

Any vessel, due to its size, draft, or cargo, that is restricted in its ability to maneuver in a certain waterway.

Underway

Any vessel not anchored, not made fast to shore and not aground, whether or not it is under power or sail.

Basic Rules of Navigation

Power driven vessels must give the right of way to the following:

- ✘ A vessel unable to maneuver.
- ✘ A vessel whose maneuverability is restricted.
- ✘ A sailing vessel.

Sailing vessels must give the right of way to the following:

- ✘ A vessel unable to maneuver.
- ✘ A vessel whose maneuverability is restricted.
- ✘ A vessel engaged in commercial fishing.

Vessels engaged in commercial fishing must give the right of way to the following:

- ✘ A vessel unable to maneuver.
- ✘ A vessel whose maneuverability is restricted.

Basic Rules of Safe Boating

✘ **Drugs and/or Alcohol and Boating DO NOT Mix.** Drugs and/or alcohol decrease your reaction time, impair your judgement, and inhibit your ability to safely operate your yacht. As a responsible boater, you will refrain from using drugs or alcohol (singly or combined) while you are operating your yacht. Operation of motorized vessels while under the influence of drugs and/or alcohol carries a severe penalty.

✘ Always maintain your yacht and its equipment in safe operating condition. Inspect the hull, engines, safety equipment, and all boating accessories on a regular basis.

✘ Stow all loose items properly to prevent injury or damage caused by heavy sea conditions.

✘ Be certain lifesaving and fire extinguishing equipment is on board. This equipment must meet or exceed regulatory standards and it should be noticeable, easily accessible and in proper operating condition. Your passengers should know where this equipment is located and how to use it.

✘ Be certain you have sufficient fuel on board for your anticipated cruising requirements. In general, anticipate using 1/3 of your fuel supply to reach your destination and 1/3 of your fuel supply to return. Always maintain 1/3 of your fuel supply in reserve for changes

in your plans due to unforeseen weather conditions or other circumstances.

✘ Use **EXTREME CAUTION** while fueling your yacht. Be certain you know the capacity of the fuel tank (s) and the amount of fuel you consume when operating at your normal cruising speeds. Read and have a thorough understanding of the **Fuel System Pages** in the Systems Operation Section of this Owner's Manual. It contains valuable information and warnings that, if strictly adhered to, will enhance your yachting pleasure and safety.

✘ Check the weather forecast before getting underway. **DO NOT** venture out if the weather is, or is expected to be, threatening. While underway, always be cognizant of changing weather conditions by frequently checking the local forecast. Monitor strong winds and electrical storms closely and head for sheltered waters or your marina **BEFORE** they are encountered.

✘ Always maintain accurate, updated charts of your cruising area on board and refer to them frequently. **DO NOT** rely on your memory of an area. All waters, particularly tidal waters, are subject to constant changes, such as shoaling and underwater hazards.

✘ Always file a Float Plan with a responsible person before you depart on your cruise. A blank Float Plan is in the back of the Owner's Manual.

✘ Instruct at least one other person on board your yacht in its basic operating procedure. This person can take over the operation of your yacht if you unexpectedly become unable to do so.

✘ **DO NOT** permit your passengers to ride on parts of your yacht that are not intended

for passenger use, such as the gunwales or the bowrail.

- ✘ Ask all persons to remain seated while your yacht is in motion, particularly during inclement weather.
- ✘ DO NOT use the swim platform or boarding ladder while the engines are in operation, whether or not your yacht is in motion.
- ✘ Always maintain a good lookout. Keep away from swimmers, divers, and water-skiers. They should display a flag when engaged in these types of water sports, but DO NOT rely upon it; if you suspect that type of activity, it is best to avoid that area, if possible.
- ✘ Understand and obey the “Rules of the Road”.
- ✘ Understand and obey all local boating laws.
- ✘ Always maintain complete control of your yacht.
- ✘ Finally, ALWAYS operate your yacht with care, courtesy, and common sense.

Voluntary Safety Inspections

The United States Coast Guard Auxiliary and boating officials in many states offer courtesy safety inspections of your yacht at no charge to you. They will examine your yacht for compliance with all safety standards and required safety equipment. You may voluntarily consent to one of these inspections and you are given sufficient time to make necessary corrections without fear of prosecution for any discrepancies found. Contact your local United States Coast Guard Auxiliary or appropriate state agency for details concerning these courtesy safety inspections.

CARBON MONOXIDE SAFETY

CARBON MONOXIDE CAN KILL!

This section is intended to provide educational information about carbon monoxide relative to boats and boating. Carbon Monoxide accumulation is affected by boat geometry, hatch, window and door openings, ventilation openings, proximity to other structures and boats, wind direction, boat speed, boat maintenance, and a multitude of other variables. This section discusses many of these and enables the boat owner to better understand some of the more predictable effects. However, this information is limited in that it cannot cover all conceivable variables. Therefore, the boat owner is cautioned not to exclusively rely on it to prevent the accumulation of carbon monoxide.

WHAT IS CARBON MONOXIDE?

Carbon monoxide is a highly poisonous gas formed by the combination of carbon and oxygen. Commonly referred to as CO, its chemical formula, “C” for carbon and “O” for oxygen. CO is a colorless, odorless, and tasteless gas that by itself can not be detected by human senses. CO diffuses in the air much more rapidly than any other gases that are detectable by the human senses. The weight of CO is about the same as air so it does not rise or fall like other gases but will distribute itself throughout the boat. CO is produced any time a material containing carbon is burned. In boating these materials include, but are not limited to, gasoline, diesel fuel, and propane. All carbon based fuels produce varying amounts of CO, depending on their carbon content. Gasoline is high in carbon and therefore produces high levels of CO. Diesel fuel is low in carbon and therefore produces lower levels of CO. However,

the exhaust of all engines and generators as well as any open flame device produce CO and the same precautions should be taken regardless of the type of fuel.

HOW A PERSON IS AFFECTED BY CARBON MONOXIDE

When breathed, carbon monoxide is absorbed by the lungs and reacts with the blood hemoglobin to form carboxyhemoglobin, which reduces the oxygen carrying capacity of the blood. The result is a lack of oxygen for the tissues with the subsequent tissue death and, if prolonged, death of the individual. Carbon monoxide in high concentrations can be fatal in a matter of minutes. Even lower concentrations must not be ignored because the effects of exposure to CO are cumulative and can be just as lethal. Certain health related problems and age increase the effects of CO. People, who smoke or are exposed to high concentrations of cigarette smoke, consume alcohol or have lung or heart disorders are particularly susceptible to an increase in the effects from CO. However, the health of all of the boat's occupants should be considered. Physical exertion accelerates the rate at which the blood absorbs CO. The early effects of CO poisoning are easy to overlook because they are similar to the effects of other boating related stresses such as eye strain, fatigue, sun exposure, seasickness, or alcohol consumption. But as the concentration of CO in the air increases, it has increasingly adverse effects on your health.

One or more of the following symptoms can signal the adverse effects of carbon monoxide accumulation. The order of this list is generally the sequence of symptoms. However, the number of symptoms and the

order of appearance may change for different people:

- Watering and Itching eyes
- Flushed Appearance
- Throbbing temples
- Inattentiveness
- Inability to think coherently
- Ringing in the ears
- Tightness across the chest
- Headache
- Drowsiness
- Incoherence
- Nausea
- Dizziness
- Fatigue
- Vomiting
- Collapse
- Convulsions

WHAT TO DO WHEN SOMEONE IS OVERCOME WITH CARBON MONOXIDE

When someone falls victim to carbon monoxide poisoning, fast and responsive action is crucial. Know the symptoms. The earlier effects of CO are detected the better the chance for recovery. The following list shows the sequence of events that must be done in an effort to revive a CO victim:

- Evacuate, Ventilate, Investigate, Take Corrective Action
- Move the person to fresh air
- Administer oxygen if available
- Contact medical help
- If the victim is not breathing, perform artificial respiration per approved CPR procedures until medical help arrives and takes over. Prompt action can make the difference between life and death.
- Ventilate area
- Investigate the source of CO and take corrective actions.

HOW DOES CARBON MONOXIDE ENTER YOUR BOAT?

Any device that burns fuel creates carbon monoxide. For example, a propane cooktop or a space heater are both potential sources for CO. But the most serious danger comes from the gasoline engines and generators aboard your own and neighboring boats. There are four basic ways that CO from a

running engine or generator can enter your boat:

The “station wagon effect” results from the aerodynamics of deck cabins and flying bridges. With the boat under way, the air flow over the top forms a low pressure area behind the cabin or transom which can suck exhaust gasses into the cockpit and the cabin. Inefficient trim angles also can cause the station wagon effect.

Obstructions are principally a problem when boats are rafted together or tied to a dock or seawall. Against an obstruction, exhaust gasses which normally dissipate may instead be directed back to your boat. Beware of open windows, hatches, doors and the location of the engine intake. Exhaust contains particularly high concentrations of CO when an engine is cold; so to protect yourself and your neighbors, minimize the time spent getting underway. Pay particular attention to potential obstructions when running a generator for long periods.

Infiltration of CO from a neighbor’s exhaust can be a problem aboard any boat at any time. Infiltration can happen any time your neighbors are running a generator or engine, even when they are many slips away.

Leaks in your own exhaust system from the engines or generator can allow harmful levels of CO to accumulate at a surprising rate. Good maintenance practices are critical to avoid this.

There are many variables that combine to affect the accumulation of carbon monoxide. Some of these variables are: the presence of weather enclosures and covers, boat layout and configuration, location of ports, hatches, windows, doors, and vents, proximity and types of structures and other boats, wind

speed and direction, speed of the boat, etc. Although it would be impossible to identify every variable or combination of variables that may affect the accumulation of carbon monoxide, the boat operator must remain aware at all times of the possibility of CO accumulation.

The following illustrations show some of the ways that carbon monoxide gas can accumulate in your boat while at dock and underway. Become familiar with these examples to prevent exposure to this poisonous gas.

! DANGER

Engine and generator exhaust from other vessels alongside your yacht, while docked or anchored, can cause excessive accumulation of Carbon Monoxide Gas (CO) within the cabin and cockpit areas of your yacht. Be alert for exhaust from other vessels.



! DANGER

Blocked hull exhaust outlets near a pier, dock, seawall, bulkhead, or any other structure can cause excessive accumulation of Carbon Monoxide Gas (CO) within the cabin areas of your yacht. Be certain hull exhaust outlets are not blocked in any way.

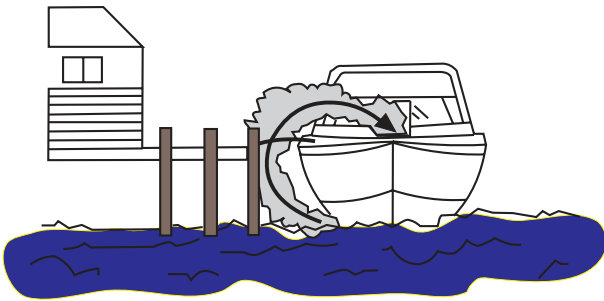

! DANGER

When protective weather coverings are in place, engine or generator exhaust from your yacht, while docked, at anchor, drifting, or underway can cause excessive accumulation of Carbon Monoxide Gas (CO) within the cabin and cockpit areas of your yacht. Always provide adequate ventilation when the weather coverings are in place and either the engine or the generator are running.



! DANGER

Engine or generator exhaust from your yacht while underway at a slow speed can cause excessive accumulation of Carbon Monoxide Gas (CO) within the cabin and cockpit areas of your yacht. A tail wind can increase the accumulation. This is often referred to as the “Station-wagon Effect”. Always provide adequate ventilation or increase your speed, if possible.



! DANGER

Engine or generator exhaust from your yacht while underway and operating with a high bow angle can cause excessive accumulation of Carbon Monoxide Gas (CO) within the cabin and cockpit areas of your yacht. Always provide adequate ventilation and redistribute the load to lower the bow angle.



HOW TO MINIMIZE THE ACCUMULATION OF CARBON MONOXIDE

Practice good inspection and maintenance habits.

Be certain hull exhaust outlets are not blocked or restricted in any way.

Be alert for exhaust gasses from other boats.

Always provide adequate ventilation when weather enclosures are in place and engines or generator is running.

Do not run with a high bow angle. Use trim tabs or redistribute the load to maintain a low bow angle.

Orient your boat to maximize the dispersion of CO.

Be aware of the effects of your actions on other boats.

Be aware of the effects of the actions of others on your boat.

Provide adequate ventilation when open flame appliances are used in the cabin.

PREVENTIVE MAINTENANCE

Frequent inspections and proper maintenance of the engine, generator, and exhaust systems as well as other various areas of your boat are critical in preventing the accumulation of carbon monoxide. It is the owner's responsibility to make sure that the entire boat is inspected and maintained against CO.

The exhaust systems of your engines and generator are under constant attack from salt water, gasses, vibration, and normal wear. Inspect every exhaust system component often. Start with a visual inspection. Check each joint for discoloration, carbon buildup, stains, water leaks, or other signs of damage. Inspect all metal parts for corrosion, discoloration or flaking. Check that all hose clamps are in good condition and properly tightened. Carefully inspect all exhaust and cooling hoses for signs of wear, dry rot, cracking, discoloration, chafing or swelling. If any of these conditions exist, have the entire system inspected and corrected by a qualified technician before starting the engines or generator.

Next, start each engine and generator one at a time. Follow the full run of the exhaust system, listening and looking for leaks. While doing this, make sure there is adequate ventilation and that your CO detector is on.

Other items to inspect are as follows: Check that access panels around the engine and exhaust are in place and fit snugly to minimize the opportunity for CO to enter the cabin. There should be no large openings where CO could enter the cabin. Ensure that all ventilation systems are in good working order, and not blocked or punctured. Check all sink drains to assure that they have a good water trap to prevent CO from coming in from the outside.

Finally, because poor running engines produce excessive CO, make sure engines and generator are tuned up. They should run smoothly and not produce black smoke. The spark plugs and ignition systems should be maintained regularly, and the fuel system and air filters should be in good order.

CARBON MONOXIDE DETECTORS

If you carefully avoid potential CO accumulation and maintain your systems properly, you have made great strides towards protecting yourself and others from the dangers of carbon monoxide. Another important line of defense is a CO Detector, used whenever you're aboard your boat. A detector is the only way to properly detect the presence of CO. There is a CO detector located in every living area on your Silverton Yacht. These CO detectors are UL Approved for Marine Use. If you replace the CO detectors at any time, they must be replaced with marine CO Detectors, not residential detectors. Most CO detectors require specific maintenance procedures to remain accurate and functional. Follow the manufacturer's instructions supplied to you in your owner's packet. Carbon Monoxide Detectors should be installed in all boats and the operation of them should be known by all aboard.

Fuel Safety



Gasoline and Diesel Fuel are extremely flammable. Proper handling is necessary to provide for the safety of you and your yacht.

- * DO NOT smoke while fueling.
- * Make sure that all accessories, both engines, and generator are turned off before beginning to fuel your yacht.
- * When fueling your yacht in warm weather, allow for expansion of the fuel and do not top off the fuel tanks. The tanks may overflow

when the fuel expands after being pumped out from cool, underground tanks or when the air temperature is cool, such as early morning or evening.

- * Always handle fuel with care.
- * Never store fuel in portable containers aboard your yacht.

EMERGENCY SITUATIONS

Swamped or Capsized Yacht

If your yacht becomes swamped or capsizes, immediately put on a PFD and set off a visual distress signal. A swamped or capsized yacht will normally stay afloat. **DO NOT** leave your yacht or attempt to swim to shore, except under extreme conditions, such as fire or explosion. A capsized yacht is much easier to see by a potential rescuer than a person swimming, resulting in a greater chance of rescue. If you attempt to swim to safety, the shore may be farther away than it appears and you may tire and not be able to reach your destination, resulting in possible drowning.

Hypothermia

If a person falls overboard or is in the water due to a swamped or capsized yacht, hypothermia may be an immediate concern. Hypothermia exists when the body loses heat faster than it can replace it. If not rescued within a short period of time, the person will become exhausted and likely drown. In general, the colder the water, the shorter the time for survival. If the person is wearing a PFD, it will greatly increase his survival time as they act as an insulator and will also keep the person afloat even if he is unconscious.

Collision

If a collision occurs, the following procedure should be strictly adhered to:

- * Be certain all passengers put on their PFD. If a passenger is unable to put on his own PFD due to a disabling injury, assist him.

- * Examine all persons on board for any injuries and administer first aid, if necessary.

- * If your yacht has a VHF radio, contact the United States Coast Guard and any other potential rescue vessel and advise of your situation and location. VHF radio contact may be made on Channel 16 and Citizen's Band (CB) radio contact may be made on Channel 22. If you have SeaKey services, you should send a "MAYDAY" Signal and mark your location. For details on these procedures refer to your SeaKey Operators Guide.

- * Inspect your yacht to determine the extent of damage and its potential for sinking.

- * Prepare to assist the other craft and its passengers, if possible.

- * If the collision resulted in penetration of your hull, prepare to quickly plug the fracture with a spare life jacket or bunk cushion once the vessels are separated.

- * Before plugging the fracture, trim the yacht to place the damaged section above the water level.

- * Remain with your yacht until assistance arrives.

Running Aground

- * If your yacht runs aground, examine everyone on board for injuries and render first aid, if necessary.

* Examine your yacht for damage to the hull and running gear. If no serious damage is noted, attempt to free the yacht by shifting weight to the bow to raise the stern and then reverse the engines and back out of the shallow water into deeper water.

* If towing is necessary, **DO NOT** attach the tow line to the deck cleats. They are not designed to take the full load of the yacht under pressure.

Silverton recommends using a commercial towing service for your safety and to decrease the potential for additional damage to your yacht as a result of removing it from the underwater obstruction.

 **DANGER**

NEVER attach a tow line to a deck cleat or anchor windlass. The cleat or windlass may pull free from the deck and cause serious personal injury or property damage.

Hazardous Weather Conditions _

Storms

Storms rarely appear without some advance warning. Check the local weather forecast before you leave port, but be aware that weather conditions can change rapidly. If you have a VHF radio, listen to the continuous weather reports issued by the National Weather Service. If you have a portable radio, keep it tuned to a station that broadcasts frequent weather reports. If you are tuned to an AM frequency, listen for static; it often means an electrical storm is approaching. Many boating clubs fly weather signals in

the form of flags or lights. Learn to recognize these signals.

Your surroundings can also be a good indicator of changing weather conditions. Watch for changes in wind direction or cloud formations. There is no substitute for a good understanding of typical weather conditions and what to do when it takes a turn for the worse.

Fog

Fog is the result of either cold air passing over a warm earth surface or warm air passing over a cold earth surface. You can judge the likelihood of fog formation by periodically measuring the air temperature and the Dew Point temperature (the temperature at which moisture in the air will develop), which is given during a normal weather forecast. If the difference between these two temperatures is small, fog is likely to develop. Always remember the following guidelines if you encounter fog conditions:

- Unless your yacht is well equipped with charts, head for shore at the first sign of fog and wait until conditions improve before continuing your cruise. If you have charts on board, take your present location bearings as the fog sets in, mark your position, and continue to log your course and speed.
- **REDUCE YOUR SPEED.**
- Be certain all persons on board are wearing their PFD.
- Station a person forward as a lookout.
- Sound your horn or fog bell at the appropriate intervals to warn other vessels of your presence. Refer to the *“Rules of the Road”* for information concerning

the proper duration and interval of the fog signal.

- Listen for fog signals from other vessels and be aware of their presence. If possible, determine their proximity to your yacht, but remember, sound carries a long distance over water and can be deceiving.
- If there is any doubt concerning the safety of continuing your excursion, anchor your yacht. Listen for other fog signals while continuing to sound your fog bell or horn. Continue your cruise when conditions improve.

FIRE

Fire aboard your yacht is always serious, but it can usually be brought under control if you are prepared and act quickly. Fire extinguishers required by the United States Coast Guard are the minimum necessary. Silverton recommends exceeding the minimum requirements by placing additional fire extinguishers where they may be needed. Inspect all fire extinguishing equipment frequently and review emergency plans on a regular basis.

As a yacht owner, you should develop a **Fire Response Plan** and familiarize all passengers with this plan before departing on your cruise. The Fire Response Plan will identify the type of fire you may encounter and the appropriate reaction to quickly extinguish it before it gets out of control. Having a Fire Response Plan in place and the assignment of certain responsibilities to your passengers will result in faster and more accurate decisions and reactions in the event of a fire aboard your yacht.

Important: *All passengers on board your yacht should know the location of your fire extinguishers and be familiar with their use.*

In the event a fire does start aboard your yacht, follow these guidelines:

✓ If you detect a fire or suspect a fire aboard your yacht, immediately turn OFF your engines and electrical power supply. DO NOT turn OFF power to your VHF radio.

✓ Be certain all persons on board put on their PFD.

✓ If the fire is in the engine/generator compartment, DO NOT open the hatch. The fire will flare with the sudden introduction of fresh air.

✓ If you are able to get to the source of the fire, aim your fire extinguisher at the base of the flames and use a sweeping action to extinguish it. Concentrating your fire extinguisher in one location may cause the fire to spread.

✓ If the fire becomes out of control, send a distress signal and call for assistance on your VHF radio. Be certain to provide any potential responders with your location and a description of your situation. If you have SeaKey Services, you should send a "MAYDAY" Signal and mark your location. For information on these procedures, refer to your SeaKey Operators Guide.

Deciding whether to stay on board your yacht or abandon ship may be difficult and depends on the extent of the fire and the weather conditions. If you decide to abandon ship, all persons on board should jump, not dive, overboard and swim a safe distance

away from the burning yacht. Be certain all persons stay together after abandoning ship.

Be certain to read and have a thorough understanding of the Portable Fire Extinguisher System Section and the Automatic Fire Extinguisher System Section of this Owner's Manual. They contain valuable information and warnings for your safety.

Prevention is the safest and most effective method of fighting fire aboard your yacht. Always follow these guidelines:

- ✘ Use extreme caution and refrain from smoking while fueling your yacht.
- ✘ Use only marine safety approved cooking and heating systems and follow the manufacturer's directions concerning their operation.
- ✘ Open flames demand constant attention. DO NOT leave any open flame unattended.
- ✘ Ensure ventilation systems are unobstructed.
- ✘ Always provide adequate ventilation when cleaning and painting.
- ✘ Use extreme caution when using liquefied petroleum gas (LPG) or compressed natural gas (CNG). Close valves to cylinders and supply lines when not in use.
- ✘ Operate exhaust blower motors at least five (5) minutes before starting the engines or generator.
- ✘ Use your sense of smell to check for fumes in the bilge and engine/generator

compartment before starting engines or generator.

- ✘ Always store flammable material in approved containers and in a locker sealed from the interior of your yacht and vented overboard.
- ✘ Remove the canvas enclosure, at least partially, before starting engines.
- ✘ Ensure there are no leaks in any fuel system, including LPG/CNG.
- ✘ Extinguish smoking materials carefully. Check cleaning materials for flammability and store as you would any flammable material.
- ✘ Always disconnect electrical power before performing any maintenance on electrical appliances.
- ✘ Always replace electrical breaker switches or fuses with the same recommended amperage. NEVER exceed the recommended amperage.
- ✘ Electrical service to your yacht should only be performed by a qualified marine electrical technician.

AIR CONDITIONING / HEATING SYSTEM (Optional)

The Air Conditioning/Heating System in your 42C is factory installed. The purpose of this system is to maintain a comfortable cabin temperature and humidity level, regardless of ambient temperature and humidity. Each air conditioning/heating unit in your 42C, which operates on the A/C electrical system, is self-contained and manufactured by Marine Air Systems. The two (2) Air Conditioning/Heating System units are described as follows:

32,000 BTU Total Capacity

This system utilizes two (2) self-contained air conditioning units, each having a capacity of 16,000 BTU's. The **Forward Unit** is located under the bed in the forward stateroom. The **Aft Unit** is located on the starboard side of the Salon, behind the lounge.

Each air conditioning unit is controlled by an independent thermostatic control panel ("Passport Control"), which is located within the respective cooling/heating zones.

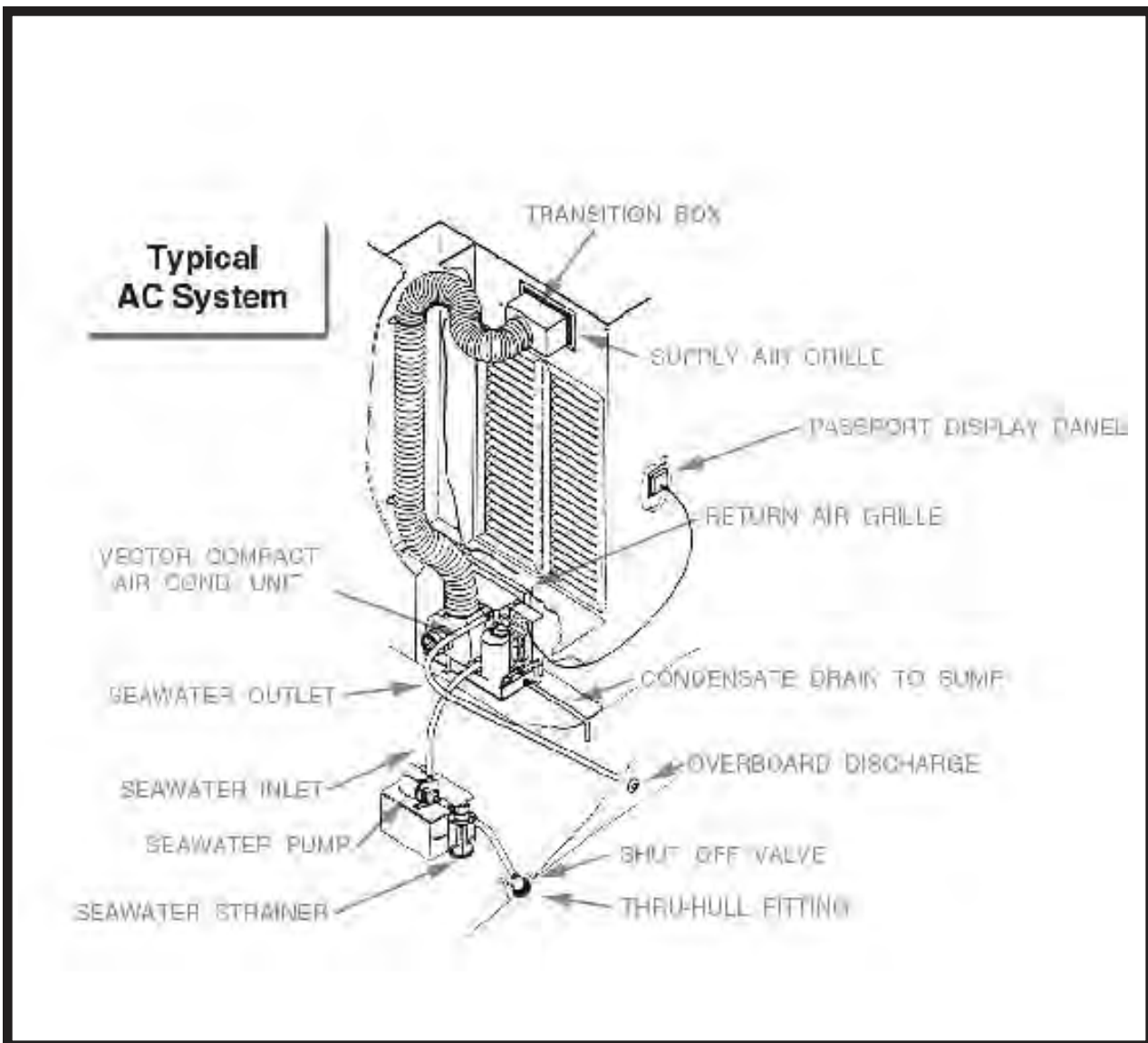

The desired zone temperature is manually set on the “Passport Control” and the air conditioning unit is activated to supply cooling or heating as required to constantly maintain the temperature selected. The photo below shows the control.



Each air conditioning unit will operate in a “Dehumidification” mode upon demand and is controlled by the “Passport Control”. Refer to the Marine Air Systems Operation and Maintenance Manual for a complete description and instruction in the operation of this mode.

Operation of the Air Conditioning/Heating System in your 42C is as follows:

- ✓ Turn ON the respective air conditioner breaker switch, located on the AC/DC Electrical Panel (See AC/DC Electrical Pages in the System Operations Section of this manual).
- ✓ Make sure seawater intake is open and seawater pump is operating properly.
- ✓ Refer to the Marine Air Systems Operation and Maintenance Manual for a detailed description of the function of each button located on the “Passport Control”.

✓ Both Air Conditioning units create condensation, which creates water that has to be drained. The forward unit drains into the shower sump pump. Make sure shower sump circuit breaker is turned ON when operating the Air Conditioning. The aft unit has its own drain which discharges directly overboard.

✓ Turn ON the power button located on the respective air conditioning unit “Passport Control”.

✓ Press the fan speed button on the “Passport Control” until the desired speed is obtained.

✓ Press the appropriate temperature control button (Down/Up) to obtain the desired temperature.

Only certified and trained service technicians should perform maintenance of your Air Conditioning/Heating System. Contact your Silverton Dealer for general maintenance and winterization of the system on your 42C. Untrained persons may carefully perform routine maintenance, such as the cleaning of filters and the exterior surfaces of the condensing coils.

REFER to the MARINE AIR SYSTEMS OPERATION AND MAINTENANCE Manual for Technical information concerning your AIR CONDITIONING / HEATING SYSTEM.

ANCHOR SYSTEM

The purpose of the Anchor System is to make fast your yacht to the ground surface below the water level. You may want to anchor your yacht for a variety of reasons, such as an overnight stay in a harbor, stationary fishing; or, if your yacht becomes disabled, to remain in one identifiable location until assistance arrives. The equipment used in anchoring your yacht, also known as “ground tackle”, is as follows:

- Anchor
- Anchor Chain or Line (Rode)
- Anchor Chock
- Anchor Cleat
- Anchor Safety Chain
- Anchor Windlass (Optional)
- Rope Locker

Anchor

Your 42C is equipped with a plow-type anchor, weighing 34.7 pounds. This universal type of anchor is very efficient for a variety of bottom terrain. However, this is not a storm anchor. Please refer to Chapman’s for the recommended need for a storm anchor.



Anchor Chain or Line (Rode)

The Anchor Rode on your 42C may be chain, rope, or a combination of both; and, depending on the option you selected when you purchased your yacht from your Silverton Dealer, the length will be as follows:

Standard Equipment: Three hundred (300) feet of nylon rope, 9/16 inch in diameter.

Optional Windlass Equipped (Standard): Fifteen (15) feet of chain coupled to one hundred fifty (150) feet of nylon rope, 9/16 inch in diameter.

Optional Windlass Equipped (Optional): Three hundred (300) feet of chain.

Anchor Chock

The Anchor Chock on your **42C** is located on the underside of the bow pulpit. The Anchor is pulled into the chocks on the pulpit, to steady the anchor.



Anchor Cleat

Your **42C** is equipped with an Anchor Cleat and its purpose is to hold the rope that secures the anchor after the anchor is set. If your **42C** is equipped with the optional Windlass Anchor Winch, the cleat will help relieve constant pressure on the winch. Once the proper scope is determined, the cleat keeps the rope at a con-

stant length. The Anchor Cleat is located in the Anchor Hatch. The photo below shows the cleat next to the access hatch hinges.



Anchor Windlass (Optional)

Your 42C may be equipped with an optional power Anchor Windlass, which is located under the Anchor Hatch. The purpose of the Anchor Windlass is to assist in lowering and raising of the anchor with a minimum of manual effort. The Anchor Windlass operates on DC electrical power and may be operated from either the helm station or foot controls, which are located on the bow pulpit. Be certain the Anchor Windlass breaker switch, which is located in the engine room, and the battery switch, which is located under the step at the Galley, is turned to the ON position. The helm station control consists of a manual rocker-type switch, located on the helm switch panel (refer to the Electrical Pages of this section of this Owner's Manual for the location of the switch). The foot controls, located adjacent to the Anchor Windlass, consist of two (2) foot depressed switches: the RED switch lowers the anchor; while the GRAY switch raises the anchor (See photograph below, which illustrates the location of the Anchor Windlass, the foot depressed control switches, the Anchor Cleat, and the Rope Locker).



Rope Locker

Your 42C is equipped with a Rope Locker, which is located on the Starboard side of the Anchor Hatch. The purpose of the Rope Locker is to store the anchor rode in a convenient location removed from the deck surface. The Rope Locker is accessed by a hatch, which covers the locker and prevents you or your passengers from accidental falls into the storage well (See previous photograph, which illustrates the location of the Rope Locker). This Rope Locker has a drain in the bottom. It is recommended that you wash off the saltwater with fresh water after use of your anchor and rope.

Scope

Scope is defined as the ratio of the length of the anchor rode to the vertical distance from the anchor chock to the bottom surface (water depth plus the height of the anchor chock above the water). Under favorable current, tidal and weather condi-

tions, a Scope ratio of 8:1 is considered satisfactory. If the rode is chain, the ratio may decrease to 5:1 under the same favorable conditions. It may be necessary to increase the scope ratio under unfavorable weather conditions, such as severe wind and tidal currents, to hold your yacht fast to the bottom. Scope ratio is very important. Please refer to your Chapman's book for all details on anchor rode.

ANCHOR SAFETY CHAIN

Attached to the anchor chain is a safety chain. This safety chain must be released before you can use your anchor. This safety chain must be released manually. This safety chain will ensure that the anchor is not released when not being used.

PROPER ANCHORING TECHNIQUES

Proper anchoring techniques are required for safe anchoring of your boat. Please refer to Chapman's book for complete instructions for anchoring your boat.

BILGE PUMP SYSTEM

The purpose of the Bilge Pump System is to remove any water that may accumulate within the bilge area of your yacht. Although a small amount of water in the bilge area is expected, the water should never be above the bilge switch. If it is, this means that the switch is not working correctly. Make sure they are not turned off. If the problem continues, please contact a service technician to solve the problem. The bilge area is defined as the interior area of the hull below the designed waterline. Your 42C is equipped with three (3) bilge pumps that are capable of pumping 1250 gallons of water per hour. The bilge water is pumped directly overboard.



Normal operation of the bilge pumps is automatic. Each bilge pump is equipped with a float-type switch that will automatically activate the pump when the bilge water reaches a certain level. The automatic switches are connected directly to the batteries and will operate even if the battery switch is turned OFF. Each of the bilge pumps can also be activated manually by individual switches located on the AC/DC Electrical Panel (See the Electrical Pages in this section of your Owner's Manual for the location of the Bilge Pump Switches). The bilge pump will operate continuously until the pressure is taken OFF the switch.

Periodic maintenance of the bilge pumps should consist of the following:

- Visually inspect each bilge pump for any debris that may have accumulated. Remove any debris noted.
- Manually test each bilge pump by activating the manual switches located on the AC/DC Electrical Panel. Listen to each bilge pump as it is manually activated. They should emit a quiet “whirring” sound. If any abnormal sounds are noted, contact your Silverton dealer for further inspection and replacement, if necessary.

IMPORTANT: After testing each bilge pump by turning ON the manual switches, be certain they are turned OFF. The constant operation of the bilge pumps will eventually discharge the batteries.

While underway, the aft bilge pump should be used. While docked, the midships bilge pump should be used.

Location of the bilge pumps is as follows:

- **FORWARD PUMP** - Access to the forward pump is through the hatch opening located on the Galley Floor.
- **MIDDLE PUMP** - Access to the middle pump is through the engine room. The pump is located in the front section of the engine room.
- **AFT PUMP** - Access to the aft pump is under the fish box located at the cockpit.



BILGE VENTILATION SYSTEM

WARNING

The engine and generator compartments on your 42C are enclosed areas and are subject to the accumulation of dangerous fuel fumes. If these fumes are not ventilated or properly exhausted from the engine/generator compartment, they may be ignited, resulting in fire or explosion and possible injury or death.

Your 42C is equipped with intake vents for the engine room. These vents are located on the port and starboard side of your 42C. The purpose of these vents is to ventilate the engine room area of your 42C.

The photo below shows the vent on the port side of your 42C.



For quicker evacuation of air from the engine room, your 42C is equipped with two (2) bilge blowers. The blowers are located in the engine compartment and exhaust out through the hull on the port and starboard sides of your 42C.

The photo below shows the blower exhaust on the starboard side of your 42C.



Operation of the bilge blowers is as follows:

- ✓ The battery switch must be turned to the ON position. The Battery Switches are located under the access hatch on the step going from the Salon to the Passageway.
- ✓ The bridge electrical breaker switch at the ship's shore service panel must be turned ON.
- ✓ Depress the blower motor switch, located on the helm switch panel. The switch location is shown in the Electrical Pages of this section of your Owner's Manual. The small light located on the blower switch will illuminate to indicate that the blower motors are in operation. The blowers can also be turned on at the AC/DC Panel. The Electrical Pages of this section of this Owner's Manual shows the location of the switch on the AC/DC Panel. There is also a Schematic of the AC/DC Panel in the Schematics Section of this Owner's Manual.

! WARNING

To reduce the risk of fire or explosion within the engine/generator compartments of your 42C, the bilge blower motors should ALWAYS be operated under the following conditions:

- ✓ Operate the blower motors for a minimum of five (5) minutes prior to starting the engines or generator.
- ✓ Operate the blower motors continuously while your yacht is traveling less than cruising speed.

The photo below shows the blower unit attached to the exhaust hose.



Located right next to the blower is the fuse for the blower.

BONDING SYSTEM

The purpose of the Bonding System is to protect your yacht's underwater components from electrolysis and galvanic corrosion. Examples of underwater components would be the propellers, propeller shafts, rudders, engine/generator, and seawater intake valves.

Electrolysis and galvanic corrosion occurs primarily in salt water, but can occur to a lesser degree in fresh water. Salt water allows electric current to flow from anodic to cathodic material. Any two metals from two components and their relative positions in the galvanic rating table will determine which metal loses material (anode) and which metal remains largely undisturbed (cathode). The distance apart on the galvanic table of the two metals determines the rate of wear.

To help prevent corrosion, sacrificial zinc anodes are fitted to the underwater components of your yacht, such as the propeller shafts and rudders. A large sacrificial



zinc anode plate is also attached to the underwater area of the transom.



The anodes on the rudder, shaft, and trim tabs are installed by your Silverton Dealer.

The purpose of these sacrificial zinc anodes is to attract any destructive electrical currents away from the metallic underwater components, thereby preventing their eventual corrosion and allowing the corrosion of the sacrificial zinc anodes. The sacrificial zinc anodes are considerably easier and cheaper to replace and their deterioration will not affect the performance of your yacht, as would the deterioration of a propeller or rudder.

The Bonding System is a network of wires (color coded green) that are connected to all metallic underwater components within the interior of the hull; which makes them one unit for electrical current purposes. This network of wires is then attached to the sacrificial zinc anode located on the transom, which allows corrosion of the anode but prevents corrosion of the underwater components.

General maintenance of the Bonding System consists of yearly replacement of the sacrificial zinc anode located on the transom and all other zinc anodes located

on the propeller shafts, rudders, etc., and should be completed during the spring launch procedure.

The anodes may require more frequent replacement, depending on your docking location and the length of your boating season. If possible, check the anodes for excessive corrosion midway through your boating season. If excessive corrosion is noted, have your dealer or a competent technician replace the sacrificial zinc anodes. Periodically check the wiring connections to make sure they are tight and free of corrosion. Tighten and clean connections as necessary.

NOTE: Silverton recommends placing sacrificial zinc anodes on the following components:

- Propeller shafts
- Rudders
- Trim Tabs

IMPORTANT: DO NOT paint any of the sacrificial zinc anodes as it will retard the flow of electric current through them and render them ineffective.

CARBON MONOXIDE (CO) DETECTOR SYSTEM

DANGER

Carbon Monoxide Gas (CO) is colorless, odorless, and tasteless. It is highly poisonous, endangering lives even at very low levels of concentration. Mild exposure causes headaches and fatigue, often resembling “flu-like” symptoms. Medium exposure causes severe headaches, drowsiness, nausea, and rapid heart rate. Extreme exposure results in unconsciousness, convulsions, cardiorespiratory failure, and death. If Carbon Monoxide Gas (CO) is detected in your yacht, immediately contact a qualified technician to locate and repair the source of the poisonous gas. **DO NOT** enter your yacht until repairs have been made and the Carbon Monoxide Gas (CO) is lowered to an acceptable level. Refer to the Carbon Monoxide Safety pages in the Boating Safety section of this Owner’s Manual.

Your 42C is equipped with three (3) SAFE-T-ALERT Carbon Monoxide Gas (CO) detector monitors, which are located within the interior as follows:

- Forward Stateroom
- Salon
- Mid Stateroom

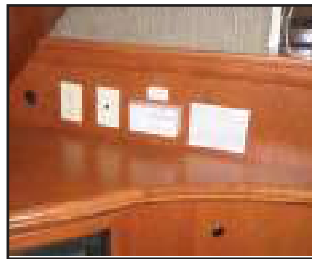

Each CO monitor is operated by DC electrical power and they are connected directly to the batteries. It is not necessary for the battery switch to be turned ON for them to operate. The fuses for the monitors are located behind the AC/DC Panel.



Operation of the CO monitors requires a ten (10) minute warm-up period, during which time, the sensor element is cleaned and the unit is stabilized. During this ten (10) minute warm-up period, the GREEN indicator light will flash ON and OFF. The GREEN indicator light will remain ON after the completion of the warm-up period until the presence of Carbon Monoxide Gas is detected. If the GREEN indicator light does not illuminate, check all wiring connections and clean and tighten, if necessary. If the GREEN indicator light still fails to illuminate, contact your Silverton Dealer for inspection and replacement. **DO NOT** attempt to make any repairs to the unit(s) yourself.

When Carbon Monoxide Gas is detected by the CO monitor, the following visual and audible signals will appear:

Low CO Warning

YELLOW flashing indicator light accompanied by a “BEEP” sound every five (5) minutes. The YELLOW indicator light will

continue to flash until the presence of CO has lowered to an acceptable level. If the CO level has not been lowered to an acceptable level, an alarm will sound in approximately fifteen (15) minutes. Contact a qualified technician to locate and repair the source of the Carbon Monoxide Gas and DO NOT enter your yacht until repairs have been made and the CO has been brought to an acceptable level.

CO Alarm

RED flashing indicator light accompanied by a pulsed alarm sound. This indicates the presence of a dangerous level of Carbon Monoxide Gas and IMMEDIATE ACTION IS REQUIRED.

Contact a qualified technician to locate and repair the source of the Carbon Monoxide Gas. DO NOT enter your yacht until repairs have been made and the CO has been brought to an acceptable level. After depressing the "Reset" switch, the RED indicator light will continue to flash and the alarm will produce a "BEEP" sound every thirty (30) seconds until the CO is lowered to the Low CO Warning level. If the CO is not lowered to this level, the pulsed alarm will resound in approximately six (6) minutes. The Low CO Warning alarm will activate if the Carbon Monoxide Gas is lowered to the low concentration level.

CO Monitor Malfunction

Indicator light flashes alternating RED/GREEN accompanied by a "BEEP" sound every fifteen (15) seconds. Depressing the "Test/Reset" switch will not discontinue the visual and audio signal. See your Silverton Dealer for inspection and replacement of the unit(s), if necessary.

Maintenance of your CO monitors is as follows:

- ✓ Test each monitor after removing your yacht from storage, prior to departing on each cruise and on a weekly basis. Refer to the SAFE-T-ALERT User's Manual included with your owner's packet for the proper test procedure.
- ✓ Frequently observe the color of the indicator light on each CO monitor and during testing to be certain the light is functioning properly.
- ✓ Vacuum the dust off the CO monitor cover with the brush attachment of your vacuum cleaner at least once a year and more frequently if your yacht is maintained in a dusty climate.
- ✓ Frequently clean the CO monitor cover with a damp cloth to remove all dirt and grease that may accumulate. Dry with a soft, dry cloth.
- ✓ DO NOT spray cleaning agents or waxes directly onto the CO monitor cover.

REFER to SAFE-T-ALERT User's Manual for additional technical information concerning the use and maintenance of your CO Monitors.

ELECTRICAL SYSTEM

This section describes the various components of the Electrical System on your **42C**. Also included is a Troubleshooting Guide for your convenience.

AC/DC PANEL

The AC/DC Panel is where all the controls for the electrical system are located. The panel is broken down into three main sections. The top part of the panel, labeled 12 Volt DC Controls, is the controls for the electrical system when it runs on batteries. The lower part of the panel, labeled 240 Volt AC Controls, is the controls for when the electrical system runs on AC.

DC ELECTRICAL SYSTEM

Located in the engine compartment, the DC Electrical System obtains its source of power from the batteries. The negative terminal of each battery is attached to a grounding stud on each engine. This is known as a “negative ground system” and is the approved system for marine DC electrical systems. The battery wiring system has two color-coded wires. The yellow wire is the ground (negative) wire and the red wire is the positive (hot) wire. Both batteries are connected to a battery switch (See photograph below).



The positions on the battery switch are ON and OFF. The switch must be turned to the ON position to supply power to the DC electrical system. When the battery switch is turned to the OFF position, power is disconnected to the DC electrical system.

NOTE: The bilge pumps, carbon monoxide detectors, and radio memory are NOT disconnected from their power source when the battery switch is turned to the OFF position. These accessories are connected directly to the battery and do not require a switch for operation.

Battery Charging System

The batteries maintain their charge from alternators, which are located on each engine. The alternators supply charging power to the batteries only while the engines are running. Your **42C** also has a converter, located in the bilge, which converts 120 volt AC electrical power from either the generator or shore power into 12 Volt DC electrical power.

Activating the DC POWER SYSTEM

There are three (3) sets of switches that must be in the ON position to activate the DC Power to your 42C. One set of switches is on the ship service box down in the engine room. These switches are normally in the ON position. The second set of switches would be the battery switches, located under the access panel on the steps going from the Salon to the Passage-way/Galley. The third set would be on the AC/DC Panel. On the top portion of the AC/DC Panel are two rows of switches. The very top switches on the top of each row are the Main Battery Switches. Each switch controls that row of switches below it. To supply power to one of the switches listed on the left side of the panel, the top switch on the left hand side must be on.

The photo below shows the top of the AC/DC Panel. Notice the two columns of switches.



There are four meters across the top of the panel. They are as follows (from left to right):

DC Amperage Meter for Battery #1 - Displays the Amperage Draw on Battery #1.

DC Volt Meter for Battery #1 - Displays the Voltage Draw on Battery #1.

DC Amperage Meter for Battery #2 - Displays the Amperage Draw on Battery #2.

DC Volt Meter for Battery #2 - Displays the Voltage Draw on Battery #2.

Below the meters are two columns of switches. The left-hand side is all the switches connected to battery #1. The right-hand side is all the switches connected to Battery #2.

The switches for the left column (BATTERY #1) are as follows (from top to bottom):

- DC Main #1: Supplies 12 Volt Power from Battery #1 to all breaker switches directly under this switch.

-Cabin Lights Salon: Supplies power to the cabin lights in the salon and galley.

-Cabin Lights Galley: Supplies power to the cabin lights in the galley.

-Forward Toilet: Supplies power to the forward toilet.

-Refrigerator 1: Supplies DC power to the refrigerator.

-Macerator: Supplies power to the Macerator pump.

-Saltwater Washdown: Supplies power to the Salt Water Washdown Unit in the cockpit.

-Oil Changer: Supplies power to the optional Oil Changer Unit.

-Spare: Supplies power to additional accessories.

The switches for the right column (Battery #2) are as follows (from top to bottom):

-DC Main #2: Supplies 12 Volt DC power from Battery #2 to all breaker switches directly under it.

-Cabin Lights Forward: Supplies power to the cabin lights in the forward stateroom and forward head.

-Courtesy Lights: Supplies Power to all courtesy lights throughout the yacht.

-Fresh Water: Supplies power to the fresh water pump.

-Refrigerator #2: Supplies DC Power to the refrigerator.

-Shore Retrieve: This switch controls the optional Glendinning.

Engine Room Lights: Supplies power to the Engine Room Lights.

-Forward Shower Pump: Supplies Power to the Forward Shower Sump Pump.

-Spare: Supplies power to additional accessories.

Below the DC Volt section of the AC/DC Panel is the Bilge Pump section of the AC/DC Panel. There are three (3) sets of breakers and switches. Each bilge pump (forward, mid, and aft) has a breaker switch and an ON/OFF Switch. Although the bilge pumps always have power to them, to operate the bilge pumps manually, you must have the battery switches ON.



BREAKER SWITCHES: The breaker switches are your safety switches. They work just like a fuse, but are reset-able. If the breaker switch is activated, before resetting the switch, locate the problem. The breaker is reset by pushing in the WHITE Button.

MANUAL SWITCH: This is the ON/OFF Switch.

! WARNING

Fuel fumes in the engine compartment can explode. Before working on any electrical wiring, ventilate the engine compartment and disconnect the batteries to prevent sparking.

! CAUTION

NEVER reset a breaker switch which has tripped automatically without first locating and correcting the problem. The electrical system and devices may be damaged.

! CAUTION

Alterations or extensions to the electrical system can cause electrical shock or fire. **ONLY** competent marine electricians should make system changes according to U.S. Coast Guard regulations.

240 VOLT AC ELECTRICAL DISTRIBUTION PANEL

The AC electrical system is a three-wire grounded system powered by either the generator (if so equipped) or the shore power. There is a "ground fault interruption circuit" (GFIC) that protects all outlets. This system prevents accidental electrical shock. If power is lost to an outlet, reset the breaker switch at the GFIC outlet.

If you are unable to reset the GFIC breaker switch, contact your Silverton Dealer or a competent marine electrician for inspection and repair. Failure to do so may result in a fire or damage to the electrical system.



The AC electrical system is supplied with 240 Volts of power upon entry to the main electrical distribution panel; which then is separated into two (2) legs of 120 Volts each.

115 Volt Switches

The following breaker switches and their function are described below in the order in which they appear on the main electrical distribution panel:

AC Amperage Gauge and Switch: The gauge displays the amperage draw on the AC circuit. The gauge reads the amperage and the switch below it selects which line the gauge will display. Line 1 is the power and switches on the left side of the AC Portion of the AC/DC Panel. Line 2 controls the power and switches on the right side of the AC portion of the AC/DC Panel.

AC Volt Gauge and Switch: The gauge displays the voltage draw on the AC circuit. The gauge reads the voltage and the switch below it selects the line the gauge will display. Line 1 is the power and the switches on the left side of the AC portion of the AC/DC Panel. Line 2 is the power and switches on the right hand side of the AC Portion of the AC/DC Panel.

Generator Blower and Start/Stop Switch: This is the ON/OFF Switch for the generator. The generator is an option that was available with your 42C. Below the ON/OFF Switch is the Generator Blower Switch.



The blower must be run for four (4) minutes before starting the generator.

SHORE POWER / GENERATOR SWITCH:

This switch selects where you will be getting your AC Power from. The slide bar is there to make sure you only select one source at any given time. In order for the three (3) generator switches to be on, the slide bar has to move over to block the three (3) Shore Power Switches from being on. In order for the three (3) Shore Power switches to be on, the Slide Bar must move over to block the three (3) Generator Switches from being on.



Converter: Supplies power to the converter, which converts DC power to AC power.

Galley Outlets: Supplies power to the outlets in the Galley.

Forward Outlets: Supplies power to the outlets in the forward cabin and forward head.

Exterior Outlets: Supplies power to the outlets found on the exterior area of the yacht.

Salon Outlets: Supplies power to the outlets in the Salon.

Microwave: Supplies power to the microwave oven outlet.

Water Heater: Supplies power to the water heater.

 **CAUTION**

Be certain the water heater is full of water and does not contain air. If the water heater is not full of water, damage to the heating elements may result when electrical power is turned ON to the unit.

Forward Air Conditioner: Supplies power to the forward air conditioner. Air pump must be ON before unit is turned ON.

Mid Air Conditioner: Supplies power to the mid air conditioner (if equipped with the optional 37,000 BTU system).

Icemaker: Supplies power to the icemaker unit.

Air Pump: Supplies power to the air conditioner raw water pump.

Vacuum System: Supplies power to the optional central vacuum cleaner system.

Range: Supplies power to the stove/oven combination.

Spare: Supplies power to additional AC accessories.

Spare: Supplies power to additional AC accessories.

Spare: Supplies power to additional AC accessories.

Spare: Supplies power to additional AC accessories.

Shore Power

Follow the procedures below to connect shore power to your yacht:

- Turn OFF all 115 volt circuit breakers at the AC portion of the AC/DC Panel. Shut down the generator if it is in operation.

 **WARNING**

Using a damaged or improper cord for shore power connection can cause electrical shock and serious personal injury. Use a cord specifically designed for shore power connection. DO NOT use a household extension cord.

- Connect the female end of the shore power cord to the yacht's inlet receptacle. Be certain the lock ring is tightly secured. If there is a cord already supplied at the dock, be sure to unhook the cord from the dockside outlet.

 **WARNING**

DO NOT connect the shore power cord to the dockside electrical source first. You can accidentally drop the cord into the water which may result in electrical shock and serious personal injury.

- Connect the Shore Power Cable to power supply. When connecting the shore power cable to the dockside outlet, be certain the cable has sufficient slack to prevent stretching during tidal changes.
- Slide the SHORE POWER/GENERATOR slide bar over on top of the generator side of the switch. With the slide over, turn on the shore power switch.

The shore power side of the distribution panel should now be operable.

If there is no power to the electrical distribution panel, check the following:

- Breaker switch at dockside power supply.
- Main breaker switch on shore power side of distribution panel.

Follow the procedures below to **disconnect** shore power from your yacht:

- Turn OFF all 115 volt circuit breakers on the main distribution panel.
- Turn OFF the dockside circuit breaker switch.
- Disconnect the shore power cord from the dockside outlet.
- Disconnect the shore power cord from the yacht's inlet receptacle.
- Store your shore power cable in a safe, dry location.

STARTING THE GENERATOR

- Turn on the generator blowers.

WARNING

The blower must be run for four (4) minutes before starting the generator.

- Start the generator (Refer to "Starting Instructions" section in the Generator

Manual included with your owner's packet). Be sure that it is operating properly.

- Turn off all 115 VAC breakers.
- Turn off the shore power switch on the Shore Power/Generator switch.
- Slide the slide bar over on top of the Shore Power Switches. With the slide bar over, you should be able to switch ON the generator switches.

WARNING

Fuel fumes in the engine compartment can explode. Before working on any electrical wiring, ventilate the engine compartment and disconnect the batteries to prevent sparking.

CAUTION

NEVER reset a breaker switch which has tripped automatically without first locating and correcting the problem. The electrical system and devices may be damaged.

CAUTION

Alterations or extensions to the electrical system can cause electrical shock or fire. ONLY competent marine electricians should make system changes according to U.S. Coast Guard regulations.

FUSE BOXES

In the AC/DC Panel, located in the upper portion of the electrical cabinet, there are two (2) fuse boxes.



Turn off all electric power to your AC/DC Panel when opening the door to the electrical cabinet. The power can be turned off by the two main DC switches at the top of the panel, and the main AC switch in the lower portion of the Panel.

The photo below shows the upper right fuse box.



In this fuse box you will find the following (on the right hand side):

From top to bottom-

- Stereo Memory - 15 amp.
- 12 VDC Outlet - 15 amp.

The photo below shows the upper left fuse box.

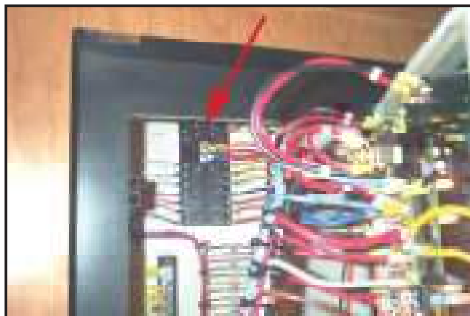

In this fuse box you will find the following (left side, from top to bottom):

- CO Monitor (forward) - 1 amp.
- CO Monitor (mid) - 1 amp.
- CO Monitor (salon) - 1 amp.
- Waste Meter - 3 amp.
- Water Meter - 3 amp.
- 12 Volt DC Stereo - 15 amp.
- Locker Lights - 10 amp.
- Shower Sump Pump - 7.5 amp.
- Oil Changer - 15 amp.
- Shore Return - 20 amp.

Also (right side, from top to bottom):

- Galley Exhaust - 5 amp.
- Head exhaust - 5 amp.
- Shower Exhaust - 5 amp.
- Panel Lights - 5 amp.
- Port Window - 15 amp.
- Starboard Window - 15 amp.
- Fish Box Pump - 20 amp.
- Amp. Antenna - 5 amp.



HELM ELECTRICAL SWITCHES

In addition to the switches on the AC/DC Panel, there are also switches at the helm.

These switches are 12 Volt Switches.

These switches will be described in order (from left to right).

ANCHOR/NAVIGATIONAL LIGHTS - This switch is a three position switch. The three positions are OFF, Navigation Lights, and Anchor Lights.

HORN - This is a push button switch. To

activate the horn, press the top of the switch.

PARALLEL - When starting your engines, you need increased amperage to your engine. This switch will parallel the batteries to achieve this.

COURTESY LIGHTS - This switch controls the courtesy lights on the bridge.

ACCESSORY - This is an extra switch for any option that has been added.

PANEL LIGHTS - This switch controls the panel lights at the helm.

BLOWER - This switch controls the blowers in the Engine Room.

Electrical Accessories

You may have purchased optional electronic accessories, such as a VHF radio, GPS system, or autohelm system, with your **42C**. These units are controlled by the switches marked ACC. located on the helm switch panel. These accessories are powered through the electrical panel. The switches used to control them are marked "SPARE".

Helm Breaker Panel

Located inside the helm is a breaker/reset panel. The panel is accessed by removing the lounge back located in front of the helm. These reset buttons are push buttons.

The photo below shows the location of the panel.



REFER to the individual electronic equipment manuals included with your Owner's Packet for specific information on the operation of your electronic accessories.

TROUBLESHOOTING GUIDE

DC ELECTRICAL SYSTEM

PROBLEM	CAUSE	SOLUTION
12 Volt DC equipment not operating	Battery Selector switch turned OFF.	Check Battery Selector Switches to ensure they are turned ON.
	Main breaker at DC Control center OFF.	Switch Breaker to ON.
	Weak or Dead Battery.	Change Battery selector switch position; recharge battery.
	Main Breaker at battery switch has been tripped.	Reset Breaker.
Battery not charging (engine running)	Engine Alternator Belt Loose.	Tighten Belt.
Battery not holding a charge	Defective Battery.	Replace Battery.
12 Volt Device not working	Circuit Breaker for device is OFF.	Switch Breaker to ON.
	Weak or Dead Battery.	Change Battery selector switch position; Recharge Battery.
	Faulty Electrical Connection.	Check 12 volt DC Connections. Tighten or repair as needed.
Cabin Lights not working (off or dim)	CABIN LIGHTS breaker OFF.	Switch breaker to ON.
	Weak or Dead Battery.	Recharge or replace battery.
	Light Bulb burned out.	Replace bulb.

TROUBLESHOOTING GUIDE

AC ELECTRICAL SYSTEM

PROBLEM	CAUSE	SOLUTION
No 120 Volt Power	Main breaker(s) in engine compartment tripped or OFF on generator.	Turn breakers ON or reset.
	Breaker(s) at AC Control Center tripped or OFF.	Turn breakers ON or reset.
	Shore power breaker tripped.	Turn Breakers ON or reset.
	Shore power cord not connected.	Check cord; plug in, if necessary.
	Loose or disconnected wire.	Tighten connections. See your dealer.
No power to 120 volt devices.	Breaker(s) at AC Control Center tripped or OFF.	Turn breakers ON or reset.
	Shore power cord not connected.	Check cord; plug in, if necessary.
	Loose or disconnected wire.	Tighten connections. See your dealer.
Inadequate power to 120 volt devices (generator running)	Electrical demand greater than generator output.	Switch OFF devices and equipment not needed.
		Increase generator RPM. Refer Generator Manual.
		Use shore power AC line, if available.

ENTERTAINMENT SYSTEM

Your **42C** is equipped with a JVC Receiver and a 5 disc CD player. The two units are shown below. The units are installed in the Salon.



Also available as an option is the 9" TV/VCR combination unit. This unit is designed to be installed in the Forward Stateroom. The unit is shown below.



Available as an option is the 20" TV and VCR unit that can be installed in the Salon. These units are shown below with the receiver and the 5 disc CD player.



The Helm CD/Radio Combination is standard equipment on your 42C. The unit is shown in the photo below.



AUTOMATIC FIRE EXTINGUISHER SYSTEM

Your 42C is equipped with a **Automatic Fire Extinguisher System**, which is permanently mounted on the forward bulkhead of the engine compartment.



The Automatic Fire Extinguisher System (AFE) is designed for use in enclosed compartments that are not normally occupied by passengers and are not normally subject to weather or water exposure. The automatic fire extinguisher is designed to extinguish Class B fires (flammable liquids) and Class C fires (electrical), which would be the type that would normally occur within the confined area of the engine/generator compartment.

NOTE: The automatic fire extinguisher system DOES NOT replace the need for additional portable-type fire extinguishers required by the United States Coast Guard.

The automatic fire extinguisher is activated when the engine/generator compartment reaches 165° Fahrenheit/74° Celsius. The system releases HALON 1301 into the compartment, which immediately converts to a safe, odorless, and electri-

cally non-conductive vapor that will not harm the components in the engine/generator compartment. In contrast to other fire extinguishing materials, HALON 1301 leaves no residue, assisting in the eventual cleaning of the compartment.

The automatic fire extinguishing system on your 42C is equipped with a GREEN indicator light, located on the helm switch panel.



The purpose of this indicator light is to alert the operator of the charge/discharge status of the Automatic Fire Extinguishing System. The indicator light will illuminate when the ignition switch is turned to the ON position when the system is fully charged. If the indicator light fails to illuminate after turning on the ignition switch, carefully examine the exterior of the engine/generator compartment for evidence of a fire that may have discharged the system by looking for signs of “scorching” and by your sense of smell.

 **WARNING**

If the Green indicator light does not illuminate after turning on the ignition switch or if it turns off at any time during operation of your yacht, either at dockside or while underway, DO NOT open the engine compartment for at least ten (10) minutes. Opening the engine compartment immediately will allow air to enter and may cause a fire “flashback”, possibly resulting in serious injury or death. The sudden rush of air into the engine compartment may also render the automatic fire extinguishing system ineffective.

If you do not observe or smell any evidence of a fire and you have waited the recommended ten (10) minutes, open your engine compartment and examine the Halon 1301 container actuator to determine if it has been discharged. (Refer to the Manufacturer’s Manual, which illustrates the charged and discharged positions of the actuator). If the system has been discharged, or appears charged but the indicator light does not illuminate, see your Silverton Dealer for further inspection and repair, if necessary.

In the event of an engine/generator compartment fire, the following steps should be taken to avoid the likelihood of personal injury or death and to minimize property damage:

-Remain calm and avoid panic.

-Immediately turn off all electrical power, including the engine ignition and the engine compartment ventilation blowers. NOTE: Do NOT turn off power to your VHF Radio.

-DO NOT open the engine/generator compartment for at least ten (10) minutes to allow the Halon vapor to extinguish the fire.

-Remove your portable fire extinguisher from its mounting bracket and prepare it for use, if necessary.

-Instruct all passengers to put on their Personal Flotation Devices (PFD’s) and move away from the source of the fire.

-Contact the United States Coast Guard on your VHF radio and advise of your situation and location. Maintain radio contact until the crisis has ended and assistance has arrived.

-If the fire is successfully extinguished, examine the engine compartment components for damage. DO NOT start your engines if any damage is noted. Request towing assistance to a safe harbor and contact your Silverton Dealer for a thorough inspection and repairs.

-When replacing parts of the fire fighting installation, only matching components shall be used bearing the same designation or being equivalent in their technical and fire resistant capabilities.

REFER to the Manufacturer’s Manual for a detailed description of your AUTOMATIC FIRE EXTINGUISHER SYSTEM. Be certain to complete the Warranty Card and mail to the manufacturer within ten (10) days of your purchase.

PORTABLE FIRE EXTINGUISHER SYSTEM

As a yacht owner or operator, you have the responsibility of having the required quantity of United States Coast Guard approved portable fire extinguishers aboard at all times, except during storage. The portable fire extinguishers must be operational and of the proper classification.

The classification of portable fire extinguishers and their appropriate use is as follows:

CLASS "A"

"Fires in ordinary combustible materials, such as wood, paper and cloth, where the quenching-cooling effect of quantities of water or high water content solution cools the burning material below the ignition temperature."

CLASS "B"

"Fires in flammable petroleum products or other flammable liquids, greases, etc., where the blanketing-smothering effect of oxygen-excluding media is most effective."

CLASS "C"

"Fires involving electrical equipment where the electrical conductivity of the extinguishing media is the first consideration."

Your **42C** is equipped with two (2) Class B/C portable, handheld fire extinguishers. Class B/C fire extinguishers will effectively fight fires of the Class "B" and Class "C" type. The Class B/C portable fire extinguisher contains pressurized dry powder, which when released, will leave a powder residue that smothers the fire and removes its source of oxygen. Once the source of oxygen is removed, the fire cannot continue to burn and it will be extinguished.

The fire extinguishers shipped with your **42C** should be mounted in a readily accessible location away from the engine compartment, but in a relative position to potential fire hazards, such as the Galley. The fire extinguishers should be mounted within plain view and all passengers on board should be familiar with their location and operation before departing your dock. Maintenance of your portable fire extinguishers should consist of periodic cleaning of the canisters and making certain they are easily seen and readily accessible. Periodically examine the gauge on each fire extinguisher to be sure they are fully charged. If the gauge indicates the fire extinguisher is not fully charged, contact your Silverton Dealer for replacement. **DO NOT** test the charge of your portable fire extinguishers by operation of them; it will discharge them unnecessarily.

REFER to the operating instructions displayed on the fire extinguisher canisters for a detailed description of their operation and use.

FRESH WATER SYSTEM

The purpose of the **Fresh Water System** is to provide a supply of pressurized potable water to the Galley, Heads, and Transom Exterior Shower on demand and as needed. Your **42C** has two (2) separate systems that are independent of each other and they are identified as follows:

- **Fresh Water Pump System**
- **Dockside Water Supply System**

Fresh Water Pump System

The Fresh Water Pump System on your **42C** consists of the following components:

Fresh Water Tanks (200 gallon capacity):

The fresh water tanks are located on the outboard sides of the engine room of your **42C**. There are two (2) tanks (100 gallons each). The photo below shows the starboard fresh water tank.



The Mechanical Schematic in the SCHEMATICS SECTION of this manual shows the location of the fresh water tanks. They are filled through a fill fitting that is marked "WATER" on the fill cap, which is located

on the port side of the forward access steps. The photo below shows the Waste Discharge cap and to its right is the Fresh Water Fill cap.



The Fresh Water fill is on the right in the photo. The Deck Layout in the Schematics Section of this manual will show the location of the Fresh Water Fill.

WARNING

Fill the fresh water tank ONLY with potable water that is safe for drinking. DO NOT fill with water that may be of questionable quality as serious illness or death may occur.

Fresh Water Pump:

The fresh water pump is located on the forward wall of the engine room. The fresh water pump operates on DC electrical power controlled by a breaker switch located on the AC/DC Electrical Panel. The fresh water pump is equipped with an automatic pressure switch and, when it is supplied with electrical power, it will operate until the entire fresh water system is pressurized to a preset level. Once the required pressure is obtained, the fresh

water pump will automatically shut off. The fresh water system should maintain the preset level of water pressure until one of the faucet or shower valves is opened. When the required pressure is lowered below the preset level, the fresh water pump will automatically return to operation.

Fresh Water Filter:

The water pumped from the fresh water tank flows through a filter located on the suction side of the fresh water pump. Its purpose is to remove impurities that may be present in the fresh water system prior to its consumption. The filter is easily removed from the fresh water pump and should be cleaned on a regular basis.

The photo below shows (from left to right) the Accumulator, Fresh Water Pump, and the Filter. The accumulator maintains a constant pressure throughout your water system.



Fresh Water Lines (Cold Water and Hot Water): The fresh water lines carry the water from the fresh water tanks, the water heater, and the various faucets located in the Galley and Head areas of your **42C**. They are constructed of poly-butylene plastic material and are 1/2 inch

inside diameter. The COLD WATER lines have pale blue manufacturer's lettering and the HOT WATER lines have pale red manufacturer's lettering for identification purposes. The fresh water lines require minimal maintenance, but they should be visually examined on a regular basis for any leaks, chafing, or cracking. Tighten any loose connections as necessary. See your Silverton Dealer for inspection of any suspected defective fresh water lines and their replacement, if necessary.

Dockside Water Supply System

Your **42C** is equipped with a dockside water inlet located in the transom storage compartment. The photo below shows the Fresh Water Inlet.



This system operates independently of the Fresh Water Pump System and simply depends on its connection to a suitable garden-type water hose for its supply of fresh water. When the water supply is connected to the water inlet and turned ON, the system is automatically pressurized without the need for the fresh water

pump. The water entering this system will not fill the fresh water tank; a check valve, located in the pressure line of the fresh water pump, prevents the water from entering the fresh water tank. Be sure to turn OFF the fresh water pump at the AC/DC Panel when connected to the shore water supply.

Refer to the WINTERIZATION AND STORAGE PAGES in the Cleaning and Maintenance Section of this Owner's Manual for the proper preparation and maintenance of your FRESH WATER SYSTEM prior to seasonal storage of your yacht.

 **WARNING**

Connect this system ONLY to a potable water system that is safe for drinking. DO NOT use water that may be of questionable quality as serious illness or death may occur.

When you are connecting your system to a dockside water supply, be certain to examine all connections and water lines for any leaks. If any leaks are noted, turn OFF the water supply immediately and make the necessary repairs before you again turn ON the water supply. Remove any trapped air from the water system by opening all faucets until the air is exhausted and there is a steady flow of water. Close the faucets after the air is removed.

 **CAUTION**

Always turn OFF the dockside water supply source when leaving your yacht unattended. A leak in the system could result in flooding and may cause your yacht to sink.

FUEL SYSTEM

WARNING

Fuel, especially gasoline, is extremely flammable. Failure to follow these recommendations and the rules of good common sense could result in fire or explosion, which could cause personal injury or death.

The purpose of the Fuel System is to maintain the necessary supply of fuel to the engines and generator upon demand and as needed. The fuel system on your **42C** is comprised of the following components, which will be described separately:

- Fuel Tanks
- Fuel Tank Fills and Vents
- Fuel Tank Grounding System
- Fuel Distribution Hoses
- Fuel Supply Valves
- Fuel Filtration
- Generator Fuel Selector Valve
- Fuel Gauge and Selector Switch

Fuel Tanks

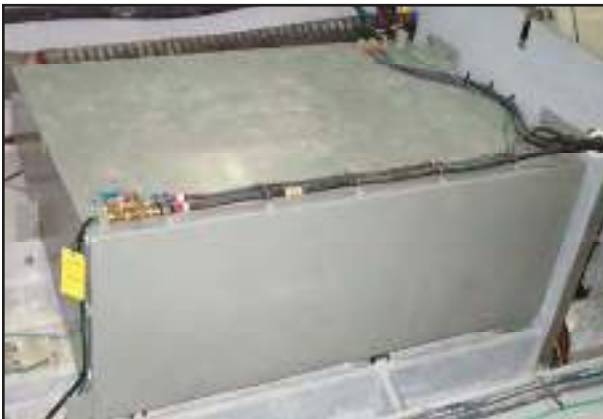

Your **42C** is equipped with two (2) fuel tanks, each having a capacity of 262 gallons, for a total fuel capacity of 524 gallons. The photo above shows the port side

fuel tank. The starboard side fuel tank is in the same location but on the starboard side. Both fuel tanks are located in the Aft Bilge and access is through the Aft Hatch in the cockpit. One tank is located on the port side and one tank is located on the starboard side. See the Mechanical Schematic in the SCHEMATICS Section of this owners Manual. The port side fuel tank supplies fuel to the port engine and the starboard fuel tank supplies the starboard engine. Either tank can supply the generator, if so equipped.

Each fuel tank is equipped with a Fuel Level Sending Unit, which provides an electrical signal to the fuel gauge to indicate the fuel level. The photo below shows the sending unit on the fuel tank.

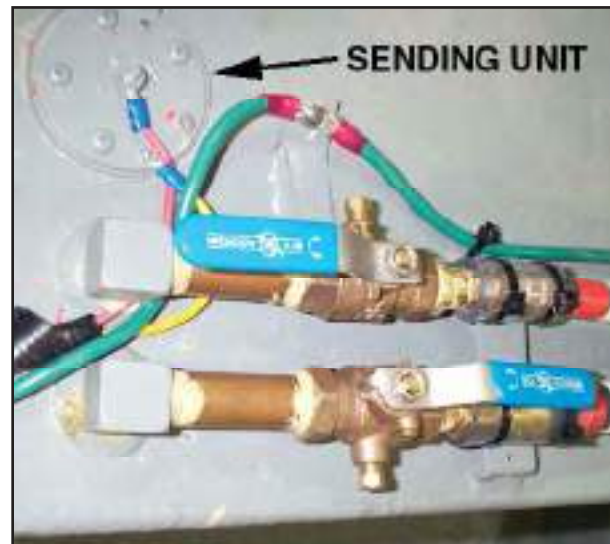

The Fuel Tanks should be inspected for signs of leaks, corrosion, and/or pitting at least once a year. Corrosion normally appears as a white chalky, discolored, or flaky appearance on the surface of the tank. Sometimes it also appears as pitting or small pockets of missing aluminum. Another indication of corrosion could be bubbles on the paint that coats the fuel

tank. If any one of these conditions are present, have an authorized Silverton Service Technician inspect the tank immediately. If a leak is found, immediately turn OFF battery switches, disconnect shore power (instructions in the electrical pages of this section of the Owner's Manual), and disable any possible source of ignition. Notify your Silverton Dealer or Silverton's Customer Service Department immediately.

! WARNING

NEVER operate your boat if a fuel leak is present!

Fuel Tank Fill and Vent

The fuel tank is filled through the Fuel Fill Fitting and the cap is marked GAS or DIESEL, depending on the type of engines that power your **42C**.

! CAUTION

Using the wrong type of fuel will result in severe damage to the engines.



The photo above shows the Port Fuel

Tank Fitting. It is located on the walkdeck, forward of the cockpit. The Starboard Fuel Tank Fitting is located in the same position, but on the starboard side. The fuel fill fittings are connected to the fuel tanks with the fuel hoses.

Each fuel tank has a hull vent fitting. These fittings are located on the port side and starboard sides of the hull. The photo below shows the port side fuel vent.

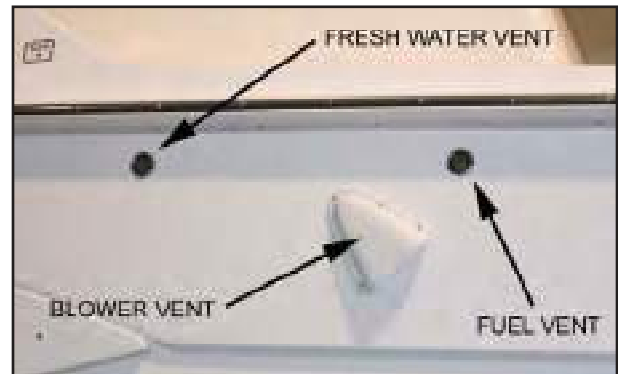

The starboard side vent is in the same location on the other side of the hull. The vent fittings are connected to the fuel tanks with the fuel vent hoses. These vents allow air to pass through them when fueling and when the engines are drawing fuel from the tanks.

The fuel fill and fuel vent hoses, fittings, and connections should be inspected for leaks and signs of dry rot or swelling at least once a year. If any of these conditions are present, have an authorized Silverton Service Technician inspect the entire fuel system immediately. If a leak is found, turn OFF the battery switches, disconnect the shore power (Refer to the electrical pages in this section of the Owner's Manual), and disable any possible source of ignition. Contact your Silverton Dealer or Silverton's Customer Service Department immediately.

! WARNING

Leaking fuel is a fire and explosion hazard; personal injury or death could occur.

If any fuel fill or vent hoses are in need of replacement, be certain that ONLY USCG TYPE A1 or A2 are used.

! WARNING

The use of any hose other than USCG TYPE A1 or A2 could result in fuel leakage. Leaking fuel is a fire and explosion hazard; personal injury or death could occur.

Fuel Tank Grounding System

The fuel tank and fuel fill on your 42C are electrically grounded (or bonded) to the ground buss of the bonding system. The grounding system is designed to prevent the discharge of static electricity, which could cause a spark, especially when fueling your yacht. An authorized Silverton Service Technician should inspect this system at least once each year.

! WARNING

While fueling, a spark caused by static electricity could result in fire or explosion, which could cause personal injury or death.

Fuel Distribution Hoses

Each engine has a fuel supply hose that runs from the pickup tube in the fuel tank to the engine. Also, each engine has a fuel return hose that runs from the engine to the fuel tank. The generator has a fuel supply hose that runs from the fuel tank to the fuel selector valve. If your 42C is diesel powered, there is also a fuel return hose routed similar to the supply hose. See the photo below which show the fuel distribution hoses at the fuel tank.



The fuel distribution supply and return hoses, fittings, and connections should be inspected often for leaks and signs of wear, dry rot, cracking, chafing, or swelling. A good way to examine the fuel hoses is to run your hand along the length of the hose including the fittings. Small leaks will be revealed as wet spots on your hand. If any evidence of hose deterioration is present, have a qualified technician replace all of the hoses with USCG TYPE A1 hoses immediately. If a leak is found, turn OFF battery switches, disconnect shore power, and disable any possible source of ignition. Do not start your engines, the generator, or any devices that could create a spark. Contact your Silverton Dealer or Customer Service Department immediately. If hoses need to

be replaced, make sure that only USCG TYPE A1 are used. TYPE A2 is not acceptable for fuel distribution.

Fuel Supply Valves

If your **42C** is powered by gasoline engines, it is equipped with an anti-siphon valves, located on each fuel supply hose at its connection to its respective fuel tank pickup tube. The purpose of the anti-siphon valve is to immediately stop the flow of fuel from the fuel tank in the event of a break in the fuel supply hose. The anti-siphon valves are automatic and do not require manual operation.

Fuel Filtration

The fuel that is supplied to the engines and generator (if so equipped) may contain impurities found in the fuel tanks or contained in the fuel from your supplier. If these impurities are not removed prior to entering the engines/generator, performance may be seriously affected. Removal of the fuel impurities is accomplished by external fuel filters, which are located within the fuel supply line.

If your 42C is equipped with gasoline engines, each engine has its own separate fuel filter, located on the forward inboard side of the engine.

If your 42C is equipped with diesel engines, each engine has a separate fuel filter located away from the engine. The fuel filter is located on the forward bulkhead in the engine room.

The photo below shows the fuel filter for the diesel engine.



If your 42C is equipped with a generator, a remote fuel filter with a fuel shut-off valve is located in the main generator fuel supply line, separate from the engine fuel supply lines. The photo below shows the generator fuel filter.



An Authorized Silverton Service Technician should replace all fuel filters annually prior to spring launch.

Generator Fuel Selector Valve

If your 42C is equipped with a generator, a fuel tank selector valve is located on the aft bulkhead of the engine compartment. This valve determines the tank from which the generator will draw its fuel from. The photo below shows the Fuel Selector Valve.



If your 42C is diesel powered, the generator fuel selector valve also determines the tank to which the unused fuel is returned. This fuel is always returned to the same tank that is supplying the fuel to the generator.

The fuel tank that is selected to supply the generator will display a lower fuel level than the other fuel tank when the generator is used for an extended period of time. The Generator Fuel Selector Valve can be set so that the generator will start taking fuel from the other fuel tank.

Fuel Gauge

The purpose of the Fuel Gauge is to allow you to constantly monitor the fuel level in the fuel tanks. The fuel gauges on your 42C are located at the helm station on the starboard and port side of the helm gauge panel.

The photo below shows the starboard fuel gauge at the Helm Panel.



The port gauge is located on the same panel on the port side.

Fueling Your 42 Convertible

Fuel Quality

Refer to your **Engine Manual**, included with your owner's packet, for specific fuel requirements for your engine, i.e., recommended octane level.

Fuel Additives

Refer to your **Engine Manual** for recommendations concerning fuel additives.

Refer to the **Winterization and Storage Pages** in the Cleaning and Maintenance Section of this Owner's Manual concerning the use of fuel stabilizers. Always follow the manufacturer's recommendation when using fuel additives or stabilizers.

General Guidelines for Fueling Your Yacht

Improper fueling procedures can cause boat fires and explosions. It is imperative that the following procedures be followed every time you fuel your boat:

WARNING

Leaking fuel is a fire and explosion hazard; personal injury or death could occur.

- ✓ Before fueling, check the fuel system for leaks and repair or replace any components prior to fueling or starting your engines, generator, or any electrical device.
- ✓ If possible, fuel your boat during daylight hours. Check fuel vents to assure the fuel tanks are not over-filled. Fuel spills are easier to detect when visibility is good.
- ✓ In very warm weather, DO NOT “top off” the fuel tanks, as the fuel will expand as it heats up and spill out the vents.
- ✓ Make sure you are using the correct fuel type required by the engine manufacturer.

CAUTION

Using the wrong type of fuel will result in severe damage to the engines.

- ✓ Be sure to turn OFF both engines, the generator, and all devices that could create a spark prior to fueling. Battery switches should also be shut off to prevent sparks from any electrical device.

- ✓ Disconnect shore power.
- ✓ Extinguish all smoking materials and any other items that may create a spark.
- ✓ Completely close all doors, ports, hatches and windows and ask guests to leave the boat during fueling.
- ✓ Before fueling, touch the fuel nozzle to the fuel fill cap to discharge any static electricity. Open the designated fill pipe, and insert the nozzle while maintaining contact with the side of the fill pipe.
- ✓ After pumping several gallons, STOP. Inspect engine and tank compartments for any signs of leakage.
- ✓ DO NOT continue fueling if leaks or the smell of fuel are present. Contact a qualified technician to inspect your boat and repair it before continuing to fuel.
- ✓ If no leaks are noted, continue fueling allowing for expansion in warmer weather. Slow the flow as approaching full to avoid overflow.
- ✓ Once full, remove nozzle, replace fill cover tightly and clean up any spills.
- ✓ After fueling has been completed, open all hatches, doors, and compartments. Visually check all fuel fittings, lines, and tanks for leakage; including engine and generator fuel lines. Immediately notify a qualified technician of any problems and correct them before proceeding.
- ✓ Turn main battery switches on to operate bilge blower. Ventilate all bilges for at least five (5) minutes.

✓ Make a final inspection of the engine and/or generator space and smell for fumes. If they are present, open all doors and ports and evacuate the boat. Notify the Dockmaster and request a qualified technician to correct the problem. If it is clear, follow the recommended engine starting procedure. When storing your boat for extended periods, it is preferable to “top-off” the tanks and add fuel conditioner and/or stabilizer. Please refer to the engine Owner’s Manual for recommendations.

FUEL SYSTEM MAINTENANCE

Maintenance of your fuel system must also be a high priority. As boats get older, maintenance may be done by people with varying degrees of expertise. Materials and methods previously used may also change.

FUEL SAFETY CHECKLIST FOR BOARDING

This fuel safety checklist is designed to be used as a quick reference to minimize the risks associated with fuel hazards. You should refer to this checklist every time you board your yacht. Read your Owner's Manual so that you have a full understanding of the fuel system on your yacht.



Fuel, especially gasoline is extremely flammable. Failure to follow these recommendations and the rules of good common sense could result in fire or explosion; which could cause personal injury or death.

- ✓ Before approaching your boat, extinguish all smoking materials and make certain there are no other devices on or near your boat that could create a spark and start a fire or cause an explosion.
- ✓ Approach your boat alone to make the initial inspection. Have your guests and crew standby at a safe distance away from your boat.
- ✓ Visually inspect your boat from the dock for any fuel leaks from the deck fills or hull vents and take notice if there is any odor of fuel. Also, check the water surface around your boat for signs of fuel.
- ✓ Once onboard, open the cabin door and sniff at the doorway and then inside the cabin for fuel odor.
- ✓ Open the engine compartment hatch and sniff for fuel odor.
- ✓ Inspect the engine compartment and all bilge compartments for fuel leaks and sniff for fuel odor.
- ✓ If there are any signs of fuel leakage, either visually or by odor, open doors, hatches, and windows. Most importantly, **DO NOT** start the engines, the generator, or any other device that could create a spark. Shut off all battery switches. Evacuate the boat and inform the Dock Master. Have a qualified technician determine the source of the leak. **NEVER** operate your boat if a fuel leak is suspected or present!
- ✓ If no signs of a fuel leak are present, board your guests and crew.
- ✓ Run exhaust blowers for five (5) minutes before starting the engines or generator.
- ✓ Always be aware of the hazards associated with fuel and follow all safety and maintenance procedures in this publication, the Safety Manual and Chapman's.

“HAPPY SAFE BOATING”

FROM THE SILVERTON TEAM

GENERATOR SYSTEM

When you purchased your 42C, a Generator System, manufactured by Kohler Company, was factory installed at the Silverton plant. If your 42C is equipped with gasoline powered engines, the generator will have an 8.0 kilowatt rating. If equipped with diesel powered engines, the generator will have an 8.0 kilowatt rating. As discussed in the Fuel System Pages of the Systems Operations section of this Owner's Manual, fuel is supplied to the generator from the fuel tank. The Generator System is controlled by a breaker switch, located on the AC/DC Electrical Panel (Check the Electrical Pages of the Systems Operations Section of this manual). The system START and STOP switch is also located on the AC/DC Electrical Panel as is a slide bar switch that permits you to change from generator electrical power to shore electrical power as desired. The Generator System is located in the forward part of the engine room.



Operation of the **Generator System** is as follows:

- ✓ Turn ON the Generator System battery switch.
- ✓ Check sea strainer for debris and remove, if noted.

✓ Be certain the seawater intake valve that services the generator is in the OPEN position. The valve is open when the handle is parallel to the valve body. Although the photos below are of the seawater intake valves for the engine, and not the generator, the photos show the open and closed positions of this type valve.



The photo above shows the valve closed.



The photo above shows the valve open.

- ✓ Turn ON the breaker located on the generator.

- ✓ Move slide bar switch to generator power mode.
- ✓ Operate generator compartment blower motor for at least five (5) minutes before starting generator and continue to run while operating your yacht below cruising speed.
- ✓ Check for presence of gasoline odor in the bilge.

Continue to operate the blower motor for several minutes to be certain the generator compartment is completely evacuated of any fuel fumes. Return the slide bar switch to the shore power mode and turn OFF the breaker switch. Turn OFF the Generator System battery switch.

Refer to “Generator” in the Electrical System pages in this section of this manual for using the generator output to power the boat.

WARNING

Gasoline vapors in the bilge can cause explosion and fire aboard your yacht.

- ✓ Start the generator (Refer to “Starting Instructions” section in the Generator Manual included with your owner’s packet).
- ✓ Depress START switch on AC/DC Electrical Panel until generator starts.

DANGER

While operating your Generator system, always be certain there is adequate ventilation in the cabin areas of your yacht to avoid the potential accumulation of Carbon Monoxide Gas (CO). Carbon Monoxide Gas is colorless, odorless, and tasteless. It is highly poisonous, endangering lives even at very low levels of concentration. Mild exposure causes headaches and fatigue, often resembling “flu-like” symptoms. Medium exposure causes severe headaches, drowsiness, nausea, and rapid heart rate. Extreme exposure results in unconsciousness, convulsions, cardiorespiratory failure and death. If Carbon Monoxide Gas is detected in your yacht, immediately contact a qualified technician to locate and repair the source of the poisonous gas. DO NOT enter your yacht until repairs have been made and the Carbon Monoxide Gas is lowered to an acceptable level. Refer to the Carbon Monoxide Gas (CO) Detector System Section of this Owner’s Manual for additional information and cautions concerning this deadly gas.

CAUTION

DO NOT depress START switch for more than thirty (30) seconds as damage to the generator starter motor may result. If the generator does not start within 30 seconds, release the START switch and allow the starter motor to cool for at least sixty (60) seconds before again attempting to start the generator.

To cease operation of the Generator system, depress the STOP switch on the AC/DC Electrical Panel. After the generator stops running, release the STOP switch.

Refer to the KOHLER COMPANY Generator Manual included with your Owner's Manual for additional technical information concerning the operation and maintenance of your generator system.



Due to the risks related to Carbon Monoxide poisoning, NEVER sleep on board your boat while the generator is running.

HOT WATER SYSTEM

Your **42C** is equipped with a 10.5 gallon water heater, which is operated on the A/C electrical system. Cold water is supplied to the water heater via the fresh water pump, which is then heated for distribution when desired. Similar to the water heater in your home, there is always a continuous supply of water to maintain a full tank at all times. The water heater in your **42C** is a “high recovery” model, meaning the cold water entering the tank is heated very quickly to replace the hot water as it is used.



Operation of the water heater is as follows:

✓ Be certain the water heater is full of water. You can easily check this by turning ON a hot water faucet. If water flows from the faucet, the water heater is full.

CAUTION

If the water heater is not full of water, damage to the heating elements may result when electrical power is turned ON to the unit.

✓ Turn ON the water heater breaker switch, which is located on the AC/DC electrical panel. The Electrical Pages in this section of this manual explain the location of this switch.

NOTE: The water heater will operate on AC electrical current only. You must either plug in your shore power cord or operate your generator (if so equipped) for the water heater to function.

✓ Allow sufficient time for the water heater to heat its contained water before using (approximately 1/2 hour).

General maintenance of the Hot Water System is as follows:

✓ Inspect all water lines and their connections at regular intervals. Tighten connections as needed. If the water lines appear worn or are not flexible, see your Silverton Dealer for replacement.

✓ Manually operate the pressure relief valve on the water heater at least once a year.

See photograph below, which illustrates the location of the valve.



! WARNING

DO NOT operate the pressure relief valve while the water heater contains hot water. Serious burns or injury could result.

- ✓ Flush out the water heater tank at least once a year, if not used regularly.
- ✓ Refer to the **Winterization and Storage pages** in the Cleaning and Maintenance section of this Owner's Manual for proper preparation for seasonal storage of the water heater.

PROPULSION SYSTEM

Propulsion of your 42C is accomplished by two inboard engines, located within the engine compartment. Depending on the option you chose upon purchase from your Silverton Dealer, the engines are either fueled by gasoline or diesel fuel. Each engine transmits its power to a separate transmission, which rotates the attached propeller shaft and the propeller. This provides forward or reverse movement of your yacht as selected from the shift control unit located on the Port side of the helm. The photo below shows the Throttle and Shift Control at the Helm.



The transmissions are counter-rotating. This is defined as when in the forward shift mode and viewing forward from aft, the Port transmission rotates the Port propeller counterclockwise and the Starboard transmission rotates the Starboard propeller clockwise.

Access to the engine compartment in your **42C** is provided through the Hatch in the forward part of the cockpit.

The engine starting procedure is as follows:

- ✓ Open and inspect the engine compartment. Use your sense of smell to detect the presence of fuel fumes.
- ✓ Turn battery switch ON.
- ✓ Operate the bilge blower motors for at least five (5) minutes. Check for air flowing out of the bilge exhaust vent. The location of the Exhaust Blower Vent is shown in the Bilge Ventilation System Pages of this section of the Owner's Manual. If you feel air flowing from the exhaust vent, the bilge blower motor is operating properly.
- ✓ Check the bilge water level. If it appears above normal, turn ON the bilge pump(s) and remove the water. Determine the source of the excess water and repair, if necessary, before starting the engines.
- ✓ Check the bilge for the presence of any oil. Determine the source of the oil and repair, if necessary, before starting the engines.
- ✓ Open both engine seawater intake valves (The location of these valves are shown on the Mechanical Layout in the Schematics Section of this Owner's Manual). The valves are open when the handles are parallel to the valve body.

See photograph below and the adjacent photograph, which illustrates the open and closed positions of the engine seawater intake valves.

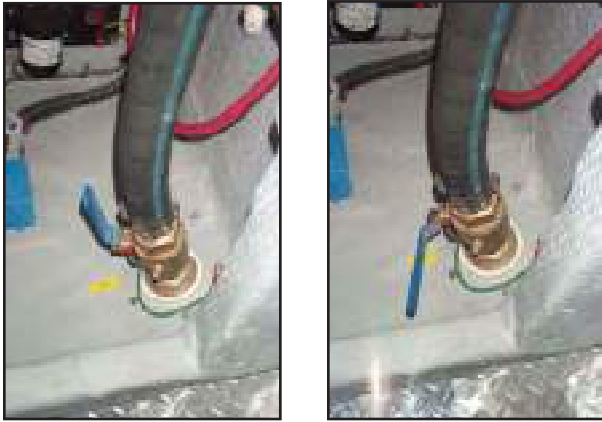

The opened position is on the left above.

- ✓ Visually examine both seawater strainers to ensure they are free of debris. Clean if debris is noted.
- ✓ Check all cooling and lubricating fluids (See photograph below, which illustrates the location of the engine oil “dipstick”). Add engine oil or transmission oil, if needed, but **DO NOT** overfill.



WARNING

DO NOT remove the cooling system filler cap when the engine is hot. Allow the engine to cool and then remove the pressure cap slowly, allowing the pressure to vent. Hot coolant, under pressure, may discharge violently and result in serious personal injury and burns.

- ✓ Place the transmission shift controls at the helm station in the neutral position. The feel of a “detent” midway between the forward and reverse positions indicates the neutral position.
- ✓ Place the throttle controls in the “idle” or “down” position.
- ✓ Turn the ignition key to ON, but not to START. The engine alarm buzzer should sound and the automatic fire extinguisher system indicator light should illuminate.
- ✓ Turn the ignition key to START and hold in this position until the engine starts. If the engine starter motor does not operate, the neutral safety switch may be out of adjustment. Slowly and carefully move the transmission shift control lever up and down until the starter motor operates (See your Silverton Dealer or a competent technician as soon as possible to obtain the proper adjustment for the neutral safety switch). Release the ignition switch as soon as the engine starts. The engine alarm buzzer should turn OFF when the engine oil pressure reaches normal operating range. The automatic fire extinguisher indicator light should remain illuminated.

 **CAUTION**

If the engine fails to start within thirty (30) seconds, release the ignition switch. Allow the starter motor to cool for at least sixty (60) seconds and then try again to start the engine. Prolonged starting attempts may result in starter motor overheating and damage.

 **CAUTION**

Failure to release the ignition switch from the START position after the engine starts may result in serious damage to the starter motor and/or engine flywheel.

 **CAUTION**

If the engine alarm buzzer DOES NOT turn OFF, turn OFF the engine immediately if the oil pressure gauge displays no, or very low, oil pressure. See your Silverton Dealer for inspection and repair, if necessary. No, or very low, oil pressure may cause serious damage to the internal mechanism of your engine(s).

 **WARNING**

If the automatic fire extinguisher indicator light DOES NOT remain illuminated, turn OFF the engine(s) immediately and follow the proper procedure to check for fire aboard your yacht as detailed in the Automatic Fire Extinguisher System Section of this Owner's Manual. A fire aboard your yacht may result in serious personal injury or death.

✓ If one of the batteries is "dead" or not sufficiently charged to start your engine, depress the "Parallel Start Switch" simultaneously while turning the ignition switch to START. The parallel start switch draws power from both batteries during the starting procedure and it is located on the helm switch panel (Refer to the Electrical pages of this section of your Owner's Manual for a location of the Switch). Release both switches immediately after the engine starts.

 **CAUTION**

DO NOT continue to depress the "Parallel Start Switch" after the engine has started. Damage to the alternator(s) may result.

After you have started both engines and determined they are running properly, the "warm-up" procedure should be followed before departing the dock/mooring. The proper "warm-up" procedure is as follows:

✓ Check the oil pressure gauges to be certain each engine has sufficient oil pressure. Gasoline engines should have between 30 and 50 psi (pounds per square inch) and diesel engines should have between 35 and 70 psi. If the oil pressure is lower than the normal operating range, turn OFF the respective engine and contact your Silverton Dealer for further inspection and repair, if necessary.

✓ Allow the engines to run at the RPM's specified in the Engine Manual until they reach the proper operating temperature. Normal operating temperature for gasoline engines is 140° F with a raw water cooling system and 170° F with a fresh water cooling system. The normal operating temperature for diesel engines is between 170° F and 190° F. If the engine temperature rises significantly above the normal operating range (10° F), turn OFF the respective engine and contact your Silverton Dealer for inspection and repair, if necessary.

✓ Check the exhaust outlets for the presence of water. Water coming from the exhaust outlets indicates proper water circulation in the engine exhaust system. Water should start coming out of the exhaust outlet shortly after the engine is started. If you do not observe any water coming from the exhaust outlet(s), turn OFF the respective engine and contact your Silverton Dealer for inspection and repair.

✓ Visually inspect the engine compartment for fuel, oil and water leaks. If leaks are found refer to your Fuel Section of this manual. Also, contact your Silverton Dealer for inspection and repair, if necessary.

✓ Visually inspect the exhaust system for leaks. If any leak is observed, immediately turn OFF the engines and contact your Silverton Dealer for inspection and repair, if necessary.

✓ Check the transmission fluid level. The engines should be running at idle speed and at normal operating temperature. The transmission fluid should read FULL on the "dipstick". If the fluid level is low, add sufficient transmission fluid to raise the level to the FULL mark or slightly lower. DO NOT overfill. If the fluid level is low, check the transmission(s) for leaks and contact your Silverton Dealer for repairs if leaks are noted.

Refer to the ENGINE MANUAL included with your owner's packet for additional technical information concerning maintenance requirements for the specific engines with which your 42C is equipped.

Bow Thruster

You may have chosen as an option when you purchased your **42C**, a **Bow Thruster System**. The purpose of this system is to aid in maneuvering your yacht in close quarters, such as departing or entering a marina boat slip. The **Bow Thruster** propels the bow of your yacht in a Port or Starboard direction, depending on your selection, which is made from a control panel located at the helm station. The **Bow Thruster** operates on DC electrical power, controlled by a breaker switch, which is located on the Bilge DC electrical panel .



Batteries for your Bow Thruster must be replaced with Sealed AGM Type Batteries ONLY.

Refer to the BOW THRUSTER Manual included with your Owner's Packet for additional technical information concerning the operation and maintenance of this optional system.

MARINE SANITATION SYSTEM

All vessels with fixed toilets that are operated on the waterways of the United States and some foreign countries are required to be equipped with an operable Marine Sanitation Device (MSD). The **Marine Sanitation System** in your **42C** is a Waste Tank system, defined by the United States Coast Guard as a Type III System. Type III Systems permit operation of the toilet without the direct discharge of untreated waste after every flush. Type III Systems can be discharged at marina dockside pump-out stations or, if in coastal waters, at least three (3) miles offshore.

NOTE: Overboard discharge capability must remain inoperative while within the 3 mile limit. This is accomplished by closing the macerator discharge thru-hull valve. Refer to the Mechanical Layout Schematic in the Schematic Section of this Owner's Manual for the location of the valve.

Your **42C** is equipped with one of the following **Marine Sanitation Systems**, depending on the option you chose from your Silverton Dealer at the time of purchase:

- *SeaLand* Vacu-Flush Toilet
- *Jabsco* Quiet-Flush Electric Toilet (Fresh Water)
- *Jabsco* Electric Toilet (Raw Water)

SeaLand Vacu-Flush Toilet

This system is operated by vacuum, combined with a small quantity of water supplied by the pressurized fresh water system (approximately one (1) pint per flush)

and is controlled by DC electrical power. Each toilet is equipped with an integral vacuum breaker that prevents a backflow of contaminated water into the potable water supply. Vacuum energy, supplied by the Vacuum Pump, is stored in a Vacuum Tank and is monitored to maintain a certain level. The Vacuum Pump is controlled by an electrical breaker switch, located on the AC/DC Electrical Panel (Refer to the Electrical Pages of this section in this Owner's Manual for the location of the switch). As the toilet is flushed, vacuum energy is depleted and the Vacuum Pump will automatically activate to restore the required level. The Vacuum Pump will operate for approximately 30 to 90 seconds until the system reaches the required operating vacuum level. Toilet waste, both liquid and solid, is removed by the vacuum energy and water combination to a Waste Tank having a capacity of forty (40) gallons (The Mechanical Layout in the Schematics Section of this Owner's Manual shows the location of the Tank).

This waste is stored in the Waste Tank until pumped out at a proper facility. The photo below shows the waste tank. It is located under the forward stateroom.



The Waste Tank is equipped with an electronic Waste Level Gauge, which monitors the volume of waste in the tank for your convenience in determining when pump-out is required.



Maintenance of your *Sea Land Vacu-Flush Sanitation System* consists of periodic cleaning of the toilet bowl with a mild nonabrasive cleaner. The Waste Tank should be thoroughly rinsed after each pump-out and a sanitation system deodorizer should be added to the Waste Tank by flushing through the toilet.

CAUTION

DO NOT use chlorine-based or caustic cleaning agents or chemicals, such as drain opening products, in your *SeaLand Vacu-Flush Sanitation System*. Use of these products may cause serious damage to the system's seals and hoses.

Refer to the SEALAND VACU-FLUSH SANITATION SYSTEM MANUAL included with your owner's packet for additional information concerning the use and maintenance

of this system, including the proper procedure for winterization and storage.

Jabsco Quiet-Flush Electric Toilet (Fresh Water)

This system is operated by water supplied by the pressurized fresh water system (approximately 1 - 2 quarts per flush) and is controlled by DC electrical power. Each toilet is equipped with a push button switch, that when depressed, activates both the rinse water supply and the macerator discharge pump simultaneously. In addition to the push button switch, a separate rocker-type switch may be used to control the rinse water supply, independent of the macerator. This feature allows conservation of your fresh water supply; as well as the ability to raise the water level, if needed, for proper evacuation of the toilet bowl under all conditions. To prevent contamination of the fresh water supply, this system is equipped with an anti-siphon breaker contained in the water control solenoid valve. The water control solenoid valve of each toilet is controlled by an electrical breaker switch, located on the AC/DC Electrical Panel (Refer to the Electrical Pages of this section of this Owner's Manual for the switch location). Toilet waste, both liquid and solid, is flushed from the toilet by the macerator to a Waste Tank having a capacity of sixty (60) gallons (See Mechanical Layout in the Schematics Section of this Owner's Manual for the location of the Waste Tank). This waste is stored in the Waste Tank until pumped out at a proper facility. The Waste Tank is equipped with an electronic Waste Level Gauge, which monitors the volume of waste in the tank for your convenience in determining when pump-out is required.

Jabsco Quiet-Flush Electric Toilet (Raw Water)

This system is identical to the fresh water system in its operation, but uses raw water pumped from the sea as its rinse water source instead of fresh water supplied by the pressurized fresh water system. This system is not equipped with a separate rocker-type switch to control the rinse water level and the volume is consistent (approximately 1 - 2 quarts per flush). As with the fresh water system, to prevent contamination of the raw water supply, this system is equipped with an anti-siphon breaker contained in the water control solenoid valve. The water control solenoid valve of each toilet is controlled by an electrical breaker switch, located on the AC/DC Electrical Panel (See the Electrical Pages in this section of this Owner's Manual for the location of the breaker switches). Toilet waste, both liquid and solid, is flushed from the toilet by the macerator to a Waste Tank having a capacity of sixty (60) gallons (Refer to the Mechanical Schematic in the Schematics Section of this Owner's Manual for the location of the Macerator and the Waste Tank). This waste is stored in the Waste Tank until pumped out at a proper facility. The Waste Tank is equipped with an electronic Waste Level Gauge, which monitors the volume of waste in the tank for your convenience in determining when pump-out is required. Maintenance of your Jabsco Quiet-Flush Electric Toilet Sanitation System consists of periodic cleaning of the toilet bowl with a mild non-abrasive cleaner. The Waste Tank should be thoroughly rinsed after each pump-out and a sanitation system deodorizer should be added to the Waste Tank by flushing through the toilet.



DO NOT use chlorine-based or caustic cleaning agents or chemicals, such as drain opening products, in your *Jabsco Quiet-Flush Sanitation System*. Use of these products may cause serious damage to the system's seals and hoses.

Refer to the JABSCO Quiet-Flush Toilet Manual included with your owner's packet for additional technical information concerning the use and maintenance of both the fresh water and raw water systems. Refer to the Winterization and Storage Section of this Owner's Manual for the proper preparation procedure for extended storage in cold climates.

Waste Filter

Your Waste System is installed with a Waste Filter. This Waste Filter is located forward of the Engine Room, on the port side. The Waste Filter is installed between the Waste Tank and the thru-hull vent for the Waste Tank. The Waste Filter should be changed at the beginning of every season.

SHOWER SUMP PUMP SYSTEM

Your 42C is equipped with a shower; it is located on the port side (See Interior Layout, which illustrates the location of both showers). The shower is equipped with a separate automatic sump pump (Refer to the Mechanical Schematic in the Schematics Section of this Owner's Manual for the location of the Shower Sump Pump). As the water drains from the shower into the sump pump to a certain level, it raises an automatic switch lever. This lever activates the shower sump pump and the water is then pumped overboard.

The photo below shows the Shower Sump Pump.



Access to the Shower Sump Pump is through a hatch located on the deck of the Galley. The photo below shows the panel removed.



The Shower Sump Pump System operates on DC electrical power, controlled by a breaker switch located on the AC/DC electrical Panel (Refer to the Electrical Pages of this section of this Owner's Manual for the location of the switches).

General maintenance of the Shower Sump Pump System involves periodic cleaning to remove any accumulated debris. Remove the six (6) screws securing the top cover for access to the debris basket and automatic float switch. If you notice that the shower does not drain properly, check the pump basket for debris and clean, if necessary. If the shower still does not drain properly, check the operation of the pump by manually raising the automatic float switch. If the sump pump is operable, but will not drain properly, check all drain lines for debris and clean as needed. See your Silverton Dealer for further inspection and repair if the shower continues to drain improperly.

! CAUTION

When operating the aft air conditioner on your 42C, the sump pump breaker switches must be turned ON. Condensation from the air conditioner drains into the Shower Sump Pump System and this water is pumped overboard by the sump pumps.

Refer to the Winterization and Storage section of this Owner's Manual for the proper preparation and maintenance of the SHOWER SUMP PUMP SYSTEM prior to seasonal storage.

STEERING SYSTEM

The steering system in your 42C is manufactured by Sea Star, a subsidiary of TeleFlex (Canada, Ltd.), and is hydraulically assisted. Hydraulic assisted steering is similar to the power steering system in your automobile and greatly reduces the manual effort necessary to steer your yacht and maintain the desired course. The Hydraulic Steering System in your 42C differs from your automobile, as a separate pump is not used to circulate the hydraulic fluid contained in the system; the system is completely filled with hydraulic fluid and is free of air. As you turn your steering wheel, the hydraulic fluid is pumped by the steering head into the appropriate fluid line, Port or Starboard, resulting in movement of the steering cylinder in the respective direction. The steering cylinder is connected to the rudders and they are subsequently turned; which enables your yacht to turn in the desired direction to Port or Starboard (See photograph below which illustrates the location of the steering cylinder and its connection to the rudders).



The Hydraulic Steering System in your 42C utilizes an adjustable tilt-type steering head, which allows you to adjust the steering wheel angle for maximum personal comfort.

The photo below shows the tilt control on the Steering Wheel.

The steering head contains a vented fill cap. The vented cap is located on the top of the steering head and forward of the steering wheel. The photo below shows the vented cap.



Maintenance of the Hydraulic Steering System should only be performed by your Silverton Dealer or a qualified technician experienced in marine hydraulic systems. Periodically examine all connections and hydraulic lines for any signs of leakage. If any leaks are noted, contact your Silverton Dealer for further inspection and repair, if necessary.

Refer to the SEA STAR Manual included with your Owner's Packet for the specific type of hydraulic fluid required and technical information concerning the Hydraulic Steering System.

SHIFT/THROTTLE CONTROL SYSTEM (MORSE CONTROLS) (OPTIONAL)

You may have chosen as an option when you purchased your 42C, an electronically controlled Shift/Throttle Control System, manufactured by Morse Controls, Inc. and factory installed at the Silverton plant. The purpose of this system is to provide the operator with smooth, positive shift. and throttle operation requiring minimal manual effort. With this system, only one (1) shift/throttle control lever is required per engine; the left control lever operates the Port engine and the right control lever operates the Starboard engine.

The Morse Shift/Throttle Control System is operated on DC electrical power, controlled by a breaker switch located on the AC/DC Electrical Panel and described as “Accessory” (Refer to the Electrical Pages in this section of this Owner’s Manual for the switch location).

Refer to the MORSE CONTROLS, INC. Manual included with your Owner’s Packet for additional technical information concerning the operation and maintenance of the MORSE SHIFT/THROTTLE CONTROL SYSTEM.

TRIM TAB SYSTEM

The purpose of the Trim Tab System on your 42C is to assist in reaching planing speed as soon as possible and to maintain a proper “running attitude” while in forward motion. “Running Attitude” is defined as the level of the boat, both fore and aft and athwartships, while the vessel is underway. Your yacht, upon reaching planing speed, should rise slightly in the bow and should not list to either side for the greatest stability and fuel economy. Your 42C is equipped with two (2) Bennett Trim Tabs, each measuring 12” x 24”, which are mounted on the trailing edge of the transom (See photographs below, which illustrate the location of the Starboard trim tab).



Each trim tab operates independently of each other and they are controlled by separate rocker-type switches located on the Helm Switch Panel (Refer to the Electrical Pages in this section of this Owner’s Manual for the location of these switches). Each trim tab is actuated by a hydraulic cylinder, which moves them in an Up or Down motion.

The position as determined by depressing the rocker-type switches as follows:

- Depressing the TOP of the switch lowers the trim tab.

- Depressing the BOTTOM of the switch raises the trim tab.

The **Trim Tab System** operates in the following manner:

- ✓ The function of the trim tab is to redirect the flow of water beyond the bottom of the transom. This creates an upward pressure on the hull bottom at the transom, which results in lowering the bow.
- ✓ When the Port trim tab is lowered, the Port stern section is raised, which in turn lowers the Starboard side of the bow.
- ✓ When the Starboard trim tab is lowered, the Starboard stern section is raised, which in turn lowers the Port side of the bow.
- ✓ Both trim tabs should be lowered/raised as needed to maintain a proper “Running Attitude”.

WARNING

Operation of the Trim Tab System may require practice to attain a level of proficiency. **DO NOT** operate either trim tab to its extreme lowered position suddenly. This may cause the bow to lower to an unsafe position while heading into or away from waves, which may cause “swamping” of your yacht, resulting in possible injury or death. **DO** operate the trim tab switches with short “bursts” until the desired “Running Attitude” is obtained.

Maintenance of the **Trim Tab System** is as follows:

- ✓Silverton recommends painting the trim tabs with good quality, antifouling bottom paint. DO NOT paint any hinges or the moving parts of the cylinders.

- ✓To reduce the risk of electrolysis and galvanic corrosion, Silverton recommends the installation of sacrificial zinc anodes on the trim tab plates at least once a year, preferably during preparation for spring launch. DO NOT paint the sacrificial zinc anodes.

- ✓Periodically examine the trim tabs for accumulation of underwater growth and clean as necessary.

- ✓Periodically examine the trim tab pump and hydraulic lines, which are located in the bilge area, for leaks (Refer to the Mechanical Schematic in the Schematic Section of this Owner's Manual for the location of the trim tab pump). Tighten connections if leaks are noted. If the hydraulic lines appear worn or chafed, contact your Silverton Dealer for inspection and replacement, if necessary. The photo below shows the trim tab pump.

Refer to the BENNETT TRIM TAB Manual included with your Owner's Packet for technical information concerning the operation and maintenance of the trim tab system.



ICEMAKER UNIT (OPTIONAL)

You may have chosen as an option when you purchased your 42C, an Icemaker Unit, manufactured by U-Line Corporation and factory installed at the Silverton plant. The purpose of this system is to provide you with a continuous supply of fresh ice upon demand and as needed.

The Icemaker Unit, which is located in the cockpit, operates on AC electrical power and is controlled by a breaker switch located on the AC/DC electrical Panel (See AC/DC Electrical Panel Layout which illustrates the location of the breaker switch that controls the Icemaker Unit). While your 42C is underway, you must operate your generator (if so equipped) to maintain operation of the Icemaker Unit.

Refer to the U-LINE CORPORATION ICEMAKER MANUAL included with your Owner's Packet for specific instructions concerning the operation and maintenance of the ICEMAKER UNIT.

LPG SYSTEM (OPTIONAL)

You may have purchased as an option with your **42C** an optional LPG Cooking System. This system is manufactured by Seaward Products. The purpose of this option is to give a alternative to electric cooking in your boat.

WARNING

Open flame appliances consume oxygen. This can cause asphyxiation or death. Maintain open ventilation. Do not use this appliance for comfort heating.

It is recommended that every time the LPG tank valve is opened for use, the operator close the valve and watch that the gauge needle remain constant. If leaks occur, repair the leak. If the leak cannot be repaired, DO NOT operate the appliance.

Regular cleaning with a soft cloth and warm detergent solution is generally enough to keep your cooktop clean and beautiful. This is done when the cooktop is cool. Use a dry cloth or paper towel to clean splatters and spills when surfaces are warm.

Due to the nature of LPG gas, it is necessary to discuss safety items associated with the operation this system.

1) This system is designed for use with Liquefied Petroleum Gas (LPG) only. Do not connect Compressed Natural Gas (CNG) to this system.

2) Keep cylinder valves and solenoid valves closed when boat is unattended. Close them immediately in any emergency. When on board, cylinder valves and solenoid valves shall be closed when appliances are not in use. Keep empty cylinder valves closed tightly. Keep protective covers caps or plugs in place.

3) Close appliance valves before opening cylinder valves.

4) Test for system leakage each time the cylinder supply valve is opened for appliance use. Close all appliance valves. Open then close cylinder supply valve. Observe pressure gauge at the regulating device and see that it remains constant for not less than three minutes before any appliance is used. If any leakage is evidenced by a pressure drop, check system with a leak detection fluid or detergent solution which does not contain ammonia and repair before operating system. NOTE: Ammonia, which is present in some soaps and detergents, attacks brass fittings. Undetectable at first, in a matter of months, these fittings may develop cracks and leaks.

DANGER

NEVER USE FLAME TO CHECK FOR LEAKS!

5) Do not obstruct quick access to LPG system components in any way.

6) Do not use LPG cylinder housing for storage of any other equipment.

7) Never leave craft unattended when LPG consuming appliances are in use.

8) Do not smoke or use open flame when replacing LPG Cylinders.

9) Inspect hoses in system at least annually. Replace every five (5) years or sooner if deterioration is found.

10) Inspect flue pipes at least annually. Replace if deterioration or openings are found.

REFER TO THE SEAWARD PRODUCTS OWNER'S MANUAL FOR ADDITIONAL OPERATION AND SAFETY INFORMATION ON YOUR LPG SYSTEM.

OIL X-CHANGE-R SYSTEM (OPTIONAL)

You may have chosen as an option when you purchased your 42C, an OIL X-CHANGE-R System, manufactured by Ray Zager & Company and factory installed at the Silverton plant. The purpose of the OIL X-CHANGE-R System is to automatically drain, fill and maintain engine and/or transmission oil with relative ease and no spilled oil, which is normally associated with your required periodic oil changes. The OIL X-CHANGE-R System consists of an enclosed pump, located in the engine compartment, which operates on DC electrical power. The system pump is controlled by a breaker switch, located on the AC/DC Electrical Panel and described as “Accessory” (Refer to the Electrical Pages in this section of this Owner’s Manual for the location of the switch for the OIL X-CHANGE-R System). Operation of the system is accomplished by turning ON the toggle switch located on the pump unit.

Refer to the OIL X-Change-R System Manual included with your Owner’s Packet for information concerning the operation and maintenance of this system.

REMOTE CONTROLLED SPOTLIGHT (OPTIONAL)

You may have chosen as an option when you purchased your 42C, a Remote Controlled Spotlight, manufactured by ITT Jabsco and factory installed at the Silver-ton plant. The spotlight unit is permanently mounted on the foredeck at the pulpit and operates on the DC electrical system. The system is controlled by a breaker switch described as “Accessory”, located on the AC/DC Electrical Panel (Refer to the Electrical Pages of this section of this Owner’s Manual for the location of the switch that controls the Remote Controlled Spotlight). The spotlight control panel is located at the helm station and power to and movement of the spotlight is controlled from this remote location (See photographs below, which illustrate the location of the Remote Controlled Spotlight and the Control Panel).

Refer to the ITT JABSCO Manual included with your Owner’s Packet for information concerning the operation and maintenance of the remote controlled spotlight.

SEAKEY

The SeaKey Satellite Communication System is installed on your yacht at the factory. It is comprised of the following items:

- High Water Alarm Switch
- SatCom Sending Unit
- Display Control Unit

Your SeaKey System always has battery power to it. This is a major advantage over the VHF Radio, which may be accidentally turned off.

HIGH WATER ALARM SWITCH



Access to the High Water High Water Switch is through the forward part of the engine room. Please be aware this Alarm Switch is about 5" higher than the normal operating bilge switches that are installed on your yacht by Silverton. Please also be advised that the switch is only in the mid compartment. Other compartments could flood first and the switch would not be activated. The switch will only be activated when the normal operating bilge pumps have failed and cannot handle the incoming water flow.

SatCom Sending Unit



The SatCom Sending Unit is installed under the helm on your yacht. This unit sends out a low frequency signal to the satellite, which in turn sends the signal to the receiving location. You must know the location of the Sending Unit. If anyone is standing in front of the Sending Unit, they could block the signal from going to the satellite. Refer to the SeaKey Owner's Guide for more information.

DISPLAY CONTROL PANEL



The Control Panel has many functions. Refer to the SeaKey Owner's Guide to understand all the important features of the control panel.

Your SeaKey system draws its' power from the batteries in your yacht. If the batteries go dead, or if the batteries are removed from the system, the system will send a signal to the receiving station. Before removing power form your system, we recommend contacting SeaKey Member Services for the proper procedures.

CLEANING AND MAINTENANCE

A periodic cleaning and maintenance schedule of the interior and exterior surface for your yacht is recommended. Not only will it maintain your yacht in pristine condition, but it will also result in a higher resale or trade-in value when you decide to purchase another Silverton yacht. A clean yacht is both pleasing to the eye and a source of pride in ownership. Cleaning and maintenance of your yacht is described in the following categories:

- * Interior Cleaning/Maintenance
- * Exterior Cleaning/Maintenance
- * Canvas Enclosure Cleaning & Maintenance

Interior Cleaning / Maintenance

There are several different types of surfaces in the interior of your yacht and all require a different method of cleaning. The surfaces and their respective cleaning and maintenance procedures are as follows:

Fiberglass

Wash with a mild soap and water solution. Thoroughly dry with a soft cloth and apply a coat of good quality wax designed for marine use.



DO NOT use abrasive cleaning agents on fiberglass surfaces, as they will scratch and dull the finish.

Wood

There are many wood surfaces in your yacht, such as galley cabinets, entertainment cabinets and trim. Care and cleaning of the wood surfaces is identical to the maintenance of the wood surfaces in your home. Frequently remove dust from the wood with a feather duster or similar cleaning tool. Apply a good quality furniture polish, such as *Liquid Gold*, to all wood surfaces on a regular basis to maintain their beauty and lustre.

Nautolex (Vinyl)

Gently wash with a mild soap and water solution and dry with a soft, lint-free cloth on a regular basis. DO NOT wait for the vinyl surface to appear soiled before you clean it, as stains and ground-in surface dirt may be difficult to remove.



DO NOT use cleaning agents containing bleach, as they will remove the color tint from the vinyl surface, causing a blotching appearance and will dry the material, resulting in surface cracks.

Upholstery

The upholstery in your yacht is high quality and stain resistant. Frequently vacuum the upholstery to remove any dirt before it accumulates and becomes imbedded. Stains may be removed by using a quality household stain remover. Be certain to follow the manufacturer's directions concerning its use.

Carpeting

The carpet in your yacht is a high quality nylon pile. Normal cleaning and maintenance is accomplished by vacuuming on a frequent and regular basis (Refer to the carpet manufacturer's pamphlet included with your Owner's Packet for additional cleaning procedures, such as stain removal).

You may have chosen as an option at the time of purchase of your yacht, a "Central Vac" vacuum cleaning system. Similar to the system in your home, only a removable vacuum hose with cleaning attachments is necessary to vacuum any portion of the interior of your yacht. The "Central Vac" system in your yacht is operated on the AC electrical system with a "Ground Fault Interrupter" circuit for your protection. The vacuum motor and canister (stores the vacuumed soil) are self-contained in one unit and located in the lower portion of the dinette seat. Access to the canister is gained through a panel located on the inboard face of the dinette seat. There is one (1) vacuum hose outlet, which is located on the face of the canister access panel (Refer to the manufacturer's pamphlet included with your Owner's Packet for specific directions concerning operation of the system).

Corian

The galley and head counter tops and head sinks are manufactured of Corian, which is a superior quality, tough, scratch-resistant material. The Corian surfaces in your yacht are a Matte/Satin finish and are easily cleaned and maintained in the following manner:

* **Cleaning:** Dirt and stains are removed by using a soap and warm water solution. Tough stains may be removed by using an ammonia-based cleaning agent. Watermarks may be removed simply by wiping the surface with a clean, damp cloth and drying with a towel.

* **Disinfecting:** Occasionally wipe the surfaces with a 50/50 water and bleach solution. Rinse with warm water and dry with a towel.

* **Sink Cleaning and Disinfecting:** General cleaning of the Corian sinks is the same procedure as described above. For a more thorough cleaning, occasionally fill the sink with a 50/50 water and bleach solution and let soak for fifteen (15) minutes. As the solution drains, wash the bottom and sides, rinse with warm water and dry with a towel.

* **Cuts and Scratches:** Cuts and scratches may be removed from your Corian surfaces. Refer to the manufacturer's pamphlet included with your Owner's Packet for the proper procedure.

Exterior Cleaning / Maintenance

The exterior surfaces of your yacht consist primarily of fiberglass, stainless steel, aluminum, safety glass, acrylic plastic and anti-fouling bottom paint. As with the interior surfaces, the exterior surfaces demand frequent cleaning and maintenance. The respective procedures are as follows:

Fiberglass

Wash with a mild soap and water solution, particularly if your yacht is used in salt or brackish water. Always thoroughly wash your yacht after each use in addition to a regular, periodic washing schedule. A more frequent washing schedule may be required, depending on the environment where your yacht is normally docked/moored. A soft scrub brush may be used on the non-skid surface areas. Thoroughly dry with a soft cloth and apply a coat of good qual-

ity wax designed for marine use, such as carnauba paste wax. **DO NOT** apply wax to the non-skid surface areas, as it will render them ineffective. If your boating season is year around, it is recommended a coat of wax be applied every three (3) months. If your boating season is restricted to the summer months, it is recommended a coat of wax be applied prior to spring launch and again at the end of the season prior to winter storage.



DO NOT use abrasive cleaning agents on fiberglass surfaces, as they will scratch and dull the finish.

Stainless Steel

The bow rail, aft deck rail, mooring cleats and other hardware on your yacht are manufactured of quality 316L grade stainless steel. Stainless steel will not rust under normal conditions, but it must be properly maintained on a regular basis. Thoroughly wash the hardware with a soap and warm water solution and rinse with fresh water. Dry with a soft cloth to remove any water stains. If discoloration or salt deposits are not removed with normal washing, a non-abrasive household cleaner or stainless steel polishing powder may be used with a soft bristle brush. Always scrub in the direction of the polishing lines imbedded in the stainless steel to avoid scratching the surface. For a superior shine, wipe the stainless steel with a light coat of kerosene, followed by a light coat of lemon oil. The kerosene enhances the lustre and protects the stainless steel and the lemon oil removes the unpleasant kerosene odor. Be careful not to spill or wipe kerosene on the fiberglass surfaces, as it will remove the coat of wax.



DO NOT use abrasive cleaning agents, steel wool pads, or brushes as these products may scratch and damage the stainless steel finish.

Aluminum

The windshield and window frames on your yacht are manufactured of aluminum, unless you purchased, as an option, stainless steel frames. The aluminum components are cleaned and maintained in the same manner as the components manufactured of stainless steel.



DO NOT use kerosene or lemon oil on any painted aluminum surfaces, as they will soften and remove the paint.



DO NOT use any abrasive cleaning agents or steel wool products when cleaning aluminum. Aluminum scratches very easily and these products will scratch the surface.

Safety Glass

The windshield and windows on your yacht are manufactured of safety glass similar to the safety glass found on your automobile. The safety glass on your yacht is much heavier and thicker than the glass on your automobile and meets or exceeds all American Boat and Yacht Council (ABYC) standards. The safety glass may be cleaned with the same soap and warm water solution used for cleaning the exterior surfaces of your yacht and then dried with a soft towel. For a thorough cleaning and to remove all water stains, use a quality window cleaner, such as *Windex*, and dry with a paper towel.



DO NOT use any abrasive cleaning agents, abrasive cleaning cloths, or pads when cleaning safety glass surfaces, as they will scratch the surface.

Acrylic Plastic

The venturi windshield, which is located on the bridge of your yacht, is manufactured of a tough acrylic plastic. Clean the acrylic plastic surfaces with a mild soap and water solution or non-ammonia based cleaner and dry with a soft cloth.



DO NOT use any abrasive cleaning agents or abrasive cleaning cloths or pads when cleaning acrylic plastic surfaces, as they will scratch the surface.

RADAR ARCH

Your radar arch (if applicable) is constructed from aluminum to give it strength, rigidity, wire access, and hardware mounting ability. It has a very durable painting finish backed by a 3-5 year limited warranty. In order to maintain the high luster finish and the warranty of this product, please follow these instructions:

GENERAL CARE:

- Wash your radar arch with mild, non-abrasive soap and water, using a soft cloth on a regular basis. This will help maintain the shine on your radar arch by keeping the salt and atmospheric acids from dulling your finish.
- To add extra shine and durability to your radar arch we suggest you wax the finish after washing the radar arch, with a clear-coat, non-abrasive wax.

Canvas Enclosure (Optional) Cleaning / Maintenance

The canvas enclosure you purchased as an option from your Silverton dealer consists of canvas fabric, vinyl windows and zippers. An aluminum tubular frame supports the enclosure and it is secured to the bridge and deck with “snaps”. Each of these components require a different cleaning and maintenance procedure and they are as follows:

Canvas Fabric

The canvas should be cleaned on a regular basis before dirt, salt, and other deposits accumulate and become imbedded in the fabric. The canvas may be cleaned, without removal from your yacht, while it is in the normal upright position. Brush off any loose dirt and then rinse with fresh water. Wash the fabric with a mild soap and lukewarm (temperature less than 100° F) water solution, rinse thoroughly with fresh water and allow to air dry.



DO NOT use any cleaning agents containing detergent, as they will remove the protective coating, resulting in stiffness and eventual cracking of the fabric.



DO NOT dry the canvas fabric by any means other than air-drying. Use of heated drying apparatus, such as a hair dryer, will result in stiffness and cracking of the material.

Vinyl Windows

The vinyl windows in your enclosure should be cleaned on a frequent basis to extend their life and maintain clarity. Rinse off any loose dirt with fresh water and then wash with a mild soap and cool water solution. After washing, rinse with fresh water and dry with a soft cloth.



DO NOT use any abrasive cleaning agents or brushes when cleaning your vinyl windows, as they will scratch the material, resulting in poor clarity.



DO NOT fold the vinyl windows after removing them from the enclosure. Roll them prior to placing them in storage. Folding the vinyl windows will cause creases and eventual cracking. If you anticipate long-term storage, place a soft cloth over the vinyl window and roll the window with the cloth in place. The cloth barrier will prevent the vinyl from sticking to itself, particularly during warm weather.

Zippers

The various sections of your canvas enclosure are secured together with zippers to permit easy removal of any or all sections without the cumbersome weight or size of the entire unit. The zippers are manufactured of high impact plastic coated stainless steel and have large teeth for smooth operation. They should be washed while you are washing the canvas and then periodically lubricated by rubbing a candle on the zipper in the closed position and then opening and closing several times to distribute the wax lubricant.

Aluminum Tubular Frame

The upper portion of your canvas enclosure is supported by a tubular aluminum frame. The frame is secured by stainless steel pins placed in brackets that are permanently mounted on the fiberglass surface at various locations on the bridge and deck. The aluminum frame is cleaned and maintained in the same manner as the other aluminum components on your yacht as previously described.



DO NOT use kerosene or lemon oil on the aluminum frame, as it will stain the canvas fabric. A small amount of lubricant, such as CRC, may be used to lubricate the stainless steel pins.

Two-Piece “Snaps”

The lower portion of your canvas enclosure is secured to the bridge and deck by two-piece “snaps”, which are manufactured of chrome-plated brass. The female portion is permanently secured in the lower seam of the canvas and the male portion is permanently secured into the fiberglass surface of the bridge and deck. Frequently examine the snaps for the presence of dirt and remove with a soap and water solution and rinse with fresh water. Periodically lubricate the female portion with a small amount of lubricant, such as *Vaseline Petroleum Jelly*.

Winterization and Storage

In most cases, the reason for storage of your yacht is winter lay-up. The information contained in this section is a general guide. Your Silverton Dealer or a competent boat yard should prepare your yacht for winter storage.

If you are removing your yacht from the water for another reason, use the information in this section as a guideline. Following the procedures in this section will help extend the life of your yacht and its equipment and simplifies recommissioning in the spring.

Indoor storage is beneficial if you are storing your yacht in a climate that produces ice and snow. The storage building should be adequately ventilated and not tightly closed. Ventilation, both around and throughout the yacht, is very important to help prevent the growth of mold and mildew.

If you use outdoor storage facilities, cover your yacht with a cover having provisions for ventilation to keep the yacht from “sweating”. Building a frame over the boat to support the cover will allow the passage of air around the yacht. The frame should be a few inches wider than the yacht so the cover will extend beyond the rubrail. The frame should also support the center

of the cover and cause it to rise in a slight “teepee” position to allow for water run-off.

NOTE: *DO NOT seal the cabin tightly to allow proper ventilation throughout.*

Before preparing your yacht for winter storage, thoroughly check the condition of the yacht and its systems and equipment. Note any repairs that may be needed. The need for additional repairs may become apparent during the winterization process. Make arrangements with your Silverton Dealer to have the repairs completed.

Cleaning and Preparation for Storage

Thoroughly clean the hull immediately after removing the yacht from the water. Pressure wash the bottom, if possible, to remove all marine growth. If pressure washing is not possible, thoroughly scrub the hull bottom. Marine growth is much easier to remove while it is still wet.

Thoroughly clean the remainder of the hull and the deck. Silverton recommends a coat of wax be applied to the hull above the waterline and to the deck for added winter protection.

Apply rust inhibitor to all metal parts.

Thoroughly clean the inside of all hull openings, thru-hull fittings and filtration screens (See **Mechanical Layout** in the Schematics Section of this Owner’s Manual, which illustrates the location of the seawater intake valves). Inspect the hull and underwater gear for signs of wear, deterioration or damage and repair, if possible, before covering and storing your yacht.

Fill the fuel tanks to prevent condensation and add a good quality fuel preservative (Refer to the fuel preservative manufacturer’s recommendation for the proper ratio).

IMPORTANT: *DO NOT overfill the fuel tanks so fuel flows from the vent(s). Allow sufficient room in the tanks for fuel to expand.*

Prepare the engines for storage. Refer to the engine manual for winterization and storage procedures.

❑ Prepare the generator and air conditioners (if so equipped) for storage. Refer to the generator manual and the air conditioner manual, included with your Owner's Packet, for the proper winterization and storage procedures.

Draining Your Yacht

Your yacht has drain plugs for draining water from the bilge (See **Mechanical Layout** in the Schematics Section of this Owner's Manual, which illustrates the location of the garboard drain plugs). Some compartments in the bilge may not drain completely due to the position of the yacht. Pump these compartments out with a portable pump and then use a sponge to remove all remaining water.

The procedure for draining and winterizing the fresh water system is as follows:

❑ Drain the fresh water supply tank by opening the hot and cold faucets in the galley for ten (10) minute intervals until the tank is empty.

❑ Open all faucets in the galley, both showers, both head sinks, and the exterior cockpit shower.

❑ Remove the fresh water filter bowl and strainer. Clean, dry and replace strainer bowl.

❑ Drain the water heater, remove the cold water intake hose and hot water output hose, and hook them together.

❑ Remove the inlet hose from the fresh water tank (See **Mechanical Layout** in the Schematics Section of this Owner's Manual, which illustrates the location of the fresh water tank) and insert it into a container of non-toxic, fresh water anti-freeze. Turn the fresh water pump ON and starting at the farthest faucet from the pump, turn ON all faucets until the anti-freeze flows out.

❑ Turn OFF the fresh water pump and reconnect the inlet hose to the fresh water tank.

❑ Pour non-toxic anti-freeze into all sink and shower drains until the liquid is discharged overboard.

Alternate procedure for draining and winterizing the fresh water system is as follows:

❑ Drain all water from the fresh water tank.

❑ Drain all water from the water heater.

❑ Remove hose from the input side of the fresh water pump and allow to completely drain.

❑ Remove hose from the output side of the fresh water pump and turn ON all faucets.

❑ Blow compressed air (15-20 lbs. psi) through the output hose until all water stops flowing from the faucets.

❑ Leave water lines at the fresh water pump disconnected to allow any trapped water vapor to drain and evaporate.

The procedure for draining and winterizing the marine sanitation system is as follows:

❑ Drain all water lines into the waste holding tank. Continue to flush fresh water into the waste holding tank and pump out into an approved waste facility until thoroughly clean.

❑ Add non-toxic, freshwater anti-freeze to the waste holding tank by flushing through the toilet.

❑ Run the macerator pump to allow anti-freeze to flow through the pump and the input/output lines.

❑ Remove the drain plug from the macerator seacock while the valve is closed and allow the line to drain. Replace the drain plug.

❑ Thoroughly clean the toilet and leave the bowl exposed to prevent mildew.

❑ Remove all seacock and strainer drain plugs to prevent from freezing. Close all seacocks.

Seacocks

- Engines
- Head System (Intake)
- Head System (Macerator pump-out)
- Generator
- Air Conditioners (if equipped)

Strainers

- Engines
- Fresh Water System
- Generator
- Air Conditioners (if equipped)

Battery Storage

The procedure for battery winterization and storage is as follows:

- ❑ Turn battery switch to OFF.
- ❑ Remove engine batteries and generator battery (if so equipped) from their respective compartments (See **Mechanical Layout** in the Schematics Section of this Owner's Manual, which illustrates the location of the engine and generator batteries).
- ❑ Place batteries on a wooden pallet or bench and store in an area where temperatures remain above freezing.
IMPORTANT: DO NOT store batteries on a concrete surface, such as a garage floor, as they will tend to discharge.
- ❑ Keep batteries fully charged during storage. Periodic charging (once a month) with a battery charger set on a low amperage charge is recommended. Check the battery electrolyte levels regularly. Add electrolyte, if needed.



Refer to the battery literature included with your Owner's Packet for additional information concerning the care and storage of your batteries.

Interior Preparation

The procedure for preparing the interior of your yacht for winter storage is as follows:

- ❑ Remove all items that will hold moisture (towels, PFD's, blankets, clothing, canvas, etc.) from the interior of the yacht to prevent mold and mildew formation.
- ❑ Remove all electronic equipment and items of value that are detachable.
- ❑ Remove all garbage and trash.
- ❑ Thoroughly clean the interior of your yacht. Clean all cabinets, drawers and cupboards. Allow the cabin area to air dry for at least one day, if possible.

❑ Stand or prop up all mattresses and cushions that are to remain on board during storage to allow air circulation around them.

❑ Place *Mildew Pacs* in various locations within the interior of your yacht to help prevent mold and mildew formation during storage (Refer to the manufacturer's recommendation for the quantity and location required).

Lifting Your Yacht

The following are guidelines that will help prevent damage to your yacht as it is being lifted:

* Never lift the yacht with a greater than normal accumulation of water in the bilge. All tanks containing fresh water should be empty.

* Place lifting slings where indicated by the sling tab labels on the gunwales (See **Thru-hull Locations Layout-Port and Starboard** in the Schematics Section of this Owner's Manual, which illustrates the location of the sling tab locations). Avoid placing slings where they may lift the propeller shaft or other underwater fittings. Padding, placed under the slings at the chine corners, will help to keep pressure to a minimum at this location.

* Disconnect the propeller shafts at the transmissions to prevent damage to the transmissions and shafts.

* Use wide, flat, lifting slings made of belting and spreader bars long enough to keep pressure off of the gunwales.



DO NOT use slings made of cable. Pressure caused by the slings on the gunwales can cause severe gelcoat crazing or more serious hull damage. The spreader bar at each lifting sling should be at least as long as the distance across the widest point the sling surrounds.

* If a marine railway or platform hoist is being used, locate and adjust the blocking to distribute the weight over several areas. The weight borne by the keel must not be so great as to cause crushing or distortion of the member.

* When lifting the yacht, keep the bow higher than the stern so the engine and generator (if so equipped) exhaust lines can drain. This will prevent water from flowing forward through the manifold and into the engine itself, where it may become trapped.



Always keep the bow higher than the stern every time the yacht is lifted. DO NOT lift the stern higher than the bow at any time as this may cause water to enter the engines. Engine failure is possible if water enters the engine cylinders. The water can cause “hydrostatic lock” and bend the piston rods. “Hydrostatic lock” is a situation where the piston cannot travel to its full upward position due to the presence of a liquid above the piston and extreme pressure is forced downward as the piston moves upward. Even a small quantity of water can cause rust or other internal engine damage.

***NOTE:** Silverton recommends an optional storage cradle with the purchase of your yacht. The cradle is factory made to conform to the bottom of your yacht for safe storage and minimizes the risk of hull distortion.*

OPERATING YOUR YACHT

Most people who purchase a Silverton yacht have boat handling knowledge and experience with other types of vessels. This section of the Owner's Manual provides basic information concerning the safe operation of your yacht and is a review of the information contained in each of the "Systems Sections". Be certain to read and have a thorough understanding of all systems described in this Owner's Manual **BEFORE** you operate your yacht. Even if you are an experienced yachtsman, you can benefit from reviewing the information contained in this section.

The first cruise on your new Silverton yacht should be a time for you to become acquainted with the vessel. Before you depart on your first cruise, you should be able to answer **YES** to the following questions:

- ✓ Has your Silverton Dealer completed the "Pre-Delivery Service Inspection"?
- ✓ Have you and your Silverton Dealer signed the "Pre-Delivery Service Record"?
- ✓ Have you completed and mailed all warranty registration cards?
- ✓ Have you read and do you have a complete understanding of this Owner's Manual and the O.E.M. Manuals included with your owner's packet?
- ✓ Does your yacht's safety equipment comply with all United States Coast Guard and local regulations?
- ✓ Is your safety equipment in operable condition and accessible, if needed?

✓ Has your Silverton Dealer reviewed the operation of your yacht and its systems with you?

✓ Has your Silverton Dealer answered all of your questions concerning the operation of your yacht and all of its systems?

If you have completed the above preliminary steps, you are ready to take your first cruise. Before you depart, give some thought to the cruise itself. Choose a calm day, if possible, and take only those people who will be members of your regular crew. Leave guests on shore, so that you are able to concentrate on learning as much as possible about your new Silverton yacht without unnecessary distractions.

Engine Startup Preparation

Make sure that you have read the Fuel Safety Checklist For Safe Boarding prior to your initial or first seasonal engine startup, and then follow the below listed procedures:

- ✓ Be certain all electrical circuit breaker switches are turned OFF.
- ✓ Raise the engine compartment access hatch and use your sense of smell to detect any fuel fumes.

If **ANY** fuel fumes are detected:

- ✓ Evacuate your yacht **IMMEDIATELY**.
- ✓ Notify the Dockmaster.
- ✓ Open all hatches, doors and windows to provide natural ventilation.
- ✓ Have a qualified marine technician exam-

ine your yacht immediately to determine the source of the fuel fumes.

- ✓ If a leak is detected, have it repaired as soon as possible by a competent technician.
- ✓ If you do not detect any fuel fumes, open all hatches, doors and windows to ventilate your yacht.
- ✓ Visually examine the engines and generator (if so equipped) for any oil leaks. If leaks are noted, have them repaired by a competent technician.
- ✓ Examine the bilge area for water accumulation. Remove excess water and locate the source of the water. Remember, a small quantity of water in your bilge is normal.

Turn ON the following switches:

- ✓ Both battery switches.
- ✓ DC Electrical Panel main breaker switch.
- ✓ Helm electronics breaker switch.
- ✓ Helm accessory breaker switch.
- ✓ Visually examine the fire extinguisher system in the engine compartment to be certain it has not been discharged.
- ✓ Check the engine oil level. Refer to the Engine Manual for specific instructions concerning the proper oil level and filling procedure.
- ✓ Check the transmission fluid level. If the level is low, add fluid, but **DO NOT** overfill. Be certain the fluid level is below the full

mark on the dipstick when the transmission is cold. The fluid will expand as it warms and will overflow if the level is too high. Refer to the Transmission Owners Manual.

- ✓ Check the generator (if so equipped) oil level. Refer to the Generator Manual for specific instructions concerning the proper oil level and filling procedure.
- ✓ If your yacht is equipped with fresh water cooled engines, remove the pressure cap from the heat exchangers and check that the coolant is filled to the neck of the filler tube. If coolant is low, refer to the Engine Manual for proper filling instructions.
- ✓ If your yacht is equipped with diesel engines, refer to the Engine Manual for the proper procedure for checking the coolant level and the proper antifreeze/water ratio.
- ✓ Open both raw water intake valves. The valves are in the open position when the handle is parallel to the valve body.
- ✓ Remove raw water strainer cap and check for debris. Remove any debris noted.
- ✓ If your yacht is equipped with a generator, be certain there is no debris in the water strainer. Remove any debris noted.
- ✓ Examine the propeller shaft stuffing boxes for excessive water leakage. One drop of water every sixty (60) seconds is normal.
- ✓ Open the fuel shutoff valves for the engines and generator. The valve is in the open position when the handle is parallel to the valve body.
- ✓ Check the oil level in the trim tab reservoir and be certain the level is between the FULL and ADD marks.

Engine Startup

IMPORTANT: Always be very careful when starting your engines. Use common sense and good judgement. Turn OFF the engine(s) immediately if you observe any unsafe operating condition.

The below listed procedures should be followed when starting your engines:

- ✓ Operate the bilge blower motors for five (5) minutes before starting your engines.
- ✓ Place shift control levers in the neutral position.
- ✓ Place throttle control levers in the “down” position.
- ✓ Turn ignition switch to ON, but not to START. Be certain the engine oil pressure alarm sounds and the Automatic Fire Extinguisher System indicator light is ON.
- ✓ Turn ignition switch to START and hold until the engine starts. Release the ignition switch immediately after the engine starts. If the starter motor does not operate when you turn the ignition switch to START, the neutral safety switch may be out of adjustment. Carefully move the shift control lever up and down slowly until the starter motor operates. Have a competent technician adjust the neutral safety switch as soon as possible.

CAUTION

If the engine fails to start within thirty (30) seconds, release the ignition switch. Allow the starter motor to cool for at least sixty (60) seconds and then try again to start the engine. Prolonged starting attempts may result in starter motor overheating and damage.

CAUTION

Failure to release the ignition switch from the START position after the engine starts may result in serious damage to the starter motor and/or engine flywheel.

- ✓ If one of the batteries is not sufficiently charged to start the engine, start the engine with the fully charged battery first. Start the other engine using the “Parallel Start” switch, which draws power from both batteries. Release the parallel start switch immediately after the engine starts.

CAUTION

DO NOT continue to depress the “Parallel Start Switch” after the engine has started. Damage to the alternator(s) may result.

- ✓ Be certain the oil pressure is between 30 and 50 psi (gasoline engines) or 35 and 70 psi (diesel engines). If the oil pressure is low, turn OFF the respective engine immediately.
- ✓ Allow the engines to operate at the recommended RPM's as specified in the Engine

Manual until they reach normal operating temperature. Normal operating temperature for gasoline engines equipped with a fresh water cooling system is 170° F and if equipped with a raw water cooling system, 140° F. Normal operating temperature for diesel engines is between 170° F and 190° F.

✓ Check for water discharging from the exhaust outlets. The presence of water indicates water circulation in the exhaust cooling system. Water should discharge through the exhaust outlets immediately after the engine starts.

✓ After engines reach their normal operating temperature, increase the RPM's to 2000. Be certain the voltmeters read between 13 and 14.5 volts.

✓ Visually inspect the exhaust system for leaks. If any leaks are detected, immediately turn OFF the respective engine, and contact a competent technician for repair.

✓ Check the transmission fluid level after the engine is warm. The transmission should be in neutral and the engines operating at idle speed. Transmission fluid should be at or slightly below the FULL mark on the dipstick. Add transmission fluid if the level is low, but **DO NOT** overfill. Refer to the Transmission Owners Manual.

Shakedown Cruise

Silverton recommends a shakedown cruise after the initial or seasonal startup. This will test the engines and various systems under normal operating conditions. Note any condition that does not meet normal operating performance standards. Repair any condition noted as soon as possible.

IMPORTANT: Before fueling your yacht, be certain you have read and have a thorough understanding of the information contained in the “**Fuel System**” **Section** of this Owner's Manual. It contains valuable information and cautions for your safety and the safety of your passengers.

Check the following for proper operation during your shakedown cruise:

☐ **Air Conditioner(s):** If your yacht is equipped with an air conditioning system, be certain each air conditioner is operating properly.

☐ **Engines:** Be certain both engines are capable of obtaining their maximum RPM range. Check for fuel, oil and water leaks. Check the exhaust system for leaks.

☐ **Generator:** If your yacht is equipped with a generator, be certain it starts and operates properly. Check for oil, water and exhaust system leaks.

☐ **Instruments:** Be certain that all instruments operate properly and provide normal readings.

☐ **Steering:** Check that the steering system is responsive.

☐ **Shift and Throttle Controls:** Be certain

the shift and throttle controls operate properly and are in the proper adjustment.

Transmissions: Check that both transmissions shift smoothly and positively.

Trim Tabs: Check that the trim tabs operate properly and are responsive to your use of the controls.

After completing your shakedown cruise, recheck all fluid levels. Check all drive belts for the proper tension. Generally examine all components to be certain they did not loosen during the cruise. Make all adjustments as necessary.

WARNING

DO NOT remove the cooling system filler cap when the engine is hot. Allow the engine to cool and then remove the pressure cap slowly, allowing the pressure to vent. Hot coolant, under pressure, may discharge violently and result in serious personal injury and burns.

Getting Underway

After your engines have warmed to normal operating temperature, you are ready to depart your dock/mooring. Check the wind, tide and current to determine the best way to safely maneuver your yacht away from the dock. Cast off all mooring lines.

Shift the transmissions into forward or reverse, depending on which way you want to depart your dock. Your engines should be at idle speed while departing your dock and power should only be used if necessary for control of your yacht.

Once your yacht has departed the dock and is in open water, accelerate to cruising speed (RPM's) as recommended in the Engine Manual.

Be certain to follow all safety precautions as mentioned in the "Boating Safety" Section of this Owner's Manual while operating your yacht.

Daily Engine Shutdown

After you have completed your cruise and secured your yacht to the dock, shut down the engines in the following manner:

- Reduce engine speed to idle.
- Place transmission controls in neutral.
- Allow engines to operate at idle speed for several minutes.
- Turn ignition switches to the OFF position to shut down the engines.
- Operate the bilge blower motors for several minutes to circulate fresh air through the engine compartment.
- Turn OFF battery switches.

SIXTEEN WAYS TO REDUCE FUEL CONSUMPTION

1. Keep the bottom of your yacht clean. A fouled bottom can increase drag up to 10% or more. A 10% increase in drag is equivalent to a 10% increase in fuel consumption.
2. **DO NOT** idle your engines needlessly. Depart your dock/mooring after warm-up.
3. Watch your trim. A well balanced yacht gets on plane faster, handles better, and runs with less surface contact.
4. Navigate better. By plotting courses to your destination instead of just waiting for them to appear somewhere in front of you, you can eliminate miles off of your distance and gallons off of your fuel consumption.
5. Know your fuel consumption. By plotting a fuel consumption/RPM curve for your yacht, you will probably find that reducing your engines' RPM's 10% can often reduce your fuel consumption 30% with only a slight reduction in speed.
6. Remove extra weight. If you are not going to use it, do not carry it aboard. Any extra weight requires more fuel to move your yacht. Do not just stop at the lockers. Remember that water weighs 64 pounds per cubic foot, so keep the bilge areas dry.
7. Improve your yacht handling ability. **DO NOT** let the yacht labor along below a planing attitude. This is the absolute peak of fuel waste.
8. Purchase good quality fuel. Be certain you are using the correct fuel for your engine.
9. Load your yacht correctly. **DO NOT** put all of the heavy gear, such as anchors, chain, canned goods and spare parts exclusively in either the bow or stern. Heavy items should be placed amidships where they will not affect the trim and plane of the yacht.
10. Check the drive train. An inboard engine that is improperly aligned can cost you money. Check to see if the transmission has sufficient fluid (too little increases friction), if the stuffing box is too tight (increases the load on the engine) or if a bent rudder or propeller are robbing you of economy. Be certain the rudders are properly aligned.
11. Check the engine cylinder compression. Low compression indicates worn piston rings or valves which will consume oil and reduce engine power.
12. Check the engine idle speed. For the times it is necessary to operate at idle speed, be certain the engine is not running too fast and using unnecessary fuel.
13. Check the engine operating temperature. Compare your normal operating temperature with the range specified in the Engine Manual and in this Owner's Manual. An overheating engine will cause excessive wear and will be less efficient.
14. Keep the engine and transmission oil clean. Dirty oil causes varnish to form on the moving surfaces of the engine/transmission. Varnish can cut into the piston ring seal and contribute to fuel waste. Varnish will cause the transmission to "slip".
15. Check for engine air leaks. A leak in the

engine intake manifold disturbs the air/fuel mixture and reduces your performance. A leak in the exhaust manifold is DANGEROUS. Carbon Monoxide Gas (CO) could enter the cabin area of your yacht.

 **DANGER**

Carbon Monoxide Gas (CO) is colorless, odorless, and tasteless. It is highly poisonous, endangering lives even at very low levels of concentration. Mild exposure causes headaches and fatigue, often resembling “flu-like” symptoms. Medium exposure causes severe headaches, drowsiness, nausea, and rapid heart rate. Extreme exposure results in unconsciousness, convulsions, cardio-respiratory failure, and death. If Carbon Monoxide Gas (CO) is detected in your yacht, immediately contact a qualified technician to locate and repair the source of the poisonous gas. DO NOT enter your yacht until repairs have been made and the Carbon Monoxide Gas (CO) is lowered to an acceptable level.

16. Keep hot water use to a minimum. The less hot water you use, the less time your generator will have to run, resulting in lower fuel consumption.

GLOSSARY

ABAFT: Toward the rear of the yacht.

ABEAM: At right angles to the yacht's keel.

ABOARD: On the yacht.

ABREAST: Side by side.

ADRIFT: Loose. Not on a mooring or tow line.

AFT: Near or at the stern.

AGROUND: Stuck fast on the bottom.

AHEAD: In a forward motion.

ALOFT: Above the deck, usually in the rigging.

AMIDSHIP: (1) The area midway between the bow and the stern of the yacht. (2) The area between the Port and Starboard side of the yacht.

AMPERE: The standard unit to measure the strength of electrical current.

ANCHOR: A shaped metal device that digs into the ground to hold the boat in place.

ANTIFOULING: Paint used on the bottom of the vessel to prevent unwanted adhesions.

ASTERN: (1) In the rear area of the yacht. (2) Direction of travel when the yacht moves in reverse.

ATHWARTSHIP: Movement from Port to Starboard or Starboard to Port.

BEAM: (1) The widest distance across the yacht. (2) A transverse structural member that stiffens and supports a portion of the deck.

BERTH: A seaman's name for a bed aboard a boat.

BILGE: The interior area of the hull below the waterline.

BILGE PUMP: A pump used to remove water that has drained into the yacht's bilge.

BOW: The forward end of the yacht.

BOW LINE: A docking line leading from the yacht's bow.

BRIDGE: Control area of a boat.

BULKHEADS: The interior walls of the yacht.

CABIN: (1) Structure above the main deck. (2) Area below the deck.

CAST OFF: Let go.

CHINE: The point where the bottom and side of the hull meet.

CHOCK: A fitting or hole through a yacht's deck through which a mooring or anchor line is routed.

CIRCUIT BREAKER: A device used to interrupt an electrical current when the current flow exceeds a predetermined level.

CLEAT: A fitting on a yacht's deck on which a mooring or anchor line is tied.

COAMING: Area around the cockpit that prevents water from coming on the boat.

COCKPIT: An exposed aft deck area substantially lower than the forward adjacent deck.

COME-ABOUT: A change in direction according to the wind.

COMPANIONWAY: The steps or ladder leading from the deck to the cabin of the yacht.

COMPARTMENTS: Rooms or spaces divided by bulkheads.

COMPASS: (1) Navigation device. (2) Drawing tool used to draw arcs or circles.

CRADLE: A wooden framework used to support a yacht when it is on land.

CURRENT: The movement of water.

DAVIT: A device used to hold up a small boat or an anchor.

DEAD AHEAD, DEAD ASTERN: Directly in front of the yacht.

DINGHY: A small open boat used for ship to shore transportation.

DISPLACEMENT: The weight of the water displaced by the yacht's hull.

DRAFT: (1) The depth of a yacht from the actual waterline to the bottom of the lowest part, such as the propeller tip or rudder. (2) The depth of water necessary to float a yacht.

DRIFT: Causes the vessel to move with the current of the water.

EVEN KEEL: To be floating evenly without listing to either side.

EXHAUST SYSTEM: The means by which the hot engine or generator gases are removed from the engine and released into the atmosphere.

FATHOM: A nautical linear measurement equal to six (6) feet.

FENDER: A rubber or plastic device used to absorb impact between vessels or a vessel and a dock.

FLARE: (1) Outward curve of the hull as it rises up the side from the waterline. (2) A pyrotechnic device used for emergency signaling.

FLOTSAM: Refuse that floats when discharged overboard. See "Jetsam".

FLYING BRIDGE: The uppermost steering station from which a yacht is controlled.

FORE-AND-AFT: A line, or anything else, that runs parallel to the longitudinal center of the yacht.

FOREDECK: The forward most part of the main deck of a vessel.

FORWARD: Toward the bow of the yacht.

FREEBOARD: The vertical distance from the waterline to the sheerline (rubrail).

GALLEY: The kitchen area of the yacht.

GASKET: A strip of sealing material used to make joints fluid tight.

GARBOARD: (1) The strake (plank) next to the keel. (2) The continuous band of planking on a ship's hull next to its keel.

GARBOARD DRAIN: A drain located at the keel leading out from the bilge area.

GELCOAT: The thin outer layer of pigmented plastic-like substance used to cover exposed fiberglass components.

GIVE-WAY VESSEL: The boat that does not have the right of way when two boats are crossing paths.

GLAND: The moveable part of the stuffing box which compresses the packing when tightened (also referred to as the "packing gland").

GRAB RAIL: Grip on the top of a cabin or on the sides of a companion ladder.

GROUND: (Electrical) The electrical potential of the earth's surface, which is zero.

GUNWALE: The horizontal surface of the deck immediately above where it meets the hull.

HATCHES: Covers the openings in a deck or floor.

HATCHWAY: Access port through the deck.

HARDTOP: A permanent cover over the cabin or cockpit.

HAWSER: A heavy rope used for mooring or towing.

HEAD: A toilet or bathroom.

HEADING: The direction that a vessel is traveling with reference to true, magnetic, or compass north.

HEADWAY: The forward motion of a vessel through the water.

HEEL: To tip or tilt to one side by means of an external force.

HELM: Steering gear for a boat.

HELMSMAN: The person steering the yacht.

HULL: The main body of the yacht.

INBOARD: (1) From either the Port or Starboard side to the centerline of the yacht. (2) The dock side of a moored yacht.

JETSAM: Refuse that sinks when discharged overboard. See "Flotsam".

KEEL: The centerline of a yacht running fore and aft at the lowest point of the hull.

KNOT: (1) A Maritime unit of speed equal to 1.15 miles per hour. (2) A term for hitches and bends in a line of rope.

LAZARETTE: Storage compartments below the deck at the stern of the yacht.

LIST: A vessel that inclines to Port or Starboard by its own means.

LOCKER: A seaman's term for a closet.

LONGITUDINAL: Lengthwise.

MIDSHIPS: Area in the center of a boat.

MOORING: An arrangement for securing a yacht to a mooring buoy or pier.

NAUTICAL MILE: An international standard for a mile that measures 6076.12 ft.

NAVIGATIONAL LIGHTS: A set of red, green and white lights which indicate the presence of a vessel and must be illuminated between the hours of dusk and dawn and during times of restricted visibility (fog, rain, snow, etc.).

OVERHEAD: The ceiling or roof of a yacht.

OUTBOARD: (1) From the centerline of a yacht to the Port and Starboard sides. (2) The seaward side of a moored yacht.

PASSAGEWAY: A corridor or hallway aboard ship.

PERSONAL FLOTATION DEVICE (PFD): Life preserver or life vest.

PIER: A loading platform that extends at an angle from the shore.

PILING: Support or protection for wharfs, piers, etc.

PITCH: (1) The vertical motion of a yacht in a seaway about the athwartship axis. (2) The axial advance in inches of a propeller during one complete revolution.

PLANING HULL: At slow speeds, a planing hull will displace water in the same manner as a displacement hull. As speed increases, the hull provides a lifting effect up onto the surface of the water.

PORT: (1) Looking forward, the left side of a yacht from bow to stern. (2) A harbor.

PORT BEAM: The left center of a yacht.

PORT BOW: Looking forward, the front, left side of the bow.

PORT QUARTER: Looking forward, the left rear section of a yacht.

PULPIT: Rails at the bow of a boat.

QUARTER: The sides of a yacht aft of amidships.

QUARTERING SEA: Sea (waves) coming from a yacht's quarter.

RADAR: An electronic system that uses high frequency radio waves.

RADIO BEARING: The direction that is determined by the radio.

RAIL: The bars that are found at the edge of a boat to prevent passengers from falling overboard.

RIGGING: Equipment used to support and control the spars and sails.

RODE: The anchor line or chain.

RUNNING LIGHTS: Refer to "Navigational Lights".

RUBRAIL, STRAKE, OR GUARD: A protective strip located along the hull.

RUDDER: A vertical plate used to steer the yacht.

SALON: The main social cabin of a yacht.

SCOPE: A ratio used to measure the distance from the bow of the boat to the bottom of the water; according to how much of the anchor was dropped.

SCREW: A propeller.

SCUPPER: A drain from the edge of the deck or cockpit that discharges overboard.

SEACOCK: A positive action shut-off valve connected directly to the hull seawater intake valve.

SHAFT: The long round member that connects the transmission to the propeller.

SHAFT LOG: A fitting at the hull bottom where the propeller shaft penetrates the hull. The shaft log permits rotation of the shaft while simultaneously preventing water from entering the hull.

SHEER: The top of the hull from bow to stern. The point in which the hull meets the deck.

SHEER STRAKE: The upper edge of the hull immediately below the deck.

SHEERLINE: (1) The curve of the boat when being viewed from the side. (2) A turn off course due to poor helmsmanship or trouble steering.

SOLE: Term used to refer to the cockpit floor or floor of the cabin.

SPRING LINE: A pivot line used in docking or to prevent the yacht from moving forward or astern while made fast to a dock.

STANCHION: The metal posts that help hold up the rails on a boat.

STARBOARD: Looking forward, the right side of a yacht from bow to stern.

STARBOARD BOW: Looking forward, the front, right side of the bow.

STARBOARD QUARTER: Looking forward, the right rear section of a yacht.

STATEROOM: A bedroom for guest or the captain.

STEM: The leading edge of a yacht's hull.

STERN: The rear of a yacht.

STRINGER: A fore and aft continuous member located in the bottom of the hull used to provide longitudinal strength.

STRUT: A propeller shaft support that is below the hull. The main strut is a large strut that is mounted immediately forward of the propeller. An intermediate strut is smaller than the main strut and is mounted between the main strut and the shaft log.

SUMP: A pit or well into which water is drained.

SUPERSTRUCTURE: A flying bridge or other structure that extends above the deck.

SWELL: Long, large wave that does not break.

SWIM PLATFORM: Low platform, used for boarding, found at the back of the boat.

TOPSIDE: To go to the uppermost deck.

TRANSOM: The stern cross section of a yacht.

UNDERWAY: A vessel that is not moored, docked, at anchor or aground.

V-BERTH: Small galley consisting of a folding table, tabletop stove, and a basin.

V-BOTTOM: A hull with the bottom section that is in the shape of a "V".

V-DRIVE: A drive system that has the output of the engine facing forward and is coupled to a transmission, which then changes the output aft.

VESSEL: A boat, ship, yacht, or another craft used to travel on water.

WAKE: The movement of waves caused by the boat's hull.

WATERLINE: The line of water on the hull when the boat is afloat and at rest.

WEATHER DECK: A deck with no overhead protection.

WHARF: A landing place or pier where ships may tie up and load or unload

WINCH: A mechanism used to increase the pull on sheet lines.

WINDLASS: A device used to raise and lower an anchor.

YAW: To go off course.

YACHT: A vessel used for pleasure instead of work.

Warning Labels

The following Warning Labels appear at various locations on your yacht and are self-explanatory. Be certain to familiarize yourself and your passengers with these Warning Labels and their contents.

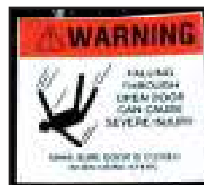
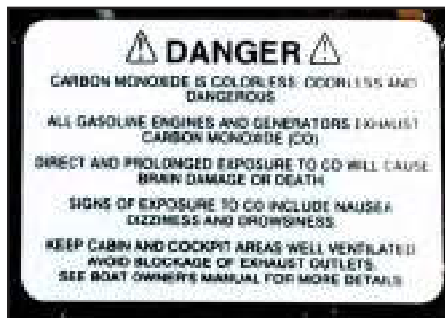

Identification Labels

The following labels identify the location or operating procedure of certain items on your yacht that are designed to assist you and increase your yachting pleasure.

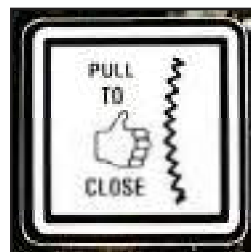
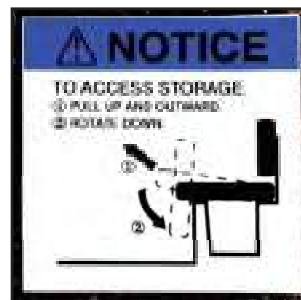
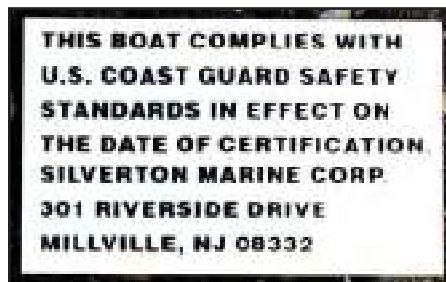

MAINTENANCE SCHEDULE

GASOLINE ENGINE MAINTENANCE SCHEDULE					
ITEM	DAILY	25 Hr.	50 Hr.	100 Hr.	YEARLY
Check oil levels					
Check fuel system for leaks					
Check cooling system for leaks					
Check exhaust system for leaks					
Check for loose or damaged parts					
Change engine oil					
Replace oil filter					
Clean flame arrestor					
Check electrical connections					
Check belt drive tension					
Tighten engine mounts					
Check engine alignment & tighten bolt					
Check condition of zinc anodes					
Check fuel canister for corrosion					
Check condition of spark plugs-NOTE 1					

DIESEL ENGINE MAINTENANCE SCHEDULE					
ITEM	DAILY	75 Hr.	250 Hr.	YEARLY	2 YRS.
Check exhaust system for leaks					
Check for loose or damaged parts					
Check fuel system lines for leaks					
Drain water and sediment from primary fuel filter					
Tighten engine mounts					
Check engine alignment & tighten bolt					
Clean or replace air cleaner elements-NOTE 2					
Check oil levels					
Check oil and filters-NOTE 3					
Check cooling system for leaks					
Check zinc anodes					
Clean seawater strainer and inspect and lubricate impeller-NOTE 4					

TRANSMISSION MAINTENANCE SCHEDULE					
ITEM	DAILY	25 Hr.	50 Hr.	100 Hr.	YEARLY
Check Transmission fluid level					
Change Transmission fluid					

PROPELLER MAINTENANCE SCHEDULE					
ITEM	DAILY	25 Hr.	50 Hr.	100 Hr.	YEARLY
Check propeller for dents or gouges-NOTE 5					

MISCELLANEOUS MAINTENANCE SCHEDULE					
ITEM	DAILY	25 Hr.	50 Hr.	100 Hr.	YEARLY
Halon fire extinguishers-NOTE 6					
Check Battery electrolyte level					
Check raw water strainers (generators, engines, AC units)					
Check pumps (bilge & shower sump) for automatic operation					

NOTE 1 - Replace spark plugs yearly
 NOTE 2 - More often if necessary
 NOTE 3 - Or once a year

NOTE 4 - More frequently if operated in shallow water
 NOTE 5 - Retrue if necessary
 NOTE 6 - Remove and weight every six months

BOAT RECORD

The Boat Record is provided to record information about the yacht and its components. This record should be filled out by the selling Dealer at the time of delivery.

Owner's Name _____ Phone (____) _____

Address _____

Dealer _____ Phone (____) _____

Address _____

Boat Name _____ Hull Number* US STNE _____

Delivery Date ____/____/____ Registration Number _____

Length _____ Beam _____ Draft _____

Approximate Displacement _____ lbs.

Approximate Height Above Waterline _____

DOCKSIDE INFORMATION

Fuel Capacity _____ Fuel Type _____ Fuel Filter _____

Engine Oil Type _____ Oil Filter _____

Generator Oil Type _____ Oil Filter _____

Transmission Oil Type _____ Oil Filter _____

ENGINE AND TRANSMISSION

Engine Manufacturer _____ Model _____

Engine Serial Number: Port _____ Stbd. _____

Transmission Manufacturer _____ Model _____

Transmission Serial Number: Port _____ Stbd. _____

GENERATOR

Manufacturer _____ Model No. _____ Serial No. _____

PROPELLER AND SHAFTS

Propeller Manufacturer _____ Model _____

No. Blades _____ Bore _____ Diameter _____ Pitch _____ Cupped _____

Shaft Length _____ Diameter _____

BATTERIES

Battery Manufacturer _____ Model _____

Rating: Engine _____ Generator _____

* The Hull Identification Number is located on the outside of the transom, on the starboard side, upper corner.

Note: The following is provided for your use in recording electronic equipment which you may add to your yacht. All equipment should be recorded so that the information is available in case of repair or for any insurance claim.

Electronic Equipment

Item: _____

Manufacturer _____ Model no. _____ Serial no. _____

Item: _____

Manufacturer _____ Model no. _____ Serial no. _____

Item: _____

Manufacturer _____ Model no. _____ Serial no. _____

Item: _____

Manufacturer _____ Model no. _____ Serial no. _____

Item: _____

Manufacturer _____ Model no. _____ Serial no. _____

Item: _____

Manufacturer _____ Model no. _____ Serial no. _____

Item: _____

Manufacturer _____ Model no. _____ Serial no. _____

Item: _____

Manufacturer _____ Model no. _____ Serial no. _____

Item: _____

Manufacturer _____ Model no. _____ Serial no. _____

Item: _____

Manufacturer _____ Model no. _____ Serial no. _____

Item: _____

Manufacturer _____ Model no. _____ Serial no. _____

DECEASED (IF MORE THAN 2 FATALITIES, ATTACH ADDITIONAL FORMS)			
NAME OF VICTIM		ADDRESS OF VICTIM	
DATE OF BIRTH [] MALE [] FEMALE		DEATH CAUSED BY [] DROWNING [] OTHER [] DISAPPEARANCE	
NAME OF VICTIM		ADDRESS OF VICTIM	
DATE OF BIRTH [] MALE [] FEMALE		DEATH CAUSED BY [] DROWNING [] OTHER [] DISAPPEARANCE	
INJURED (IF MORE THAN 2 INJURIES, ATTACH ADDITIONAL FORMS)			
NAME OF VICTIM		ADDRESS OF VICTIM	
DATE OF BIRTH	MEDICAL TREATMENT BEYOND FIRST AID? [] YES [] NO	DESCRIBE INJURY	
	ADMITTED TO HOSPITAL? [] YES [] NO		
WAS PFD WORN? [] YES [] NO	PRIOR TO ACCIDENT? [] YES [] NO	AS A RESULT OF ACCIDENT? [] YES [] NO	
WAS IT INFLATABLE? [] YES [] NO			
NAME OF VICTIM		ADDRESS OF VICTIM	
DATE OF BIRTH	MEDICAL TREATMENT BEYOND FIRST AID? [] YES [] NO	DESCRIBE INJURY	
	ADMITTED TO HOSPITAL? [] YES [] NO		
WAS PFD WORN? [] YES [] NO	PRIOR TO ACCIDENT? [] YES [] NO	AS A RESULT OF ACCIDENT? [] YES [] NO	
WAS IT INFLATABLE? [] YES [] NO			
OTHER PEOPLE ABOARD THIS BOAT (IF MORE THAN 2 PEOPLE, ATTACH ADDITIONAL FORMS)			
NAME		ADDRESS	
DATE OF BIRTH	WAS PFD WORN? [] YES [] NO	PRIOR TO ACCIDENT? [] YES [] NO	
	AS A RESULT OF ACCIDENT [] YES [] NO	WAS IT INFLATABLE? [] YES [] NO	
NAME		ADDRESS	
DATE OF BIRTH	WAS PFD WORN? [] YES [] NO	PRIOR TO ACCIDENT? [] YES [] NO	
	AS A RESULT OF ACCIDENT [] YES [] NO	WAS IT INFLATABLE? [] YES [] NO	
BOAT NO. 2 (IF MORE THAN 2 VESSELS, ATTACH ADDITIONAL IDENTIFYING INFORMATION)			
NAME OF OPERATOR		OPERATOR ADDRESS	
OPERATOR TELEPHONE NUMBER ()		BOAT REGISTRATION OR DOCUMENTATION NUMBER	STATE
NAME OF OWNER		OWNER ADDRESS	
OWNER TELEPHONE NUMBER ()			
PROPERTY DAMAGE			
ESTIMATED AMOUNT: THIS BOAT AND CONTENTS: \$		OTHER BOAT(S) AND CONTENTS: \$	OTHER PROPERTY: \$
DESCRIBE PROPERTY DAMAGED			
WITNESSES NOT ON THIS VESSEL			
NAME	ADDRESS	TELEPHONE NUMBER ()	
NAME	ADDRESS	TELEPHONE NUMBER ()	
PERSON COMPLETING REPORT			
NAME	ADDRESS	TELEPHONE NUMBER ()	
SIGNATURE	QUALIFICATION [] OPERATOR [] OWNER [] INVESTIGATOR [] OTHER	DATE SUBMITTED	
FOR AGENCY USE ONLY			
CAUSES BASED ON (CHECK ONE): [] THIS REPORT [] INVESTIGATION [] INVESTIGATION AND THIS REPORT [] OTHER			
NAME OF REVIEWING OFFICE	DATE RECEIVED	RECREATIONAL [] COMMERCIAL []	NON-REPORTABLE []
PRIMARY CAUSE	SECONDARY CAUSE		

ACCIDENT DESCRIPTION

DESCRIBE WHAT HAPPENED (SEQUENCE OF EVENTS. INCLUDE FAILURE OF EQUIPMENT. INCLUDE A DIAGRAM IF NEEDED. CONTINUE ON ADDITIONAL SHEETS IF NECESSARY. INCLUDE ANY INFORMATION REGARDING THE INVOLVEMENT OF ALCOHOL AN/OR DRUGS IN CAUSING OR CONTRIBUTING TO THE ACCIDENT. INCLUDE ANY DESCRIPTIVE INFORMATION ABOUT THE USE OF PFD'S.)

An agency may not conduct or sponsor and a person is not required to respond to an information collection, unless it displays a currently valid OMB Control Number. The Coast Guard estimates that the average burden for this report form is 30 minutes. You may submit any comments concerning the accuracy of this burden estimate or any suggestions for reducing the burden to: Commandant (G-OPB-1), U.S. Coast Guard, Washington, DC 20593-0001 or Office of Management and Budget, Paperwork Reduction Project (2115-0010), Washington, DC 20503.

Float Plan

Complete this form before going boating and leave it with a reliable person who can be depended upon to notify the Coast Guard or other rescue organization, should you not return as scheduled.

Do not file this plan with the Coast Guard.

1. Person Report Overdue

Name Phone
Address

2. Description of Boat

Registration/ Documentation No.
Length Make Type
Hull Color Trim Color
Fuel Capacity Engine Type No. of Engines
Distinguishing Features

3. Operator of Boat

Name Age
Health Phone
Address

Operator's Experience

4. Survival Equipment (Check as Appropriate)

PFDs Flares Mirrors
 Smoke Signals Flashlights Food
 Paddles Water Anchor
 Raft or Dinghy EPIRB
 Other

5. Marine Radio

Yes No
Type Freqs.

6. Trip Expectations

Depart from

Departure Date Time

Going to

Arrival Date Time

If operator has not arrived/returned by: Date Time

8. Persons on Board

Name	Age	Phone	Medical Conditions
<input type="text"/>	<input type="text"/>	<input type="text"/>	<input type="text"/>
<input type="text"/>	<input type="text"/>	<input type="text"/>	<input type="text"/>
<input type="text"/>	<input type="text"/>	<input type="text"/>	<input type="text"/>
<input type="text"/>	<input type="text"/>	<input type="text"/>	<input type="text"/>
<input type="text"/>	<input type="text"/>	<input type="text"/>	<input type="text"/>
<input type="text"/>	<input type="text"/>	<input type="text"/>	<input type="text"/>

call the Coast Guard or Local authority at the following number:

7. Vehicle Description

License No. Make

Model Color

Where is vehicle parked?

9. Remarks

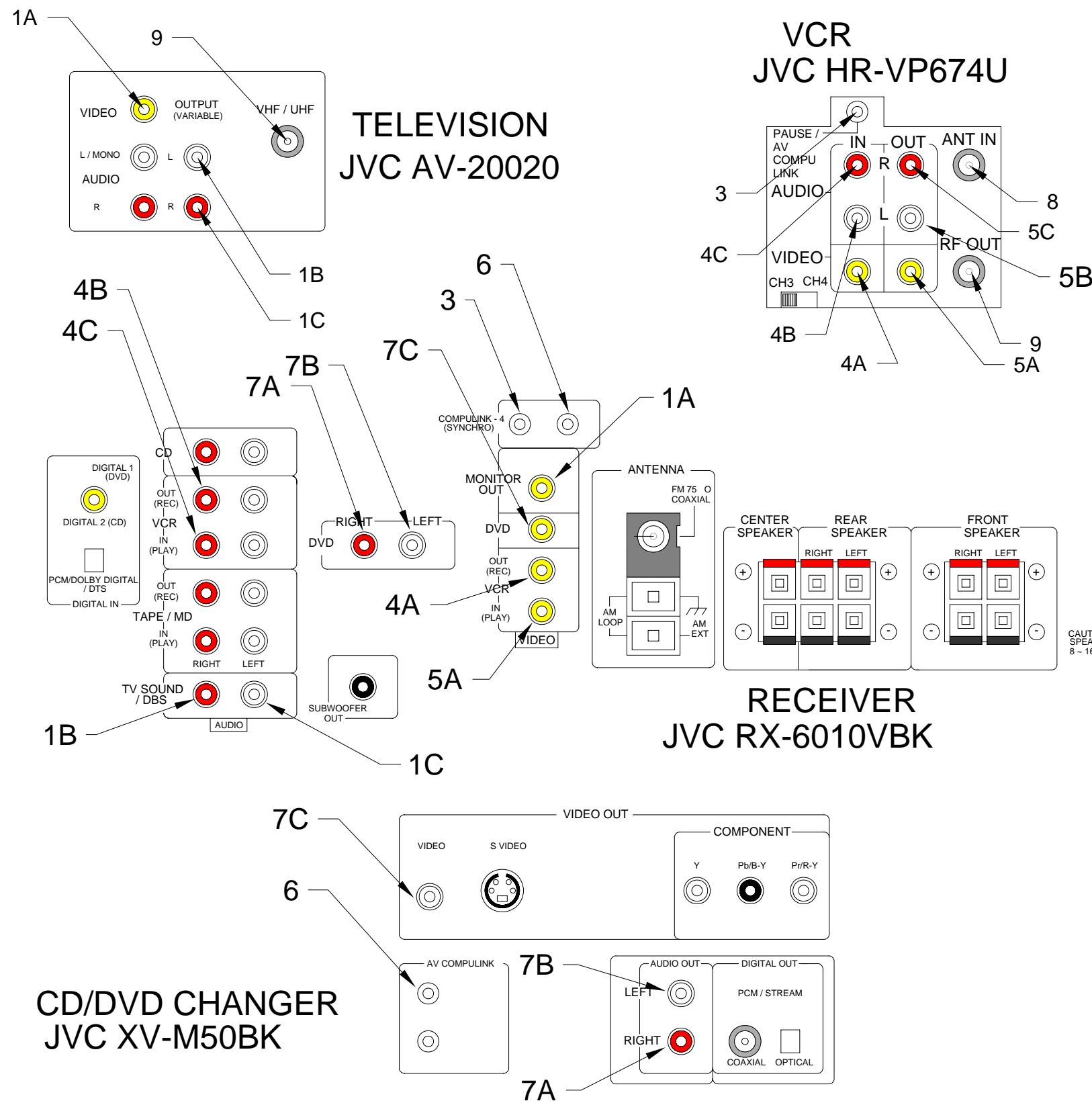

RECEIVER TO TELEVISION CONNECTIONS

WIRE NO.	CABLE TYPE	FROM RECEIVER	TO TELEVISION
1A		MONITOR OUT	VIDEO INPUT
1B	AUDIO VIDEO CABLE SET	TV SOUND LEFT	AUDIO OUT LEFT
1C		TV SOUND RIGHT	AUDIO OUT RIGHT

RECEIVER TO VCR CONNECTIONS

WIRE NO.	CABLE TYPE	FROM RECEIVER	TO VCR
3	AV COMPULINK CABLE	AV COMPULINK (TOP SOCKET ONLY)	PAUSE / AV COMPULINK
4A	AUDIO VIDEO CABLE SET	VCR VIDEO OUT	VIDEO IN
4B		VCR, OUT (REC), LEFT	AUDIO IN LEFT
4C		VCR, OUT (REC), RIGHT	AUDIO IN RIGHT
5A	AUDIO VIDEO CABLE SET	VCR VIDEO IN	VIDEO OUT
5B		VCR, IN (PLAY), LEFT	AUDIO OUT LEFT
5C		VCR, IN (PLAY), RIGHT	AUDIO OUT RIGHT

RECEIVER TO DVD CHANGER CONNECTIONS

WIRE NO.	CABLE TYPE	FROM RECEIVER	TO DVD CHANGER
6	AV COMPULINK CABLE	COMPULINK-3(SYNCHRO) (LEFT SOCKET ONLY)	COMPULINK-3(SYNCHRO) (BOTTOM SOCKET ONLY)
7A	AUDIO VIDEO CABLE SET	CD LEFT	LEFT
7B		CD RIGHT	RIGHT
7C		DVD VIDEO	DVD VIDEO

CABLE TV CABLE CONNECTIONS

WIRE NO.	CABLE TYPE	FROM	TO
8	COAXIAL TV CABLE	CABLE SOURCE	VCR ANT. IN
9	COAXIAL TV CABLE	VCR RF OUT	TV 75 OHM VHF / UHF

CAUTION: SPEAKER IMPEDANCE 8 - 16 OHM

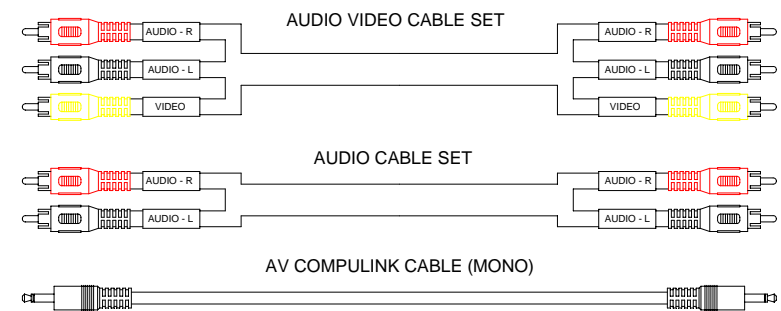

20" STEREO TV
JVC COMPONENT CONNECTIONS

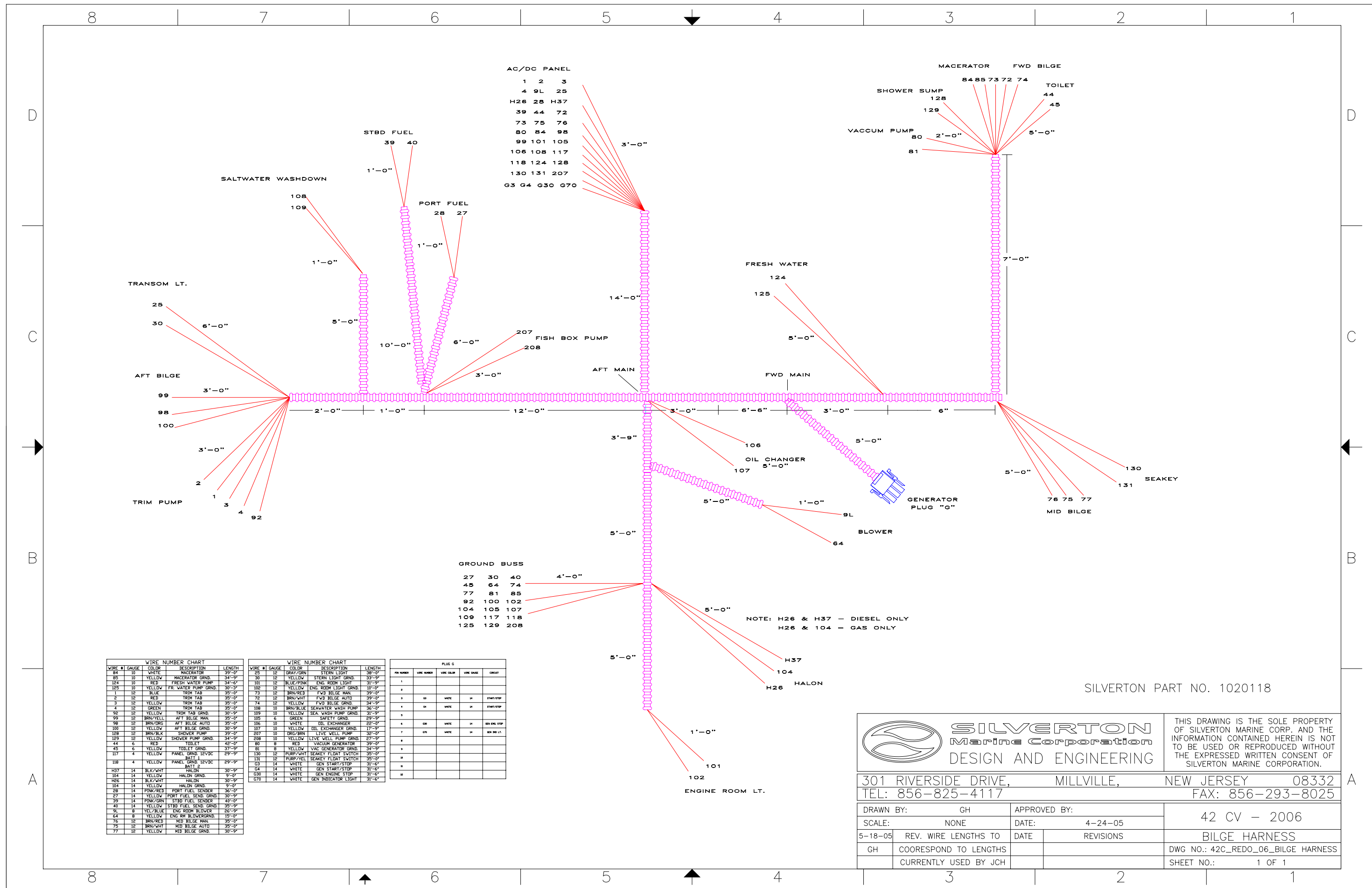

AC/DC PANEL

1	2	3	
4	9L	25	
H26	28	H37	
39	44	72	
73	75	76	
80	84	98	
99	101	105	
106	108	117	
118	124	128	
130	131	207	
G3	G4	G30	G70

GROUND BUSS

27	30	40
45	64	74
77	81	85
92	100	102
104	105	107
109	117	118
125	129	208

WIRE NUMBER CHART

WIRE #	GAUGE	COLOR	DESCRIPTION	LENGTH
84	10	WHITE	MACERATOR	39'-0"
85	10	YELLOW	MACERATOR GRND.	34'-9"
124	10	RED	FRESH WATER PUMP	34'-6"
125	10	YELLOW	FR. WATER PUMP GRND.	30'-3"
1	12	BLUE	TRIM TAB	35'-0"
2	12	RED	TRIM TAB	35'-0"
3	12	YELLOW	TRIM TAB	35'-0"
4	12	GREEN	TRIM TAB	35'-0"
98	12	YELLOW	TRIM TAB GRND.	30'-9"
99	12	BRN/YELL	AFT BILGE MAN.	35'-0"
98	12	BRN/ORG	AFT BILGE AUTO	35'-0"
100	12	YELLOW	AFT BILGE GRND.	30'-9"
128	12	BRN/BLK	SHOWER PUMP	39'-0"
129	12	YELLOW	SHOWER PUMP GRND.	34'-9"
44	6	RED	TOILET	42'-0"
45	6	YELLOW	TOILET GRND.	37'-9"
107	4	YELLOW	PANEL GRND. 12VDC	29'-9"
108	4	YELLOW	PANEL GRND. 12VDC	29'-9"
109	4	YELLOW	PANEL GRND. 12VDC	29'-9"
104	14	BLK/WHI	HALON	30'-9"
104	14	YELLOW	HALON GRND.	9'-0"
104	14	YELLOW	HALON GRND.	9'-0"
104	14	YELLOW	HALON GRND.	9'-0"
28	14	PINK/RED	PORT FUEL SENDER	36'-0"
27	14	YELLOW	PORT FUEL SEND. GRND.	30'-9"
39	14	PINK/GRN	STBD FUEL SENDER	46'-0"
40	14	YELLOW	STBD FUEL SEND. GRND.	35'-9"
9L	8	YELLOW/BLU	ENG ROOM BLOWER	86'-9"
64	8	YELLOW	ENG RM BLOWER GRND.	15'-0"
76	12	BRN/RED	MID BILGE MAN.	35'-0"
75	12	BRN/WHI	MID BILGE AUTO	35'-0"
77	12	YELLOW	MID BILGE GRND.	30'-9"

WIRE NUMBER CHART

WIRE #	GAUGE	COLOR	DESCRIPTION	LENGTH
25	12	GRAY/GRN	STERN LIGHT	38'-0"
30	12	YELLOW	STERN LIGHT GRND.	39'-9"
101	12	BLUE/PNK	ENG ROOM LIGHT	35'-9"
102	12	YELLOW	ENG ROOM LIGHT GRND.	10'-0"
73	12	BRN/RED	FWD BILGE MAN.	39'-0"
72	12	BRN/WHI	FWD BILGE AUTO	39'-0"
74	12	YELLOW	FWD BILGE GRND.	34'-9"
108	10	BRN/BLU	SEAWATER WASH PUMP	36'-0"
109	10	YELLOW	SEA. WASH PUMP GRND.	31'-9"
105	6	GREEN	SAFETY GRND.	29'-9"
106	10	WHITE	DIL. EXCHANGER	22'-0"
107	10	YELLOW	DIL. EXCHANGER GRND.	17'-9"
207	10	DRG/BRN	LIVE WELL PUMP	32'-0"
108	10	YELLOW	LIVE WELL PUMP GRND.	27'-9"
80	8	RED	VACUUM GENERATOR	39'-0"
81	8	YELLOW	VAC. GENERATOR GRND.	34'-9"
130	12	PURP/WHI	SEAKY FLDAT SWITCH	35'-0"
131	12	PURP/YEL	SEAKY FLDAT SWITCH	35'-0"
G3	14	WHITE	GEN START/STOP	31'-6"
G4	14	WHITE	GEN START/STOP	31'-6"
G30	14	WHITE	GEN ENGINE STOP	31'-6"
G70	14	WHITE	GEN INDICATOR LIGHT	31'-6"

PLUG G

PLUG NUMBER	WIRE NUMBER	WIRE COLOR	WIRE GAUGE	CIRCUIT
1				
2				
3	84	WHITE	14	START/STOP
4	84	WHITE	14	START/STOP
5				
6	64	WHITE	14	GEN ENG STOP
7	64	WHITE	14	GEN ENG STOP
8				
9				
10				
11				
12				



THIS DRAWING IS THE SOLE PROPERTY OF SILVERTON MARINE CORP. AND THE INFORMATION CONTAINED HEREIN IS NOT TO BE USED OR REPRODUCED WITHOUT THE EXPRESSED WRITTEN CONSENT OF SILVERTON MARINE CORPORATION.

301 RIVERSIDE DRIVE, MILLVILLE, NEW JERSEY 08332
 TEL: 856-825-4117 FAX: 856-293-8025

DRAWN BY:	GH	APPROVED BY:	
SCALE:	NONE	DATE:	4-24-05
5-18-05	REV. WIRE LENGTHS TO	DATE	REVISIONS
GH	COORESPOND TO LENGTHS		
	CURRENTLY USED BY JCH		

42 CV - 2006
 BILGE HARNESS
 DWG NO.: 42C_REDO_06_BILGE HARNESS
 SHEET NO.: 1 OF 1

SILVERTON PART NO. 1020118

8 | 7 | 6 | 5 | 4 | 3 | 2 | 1

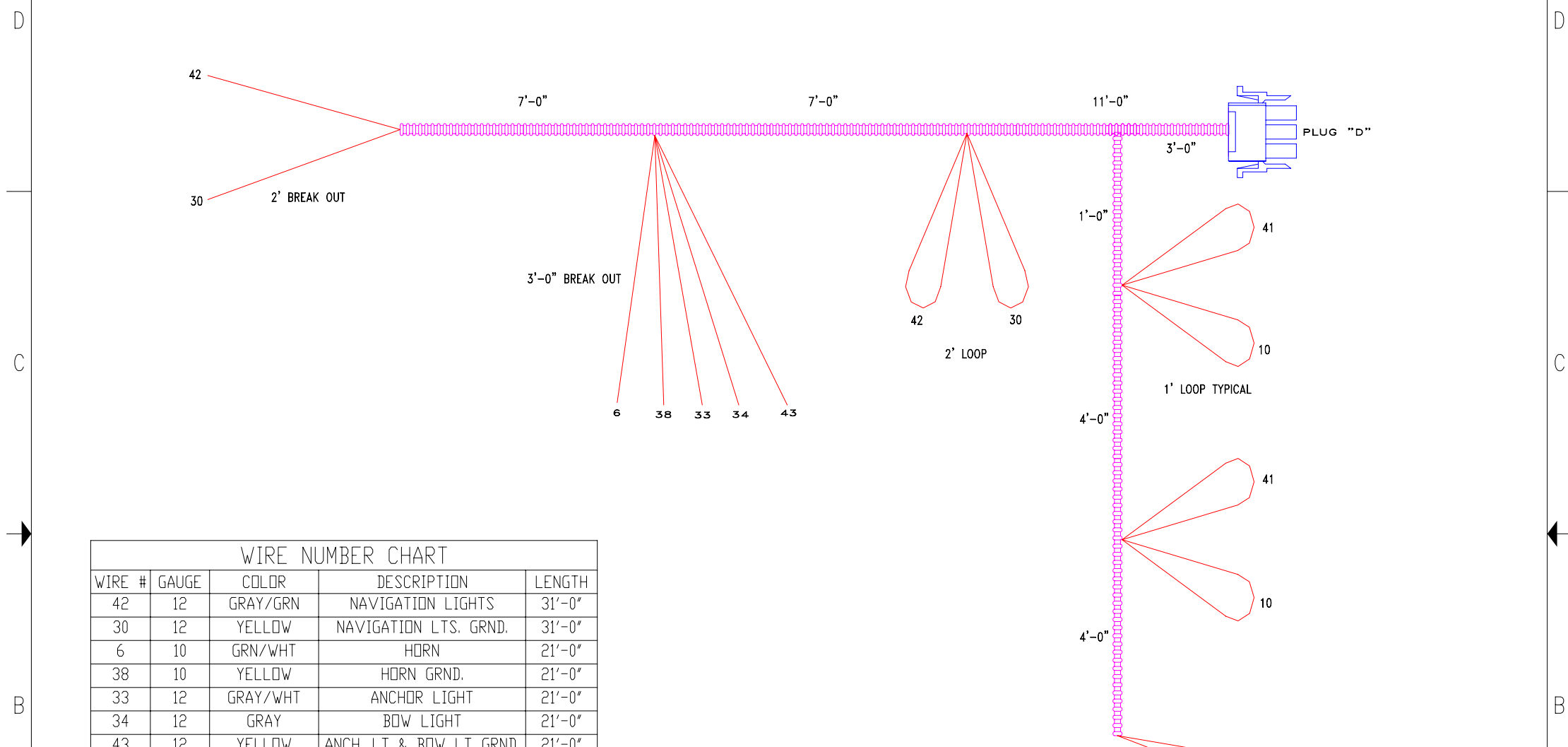

WIRE NUMBER CHART

WIRE #	GAUGE	COLOR	DESCRIPTION	LENGTH
42	12	GRAY/GRN	NAVIGATION LIGHTS	31'-0"
30	12	YELLOW	NAVIGATION LTS. GRND.	31'-0"
6	10	GRN/WHT	HORN	21'-0"
38	10	YELLOW	HORN GRND.	21'-0"
33	12	GRAY/WHT	ANCHOR LIGHT	21'-0"
34	12	GRAY	BOW LIGHT	21'-0"
43	12	YELLOW	ANCH. LT & BOW LT GRND.	21'-0"
41	12	YELLOW	COURTESY LIGHTS GRND.	17'-0"
10	12	BLUE/WHT	COURTESY LIGHTS	17'-0"

PLUG "D"

TERM #	WIRE #	GAUGE	COLOR	DESCRIPTION
1	42	12	GRAY/GRN	NAVIGATION LIGHTS
2	30	12	YELLOW	NAVIGATION LIGHTS GRND.
3	6	10	GRN/WHT	HORN
4	38	10	YELLOW	HORN GRND.
5	33	12	GRAY/WHT	ANCHOR LIGHT
6	34	12	GRAY	BOW LIGHT
7	43	12	YELLOW	ANCH. LT & BOW LT GRND.
8	41	12	YELLOW	COURTESY LIGHTS GRND.
9	10	12	BLUE/WHT	COURTESY LIGHTS

SILVERTON PART NO. 1020119



THIS DRAWING IS THE SOLE PROPERTY OF SILVERTON MARINE CORP. AND THE INFORMATION CONTAINED HEREIN IS NOT TO BE USED OR REPRODUCED WITHOUT THE EXPRESSED WRITTEN CONSENT OF SILVERTON MARINE CORPORATION.

301 RIVERSIDE DRIVE, MILLVILLE, NEW JERSEY 08332
 TEL: 609-825-4117 FAX: 609-293-8025

DRAWN BY:	GH	APPROVED BY:		42 CONVERTIBLE - 2006
SCALE:	NONE	DATE:	5-2-05	
DATE:	DISTRIBUTION	DATE:	REVISIONS	BRIDGE HARNESS
				DWG NO.: 42C_REDO_06_BRIDGE_HARNESS
				SHEET NO.: 1 OF 1

8 | 7 | 6 | 5 | 4 | 3 | 2 | 1

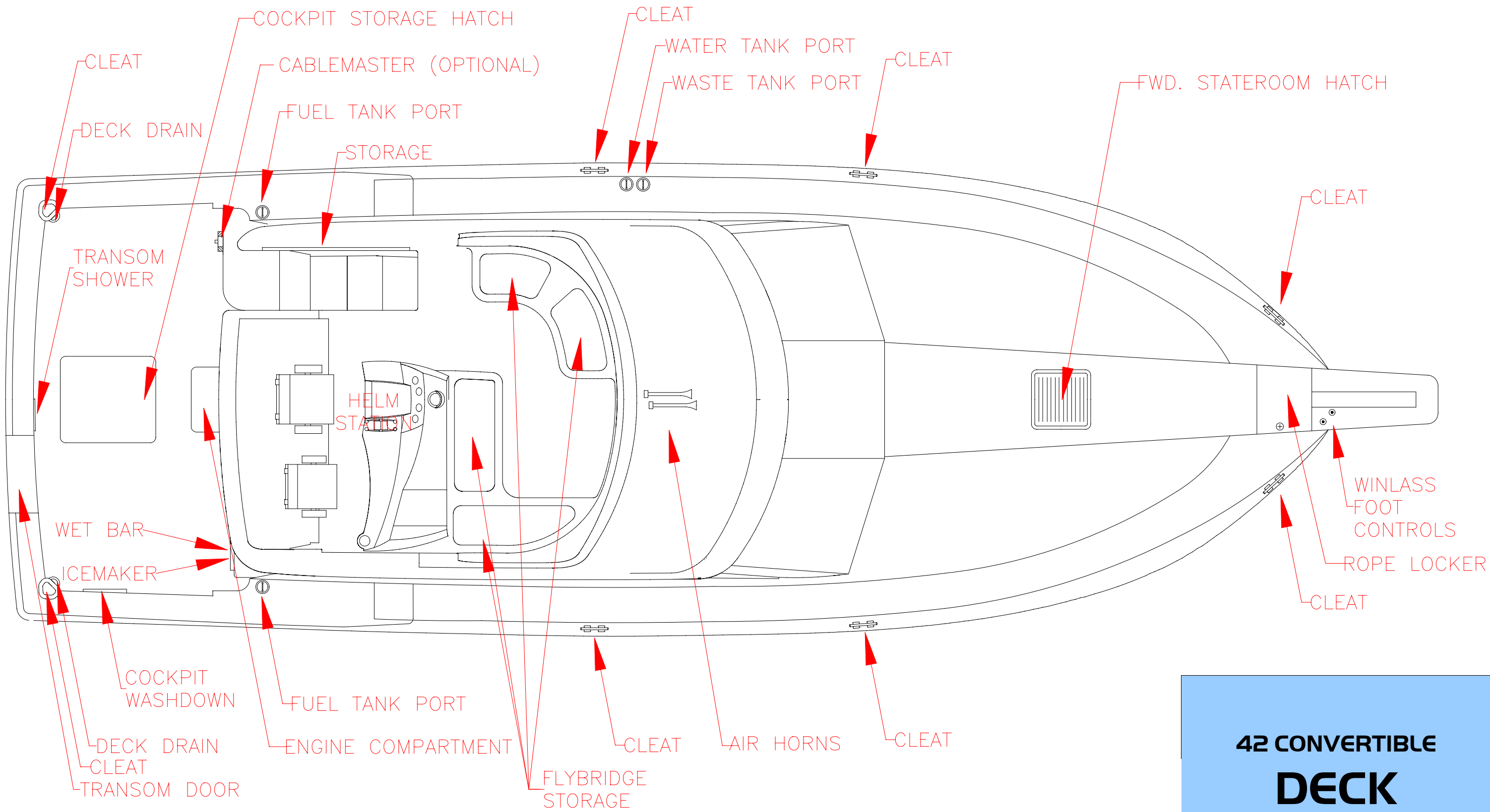

**42 CONVERTIBLE
DECK**

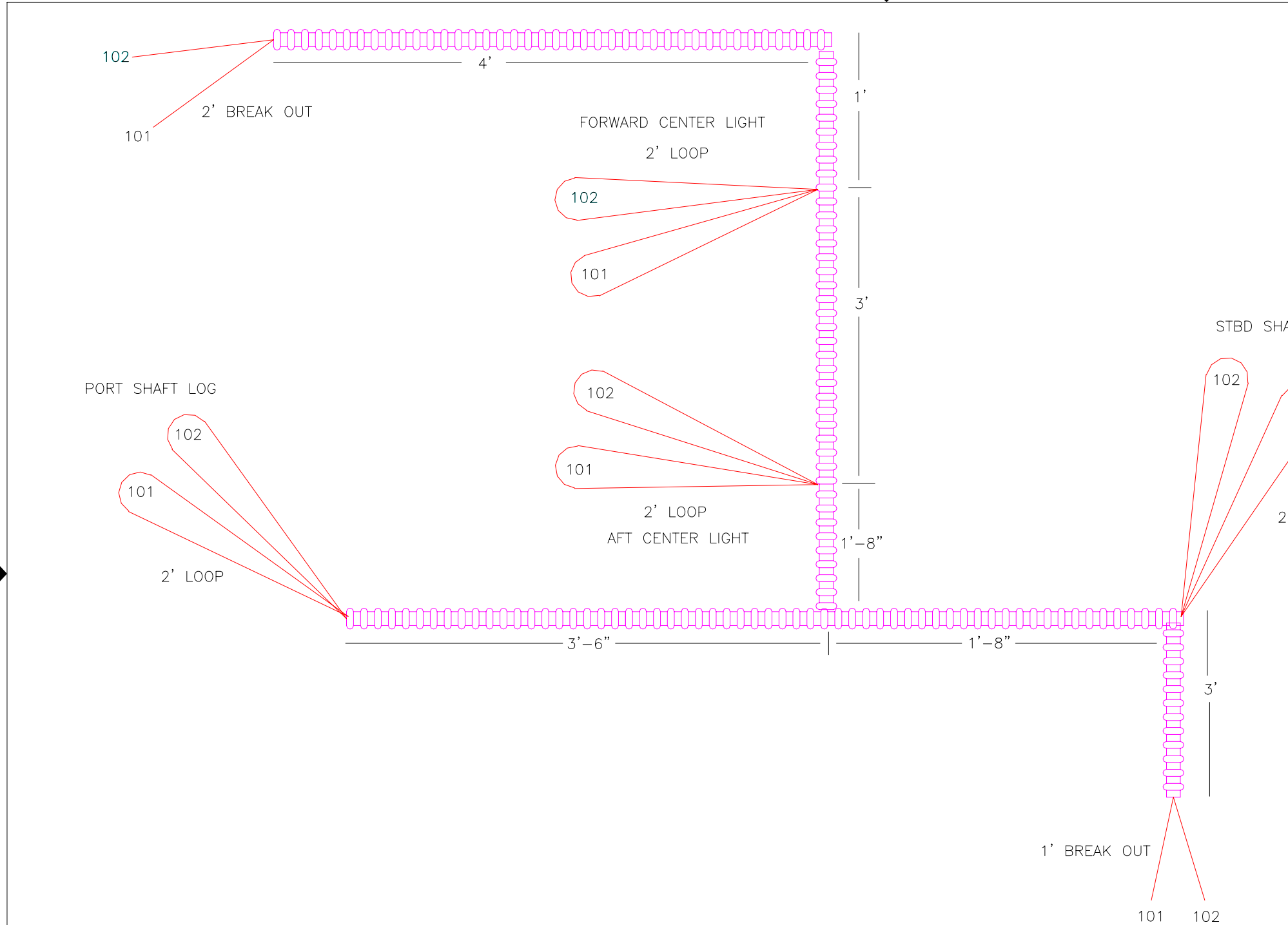

REVISIONS		
DATE	INIT.	DESCRIPTION

SILVERTON PART NO. 1020125

WIRE NUMBER CHART				
WIRE #	GAUGE	COLOR	DESCRIPTION	LENGTH
101	12	BLUE/PINK	ENGINE ROOM LIGHTS	40'-0"
102	12	YELLOW	ENG. ROOM LIGHTS GRND.	40'-0"

Silverton
Y A C H T

S. RACE & RIVERSIDE DR.
MILLVILLE N.J.
08332
609-825-4117
(FAX) 609-825-2898

42 CONVERTIBLE - 2006			
ENGINE ROOM LIGHT HARNESS			
SIZE	DWN BY	DWG NO.	REV
	GH	42C_REDO_06_ENG_ROOM_LIGHT_HARNESS	
SCALE	NONE	DATE:	4-24-05
SHEET		1 OF 1	

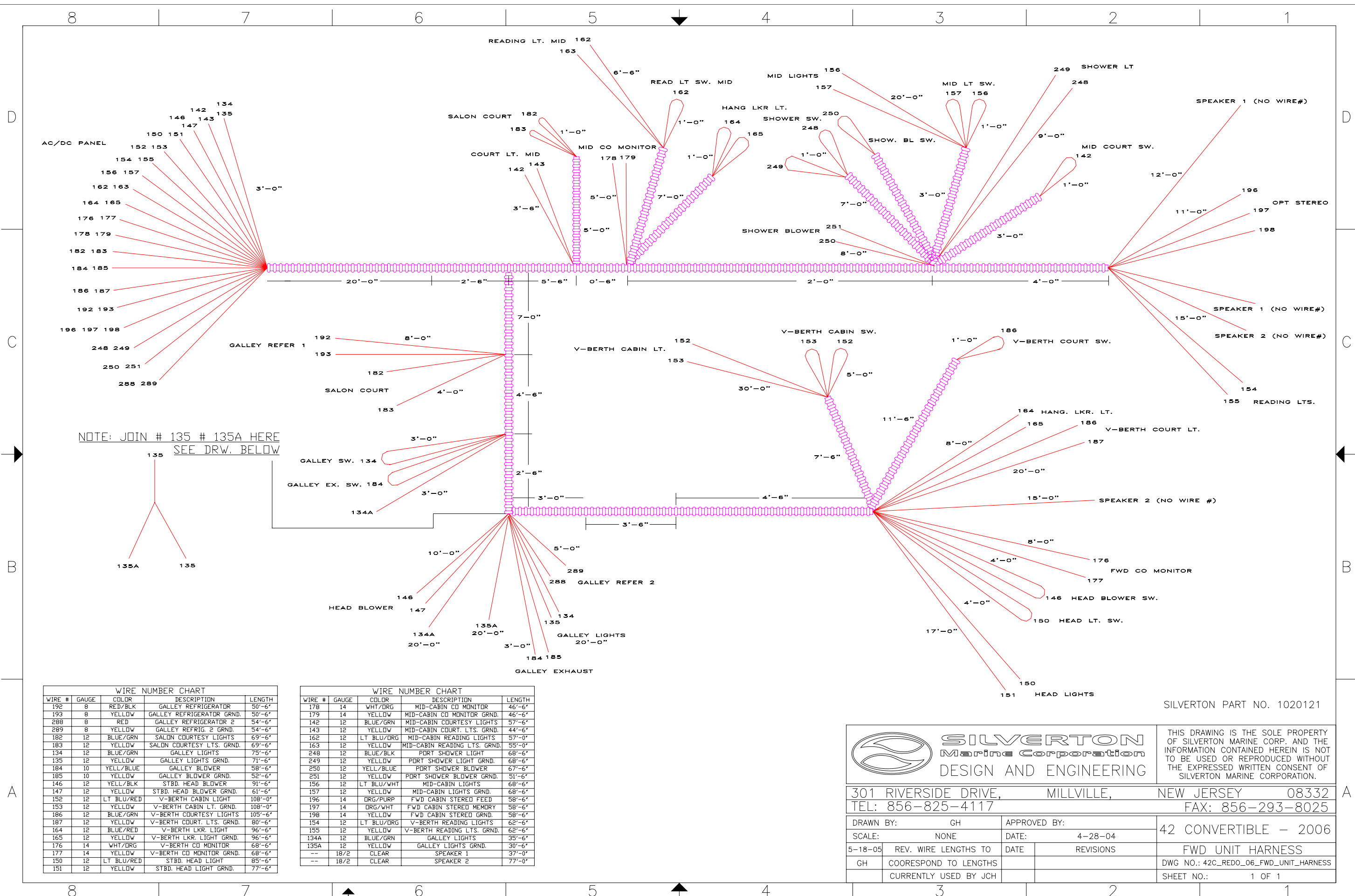

NOTE: JOIN # 135 # 135A HERE
SEE DRW. BELOW

WIRE #	GAUGE	COLOR	DESCRIPTION	LENGTH
192	8	RED/BLK	GALLEY REFRIGERATOR	50'-6"
193	8	YELLOW	GALLEY REFRIGERATOR GRND.	50'-6"
289	8	RED	GALLEY REFRIGERATOR 2	54'-6"
289	8	YELLOW	GALLEY REFRIG. 2 GRND.	54'-6"
182	12	BLUE/GRN	SALON COURTESY LIGHTS	69'-6"
183	12	YELLOW	SALON COURTESY LTS. GRND.	69'-6"
134	12	BLUE/GRN	GALLEY LIGHTS	75'-6"
135	12	YELLOW	GALLEY LIGHTS GRND.	75'-6"
184	10	YELL/BLUE	GALLEY BLOWER	58'-6"
185	10	YELLOW	GALLEY BLOWER GRND.	52'-6"
146	12	YELL/BLK	STBD. HEAD BLOWER	91'-6"
147	12	YELLOW	STBD. HEAD BLOWER GRND.	61'-6"
152	12	LT. BLU/RED	V-BERTH CABIN LIGHT	108'-0"
153	12	YELLOW	V-BERTH CABIN LT. GRND.	108'-0"
186	12	BLUE/GRN	V-BERTH COURTESY LIGHTS	105'-6"
187	12	YELLOW	V-BERTH COURT. LTS. GRND.	80'-6"
164	12	BLUE/RED	V-BERTH LKR. LIGHT	96'-6"
165	12	YELLOW	V-BERTH LKR. LIGHT GRND.	96'-6"
176	14	WHT/DRG	V-BERTH CO MONITOR	68'-6"
177	14	YELLOW	V-BERTH CO MONITOR GRND.	68'-6"
150	12	LT. BLU/RED	STBD. HEAD LIGHT	85'-6"
151	12	YELLOW	STBD. HEAD LIGHT GRND.	77'-6"

WIRE #	GAUGE	COLOR	DESCRIPTION	LENGTH
178	14	WHT/DRG	MID-CABIN CO MONITOR	46'-6"
179	14	YELLOW	MID-CABIN CO MONITOR GRND.	46'-6"
142	12	BLUE/GRN	MID-CABIN COURTESY LIGHTS	57'-6"
143	12	YELLOW	MID-CABIN COURT. LTS. GRND.	47'-6"
162	12	LT. BLU/DRG	MID-CABIN READING LIGHTS	55'-0"
163	12	YELLOW	MID-CABIN READING LTS. GRND.	58'-6"
248	12	BLUE/BLK	PORT SHOWER LIGHT	68'-6"
249	12	YELLOW	PORT SHOWER LIGHT GRND.	68'-6"
250	12	YELL/BLUE	PORT SHOWER BLOWER	67'-6"
251	12	YELLOW	PORT SHOWER BLOWER GRND.	51'-6"
156	12	LT. BLU/WHT	MID-CABIN LIGHTS	68'-6"
157	12	YELLOW	MID-CABIN LIGHTS GRND.	68'-6"
196	14	DRG/PURP	FWD CABIN STEREO FEED	58'-6"
197	14	DRG/WHT	FWD CABIN STEREO MEMORY	58'-6"
198	14	YELLOW	FWD CABIN STEREO LIGHTS	58'-6"
154	12	LT. BLU/DRG	V-BERTH READING LIGHTS	62'-6"
155	12	YELLOW	V-BERTH READING LTS. GRND.	62'-6"
134A	12	BLUE/GRN	GALLEY LIGHTS	35'-6"
135A	12	YELLOW	GALLEY LIGHTS GRND.	30'-6"
--	18/2	CLEAR	SPEAKER 1	37'-0"
--	18/2	CLEAR	SPEAKER 2	77'-0"

SILVERTON PART NO. 1020121



THIS DRAWING IS THE SOLE PROPERTY OF SILVERTON MARINE CORP. AND THE INFORMATION CONTAINED HEREIN IS NOT TO BE USED OR REPRODUCED WITHOUT THE EXPRESSED WRITTEN CONSENT OF SILVERTON MARINE CORPORATION.

301 RIVERSIDE DRIVE, MILLVILLE, NEW JERSEY 08332
TEL: 856-825-4117 FAX: 856-293-8025

DRAWN BY: GH	APPROVED BY:	42 CONVERTIBLE - 2006
SCALE: NONE	DATE: 4-28-04	DWG NO.: 42C_REDO_06_FWD_UNIT_HARNESS
5-18-05	REV. WIRE LENGTHS TO DATE	REVISIONS
GH	COORESPOND TO LENGTHS	
	CURRENTLY USED BY JCH	
		SHEET NO.: 1 OF 1

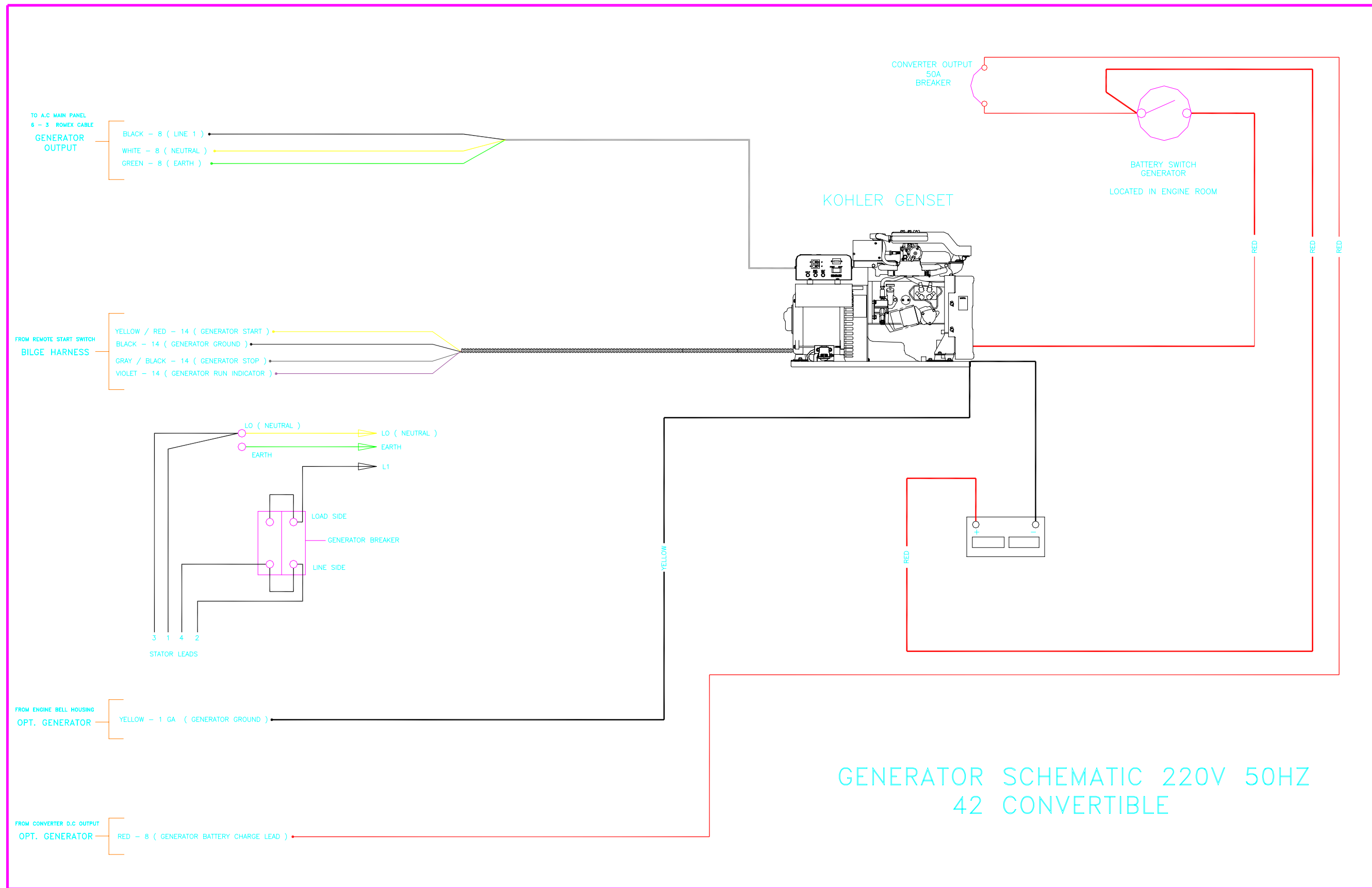

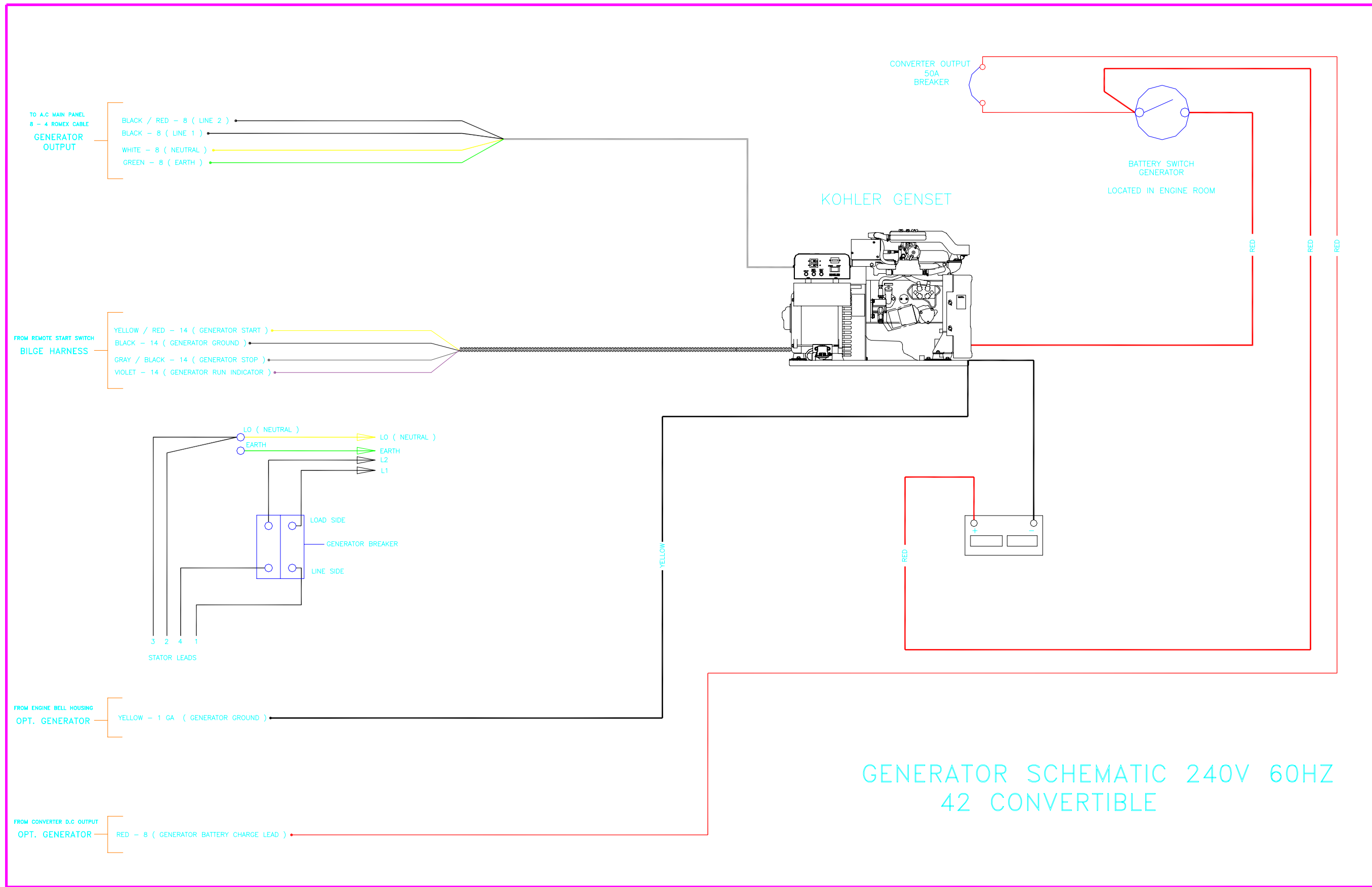

GENERATOR SCHEMATIC 240V 60HZ
42 CONVERTIBLE

PRINTED 2-6-03

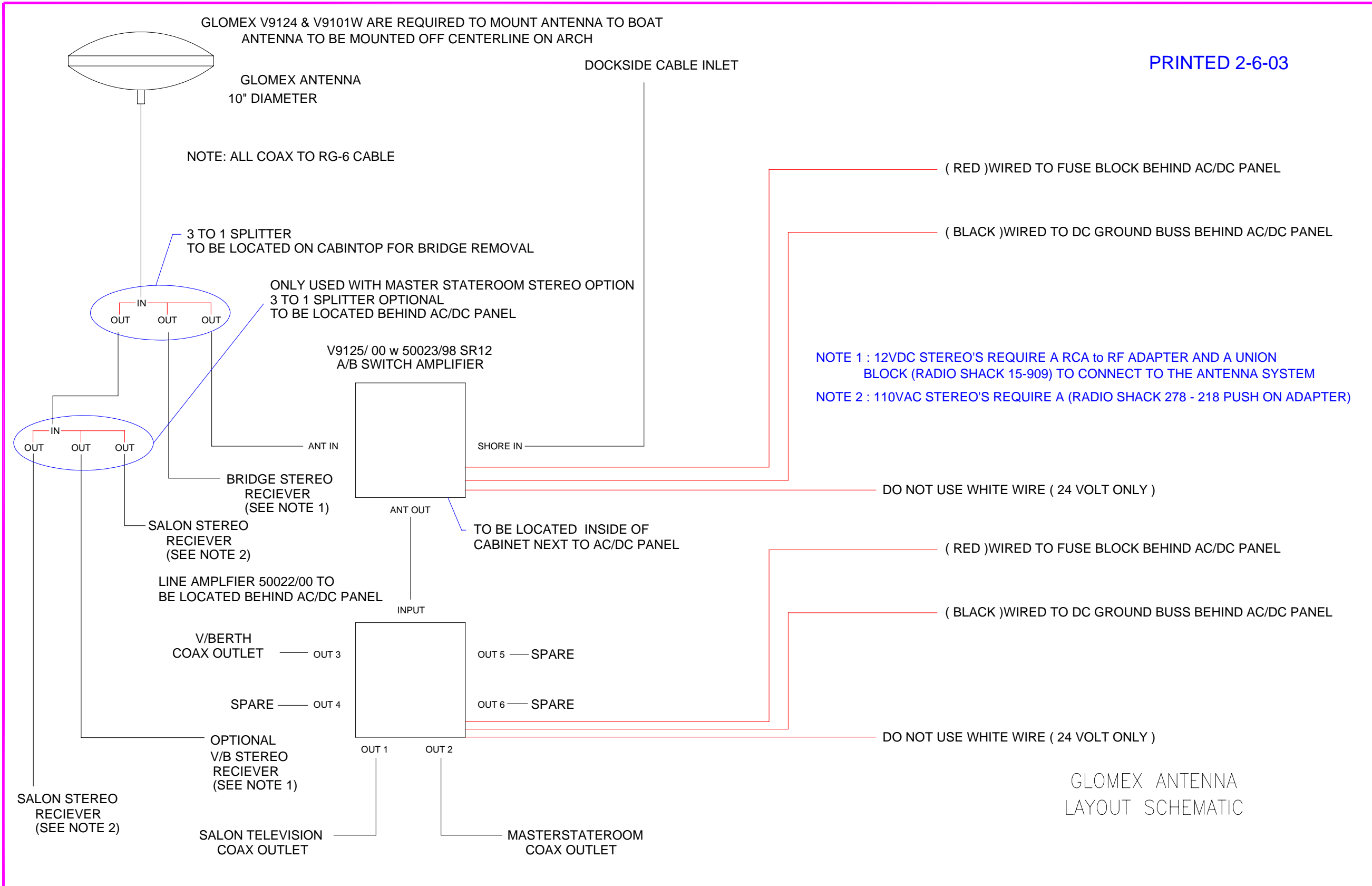

GLOMEX ANTENNA LAYOUT SCHEMATIC

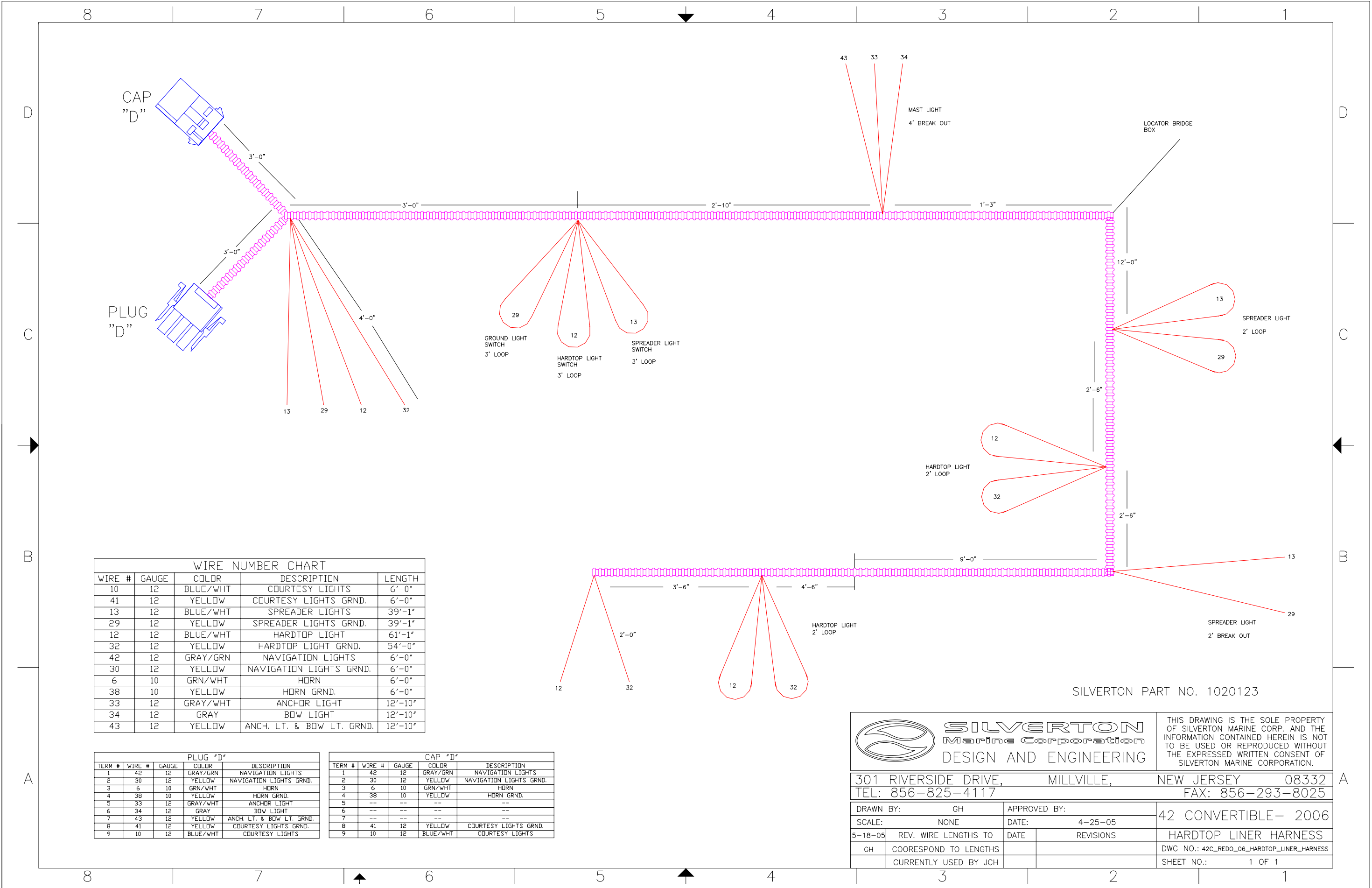

WIRE NUMBER CHART				
WIRE #	GAUGE	COLOR	DESCRIPTION	LENGTH
10	12	BLUE/WHT	COURTESY LIGHTS	6'-0"
41	12	YELLOW	COURTESY LIGHTS GRND.	6'-0"
13	12	BLUE/WHT	SPREADER LIGHTS	39'-1"
29	12	YELLOW	SPREADER LIGHTS GRND.	39'-1"
12	12	BLUE/WHT	HARDTOP LIGHT	61'-1"
32	12	YELLOW	HARDTOP LIGHT GRND.	54'-0"
42	12	GRAY/GRN	NAVIGATION LIGHTS	6'-0"
30	12	YELLOW	NAVIGATION LIGHTS GRND.	6'-0"
6	10	GRN/WHT	HORN	6'-0"
38	10	YELLOW	HORN GRND.	6'-0"
33	12	GRAY/WHT	ANCHOR LIGHT	12'-10"
34	12	GRAY	BOW LIGHT	12'-10"
43	12	YELLOW	ANCH. LT. & BOW LT. GRND.	12'-10"

PLUG "D"				
TERM #	WIRE #	GAUGE	COLOR	DESCRIPTION
1	42	12	GRAY/GRN	NAVIGATION LIGHTS
2	30	12	YELLOW	NAVIGATION LIGHTS GRND.
3	6	10	GRN/WHT	HORN
4	38	10	YELLOW	HORN GRND.
5	33	12	GRAY/WHT	ANCHOR LIGHT
6	34	12	GRAY	BOW LIGHT
7	43	12	YELLOW	ANCH. LT. & BOW LT. GRND.
8	41	12	YELLOW	COURTESY LIGHTS GRND.
9	10	12	BLUE/WHT	COURTESY LIGHTS

CAP "D"				
TERM #	WIRE #	GAUGE	COLOR	DESCRIPTION
1	42	12	GRAY/GRN	NAVIGATION LIGHTS
2	30	12	YELLOW	NAVIGATION LIGHTS GRND.
3	6	10	GRN/WHT	HORN
4	38	10	YELLOW	HORN GRND.
5	--	--	--	--
6	--	--	--	--
7	--	--	--	--
8	41	12	YELLOW	COURTESY LIGHTS GRND.
9	10	12	BLUE/WHT	COURTESY LIGHTS



THIS DRAWING IS THE SOLE PROPERTY OF SILVERTON MARINE CORP. AND THE INFORMATION CONTAINED HEREIN IS NOT TO BE USED OR REPRODUCED WITHOUT THE EXPRESSED WRITTEN CONSENT OF SILVERTON MARINE CORPORATION.

301 RIVERSIDE DRIVE, MILLVILLE, NEW JERSEY 08332
 TEL: 856-825-4117 FAX: 856-293-8025

DRAWN BY: GH	APPROVED BY:	42 CONVERTIBLE - 2006	
SCALE: NONE	DATE: 4-25-05	HARDTOP LINER HARNESS	
5-18-05	REV. WIRE LENGTHS TO	DATE	REVISIONS
GH	COORESPOND TO LENGTHS		DWG NO.: 42C_REDO_06_HARDTOP_LINER_HARNESS
	CURRENTLY USED BY JCH		SHEET NO.: 1 OF 1

SILVERTON PART NO. 1020123

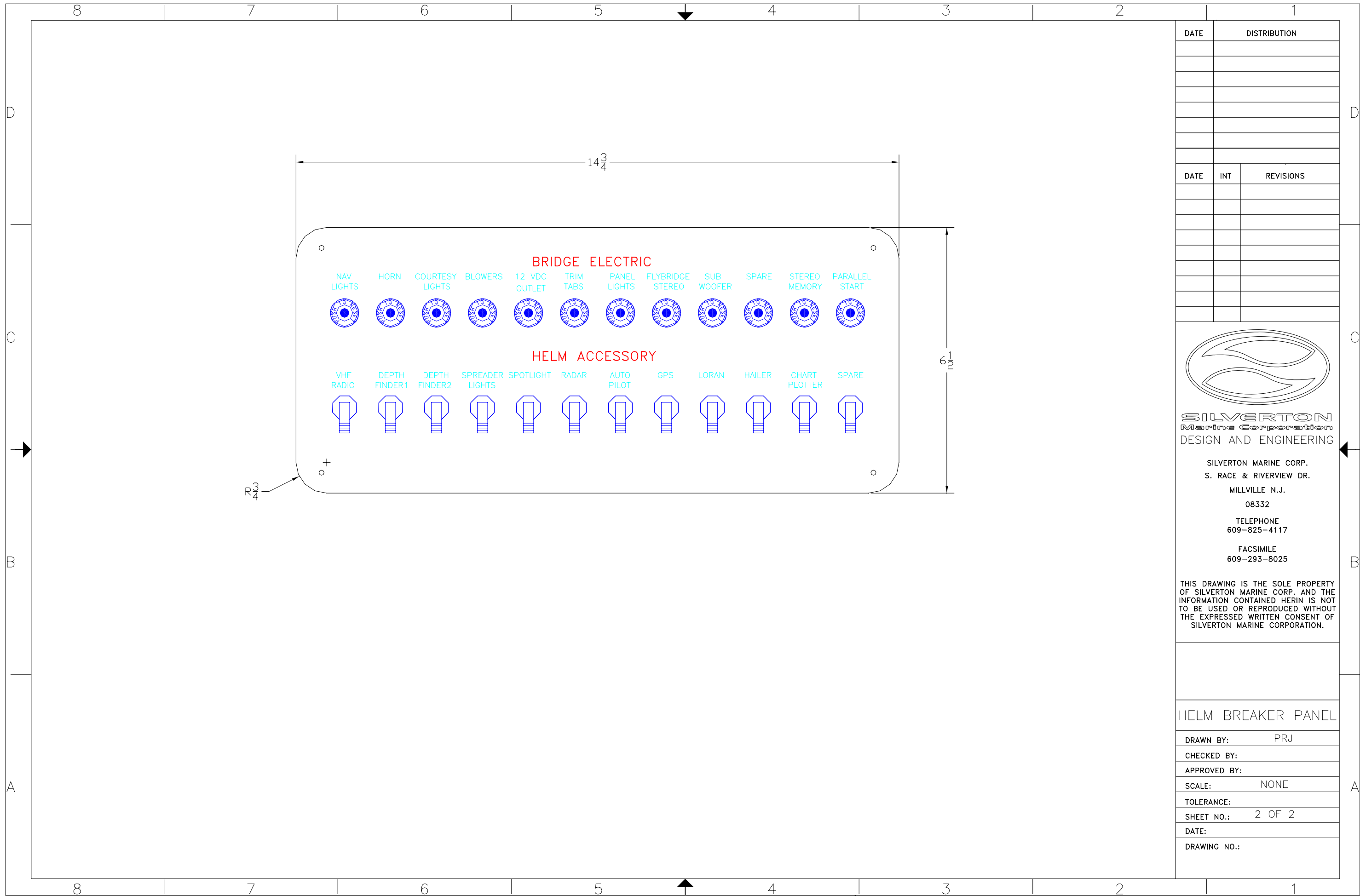

DATE	DISTRIBUTION

DATE	INT	REVISIONS

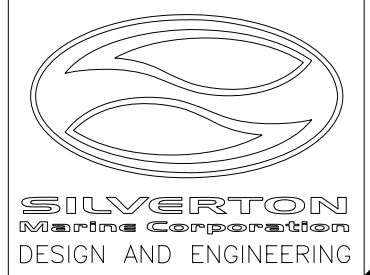

SILVERTON MARINE CORP.
S. RACE & RIVERVIEW DR.
MILLVILLE N.J.
08332
TELEPHONE
609-825-4117
FACSIMILE
609-293-8025

THIS DRAWING IS THE SOLE PROPERTY OF SILVERTON MARINE CORP. AND THE INFORMATION CONTAINED HEREIN IS NOT TO BE USED OR REPRODUCED WITHOUT THE EXPRESSED WRITTEN CONSENT OF SILVERTON MARINE CORPORATION.

HELM BREAKER PANEL	
DRAWN BY:	PRJ
CHECKED BY:	
APPROVED BY:	
SCALE:	NONE
TOLERANCE:	
SHEET NO.:	2 OF 2
DATE:	
DRAWING NO.:	

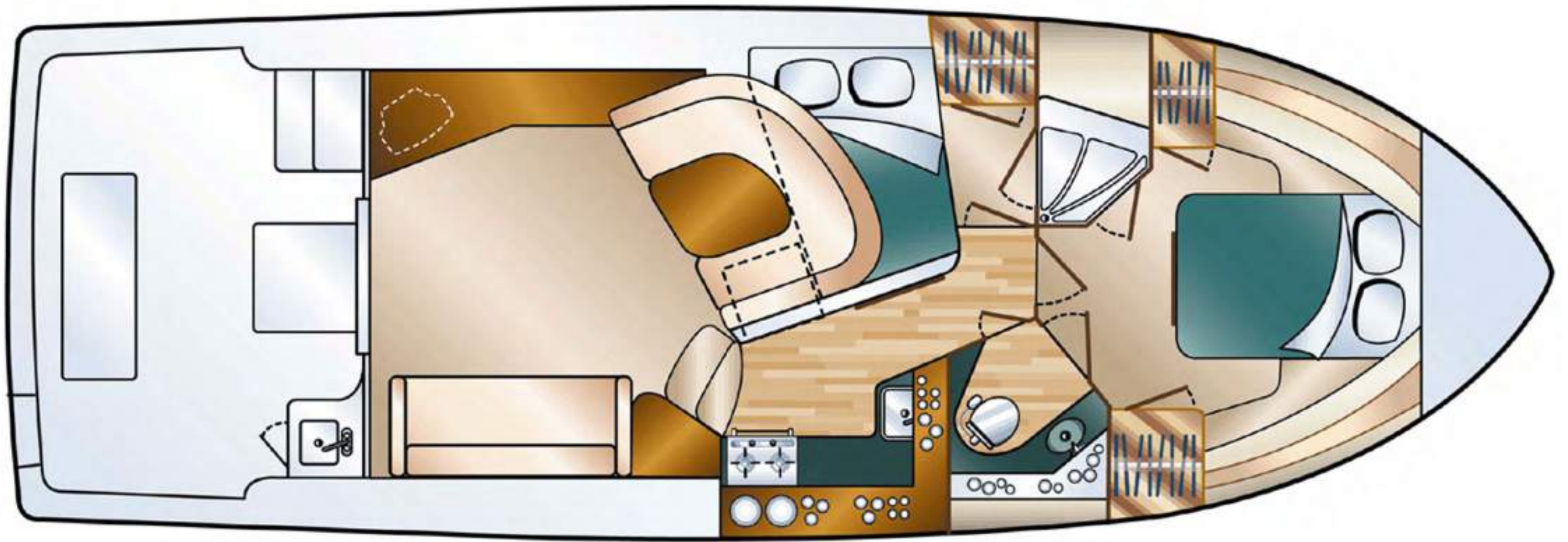

42 CONVERTIBLE
INTERIOR

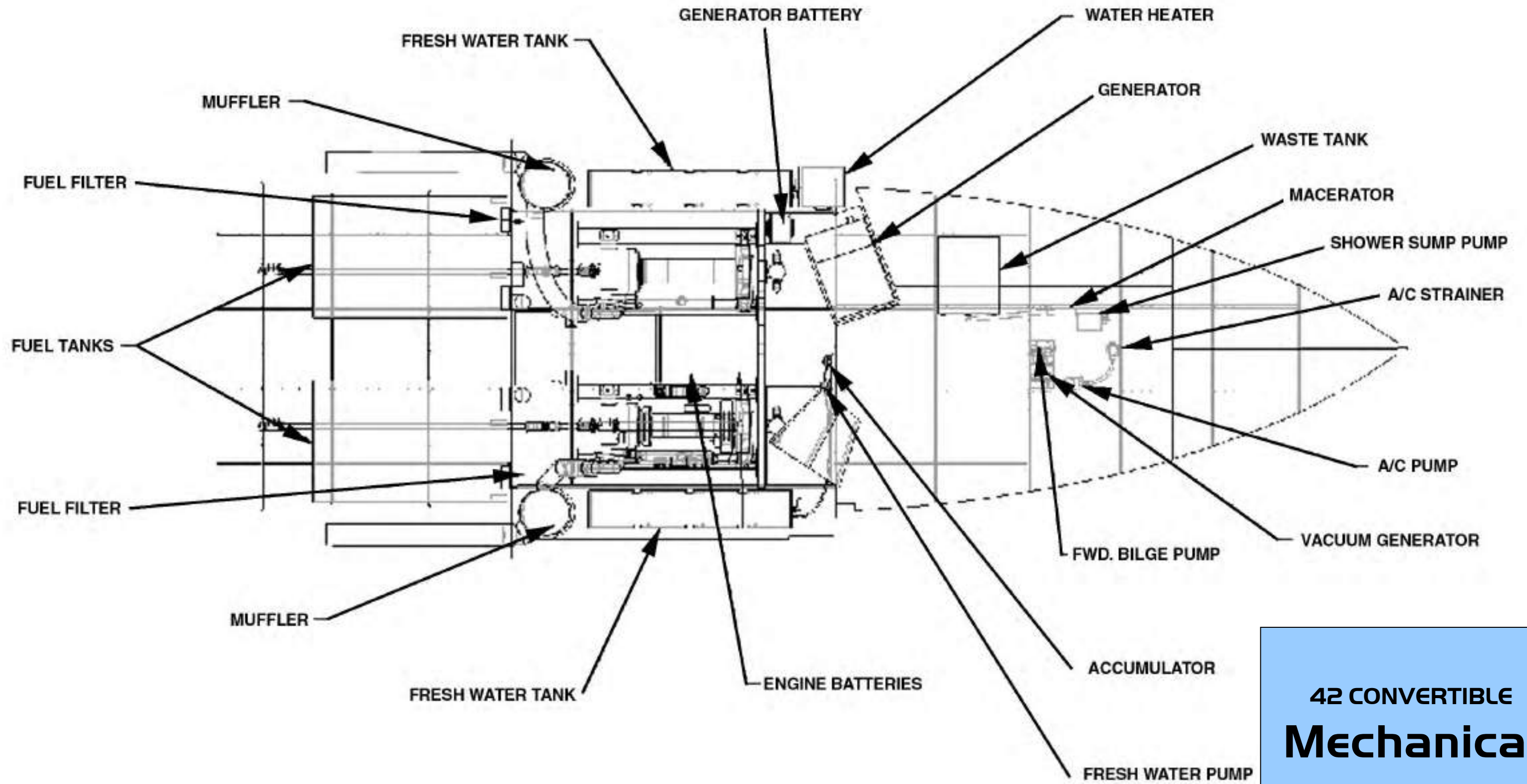

42 CONVERTIBLE
Mechanical

42 Convertible
Port Thru-Hulls



REVISIONS		
DATE	INIT.	DESCRIPTION
10-22-02	GH	REVISE POWER SOURCE TO HELM

"Y" HARNESS
SUPPLIED W/REMOTE CONTROL PANEL

REMOTE CONTROL PANEL - SALON

CONTROL PANEL - HELM

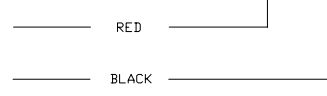
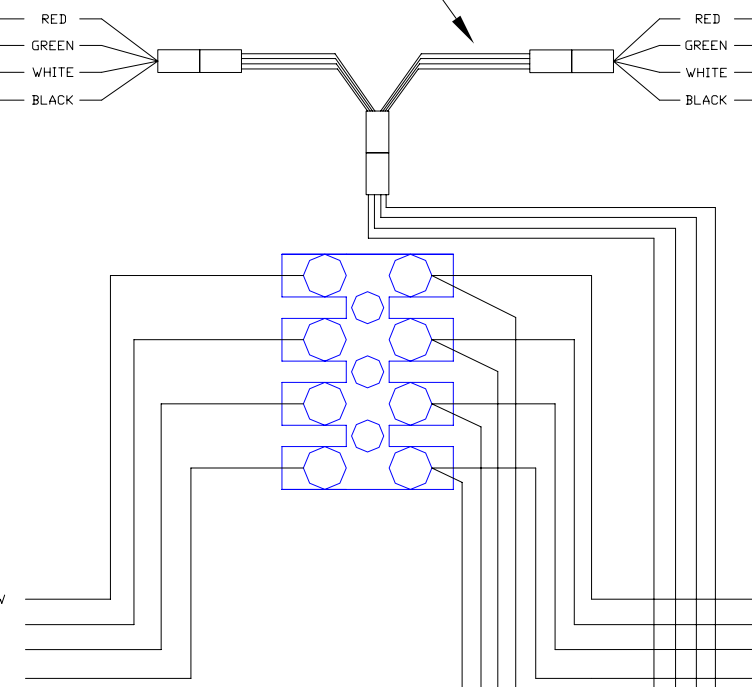
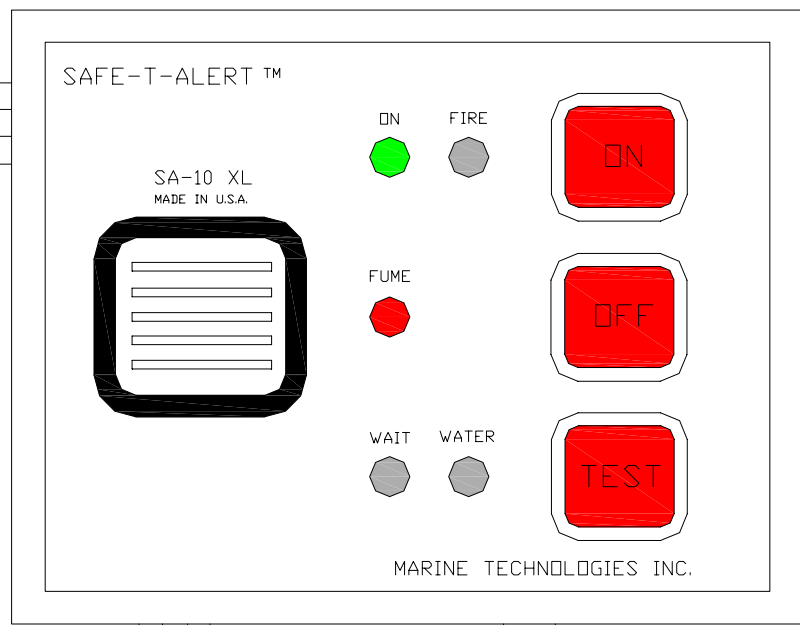
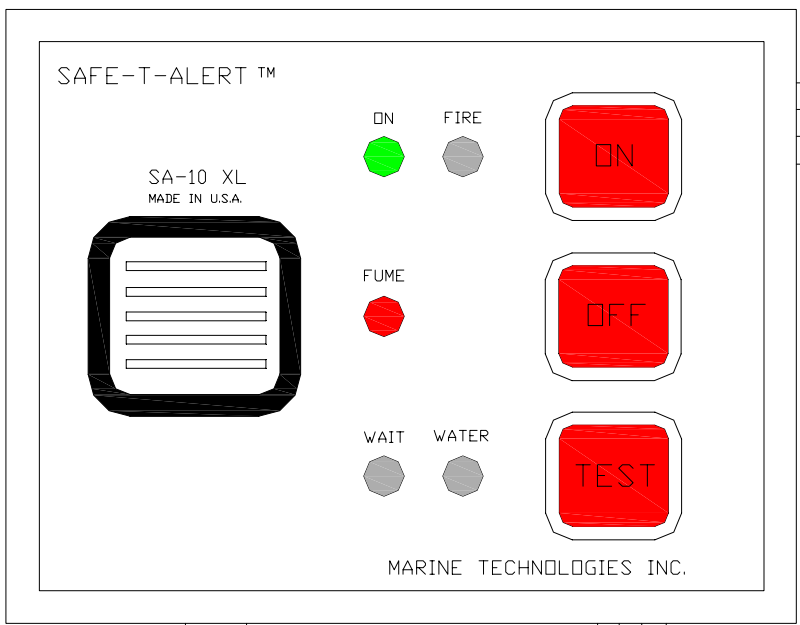

TAPE RED & BLACK POWER LEADS
ON REMOTE CONTROL PANEL
TO PREVENT SHORT

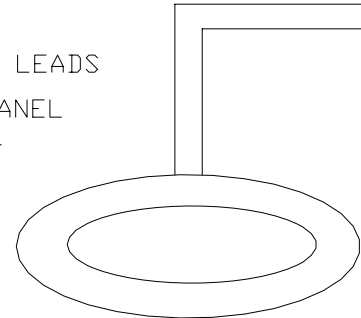

HEAT SENSOR

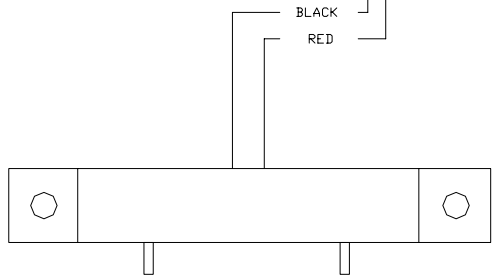

WATER SENSOR

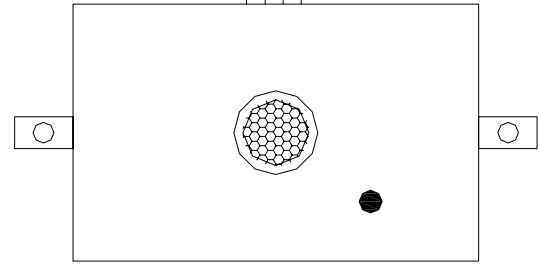
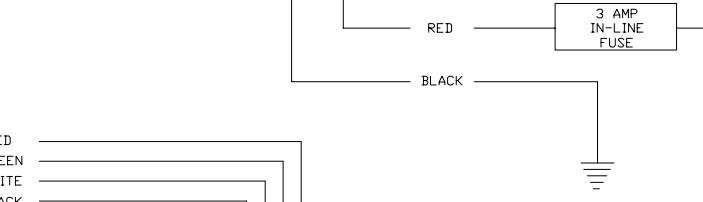

FUME SENSOR

NOTE:

INSTALL SALON CONTROL PANEL WITHIN CLOSE PROXIMITY TO AC/DC PANEL
 INSTALL REMOTE CONTROL PANEL IN CONVENIENT LOCATION ON HELM
 LOCATE HEAT SENSOR AS HIGH AS POSSIBLE IN ENGINE ROOM
 LOCATE WATER SENSOR HORIZONTALLY 4" ABOVE BILGE PUMP AUTO SWITCH
 LOCATE FUME SENSOR ON FORWARD ENGINE COMPARTMENT BULKHEAD AT STARTER HEIGHT
 MOUNT SMALL 12 POINT TERMINAL BLOCK ON BACKBOARD OF AC/DC PANEL

	SAFE-T-ALERT ALARM SYSTEM		
	ALL MODELS		
SIZE	DWN BY	DWG NO.	REV
	GH	EALL757	
SCALE	SHEET		
	NONE		

S. RACE & RIVERSIDE DR.
MILLVILLE N.J.
08332
856-825-4117
(FAX) 856-825-2898

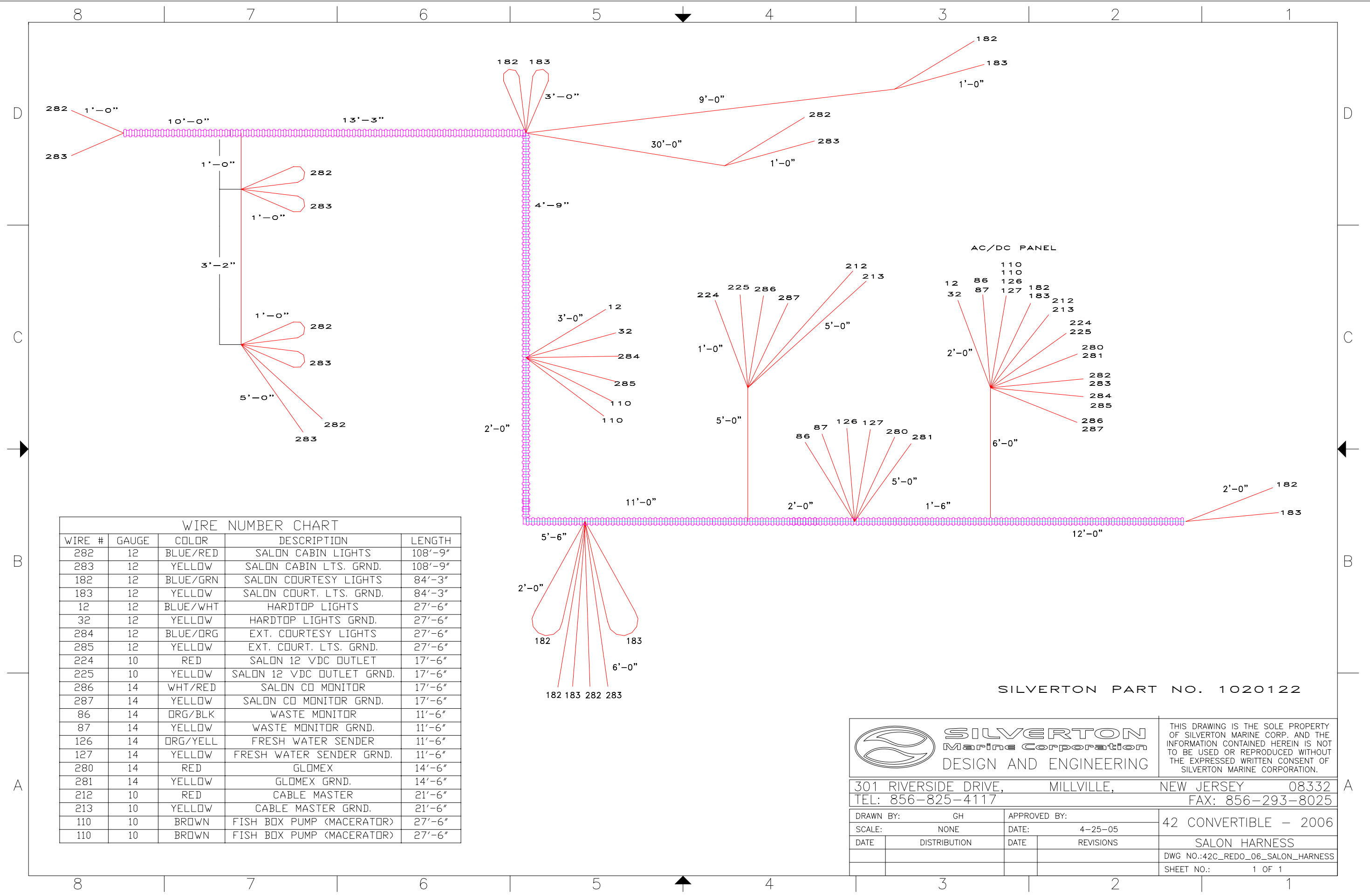

WIRE NUMBER CHART				
WIRE #	GAUGE	COLOR	DESCRIPTION	LENGTH
282	12	BLUE/RED	SALON CABIN LIGHTS	108'-9"
283	12	YELLOW	SALON CABIN LTS. GRND.	108'-9"
182	12	BLUE/GRN	SALON COURTESY LIGHTS	84'-3"
183	12	YELLOW	SALON COURT. LTS. GRND.	84'-3"
12	12	BLUE/WHT	HARDTOP LIGHTS	27'-6"
32	12	YELLOW	HARDTOP LIGHTS GRND.	27'-6"
284	12	BLUE/ORG	EXT. COURTESY LIGHTS	27'-6"
285	12	YELLOW	EXT. COURT. LTS. GRND.	27'-6"
224	10	RED	SALON 12 VDC OUTLET	17'-6"
225	10	YELLOW	SALON 12 VDC OUTLET GRND.	17'-6"
286	14	WHT/RED	SALON CD MONITOR	17'-6"
287	14	YELLOW	SALON CD MONITOR GRND.	17'-6"
86	14	ORG/BLK	WASTE MONITOR	11'-6"
87	14	YELLOW	WASTE MONITOR GRND.	11'-6"
126	14	ORG/YELL	FRESH WATER SENDER	11'-6"
127	14	YELLOW	FRESH WATER SENDER GRND.	11'-6"
280	14	RED	GLOMEX	14'-6"
281	14	YELLOW	GLOMEX GRND.	14'-6"
212	10	RED	CABLE MASTER	21'-6"
213	10	YELLOW	CABLE MASTER GRND.	21'-6"
110	10	BROWN	FISH BOX PUMP (MACERATOR)	27'-6"
110	10	BROWN	FISH BOX PUMP (MACERATOR)	27'-6"

SILVERTON PART NO. 1020122

 SILVERTON Marine Corporation DESIGN AND ENGINEERING		THIS DRAWING IS THE SOLE PROPERTY OF SILVERTON MARINE CORP. AND THE INFORMATION CONTAINED HEREIN IS NOT TO BE USED OR REPRODUCED WITHOUT THE EXPRESSED WRITTEN CONSENT OF SILVERTON MARINE CORPORATION.	
		301 RIVERSIDE DRIVE, MILLVILLE, NEW JERSEY 08332 TEL: 856-825-4117 FAX: 856-293-8025	
DRAWN BY: GH SCALE: NONE	APPROVED BY: DATE: 4-25-05	42 CONVERTIBLE - 2006	
DATE: _____ DISTRIBUTION: _____	DATE: _____ REVISIONS: _____	SALON HARNESS DWG NO.: 42C_REDO_06_SALON_HARNESS SHEET NO.: 1 OF 1	

**42 Convertible
Starboard Thru-Hulls**



Starboard Navigation Light

Fresh Water Tank Vent

Engine Room Blower Exhaust

Fuel Tank Vent

Rope Locker Drain

Engine Exhaust

Wet Bar Drain

Aft Bilge Pump Discharge

Bilge Ventilation Drain

A/C Condensation Drain

Mid Bilge Pump Ventilation

6 Discharge Vents(Aft to Forward)

Galley Sink Drain
Vanity Sink Drain
Fwd. Bilge Pump Discharge
Shower Sump Pump Discharge
A/C Discharge (2 Discharges)

3 Drains on Stern(Starboard to Port)
Cockpit Drains (2) and Generator Exhaust

REVISIONS		
DATE	INIT.	DESCRIPTION

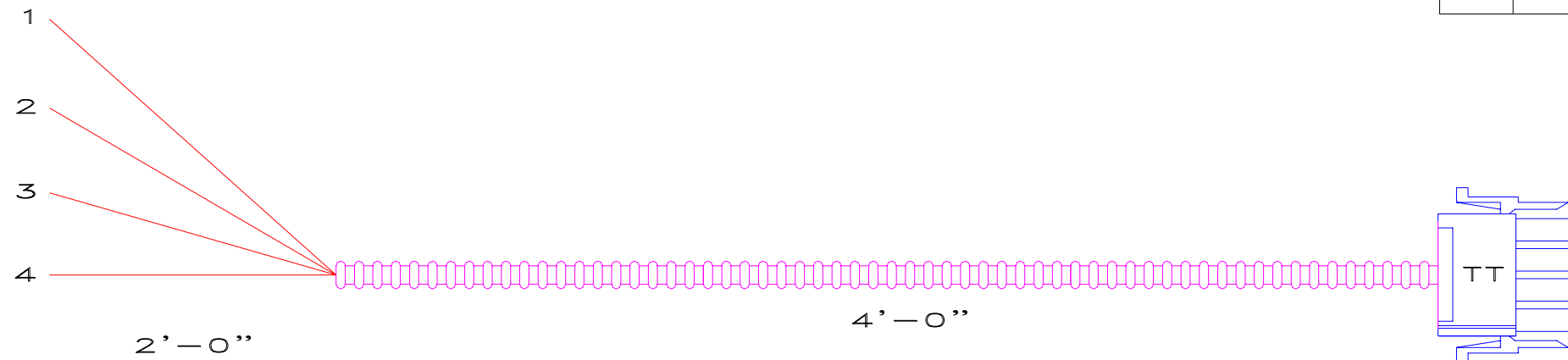

WIRE NUMBER CHART				
WIRE #	GAUGE	COLOR	DESCRIPTION	LENGTH
1	12	BLUE	TRIM TABS	6'-0"
2	12	RED	TRIM TABS	6'-0"
3	12	YELLOW	TRIM TABS	6'-0"
4	12	GREEN	TRIM TABS	6'-0"

PLUG TT				
WIRE #	GAUGE	COLOR	DESCRIPTION	LENGTH
1	12	BLUE	TRIM TABS	6'-0"
2	12	RED	TRIM TABS	6'-0"
3	12	YELLOW	TRIM TABS	6'-0"
4	12	GREEN	TRIM TABS	6'-0"

SILVERTON PART NO. 1020126

 S. RACE & RIVERSIDE DR. MILLVILLE N.J. 08332 609-825-4117 (FAX) 609-825-2898	42 CONVERTIBLE - 2006		
	TRIM TAB SWITCH JUMPER HARNESS		
SIZE	DWN BY	DWG NO.	REV
SCALE	NONE	42C_REDO_06_TRIM_TAB_SWITCH_JUMPER_HARNESS	1 OF 1
DATE:	4-24-05	SHEET	1 OF 1

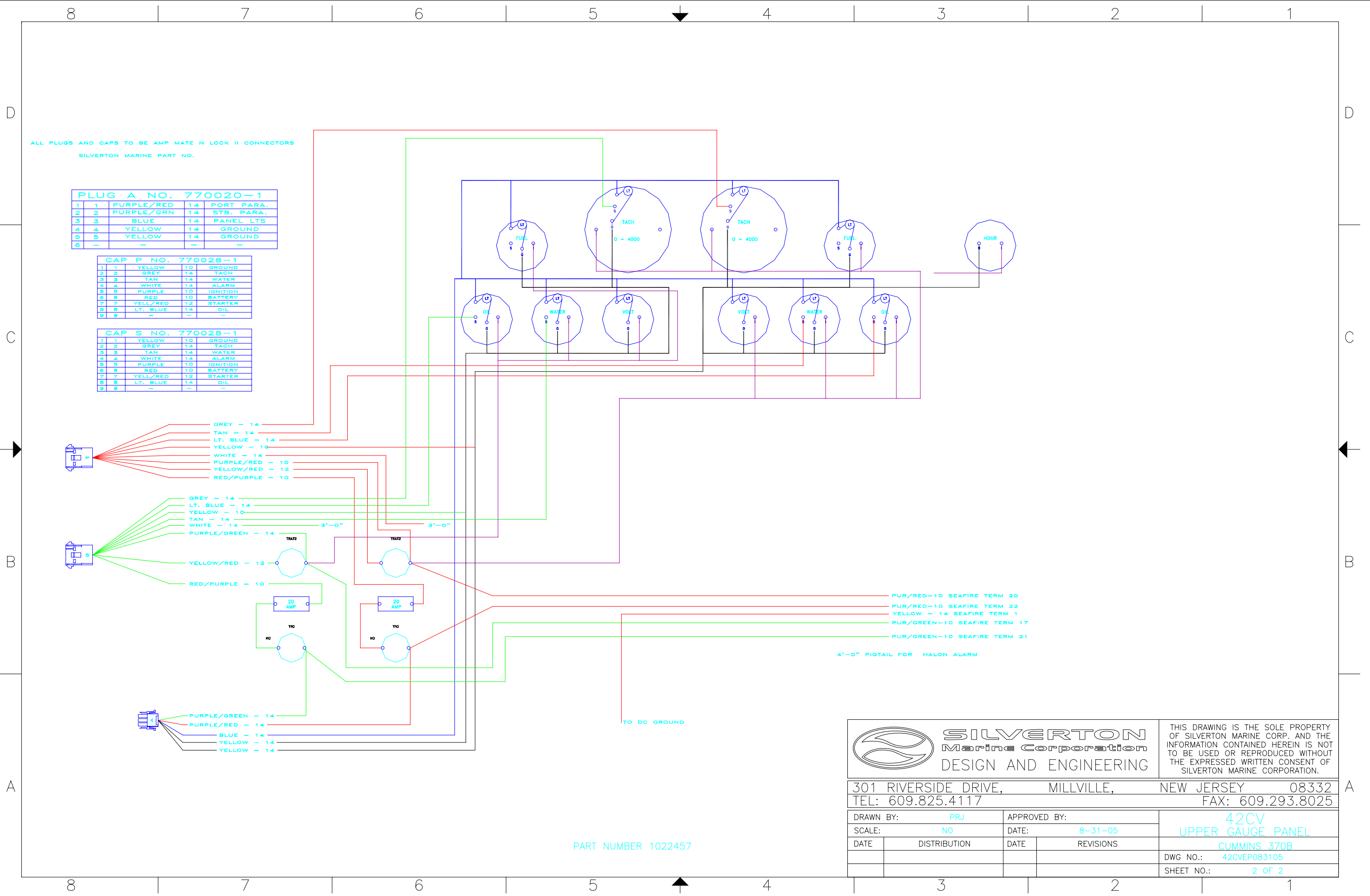

PART NUMBER 1022457



THIS DRAWING IS THE SOLE PROPERTY OF SILVERTON MARINE CORP. AND THE INFORMATION CONTAINED HEREIN IS NOT TO BE USED OR REPRODUCED WITHOUT THE EXPRESSED WRITTEN CONSENT OF SILVERTON MARINE CORPORATION.

301 RIVERSIDE DRIVE, MILLVILLE, NEW JERSEY 08332
TEL: 609.825.4117 FAX: 609.293.8025

DRAWN BY: PRJ		APPROVED BY:		42CV UPPER GAUGE PANEL
SCALE: NO		DATE: 8-31-05		
DATE	DISTRIBUTION	DATE	REVISIONS	CUMMINS 370B
				DWG NO.: 42CVEP083105
				SHEET NO.: 2 OF 2

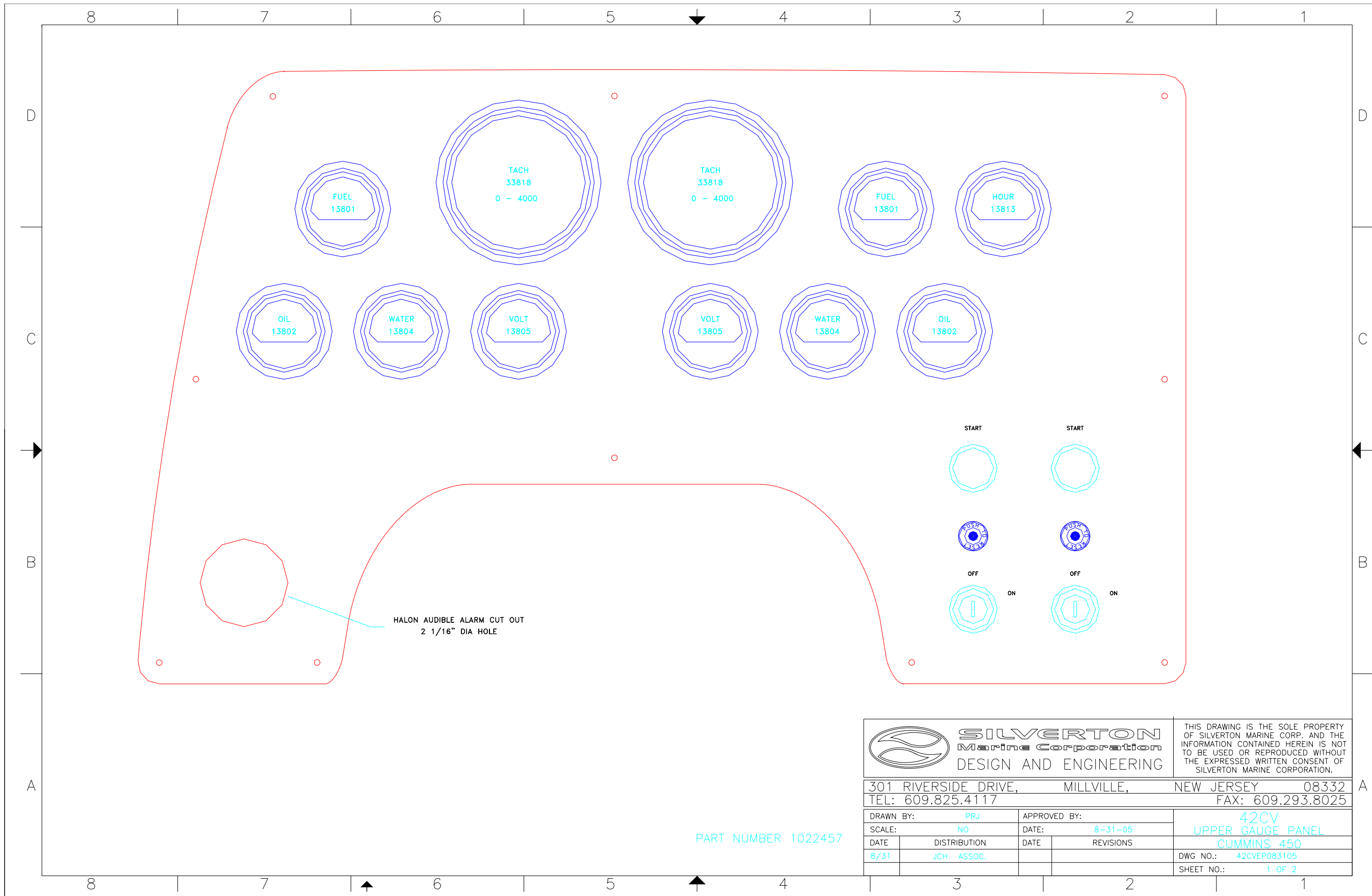

PART NUMBER 1022457

 SILVERTON Marine Corporation DESIGN AND ENGINEERING		THIS DRAWING IS THE SOLE PROPERTY OF SILVERTON MARINE CORP. AND THE INFORMATION CONTAINED HEREIN IS NOT TO BE USED OR REPRODUCED WITHOUT THE EXPRESSED WRITTEN CONSENT OF SILVERTON MARINE CORPORATION.
301 RIVERSIDE DRIVE, MILLVILLE, NEW JERSEY 08332 TEL: 609.825.4117		FAX: 609.293.8025
DRAWN BY: PRJ	APPROVED BY:	42CV UPPER GAUGE PANEL
SCALE: NO	DATE: 8-31-05	CUMMINS 450
DATE: 8/31	DISTRIBUTION: JCH ASSOC.	DWG NO.: 42CVP083105
		SHEET NO.: 1 OF 2

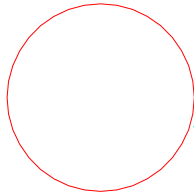
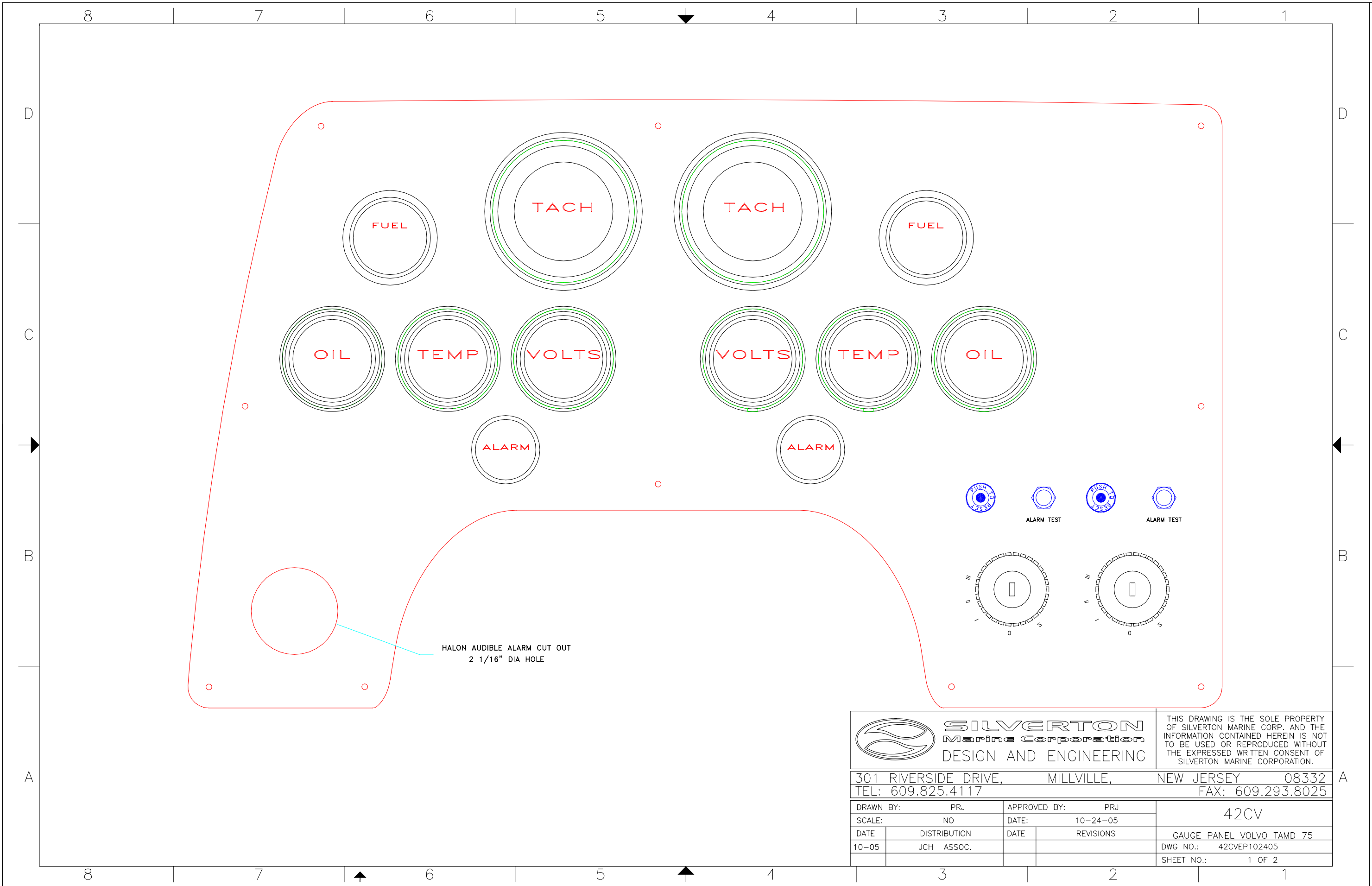

HALON AUDIBLE ALARM CUT OUT
2 1/16" DIA HOLE

 SILVERTON Marine Corporation DESIGN AND ENGINEERING		THIS DRAWING IS THE SOLE PROPERTY OF SILVERTON MARINE CORP. AND THE INFORMATION CONTAINED HEREIN IS NOT TO BE USED OR REPRODUCED WITHOUT THE EXPRESSED WRITTEN CONSENT OF SILVERTON MARINE CORPORATION.	
301 RIVERSIDE DRIVE, TEL: 609.825.4117		MILLVILLE, NEW JERSEY 08332 FAX: 609.293.8025	
DRAWN BY: PRJ	APPROVED BY: PRJ	42CV	
SCALE: NO	DATE: 10-24-05		
DATE: 10-05	DISTRIBUTION: JCH ASSOC.	DATE:	REVISIONS:
		GAUGE PANEL VOLVO TAMD 75	
		DWG NO.: 42CVEP102405	
		SHEET NO.: 1 OF 2	

8 | 7 | 6 | 5 | 4 | 3 | 2 | 1

D
C
B
A

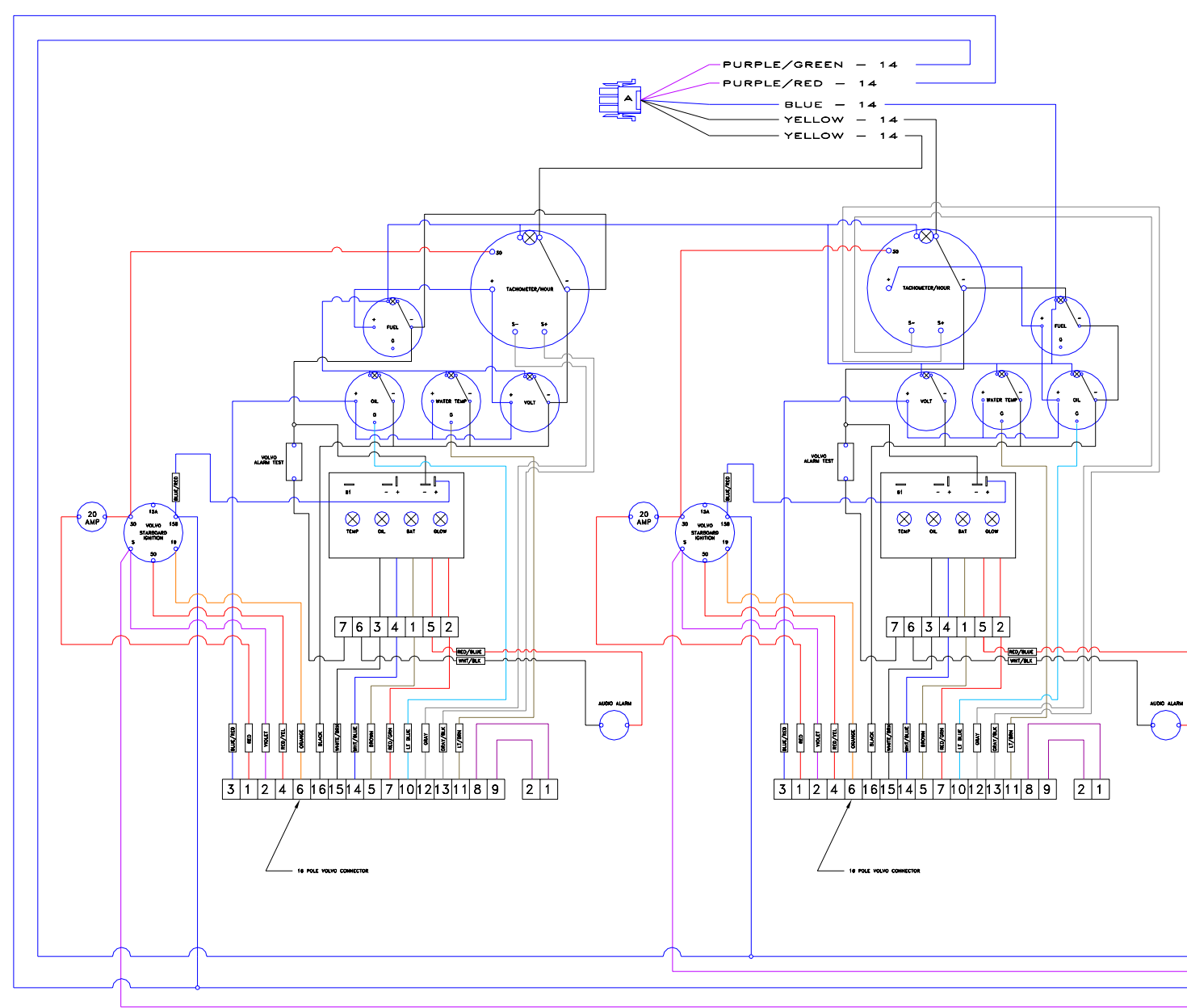

PURPLE/GREEN - 14
 PURPLE/RED - 14
 BLUE - 14
 YELLOW - 14
 YELLOW - 14

PLUG A NO. 770020-1			
1	1	PURPLE/RED	14 PORT PARA.
2	2	PURPLE/GRN	14 STB. PARA.
3	3	BLUE	14 PANEL LTS
4	4	YELLOW	14 GROUND
5	5	YELLOW	14 GROUND
6	-	-	-

18 POLE VOLVO CONNECTOR

3 1 2 4 6 16 15 14 5 7 10 12 13 11 8 9 2 1

7 6 3 4 1 5 2

TEMP OIL BAT GLOW

18 POLE VOLVO CONNECTOR

3 1 2 4 6 16 15 14 5 7 10 12 13 11 8 9 2 1

7 6 3 4 1 5 2

TEMP OIL BAT GLOW

PUR/RED-10 SEAFIRE TERM 22
 PUR/RED-10 SEAFIRE TERM 18
 PUR/GREEN-10 SEAFIRE TERM 21
 PUR/GREEN-10 SEAFIRE TERM 15
 YELLOW - 14 SEAFIRE TERM 1

4'-0" PIGTAIL FOR HALON ALARM

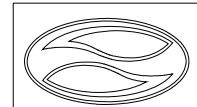

SILVERTON
 Marine Corporation
 DESIGN AND ENGINEERING

THIS DRAWING IS THE SOLE PROPERTY OF SILVERTON MARINE CORP. AND THE INFORMATION CONTAINED HEREIN IS NOT TO BE USED OR REPRODUCED WITHOUT THE EXPRESSED WRITTEN CONSENT OF SILVERTON MARINE CORPORATION.

301 RIVERSIDE DRIVE, MILLVILLE, NEW JERSEY 08332
 TEL: 609.825.4117 FAX: 609.293.8025

DRAWN BY: PRJ		APPROVED BY: PRJ		42CV
SCALE: NO		DATE: 10-24-05		
DATE: 10-05	DISTRIBUTION: JCH ASSOC.	DATE:	REVISIONS:	GAUGE PANEL VOLVO TAMD 75
				DWG NO.: 42CVEP102405
				SHEET NO.: 2 OF 2

8 | 7 | 6 | 5 | 4 | 3 | 2 | 1

NO.	GAUGE	COLOR	LENGTH
215	12	WHITE	
216	12	GREEN	
217	12	BROWN	
218	12	PINK	

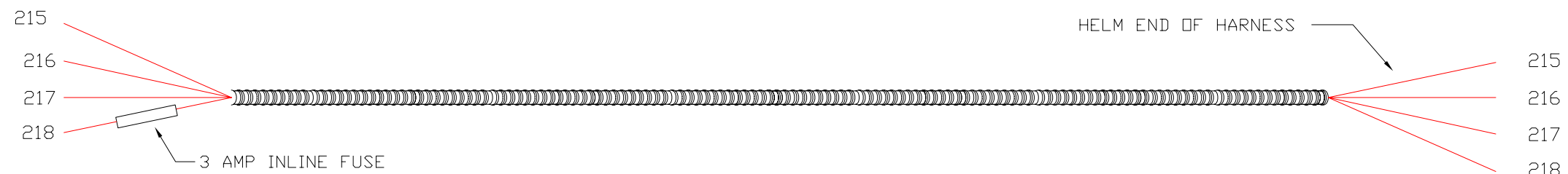

DATE	DISTRIBUTION

DATE	INT	REVISIONS

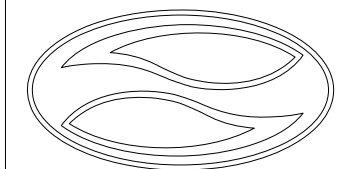

SILVERTON
Marine Corporation
DESIGN AND ENGINEERING

SILVERTON MARINE CORP.
S. RACE & RIVERVIEW DR.
MILLVILLE N.J.
08332
TELEPHONE
609-825-4117
FACSIMILE
609-293-8025

THIS DRAWING IS THE SOLE PROPERTY
OF SILVERTON MARINE CORP. AND THE
INFORMATION CONTAINED HEREIN IS NOT
TO BE USED OR REPRODUCED WITHOUT
THE EXPRESSED WRITTEN CONSENT OF
SILVERTON MARINE CORPORATION.

48C

VOLVO BOW THRUSTER

DRAWN BY:	PRJ
CHECKED BY:	
APPROVED BY:	
SCALE:	
TOLERANCE:	
SHEET NO.:	
DATE:	9-23-03
DRAWING NO.:	EAEH092303

WASTE / WATER MONITOR
ELECTRICAL SCHEMATIC

