

SCARAB®

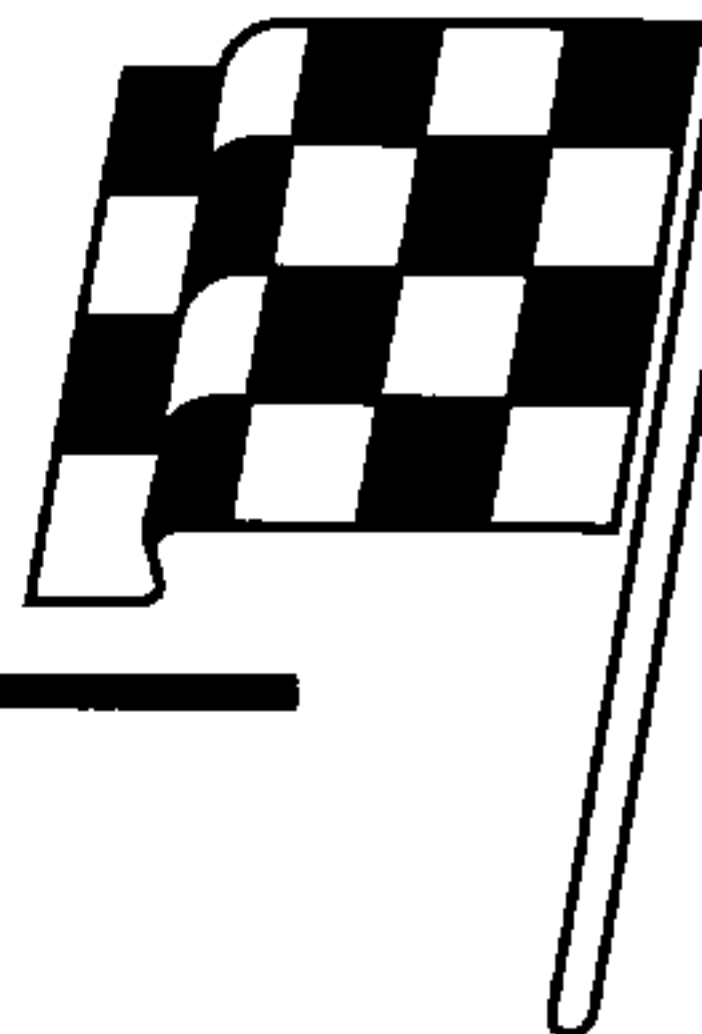

OWNER'S MANUAL

Model/Number: _____

Hull Identification Number: _____

Date of Purchase/First Use: _____

Dealer Name: _____

Address: _____

Phone Number: _____



Wellcraft

WORLD CLASS PERFORMANCE™

Genmar

Catalog Requests Call 1-800-603-BOAT

© 1996 Wellcraft Marine Corp., a subsidiary of Genmar Industries, Inc. 1651 Whitfield Avenue, Sarasota, FL 34243

For a complete list of standard and optional features and equipment, consult your local Wellcraft dealer. Due to a policy of continual product improvement, specifications are subject to change without notice. The weights and volumes shown are estimated and can vary from boat to boat because of equipment, etc. Wellcraft boats meet or exceed both NMMA and U.S. Coast Guard standards. Wellcraft is a trademark of Genmar Industries, Inc. Scarab is a registered trademark of Team Scarab, Inc.

Printed in USA. Part No. 2601-2872

This manual has been compiled to help you operate your craft with safety and pleasure. It contains the details of the craft, the equipment supplied or fitted, its systems, and information on its operation and maintenance. Please read it carefully and familiarize yourself with the craft before using it.

If this is your first craft, or if you are changing to a type of craft you are not familiar with, for your own comfort and safety, please ensure that you obtain handling and operating experience before "assuming command" of the craft. Your dealer or national sailing federation or yacht club will be pleased to advise you of local sea schools and competent instructors.

PLEASE KEEP THIS MANUAL IN A SECURE PLACE, AND HAND IT OVER TO THE NEW OWNER WHEN YOU SELL THE CRAFT.



BOATS DESIGNED WITH NATURE IN MIND.

As privileged visitors to the world's oceans, lakes and waterways, we share an obligation to help protect our marine environment. Wellcraft is leading the way with a variety of unique systems designed to help minimize the impact of recreational boating.

TABLE OF CONTENTS

1 BOATING SAFETY.....1-1	
Safety Precautions	1-1
Drugs, Alcohol and Boating	1-2
Boating Regulations	1-2
Boater Responsibilities	1-3
Required Safety Equipment	1-6
Carbon Monoxide and Boating	1-12
Emergencies	1-14
Hazardous Conditions	1-18
Passenger Safety	1-19
Operations By Minors	1-20
Safe Operation	1-20
Water Sports	1-20
Ozone Depleting Substances	1-21
Summary	1-22
2 BASIC RULES OF THE ROAD2-1	
Aids to Navigation	2-1
Right-of-Way	2-5
3 SPECIFICATIONS AND LAYOUT3-1	
Specifications	3-2
29 Scarab	
Safety Labels	3-6
Helm Layout	3-7
Side View of Equipment Locations.....	3-8
Top View of Equipment Locations.....	3-9
Electrical Controls.....	3-10
302 Scarab	
Safety Labels	3-11
Helm Layout	3-12
Side View of Equipment Locations.....	3-13
Top View of Equipment Locations.....	3-14
31 Scarab	
Safety Labels	3-15
Helm Layout	3-16
Side View of Equipment Locations.....	3-17
Top View of Equipment Locations.....	3-18
Electrical Controls.....	3-19
38 Scarab	
Safety Labels	3-20
Helm Layout	3-21
Side View of Equipment Locations.....	3-22
Top View of Equipment Locations.....	3-23
Electrical Controls.....	3-24
3 SPECIFICATIONS AND LAYOUT CONT.	
43 Scarab	
Safety Labels	3-25
Helm Layout	3-26
Side View of Equipment Locations.....	3-27
Top View of Equipment Locations.....	3-28
Electrical Controls.....	3-29
4 CONTROLS AND INDICATORS.....4-1	
Shift/Throttle Control	4-1
Steering	4-2
Trim Tabs.....	4-3
Stern Drive Trim	4-4
Instruments.....	4-5
Switches	4-9
Engine Alarm System.....	4-12
Accessories.....	4-13
5 BOAT SYSTEMS.....5-1	
Electrical Systems	5-1
Water Systems	5-6
Fuel System.....	5-11
Air Conditioner.....	5-12
Propulsion.....	5-12
Engine Exhaust System.....	5-12
Refrigerator.....	5-12
6 GETTING UNDERWAY6-1	
Launch and Cruise Checklist	6-1
Fueling.....	6-2
Safety Checklist.....	6-4
Loading.....	6-5
Starting.....	6-6
Stopping for the Day.....	6-7
Line Handling.....	6-8
Discharge of Oil.....	6-8
Disposal of Plastics & Other Garbage ...	6-8
MARPOL Treaty	6-8
Additional Underway Information.....	6-9
7 RUNNING7-1	
Maneuvering	7-1
Performance Boating	7-3
Propellers.....	7-9
Towing	7-10
Anchoring	7-11



SCARAB®

8 CARE AND MAINTENANCE	8-1
Maintenance Schedule	8-1
Wiring	8-4
General Maintenance	8-5

9 TROUBLESHOOTING	9-1
--------------------------------	------------

10 STORAGE	10-1
-------------------------	-------------

11 TRAILERING	11-1
Classifications	11-1
Hitch	11-2
Safety Chains	11-2
Trailer Brakes	11-3
Trailer Checklist	11-3
Backing Up Trailers	11-4
Launching	11-4
Loading	11-5
Slings/Lifting	11-6

12 GLOSSARY OF BOATING TERMS ...	12-1
---	-------------

OWNERS RECORDS

Boat Data Sheet	A
Service/Maintenance Log	B
Fuel Log	C
Float Plan	D

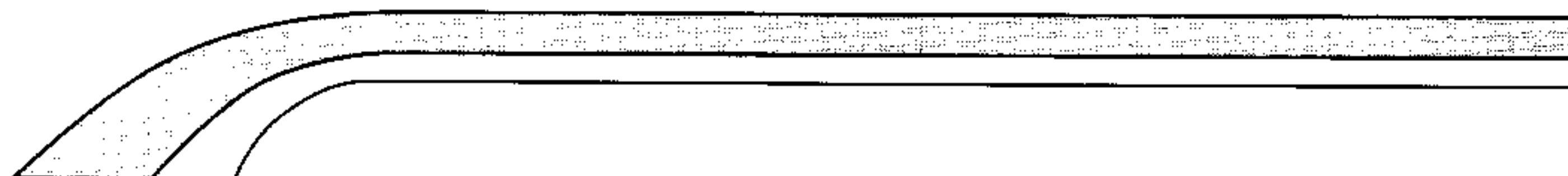

Introduction

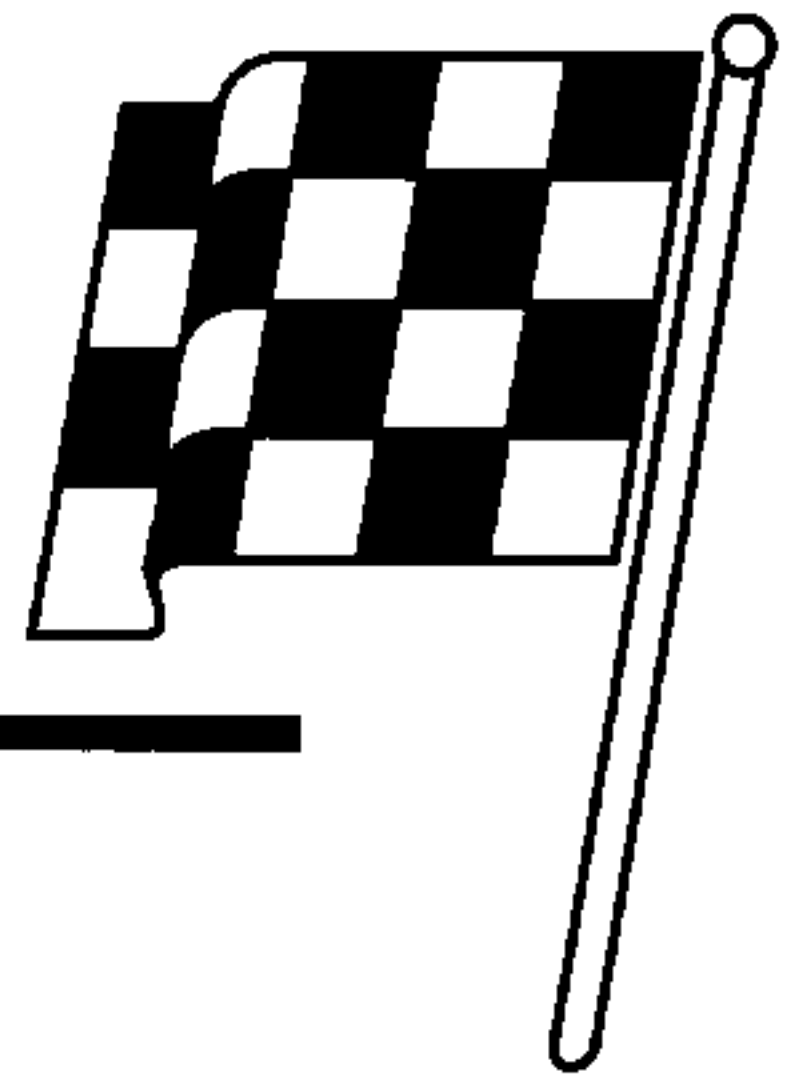

Thank you for buying a Wellcraft product. Welcome to the world of breathtaking speed and superb handling that is high performance powerboating - Scarab style!

This owner's manual is your guide to the systems and safe operating procedures of your new boat. It has been written for the beginning boater, but we recommend that even experienced captains read the contents thoroughly.

Pay close attention to all highlighted safety warnings and cautions and remember that along with the freedom and exhilaration of high performance powerboating comes the responsibility that you have for the safety of your passengers and the other boaters who share the water with you.

The information contained in this manual may be general in some cases and more detailed in others. Supply manuals from the manufacturers of major components in your boat such as engines, custom exhaust systems, trim tabs, marine toilets and electronics are included in the "Important Papers" zipper bag. Please read these manuals and become familiar with their contents before heading out on the water.

The information in the component instruction manuals may be different from the information in this manual because of product improvements. If you notice a discrepancy, ALWAYS FOLLOW THE INSTRUCTIONS IN THE SUPPLIER'S MANUAL. Additionally, the suppliers of these products maintain their own manufacturer's warranty and service facilities. To register your ownership, fill out and mail each warranty card. Use your Owner's Portfolio to retain instructions and data on additional equipment or accessories installed after delivery.

IMPORTANT: Operation, maintenance and safety information is outlined by the manufacturer of most installed equipment. Properly operating and maintaining the equipment on your boat will help you to enjoy many years of SAFE boating.

Due to our policy of continuous product improvement, the illustrations used in this manual may not be identical to the components, controls, gauges, etc. on your boat, as they are intended

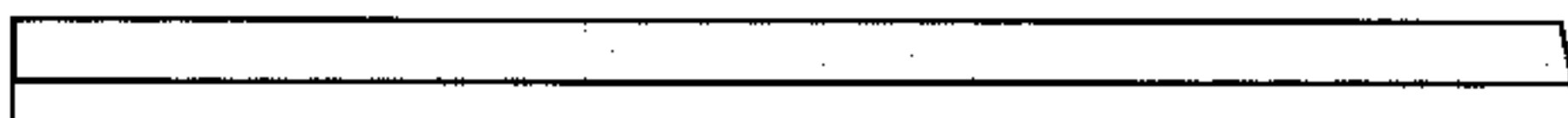

SCARAB[®]

to be representative reference views. Some controls, indicators or information may be optional and not included on your craft.

We'd also like to remind you to be kind to our environment while you're boating. Don't throw garbage and other refuse overboard. And do your best to keep harmful compounds like gasoline and antifreeze out of the water.

Your Wellcraft dealer is the best source for answers to any questions you may have.

CONSTRUCTION STANDARDS

All Wellcraft boats meet or exceed the construction standards set by the U.S. Coast Guard, the National Marine Manufacturers Association (NMMA) and the American Boat and Yacht Council (ABYC) concerning:

- ◆ Navigational Lights
- ◆ Factory Installed Fuel Systems
- ◆ Engine And Fuel Tank Compartment Ventilation
- ◆ Flotation
- ◆ Steering Systems
- ◆ Backfire Flame Arresters

Most Wellcraft models have also been certified to carry the CE mark. The CE mark certifies that the boat meets relevant parts of the European Directive for Recreational Craft 94/25/EC of the European Parliament, including the International Organization for Standardization (ISO) and Recreational Marine Agreement Group (RMAG) guidelines in effect at the time of manufacture.

OWNER REGISTRATION

It is important that the Warranty Registration Card be returned promptly (within 15 days of original purchase) to Wellcraft in order to validate your warranty. In addition, the customer information on the card provides Wellcraft with a means to contact you in the event of a recall as required under the Federal Boat Safety Act.

All boat manufacturers are required by *The Federal Boat Safety Act of 1971* to notify first time owners in the event any defect is discovered "which creates a substantial risk of personal injury to the public." In order that we can comply with the law, if it becomes necessary, it is essential that your warranty registration card with the owner's name, address and the boat serial number be completed and mailed to Wellcraft Marine, 1651 Whitfield Ave., Sarasota, Florida 34243.

WARRANTY/CLAIMS PROCEDURE

The Wellcraft Limited Warranty, in its entirety, appears on the Warranty Registration Card included with this manual. We have made every effort to simplify our warranty so that it may be easily understood. However, if you have any questions regarding the warranty please don't hesitate to contact us.

Wellcraft Marine

Attn: Customer Service
1651 Whitfield Ave.
Sarasota, FL 34243
Phone: (941) 753-7811
Fax: (941) 751-7889

Owner Responsibility

The new Wellcraft owner must indicate an understanding of the terms and conditions of the Wellcraft Limited Warranty by signing the warranty registration card where indicated.

The warranty registration card should be properly completed by the dealer, signed by the new owner, and returned to Wellcraft Marine Corp. within fifteen (15) days after the original purchase in order to validate the warranty. We will acknowledge receipt of your card and advise you that your warranty has been validated and is in force.

Should you experience a problem with your new Scarab as a result of defective materials or workmanship, contact your factory authorized Wellcraft dealer, preferably where you purchased your boat. It is important to note that all warranty repairs must be processed by an authorized Wellcraft dealer.

For protection against theft, record the Hull Identification Number (HIN) and model of your boat along with the model and serial numbers of the engines, stern drives and accessories. The HIN is located on the upper starboard side of the transom or the upper starboard side of the hull near the transom.

NOTICE

Alteration of a HIN without the specific written permission of the Commandant, U.S. Coast Guard is specifically prohibited by Federal Statutes and Coast Guard regulations.

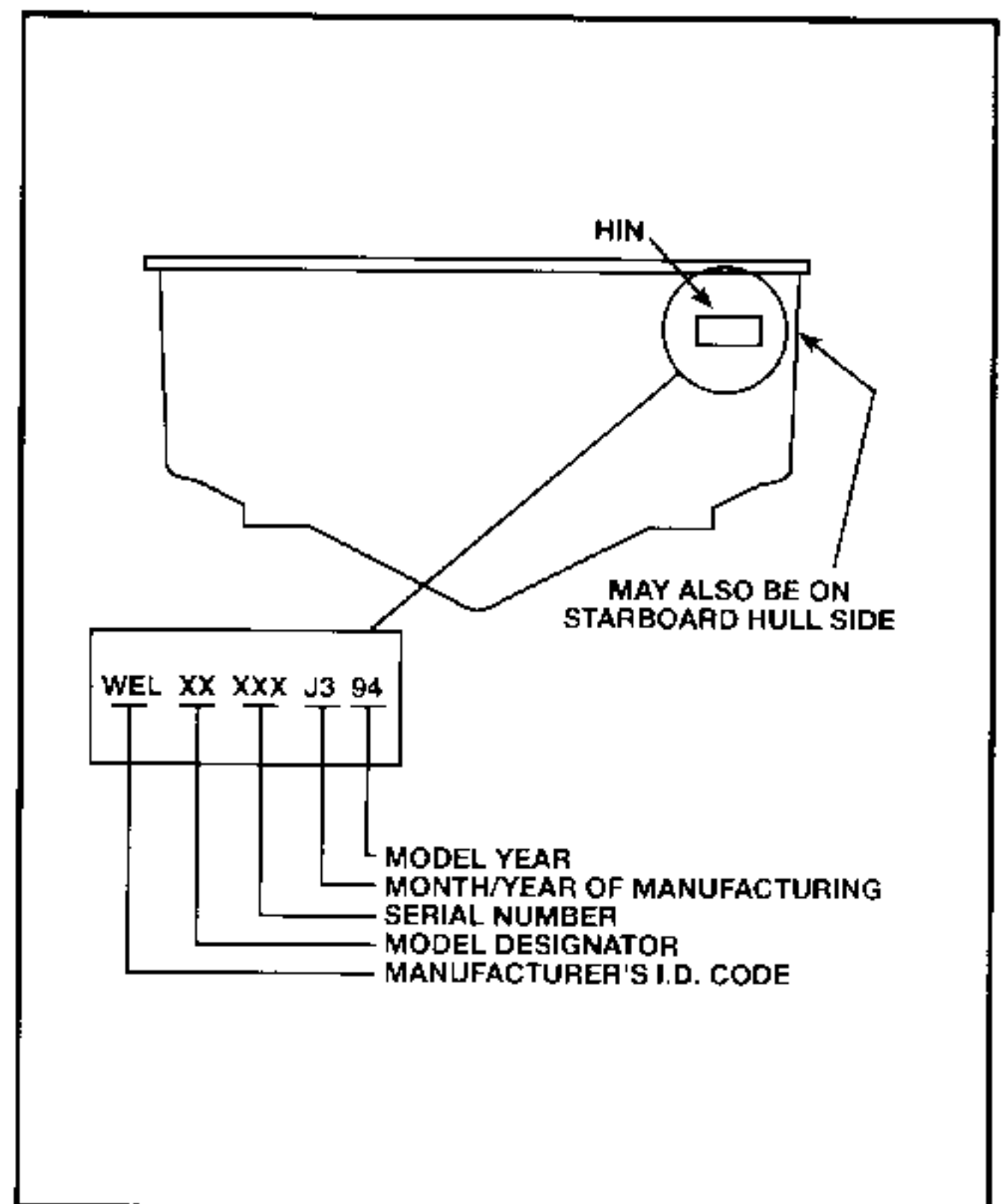

SCARABTM

BOATING TERMINOLOGY

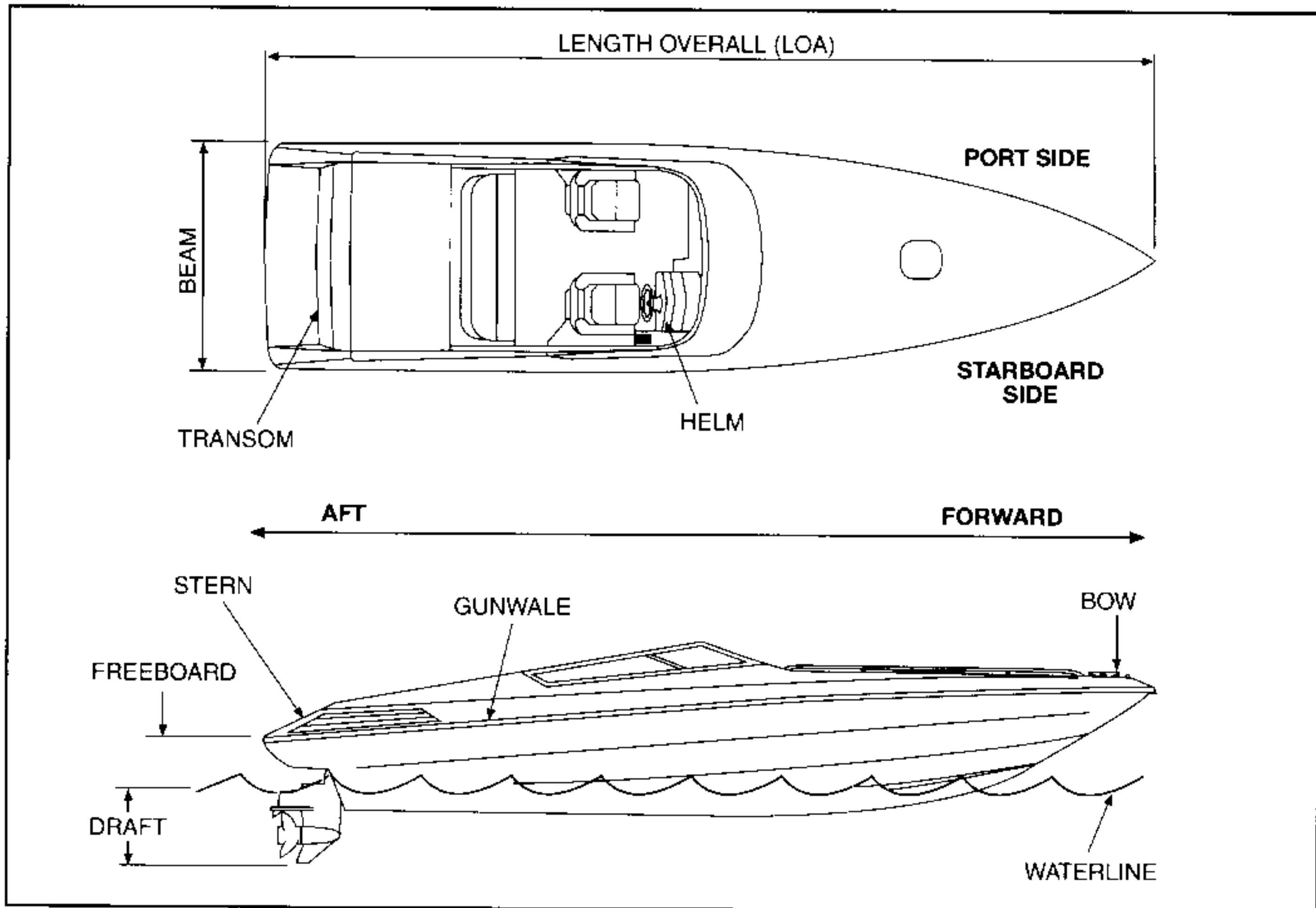

Owner's Logs and Records

At the end of this manual are several forms which you will find very helpful.

Use the **Boat Data Record** to record all important information about your boats and the major components installed. After you have entered all the data, remove this form from your Owner's Manual and store in a safe place. **Do not** keep this form aboard your boat.

The **Float Plan** provides a record of your destination, departure and return times, boat description, passenger list, and other information about the trip you have planned. At the bottom of the form is space for listing emergency telephone numbers in case your return is delayed past the expected time. It also has space for indicating information about the person filing this report. Leave the completed form ashore with a responsible person. We recommend you make several copies of this form each boating season to assure an ample supply.

The **Fuel Log** is a handy way to record information covering engine hours, fuel on board, and range as well as engine speed, travel speed and fuel consumption.

The **Service/Maintenance Log** provides a record of maintenance work completed on your boat, the date of completion and the engine hour reading. This log will also help you identify the frequency of routine maintenance work, such as engine oil changes. If you should decide to sell your boat, it will demonstrate to prospective buyers that you have done a good job of taking care of your boat.



SCARAB[®]

PRE-DELIVERY CHECKLIST FOR:

HULL SERIAL NUMBER _____

MODEL _____

WELLCRAFT STERN DRIVE & OUTBOARD

BEFORE LAUNCHING:

- 1. Inspect all thru-hull fittings, tight and sealed
- 2. Connections to thru-hull fittings (interior)
- 3. Drain plugs installed (hull, engines, cooling system)
- 4. Drive unit(s) installed, oil level(s) checked
- 5. Check tie bar for alignment of twin engines
- 6. Install speedometer pitot tube
- 7. Steering (proper direction, full travel, tightness)
- 8. Propellers installed (R.H. stbd., L.H. port) check size
- 9. Gas vents clear
- 10. Bilge clean, amber holes open
- 11. Water hose test for leaks (windows, doors, hatches)

AFTER LAUNCHING:

- 12. Check for leaks
 - A. Thru-hull fittings
 - B. Sea-cocks (if applicable)
- 13. Electrical equipment operation
 - A. 12Vdc
 - B. 120Vac
- 14. Fuel system (check for leaks)
- 15. Steering action, free movement, no binding

BEFORE OPERATION OF ENGINES:

- 16. Wiring connections tight
- 17. Hose connections tight, no leaks
- 18. Throttle cable travel, tension
- 19. Open sea cocks
- 20. Check all fluid levels (engines)
- 21. Fuel shut-off valves open

Operate blower at least 5 minutes & check bilge for gas fumes

AFTER STARTING ENGINES:

- 22. Exhaust water flow
- 23. Fuel system leaks (gauges read correctly)
- 24. Cooling system leaks
- 25. Adjust idle speed (600-700 RPM in gear)
- 26. Shift thru gears (full travel) — must reach detents
- 27. All engine gauges function correctly
- 28. Fill out engine pre-delivery forms (if applicable)
- 29. Check ignition interrupter switches (if applicable)

WATER TEST:

- 30. Sg. (Stbd. Engine) _____ RPM (top - trimmed)
- 31. Port engine _____ RPM (top - trimmed)
- 32. Steering control
- 33. Trim tab operation (if applicable)
- 34. Accessories (lights, wipers, pumps, etc.)

FINAL: ACCESSORIES

- 35. A/C pump
- 36. A/C compressor
- 37. Generator
- 38. Manne head, macerator pump & holding tank
- 39. Canvas
- 40. Converter (battery charger)
- 41. Appliances (stove, microwave, refig., stereo, etc.)
- 42. Water (pressure) system and hot water tank
- 43. Battery separators (if applicable)
- 44. All manuals and warranties packed aboard

CUSTOMER DELIVERY: (To be filled in at time of delivery)

- Boat and engine(s) pre-delivery check list complete
- Operation and maintenance manuals provided
- Warranty(s) explained and form(s) completed
- Required Coast Guard equipment on board

Dealer Name: _____

Account #: _____

Dealer Signature _____

Customer Signature _____ Date _____

Return to: WELLCRAFT (Warranty Department) 1651 Whitfield Avenue • Sarasota, FL 34243

WELLCRAFT INBOARD

BEFORE LAUNCHING

- 1. Inspect all thru-hull fittings, tight and sealed
- 2. Connections to thru-hull fittings (interior)
- 3. Drain plugs installed (hull, engines, cooling system)
- 4. Propellers installed (R.H. Stbd., L.H. port) check size
- 5. Propeller shafts turn free
- 6. Rudder Alignment, connection tight
- 7. Prop shaft aligned properly in shaft log
- 8. Strut properly aligned, shaft running squarely through out-ast bearing
- 9. Zincs installed
- 10. Gas vents clear
- 11. Bilge clean, amber holes open
- 12. Water hose test for leaks (windows, doors, hatches)

AFTER LAUNCHING:

- 13. Check for leaks
 - A. Thru-hull fittings
 - B. Sea-cocks (if applicable)
 - C. Prop shaft packing glands
 - D. Rudder shaft packing glands
- 14. Check propeller shaft coupling alignment (.003" max)
- 15. Bend lock tabs on engine mounts
- 16. Electrical equipment operation
 - A. 12Vdc
 - B. 120Vac
 - C. 220Vac
- 17. Fuel system (check for leaks)
- 18. Steering action, free movement, no binding

BEFORE OPERATION OF ENGINES:

- 19. Wiring connections tight
- 20. Hose connections tight, no leaks
- 21. Coolant level (closed cooling system)
- 22. Throttle cable travel, tension
- 23. Transmission cable travel
- 24. Open sea cocks
- 25. Check all fluid levels (engine(s))

Operate blower at least 5 minutes & check bilge for gas fumes

AFTER STARTING ENGINES:

- 26. Exhaust water flow
- 27. Fuel system leaks (gauges read correctly)
- 28. Cooling system leaks
- 29. Engine water temperature (after warm-up)
- 30. Adjust idle speed (600-700 RPM in gear)
- 31. Shift thru gears (full travel) — must reach detents
- 32. All engine gauges function correctly
- 33. Fill out engine pre-delivery forms (if applicable)

WATER TEST:

- 34. Stbd. engine RPM _____ (top)
- 35. Port engine RPM _____ (top)
- 36. Steering control
- 37. Trim tab operation (if applicable)
- 38. Accessories (lights, wipers, pumps, etc.)
- 39. Re-Check shaft alignment after 72 hours in water (see 14 above)

FINAL: ACCESSORIES

- 40. A/C pump
- 41. A/C compressor
- 42. Generator
- 43. Canvas
- 44. Manne head, macerator pump and holding tank
- 45. Converter (battery charger)
- 46. Appliances (stove, microwave, refig., stereo, etc.)
- 47. Water pressure system and hot water tank
- 48. All manuals and warranties packed aboard

Operation of equipment explained:

- Boat
- Engine(s)
- Accessories
- Trailer (if applicable)

Boating Safety

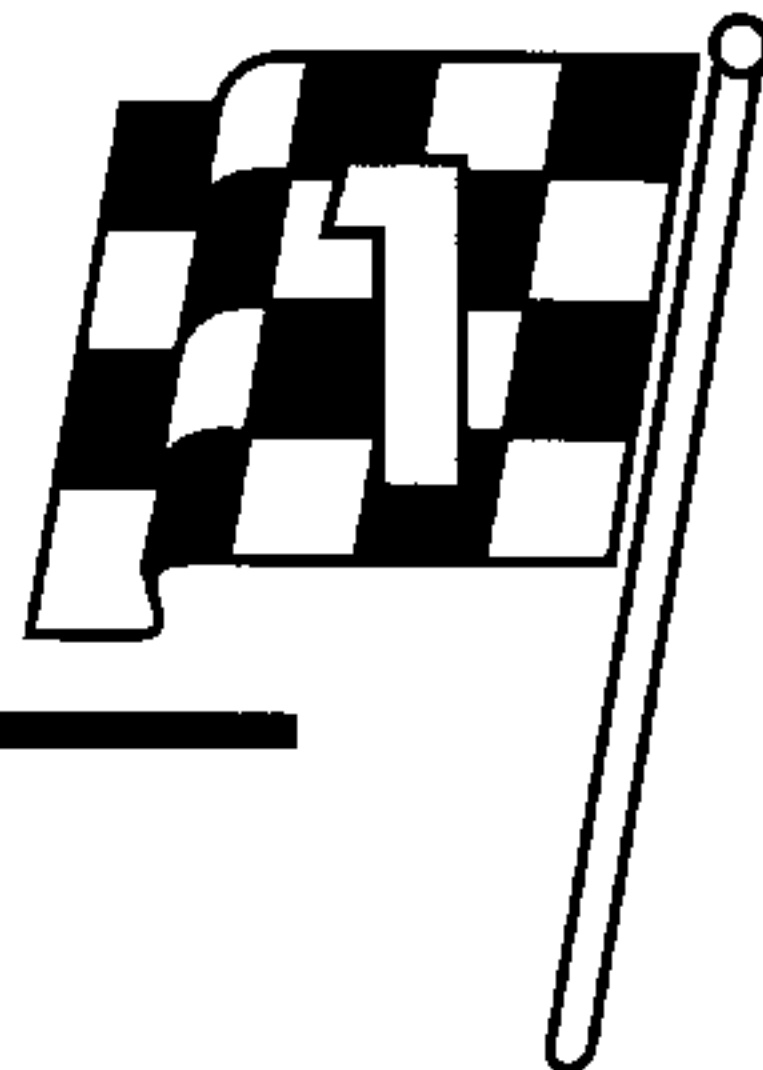

SAFETY PRECAUTIONS

The popularity of boating and other water sports have undergone an explosion of growth in the past few years. Because of this, safety is an important issue for everyone who shares in the use of our waterways. This section covers general boating safety information. Throughout this manual, specific precautions and symbols identify safety related information.

 The Safety Alert Symbol means attention! become alert! your safety is involved!

DANGER

This symbol and signal word indicate an immediate hazard. If you ignore this safety message, severe personal injury or death **WILL** result.

WARNING

This symbol and signal word indicate a potentially hazardous situation which, if not avoided, **CAN** cause **SEVERE** injury, death or substantial property damage if the warning is ignored.

CAUTION

This symbol and signal word indicate a potentially hazardous situation which, if not avoided, **WILL** or **CAN** cause minor personal injury or property damage if the warning is ignored.

NOTICE

This signal word indicates installation, operation, or maintenance information which is important but not hazard-related.

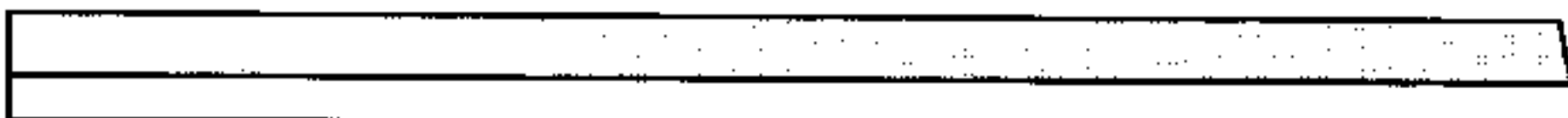

SCARAB[®]

The precautions listed in this manual are not all-inclusive. If a procedure, method, tool or part is not specifically recommended, you must satisfy yourself that it is safe for you and others and that your boat will not be damaged or made unsafe as a result of your decision. **REMEMBER - ALWAYS USE COMMON SENSE WHEN OPERATING!**

DRUGS, ALCOHOL AND BOATING

WARNING

Alcohol consumption and boating do not mix. Operating any boat while intoxicated or under the influence of drugs is both dangerous and illegal. Impaired vision or judgment on the water can quickly lead to disaster. Driving any boat, especially a high performance boat, requires sober, attentive care.

The 1994 Federal Boating Safety Act may require boaters convicted of boating while intoxicated or reckless boating to complete an approved boating safety course.

Federal laws prohibit operating a boat under the influence of alcohol or drugs. These laws are vigorously enforced.

The boat operator is responsible for the safety of all passengers. Refrain from the use of drugs and/or alcohol while operating your boat. Operation of motorized vessels while under the influence is a Federal offense carrying a significant penalty. The use of drugs and/or alcohol will decrease reaction time, impede judgment, impair vision and inhibit your ability to safely operate a boat.

BOATING REGULATIONS

The U.S. Coast Guard is the authority of the waterways - they are there to help the boating public. In addition, state boating regulations are enforced by local authorities. Some state regulations require the operator to participate in a safe boating course in order to obtain an operator's license. You are subject to marine traffic laws and "Rules of the Road" for both federal and state waterways, and you must stop if signaled to do so by enforcement officers and permit your boat to be boarded if asked.

The U.S. Coast Guard conducts random boardings of boats as part of their effort to stem the flow of illegal drugs into the country. Boardings are **not necessarily based on suspicion of illegal activities**. If you are subjected to a random boarding by the Coast Guard, be aware of the following:

- ◆ Coast Guard personnel will always properly identify themselves,
- ◆ will always be in uniform, coveralls or survival suit displaying the Coast Guard insignia, and
- ◆ will always be in a marked Coast Guard or Navy vessel flying the Coast Guard ensign.

Please provide full cooperation to official Coast Guard boarding parties. The boarding will be over quickly with minimum disruption of your outing.

There are many pamphlets prepared by the Coast Guard available to you. These pamphlets explain "Rules of the Road," signal lights, buoys, safety, international and inland regulations and much more than is presented in this manual. For more information, contact your local U.S. Coast Guard Unit or call the Coast Guard Boating Safety Hotline at 1-800-368-5647.

BOATER RESPONSIBILITIES

Registration

The Federal Boat Safety Act of 1971 requires that all boats equipped with propulsion machinery have a number obtained from the state where the boat is most often used on the water. This State, called the State of principal use, will issue a **Certificate of Number** which must be on board whenever the boat is in use. In addition, the state-issued number must be properly displayed on the forward half of the boat. Contact your state boating authorities for more information on registration. Your dealer may be able to supply you with the appropriate forms.

For boats of at least five **net** tons, another option besides registration exists; you can have your boat **documented**. When a boat is documented - in other words, issued official papers by the Coast Guard in much the same way large ships are issued papers - the numbering requirements of the 1971 Federal Boat Safety Act no longer apply to that boat. There may be several advantages to Federal documentation of your boat, including: no annual renewal fees as with state registration, no registration concerns over operating in the waters of other states and pre-

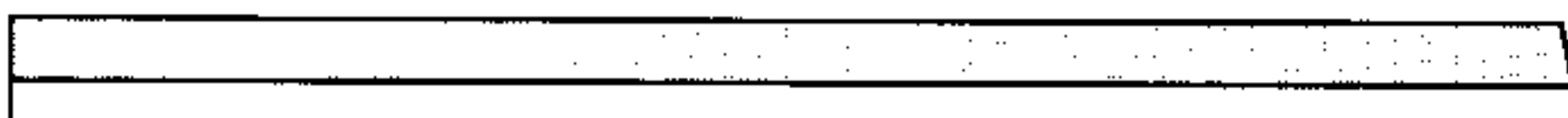

SCARAB®

ferred status for mortgages. However, your boat must be measured before it can be documented, although for pleasure boats this procedure is not complicated. Contact your local Coast Guard office for more information on documentation.

Education

This manual is not intended to provide complete training on all aspects of boat operation. We strongly recommend that all operators of this boat seek additional training on boat handling and safety. Many states require operators under the age of 18 to be licensed in small boat operation and offer courses for training and certification.

The following is a listing of some of the agencies and organizations that offer boat safety training or information:

- ◆ American Red Cross
- ◆ U.S. Power Squadrons
- ◆ U.S. Coast Guard Auxiliary
- ◆ State Boating Offices

In addition, Wellcraft has developed and highly recommends the industry-leading Wellcraft High Performance Driver and Safety School for purchasers of new twin or triple engine Scarabs. At this school, boat owners are able to learn the basics of high performance driving and boat handling from the experts at Wellcraft. Because of the high caliber of instruction, graduates of the Wellcraft High Performance Driver and Safety School are eligible for a 10% discount on boat insurance through National Marine Underwriters.

Also, a video demonstrating the fundamentals of high performance boating entitled TOP GUN is available through the National Marine Manufacturers Association (NMMA), Dept. B, 401 N. Michigan Ave., Chicago, IL 60611, (312) 836-4747.

You must make yourself and all other operators aware of the various federal, state and local laws and regulations, including those dealing with speed, noise, wake, discharge of oil, solid waste disposal, and marine sanitation disposal. You should also be familiar with the U.S. Coast Guard Boating Accident Report form. The U.S. Coast Guard Boating Safety Hotline is 1-800-368-5647 or 1-202-267-1070.

Insurance

We highly recommend that you purchase insurance before operating your new boat. Protection against loss by fire, theft or other causes, and liability protection against accidents is a must for responsible boaters. The boat owner can be legally respon-

sible for any damage or injury caused when he or someone else operating the boat is involved in an accident. Many states have laws detailing minimum insurance needs. Your insurance agent and your dealer can supply you with more information.

Owner Responsibilities Summary

1. Sign the warranty registration card including your address and the boat and hull serial numbers and mail it to us.
2. Inspect the boat at the time of delivery to verify that all systems and components are operating safely and acceptably. Read all manuals and instructions.
3. Operate all equipment in compliance with the manufacturer's instructions.
4. Review the pre-delivery checklist for the boat and engine with your dealer when you take delivery.
5. Schedule your boat's 20-hour checkup with your dealer.
6. Know your boat and the rules of the road before you use your boat.

IMPORTANT: Make sure that your dealer checks the engine alignment during your boat's 20-hour checkup. The engine alignment check should be performed in accordance with the recommended procedures as stated by the engine manufacturer in your engine owner's manual. Failure to do so could result in drive train damage which is not covered under the warranty.

7. We recommend that you reference your engine warranty certificate for initial inspection and service requirements.
8. Perform or provide for the scheduled maintenance checks outlined in this manual and all related service guides and manuals.

Along with boating, comes responsibility. Responsibility for safety, boating laws, and the environment. Please think about the future of our waterways, oceans and marine life while you're out enjoying them and take all necessary measures to help protect what natural habitats we have left. Keeping our waterways and marine habitats free from debris, and showing consideration for the creatures who thrive in these environments are some ways you can help assure the pleasure of boating for years to come.



SCARAB[®]

The operator is also responsible for complying with the following procedures and operational requirements:

- ◆ State registration
- ◆ Insurance
- ◆ Warranty registration
- ◆ Warranty terms and conditions
- ◆ Rules of the road
- ◆ Break-in procedure
- ◆ Proper maintenance of the boat and its systems
- ◆ Safety equipment
- ◆ Safety training of passengers and crew
- ◆ Knowledge of boat systems
- ◆ Seaworthiness/operational inspection
- ◆ Safe operating practices
- ◆ Avoiding use of drugs/alcohol
- ◆ Environmental regulations
- ◆ Accident reports

Dealer Responsibilities

Your dealer will complete the pre-delivery checklist with you when you take delivery of your boat. A copy of the checklist is at the end of this section. Your dealer will also provide the following services:

1. Sign the checklist to certify that your boat is in top-notch condition and that all components are working properly.
2. Discuss the terms of all warranties and emphasize the importance of registering each warranty with the manufacturer.
3. Explain the proper procedures for obtaining warranty service.
4. If requested, provide you with comprehensive instruction in the operation of your boat and all its installed systems and components.

REQUIRED SAFETY EQUIPMENT

WARNING

As the boat owner, obtaining and maintaining necessary U.S. Coast Guard approved safety equipment is your responsibility. For more information about equipment required by Federal laws in addition to safety recommendations, see the Coast Guard publication, *Federal Requirements and Safety Tips for Recreational Boats*.

MINIMUM REQUIRED SAFETY EQUIPMENT			
EQUIPMENT	CLASS 1 (16 to less than 26 ft.) (4.9 to less than 7.9 m)	CLASS 2 (26 to less than 40 ft.) (7.9 to less than 12.2 m)	CLASS 3 (40 to not more than 65 ft.) (12.2 to not more than 19.8 m)
PERSONAL FLOTATION DEVICES (PFDs)	One approved Type I, II, III or V (if used according to Coast Guard requirements) device aboard for each person on board or being towed on water skis, etc.; and, in addition, one throwable Type IV device.		
FIRE EXTINGUISHER Must say Coast Guard Approved.	At least one B-I type approved hand portable fire extinguisher (Not required on outboard motorboats less than 26 feet in length and not carrying passengers for hire if the construction of such motorboats will not permit entrapment of explosive or flammable gasses or vapors and if fuel tanks are not permanently installed.)	At least two B-I type approved portable fire extinguishers; OR at least one B-II type approved portable fire extinguisher.	At least three B-I type approved portable fire extinguishers; OR at least one B-I type plus one B-II type approved portable fire extinguisher.
VISUAL DISTRESS SIGNALS (Required on coastal waters only.)	Orange flag with black square-and-disk (day), and an S-O-S electric light (night) or three orange smoke signals, hand held or floating (day); or three red flares of hand held, meteor, or parachute type (day/night).		
BELL, WHISTLE	Every vessel less than 12 meters (39.4 ft.) in length must carry an efficient sound producing device	Every vessel 12 meters (39.4 ft.) but less than 20 meters (65.6 ft.) in length must carry a whistle and a bell. The whistle must be audible for 1/2 nautical mile. The mouth of the bell must be at least 200 mm (7.87 inches) in diameter.	

Personal Flotation Devices

Federal law requires at least one Type I, II or III USCG approved Personal Flotation Device (PFD) for each person on board or being towed on water skis; and, in addition, one throwable Type IV PFD. A Type V PFD may be substituted for any of the Type I, II or III PFDs if it is used in accordance with Coast Guard regulations.

The 1994 Federal Boating Safety Act may require children, age 12 and younger, to wear PFDs at all times whenever they are in an open deck of a boat. In addition, many states have laws requiring children under a certain age to wear a PFD. Know and follow the law in your state.

WARNING

It is especially important that children, handicapped people and non-swimmers wear a PFD at all times. Children and non-swimmers need special instruction in the use of PFDs. When suddenly thrown into an unfamiliar environment such as rough water, children and non-swimmers tend to panic. Panic causes the victim to thrash about in an attempt to "climb out" of the water. The violent movement of the arms and legs will upset the stability of the PFD so that it may not stay in the face up position. In addition, children must wear PFDs sized specifically for children.

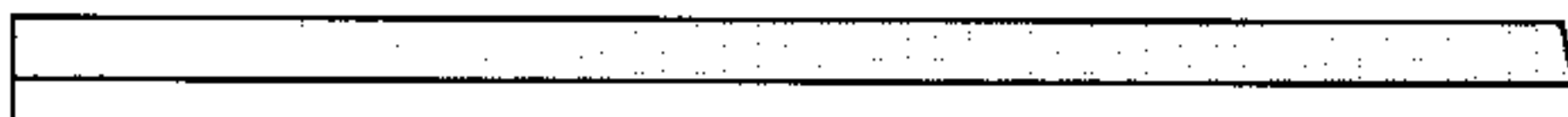

SCARAB®

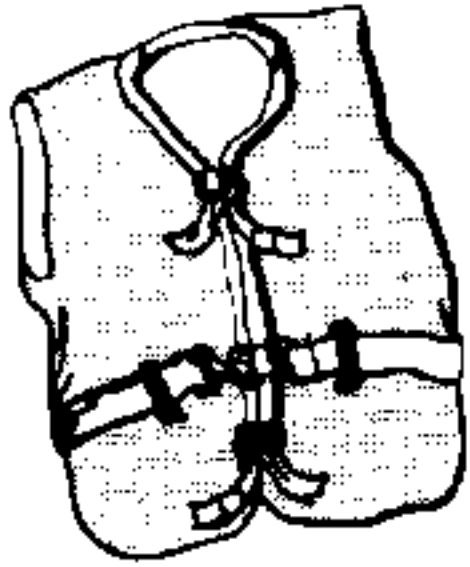

TYPE I - LIFE PRESERVERS

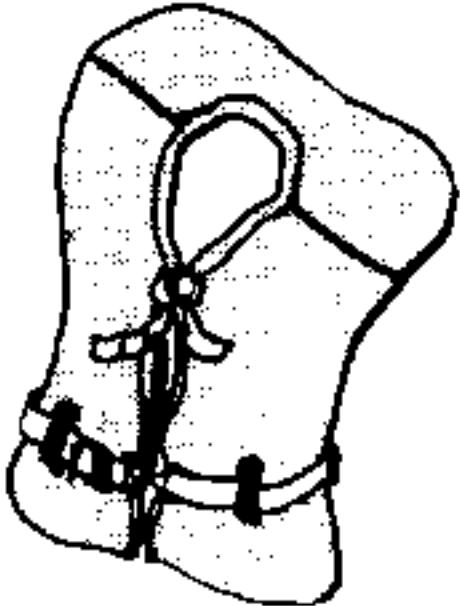

TYPE II - BUOYANT VESTS

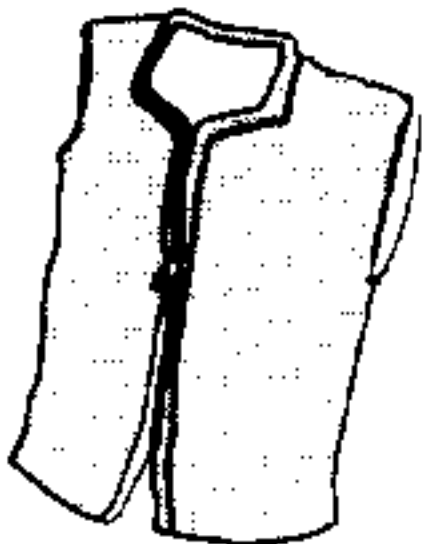

TYPE III - FLOTATION AIDS



TYPE IV
THROWABLE DEVICES

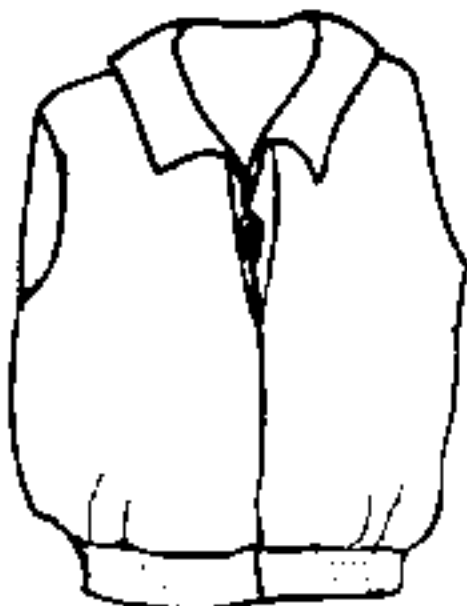

TYPE V HYBRID PFD MUST BE
WORN WHEN UNDERWAY

Children and non-swimmers should be allowed to try on their PFDs in the water. It is important that they feel comfortable in the water wearing a PFD. Parents should note, however, that PFDs are not a substitute for adult supervision.

A PFD may save your life, but only if you wear it. If you choose not to wear your PFD at all times, you must keep it in a readily accessible place - not in a closed compartment or stored under other gear. In addition, **throwable PFDs must be immediately available for use.**

Be sure to try on PFDs before heading out on the water and make adjustments for a comfortable fit. The five types of acceptable PFDs are:

Type I - good for offshore or rough water use. Will turn most unconscious persons face up in water.

Type II - good for near shore and most inland waters. Will turn some unconscious persons face up in water.

Type III - good for calm, inland waters. Designed to enhance a variety of water sports. The Type III is not designed to turn an unconscious person face up in the water, though it has the same buoyancy as a Type II.

Type IV - designed to be thrown to a person in the water. They are easy to hang on to in the water, but do not protect as well as Types I, II or III. **Cushions should never be worn on a person's back and must always be kept handy for emergency situations.**

Type V - (Special Use Device) may be substituted for any of the Type I, II or III PFDs if, and only if, these following conditions are met:

- ◆ The label on the PFD says that it is approved for the activity in which the boat is being used or is an approved substitute for a PFD of the Type required on the boat.
- ◆ The PFD is used in accordance with all requirements described on the label and in its owner's manual.
- ◆ The PFD is worn at all times when underway.

Examples of Type V PFDs include: Type V hybrid inflatable devices, boardsailing vests, decksuits and work vests among others.



WARNING

Type V Hybrids *must* be worn when underway to meet Coast Guard regulations for substitution.

Keep the following PFD points in mind:

- ◆ Set an example and wear your PFD. Ask your passengers to wear them also.
- ◆ At the beginning of each season, check PFDs for damage and test them for proper flotation.
- ◆ Remove PFDs from packaging and stow in the boat for quick access. Do not stow PFDs near grease or oil.
- ◆ Teach children how to float in the water with a PFD.
- ◆ Do not use a PFD as a boat fender.

Fire Extinguishers

U.S. Coast Guard approved fire extinguishers are required on all Class 1, 2 and 3 boats. Hand portable fire extinguishers should be mounted in readily accessible areas away from the engine compartment. Automatic extinguishers, like those installed in many Scarab models, are permanently mounted inside the engine compartment. All passengers should know the location and operating procedure of each fire extinguisher.

Any marine fire extinguisher must be classified to extinguish type B fires (gasoline, oil or grease). The size and number of hand portable fire extinguishers required depend on the length of the boat. For boats with fire suppression systems, the number of hand portable fire extinguishers required by the Coast Guard is reduced by one B-I approved extinguisher. Check each extinguisher's pressure gauge regularly for proper pressure and have the extinguisher filled if necessary.

Most Scarab models are equipped with an automatic fire extinguishing system to provide protection in the event of an engine compartment fire. The system is automatically actuated when temperatures reach a preset limit. When actuation occurs, a loud popping sound may be heard followed by "rushing" air sound. When a discharge occurs, immediately shut down all electrical and mechanical systems and powered ventilation.

WARNING

If the fire suppression system discharges, wait for at least 15 minutes before opening engine hatch. The system displaces oxygen to "smother" the fire. Opening the hatch too soon may feed oxygen to the fire and flashback can occur.

CAUTION

Fire suppression system cylinders must be accurately weighed periodically according to manufacturer's specifications to ensure that they are adequately charged.

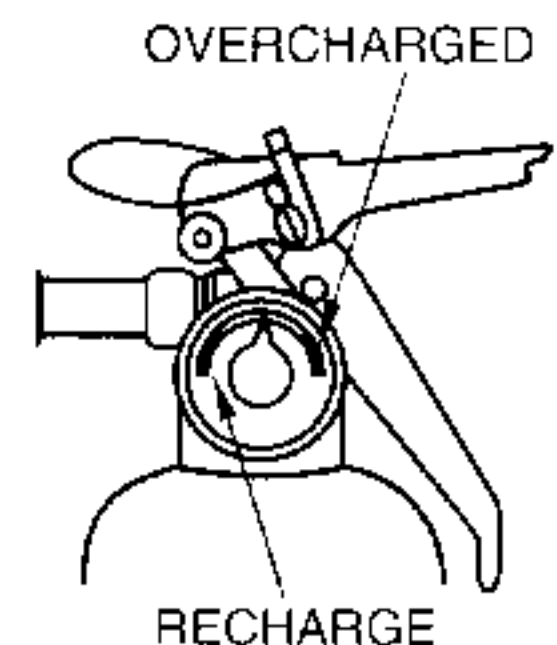

SCARAB[®]

VISUAL DISTRESS SIGNALS

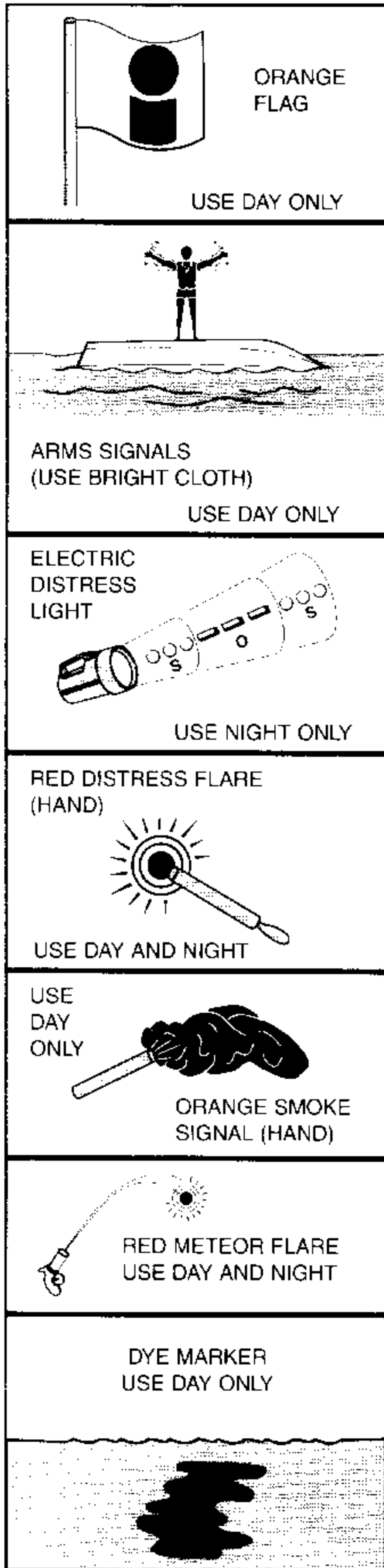

Visual Distress Signals

All boats operating on coastal waters (including the Great Lakes) are required to carry the following Coast Guard approved visual distress signals.

Day use only

- ◆ Three orange smoke signals or one orange flag with black square and disk

Night use only

- ◆ One S-O-S electric light

Day and night use

- ◆ Three flares of the hand held, meteor or parachute type

WARNING

Pyrotechnic signaling devices can cause injury and property damage if not handled properly. Follow manufacturer's directions regarding the proper use of signaling devices and always stow devices in a location out of the reach of children, yet readily available to adults.

Additional Safety Equipment

Federal Regulations do not require several items which a prudent boater would not think of leaving the dock without. For example, anchors are not required by federal law, but because of the danger of drifting into hazardous water in the event of engine failure, it would be foolish to leave the shore without an anchor.

With that in mind, the following additional safety equipment is highly recommended for safe boating:

- ◆ A proper anchor rig along with a second anchor
- ◆ A manual bilge pump
- ◆ Mooring lines
- ◆ A ring life buoy with a length of light line attached
- ◆ Fenders
- ◆ A boat hook
- ◆ A searchlight
- ◆ Charts
- ◆ An emergency supply of drinking water and food

- ◆ A first aid kit
- ◆ A sea anchor
- ◆ A portable VHF marine radio
- ◆ An Emergency Position Indicating Radiobeacon (EPIRB)

VHF Radios

Although not required by law, a radio is considered by many to be an indispensable safety item. Observe the following Coast Guard guidelines when using your VHF radio:

- ◆ Always use your radio call sign at the beginning and end of each transmission.
- ◆ Be sure only qualified persons operate the radio. Know the rules.
- ◆ Limit calls to other vessels to 30 seconds. If no reply is received, wait 2 minutes. Try again. Keep communications brief- avoid chit-chat.
- ◆ Use low power when feasible to avoid interfering with other important communications.
- ◆ Never transmit false distress messages and never use profanity on the air.

The Coast Guard continually monitors Channel 16 for distress signals. If you are in distress (where you or your boat are threatened by **grave or imminent danger requiring immediate assistance**) use MAYDAY, MAYDAY, MAYDAY on Channel 16.

Your dealer can provide you with information on the operation and licensing of VHF radios. To obtain a VHF license, you need to fill out an FCC Form 506.

Emergency Position Indicating Radiobeacon (EPIRB)

Every boat that goes offshore (beyond reliable VHF radio range) should carry a battery powered class A EPIRB (which is activated automatically when tossed into the water) or a Class B EPIRB (which is manually activated). These devices transmit a distress signal which can be picked up by military and commercial aircraft as well as passing satellites.

EPIRBs should be checked for readiness while underway by operating the test switch for one second only during the first five minutes of every hour on the water.

Like radios, EPIRBs must be licensed; but the small inconvenience and expense is worthwhile. There have been many instances of the survivors of a sunken boat being rescued with the help of an EPIRB.



SCARAB®

CARBON MONOXIDE AND BOATING

DANGER

Carbon monoxide (CO) is an odorless and colorless gas. You cannot see it or smell it. Inhaling it for a short time can cause unconsciousness and brain damage. Prolonged exposure can kill!

Carbon monoxide (CO) is an odorless and colorless gas about the same weight as air. Because of this, CO will distribute itself throughout an enclosed space and cannot be detected by sight or smell. Sources of CO shipboard include exhaust from engines and generators, space and water heaters, cooking stoves, and any other device used to burn carbon based materials such as charcoal grills; **EITHER FROM YOUR VESSEL OR OTHERS AROUND YOU!**

CO in high concentrations can be fatal in a matter of minutes. Lower concentrations can cause health-related problems and because effects are cumulative, can be lethal over a period of time. Common CO poisoning symptoms include: watering and itchy eyes, flushed appearance, throbbing temples, inability to think coherently, ringing in the ears, tightness across the chest, headaches, drowsiness, nausea, dizziness, fatigue, vomiting, collapse and convulsions.

If any of the above symptoms are evident, treatment must begin immediately! **Prompt action can make the difference between life and death.** Evacuate the area and move the person to fresh air. Administer oxygen if available and get medical help.

Open all windows and hatches to ventilate the area. Investigate the source of CO and take immediate corrective action; be especially aware of sources adjacent to the boat.

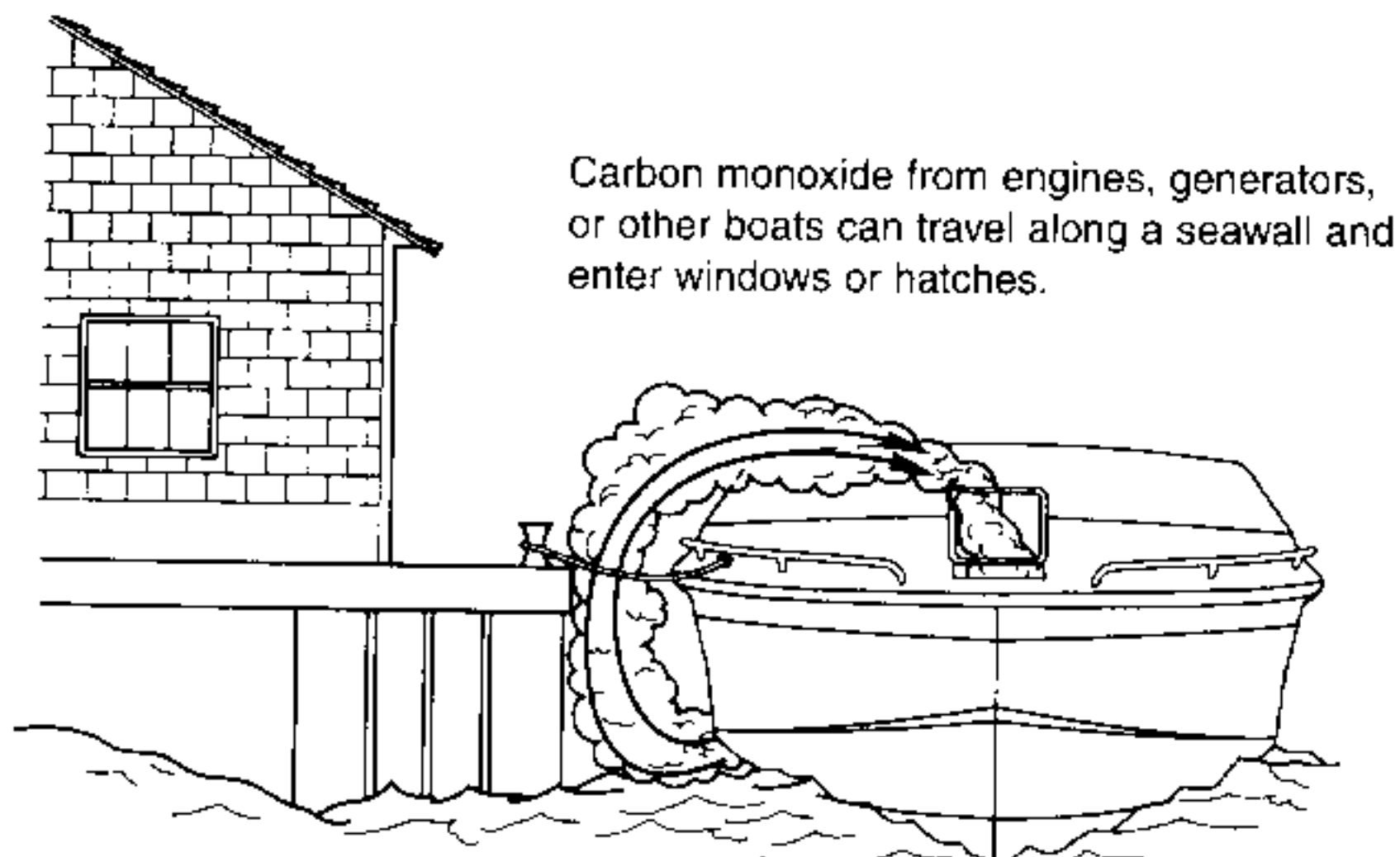

Boathouses, seawalls and other boats in close proximity and/or confined areas can contribute to increased CO levels. Operators must be aware that the operation, mooring and anchoring in an area containing other boats may contain CO not of the operator's making or, likewise, operators must be aware of the affect of his actions on other boats. *Operation of the engines while moored may affect CO concentrations on your vessel and others around you!*

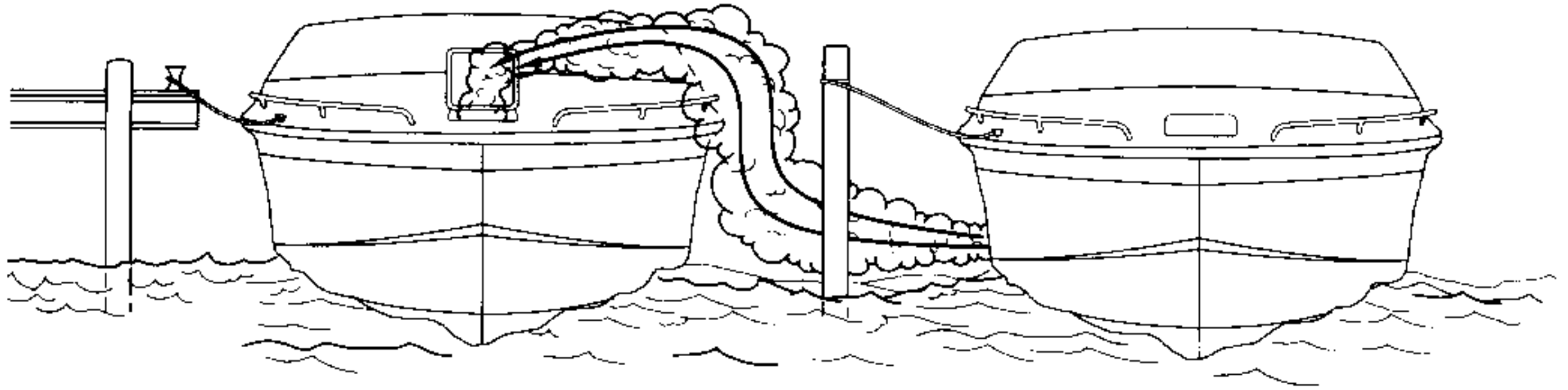

While underway, CO concentrations can increase by what is known as backdrafting or "station wagon effect." Backdrafting is affected by factors such as relative wind direction, speed and inefficient trim angles (bow too high). The general rule of thumb while underway is to avoid low pressure pockets that allow CO to enter spaces by providing positive air flow through the hull. This can be accomplished by opening hatches and operating blowers whenever possible.

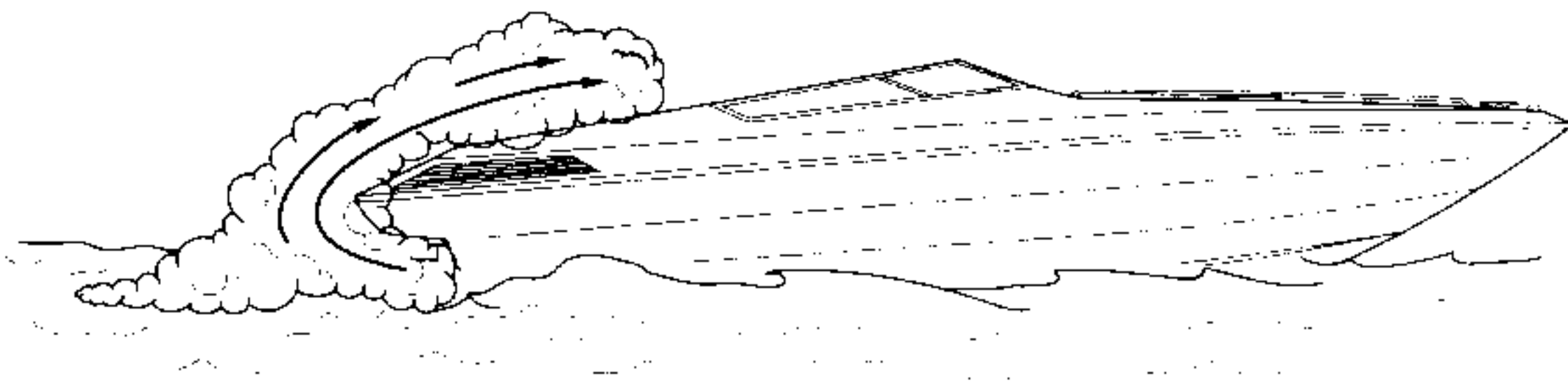

BACKDRAFTING - Station Wagon Effect (Inefficient Trim Angle)
Under certain conditions, moving air currents can direct carbon monoxide fumes into the boat. These fumes can accumulate to dangerous levels without proper airflow.

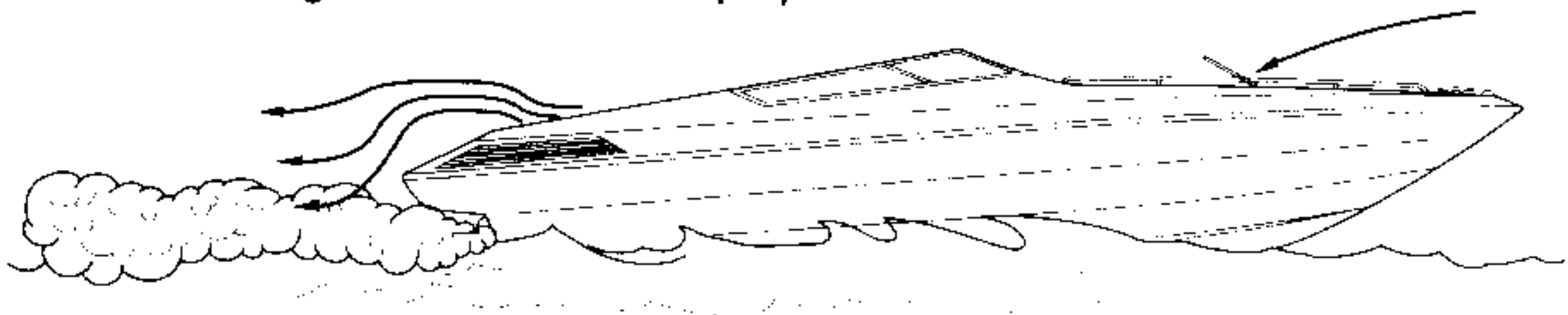

DESIRED AIRFLOW THROUGH THE BOAT



SCARAB[®]

Even with the best of boat design and construction plus utmost care in inspection, operation, and maintenance, hazardous levels of CO may still be present in accommodation spaces under certain conditions. Continuing observation of passengers for symptoms of CO intoxication can be supplemented by an alarm type CO detection device in the accommodation space.

EMERGENCIES

Be prepared to deal with emergencies before they happen. Try to formulate a plan for each type of emergency in advance so that decisions can be made quickly and without hesitation. Precious moments lost can mean the difference between losing and saving a life.

Reporting

In the event of an accident, the operator of the boat is responsible for filing a report with the appropriate state authorities. In general, reports are necessary for accidents involving loss of life, injury or property damage over \$500. In the case of accidents with reportable injuries or death, a formal report is required within 48 hours. If only property damage is involved, a report must be made within ten days. The 1994 Recreational Boating Act may impose a \$1,000 civil fine for people who fail to submit a boating accident report.

Giving Assistance

If you see a distress signal, you must assume it is a real emergency and render assistance immediately. By law, the operator of a boat must render assistance to any individual or boat in distress as long as his boat is not endangered in the process. The 1971 Boating Safety Act grants protection to a "Good Samaritan" boater offering good faith assistance and absolves a boater from civil liability arising from assistance given.

Flooding

If you suspect flooding, activate the bilge pump(s) immediately. Open the engine compartment and look for the cause. Check all hoses, through hull fittings, sea cocks and strainers. If flooding occurs as a result of collision or grounding damage, call for assistance and head for shore if possible.

Collision

If your boat collides with another boat, pier, signal marker or other object, you must first check for injuries before heading to shore. If flooding occurs, activate the bilge pump(s) and try to

stop the leakage with tape, clothing or whatever else is available. If the damage is at or above the waterline, plane the boat if possible and head for port. Radio ahead so the boat can be removed from the water when you get there.

Medical Emergency

Accidents can happen while boating. Be prepared to handle medical emergencies by keeping a first aid kit and dry blankets on board. Contact your local Red Cross for information on first aid and CPR training.

A basic education on the proper action to take for hypothermia, bone fractures, bleeding, shock and other common emergencies is a must for all captains.

Propulsion Failure

If you experience problems with an engine or drive unit, you must first eliminate the possibility of simple problems before calling for help. Turn off the engine(s) and check the following:

- ◆ Is there fuel in the fuel tank?
- ◆ Is the fuel manifold turned off or drawing from an empty tank?
- ◆ Are the engine cooling water sea strainers clogged?
- ◆ Is the propeller fouled with weeds, netting, etc.?
- ◆ Is there a leak in a hose?
- ◆ Is there oil in the engine?

Once you have verified the above problems are not the fault, call for help giving your position and a detailed description of your boat. Boats with twin and triple engines can "limp" back to port with a single engine if possible.

Control Failure

In the unlikely event of a control failure, shut down the engine(s) immediately. If necessary, turn off the ignition switch(es) or pull the ignition interrupter lanyard. Carefully check the control connections in the engine compartment to see if they are secure. If not, try to locate the attaching hardware and reassemble. If that is not possible, try to use whatever is available such as paper clips, hair clips, tape, etc. to secure the connections. If a temporary repair is made, return to port at the slowest steerable speed and be prepared to take emergency action should the tempo-

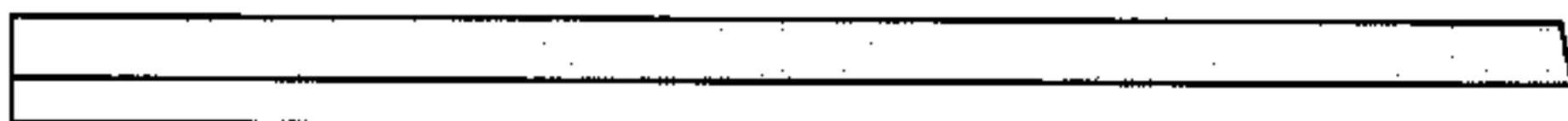

SCARAB[®]

rary repair fail also. Have your dealer make repairs before using the boat again.

Steering Failure

If the helm does not respond, or changes response from steering input, shut down the engine(s) immediately. Check the steering connections to the drive unit in the engine compartment. Some boats have a push/pull cable while others will have hydraulic hose connections.

With cable connections, check the attaching hardware and tighten if necessary. If hydraulic hose connections are leaking, tighten the connections and check the hydraulic reservoir level. Most drives are power assisted and have their own hydraulic reservoir and engine mounted drive pump; check the reservoir level and engine mounted drive pump belt.

If the steering is not operating properly, do not operate the boat - call for assistance.

Fires

Most fires occur just after refueling. They are usually caused by careless fueling practices such as spilling fuel or smoking while fueling.

In the event of an on board fire, stop the engines and work fast. Direct a fire extinguisher at the base of the flames using a sweeping motion. Remember that most hand portable marine fire extinguishers **have a discharge time of only 8 to 20 seconds**. If practical, throw burning materials into the water.

In the event of an engine compartment fire, shut off the fuel supply first if possible (while the fuel manifold for most Scarabs is located inside the engine compartment and, therefore, inaccessible in the event of an engine fire, fuel shutoff valves for some tanks are located under deck plates in the cockpit floor), then direct a fire extinguisher at the base of the flames using a sweeping motion if your boat is not equipped with a fire suppression system. If your boat has a fire suppression system:

- ◆ Shut off all electrical power, including the engine ignition and blower. **Do not open the engine compartment!**
- ◆ Have all passengers put on PFDs and get your portable fire extinguisher ready.
- ◆ Allow 15 minutes for the system's agent to "soak" in the engine compartment and, during this time, make radio contact for help if you are away from the dock.

If you are unable to control the fire, get off the boat if you are docked or, if you are out on the water, get out of the boat and swim at least 25 yards upwind from the boat and use the visual distress signals to get assistance. Gasoline will float on top of water and can burn. If you have to abandon your boat, swim upwind far enough to avoid fuel that may spread over the surface of the water.

Deciding on abandoning the boat or staying to fight the fire is difficult and depends on many factors. **Try to formulate a fire plan in advance to make that decision quickly and without hesitation.**

Capsizing Or Man Overboard

By far, the largest number of boating fatalities involve capsizing and falling overboard accidents. By being prepared ahead of time with an appropriate plan of action, you can greatly lower your chance and your passengers' chances of becoming a tragic statistic.

Capsizing - A boat may capsize or swamp when least expected. Like planning for fires, try to plan in advance for capsizing. Keep in mind the following guidelines:

- ◆ Wear PFDs or have them on hand at all times.
- ◆ If you capsize and others were on board, try to locate them and guide them to the safety of the hull.
- ◆ **Stay with the boat as long as it is afloat.** Climb up on the hull, or hold on to it, and try to remain calm and wait for assistance. Use a visual distress signal to alert rescuers to your position.
- ◆ Don't try to swim to shore. It's usually farther than it looks.

Man Overboard - Think through the following guidelines and formulate an action plan to use in the event that a passenger should fall overboard:

- ◆ Remember, every second counts. You must act fast.
- ◆ Move throttles to idle position immediately and yell "MAN OVERBOARD."
- ◆ Throw some floating object overboard immediately. Keep your required Type IV PFD accessible at all times for such an emergency.
- ◆ Keep the person in the water in sight at all times. Have a passenger do nothing but watch the person.

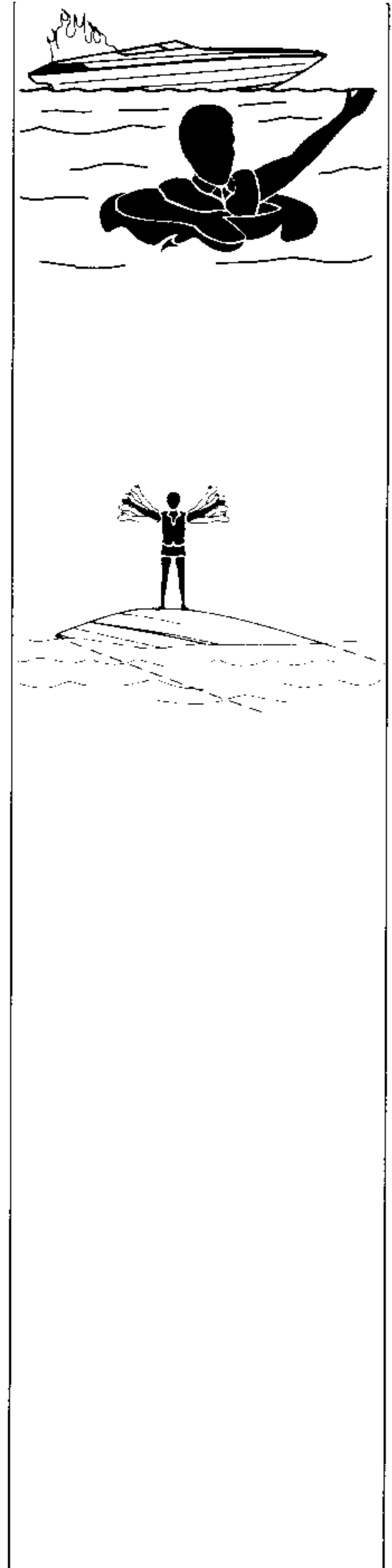

- ◆ Have a passenger ready to aid the person in the water by removing any excess clothes and **putting on a PFD**.
- ◆ Approach from downwind and stop a short distance from the person in the water, pass them a line, then put the engine(s) in neutral to stop the propeller(s).
- ◆ If the person is not immediately rescued, get on VHF channel 16 with the urgent communication signal "Pan-Pan" - pronounced "Pahn-Pahn" - spoken three times before the call to get help from the Coast Guard and nearby boats (do not use "Mayday," this is for craft in distress only).

HAZARDOUS CONDITIONS

Every waterway poses hazards that you should avoid: shallow water, tree stumps, sandbars, etc. Ask local boaters for information and consult a marine chart when boating on unfamiliar waters. The following information is only a partial list of all the possible water hazards.

Weather

Storms - Take common sense precautions if you are forced to operate your boat in stormy conditions:

- ◆ Wear PFDs.
- ◆ Stow gear below deck.
- ◆ Reduce speed and head for the nearest place of refuge.
- ◆ If you lose power, keep the boat headed into the waves by rigging a sea anchor off the bow.

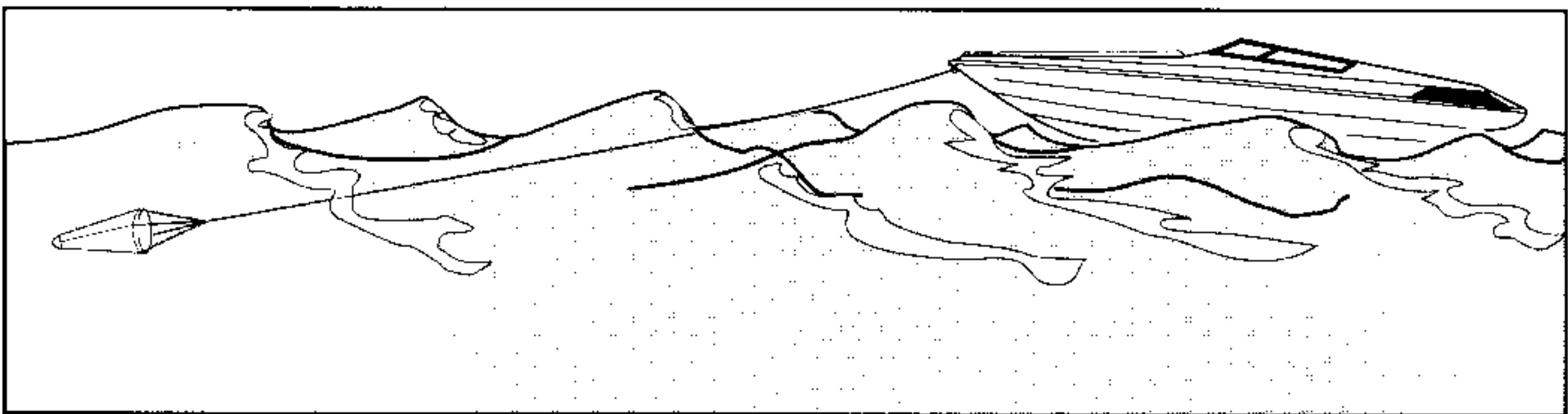

Fog - It is best to avoid operating your boat in foggy weather. When fog sets in suddenly, slow down, take bearings and log course and speed. You are required to emit a five second blast from your horn or whistle once every two minutes. Additionally, have passengers wear PFDs and watch for oncoming vessels.

Shallow Water Operation

Operating in shallow water can present a number of hazards. If the drive unit strikes an underwater hazard, check for boat and drive unit damage. If the engine vibrates excessively after striking an underwater obstruction, it may indicate a damaged propeller. If vibration is noticeable, return to port slowly to prevent further drive and engine damage from an out-of-balance condition.

In coastal areas, tides can change water levels by as much as 30 feet. Check with local marinas or Coast Guard stations for tide tables and current charts.

Sand Bars/Grounding

Sand bars in narrow inlets are constantly shifting, making it difficult to mark them with buoys. Sometimes sand bars are indicated by waves as they form into breakers when passing over sand bars. If you ground your boat on a sand bar, shut down the engine(s) and seek help from another boater or radio for help.

If you should ground your boat, see your Scarab dealer as soon as possible - sand ingested into the engine cooling system is a major cause of engine damage.

Warning Markers

It is a good idea to ask local authorities if there are hazardous areas and how they are marked. Boaters must also recognize the flag designs which indicate that scuba divers are present and keep well clear of the area.

Watch for swimmers. Swimming areas may not be marked. Steer clear from the area and always remain alert.

Distress flags indicate a fellow boater is in need of assistance.

Navigation markers serve as a means of identifying navigable routes and indicate water hazards. Boaters should become familiar with navigation markers and stay within marked boundaries and clear of hazards.

PASSENGER SAFETY

The operator of a boat is responsible for the safety of all passengers. On high performance boats, special precautions must be taken to ensure the safety and comfort of passengers. Passengers must be made aware of the possibility of being seriously injured if they are not securely braced while the boat is running at high speeds.

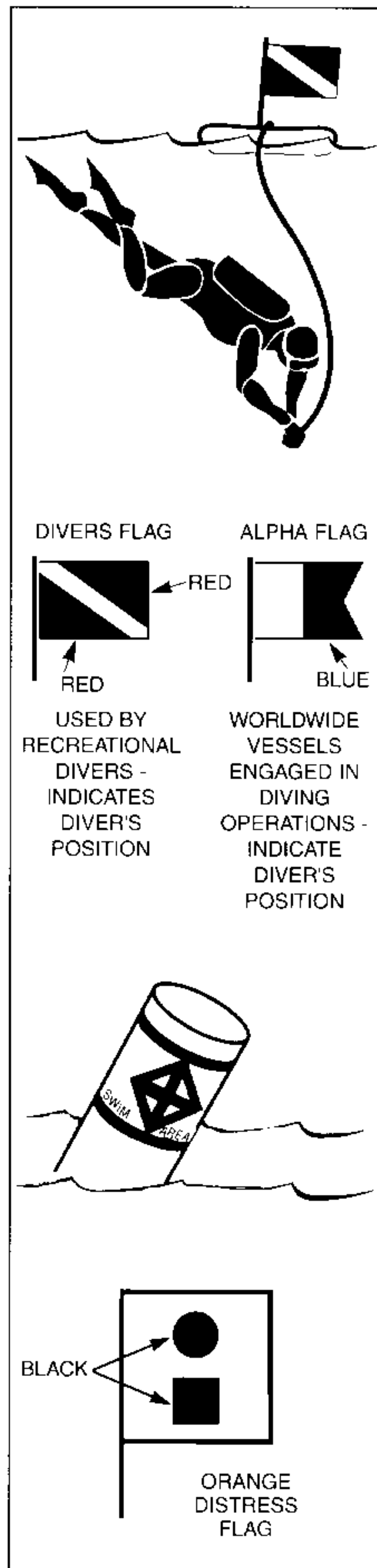

SCARAB

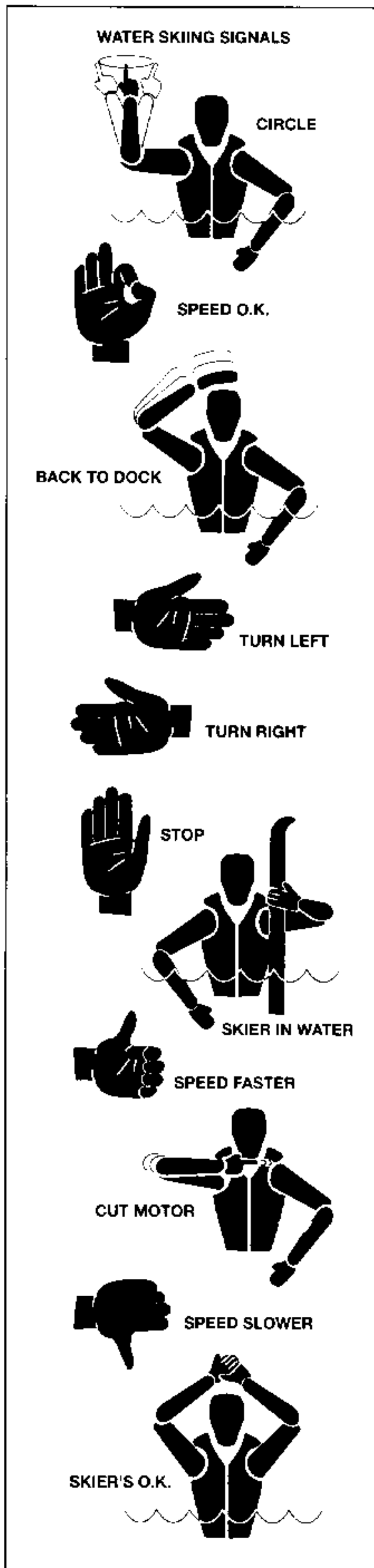

Whenever you are going for an outing with guests, make sure that at least one passenger is familiar with the operation and safety aspects of the boat in case of emergency. Show all passengers the location of emergency equipment and explain how to use it. Don't allow passengers to drag their feet or hands in the water or sit on the bow, deck or gunwale while the boat is moving.

OPERATION BY MINORS

Minors should always be supervised by an adult whenever operating a boat. Many states have laws regarding the minimum age and licensing requirements of minors. Be sure to contact the state boating authorities for information.

SAFE OPERATION

Avoid product misuse including but not limited to the following:

- ◆ Riding seat back, gunwhale, engine cover, bow or other unsafe positions.
- ◆ Failure to use handhold or purchase points.
- ◆ Overloading or improper handling.
- ◆ Excessive speed for the operating conditions.
- ◆ Speed in excess of the local legal limit.
- ◆ Use in weather or sea conditions beyond the skill or experience of the operator or the comfortable capability of the boat or passengers.
- ◆ Continued operation with operator's visibility blocked or impaired.
- ◆ Operating under the influence of drugs or alcohol.

WATER SPORTS

When using your boat for water sports, be safe and courteous and follow these guidelines:

- ◆ Be considerate to others you share the water with.
- ◆ Stay clear of other boats, skiers and fishermen.
- ◆ Return immediately to a fallen skier.
- ◆ Never swim alone or at night.
- ◆ Turn off engine and anchor your boat before swimming.

WARNING

Skiers must wear a USCG approved flotation device. A type III water-ski vest is an approved and practical PFD.

Keep at least 100' away from all other objects.

When skiing, have an experienced driver and aft-facing observer in the boat.

Never ski in shallow water or at night.

Never jump from a moving boat.

Always keep a downed skier in sight.

Turn the engine(s) OFF before you get close to someone in the water.

Do not allow the skier(s) near the propeller(s), even when the engine is off. Propeller blades can be sharp and can continue to turn even after the engine is off.

OZONE DEPLETING SUBSTANCES

WARNING

Your boat may contain CFC-12 substances which harm public health and the environment by destroying ozone in the upper atmosphere.

Although Wellcraft Marine has eliminated the use of ALL Class I ozone depleting substances from its manufacturing process, your Scarab may be equipped with products such as refrigeration units and fire suppression systems which contain a Class I ozone depleting substance. In order to help safeguard the environment, it is important to follow the manufacturer's recommendations for the maintenance of items which contain CFCs.

For more information on the Environmental Protection Agency's (EPA) rule requiring the above warning, call the Stratospheric Ozone Information Hotline at 1-800-296-1996.

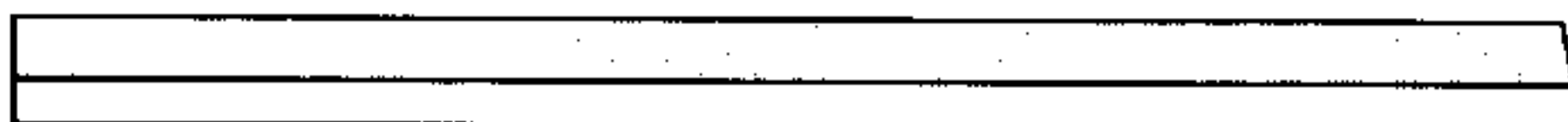

SCARAB[®]

SUMMARY

Your safety, the safety of your passengers and the safety of other boaters are among your responsibilities as operator of this boat. Your boat must be in compliance with U.S. Coast Guard safety equipment regulations. You should know how to react correctly to adverse weather conditions, have good navigation skills and follow the "Rules of the Road" as defined by the Coast Guard and state/county/local regulations.

You must never operate a boat while under the influence of alcohol or any other drug. You are also responsible for the alcohol/drug use and on board behavior of your passengers. Drugs reduce your reaction time and affect your better judgment. When combined with the sun, wind, noise and activity of boating, drugs compound fatigue and can be very dangerous.

Before each outing you should check all safety equipment such as bilge pumps, fire extinguishers, PFDs, flares, distress flags, flashlights, ignition interrupter switch, etc. They should be operable, readily visible and easily accessible.

Complete a float plan and tell someone of your travel plans. Check local weather reports before casting off. Do not leave the dock area when strong winds and electrical storms are in the area or predicted to be in the area.



WARNING

Read and understand this manual and all other manuals provided with your boat. Be sure that you understand all controls and operating instructions before attempting to operate the boat. Improper operation can be extremely dangerous.

Basic Rules of the Road



WARNING

The nautical Rules of the Road must be followed to prevent collisions between vessels. Like traffic laws for automobiles, the operator is legally required to follow safe operating rules.

Copies of the Navigation Rules may be obtained from the Superintendent of Documents, U.S. Government Printing Office, Washington, DC 20402. (202) 783-3238.

The following information outlines only the most basic of the nautical Rules of the Road. For more information, contact your local U.S. Coast Guard Auxiliary or other boating education agency.

NOTICE

The U.S. Coast Guard requires that a copy of the Inland Navigation Rules be carried on board any boat 39.4 feet or more in length.

AIDS TO NAVIGATION

Learn to recognize the different buoys and day markers - they are the signposts of the waterway. In the U.S., two major navigation systems are used: the **IALA-B Lateral System** maintained by the U.S. Coast Guard on all waters under federal jurisdiction and the **Uniform State Waterways Marking System (USWMS)** maintained by each state on waters that lie wholly within its boundaries. The type of buoys and markers used as aids to navigation depend upon the area of jurisdiction. Check with local boating authorities for information on the system used in your area.

The only buoys you are permitted to moor to are mooring buoys. Mooring to a navigation buoy or other navigational aid or regulatory marker is illegal.

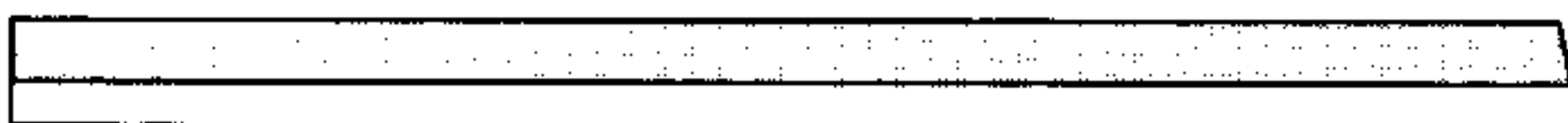

SCARAB[®]







IALA-B Lateral System

The IALA-B Lateral System applies to all waters under federal jurisdiction. The traditional phrase, "red, right, returning," will help you remember the IALA-B Lateral System:

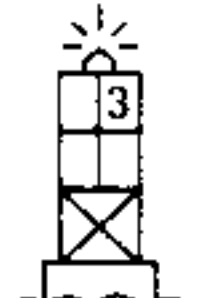
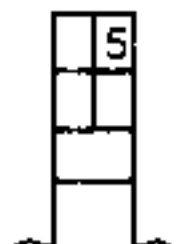
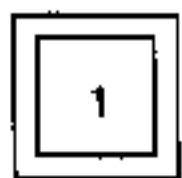
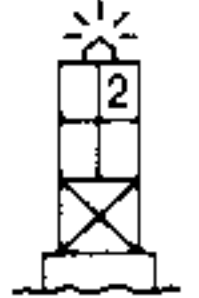
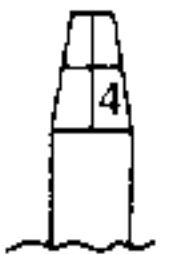
When entering a channel from seaward (returning from sea), the right side (starboard) of the channel is marked with RED, even numbered buoys. The left (port) side of the channel is marked with GREEN, odd numbered buoys.

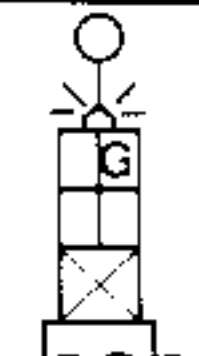
The middle of the channel is marked with RED and WHITE vertically striped buoys-pass close to these buoys.

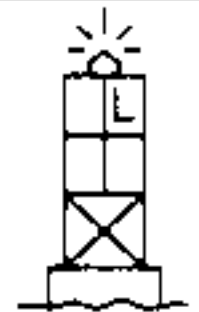
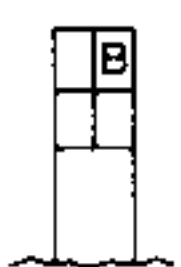
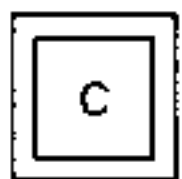
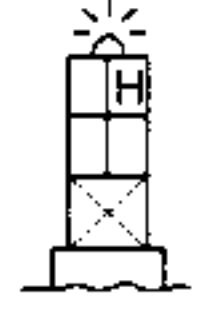
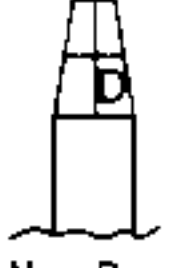
Obstructions, channel junctions, etc. are marked with RED and GREEN horizontally striped buoys. A RED band at the top means the preferred channel is to the left of the buoy; a GREEN top band means the preferred channel is to the right of the buoy.

Federal Waterways Marking System (FWMS)				
Lateral Aids Marking the Sides of Channels as seen When Entering From Seaward	Port Side Odd Numbers (Green)	 Lighted Buoy (Green Light)	 Can Buoy	 Daymark
	Starboard Side Even Numbers (Red)	 Lighted Buoy (Red Light)	 Nun Buoy	 Daymark
Safe Water Aids Marking Mid-Channels and Fairways (No Numbers—May be Lettered)	(Red)	 Lighted (White Light)	 Spherical Buoy	 Daymark
Preferred Channel Aids (No Numbers—May be Lettered)	Preferred Channel to Starboard (Green and Red)	 Lighted Buoy (Green Light)	 Can Buoy	 Daymark
	Preferred Channel to Port (Green and Red)	 Lighted Buoy (Red Light)	 Nun Buoy	 Daymark

Day markers are colored and numbered the same as buoys. RED, triangular day markers with even numbers mark the starboard side of the channel. GREEN, square day markers with odd numbers mark the port side of the channel.

Intracoastal Waterway

On the Intracoastal Waterway (ICW), the coloring of the buoys conforms with the lateral system described above with minor exceptions. Along the entire length of the ICW proceeding south from New Jersey, around Florida and west to Texas, green buoys will be on the left side of the ICW and red buoys will be on the right side. In addition, ICW buoys have a distinctive yellow marking which identifies the ICW route.

USWMS System

The Uniform State Waterways Marking System (USWMS) is a common aids to navigation system used by states on waters wholly within their boundaries. In the USWMS System, well-defined channels are marked with red and black buoys, and boats should pass between them. When traveling upstream, black buoys mark the left side of the channel and red buoys mark the right side of the channel.

The USWMS Cardinal System is used when there is no well-defined channel or where an obstruction may be approached from more than one direction. With the cardinal system:

- ◆ Pass north or east of BLACK-TOPPED WHITE buoy.
- ◆ Pass south or west of RED-TOPPED WHITE buoy.
- ◆ RED and WHITE VERTICALLY STRIPED buoy indicates boat should pass outside of the buoy (away from shore).

Uniform State Regulatory Markers

USWMS regulatory markers are white with international orange geometric shapes; you must obey regulatory markers.

Lights, bells and horns are used on buoys for night or poor visibility conditions. Buoys with unique light flashing characteristics are identified on nautical charts with the specific flashing pattern.



SCARAB®

UNIFORM STATE WATERWAY MARKING SYSTEM (USWMS)

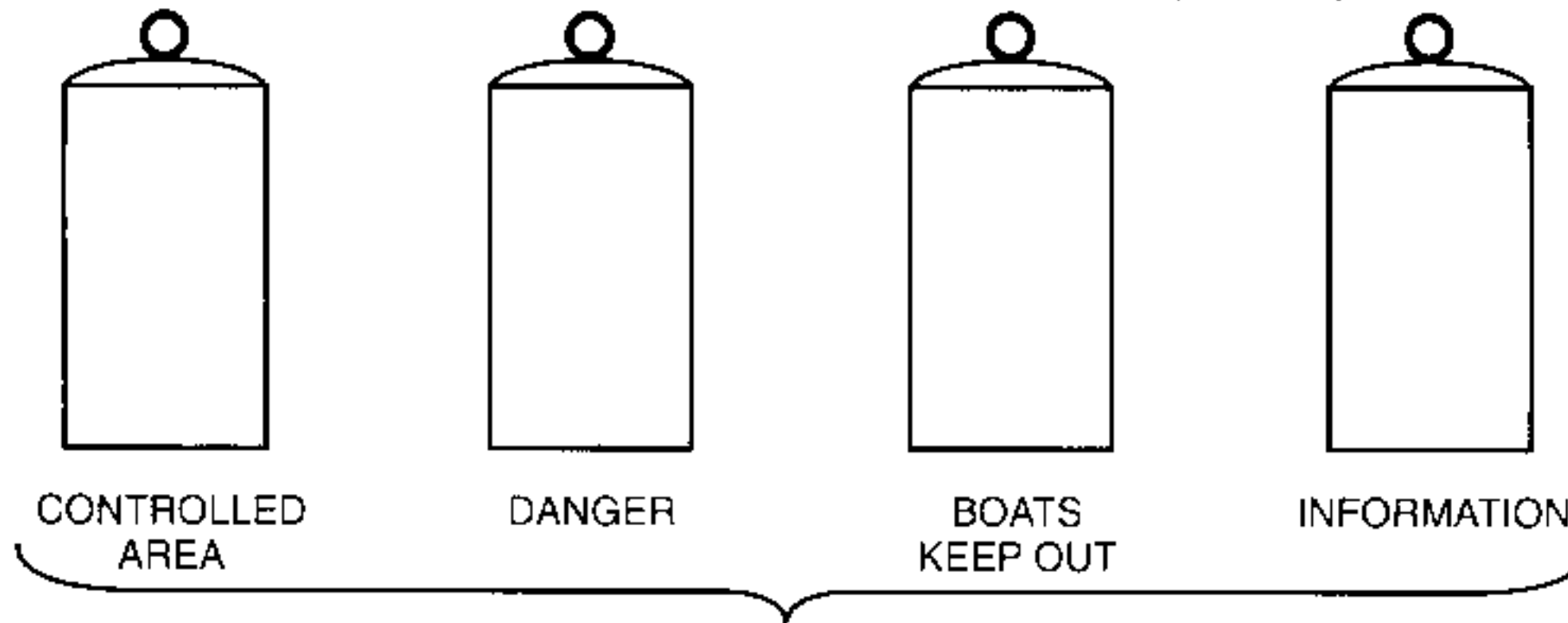

WHITE WITH INTERNATIONAL ORANGE

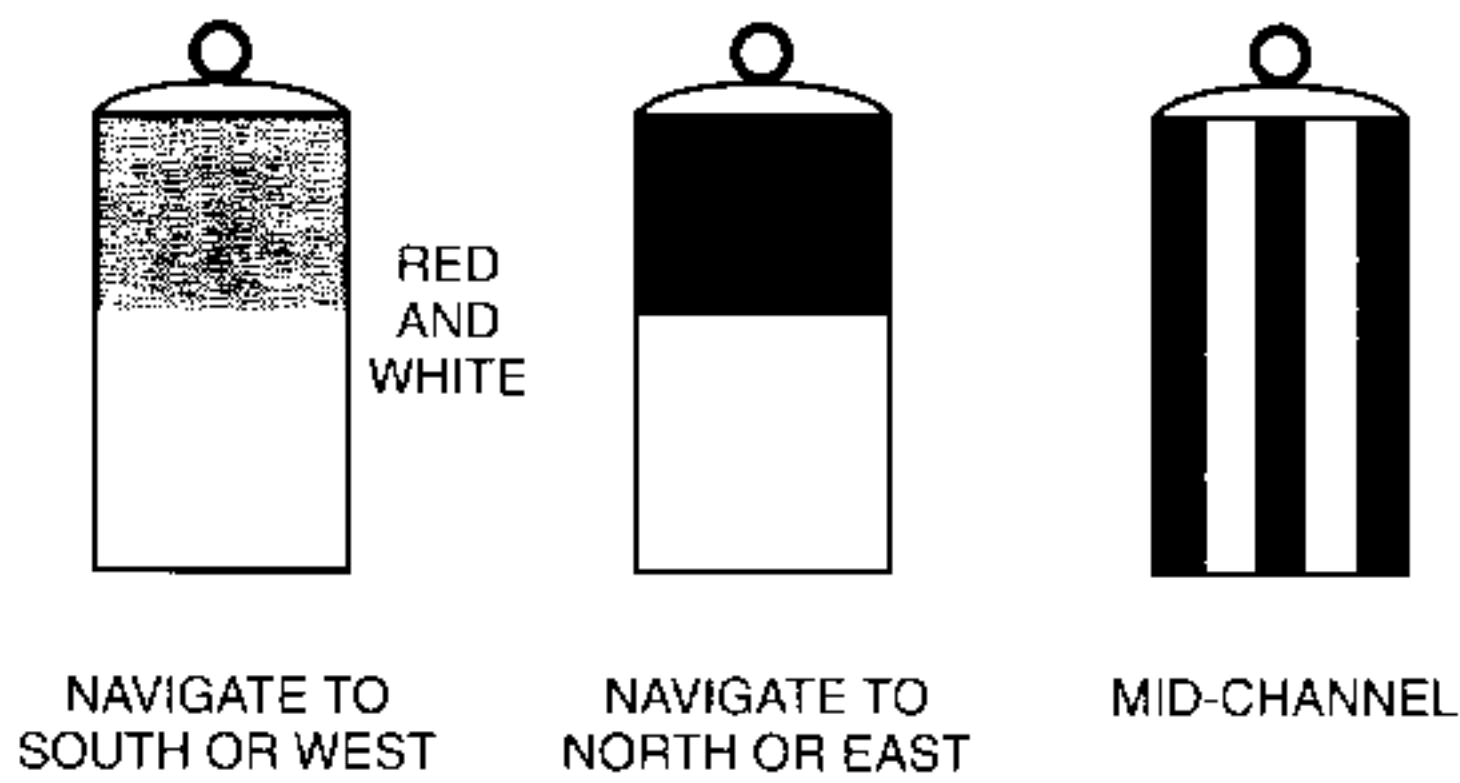
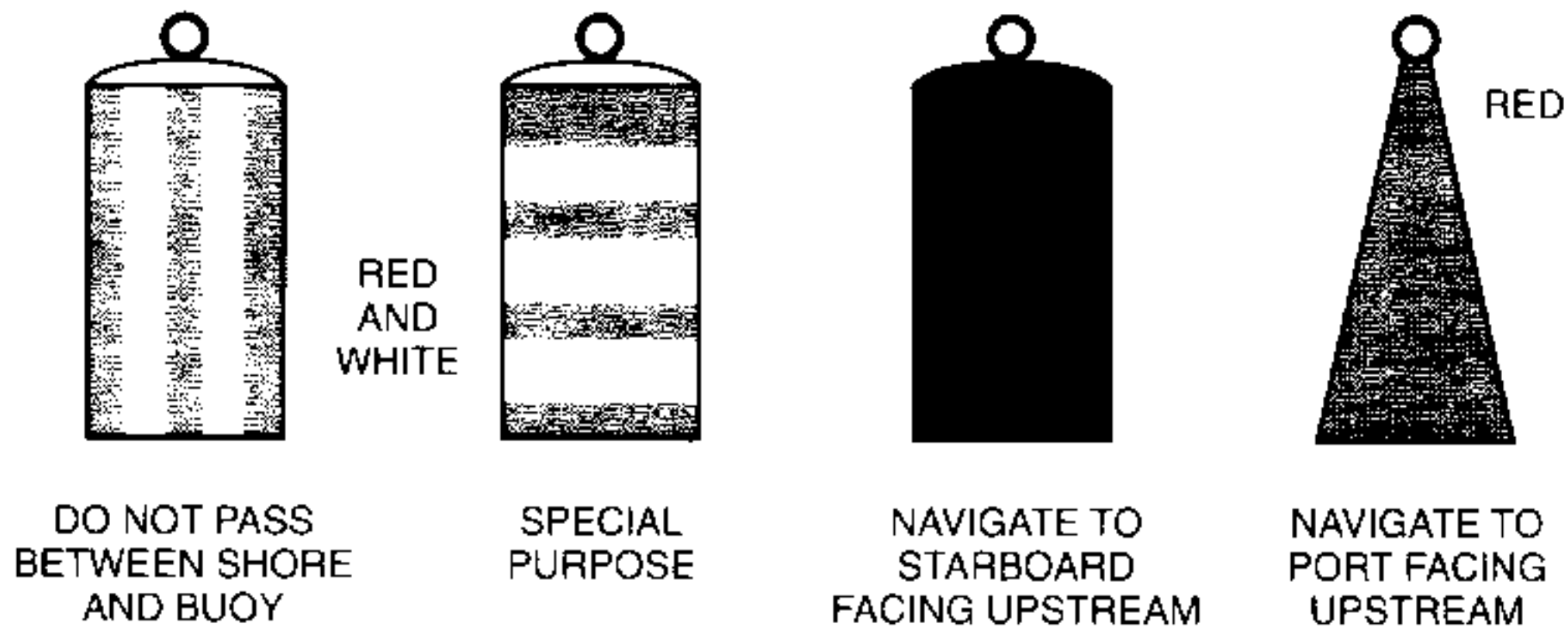

Light Structures

Maneuvering a boat at night can be dangerous and confusing. To aid boaters with navigation and warn of hazards, the U.S. Coast Guard, along with state and local authorities, maintains a variety of light structures.

Minor Lights - are colored according to the buoyage marking system in use. They are similar to lighted buoys, except they are usually higher and on more stable platforms to increase visibility. Most minor lights are part of a series to mark a channel, river or harbor.

Range Lights - are usually visible in one direction and help a boat operator navigate in a generally safe direction. Steering a course to keep range lights arranged in a line (one on top of the other) will help guide a boat through a channel.

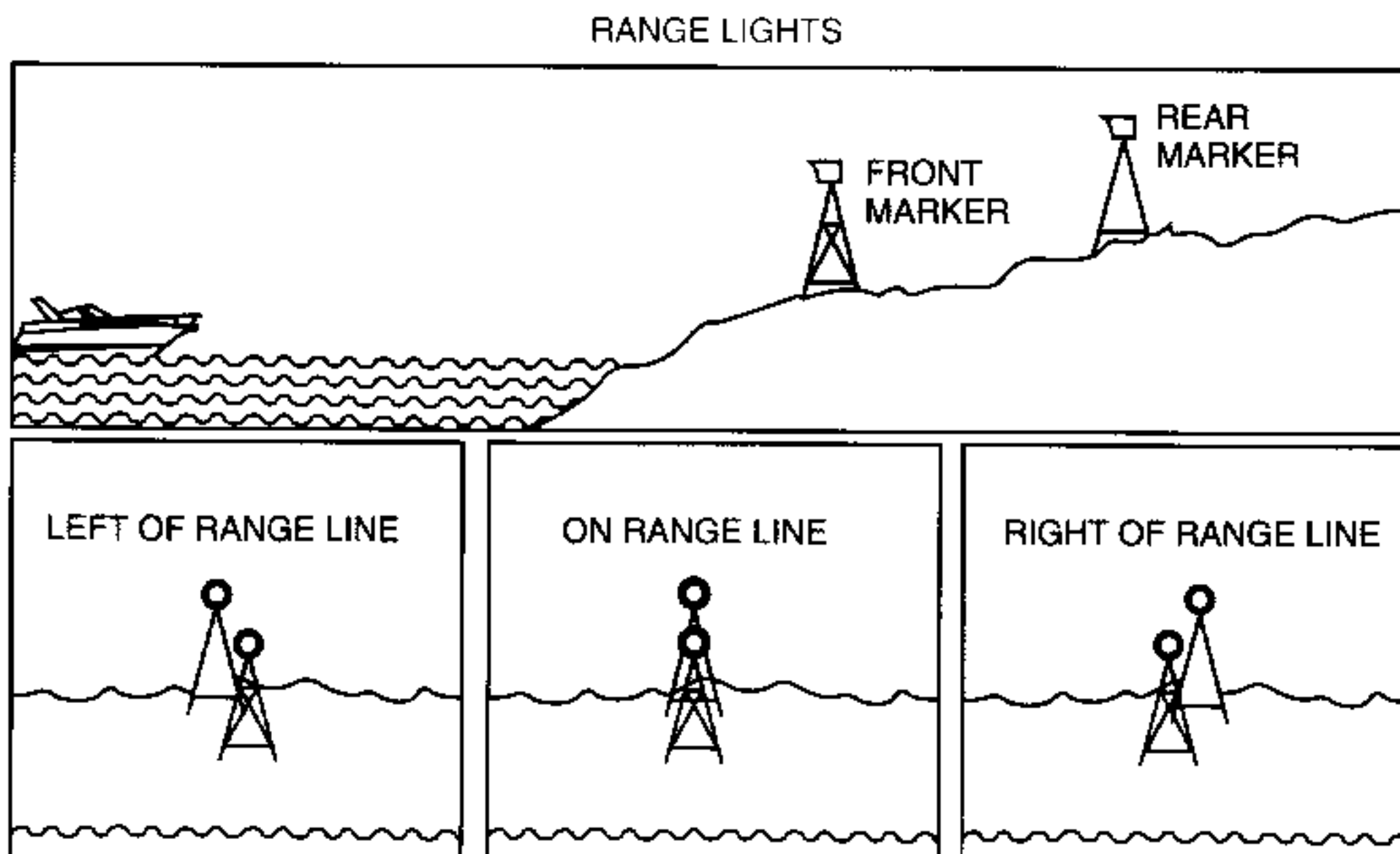

RIGHT-OF-WAY

In general, boats with less maneuverability have right-of-way over more agile craft. A power-driven vessel, like your Scarab, must keep out of the way of the following:

- ◆ **A vessel not under command or aground.** These vessels have no maneuverability due to some unusual circumstance such as a breakdown.
- ◆ **A vessel restricted in its ability to maneuver.** These vessels are performing work which limits their maneuverability such as: surveying, dredging, laying cable or pipe and servicing navigational markers among others.

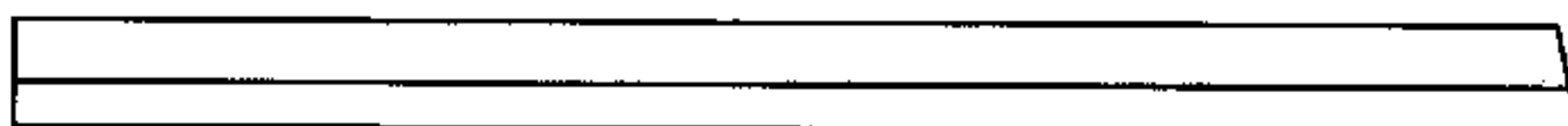

SCARAB[®]

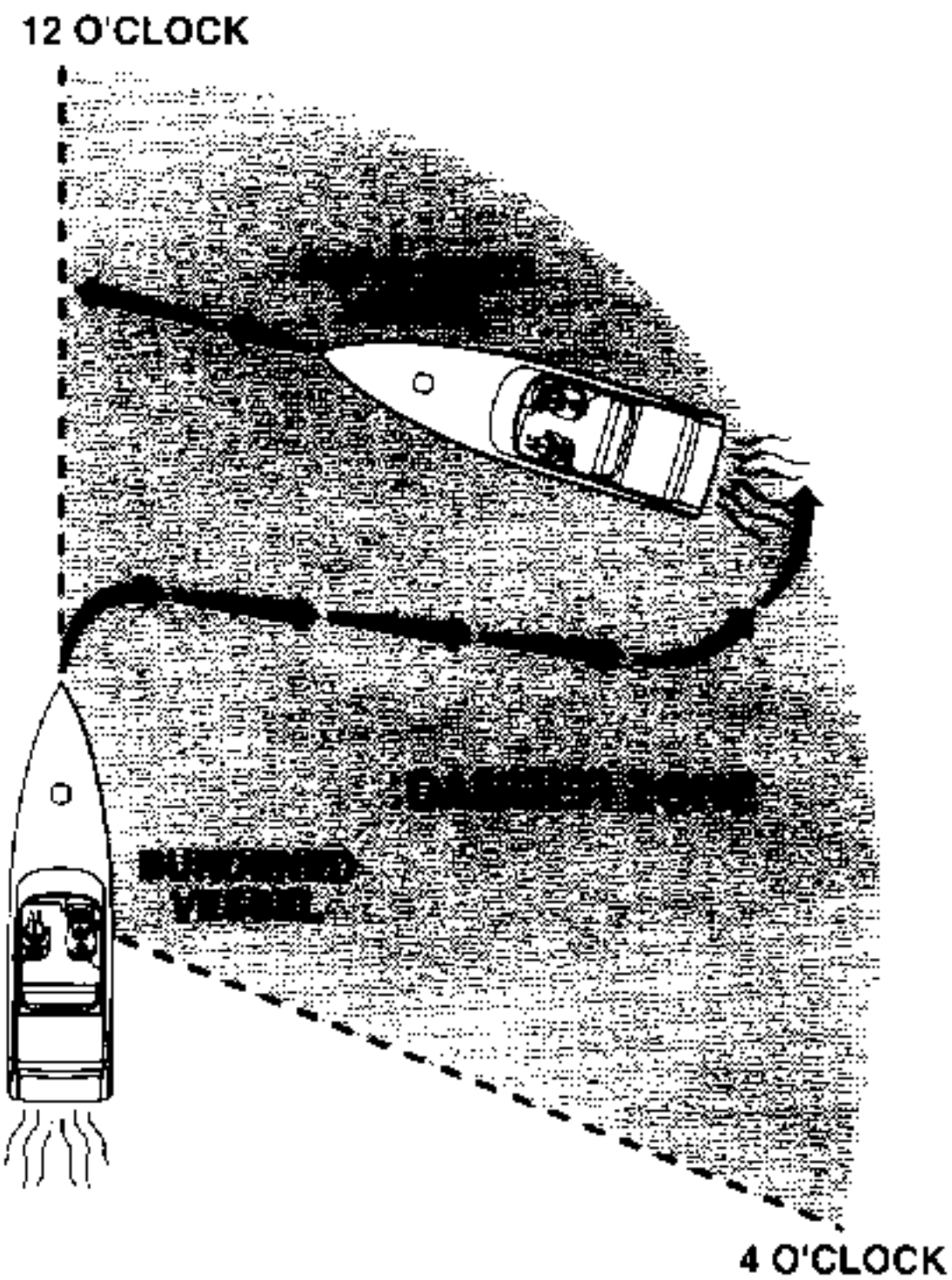

- ◆ **A vessel engaged in fishing.** These include boats fishing with nets, lines or trawls; but not trolling lines.
- ◆ **Sailboats.** Sailboats have the right-of-way over powerboats; however, if a sailboat is getting forward motion from a propeller, it is considered a powerboat.

When two powerboats are close enough to each other so that there is a chance that they might run into each other, the following rules apply:

Crossing Situation

In crossing situations, the boat on the right from the 12 o'clock to the 4 o'clock position has the right-of-way. It must hold course and speed. The boat without right-of-way must keep clear and pass to the stern.

Meeting Head-On

Neither boat has the right-of-way in this situation. Both boats should decrease speed and pass port to port. However, if both boats are on the left side of a channel, each vessel should sound two short horn blasts and pass starboard to starboard.

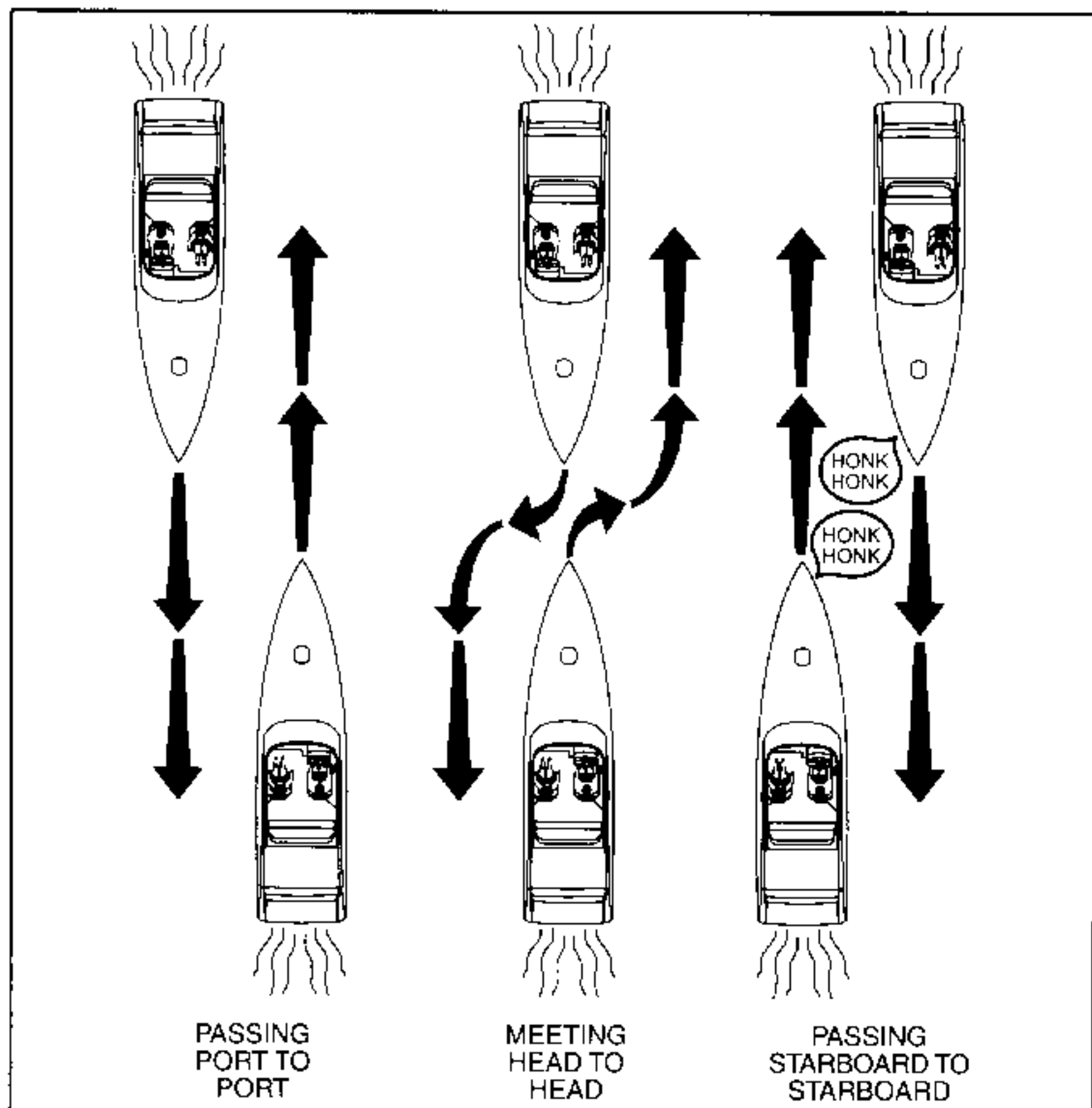

Overtaking

The boat that is overtaking one ahead of it must yield the right-of-way to the boat being passed and must make any adjustments necessary to keep out of its way. The boat being passed should hold its course and speed.

Whistle Signals

Signaling other boats with a whistle is similar to using turn signals on an automobile. Although it is not necessary to use a whistle signal every time a boat is nearby, boat operators must signal their intentions when necessary to avoid potentially confusing or hazardous situations.

It is customary for the privileged boat to signal first and the give-way boat to return the same signal to acknowledge she understands and will comply. Use the danger signal (five or more short and rapid blasts) if intent is not clear.

Use the following whistle blasts early enough to be noticed and understood by other boaters:

One long blast (two to six seconds): Warning signal when coming out of slip. Also used every two minutes when operating in reduced visibility.

One short blast: I intend to leave you on my port side.

Two short blasts: I intend to leave you on my starboard side.

Three short blasts: My engines are in reverse.

Five or more short and rapid blasts: Danger!

WARNING

Never answer a one-blast signal with two blasts or vice versa. This could cause confusion and result in a collision.

The General Prudential Rule

The general prudential rule regarding right-of-way is that if a collision appears unavoidable, neither boat has right-of-way. As prescribed in the Rules of the Road, both boats must act to avoid collision.

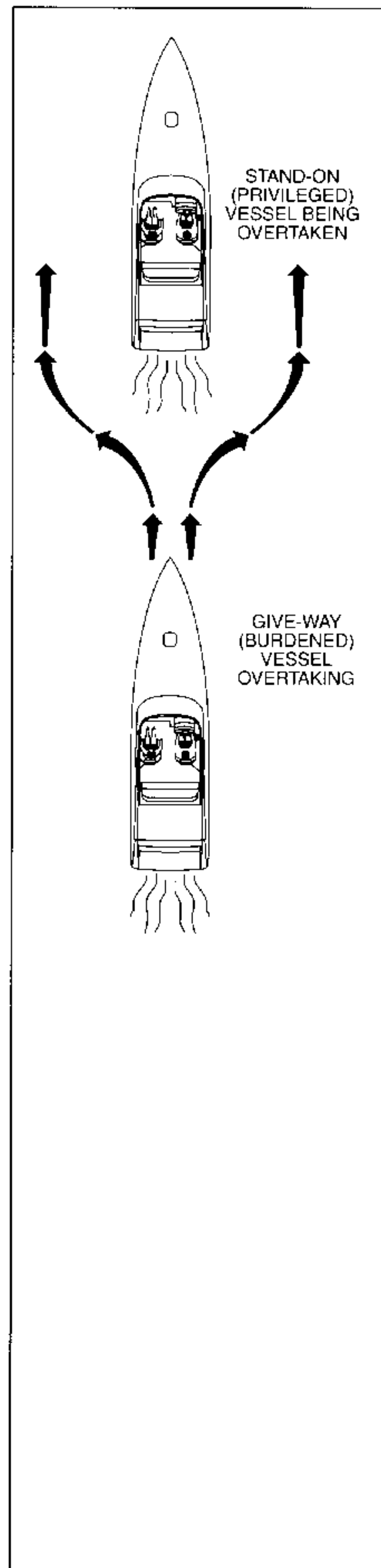

SCARAB®

Night Running

Boats operating between sunset and sunrise (hours vary by state) must use navigational lights. Nighttime operation, especially during bad weather or fog, can be dangerous. All Rules of Road apply at night, but it is best to slow down and stay clear of all boats regardless of who has right-of-way.

Protect your night vision by avoiding bright lights and have a passenger, if possible, help keep watch for other boats, water hazards and aids to navigation.

The size, speed and direction of other vessels are determined at night from the running lights. A green light indicates the starboard side of a boat and a red light indicates the port side. Generally, if you see a green light, you have the right-of-way; if you see a red light, give-way to the vessel.

Your Scarab is equipped with a removable, white "all around" pole light which must be installed and operational for night running or temporary anchorage at night. For more information, refer to the Controls and Indicators section.

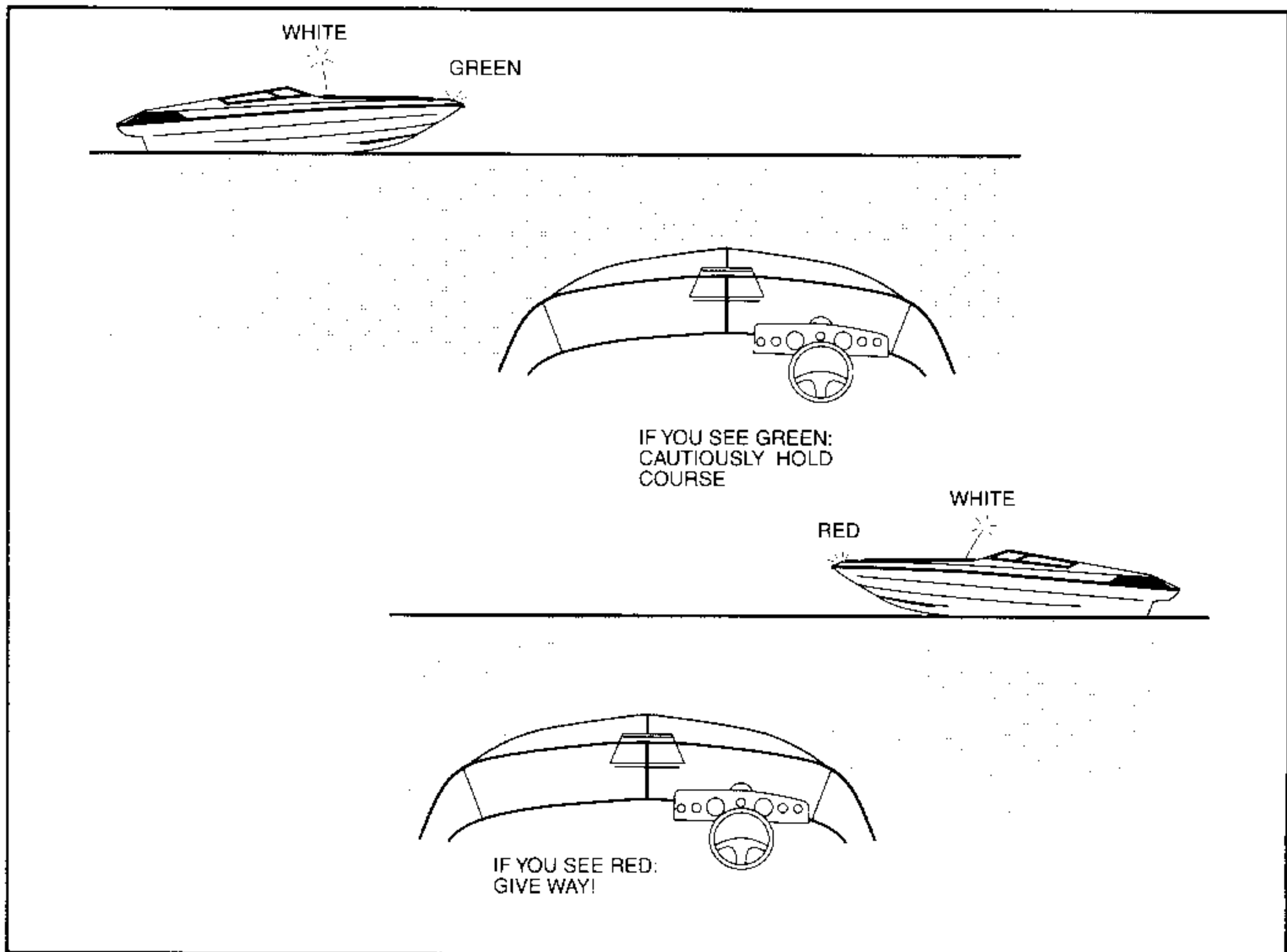

Specifications and Layout

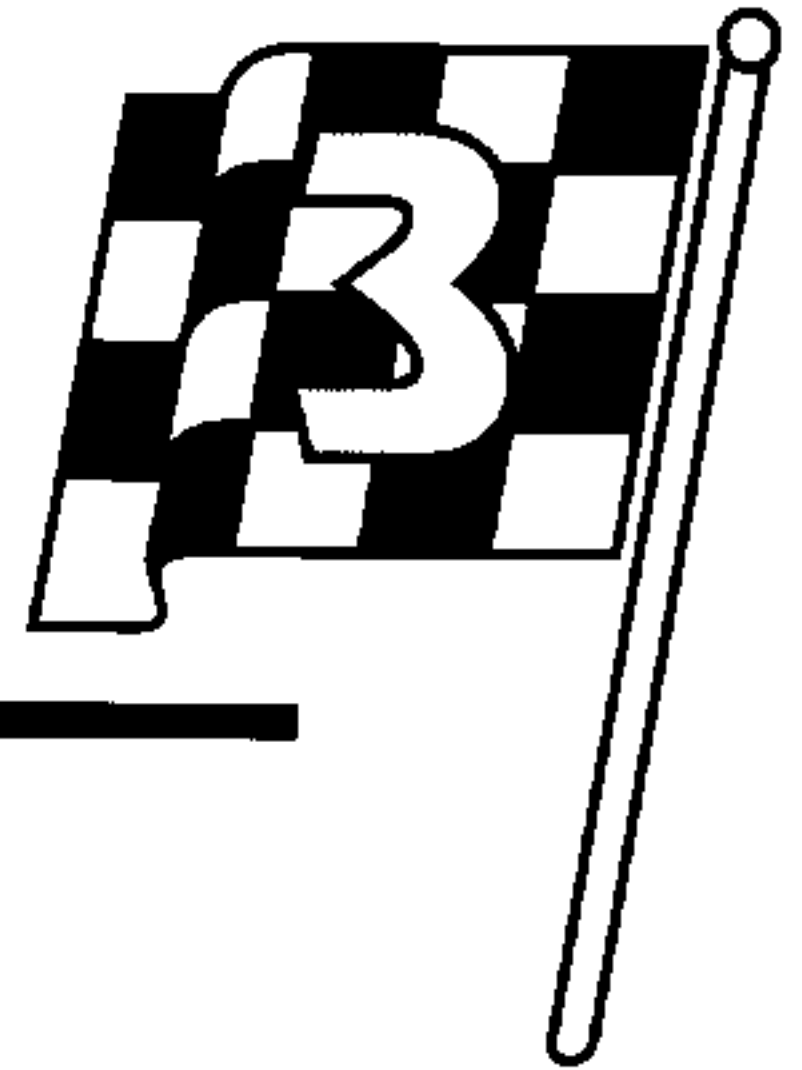

This section contains model specific information for your boat. Use the information to become familiar with your boat.

Specifications

The specification chart provides you with important information about your boat, including: Fuel Capacity, which you should be aware of in order to plan your trip; Draft, which is important when navigating shallow water; and Class, which is used to determine safety equipment requirements. Take the time to become familiar with the specifications of your boat.

Safety Labels

This diagram shows the location of safety labels on your boat. Safety labels are affixed to your boat at specific locations in order to call your attention to potentially dangerous situations. Become familiar with these labels before heading out on the water and do not paint over, cover up or remove any of these labels – they have been installed for your protection. In the event that a label becomes damaged or destroyed, contact your Wellcraft dealer for a replacement.

Helm Layout

This diagram will help you identify the various switches, gauges and controls in the helm area of your boat. Take the time to become familiar with all the instruments and controls of your boat before heading out on the water.

Side and Top Views of Equipment Locations

These diagrams will help you locate and become familiar with the important features of your boat. Before heading out on the water, take the time to locate all the major components of your boat, and if you have any questions about the function or location of any piece of equipment, contact your Wellcraft dealer who will be willing to help you.



SCARAB®

Electrical Controls

This diagram shows most fuses, battery switches and breaker panels located on your boat. The fuses in this diagram are all clearly located and labeled as to their function and amp rating to help you in the event you have to replace a fuse.

SPECIFICATIONS

NOTICE

All specifications and diagrams contained in this section were correct at the time of publication, but are subject to change without notice. Wellcraft's policy of continual product improvement may mean that some changes have taken place and that there may be minor discrepancies between the information presented in this section and your particular boat.

SCARAB BOAT SPECIFICATION CHARTS

29 SCARAB

Specification	U.S	Metric
Centerline Length.....	29'5"	8.97 m
Beam.....	7'6"	2.29 m
Dry Unladen Weight (estimated with single).....	5500 lbs	2494.8 kg
Dry Unladen Weight (estimated with twin).....	6300 lbs	2857.7 kg
Fuel Capacity.....	100 gal	378 l
Max Horsepower Option (single).....	415 HP	309 kw
Max Horsepower Option (twin).....	600 HP	447.42 kw
Deadrise.....	23°	23°
Draft (stern drive UP).....	22"	0.56 m
Draft (stern drive DOWN).....	36"	0.92 m
Bridge Clearance *.....	4'7"	1.39 m
Class (used to determine safety equipment requirements).....	2	
Design Category.....	N/A	B
Certification.....	NMMA	CE
Maximum Load:.....	Weight.....	1350 kg
Maximum Load:.....	People.....	8

302 SCARAB

Specification	U.S	Metric
Centerline Length.....	29'6"	8.99 m
Beam.....	8'	2.44 m
Dry Unladen Weight (estimated).....	5000 lbs	2268 kg
Fuel Capacity.....	150 gal	567.8 l
Max Horsepower Option.....	500 HP	372.9 kw
Deadrise.....	24°	24°
Draft Drives Down.....	36"	0.91 m
Bridge Clearance (without top*).....	5'10"	1.78 m
Design Category.....	N/A	C
Certification.....	NMMA	CE
Maximum Load:.....	Weight.....	1299 kg
Maximum Load:.....	People.....	10

* With average load; antennas, canvas, etc. not included.



SCARAB®

SCARAB BOAT SPECIFICATION CHARTS

31 SCARAB

Specification	U.S	Metric
Centerline Length.....	31'1"	9.47 m
Beam.....	8'6"	2.59 m
Dry Unladen Weight (estimated).....	7900 lb	3583.44 kg
Fuel Capacity.....	146 gal	552.61 l
Water Capacity.....	7 gal	26.5 l
Max Horsepower Option.....	980 HP	731 kw
Deadrise.....	23°	23°
Draft (stern drives UP).....	26"	0.66 m
Draft (stern drives DOWN).....	36"	0.92 m
Bridge Clearance *.....	5'0"	1.52 m
Class (used to determine safety equipment requirements).....	2	
Design Category.....	N/A	
Certification.....	NMMA	

38 SCARAB

Specification	U.S	Metric
Centerline Length.....	37'10"	11.53 m
Beam.....	8'9"	2.67 m
Dry Unladen Weight (estimated).....	9100 lbs	4127.76 kg
Fuel Capacity.....	194 gal	734.29 l
Max Horsepower Option (Twin).....	1100 HP	820 kw
Deadrise.....	24°	24°
Draft (stern drive UP).....	24"	0.61 m
Draft (stern drive DOWN).....	36"	0.92 m
Bridge Clearance * (W/O Arch).....	5'2"	1.58 m
Bridge Clearance * (W/Arch).....	6'6"	1.98 m
Headroom.....	4'9"	1.45 m
Class (used to determine safety equipment requirements).....	2	
Design Category.....	N/A	
Certification.....	NMMA	

* With average load; antennas, canvas, etc. not included.

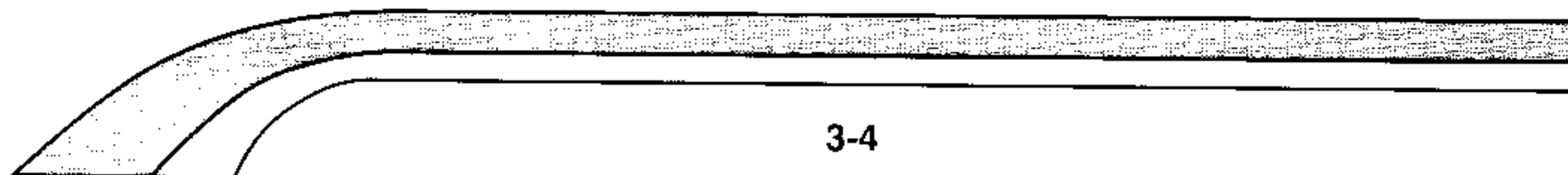

SCARAB BOAT SPECIFICATION CHARTS

43 SCARAB

Specification	U.S	Metric
Centerline Length.....	43'2"	13.16 m
Beam.....	8'9"	2.67 m
Dry Unladen Weight (estimated).....	12000 lbs	5439.6 kg
Fuel Capacity.....	250 gal	946 l
Water Capacity.....	26 gal	98 l
Max Horsepower Option (Triple).....	1650 HP	1230 kw
Deadrise.....	24°	
Draft (stern drives UP).....	26"	0.66 m
Draft (stern drives DOWN).....	38"	0.97 m
Bridge Clearance *.....	5'0"	1.45 m
Headroom.....	4'9"	1.45 m
Class (used to determine safety equipment requirements).....	3	
Design Category.....	N/A	
Certification.....	NMMA	

* With average load; antennas, canvas, etc. not included.



SCARAB[®]

SAFETY LABELS – 29 Scarab

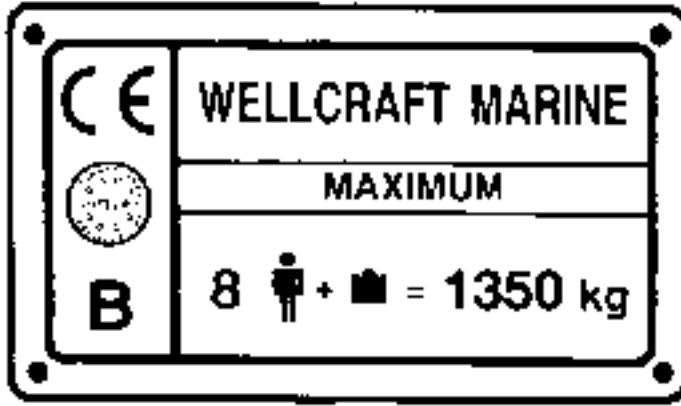

WARNING

- To minimize shock and fire hazards:
- Turn off the boat's shore connection switch before connecting or disconnecting shore cable.
 - Connect shore-power cable at the boat first.
 - If polarity warning indicator is activated, immediately disconnect cable.
 - Close shore-power inlet cover tightly.
DO NOT ALTER SHORE-POWER CABLE CONNECTORS

(WITH OPTIONAL SHORE-POWER)



BOATMAN'S CHECKLIST

- For maximum enjoyment and safety, check each of these items BEFORE you start your engine:
- ✓ DRAIN PLUG (Securely in place?)
 - ✓ LIFE-SAVING DEVICES (One for every person on board?)
 - ✓ STEERING SYSTEM (Working smoothly and properly?)
 - ✓ FUEL SYSTEM (Adequate fuel? Leaks? Fumes?)
 - ✓ BATTERY (Fully charged? Cable terminals clean and tight?)
 - ✓ ENGINE (In neutral?)
 - ✓ CAPACITY PLATE (Are you overloaded or overpowered?)
 - ✓ WEATHER CONDITIONS (Safe to go out?)
 - ✓ ELECTRICAL EQUIPMENT (Lights, horn, pump, etc.?)
 - ✓ EMERGENCY GEAR (Fire extinguisher, bailer, paddle, anchor & line, signaling device, tool kit, etc.?)

WARNING

SUDDEN MOVEMENT OF BOAT CAN CAUSE LOSS OF BALANCE, FALLS, OR EJECTION FROM THE BOAT. SEVERE OR FATAL INJURY MAY RESULT. DO NOT OCCUPY THE MOTOR CUSHION AREA WHILE THE BOAT IS UNDERWAY.



WARNING

PROPELLER LOCATED BEHIND THIS BOAT. CONTACT MAY CAUSE SEVERE INJURY OR FATALITY. DO NOT APPROACH OR USE LADDER AND PLATFORM WHEN THE ENGINE IS RUNNING.

CLEANING "PLEXIGLASS" SURFACES:
WASH ACRYLIC WITH A MILD SOAP OR DETERGENT AND PLENTY OF LUKE WARM WATER. USE A CLEAN SOFT CLOTH. RINSE WITH CLEAR WATER.

CAUTION:
DO NOT USE WINDOW CLEANING SPRAYS, SCOURING COMPOUNDS, OR SOLVENTS SUCH AS GASOLINE, BENZENE, OR LACQUER THINNER.

Model	Year	Weight	Capacity
29 Scarab	1998-2000	1350 kg	8 persons
30 Scarab	1998-2000	1500 kg	10 persons
32 Scarab	1998-2000	1800 kg	12 persons
34 Scarab	1998-2000	2100 kg	14 persons
36 Scarab	1998-2000	2400 kg	16 persons
38 Scarab	1998-2000	2700 kg	18 persons
40 Scarab	1998-2000	3000 kg	20 persons
42 Scarab	1998-2000	3300 kg	22 persons
44 Scarab	1998-2000	3600 kg	24 persons
46 Scarab	1998-2000	3900 kg	26 persons
48 Scarab	1998-2000	4200 kg	28 persons
50 Scarab	1998-2000	4500 kg	30 persons

WARNING

GASOLINE VAPORS CAN EXPLODE BEFORE STARTING ENGINE:
- CHECK ENGINE COMPARTMENT FOR GASOLINE OR VAPORS.
- OPERATE BLOWER FOR 4 MINUTES. RUN BLOWER BELOW CRUISING SPEED.

DANGER

CARBON MONOXIDE IS COLORLESS, ODORLESS AND DANGEROUS. ALL GASOLINE POWERED ENGINES AND GENERATORS EXHAUST CARBON MONOXIDE (CO). DIRECT AND PROLONGED EXPOSURE TO CO WILL CAUSE BRAIN DAMAGE OR DEATH. SIGNS OF EXPOSURE TO CO INCLUDE NAUSEA, DIZZINESS AND DROWSINESS. Keep Cabin and Cockpit Areas Well Ventilated. Avoid Blockage of Exhaust Outlets. See Owner's Manual for More Details.

DISCHARGE OF OIL PROHIBITED

THE FEDERAL WATER POLLUTION CONTROL ACT PROHIBITS THE DISCHARGE OF OIL OR OILY WASTE INTO OR UPON THE NAVIGABLE WATERS AND CONTIGUOUS ZONE OF THE UNITED STATES IF SUCH DISCHARGE CAUSES A FILM OR SHEEN UPON, OR DISCOLORATION OF, THE SURFACE OF THE WATER, OR CAUSES A SLUDGE OR EMULSION BENEATH THE SURFACE OF THE WATER. VIOLATORS ARE SUBJECT TO A PENALTY OF \$5,000

WARNING

LEAKING FUEL IS A FIRE AND EXPLOSION HAZARD. INSPECT SYSTEM REGULARLY. EXAMINE FUEL SYSTEM FOR LEAKS OR CORROSION AT LEAST ANNUALLY.

(ABOVE ENGINE FLAME ARRESTER COVER)

Contact your Wellcraft dealer for replacements.

HELM LAYOUT - 29 Scarab

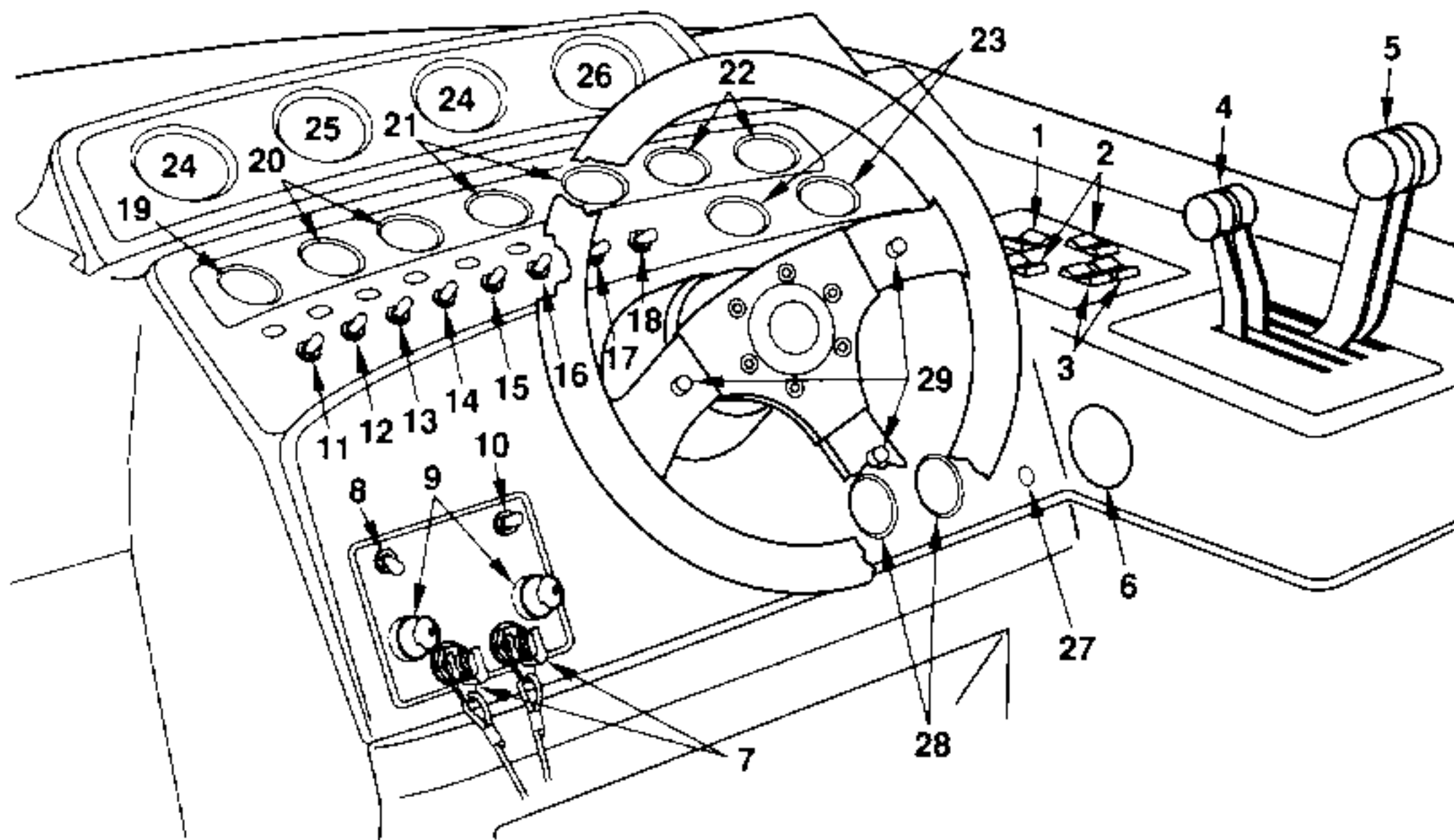

29 SCARAB (Twin Engine Configuration)

- | | | | |
|---|----------------------|-------------------------|------------------------------|
| 1. Trailer Switch | 8. Blower | 15. Cabin Lights | 22. Engine Water Temperature |
| 2. Trim Tab Switches | 9. Ignition Switches | 16. Engine Room Lights | 23. Power Trim Gauges |
| 3. Drive Trim Switches | 10. Hatch Lift | 17. Bilge Pump Switch | 24. Tachometers |
| 4. Shift Levers | 11. Panel Lights | 18. Horn | 25. Synchronizer |
| 5. Throttle Levers | 12. Nav Lights | 19. Fuel Gauge | 26. Speedometer |
| 6. Automatic Fire Suppression Indicator | 13. Anchor Lights | 20. Voltmeters | 27. Accessory Plug |
| 7. Ignition Interrupters | 14. Cockpit Lights | 21. Engine Oil Pressure | 28. Hourmeters |
| | | | 29. Optional Trim Control |

Select items listed above may be optional equipment.

SCARAB®

SIDE VIEW OF EQUIPMENT LOCATIONS – 29 Scarab

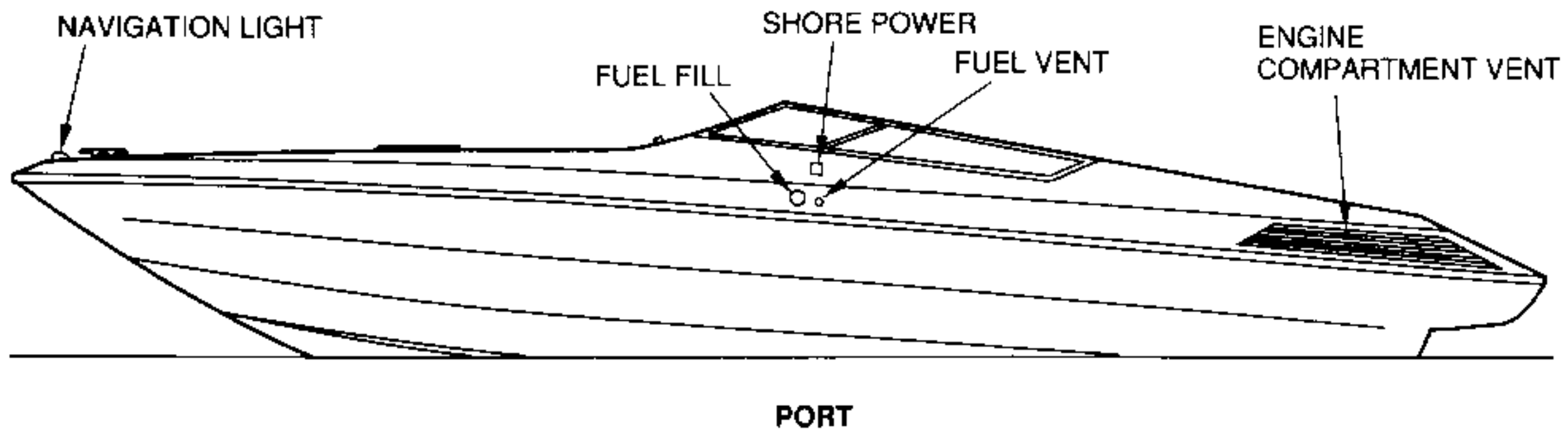
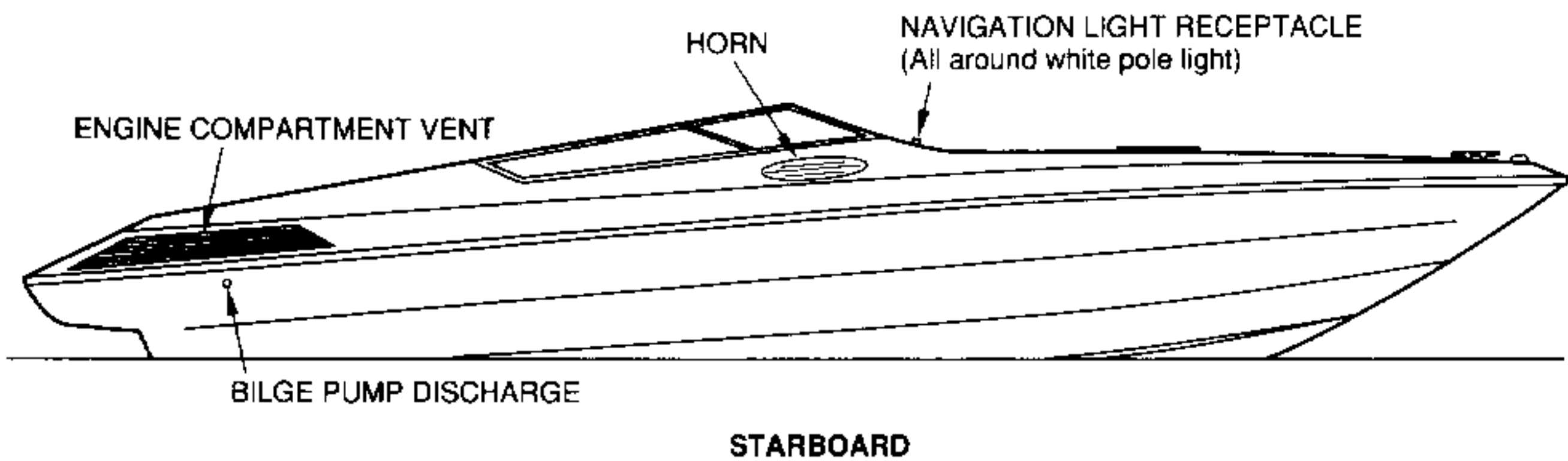

TOP VIEW OF EQUIPMENT LOCATIONS - 29 Scarab

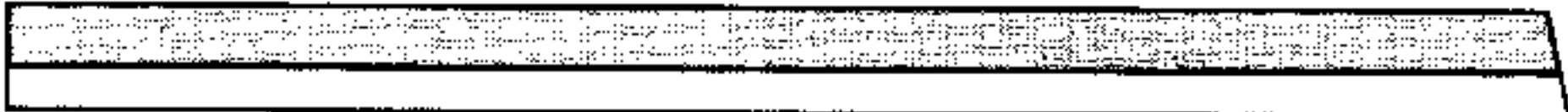
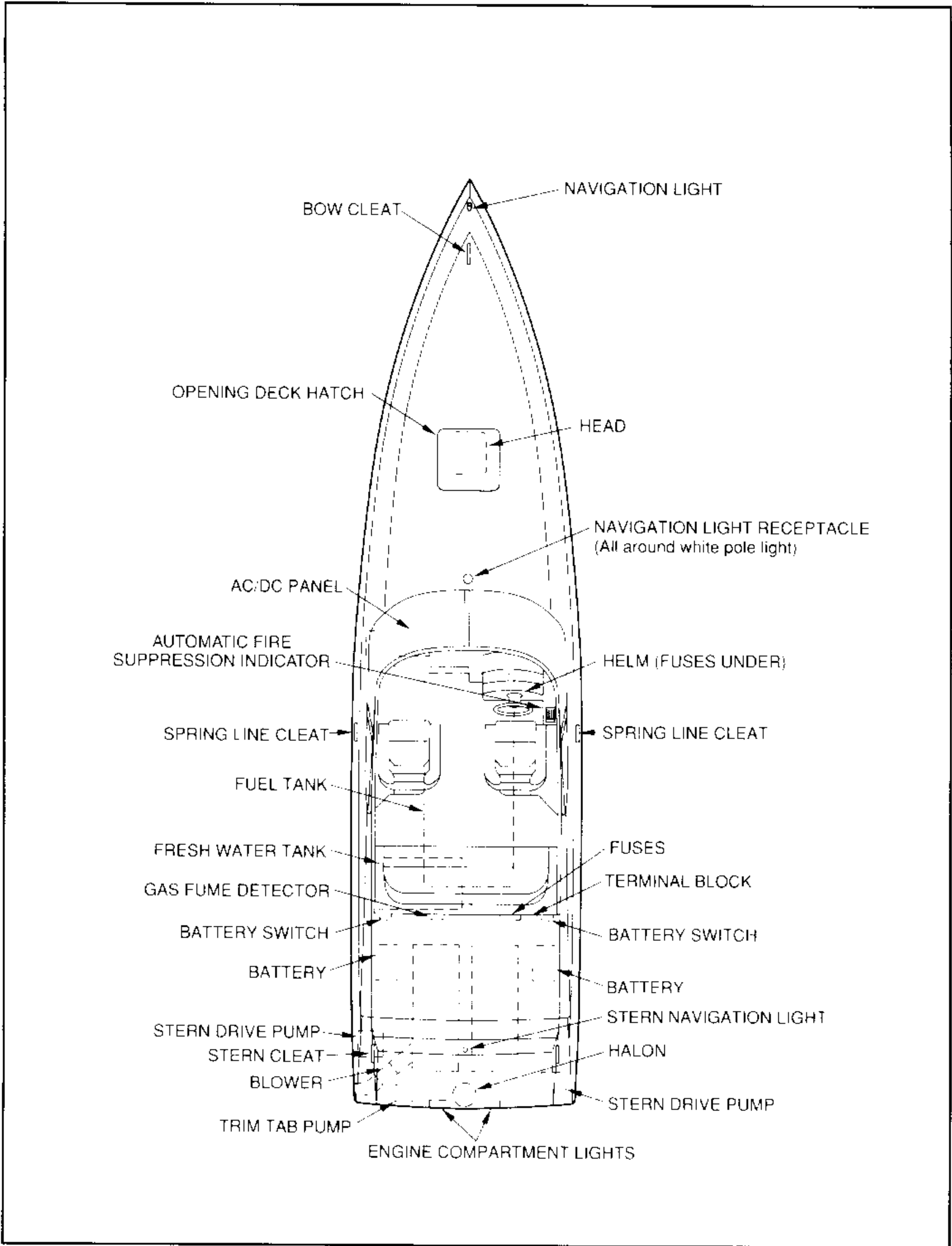

ELECTRICAL CONTROLS – 29 Scarab

(Typical Twin Engine Configuration Shown)

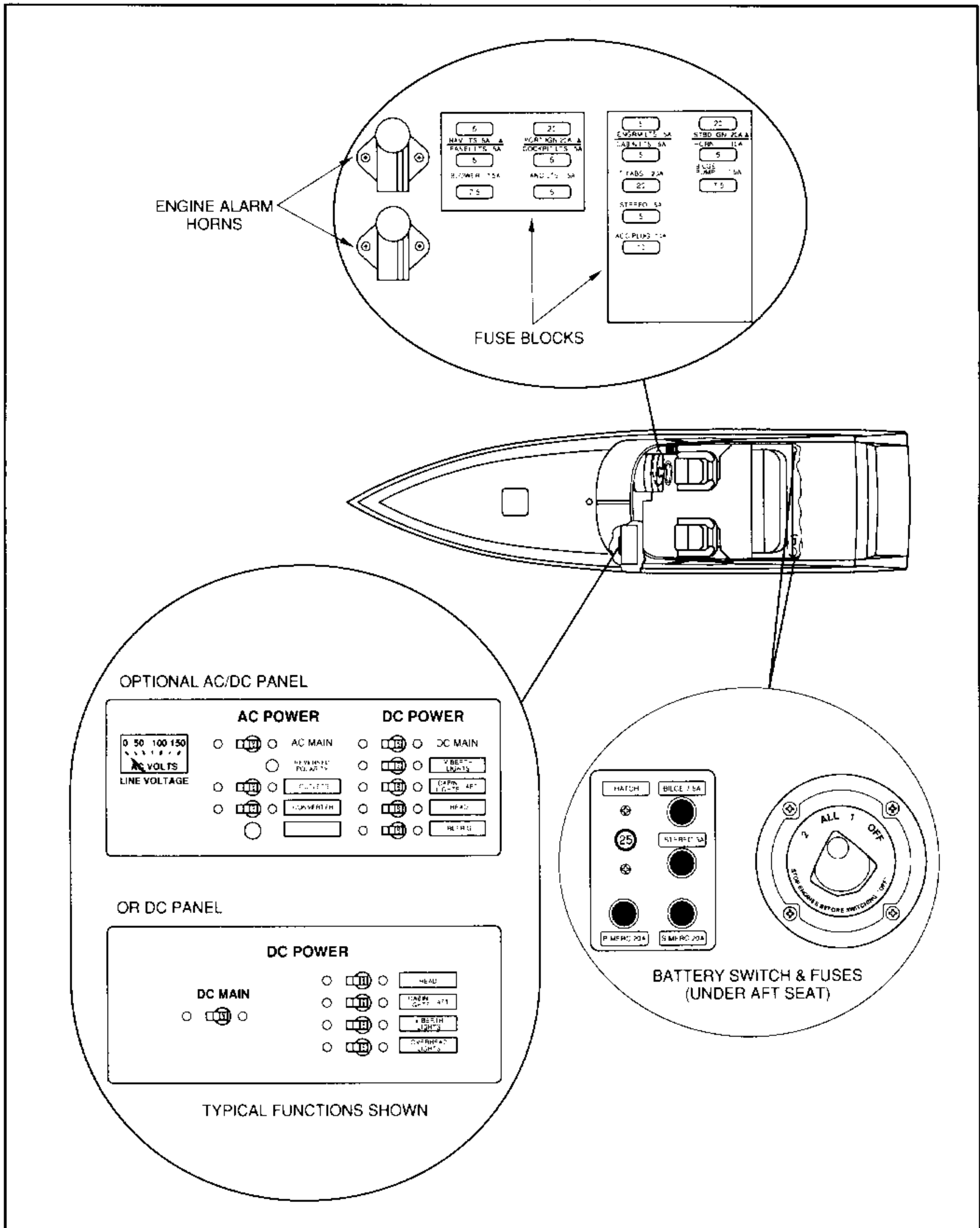

SAFETY LABELS – 302 Scarab

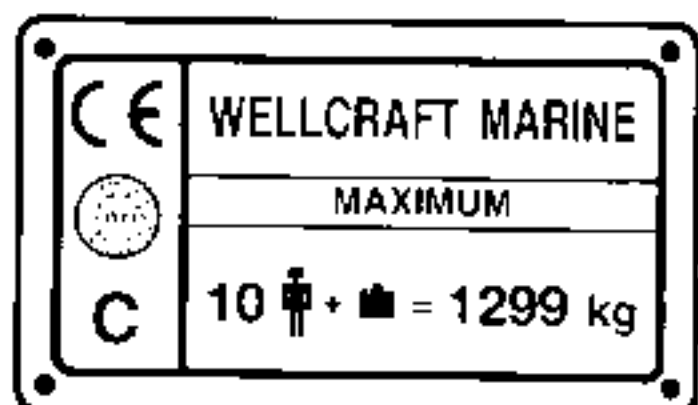

NOTICE
LIFE VEST STORED HERE

NOTICE
MANUFACTURERS MAXIMUM
HORSEPOWER RATING - 500 H.P.

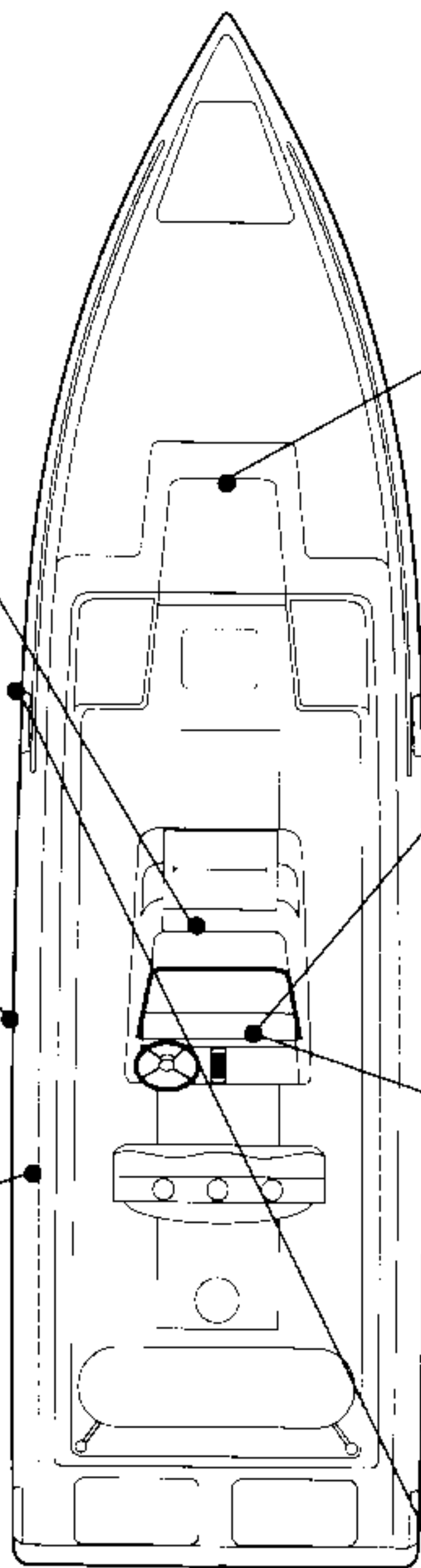

CLEANING "PLEXIGLASS" SURFACES:
WASH ACRYLIC WITH A MILD SOAP OR DETERGENT AND PLENTY OF LUKE WARM WATER. USE A CLEAN SOFT CLOTH. RINSE WITH CLEAR WATER.
CAUTION:
DO NOT USE WINDOW CLEANING SPRAYS, SCOURING COMPOUNDS, OR SOLVENTS SUCH AS GASOLINE, BENZENE, OR LACQUER THINNER.

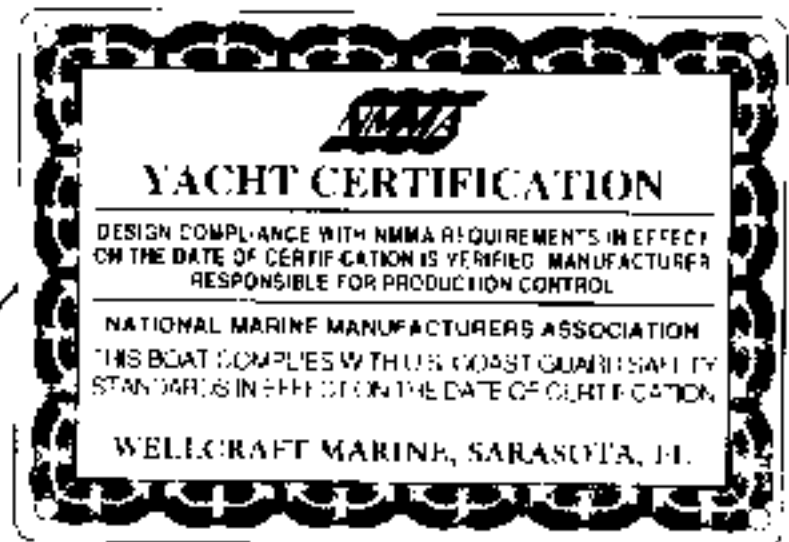

- BOATMAN'S CHECKLIST**
- For maximum enjoyment and safety, check each of these items BEFORE you start your engine.
- ✓ DRAIN PLUG (Securely in place?)
 - ✓ LIFE-SAVING DEVICES (One for every person on board?)
 - ✓ STEERING SYSTEM (Working smoothly and properly?)
 - ✓ FUEL SYSTEM (Adequate fuel? Leaks? Fumes?)
 - ✓ BATTERY (Fully charged? Cable terminals clean and tight?)
 - ✓ ENGINE (In neutral?)
 - ✓ CAPACITY PLATE (Are you overloaded or overpowered?)
 - ✓ WEATHER CONDITIONS (Safe to go out?)
 - ✓ ELECTRICAL EQUIPMENT (Lights, horn, pump, etc.?)
 - ✓ EMERGENCY GEAR (Fire extinguisher, bailer, paddle, anchor & line, signaling device, tool kit, etc.?)

WARNING

LEAKING FUEL IS A FIRE AND EXPLOSION HAZARD. INSPECT SYSTEM REGULARLY. EXAMINE FUEL SYSTEM FOR LEAKS OR CORROSION AT LEAST ANNUALLY.

(ABOVE ENGINE FLAME ARRESTER COVER)

Contact your Wellcraft dealer for replacements.

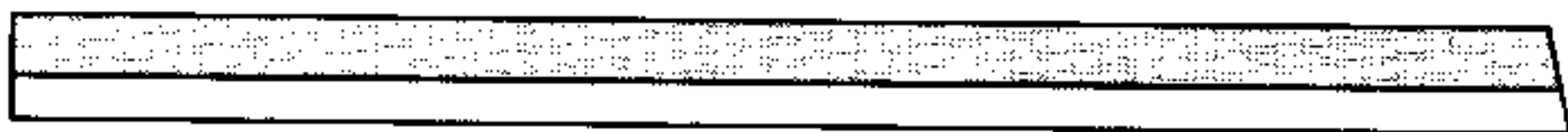

HELM LAYOUT - 302 Scarab

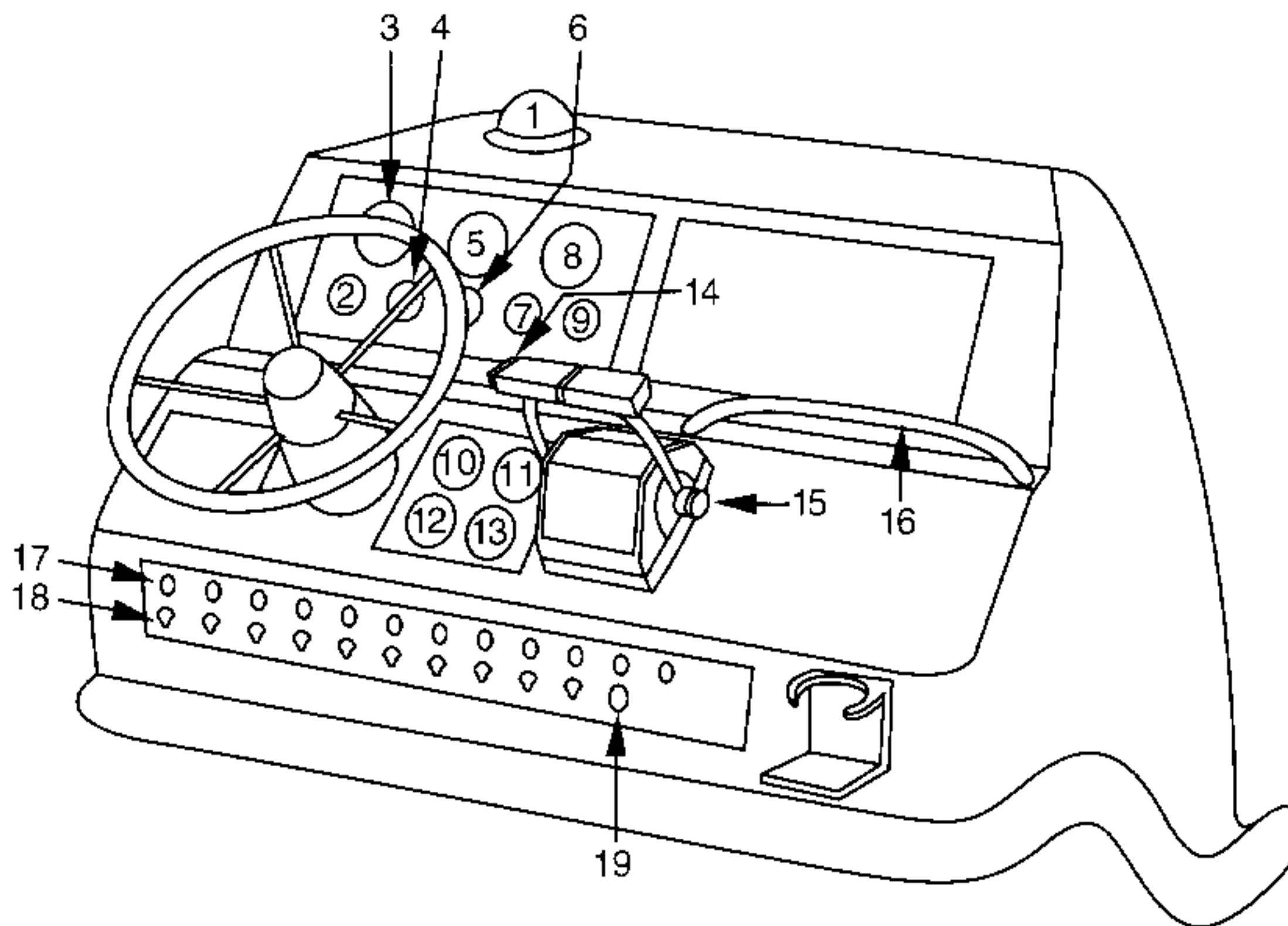

302 SCARAB

- | | | |
|-------------------------|----------------------------|-----------------------------|
| 1. Compass | 9. Trim Gauge | 17. Circuit Breakers |
| 2. Fuel Gauge | 10. Engine Warning | 18. Switches |
| 3. Tachometer | 11. Engine Warning | 19. 12V DC Accessory Outlet |
| 4. Water Pressure Gauge | 12. Voltmeter | |
| 5. Tachometer | 13. Voltmeter | |
| 6. Water Pressure Gauge | 14. Trim Switch | |
| 7. Trim Gauge | 15. Neutral Warm-Up Button | |
| 8. Speedometer | 16. Grab Rail | |

Selected items listed above may be optional equipment.

SIDE VIEW OF EQUIPMENT LOCATIONS – 302 Scarab

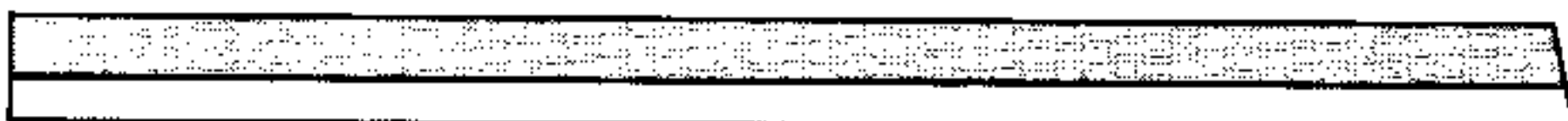
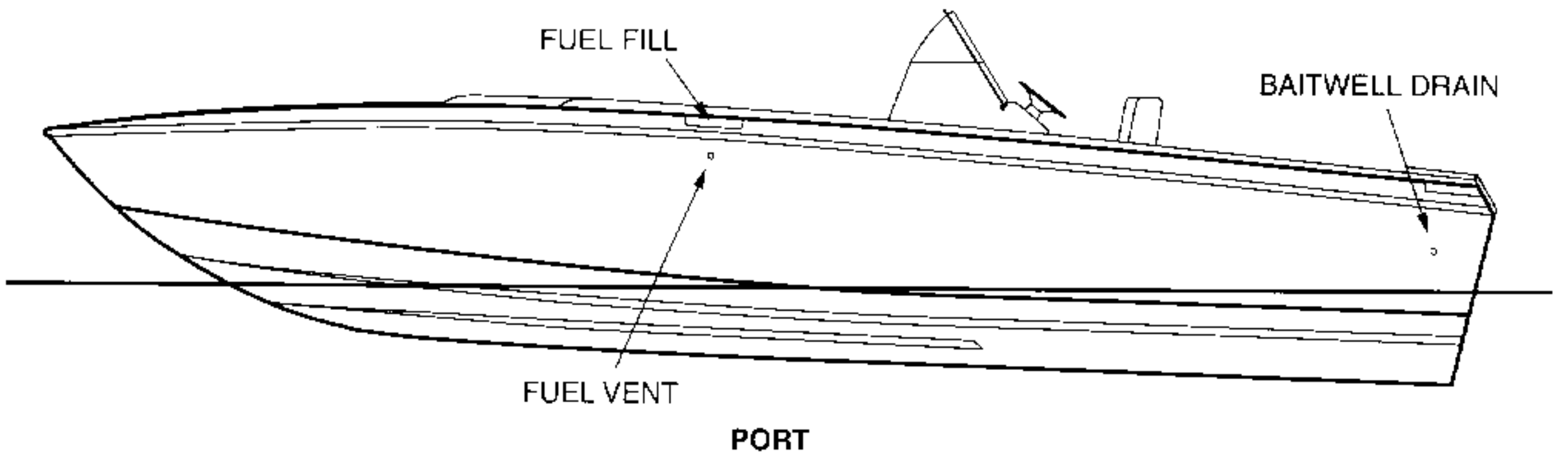
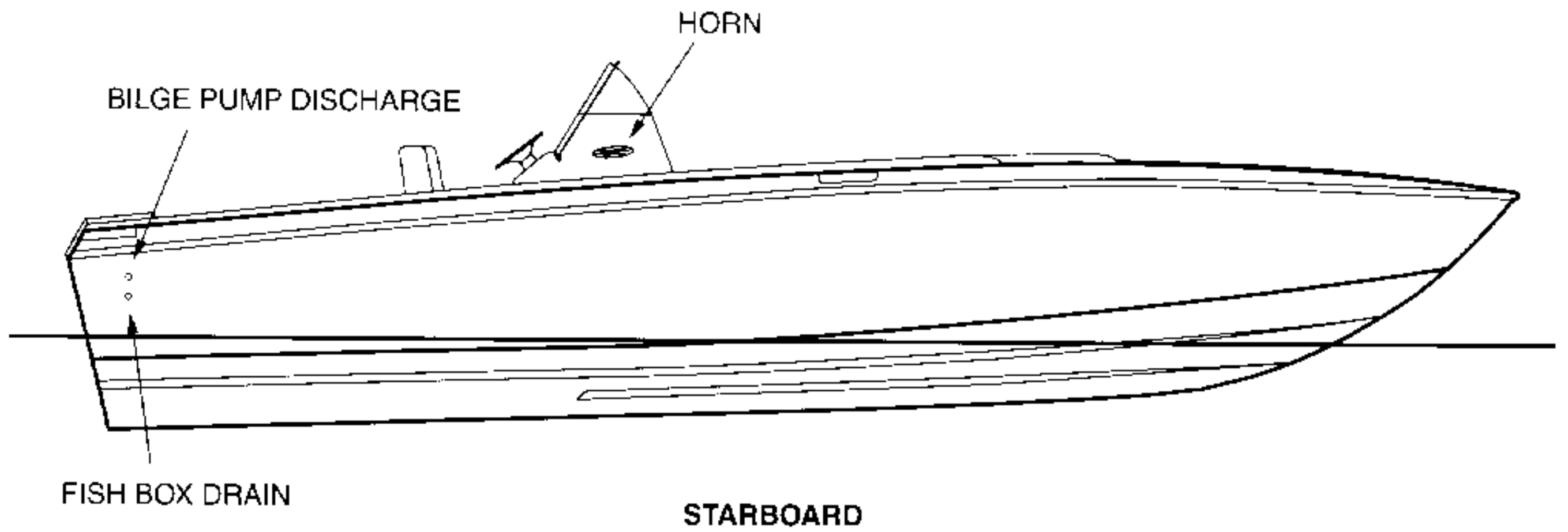

SCARAB®

TOP VIEW OF EQUIPMENT LOCATIONS - 302 Scarab

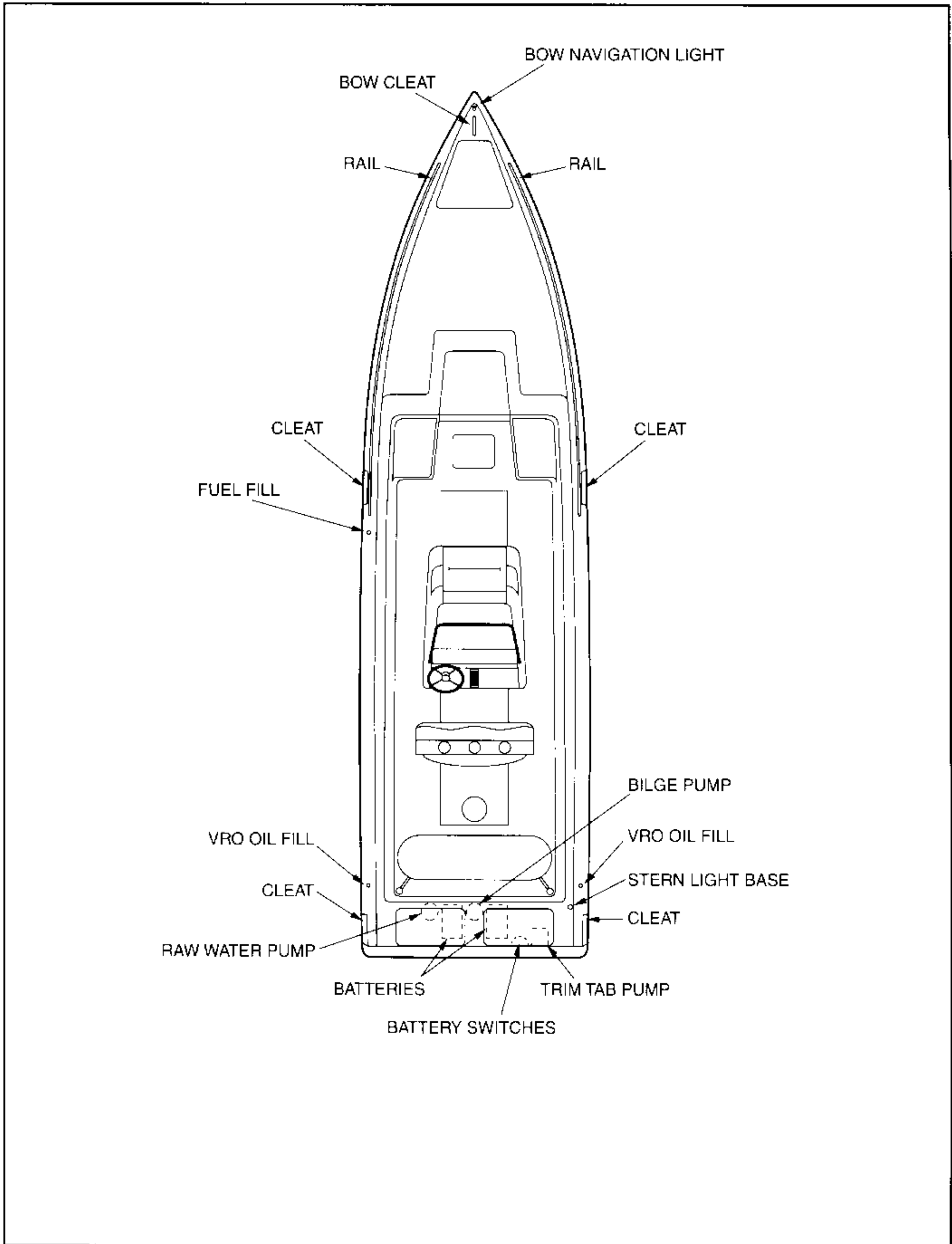

SAFETY LABELS - 31 Scarab

⚠ WARNING

- To minimize shock and fire hazards:
- (1) Turn off the boat's shore connection switch before connecting or disconnecting shore cable.
 - (2) Connect shore-power cable at the boat first.
 - (3) If polarity warning indicator is activated, immediately disconnect cable.
 - (4) Close shore-power inlet cover tightly. DO NOT ALTER SHORE-POWER CABLE CONNECTORS

(WITH OPTIONAL SHORE-POWER)

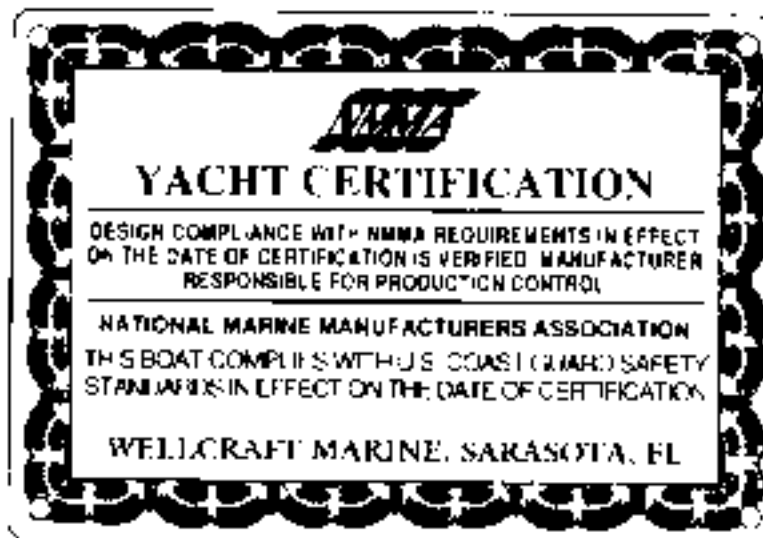

BOATMAN'S CHECKLIST

- For maximum enjoyment and safety, check each of these items BEFORE you start your engine:
- ✓ DRAIN PLUG (Securely in place?)
 - ✓ LIFE-SAVING DEVICES (One for every person on board?)
 - ✓ STEERING SYSTEM (Working smoothly and properly?)
 - ✓ FUEL SYSTEM (Adequate fuel? Leaks? Fumes?)
 - ✓ BATTERY (Fully charged? Cable terminals clean and tight?)
 - ✓ ENGINE (In neutral?)
 - ✓ CAPACITY PLATE (Are you overloaded or overpowered?)
 - ✓ WEATHER CONDITIONS (Safe to go out?)
 - ✓ ELECTRICAL EQUIPMENT (Lights, horn, pump, etc.?)
 - ✓ EMERGENCY GEAR (Fire extinguisher, bailer, paddle, anchor & line, signaling device, tool kit, etc.?)

⚠ WARNING

SUDDEN MOVEMENT OF BOAT CAN CAUSE LOSS OF BALANCE, FALLS, OR EJECTION FROM THE BOAT. SEVERE OR FATAL INJURY MAY RESULT. DO NOT OCCUPY THE MOTOR CUSHION AREA WHILE THE BOAT IS UNDERWAY.



⚠ WARNING

PROPELLER LOCATED BEHIND THIS BOAT. CONTACT MAY CAUSE SEVERE INJURY OR FATALITY. DO NOT APPROACH OR USE LADDER AND PLATFORM WHEN THE ENGINE IS RUNNING.

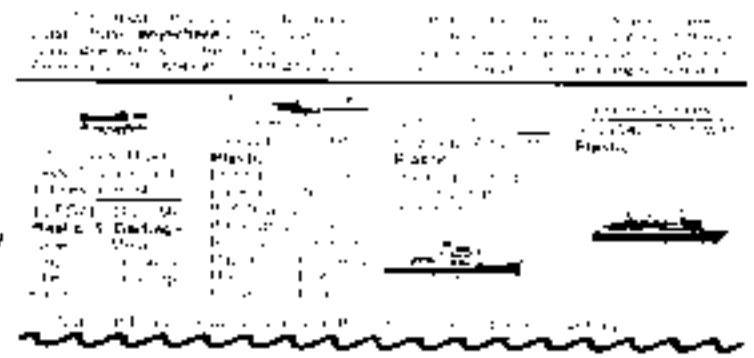

NOTICE

THIS FILL FOR WATER ONLY!

NOTICE

LIFE VEST STORED HERE

⚠ WARNING

GASOLINE VAPORS CAN EXPLODE BEFORE STARTING ENGINE:
 - CHECK ENGINE COMPARTMENT FOR GASOLINE OR VAPORS.
 - OPERATE BLOWER FOR 4 MINUTES. RUN BLOWER BELOW CRUISING SPEED.

⚠ DANGER

CARBON MONOXIDE IS COLORLESS, ODORLESS AND DANGEROUS. ALL GASOLINE POWERED ENGINES AND GENERATORS EXHAUST CARBON MONOXIDE (CO.) DIRECT AND PROLONGED EXPOSURE TO CO WILL CAUSE BRAIN DAMAGE OR DEATH. SIGNS OF EXPOSURE TO CO INCLUDE NAUSEA, DIZZINESS AND DROWSINESS. Keep Cabin and Cockpit Areas Well Ventilated. Avoid Blockage of Exhaust Outlets. See Owner's Manual for More Details.

DISCHARGE OF OIL PROHIBITED

THE FEDERAL WATER POLLUTION CONTROL ACT PROHIBITS THE DISCHARGE OF OIL OR OILY WASTE INTO OR UPON THE NAVIGABLE WATERS AND CONTIGUOUS ZONE OF THE UNITED STATES IF SUCH DISCHARGE CAUSES A FILM OR SHEEN UPON, OR DISCOLORATION OF, THE SURFACE OF THE WATER, OR CAUSES A SLUDGE OR EMULSION BENEATH THE SURFACE OF THE WATER. VIOLATORS ARE SUBJECT TO A PENALTY OF \$5,000

⚠ WARNING

LEAKING FUEL IS A FIRE AND EXPLOSION HAZARD. INSPECT SYSTEM REGULARLY. EXAMINE FUEL SYSTEM FOR LEAKS OR CORROSION AT LEAST ANNUALLY.

(ABOVE ENGINE FLAME ARRESTER COVER)

Contact your Wellcraft dealer for replacements.

SCARAB®

HELM LAYOUT - 31 Scarab

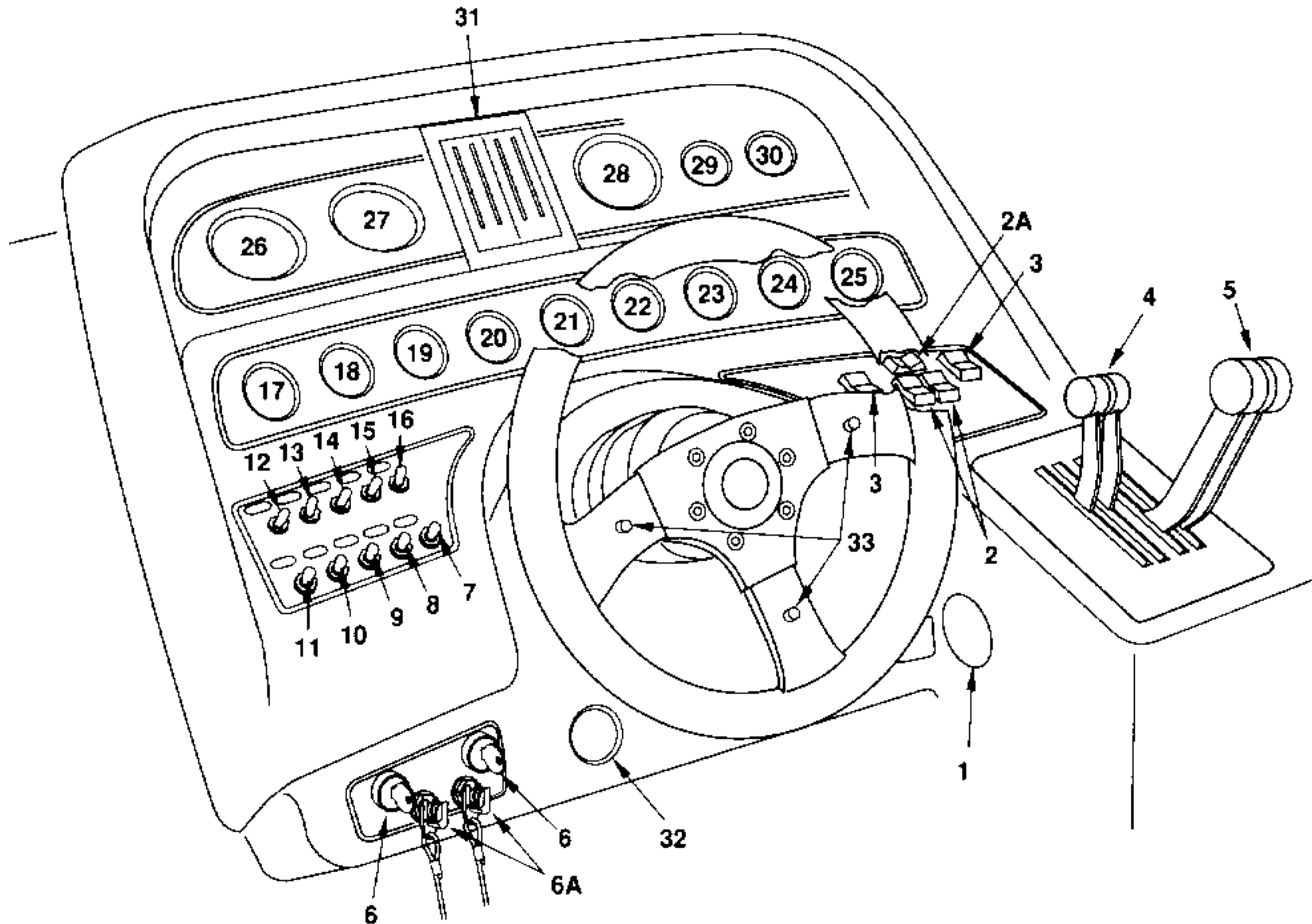

31 SCARAB

- | | | |
|---|------------------------------|---------------------------------|
| 1. Automatic Fire Suppression Indicator | 11. Blower | 23. Engine Oil Pressure |
| 2. Drive Trim Switches | 12. Panel Lights | 24. Engine Oil Temperature |
| 2A. Drive Trailer Switch | 13. Nav Anchor | 25. Engine Oil Temperature |
| 3. Trim Tab Switches | 14. Bilge Pump Switch | 26. Tachometer |
| 4. Shift Levers | 15. Engine Room Lights | 27. Tachometer |
| 5. Throttle Levers | 16. Hatch Lift | 28. Speedometer |
| 6. Ignition Switches | 17. Voltmeter | 29. Power Trim Gauge |
| 6A. Ignition Interrupters | 18. Voltmeter | 30. Power Trim Gauge |
| 7. Horn | 19. Engine Water Temperature | 31. Trim/Tab Position Indicator |
| 8. Courtesy Lights | 20. Engine Water Temperature | 32. Hourmeter |
| 9. Access Lights | 21. Fuel Gauge | 33. Optional Trim Control |
| 10. Battery Parallel | 22. Engine Oil Pressure | |

Select items listed above may be optional equipment.

SIDE VIEW OF EQUIPMENT LOCATIONS - 31 Scarab

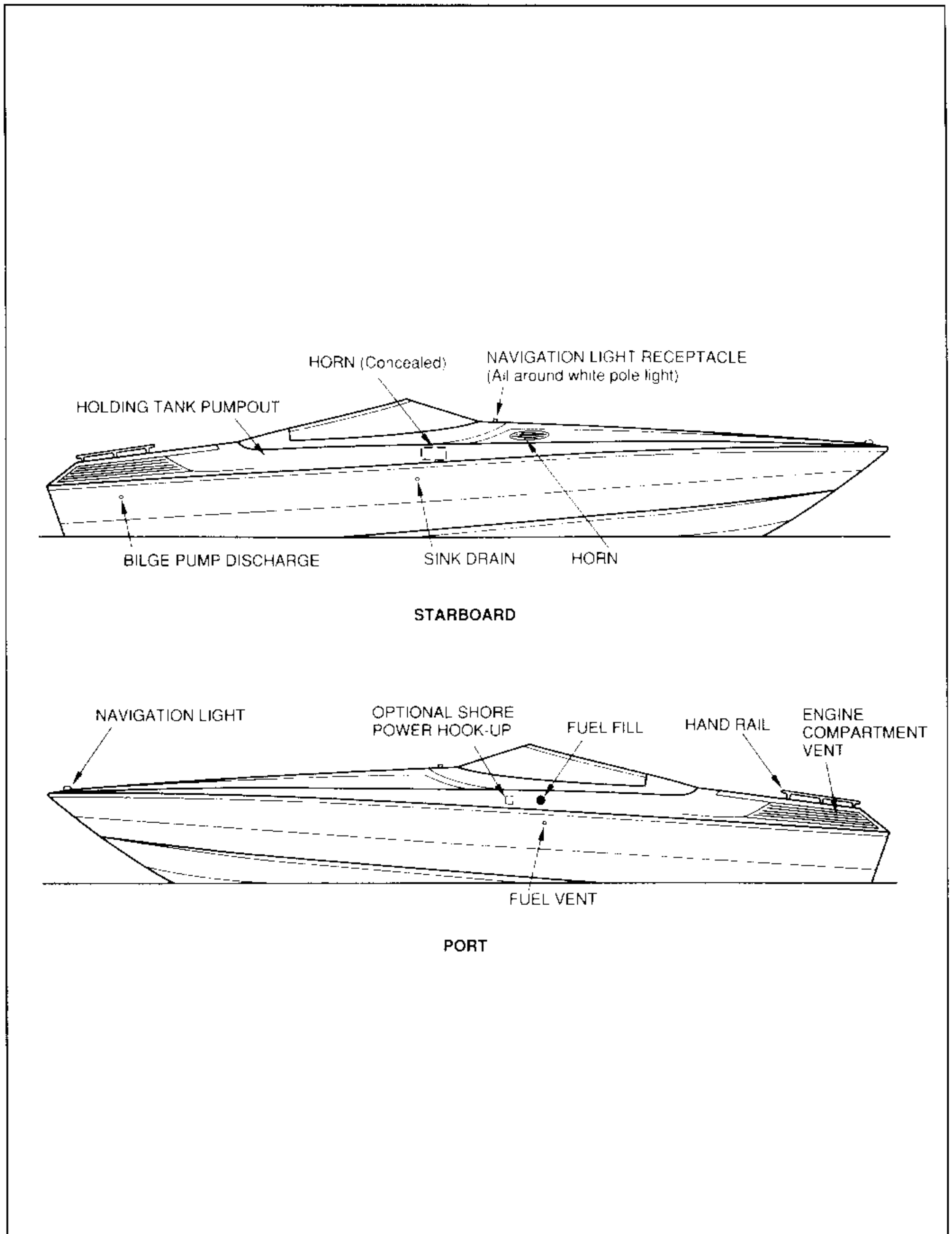

SCARAB[®]

TOP VIEW OF EQUIPMENT LOCATIONS - 31 Scarab

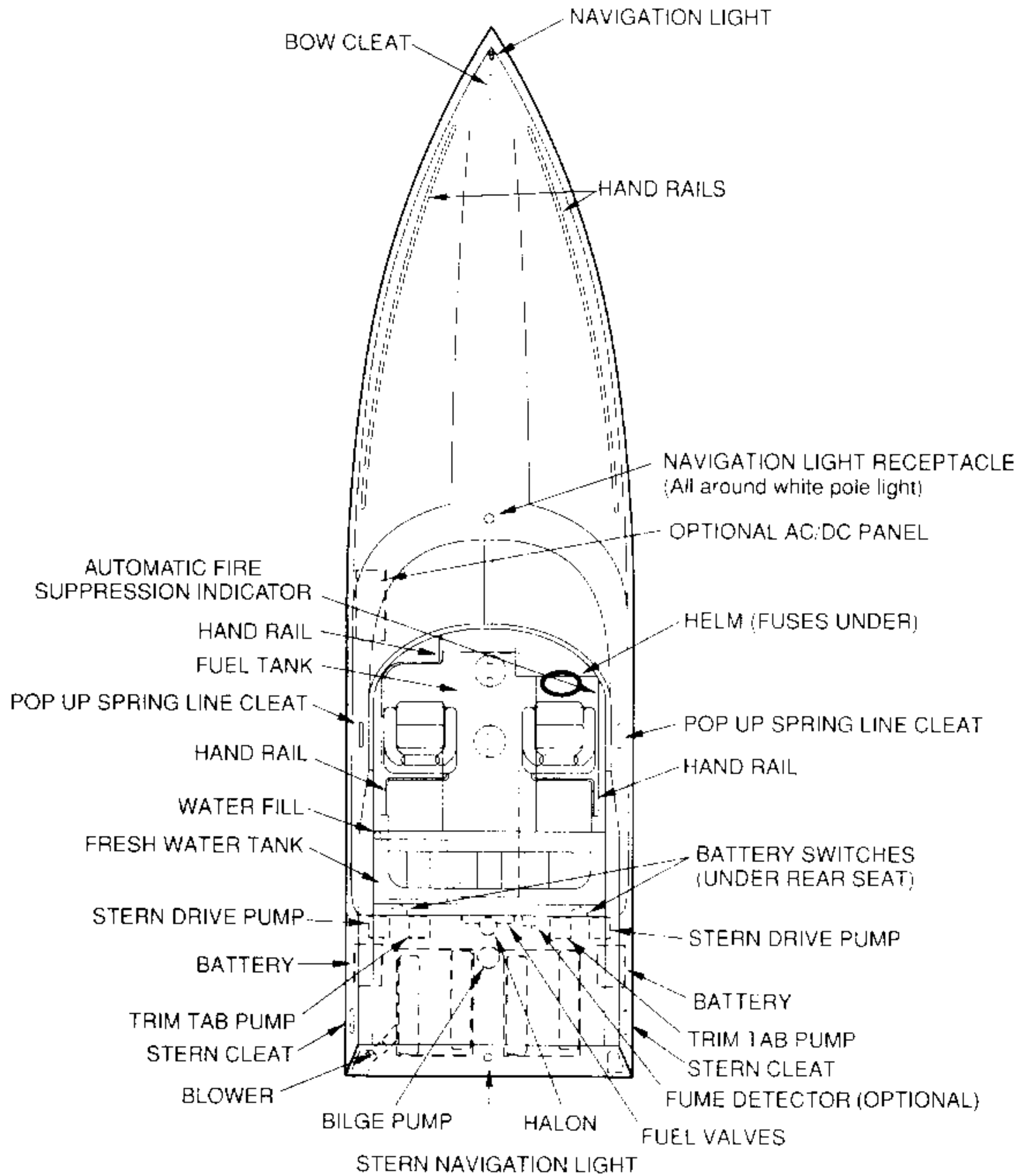

ELECTRICAL CONTROLS – 31 SCARAB

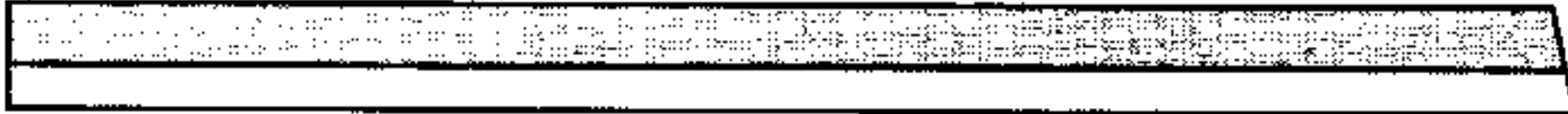
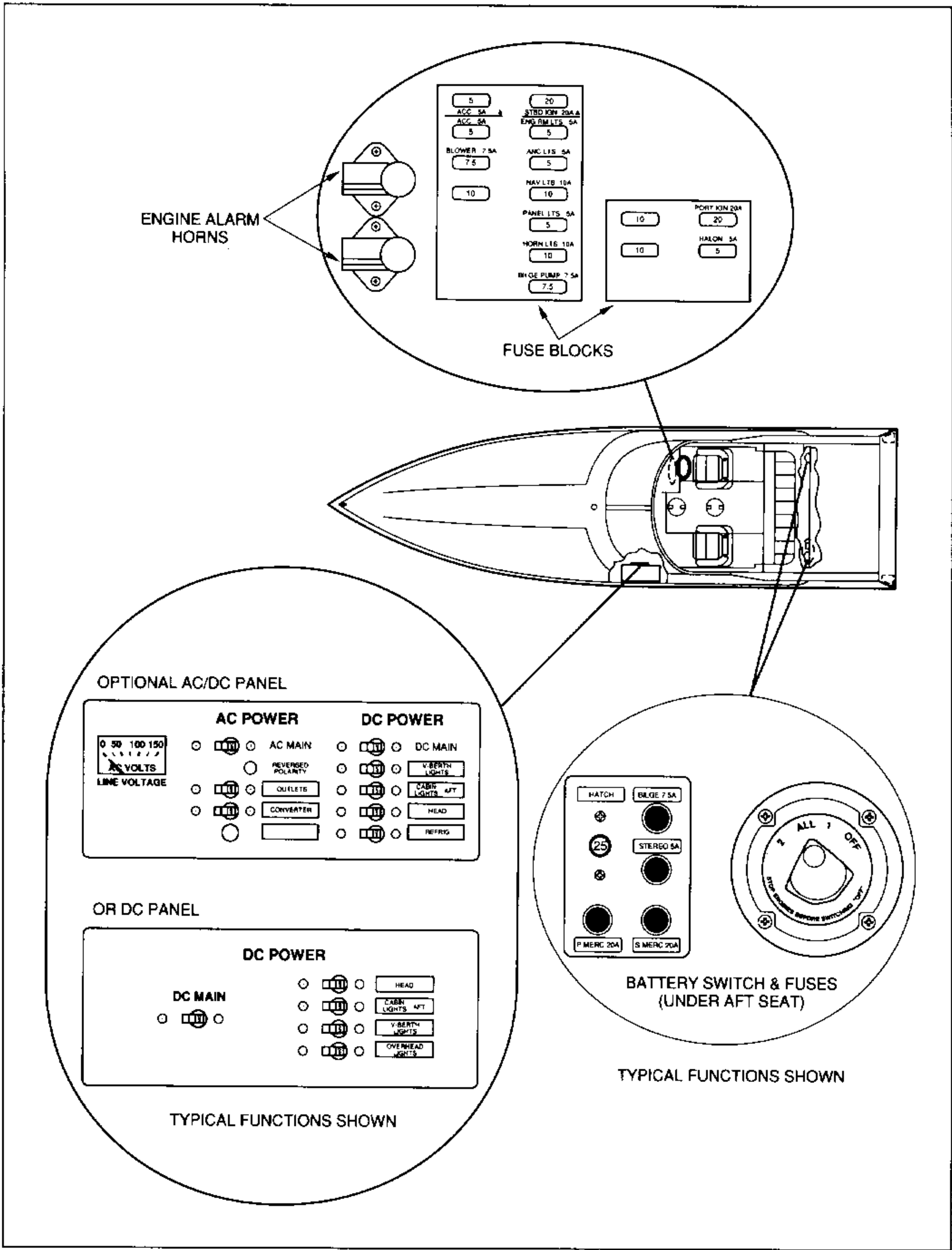

SAFETY LABELS – 38 Scarab



WARNING

- To minimize shock and fire hazards:
- (1) Turn off the boat's shore connection switch before connecting or disconnecting shore cable.
 - (2) Connect shore-power cable at the boat first.
 - (3) If polarity warning indicator is activated, immediately disconnect cable.
 - (4) Close shore-power inlet cover tightly. **DO NOT ALTER SHORE-POWER CABLE CONNECTORS**

(WITH OPTIONAL SHORE-POWER)



BOATMAN'S CHECKLIST

- For maximum enjoyment and safety, check each of these items BEFORE you start your engine:
- ✓ DRAIN PLUG (Securely in place?)
 - ✓ LIFE-SAVING DEVICES (One for every person on board?)
 - ✓ STEERING SYSTEM (Working smoothly and properly?)
 - ✓ FUEL SYSTEM (Adequate fuel? Leaks? Fumes?)
 - ✓ BATTERY (Fully charged? Cable terminals clean and tight?)
 - ✓ ENGINE (In neutral?)
 - ✓ CAPACITY PLATE (Are you overloaded or overpowered?)
 - ✓ WEATHER CONDITIONS (Safe to go out?)
 - ✓ ELECTRICAL EQUIPMENT (Lights, horn, pump, etc.?)
 - ✓ EMERGENCY GEAR (Fire extinguisher, bilge, paddle, anchor & line, signaling device, tool kit, etc.?)

WARNING

SUDDEN MOVEMENT OF BOAT CAN CAUSE LOSS OF BALANCE, FALLS, OR EJECTION FROM THE BOAT. SEVERE OR FATAL INJURY MAY RESULT. DO NOT OCCUPY THE MOTOR CUSHION AREA WHILE THE BOAT IS UNDERWAY.

NOTICE

THIS FILL FOR WATER ONLY!

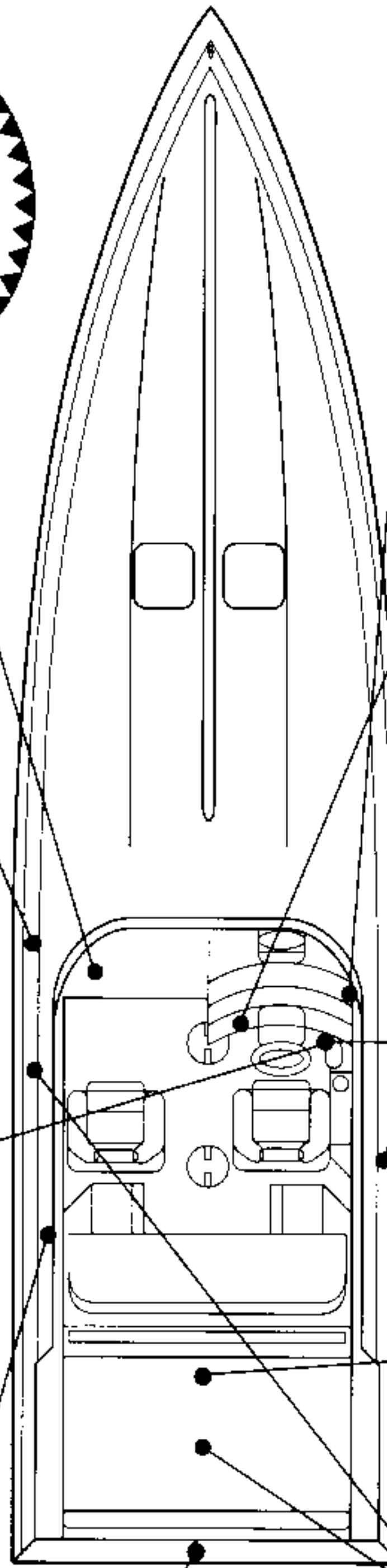

CLEANING "PLEXIGLASS" SURFACES:
WASH ACRYLIC WITH A MILD SOAP OR DETERGENT AND PLENTY OF LUKE WARM WATER. USE A CLEAN SOFT CLOTH. RINSE WITH CLEAR WATER.

CAUTION:
DO NOT USE WINDOW CLEANING SPRAYS, SCOURING COMPOUNDS, OR SOLVENTS SUCH AS GASOLINE, BENZENE, OR LACQUER THINNER.

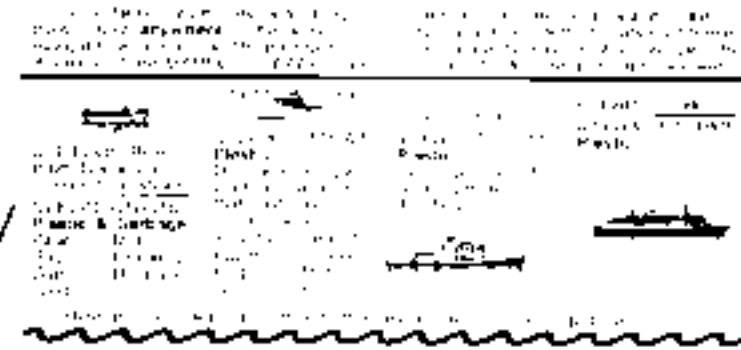

NOTICE

LIFE VEST STORED HERE

WARNING

GASOLINE VAPORS CAN EXPLODE BEFORE STARTING ENGINE:
- CHECK ENGINE COMPARTMENT FOR GASOLINE OR VAPORS.
- OPERATE BLOWER FOR 4 MINUTES. RUN BLOWER BELOW CRUISING SPEED.

DANGER

CARBON MONOXIDE IS COLORLESS, ODORLESS AND DANGEROUS. ALL GASOLINE POWERED ENGINES AND GENERATORS EXHAUST CARBON MONOXIDE (CO). DIRECT AND PROLONGED EXPOSURE TO CO WILL CAUSE BRAIN DAMAGE OR DEATH. SIGNS OF EXPOSURE TO CO INCLUDE NAUSEA, DIZZINESS AND DROWSINESS. Keep Cabin and Cockpit Areas Well Ventilated. Avoid Blockage of Exhaust Outlets. See Owner's Manual for More Details.

DISCHARGE OF OIL PROHIBITED

THE FEDERAL WATER POLLUTION CONTROL ACT PROHIBITS THE DISCHARGE OF OIL OR OILY WASTE INTO OR UPON THE NAVIGABLE WATERS AND CONTIGUOUS ZONE OF THE UNITED STATES IF SUCH DISCHARGE CAUSES A FILM OR SHEEN UPON, OR DISCOLORATION OF, THE SURFACE OF THE WATER, OR CAUSES A SLUDGE OR EMULSION BENEATH THE SURFACE OF THE WATER.

VIOLATORS ARE SUBJECT TO A PENALTY OF \$5,000

WARNING

LEAKING FUEL IS A FIRE AND EXPLOSION HAZARD. INSPECT SYSTEM REGULARLY. EXAMINE FUEL SYSTEM FOR LEAKS OR CORROSION AT LEAST ANNUALLY.

(ABOVE ENGINE FLAME ARRESTER COVER)

WARNING

PROPELLER LOCATED BEHIND THIS BOAT. CONTACT MAY CAUSE SEVERE INJURY OR FATALITY. DO NOT APPROACH OR USE LADDER AND PLATFORM WHEN THE ENGINE IS RUNNING.

(WITH OPTIONAL PLATFORM)

Contact your Wellcraft dealer for replacements.

HELM LAYOUT - 38 Scarab

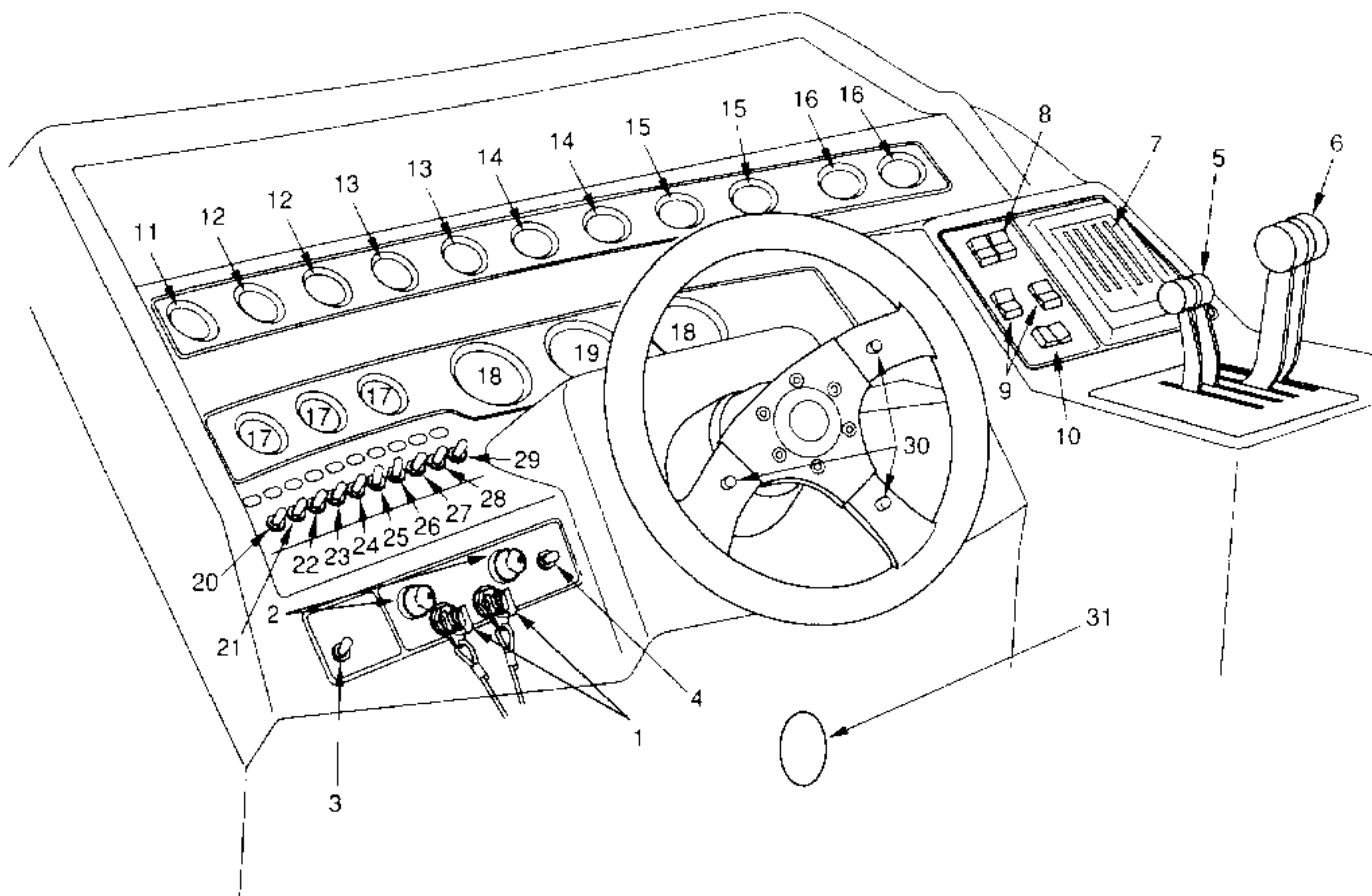

38 SCARAB

- | | | |
|---|------------------------------|---|
| 1. Ignition Interrupters | 11. Clock | 22. Exhaust |
| 2. Ignition Switches | 12. Voltmeters | 23. Nav/Anchor |
| 3. Blower | 13. Engine Water Temperature | 24. Panel Lights |
| 4. Hatch Lift | 14. Engine Oil Pressure | 25. Courtesy Lights |
| 5. Shift Levers | 15. Engine Oil Temperature | 26. Engine Room Lights |
| 6. Throttle Levers | 16. Water Pressure | 27. Bilge Pump Switch |
| 7. Trim Tab/Drive Trim
Position Indicators | 17. Fuel Gauges | 28. Battery Parallel |
| 8. Drive Trim Switches | 18. Tachometers | 29. Horn |
| 9. Trim Tab Switches | 19. Speedometer | 30. Optional Trim Control |
| 10. Trailer Switch | 20. Accy | 31. Automatic Fire Suppression
Indicator |
| | 21. Accy | |

Selected items listed above may be optional equipment.



SIDE VIEW OF EQUIPMENT LOCATIONS – 38 Scarab

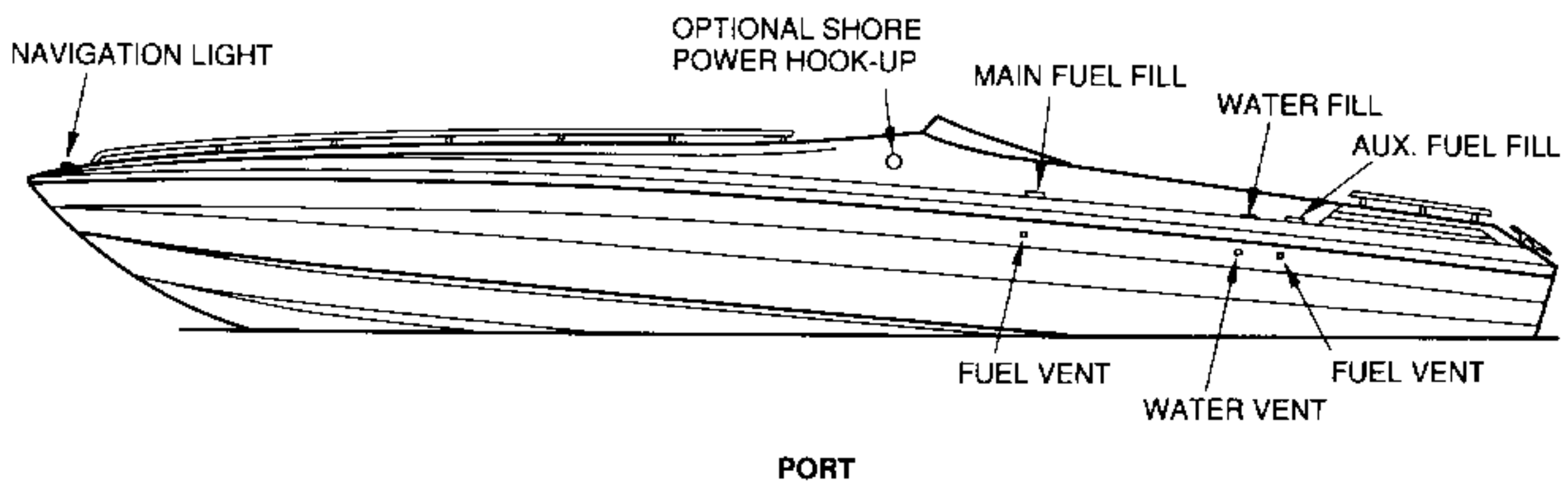
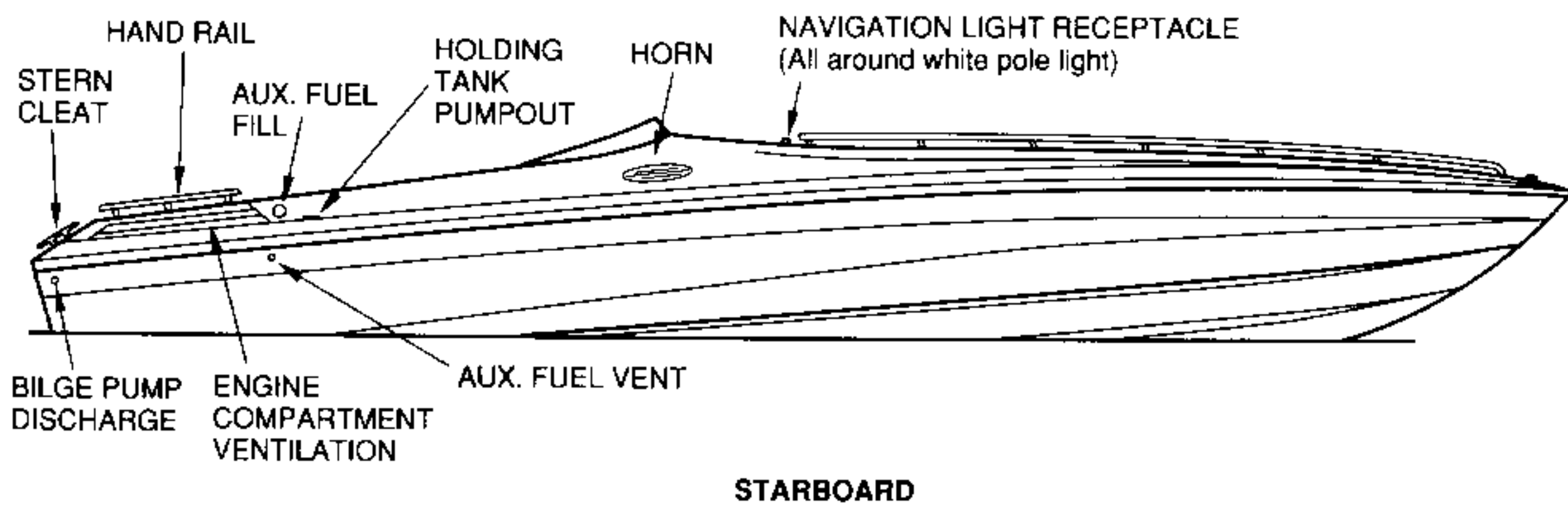

TOP VIEW OF EQUIPMENT LOCATIONS – 38 Scarab

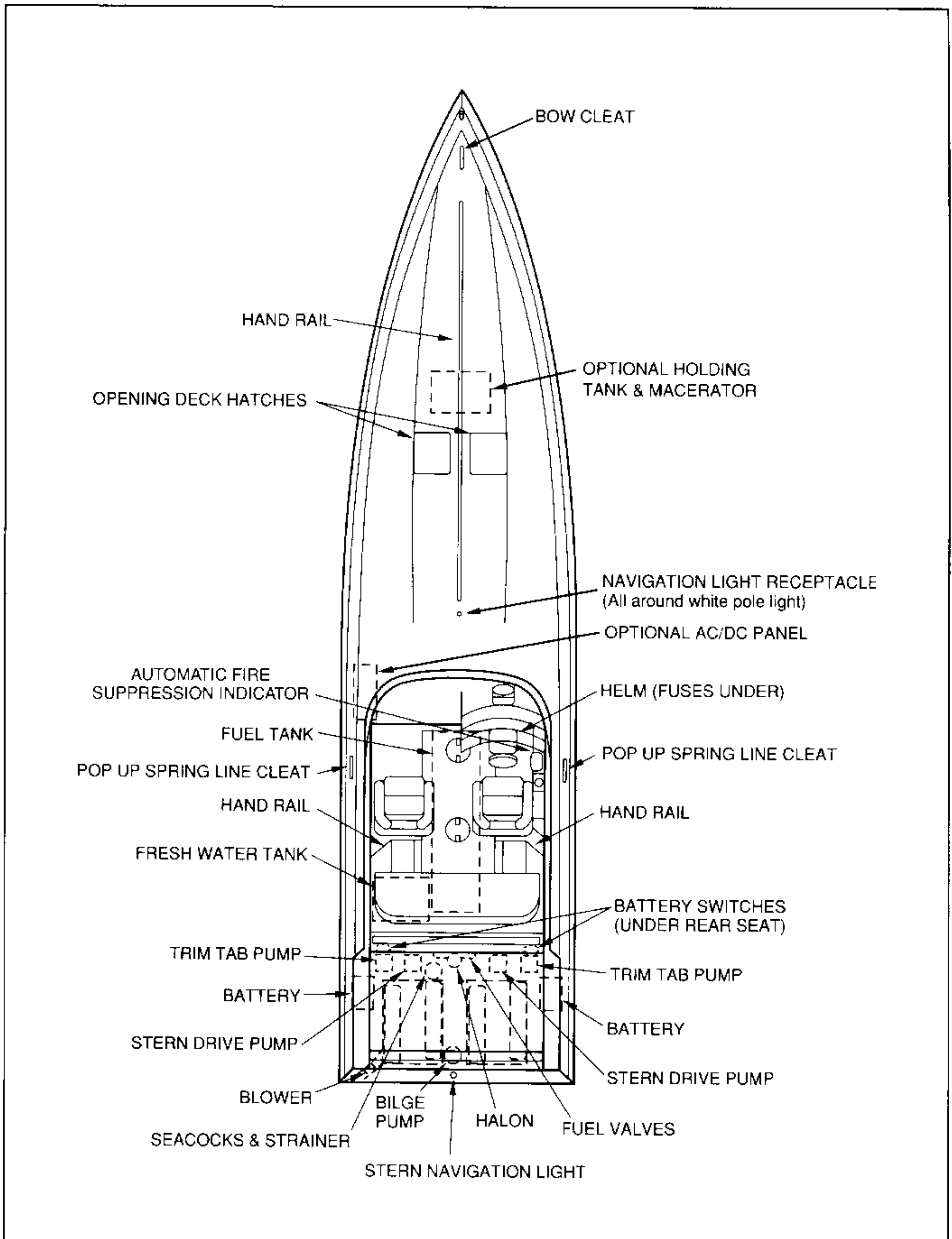

SCARAB®

ELECTRICAL CONTROLS - 38 Scarab

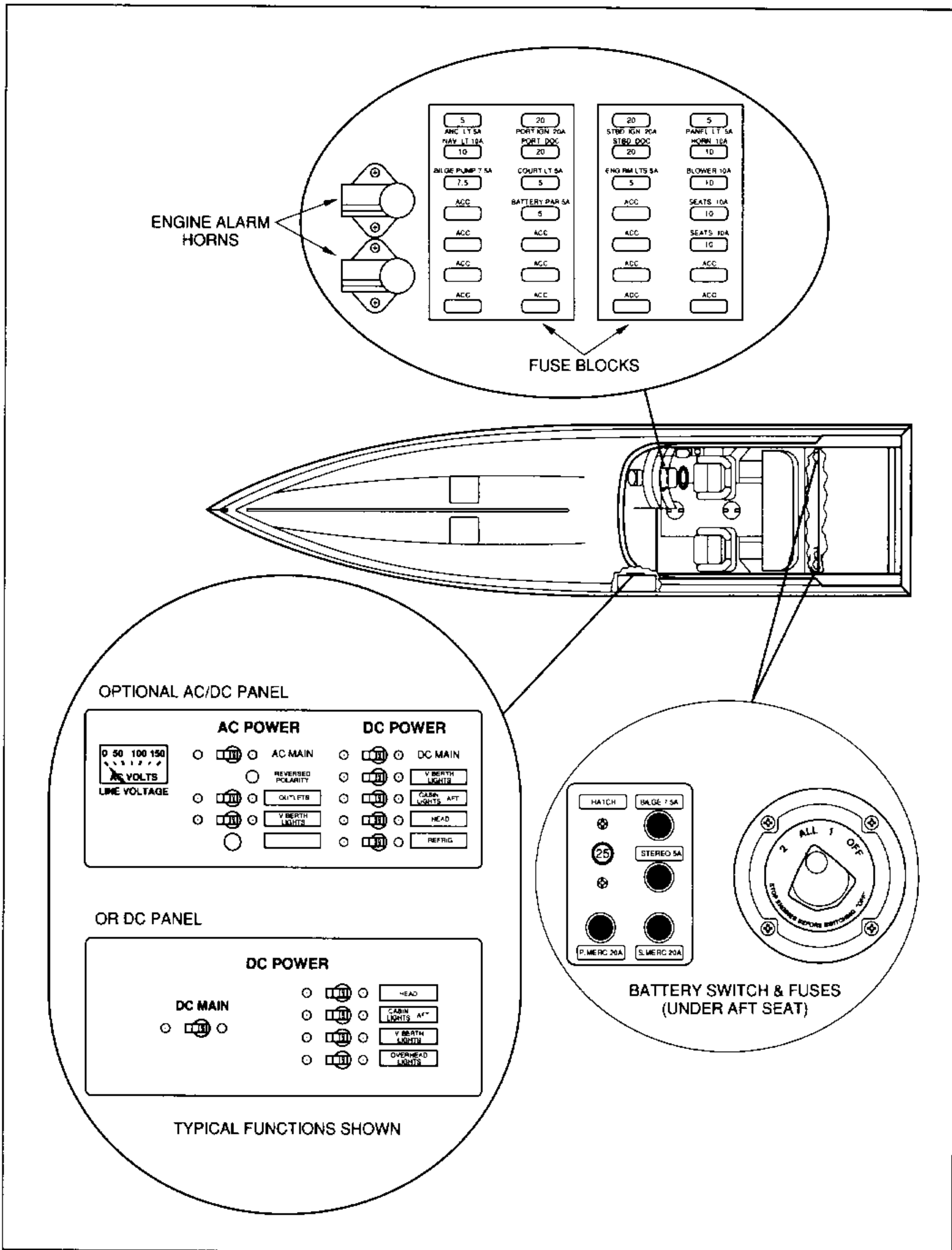

SAFETY LABELS – 43 Scarab



WARNING

- To minimize shock and fire hazards:
- (1) Turn off the boat's shore connection switch before connecting or disconnecting shore cable.
 - (2) Connect shore-power cable at the boat first.
 - (3) If polarity warning indicator is activated, immediately disconnect cable.
 - (4) Close shore-power inlet cover tightly. DO NOT ALTER SHORE-POWER CABLE CONNECTORS.



BOATMAN'S CHECKLIST

- For maximum enjoyment and safety, check each of these items BEFORE you start your engine:
- ✓ DRAIN PLUG (Securely in place?)
 - ✓ LIFE-SAVING DEVICES (One for every person on board?)
 - ✓ STEERING SYSTEM (Working smoothly and properly?)
 - ✓ FUEL SYSTEM (Adequate fuel? Leaks? Fumes?)
 - ✓ BATTERY (Fully charged? Cable terminals clean and tight?)
 - ✓ ENGINE (In neutral?)
 - ✓ CAPACITY PLATE (Are you overloaded or overpowered?)
 - ✓ WEATHER CONDITIONS (Safe to go out?)
 - ✓ ELECTRICAL EQUIPMENT (Lights, horn, pump, etc.?)
 - ✓ EMERGENCY GEAR (Fire extinguisher, bailer, paddle, anchor & line, signaling device, tool kit, etc.?)

WARNING

SUDDEN MOVEMENT OF BOAT CAN CAUSE LOSS OF BALANCE, FALLS, OR EJECTION FROM THE BOAT. SEVERE OR FATAL INJURY MAY RESULT. DO NOT OCCUPY THE MOTOR CUSHION AREA WHILE THE BOAT IS UNDERWAY.

NOTICE

THIS FILL FOR WATER ONLY!

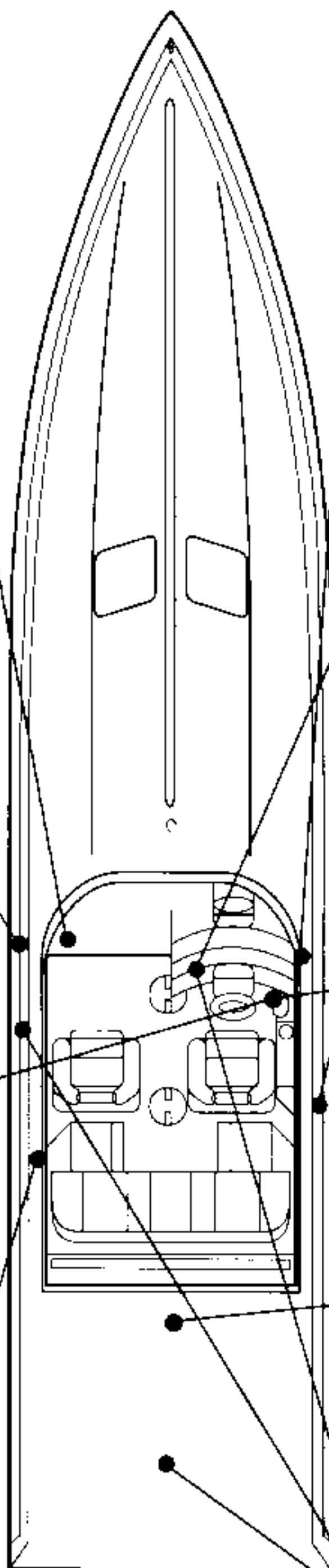

CLEANING "PLEXIGLASS" SURFACES:
WASH ACRYLIC WITH A MILD SOAP OR DETERGENT AND PLENTY OF LUKE WARM WATER. USE A CLEAN SOFT CLOTH. RINSE WITH CLEAR WATER.

CAUTION:
DO NOT USE WINDOW CLEANING SPRAYS, SCOURING COMPOUNDS, OR SOLVENTS SUCH AS GASOLINE, BENZENE, OR LACQUER THINNER.

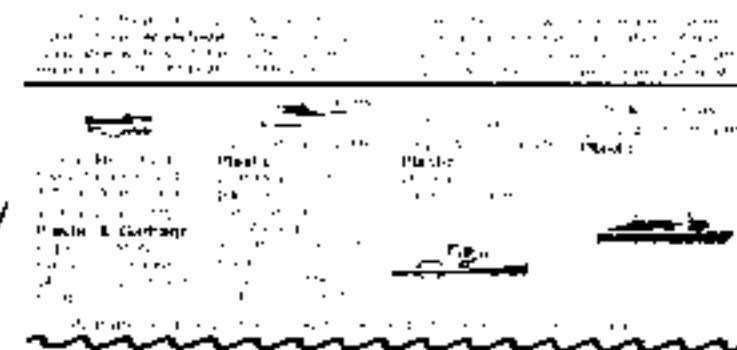

NOTICE

LIFE VEST STORED HERE

WARNING

GASOLINE VAPORS CAN EXPLODE BEFORE STARTING ENGINE:
- CHECK ENGINE COMPARTMENT FOR GASOLINE OR VAPORS.
- OPERATE BLOWER FOR 4 MINUTES. RUN BLOWER BELOW CRUISING SPEED.

DANGER

CARBON MONOXIDE IS COLORLESS, ODORLESS AND DANGEROUS. ALL GASOLINE POWERED ENGINES AND GENERATORS EXHAUST CARBON MONOXIDE (CO.) DIRECT AND PROLONGED EXPOSURE TO CO WILL CAUSE BRAIN DAMAGE OR DEATH. SIGNS OF EXPOSURE TO CO INCLUDE NAUSEA, DIZZINESS AND DROWSINESS. Keep Cabin and Cockpit Areas Well Ventilated. Avoid Blockage of Exhaust Outlets. See Owner's Manual for More Details.

DISCHARGE OF OIL PROHIBITED

THE FEDERAL WATER POLLUTION CONTROL ACT PROHIBITS THE DISCHARGE OF OIL OR OILY WASTE INTO OR UPON THE NAVIGABLE WATERS AND CONTIGUOUS ZONE OF THE UNITED STATES IF SUCH DISCHARGE CAUSES A FILM OR SHEEN UPON, OR DISCOLORATION OF, THE SURFACE OF THE WATER, OR CAUSES A SLUDGE OR EMULSION BENEATH THE SURFACE OF THE WATER.

VIOLATORS ARE SUBJECT TO A PENALTY OF \$5,000

WARNING

LEAKING FUEL IS A FIRE AND EXPLOSION HAZARD. INSPECT SYSTEM REGULARLY. EXAMINE FUEL SYSTEM FOR LEAKS OR CORROSION AT LEAST ANNUALLY.

(ABOVE ENGINE FLAME ARRESTER COVER)

Contact your Wellcraft dealer for replacements.

SCARAB®

HELM LAYOUT - 43 Scarab

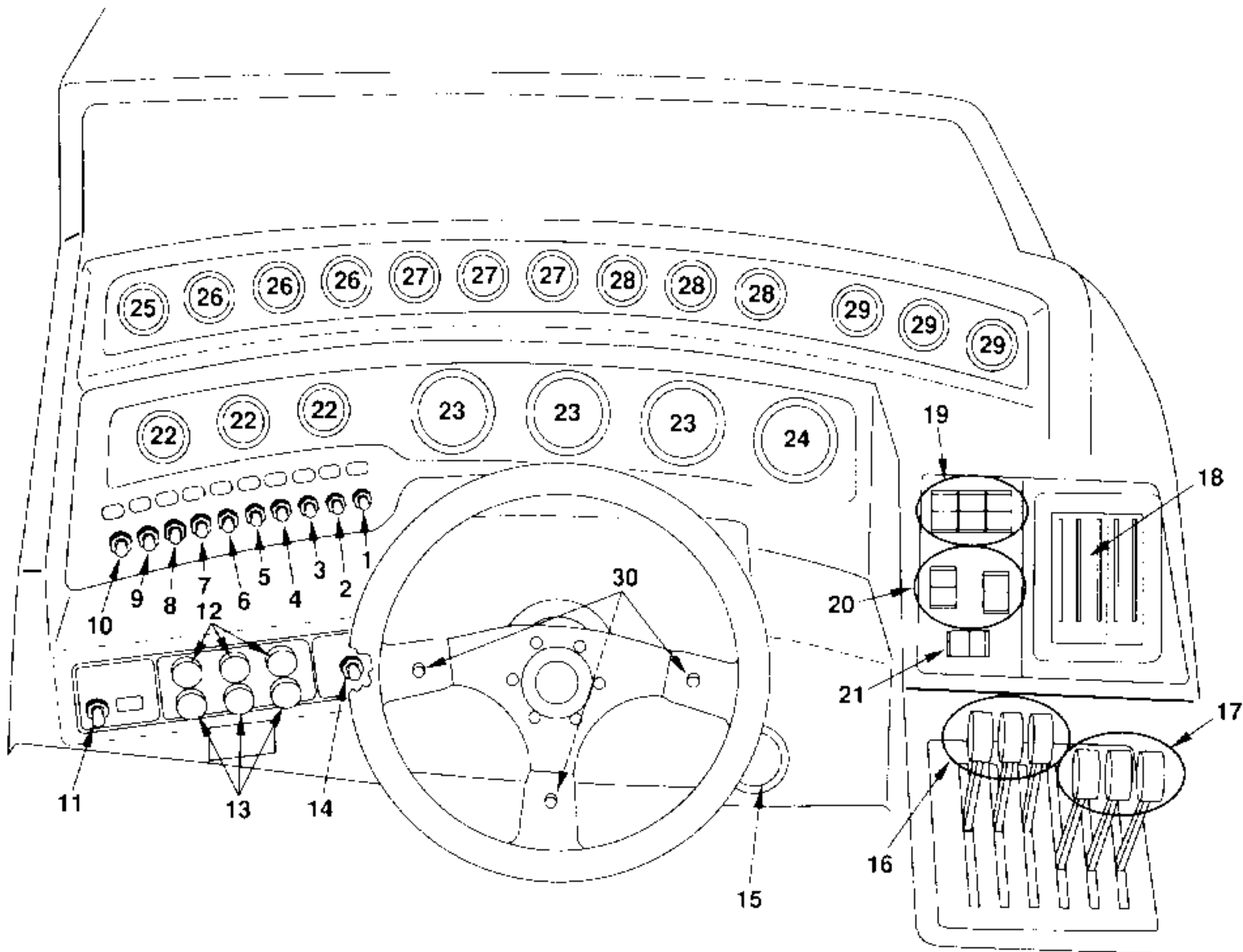

43 SCARAB

- | | | |
|-----------------------|--|------------------------------|
| 1. Horn | 11. Blower | 21. Trailer Switch |
| 2. Battery Parallel | 12. Ignition Switches | 22. Fuel Gauges |
| 3. Bilge Pump Switch | 13. Ignition Interrupters | 23. Tachometers |
| 4. Engine Room Lights | 14. Hatch Lift | 24. Speedometer |
| 5. Courtesy Lights | 15. Fire Suppression Indicator | 25. Clock |
| 6. Panel Lights | 16. Shift Levers | 26. Voltmeters |
| 7. Nav/Anchor | 17. Throttle Levers | 27. Engine Oil Pressure |
| 8. Exhaust | 18. Trim Tab/Drive Trim
Position Indicators | 28. Engine Water Temperature |
| 9. Accy | 19. Drive Trim Switches | 29. Engine Oil Temperature |
| 10. Accy | 20. Trim Tab Switches | 30. Optional Trim Control |

Selected items listed above may be optional equipment.

SIDE VIEW OF EQUIPMENT LOCATIONS - 43 Scarab

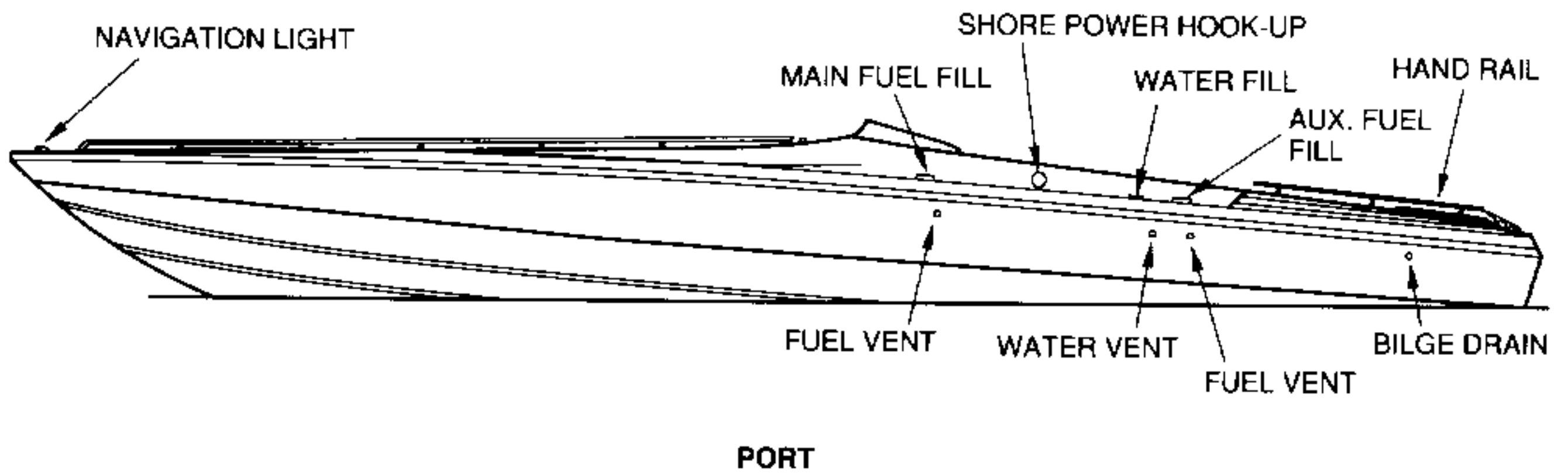
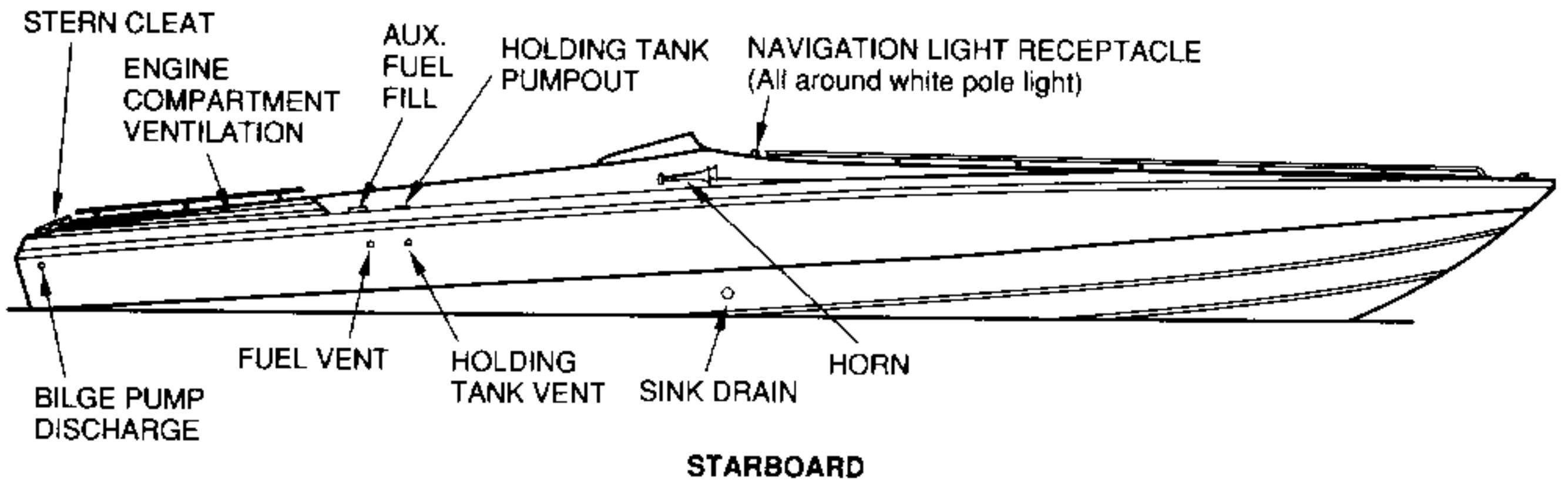

SCARAB[®]

TOP VIEW OF EQUIPMENT LOCATIONS - 43 Scarab

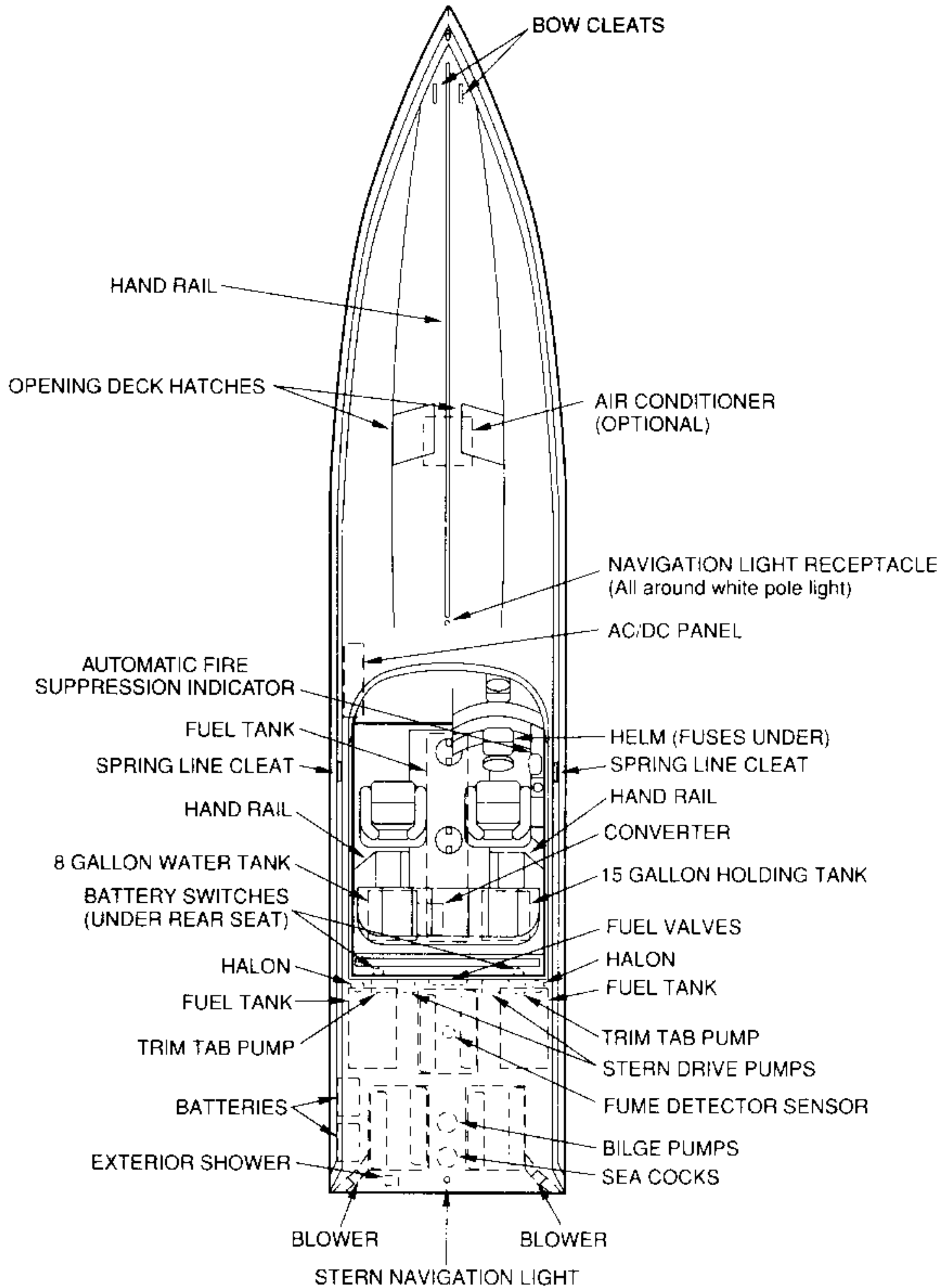

ELECTRICAL CONTROLS - 43 Scarab

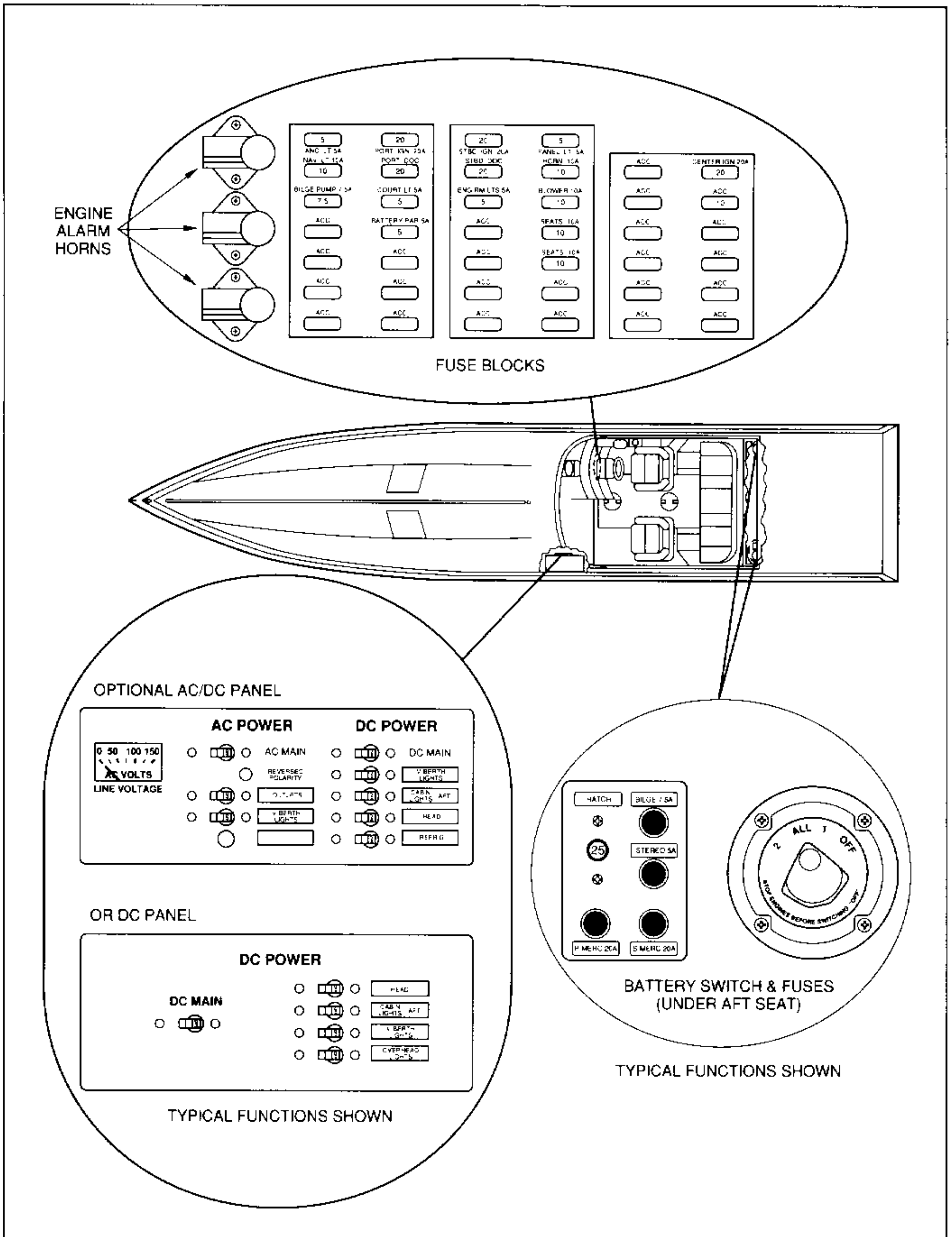

SCARAB®

Controls and Indicators

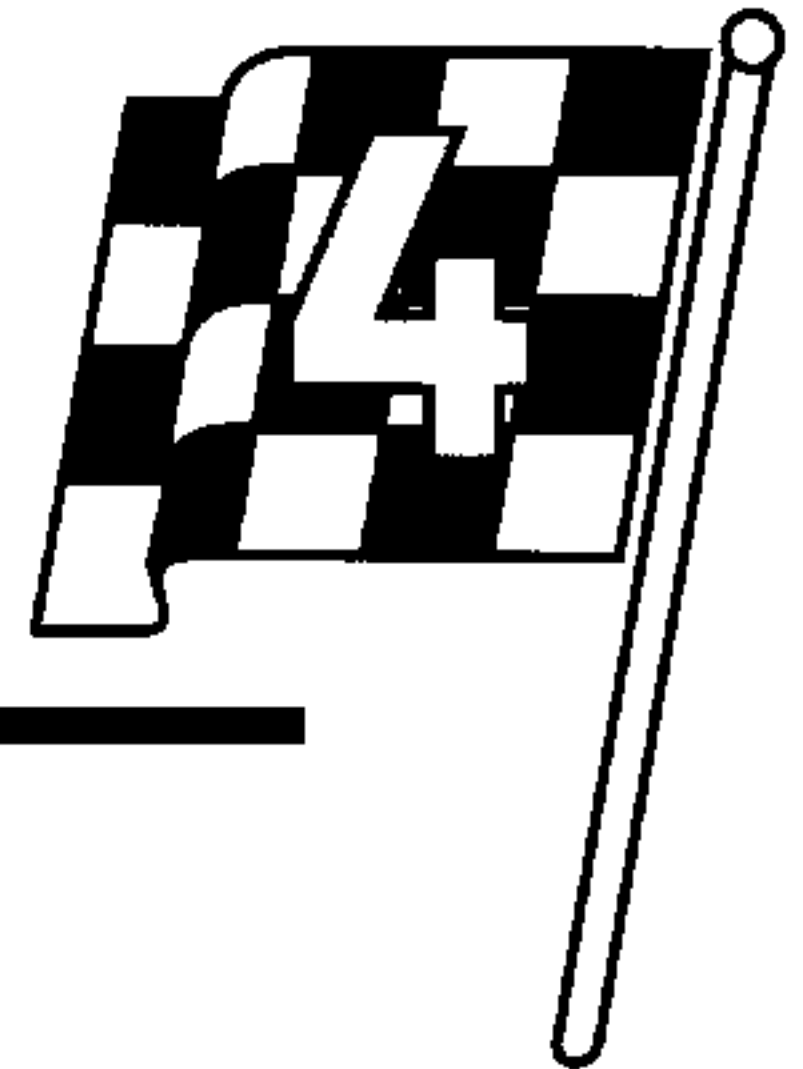

SHIFT/THROTTLE CONTROL

The shift/throttle controls differ slightly between models and engine configurations. Some optional control packages may also be slightly different from the following description. Be sure to consult the engine and remote control manual for operational differences.

NOTICE

All shift/throttle controls are equipped with a safety switch for "start in neutral only" operation.

WARNING

Never shift into or out of gear unless the throttle lever(s) is in the idle position and the boat has lost most of its headway. Shifting with the engine speed above idle can cause serious damage to your boat's drive unit.

Single Lever Engine Control

A single lever engine control operates as both a gear shifter and a throttle for a single engine. Shifting is accomplished by moving the lever into the first 15° of travel; push the lever for forward and pull the lever back for reverse. By advancing the lever beyond 15°, you move from the shifting range to the throttle range. Never attempt to shift without the engine running. For engine warm-up, there is a button at the base of the shift/throttle lever which, when depressed, allows the throttle to be advanced while the transmission remains in neutral.

Twin Lever Engine Control

With twin lever engine controls, there is one shift lever and one throttle lever for each engine. This is the most common type of engine control for large boats, and it is the type used on all Scarab models with the exception of the 22 Scarab which uses a single lever engine control.

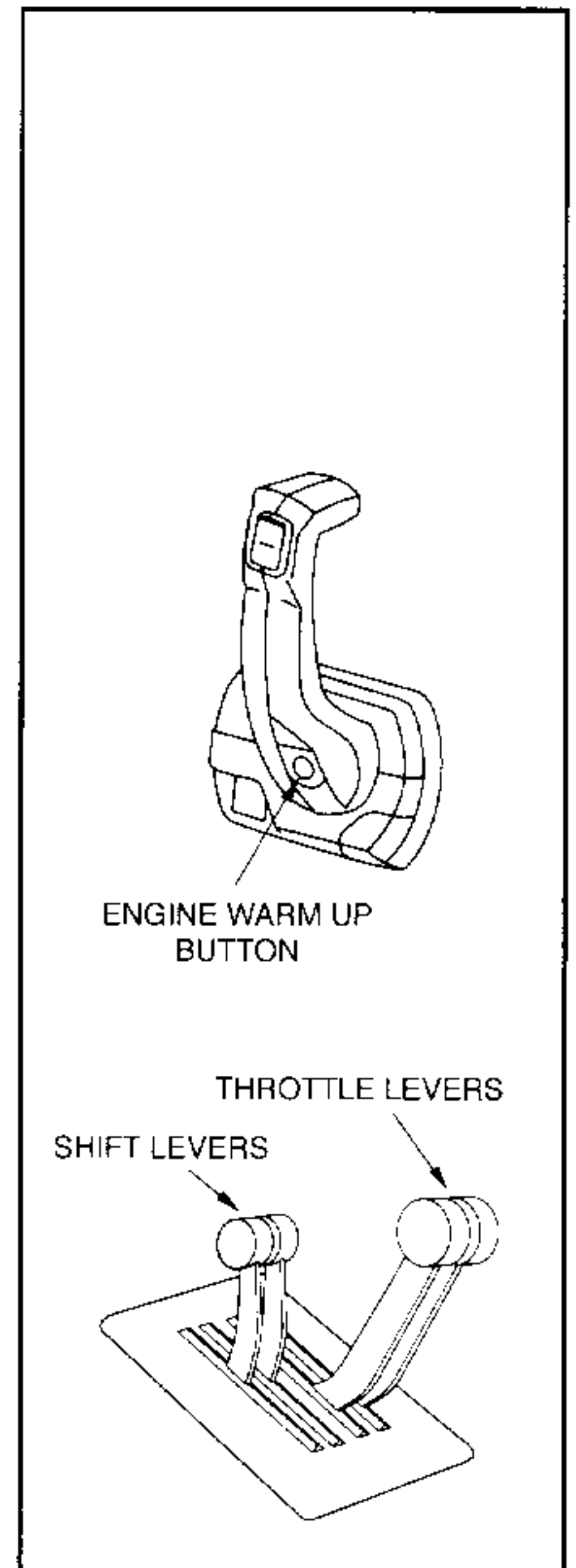

SCARAB®

On multiple engine boats, twin lever engine controls will normally be arranged with shift levers (all one size) grouped together and throttle levers (all the same size, but usually larger than the shift levers) grouped together. For the shift lever(s), neutral is the detent position in the middle of the lever's travel. Pushing the lever ahead shifts the engine transmission into forward and pulling the lever all the way back shifts the engine transmission into reverse. For the throttle lever(s), full throttle position is all the way forward and idle position is all the way back.

STEERING

Various steering systems are used on Wellcraft boats. On smaller boats, a push/pull cable system is most common. On larger boats, power assisted and fully hydraulic systems are common. All steering systems require periodic maintenance to be trouble-free and safe. Regular checks are essential. Be sure to read the manufacturer supplied operator's manual before heading out on the water.

WARNING

If your boat is equipped with Teleflex steering, re-torque all attaching bolts and hardware according to specifications provided in manufacturer's instructions after a few hours of running and at regular intervals thereafter. Loosening or separation of one or more fasteners may cause failure of the steering system resulting in a serious injury-causing accident.

WARNING

Boat steering is not self-centering. Steering is affected by engine and propeller torque, trim tab setting, wave and current action and the speed of the hull through the water. Constant attention to steering is required for safe operation.

TRIM TABS

Trim tabs are mounted to the transom of high performance powerboats to add lift to the boat's stern, thereby changing the boat's attitude. This lift can help a boat get up on plane faster and remain on plane at slower speeds than would otherwise be possible without tabs. Used independently, tabs can also correct listing conditions caused by crosswinds (which deep-V hulls are susceptible to), unbalanced loading and quartering seas.

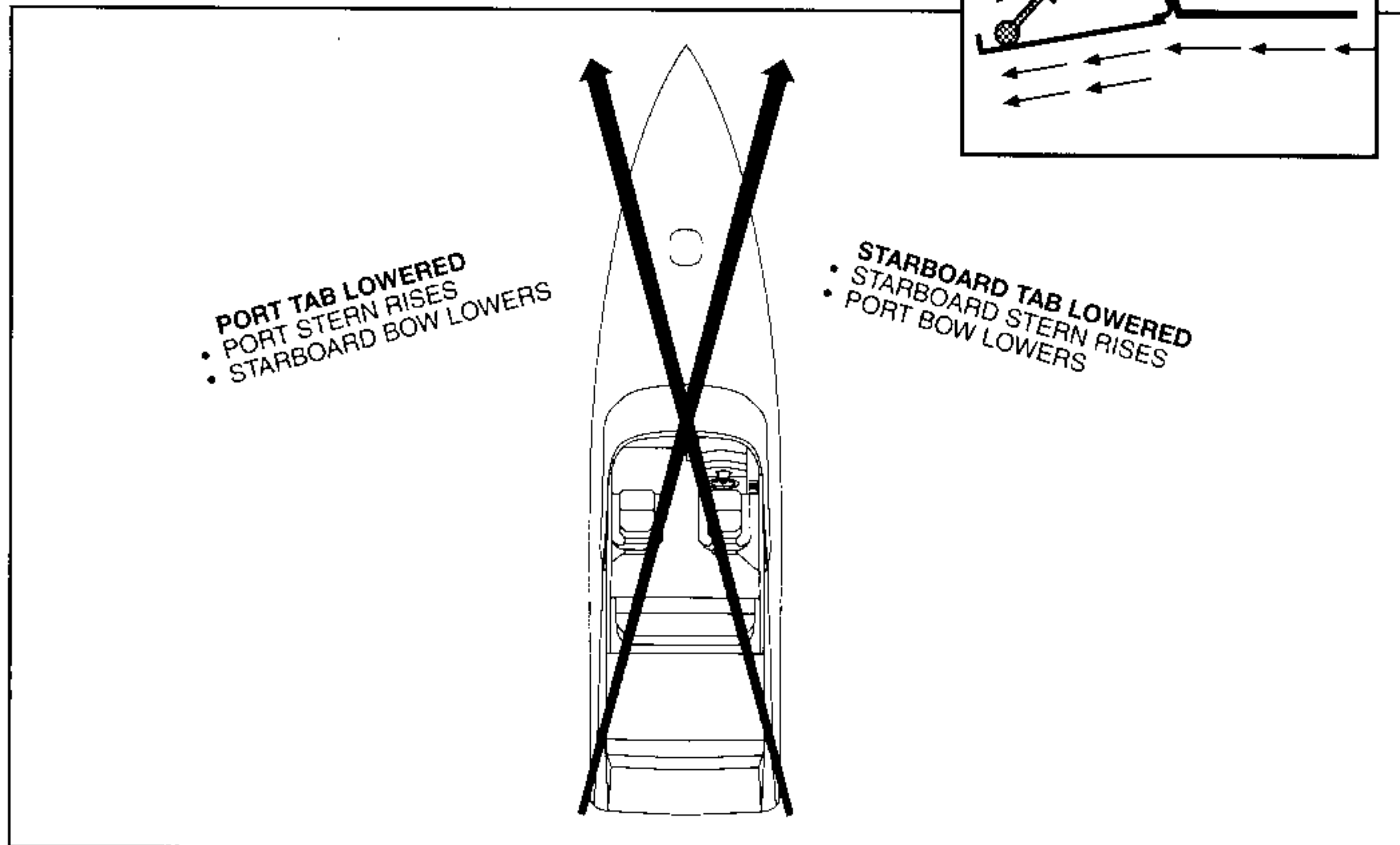
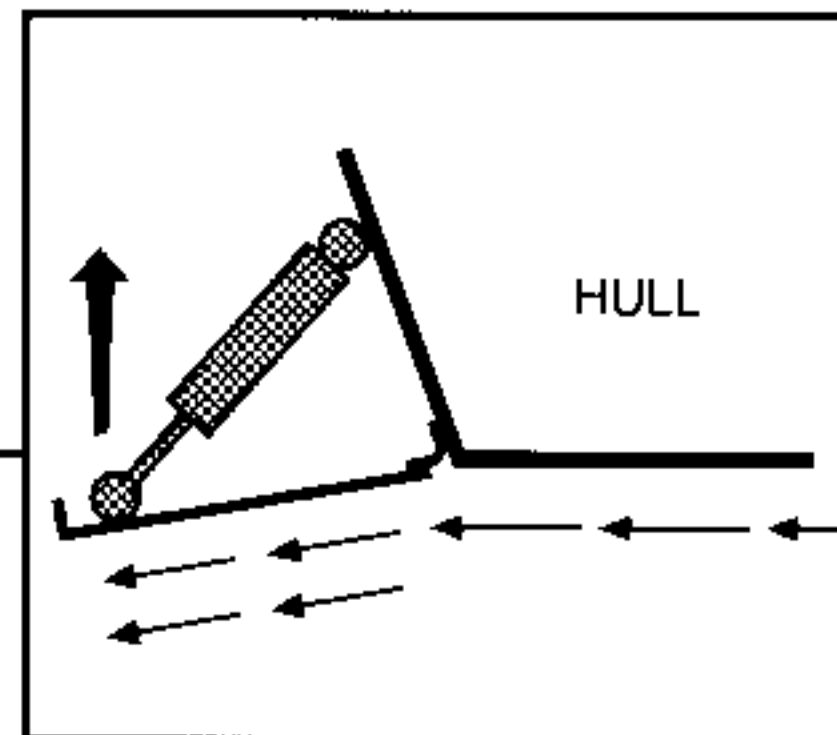

Two rocker switches, located just ahead of the shift/throttle levers, control a hydraulic pump which directs oil to and from hydraulic actuators (cylinders) which raise and lower the trim tabs. When trim tabs are lowered, pressure from water pushing up against the tabs raises the stern of the boat and lowers the bow. When the port and starboard trim tabs are used independently, the bow side opposite the trim tab being lowered will lower. For example, lowering the port tab will cause the port stern to raise and the starboard bow to lower.

The trim tab switches are "cross" wired so that the inboard switch, labeled PORT BOW, controls the starboard trim tab and the outboard switch, labeled STBD BOW, controls the port trim tab. By wiring the switches in this manner, boat trim is easier to understand; you control the starboard bow attitude with the starboard switch and the port bow attitude with the port switch.



SCARAB®

STERN DRIVE TRIM

Drive trim is the hydraulic system that controls the angle of the lower unit. Switches labeled **OUTDRIVES** give the operator the ability to adjust the lower unit angle at cruising speed to achieve an ideal planing angle (approximately 3-5° to the water) for the best performance and fuel economy. There will always be a separate trim switch for each lower unit, however, on twin engine boats, the lower units should always be trimmed together. A **TRAILER** switch allows the operator to raise the lower unit for trailering, beaching, launching and *slow speed* operation in shallow water.

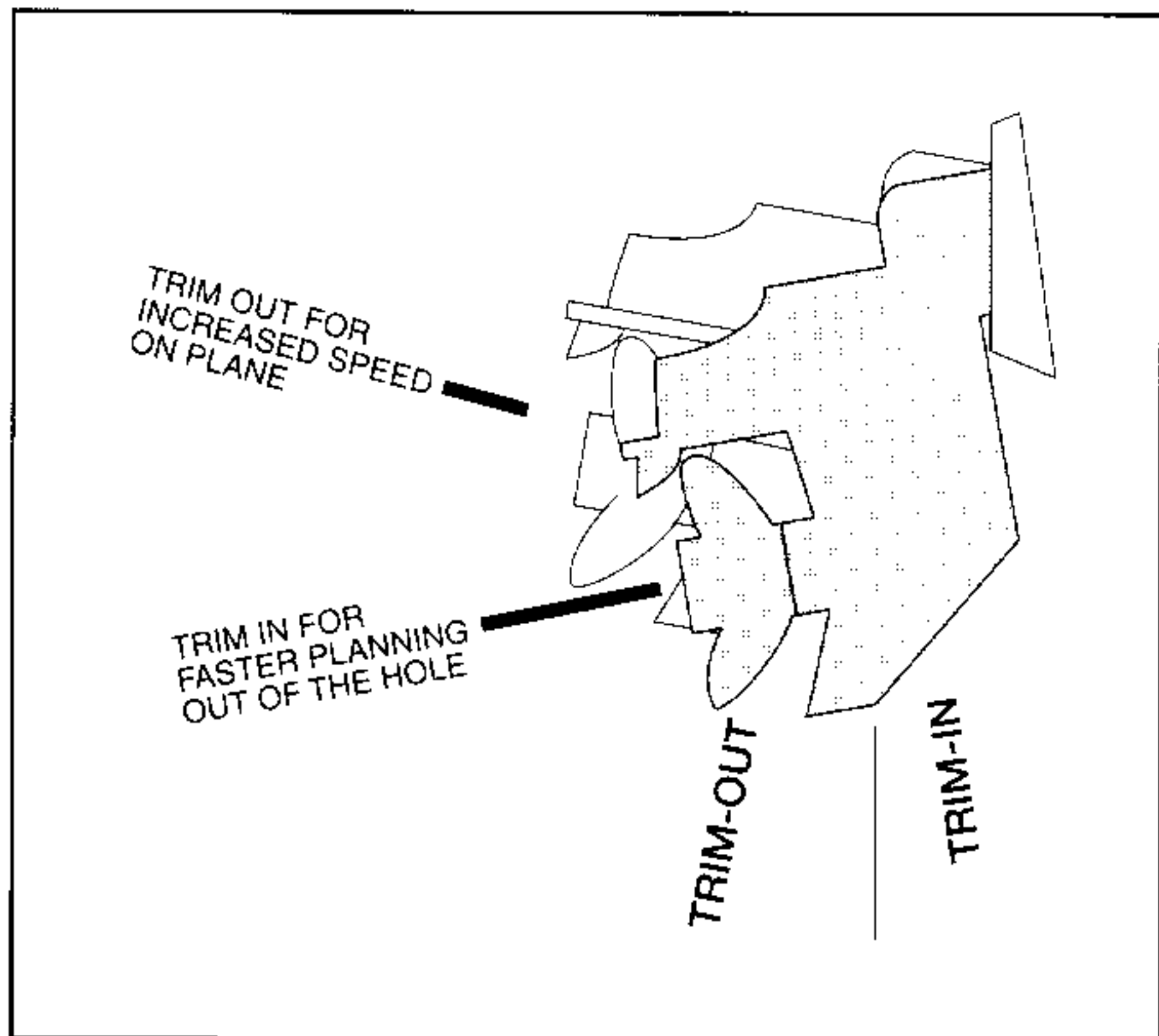

Drive trim switches will be in different locations on your boat depending on whether your boat has a single lever engine control, double lever engine control or an optional Latham steering wheel with built-in trim switches. See section 3, Specifications and Layout, for the particular locations on your model. On boats equipped with multiple engines, each engine will have a rocker type **OUTDRIVE** switch and a **TRAILER** switch.

When on plane, drive trim adjustments are critical in achieving the best performance from your boat. If your boat is **under-trimmed** (the lower unit is too far **IN**), the following conditions are likely:

- ◆ Your bow will be too low in relation to the stern, digging into the water. This will create an unstable steering condition known as “bow steering.”
- ◆ Your fuel economy and boat speed will both be below their ideal range.

If your boat is overtrimmed (the lower unit is too far OUT), these following conditions are likely:

- ◆ The propeller(s) will ventilate causing loss of speed and possible engine over-revving.
- ◆ Severe damage to the lower unit may occur if it is trimmed out beyond the gimbal ring support flanges.

WARNING

Never trim drive unit up/out using TRAILER switch while boat is underway. Use extreme caution when operating with drive unit raised, severe damage to drive unit may result at engine speeds above 1200 RPM.

- ◆ Your bow may begin to bounce - a condition known as porpoising. If this happens, bring the lower unit(s) in until the bow rides smoothly.

NOTICE

If TRAILER button(s) are held depressed after drive unit reaches end of upward travel, an internal circuit breaker will open and pump will stop. Should this happen, release button(s) and allow motor to cool for about one minute.

INSTRUMENTS

Instrument type, number and location vary with engine options and some may not appear on your model. If your boat is equipped with multiple engines, there may be two or more sets of some of the instruments described in this section; one set for each engine.

Small fluctuations in gauge readings on occasion are not unusual. If an instrument reading is outside of normal or recommended ranges, investigate the cause immediately or see your dealer. Consult the engine operator's manual for the normal recommended ranges.

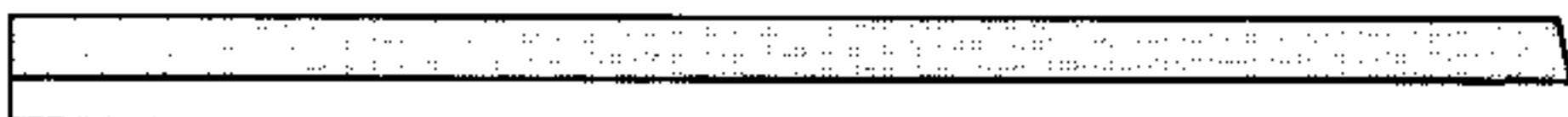

SCARAB[®]

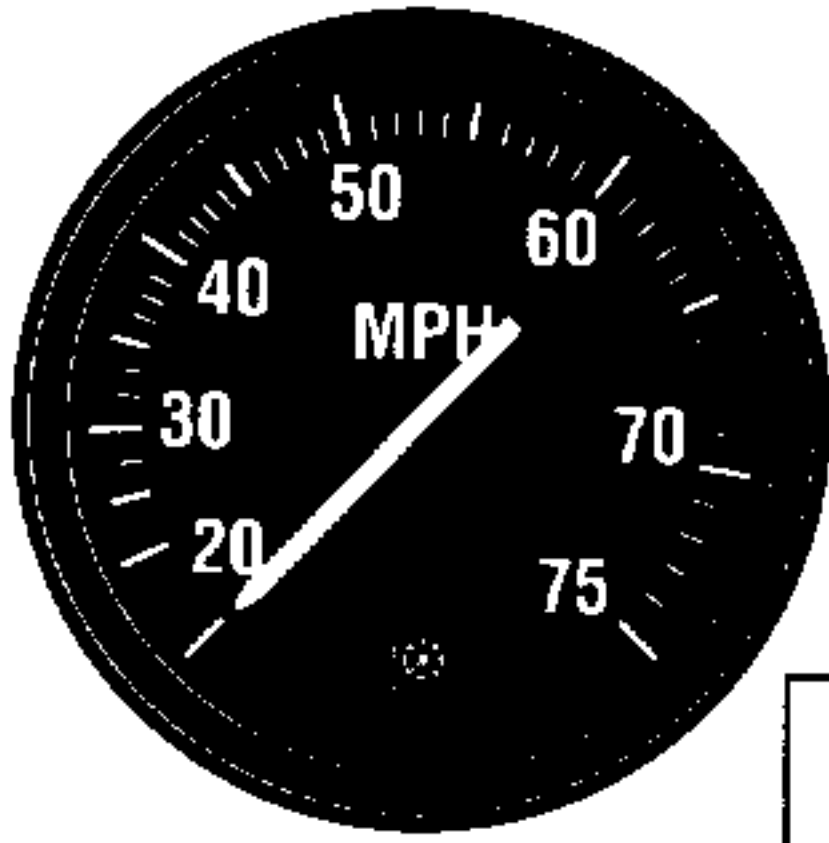

Speedometer

Measures boat speed in miles or kilometers per hour or knots depending on model and dial markings used. To make sure that the speedometer is working as it should, occasionally check to make sure that there are no kinks in the tubing leading from the speedometer's pickup to the panel-mounted gauge, and that there are no weeds, grass or debris clogging the pickup intake.

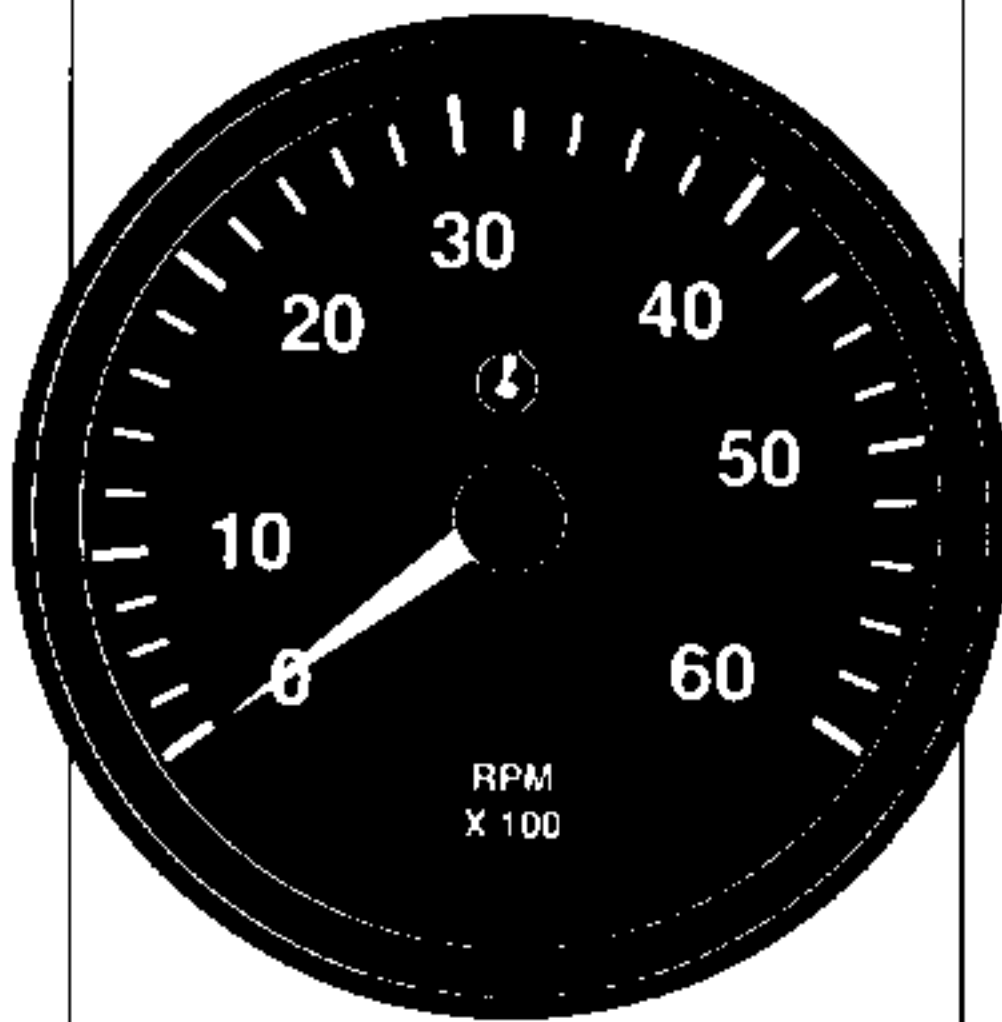
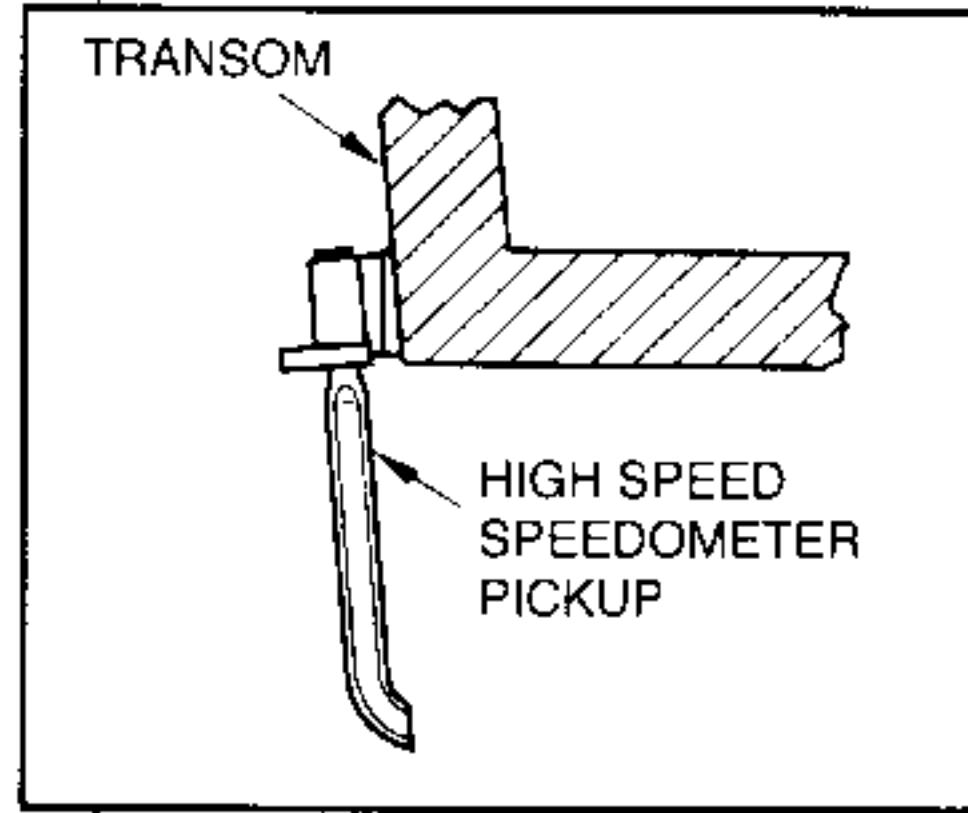

Tachometer

Measures engine speed in revolutions per minute (RPM). Use this gauge to keep the engine within the proper operating range. The tachometer is also used in conjunction with the speedometer to achieve an efficient running speed. Consult the engine manual for the proper RPM operating range for your engine.

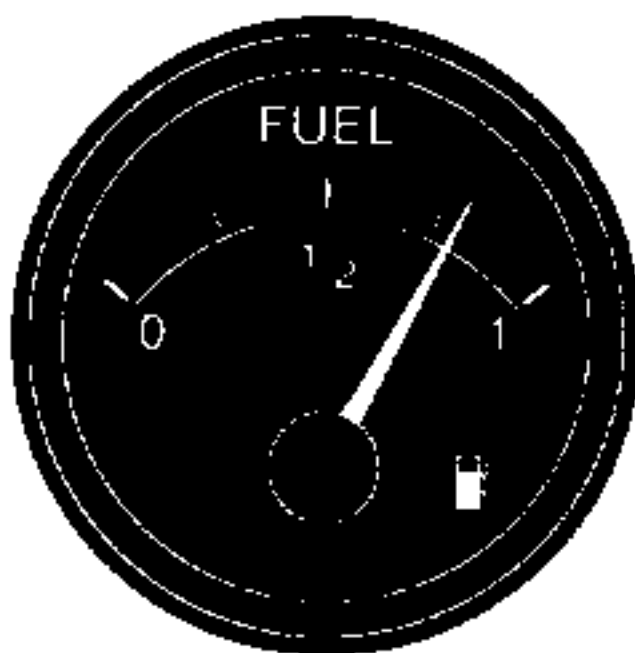

Fuel Gauge

This gauge measures the approximate fuel level in the fuel tanks. Since the accuracy of the gauge varies with the attitude of your boat (trim and list) and the fuel pickup tube cannot withdraw all of the fuel in the tank, it is wise to observe the One Third Rule. Use one third of your fuel to go out, one third to come back and one third as a reserve.

Voltmeter

Measures the condition of the main or cranking battery in volts DC. Normal operating voltage when the engine is running at 1000 RPMs or higher is between 12 and 15 volts. If your battery is fully charged, the voltmeter should read in the 11.5 to 12.5 volt range when the ignition is on and the engine is not running. Check your charging system as well as your batteries if the voltmeter reads below these normal ranges. An oscillating voltmeter reading may indicate loose belts or loose electrical connections.

Engine Water Temperature Gauge

Measures the engine water/coolant temperature inside the engine. Consult the engine manual for the normal operating range. After starting the engine, always check your temperature gauge for abnormally high readings and shut off the engine immediately if you see a gauge reading outside the manufacturer's operating range. If you shut off the engine because of a high engine water temperature reading, check the cooling water pickup in the lower unit for blockage. If no blockage is found, consult your Scarab dealer.

Engine Oil Pressure Gauge

Measures the pressure of the lubricating oil inside the engine. Consult the engine manual for the normal operating range. Many serious problems within the engine can be reflected on the oil pressure gauge. If a loss of oil pressure is indicated, shut down the engine at once or serious engine damage can result. Check the oil level. If oil level is correct, consult your Scarab dealer.

Engine Oil Temperature Gauge

Measures the temperature of the lubricating oil inside the engine. Consult the engine manual for the normal operating range. After starting the engine, always check the temperature gauge for abnormally high readings and shut off the engine immediately if you see a gauge reading outside the manufacturer's operating range.

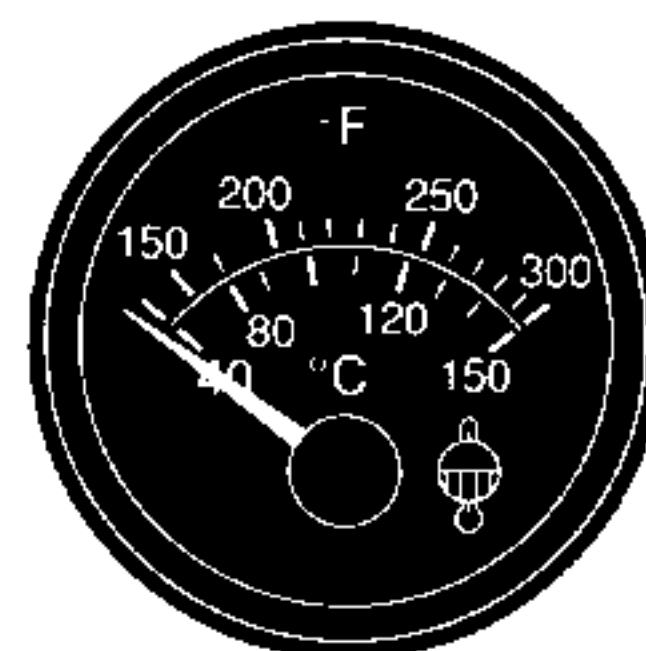
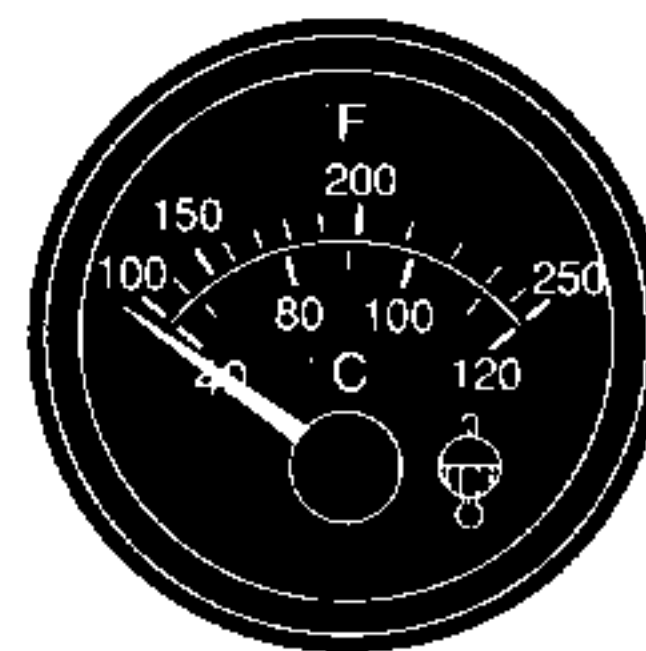
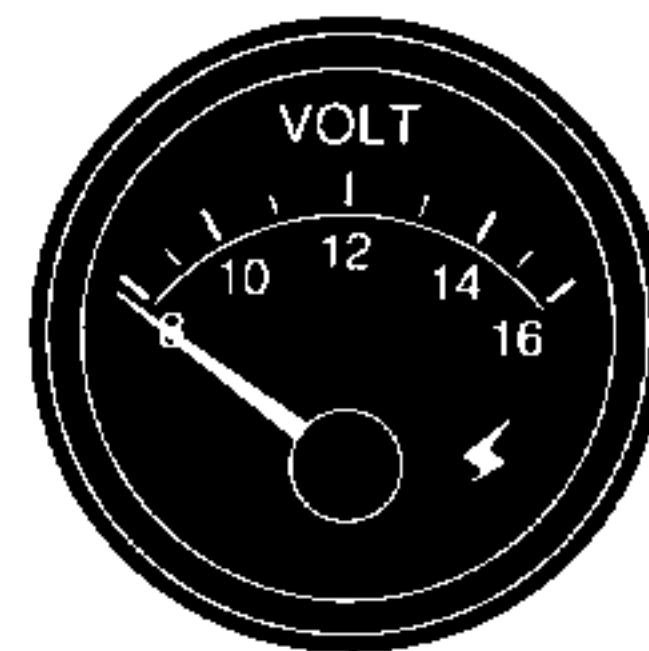

SCARAB®

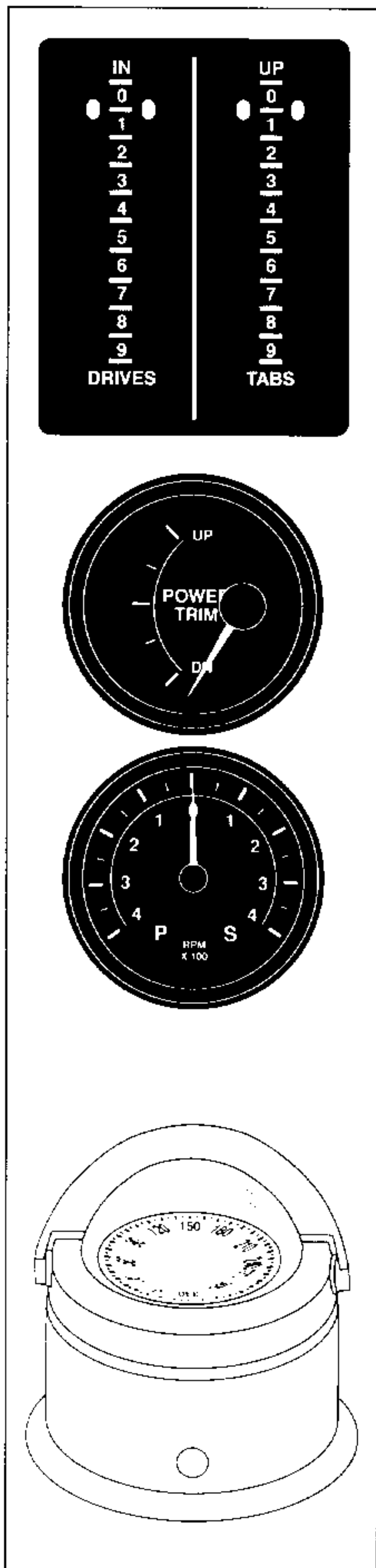

Trim Tab/Outdrive Position Indicator

Mechanically displays the position of the trim tabs and outdrives. The pointers on the face of the indicator are connected directly to the trim tabs and the outdrives with a push/pull cable.

The top of the TABS scale indicates a trim tab is in the full UP position and as far out of the water as possible, while the bottom of the scale indicates that a trim tab is in the full DOWN position and is as far into the water as possible.

The top of the DRIVES scale indicates a lower unit is trimmed IN as far as possible, while the bottom of the scale indicates that the lower unit is trimmed as far OUT as possible.

Power Trim Gauges

Displays the position of the outdrives.

Synchronizer

Displays the relationship between the RPM readings of twin engines. If the needle is at zero, it means that the port and starboard engines are running in sync with each other. If the needle is off zero, adjust engine speed until the engines are back in sync. If engines are not synchronized, several unwanted conditions may occur, including: harmful vibrations being transmitted through the hull, increased fuel consumption and a need for constant course correction.

Hour Meter(s)

Allow you to monitor the running time of your engines for scheduling maintenance. The hour meter is started when the ignition switch is turned on whether the engine is running or not.

Compass

Aids with navigation by indicating where magnetic NORTH is located. The compass must be compensated for deviation caused by ferrous metal, magnets and electrical wiring in its vicinity.

After all optional equipment has been installed in the helm area, the compass should then be compensated. Since the compass is an important navigational aid, the compensating should be done by a qualified compass adjuster. It is seldom that a compass can be corrected to zero deviation on all headings, so he will provide you with a deviation card or chart showing the correction to be applied when laying out a compass course or making your navigational calculations.

After the compass is adjusted, do not permit items which might affect it (such as metal tools or a flashlight) to be placed near the compass, even temporarily. The compass must be readjusted if any influencing item for which it has been compensated is removed or relocated or added in the vicinity. As a rule of thumb, electrical or metal items should be kept three or more feet away from the compass so as not to affect its magnetic field.

Get to know your compass. Watch how it swings. Check that its readings are consistent on frequently traveled courses. Note if it becomes sluggish and, above all, if it becomes erratic. These two signs warn of alien magnetism or damaged compass.

SWITCHES

Each electrical circuit on your boat is equipped with a control switch and protected by a fuse or circuit breaker. Fuses are normally found in two locations: main fuse blocks located underneath the helm and a smaller fuse box located either in the engine compartment or under the aft seat. Refer to Section 5, Boat Systems, for more information on fuses.

Ignition Interrupter w/Lanyard

The Ignition Interrupter is a safety switch which shuts off the engine in the event the driver is thrown from the helm. A lanyard attached to the Ignition Interrupter must always be attached to a strong piece of clothing on the driver such as a belt loop (an even better alternative would be to keep the lanyard attached to your life jacket as a reminder to you and your passengers to wear PFDs when the boat is underway). If the driver is thrown from the helm, the lanyard will pull a fork off the Ignition Interrupter and the engines will stop. To replace the fork, depress the button on the Ignition Interrupter and slide the fork into position over the button.

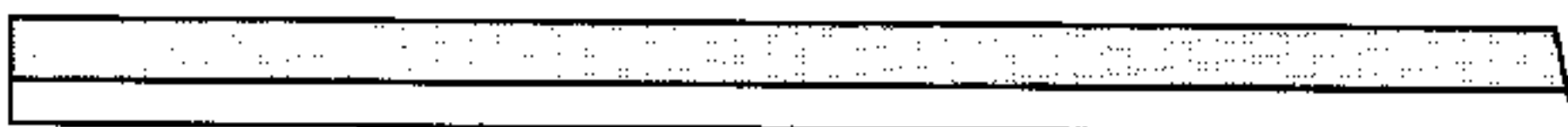
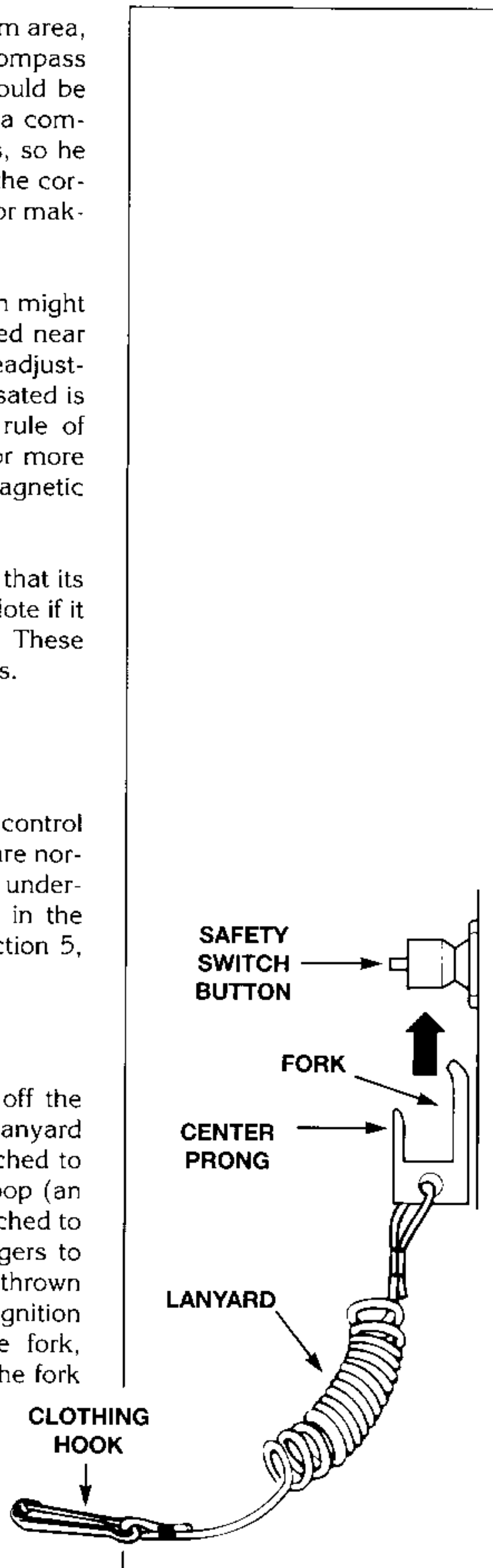

SCARAB[®]

WARNING

The Ignition Interrupter switch must never be removed or modified and must always be kept free from obstructions that could interfere with its operation.

At least once a month: Check the Ignition Interrupter switch for proper operation. With the engine running and the boat safely tied to a pier or wharf, grasp the lanyard and pull the fork off. If the engine does not stop, see your dealer for replacement of the switch before heading out on the water. Check each engine separately if your boat is equipped with multiple engines.

Battery Switch(es)

Depending on your boat model, these are located either within the engine compartment or on the cockpit side of the forward engine compartment bulkhead.

Battery switch(es) connect(s) the battery(ies) to the electrical system. They (it) provide(s) isolation and positive disconnect of battery(ies) to protect against tampering, electrical fire hazards and battery run-down. Rotate switch to the OFF position when the boat is not in use.

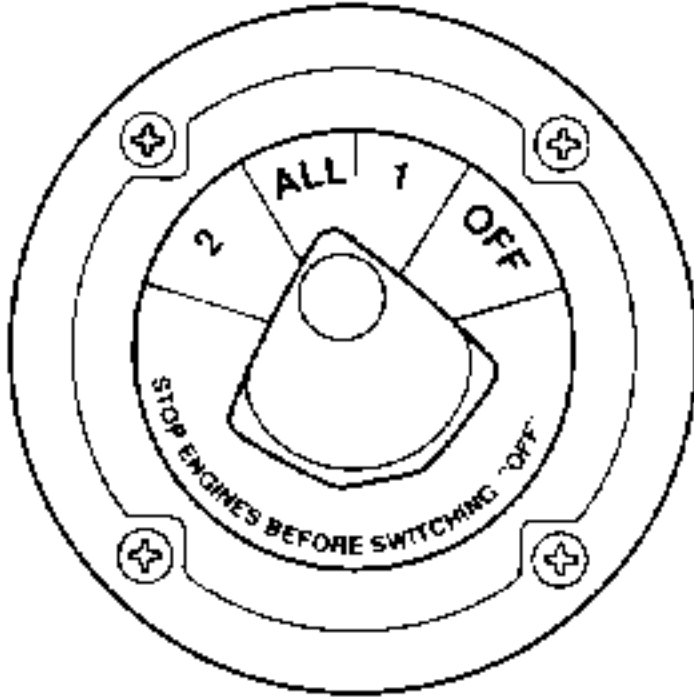

CAUTION

Never turn switch to the OFF position while the engine is running or serious alternator/electrical system damage could occur.

NOTICE

The bilge pump AUTO circuit, stereo memory circuit and circuit for the MerCathode® system (if installed) remain energized even with the battery switches in the OFF position.

Navigation Lights Switch

Turns on the running and anchor lights for night operation. Before operating at night, the stowaway white all-round light pole must be mounted.

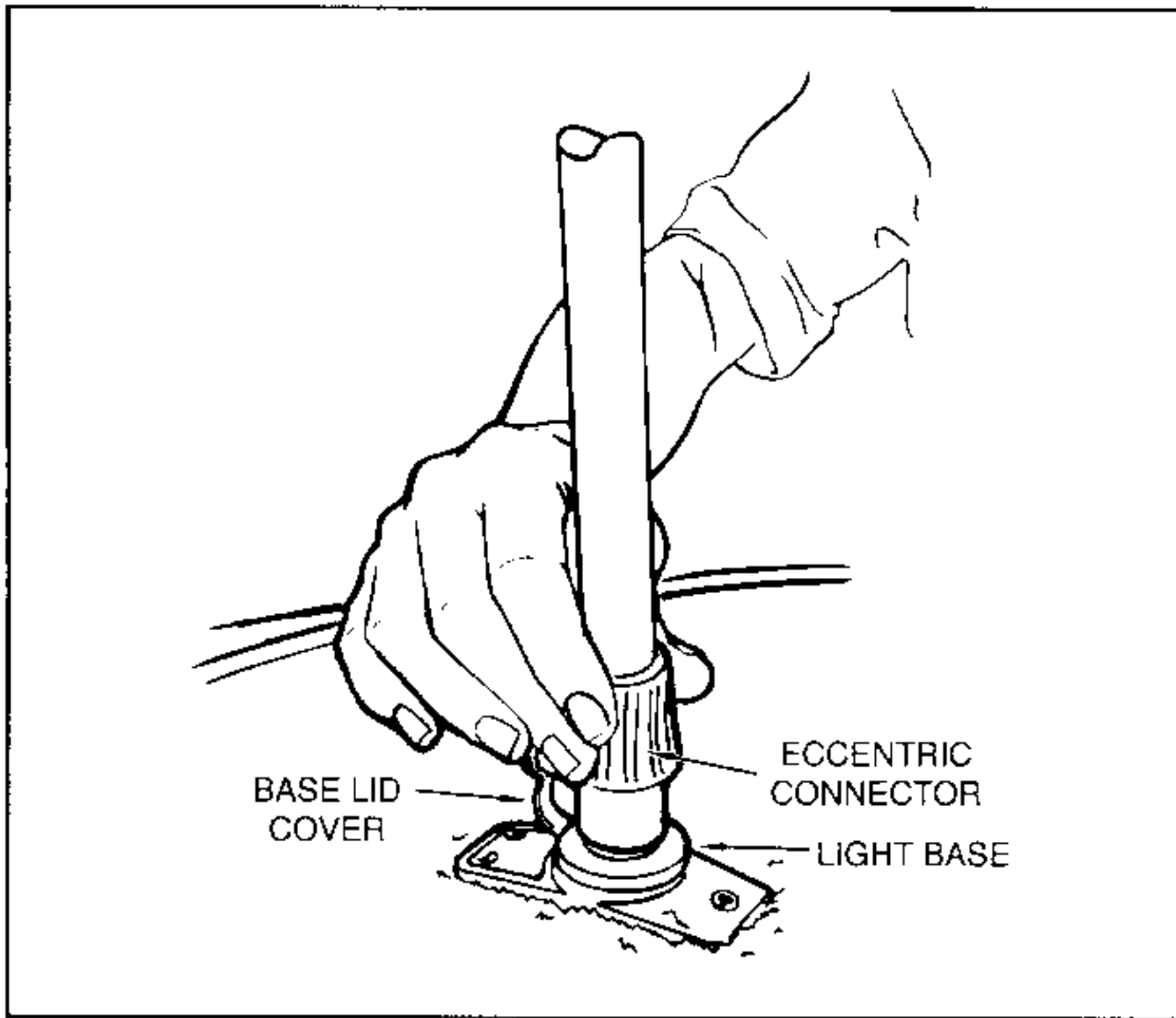

Anchor Light Switch

Turns on only the white all-round light for night anchoring.

Blower Switch(es)

Activates the engine compartment ventilation blower to remove explosive fumes from area.

WARNING

The blower must be operated for a minimum of five minutes before each time the engine is started. In addition, the blower should be operated continuously when at idle or slow speed running. Failure to operate the blower can lead to conditions favorable for an explosion which can cause severe personal injury or death.

Bilge Pump Switch

This switch manually turns on the bilge pump and when switched on, the bilge pump will run continuously until the bilge pump switch is returned to the automatic mode setting. When the bilge pump switch is off, the bilge pump is in the automatic mode and will run whenever the water level in the bilge is high enough to raise the float in the bilge pump's automatic float switch.

SCARAB[®]

To test the operation of the automatic float switch, manually raise the float in the switch by rotating the pivot shaft extension where the wires enter the switch until the pump begins operating. If the pump fails to turn on, replace the automatic float switch before heading out on the water.

Hatch Lift Switch

Electrically raises the engine compartment hatch. In the event that dead batteries prevent the hatch lift switch from operating, the hatch can be manually opened by pulling upward on the lifting loop and removing the quick release pin on the lift arm.

WARNING

When pin is removed, the hatch should be secured in a manner to keep it from accidental closing which could result in personal injury.

Battery Parallel Switch

Connects both batteries if greater starting power is needed. If starting is difficult because of a weak battery, hold the battery parallel switch in the ON position while turning the ignition key. Once the engine starts, release the battery parallel switch. The battery parallel switch only works when battery switches are not in the ALL or OFF position.

ENGINE ALARM SYSTEM

Sounds alarm if the engine temperature exceeds set limit or if oil pressure drops below a set range. If alarm sounds during operation, immediately shut down engines and determine the cause before restarting.

The engine alarm system has a built-in test feature to ensure proper operation. Approximately every five hours of operation, turn the ignition key to the RUN position, but do not start the engine. Within 7 to 14 seconds, the alarm will sound if the system is functioning properly. If the alarm does not sound, consult your dealer.

ACCESSORIES

AUTOMATIC FIRE SUPPRESSION SYSTEM

Your boat may be equipped with an automatic fire suppression system in the engine compartment. This system uses a fire extinguishing agent. A heat-sensitive automatic nozzle releases the agent as a vapor, cutting off the supply of oxygen to the fire. The system's indicator light is illuminated when the system is fully charged. When the system is discharged, the indicator light will go out. The light is on the dash or a separate monitoring panel, depending on boat model.

WARNING

If system discharges, immediately turn OFF engine, bilge blower(s), and electrical systems. Extinguish all smoking materials. Do not open engine compartment. Fresh air supplies oxygen to fire and fire may flash back through opening.

If the system discharges, do not open engine compartment for at least 15 minutes. Hot metals or fuel can also begin cooling during this time. Cautiously inspect compartment for cause of fire and damage to equipment. Have portable extinguishers readily available. *Do not breathe fire caused fumes or vapors.*

Note: The fire suppression agent is an ozone-depleting substance. In order to help safeguard the environment, following the manufacturer's maintenance recommendations is important. Be sure to check the equipment manual for detailed information about safety precautions and procedures for operating and maintaining the fire suppression system.

Exhaust Valve

The optional two-position exhaust valve controls the output of engine exhaust either to through-transom exhaust pipes or down through the propeller hub.

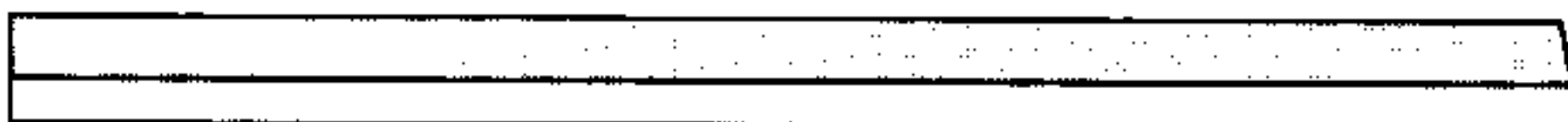

SCARAB[®]

In position one, engine exhaust is routed through the transom pipes. This position produces the most engine power, but is not acceptable near shore.

In position two, engine exhaust is routed down through the hub of the propeller where it is released underwater, thereby providing quieter engine sound when in marinas and around other boats.

With all through-transom exhaust systems, check local regulations regarding noise restrictions.

Gas Fume Detector

The optional gas fume detector will sound an alarm when potentially explosive gasoline vapor is detected in the engine compartment. The sensor for the vapor detector is mounted in the bilge area where fumes collect. Test the unit before each cruise according to manufacturer's directions to check for proper performance.

WARNING

The gas fume detector is not intended to eliminate the need to physically sniff and inspect the bilge for gas fumes and leaks. Also, it does not eliminate the need to use blowers.

If the gas fume detector indicates a dangerous condition, do the following:

- ◆ DO NOT operate electrical equipment.
- ◆ Extinguish open flames and smoking materials immediately.
- ◆ Turn engine(s) OFF.
- ◆ Wait 5 minutes before opening the engine compartment to investigate the cause.
- ◆ Determine cause and correct immediately before resuming operation.

Accessory Receptacle

This power receptacle can be used to plug in 12-volt powered devices such as chart lights and hand held spotlights.

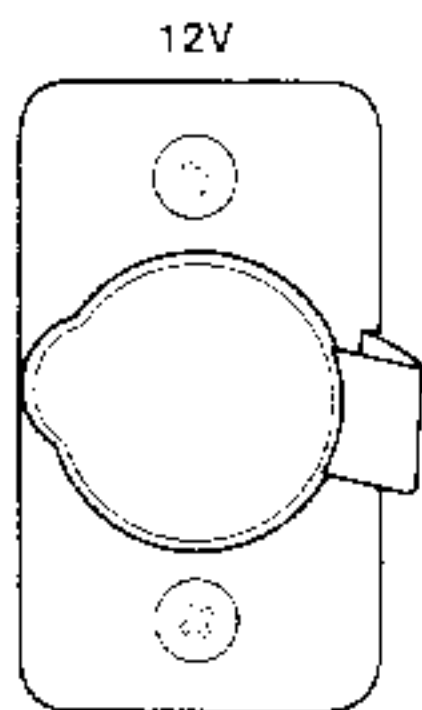
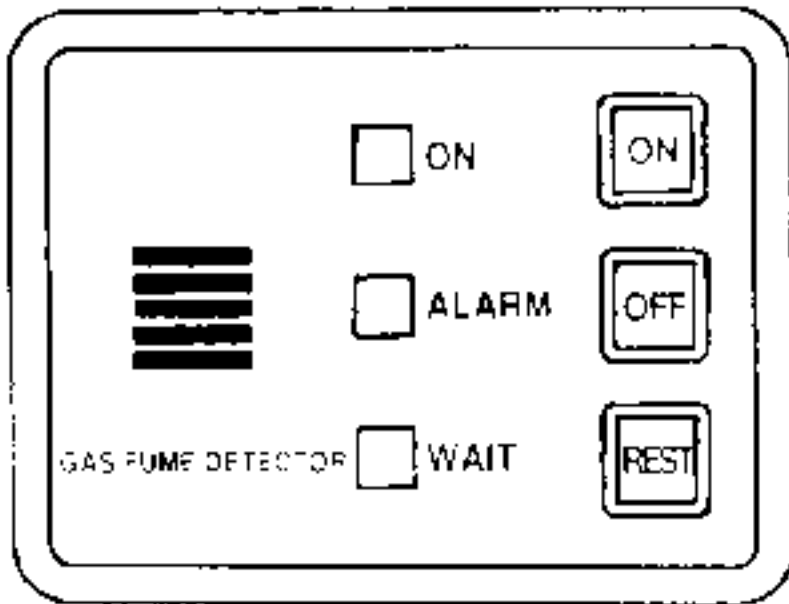

Boat Systems

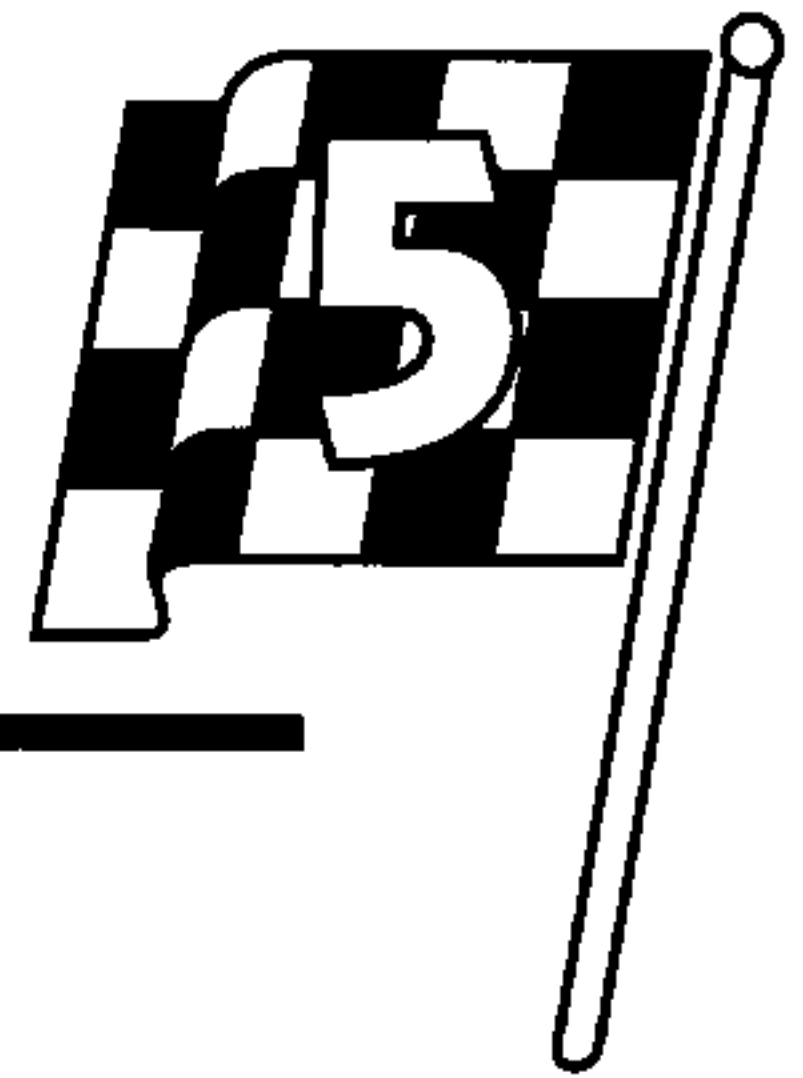

This section describes the basic operational principles for the major systems on your Scarab. The procedures and illustrations in this section are typical and are intended to be representative of the system on your boat. **Be sure to read all individual component operator's manuals included in your "Important Papers Kit" before heading out on the water.**

ELECTRICAL SYSTEMS

There may be two electrical systems used on your boat: a 12-Volt direct current (DC) system and an optional 120-Volt alternating current (AC) system. The DC system supplies electricity to all of the boat's electrical circuits (lights, pumps, blowers, ignition, etc.). The AC system supplies power to the electrical outlets and to AC powered systems (e.g., air conditioner) when the boat is connected to shore power.

DC Electrical System

WARNING

Considerable care has been taken to design a safe electrical system to protect you from hazardous shocks. Any modifications to the system should always be done by a qualified technician to protect you from hazardous shock.

Your boat has a 12-Volt negative ground DC system which derives its power from your boat's batteries. The positive wire is hot and feeds current from the batteries to the various 12-Volt systems and the negative wire is the ground.

While the engines are running, all batteries are charged by the engine alternator(s) and the rate of charge is controlled by an internal voltage regulator.

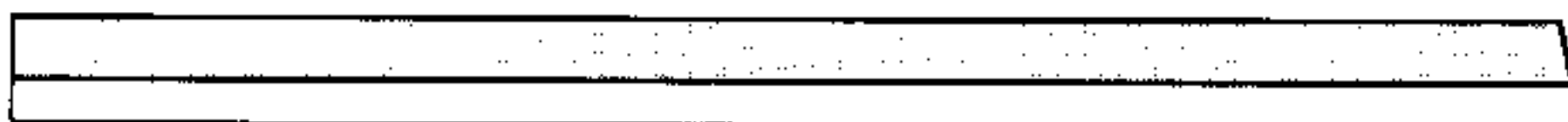

SCARAB[®]

Fuses

If a particular piece of equipment or light stops working, the first place to look is the fuse. If a circuit is overloaded, the fuse protecting the piece of equipment on that circuit will “blow” (the metal element inside the fuse will melt) and the fuse will need to be replaced.

CAUTION

When replacing any fuse, be certain to use a fuse with the same amp rating as the one being removed to protect equipment and wiring from damage.

On all Scarab models (with the exception of the 22 Scarab) fuses are located underneath the helm console and on the forward or aft face of the engine room bulkhead. See Section 3, Specifications and Layout, for the particular locations and amp ratings of the fuses on your boat.

The fuses located under the helm console are accessed through a door under the console. These fuses are blade style fuses similar to the ones found in automobiles. The fusible (or meltable) element is visible in the middle of the fuse. These fuses are snap-locked into the fuse holder.

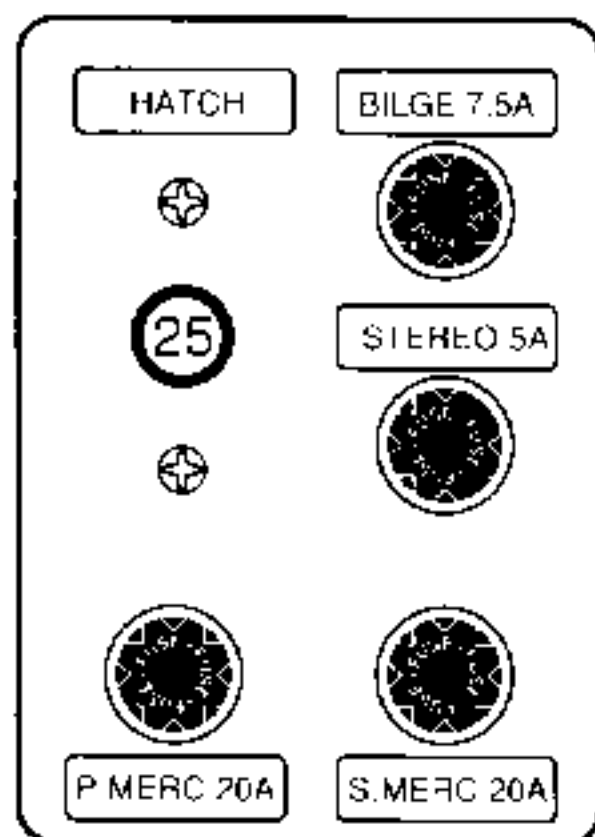

The fuses located on the engine room bulkhead are contained in a molded plastic box and are of two different types. For the engine hatch circuit only, there is a 25-amp push-in-to-reset circuit breaker. If this circuit breaker trips, allow a minute for the breaker to cool off, then press the button to reset the circuit. All other circuits tied into this molded box are protected by standard glass fuses. These can be removed and inspected or replaced by turning the knob grip on the fuse holder. The fuse will be gripped by the fuse holder knob for safer handling.

AC Electrical System (Shore Power)

WARNING

Considerable care has been taken to design a safe electrical system to protect you from hazardous shocks. Any modifications to the system should always be done by a qualified technician to protect you from hazardous shock.

Your boat may be outfitted with an optional 120-Volt (AC) electrical system which provides 30 amperes of current. The 120-Volt AC power is supplied to your boat by a shoreline cable

which attaches to the shore power inlet. In a color coded AC electrical system like the optional shore power systems available for certain Scarab models, ground wires are always green, neutral wires are always white and "hot" wires are always black.

AC/DC Control Panel

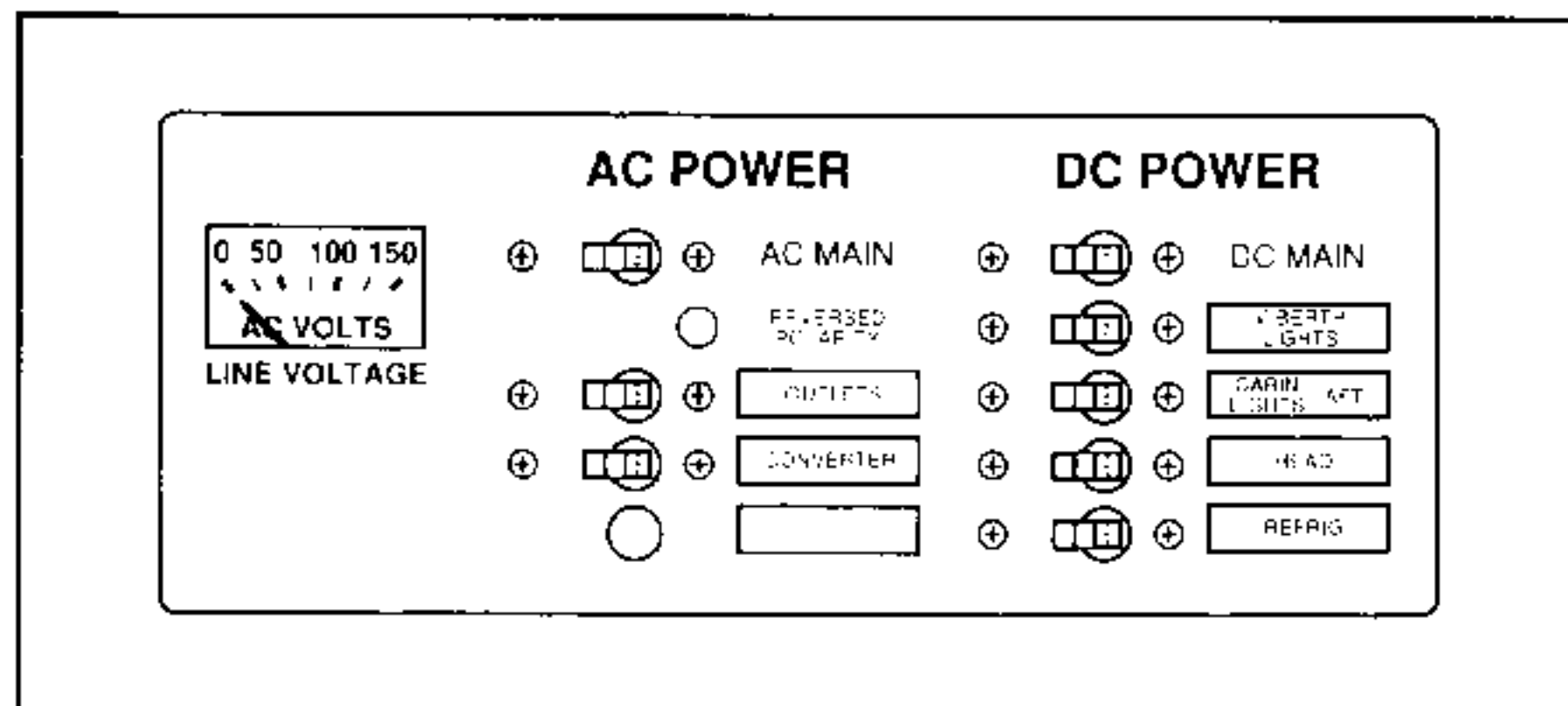

The optional AC/DC control panel located in the cabin consists of an AC voltmeter, a main DC breaker, a main AC breaker, a reversed polarity indicator light and individual circuit breakers for AC and DC circuits.

Voltage Meter - Allows you to monitor the AC voltage. Damage to components can occur if voltage entering your system is less than 105 volts. Do not use AC powered equipment if you get a reading of 105 volts or less.

Reversed Polarity Light - Indicates if the polarity of the shore-side power source has been reversed, but will not indicate if the boat polarity (wiring) is reversed.

WARNING

Every effort has been made at the factory to assure proper wiring polarity for the boat AC system. Any modification performed on the boat AC system must be made by a qualified marine technician and checked to assure compliance with ABYC guidelines and National Electrical Codes.

WARNING

If a reversed polarity warning is indicated, DO NOT USE the shore power source. Immediately turn off the power source on shore and disconnect the shore power cord. Reversed polarity is a dangerous condition which may cause shock, electrocution or death.

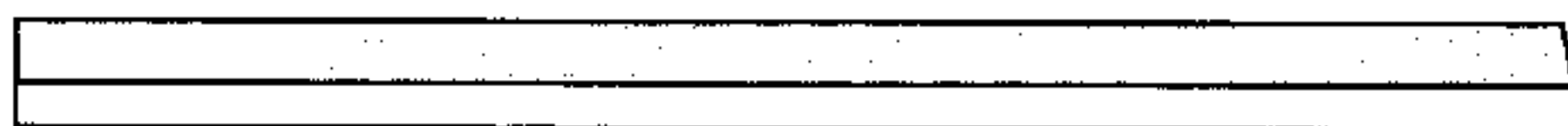

Main AC Breaker - Switches the entire AC system "ON" and "OFF." This allows you to check for proper voltage and polarity immediately after shore power cord connection has been made and before individual circuits are enabled.

Individual Circuit Breakers - Allow you to manually enable or interrupt a circuit by flipping the switch "ON" or "OFF," and they also protect the system receiving the load by automatically breaking the circuit in cases of shorts or overloads.

 **CAUTION**

Never reset a breaker which has been automatically tripped without first discovering and correcting the cause of the problem.

On boats not equipped with optional shore power, there will be a DC panel located in the cabin with a main DC breaker and individual circuit breakers for DC powered equipment.

Shore Power Connection

All shore power systems require a special marine grade three-conductor cable to make a proper connection to the shore. Dockside connections are plug-in and twist-to-lock type, while boat side connections plug in and are locked in position with a threaded locking collar to prevent accidental disconnection and enhance water resistance.

To protect against electrical shock, plugs and receptacles for different systems are designed in non-interchangeable configurations. A plug from one system cannot fit into the receptacle of another system. Never attempt to modify a shore power cable and use only commercially available adapters for system modification.

To connect shore power:

 **WARNING**

Some marinas have been known to "break" shore power ground circuits to prevent electrolysis. Opening the ground circuit creates a potentially dangerous on board shock hazard. Ensure that your shore power cable ground circuit is always continuous.

1. Turn OFF the boat's main AC breaker switch.
2. If the outlet on the pier has a breaker, turn the breaker to the OFF position.

3. Connect shore power cable at the boat first.
4. Make sure the cable has more slack than the mooring lines.
5. Remove the cap from the outlet on the pier. Connect the other end of shore cable to the outlet on the pier and lock in position.
6. Set the shore breaker to the ON position.
7. Turn ON the main AC breaker switch.
8. If polarity warning indicator is activated or if voltage is low, immediately disconnect cable.

NOTICE

If polarity is reversed, the main AC breaker will “trip” automatically.

To disconnect shore power:

1. Turn OFF the boat’s main AC breaker switch.
2. If there is a disconnect switch on the shore, set the breaker to the OFF position.
3. Disconnect shore power cable at shore outlet first.
4. Disconnect the power cable from the receptacle on the boat. Replace the cap over the receptacle.
5. Inspect the shore power cable for damage before stowing.

Ground Fault Circuit Interrupter (GFCI) Outlets

GFCI outlets are provided to protect you against hazardous electrical shock from improper grounding in locations which could normally be expected to be wet (i.e., cockpit, galley and head). The GFCI outlet should be tested monthly. To test the GFCI outlet:

1. Push the black test button and the red reset button should pop out. The receptacle and the circuit are now off. If the red reset button doesn’t pop out, the electrical shock protection of the outlet has been lost and the GFCI outlet must be replaced - contact a licensed electrician or your Scarab dealer.
2. Push the reset button in until it clicks. The receptacle is now reset. If the reset button does not click, there is either a short in the circuit or the equipment being used or a ground fault in the equipment. Unplug all appliances from the outlet and

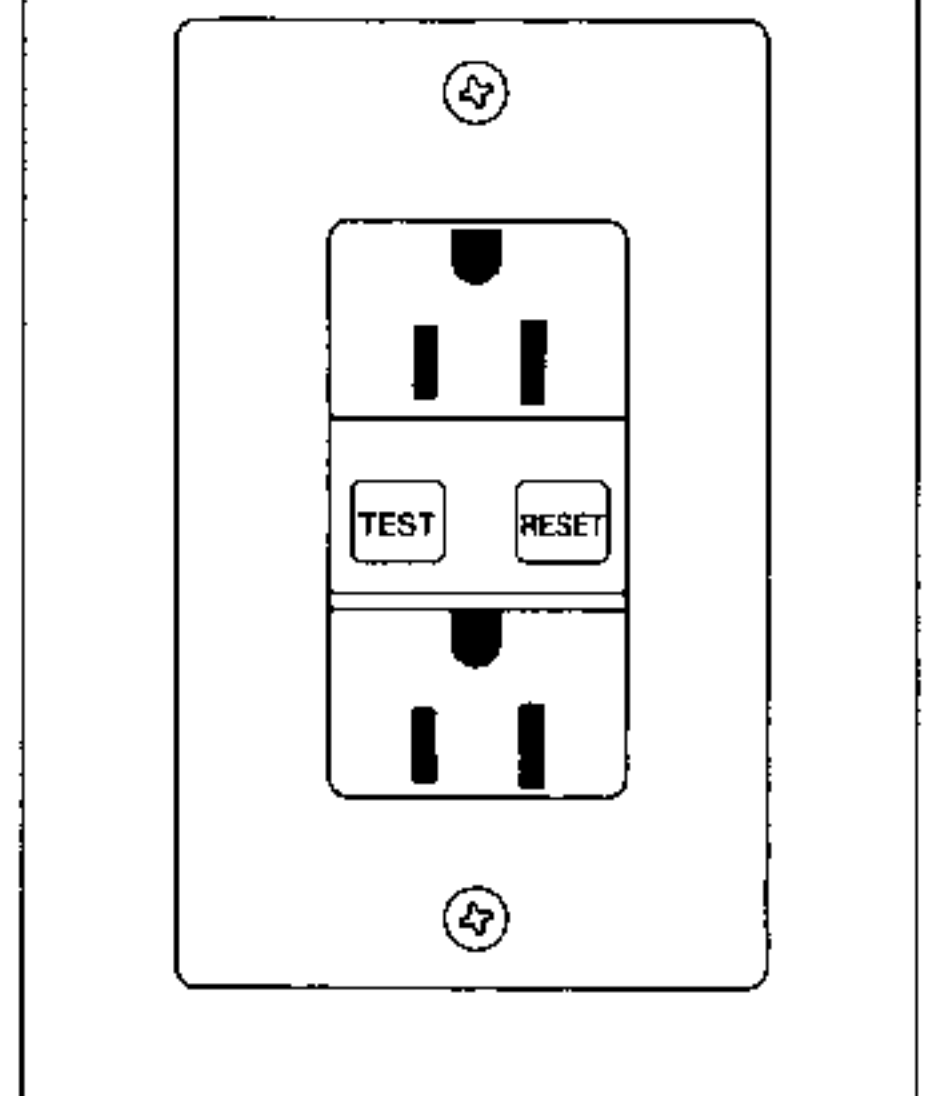
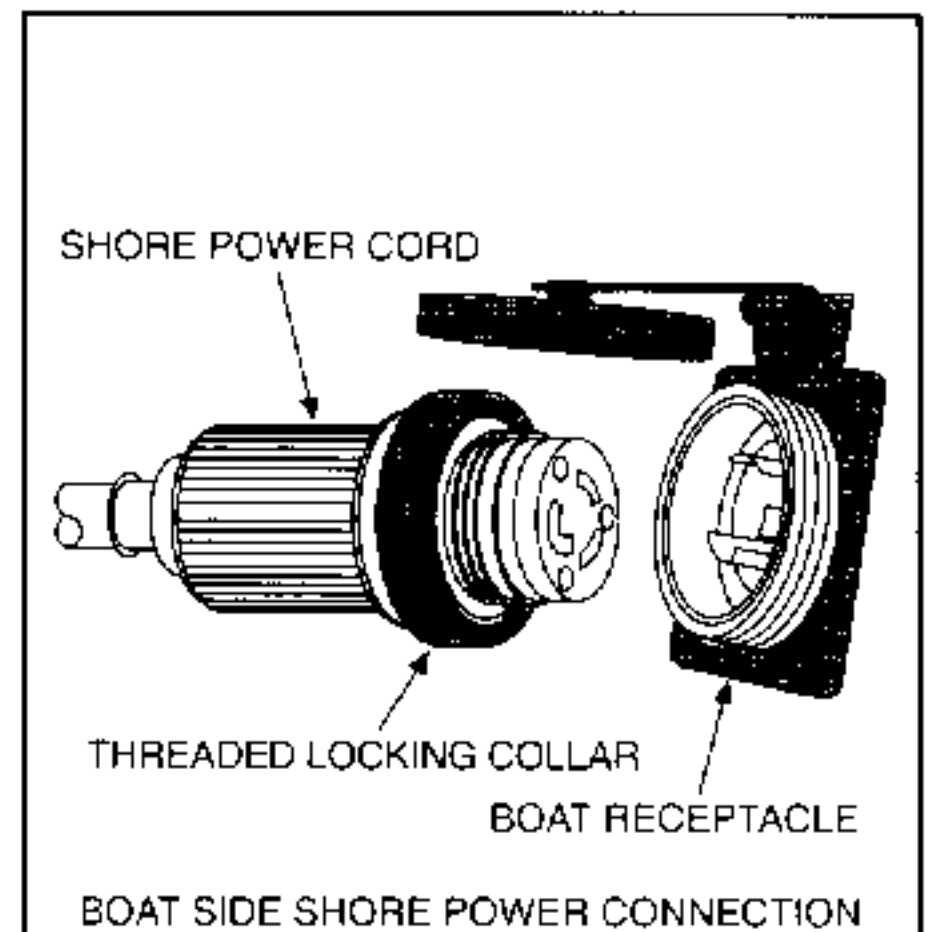

reset the GFCI. One at a time, plug the equipment back in and turn it on. The item that causes the GFCI to trip is the problem and should not be used.

Converter

The optional converter is an automatic battery charger which operates from the shore power. The converter will either deliver full output to a discharged battery or deliver a trickle charge to a battery with minimal discharge. Consult the converter operator's manual for more information.

When using a battery charger, it is important to check and top off your batteries with distilled water regularly. Trickle charging can lead to gassing, a process in which excess charging current boils off water in the battery cells.

WATER SYSTEMS

Some Scarab models may be equipped with two or more water systems: a freshwater system, a raw water system and a head and waste containment system.

The freshwater system provides potable (drinkable) water to items such as sinks and washdowns.

The raw water system provides outside water to air conditioning (if installed).

The head and waste containment system provides outside (raw) water to the head.

Individual components like marine heads (toilet) and air conditioning units will have user manuals supplied by their manufacturers which contain detailed instructions for operation and maintenance. These manuals can be found in your "Important Papers Kit" and should be read before heading out on the water.

Freshwater System

If your boat is equipped with a freshwater tank, fill the tank only with potable water. Using and refilling the tank often will help keep it a source of clean drinking water.

On boats with a freshwater system, water is drawn from the tank by a self-priming pump. Before entering the pump, the water passes through a screen filter to capture large contaminants. The pump provides a flow of water at a preset pressure to the remainder of the system.

Initial Freshwater System Start-up

1. Fill the freshwater tank with approximately 20 gallons of potable water.
2. Turn the WATER PRESSURE breaker on the AC/DC panel "ON."
3. Open the cold water galley faucet to allow air to escape. Close the faucet when a steady flow of water is apparent.
4. Bleed air from the remainder of the faucets, showers, etc. in the same manner as step 3. After all lines have been bled, the pump will build to operating pressure and then shut off.
5. You may now continue to fill the tank to its capacity.

CAUTION

The freshwater pump works on demand and WILL NOT automatically shut off when the tank is empty. If the breaker switch is in the "ON" position and the tank is empty, the pump will run continuously and may over-heat.

Freshwater System Maintenance

The following maintenance actions should be performed monthly to keep the freshwater system clean and sanitary:

- ◆ Drain the freshwater tank completely. Refill tank with clean, fresh water and drain again.
- ◆ Clean freshwater pump inlet filter screen (if equipped).
- ◆ Replace freshwater system filter(s), if equipped.

Sanitizing The Freshwater System

If water in the tank has been allowed to stagnate and you suspect that the freshwater system may be contaminated, sanitize the system. To sanitize:

1. Drain the freshwater tank completely.
2. Mix a solution of 1/4 cup household bleach to 1 gallon of water for every 15 gallons of tank capacity. Pour the solution into the fresh water tank.
3. Fill the tank with clean, fresh water.



SCARAB®

4. Turn freshwater pump "ON" and bleed air from all faucets.
5. After approximately 3 hours, drain the system completely.
6. Flush the system with one full tank of water.
7. Fill tank with clean, fresh drinking water.

If you can smell or taste bleach in the water:

1. Drain the system completely.
2. Mix a solution of one quart of white vinegar to 5 gallons of water. Pour the solution into the freshwater tank.
3. Allow the solution to remain in the tank until approximately one hour of cruising time is logged. Boat motion will "slosh" the vinegar/water solution to help clean the tank.
4. Allow the solution to remain in the tank for at least one week.
5. Drain the freshwater system completely.
6. Flush the system with one full tank of water.
7. Fill the tank with clean, fresh drinking water.

Raw Water System

Boats equipped with an air conditioning unit or an electric marine head will have raw water intakes.

All raw water systems have two things in common: each will have its own through-hull raw water intake and a seacock. The seacock is very important as it protects a boat from sinking if a downstream hose or fitting should fail. It is, therefore, very important to close any seacock not in use. When a seacock is open, its handle will be in line with the hose attached to the tail-piece of the seacock. When a seacock is closed, its handle will be at a right angle to the hose.

Marine Head (Toilet) And Waste Containment System

Marine heads installed on Scarabs are of two different varieties: A portable head (standard on 29 Scarab only) or china bowl. The china bowl head is electrically operated and comes with either a holding tank or optional holding tank with Y-valve and macerator pump (there is no head installed on the 22' Scarab). Follow the manufacturer's instructions for the proper use of the head installed in your boat.

The following are some of the features of the holding tank and Y-valve head systems:

Waste Holding Tank

On boats with a china bowl head, a waste holding tank is provided that is emptied through the deck plate fitting marked "WASTE." Waste is pumped from the head through a sanitary waste hose to the top portion of the tank. A sanitary waste hose is attached to the bottom of the tank and runs to the dockside pump-out plate. An overboard vent keeps the tank at atmospheric pressure regardless of waste levels.

All the components which comprise the waste system are made of materials specially formulated to prevent odor permeation and to resist chemical actions. It is strongly recommended that you regularly add appropriate chemicals to your marine head to help control odor and break down the waste. Follow the manufacturer's instructions on the chemical before using. In addition, empty the holding tank on a regular basis and flush the head with seawater to rinse the holding tank.

CAUTION

Do not flush into a full holding tank. Attempting to flush the head when the tank is full could result in damage to the waste system.

A waste tank indicator may be installed to provide a visual indication of the amount of waste in the tank.

Waste Disposal

Dockside Pump-out - This system directs all waste to the holding tank. To clear the tank of waste water, you will need to use the dockside pump-out services provided at marinas.

To empty the tank of waste, hook a suction hose to the pump-out plate and to the dockside pump. The marina will handle the proper disposal of the waste and may charge for this service.

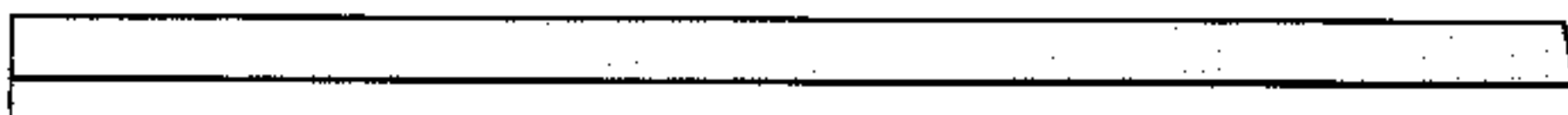
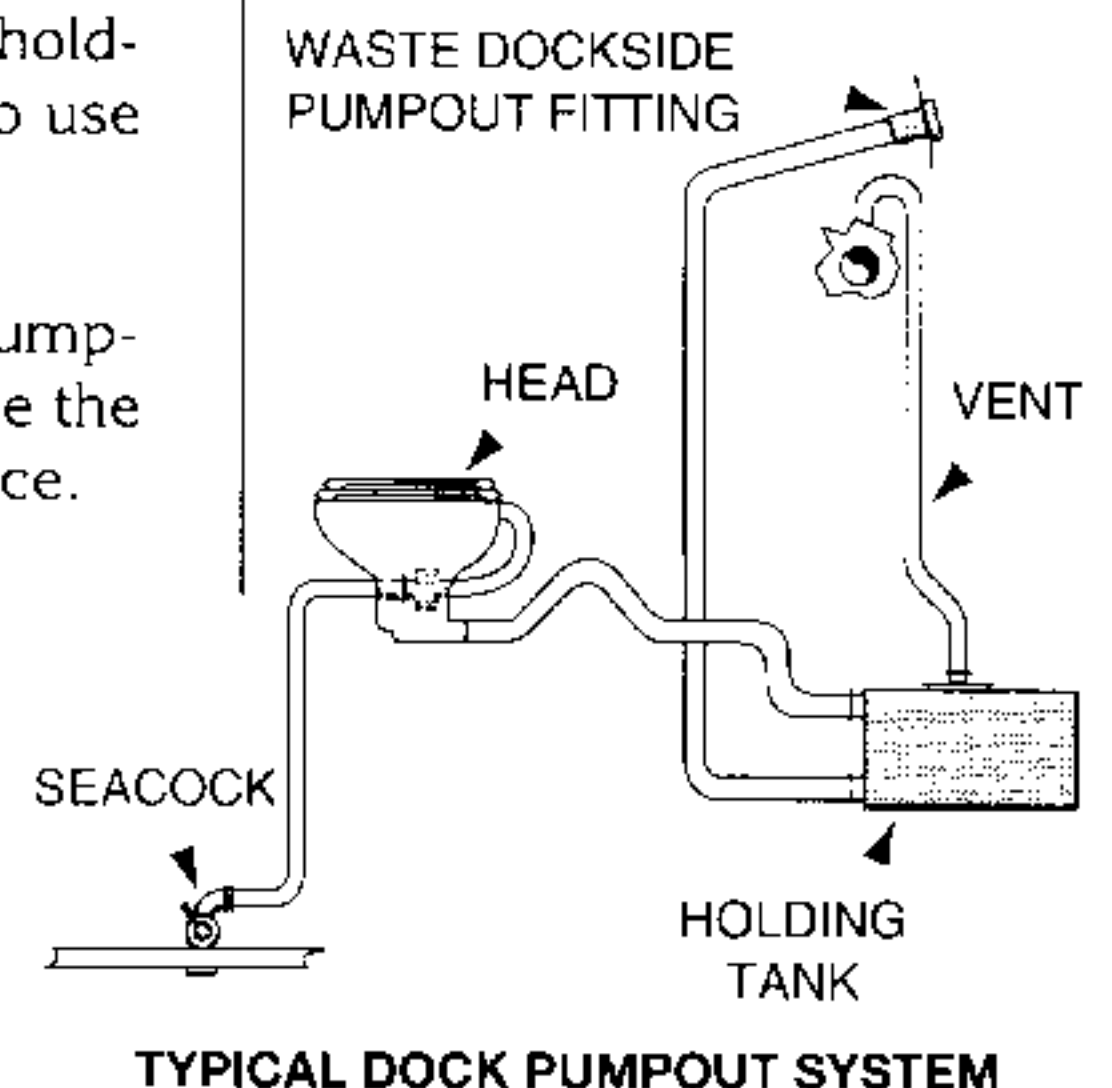

Macerator Pump - On the optional Y-valve and macerator pump head system, a Y-valve is installed in the tank discharge hose. The macerator pump is located between the Y-valve and the discharge through-hull fitting. In this configuration all waste is flushed from the head to the holding tank. The Y-valve permits you to use the dockside pump-out feature or to use the macerator to pump the waste from the holding tank overboard.

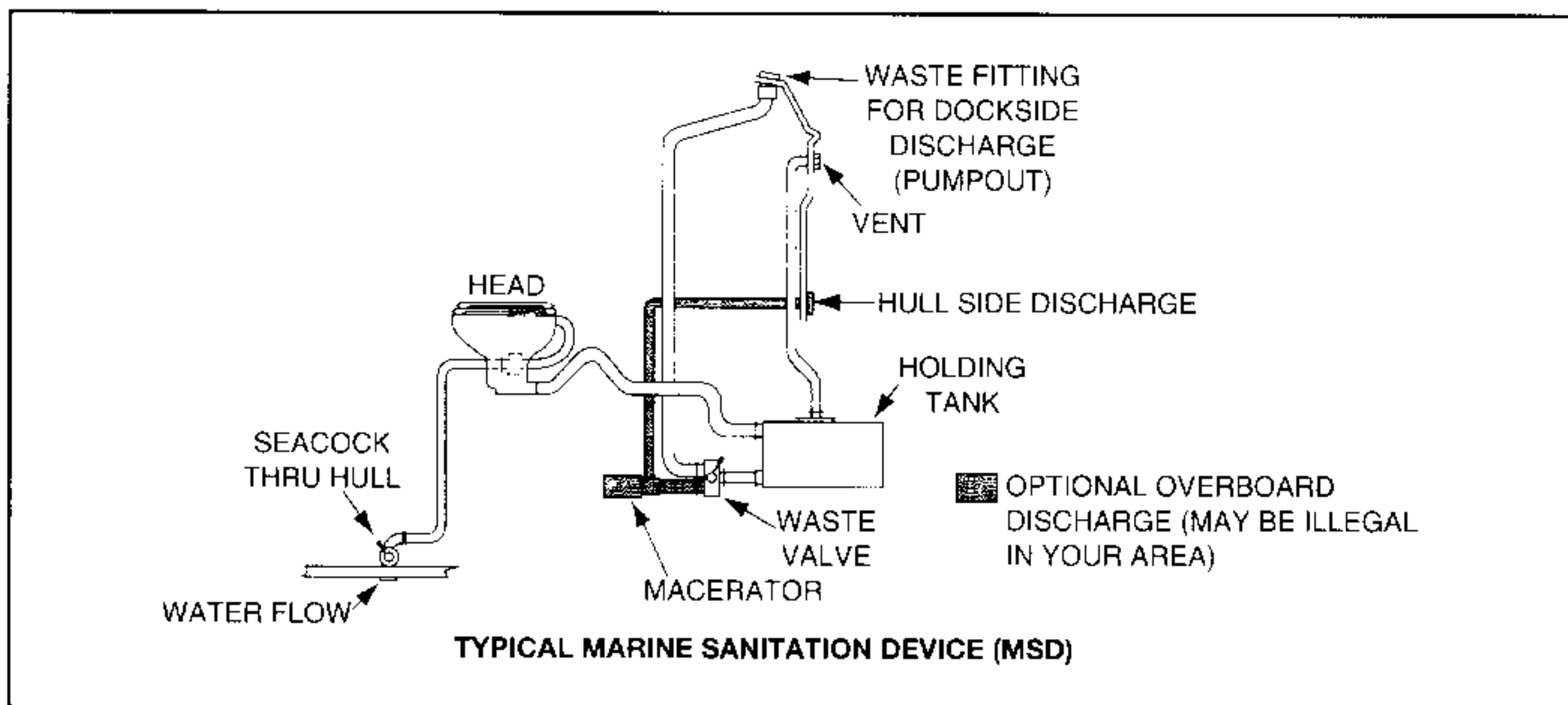

NOTICE

Overboard discharge of waste should only be used in approved areas. A direct discharge of raw sewage from a boat is only allowed when the boat is outside U.S. waters more than three miles from shore. In addition, when operating your boat in special "No Discharge Zones" (as approved by the U.S. Environmental Protection Agency), marine heads which have the ability to discharge overboard must be *secured to prevent discharge*. It is your responsibility to comply with local regulations regarding the discharge of waste.

To pump out the holding tank using the macerator pump:

1. Move the Y-valve lever to overboard position.

CAUTION

Do not run the pump dry. Running the pump when there is no waste to pump out of the holding tank will shorten the life of the pump.

2. Activate the macerator pump by turning its circuit breaker located on the panel in the cabin "ON."

3. Turn on the switch adjacent to the macerator pump.
4. Turn macerator pump "OFF" after the pump-out is complete. You can tell when the pump-out is complete by listening to the load on the macerator pump motor lighten as well as watching the discharge slow down.

FUEL SYSTEM

On all Scarab models, fuel shutoff valves are located on top of the fuel tanks directly under deck plates in the floor of the cockpit. One exception is the 43 Scarab which has auxiliary fuel tanks mounted in the engine compartment. These auxiliary tanks have no accessible fuel shutoff valves outside the engine compartment.

Also, all fuel lines from the fuel tanks (on 29, 31, 38 and 43 Scarabs) run back to a fuel manifold on the forward bulkhead of the engine compartment. From the manifold, fuel lines run to the engines. Ball valves below the manifold control the direction of the fuel. Using these valves, fuel flow can be stopped to the engines; and on some models with auxiliary tanks, fuel flow can be controlled for better boat trim. The ball valve is open when the handle is oriented along the axis of the fuel line and is closed when the handle is oriented perpendicular to the fuel line.

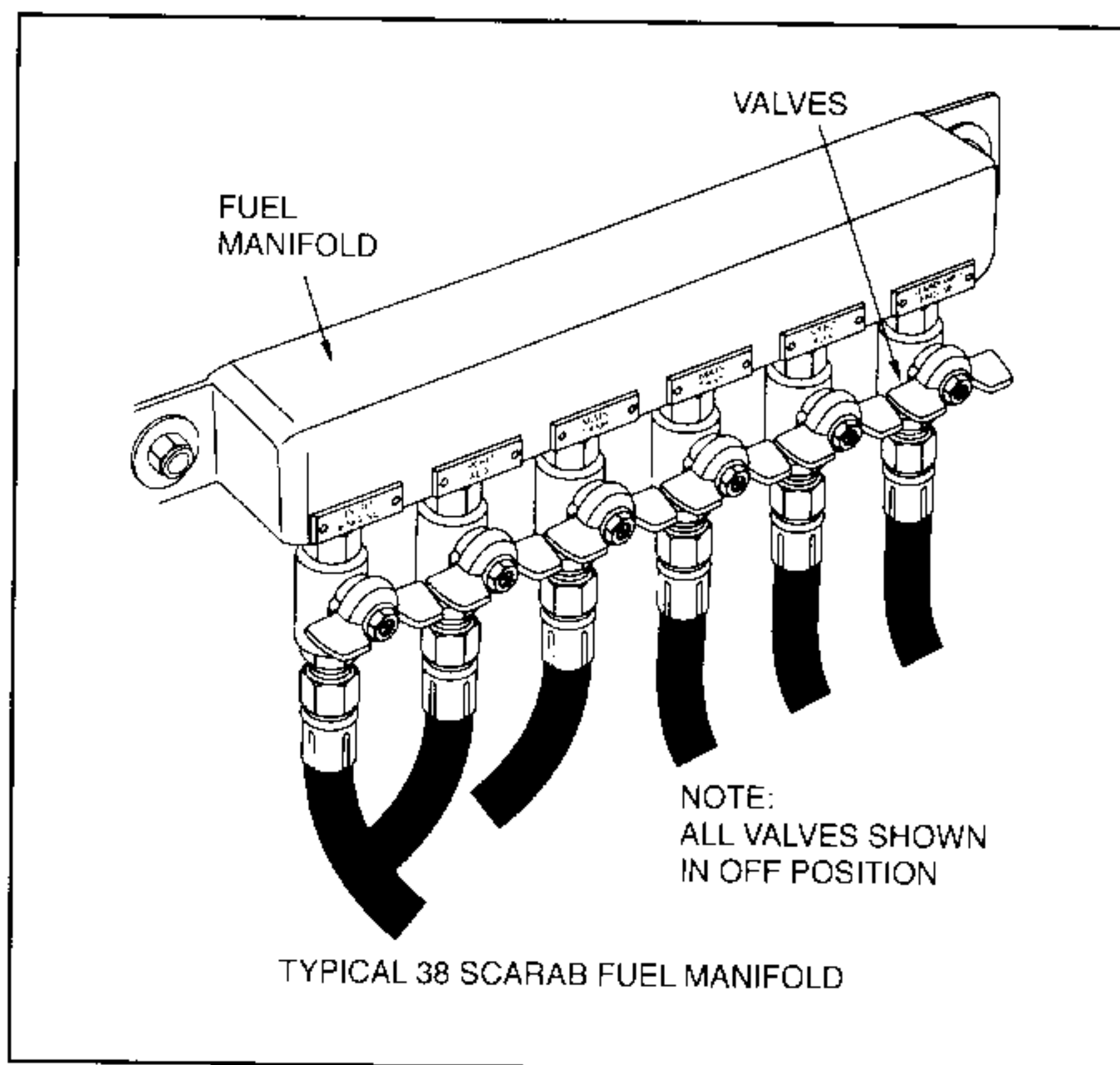
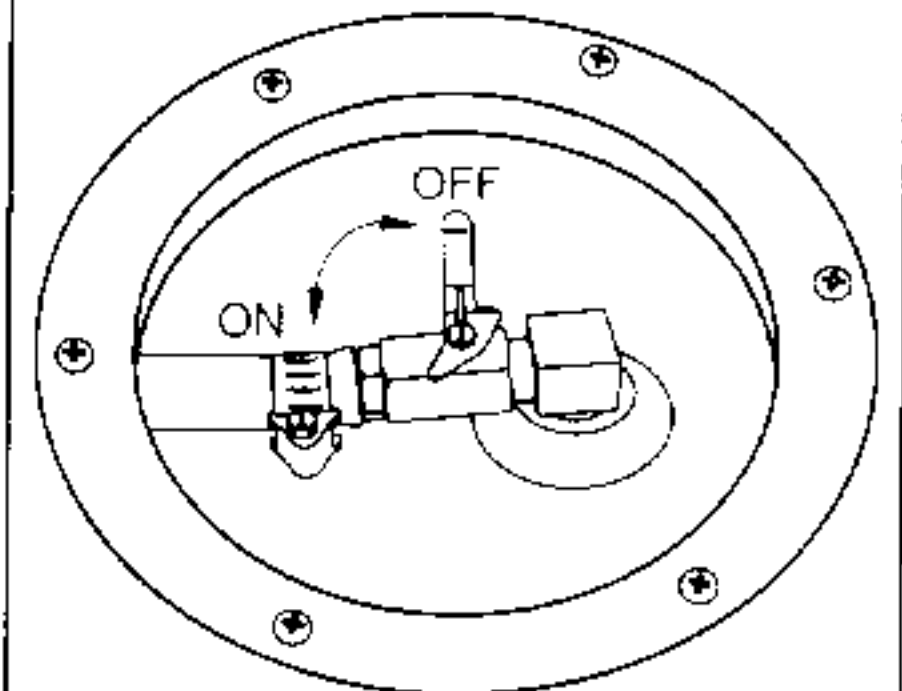

SCARAB®

AIR CONDITIONER

Air conditioning is an option on some models that are equipped with shore power. An optional air conditioning unit will run only on shore-supplied AC power. In addition, a raw water intake and seacock is required to provide water to the system. Be sure to read the manufacturer's operating instructions before using your air conditioning unit.

WARNING

Your air conditioning unit may contain a Class I ozone-depleting substance which harms public health and the environment by destroying ozone in the upper atmosphere. It is important to follow the manufacturer's recommendations for the maintenance of items which contain ozone-depleting substances in order to prevent their release into the atmosphere.

PROPULSION

Because of the wide variety of engine/drive system combinations available on Scarabs, no attempt has been made to cover them. Please refer to the engine/drive information provided in the "Important Papers" zipper bag for the manufacturer's information or consult with your dealer.

ENGINE EXHAUST SYSTEM

The engine exhaust system removes harmful gas created by the engine during combustion. Inspect the system for leaks before each use of the boat. Make sure all hose clamps and connections are tight and there are no cracks in any exhaust system component that would allow carbon monoxide gases to escape. See your dealer for operational instructions on optional exhaust systems.

REFRIGERATOR

Some models are equipped with a 12 VDC/120 VAC refrigerator. The refrigerator can be removed if necessary to keep food cool to or from the boat. To operate the refrigerator:

NOTICE

If you plan to use the refrigerator for long periods of time without running the engines, be sure that the batteries are fully charged.

1. Turn ON the boat's main DC breaker.
2. Turn ON the DC refrigerator breaker.
3. Turn ON the power switch on the refrigerator.

Refer to the "Important Papers" zipper bag for more information on the refrigerator.

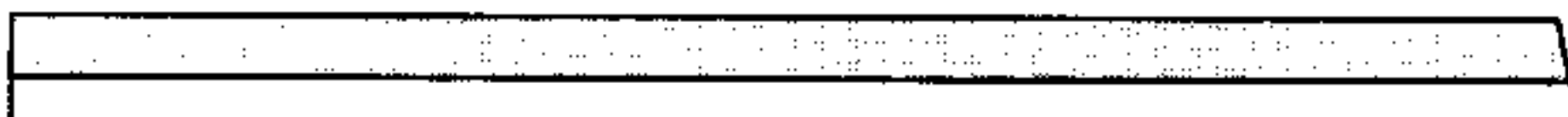

SCARAB[®]

Getting Underway

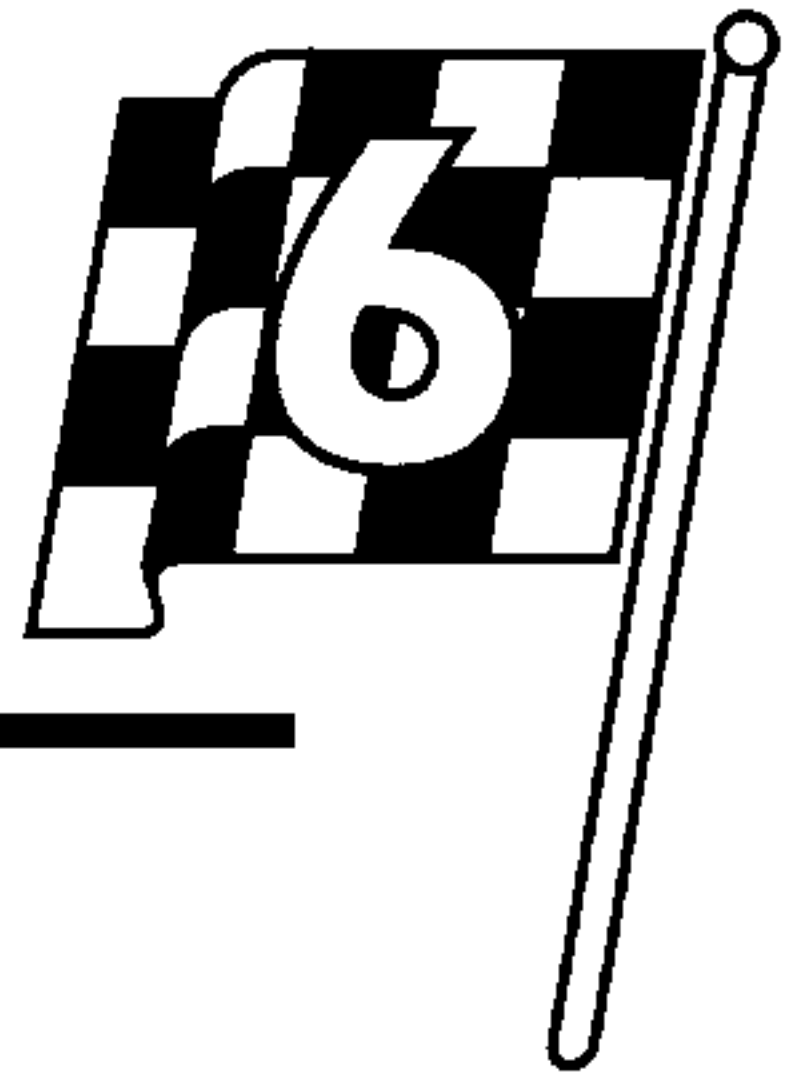

This section describes the preparation required before taking your boat out on the water.

LAUNCH AND CRUISE CHECKLIST

- Get a current weather report. If the weather will not be favorable, postpone your trip.
- Install hull drain plugs.
- Inspect the hull and propeller for damage. Excessive dirt or marine growth will affect your boat's performance and fuel efficiency.
- Check the electrical system and navigation lights.
- If your boat has been in the water, run the bilge pump until the flow of water stops.
- If your boat has been out of the water, check to see that all bilge water has drained out. Then install the drain plug.
- Check that all required safety equipment is on board and in good working condition. Examples include personal flotation devices (PFDs), horn, fire extinguisher, visual distress signals, etc. Take along a gallon of drinking water.
- Check that all other required equipment is on board. Examples include mooring lines, anchor and line, tool kit, first aid kit, etc.
- Open engine compartment. Inspect for fuel odors and visible leaks in the fuel, oil, coolant, exhaust and power steering systems.
- Visually inspect engine for cracked hose, defective belts, or other signs of engine problems. Check engine oil and battery water levels. Check power steering fluid level. Check battery electrolyte range.
- Check fuel level. Fuel tanks should be filled to slightly less than capacity. Allow for fuel expansion.
- Check that all engine drains are closed (stern drives).
- Make sure navigation charts and equipment are on board.
- Check operation of bilge blower, steering system, navigation lights, and operation of horn.
- Make sure passengers and crew know what to do in case of an emergency and how to operate safety equipment.
- Make sure all required documents are on board.
- File a float plan with a responsible party ashore.

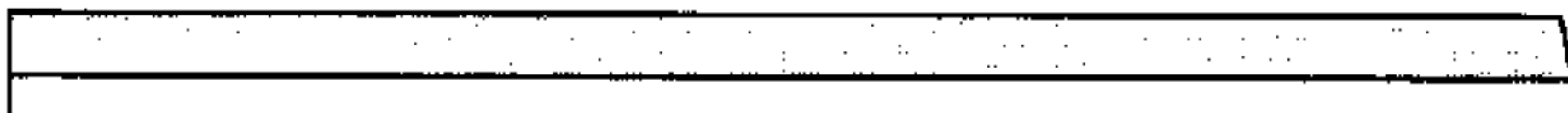

SCARAB[®]

FUELING

Fuel fill locations for your boat are shown in Section 3, *Specifications and Layout*.

CAUTION

To avoid engine damage, use a high quality fuel from a reliable source. Marine engines operate under greater strain than automotive engines. Knocking due to poor fuel can cause severe engine damage. Refer to your engine owner's manual for the proper fuel type and octane rating. Consult your dealer for any special fuel suggestions for high performance boats and climatic conditions in your area.

WARNING

Gasoline is extremely flammable and highly explosive under certain conditions. When refueling, always stop the engine and never smoke or allow open flames or sparks within 50 feet of the fueling area.

Follow these guidelines to safely fuel your boat:

- ◆ Know your fuel tank capacity (see Section 3, *Specifications and Layout*). Be sure to have enough fuel to reach your destination with adequate reserve for course change due to weather or other problems. If departing for an extended cruise, know the availability of fuel along your route.
- ◆ Avoid fueling at night except under well-lit conditions. Gas spills are unnoticeable in the dark.
- ◆ Know the location of your fire extinguisher in case of emergency.
- ◆ Moor your boat securely to the dock.
- ◆ Close all doors, hatches, windows and other compartments.
- ◆ Make sure all power is off and do not operate any electrical equipment, blowers or engines.
- ◆ Remove fuel fill cap. To unscrew a "slot" type fuel cap, use the cap key provided by putting the two prongs of the key into the two holes in the top of the cap and turn the key and cap counterclockwise.

- ◆ Insert hose nozzle and make sure nozzle is in contact with metal fill opening. This will reduce the risk of static spark.
- ◆ Add fuel. Do not fill all the way to capacity to allow for fuel expansion.
- ◆ Check oil level.

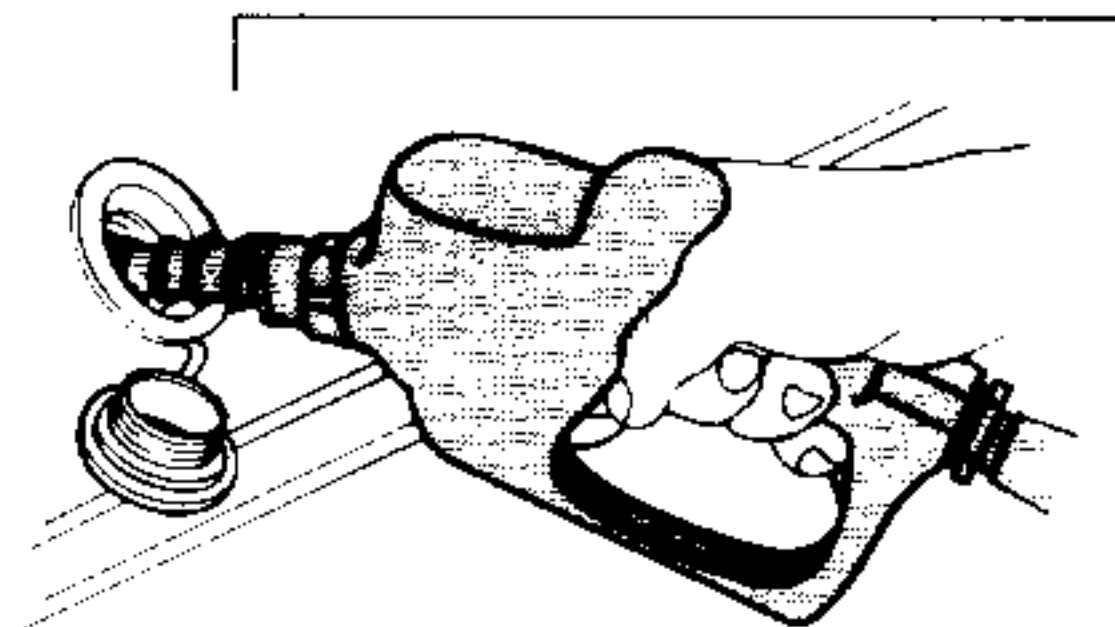

 **CAUTION**

Each time you fill up, inspect fuel lines for leaks and hose deterioration.

NOTICE

The Federal Water Pollution Control Act prohibits the discharge of oil or oily waste into the water. Violators can be fined \$5,000. We urge you to protect our fragile environment by avoiding any type of fuel or oil discharge into our waterways.

After fueling, you should:

- ◆ Close fill cap securely and wipe up spillage.
- ◆ Open all windows, hatches, doors and compartments.
- ◆ Check all fuel lines and connections for leakage.
- ◆ Operate bilge blower for at least five minutes, then perform a sniff test of the engine compartment.

 **WARNING**

Make sure the engine compartment is free of gasoline vapors before you start your engine. Run the blower for at least five minutes, then open your engine hatch and sniff for gasoline vapors before starting your engine. Keep your blower running until you have reached cruising speed and turn your blower back on when at idle or slow speed running.

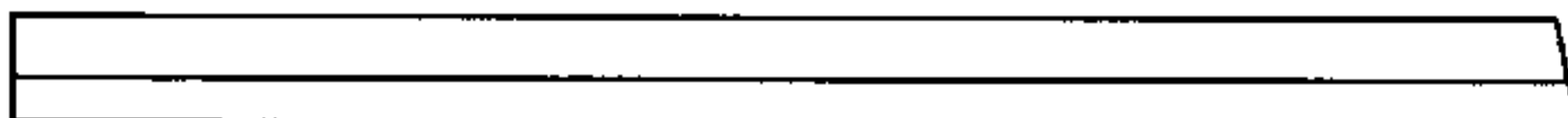

SCARAB®

SAFETY CHECKLIST

The following checks are essential to safe boating and must be performed before starting the engine. Get in the habit of performing these checks in the same order before each outing so that it becomes routine.

WARNING

DO NOT launch the boat if any problem is found during the Safety Check. An ignored problem could lead to a tragic accident. Contact your dealer to have any problem attended to before you head out on the water.

Safety Check

- ◆ File a float plan or, at a minimum, tell your destination and approximate return time to a reliable person who can be depended upon to notify the Coast Guard or other rescue organization in the event you do not return as scheduled.
- ◆ Check the weather report, wind and water conditions along your route.
- ◆ Check that the required safety equipment is on board.
- ◆ Check that the fire extinguisher is fully charged.
- ◆ Check that bilge drain plug is installed properly.
- ◆ Check that no fuel, oil or water is leaking or has leaked into the bilge compartment and that no oil is leaking from the drive unit.
- ◆ Check all hoses and connections for leakage and damage.
- ◆ Check engine oil levels.
- ◆ Check trim tab pump fluid levels.
- ◆ Check hydraulic steering fluid level.
- ◆ Check that battery terminals are clean and tight.
- ◆ Check electrical circuits (lights, pumps, horn, etc.) for proper operation.

- ◆ Move the throttle and shift levers back and forth through their entire range of travel and turn the steering wheel right and left through its entire range of travel, checking to make sure there is no loose hardware and that all cables are free from interference and binding.
- ◆ Check the batteries in flashlights, radios and other portable equipment.
- ◆ Check that your marine radio is operating properly and show at least one passenger how to use the radio to call for help in the event of an emergency.

LOADING

When boarding the boat, always step in lightly; do not jump. Avoid stepping on potentially slippery surfaces and board one person at a time.

Do not board the boat while carrying gear. Always pass gear on board.

The performance of your boat can be affected by load weight and uneven load distribution. Passengers should board one at a time and should distribute themselves to maintain proper trim. Remember to distribute weight evenly from starboard to port and also fore and aft and never exceed the maximum capacity rating of your boat.

WARNING

Passengers must not ride on the bow, deck, gunwale, engine hatch or swim platform while underway.

The operator of a boat is responsible for letting all passengers know how to conduct themselves while underway, including:

- ◆ Where to sit
- ◆ When it is safe to move around the boat
- ◆ Where grab rails are located

Securely stow all extra gear in stowage areas to prevent load shifting. Do not stow gear on top of safety equipment. Safety equipment must be quickly accessible.

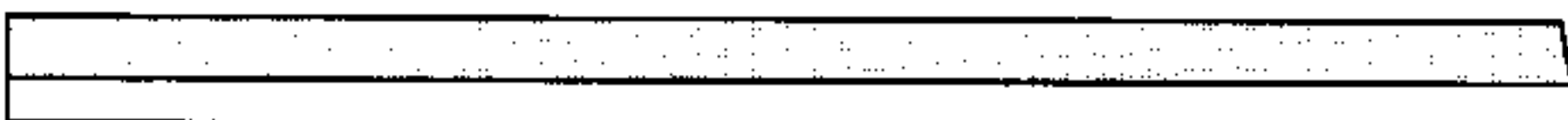

SCARAB[®]

STARTING

The following starting guidelines cover a wide variety of engine power and accessory options. Be sure to follow the starting instructions contained in the engine operator's manual.

1. Complete Safety Checklist before every outing.
2. Turn battery selection switch(es) to 1, 2 or ALL position. ALL position will provide power from both batteries for starting. The normal position for operation is with the battery switch(es) in the battery 1 or 2 positions.
3. Open engine hatch.
4. Open fuel feed valve(s).
5. Operate bilge blower for at least five minutes prior to starting engine(s).

WARNING

Make sure the engine compartment is free of gasoline vapors before you start your engine. Run the blower for at least five minutes, then open your engine hatch and sniff for gasoline vapors before starting your engine. Keep your blower running until you have reached cruising speed and turn your blower back on when at idle or slow speed running. The engine blower will not remove gasoline vapors if liquid gasoline is present in bilge.

6. Use manual bilge pump switch to remove any water in bilge below the automatic switch level.
7. Close engine hatch.
8. Attach ignition interrupter lanyard to the switch on the helm and to a strong piece of clothing such as a belt on the operator.
9. Move stern drive(s) to full IN position.
10. Move trim tab controls to the full UP position.
11. Put shift lever(s) in NEUTRAL position.
12. Advance throttle lever forward slightly unless your boat is equipped with electronic fuel injection, in which case, leave the throttle lever at idle.

13. Turn the ignition key switch of one engine to START position. Release key immediately after engine starts.
14. If engine will not start and is not fuel injected, move throttle to FULL position once or twice to actuate the carburetor accelerator pump.
15. Operate engine at approximately 1000 to 1500 RPM and observe gauge readings for a few minutes before starting other engine(s), if equipped.
16. Repeat steps for remaining engine(s), if equipped.
17. Make sure gauges indicate normal operating ranges. If not, shut down engine(s) immediately and determine cause.
18. If your boat is equipped with through-transom exhaust, check for proper water circulation by looking for the cooling water coming from the exhaust pipe. This should occur very shortly after the engine is started.
19. After the engine(s) has (have) warmed up to normal operating temperature, reduce throttle to idle speed until you're ready to depart.

CAUTION

Your boat is equipped with a warning alarm that will sound if an engine problem develops. Continued operation after the warning alarm has sounded may cause severe engine damage. If the warning alarm sounds, IMMEDIATELY throttle back to idle speed, shift into neutral, check the gauges and stop the engine.

STOPPING FOR THE DAY

Slowly bring the throttle(s) to the idle position and the shift control(s) to the NEUTRAL position. Bring the trim tabs to the UP position and the outdrives IN. If the boat has been driven for a long period of time at high speed, allow the engine a 2-3 minute cool-down period at low idle.

1. Turn the ignition key(s) to the OFF position and remove ignition key(s).
2. To prevent marine growth from accumulating on the hydraulic cylinder shafts, make sure trim tabs are UP.
3. Stow and secure all equipment.



SCARAB[®]

4. Pump bilges dry using the manual position on the bilge pump switch.
5. Close all inlet seacocks and fuel valves.
6. Inspect boat for damage.
7. Turn battery selection switches to OFF.
8. If you operated in saltwater, rinse your boat with fresh water.

LINE HANDLING

The proper use of dock lines is important when securing your boat. Dock or mooring lines are used to keep the boat from moving parallel to the dock or sideways within a berth. Since each mooring situation is different, there are many ways to secure a boat to the dock. Your local Coast Guard Auxiliary holds courses in small boat handling that covers boat mooring and other line handling.

DISCHARGE OF OIL

The Federal Water Pollution Control Act prohibits the discharge of oil or oily waste into or upon the navigable waters of the United States or the waters of the contiguous zone if such discharge causes a film or sheen upon or a discoloration of the surface of the water or causes a sludge or emulsion beneath the surface of the water. Violators are subject to a penalty of \$5,000.

DISPOSAL OF PLASTICS & OTHER GARBAGE

Plastic refuse dumped in the water can kill fish and marine wildlife and can foul boat propellers and cooling water intakes. Other forms of waterborne garbage can litter our beaches and make people sick. U.S. Coast Guard regulations prohibit the dumping of plastic refuse or other garbage mixed with plastic into the water anywhere, and restrict the dumping of other forms of garbage within specified distances from shore.

MARPOL TREATY

Boats 26 feet or longer must display a sign stating the disposal regulations of the Federal Water Pollution Control Act. The U.S. Coast Guard has issued these regulations to implement Annex

V of the International Convention for the Prevention of Pollution from Ships, 1973, commonly known as Annex V of the MARPOL (Marine Pollution) Treaty 73/78. They apply to all U.S. boats wherever they operate (except waters under the exclusive jurisdiction of a State) and foreign boats operating in U.S. waters out to and including the Exclusive Economic Zone (200 miles). It is important to know these regulations and adhere to them.

The regulations require U.S. recreational boaters, if your boat is 26 feet or more in length, to affix one or more USCG Trash Dumping Restrictions placards to your boat. The placard warns against the discharge of plastic and other forms of garbage within the navigable waters of the United States and specify discharge restrictions beyond the territorial sea. (The territorial sea generally ends three nautical miles from the seashore.) In addition, the placard must contain the warning that a person who violates these requirements is liable to civil (\$25,000) and criminal (imprisonment) penalties. The placard also must note that State and local regulations may further restrict the disposal of garbage.

Operators shall display one or more placards in a prominent location and in sufficient numbers so they can be observed and read by crew and passengers. These locations might include embarkation points, food service areas, galleys, garbage handling spaces and common deck spaces frequented by crew and passengers. We recommend that these placards be installed on all boats. The placards may be purchased from local marinas, boat dealerships and marine equipment suppliers. A special placard is available for boats operating on the Great Lakes.

IMPORTANT: It is illegal to discharge waste from your marine sanitary device (toilet) into the water in most areas. It is your responsibility to be aware of and adhere to all local laws concerning waste discharge. Consult with the Coast Guard, local marina or your dealer for additional information.

NOTE: Some states and localities have legal limits on speed, noise and trailer specifications. It is your responsibility to be aware of these laws and limits and to insure that your boat (and trailer) comply. Consult with your local Marine Patrol or local Coast Guard office.

ADDITIONAL UNDERWAY INFORMATION

Be sure to run the bilge blower whenever the boat is operated under cruising speed.



SCARAB®

Keep all bilge blower and engine compartment vents free of obstructions to allow proper ventilation.

Always be aware of local laws on noise limits. Noise means engine noise, radio noise or even yelling by people on your boat. Good seamanship demands that you operate your boat quietly so as not to infringe on the rights of others. Don't use thru-transom exhaust unless you are well off shore.

You are responsible for any damage or injury caused by your boat's wake. Observe no wake speed zone warnings. Operate your boat with regard for the safety of other boats and people in your boating area.

Keep your engine well tuned to decrease exhaust hydrocarbon emissions that pollute the air and water.

Running

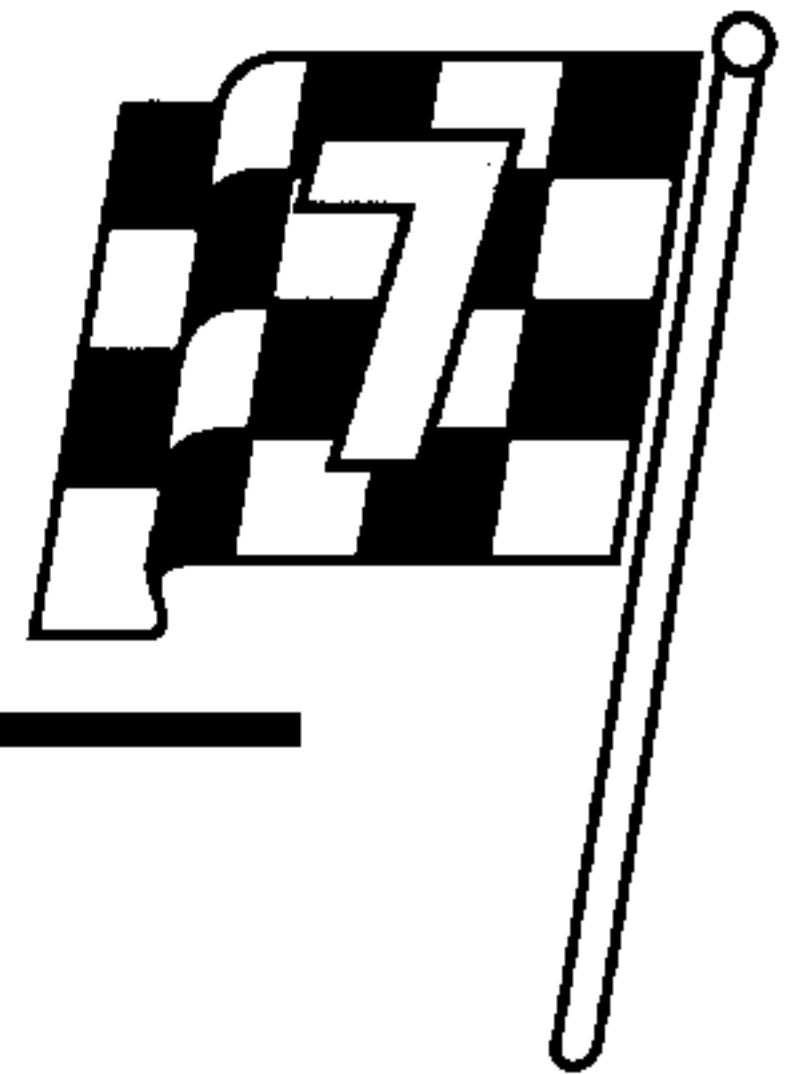

Because of the high speeds attainable by Scarabs with even standard engine/drive packages, we strongly recommend that you and other persons who may operate your boat seek additional training before attempting high-speed boating. Inexperienced boaters should practice with someone familiar with performance boats and should develop a comfortable, confident "feel" for their boat at slower speeds before attempting any high speed runs. **Remember: Keep safe by keeping within your ability.**

In addition, we at Wellcraft conduct a high performance driving school for purchasers of new twin or triple engine Scarabs which covers boat handling, offshore operating and safety as well as provides an opportunity to gain hands-on experience in proper drive trim and trim tab operation, offshore maneuvering and docking.

This section is designed to present the most basic operational principles for high performance boats. It is NOT intended to cover all conditions encountered during operation.

MANEUVERING

Multiple-Engine Maneuvering At Slow Speed

Keep the following guidelines in mind when maneuvering your high performance boat at slow speed (for example, when entering and leaving a slip):

- ◆ Practice. If you are a novice, practice maneuvering in calm water with no wind and lots of room until you get the feel for the boat and its controls.
- ◆ Steer by making small, early corrections to keep your boat from gaining any turning momentum and wandering.
- ◆ Steer with the aid of the shift/throttle levers. The steering wheel alone is not as effective at very slow speeds as is using the shift/throttle levers along with the steering wheel to steer.



SCARAB®

With the stern drives pointed straight ahead, you could steer using only the shift/throttle control levers.

- ◆ Pay attention to conditions. Check the wind and water currents and use them to your advantage when docking your boat - don't fight them.
- ◆ Proceed slowly. Give yourself time to think and react.

To turn in close quarters, start with the stern drives pointed straight ahead. By using the forward thrust of one engine and the reverse thrust of the other, your boat can be made to pivot on-a-dime. For example, with the port engine in forward and the starboard engine in reverse, the bow of your boat will pivot to starboard. At this point, when the bow begins to swing around, you can increase the turning rate of your boat by turning the steering wheel in the direction of the turn.

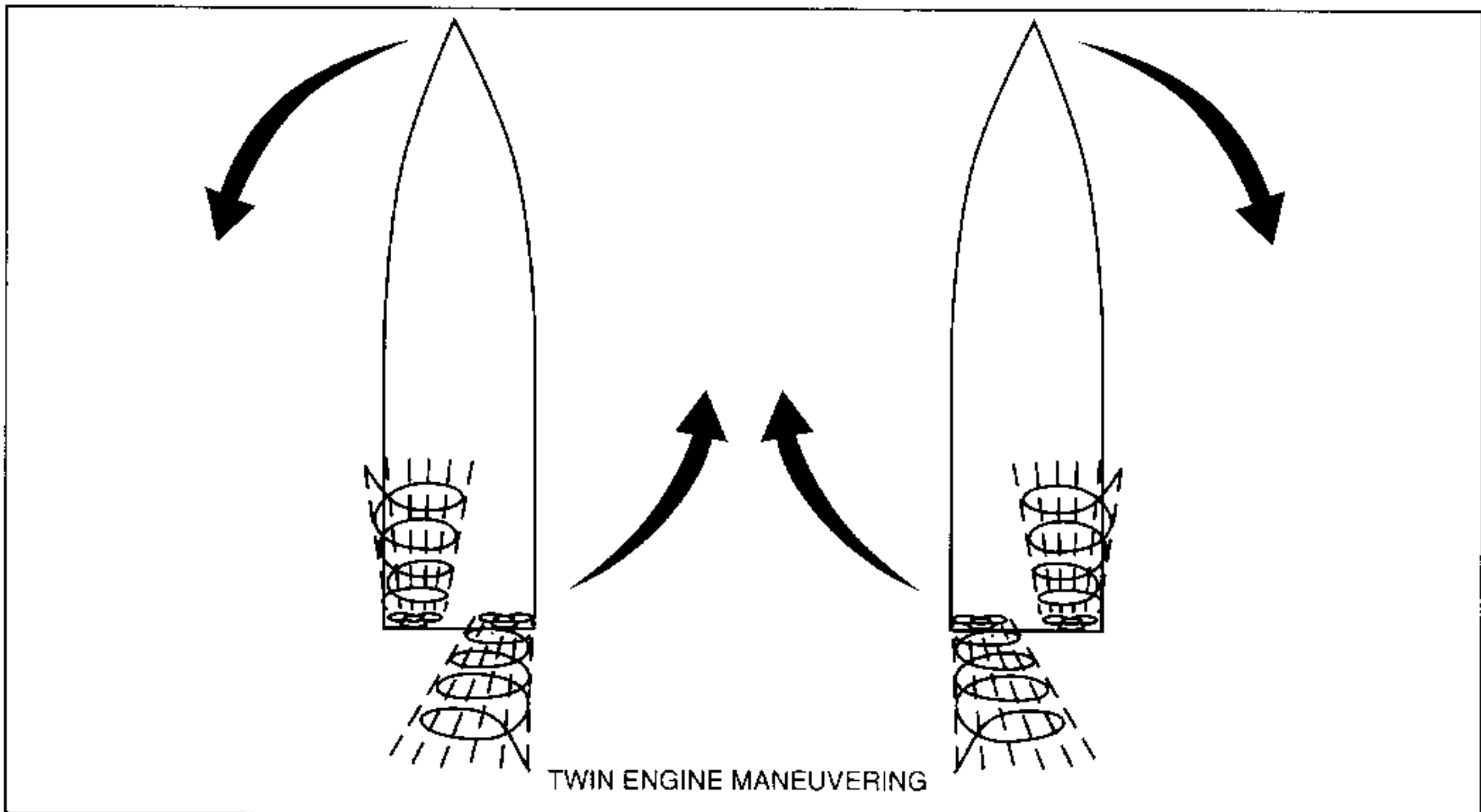

Stopping

Stopping under control is a technique that must be practiced. Since a boat has no brakes, coasting and reverse thrust is used to slow and stop the boat. The momentum of the boat will vary according to the load as well as the speed. Make it a habit to slow to idle (no wake) speed before shifting into reverse.

Docking

The most important thing to remember when docking your boat is to **take your time**. Keep your engines at idle speed in close quarters. Safe docking is slow and deliberate.

CAUTION

Approach docks at a very slow speed. Failure of reverse gear or the unintentional killing of the engine can result in a collision.

When docking, keep the following guidelines in mind:

- ◆ Bring your boat to a stop a comfortable distance from the dock, then proceed slowly, keeping your boat under control.
- ◆ Have fenders, mooring lines and crew (if available) ready. Many Scarab models have stainless steel “pop-up” deck cleats. To expose the cleat, press down on the button adjacent to the cleat.
- ◆ Try to use the wind and current to your advantage when docking. If the wind or current is pushing you away from the dock, use a sharper angle of approach.
- ◆ Approach the dock slowly and after a line has been passed ashore, stop the boat’s headway with the engine(s) and swing the stern in towards the pier.

CAUTION

Before tying up, be sure to use enough fenders to protect the boat from damage and only attach lines to deck cleats, never handrails or windshield frames.

PERFORMANCE BOATING

Your Wellcraft Scarab is designed for high-speed performance. By following these performance boating guidelines, not only will you get the highest performance level from your boat, but more important, your boating will be safer.

Performance Preparation

Performance boating in even mild seas can put tremendous forces on components and equipment. It is especially important to thoroughly inspect for loose or missing parts before leaving port in addition to completing the **Safety Checklist** in Section 6.



SCARAB[®]

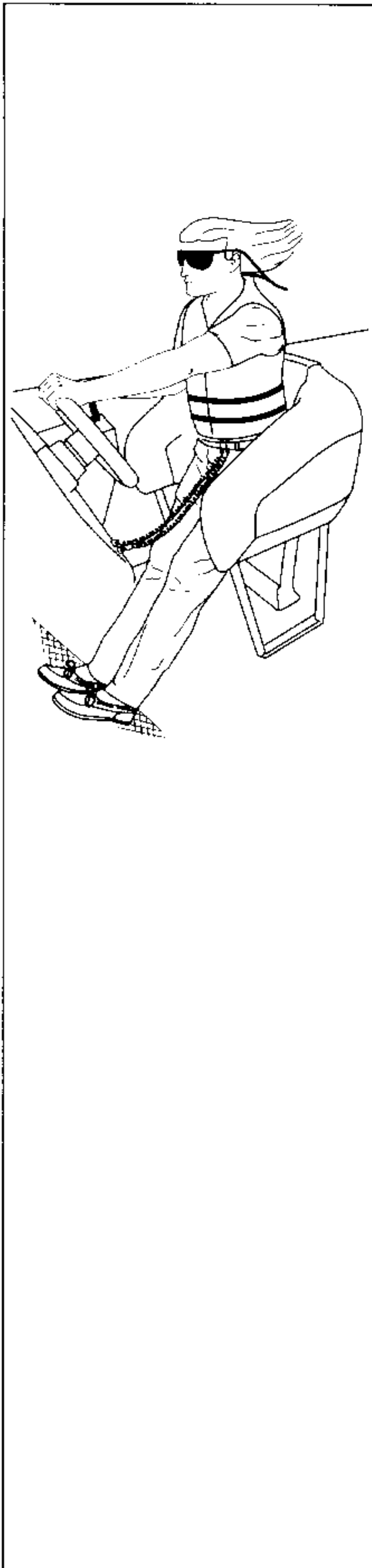

To obtain the highest level of performance from your boat, the bottom of the hull must be kept free of barnacles and marine growth. Marine growth can be the single greatest cause of poor boating performance. Daily removal of salt or lake water and freshwater rinsing of the hull is highly recommended.

Bolster Seats

Bolster seats are designed to be unlatched and swung down for high-speed boating. The wraparound construction of bolster seats lessens the shock of pounding waves and keeps the operator firmly behind the helm. To unlock the seat, reach under the front side of the seat, pull the release handle and allow the seat bottom to swing down and lock into place. You should position yourself with your feet on the helm footrest with the small of your back supported by the bolster.

On models with optional electric bolster seats installed, a rocker switch located on the inboard side of the seat controls the raising and lowering of the seat bottom.

WARNING

If at any time during high-speed operation you have a sensation of losing control, *slow down immediately*. Also, keep in mind that other passengers in your boat do not have the security of a bolster seat, steering wheel or of knowing what's ahead. Therefore, before accelerating, slowing down or turning, make your passengers aware of your intentions so that they can properly brace themselves.

Getting On Plane

If you have never had your boat on plane before, it is a good idea to choose a calm day for your first on-plane experience and leave any passengers on shore until you are comfortable driving your boat at planing speed.

- ◆ With your boat in an area where it is legal and prudent to drive at planing speed, check to be sure that the ignition interrupter lanyards are securely fastened.
- ◆ Bring drives all the way in and check to make sure that the trim indicator reads correctly.

- ◆ Put the trim tabs down slightly. Depending on your particular boat, more or less tab may be useful when getting on plane. With practice, you will be able to determine the correct amount of tab that will allow you to bring your boat on plane while, at the same time, allow you to keep maximum forward visibility.

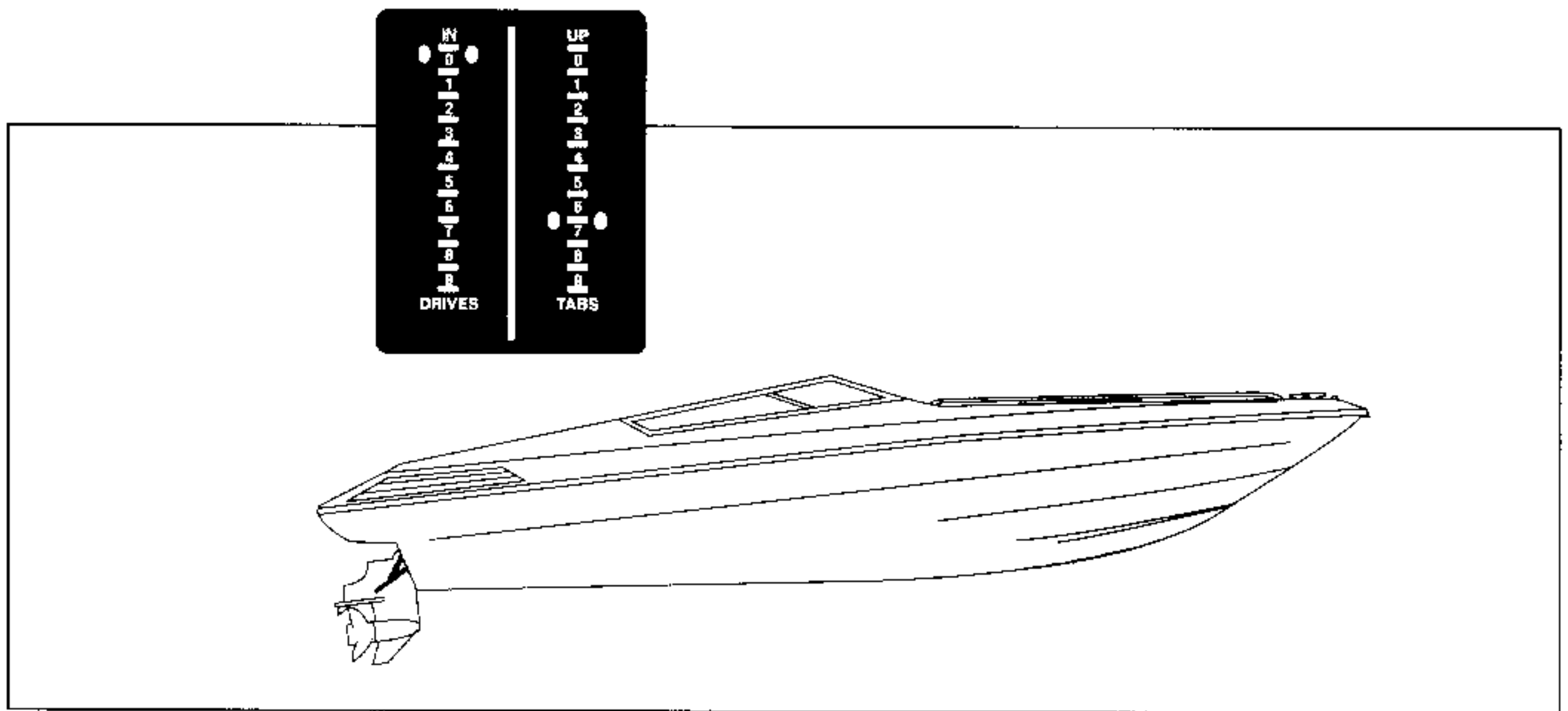

WARNING

Before you bring your boat on plane, make sure that all passengers are aware of your intentions and that they are properly braced.

WARNING

Before applying throttle to bring your boat on plane, be sure that the area ahead of your boat is clear. The bow will rise out of the water momentarily before you plane, temporarily obstructing your forward vision.

- ◆ Check all around your boat for traffic and remember that you are responsible for any damage caused by your wake—so use good sense when bringing your boat on plane.
- ◆ Steadily and slowly apply throttle (to plane, your engines should be turning no more than two-thirds of their top RPM). As your boat picks up speed and the bow begins to drop, start bringing your trim tabs up.

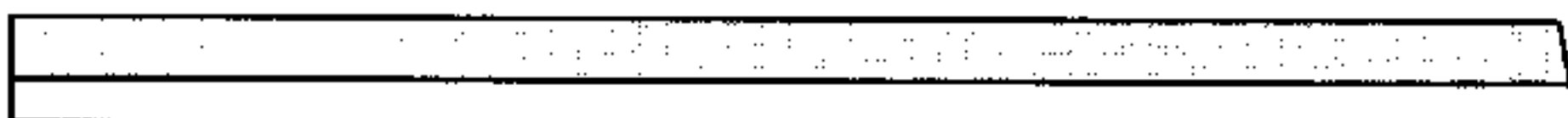

SCARAB®

WARNING

Under certain conditions, there can be a noticeable pull on the steering wheel, commonly referred to as “steering torque.” Because of this, keep a firm grip on the steering wheel under all circumstances to avoid loss of control and possible ejection due to boat spinout.

- ◆ When your boat comes up on plane, bring the trim tabs all the way up. With your drive trim still in, you may feel some steering torque pulling to the right (if your boat has a single engine). Trimming out your drive will decrease this steering torque.

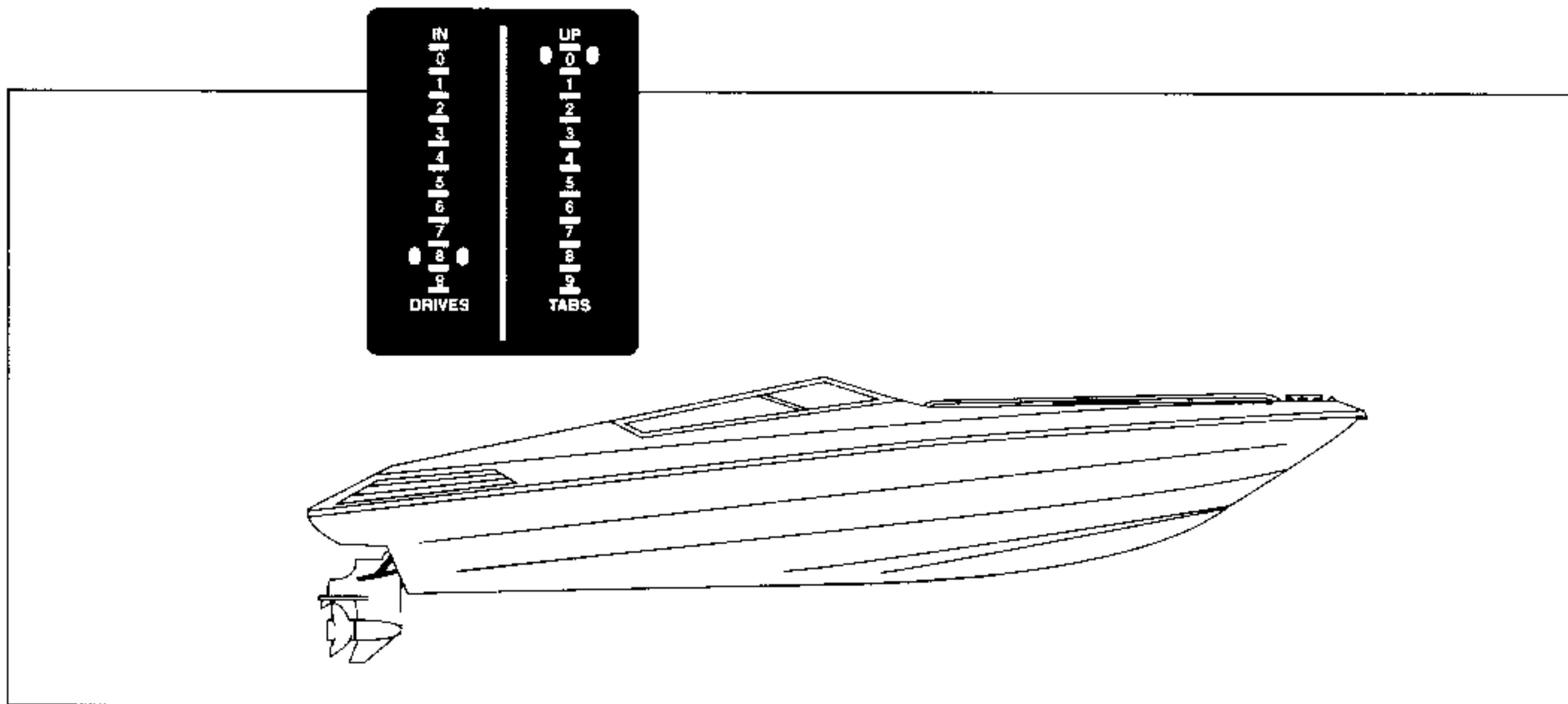

- ◆ When you feel comfortable at a reasonable planing speed, you can slowly increase throttle and trim the drives out farther to achieve top speed. On most Scarab models (Merc 502 MAG EFI Bravo I powered and down), the trim limit switch is factory preset to provide maximum performance at top speed and eliminating ventilation which can cause propeller speedup and a reduction in boat speed.
- ◆ You can use the speedometer and tachometer to adjust boat trim in the following way: At cruising speed with outdrives in a mid-position, slowly start to bring the outdrives out until you notice an increase in RPM with a slight drop in speed. At this point, bring the outdrive in just slightly. You will now be at the best running angle for cruising.

CAUTION

Keep engine speed (RPM) well below the maximum “red line” RPM to extend engine life. Do not operate at full throttle for more than 30-60 seconds.

CAUTION

Do not use the “trailer” switch to trim the drive while the boat is underway; this may bring drives out past their trim limit causing severe damage to the drive.

Coming Off Plane

WARNING

Check behind you before coming off plane. Many accidents occur each year as a result of drivers coming off plane ahead of a boat which is unable to slow down in time to avoid collision.

- ◆ Bring the drives all the way in.
- ◆ Slowly pull back the throttles. Using a little down tab when coming off plane will make slowing down smoother and drier.
- ◆ Glance back and see if a large following wave is approaching the transom. If it is, give the engine a little throttle as the wave arrives to keep it from rolling over the transom.

Running In Open Water

WARNING

Be attentive when operating at high speed. At a high rate of speed, situations can change very quickly requiring the operator to take fast action to avoid collision.

- ◆ At high speeds, keep your hands on the steering wheel and throttles at all times.
- ◆ At high speed, boats are very sensitive to trim tabs. When using trim tabs, push the trim tab rocker switches in half second touches. Holding the rocker switches down too long will overtrim the boat.

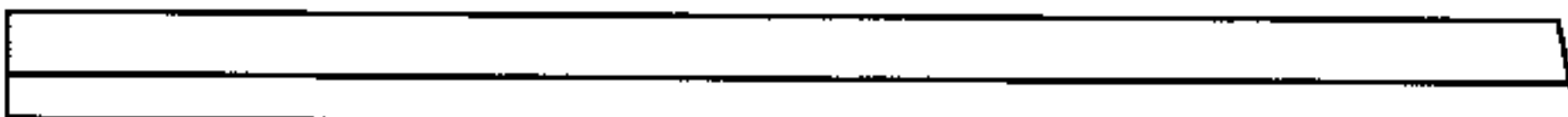

SCARAB[®]

- ◆ When executing a turn at high speed, slow down a little and bring the drives in a little. This will put the bow down slightly and give you better control during the turn. Begin turning with a little wheel, then wait for the boat to “bite” (start turning) before applying more wheel.
- ◆ If your boat’s drive unit leaves the water, pull back on the throttles immediately to keep the engines from over-revving, then set them at a slower speed-you probably are going too fast for the sea conditions.
- ◆ In a head sea, put the tabs to a mid-position to level and smooth the ride.
- ◆ In a following sea, put the drives out and the tabs up. This will lift the bow and offset the waves which lift the stern.
- ◆ If your boat is listing slightly due to uneven loading, a little down tab on the lower side will level the ride.
- ◆ If your boat is listing due to a quarter following sea, a little down tab on the side opposite the side which is lifting will produce a drier ride.



CAUTION

Keep stern drives parallel so as not to damage the steering tie bar end joints.

Performance Accessories

Your Scarab may be equipped with high performance engines and other equipment from the factory. In most cases, this equipment is designed specifically for high performance marine applications and should not be modified in any way. The most important after-market performance product is the propeller. Once you have determined your performance boating needs, talk with your Scarab dealer for propeller applications.

PROPELLERS

Care and proper selection of your propeller is very important if you want to achieve the ultimate performance from your Scarab.

Taking proper care of your boat's propeller(s) is necessary for good performance, since even slight damage can cause a significant loss of speed. Propeller damage also produces imbalance vibrations that can cause fatigue damage to the drive unit and engine. Frequently check your propeller(s) for damage and have the propeller(s) repaired and balanced or replaced if necessary. Also, remember to carry a spare on board just in case.

For your Scarab to achieve her ultimate speed, the proper propeller(s) must be selected. Your engine(s) should be propped to allow operation at or near the top end of the recommended maximum RPM range at wide-open throttle (WOT). This will allow your engine to develop full power, but stay below the damaging RPM range.

Selection of a propeller can be complicated. Since many variables are involved in propeller selection, your Scarab dealer will be your best source of information on propeller selection. The following will help you understand some of the basics about propellers.

Propellers are identified by two numbers (such as 13 x 19) and a material identification (such as stainless steel, aluminum or plastic). In the number sequence, the first number is the diameter of the propeller and the second number is the pitch of the propeller.

The diameter of a propeller is the diameter of the circle swept by the tips of the blades. Diameter is the most important single factor in propeller selection—small changes in propeller diameter have more effect on power absorption than large changes in pitch or blade area.

The pitch of a propeller is the theoretical distance it will advance through the water in one revolution. For example, for the 13 x 19 propeller mentioned above, a boat should travel 19 inches through the water during one revolution of the propeller. Because of slippage, however, this theoretical distance is always somewhat greater than the actual distance traveled. Pitch has a direct effect on engine speed. At full throttle, for example, a 19" pitch propeller would result in higher engine RPMs than a 21" pitch propeller.

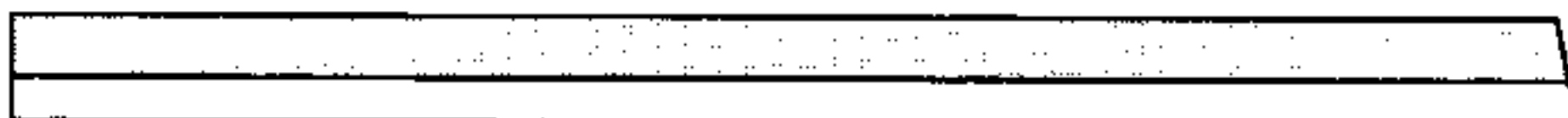
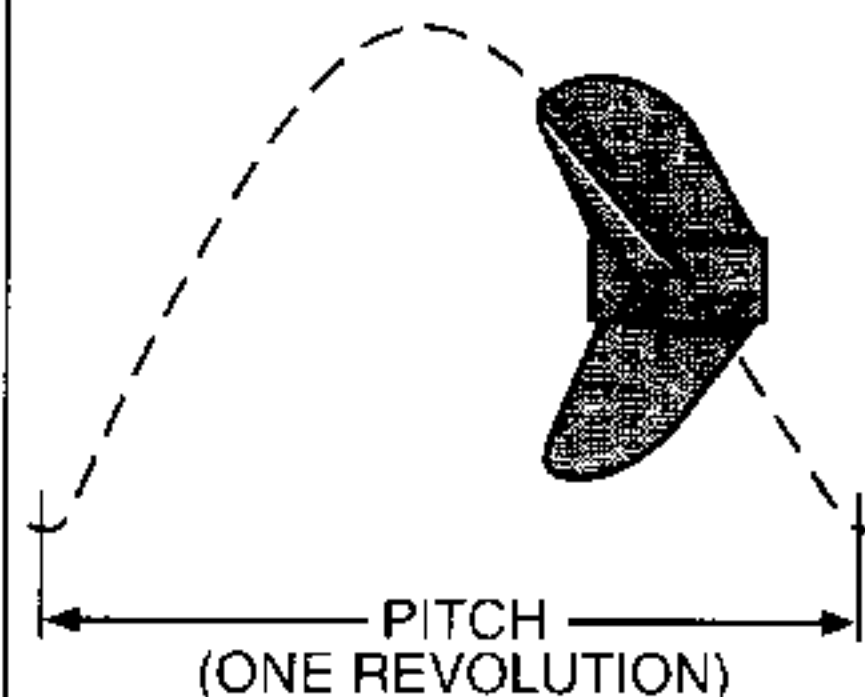
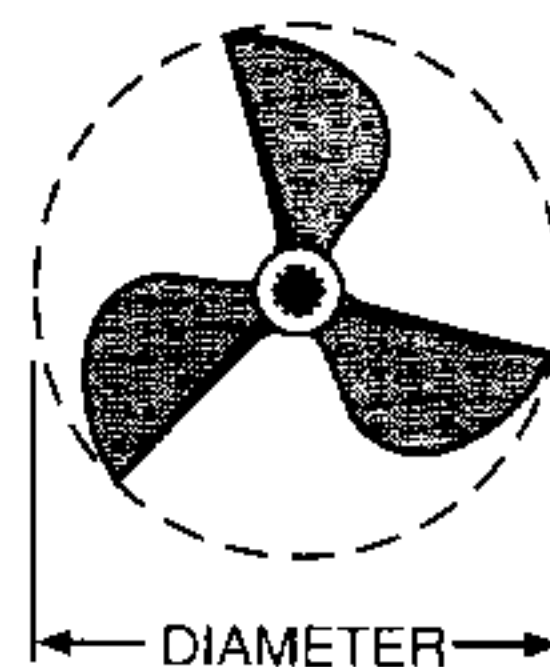

SCARAB®

There are three important conditions related to propellers you should be familiar with: ventilation, cavitation and high-speed gearcase blowout.

Ventilation is caused when air or exhaust gas is drawn into the propeller blades. Since there is less water in contact with the propeller blades, the propeller over-revs and loses much of its thrust. This can occur when trying to plane in a sharp turn or if your drive unit is trimmed out too far.

If your propeller has nicks in its leading edge, is severely bent or too small in diameter for its engine (among several causes), cavitation can occur. Air bubbles from the leading edge of the propeller condense as they pass over the propeller blade causing pitting and erosion. If you notice this erosion or "cavitation burn" on the blade of your propeller, the leading edge of the blade probably needs to be rounded or repaired or your propeller selection needs to be changed.

High-speed gearcase blowout, or simple "blowout," is a phenomenon that can limit your boat's top speed. Cavitation bubbles coming off the gearcase torpedo (the cylindrical bulge in front of the propeller on the lower unit) connect up with engine exhaust gases. Once this connection is made, exhaust gas feeds into the propeller blades causing four reactions:

- ◆ The bow drops
- ◆ The boat veers slightly to the left
- ◆ The engine revs up by 200 RPM to 300 RPM
- ◆ The boat slows down by a couple of miles per hour

If "blowout" is experienced, contact your Scarab dealer for recommended solutions.

TOWING

If you need a tow or wish to tow another boat, use great care. The boat structure can be damaged by excessive pulling strain. You should always offer help to a boat in trouble; however, towing a capsized, grounded or hull damaged boat is dangerous. In these situations, **give assistance to the occupants, then call the proper authorities.**

If seas are rough, it may not be easy to extend tow line from one boat to another. In these cases, use a light throwing line with a weight on one end and with the heavier towing line secured to it.

WARNING

When towing, use only the bow and stern eyes-never use cleats, handrails, etc. If the boat has no bow eye, do not attempt to tow, special towing techniques and equipment are needed. Call a professional towing service.

Never attempt to tow a much larger or grounded vessel. Because of the tremendous stress caused by towing, use a tow line that is rated at least four times the gross weight of the boat being towed. Tow ropes must always be in good condition and free of any cuts or abrasions.

When towing, attach the tow line to the bow eye on the disabled boat, then attach the opposite end of the bridle only to the stern eyes of the tow boat. Wrap the bridle with chafing gear where it rubs against the boat or any corners. Leave at least two boat lengths between the boats for adequate movement.

WARNING

Do not allow anyone to be in line with the tow rope. If the rope should break or pull free, a dangerous recoil could occur which may seriously injure or kill anyone in its path.

Adjust the tow line to match wave action. Keep the boats on the crest or in the trough of the waves at the same time. In protected, calm waters, shorten the line for better handling. Always tow at moderate speed, allowing for adverse wind and wave conditions. Have the operator of the towed boat steer with you if possible.

ANCHORING

Dropping Anchor

There are many types of anchors available on the market. A proper anchor rig will have a short length (8-10 feet) of anchor chain attached directly to the anchor. This piece of chain between the anchor and the nylon anchor line (rode) absorbs most of the force as the boat rides at anchor and protects the anchor rode from chafing. The choice of one anchor over another depends on many factors. For more information on anchors, consult your dealer.



SCARAB®

CAUTION

Always anchor from the bow; *never anchor from the stern*. A small amount of current will make the boat unsteady.

When anchoring, it is helpful to keep a few guidelines in mind:

- ◆ Head the boat into the wind or current over the spot where you want to lower the anchor.
- ◆ Stop the boat before lowering the anchor.
- ◆ When the anchor hits bottom, slowly back up the boat, paying out anchor rode that is 6 to 7 times the depth of the water. For example, if you are in 10 feet of water, let out 60 to 70 feet of rode.

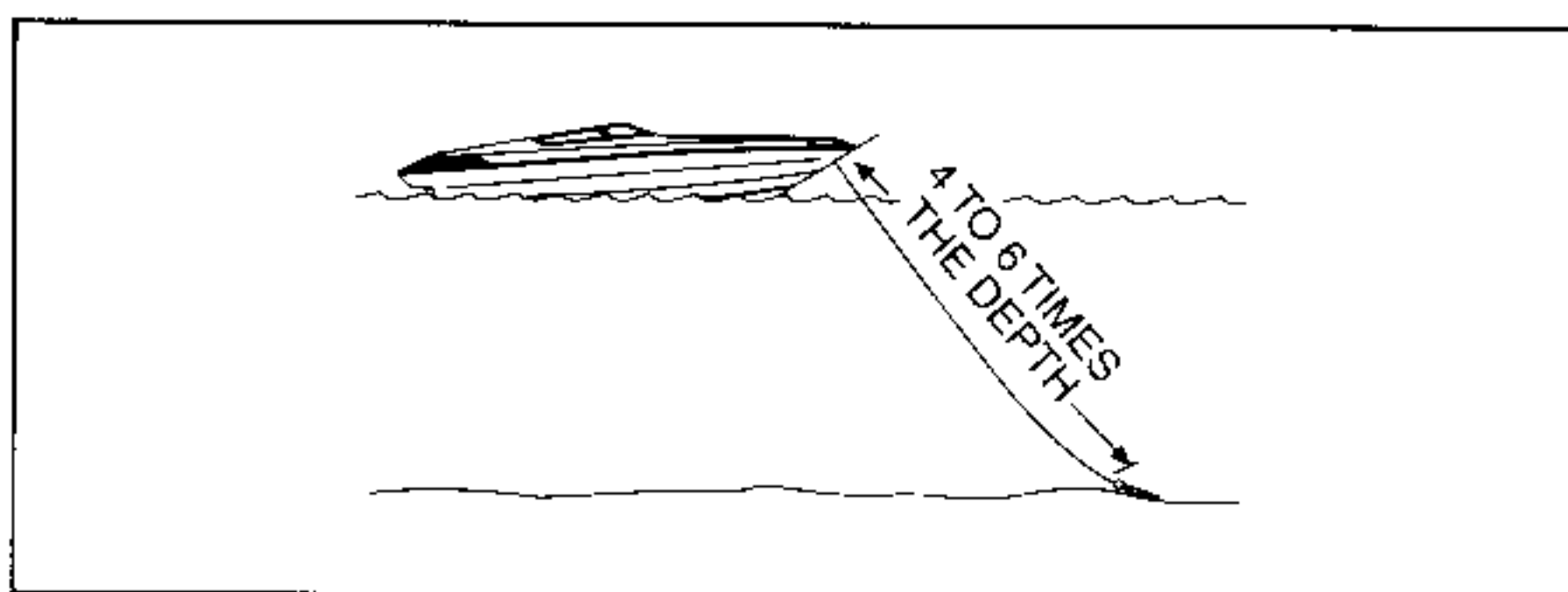

- ◆ Secure the anchor rode to the bow cleat. Pull on the rope to make sure anchor is holding.

Occasionally check your position against the shoreline. If the anchor is dragging and you are drifting, reset the anchor.

Weighing (Pulling In) Anchor

Pull in the anchor rode or slowly power forward while another person pulls in the anchor rode until the rode is vertical, then pull up the anchor.

If the anchor is stuck, tie the anchor rode to the bow cleat. The boat's momentum as it rides up and down on waves may free the anchor.

If the anchor remains stuck, pay out a few feet of anchor rode, attach the rode to the bow cleat and maneuver around the anchor slowly with the anchor rode taut until you find the angle that will pull the anchor loose.

Care and Maintenance

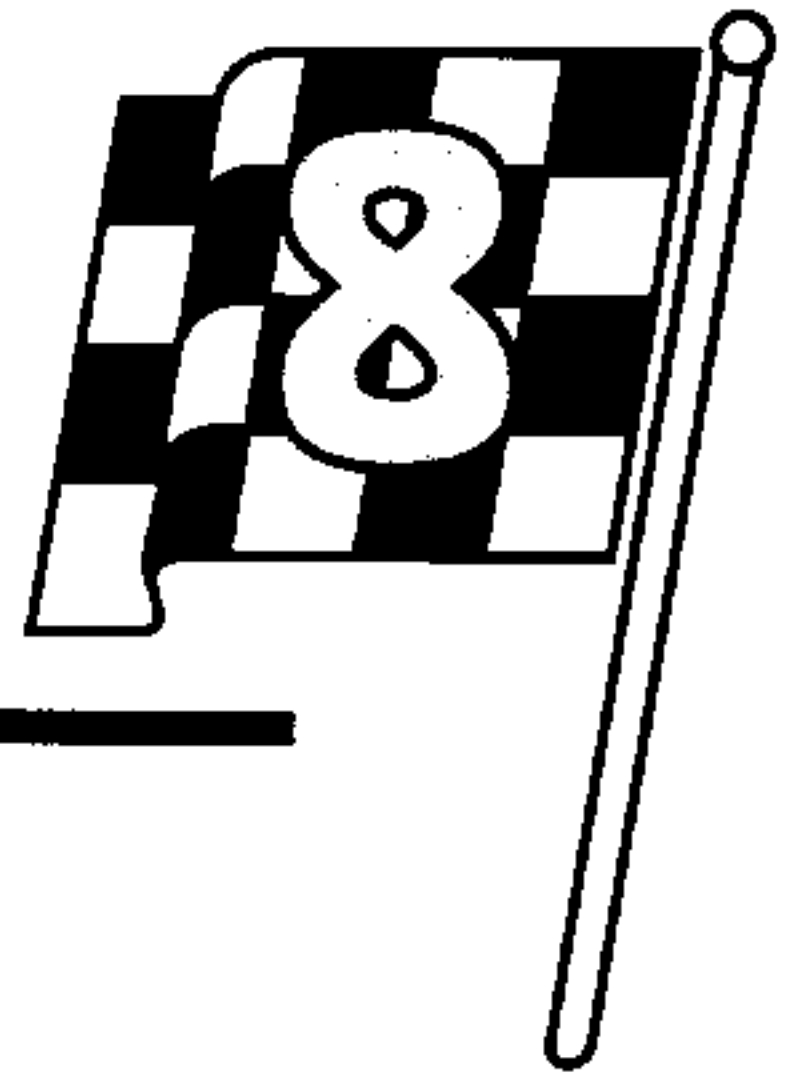

This section describes how to properly maintain your boat. It includes a maintenance checklist you should follow as well as general information. By performing these inspections, not only will your Scarab remain beautiful for years to come, but you will be safer on the water.

Notice

Do not attempt any repairs on your boat unless qualified to do so. Your dealer is qualified to make repairs or modifications which will not compromise safety, design integrity, or warranty coverage. Only use approved marine replacement parts available from your dealer.

In addition, top performance can only be achieved if your Scarab is properly maintained. For example, marine growth on the hull of your boat can have a drastic impact on speed.

MAINTENANCE SCHEDULE

Performing the following maintenance is necessary to ensure your safety on the water. In addition to the following inspections, follow the manufacturer's maintenance instructions in the major component owner's manuals supplied with your boat.

Each Time Your Boat Is Hauled Out:

- ◆ Inspect all through-hull fittings for corrosion. Replace any corroded fittings and look for causes of electrolytic action if there was corrosion.
- ◆ Inspect your stern drives for damage. If a propeller is damaged, have it repaired or replaced.
- ◆ Inspect the hull for gelcoat damage. Have your dealer repair gelcoat damage as soon as possible.
- ◆ Hose down your boat with fresh water.
- ◆ Check fluid levels in batteries and clean terminals with a wire brush if corroded.



SCARAB[®]

- ◆ Inspect zinc anodes for deterioration and replace if 50% or more of the anode is deteriorated.
- ◆ Inspect the steering for looseness or binding and perform service in accordance with steering system manufacturer's recommendations if required.

Every 100 hours Of Operation Or Semiannually:

- ◆ Inspect the engine and stern drive mounting hardware for tightness.
- ◆ Clean the engine flame arrester and ventilation hoses.
- ◆ Clean and polish the hull bottom using a marine recommended cleaner and wax.
- ◆ Clean the baskets of all seawater strainers (if installed).
- ◆ Weigh the automatic fire system cylinder and compare its actual weight with the weight stamped on it in accordance with manufacturer's recommendations. **This is the only way to verify the charge of an automatic fire extinguisher.**
- ◆ Inspect the bilge pumps and float switches. Float switches gradually lose sensitivity due to an accumulation of bilge oil on the operating surfaces. Remove and clean or replace the float switches periodically.
- ◆ Clean and inspect the entire bilge. Dirt in the bilge will accumulate, soak up oil and eventually become a fire hazard, so keep your bilge clean. See your dealer for environmentally safe bilge cleaners.
- ◆ Visually inspect all electrical connections for chafing and corrosion and tighten connections if they are loose.
- ◆ Carefully inspect all lifesaving equipment for cut or torn fabric and other signs of deterioration and replace if necessary.
- ◆ Carefully check hull for cracks and contact your dealer if you suspect damage has occurred.

- ◆ Check the entire fuel system for any evidence of line deterioration or fuel leaks. If any suspicious lines or connections are discovered, have them repaired or replaced before going out on the water.
- ◆ Visually inspect your bonding system for corrosion.

Annually:

- ◆ Have a qualified technician thoroughly inspect your entire electrical system, including performing a leakage test of each circuit.
- ◆ Have a qualified technician thoroughly inspect your boat's bonding system.
- ◆ Carefully inspect fuel tanks. Fuel tanks can develop leaks as a result of damage due to rubbing and abrasion or salt corrosion.



SCARAB®

WIRING

The American Boating and Yacht Council (ABYC) has developed a standard color coding system for boat wiring. Most boat manufacturers, including Wellcraft, voluntarily comply with this standard so that boat owners can easily troubleshoot their DC electrical system and install new equipment. The following is the standard color coding system used on your Scarab:

WIRE COLOR	USE	PATH
Green	Bonding	To Main Bonding Strap
Black	Grounds, Negative Main	
Red	Positive Mains	+ Side Of Battery To Fuses, Breakers, Distribution Panels, Start Ignition Switches
Yellow w/Red Stripe	Starting Circuit	Starting Switch To Solenoid
Yellow	Bilge Blower, Alternator Field	Fuse Or Switch To Blower, Alternator Field To Regulator Field Terminal
Dark Gray	Navigation Lights, Tachometer	Fuse Or Switch To Lights, Tachometer Sender To Gauge
Brown	Bilge Pumps	Fuse Or Switch To Pumps
Orange	Accessory Feed	To Accessory Fuses Or Switches
Purple	Ignition, Instrument Feed	Ignition Switch To Coil And Electrical Instruments, Distribution Panel To Electric Instruments
Dark Blue	Cabin And Instrument Lights	Fuse Or Switch To Lights
Light Blue	Oil Pressure	Oil Pressure Sender To Gauge
Tan	Water Temperature	Water Temperature Sender To Gauge
Pink	Fuel Gauge	Fuel Gauge Sender To Gauge
Gray-Blue*	Anchor Light	Fuse Or Switch To Light
Purple-White*	Power Trim	
Tan-Black*	Oil Temperature	
Brown-Red*	Bilge SW (Float)	
Yellow-Black*	Horn	
Tan-Blue*	Warning System	

* At Wellcraft's discretion, these color/stripe wires are used for functions not designated in ABYC's system

GENERAL MAINTENANCE

Saltwater Corrosion

The entire boat should be rinsed with freshwater immediately after use in saltwater. If the boat is used primarily in saltwater, wax the hull monthly and apply corrosion inhibitor to all hardware. See your dealer for products suitable for the marine saltwater environment. Freshwater internal flushing is recommended when used in salt, polluted or brackish waters.

Cleaning

Routine, periodic cleaning is the only practical way to keep the surface of your boat looking shiny and new. Keeping your boat in "showroom" condition means greater personal satisfaction and higher resale value. Special cleaning products are available from your dealer to remove mildew. Boats left outdoors will gradually deteriorate from exposure to sunlight, water, dust and chemicals in the air. Outdoor exposure may cause your boat's surface to show a variety of changes, including:

- ◆ Chalking (fine, powdery whiteness on the surface)
- ◆ Fading (gradual loss of color)
- ◆ Yellowing
- ◆ Loss of gloss

Darker colors tend to exhibit these changes more rapidly than light colors because they absorb more of the sun's rays (ultraviolet and infrared).

Boat surfaces, even molded-in texture surface treatments found in normal walkways and steps, can be very slippery when covered with soap suds. Use caution to protect yourself and others from slips and falls when cleaning. Deck shoes/boat shoes are recommended whenever in the boat.

CAUTION

Do not apply wax to textured or normally used portions of the floor, deck or gunwales.

When washing the boat, be sure to use a mild detergent and warm water solution. **DO NOT** use abrasive cleaners, solvents, ammonia or chlorine, as these will damage the gelcoat surface. Under extreme conditions, special cleaners may be used to remove marine growth such as scum or algae from the hull; see your dealer.



SCARAB®

Waxing the entire gelcoat surface at least twice a season is recommended for all climates. Use of a specially formulated marine gelcoat wax will help prevent soil and scum adhesion. If the gelcoat has chalked or faded from lack of proper maintenance, buffing may be necessary to bring back the shiny appearance. Hand buffing with #7 rubbing compound or power buffing with glazing compound #1 will quickly restore the surface. To prevent the gelcoat colors from fading, keep your boat covered whenever it is not in use.

Bottom Maintenance

We recommend your Scarab high performance boat be removed from saltwater and rinsed after each use to prevent unwanted marine growth on the hull and to maintain ultimate high performance. The bottom of your high performance boat must be kept clean! Any buildup of marine life from water will create drag and affect the boat's performance and efficiency. Never use wire brushes or scouring pads on the bottom of your boat, as this can cause small scratches that actually trap dirt.

Gelcoat blistering (osmotic blistering) is a naturally occurring condition not covered by Wellcraft's warranty. Blisters can occur on any gelcoated surface immersed in water over a period of time.

The best way to prevent blistering is to minimize the amount of time the boat remains in the water. If the boat must remain in the water, the application of a "blister guard" system to the hull below the waterline will lessen the possibility of blistering. The application of blister guard will decrease the maximum speed of your boat. Proper application is essential; contact your Wellcraft dealer or marine service center for additional information.

Upholstery

Regular washing with mild detergent and warm water or automotive vinyl cleaners is sufficient to keep the vinyl coverings in good condition. Keep the cushions from becoming soaked and dry them off thoroughly after washing to prevent mildew accumulation after the boat is covered. Prop the cushions up in the boat when covered to allow air circulation and spray them with mildew repellent.

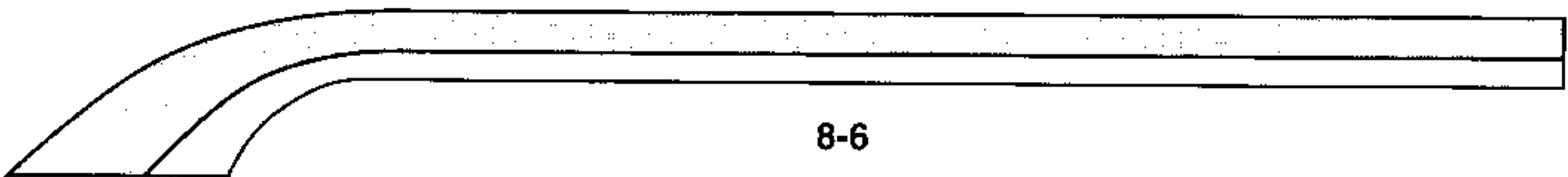

NOTICE

Certain automotive, household and industrial cleaners can cause further damage and discoloration. Solvents and dry cleaning fluids or products that contain dyes such as waxes should be used with caution. Whenever cleaning stubborn stains, be sure to test the treatment in an unseen area first. The following stain treatments should be used with discretion. Between steps, be sure to rinse thoroughly with plenty of clean water and allow to dry.

Do not use solvents and bleaches on vinyl. They can cause permanent damage. Use cleaners made specially for vinyls.

The ultraviolet rays of the sun and ozone in the atmosphere (particularly in wind blown spray) can cause cracking and "aging" of upholstery. While vinyl seats have been chemically treated to retard these problems, the best countermeasures are keeping the boat covered and shaded when not in use.

Carpeting

Spills and stains should be treated immediately. The longer a spot remains, the more difficult it will be to remove. Blot up spills with clean, white, absorbent materials. Remove solid built-up materials with a rounded tablespoon, spatula or edge of a dull knife.

Pretest spot removal agents in an inconspicuous area. Apply several drops of solution on the carpet and rub gently with a clean, white towel. If color transfers to the cloth or a color change occurs, a professional cleaner should be consulted. **Do Not Overwet!** Use small amounts of the cleaning agents and blot frequently. Always blot, do not rub or brush. Work from the outer edge of the spot towards the center to prevent rings. Treat the stained area with each spotting solution until the stain is removed. It may not be necessary to complete the entire series of steps. The final step is always to gently rinse the area with water, then absorb all the remaining moisture with absorbent towels.

Be patient. Some stains respond slowly. All spots and stains cannot be removed from every fabric due to differences in fibers, dyes, constructions, finishes, composition of the stain, length of time the stain has remained on the article, etc. Some stains require professional treatment.

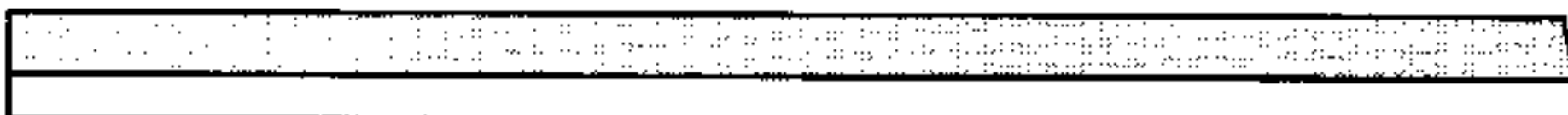

SCARAB®

Cleaning Solutions (See Table)

Notice

Use cleaning solutions sparingly. Never discharge cleaning solutions into the waterways. Do not use products containing phosphates, chlorine, solvents, or non-biodegradable or petroleum based products.

Ammonia Solution - Mix one tablespoon of clear household ammonia with one-half cup of water.

Detergent Solution - Mix one tablespoon of colorless, mild detergent or dishwashing liquid in a cup of lukewarm water.

Dry Cleaning Solvent - Volatile dry spotter or commercial spotter such as Carbona, Energine or K2R. Use in small amounts; it can be harmful to sizings, backings or stuffing materials. Do not use gasoline, lighter fluid or carbon tetrachloride.

Enzyme Detergent - Mix a solution of enzyme detergent following the directions on the label. Do not soak or overwet. Allow the solution to remain on the stain for the recommended length of time before removing.

POG - Paint, oil or grease remover available in hardware stores.

Vinegar Solution - Mix one-third cup of white household vinegar with two-thirds cups of water.

Stains	Description	Cleaning Instructions
Blood	Red when fresh, dries to dark brown with irregular edge.	<ol style="list-style-type: none"> 1. Apply cool detergent solution, blot. 2. Apply cool ammonia solution, blot. 3. Apply enzyme detergent, blot. 4. Rinse thoroughly with water, blot until dry. 5. If stain remains, apply rust remover or oxalic acid solution. 6. Bleaching with 3-5% hydrogen peroxide may be necessary.
Butter & Margarine	Greasy, yellowish-red. <ul style="list-style-type: none"> • Contains vegetable dye, corn oil, milk, salt, preservatives, vegetable fats. 	<ol style="list-style-type: none"> 1. Apply dry cleaning solvent, blot. 2. Apply detergent solution, blot until dry. 3. Apply vinegar solution, blot. 4. Rinse with water, blot until dry.
Catsup & Tomato Sauce	Reddish-brown, absorbed and built up. <ul style="list-style-type: none"> • Contains tomatoes, salt, sugar, spices, tannin, vinegar. 	<ol style="list-style-type: none"> 1. Apply cool detergent solution, blot. 2. Apply ammonia solution, blot. 3. Apply enzyme detergent, blot. 4. If stain remains, bleach with 3-5% hydrogen peroxide or sodium perborate. 5. Rinse thoroughly with water, blot until dry.

Stains	Description	Cleaning Instructions
Jam & Jelly	<p>Reddish or bluish, absorbed and built up.</p> <ul style="list-style-type: none"> • Contains pulp of fruit, sugar tannin preservatives. 	<ol style="list-style-type: none"> 1. Apply detergent solution, blot. 2. Apply vinegar solution, blot. 3. Rinse with water, blot. 4. Apply enzyme detergent, blot. 5. Rinse with water, blot until dry.
Lipstick	<p>Various colors, soft and greasy.</p> <ul style="list-style-type: none"> • Contains pigment or dye in fat, waxes and oils. 	<ol style="list-style-type: none"> 1. Scrape off excess with spatula or dull knife. 2. Apply POG, blot, making sure not to reapply stain onto fabric. 3. Apply dry cleaning solvent, blot. 4. Apply detergent, blot. 5. Apply ammonia solution, blot. 6. Apply vinegar solution, blot. 7. Rinse with water, blot until dry. *Try to avoid wet cleaning on wool. Use POG and dry cleaning solvents as long as possible.
Mildew	<p>Grayish or brownish fungus with black spots. May permanently damage fibers.</p>	<ol style="list-style-type: none"> 1. Apply enzyme detergent, blot. 2. Apply ammonia solution, blot. 3. Rinse thoroughly with water, blot. 4. Apply solution of oxidizing bleach (chlorine or perborate) *DO NOT use chlorine bleach on wool or silk. 5. Rinse thoroughly with water, blot until dry.
Mud	<p>Grayish, brownish, reddish absorbed and built up.</p> <ul style="list-style-type: none"> • Contains soil with greases and oils, clay, iron. 	<ol style="list-style-type: none"> 1. Brush or scrape off as much as possible. 2. Apply detergent solution, blot. 3. Apply ammonia solution, blot. 4. Rinse thoroughly with water, blot until dry. 5. If stain remains, apply POG and dry cleaning solvent alternately, blot until dry.
Mustard	<p>Yellowish, absorbed or built up.</p> <ul style="list-style-type: none"> • Contains mustard seed, vinegar, salt, tumeric, oils, spices. 	<ol style="list-style-type: none"> 1. Apply detergent solution, blot. 2. Apply vinegar solution, blot. 3. Apply enzyme detergent, blot. 4. If stain remains, rust remover (oxalic acid solution) or bleaching may be necessary. *DO NOT use ammonia or alkalies.
Nail Polish	<p>Various colors, stiff, shiny and built up.</p> <ul style="list-style-type: none"> • Contains dye or pigment in a liquid cellulose acetate base, solvent, plasticizer. 	<ol style="list-style-type: none"> 1. Apply dry cleaning solvent. 2. Apply POG, blot. 3. Apply amyl acetate if available or nail polish remover - PRETEST FIRST. 4. If stain remains, apply detergent solution, blot until dry. 5. Apply ammonia solution, blot. 6. Apply vinegar solution, blot. 7. Rinse with water, blot until dry.



SCARAB®

Stains	Description	Cleaning Instructions
Urine	Yellowish or brownish, darkened with age, absorbed. <ul style="list-style-type: none"> • Contains urea, uric acid, ammonia, organic acids, cholesterol, albumins, proteoses. 	<ol style="list-style-type: none"> 1. Blot up as much as possible if still wet. 2. Apply detergent solution, blot. 3. Apply ammonia solution, blot. 4. Apply vinegar solution, blot. 5. Rinse thoroughly with water, blot until dry. 6. If stain remains, apply rust remover or oxalic acid solution. 7. Bleaching with 3-5% hydrogen peroxide or sodium perborate might be necessary. *Urine may cause permanent dye removal from fibers.
Vomit	Various colors, absorbed and built up. <ul style="list-style-type: none"> • Contains food, mucus, albumins, acids. 	<ol style="list-style-type: none"> 1. Blot up as much as possible. 2. Apply enzyme detergent, blot. 3. Apply ammonia solution, blot. 4. Apply vinegar solution, blot. 5. Rinse thoroughly with water, blot until dry.
Wine	Reddish or purplish, absorbed. <ul style="list-style-type: none"> • Contains alcohol, sugar, tannin, coloring matter. 	<ol style="list-style-type: none"> 1. Apply detergent solution, blot. 2. Apply vinegar solution, blot. 3. Apply ammonia solution, blot. 4. If necessary, bleach with 3-5% hydrogen peroxide or sodium perborate. 5. Rinse thoroughly with water, blot until dry.

Bilge

Inspection - The deep parts of the hull beneath the cabin, sole cockpit floor and engine(s) are the bilges. A mechanical or hand bilge pump may be used to pump water from the deepest bilge. The bilge should be checked before getting underway to make sure it is free of excessive water. Should your bilge become filled with oil or fuel, check for engine leaks and correct immediately. **If your boat is in the water, do not pump oil or fuel overboard.**

Electrically operated bilge pumps are subject to malfunction and are no substitute for frequent inspection of the bilge, especially during periods of long rain, high seas or storm conditions. Also, it is very important to keep your bilges clean as a safety precaution. Fuel, oil and water leaks are far more noticeable in a clean bilge.

To clean the bilges, first pump bilges dry and remove all loose dirt and debris. Be sure the bilge pump strainers are clean. Oil stains are best removed by use of a bilge cleaner available from your dealer or a marina.

WARNING

Do not use flammable solvents to clean your bilge.

NOTICE

“The Federal Water Pollution Control Act prohibits the discharge of oil or oily waste into or upon the navigational waters of the United States or the waters of the contiguous zone if such discharge causes a film or sheen upon or discoloration of the surface of the water or causes a sludge or emulsion beneath the surface of the water. Violators are subject to a penalty of \$5,000.00.”

Bilge Pump(s)

Periodically check the bilge pump(s) inlet screens for debris. Foreign materials can clog the screen or become lodged in the bilge pump impeller, which can cause the pump to malfunction. Inspect all clamps and hoses for tightness on a regular basis.

Plexiglas

Plexiglas is susceptible to scratching. When cleaning, always apply clean, lukewarm water and wipe with a soft, lint-free cloth. **DO NOT** use the following:

- ◆ Abrasive cleaners
- ◆ Solvents
- ◆ Glass cleaning solutions containing ammonia
- ◆ Acetone, benzene, gasoline
- ◆ Dry cleaning fluids
- ◆ Alcohol or carbon tetrachloride

Sunbrella®

All Scarab canvas is made using Sunbrella® Brand marine fabric. Sunbrella® fabric should be cleaned regularly before dirt is allowed to become embedded in the fabric. The fabric can be cleaned with a mild solution of natural soap in lukewarm water. **Do not use detergents.**

For more stubborn stains, soak the fabric for approximately twenty minutes in a solution of no more than 1/2 cup (4 oz.) of a non-chlorinated bleach and 1/2 cup of natural soap per gallon of lukewarm water. Then rinse thoroughly in cold water.

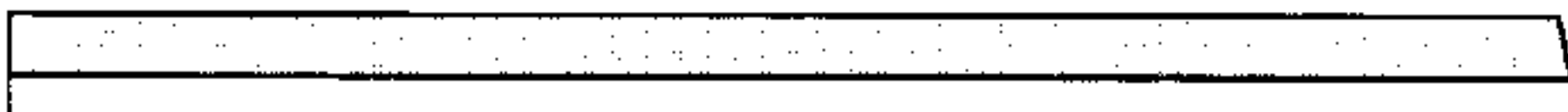

SCARAB®

NOTICE

Excessive soaking in bleach can deteriorate sewing threads. This method of cleaning may remove part of the water repellency and the fabric should receive an application of an air-curing fluorocarbon water repellent treatment if water repellency is a factor.

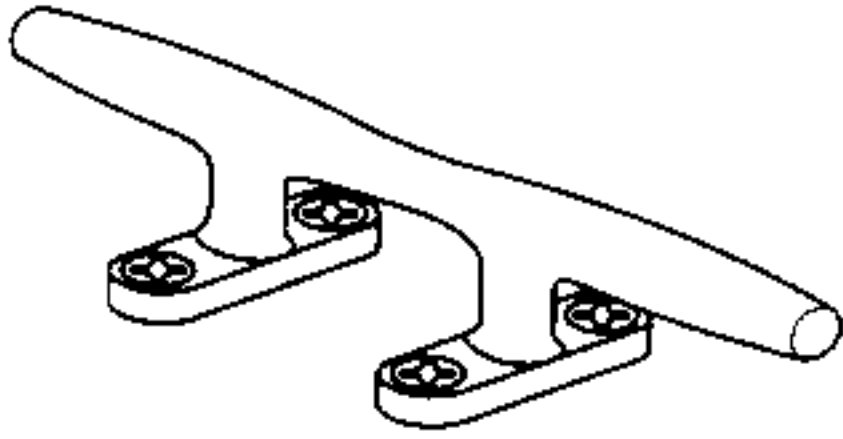

Sunbrella® is made from 100% solution-dyed acrylic fiber which is thermoplastic. Do not subject Sunbrella® fabric to excessive heat.

Stainless Steel

Stainless steel is not totally resistant to corrosion. To keep stainless steel hardware in top shape:

- ◆ Clean all stainless steel hardware frequently with soap and water. Never use coarse abrasives like steel wool or acids or bleach on stainless steel.
- ◆ Remove rust spots as soon as possible with a chrome or brass polish. Pitting will develop under rust that remains on stainless steel surfaces.
- ◆ Use a good, quality car wax to protect stainless steel hardware.

Periodic inspection of your boat for tightness and fit of screws, bolts, clamps and fittings is recommended. Keep sufficient tools available to adjust your boat's hardware whenever it becomes necessary.

Marine Head (Toilet)

If your boat has been equipped with a marine head, it is important that you follow the head manufacturer's directions for proper maintenance. If properly maintained, your marine head should offer you years of trouble-free service. Different models of marine heads are available. Refer to the head manufacturer's instruction pamphlet located in your owner's information packet for the proper care and operation of your specific model. Emphasize to guests that your marine toilet will not handle rags, sanitary napkins or hard, solid objects.

CAUTION

Do not use household toilet bowl cleaners or deodorants that are not specifically made for marine heads.

Less odor will be generated if freshwater from the drinking supply is left in the toilet bowl instead of seawater. Merely pour a pint or so into bowl to form a water seal.

Repair kits and instructions for their use should be carried on board to avoid delays in head repairs.

Holding Tank

If your boat has an optional waste holding tank installed, various chemicals are available to control odors and help break down solids. Consult your marine dealer as to what to use. After you empty your holding tank, fill tank with fresh water and pump it out again to rinse. Another method is to empty your tank and add fresh water and mild toilet bowl cleaner or cold water detergent. Let stand in tank for 15-20 minutes, then pump out. Rinse tank thoroughly with fresh water.

NOTICE

Overboard discharge of waste should only be used in approved areas. Retaining sewage on board is permitted countrywide by EPA/USCG regulations. Dumping sewage overboard is subject to local state control as well as the type of water areas in which the boat will be used. Determine from local authorities what system is allowed in your boating location.

There are many marinas that are certified to pump out your holding tank.

Detectors

The optional gas fume detector requires little maintenance. Consult the manufacturer's instructions for periodic testing procedures.

Trim Tabs

Inspect the trim tab pump periodically for fluid level. Fill with recommended fluid until full (if needed). Also inspect trim tabs for loose fasteners, leaking cylinders and harness connections.

Batteries

WARNING

Observe the following precautions when working on or around batteries.

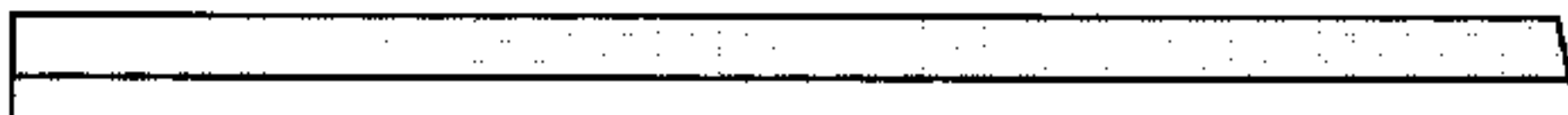

SCARAB®

- ◆ Batteries can explode and spray sulfuric acid in all directions under certain circumstances causing blindness and other severe injuries. Use care never to generate sparks near batteries and always wear safety glasses and protective clothing when working on or near batteries.
- ◆ Be careful never to touch both battery terminals with a tool at the same time.
- ◆ Always turn off battery charger and battery switch before working on batteries.
- ◆ Never attempt starting your engine with jumper cables under any circumstances. The risk of spark at the battery post igniting gasoline fumes from the bilge or hydrogen fumes from the battery are too great.

Keep batteries topped off with distilled water. Maintain a water level of 1/4 to 1/2 inch above the plates inside the battery. Be careful not to overfill past this level, since fluid may leak out of the battery during charging.

Check the battery terminals frequently for signs of corrosion. If corrosion is evident, remove the vent caps and seal the vent wells with corks to prevent any cleaning solution from getting inside the battery, then clean the terminal posts with a baking soda and water cleaning solution and a wire brush.

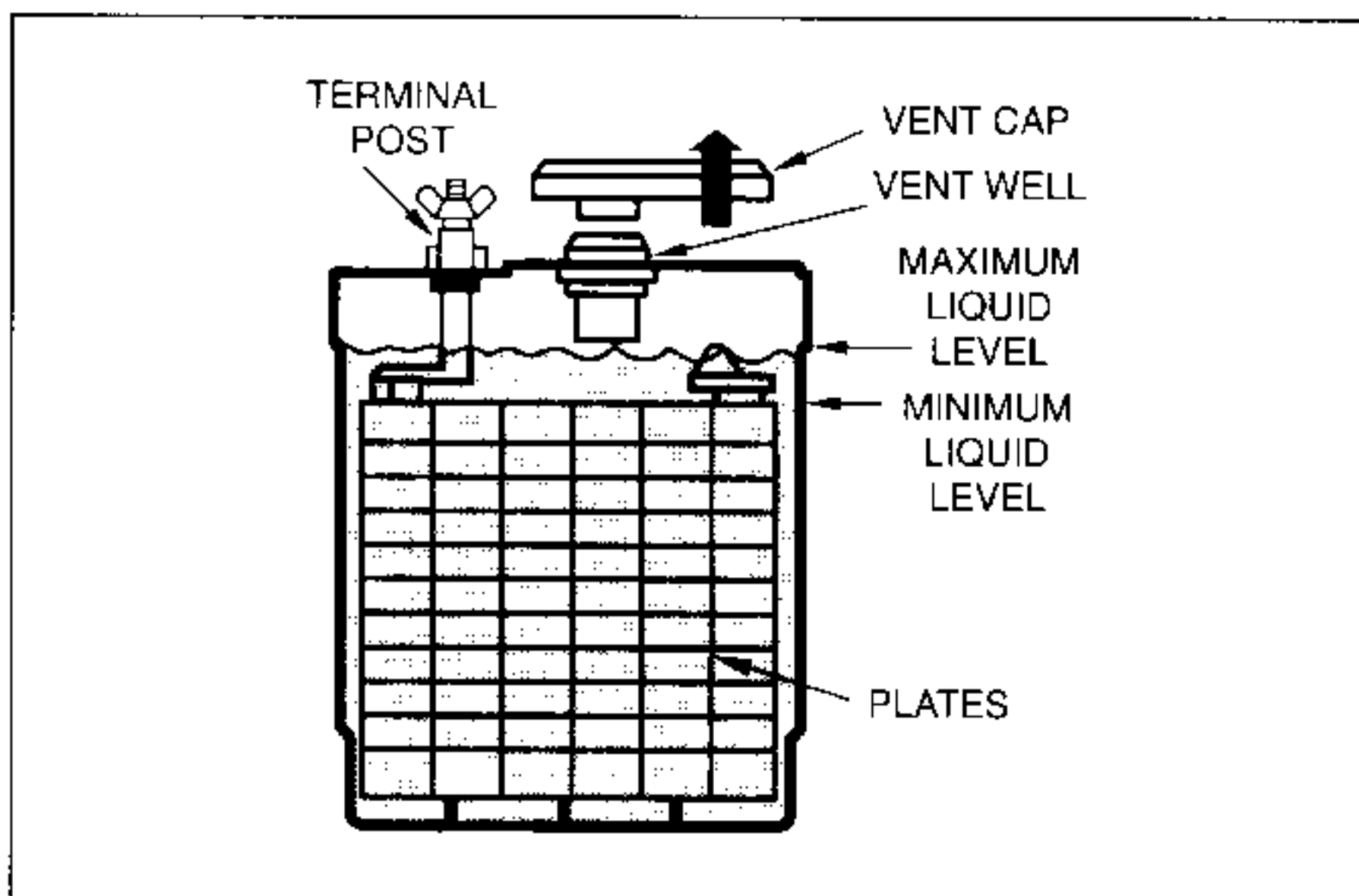

Galvanic Corrosion

Galvanic corrosion (electrolysis), to the boater, is the break-up of metals due to the effects of electrolytic action. When two dissimilar metals are immersed in a conductive fluid (salt water), an electric current is produced, much like a battery. As the current flows, it takes with it tiny bits of the softer metal. If not stopped, a great deal of damage could occur.

If you operate in salt, polluted, or brackish waters, your boat should be equipped with a transom mounted zinc anode to prevent damage to those metal parts coming in contact with the water. The zinc is, by design, self-sacrificing. It is slowly eroded away by electrolytic action and requires periodic inspection for deterioration. If the zinc shows extreme erosion, it must be replaced to continue protection, or damage to other metal parts may result.

Most engines are equipped with one or more zinc anodes which must also be inspected regularly for deterioration. Some boat models may be equipped with an electronic cathode system. This system emits a low current electrical charge into the water close to the metal components. This charge cancels the effect of electrolysis.

CAUTION

Never paint or coat zinc anodes or cathodes with any substance. Once covered, they do not provide protection from galvanic corrosion. Replace anodes if they have deteriorated 50% or more.

Some boats may be equipped with an electronic galvanic corrosion protection system. These systems consist of a controller mounted in the engine compartment and two sensors mounted on the outside of the boat transom, below the waterline.

The controller is powered by the boat battery and automatically adjusts to changes in the surrounding water. Since there is no sacrificial action from the sensors, maintenance to the system is limited to making sure all electrical connections are clean and tight, and the battery is fully charged.



SCARAB[®]

Troubleshooting

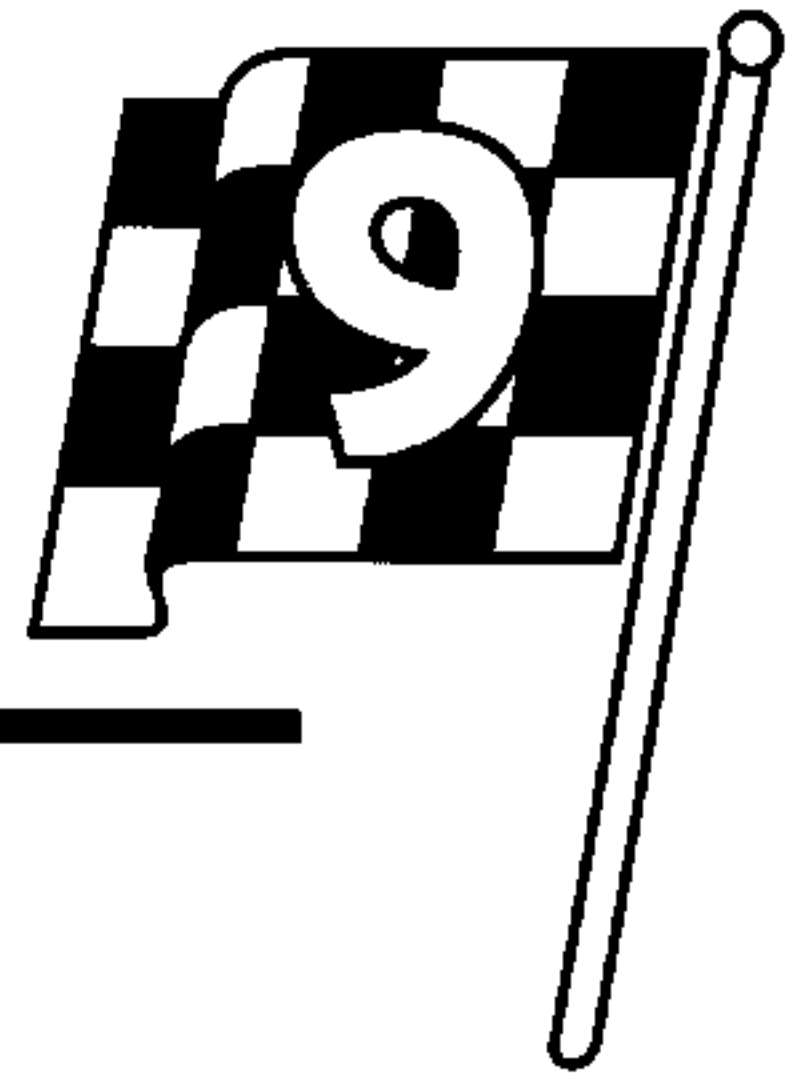

The following troubleshooting charts will assist you in locating and correcting minor mechanical and electrical problems with your boat. Major engine, stern drive and electrical problems are best left to the experts. Contact your Scarab dealer for problems which require the skill of a trained service technician.

For complete engine or major component troubleshooting procedures, refer to the appropriate owner's manual provided in the "Important Papers" zipper bag.

WARNING

Before attempting any checks or repairs around engines or electrical components, shut all systems off and disconnect battery cables to avoid possible personal injury or damage to equipment.

Engine Troubleshooting

A comprehensive engine troubleshooting guide is contained in the engine operation and maintenance manual included in your "Important Papers" zipper bag, and you should look there for solutions to problems such as:

- ◆ Engine fails to crank
- ◆ Engine cranks, but does not start or starts hard
- ◆ Engine runs rough
- ◆ Excessive engine temperature
- ◆ Low engine oil pressure
- ◆ Remote control problems
- ◆ Power trim problems
- ◆ Steering wheel problems



SCARAB[®]

DC Electrical System Troubleshooting

Symptom	Possible Cause	Remedy
12 V equipment not working	Battery selector switch turned to OFF.	Turn selector switch ON for starboard (2) battery.
	Weak or dead battery.	Recharge battery.
Battery not charging (engine running)	Engine alternator belt loose.	Tighten belt.
Battery not holding a charge	Bad battery.	Replace battery.
12 V device not working	Circuit breaker for device is OFF.	Switch breaker to ON.
	Weak or dead battery.	Change battery selector switch position; recharge battery.
	Faulty electrical connection.	Check 12 V connections. Tighten or repair as needed.
	Weak or dead battery.	Change battery selector switch position; recharge battery.
	Light bulb burned out.	Replace bulb.

AC Electrical System Troubleshooting

Symptom	Possible Cause	Remedy
No AC power	Main breaker(s) in engine compartment tripped or off.	Turn breakers on or reset.
	Breaker(s) at AC CONTROL panel tripped or off.	Turn breakers on or reset.
	Shore power cord not connected.	Check cord; plug in if necessary.
	Loose or disconnected wire.	Tighten connections. See your dealer.
No power to AC devices	Breaker(s) at AC CONTROL panel tripped or off.	Turn breakers on or reset.
	Shore power cord not connected.	Check cord; plug in if necessary.

AC Electrical System Troubleshooting cont.

Symptom	Possible Cause	Remedy
No power to AC devices (Continued)	Loose or disconnected wire.	Tighten connections. See your dealer.
Inadequate power to AC devices (generator running)	Electrical demand greater than generator output.	Switch off devices and equipment not needed.
No power at AC outlets	Outlet breakers in AC CONTROL panel OFF. Ground fault interrupter tripped.	Switch breakers to ON. Reset button on outlet and test.

Water Systems Troubleshooting

Symptom	Possible Cause	Remedy
Sink/exterior shower does not operate	Freshwater pump circuit breaker tripped.	Reset breaker.
	Freshwater tank is empty.	Fill tank.
	Freshwater pump is defective.	See your Wellcraft dealer.
	Water system is clogged or ruptured.	Check for obstructions or leaks in the water system and repair as required.
Marine head will not flush	Head circuit breaker is tripped.	Reset breaker.
	Weak battery.	Charge battery.
	Head seacock closed.	Open seacock.

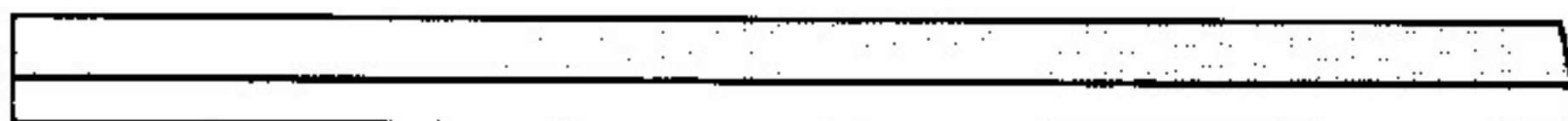

SCARAB®

Fuel System Troubleshooting

Symptom	Possible Cause	Remedy
Fuel overflows at fill plate (tank not full)	Fill or vent line blocked.	Check lines. Clear obstruction from line or straighten line if kinked.
Water or moisture in fuel tank	Cap on deck fuel fill plate not tight. Condensation forming on walls of partially filled tank. Poor quality fuel from marina tanks.	Check cap; tighten. Gasoline engines: Add fuel drying product to fuel supply. See your dealer for recommendations. Diesel engines: Check fuel/water separators; drain if necessary. Check with your dealer. Follow remedies for "Condensation" above. If remedies fail to correct problem, fuel tank and lines may need to be drained and flushed. See your dealer for service.
Engine cranks but will not start (fuel system)	Lack of fuel. Clogged fuel filter. No fuel reaching engine with all fuel valves open. Contaminated fuel.	Clean fuel filter, check fuel level; check whether anti-siphon valve, if so equipped, is stuck shut. Improper starting procedure. Review starting procedures in engine manual. Check and replace fuel filter element. Check fuel pump, fuel pump filter, carburetor fuel filter, and fuel tank line for cracked flanges or restricted fittings. Inspect for water or other contaminants in fuel. If contaminated, drain tank and flush with fresh fuel.

Performance Troubleshooting

Use the following chart in conjunction with the troubleshooting section in the engine operation and maintenance manual included in your "Important Papers Kit."

Symptom	Possible Cause	Remedy
Vibrations/reduced speed	Propeller nicks, rolled tips or bent blades.	Repair or replace propeller.
	Loose engine mounting bolts.	Inspect and tighten bolt if loose.
Reduced speed	Marine growth on hull.	Clean hull bottom frequently.
	Change in elevation, climate.	Change to different pitched propeller or gear ratio with the help of your Scarab dealer.
Engine operating outside of recommended RPM range	Improper propeller size.	Replace propeller with correct size.
Poor handling/reduced speed	Excessive bilge water.	Pump out bilge and check for cause of water entry.
	Uneven weight distribution.	Reduce load or redistribute load more evenly.
Boat slow to plane off	Drive trim too far out.	Bring drive(s) in.
Porpoising	Drive trim too far out.	Bring drive(s) in.
Bow steering/reduced speed	Drive trim too far in.	Bring drive(s) out.

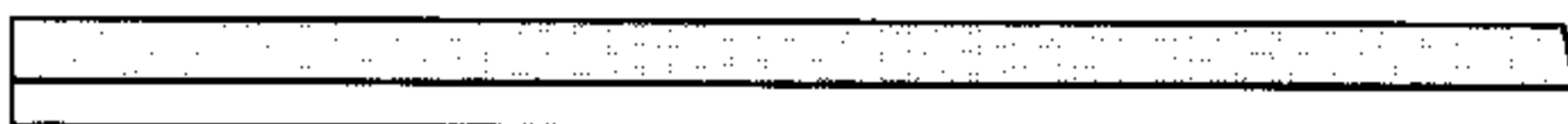

SCARAB®

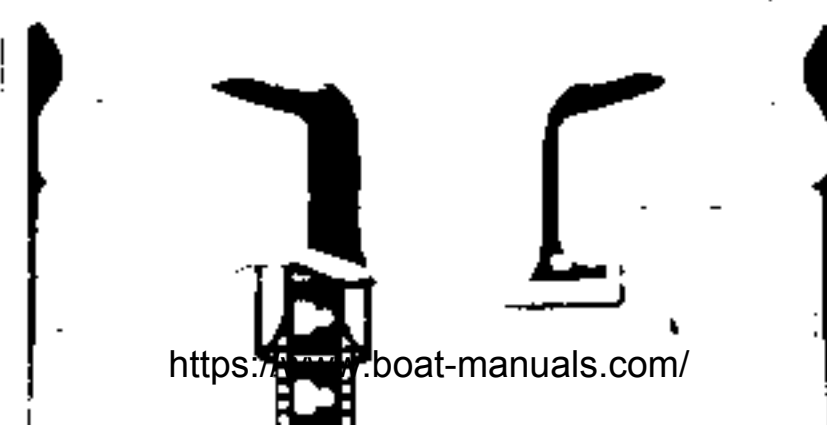

Recommended Equipment and Parts

The following list (not an exhaustive list) indicates some additional recommended equipment which should be considered for safe, enjoyable boating.

Tools

- ◆ Spark plug wrench
- ◆ Hammer
- ◆ Screwdrivers
- ◆ Jackknife
- ◆ Pliers
- ◆ Electrician's tape
- ◆ Adjustable wrench
- ◆ Lubricating oil
- ◆ Prop wrench
- ◆ Duct tape

Spare Parts

- ◆ Extra Bulbs
- ◆ Spare Propeller
- ◆ Extra fuses
- ◆ Extra drain plug
- ◆ Spark plugs
- ◆ Spare wire
- ◆ Extra prop nut/washer

Basic Gear

- ◆ Flashlight
- ◆ Spare batteries
- ◆ Tow line
- ◆ Oar or paddle
- ◆ Mooring lines
- ◆ Compass
- ◆ Dock fenders
- ◆ Distress signals
- ◆ First aid kit
- ◆ Boat hook
- ◆ Foul weather gear
- ◆ VHF radio
- ◆ EPIRB
- ◆ Suntan lotion
- ◆ Extra warm clothing
- ◆ Charts
- ◆ Second anchor & line
- ◆ Ring life buoy with length of line attached
- ◆ Dewatering device (pump or bailer)
- ◆ Emergency supply of drinking water and food

Storage

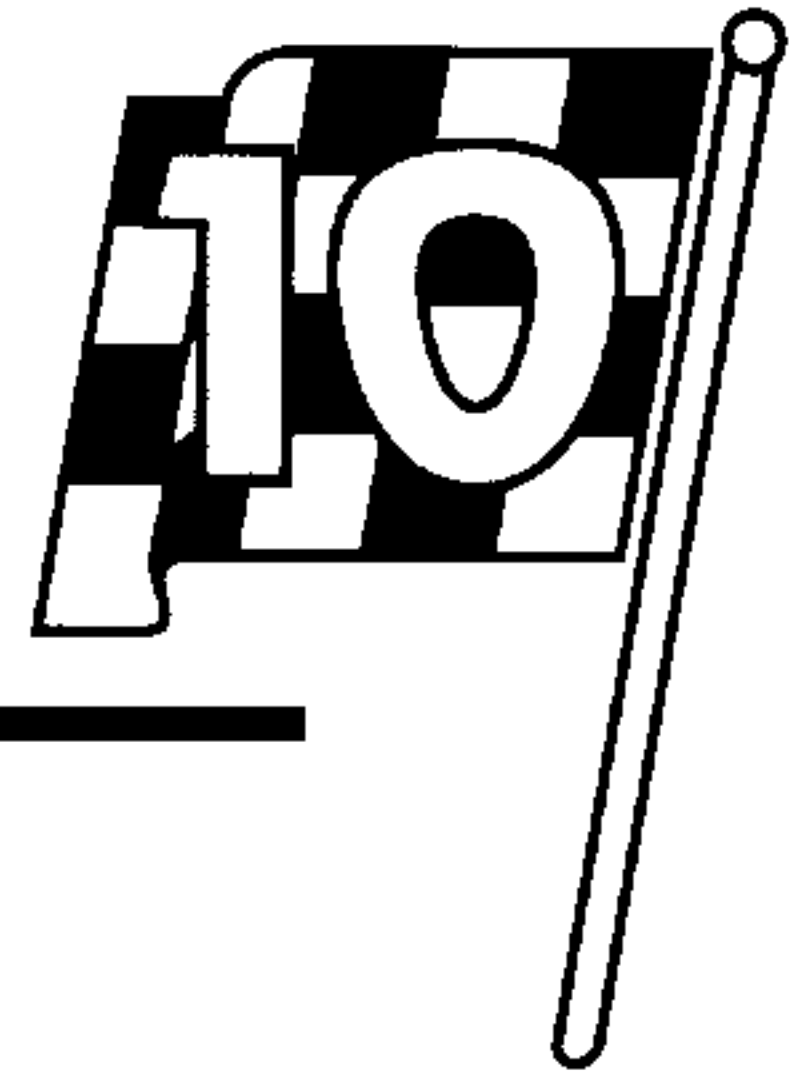

Storage or winter lay-up requires special preparation to prevent damage to the boat. Perform all annual maintenance at this time. Without proper preparation, storage for long periods of time may cause internal parts of the engine and transmission to rust because of lack of lubrication. Or, if the boat is stored in below freezing temperatures, water inside the bilge or cooling system may freeze causing damage. Damage to the boat due to improper storage will not be covered by the warranty. The following procedures should help prevent damage to your boat.

While The Boat Is Still In The Water:

1. Fill fuel tank and add the proper amount of fuel stabilizer and conditioner according to the manufacturer's recommendations.
2. Operate boat for at least 15 minutes to be sure that treated fuel has reached engine.

When The Boat Is Removed From The Water

NOTICE

Remove the bilge drain plug immediately after taking the boat out of the water. After washing, raise the bow of the boat high to allow as much water as possible to drain while performing other storage preparations.

Refer to the engine operation and maintenance manual for detailed instructions on performing steps marked with an * in the following list:

- ◆ Thoroughly clean the hull, deck and interior of the boat as soon as it is removed from the water.
- ◆ Flush the engine cooling system.*
- ◆ Protect or "fog" internal engine components with a manufacturer's approved storage seal spray.*

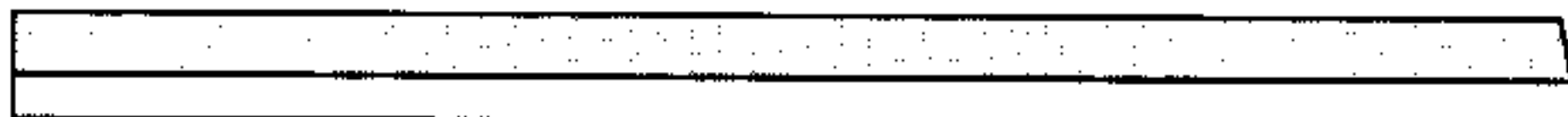

SCARAB®

- ◆ Perform all scheduled maintenance, including lubricating required components and changing filters.*

NOTICE

Follow any additional precautions in the engine operation and maintenance manual.

- ◆ Apply a coat of wax to the entire surface of the boat and rust inhibitor on all metal parts (except zinc anodes).
- ◆ Clean all traces of dirt, oil, grime and grease from the engine and bilge. Touch up areas of engine where paint has been removed.
- ◆ Store the bilge drain plug in a plastic bag and tape it to the throttle control lever so that it is easily found for reactivation.
- ◆ Open all faucets and allow freshwater pump to empty water tank and intake lines. Run the pump dry before turning it off. Then flush system with "Freeze Ban" or other equal non-toxic antifreeze in accordance with manufacturer's recommendations.
- ◆ Remove the batteries from the boat. Clean, fully charge and store the batteries in an area not subject to freezing temperatures. Never store batteries close to heat, spark or flame-producing devices.
- ◆ Open all drains.
- ◆ Empty holding tank for sanitary system, if applicable, and flush with fresh water.
- ◆ Prepare the marine head for storage with a non-toxic antifreeze in accordance with manufacturer's recommendations.
- ◆ Remove strainer drain plugs to prevent freeze damage and leave seacocks open.
- ◆ Be sure the boat bottom is properly supported to prevent damage. Improperly cradled boats are susceptible to hull damage.

Reactivating The Boat After Storage

- ◆ Charge and install batteries in boat.
- ◆ Check engine compartment and bilge for signs of nesting animals and clean as necessary.
- ◆ Check entire engine for cracks and leaks caused by freeze damage.
- ◆ Check hose condition and all hose clamps for tightness.
- ◆ Install bilge drain plug.
- ◆ Open and close all seacocks, if applicable, to check operation.
- ◆ Thoroughly check for loose mechanical or electrical connections and broken or missing parts.
- ◆ Open all faucets and fill freshwater holding tank with water. Turn freshwater pump on to allow water to flow through faucets until all antifreeze is flushed out and the water runs clear, then close faucets. Fill the freshwater tank until full, then check the entire system for water leaks.
- ◆ Check and lubricate steering system. Check hydraulic fluid levels for hydraulic steering.
- ◆ Take the boat to the water and start it. It may take a minute of cranking to allow the fuel system to prime. When the engine starts, keep a close watch over the gauge readings and check for leakage and abnormal noises. Keep speeds low until the engine has reached normal operating temperature.

Refer to engine and boat accessory manuals for further reactivation instructions.

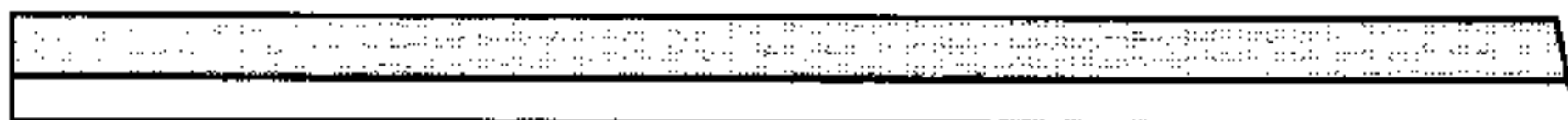

SCARAB[®]

Trailering

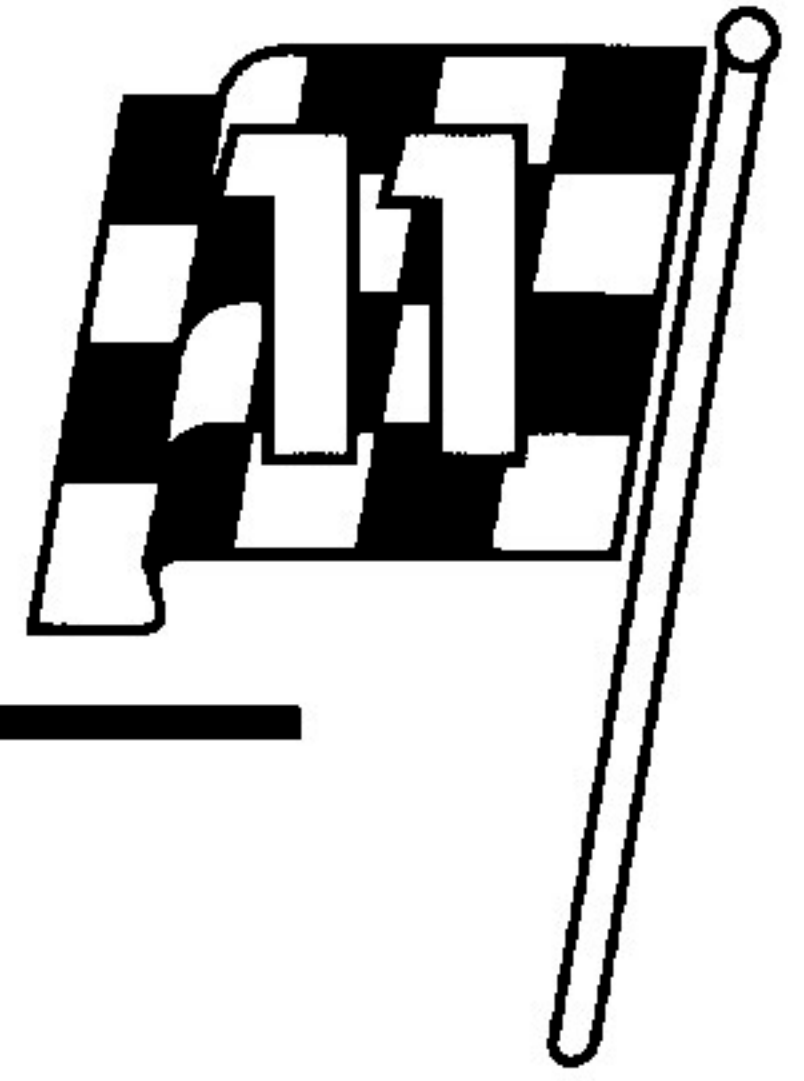

This section provides basic safety information about trailering. Your dealer should be able to provide you with specific information about the best trailer for your particular boat.

Trailer laws regarding lighting, registration, trailer brakes, etc. vary from state to state. Your dealer can usually help you find out which laws apply to you; otherwise, contact your state department of motor vehicles for information.

WARNING

The total weight of your loaded trailer must not exceed the capacity marker on the hitch of your tow vehicle. Overloading can cause hitch failure leading to injury-causing accidents.

CLASSIFICATIONS

Trailers are separated into four classes based on gross vehicle weight (GVW). Gross vehicle weight is equal to the trailer's weight plus the maximum load it may carry at 60 MPH.

- ◆ Class 1.....GVW under 2000 lbs
- ◆ Class 2.....GVW over 2000 lbs and under 3500 lbs
- ◆ Class 3.....GVW over 3500 lbs and under 5000 lbs
- ◆ Class 4.....GVW over 5000 lbs and under 10,000 lbs

WARNING

The total weight of your trailer, boat and gear must not exceed the GVWR of the trailer. Overloading can lead to injury-causing accidents.

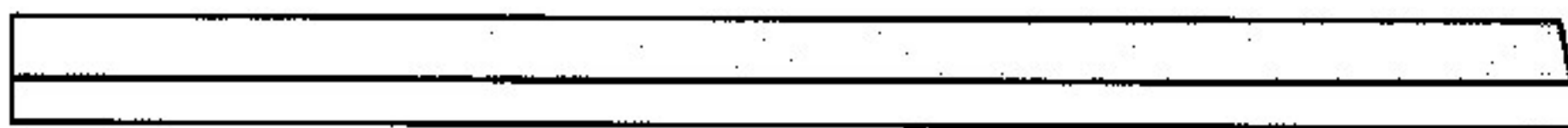

SCARAB[®]

11-1

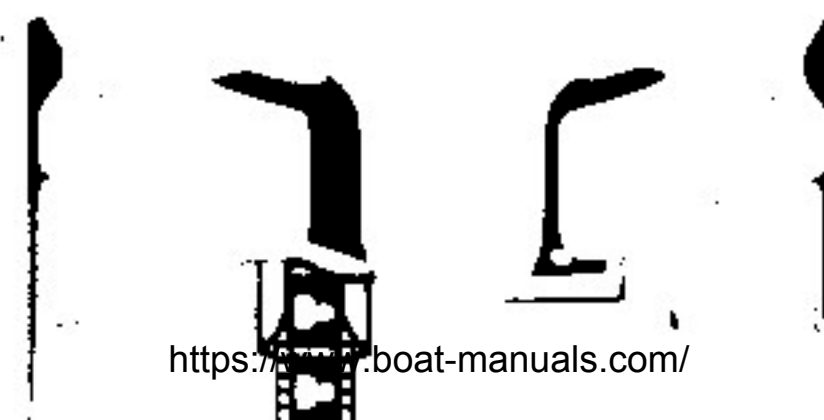

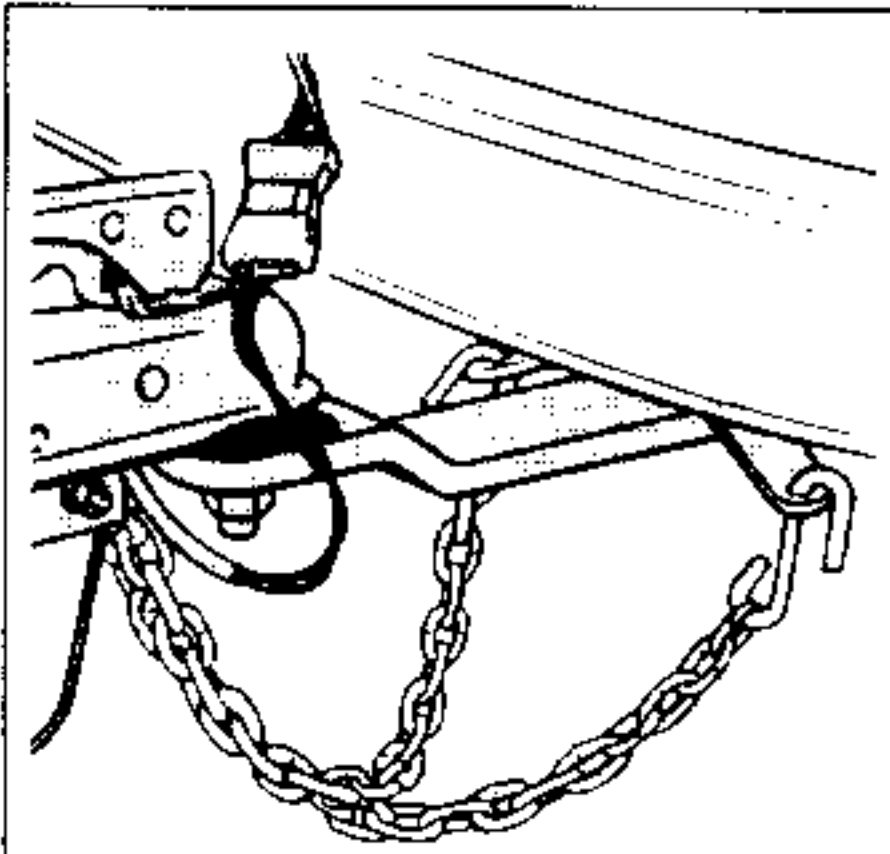

HITCH

Hitches are divided into classes that specify the gross trailer weight (GTW) and maximum tongue weight for each class. Always use a hitch with the same class number as the trailer.

Most boat trailers connect to a ball hitch that is bolted or welded to the towing vehicle. Special heavy-duty equalizing hitches are necessary for trailer tongue weights of 350 pounds or greater.

The trailer hitch coupler must match the size of the hitch ball. The correct ball diameter is marked on the trailer coupler.

SAFETY CHAINS

Safety chains on your boat trailer provide added insurance that it will not become completely detached from the towing vehicle when underway.

Crisscross the chains **under** the trailer tongue to prevent the tongue from dropping to the road if the trailer separates from the hitch ball. Safety chain should be of the "Proof Coil" type and for trailer classes 1, 2 and 3, must have a minimum breaking strength equal to the upper limit of the class GVWR. For example, safety chain for a class 2 trailer (GVWR 2000-3500 lbs) must have a minimum breaking strength of 3500 lbs. For class 4 trailers, the breaking strength of a chain must equal the GVWR of the trailer.

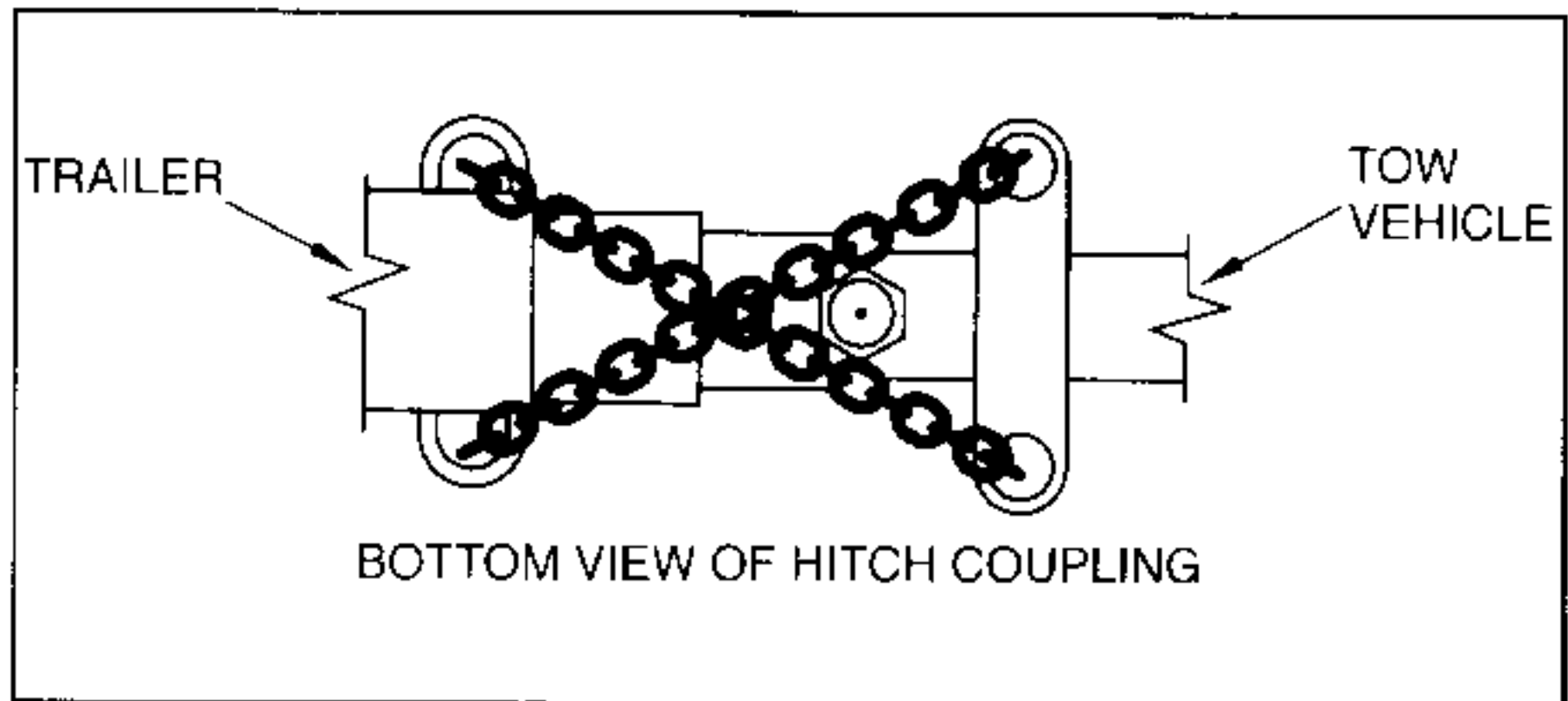

TRAILER BRAKES

In some states, any trailer with a gross vehicle weight rating (GVWR) of 1500 lbs or more is required to have brakes. Usually, this brake is a self-contained, hydraulic surge system with either a drum or disk brake. Some trailer brake systems are electronically actuated and require a control box inside the towing vehicle. Consult your trailer manufacturer's owner's manual for more information on the operation and maintenance of trailer brakes.

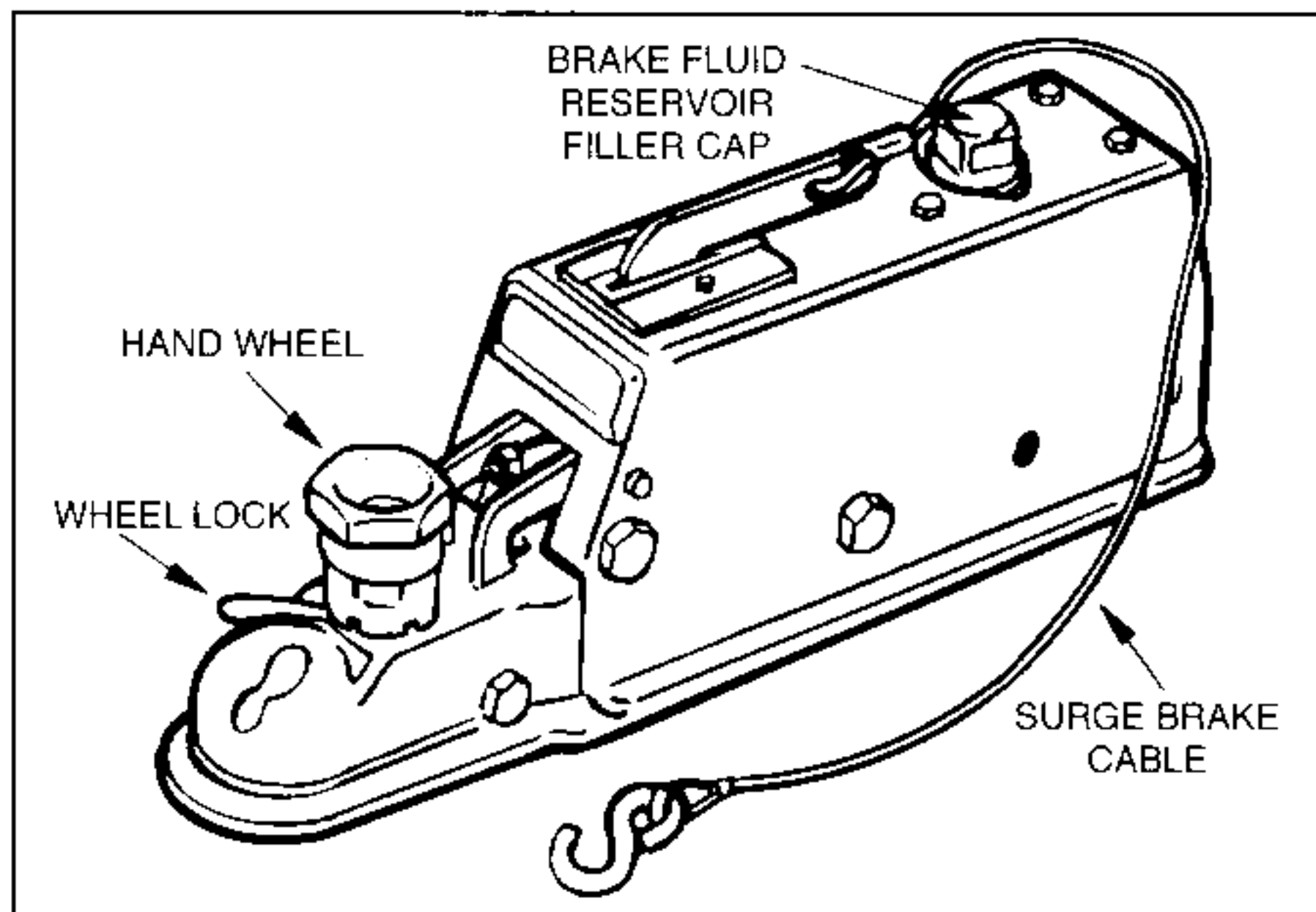

TRAILERING CHECKLIST

The following checks are essential to safe trailering and must be performed before every trip. Get in the habit of performing these checks in the same order before each outing so that it becomes routine.

WARNING

Repair or replace any broken or missing parts found during the Trailering Checklist before starting your trip. An ignored problem could lead to a tragic accident.

- ◆ Check trailer brake operation and brake fluid level.
- ◆ Check springs and undercarriage.
- ◆ Check tires for proper inflation.



SCARAB®

- ◆ Check that wheel bearings are properly greased and that all lug nuts are tightened.
- ◆ Your boat should be fastened to the trailer by the winch cable and a bow tie-down to the winch stand or trailer tongue. The stern of your boat should be tied down to the trailer from the stern eyes.
- ◆ Check that the taillights and turn signals function properly.

When on the road, check the trailer wheel hubs every time you stop. If the hub feels abnormally hot, the bearing should be inspected before continuing your trip.

BACKING UP TRAILERS

If you have never towed a trailer before, take some time to practice backing your trailer in an empty parking lot before taking it to the dock. Keep in mind the following guidelines for backing a trailer:

- ◆ Back **slowly** and make small steering adjustments.
- ◆ Turn the car wheels in the opposite direction you want the back end of the trailer to go.
- ◆ After the trailer begins moving in the direction you want it to go, turn the car to follow it.
- ◆ Have a second person help you by watching the back of the trailer and directing you with hand signals.

LAUNCHING

Before launching your boat, stay to one side and watch a couple of launchings to notice any problems on the ramp and the effects of the wind and the current on launching. It's a common courtesy to prepare the boat for launching away from the ramp.

This preparation includes:

1. Checking that the bilge drain plug is in place.
2. Removing any trailering tie-downs from the boat.
3. Attaching the docking lines and fenders.
4. Disconnecting the trailer lights from the car.

When launching, keep the following guidelines in mind:

- ◆ Back the boat down the ramp until the trailer is adequately submerged to allow launching. Each boat/trailer combination may be slightly different in this respect, so ask your dealer about the recommended practice regarding your particular trailer.

CAUTION

Use care not to allow your boat to enter the water too rapidly which may force water through the exhaust system and into the engine cylinders causing severe damage.

- ◆ Set the parking brake and block a wheel on each side of the car for safety.
- ◆ Board the boat and start the engine. If possible, remain on the trailer until the engine has warmed up.

LOADING

When loading your boat onto the trailer, keep in mind the following guidelines:

- ◆ Approach the trailer using “bursts” of propeller thrust to move towards the trailer at the slowest steerable speed and guide the boat onto the support bunks. Take your time and, if you need to, don’t be afraid to back up and start again.
- ◆ Check to see that the boat is centered on the support rails and is headed in a straight line for the bow stop (bumper board)
- ◆ Using a very light touch on the throttle, ease the boat forward until the bow comes to rest against the bow stop.
- ◆ Attach and tighten the winch cable.
- ◆ Pull the trailer up the ramp and out of the way of other boaters using the ramp, attach any additional tie-downs and connect the trailer light harness.
- ◆ Pull the drain plug.

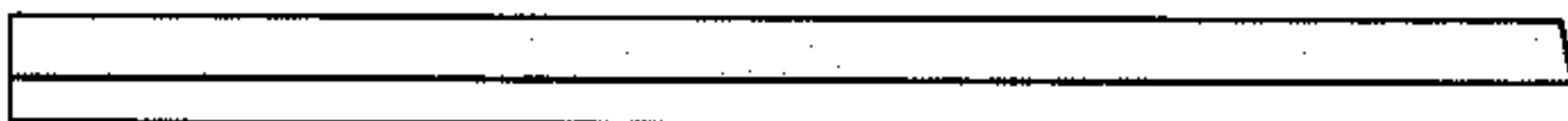

SCARAB[®]

SLINGING/LIFTING

If your boat is to be removed from the water without a trailer, follow these guidelines:

- ◆ Never attach lifting cables to cleats, ski tow eyes or handrails. Attach cables only to the lifting eyes in the transom and bow.
- ◆ Cover lifting cables with rubber hose or other protectors to prevent damage to the hull finish.
- ◆ Attach guidelines to the bow and stern to control movement of the boat when it is in the air.
- ◆ Use spreader bars and keep lifting pressure vertical to prevent side load damage.

Glossary of Boating Terms

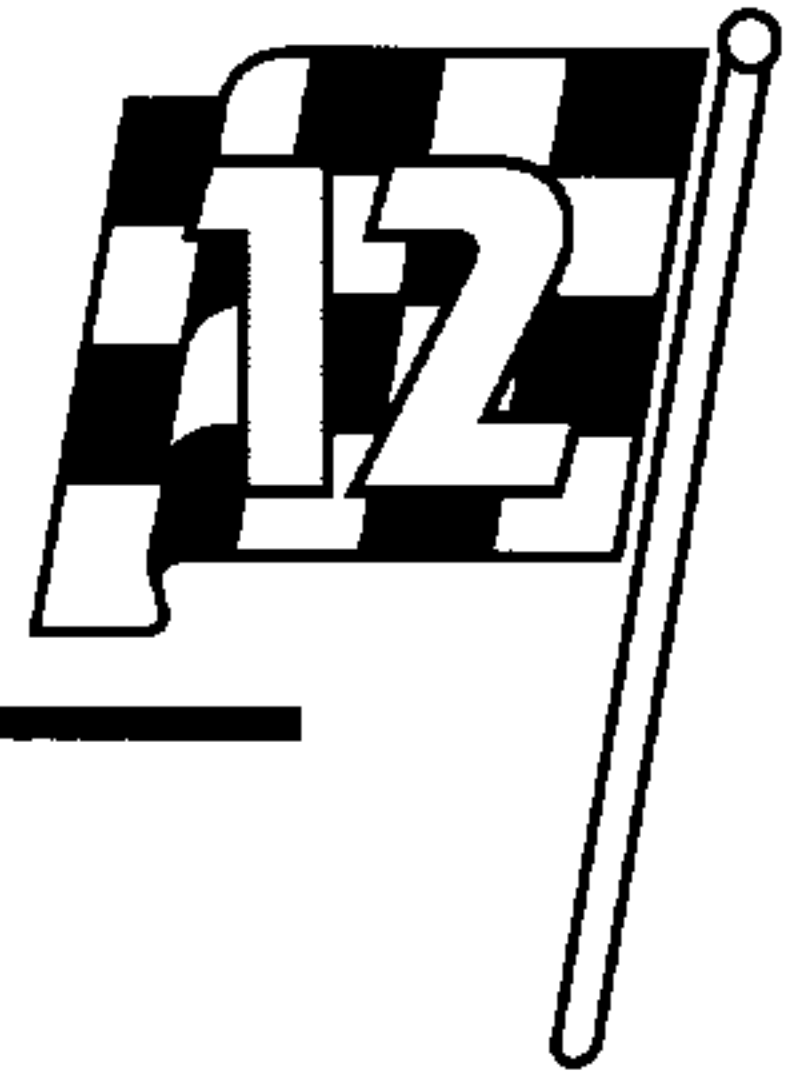

The following are commonly used boating terms provided for convenient reference:

ABOARD - On or in the boat.

ABYC - American Boat and Yacht Council. A standard setting organization dealing with boat safety and construction.

AFLOAT - On the water.

AFT - Toward the rear or stern of the boat.

AGROUND - The boat stuck with its keel on the sea or lake bottom.

AIDS TO NAVIGATION - Recognizable objects on land or sea such as buoys, towers or lights which are used to fix position to identify safe and unsafe waters.

AMIDSHIPS - Center or middle of the boat.

ANCHOR RODE - The line connecting the anchor to the boat.

ANTIFOULING - A type of paint commonly used on boat bottoms to repel marine growth. The use of antifouling paint is not recommended on high performance boats because of its adverse effect on speed.

BAIL - To remove water from the inside of a boat with a pump, bucket, sponge, etc.

BEAM - (1) The widest part of a boat; (2) the direction at a right angle to the centerline of the boat.

BEARING - The relative position or direction of an object from the boat.

BILGE - The lowest interior part of the boat hull.

BOARDING - To get on the boat.

BOLSTER SEAT - The wraparound style chair commonly found on high performance offshore boats.

BOW - The front of the boat.

BROACHING - The uncontrolled turning of a boat so that the side of the hull faces the waves.

BULKHEAD - A vertical partition or wall in a boat.

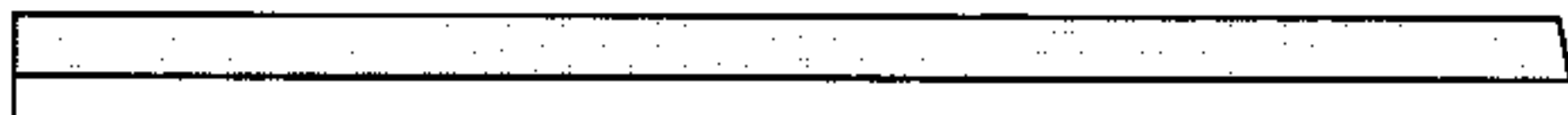

SCARAB®

BUOY - A floating aid to navigation that is anchored in a particular location.

BURDENED BOAT - A term for the boat which does not have the right-of-way in a meeting or crossing situation. See also give-way boat.

CAPACITY PLATE - A printed plate that provides maximum weight capacity and engine horsepower rating information. It is located in full view of the helm.

CAPSIZE - When a boat turns over.

CARDINAL POINTS - The four main points on a compass: North, South, East and West.

CAST OFF - To unfasten lines when leaving from a mooring or dock.

CLEAT - A deck fitting with "horns" to which lines are fastened.

COAST GUARD - The Federal marine law enforcement and rescue agency of the U.S.

COLREGS - The Rules of the Road outside the prescribed international demarcation lines; officially called International Regulations for Preventing Collisions at Sea.

CURRENT - The horizontal movement of water.

DAY MARK - A marker used to show one side of a channel or an obstruction.

DRAFT - The vertical distance from the waterline to the keel or the minimum depth of water needed for a boat to be able to float.

EPIRB - Emergency Position Indicating Radio Beacon. A small transmitter used in emergency situations.

FENDER - An object placed alongside a boat at a pier for cushioning.

FLAME ARRESTER - A safety feature located on boat engines which prevent an exhaust backlash from causing an explosion.

FORE - Towards the front or bow of the boat.

GIVE-WAY BOAT - A term for the boat which does not have the right-of-way in a meeting or crossing situation. See also burdened boat.

HAIL - A call to another boat or ship.

HEAD - A marine toilet.

HEADING - The direction in which a boat is pointed.

HEAD SEAS - Waves meeting a boat head on.

HELM - The steering wheel.

HOLDING TANK - A storage tank for the toilet so that waste is not pumped overboard.

HULL - The body of the boat.

INLAND RULES - The Rules of the Road inside the international demarcation lines at the entrance to most harbors, bays, rivers and inlets. The Inland Rules are the most common set of rules used by recreational boaters and are similar, but not identical to, the International Rules of the Road (COLREGS).

INTRACOASTAL WATERWAY (ICW) - Bays, rivers and canals along the coast which allow travel up and down the coast without going into open seas.

KEEL - The lowest portion of a boat.

LEEWAY - The sideways drift of a boat.

LIST - When a boat leans to one side because of an unbalanced load or wind.

MOORING - An anchor and associated tackle which holds a boat in one location.

NOTICES TO MARINERS - Information produced by the Coast Guard and Defense Mapping Agency Hydrographic Center concerning such things as changes in channels and navigation aids.

NO WAKE SPEED - Usually less than five miles per hour.

PFD - Personal Flotation Device, often called life preserver.

PLANING - When a powerboat achieves a sufficient speed to rise up onto the surface of the water.

PORT - The left side of a boat facing forward.

PRIVILEGED BOAT - A term for the boat which has the right-of-way in a meeting or crossing situation. See also stand-on boat.

RULES OF THE ROAD - The regulations which govern how vessels should operate in order to avoid collision. See also COLREGS.

RUNNING LIGHTS - Navigation lights which a boat uses when moving at night or in poor visibility conditions.

SEA ANCHOR - A canvas cone dragged through the water and attached to the bow of a boat in storm conditions to keep the bow into the waves.

SQUALL - A sudden windstorm often with rain.

STAND-ON BOAT - A term for the boat which has the right-of-way in a meeting or crossing situation. See also privileged boat.

STARBOARD - The right side of a boat facing forward.



SCARAB®

STATUTE MILE - 5280 feet (the common land mile). A nautical mile is 6076 feet.

STERN - The back of the boat.

STERN DRIVE - The drive system on Scarabs where the engine is inside the boat and a lower drive unit is outside mounted on the transom.

THROUGH-HULL - A fitting that connects a pipe or hose through the boat hull to the sea.

TRANSOM - The flat area across the stern.

TRIM - Front to back and side to side balance of the boat.

UNDERWAY - When the boat is in motion.

WAKE - The waves that a boat leaves behind when moving through the water. The operator of a boat is responsible for any damage caused by the wake his or her boat creates.

VISUAL DISTRESS SIGNAL - Devices such as flags, lights and flares used to signal the need for assistance.

BOAT DATA SHEET

Wellcraft Model Name _____ Hull Identification Number _____

Name of Boat _____ State _____ Length _____ Beam _____

Hull Color(s) _____ Weight _____

Draft (Drive Down) _____ Draft (Drive Up) _____ Freeboard (Forward) _____ (Aft) _____

Draft-Inboard _____

Engine(s)

Make _____ Model Name _____ H.P. _____ Model No. _____

Oil: SAE _____ Quarts per Engine _____ Oil Filter No. _____

Port Serial No. _____ Transom Plate Serial No. _____

Center Serial No. _____ Transom Plate Serial No. _____

Starboard Serial No. _____ Transom Plate Serial No. _____

Drive Unit(s)

Manufacturer _____ Gear Ratio _____ Model No. _____

Port Serial No. _____ Center Serial No. _____ Starboard Serial No. _____

Fuel Tank Capacity _____ Number of Tanks _____ Fuel Filter No. _____

Water Tank Capacity _____ Number of Tanks _____

Generator

Make _____ Model Name _____ Model No. _____

Serial No. _____ K.W. _____

Radio-VHF

Make _____ Type _____ Model No. _____ Serial No. _____

Radio-Stereo

Make _____ Type _____ Model No. _____ Serial No. _____

Battery Make _____ Type _____

Propeller(s) Manufacturer _____ Diameter/Pitch _____ / _____

No. of Blades _____ Style _____ Material _____ Mfg. Part No. _____

Key Numbers Cabin _____ Glove Box _____ Ignition Switch(s) _____

Other Equipment

Selling Dealer

Name _____

Address _____

Phone No. _____

Salesman _____

Servicing Dealer

Name _____

Address _____

Phone No. _____

Service Manager _____

SERVICE/MAINTENANCE LOG

DATE	HOUR METER READING	SERVICE/REPAIRS PERFORMED

FUEL LOG

DATE	HOURS RUN	FUEL (GALS)	RANGE (MI)	RPM	MPH	GPH

FLOAT PLAN

Copy this page and fill out the copy before going boating. Leave the completed copy with a reliable person who can be depended upon to notify the Coast Guard, or other rescue organization, should you not return as scheduled. DO NOT file this plan with the Coast Guard.

Name _____ Telephone _____

Description of Boat: Type _____ Color _____ Trim _____

Registration Number _____

Length _____ Name _____ Make _____

Wellcraft Hull Identification Number _____

Other Info. _____

Persons Aboard: Name Age Address & Telephone

Name	Age	Address & Telephone

Engine Type: _____ HP _____

No. of Engines: _____ Fuel Capacity: _____

Survival Equipment:

PFDs _____ Flares _____ Mirror _____

Smoke Signals _____ Flashlight _____ Food _____

Paddles _____ Water _____ Anchor _____

Raft or Dinghy _____ EPIRB _____ Sea Anchor _____

Navigation Equipment

Compass _____ Loran _____ GPS _____

Radio: Yes _____ No _____ Type _____ Freq _____

Phone: Yes _____ No _____ Phone No. _____

Destination _____ Est. Time of Arrival _____

Expect to Return By _____

Auto Type _____ License No. _____ Parked _____

If not returned by _____ call the Coast Guard, or _____
(Local Marine Authority)

Coast Guard Telephone Number: _____

Local Marine Authority Telephone Number: _____