

**DF4A
DF5A
DF6A**

OWNER'S MANUAL

IMPORTANT

▲ WARNING/ ▲ CAUTION/ NOTICE/ NOTE

Please read this manual and follow its instructions carefully. To emphasize special information, the symbol ▲ and the words **WARNING**, **CAUTION**, **NOTICE** and **NOTE** have special meanings. Pay special attention to the messages highlighted by these signal words.

▲ WARNING

Indicates a potential hazard that could result in death or serious injury.

▲ CAUTION

Indicates a potential hazard that could result in minor or moderate injury.

NOTICE

Indicates a potential hazard that could result in damage to the motor or boat.

NOTE:

Indicates special information to make maintenance easier or instructions clearer.



This symbol appears in various locations on your Suzuki product to refer you to important information in the owner's manual.

IMPORTANT NOTICE TO OWNERS

▲ WARNING

Failure to take the proper precautions may increase the risk of death or severe injury to you and your passengers.

- Prior to first-time use of your outboard motor, familiarize yourself thoroughly with the contents of this owner's manual. Be aware of all outboard motor features and all safety and maintenance requirements.
- Inspect the boat and motor before each trip. See the **INSPECTION BEFORE BOATING** section for important items.

- Become thoroughly familiar with all operating and handling characteristics of your boat and motor. Practice at low and moderate speeds until you are competent at handling the boat and motor. Do not attempt to operate at maximum performance until you are completely familiar with all of these characteristics.
- Carry boating safety and emergency equipment. This important equipment includes; flotation aids for each person (plus one throwable buoyant cushion in any boat 16 feet or longer), fire extinguisher, sound signaling device, visual distress signals, anchor, bilge pump, bucket, compass, emergency starter rope, extra fuel and oil, first aid kit, flashlight, food and water, mirror, paddles, tool kit, and transistor radio. Be sure you are carrying the equipment appropriate for your trip before launching.
- Never start the engine or let it run indoors or where there is little or no ventilation. Exhaust gas contains carbon monoxide, a gas that is colorless and odorless and can cause death or severe injury.
- Instruct your passengers on how to operate the boat, how to deal with emergencies, and how to operate safety and emergency equipment.
- Do not hold onto the motor cover or any other parts of your outboard motor while getting on or off your boat.
- Ensure that everyone wears a life jacket on board.
- Never operate the boat while under the influence of alcohol or other drugs.
- Distribute all weight load evenly in the boat.
- Have all scheduled maintenance performed. Consult your authorized Suzuki marine dealer as required.
- Do not modify or remove any outboard motor standard equipment. To do so may make the motor unsafe to use.
- Learn and obey all applicable navigation rules.
- Pay attention to all weather forecasts. Do not set out if weather is unsettled.
- Use extreme caution when purchasing replacement parts or accessories. Suzuki strongly recommends that you use only genuine Suzuki replacement parts/accessories or their equivalent. Inappropriate or poor quality replacement parts or accessories can create unsafe operating conditions.

- Never remove the flywheel cover (except for when emergency starting).

NOTE:

Mounting radio transceiver or navigational equipment antennae too close to the engine cowling can cause electrical noise interference. Suzuki recommends that antennae be mounted at least one meter (40 inches) away from the engine cowling.

This manual should be considered a permanent part of the outboard motor and should remain with the outboard motor when resold or otherwise transferred to a new owner or operator. Please read this manual carefully before operating your new Suzuki and review the manual from time to time. It contains important information on safety, operation, and maintenance.

FOREWORD

Thank you for choosing a Suzuki outboard motor. Please read this manual carefully and review it from time to time. It contains important information on safety, operation, and maintenance. A thorough understanding of the information presented in this manual will help you experience safe, enjoyable boating.

All information in this manual is based on the latest product information available at the time of publication. Due to improvements or other changes, there may be discrepancies between this manual and your outboard motor. Suzuki reserves the right to make changes at any time without notice.

TABLE OF CONTENTS

IDENTIFICATION NUMBER	
LOCATION.....	5
FUEL AND OIL.....	5
LOCATION OF SAFETY LABELS	8
LOCATION OF PARTS.....	10
MOTOR MOUNTING.....	11
PROPELLER SELECTION AND INSTALLATION.....	12
ADJUSTMENT.....	13
OVER-REVOLUTION LIMITING SYSTEM.....	15
OPERATION OF TILTING SYSTEMS.....	16
INSPECTION BEFORE BOATING ...	19
BREAK-IN	21
OPERATION	22
MOTOR REMOVAL AND TRANSPORTING	32
TRAILERING.....	34
INSPECTION AND MAINTENANCE.....	35
FLUSHING THE WATER PASSAGES.....	43
SUBMERGED MOTOR.....	45
STORAGE PROCEDURE	46
AFTER STORAGE	47
TROUBLESHOOTING.....	47
SPECIFICATIONS	48
INFORMATION REGARDING EC – DIRECTIVE	48

IDENTIFICATION NUMBER LOCATION

The model and identification numbers of your outboard motor are stamped on a plate attached to the clamp bracket. It is important to know these numbers when you place a parts order or if your motor is stolen.

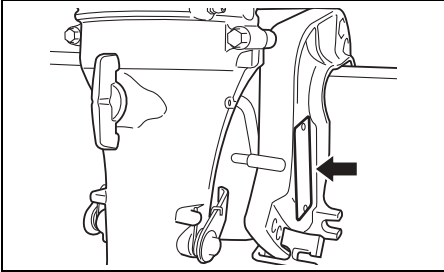

FUEL AND OIL

GASOLINE

Suzuki highly recommends that you use alcohol-free unleaded gasoline whenever possible, with a minimum octane rating of 91 (Research method). However, blends of unleaded gasoline and alcohol with equivalent octane content may be used, provided the guidelines that follow are met.

NOTICE

Use of leaded gasoline can cause engine damage. Use of improper or poor quality fuel can affect performance and may damage your motor and fuel system.

Use only unleaded gasoline. Do not use fuel having lower than the recommended octane, or fuel that may be stale or contaminated by dirt/water etc.

NOTE:

Oxygenated fuels are fuels which contain oxygen-carrying additives such as MTBE or alcohol.

Gasoline Containing MTBE

Unleaded gasoline containing MTBE (Methyl Tertiary Butyl Ether) may be used in your outboard motor if the MTBE content is not greater than 15%. This oxygenated fuel does not contain alcohol.

Gasoline/Ethanol Blends

Blends of unleaded gasoline and ethanol (grain alcohol), also known as gasohol, are commercially available in some areas. Gasoline containing a maximum of 10% ethanol may be used in your outboard motor without jeopardizing the New Outboard Motor Limited Warranty.

Gasoline/Methanol Blends

Blends of unleaded gasoline and methanol (wood alcohol) are also commercially available in some areas. **DO NOT USE** fuels containing more than 5% methanol under any circumstances. Fuel system damage or outboard motor performance problems resulting from the use of such fuels are not the responsibility of Suzuki and may not be covered under the New Outboard Motor Limited Warranty.

Fuel containing 5% or less methanol may be suitable for use in your outboard motor if they contain cosolvents and corrosion inhibitors.

Pump Labeling for Gasoline/Alcohol Blends

In some states, pumps that dispense gasoline/alcohol blends are required to be labeled for the type and percentage of alcohol content, and whether important additives are present. Such labels may provide enough information for you to determine if a particular blend of fuel meets the requirements listed above. In other states, pumps may not be clearly labeled as to the content or type of alcohol and additives. If you are not sure that the fuel you intend to use meets these requirements, check with the service station operator or the fuel suppliers.

NOTE:

If you are not satisfied with the operation or fuel economy of your outboard motor when you are using gasoline/alcohol blends, you should switch back to unleaded gasoline containing no alcohol.

Be sure that any gasoline/alcohol blend you use has octane ratings of at least 91 octane (Research method).

If engine pinging is experienced, substitute another brand as there are differences between brands.

Unleaded gasoline will extend spark plug life.

▲ WARNING

Gasoline is extremely flammable and toxic. It can cause a fire and can be hazardous to people and pets.

Always take the following precautions when refueling:

- Never permit anyone other than an adult to refill the fuel tank.
- If you use a portable fuel tank, always stop the motor and remove the fuel tank from the boat to refill it.
- Do not fill the fuel tank all the way to the top or fuel may overflow when it expands due to heating by the sun.
- Be careful not to spill fuel. If you do, wipe it up immediately.
- Do not smoke, and keep away from open flames and sparks.

NOTICE

Gasoline kept in the fuel tank for long periods of time will produce varnish and gum, which can damage the engine.

Always use fresh gasoline.

NOTICE

Fuels containing alcohol can cause paint damage, which is not covered under the New Outboard Motor Limited Warranty.

Be careful not to spill fuel containing alcohol while refueling. If fuel is spilled, wipe it up immediately.

NOTE:

The separate fuel tank (optional part) is its dedicated fuel reservoir and should not be used as a fuel storage container.

ENGINE OIL

NOTICE

Use of poor quality engine oil can adversely affect engine performance and life.

Suzuki recommends that you use Suzuki Marine 4-Cycle Engine Oil or its equivalent.

Oil quality is a major contributor to your engine's performance and life. Always select good quality engine oil.

Suzuki recommends the use of SAE 10W-40 or 10W-30 SUZUKI MARINE 4-CYCLE ENGINE OIL. If SUZUKI MARINE 4-CYCLE ENGINE OIL is not available, select a NMMA certified FC-W oil or good quality 4-cycle motor oil from the following chart according to the average temperatures in your area.

API Classification	SAE Viscosity Grade	
SG	10W-40	
SH	10W-40	
SJ	10W-40	
SL	10W-30	
SM	10W-30	
TEMP.		

NOTE:

In very cold weather (below 5°C (41°F)), use SAE (or NMMA FC-W) 5W-30 for easier starting and smooth operation.

GEAR OIL



Suzuki recommends the use of SUZUKI OUTBOARD MOTOR GEAR OIL. If it is not available, use SAE 90 hypoid gear oil which is rated GL-5 under the API classification system.

LOCATION OF SAFETY LABELS

Read and follow all of the labels on your outboard motor or fuel tank. Make sure you understand all of the labels.

Keep the labels on your outboard motor or fuel tank. Do not remove them for any reason.

WARNING
AVERTISSEMENT

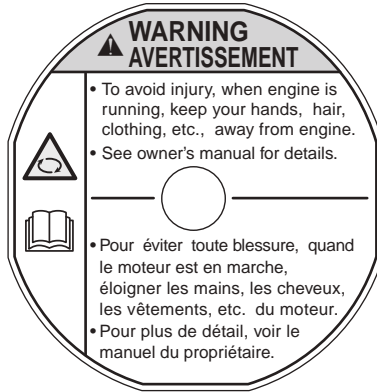

• To avoid injury, when engine is running, keep your hands, hair, clothing, etc., away from engine.
• See owner's manual for details.

• Pour éviter toute blessure, quand le moteur est en marche, éloigner les mains, les cheveux, les vêtements, etc. du moteur.
• Pour plus de détail, voir le manuel du propriétaire.

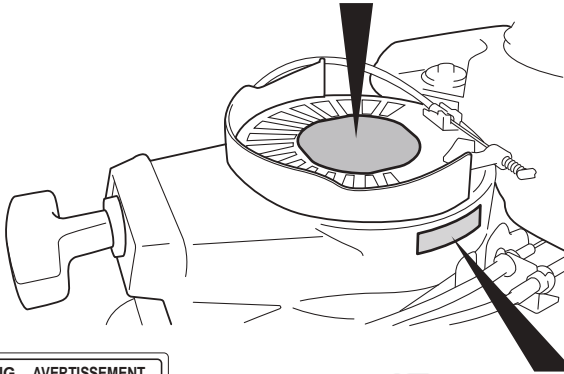

WARNING **AVERTISSEMENT**

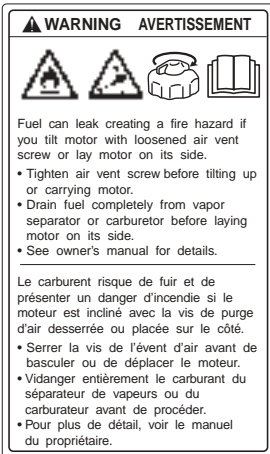

Fuel can leak creating a fire hazard if you tilt motor with loosened air vent screw or lay motor on its side.

- Tighten air vent screw before tilting up or carrying motor.
- Drain fuel completely from vapor separator or carburetor before laying motor on its side.
- See owner's manual for details.

Le carburant risque de fuir et de présenter un danger d'incendie si le moteur est incliné avec la vis de purge d'air desserrée ou placée sur le côté.

- Serrer la vis de l'évent d'air avant de basculer ou de déplacer le moteur.
- Vidanger entièrement le carburant du séparateur de vapeurs ou du carburateur avant de procéder.
- Pour plus de détail, voir le manuel du propriétaire.

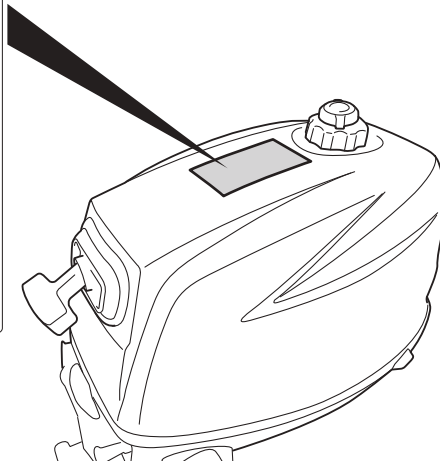
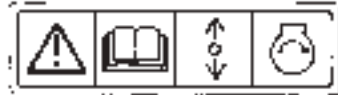



WARNING AVERTISSEMENT





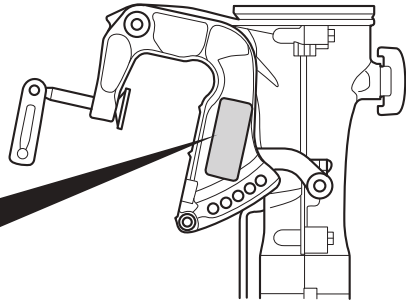



Secure both mounting bolts and clamps to avoid motor drop. See owner's manual.

Fixer les deux boulons de montage et des brides pour éviter la chute du moteur. Voir le manuel du propriétaire.



Label symbol meanings

These symbols mean as follows;

-  : General warning symbol (Caution or Warning)
-  : Read owner's manual carefully
-  : Remote control lever/gear shift lever operation-two direction; Forward/Neutral/Reverse
-  : Engine start
-  : Hazard caused by fire
-  : Hazard caused by laying the motor on its side
-  : Hazard caused by rotating parts
-  : Hazard caused by fuel leak



REMOVE FROM BOAT FOR FILLING

CAUTION

KEEP TANK FULLY CLOSED WHEN NOT IN USE. KEEP AWAY FROM HEAT, SPARKS AND OPEN FLAMES. SECURE CAPS! DO NOT FILL WHILE THE AREA IS HOT. DO NOT FILL FOR LONG PERIODS. APPROXIMATELY 10 MINUTES PER GALLON. MANUFACTURER'S INSTRUCTIONS.

EXTREMELY FLAMMABLE DANGER

REMOVED FROM BOAT BEFORE FILLING TO PREVENT FIRE OR EXPLOSION. DO NOT FILL FOR LONG PERIODS. APPROXIMATELY 10 MINUTES PER GALLON. MANUFACTURER'S INSTRUCTIONS.

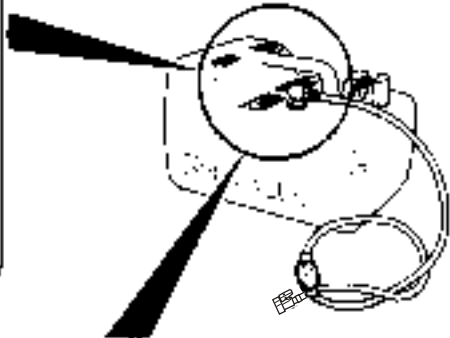

WARNING	AVERTISSEMENT
<ul style="list-style-type: none"> • Do not over fill. Fill to safe fill level as indicated on the tank. • Store in well ventilated area. • Tank is to be stored to reduce the likelihood of shifting and mechanical damage. • Remove tank from boat for filling. • Open vent on cap before starting engine. • Replace cap gasket if it shows signs of swelling or it is broken or missing. • Do not over tighten threaded fittings. 	<ul style="list-style-type: none"> • Ne pas trop remplir le réservoir. Remplir le réservoir jusqu'au niveau sécurisé et marqué comme indiqué sur le réservoir. • Ranger dans un endroit bien aéré. • Le réservoir doit être rangé pour réduire les chances de bouger et d'endommager mécaniquement. • Ouvrir le bouchon de la tête avant de commencer à tourner. • Couvrir le bouchon d'étanchéité ou bouchon de réserve avant le démarrage du moteur. • Remplacer le joint d'étanchéité de bouchon de réserve si il montre un signe de gonflement de la tête ou si il est manquant. • Ne pas trop serrer les accessoires à vis.

LOCATION OF PARTS

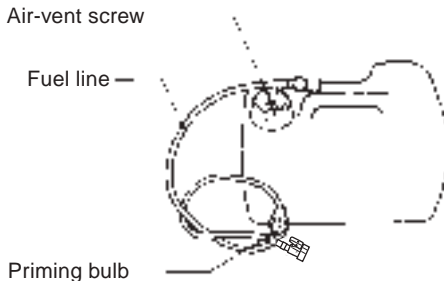
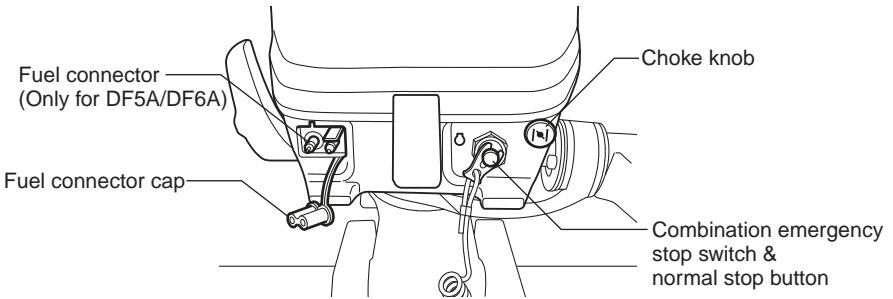
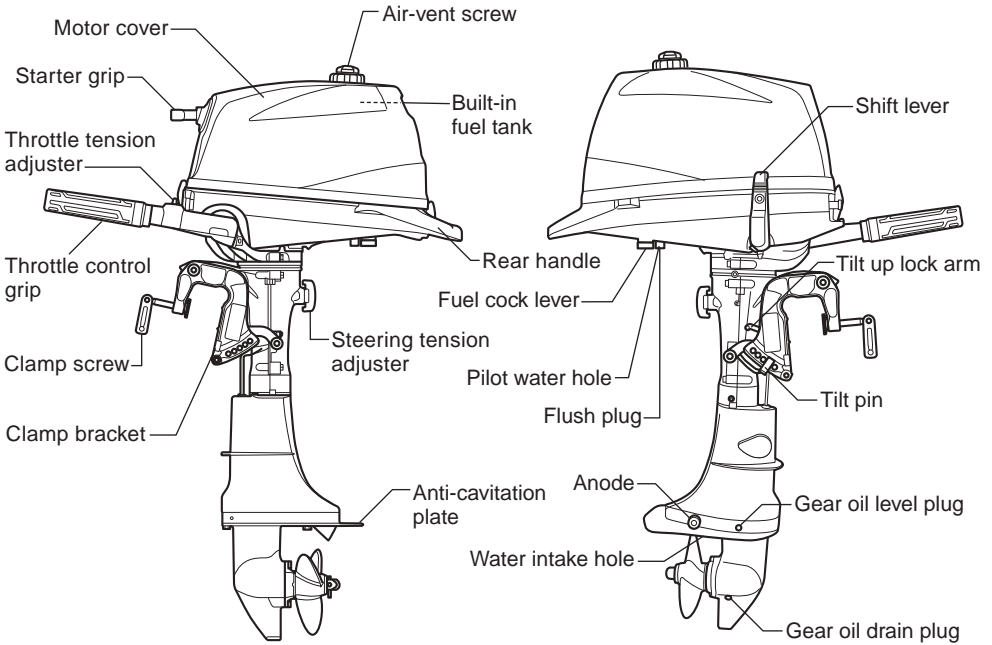

SEPARATE FUEL TANK
 (Optional parts for DF5A/DF6A)

<https://www.boat-manuals.com/>

MOTOR MOUNTING

⚠ WARNING

Overpowering your boat can be hazardous. Excessive horsepower will have an adverse effect on hull safety and may cause operating/handling difficulties. The boat may also sustain stress and hull damage.

Never install an outboard motor with horsepower exceeding the manufacturer's recommended maximum horsepower listed on the boat's "Certification Plate". Contact your authorized Suzuki marine dealer if you are unable to locate the hull "Certificate Plate".

Proper transom height is important for good performance. A motor mounted on a transom that is too high causes the propeller to slip resulting in wasted power or overheating. A motor mounted on a transom that is too low will increase drag, causing reduced speed. Make sure that when the motor is lowered all the way down, the anti-cavitation plate is located 0 – 25 mm (0 – 1.0 in) below the bottom of the boat.

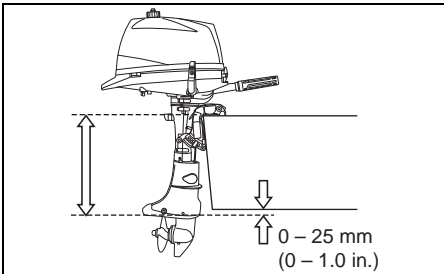

NOTICE

Operating your outboard motor with the anti-cavitation plate above water can cause overheating and severe damage to your outboard motor.

Do not operate your outboard motor with the anti-cavitation plate above water.

Center the motor on the transom and secure it by alternately tightening the clamp bracket screws by hand. Make sure you accurately center the motor, or the boat will pull to one side during operation.

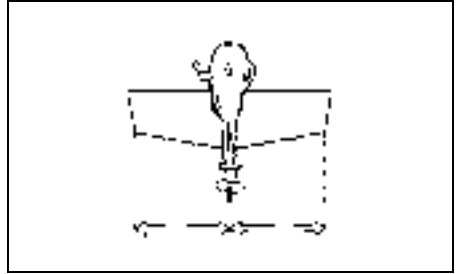

Install 8 mm bolts, washers, lock washers and nuts, as illustrated and tighten the bolts sequentially. Be sure to seal the holes with sealant to prevent water leakage.

NOTICE

Over tightening the transom bolts can damage the clamp bracket.

- Do not over tighten the transom bolts.
- Do not use an impact tool to tighten or loosen the transom nuts.

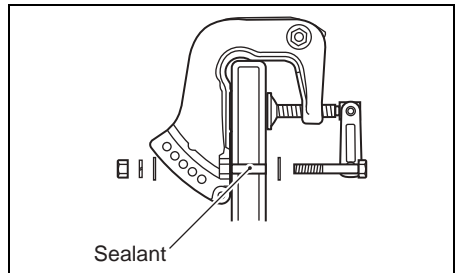

NOTICE

If you attempt to mount the outboard to the transom without having mechanical experience or without being certain where to drill holes, you can seriously damage the boat.

If you do not have mechanical experience or are not sure of where to drill holes in the boat's transom, you should have your motor mounted by your authorized Suzuki marine dealer.

After installing the motor, check to make sure that steering and tilt movement are not obstructed by any part of the boat.

▲ WARNING

If the motor is not properly secured to the transom, it can come off.

Be sure to bolt the motor to the transom. The motor may come off if it is held only by the clamp screws. Occasionally check the clamp screws for tightness.

PROPELLER SELECTION AND INSTALLATION

PROPELLER SELECTION

It is essential to use a propeller on your outboard motor that is properly matched to your boat's operating characteristics. The speed of the engine when you operate your boat at full throttle depends on the propeller you use.

Excessive engine speed can seriously damage the motor, while low engine speed at full throttle will adversely affect performance. Your operating load will also affect propeller selection. Smaller loads generally require larger-pitch propellers; larger loads generally require smaller-pitch propellers. Your authorized Suzuki Marine Dealer will assist you in selecting a suitable propeller for your boat.

NOTICE

Installing a propeller with either too much or too little pitch will cause incorrect maximum engine speed, which may result in severe damage to the motor.

Ask your authorized Suzuki marine dealer to assist you in selecting a suitable propeller for your boat.

You can determine if your propeller is appropriate for use with your boat by using a tachometer to measure engine speed when operating your boat at full throttle, under minimum load conditions. If you are using an appropriate propeller, the engine speed will be within the following range:

Full throttle operating range	DF4A	4000 – 5000 r/min. (min ⁻¹)
	DF5A	4500 – 5500 r/min. (min ⁻¹)
	DF6A	4750 – 5750 r/min. (min ⁻¹)

If the engine speed is not within this range, consult your authorized Suzuki Marine Dealer to determine which propeller size is best for you.

PROPELLER INSTALLATION

⚠ WARNING

Failure to take proper precautions when installing or removing the propeller can result in severe personal injury.

When installing or removing the propeller:

- Always shift into “Neutral” and remove the emergency stop switch lock plate so that the motor cannot be started accidentally.
- Wear gloves to protect hands, and “lock” the propeller by placing a block of wood between the blades and the anti-cavitation plate.

To install a propeller on your outboard motor, use the following procedure:

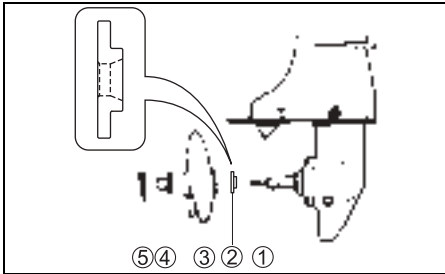

1. Coat the propeller shaft splines ① liberally with Suzuki water resistant grease to help prevent corrosion.
2. Place the stopper ② on the shaft.
3. Slide the propeller ③ onto the shaft.
4. Screw on the propeller nut ④ and tighten it. Align the hole in the propeller nut with the hole in the shaft, then insert the cotter pin ⑤ and bend it so that it can't come off.

To remove the propeller, reverse the above procedure.

ADJUSTMENT

TRIM ANGLE ADJUSTMENT

To help maintain steering stability and good performance, always maintain the proper trim angle as shown in the illustration. The appropriate trim angle varies depending on the combination of the boat, engine, and propeller, as well as operating conditions.

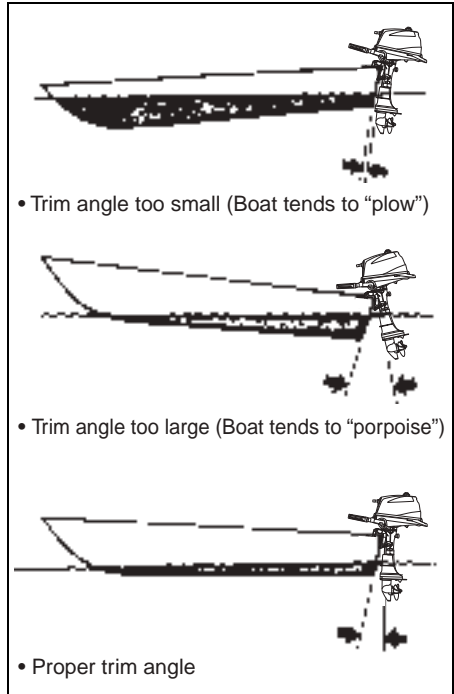

Make a test run in the boat to determine if the trim angle needs to be adjusted.

To adjust the trim angle:

1. Hold the motor in the fully tilted up position. (Refer to the TILT UP LOCK ARM section.)
2. Reposition the tilt pin (A) in the desired holes.

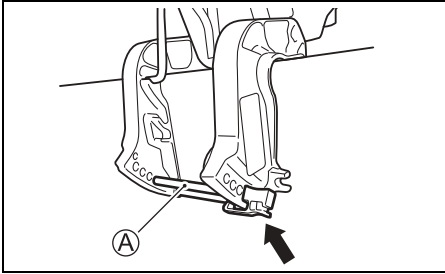

3. Lower the motor back down.

To lower the bow, move the pin towards the boat. To raise the bow, move the pin away from the boat.

▲ WARNING

Trim angle greatly affects steering stability. If the trim angle is too small, the boat may “plow” or “bow steer”. If the trim angle is too large, the boat may “chine walk” from side to side or “porpoise” up and down. These conditions, which result in loss of steering control, can cause occupants to be thrown overboard.

Always maintain proper trim angle based on the combination of your boat, engine, and propeller, as well as operating conditions.

▲ WARNING

If you operate the motor with the tilt pin removed, you may not be able to control steering as expected.

Do not operate the motor with the tilt pin removed.

STEERING TENSION ADJUSTMENT

The steering on your outboard motor should be smooth and not tight. Adjust the steering tension so that there is only a slight resistance to steering movement.

To increase the steering tension, turn the steering tension adjuster (A) clockwise. To decrease the steering tension, turn the steering tension adjuster counterclockwise.

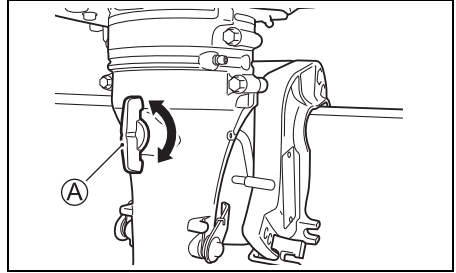

THROTTLE TENSION ADJUSTMENT

The tension of the throttle control grip can be adjusted according to your preference. To increase the tension, turn the throttle tension adjuster (A) clockwise. To decrease the tension, turn the adjuster counterclockwise.

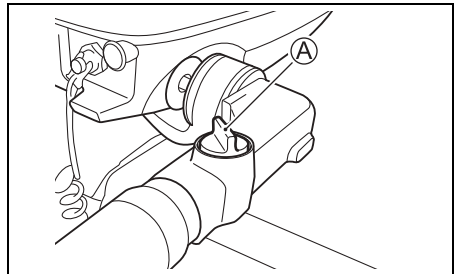

IDLE SPEED ADJUSTMENT

The idle speed of your outboard motor has been factory-adjusted to provide a smooth, stable idle.

If it is necessary to adjust the idle speed, use the following procedure.

1. Warm up the engine for about 5 minutes.
2. Make sure that the motor is in "NEUTRAL" and the throttle control grip is fully closed.
3. Turn the idle adjustment screw (A) clockwise to increase idle speed or counterclockwise to decrease idle speed.

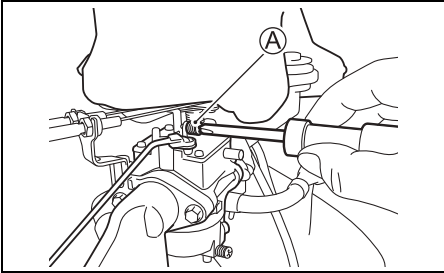

Idle speed (in Neutral)	DF4A	1250 – 1350 r/min. (min ⁻¹)
	DF5A	
	DF6A	

NOTE:

If idle speed cannot be set within the specified range, contact your authorized Suzuki Marine Dealer.

OVER-REVOLUTION LIMITING SYSTEM

This motor is equipped with a revolution limiting system which activates when engine speed exceeds 6000 r/min.

Over-revolution can result from cavitation when turning hard, a propeller with a slipping bush or worn-down blades, or a trim setting that is too high.

If the over-revolution limiting system activates, the motor will exhibit a rough running condition and you must immediately reduce engine speed to within the recommended operating range.

If the system activates frequently, consult your authorized Suzuki Marine Dealer.

NOTICE

If the Over-Revolution Limiting System activates at recommended maximum throttle and you are sure that the propeller pitch is sufficient and there are no factors like "over-trimming" or "ventilation", there may be a problem with the Over-Revolution Limiting System.

Consult your authorized Suzuki marine dealer if the Over-Revolution Limiting System activates for no apparent reason.

OPERATION OF TILTING SYSTEMS

TILT LOCK

When you move shift the motor into "REVERSE" gear, the motor will automatically lock so that it will not lift out of the water due to forces such as propeller thrust.

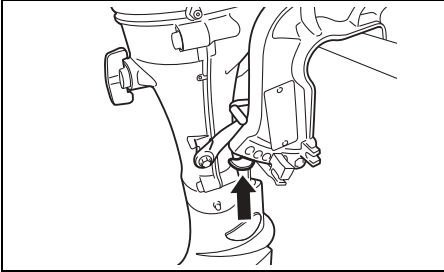

⚠ WARNING

When the shallow water position is used, the tilt lock will not work. As a result, forces such as from propeller thrust during operation in "REVERSE" gear, rapid deceleration, and striking an underwater object can cause the motor to lift out of the water, resulting in personal injury.

When using the shallow water position, proceed with caution and only at very low speeds.

TILT UP LOCK ARM

The tilt up lock arm is used to hold the motor in the fully tilted up position and shallow water position.

FULL TILT UP POSITION

To hold the motor in the fully raised position:

⚠ WARNING

If you place your hands near the mounting bracket or under the motor when tilting it, your hands can be crushed if the motor slips from your grasp.

Never place your hands near the mounting bracket or under the motor when tilting it.

1. Shift into "NEUTRAL".
2. Turn the fuel cock lever to the right (off position) and tighten the air vent screw on the fuel filler cap.

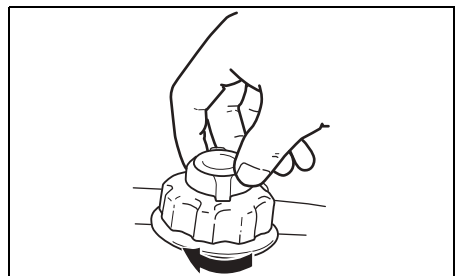
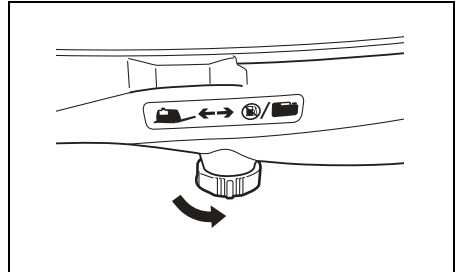

Using separate fuel tank:

Disconnect the fuel line from the separate fuel tank.

Install the fuel connector cap ① to fuel connector.

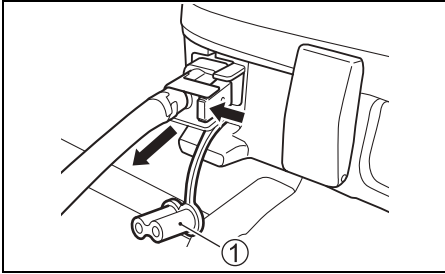

⚠ WARNING

If you do not take proper precautions when tilting up the motor, fuel may leak out.

- Do not fill the fuel tank above the upper limit.
- For motors with a built-in fuel tank, be sure to turn the fuel cock lever to the right (off position) and tighten the air-vent screw on the fuel filler cap before tilting up the motor.
- Lower the motor back down to normal position before opening the air vent screw on the fuel filler cap of the built-in fuel tank.
- For motors with a separate fuel tank, disconnect the fuel line whenever you leave the motor tilted up for a long period of time.

3. Grab the handle on the back of the motor cover and tilt the motor all the way up until it is automatically locked in the fully tilted up position by the tilt up lock arm ①.

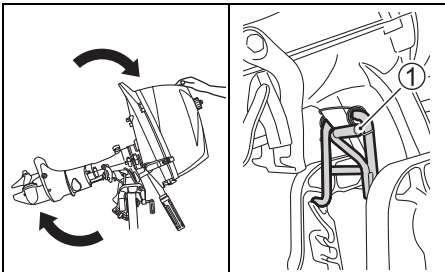

NOTICE

If you use the throttle grip handle to raise or lower the motor, the handle may break.

Never use the throttle grip handle to raise or lower the motor.

To lower the motor back down, pull the motor slightly toward you, pull up on the tilt up lock arm ① and slowly let the motor down.

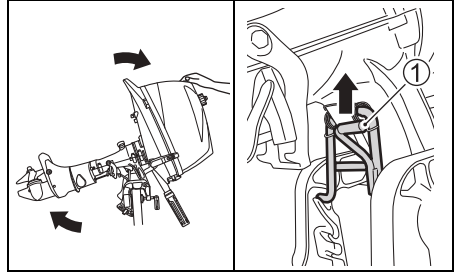

NOTICE

If you use the tilt up lock arm to hold the motor in the fully tilted position for trailering, the tilt up lock arm could release resulting in damage to the motor.

When trailering your boat, never use the tilt up lock arm to hold the motor in the fully tilted position.

Alternative power source

NOTICE

Your outboard motor or boat can be damaged if the outboard is not tilted out of the water and locked while the boat is being powered by an alternative power source.

Make sure that the outboard motor is tilted out of the water and locked whenever the boat is being powered by an alternative power source.

SHALLOW WATER POSITION

To set the motor in the shallow water position:

1. Shift into "NEUTRAL".
2. Slowly tilt the motor up until you hear it make a "click" sound.
3. Slowly lower the motor. It will stop in a position that is slightly tilted up from the normal trim angle.

NOTE:

There are two shallow water positions. Use whichever one is appropriate, depending on the depth of the water.

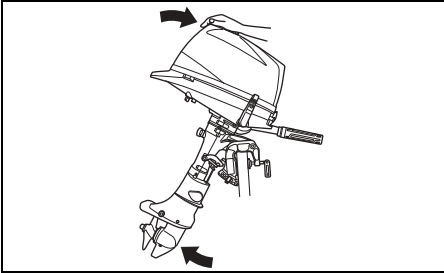

To lower the motor back down:

1. Pull the motor toward you to position (A) until you hear it make a "click" sound.
2. Slowly let the motor down.

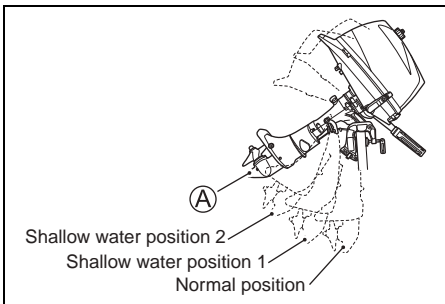

▲ WARNING

When the shallow water position is used, the tilt lock will not work. As a result, forces such as from propeller thrust during operation in "REVERSE" gear, rapid deceleration, and striking an underwater object can cause the motor to lift out of the water, resulting in personal injury.

When using the shallow water position, proceed with caution and only at very low speeds.

▲ WARNING

If you do not take proper precautions when shallow water position is used, fuel may leak out from the built-in fuel tank.

- Do not fill the fuel tank above the upper limit.
- When an engine stops, tighten the air vent screw on the fuel filler cap of the built-in fuel tank.
- Lower the motor back down to normal position before opening the air vent screw on the fuel filler cap of the built-in fuel tank.

INSPECTION BEFORE BOATING

⚠ WARNING

Failure to inspect your boat and motor before beginning a trip can be hazardous.

Before boating, always perform the inspections described in this section.

It is important to make sure that your boat and motor are in good condition and that you are properly prepared for an emergency. Always perform the following checks before you begin boating:

- **Make sure that you have enough fuel for the intended run.**

Fuel capacity: 1.0 L (0.26/0.22 US/Imp. gal.)

⚠ WARNING

If you overfill the built-in fuel tank, fuel may overflow.

Do not fill the tank above the upper limit **A**.

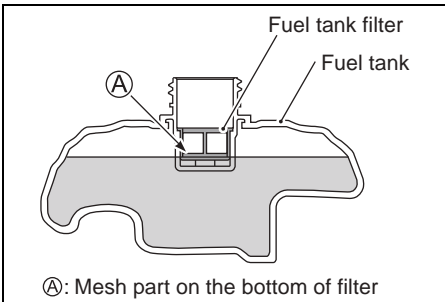
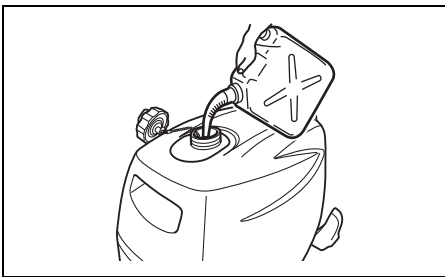

- Check the level of engine oil in the sump.

NOTICE

Running the engine with an insufficient amount of oil can cause serious engine damage.

Always check the oil level before each trip and add oil if necessary.

To check the engine oil level:

NOTE:

To avoid an incorrect assessment of engine oil level, check the level only when the engine has cooled.

1. Place the motor in a vertical position and remove the motor cover **1** by unlocking the lever **2** and **3**.

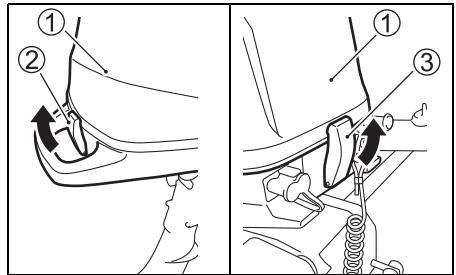

2. Remove the oil filler cap (dipstick) **4** and wipe oil off with a clean cloth.
3. To check the oil level, touch the filler cap threads onto the filler cap edge as shown. Do not screw the filler cap.

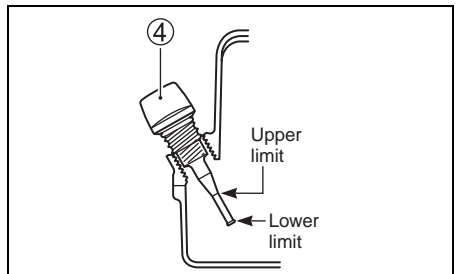

NOTE:

By Window ④, the volume of engine oil cannot be confirmed.

When the motor running, window ④ is a window confirming that engine oil lubricates.

Check the oil level by using the oil filler cap (dipstick).

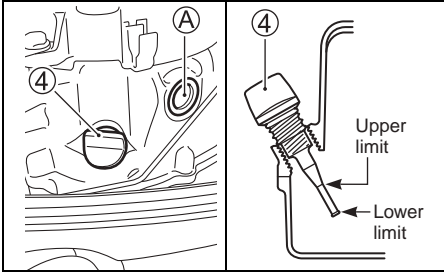

The oil on the filler cap (dipstick) should be between the upper and lower limits shown on the filler cap.

If the oil level indication is near the lower limit, add enough oil to raise the level to the upper limit.

NOTE:

If the engine oil is contaminated or discolored, replace with fresh engine oil (Refer to INSPECTION AND MAINTENANCE/Engine oil section).

To fill the engine oil:

1. Remove the oil filler cap (dipstick) ④ and wipe oil off with a clean cloth.
2. Fill the recommended engine oil to the upper level. To check the upper oil level, touch the filler cap threads onto the filler cap edge as shown. Do not screw the filler cap.

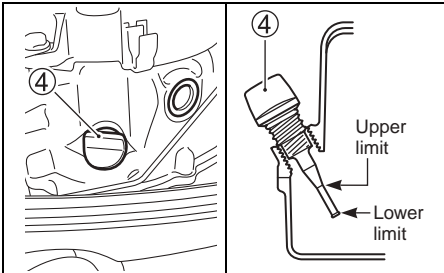

NOTICE

Running the engine with an excessive amount of oil can damage the engine.

Do not overfill the engine with oil.

3. Tighten the oil filler cap securely.

- Visually check the propeller to make sure it is not damaged.
- Make sure that the motor is securely mounted to the transom.
- Make sure that the tilt pin is securely installed in the proper position.
- Make sure the starter rope is free from any evidence of fraying or wear.
- Make sure you have the boating safety and emergency equipment on board.

BREAK-IN

Proper operation during this break-in period will help ensure maximum life and performance from your engine. The following guidelines will explain proper break-in procedures.

NOTICE

Failure to follow the break-in procedures described below can result in severe engine damage.

Be sure to follow the engine break-in procedures described below.

Break-in period: 10 hours

Break-in procedure

1. For the initial 2 hours:
Allow sufficient idling time (about 5 minutes) for the engine to warm up after cold engine starting.

NOTICE

Running at high speed without sufficient warm-up may cause severe engine damage such as piston seizure.

Always allow sufficient idling time (5 minutes) for the engine to warm-up before running at high speed.

After warming up, run the engine at idling speed or the lowest in-gear speed for about 15 minutes.

During the remaining 1 hour and 45 minutes, if safe boating conditions permit, operate the engine in gear at less than 1/2 (half) throttle (3000 r/min.).

NOTE:

You may throttle up beyond the recommended operating range to plane your boat, then immediately reduce the throttle to the recommended operating range.

2. For the next 1 hour:
Safe boating conditions permitting, operate the engine in gear at 4000 r/min. or at three-quarter throttle. Avoid running the engine at full throttle.
3. Remaining 7 hours:
Safe boating conditions permitting, operate the engine in gear at desired engine speed. You may occasionally use full throttle; however do not operate the engine continuously at full throttle for more than 5 minutes at any time.

NOTICE

Running continuously at full throttle for more than 5 minutes at a time during the last 7 hours of break-in operation may cause severe engine damage such as seizure.

During the last 7 hours of break-in operation, do not operate at wide open throttle for more than 5 minutes at a time.

OPERATION

BEFORE ATTEMPTING TO START THE ENGINE

Using BUILT-IN FUEL TANK

1. The motor has been lowered into the water.
2. Twist the air-vent screw on the fuel tank cap counterclockwise to open the vent.

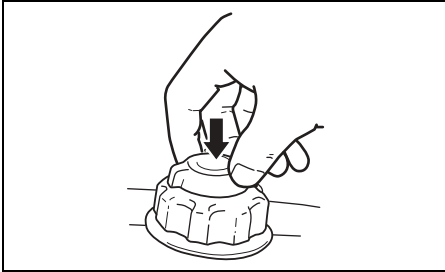

3. Turn the fuel cock lever to left.

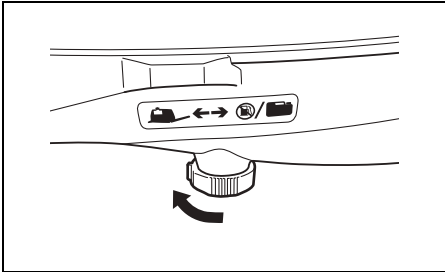

NOTE:

When turning the fuel cock lever to left, fuel flow from the built-in tank.

4. Disconnect the fuel line of the separate fuel tank from the fuel connector on the engine side (If the separate fuel tank used). Install the fuel connector cap ① to fuel connector.

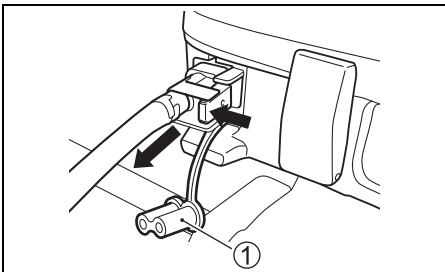

NOTE:

When using the built-in fuel tank, disconnect the fuel line of the separate fuel tank from the fuel connector on the engine side. If not, the fuel from the built-in tank may not flow correctly.

5. Make sure that the motor is in "NEUTRAL".

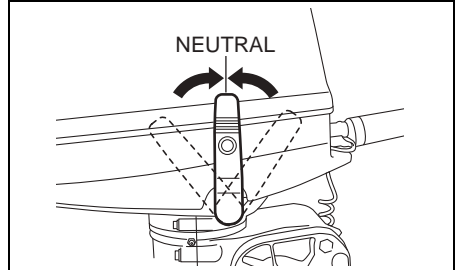

NOTICE

When the motor is in gear, the recoil starter cannot be operated and attempting to use it can damage the recoil starter.

Make sure that the motor is in "NEUTRAL" before pulling the recoil starter rope.

6. The lock plate is in place and the end of the emergency stop switch cord is attached to a part of your body.

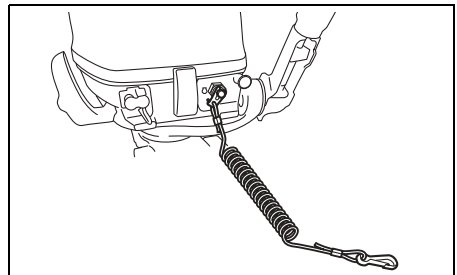

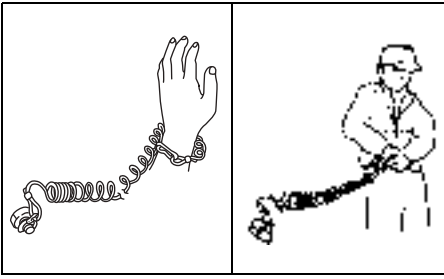

⚠ WARNING

Failure to properly attach the emergency stop switch cord or to take proper precautions to help ensure that the emergency stop switch works as intended may result in serious injury or death to the operator or passengers.

Always take the following precautions:

- Make sure that the emergency stop switch cord is fastened securely to the operator's wrist or to an appropriate clothing area (belt etc.).
- Ensure that no obstructions impede or restrict emergency stop switch operation.
- Be careful not to pull the stop switch cord or knock out the lock plate during normal operation. The motor will stop abruptly, and the loss of forward motion may unexpectedly throw occupants forward.

NOTE:

A spare plastic lock plate is provided for temporary use only. Remove it from the cord and place it in a safe place on board your boat. If you lose or break the emergency stop switch cord/lock plate assembly, replace it as soon as possible so that you can resume normal use of the emergency stop switch.

Using SEPARATE FUEL TANK (For DF5A/DF6A)

1. The motor has been lowered into the water.
2. The fuel hose is securely connected to the fuel tank and the motor.

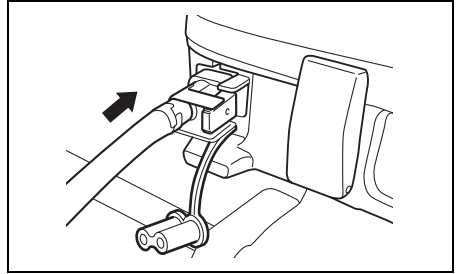

3. Twist the both air-vent screws on the fuel tank caps counterclockwise to open the vent.

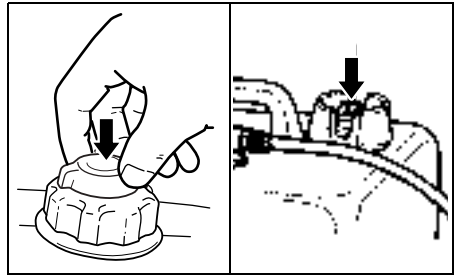

4. Turn the fuel cock lever to right.

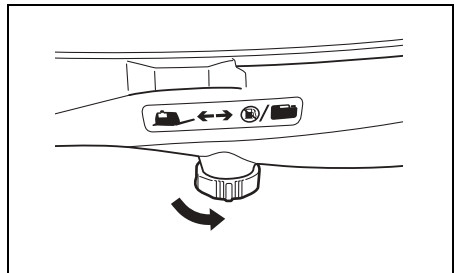

NOTE:

When using the separate tank, turn the fuel cock lever to right to flow to the carburetor from the separate tank.

5. Make sure that the motor is in "NEUTRAL".

6. The lock plate is in place and the end of the emergency stop switch cord is attached to a part of your body.

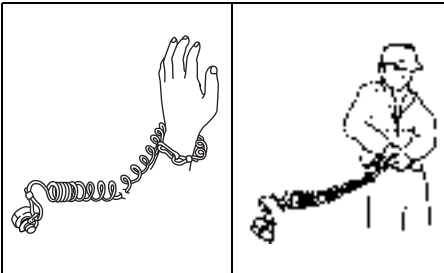
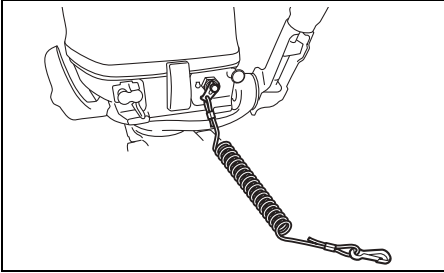

▲ WARNING

Failure to properly attach the emergency stop switch cord or to take proper precautions to help ensure that the emergency stop switch works as intended may result in serious injury or death to the operator or passengers.

Always take the following precautions:

- Make sure that the emergency stop switch cord is fastened securely to the operator's wrist or to an appropriate clothing area (belt etc.).
- Ensure that no obstructions impede or restrict emergency stop switch operation.
- Be careful not to pull the stop switch cord or knock out the lock plate during normal operation. The motor will stop abruptly, and the loss of forward motion may unexpectedly throw occupants forward.

NOTE:

A spare plastic lock plate is provided for temporary use only. Remove it from the cord and place it in a safe place on board your boat. If you lose or break the emergency stop switch cord/lock plate assembly, replace it as soon as possible so that you can resume normal use of the emergency stop switch.

7. Squeeze the fuel line priming bulb several times until you feel resistance.

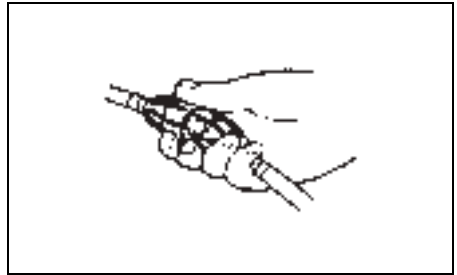

NOTE:

Do not squeeze the priming bulb while the engine is running, as the carburetor may overflow.

NOTE:

Only for DF5A/DF6A

When starting the engine on gasoline from the built-in fuel tank after the separate fuel tank becomes empty:

1. Disconnect the fuel line of the separate fuel tank from the fuel connector on the engine side.
Install the fuel connector cap to fuel connector.
2. Pour fuel into the built-in fuel tank and wait about 1/3 minute before starting.
3. Turn the fuel cock lever to left.

STARTING THE ENGINE

⚠ WARNING

Exhaust gas contains carbon monoxide, a dangerous gas that is difficult to detect because it is colorless and odorless. Breathing carbon monoxide can cause death or severe injury.

Never start the engine or let it run indoors or where there is little or no ventilation.

NOTE:

If the engine fails to start, check the emergency stop switch lock plate. If the lock plate is not in position, the engine cannot be started.

1. If the engine is cold:

Pull the choke knob ① fully out. Align the arrow mark on the throttle control grip ② with the position A.

If the engine is warm:

Align the arrow mark on the throttle control grip ② with the position A. Do not use the choke.

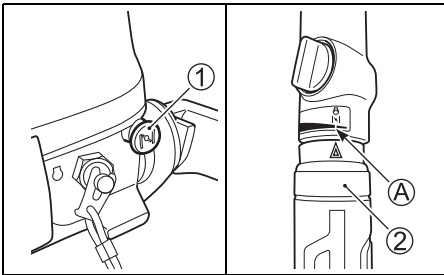

NOTE:

You may need to use the choke when restarting a warm engine. If your engine does not start quickly when warm, follow the procedure for cold starting.

2. Firmly grasp the starter grip ③ and pull slowly until resistance is felt. When you feel it engage, pull the rope sharply to start the engine. Do not release the rope when it is pulled out. Hold the rope and allow it to recoil slowly.

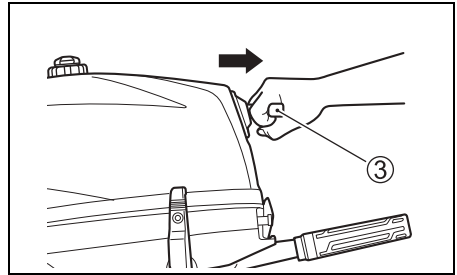

NOTICE

If you pull the starter grip while the engine is running, the starter system could be damaged.

Never pull the starter grip while the engine is running.

3. After starting, use the throttle control grip ② to bring the engine to idle.
4. Push the choke knob in.

NOTE:

In cold weather, you may have to leave the choke knob out for a longer period of time for the engine to warm up.

5. Warm up the engine for about 5 minutes.

NOTICE

Operating the engine at high RPM or “wide open throttle” immediately after starting the engine without allowing the engine to warm up may cause engine failure.

Always allow the engine to warm up sufficiently before operating it at high speeds.

Cooling water check

As soon as the engine starts, water should spray out of the pilot water hole, indicating that the water pump and cooling system are working properly. If you notice that water does not spray out of the pilot water hole, stop the engine as soon as possible and consult your authorized Suzuki Marine Dealer.

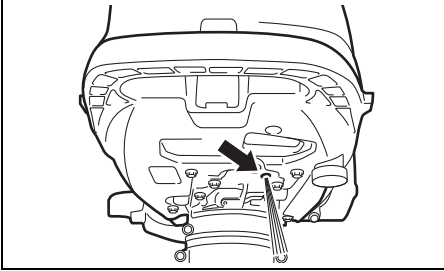

NOTICE

Never operate your outboard motor when there is no water coming out of the pilot water hole, or severe damage can result.

After starting the engine, check to make sure that there is water coming out of the pilot water hole.

⚠ WARNING

Operating the boat when the emergency stop switch is not operating properly can be hazardous.

Before starting off, check to make sure that the emergency stop switch operates properly.

EMERGENCY STARTING

If you must get the engine running, but are unable to do so because of starter system failure, you can use the emergency starting procedure to start the engine.

⚠ WARNING

If you touch electrical components when rope-starting the engine, you can get a severe electrical shock.

When rope-starting the engine, be careful not to touch electrical components such as ignition coils or spark plug leads.

To start the engine when the starter system fails:

1. Pull out the emergency stop switch lock plate.

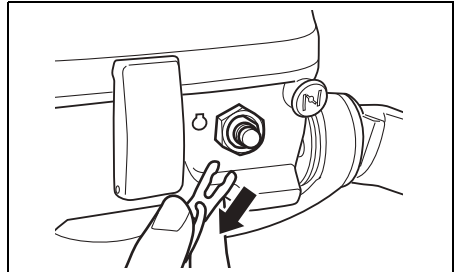

2. Shift the motor into "NEUTRAL".

⚠ WARNING

When you use the emergency starting procedure, the start-in-gear protection system will not work. If the shift lever is not in the "NEUTRAL" position, the boat can start off unexpectedly when the engine is started, throwing occupants or causing an accident.

Make sure that the shift lever is in the "NEUTRAL" position before attempting to start the motor using the emergency starting procedure.

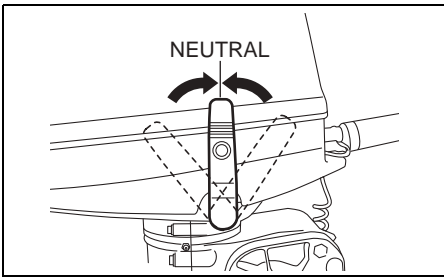

3. Turn the fuel cock lever to the right (off position).

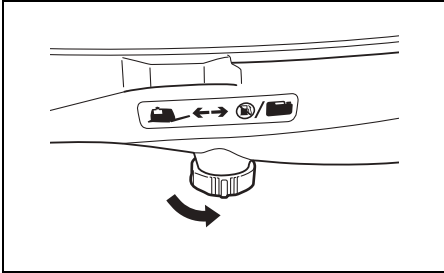

4. Tighten the air-vent screw on fuel filler cap.

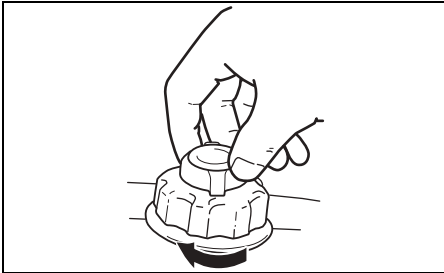

5. Remove the motor cover.
6. Loosen the lock nut ①, take off the NSI cable from the recoil starter.

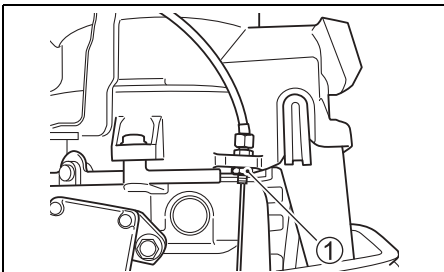

7. Separate the end of cable from the recoil starter.

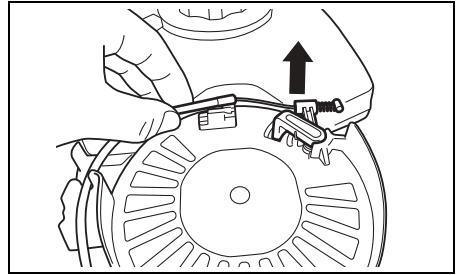

8. Put the NSI cable inside of the side cover.

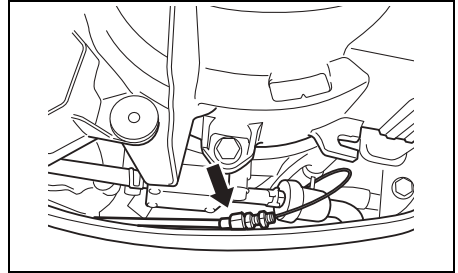

9. Remove the bolts securing the fuel tank in place.

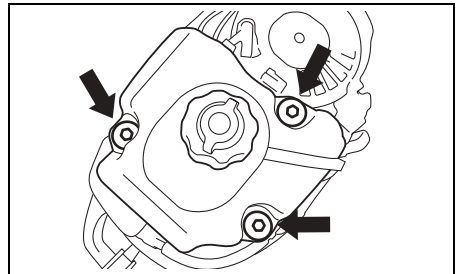

10. Remove a washer ② from fuel tank.

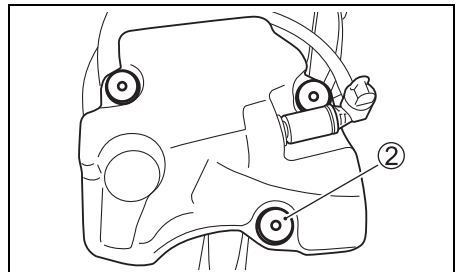

11. Disconnect the throttle cables from clamp ③.

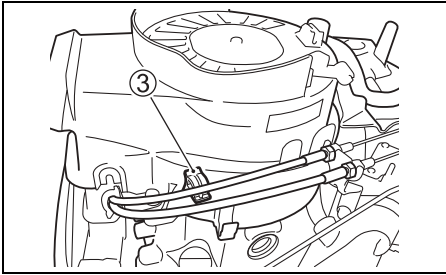

12. Remove the bolts securing the recoil starter in place.

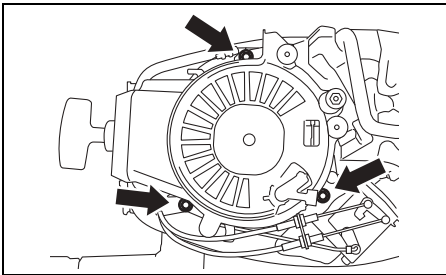

13. Install the clamp ④ with recoil starter securing bolt.
Bind the throttle cables to the clamp ④.

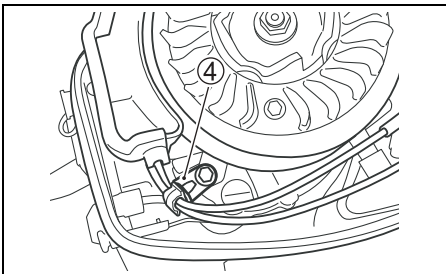

14. Remove the air vent duct ⑤.

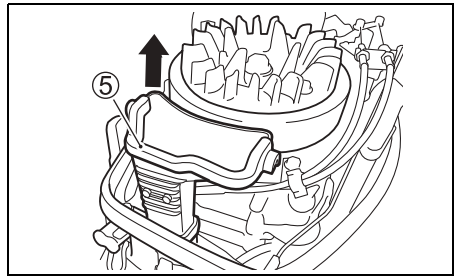

15. Remove the cushion ⑥.

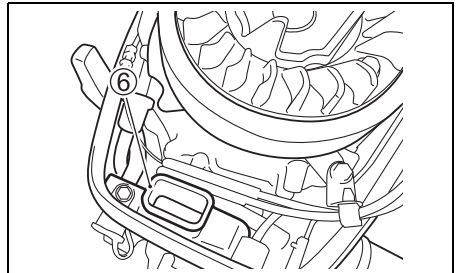

16. Remove the bolts securing the cooling fan ⑦ in place.

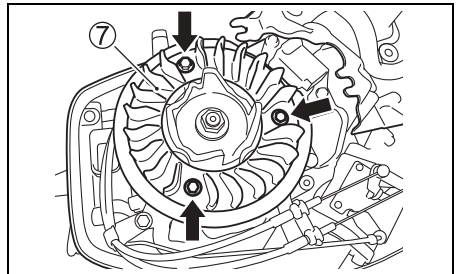

17. Put the fuel tank in place by aligning the position of fuel cock ⑧ with that of fuel cock lever ⑨.

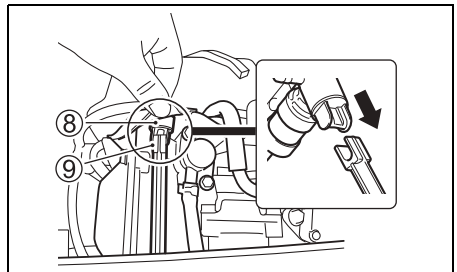

18. Fuel tank is secured with two bolts.

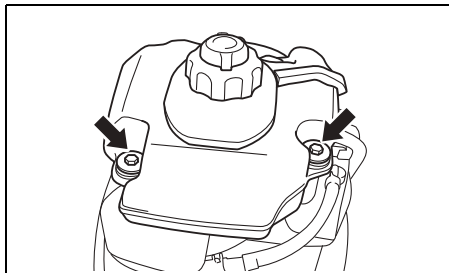

19. Turn the fuel cock lever to the left (on position).

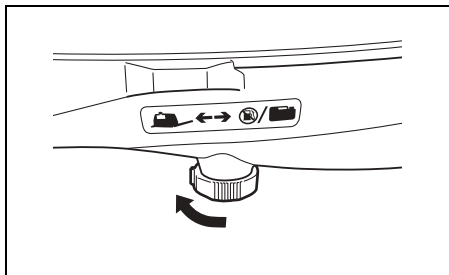

20. Twist the air-vent screw on the fuel tank cap counterclockwise to open the vent.



21. Tie a knot in one end of the emergency starter rope located in the tool kit. Tie the other end around the screw-driver handle in the tool kit.
22. Hook the knotted end of the rope in the pulley notch and wind the rope around the pulley in a clockwise direction.
23. Put the emergency stop switch lock plate in place.
24. After following steps of the normal starting procedure, pull the emergency starter rope sharply to start the engine.

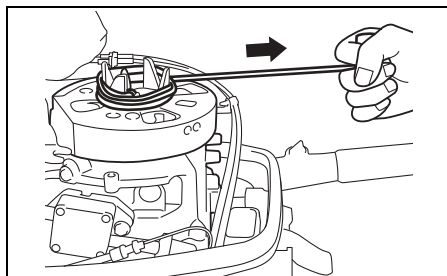

▲ WARNING

If you attempt to reinstall the recoil starter assembly or motor cover after starting the engine you can be injured.

Do not attempt to reinstall the recoil starter assembly or motor cover after starting the engine.

▲ WARNING

When the engine is running, there are many moving parts that could cause severe personal injury.

When the engine is running, keep your hands, hair, clothing, etc., away from the engine.

NOTE:

Be sure to have the starter system repaired as soon as possible. You should not continue to use the emergency starting procedure for routine engine starting.

SHIFTING AND SPEED CONTROL

NOTICE

Severe engine damage may occur if (a) engine speed is not allowed to return to idle and boat speed is not reduced when shifting from "FORWARD" to "REVERSE" or from "REVERSE" to "FORWARD", or (b) care is not taken when operating the boat in reverse.

Always allow the engine speed to return to idle before shifting. Exercise caution and use minimal speed when operating the boat in reverse. Be sure the handle/shift lever is in the desired position before accelerating.

NOTICE

If you shift gears when the engine is not running, the shifting mechanism can be damaged.

Avoid shifting gears when the engine is not running.

Shifting

To shift the motor into "FORWARD", set the throttle control grip to the idle position and pull the shift lever towards you firmly.

To shift into "REVERSE", set the throttle to the idle position, and push the shift lever away from you firmly.

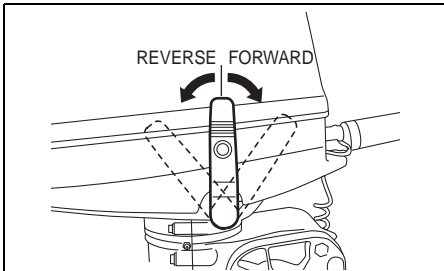

Speed Control

After shifting, control the engine speed by twisting the throttle control grip.

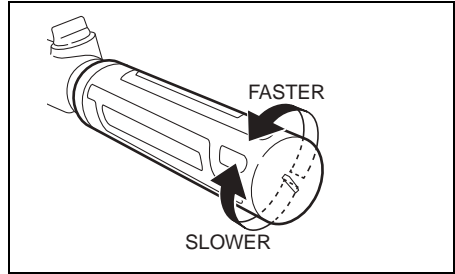

STOPPING THE ENGINE

NOTE:

When it is necessary to stop the engine in an emergency, pull the emergency stop switch lock plate out of the emergency stop switch by pulling the emergency stop switch cord.

To stop the engine:

1. Turn the throttle control grip to the idle position.
2. Shift into "NEUTRAL".
3. After operating at full throttle, cool off the engine a few minutes by allowing it to idle or troll at low speed.
4. Push and hold in the stop button (A) until the engine stops.

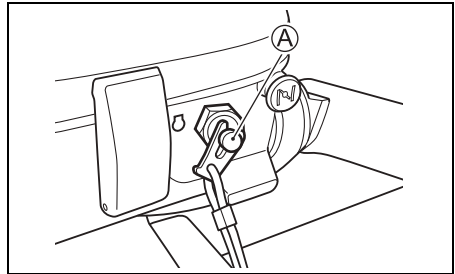

5. After stopping the engine, turn the fuel cock lever to right.
6. After stopping the engine, disconnect the fuel connector from outboard motor. (if using separate fuel tank).

⚠ WARNING

If you leave the motor stopped for a long period of time with the fuel line connected or the fuel cock lever in the on position, fuel can leak out.

Disconnect the fuel line and turn the fuel cock lever to the off position whenever you leave the motor stopped for a long period of time.

7. Turn the air-vent screw on the fuel tank cap clockwise to shut the vent.

NOTE:

To make sure that the emergency stop switch operates properly, stop the engine occasionally by pulling out the lock plate, while operating the engine at idling speed.

MOORING

The motor should be tilted up out of the water when you moor the boat in shallow water or if the motor will not be used for some time, to protect it from damage by underwater obstacles at low tide or corrosion from salt water.

Refer to the TILT UP LOCK ARM section for details on how to tilt up the motor.

⚠ WARNING

If you leave the motor tilted up for a long period of time with the fuel line connected, fuel can leak out.

Disconnect the fuel line whenever you leave the motor tilted up for a long period of time.

NOTICE

Improperly securing your boat may cause damage to your boat or motor, or other property damage.

Do not allow your motor to rub against quay walls, piers or other boats when the boat is tied up.

OPERATION IN SHALLOW WATER

When operating your outboard motor in shallow water, use the shallow water position to tilt the motor slightly from the normal trim angle. When using the shallow water position, however, you should only operate the motor at slow speeds. Refer to the SHALLOW WATER POSITION section.

⚠ WARNING

When the shallow water position is used, the tilt lock will not work. As a result, forces such as from propeller thrust during operation in "REVERSE" gear, rapid deceleration, and striking an underwater object can cause the motor to lift out of the water, resulting in personal injury.

When using the shallow water position, proceed with caution and only at very low speeds.

NOTICE

If you do not take proper precautions when operating your boat in shallow water, your outboard motor or boat could be damaged.

- When you operate your motor in shallow water using the shallow water position, make sure that the water intake holes remain in the water at all times and that water is always spraying out of the water discharge hole.
- Do not allow your motor to hit bottom, particularly when operating in "REVERSE" gear, or serious damage can result. When the motor hits bottom while operating in "REVERSE" gear, the shock acts directly on the transom, and both the motor and the boat could be damaged.

OPERATION IN SALT WATER

After operating the motor in salt water, you should flush the water passages with clean, fresh water as outlined in the FLUSHING THE WATER PASSAGES section. If you do not flush the water passages, salt can corrode the motor and shorten its life.

OPERATION IN FREEZING WEATHER

When operating your outboard motor in freezing temperatures, you should keep the lower unit submerged in the water at all times.

When taking motor out of the water, stand it up in a vertical position until the cooling system drains completely.

NOTICE

If you leave your outboard motor out of the water in freezing temperatures with water still in the cooling system, the water can freeze and expand, causing severe damage to the motor.

When your outboard is in the water in freezing temperatures, keep the lower unit submerged in the water at all times. When the motor is stored out of the water in freezing temperatures stand it up in the vertical position so that the cooling system drains completely.

MOTOR REMOVAL AND TRANSPORTING

MOTOR REMOVAL

1. Make sure that the engine has stopped completely.
2. Turn the fuel cock lever to right.
3. Tighten the built-in fuel tank cap and its air-vent screw.
4. Remove the fuel hose from the motor (if provided).

NOTE:

When the fuel hose is disconnected from the fuel connector, fix a connector plug cap to the fuel connector.

5. Drain the gasoline from the carburetor as follows:
 - (1) Remove the motor cover.
 - (2) Loosen the carburetor drain screw (A) and drain the gasoline into a suitable container.

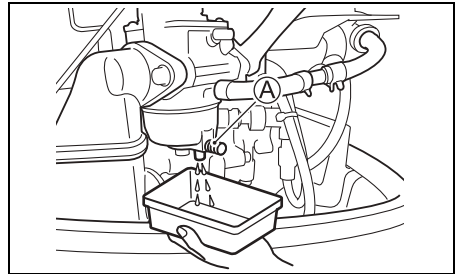

▲ WARNING

Gasoline is extremely flammable and toxic. It can cause a fire and can be hazardous to people and pets.

Use a proper, safe container to store any gasoline drained from the outboard motor. Keep gasoline away from sparks, flames, people, and pets.

(3) After draining, retighten the drain screw.

6. Remove the mounting bolts.
7. Loosen the clamp screws.
8. Lift the motor off the transom.
9. Stand the motor vertically and drain the water from the lower unit.
10. To carry, hold the motor by gripping the hand grip and rear handle in the engine lower cover.

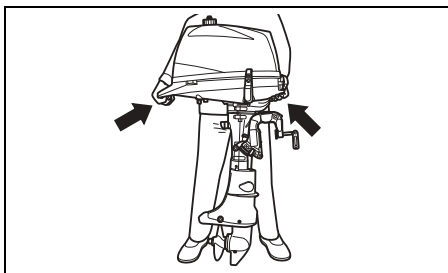
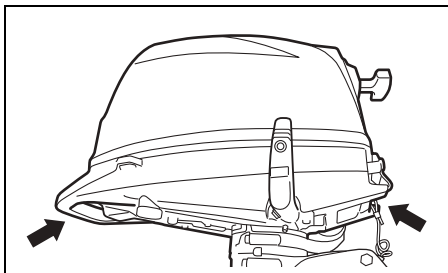

MOTOR TRANSPORTING

When transporting the motor, place the motor either vertically or horizontally.

Vertical transport:

Incline the handle backward, and attach the motor to the carrier by securing the clamp bracket with two clamp screws.

Never use display stand for transportation of the motor.

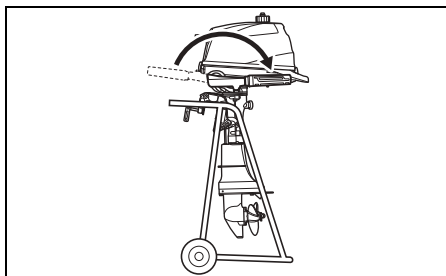

Horizontal transport:

Incline the tiller handle backward and rest the motor on a case protector with the port side, starboard side or front side downwards as shown.

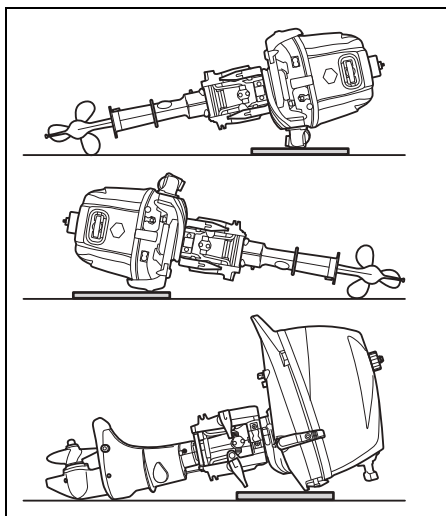

▲ WARNING

Spilled fuel or fuel vapor can cause a fire and is hazardous to health.

Always take the following precautions:

- Drain the fuel from the fuel line and carburetor before transporting the boat/outboard motor and before removing the motor from the boat.
- DO NOT lay motor on its side without draining fuel.
- Keep the motor away from open flames or sparks.
- Wipe up spilled fuel immediately.

NOTICE

If you do not take proper precautions when transporting your outboard, it can be damaged.

- Do not rest the engine in any of the positions shown below, as water and oil may enter the cylinder through the exhaust port or the outer casings may be damaged.
- Do not place the engine on its side before the cooling water has drained from it completely, as water may enter the cylinder through the exhaust port and cause problems.

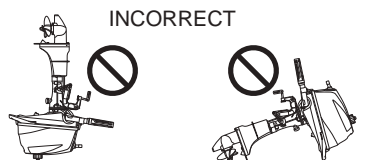

NOTICE

If you let the lower unit of your outboard sit higher than the power head during transporting or storing, water may trickle into the power head, causing damage to the engine.

Never let the lower unit sit higher than the power head when transporting or storing your outboard.

TRAILERING

When trailering your boat with the motor attached, keep the motor in the normal operating position unless there is not enough ground clearance. If you need more ground clearance, trailer the motor in a tilted position using a transom saver bar or similar device to support the weight of the motor.

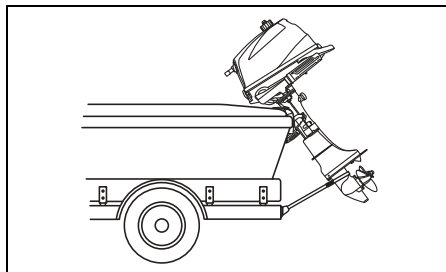

NOTICE

If you use the tilt up lock arm to hold the motor in the fully tilted up position when trailering the boat, towing motion or poor road surfaces may cause unexpected tilt lock release, resulting in damage to the motor and the tilt lock mechanism.

Never use the tilt up lock arm to hold the motor in the fully tilted up position when trailering the boat. Use a transom saver bar or similar device to support the weight of the motor.

INSPECTION AND MAINTENANCE

MAINTENANCE SCHEDULE

It is important to inspect and maintain your outboard motor regularly. Follow the chart below. At each interval, be sure to perform the indicated service. Maintenance intervals should be judged by number of hours or number of months, whichever comes first.

WARNING

Exhaust gas contains carbon monoxide, a dangerous gas that is difficult to detect because it is colorless and odorless. Breathing carbon monoxide can cause death or severe injury.

Never start the engine or let it run indoors or where there is little or no ventilation.

Interval Item to be serviced	Initial 20 hrs. or 1 month	Every 100 hrs. or 12 months	Every 200 hrs. or 12 months	Every 300 hrs. or 36 months
Spark plug	–	I	I	I
Breather & Fuel line	I	I	I	I
Engine oil	R	R	R	R
Gear oil	R	R	R	R
Lubrication	I	I	I	I
Anodes	I	I	I	I
* Anodes (internal cylinder block/cylinder head)	–	I	I	I
* Engine oil filter	R	–	R	–
* Fuel filter	I	I	I	I
	Replace every 400 hours or 2 years.			
* Carburetor	I	I	I	I
* Idle speed	I	–	I	–
* Valve lash	I	–	I	–
* Water pump	–	–	I	–
* Water pump impeller	–	–	I	R
* Propeller nut & pin	I	I	I	I
* Bolts & Nuts	T	T	T	T
* Thermostat	–	I	I	I

I: Inspect and clean, adjust, lubricate, or replace, if necessary T: Tighten R: Replace

▲ WARNING

Improper maintenance or failure to perform recommended maintenance can be hazardous. Poor maintenance or lack of maintenance increases the chance of an accident or equipment damage.

Be sure to have maintenance performed according to the schedule in the above chart. Suzuki recommends that only your authorized Suzuki marine dealer or a qualified service mechanic perform maintenance on those items in the chart above which are marked with an asterisk (*). You may perform maintenance on the unmarked items by referring to the instructions in this section if you have mechanical experience. If you are not sure whether you can successfully complete any of the unmarked maintenance jobs, ask your authorized Suzuki marine dealer to do the maintenance for you.

▲ WARNING

The safety of you and your passengers depends on how well you maintain your outboard motor.

Follow all inspection and maintenance instructions carefully. If you do not have prior mechanical experience, do not attempt to perform maintenance on your outboard motor. You could be injured or may damage the motor.

NOTICE

The maintenance intervals in the chart are designed for normal usage of your outboard motor. If your outboard motor is used under severe conditions as outlined below, you may need to perform maintenance more often than indicated in the chart.

- Frequent full throttle operation
- Prolonged continuous operation at the maximum speed
- Prolonged continuous operation at idling speed or trolling speed
- Frequent operation in muddy, silty, sandy, acidic or shallow water
- Operation without appropriate warmup
- Frequent abrupt acceleration and deceleration
- Frequent shift operation

Failure to perform maintenance more frequently could result in damage.

Consult your authorized Suzuki marine dealer regarding appropriate maintenance intervals for your usage conditions. When replacing parts on your outboard motor, Suzuki strongly recommends that you use genuine Suzuki parts or their equivalent.

SPARK PLUG

Your outboard motor comes equipped with the following "standard" spark plug for normal usage.

NGK CPR6EA-9	Standard
--------------	----------

NOTICE

Non-resistor types of spark plugs will interfere with the function of the electronic ignition, causing misfiring, or causing problems with other electronic boat equipment and accessories.

Use **ONLY** resistor type spark plugs in your outboard motor.

A normally operating spark plug is very light-brown in color. If the standard plug is not suitable for your operating, consult your authorized Suzuki Marine Dealer.

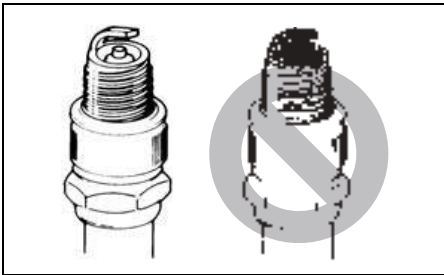

NOTICE

Use of improper spark plugs or improperly tightening spark plugs can cause severe engine damage.

- Do not experiment with other spark plug brands unless you can determine that they are directly equivalent to the specified brand, or you may experience engine damage which will not be covered under warranty. Note that aftermarket cross-reference charts may not be accurate.
- To install a spark plug; seat it as far as possible by hand, then use a wrench to tighten it to either the recommended torque setting or the specified rotation angle.

Tightening torque	
10 – 12 N·m (1.0 – 1.2 kg·m, 7.2 – 8.7 lb·ft)	
Rotation angle	
New plug	1/2 – 3/4 of a turn
Re-use plug	1/12 – 1/8 of a turn

- Do not overtighten or cross-thread a spark plug, as this will damage the aluminum threads of the cylinder head.

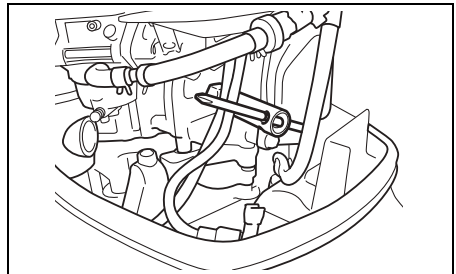

To maintain a strong spark, you should clean and adjust the plugs at the intervals shown in the maintenance chart. Remove carbon deposits from the spark plugs using a small wire brush or spark plug cleaner, and adjust the gap according to the following chart:

Spark plug gap	0.8 – 0.9 mm (0.031 – 0.035 in.)
----------------	-------------------------------------

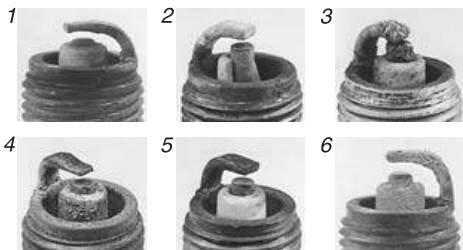
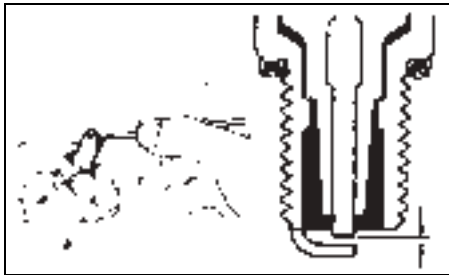

1. Excessive wear 2. Breakage 3. Melting
4. Erosion 5. Yellow deposits 6. Oxidation

NOTE:

If the spark plug condition is found as shown in the illustration above, ensure it is replaced with new one. Otherwise, it will cause difficulty in starting the engine, increase fuel consumption, and result in engine troubles.

BREATHER AND FUEL LINE

Inspect the breather and fuel line for leaks, cracks, swelling, or other damage. If the breather and fuel line is damaged in any way, it must be replaced. Consult your authorized Suzuki Marine Dealer if it is necessary to replace them.

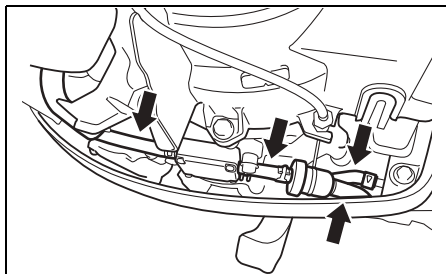
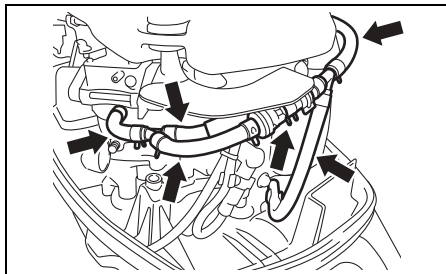
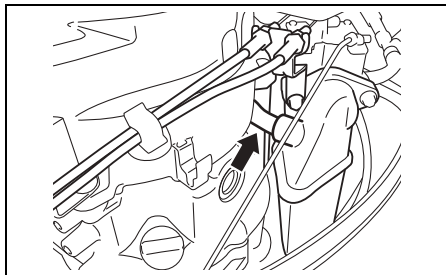

▲ WARNING

Fuel leakage can contribute to an explosion or fire, resulting in serious personal injury.

Have your authorized Suzuki Marine Dealer replace the fuel line if there is any evidence of leaking, cracking or swelling.

ENGINE OIL

▲ WARNING

Never perform any **ENGINE OIL** procedure with the motor running, as serious injury can occur.

The motor must be shut off before any **ENGINE OIL** procedures are performed.

NOTICE

Extended trolling can reduce oil life. Your engine may be damaged if you do not change engine oil more frequently under this type of use.

Change your engine oil more frequently if your engine is used for extended trolling.

Engine oil change

The oil should be changed when engine is warm so that the oil will drain thoroughly from the engine.

To change the engine oil:

1. Place the motor in a vertical position and remove the motor cover.
2. Remove the oil filler cap.

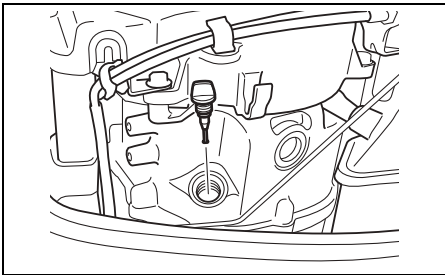

3. Fully steer the motor to the starboard side.
4. Place a drain pan under the engine oil drain plug.

▲ CAUTION

The engine oil temperature may be high enough to burn your fingers when the drain plug is loosened.

Wait until the drain plug is cool enough to touch with bare hands before removing it.

5. Remove the engine oil drain plug and gasket, then let the engine oil drain.

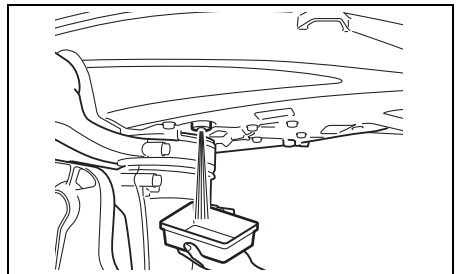
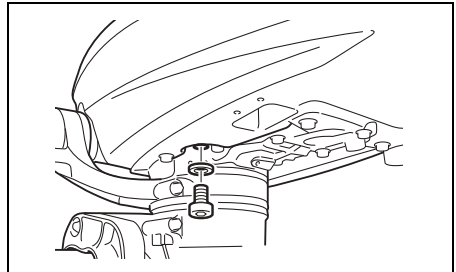

6. After draining, secure the engine oil drain plug with a new gasket.

NOTICE

A previously-used gasket may leak, resulting in engine damage.

Do not re-use gaskets. Be sure to always use new gaskets.

7. Fill with recommended engine oil to the upper level.

Oil capacity: 0.7 L

8. Check the engine oil level. Refer to the INSPECTION BEFORE BOATING section.

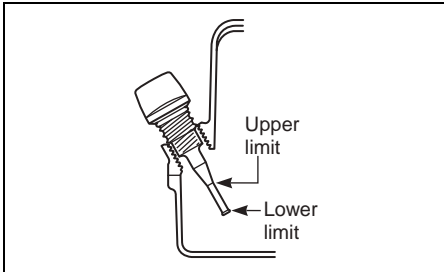

NOTE:

To avoid incorrect measurement of engine oil level, check oil level only when the engine has cooled.

9. Reinstall the oil filler cap.

▲ WARNING

Engine oil can cause injury to people or pets. Repeated, prolonged contact with used engine oil may cause skin cancer. Even brief contact with used oil may irritate skin.

- Keep new and used oil away from children and pets.
- Wear a long-sleeve shirt and waterproof gloves when handling oil.
- Wash with soap if oil contacts your skin.
- Launder any clothing or rags that are wet with oil.

NOTE:

Recycle or properly dispose of used engine oil. Do not throw it in the trash, or pour it on the ground, down a drain, or into the water.

GEAR OIL

To check the gear oil level, remove the upper oil level plug and look into the hole. The oil level should be at the bottom edge of the hole. If the oil level is low, add the specified gear oil until the level reaches the bottom edge of the hole. Then, reinstall and tighten the plug.

To change the gear oil:

1. Make sure the motor is in an upright position. Place a drain pan under the lower casing.
2. Remove the gear oil drain plug ①, then remove the gear oil level plug ②.

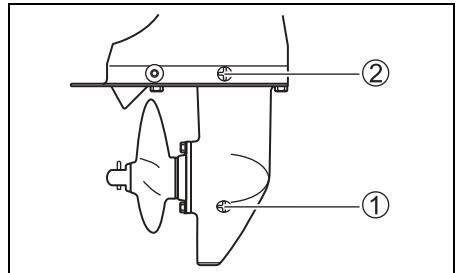

3. After the oil has drained completely, inject the specified gear oil into the lower drain hole until it just starts to come out of the upper hole. Approximately 190 ml (6.4/6.7 US/Imp. oz.) of oil will be required.
4. Reinstall and tighten the gear oil level plug ②, then quickly reinstall and tighten the gear oil drain plug ①.

NOTE:

To avoid insufficient injection of gear oil, check the gear oil level 10 minutes after doing the procedure in the step 4. If the oil level is low, slowly inject the gear oil up to the correct level.

⚠ WARNING

Gear oil can cause injury to people or pets. Repeated, prolonged contact with used gear oil may cause skin cancer. Even brief contact with used oil may irritate skin.

- Keep new and used oil away from children and pets.
- Wear a long-sleeve shirt and waterproof gloves when handling oil.
- Wash with soap if oil contacts your skin.
- Launder any clothing or rags that are wet with oil.

NOTE:

Recycle or properly dispose of used gear oil. Do not throw it in the trash, or pour it on the ground, down a drain, or into the water.

NOTICE

If fishing line wraps around the rotating propeller shaft, the propeller shaft oil seal can become damaged and can allow water to enter the gear case causing severe damage.

If the gear oil has a milky color, it is contaminated with water. Immediately contact your authorized Suzuki marine dealer for advice. Do not operate your outboard until the oil is changed and the cause of the contamination is corrected.

LUBRICATION

Proper lubrication is important for the safe, smooth operation and long life of each working part of your outboard motor. The following chart shows the lubrication points of your motor and the recommended lubricant:

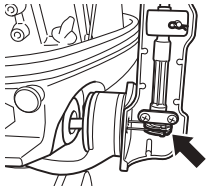
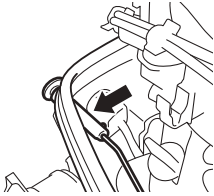
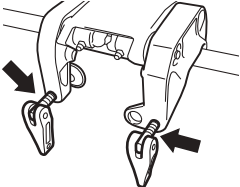
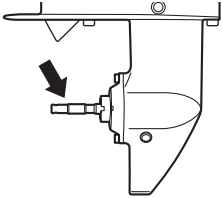
LOCATION	LUBRICANT
 <p data-bbox="642 504 797 531">Throttle linkage</p>	<p data-bbox="871 639 1021 715">Marine-grade water resistant grease</p>
 <p data-bbox="658 745 779 772">Choke knob</p>	
 <p data-bbox="654 986 786 1013">Clamp screw</p>	
 <p data-bbox="647 1233 797 1257">Propeller shaft</p>	

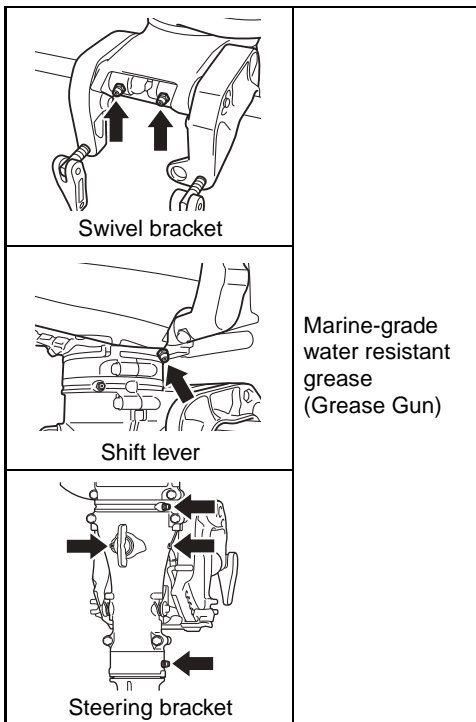

NOTE:

Before applying grease through the steering bracket grease nipple, lock the motor in the fully tilted up position.

NOTE:

There are two types of grease nipples which are open hole type and nipple type on the steering bracket. Use the suitable grease gun for grease application. If no appropriate tool available, consult your authorized Suzuki Marine Dealer.

ANODES

The motor is protected from exterior corrosion by anodes. These pieces of anodes control electrolysis and prevent corrosion. The anodes will corrode in place of the parts they are protecting. You should periodically inspect each of the anodes and replace them when 2/3 of the metal has corroded away.

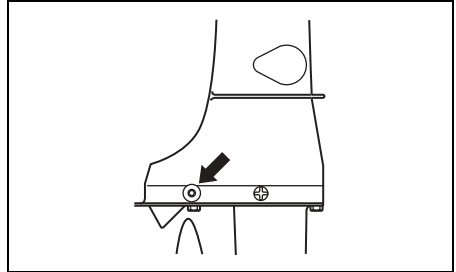

NOTICE

If anodes are not properly maintained, underwater aluminum surfaces (such as the lower unit) will suffer galvanic corrosion damage.

- Periodically inspect anodes to make sure they have not become detached.
- Do not paint anodes, as this will render them ineffective.
- Periodically clean anodes with a wire brush to remove any coating which might decrease their protective ability.

NOTE:

Consult your authorized Suzuki Marine Dealer for inspection and replacement of internal anodes attached to the cylinder block/cylinder head.

FUEL FILTER

The fuel filter must be inspected by authorized Suzuki Marine Dealer periodically. Inspect fuel filter at initial 20 hours (1 month). Inspect fuel filter at every 100 hours (12 months). Replace fuel filter with a new one at every 400 hours (2 years).

ENGINE OIL FILTER

The engine oil filter must be changed by authorized Suzuki Marine Dealer periodically. Replace engine oil filter with a new one at initial 20 hours (1 month). Replace engine oil filter with a new one at every 200 hours (12 months).

FLUSHING THE WATER PASSAGES

After operation in muddy, brackish, or salt water, you should flush the water passages and motor surface with clean, fresh water. If you do not flush the water passages, salt can corrode the motor and shorten its life. Flush the water passages as follows.

ENGINE RUNNING – Vertical position –

Suzuki recommends that you flush the water passages by using this method.

WARNING

Exhaust gas contains carbon monoxide, a dangerous gas that is difficult to detect because it is colorless and odorless. Breathing carbon monoxide can cause death or severe injury.

Never start the engine or let it run indoors or where there is little or no ventilation.

WARNING

Failure to take proper precautions when flushing the water passages can be hazardous.

When flushing the water passages, always take the following precautions:

- Make sure that the engine remains in NEUTRAL. If shifted into gear, the propeller shaft will turn and could cause severe personal injury.
- Make sure the motor is properly clamped to a secure stand or boat, and remain in attendance until flushing is completed.
- Keep children and pets away from the area, and stay clear of all moving parts.

NOTICE

Severe engine damage can occur in as little as 15 seconds if the engine is started without supplying water to the cooling system.

Never start the motor without supplying water to the cooling system.

1. Shift the motor into “NEUTRAL”.
2. Remove the propeller from the motor. Refer to the PROPELLER SELECTION AND INSTALLATION section.
3. Install the motor on a large container such as an empty 200 liter drum.

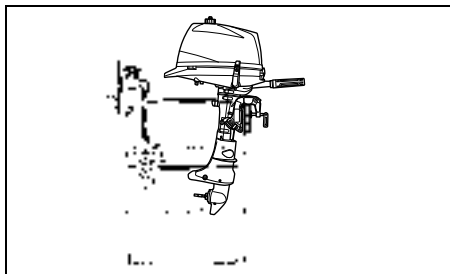

4. Fill the container with clean, fresh water as illustrated.
5. Start the motor and let it idle for about five minutes. This will clean the salt water out of the cooling system.
6. Shut off the motor. Remove the motor from the container and maintain motor in a vertical position until the engine has drained completely. Reinstall the propeller as outlined in the PROPELLER SELECTION AND INSTALLATION section.
7. Clean the motor surface and apply a coat of automotive wax on the external finish of the motor.

ENGINE NOT RUNNING

– Vertical position –

To flush the water passages, you must obtain an optional flushing attachment from your authorized Suzuki Marine Dealer.

1. Remove the flush plug and install the flushing attachment ①.

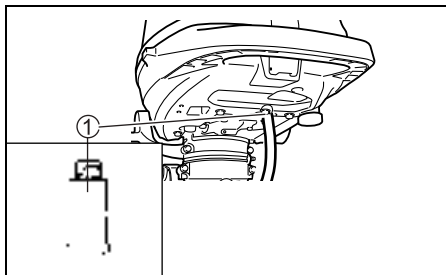

2. Connect a garden hose to the flushing attachment.
3. Turn on the water to obtain a good water flow. Flush the engine for about five minutes.
4. Turn off the water.
5. Remove the hose and flushing attachment then reinstall the plug into the flushing port.
6. Leave the motor in a vertical position until the engine is drained completely.

ENGINE NOT RUNNING

– Full tilt up position –

1. Raise the engine to the full tilt up position.
2. Follow the “ENGINE NOT RUNNING – Vertical position” instructions.
DO NOT RUN ENGINE IN THE FULL TILT UP POSITION.
3. Lower the motor to a vertical position until the engine is drained completely.

SUBMERGED MOTOR

A motor that has been accidentally submerged in water must be overhauled as soon as possible to prevent corrosion. In the event that your motor is accidentally submerged, take the following steps:

1. Get the motor out of the water as soon as possible.
2. Wash it thoroughly with fresh water to completely remove all salt, mud, and seaweed.
3. Remove the spark plugs. Drain the water from the cylinders through the spark plug holes by manually turning the flywheel several times.
4. Check if any water is evident in the engine oil. If water is seen, remove the oil drain plug and drain the oil. After draining, tighten the oil drain plug.
5. Drain the fuel line and the carburetors.

WARNING

Gasoline is extremely flammable and toxic. It can cause a fire and can be hazardous to people and pets.

Keep flames and sparks away from gasoline. Dispose of unwanted fuel properly.

6. Pour engine oil into the engine through the spark plug holes and carburetors. Coat the engine inner parts with oil by turning the engine over with the emergency starter rope or recoil starter.

NOTICE

Severe engine damage may occur if you continue cranking the engine when you encounter friction or resistance.

If you encounter friction or resistance while cranking the engine, stop at once and do not attempt to start the engine until you find and correct the problem.

7. Take the motor to your authorized Suzuki Marine Dealer as soon as possible to be overhauled.

NOTICE

If the fuel supply is contaminated with water, engine damage may occur.

If the boat's fuel tank filler and vent were submerged, inspect the fuel supply to make sure it is not contaminated with water.

STORAGE PROCEDURE

MOTOR STORAGE

When storing your motor for a long period of time (for example, at the end of the boating season), it is recommended that you take your motor to your authorized Suzuki Marine Dealer. However, if you choose to prepare the motor for storage yourself, follow the procedure outlined below:

1. Change the gear oil as outlined in the GEAR OIL section.
2. Change the engine oil as outlined in the ENGINE OIL section.
3. Fill a fuel stabilizer to the fuel tank according to the instructions on the stabilizer can.
4. Flush the water passages in the motor thoroughly. Refer to the FLUSHING THE WATER PASSAGES section.
5. Readjust the water flow, run the engine at about 1500 r/min. in neutral for five minutes to distribute the stabilized fuel through the engine.
6. Stop the engine. Then turn off the water.
7. Turn the fuel cock lever to right.

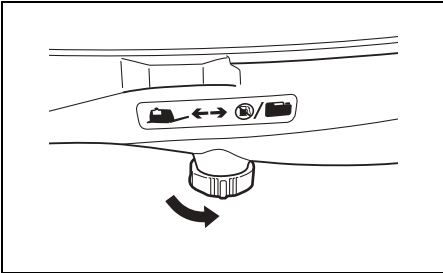

8. Disconnect the fuel line of the separate fuel tank from the fuel connector on the engine side (if provided). Install the fuel connector cap to fuel connector.
9. Lubricate all other specified parts. Refer to the LUBRICATION section.
10. Apply a coat of automotive wax on the external finish of the motor. If paint damage is evident, apply touch up paint before waxing.
11. Store the motor in an upright position in a dry, well-ventilated area.

▲ WARNING

When the engine is running, there are many moving parts that could cause severe personal injury.

When the engine is running, keep your hands, hair, clothing, etc., away from the engine.

NOTICE

Severe engine damage can occur in as little as 15 seconds if the engine is started without supplying water to the cooling system.

Never start the motor without supplying water to the cooling system.

AFTER STORAGE

When taking your motor out of storage, follow the procedure below to return it to operating condition:

1. Thoroughly clean the spark plugs. Replace them if necessary.
2. Check the gear-case oil level and if necessary, add gear oil according to the procedure outlined in the GEAR OIL section.
3. Lubricate all moving parts according to the LUBRICATION section.
4. Check the engine oil level.
5. Clean the motor and wax the painted surfaces.

TROUBLESHOOTING

This troubleshooting guide is provided to help you find the cause of common complaints.

NOTICE

Failure to troubleshoot a problem correctly can damage your outboard motor. Improper repairs or adjustments may damage the outboard motor instead of fixing it. Such damage may not be covered under warranty.

If you are not sure about the proper action to correct a problem, consult your Suzuki marine dealer.

Recoil starter will not operate:

- Shift lever is not in NEUTRAL.

Engine will not start (hard to start):

- Emergency stop switch lock plate is not in position.
- Fuel tank is empty.
- Fuel hose is not properly connected to engine. (For DF5A/DF6A)
- Fuel hose is kinked or pinched.
- Spark plug is fouled.

Engine idles unstably or stalls:

- Choke knob is not pushed in securely.
- Fuel hose is kinked or pinched.
- Spark plug is fouled.

Engine speed will not increase (Engine power is low):

- Engine is overloaded.
- Propeller is damaged.
- Propeller is not properly matched to loads.

Engine vibrates excessively:

- Engine mounting bolts or clamp screws are loose.
- Foreign object (seaweed etc.) is tangled on propeller.
- Propeller is damaged.

Engine overheats:

- Cooling water intake(s) are blocked.
- Engine is overloaded.
- Propeller is not properly matched to loads.

SPECIFICATIONS

Item	DF4A	DF5A	DF6A
Engine Type	4 Stroke		
Number of Cylinders	1		
Bore and Stroke	60.4 × 48.0 mm (2.38 × 1.89 in.)		
Piston Displacement	138 cm ³ (8.4 cu. in.)		
Maximum output	2.9 kW (4PS)	3.68 kW (5PS)	4.4 kW (6PS)
Full Throttle Operating Range	4000 – 5000 r/min. (min ⁻¹)	4500 – 5500 r/min. (min ⁻¹)	4750 – 5750 r/min. (min ⁻¹)
Ignition System	Digital CDI		
Engine Lubrication	Trochoid pump lubrication		
Engine Oil Capacity	0.7 L (0.74/0.62 US/Imp. qt.)		
Gear Oil Capacity	190 cm ³ (ml) (6.4/6.7 US/Imp. oz.)		
Build-in Fuel Tank Capacity	1.0 L (0.26/0.22 US/Imp. gal.)		
Spark Plug	NGK CPR6EA-9		
Spark Plug Gap	0.8 – 0.9 mm (0.031- 0.035 in.)		
Valve Lash	IN: 0.13 – 0.17 mm (0.005 – 0.007 in.) EX: 0.13 – 0.17 mm (0.005 – 0.007 in.)		
Fuel Type	Alcohol-free unleaded gasoline		
Minimum Fuel Octane Rating	91 (Research method)		

INFORMATION REGARDING EC – DIRECTIVE

(For European countries)

Sound Pressure Level

Regulation	Sound pressure level limit
2013 / 53 / EU	67 dB(A)

Sound pressure level is measured according to ISO 14509-1:2008.

Vibration on tiller handle grip

Standard	Vibration total value	Uncertainty
ICOMIA standard 38-94	3.0 m/s ²	0.6 m/s ²

The vibration measurement is performed specified in ISO 5349-1986.

WIRING DIAGRAM

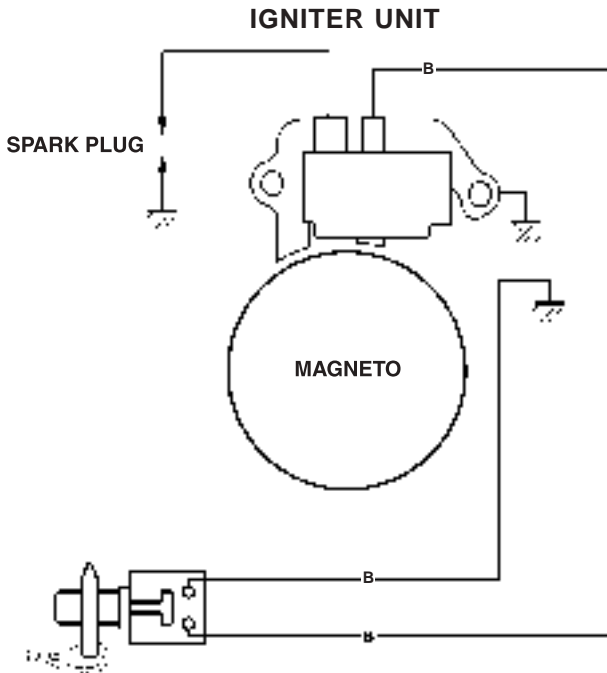

EMERGENCY STOP & ENGINE STOP SWITCH

Emergency stop switch: Lock plate IN→RUN

Lock plate OUT→STOP

Engine stop switch: Button pushed→STOP

Wire color
B : Black

Prepared by

SUZUKI MOTOR CORPORATION

January, 2016

Part No. 99011-97L00-055

Printed in Thailand

© COPYRIGHT SUZUKI MOTOR CORPORATION 2016