

DF2.5

OWNER'S MANUAL

IMPORTANT

▲ WARNING/ ▲ CAUTION/ NOTICE/ NOTE

Please read this manual and follow its instructions carefully. To emphasize special information, the symbol ▲ and the words **WARNING**, **CAUTION**, **NOTICE** and **NOTE** have special meanings. Pay special attention to the messages highlighted by these signal words.

▲ WARNING

Indicates a potential hazard that could result in death or serious injury.

▲ CAUTION

Indicates a potential hazard that could result in minor or moderate injury.

NOTICE

Indicates a potential hazard that could result in damage to the motor or boat.

NOTE:

Indicates special information to make maintenance easier or instructions clearer.



This symbol appears in various locations on your Suzuki product to refer you to important information in the owner's manual.

IMPORTANT NOTICE TO OWNERS

▲ WARNING

Failure to take the proper precautions may increase the risk of death or severe injury to you and your passengers.

- Prior to first-time use of your outboard motor, familiarize yourself thoroughly with the contents of this owner's manual. Be aware of all outboard motor features and all safety and maintenance requirements.
- Inspect the boat and motor before each trip. See the **INSPECTION BEFORE BOATING** section for important items.

- Become thoroughly familiar with all operating and handling characteristics of your boat and motor. Practice at low and moderate speeds until you are competent at handling the boat and motor. Do not attempt to operate at maximum performance until you are completely familiar with all of these characteristics.
- Carry boating safety and emergency equipment. This important equipment includes; flotation aids for each person (plus one throwable buoyant cushion in any boat 16 feet or longer), fire extinguisher, sound signaling device, visual distress signals, anchor, bilge pump, bucket, compass, emergency starter rope, extra fuel and oil, first aid kit, flashlight, food and water, mirror, paddles, tool kit, and transistor radio. Be sure you are carrying the equipment appropriate for your trip before launching.
- Never start the engine or let it run indoors or where there is little or no ventilation. Exhaust gas contains carbon monoxide, a gas that is colorless and odorless and can cause death or severe injury.
- Instruct your passengers on how to operate the boat, how to deal with emergencies, and how to operate safety and emergency equipment.
- Do not hold onto the motor cover or any other parts of your outboard motor while getting on or off your boat.
- Ensure that everyone wears a life jacket on board.
- Never operate the boat while under the influence of alcohol or other drugs.
- Distribute all weight load evenly in the boat.
- Have all scheduled maintenance performed. Consult your authorized Suzuki marine dealer as required.
- Do not modify or remove any outboard motor standard equipment. To do so may make the motor unsafe to use.
- Learn and obey all applicable navigation rules.
- Pay attention to all weather forecasts. Do not set out if weather is unsettled.
- Use extreme caution when purchasing replacement parts or accessories. Suzuki strongly recommends that you use only genuine Suzuki replacement parts/accessories or their equivalent. Inappropriate or poor quality replacement parts or accessories can create unsafe operating conditions.

- Never remove the flywheel cover (except for when emergency starting).

NOTE:

Mounting radio transceiver or navigational equipment antennae too close to the engine cowling can cause electrical noise interference. Suzuki recommends that antennae be mounted at least one meter (40 inches) away from the engine cowling.

This manual should be considered a permanent part of the outboard motor and should remain with the outboard motor when resold or otherwise transferred to a new owner or operator. Please read this manual carefully before operating your new Suzuki and review the manual from time to time. It contains important information on safety, operation, and maintenance.

FOREWORD

Thank you for choosing a Suzuki outboard motor. Please read this manual carefully and review it from time to time. It contains important information on safety, operation, and maintenance. A thorough understanding of the information presented in this manual will help you experience safe, enjoyable boating.

All information in this manual is based on the latest product information available at the time of publication. Due to improvements or other changes, there may be discrepancies between information in this manual and your outboard motor. Suzuki reserves the right to make changes at any time without notice.

TABLE OF CONTENTS

IDENTIFICATION NUMBER	
LOCATION	5
FUEL AND OIL	5
LOCATION OF SAFETY LABELS	7
LOCATION OF PARTS	8
MOTOR MOUNTING	9
PROPELLER SELECTION AND	
INSTALLATION	10
ADJUSTMENT	11
OPERATION OF TILTING	
SYSTEMS	14
INSPECTION BEFORE	
BOATING	16
BREAK-IN	18
OPERATION	19
MOTOR REMOVAL AND	
TRANSPORTING	26
INSPECTION AND	
MAINTENANCE	28
FLUSHING THE WATER	
PASSAGES	35
SUBMERGED MOTOR	36
STORAGE PROCEDURE	37
AFTER STORAGE	38
TROUBLESHOOTING	38
SPECIFICATIONS	39
INFORMATION REGARDING	
EC – DIRECTIVE	39

IDENTIFICATION NUMBER LOCATION

The model and identification numbers of your outboard motor are stamped on a plate attached to the driveshaft housing. It is important to know these numbers when you place a parts order or if your motor is stolen.

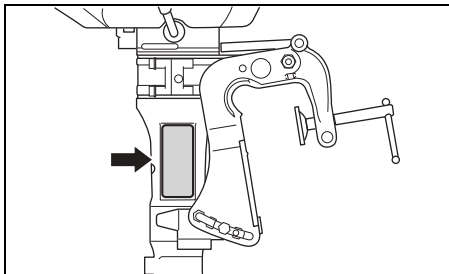

FUEL AND OIL

GASOLINE

Suzuki highly recommends that you use alcohol-free unleaded gasoline whenever possible, with a minimum octane rating of 91 (Research method). However, blends of unleaded gasoline and alcohol with equivalent octane content may be used, provided the guidelines that follow are met.

NOTICE

Use of leaded gasoline can cause engine damage. Use of improper or poor quality fuel can affect performance and may damage your motor and fuel system.

Use only unleaded gasoline. Do not use fuel having lower than the recommended octane, or fuel that may be stale or contaminated by dirt/water etc.

NOTE:

Oxygenated fuels are fuels which contain oxygen-carrying additives such as MTBE or alcohol.

Gasoline Containing MTBE

Unleaded gasoline containing MTBE (Methyl Tertiary Butyl Ether) may be used in your outboard motor if the MTBE content is not greater than 15%. This oxygenated fuel does not contain alcohol.

Gasoline/Ethanol Blends

Blends of unleaded gasoline and ethanol (grain alcohol), also known as gasohol, are commercially available in some areas. Gasoline containing a maximum of 10% ethanol may be used in your outboard motor without jeopardizing the New Outboard Motor Limited Warranty.

Gasoline/Methanol Blends

Blends of unleaded gasoline and methanol (wood alcohol) are also commercially available in some areas. **DO NOT USE** fuels containing more than 5% methanol under any circumstances. Fuel system damage or outboard motor performance problems resulting from the use of such fuels are not the responsibility of Suzuki and may not be covered under the New Outboard Motor Limited Warranty.

Fuel containing 5% or less methanol may be suitable for use in your outboard motor if they contain cosolvents and corrosion inhibitors.

Pump Labeling for Gasoline/Alcohol Blends

In some states, pumps that dispense gasoline/alcohol blends are required to be labeled for the type and percentage of alcohol content, and whether important additives are present. Such labels may provide enough information for you to determine if a particular blend of fuel meets the requirements listed above. In other states, pumps may not be clearly labeled as to the content or type of alcohol and additives. If you are not sure that the fuel you intend to use meets these requirements, check with the service station operator or the fuel suppliers.

NOTE:

If you are not satisfied with the operation or fuel economy of your outboard motor when you are using gasoline/alcohol blends, you should switch back to unleaded gasoline containing no alcohol.

Be sure that any gasoline/alcohol blend you use has octane ratings of at least 91 octane (Research method).

If engine pinging is experienced, substitute another brand as there are differences between brands.

Unleaded gasoline will extend spark plug life.

▲ WARNING

Gasoline is extremely flammable and toxic. It can cause a fire and can be hazardous to people and pets.

Always take the following precautions when refueling:

- Never permit anyone other than an adult to refill the fuel tank.
- If you use a portable fuel tank, always stop the motor and remove the fuel tank from the boat to refill it.
- Do not fill the fuel tank all the way to the top or fuel may overflow when it expands due to heating by the sun.
- Be careful not to spill fuel. If you do, wipe it up immediately.
- Do not smoke, and keep away from open flames and sparks.

NOTICE

Gasoline kept in the fuel tank for long periods of time will produce varnish and gum, which can damage the engine.

Always use fresh gasoline.

NOTICE

Fuels containing alcohol can cause paint damage, which is not covered under the New Outboard Motor Limited Warranty.

Be careful not to spill fuel containing alcohol while refueling. If fuel is spilled, wipe it up immediately.

ENGINE OIL

NOTICE

Use of poor quality engine oil can adversely affect engine performance and life.

Suzuki recommends that you use Suzuki Marine 4-Cycle Engine Oil or its equivalent.

Oil quality is a major contributor to your engine's performance and life. Always select good quality engine oil.

Suzuki recommends the use of SAE 10W-40 or 10W-30 SUZUKI MARINE 4-CYCLE ENGINE OIL. If SUZUKI MARINE 4-CYCLE ENGINE OIL is not available, select a NMMA certified FC-W oil or good quality 4-cycle motor oil from the following chart according to the average temperatures in your area.

API Classification	SAE Viscosity Grade	
SG		
SH	10W-40	
SJ		
SL	10W-30	
SM		
TEMP.	°C	°F
	-20	-4
	-10	14
	0	32
	10	50
	20	68
	30	86
	40	104

NOTE:

In very cold weather (below 5°C (41°F)), use SAE (or NMMA FC-W) 5W-30 for easier starting and smooth operation.

GEAR OIL

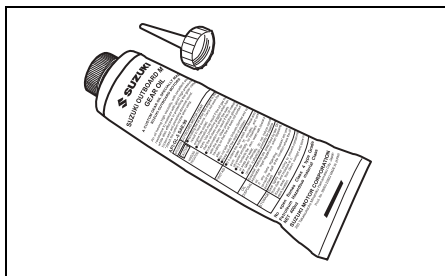

Suzuki recommends the use of SUZUKI OUTBOARD MOTOR GEAR OIL. If it is not available, use SAE 90 hypoid gear oil which is rated GL-5 under the API classification system.

LOCATION OF SAFETY LABELS

Read and follow all of the labels on your outboard motor or fuel tank. Make sure you understand all of the labels.

Keep the labels on your outboard motor or fuel tank. Do not remove them for any reason.

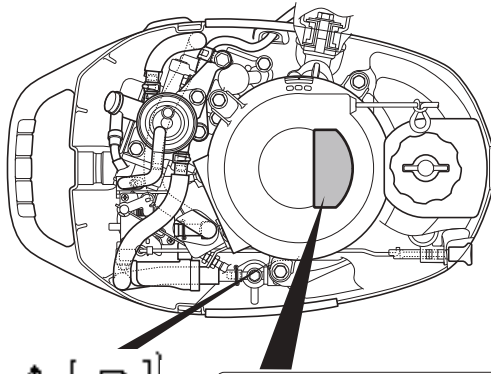

▲ WARNING AVERTISSEMENT





 • To avoid injury, when engine is running, keep your hands, hair, clothing, etc., away from engine.

 • See owner's manual for details.

• Pour éviter toute blessure, quand le moteur est en marche, éloigner les mains, les cheveux, les vêtements, etc. du moteur.

• Pour plus de détail, voir le manuel du propriétaire.

▲ WARNING AVERTISSEMENT

   

Fuel can leak creating a fire hazard if you tilt motor with loosened air vent screw or lay motor on its side.

- Tighten air vent screw before tilting up or carrying motor.
- Drain fuel completely from vapor separator or carburetor before laying motor on its side.
- See owner's manual for details.

Le carburant risque de fuir et de présenter un danger d'incendie si le moteur est incliné avec la vis de purge d'air desserrée ou placée sur le côté.

- Serrer la vis de l'évent d'air avant de basculer ou de déplacer le moteur.
- Vidanger entièrement le carburant du séparateur de vapeurs ou du carburateur avant de procéder.
- Pour plus de détail, voir le manuel du propriétaire.

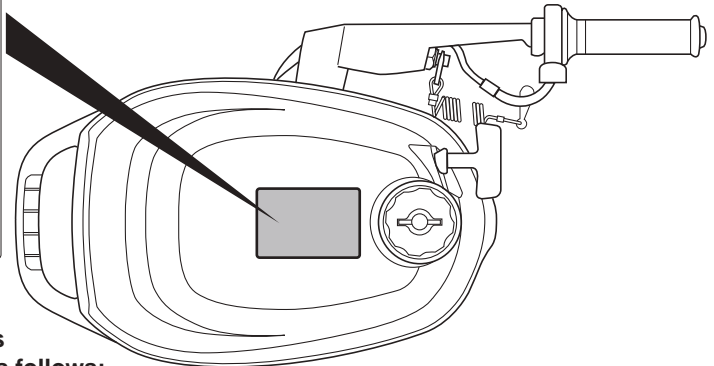

Label symbol meanings

These symbols mean as follows;



: General warning symbol
(Caution or Warning)



: Read owner's manual carefully



: Remote control lever/gear shift lever operation-two direction; Forward/Neutral/Reverse

• • : Engine start



: Hazard caused by fire



: Hazard caused by laying the motor on its side



: Hazard caused by rotating parts



: Hazard caused by fuel leak

LOCATION OF PARTS

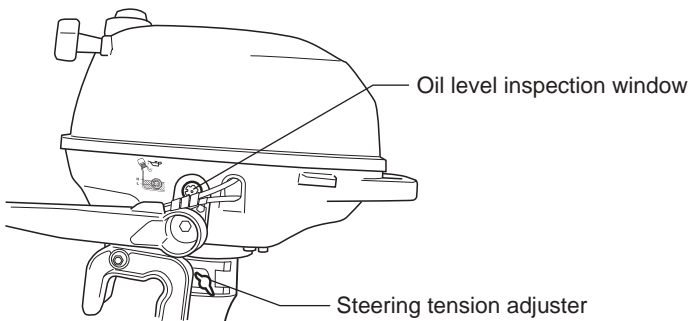
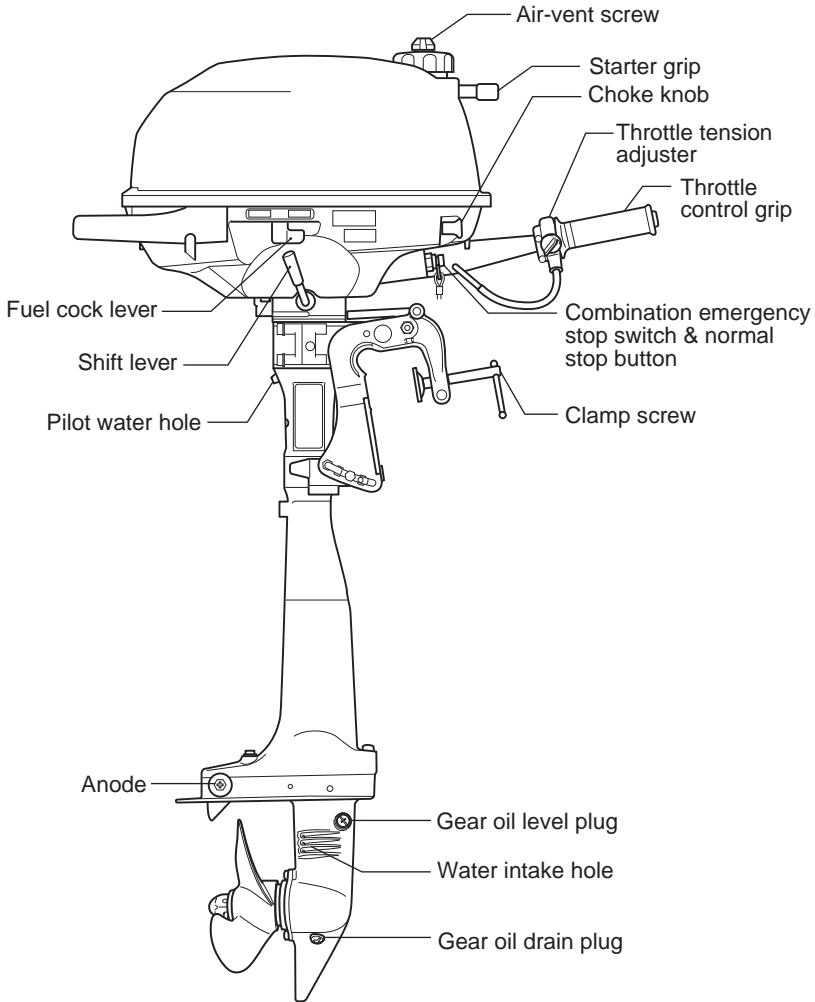

MOTOR MOUNTING

⚠ WARNING

Overpowering your boat can be hazardous. Excessive horsepower will have an adverse effect on hull safety and may cause operating/handling difficulties. The boat may also sustain stress and hull damage.

Never install an outboard motor with horsepower exceeding the manufacturer's recommended maximum horsepower listed on the boat's "Certification Plate". Contact your authorized Suzuki marine dealer if you are unable to locate the hull "Certificate Plate".

Proper transom height is important for good performance. A motor mounted on a transom that is too high causes the propeller to slip resulting in wasted power or overheating. A motor mounted on a transom that is too low will increase drag, causing reduced speed. Make sure that when the motor is lowered all the way down, the anti-cavitation plate is located 0 – 25 mm (0 – 1.0 in) below the bottom of the boat.

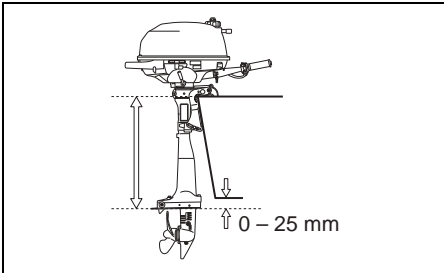

NOTICE

Operating your outboard motor with the anti-cavitation plate above water can cause overheating and severe damage to your outboard motor.

Do not operate your outboard motor with the anti-cavitation plate above water.

Center the motor on the transom and secure it by alternately tightening the clamp bracket screws by hand. Make sure you accurately center the motor, or the boat will pull to one side during operation.

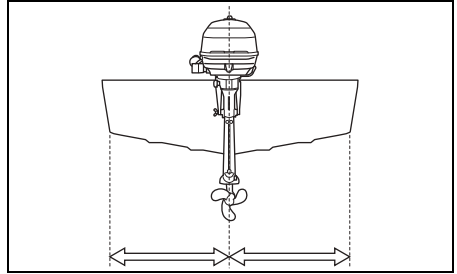

After installing the motor, check to make sure that steering and tilt movement are not obstructed by any part of the boat.

⚠ WARNING

If the motor is not properly secured to the transom, it can come off.

Be sure to attach a sturdy rope or cable between the boat and the hole on the clamp bracket for security. Occasionally check the clamp screws for tightness.

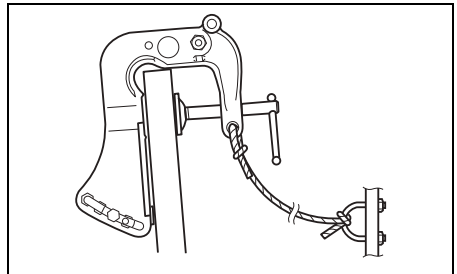

PROPELLER SELECTION AND INSTALLATION

PROPELLER SELECTION

It is essential to use a propeller on your outboard motor that is properly matched to your boat's operating characteristics. The speed of the engine when you operate your boat at full throttle depends on the propeller you use.

Excessive engine speed can seriously damage the motor, while low engine speed at full throttle will adversely affect performance. Your operating load will also affect propeller selection. Smaller loads generally require larger-pitch propellers; larger loads generally require smaller-pitch propellers. Your authorized Suzuki Marine Dealer will assist you in selecting a suitable propeller for your boat.

NOTICE

Installing a propeller with either too much or too little pitch will cause incorrect maximum engine speed, which may result in severe damage to the motor.

Ask your authorized Suzuki marine dealer to assist you in selecting a suitable propeller for your boat.

You can determine if your propeller is appropriate for use with your boat by using a tachometer to measure engine speed when operating your boat at full throttle, under minimum load conditions. If you are using an appropriate propeller, the engine speed will be within the following range:

Full throttle operating range	5 250 – 5 750 r/min. (min ⁻¹)
-------------------------------	---

If the engine speed is not within this range, consult your authorized Suzuki Marine Dealer to determine which propeller size is best for you.

PROPELLER INSTALLATION

⚠ WARNING

Failure to take proper precautions when installing or removing the propeller can result in severe personal injury.

When installing or removing the propeller:

- Always shift into "Neutral" and remove the emergency stop switch lock plate so that the motor cannot be started accidentally.
- Wear gloves to protect hands, and "lock" the propeller by placing a block of wood between the blades and the anti-cavitation plate.

There are two types of lower unit. It is necessary to install the propeller suitable for each unit.

To install a propeller on your outboard motor, use the following procedure:

ADJUSTMENT

TRIM ANGLE ADJUSTMENT

To help maintain steering stability and good performance, always maintain the proper trim angle as shown in the illustration. The appropriate trim angle varies depending on the combination of the boat, engine, and propeller, as well as operating conditions.

1. Coat the propeller shaft splines ① liberally with Suzuki water resistant grease to help prevent corrosion.
2. Place the stopper ② on the shaft.
3. Align the propeller ③ with the propeller shaft splines and slide the propeller onto the shaft.
4. Screw on the propeller nut ④ and tighten it.
5. Align the hole in the propeller nut with the hole in the shaft, then insert the cotter pin ⑤ and bend it so that it can't come off.

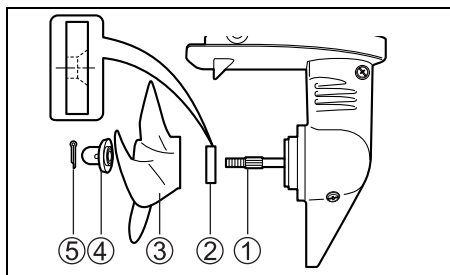

To remove the propeller, reverse the above procedure.

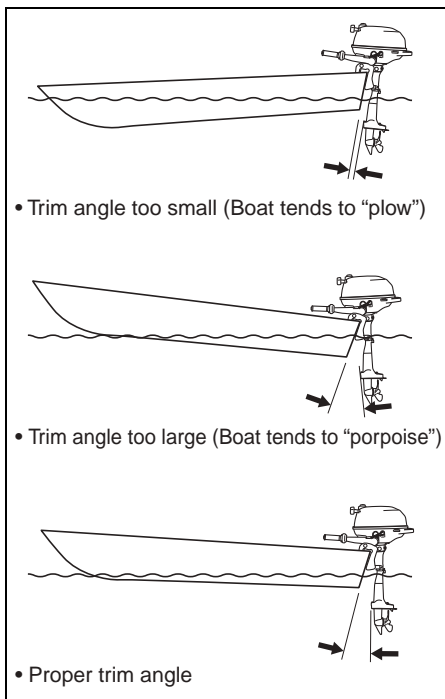

Make a test run in the boat to determine if the trim angle needs to be adjusted.

To adjust the trim angle:

1. Hold the motor in the fully tilted up position. (Refer to the TILT UP LOCK ARM section.)
2. Turn the lock nut ① counterclockwise while holding the nut ②. Loosen the nut ②.

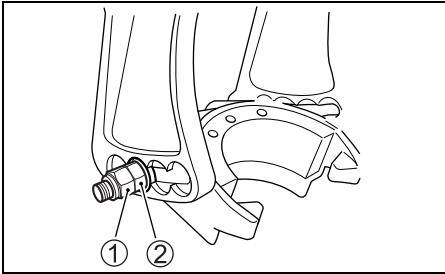

3. Pull the spacer ③ and tilt pin ④ out to the limit on both sides of the swivel bracket.

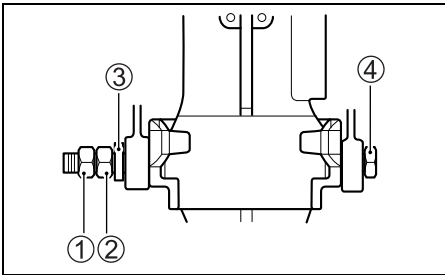

4. Reposition the tilt pin in the desired holes.
5. Push the spacer ③ and tilt pin ④ back in and tighten the nut ② and lock nut ①.
6. Lower the motor back down.

To lower the bow, move the pin towards the boat. To raise the bow, move the pin away from the boat.

▲ WARNING

Trim angle greatly affects steering stability. If the trim angle is too small, the boat may “plow” or “bow steer”. If the trim angle is too large, the boat may “chine walk” from side to side or “porpoise” up and down. These conditions, which result in loss of steering control, can cause occupants to be thrown overboard.

Always maintain proper trim angle based on the combination of your boat, engine, and propeller, as well as operating conditions.

▲ WARNING

If you operate the motor with the tilt pin removed, you may not be able to control steering as expected.

Do not operate the motor with the tilt pin removed.

STEERING TENSION ADJUSTMENT

The steering on your outboard motor should be smooth and not tight. Adjust the steering tension so that there is only a slight resistance to steering movement.

To increase the steering tension, turn the steering tension adjuster Ⓐ clockwise. To decrease the steering tension, turn the steering tension adjuster counterclockwise.

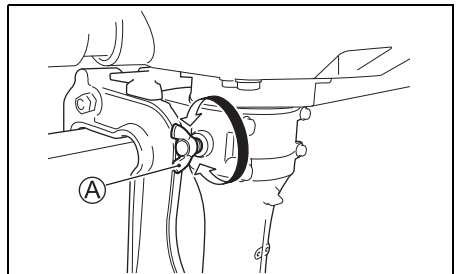

THROTTLE TENSION ADJUSTMENT

The tension of the throttle control grip can be adjusted according to your preference. To increase the tension, turn the throttle tension adjuster **A** clockwise. To decrease the tension, turn the adjuster counterclockwise.

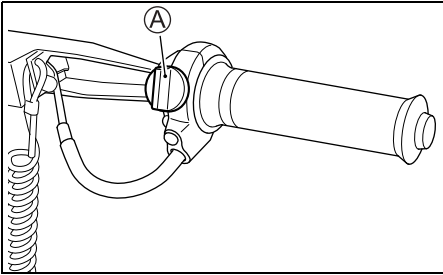

IDLE SPEED ADJUSTMENT

The idle speed of your outboard motor has been set by your dealer. If it is necessary to adjust the idle speed, use the following procedure:

The part of motor cover on DF2.5 is used as the holder of recoil starter grip, too. Idle speed adjustment is recommended to be made by the Suzuki authorized dealer. The motor cover can not be completely removed unless you first remove the starter grip. Please refer to the steps mentioned below.

1. Slightly remove the motor cover.
2. Tie a knot in the rope inside of the motor cover, in order to prevent the rope binding onto the recoil reel when the starter grip is off.

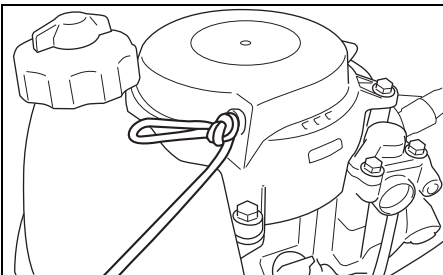

3. Take off the starter grip.
4. Completely remove the motor cover.

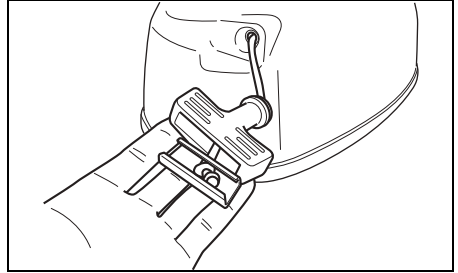

5. Install the starter grip holder to the end of rope.
6. Loosen a knot in the rope.

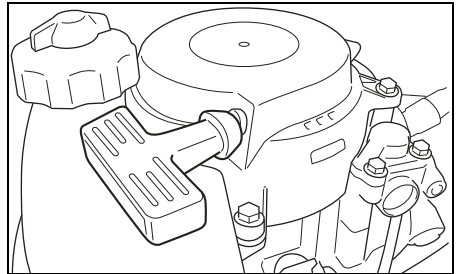

7. Start the engine. (Refer to starting the engine section)
8. Warm up the engine for about 5 minutes.

9. Make sure that the motor is in "NEUTRAL" and the throttle control grip is fully closed.
10. Turn the idle adjustment screw **A** clockwise to increase idle speed or counterclockwise to decrease idle speed.
11. Stop the engine.

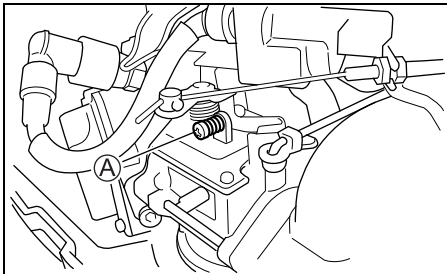

Idle speed (in Neutral)	1800 – 2000 r/min. (min ⁻¹)
----------------------------	--

12. Reinstall the motor cover by the opposite steps of the above 1 to 6.

NOTE:

If idle speed cannot be set within the specified range, contact your authorized Suzuki Marine Dealer.

OPERATION OF TILTING SYSTEMS

TILT UP LOCK ARM

The tilt up lock arm is used to hold the motor in the fully tilted up position.

▲ WARNING

If you do not take proper precautions when tilting up the motor, fuel may leak out.

For motors with a built-in fuel tank, be sure to turn the fuel cock lever to the right (off position) and tighten the air-vent screw on the fuel filler cap before tilting up the motor.

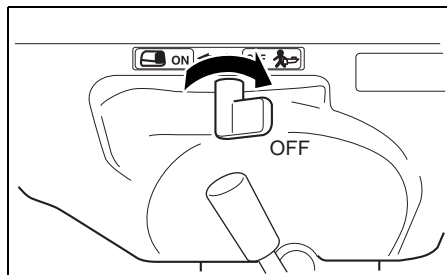

FULL TILT UP POSITION

To hold the motor in the fully raised position:

▲ WARNING

If you place your hands near the mounting bracket or under the motor when tilting it, your hands can be crushed if the motor slips from your grasp.

Never place your hands near the mounting bracket or under the motor when tilting it.

1. Shift into "NEUTRAL".
2. Turn the motor to the front, to free the reverse thrust stopper (A).

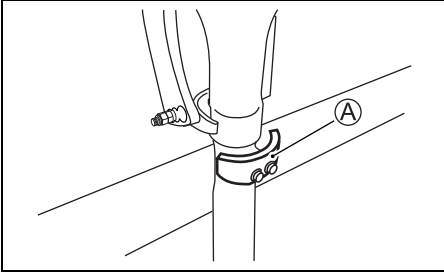

3. Turn the fuel cock lever to the right (off position) and tighten the air vent screw on the fuel filler cap.

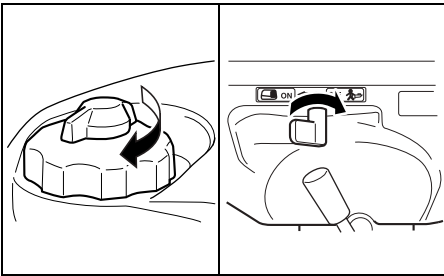

▲ WARNING

If you do not take proper precautions when tilting up the motor, fuel may leak out.

For motors with a built-in fuel tank, be sure to turn the fuel cock lever to the right (off position) and tighten the air-vent screw on the fuel filler cap before tilting up the motor.

4. Grab the handle on the back of the motor lower cover and tilt the motor all the way up until it is automatically locked in the fully tilted up position by the tilt up lock arm (1).

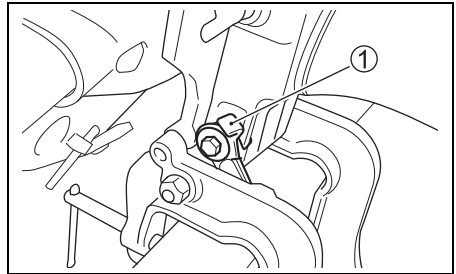
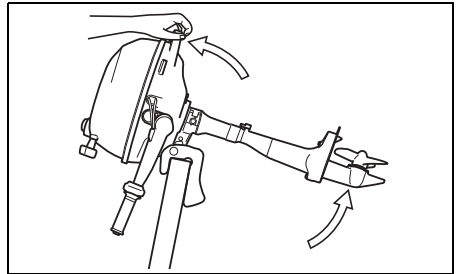

NOTICE

If you use the throttle grip handle to raise or lower the motor, the handle may break.

Never use the throttle grip handle to raise or lower the motor.

To lower the motor back down, pull the motor slightly toward you, pull up on the tilt up lock arm ① and slowly let the motor down.

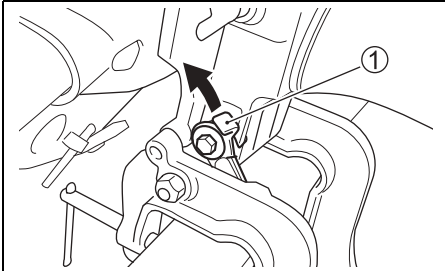
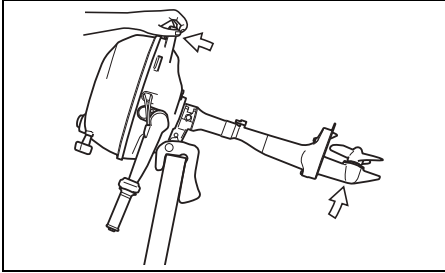

NOTICE

If you use the tilt up lock arm to hold the motor in the fully tilted position for trailering, the tilt up lock arm could release resulting in damage to the motor.

When trailering your boat, never use the tilt up lock arm to hold the motor in the fully tilted position.

INSPECTION BEFORE BOATING

▲ WARNING

Failure to inspect your boat and motor before beginning a trip can be hazardous.

Before boating, always perform the inspections described in this section.

It is important to make sure that your boat and motor are in good condition and that you are properly prepared for an emergency. Always perform the following checks before you begin boating:

- Make sure that you have enough fuel for the intended run.

Fuel capacity: 0.9 L (0.24/0.20 US/Imp. gal.)

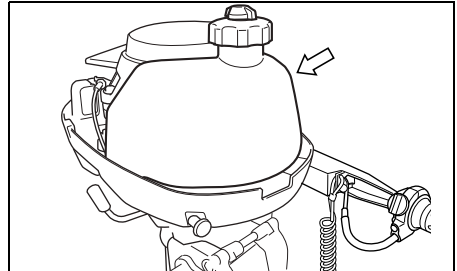

- Check the level of engine oil in the sump.

NOTICE

Running the engine with an insufficient amount of oil can cause serious engine damage.

Always check the oil level before each trip and add oil if necessary.

To check the engine oil level:

NOTE:

To avoid an incorrect assessment of engine oil level, check the level only when the engine has cooled.

1. Place the motor in a vertical position.
2. Check the engine oil level through the oil level inspection window ①.
The oil should be between the upper and lower limits.

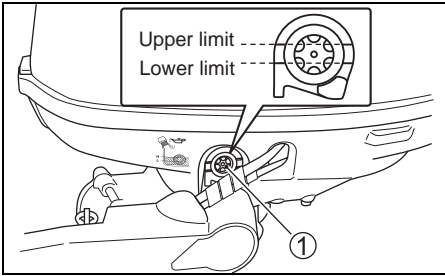

NOTE:

If the engine oil is contaminated or discolored, replace with fresh engine oil (Refer to INSPECTION AND MAINTENANCE/Engine oil section).

Seeing the window ①, add enough oil to raise the level to the upper limit.

To add the engine oil:

1. Remove the motor cover by unlocking the fasteners ② and ③.

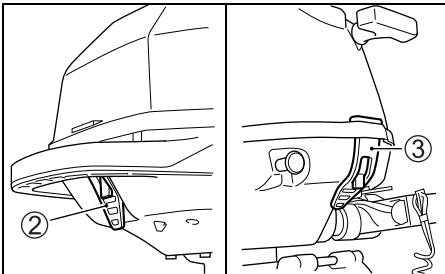

2. Remove the oil filler cap ④.

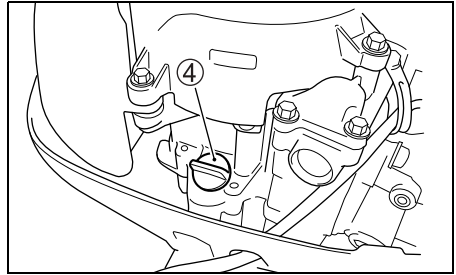

3. Add the recommended engine oil until the oil level reaches the upper limit.

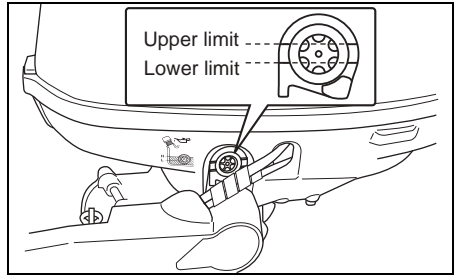

NOTICE

Running the engine with an excessive amount of oil can damage the engine.

Do not overfill the engine with oil.

4. Tighten the oil filler cap securely.

- Visually check the propeller to make sure it is not damaged.
- Make sure that the motor is securely mounted to the transom.
- Make sure that the tilt pin is securely installed in the proper position.
- Make sure the starter rope is free from any evidence of fraying or wear.
- Make sure you have the boating safety and emergency equipment on board.

BREAK-IN

Proper operation during the break-in period will help ensure maximum life and performance from your engine. The following guidelines will explain proper break-in procedures.

NOTICE

Failure to follow the break-in procedures described below can result in severe engine damage.

Be sure to follow the engine break-in procedures described below.

Break-in period: 10 hours

Break-in procedure

1. For the initial 2 hours:
Allow sufficient idling time (about 5 minutes) for the engine to warm up after cold engine starting.

NOTICE

Running at high speed without sufficient warm-up may cause severe engine damage such as piston seizure.

Always allow sufficient idling time (5 minutes) for the engine to warm-up before running at high speed.

After warming up, run the engine at idling speed or the lowest in-gear speed for about 15 minutes.

During the remaining 1 hour and 45 minutes, if safe boating conditions permit, operate the engine in gear at less than 1/2 (half) throttle (3000 r/min.).

NOTE:

You may throttle up beyond the recommended operating range to plane your boat, then immediately reduce the throttle to the recommended operating range.

2. For the next 1 hour:
Safe boating conditions permitting, operate the engine in gear at 4000 r/min. or at three-quarter throttle. Avoid running the engine at full throttle.
3. Remaining 7 hours:
Safe boating conditions permitting, operate the engine in gear at the desired engine speed.
You may occasionally use full throttle; however do not operate the engine continuously at full throttle for more than 5 minutes at any time.

NOTICE

Running continuously at full throttle for more than 5 minutes at a time during the last 7 hours of break-in operation may cause severe engine damage such as seizure.

During the last 7 hours of break-in operation, do not operate at wide open throttle for more than 5 minutes at a time.

OPERATION

BEFORE ATTEMPTING TO START THE ENGINE

1. Make sure the motor has been lowered into the water.
2. Twist the air-vent screw on the fuel tank cap counterclockwise to open the vent.

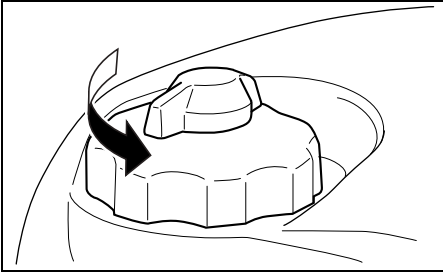

3. Turn the fuel cock lever to the left.

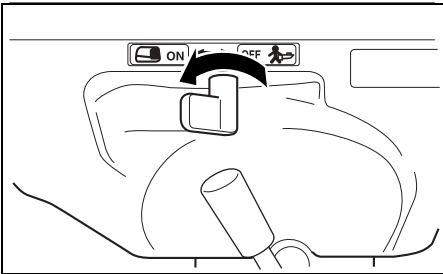

NOTE:

When turning the fuel cock lever to the left, fuel can flow from the built-in tank.

4. Make sure that the motor is in "NEUTRAL".

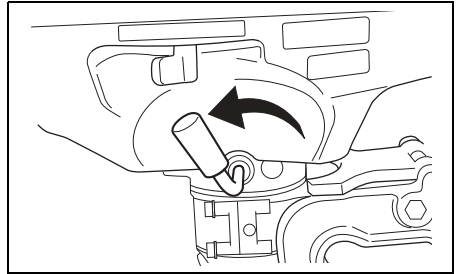

⚠ WARNING

This outboard does not have a start-in-gear protection system. If the shift lever is not in the "NEUTRAL" position, the boat will move suddenly when the engine is started. This can cause personal injury.

Make sure that the shift lever is in the "NEUTRAL" position before attempting to start the engine.

5. The lock plate (A) is in place and the end of the emergency stop switch cord is attached to a part of your body.

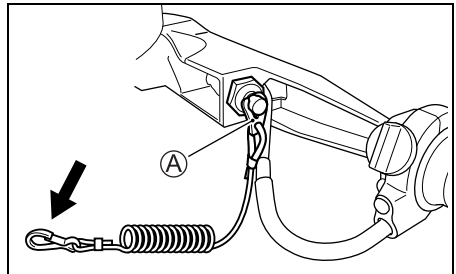

⚠ WARNING

Failure to properly attach the emergency stop switch cord or to take proper precautions to help ensure that the emergency stop switch works as intended may result in serious injury or death to the operator or passengers.

Always take the following precautions:

- Make sure that the emergency stop switch cord is fastened securely to the operator's wrist or to an appropriate clothing area (belt etc.).
- Ensure that no obstructions impede or restrict emergency stop switch operation.
- Be careful not to pull the stop switch cord or knock out the lock plate during normal operation. The motor will stop abruptly, and the loss of forward motion may unexpectedly throw occupants forward.

NOTE:

A spare plastic lock plate is provided for temporary use only. Remove it from the cord and place it in a safe place on board your boat. If you lose or break the emergency stop switch cord/lock plate assembly, replace it as soon as possible so that you can resume normal use of the emergency stop switch.

STARTING THE ENGINE

⚠ WARNING

Exhaust gas contains carbon monoxide, a dangerous gas that is difficult to detect because it is colorless and odorless. Breathing carbon monoxide can cause death or severe injury.

Never start the engine or let it run indoors or where there is little or no ventilation.

NOTE:

If the engine fails to start, check the emergency stop switch lock plate. If the lock plate is not in position, the engine cannot be started.

1. If the engine is cold:
Pull the choke knob ① fully out. Align the arrow mark ② on the throttle control grip with the position Ⓐ.
- If the engine is warm:
Align the arrow mark ② on the throttle control grip with the position Ⓐ. Do not use the choke.

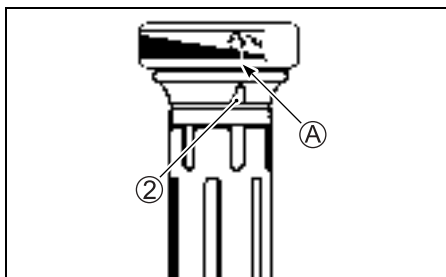
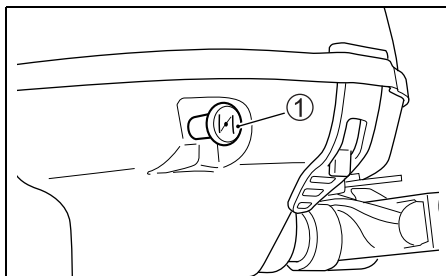

NOTE:

You may need to use the choke when restarting a warm engine. If your engine does not start quickly when warm, follow the procedure for cold starting.

2. Firmly grasp the starter grip and pull slowly until resistance is felt. When you feel it engage, pull the rope sharply to start the engine. Do not release the rope when it is pulled out. Hold the rope and allow it to recoil slowly.

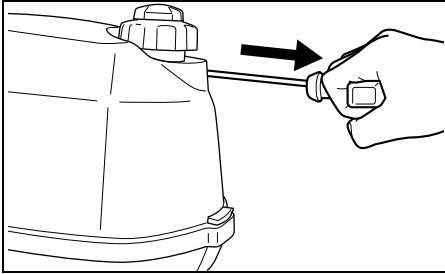

⚠ WARNING

This outboard does not have a start-in-gear protection system. If the shift lever is not in the “NEUTRAL” position, the boat will move suddenly when the engine is started. This can cause personal injury.

Make sure that the shift lever is in the “NEUTRAL” position before attempting to start the engine.

NOTICE

If you pull the starter grip while the engine is running, the starter system can be damaged.

Never pull the starter grip while the engine is running.

3. After starting, use the throttle control grip to bring the engine to idle.
4. Push the choke knob in.

NOTE:

In cold weather, you may have to leave the choke knob out for a longer period of time for the engine to warm up.

5. Warm up the engine for about 5 minutes.

NOTICE

Operating the engine at high RPM or “wide open throttle” immediately after starting the engine without allowing the engine to warm up may cause engine failure.

Always allow the engine to warm up sufficiently before operating it at high speeds.

Cooling water check

As soon as the engine starts, water should spray out of the pilot water hole ①, indicating that the water pump and cooling system are working properly. If you notice that water does not spray out of the pilot water hole, stop the engine as soon as possible and consult your authorized Suzuki Marine Dealer.

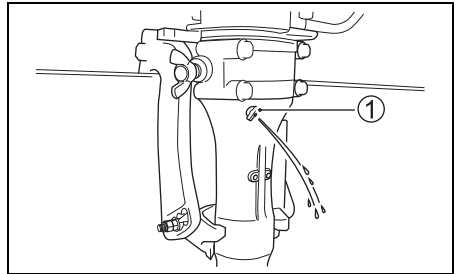

NOTICE

Never operate your outboard motor when there is no water coming out of the pilot water hole, or severe damage can result.

After starting the engine, check to make sure that there is water coming out of the pilot water hole.

⚠ WARNING

Operating the boat when the emergency stop switch is not operating properly can be hazardous.

Before starting off, check to make sure that the emergency stop switch operates properly.

EMERGENCY STARTING

If you must get the engine running, but are unable to do so because of starter system failure, you can use the emergency starting procedure to start the engine.

⚠ WARNING

If you touch electrical components when rope-starting the engine, you can get a severe electrical shock.

When rope-starting the engine, be careful not to touch electrical components such as ignition coils or spark plug leads.

To start the engine when the starter system fails:

1. Shift the motor into “NEUTRAL”.

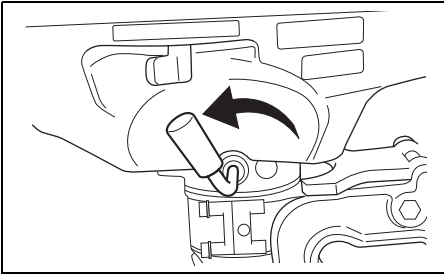

⚠ WARNING

This outboard does not have a start-in-gear protection system. If the shift lever is not in the “NEUTRAL” position, the boat will move suddenly when the engine is started. This can cause personal injury.

Make sure that the shift lever is in the “NEUTRAL” position before attempting to start the engine.

2. Remove the motor cover.
3. Remove the bolts securing the recoil starter in place.

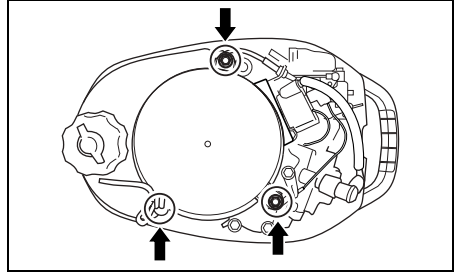

4. Lift off the recoil starter assembly. Re-tighten the fuel tank by using the recoil starter bolts removed.
5. Tie a knot in one end of the emergency starter rope located in the tool kit. Tie the other end around the screw-driver handle in the tool kit.
6. Hook the knotted end of the rope in the pulley notch and wind the rope around the pulley in a clockwise direction.
7. Put the emergency stop switch lock plate in place.
8. After following the steps of the normal starting procedure, pull the emergency starter rope sharply to start the engine.

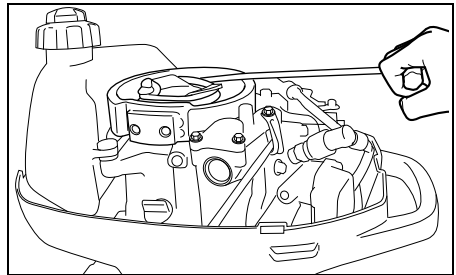

⚠ WARNING

If you attempt to reinstall the recoil starter assembly or motor cover after starting the engine you can be injured.

Do not attempt to reinstall the recoil starter assembly or motor cover after starting the engine.

⚠ WARNING

When the engine is running, there are many moving parts that could cause severe personal injury.

When the engine is running, keep your hands, hair, clothing, etc., away from the engine.

NOTE:

Be sure to have the starter system repaired as soon as possible. You should not continue to use the emergency starting procedure for routine engine starting.

SHIFTING AND SPEED CONTROL

NOTICE

If you shift gears when the engine is not running, the shifting mechanism can be damaged.

Avoid shifting gears when the engine is not running.

Shifting

To shift the motor into "FORWARD", set the throttle control grip to the idle position and pull the shift lever towards you firmly.

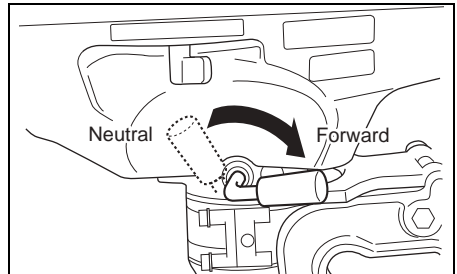

Speed Control

After shifting, control the engine speed by twisting the throttle control grip.

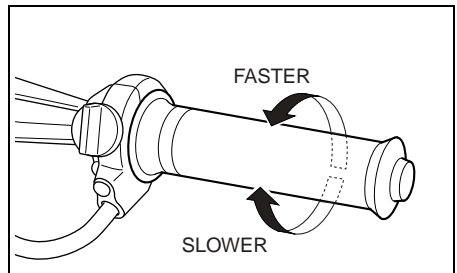

REVERSE OPERATION

To operate the boat in the reverse direction:

1. Set the throttle control grip to the idle position.
2. Turn the motor completely around with the steering handle and then fold it towards you.

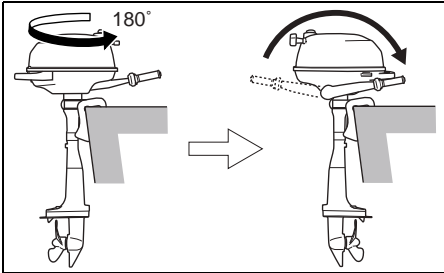

3. Operate the motor at a low speed.

NOTICE

If you allow your motor to hit bottom, your outboard motor or boat could be damaged. When the motor hits bottom while operating in the reverse direction, the shock acts directly on the boat transom, and both the motor and the boat could be damaged.

Do not allow your motor to hit bottom, particularly when operating in the reverse direction.

STOPPING THE ENGINE

NOTE:

When it is necessary to stop the engine in an emergency, pull the emergency stop switch lock plate out of the emergency stop switch by pulling the emergency stop switch cord.

To stop the engine:

1. Turn the throttle control grip to the idle position.
2. Shift into "NEUTRAL".
3. After operating at full throttle, cool off the engine a few minutes by allowing it to idle or troll at low speed.
4. Push and hold in the stop button (A) until the engine stops.

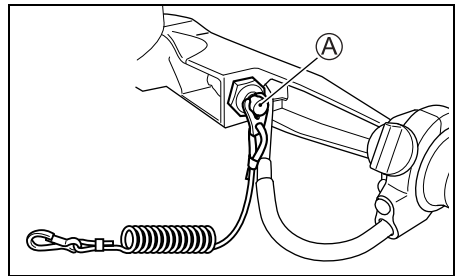

5. After stopping the engine, turn the fuel cock lever to right.

▲ WARNING

If you leave the motor stopped for a long period of time with the fuel cock lever in the on position, fuel can leak out.

Turn the fuel cock lever to the off position whenever you leave the motor stopped for a long period of time.

6. Turn the air-vent screw on the fuel tank cap clockwise to shut the vent.

NOTE:

To make sure that the emergency stop switch operates properly, stop the engine occasionally by pulling out the lock plate, while operating the engine at idling speed.

MOORING

The motor should be tilted up out of the water when you moor the boat in shallow water or if the motor will not be used for some time, to protect it from damage by underwater obstacles at low tide or corrosion from salt water. Refer to the TILT UP LOCK ARM section for details on how to tilt up the motor.

NOTICE

Improperly securing your boat may cause damage to your boat or motor, or other property damage.

Do not allow your motor to rub against quay walls, piers or other boats when the boat is tied up.

OPERATION IN SHALLOW WATER

When operating your outboard motor in shallow water, you should only operate the motor at slow speeds.

NOTICE

If you do not take proper precautions when operating your boat in shallow water, your outboard motor or boat could be damaged.

Do not allow your motor to hit bottom, particularly when operating it in the reverse direction, or serious damage can result. When the motor hits bottom while operating in the reverse direction, the shock acts directly on the transom, and both the motor and the boat could be damaged.

OPERATION IN SALT WATER

After operating the motor in salt water, you should flush the water passages with clean, fresh water as outlined in the FLUSHING THE WATER PASSAGES section. If you do not flush the water passages, salt can corrode the motor and shorten its life.

OPERATION IN FREEZING WEATHER

When operating your outboard motor in freezing temperatures, you should keep the lower unit submerged in the water at all times. When taking the motor out of the water, stand it up in a vertical position until the cooling system drains completely.

NOTICE

If you leave your outboard motor out of the water in freezing temperatures with water still in the cooling system, the water can freeze and expand, causing severe damage to the motor.

When your outboard is in the water in freezing temperatures, keep the lower unit submerged in the water at all times. When the motor is stored out of the water in freezing temperatures stand it up in the vertical position so that the cooling system drains completely.

MOTOR REMOVAL AND TRANSPORTING

MOTOR REMOVAL

1. Make sure that the engine has stopped completely.
2. Turn the fuel cock lever to the right.
3. Tighten the built-in fuel tank cap and its air-vent screw.
4. Drain the gasoline from the carburetor as follows:
 - (1) Remove the motor cover.
 - (2) Loosen the carburetor drain screw **A** and drain the gasoline into a suitable container.

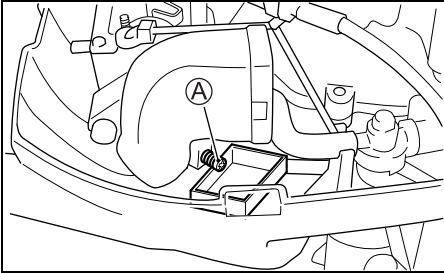

⚠ WARNING

Gasoline is extremely flammable and toxic. It can cause a fire and can be hazardous to people and pets.

Use a proper, safe container to store any gasoline drained from the outboard motor. Keep gasoline away from sparks, flames, people, and pets.

- (3) After draining, retighten the drain screw.

5. Loosen the clamp screws.
6. Lift the motor off the transom.
7. Stand the motor vertically and drain the water from the lower unit.
8. To carry, hold the motor by gripping the lower cover handle.

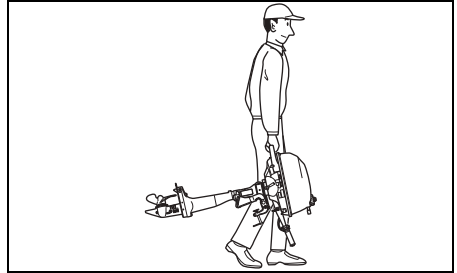

MOTOR TRANSPORTING

When transporting the motor, place the motor in either a vertical or horizontal position.

Vertical transport:

Raise the tiller handle and attach the motor to the carrier by securing clamp bracket with two clamp screws.

Never use display stand for transportation of the motor.

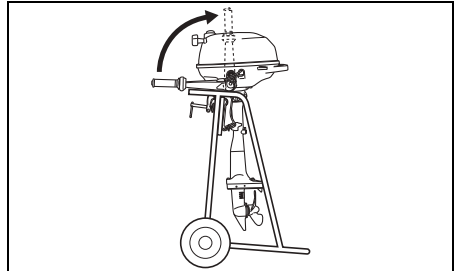

Horizontal transport:

Raise the tiller handle and rest the motor on a case protector with the port side downwards as shown.

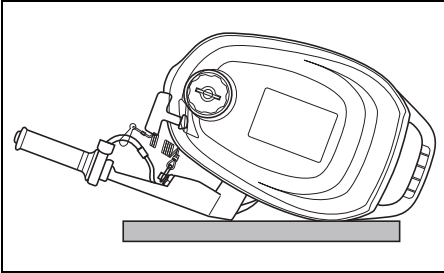
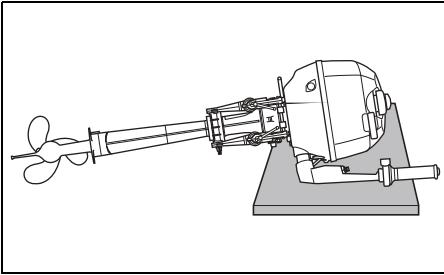

⚠ WARNING

Spilled fuel or fuel vapor can cause a fire and is hazardous to health.

Always take the following precautions:

- Drain the fuel from the fuel line and carburetor before transporting the boat/outboard motor and before removing the motor from the boat.
- DO NOT lay motor on its side without draining fuel.
- Keep the motor away from open flames or sparks.
- Wipe up spilled fuel immediately.

NOTICE

If you do not take proper precautions when transporting your outboard, it can be damaged.

- Do not rest the engine in any of the positions shown below, as water and oil may enter the cylinder through the exhaust port or the outer casings may be damaged.
- Do not place the engine on its side before the cooling water has drained from it completely, as water may enter the cylinder through the exhaust port and cause problems.

INCORRECT

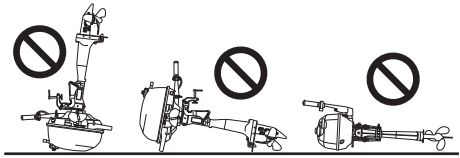

NOTICE

If you let the lower unit of your outboard sit higher than the power head during transporting or storing, water may trickle into the power head, causing damage to the engine.

Never let the lower unit sit higher than the power head when transporting or storing your outboard.

INSPECTION AND MAINTENANCE

MAINTENANCE SCHEDULE

It is important to inspect and maintain your outboard motor regularly. Follow the chart below. At each interval, be sure to perform the indicated service. Maintenance intervals should be judged by number of hours or number of months, whichever comes first.

⚠ WARNING

Exhaust gas contains carbon monoxide, a dangerous gas that is difficult to detect because it is colorless and odorless. Breathing carbon monoxide can cause death or severe injury.

Never start the engine or let it run indoors or where there is little or no ventilation.

Interval Item to be serviced	Initial 20 hrs. or 1 month	Every 100 hrs. or 12 months	Every 200 hrs. or 12 months	Every 300 hrs. or 36 months
Spark plug	–	I	I	I
Breather & Fuel line	I	I	I	I
Engine oil	R	R	R	R
Gear oil	R	R	R	R
Lubrication	I	I	I	I
Anodes (external)	I	I	I	I
* Anodes (internal cylinder block/cylinder head)	–	I	I	I
* Fuel filter	–	I	I	I
* Carburetor	I	I	I	I
* Idle speed	I	–	I	–
* Valve lash	I	–	I	–
* Water pump	–	–	I	–
* Water pump impeller	–	–	I	R
* Propeller pin/nut	I	I	I	I
* Bolts & Nuts	T	T	T	T
* Thermostat	–	I	I	I

I: Inspect and clean, adjust, lubricate, or replace, if necessary T: Tighten R: Replace

▲ WARNING

Improper maintenance or failure to perform recommended maintenance can be hazardous. Poor maintenance or lack of maintenance increases the chance of an accident or equipment damage.

Be sure to have maintenance performed according to the schedule in the above chart. Suzuki recommends that only your authorized Suzuki marine dealer or a qualified service mechanic perform maintenance on those items in the chart above which are marked with an asterisk (*). You may perform maintenance on the unmarked items by referring to the instructions in this section if you have mechanical experience. If you are not sure whether you can successfully complete any of the unmarked maintenance jobs, ask your authorized Suzuki marine dealer to do the maintenance for you.

▲ WARNING

The safety of you and your passengers depends on how well you maintain your outboard motor.

Follow all inspection and maintenance instructions carefully. If you do not have prior mechanical experience, do not attempt to perform maintenance on your outboard motor. You could be injured or may damage the motor.

NOTICE

The maintenance intervals in the chart were established for normal usage of your outboard motor. If your outboard motor is used under severe conditions such as frequent full throttle operation or frequent operation in muddy, silty, sandy, acidic, or shallow water, you may need to perform maintenance more often than indicated in the chart. Failure to perform maintenance more frequently could result in damage.

Consult your authorized Suzuki marine dealer regarding appropriate maintenance intervals for your usage conditions. When replacing parts on your outboard motor, Suzuki strongly recommends that you use genuine Suzuki parts or their equivalent.

SPARK PLUG

Your outboard motor comes equipped with the following "standard" spark plug for normal usage.

NGK CR6HSA	Standard
------------	----------

NOTICE

Non-resistor types of spark plugs will interfere with the function of the electronic ignition, causing misfiring, or causing problems with other electronic boat equipment and accessories.

Use **ONLY** resistor type spark plugs in your outboard motor.

A normally operating spark plug is very light-brown in color. If the standard plug is not suitable for your operating, consult your authorized Suzuki Marine Dealer.

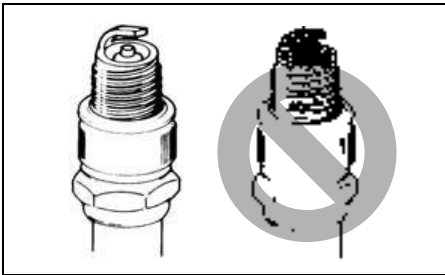

NOTICE

Use of improper spark plugs or improperly tightening spark plugs can cause severe engine damage.

- Do not experiment with other spark plug brands unless you can determine that they are directly equivalent to the specified brand, or you may experience engine damage which will not be covered under warranty. Note that aftermarket cross-reference charts may not be accurate.
- To install a spark plug; seat it as far as possible by hand, then use a wrench to tighten it to either the recommended torque setting or the specified rotation angle.

Tightening torque	
10 – 12 N·m (1.0 – 1.2 kg·m, 7.2 – 8.7 lb·ft)	
Rotation angle	
New plug	1/2 – 3/4 of a turn
Re-use plug	1/12 – 1/8 of a turn

- Do not overtighten or cross-thread a spark plug, as this will damage the aluminum threads of the cylinder head.

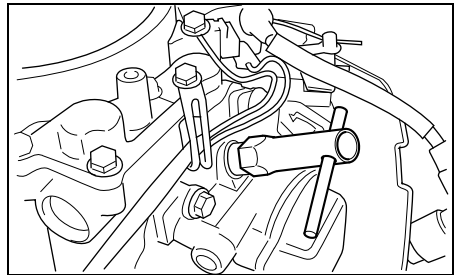

To maintain a strong spark, you should clean and adjust the plug at the intervals shown in the maintenance chart. Remove carbon deposits from the spark plug using a small wire brush or spark plug cleaner, and adjust the gap according to the following chart:

Spark plug gap	0.6 – 0.7 mm (0.024 – 0.028 in.)
----------------	-------------------------------------

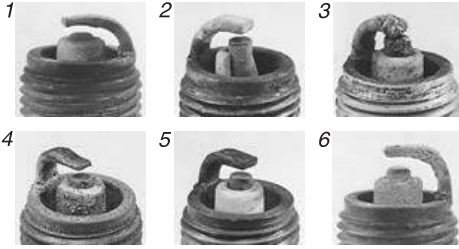
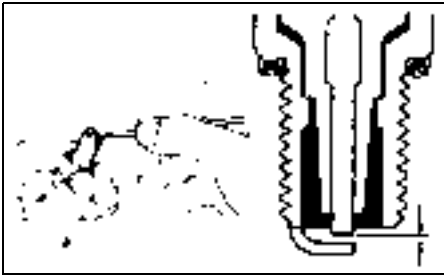

1. Excessive wear 2. Breakage 3. Melting
4. Erosion 5. Yellow deposits 6. Oxidation

NOTE:

If the spark plug condition is found as shown in the illustration above, ensure it is replaced with new one. Otherwise, it will cause difficulty in starting the engine, increase fuel consumption, and result in engine troubles.

BREATHER AND FUEL LINE

Inspect the breather and fuel line for leaks, cracks, swelling, or other damage. If the breather and fuel line is damaged in any way, it must be replaced. Consult your authorized Suzuki Marine Dealer if it is necessary to replace them.

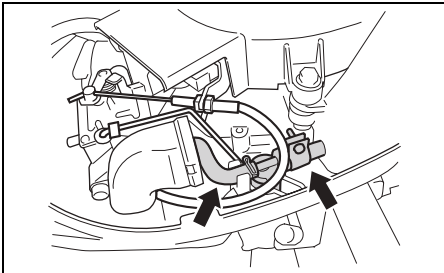

▲ WARNING

Fuel leakage can contribute to an explosion or fire, resulting in serious personal injury.

Have your authorized Suzuki Marine Dealer replace the fuel line if there is any evidence of leaking, cracking or swelling.

ENGINE OIL

▲ WARNING

Never perform any ENGINE OIL procedure with the motor running, as serious injury can occur.

The motor must be shut off before any ENGINE OIL procedures are performed.

NOTICE

Extended trolling can reduce oil life. Your engine may be damaged if you do not change engine oil more frequently under this type of use.

Change your engine oil more frequently if your engine is used for extended trolling.

Engine oil change

The oil should be changed when engine is warm so that the oil will drain thoroughly from the engine.

To change the engine oil:

1. Place the motor in a vertical position and remove the motor cover.
2. Remove the oil filler cap.

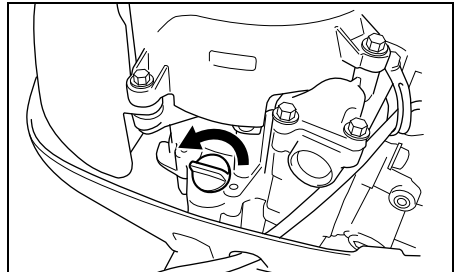

▲ CAUTION

The engine oil temperature may be high enough to burn your fingers when the drain plug is loosened.

Wait until the drain plug is cool enough to touch with bare hands before removing it.

3. Place a drain pan under the engine oil drain plug.
4. Remove the engine oil drain plug and gasket, then let the engine oil drain.

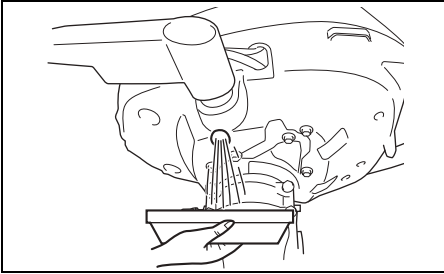

5. After draining, secure the engine oil drain plug with a new gasket.

NOTICE

A previously-used gasket may leak, resulting in engine damage.

Do not re-use gaskets. Be sure to always use new gaskets.

6. Fill with recommended engine oil to the upper limit.

Oil capacity: 0.38 L

7. Check the engine oil level. Refer to the INSPECTION BEFORE BOATING section.

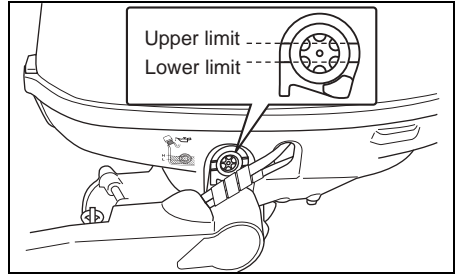

NOTE:

To avoid incorrect measurement of engine oil level, check oil level only when the engine has cooled.

8. Reinstall the oil filler cap.

▲ WARNING

Engine oil can cause injury to people or pets. Repeated, prolonged contact with used engine oil may cause skin cancer. Even brief contact with used oil may irritate skin.

- Keep new and used oil away from children and pets.
- Wear a long-sleeve shirt and waterproof gloves when handling oil.
- Wash with soap if oil contacts your skin.
- Launder any clothing or rags that are wet with oil.

NOTE:

Recycle or properly dispose of used engine oil. Do not throw it in the trash, or pour it on the ground, down a drain, or into the water.

GEAR OIL

To check the gear oil level, remove the upper oil level plug and look into the hole. The oil level should be at the bottom edge of the hole. If the oil level is low, add the specified gear oil until the level reaches the bottom edge of the hole. Then, reinstall and tighten the plug.

To change the gear oil:

1. Make sure the motor is in an upright position. Place a drain pan under the lower casing.
2. Remove the gear oil drain plug ①, then remove the gear oil level plug ②.

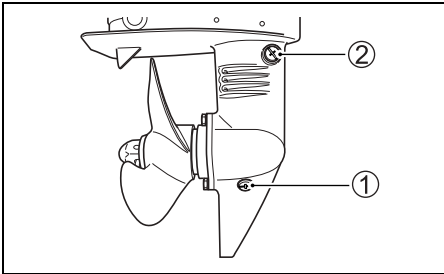

3. After the oil has drained completely, inject the specified gear oil into the lower drain hole until it just starts to come out of the upper hole. Approximately 70 ml (2.4/2.5 US/Imp. oz.) of oil will be required.
4. Reinstall and tighten the gear oil level plug ②, then quickly reinstall and tighten the gear oil drain plug ①.

NOTE:

To avoid insufficient injection of gear oil, check the gear oil level 10 minutes after doing the procedure in the step 4. If the oil level is low, slowly inject the gear oil up to the correct level.

▲ WARNING

Gear oil can cause injury to people or pets. Repeated, prolonged contact with used gear oil may cause skin cancer. Even brief contact with used oil may irritate skin.

- Keep new and used oil away from children and pets.
- Wear a long-sleeve shirt and waterproof gloves when handling oil.
- Wash with soap if oil contacts your skin.
- Launder any clothing or rags that are wet with oil.

NOTE:

Recycle or properly dispose of used gear oil. Do not throw it in the trash, or pour it on the ground, down a drain, or into the water.

NOTICE

If fishing line wraps around the rotating propeller shaft, the propeller shaft oil seal can become damaged and can allow water to enter the gear case causing severe damage.

If the gear oil has a milky color, it is contaminated with water. Immediately contact your authorized Suzuki marine dealer for advice. Do not operate your outboard until the oil is changed and the cause of the contamination is corrected.

LUBRICATION

Proper lubrication is important for the safe, smooth operation and long life of each working part of your outboard motor. The following chart shows the lubrication points of your motor and the recommended lubricant:

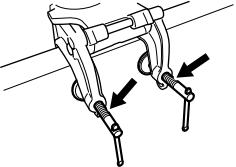
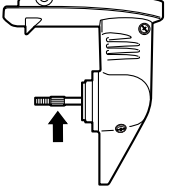
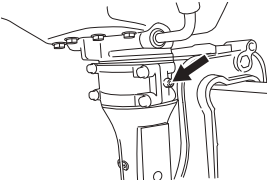
LOCATION	LUBRICANT
 <p>Clamp screw</p>	Marine-grade water resistant grease
 <p>Propeller shaft</p>	
 <p>Swivel bracket</p>	Marine-grade water resistant grease (Grease Gun)

NOTE:

Before applying grease through the swivel bracket grease nipple, lock the motor in the fully tilted up position.

ANODE

The motor is protected from exterior corrosion by an anode. This anode controls electrolysis and prevent corrosion. The anode will corrode in place of the parts they are protecting. You should periodically inspect the anode and replace it when 2/3 of the metal has corroded away.

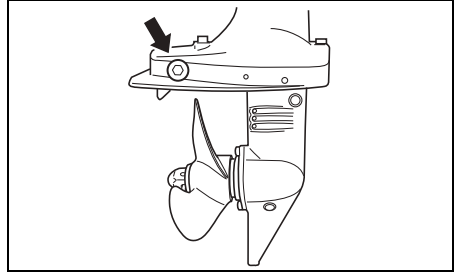

NOTICE

If anodes are not properly maintained, underwater aluminum surfaces (such as the lower unit) will suffer galvanic corrosion damage.

- Periodically inspect anodes to make sure they have not become detached.
- Do not paint anodes, as this will render them ineffective.
- Periodically clean anodes with a wire brush to remove any coating which might decrease their protective ability.

NOTE:

Consult your authorized Suzuki Marine Dealer for inspection and replacement of internal anodes attached to the cylinder block/cylinder head.

FUEL FILTER

The fuel filter must be inspected by authorized Suzuki Marine Dealer periodically. Inspect fuel filter at every 100 hours (12 months).

FLUSHING THE WATER PASSAGES

After operation in muddy, brackish, or salt water, you should flush the water passages and motor surface with clean, fresh water.

If you do not flush the water passages, salt can corrode the motor and shorten its life. Flush the water passages as follows.

ENGINE RUNNING – Vertical position –

Suzuki recommends that you flush the water passages by using this method.

⚠ WARNING

Exhaust gas contains carbon monoxide, a dangerous gas that is difficult to detect because it is colorless and odorless. Breathing carbon monoxide can cause death or severe injury.

Never start the engine or let it run indoors or where there is little or no ventilation.

⚠ WARNING

Failure to take proper precautions when flushing the water passages can be hazardous.

When flushing the water passages, always take the following precautions:

- Make sure that the engine remains in NEUTRAL. If shifted into gear, the propeller shaft will turn and could cause severe personal injury.
- Make sure the motor is properly clamped to a secure stand or boat, and remain in attendance until flushing is completed.
- Keep children and pets away from the area, and stay clear of all moving parts.

NOTICE

Severe engine damage can occur in as little as 15 seconds if the engine is started without supplying water to the cooling system.

Never start the motor without supplying water to the cooling system.

1. Shift the motor into “NEUTRAL”.
2. Remove the propeller from the motor. Refer to the PROPELLER SELECTION AND INSTALLATION section.
3. Install the motor on a large container such as an empty 200 liter drum.

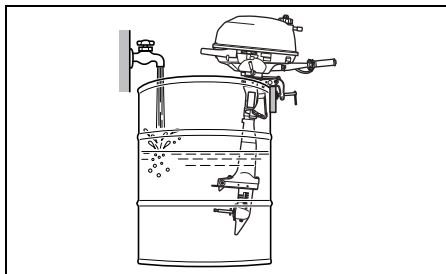

4. Fill the container with clean, fresh water as illustrated.
5. Start the motor and let it idle for about five minutes. This will clean the salt water out of the cooling system.
6. Shut off the motor. Remove the motor from the container and keep the motor in a vertical position until the engine has drained completely. Reinstall the propeller as outlined in the PROPELLER SELECTION AND INSTALLATION section.
7. Clean the motor surface and apply a coat of automotive wax on the external finish of the motor.

SUBMERGED MOTOR

A motor that has been accidentally submerged in water must be overhauled as soon as possible to prevent corrosion. In the event that your motor is accidentally submerged, take the following steps:

1. Get the motor out of the water as soon as possible.
2. Wash it thoroughly with fresh water to completely remove all salt, mud, and seaweed.
3. Remove the spark plug. Drain the water from the cylinder through the spark plug hole by manually turning the flywheel several times.
4. Check if any water is evident in the engine oil. If water is seen, remove the oil drain plug and drain the oil. After draining, tighten the oil drain plug.
5. Drain the fuel line and the carburetor.

⚠ WARNING

Gasoline is extremely flammable and toxic. It can cause a fire and can be hazardous to people and pets.

Keep flames and sparks away from gasoline. Dispose of unwanted fuel properly.

6. Pour engine oil into the engine through the spark plug hole and carburetor. Coat the engine inner parts with oil by turning the engine over with the emergency starter rope or recoil starter.

NOTICE

Severe engine damage may occur if you continue cranking the engine when you encounter friction or resistance.

If you encounter friction or resistance while cranking the engine, stop at once and do not attempt to start the engine until you find and correct the problem.

7. Take the motor to your authorized Suzuki Marine Dealer as soon as possible to be overhauled.

NOTICE

If the fuel supply is contaminated with water, engine damage may occur.

If the boat's fuel tank filler and vent were submerged, inspect the fuel supply to make sure it is not contaminated with water.

STORAGE PROCEDURE

MOTOR STORAGE

When storing your motor for a long period of time (for example, at the end of the boating season), it is recommended that you take your motor to your authorized Suzuki Marine Dealer. However, if you choose to prepare the motor for storage yourself, follow the procedure outlined below:

1. Change the gear oil as outlined in the GEAR OIL section.
2. Change the engine oil as outlined in the ENGINE OIL section.
3. Add a fuel stabilizer to the fuel tank according to the instructions on the stabilizer can.
4. Flush the water passages in the motor thoroughly. Refer to the FLUSHING THE WATER PASSAGES section.
5. Run the engine at about 2500 r/min. in neutral for five minutes to distribute the stabilized fuel through the engine.
6. Stop the engine.
7. Turn the fuel cock lever to the right.

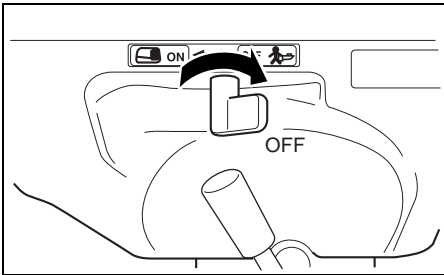

8. Tighten the air-vent screw on the fuel filler cap of the built-in tank.
9. Lubricate all other specified parts. Refer to the LUBRICATION section.
10. Apply a coat of automotive wax on the external finish of the motor. If paint damage is evident, apply touch up paint before waxing.
11. Store the motor in an upright position in a dry, well-ventilated area.

▲ WARNING

When the engine is running, there are many moving parts that could cause severe personal injury.

When the engine is running, keep your hands, hair, clothing, etc., away from the engine.

NOTICE

Severe engine damage can occur in as little as 15 seconds if the engine is started without supplying water to the cooling system.

Never start the motor without supplying water to the cooling system.

AFTER STORAGE

When taking your motor out of storage, follow the procedure below to return it to operating condition:

1. Thoroughly clean the spark plug. Replace them if necessary.
2. Check the gear-case oil level and if necessary, add gear oil according to the procedure outlined in the GEAR OIL section.
3. Lubricate all moving parts according to the LUBRICATION section.
4. Check the engine oil level.
5. Clean the motor and wax the painted surfaces.

TROUBLESHOOTING

This troubleshooting guide is provided to help you find the cause of common complaints.

NOTICE

Failure to troubleshoot a problem correctly can damage your outboard motor. Improper repairs or adjustments may damage the outboard motor instead of fixing it. Such damage may not be covered under warranty.

If you are not sure about the proper action to correct a problem, consult your Suzuki marine dealer.

Engine will not start (hard to start):

- Emergency stop switch lock plate is not in position.
- Fuel tank is empty.
- Fuel hose is kinked or pinched.
- Spark plug is fouled.

Engine idles unstably or stalls:

- Choke knob is not pushed in securely.
- Fuel hose is kinked or pinched.
- Spark plug is fouled.

Engine speed will not increase (Engine power is low):

- Engine is overloaded.
- Propeller is damaged.
- Propeller is not properly matched to loads.

Engine vibrates excessively:

- Clamp screws are loose.
- Foreign object (seaweed etc.) is tangled on propeller.
- Propeller is damaged.

Engine overheats:

- Cooling water intake(s) are blocked.
- Engine is overloaded.
- Propeller is not properly matched to loads.

SPECIFICATIONS

Item	DF2.5
Engine Type	4 Stroke
Number of Cylinders	1
Bore and Stroke	48.0 × 38.0 mm (1.89 × 1.50 in.)
Piston Displacement	68 cm ³ (4.1 cu. in.)
Maximum output	1.8 kW (2.5PS)
Full Throttle Operating Range	5 250 – 5 750 r/min. (min ⁻¹)
Ignition System	Digital CDI
Engine Lubrication	Trochoid pump lubrication
Engine Oil Capacity	0.38 L (0.40/0.33 US/Imp. qt.)
Gear Oil Capacity	70 cm ³ (ml) (2.4/2.5 US/Imp. oz.)
Built-in Fuel Tank Capacity	0.9 L (0.24/0.20 US/Imp. gal.)
Spark Plug	NGK CR6HSA
Spark Plug Gap	0.6 – 0.7 mm (0.024 – 0.028 in.)
Valve Lash	IN. : 0.13 – 0.17 mm (0.006 – 0.007 in.) EX.: 0.13 – 0.17 mm (0.006 – 0.007 in.)
Fuel Type	Alcohol-free unleaded gasoline
Minimum Fuel Octane Rating	91 (Research method)

INFORMATION REGARDING EC – DIRECTIVE

(For European countries)

A-weighted Sound Power Level

The A-weighted sound power level of this motor measured under related EC Directive is as follows:

Regulation	A-weighted sound power level	Uncertainty
2006 / 42 / EC	78 dB(A)	2.5 dB(A)

The A-weighted sound power level measurement is based on ICOMIA standard 39-94.

Vibration

Tiller handle grip vibration total value of this motor measured under related EC Directive is as follows:

Regulation	Vibration total value	Uncertainty
2006 / 42 / EC	2.8 m/s ²	0.5 m/s ²

The vibration measurement is based on ICOMIA standard 38-94.

Prepared by

SUZUKI MOTOR CORPORATION

Outboard Motor Engineering Department

July, 2015

Part No. 99011-97J40-055

Printed in Thailand

© COPYRIGHT SUZUKI MOTOR CORPORATION 2015