

SEA-DOO®



2019 OPERATOR'S GUIDE

Includes Safety, Watercraft and
Maintenance Information



SPARK® SERIES

WARNING

Read this guide thoroughly.
It contains important safety information.
Minimum recommended operator's age: 16 years old.
Keep this Operator's Guide in the watercraft.

WARNING

Disregarding any of the safety precautions and instructions contained in this Operator's Guide, *SAFETY VIDEO* and on-product safety labels could cause injury including the possibility of death!

CALIFORNIA PROPOSITION 65 WARNING

 **WARNING:** Operating, servicing and maintaining a recreational marine vessel can expose you to chemicals including engine exhaust, carbon monoxide, phthalates, and lead, which are known to the State of California to cause cancer and birth defects or other reproductive harm. To minimize exposure, avoid breathing exhaust, do not idle the engine except as necessary, service your vehicle in a well-ventilated area and wear gloves or wash your hands frequently when servicing your vehicle. For more information go to www.p65warnings.ca.gov/products/passenger-vehicle.



In Canada, products are distributed by Bombardier Recreational Products Inc. (BRP).

In USA, products are distributed by BRP US Inc.

This is a non-exhaustive list of trademarks that are the property of Bombardier Recreational Products Inc. or its affiliates:

ACE™

iBRTM

iTCTM

Rotax®

SPARK™

D.E.S.S.™

iControl™

O.T.A.S.™

Sea-Doo®

XPSTM

FOREWORD

Deutsch	Dieses Handbuch ist möglicherweise in Ihrer Landessprache verfügbar. Bitte wenden Sie sich an Ihren Händler oder besuchen Sie: www.operatorsguides.brp.com
English	This guide may be available in your language. Check with your dealer or go to: www.operatorsguides.brp.com
Español	Es posible que este manual esté disponible en su idioma. Consulte a su distribuidor o visite: www.operatorsguides.brp.com
Français	Ce guide peut être disponible dans votre langue. Vérifier avec votre concessionnaire ou aller à: www.operatorsguides.brp.com
Italiano	Questa guida potrebbe essere disponibile nella propria lingua. Contattare il concessionario o consultare: www.operatorsguide.brp.com
中文	本手册可能有您的语种的翻译版本。请向经销商询问，或者登录 www.operatorsguides.brp.com 查询。
日本語	このガイドは、言語によって翻訳版が用意されています。ディーラーに問い合わせるか、次のアドレスでご確認ください： www.operatorsguides.brp.com
Nederlands	Deze handleiding kan beschikbaar zijn in uw taal. Vraag het aan uw dealer of ga naar: www.operatorsguides.brp.com
Norsk	Denne boken kan finnes tilgjengelig på ditt eget språk. Kontakt din forhandler eller gå til: www.operatorsguides.brp.com
Português	Este manual pode estar disponível em seu idioma. Fale com sua concessionária ou visite o site: www.operatorsguides.brp.com
Русский	Воспользуйтесь руководством на вашем языке. Узнайте о его наличии у дилера или на странице по адресу www.operatorsguide.brp.com
Suomi	Käyttöohjekirja voi olla saatavissa omalla kielelläsi. Tarkista jälleenmyyjältä tai käy osoitteessa: www.operatorsguides.brp.com
Svenska	Denna bok kan finnas tillgänglig på ditt språk. Kontakta din återförsäljare eller gå till: www.operatorsguides.brp.com

Congratulations on your purchase of a new Sea-Doo® personal watercraft (PWC). It is backed by the BRP warranty and a network of authorized Sea-Doo personal watercraft dealers ready to provide the parts, service or accessories you may require.

Your dealer is committed to your satisfaction. He has taken training to perform the initial setup and inspection of

your watercraft as well as completed the final adjustments before you took possession. If you need more complete servicing information, please ask your dealer.

At delivery, you were also informed of the warranty coverage and signed the *PREDELIVERY CHECK LIST* to ensure your new watercraft was prepared to your entire satisfaction.

Know Before you Go

To learn how to reduce the risk for you or other persons being injured or killed, read the following sections before you operate the watercraft:

- SAFETY INFORMATION
- WATERCRAFT INFORMATION.

Read and understand all safety labels on your watercraft and watch attentively your *SAFETY VIDEO* located at <https://www.sea-doo.com/safety>.



Failure to follow the warnings contained in this Operator's Guide can result in serious injury or death.

BRP highly recommends that you take a safe boating course. Please check with your dealer or local authorities for availability in your area.

In certain areas, an operator competency card is mandatory to operate a pleasure craft.

⚠ WARNING

Get familiar with this PWC; it may exceed the performance of other PWCs you have ridden.

Safety Messages

This Operator's Guide utilizes the following symbols and words to emphasize particular information:

The safety alert symbol **⚠** indicates a potential injury hazard.

⚠ WARNING

Indicates a potential hazard which, if not avoided, could result in serious injury or death.

⚠ CAUTION Indicates a potentially hazardous situation which, if not avoided, could result in minor or moderate injury.

NOTICE Indicates an instruction which, if not followed, could severely damage watercraft components or other property.

About this Operator's Guide

This Operator's Guide has been prepared to acquaint the owner/operator or passenger with this personal watercraft and its various controls, maintenance and safe riding instructions.

Keep this Operator's Guide in the watercraft as you can refer to it for operation, instructing others, maintenance and troubleshooting.

Note that this guide is available in several languages. In the event of any discrepancy, the English version shall prevail.

If you want to view and/or print an extra copy of your Operator's Guide, simply visit the following website www.operatorsguides.brp.com.

The information contained in this document is correct at the time of publication. However, BRP maintains a policy of continuous improvement of its products without imposing upon itself any obligation to install them on products previously manufactured. Due to late changes, some differences between the manufactured product and the descriptions and/or specifications in this guide may occur. BRP reserves the right at any time to discontinue or change specifications, designs, features, models or equipment without incurring any obligation upon itself.

This Operator's Guide should remain with the watercraft when it's sold.

TABLE OF CONTENTS

FOREWORD	1
Know Before you Go	2
Safety Messages	2
About this Operator's Guide	2

SAFETY INFORMATION

GENERAL PRECAUTIONS	8
Avoid Carbon Monoxide Poisoning	8
Avoid Gasoline Fires and Other Hazards	8
Avoid Burns from Hot Parts	8
Accessories and Modifications	8
SPECIAL SAFETY MESSAGES	10
Reminders Regarding Safe Operation	10
Water Sports (Towing with the Watercraft) (3UP Models Only)	14
Hypothermia	16
Safe Boating Courses	17
Carrying Loads	17
ACTIVE TECHNOLOGIES (iCONTROL)	18
Introduction	18
iTc (intelligent Throttle Control)	18
iBR (intelligent Brake and Reverse System) (Models with iBR)	19
SAFETY EQUIPMENT	20
Required Safety Equipment	20
Additional Recommended Equipment	22
PRACTICE EXERCISES	23
Where to Practice Exercises	23
Practice Exercises	23
Important Factors Not to Neglect	24
NAVIGATION RULES	25
Operating Rules	25
FUELING	27
Fueling Procedure	27
Fuel Requirements	28
TRAILERING INFORMATION	30
IMPORTANT ON-PRODUCT LABELS	31
Hang Tag	31
Watercraft Safety Labels	32
Compliance Labels	37
PRE-RIDE INSPECTION	41
What to Do Before Launching the Watercraft	41
What to Do After Launching the Watercraft	45

WATERCRAFT INFORMATION

CONTROLS	48
1) Handlebar	50
2) Engine START/STOP Button	50
3) Engine Cut-Off Switch	50
4) Throttle Lever	51
5) iBR Lever (intelligent Brake and Reverse) (Models with iBR)	52
6) Mode Button.....	52
7) Variable Trim System (VTS) Button (Trixx Models)	53
MULTIFUNCTION GAUGE (LCD)	54
Multifunction Gauge Description	54
Navigating the Multifunction Display	56
EQUIPMENT	58
1) Glove Box	59
2) Safety Equipment Kit Storage Compartment	59
3) Storage Bin (Convenience Package)	60
4) Seat.....	60
5) Passenger Handholds.....	61
6) Boarding Step (Convenience Package)	61
7) Boarding Platform	62
8) Front and Rear Eyelet	63
9) Bilge Drain Plug	63
10) Sponsons	64
11) Rear Footrests (Trixx Models).....	64
12) Adjustable Handlebar Riser (Trixx Models)	64
13) Audio System (If equipped)	64
BREAK-IN PERIOD	67
Operation During Break-In Period.....	67
OPERATING INSTRUCTIONS	68
Boarding the Watercraft	68
How to Start Engine.....	71
How to Stop the Engine	72
How to Steer the Watercraft	72
How to Engage Neutral (Models with iBR)	73
How to Engage Forward (Models with iBR).....	73
How to Engage and Use Reverse (Models with iBR).....	74
How to Engage and Use Braking (Models with iBR)	75
How to Use the Variable Trim System (VTS)	76
General Operating Recommendations	77
OPERATING MODES (ROTAX 900 HO ACE)	80
Touring Mode.....	80
Sport Mode	80
SPECIAL PROCEDURES	83
Jet Pump Water Intake and Impeller Cleaning	83
iBR Override Function (Models Equipped with iBR).....	84

SPECIAL PROCEDURES (cont'd)	
Capsized Watercraft	85
Submerged Watercraft	86
Water-Flooded Engine	86
Towing the Watercraft in Water	87

MAINTENANCE INFORMATION

MAINTENANCE SCHEDULE	90
MAINTENANCE PROCEDURES	93
Engine Oil	93
Engine Coolant	96
Steering Alignment	97
Central Body	98
Battery	103
Ignition Coils	105
Spark Plugs	106
Exhaust System	107
Heat Exchanger and Water Intake Grate	108
Sacrificial Anode	108
Fuses	109
WATERCRAFT CARE	111
Post-Operation Care	111
Watercraft Cleaning	111
STORAGE AND PRESEASON PREPARATION	112
Storage	112
Preseason Preparation	114

TECHNICAL INFORMATION

WATERCRAFT IDENTIFICATION	116
Hull Identification Number	116
Engine Identification Number	116
Engine Manufacturer Identification	116
RF D.E.S.S. KEY (IF APPLICABLE)	117
ENGINE EMISSIONS INFORMATION	118
Manufacturer's Responsibility	118
Dealer's Responsibility	118
Owner Responsibility	118
EPA Emission Regulations	118
EVAPORATIVE EMISSION CONTROL SYSTEM	118
SPECIFICATIONS	119

TROUBLESHOOTING

TROUBLESHOOTING GUIDELINES 124

MONITORING SYSTEM 129

 Fault Indicators and Message Display Information..... 130

 Beeper Code Information 132

WARRANTY

BRP LIMITED WARRANTY – USA AND CANADA: 2019 SEA-DOO® PERSONAL WATERCRAFT..... 136

US EPA EMISSION-RELATED WARRANTY 140

CALIFORNIA AND NEW YORK EMISSION CONTROL WARRANTY STATEMENT FOR MODEL YEAR 2019 SEA-DOO® PERSONAL WATERCRAFT..... 143

CALIFORNIA EVAPORATIVE EMISSIONS CONTROL SYSTEM WARRANTY STATEMENT..... 147

BRP INTERNATIONAL LIMITED WARRANTY: 2019 SEA-DOO® PERSONAL WATERCRAFT..... 149

BRP LIMITED WARRANTY FOR THE EUROPEAN ECONOMIC AREA, THE COMMONWEALTH OF THE INDEPENDENT STATES, TURKEY: 2019 SEA-DOO® PERSONAL WATERCRAFT..... 153

CUSTOMER INFORMATION

PRIVACY INFORMATION 160

CONTACT US..... 161

 North America 161

 Europe 161

 Oceania 161

 South America..... 161

 Asia..... 161

CHANGE OF ADDRESS/OWNERSHIP..... 162

SAFETY INFORMATION

GENERAL PRECAUTIONS

Avoid Carbon Monoxide Poisoning

All engine exhaust contains carbon monoxide, a deadly gas. Breathing carbon monoxide can cause headaches, dizziness, drowsiness, nausea, confusion and eventually death.

Carbon monoxide is a colorless, odorless, tasteless gas that may be present even if you do not see or smell any engine exhaust. Deadly levels of carbon monoxide can collect rapidly, and you can quickly be overcome and unable to save yourself. Also, deadly levels of carbon monoxide can linger for hours or days in enclosed or poorly ventilated areas. If you experience any symptoms of carbon monoxide poisoning, leave the area immediately, get fresh air and seek medical treatment.

To prevent serious injury or death from carbon monoxide:

- Never run the watercraft in poorly ventilated or partially enclosed areas such as watercraft houses, seawalls or other boats in close proximity. Even if you try to ventilate engine exhaust, carbon monoxide can rapidly reach dangerous levels.
- Never run the watercraft outdoors where engine exhaust can be drawn into a building through openings such as windows and doors.
- Never stand behind the watercraft while the engine is running. A person standing behind a running engine may inhale high concentrations of exhaust fumes. Inhalation of concentrated exhaust fumes that contain carbon monoxide can result in CO poisoning, serious health problems and death.

Avoid Gasoline Fires and Other Hazards

Gasoline is extremely flammable and highly explosive. Fuel vapors can spread and be ignited by a spark or

flame many feet away from the engine. To reduce the risk of fire or explosion, follow these instructions:

- Use only an approved red gasoline container to store fuel.
- Strictly adhere to the instructions in *FUELING* section.
- Never start watercraft if gasoline or gasoline vapor odors is present in the engine compartment.
- Never start or operate the engine if the fuel cap is not properly secured.
- Do not carry gasoline containers in the storage bin (if equipped).
- Use only a BRP approved LinQ fuel caddy, which should be properly installed and secured. Never tow a skier or wakeboarder while having a fuel caddy installed. Always follow the instructions for LinQ accessories. Never refill the fuel caddy on the PWC. Refill on shore.

Gasoline is poisonous and can cause injury or death.

- Never siphon gasoline with your mouth.
- If you swallow gasoline, get any in your eyes, or inhale gasoline vapors, see a doctor immediately.

If gasoline is spilled on you, wash thoroughly with soap and water and change your clothes.

Avoid Burns from Hot Parts

Certain components may become hot during operation. Avoid contact during and shortly after operation to avoid burns.

Accessories and Modifications

Do not make unauthorized modifications, or use accessories that are not approved by BRP. Since these changes have not been tested by BRP, they may increase the risk of accidents or injuries, and they can make the watercraft illegal for use on water.

See your authorized Sea-Doo dealer for available accessories for your watercraft.

SPECIAL SAFETY MESSAGES

Reminders Regarding Safe Operation

The performance of this watercraft may significantly exceed that of other watercraft you may have operated. Make sure you read and understand the content of this Operator's Guide to become completely familiar with the controls and operation of the watercraft before embarking on your first trip, or taking on a passenger(s). If you have not had the opportunity to do so, practice driving solo in a suitable traffic free area to become accustomed to the feel and response of each control. Be fully familiar with all controls before accelerating above idle speed. Do not assume that all PWCs handle identically. Each model differs, often substantially.

Always keep in mind that as the throttle lever is returned to the idle position, less directional control is available. To turn the watercraft, both steering and throttle are necessary. Do not release throttle when trying to steer away from objects. Your need throttle to steer. If the engine is shut off, directional control is lost.

Although most watercraft have no means of braking, advancement in technologies now permit us to offer some models that are equipped with a braking system called the iBR™ system. Practice braking maneuvers in a safe traffic-free area to become familiar with handling under braking and with stopping distances under various operating conditions.

WARNING

Stopping distance will vary depending on initial speed, load, wind, number of riders and water conditions. The amount of braking power commanded by the operator using the iBR lever (Intelligent Brake and Reverse) will also affect stopping distance.

When braking, riders must brace themselves against the deceleration force to prevent from moving forward on the watercraft and losing balance.

When operating an iBR equipped watercraft, be aware that other boats following or operating in close proximity may not be able to stop as quickly.

When at speed and the brake is first applied, a plume of water will shoot up in the air behind the watercraft which may cause the operator of a following watercraft to momentarily lose sight of your PWC. It is important to inform the operator of a watercraft who intends to follow in a convoy formation, of the braking and maneuvering capability of your PWC, what the plume of water indicates, and that a greater distance should be maintained between watercraft.

When actuating the iBR control lever while the watercraft has some forward speed, the braking mode will engage and generate a deceleration proportional to the iBR lever position. The more you pull in the iBR lever, the greater the braking force becomes. Be careful to gradually actuate the iBR lever to adjust the intensity of the braking force, and to simultaneously release the throttle lever.

The brake feature of the iBR system cannot prevent your PWC from drifting due to current or wind. It has no braking effect on the rearward motion. Also note that your engine must be running to be able to use the brake.

The personal watercraft jet thrust can cause injury. The jet pump may pick up debris and throw it rearward causing a risk of injuring people, damaging the jet pump, or other property.

Observe the instructions on all safety labels. They are there to help assure that you have a safe and enjoyable outing.

Do not store any objects in areas that are not designed specifically for storage.

Riding with passenger(s), pulling tubes, a skier, or a wake boarder makes the PWC handle differently and requires greater skill.

All PWC models come equipped with tow eyelets that can be used for mooring and as tie-down points when trailering, can be used to attach a tow rope for a skier, tube or wake boarder. Do not use these attachment points or any other portion of the watercraft to tow a para-sail or any other craft. Personal injury or severe damage may occur.

Combustion engines need air to operate; consequently this PWC cannot be totally watertight. Any maneuvers such as turning constantly in tight circles, plunging the bow through waves, or capsizing the watercraft, that cause the air inlet openings to be under water may cause severe engine problems due to water ingestion. Refer to *OPERATING INSTRUCTIONS* and the *WARRANTY* section contained in this Operator's Guide.

Engine exhaust contains carbon monoxide (CO), which can cause serious health problems or death if inhaled in sufficient quantities. Do not operate the PWC in a confined area or allow CO to accumulate around the PWC, or in enclosed or sheltered areas such as when docked, or when rafting. Be aware of the risk of CO emanations from exhaust of other PWCs.

Know the waters in which the watercraft is to be operated. Current, tides, rapids, hidden obstacles, wakes and waves etc. can affect safe operation. It is not advisable to operate the watercraft in rough waters or inclement weather.

In shallow water, proceed with caution and at very low speeds. Grounding or abrupt stops may result in injury and

watercraft damage. Debris may also be picked up and thrown rearward by the jet pump onto people or property.

Keep the tether cord attached to the operator's PFD or wrist (wrist strap required) at all times and keep it free from snagging on the handlebars to help ensure the engine stops should the operator fall off. After riding, remove the tether cord from the engine cut-off switch to avoid unauthorized use by children or others. If the operator falls off the watercraft and the tether cord is not attached as recommended, the watercraft engine will not stop.

Ride within your limits and level of riding ability.

Always ride responsibly and safely. Use common sense and courtesy.

Respect the environment and the rights of other users of the waterways. As the operator and owner of a PWC, you are responsible for damage by the wake of your PWC. Do not let anyone throw refuse overboard.

While your watercraft has the capacity of operating at high speeds, it is strongly recommended that high speed operation only be applied when ideal conditions exist and are permitted. Higher speed operation requires a higher degree of skill and increases the risk of severe injuries.

The forces generated on the body of riders while turning, negotiating waves or wakes, operating in choppy waters, or falling off the watercraft, especially at higher speeds, may cause injury including the possibility of broken bones or more serious bodily injuries. Remain flexible and avoid sharp turns.

PWCs are not designed for night-time operation.

Avoid riding in very rough waters or practicing extreme maneuvers like jumping wakes or waves.

Before Getting Underway

For safety reasons and proper care, always perform the pre-ride inspection as specified in your Operator's Guide before operating your watercraft.

Do not exceed the payload or passenger capacities for your watercraft. Overloading can affect maneuverability, stability and performance. Also, heavy seas reduce capacity. A payload or person capacity plate is not an excuse for failure to use common sense or good judgment.

Regularly inspect the PWC, hull, engine, safety equipment, and all other boating gear and keep them in safe operating condition.

Be sure you have the minimum required safety equipment, PFDs and any additional gear needed for your cruise.

Ensure that all lifesaving equipment, including fire extinguisher (not supplied with vehicle), are in safe operating condition and easily accessible. Show all passengers where this equipment is stored on the PWC, and make sure they know how to use it.

There are several classes of fire extinguishers, for marine application we recommend the use of a properly sized class 5 B:C.

Additionally, your fire extinguisher should be certified by ULC, UL or USCG. Taking proper care of your fire extinguisher is mandatory.

Often check if the fire extinguisher is loaded to its proper operating pressure and make sure that you and your guests know how to use it. Maintenance, repair and refilling must be carried out by qualified personnel in accordance with the manufacturer's instructions. For monthly fire extinguisher maintenance, turn the fire extinguisher back and shake it vigorously to prevent the chemical in the fire extinguisher from hardening.

Always be cautious when manipulating the fire extinguisher. Pay attention not to damage the mechanism (nozzle, dial, handle, etc) when storing it on the PWC.

Keep an eye on the weather. Check local weather broadcasts before departure. Be alert to changing conditions.

Keep accurate and up-to-date charts of the boating area on board. Before getting underway, check water conditions in the planned boating area.

Ensure there is enough fuel on board for the planned trip. Always verify fuel level before use and during the ride. Apply the principle of 1/3 of the fuel to reach your destination, 1/3 to return, and keep 1/3 in reserve. Allow for changes due to adverse weather or other delays.

Operator and Passenger Awareness

Read and understand all safety labels on the Sea-Doo PWC, the Operator's Guide, all other safety documents, and watch the *SAFETY VIDEO* before operating the PWC.

Respect applicable laws. Check local and federal boating laws applicable to the waterways where you intend to use your watercraft. Learn the local navigation rules. Know and understand the applicable navigation system (such as buoys and signs).

Remember that sun, wind, fatigue or illness may impair your judgement and reaction time.

Operation of this PWC by a person under 16 years of age, or a person with a disability that impairs vision, reaction time, judgment, or operation of the controls is NOT recommended.

Always properly use the tether cord when operating the watercraft and ensure that all passengers are familiar with its use.

Ensure that any operator and all passengers know how to swim and how to reboard the PWC from the water.

Boarding in deep water can be strenuous. Practice in chest-deep water before operating or embarking your watercraft in deep water. Ensure that any operator and all passengers wear a PFD at all times and take extra precautions when boating.

Never turn handlebar while someone is near the rear of watercraft. Keep away from steering moving parts (nozzle, iBR gate, linkages, etc.).

Do not start the engine or operate the watercraft if anyone is in the water nearby, or near the rear of the watercraft.

Be aware of the iBR gate movement when starting the engine, shutting down the engine or using the iBR lever. Automatic movement of the gate may squeeze fingers or toes of people taking a hold on the back or your PWC.

The operator and passenger(s) should be properly seated and have a firm grip on a handhold before starting the watercraft, and at all times when the watercraft is in motion. All passenger(s) should be instructed to use the handholds provided, or to hold on to the waist of the person in front of them. Each passenger must be able to simultaneously place both feet firmly flat against each footwell when properly seated. When going over waves, or in rough water, passenger(s) may raise their body slightly off the seat to absorb the shocks with their legs.

When braking or decelerating, riders must brace themselves against the deceleration force to prevent from moving forward on the watercraft and losing balance.

When accelerating on a PWC with passenger(s), whether from a complete stop or while underway, always do so progressively. Fast acceleration may cause your passenger(s) to lose their balance and fall rearward off the watercraft. Make sure that your passenger(s) are aware of or can anticipate any rapid acceleration.

Severe internal injuries can occur if water is forced into body cavities as a result of falling into water or being near a jet thrust nozzle. Consequently, the wearing of a wet suit bottom is highly recommended.

Keep away from the intake grate while the engine is running. Items such as long hair, loose clothing, or PFD straps can become entangled in moving parts.

If the throttle lever is depressed while braking, the iBR system will disable the throttle command by the user. When releasing the iBR lever while the throttle lever is still depressed, the throttle command will regain control and generate an acceleration after a short delay. Release throttle lever if acceleration is not needed.

Before reboarding, make sure engine is off and the tether cord is removed from the engine cut-off switch.

To prevent accidental starting, always remove the tether cord from the engine cut-off switch when swimmers are boarding, nearby, or during removal of any weeds or debris from the intake grate.

On a PWC, never place your feet and legs in the water to aid turning.

Operation by Minors

Minors should always be supervised by an adult whenever operating a watercraft. Laws regarding the minimum age and licensing requirements of minors may vary from one jurisdiction to another. Be sure to contact the local boating authorities for information regarding the legal operation of a PWC in the intended jurisdiction of use. BRP recommends a minimum operator age of 16 years old.

Drugs and Alcohol

Never use with drugs or alcohol. Like driving a car, driving a watercraft requires the operator to be sober, attentive and alert. Operating a watercraft

while intoxicated or under the influence of drugs is not only dangerous, but it is also a Federal offense carrying a significant penalty. These laws are vigorously enforced. The use of drugs and alcohol, singly or in combination, decreases reaction time, impedes judgment, impairs vision, and inhibits your ability to safely operate a watercraft.

⚠ WARNING

Alcohol consumption and boating do not mix! Operating with the use of drugs or alcohol endangers the lives of your passengers, other boaters, and yourself. Federal laws prohibit operating a watercraft with the use of drugs or alcohol.

Water Sports (Towing with the Watercraft) (3UP Models Only)

⚠ WARNING

Avoid personal injury! Your PWC is not designed for and should not be used for pulling another craft, parasails, kites, gliders, or any device which can become airborne. Use your watercraft only for water sports it was designed for.

Water skiing, wakeboarding, or riding a towed inflatable apparatus are some of the more popular water sports. Taking part in any water sport requires increased safety awareness by the participant and the watercraft operator. If you have never towed someone behind your PWC before, it is a good idea to spend some hours as an observer, working with and learning from an experienced operator. It is also important to be aware of the skill and experience of the person being towed.

Everyone participating in a water sport should observe these guidelines:

- Riding with passenger(s) or pulling a tube, skier or wakeboarder makes the watercraft handle differently and requires greater skill.
- Always respect the safety and comfort of your passenger(s) and person being towed on skis, wakeboard or other water products.
- Always carry an observer when pulling a tube, skier or wakeboarder to observe the person being towed and inform the operator about the participants' hand signals. The operator must focus his attention on operating the watercraft and the waters ahead.
- Proceed with only as much speed as required and follow the observers' instructions.
- When pulling a tube, skier, or a wakeboarder, do not make tight sharp turns or use the braking system unless absolutely necessary. Remember that although this PWC is manoeuvrable and has stopping capabilities (models with iBR), the person in tow may not be able to avoid an obstacle, or the PWC with which it is being towed.
- Allow only capable swimmers to take part in any water sport.
- Always wear an approved personal flotation device (PFD). Wearing a properly designed PFD helps a stunned or unconscious person stay afloat.
- Be considerate to others you share the water with.
- Both the operator and observer should monitor the location of the tow rope when participating in watersports. A slack tow rope can become entangled with a person(s) or objects on the PWC or in the water, particularly when making a tight turn or circling, and cause serious personal injury.

- Do not tow a person in any water sport on a short tow rope such that the person inhales exhaust fumes in concentration. Inhalation of concentrated exhaust fumes, which contain carbon monoxide, can result in CO poisoning, personal injury and death.
- Use a tow rope of sufficient length and size, and make sure it is adequately secured to your watercraft. Always store tow rope when not in use, see *STORING THE TOW ROPE AFTER USE*. While some watercraft are equipped or can be fitted with a specially designed towing mechanism, avoid installing a tow pole on a PWC. It can become a hazard should someone fall on it.
- Give immediate attention to a person who has fallen. He or she is vulnerable in the water alone and may not be seen by other boaters.
- Approach a person in the water from the lee side (opposite the direction of the wind). Turn off the motor before coming close to the person.
- Participate in water sports only in safe areas. Stay away from other boats, channels, beaches, restricted areas, swimmers, and heavily traveled waterways and underwater obstructions.
- Turn off the engine and anchor the watercraft before swimming.
- Swim only in areas designated as safe for swimming. These are usually marked with a swim area buoy. Do not swim alone or at night.



SWIM AREA BUOY

- Do not water ski between sunset and sunrise. It is illegal in most areas.
- Do not drive the watercraft directly behind a water skier, tuber or wakeboarder. At 40 km/h (25 MPH) per hour, the watercraft will overtake a person who falls in the water 60 m (197 ft) in front of your watercraft in about 5 seconds.
- Shut off the engine and remove the tether cord from the engine cut-off switch when anyone is in the water nearby.
- Stay at least 45 m (148 ft) away from areas marked by a diver down float.

Avoid personal injury! Do not allow anyone near the propulsion system or intake grate, even when the engine is off. Items such as long hair, loose clothing or personal flotation device straps can become entangled in moving parts resulting in serious injury or drowning. In shallow water, shells, sand, pebbles or other objects could be drawn up by the jet pump and be thrown rearward.

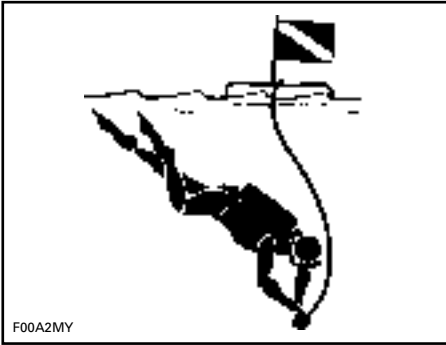

DIVER DOWN FLOAT

For more information on approved, legal and safe practice of water sports, please contact the local legal authority on water sports safety for the area you plan to practice in.

Storing the Tow Rope After Use

Tow rope should be taken out of water and stored on vehicle after each use.

⚠ WARNING
 Always remove tow rope from water and secure it to vehicle when not in use.

Tow rope should be stored in appropriate storage location:

- If vehicle is equipped with a BRP Tow Pro, secure tow rope using Tow Pro storage strap.
- If vehicle is not equipped with a BRP Tow Pro, store tow rope in Spark Cargo Net or equivalent. See an authorized Sea-Doo dealer for information.

⚠ WARNING
 Never carry any loose, heavy, sharp, or breakable objects in the storage bin.

Hypothermia

Hypothermia, the loss of body heat resulting in a subnormal body temperature, is a significant cause of death in boating accidents. After an individual has succumbed to hypothermia, he or she will lose consciousness and then drown.

PFDs can increase survival time because of the insulation they provide.

Naturally, the warmer the water, the less insulation one will require. When operating in cold water (below 4°C (40°F)) consideration should be given to using a coat or jacket style PFD as they cover more body area than the vest style PFDs.

Some points to remember about hypothermia protection:

- While afloat in the water, do not attempt to swim unless it is to reach a nearby watercraft, fellow survivor, or a floating object onto which you can lean or climb. Unnecessary swimming increases the rate of body heat loss. In cold water, drown-proof methods that require putting your head in the water are not recommended. Keep your head out of the water. This will greatly lessen heat loss and increase your survival time.
- Maintain a positive attitude about your survival and rescue. This will improve your chances of extending your survival time until you can be rescued. Your will to live does make a difference!
- If there is more than one person in the water, huddling together is recommended. This action tends to reduce the rate of heat loss and thus increase the survival time.
- Always wear your PFD. It won't help you fight off the effects of hypothermia if you don't have it on when you go into the water.

Safe Boating Courses

Many countries recommend or require a boating safety course. Check with your local competent authorities.

Check local and federal boating laws applicable to the waterways where you intend to use your watercraft. Learn the local navigation rules. Know and understand the applicable navigation system (such as buoys and signs).

Carrying Loads

When carrying load on the rear platform of the watercraft or onto cargo accessories, reduce your speed and adapt your driving behavior to reduce the risk of ejection from watercraft or contact with cargo possibly leading to injuries.

ACTIVE TECHNOLOGIES (iCONTROL)

Introduction

NOTE: Some functions or features described in this section may not apply to every PWC model, or may be available as an option.

iControl™ (intelligent Control systems) provides an environment whereby the operator can control many systems without taking his hands off the handlebars.

All controls are at the operator's finger tips and activated by pressing a button or pulling a lever. The operator's attention can thus remain focused on the water and driving the watercraft.

Each control is electronic and provides a command signal to an electronic module whose function is to assure proper operation of its system within set parameters.

The various systems grouped under iControl are the:

- iTCT™ (intelligent Throttle Control)
- iBR (intelligent Brake and Reverse) (if equipped)
- O.T.A.S. (Off Throttle Assisted Steering) (if equipped).

These systems function together to provide features such as braking, improved watercraft response to operator inputs, increased maneuverability and control.

It is extremely important for operators to read all information contained in this Operator's Guide so as to become familiar with this watercraft, its systems, controls, capabilities and limitations.

iTC (intelligent Throttle Control)

The system uses an electronic throttle control (ETC) that provides command signals to the ECM (Engine Control Module). With this system, there is no need for a traditional throttle cable.

The iTCT allows the following operating modes:

- Touring mode
- Sport mode
- O.T.A.S.™ (If equipped).

Touring Mode (Rotax 900 HO ACE)

In touring mode, available engine power and acceleration is reduced when accelerating from a complete stop and when operating in the low engine power range under certain conditions.

When throttle is applied, the engine will progressively accelerate through its operating range whereby full power eventually becomes available. If the engine is throttled down sufficiently and for a long enough period of time, engine power and acceleration will again be reduced.

Sport Mode (Rotax 900 HO ACE)

In sport mode, maximum engine power is available throughout the engine operational range.

Refer to *MULTIFUNCTION GAUGE* for detailed instructions.

O.T.A.S.™ System (If equipped) (Off-Throttle Assisted Steering)

The O.T.A.S.™ (Off Throttle Assisted Steering) is also controlled by the iTCT.

The O.T.A.S. (Off-Throttle Assisted Steering) system provides additional maneuverability in off-throttle situations.

The O.T.A.S. system is electronically activated when the operator initiates a full turn and releases the throttle at the same time.

Limitations

The O.T.A.S. system cannot help you maintain control or prevent collisions in all situations.

Refer to *OPERATING INSTRUCTIONS* for details.

iBR (intelligent Brake and Reverse System) (Models with iBR)

This watercraft uses an electronically controlled braking and reverse system called the iBR system (intelligent Brake and Reverse).

The iBR module controls the position of the iBR gate to provide:

- Forward
- Reverse
- Neutral
- Braking.

The operator commands the position of the iBR gate using either the throttle lever for forward position, or the iBR lever for neutral, reverse, and for the braking function.

NOTE: The iBR lever can only be used to command a change in the gate position if the engine is running.

Using the iBR system significantly reduces the stopping distance of this watercraft and can increase its maneuverability as it can be used in a straight line, in a turn, at high or low speeds, or to propel the watercraft in reverse for docking or maneuvering in very close quarters.

Under ideal conditions, experienced operators were consistently able to reduce the stopping distance of a watercraft equipped with an iBR system by approximately 33%, from an initial speed of 80 km/h (50 MPH).

Limitations

Even when equipped with an iBR system, watercraft do not have the ability of land based vehicles.

Stopping distance will vary notably depending on initial speed, load, wind, current, water conditions and the amount of braking.

The iBR system has no effect on the rearward motion.

It cannot prevent your watercraft from drifting in current or wind.

SAFETY EQUIPMENT

Required Safety Equipment

The operator and the passenger(s) must wear an approved Personal Flotation Device (PFD) that is suitable for PWC use.

Operator and passenger(s) should have ready access to shatterproof glasses should riding conditions or personal preference warrant.

Wind, water spray, bugs and speed may cause a person's eyes to water and create blurred vision.

As the owner of the watercraft, you are responsible for assuring that all required safety equipment is aboard. You should also consider supplying additional equipment as needed for your safety and that of your passengers. Check state and local regulations about required safety equipment.

Safety equipment required by regulations is mandatory. If local regulations require additional equipment, it must be approved by a competent authority. Minimum requirements include the following:

- Personal flotation devices (PFDs)
- A buoyant heaving line of 15 m (50 ft) minimum
- A watertight flashlight or approved flares
- Signaling device
- Sound producing devices (air horn or whistle).

Recommended Protective Gear

The operator and passenger(s) of PWCs must wear protective gear, including:

- A wet suit bottom, or thick tightly woven and snug fitting clothing that provides equivalent protection. As an example, thin bike shorts would not be appropriate. Severe internal injuries can occur if water is forced into body cavities as a result of falling in the water or being near jet thrust nozzle. Normal swimwear does not adequately protect against forceful entry of water into the lower male or female body opening(s).
- Footwear, gloves, safety goggles or glasses are also recommended. Some type of lightweight, flexible foot protection is recommended. This will help reduce possible injury, should you step on sharp underwater objects.

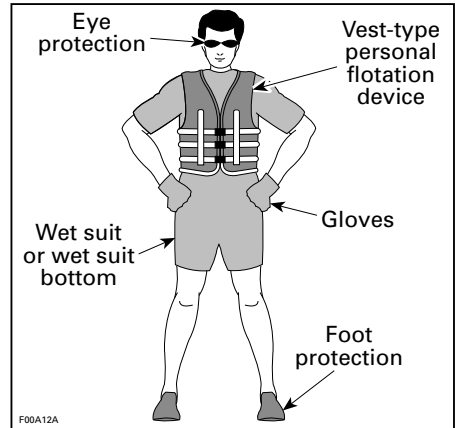

Personal Flotation Devices (PFDs)

Each person on a recreational watercraft must wear a personal flotation device (PFD) at all times. Ensure that these PFDs meet your country's regulations.

A PFD provides buoyancy to help keep the head and face above the water, and to help maintain a satisfactory body position while in the water. Body weight and age should be considered when selecting a PFD. The buoyancy provided by the PFD should support your weight in water. The size of the PFD should be appropriate for the wearer. Body weight and chest size are common methods used to size PFDs. It is your responsibility to ensure that you have the proper number and types of PFDs on board to comply with federal and local regulations, and that your passengers know where they are and how to use them.

PFD Types

There are five types of approved PFDs.

PFD Type I, Wearable, has the greatest required buoyancy. Its design allows for turning most unconscious persons in the water from face down position to a vertical or slightly backward, face-up position. It can greatly increase the chances of survival. Type I is most effective for all waters, especially offshore when rescue may be delayed. It is also the most effective in rough waters.

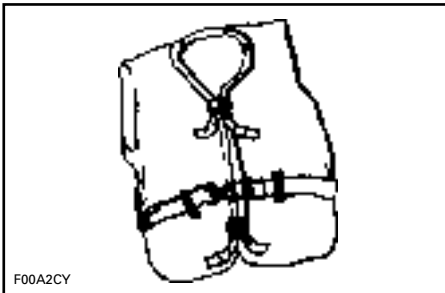

TYPE I — WEARABLE

PFD Type II, Wearable, turns its wearer in the same way as Type I, but not as effectively. The Type II does not turn as many persons under the same conditions as a Type I. You may prefer to use this PFD where there is a probability of quick rescue such as in areas where other people are commonly involved in water activities.

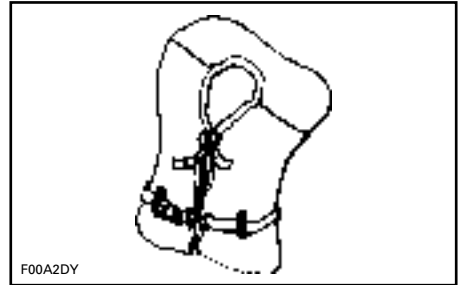

TYPE II — WEARABLE

PFD Type III, Wearable, allows wearers to place themselves in a vertical or slightly backward position. It does not turn the wearer. It maintains the wearer in a vertical or slightly backward position and has no tendency to turn the wearer face down. It has the same buoyancy as a Type II PFD and may be appropriate in areas where other people are commonly involved in water activities.

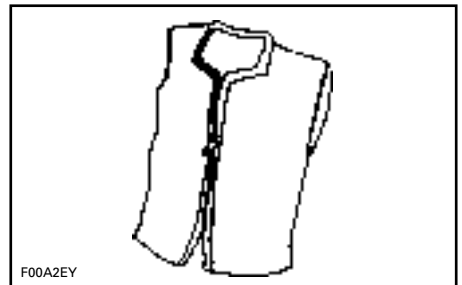

TYPE III — WEARABLE

PFD Type V, Wearable, must be worn. When inflated, it provides buoyancy equivalent to Type I, II or III PFDs. When it is deflated, however, it may not support some people.



TYPE V — WEARABLE

Helmets

Some Important Considerations

Helmets are designed to offer some degree of protection in case of impacts to the head. In most motorized sports, the benefits of wearing a helmet clearly outweigh the drawbacks. However, in the case of motorized watersports such as riding personal watercraft, this is not necessarily true as there are some particular risks associated with the water.

Benefits

A helmet helps to reduce the risk of injury in case of a head impact against a hard surface such as another craft in the case of a collision. Similarly, a helmet with a chin guard might help prevent injuries to the face, jaw or teeth.

Risks

On the other hand, in some situations when falling off the watercraft, helmets have a tendency to catch the water, like a "bucket", and put severe stresses on the neck or spine. This could result in choking, severe or permanent neck or spine injury or death.

Helmets may also interfere with peripheral vision and hearing, or increase fatigue which, could contribute to increase the risk of a collision.

Weighing the Risks vs Benefits

In order to decide whether or not you should wear a helmet, it is best to consider the particular environment you will be riding in, as well as other factors such as personal experience. Will there be a lot of traffic on the water? What is your riding style?

The Bottom Line

Since each option minimizes some risks, but increases others, before each ride you must decide whether to wear or not wear a helmet based on your particular situation.

If you decide to wear a helmet, you must then decide what type is the most appropriate for the circumstances. Look for helmets that meet DOT or Snell standards, and if possible, choose one designed for motorized watersports.

Additional Recommended Equipment

It is recommended that you acquire additional equipment for safe, enjoyable cruising. This list, which is not all inclusive, includes items you should consider acquiring.

- Local map
- First aid kit
- Tow rope
- Flares
- Mooring cords.

A cellular telephone in a waterproof bag or container has also been found to be beneficial to boaters when in distress or just for contacting someone on shore.

PRACTICE EXERCISES

It is always a good idea to practice and get familiar with all controls, functions and handling characteristics of your watercraft before venturing on the water.

Always secure the tether cord to the engine cut-off switch and the clip to your PFD or a wrist strap.

Where to Practice Exercises

Find a suitable area to practice the exercises. Ensure the area meet the following requirements:

- No traffic
- No obstacles
- No swimmers
- No current
- Ample space to maneuver
- Water depth is adequate.

Practice Exercises

Practice **alone** the following exercises.

Turning

Practice turning in circles in both directions at slow speed. When comfortable with the exercise, increase difficulty by making some figure 8.

When this is mastered, repeat the above exercises but at increased speed.

Stopping Distances

Watercraft not Equipped with iBR

Practice stopping the watercraft in a straight line at different speeds.

Remember, water drag is the main factor which reduces the watercraft speed and thus the stopping distance.

NOTE: The watercraft speed, load, current and wind also play an important role in affecting stopping distances.

Watercraft Equipped with iBR

Practice stopping the watercraft in a straight line at various speeds and braking force.

Remember that watercraft speed, load, water conditions, current and wind also affect stopping distances.

Reverse (Watercraft Equipped with iBR)

Practice reverse operation to learn how the watercraft operates in reverse and reacts with steering inputs.

NOTE: Always perform this exercise at slow speeds.

Avoiding an Obstacle

Practice obstacle avoidance (choose a virtual point on the water) by steering the watercraft and maintaining throttle.

Repeat exercise, but this time release throttle while turning.

Repeat exercise, but this time while applying iBR lever. Notice that the iBR system also takes control of the throttle.

NOTE: With this exercise, you will learn that you need throttle to steer the watercraft in a different direction.

Docking

Watercraft not Equipped with iBR

NOTE: You can use the start and stop button to reduce the docking speed.

Practice docking using the throttle and steering to become familiar with the response of the PWC and to develop good control skills.

Watercraft Equipped with iBR

Practice docking using the throttle, iBR lever and the steering to become familiar with the response of the PWC, and to develop good control skills.

NOTE: Remember that steering direction is reversed when backing.

Important Factors Not to Neglect

In addition, always remember that the following conditions have a direct impact on how your watercraft will behave and respond to different inputs:

- Loads
- Currents
- Wind
- Water conditions.

Make sure to be alert to these conditions, and adapt accordingly. If possible, practice further in these conditions.

For delicate maneuvers, the best advice is always to try to reduce your speed to a minimum.

NAVIGATION RULES

Operating Rules

Operating a watercraft can be compared with driving on unmarked highways and roads. To prevent collisions or avoid other boaters, a system of operating rules must be followed. It's not only common sense... it's the law!

Generally keep to your right and safely avoid collisions by keeping a safe distance from other watercraft, boats, people and objects.

The following illustration identifies different parts of a boat that are used as directional reference points, the bow being the front of the boat. The port side of boat (left side) is visually identifiable by a RED light off the bow, and the starboard side (right side) by a GREEN light.

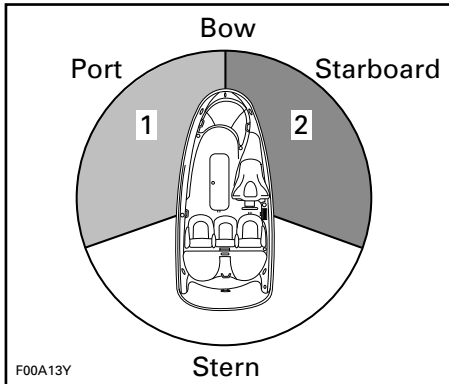

TYPICAL - DIRECTIONAL REFERENCE POINTS

1. RED light
2. GREEN light (yield zone)

Crossing

Give the right of way to a watercraft **ahead and to your right**. Never cross in front of a boat, you should see his RED light, he should see your GREEN light (he has the right of way).

Personal watercraft (PWC) do not have these colored lights, but the rule still applies.

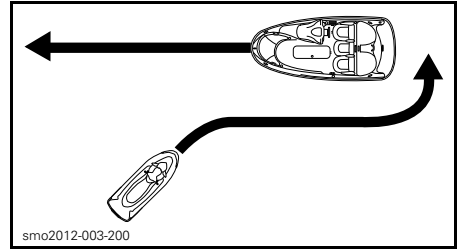

TYPICAL

Like a street traffic light, if you see a **RED** light, **STOP**, give the right of way. The other boat is to your right and it has the right of way.

If you see a **GREEN** light, **pass with caution**. The other boat is to your left, you have the right of way.

Meeting Head-On

Keep right.

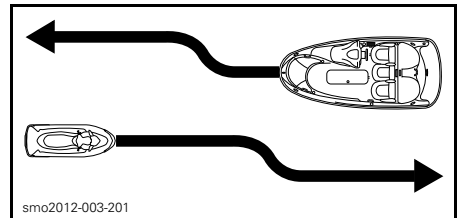

TYPICAL

Passing

Give the right of way to other crafts and keep clear.

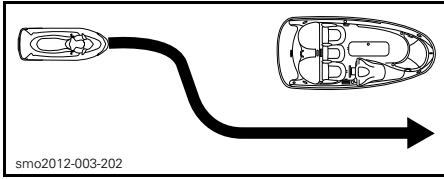

TYPICAL

Navigation System

Navigational aids, such as signs or buoys, can assist you in identifying safe waters. Buoys will indicate whether you should keep to the right (starboard) or to the left (port) of the buoy, or to which channel you can continue. They may also indicate whether you are entering a restricted or controlled area such as a no wake or low speed zone. They may also indicate hazards or pertinent boating information. Markers may be located on shore or on the water. They can also indicate speed limits, no power craft or boating, anchorage and other useful information. (The shape of each type of marker will provide assistance).

Make sure you know and understand the navigation system applicable to the waterways where you intend to use the watercraft.

Collision Avoidance

Do not release the throttle when trying to steer away from an obstacle. Engine power and jet pump thrust is required to steer the watercraft.

Always keep a constant lookout for other water users, other boats or objects, especially when turning. Be alert for conditions that may limit your visibility or block your vision of others.

Respect the rights of other recreationists and/or bystanders and always keep a safe distance from all other watercraft, boats, people and objects.

Do not wake or wave jump, ride the surf line or attempt to spray or splash others with your watercraft. You may misjudge the ability of the watercraft or your own riding skills and strike a boat, watercraft or person.

This watercraft has the capability of turning more sharply than other boats, however, unless in an emergency, do not negotiate sharp, high speed turns. Such maneuvers make it hard for others to avoid you or understand where you are going. Also, you and/or your passenger(s) could be thrown from the watercraft.

Models with iBR

Unlike most other watercraft, this PWC has a braking system (iBR).

When operating an iBR equipped watercraft, be aware that other boats following or operating in close proximity may not be able to stop as quickly.

When at speed and the brake is first applied, a plume of water will shoot up in the air behind the watercraft indicating a braking manoeuvre.

It is important to inform the operator of a watercraft who intends to follow in a convoy formation of the braking and maneuvering capability of your PWC, what the plume of water indicates, and that a greater distance should be maintained between both of you.

Stopping distance will vary depending on initial speed, load, wind and water conditions.

Although the preferable maneuver to avoid an obstacle is to steer away while applying throttle, the iBR can also be used by fully braking and turning in the appropriate direction to avoid the obstacle.

FUELING

Fueling Procedure

⚠ WARNING

Fuel is flammable and explosive under certain conditions. Always work in a well ventilated area. Do not smoke or allow open flames or sparks in the vicinity.

1. Turn off engine.

⚠ WARNING

Always stop the engine before refueling.

2. Do not allow anyone to remain on the watercraft.
3. Tie watercraft securely to the fueling pier.
4. Have a fire extinguisher (not supplied with vehicle) close at hand.
5. Remove the seat. Refer to *SEAT* in *EQUIPMENT* section.
6. Locate fuel tank cap.



1. Fuel tank cap

7. Slowly unscrew the fuel cap counterclockwise.

⚠ WARNING

Fuel tank may be pressurized, fuel vapors may be released while removing the fuel tank cap.

8. Insert the gas pump spout into the filler neck and fill up the fuel tank.

⚠ WARNING

To prevent fuel back-flow, fill tank slowly so the air can escape from the fuel tank.

9. Stop filling immediately after the release of the gas pump nozzle handle and wait a moment before removing the spout. Do not retract the gas pump nozzle to put more fuel in fuel tank.

⚠ WARNING

Do not overfill or top off the fuel tank and leave the watercraft in the sun. As temperature increases, fuel expands and may overflow.

10. Reinstall fuel tank cap and tighten it clockwise until you hear a ratchet sound.

⚠ WARNING

Always wipe off any fuel spillage from the watercraft.

11. After refueling, always ensure there is no gasoline vapor odor inside the engine compartment.
12. To access the engine compartment, turn the LH access cover knob 1/4 turn clockwise, then pull out to unsnap the rear portion and slide rearward to remove.



LH ACCESS COVER

1. To unlock, turn the knob 1/4 turn clockwise

⚠ WARNING

Do not start watercraft if gasoline or gasoline vapor odor is present.

13. Reinstall the LH access cover in reverse of removal procedure and lock the knob by turning it 1/4 turn counterclockwise.



LH ACCESS COVER

1. To lock, turn the knob 1/4 turn counterclockwise

14. To reinstall the seat, refer to *SEAT* in *EQUIPMENT* section.

Fuel Requirements

NOTICE Always use fresh gasoline. Gasoline will oxidize; the result is loss of octane, volatile compounds, and the production of gum and varnish deposits which can damage the fuel system.

Alcohol fuel blending varies by country and region. Your vehicle has been designed to operate using the recommended fuels, however, be aware of the following:

- Use of fuel containing alcohol above the percentage specified by government regulations is not recommended and can result in the following problems in the fuel system components:
 - Starting and operating difficulties.
 - Deterioration of rubber or plastic parts.
 - Corrosion of metal parts.
 - Damage to internal engine parts.
- Inspect frequently for the presence of fuel leaks or other fuel system abnormalities if you suspect the presence of alcohol in gasoline exceeds the current government regulations.
- Alcohol blended fuels attract and hold moisture which may lead to fuel phase separation and can result in engine performance problems or engine damage.

Recommended Fuel

Use unleaded gasoline containing MAXIMUM 10% ethanol.

Use common unleaded gasoline with an AKI (RON+MON)/2 octane rating of 87, or an RON octane rating of 91.



NOTICE Never experiment with other fuels. Engine or fuel system damages may occur with the use of an inadequate fuel.

NOTICE Do NOT use fuel from fuel pumps labeled E85.

Use of fuel labeled E15 is prohibited by U.S. EPA Regulations.

TRAILERING INFORMATION

NOTICE The span of the trailer wood bunks including bunk width should be adjusted to provide support throughout the full length of the hull. The ends of both trailer wood bunks should not exceed the length of the watercraft.

Ensure the trailer wheels are positioned so that the center of gravity of the watercraft is slightly ahead of the wheels to properly support the weight of the watercraft.

WARNING

Never tip this watercraft on end for transporting. We recommend that you carry the watercraft in its normal operating position.

Check the applicable laws and regulations in your area concerning towing a trailer, especially for the following items:

- Brake system
- Tow vehicle weight
- Mirrors.

Take the following precautions when towing the watercraft:

- Respect tow vehicle maximum weight capacity and the tongue weight capacity as recommended by manufacturer.
- Tie the watercraft to both front and rear (bow/stern) eyelets so that it is firmly secured on the trailer. Use additional tie-downs if necessary.
- Ensure fuel tank cap, storage bin front cover (if equipped), glove box cover and seat are properly latched.
- Observe trailering safety precautions.

NOTICE Do not route ropes or tie-downs over the seat or grab handle as they could be permanently damaged. Do not use pump or reverse gate to route ropes and tie-downs as they could be permanently damaged. Wrap ropes or tie-downs with rags or similar protectors where they can come into contact with the watercraft body.

WARNING

Make sure seat is securely latched prior to trailering.

A Sea-Doo cover can protect the watercraft, particularly when driving on dirt roads, to prevent dirt entry through the air inlet openings.

WARNING

When trailering the watercraft, NEVER leave any equipment on the watercraft.

IMPORTANT ON-PRODUCT LABELS

Hang Tag

This PWC comes with hang tag and label containing important safety information.

Any person who rides this vehicle should read and understand this information before riding.



EN-219905280-DEC

Watercraft Safety Labels

These labels are affixed to the vehicle for the safety of the operator, passenger(s) or bystanders.

The labels illustrated on the following pages are on your watercraft. If missing or damaged, they can be replaced free of charge. See an authorized Sea-Doo dealer. Please read the following labels carefully before operating this watercraft.

NOTE: The first illustration of the watercraft indicates the approximate locations of the various labels. A dotted line indicates that the label is not on the outer surface, and that the seat or a cover of some type must be opened to see the label.

NOTE: In the event of any discrepancy between this guide and the vehicle, the safety labels on the vehicle have precedence over the labels in this guide.

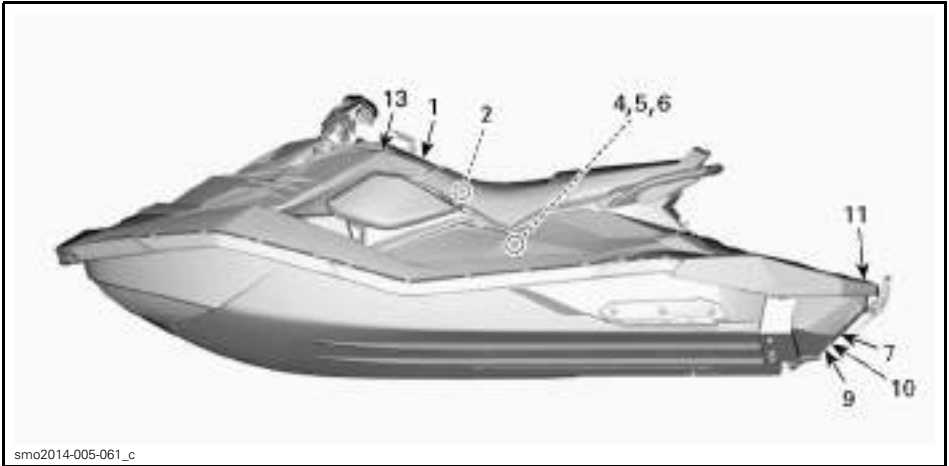

TYPICAL - 3UP - WITH iBR AND CONVENIENCE PACKAGE SHOWN

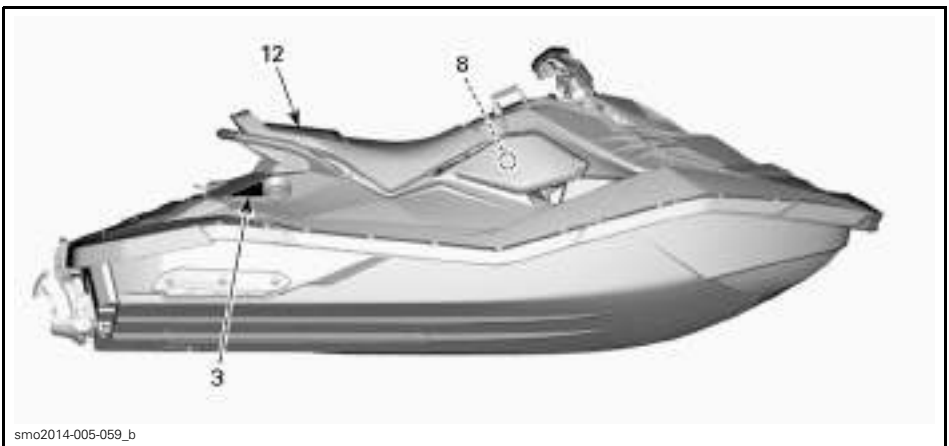

TYPICAL

⚠ WARNING

Collisions result in more **INJURIES AND DEATHS** than any other type of accident for personal watercraft (PWC).

TO AVOID COLLISIONS: SCAN CONSTANTLY for people, objects, and other watercraft. Be alert for conditions that limit your visibility or block your vision of others.



OPERATE DEFENSIVELY at safe speeds and keep a safe distance away from people, objects, and other watercraft. • Do not follow directly behind PWCs or other boats. • Do not go near others to spray or splash them with water. • Avoid sharp turns or other maneuvers that make it hard for others to avoid you or understand where you are going. • Avoid areas with submerged objects or shallow water.

TAKE EARLY ACTION to avoid collisions. Remember, generally PWCs and other boats do not have brakes.

DO NOT RELEASE THROTTLE WHEN TRYING TO STEER away from objects - you need throttle to steer. Always check throttle and steering controls for proper operation before starting PWC.

Follow navigation rules and province / state and local laws that apply to PWCs. Read and understand all safety labels, locate and read operator's guide and watch the safety video using the QR code link or visit Sea-Doo web site before operation.



⚠ WARNING

To reduce the risk of **SEVERE INJURY OR DEATH: WEAR A PERSONAL FLOTATION DEVICE (PFD).**

All riders must wear a Coast Guard approved PFD that is suitable for personal watercraft (PWC) use.

WEAR PROTECTIVE CLOTHING. Severe internal injuries can occur if water is forced into body cavities as a result of falling into water or being near jet thrust nozzle. Normal swimwear does not adequately protect against forceful water entry into lower body opening(s) of males or females. All riders must wear a wet suit bottom or clothing that provides equivalent protection (see operator's guide). Footwear, gloves, and goggles / glasses are recommended.



KNOW BOATING LAWS. BRP recommends a minimum operator age of 16 years old. Know the operator age and training requirements for your province / state.

A boating safety course is recommended and may be required in your province / state. **ATTACH ENGINE SHUT-OFF CORD (LANYARD)** to PFD and keep it free from handlebars so that engine stops if operator falls off. After riding, remove cord from PWC to avoid unauthorized use by children or others.

RIDE WITHIN YOUR LIMITS AND AVOID AGGRESSIVE MANEUVERS to reduce the risk of loss of control, ejection, and collision. This is a high performance boat - not a toy. Sharp turns or jumping wakes or waves can increase the risk of back / spinal injury (paralysis), facial injuries, and broken legs, ankles, and other bones. Do not jump wakes or waves. **DO NOT APPLY THROTTLE WHEN ANYONE IS AT REAR OF PWC** - turn engine off or keep engine at idle. Water and / or debris exiting jet thrust nozzle can cause severe injury.

KEEP AWAY FROM INTAKE GRATE while engine is on. Items such as long hair, loose clothing, or PFD straps can become entangled in moving parts resulting in severe injury or drowning.



NEVER RIDE AFTER CONSUMING DRUGS OR ALCOHOL.

READ AND FOLLOW OPERATOR'S GUIDE.



219905531

EN-219905531-DEC_a

LABEL 1

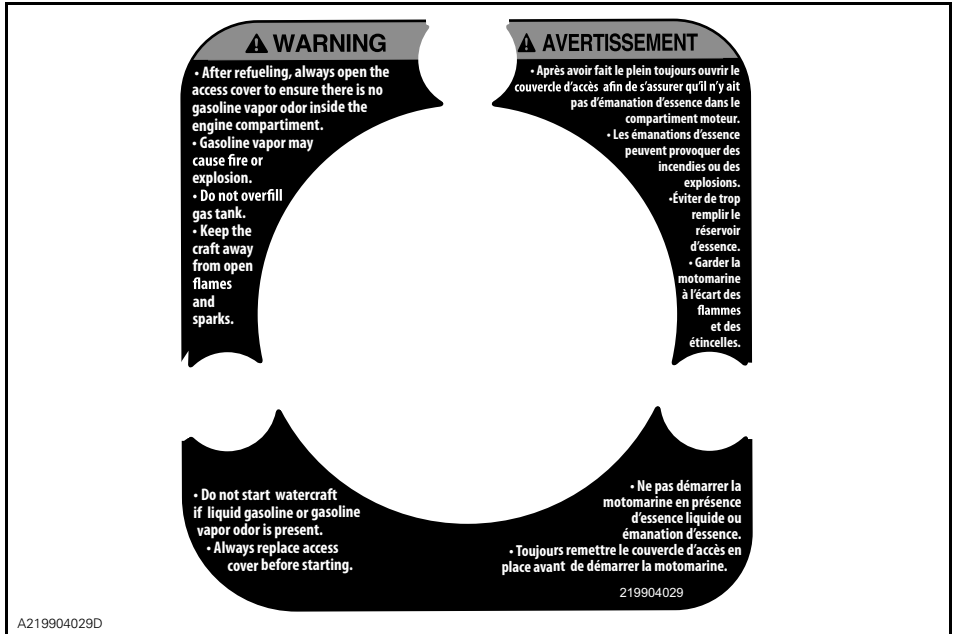

LABEL 2

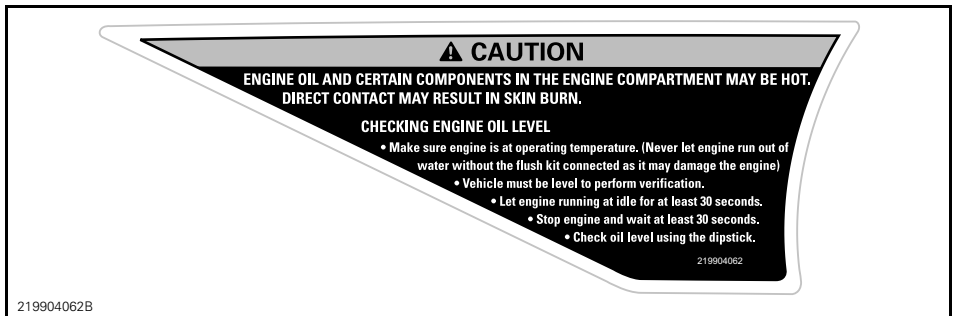

LABEL 3



LABEL 4

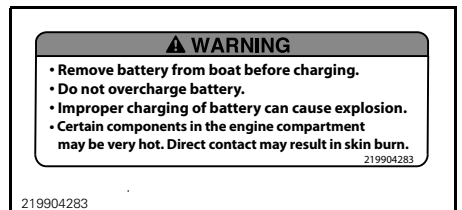

LABEL 5



F00A2TY

LABEL 6



219904396

LABEL 9- MODELS WITH iBR

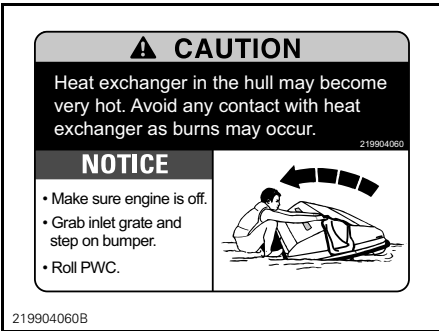

219904060

219904060B

LABEL 7



EN-219904804-DEC

LABEL 10 - MODELS WITH iBR



219904805-DEC

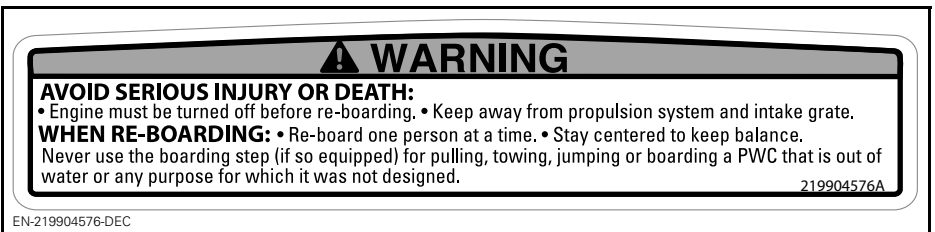

219904576A

EN-219904576-DEC

LABEL 11



smo2014-005-087_a

LABEL 12 - STAMPED ON REAR OF SEAT OF 2UP MODELS

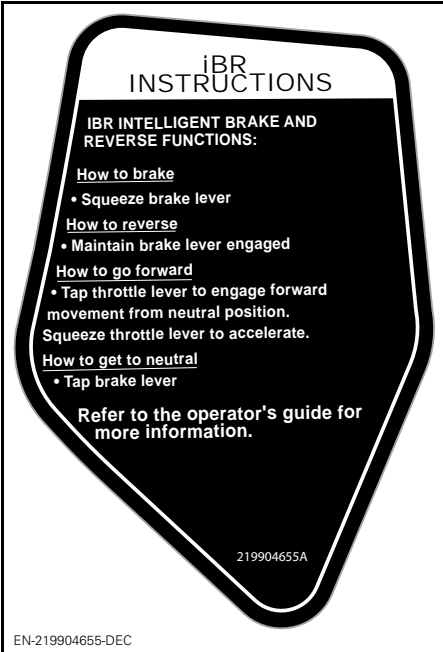

EN-219904655-DEC

LABEL 13 - LOCATED ON CONSOLE

Compliance Labels



TYPICAL



TYPICAL



LABEL 1 - TYPICAL EMISSION CONTROL LABEL

CANADIAN COMPLIANCE NOTICE AVIS DE CONFORMITÉ CANADIEN	
MAXIMUM RECOMMENDED SAFE LIMITS LIMITES MAXIMALES DE SÉCURITÉ RECOMMANDÉES	
Max. = 2	160 kg 352 lbs/lb
Max. + =	160 kg 352 lbs/lb
CATEGORY / CATÉGORIE: C MAXIMUM WAVE / VAGUE MAXIMALE 2.0 m MAXIMUM WIND SPEED / VITESSE DE VENT MAXIMALE 33.0 knots/noeuds	
BOMBARDIER RECREATIONAL PRODUCTS INC. VALCOURT, QUÉBEC, CANADA (YDV)	
MODEL / MODÈLE: XXXXXXXXX	
THE MANUFACTURER DECLARES THAT THIS PRODUCT COMPLIES WITH THE CONSTRUCTION REQUIREMENTS OF THE SMALL VESSEL REGULATIONS, AS THEY READ ON THE DAY ON WHICH THE CONSTRUCTION OF THE VESSEL WAS STARTED OR ON THE DAY ON WHICH THE VESSEL WAS IMPORTED. LE FABRICANT ATTESTE QUE CE PRODUIT EST CONFORME AUX EXIGENCES DE CONSTRUCTION DU RÉGLEMENT SUR LES PETITS BÂTIMENTS EN VIGUEUR À LA DATE DU DÉBUT DE SA CONSTRUCTION OU DE SON IMPORTATION.	
MAXIMUM CAPACITIES ABOVE INFORMATION ALSO APPLIES IN THE U.S.A.	CAN ICES-2 / NMB-2*

LABEL 2 - 2UP MODELS - TYPICAL CANADIAN COMPLIANCE NOTICE (CAN MODELS ONLY)

CANADIAN COMPLIANCE NOTICE AVIS DE CONFORMITÉ CANADIEN	
MAXIMUM RECOMMENDED SAFE LIMITS LIMITES MAX. DE SÉCURITÉ RECOMMANDÉES	
Max. = 2	160 kg 352 lb
Max. + =	160 kg 352 lb
CATEGORY / CATÉGORIE: C MAXIMUM WAVE / VAGUE MAXIMALE 2.0 m MAXIMUM WIND SPEED / VITESSE DE VENT MAXIMALE 33.0 knots/noeuds	
BOMBARDIER RECREATIONAL PRODUCTS INC. 570, Montagne, Valcourt, QC, CA, JOE 2L0 (YDV) Skaldenstraat 125, Gent, 9042, BE	
MODEL / MODELE: XXX XXX XXX	
THE MANUFACTURER DECLARES THAT THIS PRODUCT COMPLIES WITH THE CONSTRUCTION REQUIREMENTS OF THE SMALL VESSEL REGULATIONS, AS THEY READ ON THE DAY ON WHICH THE CONSTRUCTION OF THE VESSEL WAS STARTED OR ON THE DAY ON WHICH THE VESSEL WAS IMPORTED. / LE FABRICANT ATTESTE QUE CE PRODUIT EST CONFORME AUX EXIGENCES DE CONSTRUCTION DU RÉGLEMENT SUR LES PETITS BÂTIMENTS EN VIGUEUR À LA DATE DU DÉBUT DE SA CONSTRUCTION OU DE SON IMPORTATION.	
MAXIMUM CAPACITIES ABOVE INFORMATION ALSO APPLIES IN THE U.S.A.	

LABEL 2 - 2UP MODELS - TYPICAL (WATERCRAFT OUTSIDE NORTH AMERICA)

CANADIAN COMPLIANCE NOTICE AVIS DE CONFORMITÉ CANADIEN	
MAXIMUM RECOMMENDED SAFE LIMITS LIMITES MAXIMALES DE SÉCURITÉ RECOMMANDÉES	
Max.  = 3	205 kg 450 lbs/lb
Max.  +  =	205 kg 450 lbs/lb
CATEGORY / CATÉGORIE: C	
MAXIMUM WAVE / VAGUE MAXIMALE 2.0 m	
MAXIMUM WIND SPEED / VITESSE DE VENT MAXIMALE 33.0 knots/noeuds	
BOMBARDIER RECREATIONAL PRODUCTS INC.	
570, Montagne, Valcourt, QC, CA, JOE 2LO (YDV)	
MODEL / MODÈLE: XXXXXXXXX 	
THE MANUFACTURER DECLARES THAT THIS PRODUCT COMPLIES WITH THE CONSTRUCTION REQUIREMENTS OF THE SMALL VESSEL REGULATIONS, AS THEY READ ON THE DAY ON WHICH THE CONSTRUCTION OF THE VESSEL WAS STARTED OR ON THE DAY ON WHICH THE VESSEL WAS IMPORTED. LE FABRICANT ATTESTE QUE CE PRODUIT EST CONFORME AUX EXIGENCES DE CONSTRUCTION DU RÉGLEMENT SUR LES PETITS BÂTIMENTS EN VIGUEUR À LA DATE DU DÉBUT DE SA CONSTRUCTION OU DE SON IMPORTATION.	
MAXIMUM CAPACITIES ABOVE INFORMATION ALSO APPLIES IN THE U.S.A.	CAN ICES-2 / NMB-2*

smo2015-005-004_a

LABEL 2 - 3UP MODELS - TYPICAL
CANADIAN COMPLIANCE NOTICE (CAN
MODELS ONLY)

CANADIAN COMPLIANCE NOTICE AVIS DE CONFORMITÉ CANADIEN	
MAXIMUM RECOMMENDED SAFE LIMITS LIMITES MAX. DE SÉCURITÉ RECOMMANDÉES	
Max.  = 3	205 kg 450 lb
Max.  +  =	205 kg 450 lb
CATEGORY / CATÉGORIE: C	
MAXIMUM WAVE / VAGUE MAXIMALE 2.0 m	
MAXIMUM WIND SPEED / VITESSE DE VENT MAXIMALE 33.0 knots/noeuds	
BOMBARDIER RECREATIONAL PRODUCTS INC.	
570, Montagne, Valcourt, QC, CA, JOE 2LO (YDV)	
Skaldenstraat 125, Gent, 9042, BE	
MODEL / MODELE: XXX XXX XXX 	
THE MANUFACTURER DECLARES THAT THIS PRODUCT COMPLIES WITH THE CONSTRUCTION REQUIREMENTS OF THE SMALL VESSEL REGULATIONS, AS THEY READ ON THE DAY ON WHICH THE CONSTRUCTION OF THE VESSEL WAS STARTED OR ON THE DAY ON WHICH THE VESSEL WAS IMPORTED. / LE FABRICANT ATTESTE QUE CE PRODUIT EST CONFORME AUX EXIGENCES DE CONSTRUCTION DU RÉGLEMENT SUR LES PETITS BÂTIMENTS EN VIGUEUR À LA DATE DU DÉBUT DE SA CONSTRUCTION OU DE SON IMPORTATION.	
MAXIMUM CAPACITIES ABOVE INFORMATION ALSO APPLIES IN THE U.S.A.	

EN-219001696-152-DEC

LABEL 2 - 3UP MODELS - TYPICAL
(WATERCRAFT OUTSIDE NORTH AMERICA)

<p>THIS BOAT IS MANUFACTURED BY BOMBARDIER RECREATIONAL PRODUCTS INC. PER 46 U.S.C. 4305 AND U.S. COAST GUARD GRANT OF EXEMPTION (CGB 88-001) THE COAST GUARD EXEMPTS THIS VESSEL FROM ONE OR MORE SAFETY REGULATIONS. CGB 88-001 STATES THAT CERTAIN REGULATIONS ARE INAPPLICABLE IN LIGHT OF THIS VESSEL'S CHARACTERISTICS AND THAT THE EXEMPTION WILL NOT HAVE AN ADVERSE EFFECT ON RECREATIONAL BOATING SAFETY. THIS BOAT COMPLIES WITH U.S. COAST GUARD SAFETY STANDARDS IN EFFECT ON THE DATE OF CERTIFICATION. ALL PERSONS SHOULD WEAR A LIFE JACKET (PERSONAL FLOTATION DEVICE) WHILE OPERATING OR RIDING ON THIS WATERCRAFT.</p> <p>ASSEMBLED IN MEXICO</p> <p>219905499</p>
--

EN-219905499-EN

LABEL 3 - TYPICAL



**LABEL 4- - APPLICABLE FOR ALL MODELS
IN CANADA AND UNITED STATES.
APPLICABLE FOR MODELS EVERYWHERE
EXCEPT CANADA AND UNITED STATES
WHEN EQUIVALENT TO A MODEL
CERTIFIED TO US. EPA STANDARDS**



LOCATED NEAR GAS CAP

PRE-RIDE INSPECTION

We encourage you to have an Annual Safety Inspection of your vehicle. Please contact an authorized BRP dealer for further details. Though not required, it is recommended that an authorized BRP dealer performs the preseason preparation of your vehicle. Each visit to your authorized BRP dealer is a great opportunity for your dealer to verify if your vehicle is included in any safety campaign. We also urge you to visit your authorized BRP dealer in a timely manner if you become aware of any safety related campaigns.

WARNING

Perform a pre-ride inspection before each ride to detect potential problems during operation. The pre-ride inspection can help you monitor wear and deterioration before they become a problem. Correct any problems that you discover to reduce the risk of a breakdown or crash.

Before performing the pre-ride inspection, read and understand the *CONTROLS* section.

What to Do Before Launching the Watercraft

WARNING

Engine should be off and the tether cord cap should always be removed from the engine cut-off switch prior to verifying any of the following points. Only start watercraft once all items have been checked and operate properly.

Check the items listed in the following table before launching the watercraft.

ITEM	OPERATION	✓
Hull	Inspect hull, ride plate and water inlet grate for damages.	
Jet pump water intake	Inspect/clean.	
Drain plug	Tighten.	
Fuel tank	Refill.	
Engine compartment	Check for any visible fluid leaks and gasoline vapor odor.	
Engine oil level	Check/refill.	
Engine coolant level	Check/refill.	
Heat exchanger condition	Inspect.	
Steering system	Check operation.	

ITEM	OPERATION	✓
iTC lever	Check operation. (Depress and release the lever to check for freedom of movement. If any friction is felt, the lever must be taken apart, cleaned, inspected for wear and lubricated)	
iBR lever (models with iBR)	Check operation. (Depress and release the lever to check for freedom of movement. If any friction is felt, the lever must be taken apart, cleaned, inspected for wear and lubricated)	
Storage bin front cover (if equipped), boarding platform and seat	Ensure they are closed and latched.	
Self-contained removable storage bin (if applicable)	Ensure it is installed on watercraft and properly closed and latched.	
Engine START/STOP button	Check operation.	
Engine cut-off switch and the monitoring beeper	Check operation.	
Battery condition and connections	Check operation.	
Sacrificial anode	Inspect every month (more often in saltwater use) and change if necessary	

Hull

Inspect hull for cracks and other damages.

Jet Pump Water Intake

Remove weeds, shells, debris or anything else that could restrict the flow of water and damage the propulsion unit. Clean as necessary. If any obstruction cannot be removed, refer to an authorized Sea-Doo dealer for servicing.

NOTE: There is a reinforcement plate on LH side of hull to maintain symmetry so the hydrodynamics of PWC are not affected.

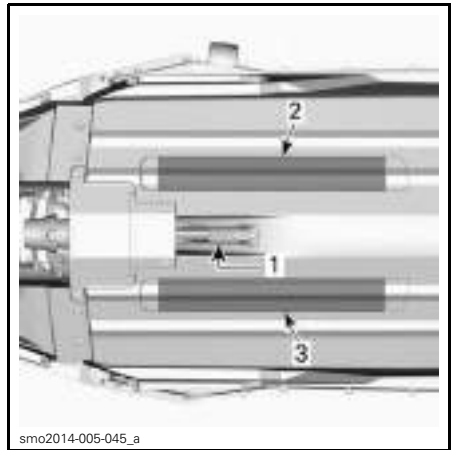

TYPICAL
 1. Water intake
 2. Heat exchanger
 3. Reinforcement plate

Drain Plug

Secure bilge drain plug.



TYPICAL

1. Bilge drain plug

Step 1: Untighten

Step 2: Tighten

⚠ WARNING

Ensure bilge drain plug is properly secured prior to launching the watercraft in water.

Fuel Tank

Fill the fuel tank.

⚠ WARNING

Strictly adhere to instructions detailed in *FUELING PROCEDURE*.

Engine Compartment

Inspect the engine compartment for fuel vapor odor.

⚠ WARNING

Should any leak or gasoline odor be present, do not apply electrical power or start the engine. You should seek service from an authorized Sea-Doo dealer, repair shop, or person of your own choosing for maintenance, repair, or replacement. Please refer to the *US EPA EMISSIONS-RELATED WARRANTY* contained herein for information about warranty claims.

To access the engine compartment, turn the LH access cover knob 1/4 turn clockwise, then pull out to unsnap the rear portion and slide rearward to remove.



LH ACCESS COVER

1. To unlock, turn the knob 1/4 turn clockwise



ENGINE COMPARTMENT - LH ACCESS COVER REMOVED

Reinstall the LH access cover in the reverse of the removal procedure and lock the knob by turning it 1/4 turn counterclockwise.



sno2015-005-005_b

LH ACCESS COVER

1. To lock, turn the knob 1/4 turn counterclockwise

Engine Oil

Ensure oil level is within specification as described in *MAINTENANCE PROCEDURES* section.

Engine Coolant

Ensure coolant level is within specification as described in *MAINTENANCE PROCEDURES* section.

Check for coolant leaks on engine, in bilge and from heat exchanger.

CAUTION When operating the engine with the watercraft out of the water, the engine and heat exchanger may become very hot. Avoid any contact with hot engine parts and the heat exchanger as burns may occur.

Steering System

If steering is misaligned, follow alignment instructions in *MAINTENANCE PROCEDURES* section.

Assisted by another person, check steering operation for free movement.

When the handlebar is horizontal, the jet pump nozzle should be in the straight ahead position. Turn the handlebar from left to right and make sure nozzle turns.

WARNING

Check handlebar and corresponding steering nozzle operation before starting. Never turn handlebar while someone is near the rear of the watercraft. Keep away from steering moving parts (nozzle, iBR gate (models with iBR), linkages etc.).

Throttle Lever

Check the Electronic Throttle Control lever (ETC) for free and smooth operation. It should return to its initial position immediately after it is released.

WARNING

Check throttle lever operation before starting the engine. If any friction is felt in the throttle lever, refer to an authorized Sea-Doo dealer.

iBR Lever (Models with iBR)

Check the iBR lever for free and smooth operation. It should return to its initial position immediately after it is released.

WARNING

Check iBR lever operation before starting the engine. If any friction is felt in the iBR lever, refer to an authorized Sea-Doo dealer.

Storage bin (Convenience Package), Glove Box and Seat

Ensure the storage bin front cover (if equipped), glove box cover, and seat are closed and latched.

⚠ WARNING

Ensure the seat, glove box cover, and storage bin front cover (if equipped) are securely latched.

Engine Cut-Off Switch and Engine START/STOP Button

Install the tether cord cap on the engine cut-off switch.

Press the engine START/STOP button to start the engine, then stop it by pressing the engine START/STOP button a second time.

NOTE: The engine will always start if the tether cord cap is properly install. The ECU will power down after 1 hour, but if you push the start button, it will wake-up and start.

Restart the engine, then stop it by removing the tether cord from the engine cut-off switch.

⚠ WARNING

Should the tether cord cap be loose or fail to remain on the engine cut-off switch, replace the tether cord immediately in order to avoid unsafe use. If removing the tether cord cap from the engine cut-off switch or pressing the engine START/STOP button does not stop the engine, do not use the watercraft. See your authorized Sea-Doo dealer.

What to Do After Launching the Watercraft

Check the item listed in the following table after launching the watercraft and before going for a ride.

ITEM	OPERATION	✓
Multifunction gauge	Check operation	
Intelligent Brake and Reverse System (iBR) (models with iBR)	Check operation	
Variable Trim System (VTS) (as applicable)	Check operation	

Multifunction Gauge

1. Press engine START/STOP button and install the tether cord cap on the engine cut-off switch.
2. As the multifunction gauge cycles through its self-test function, ensure all indications come on.

⚠ WARNING

Always attach the tether cord clip to your PFD or to the wrist (wrist strap required).

iBR System (Models with iBR)

NOTICE Ensure there is sufficient space ahead and behind watercraft to safely carry out the iBR system test to avoid a collision. Watercraft will move during test.

1. Remove the moorings securing the watercraft to the dock.
2. Start the engine and ensure the watercraft does not move.
3. On the left handlebar, depress the iBR lever completely in, the watercraft should move slowly backwards.
4. Release the iBR lever, there should not be any reverse thrust.

 **WARNING**

Always ensure proper iBR system operation before taking the watercraft out for a ride.

Variable Trim System (If Applicable)

With the engine running in forward position, use the VTS system to move the jet pump nozzle up and down alternately to check VTS operation. Confirm the VTS position display movement in the multifunction gauge

Also test the VTS preset trim positions by double clicking the VTS UP/DOWN button.

Refer to *OPERATING INSTRUCTIONS* for detailed instructions.

WATERCRAFT INFORMATION

CONTROLS

NOTE: Some vehicle safety labels are not shown on illustrations. For information on vehicle safety labels, refer to *WATERCRAFT SAFETY LABELS*.

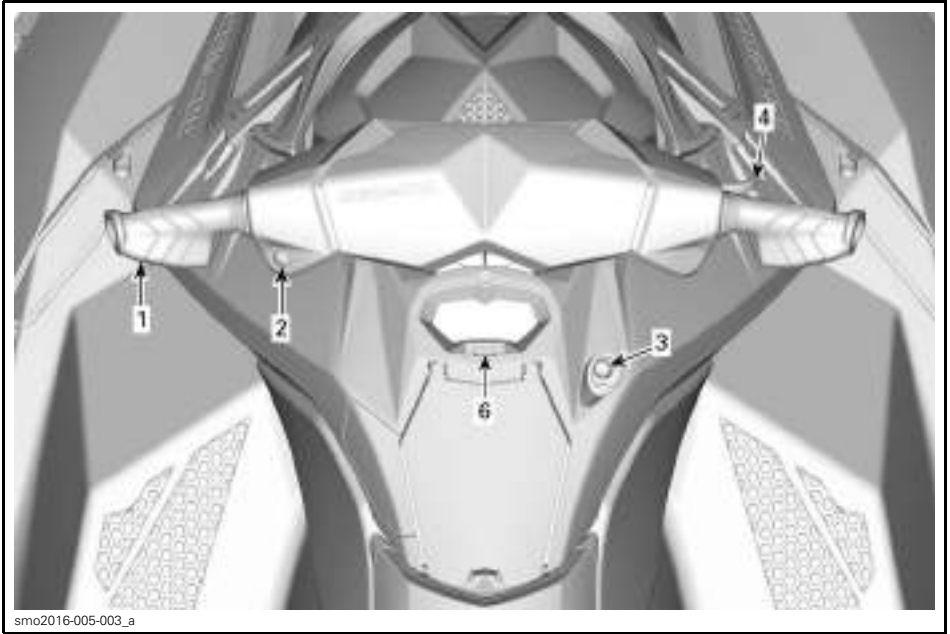

smo2016-005-003_a

TYPICAL - MODELS WITHOUT iBR

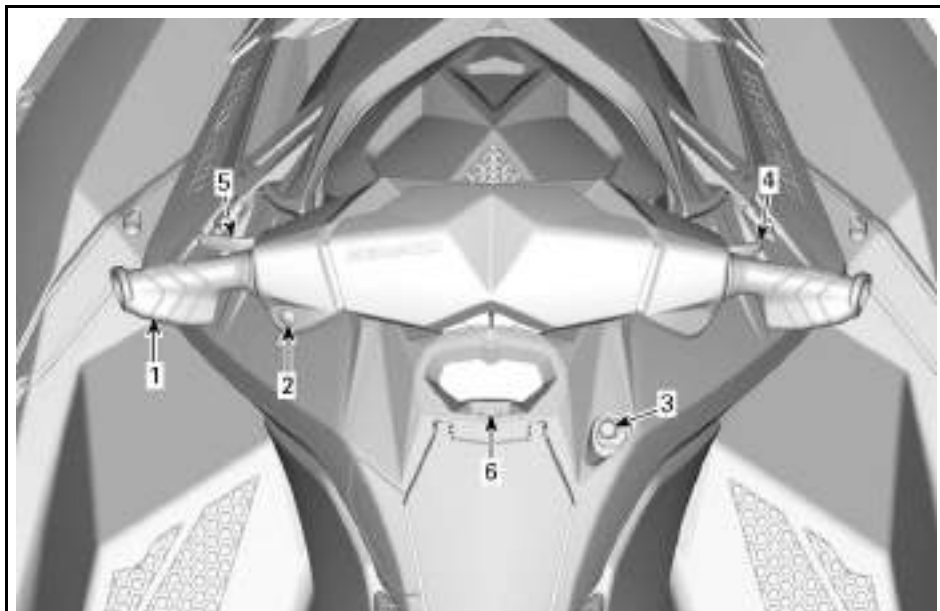

smo2016-005-002_a

TYPICAL - MODELS WITH iBR

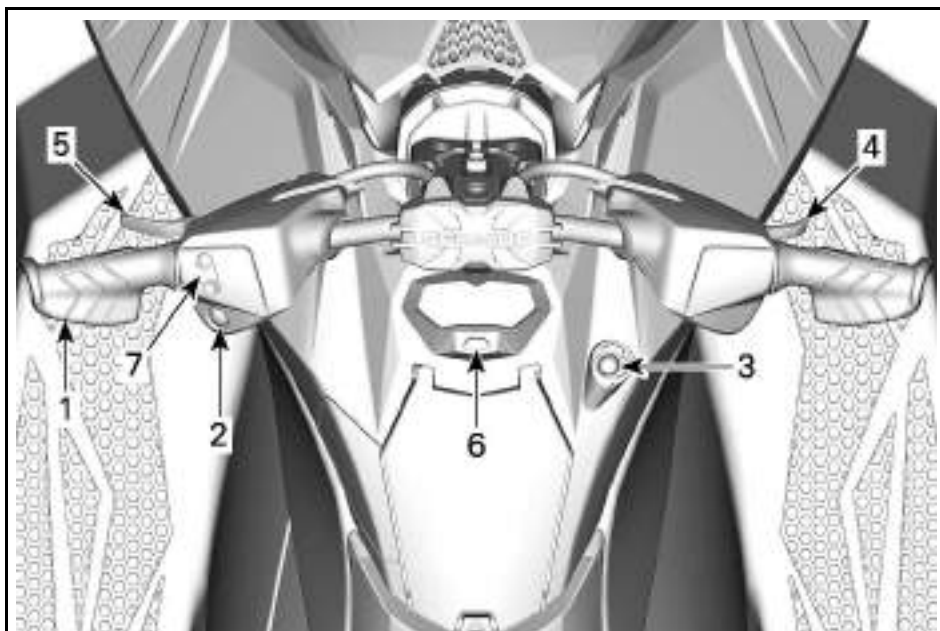

219001697-101_a

TRIXX MODELS

1) Handlebar

The handlebar controls the direction of the watercraft. During forward operation, turning the handlebar to the right steers the watercraft to the right and inversely.

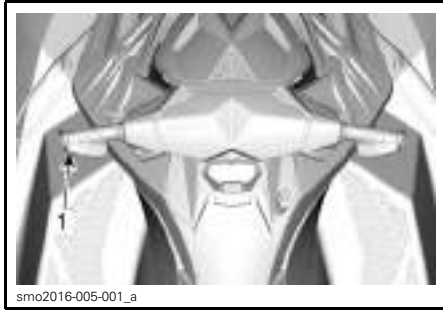

smo2016-005-001_a

TYPICAL

1. Handlebar

⚠ WARNING

Check handlebar and corresponding steering nozzle operation before starting. Never turn handlebar while someone is near the rear of the watercraft. Keep away from the propulsion system.

2) Engine START/STOP Button

The engine START/STOP button is located on the LH handlebar.



smo2014-005-052_b

TYPICAL

1. Engine START/STOP button

Engine Starting and Stopping

Refer to *OPERATING INSTRUCTIONS* for detailed instructions.

Waking Up the Electrical System

Press the engine START/STOP button once without installing the tether cord on the engine cut-off switch.

This will power up the electrical system; the multifunction gauge will cycle through a self-test function and will then go blank after a few seconds.

The electrical system will stay powered up for approximately 75 seconds after the engine START/STOP button was depressed.

NOTE: If the engine START/STOP button is pressed and held without the tether cord installed, the multifunction gauge displays will stay on as long as the engine START/STOP button is held.

3) Engine Cut-Off Switch

The engine cut-off switch is located on the RH side of the multifunction gauge.



smo2014-005-052_c

TYPICAL

1. Engine cut-off switch

To allow engine starting, the tether cord cap must be securely snapped onto the engine cut-off switch.

⚠ WARNING

Always attach the tether cord clip to the operator's personal flotation device (PFD) or wrist (wrist strap required).



smo2014-005-093_a

TYPICAL

1. Tether cord cap on the engine cut-off switch
2. Tether cord clip secured to operator's PFD

To stop engine, pull the tether cord cap from the engine cut-off switch.

⚠ WARNING

Should the engine be stopped, the brake function (models with iBR) and watercraft directional control is lost.

⚠ WARNING

Always disconnect the tether cord when the watercraft is not in operation in order to prevent accidental engine starting or to avoid unauthorized use by others, children, and to prevent theft.

Radio Frequency Digitally Encoded Security System (RF D.E.S.S.) (Convenience Package)

The tether cord cap contains a D.E.S.S. key that is programmed to give it a unique electronic serial number. This is the equivalent of a conventional key.

The D.E.S.S. system reads the key in the tether cord cap that is installed on the engine cut-off switch, and only allows engine starting for keys it recognizes.

The D.E.S.S. system brings great flexibility. You can buy additional tether cords and have the D.E.S.S. keys programmed to your watercraft.

A total of ten D.E.S.S. keys can be programmed to the same watercraft.

To have a key programmed to your watercraft, see your authorized BRP Sea-Doo dealer.

RF D.E.S.S. Key Recognition

Two short beeps indicate the system is ready to allow engine starting. Otherwise, refer to the *TROUBLESHOOTING* section.

RF D.E.S.S. Key Types

Two types of keys can be used:

- Normal key
- Learning key.

To ease key type recognition, the tether cord float comes in different colors.

KEY TYPE	FLOAT COLOR
Normal	Yellow
Learning	Green

The multifunction gauge displays the type of key used (NORMAL KEY or LEARNING KEY).

The SEA-DOO learning key, limits the speed of the watercraft and the engine torque, therefore enabling first time users and less experienced operators to learn how to operate the watercraft while gaining the necessary confidence and control.

4) Throttle Lever

The throttle lever on the RH handlebar electronically controls the engine speed.

To increase or maintain watercraft speed, pull on the throttle lever with your finger.

To decrease watercraft speed, release the throttle lever.



TYPICAL
1. Throttle lever

The throttle lever is spring loaded and should return to rest position (idle) when not pressed.

5) iBR Lever (intelligent Brake and Reverse) (Models with iBR)

The iBR lever on the LH handlebar can electronically command:

- Reverse
- Neutral
- Braking.

NOTE: A minimum of 25% lever travel is required to activate iBR functions.

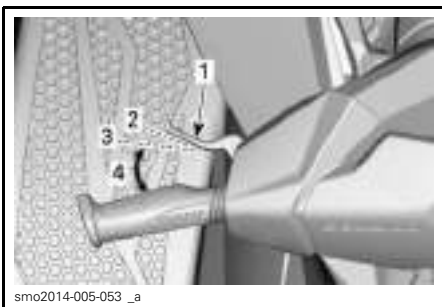

TYPICAL - iBR LEVER
1. iBR lever
2. Lever rest position
3. 25% stroke required to activate iBR function
4. Operating range

At speeds below 7 km/h (5 MPH), pulling the iBR lever in will engage reverse.

At speeds above 7 km/h (5 MPH), pulling the iBR lever in will engage the brake.

When the iBR lever is released after braking or reverse operation, neutral is engaged.

⚠ WARNING

If the throttle lever is still pulled in when releasing the iBR lever, forward movement will be initiated after a short delay. If forward acceleration is not desired, release the throttle lever.

Refer to *OPERATING INSTRUCTIONS* for detailed instructions.

NOTE: Braking power is relative to iBR lever position.

6) Mode Button

The MODE button is located directly below the multifunction gauge.

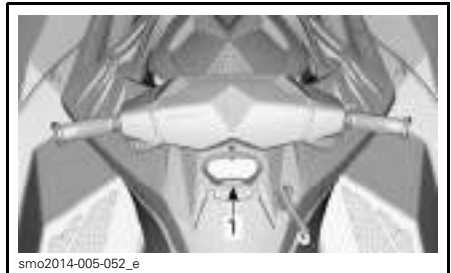

TYPICAL
1. MODE button

Rotax 900 ACE

It is used to scroll through the multifunction displays.

Rotax 900 HO ACE

It is used to activate or deactivate SPORT mode and to scroll through the multifunction displays.

Refer to *MULTIFUNCTION GAUGE* for details.

7) Variable Trim System (VTS) Button (Trixx Models)

The VTS button is located on the LH handlebar.



219001697-202_b

VTS CONTROL BUTTON

1. Bow up
2. Bow down

The VTS control button is used to adjust the riding attitude of the watercraft.

Refer to *OPERATING INSTRUCTIONS* for details.

MULTIFUNCTION GAUGE (LCD)

The multifunction gauge (LCD) is located above the glove box.

Multifunction Gauge Description

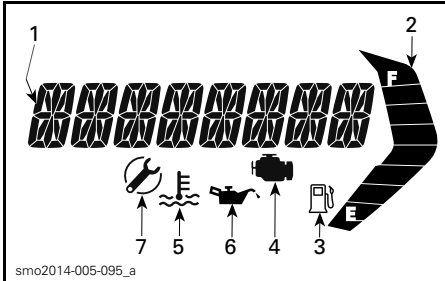

smo2014-005-095_a

1. Multifunction display
2. Fuel level display
3. Low fuel level indicator
4. Check engine indicator
5. Engine temperature indicator
6. Low oil pressure indicator
7. Maintenance reminder indicator

Rotax 900 HO ACE

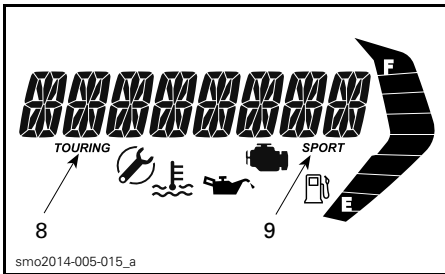

smo2014-005-015_a

TYPICAL

8. Touring mode indicator
9. Sport mode indicator

Models with iBR

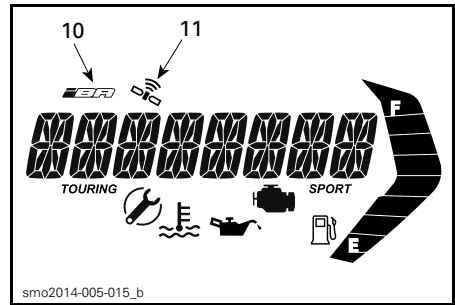

smo2014-005-015_b

10. iBR fault indicator
11. GPS satellites synch

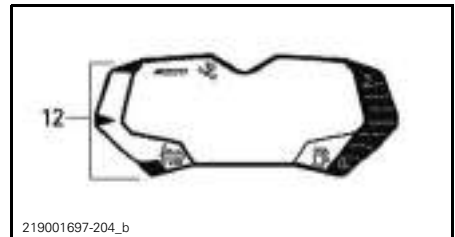

219001697-204_b

12. VTS position display

1) Multifunction Display

The multifunction display is used to:

- Display the WELCOME message on power up.
- Activating and setting modes of operation.
- Display scrolling messages of function activation or system faults.
- Display fault messages.

2) Fuel Level Display

Bar gauge continuously indicates the level of fuel in the fuel tank while riding.

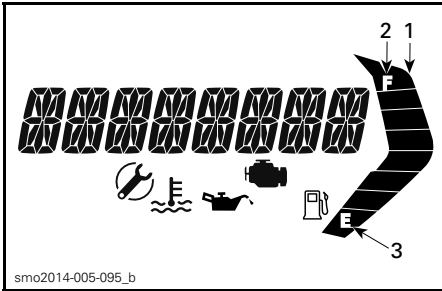

1. Fuel level display
2. Top segment
3. Bottom segment

When the fuel tank is full, 8 segments (bars) of the indicator are turned on.

When the fuel tank is almost empty, the two bottom segments flash and the low fuel indicator lamp starts flashing.

3) Low Fuel Level Indicator



When this indicator starts flashing, it indicates that there is approximately 12 L (3.2 U.S. gal.) of fuel left in fuel tank.

4) Check Engine Indicator



When this indicator is ON, it indicates an engine fault, look for a message at the LCD display.

When this indicator blinks, it indicates that the **LIMP HOME** mode is activated.

When the check engine indicator comes on, you may seek service from an authorized Sea-Doo dealer, repair shop, or person of your own choosing for maintenance, repair, or replacement. Please refer to the *US EPA EMISSIONS-RELATED WARRANTY* contained herein for information about warranty claims.

Refer to *TROUBLESHOOTING* section for more details.

5) Engine Temperature Indicator



When this indicator is ON, it indicates that engine or exhaust system may be overheating.

6) Low Oil Pressure Indicator



When this indicator is ON, it indicates low oil pressure, look for a message at the LCD display.

7) Maintenance Reminder Indicator



The maintenance reminder indicator comes ON when required maintenance is due.

When the maintenance reminder indicator comes on, you may seek service from an authorized Sea-Doo dealer, repair shop, or person of your own choosing for maintenance, repair, or replacement. Please refer to the *US EPA EMISSIONS-RELATED WARRANTY* contained herein for information about warranty claims.

8) Touring Mode Indicator (Rotax 900 HO ACE)

When the TOURING mode indicator is ON, the default TOURING mode is active.

NOTE: TOURING mode indicator will turn off once SPORT mode is activated and will come on again when SPORT mode is deactivated.

9) Sport Mode Indicator (Rotax 900 HO ACE)

The SPORT mode indicator is normally off.

When sport mode is selected, the SPORT mode indicator will come on and stay on until sport mode is deactivated, or the watercraft is shut down.

10) iBR Fault Indicator (Models with iBR)



The iBR fault indicator comes ON when a fault in the iBR system has been detected.

Refer to *TROUBLESHOOTING* for details.

11) GPS Active Indicator (If equipped)



A GPS incorporated in the multifunction gauge provides the speed in the multifunction display.

This is confirmed when the GPS active indicator is visible in the digital screen.

12) VTS Indicator (Models with VTS)

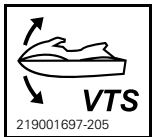

The VTS indicator comes ON while operating the VTS.

The LH bar gauge is also turned on to indicate the relative position of the watercraft bow.

Navigating the Multifunction Display

WARNING

Do not adjust display while riding, you could lose control.

Selecting Functions

When the electrical system is powered up and the cluster has completed its self test function, a WELCOME ABOARD SEA-DOO scrolling message will appear for a few seconds. After the welcome message, the multifunction display will display the last selected option.

NOTE: You can skip the welcome message by pressing the MODE button.

The multifunction display is also used to display a menu for the selection of various functions which permit changing the numerical display indication, system modes of operation (Rotax 900 HO ACE), and active system fault messages.

NOTE: To change the unit of measurement or the language displayed, see your authorized Sea-Doo dealer.

1. To select the various options available through the multifunction display, press quickly the MODE button repeatedly until the desired display options is visible:
 - SPEED
 - RPM
 - HOUR

Display Option Description

Speed

The SPEED can be displayed in km/h or MPH depending on the unit of measurement setting.

Models with iBR

The speed indication is based on a GPS (Global Positioning System) incorporated within the multifunction gauge.

If for some reason the GPS signal is lost, a default mode is used whereby, the speed is calculated using information received from other systems to provide an estimated watercraft speed.

RPM

The RPM is displayed as a numerical value.

Hour

The HOUR is used to display the accumulated engine hours.

EQUIPMENT

NOTE: Illustrations may not be accurate for every model and are only provided as a visual guide.

NOTE: Some vehicle safety labels are not shown on illustrations. For information on vehicle safety labels, refer to *WATERCRAFT SAFETY LABELS*.



TYPICAL - 2UP MODELS



TYPICAL - 3UP MODELS

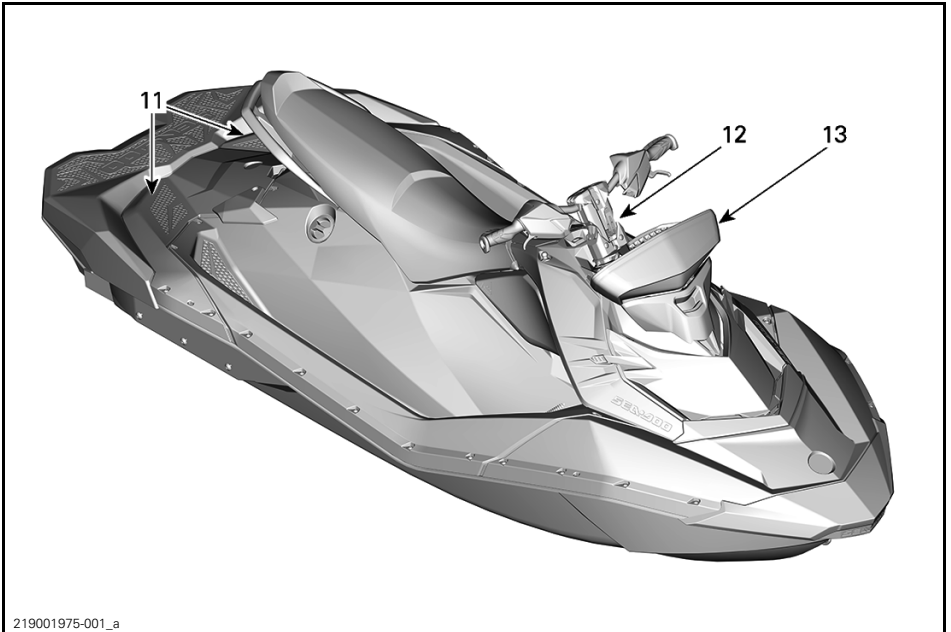

219001975-001_a

TYPICAL - TRIXX MODELS AND AUDIO SYSTEM

1) Glove Box

A small storage compartment for personal articles, and the *SAFETY DVD*, located at front of seat.

NOTE: Glove box is not watertight.

Push tab forward to open glove box.



smo2014-005-006_a

1. Glove box
2. Tab

2) Safety Equipment Kit Storage Compartment

A small area to store safety equipment kit or emergency kit only (not supplied with vehicle).

NOTICE This area is not intended for general storage. Do not store any other items in this area. Storing other items in this area can damage the vehicle.

To open this storage compartment, manually release and remove the RH side panel.



1. RH side panel



TYPICAL - RH SIDE PANEL REMOVED

3) Storage Bin (Convenience Package)

A convenient area to carry personal articles.

To open the storage bin front cover, release the lid hooks on each side. Always close and latch cover when riding.

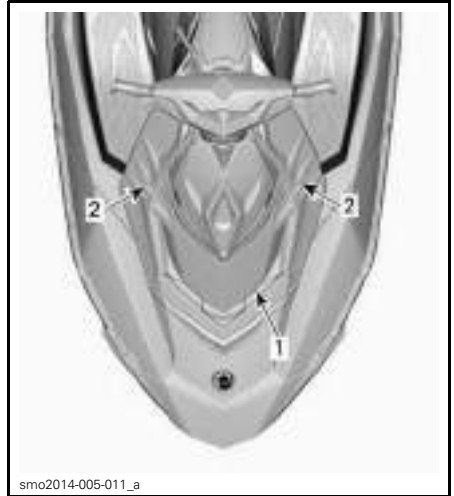

TYPICAL

1. Front cover
2. Lid hooks

⚠ WARNING

Never carry any loose, heavy, sharp, or breakable objects in the storage bin. Do not exceed maximum load capacity; 2.5 kg (5 lb). Never operate the watercraft with the storage bin front cover open. This is not a watertight compartment.

4) Seat

The seat latch is located under the back end of the seat.

To remove the seat, push up on the latch handle. Release the latch handle and slide the seat backward.



TYPICAL - SEAT LATCH
1. Seat latch handle

Removing the seat provides access to the rear storage compartment (3UP models only), operator's guide, the fire extinguisher (not supplied with vehicle) and the fuel cap.



TYPICAL - SEAT REMOVED
1. Fire extinguisher
2. Fuel cap



TYPICAL - FLIP SIDE OF REMOVED SEAT
1. Operator's guide

To install the seat, position the seat in place and push the seat forward until the latch clicks.

Pull up on the rear portion of the seat to ensure it is properly latched.

5) Passenger Handholds

The seat strap provides a handhold for a passenger to hold on to when riding.

The sides of the molded grab handle at the rear of the seat also provide a handhold for a passenger.

NOTICE Never use the molded grab handle to tow anything or to lift the watercraft.



TYPICAL - PASSENGER HANDHOLDS
1. Seat strap
2. Molded grab handle

The rear portion of the molded grab handle also provides a handhold for the skier/wakeboarder spotter (3up models) or for boarding the watercraft from the water.

6) Boarding Step (Convenience Package)

A convenient step used for boarding the watercraft from the water.

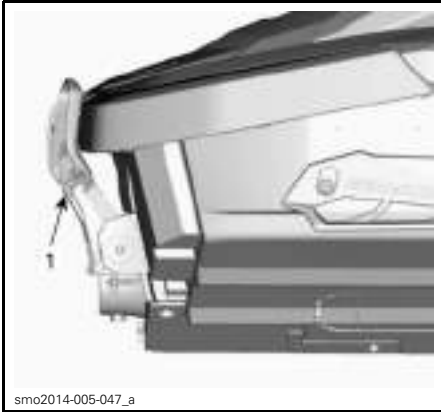

TYPICAL

1. Boarding step

⚠ WARNING

The engine must be shut off before attempting to board the watercraft using the boarding step.

Pull down the step with your hand and hold until a knee is put on the step.



BOARDING STEP HELD DOWN FOR BOARDING FROM WATER

NOTICE

- Never use the step for boarding a watercraft that is out of water.
- Never use the step for pulling, towing, diving or jumping, or any other purpose other than as a boarding step.
- Only one person at a time on the step.
- Only board the step with a knee, not a foot.

Models with iBR

⚠ WARNING

Be aware of the iBR gate movement when starting the engine, shutting down the engine or using the iBR lever. Automatic movement of the gate may squeeze fingers or toes of people taking a hold on the back or your PWC.

7) Boarding Platform

The rear deck area serves as the boarding platform.

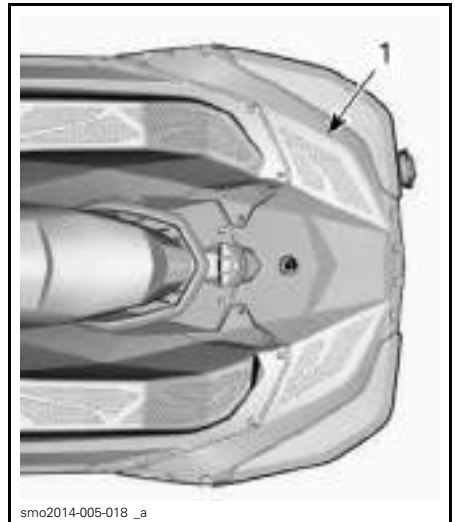

TYPICAL - 2UP MODELS

1. Boarding platform

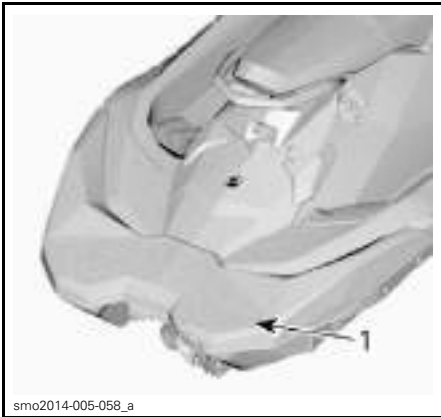

smo2014-005-058_a

TYPICAL - 3UP MODELS

1. Boarding platform

Rear Eyelet

smo2014-005-090_b

TYPICAL

1. Rear eyelet

8) Front and Rear Eyelet

Eyelets can be used for mooring, towing a water skier (3UP models), wakeboarder or tuber (3UP models), and as tie-down points when trailering your watercraft.

Front Eyelet

smo2014-005-019_a

TYPICAL

1. Front eyelet



smo2014-005-005_a

TYPICAL

1. Drain plug

Step 1: Untighten

Step 2: Tighten

NOTICE Ensure drain plug is properly secured prior to launching the watercraft in water.

10) Sponsons

Two fixed sponsons, one on each side at the rear of the hull, assist in watercraft stability. The sponsons are not adjustable.



smo2014-005-046_a

1. Sponson

11) Rear Footrests (Trixx Models)

Angled footrests used to enhance control when purposely raising the bow.

12) Adjustable Handlebar Riser (Trixx Models)

The handlebar height can be set to suit the operator's preference.

1. Unlock the mechanism using the lever.



219001697-201_a

2. Adjust the handlebar to the desired height.
3. Lock the mechanism using the lever.



219001697-201_b

13) Audio System (If equipped)

Some models are equipped with a portable audio system.

The BRP audio system is composed of two waterproof speakers, two tweeters, one passive radiator, a keypad, a charging port and a vent port. The system connects via bluetooth to a smartphone.

When the Play/Pause/Power button is pressed, the system will be powered.

Bluetooth Pairing Mode - When the unit is powered On, the system will automatically try to pair with the last connected device or will go in pairing mode if no paired devices are detected. When the system is in pairing mode, all the button lights will blink. To manually enter the pairing mode, hold down the **Play/Pause/Power** button for 1 second. The buttons will start blinking to indicate it's in pairing mode. Search for **BRP Sound System** from your device's Bluetooth menu. 3 beeps will indicate successful pairing.

When paired, select a playlist or other source of music from your smartphone.

NFC Pairing Mode - To pair using the NFC, place your smartphone near the NFC logo on top of the unit.

Never pair a smartphone or change the playlist or music source on the device while driving or operating the vehicle.

NOTE: On applicable devices.

⚠ WARNING

Using a smartphone or trying to pair a device while driving can distract the driver from operating the watercraft. Always use buttons with caution and always stay alert on the water, keeping eye contact with your environment at all times.



1. Audio system

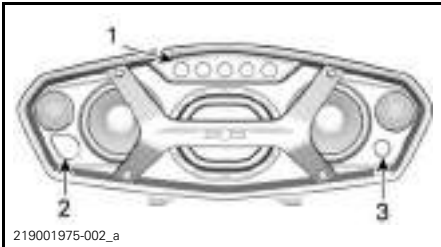

1. Key pad
2. Charging port
3. Vent port



1. Play/Pause/Power
2. Volume UP
3. Volume DOWN
4. Previous track
5. Next track

Play/Pause/Power - The Play/Pause/Power button gives you the ability to play or to pause the current track with a single press. Pressing the Play/Pause/Power button will turn the unit On if currently Off or

holding the Play/Pause/Power button for 3 seconds will turn the unit Off if currently On. The unit will emit 4 small beeps to indicate when power is turned Off.

Volume Up and Volume Down - These buttons will turn up or turn down the output of the volume. When the unit has reached the minimum or maximum output level, the unit will beep to indicate that no further adjustment is possible.

AUDIO CONTROLS		
State	Audio feedback	Visual feedback
Power ON	Fade in	White
Power OFF	Fade out	-
Pairing Mode	-	All buttons flashing white
Pairing Mode success	3 beeps	-
Max volume	1 long beep	-
Min volume	1 long beep	-
Paused	-	Play/Power button flashing white
Low battery	-	Play/Power button steady red
Charging	-	Play/Power button steady blue
Battery fully charged	-	Play/Power button steady white

AUDIO CONTROLS		
State	Audio feedback	Visual feedback
Battery too low to power ON	-	Play/Power button flashing red 3 times
Battery level	-	0 to 20% : 1 button steady white
		21 to 40% : 2 buttons steady white
		41 to 60% : 3 buttons steady white
		61 to 80% : 4 buttons steady white
		81 to 100% : 5 buttons steady white

NOTE: Power, Play/pause button flashing rapidly (red and blue) during 5 secs followed by a shutdown indicate the unit is not operating in appropriate temperature.

This system is completely self contained and has no electrical connection to the PWC. It needs to be connected to a 110V household electrical outlet to be charged.

NOTICE Use only the supplied charging adapter to charge the audio system.

Battery level: To show the battery level; hold both volume buttons simultaneously.

When not in use, the unit will shut down after 10 minutes.

To remove;

1. Push button
2. Lift handle



Step 1: Push button
Step 2: Lift handle

To install, make sure the front locking tabs are properly engaged before lowering.



CAUTION Prolonged exposition to loud music can damage your hearing. Therefore, we suggest a 10 minutes break time every 45 minutes of listening.

BREAK-IN PERIOD

Operation During Break-In Period

A break-in period of 5 operating hours is recommended before running the watercraft at sustained full throttle.

During this period, maximum throttle should not exceed 1/2 to 3/4 opening. However, brief full acceleration and speed variations contribute to a good break-in.

NOTICE Continued wide open throttle accelerations or operation, prolonged cruising speeds are detrimental during the break-in period.

OPERATING INSTRUCTIONS

⚠ WARNING

Always perform the *PRE-RIDE INSPECTION* before operating this watercraft. Be sure to read the *SAFETY INFORMATION* and the *WATERCRAFT INFORMATION* sections and be thoroughly familiar with the iControl technology.

Should any control or instruction not be fully understood, refer to an authorized Sea-Doo dealer.

Boarding the Watercraft

As with any watercraft, boarding should be done carefully and engine must not be running.

⚠ WARNING

Engine must be OFF and tether cord must be removed when boarding the watercraft or when using the boarding step. Never use propulsion system components as a supporting point to board the watercraft.

Models with iBR

⚠ WARNING

Never use the iBR gate as a step or support to board the watercraft. Be careful not to bump yourself on the gate when boarding.

Boarding from a Dock

When boarding from a dock, slowly place one foot on the watercraft footboard nearest the dock while holding the handlebar, and at the same time, transfer the body weight to the other side in order to balance the watercraft.

Then bring the other foot over the seat and place it on the other footboard. Push the watercraft away from the dock.



Boarding from Water

Ensure there is at least 90 cm (3 ft) of water underneath the lowest rear portion of the hull.

Take into account that the hull will be lower in the water when all passengers are aboard. Be certain to maintain the specified depth so sand, pebbles and rocks will not be drawn up in the propulsion system.

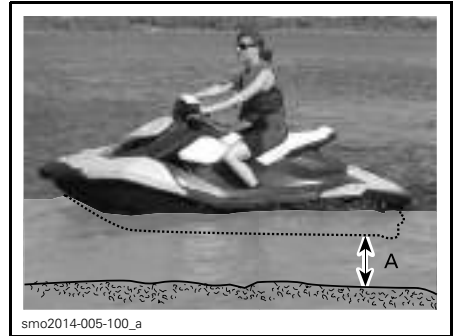

A. Maintain at least 90 cm (3 ft) underneath the lowest rear portion of the hull when all passengers are aboard

NOTICE Starting the engine or riding the watercraft in shallower water may damage the propulsion system.

Operator Alone

Models Without a Boarding Step

1. Using one hand, grab the rear handle.

2. With the other hand on the boarding platform, lift your body until you can lay one knee on the boarding platform.



3. Lay the other knee on the boarding platform.



4. Take hold of the seat strap to help maintain your balance and step forward onto the footboards on either side of the seat.



Sit astride the seat.

Models with a Boarding Step

Using one hand, lower the boarding step.

Using the other hand, take hold of the edge of the boarding platform, then pull yourself up so that you can knee onto the boarding step.

NOTICE

- Never use propulsion system components to board.
- Only board the step with a knee, not a foot.

Reach forward with one hand and take hold of the molded handle behind the seat, then knee onto the boarding step.



Holding on to the handle behind the seat, step up onto the boarding platform.



Take hold of the seat strap to help maintain your balance and step forward onto the footboards on either side of the seat.



Sit astride the seat.

Operator with a Passenger

The operator climbs on the watercraft in the same way as explained previously.

⚠ WARNING

Engine must be OFF and tether cord must be removed when boarding the watercraft or when using the boarding step. Never use propulsion system components as a supporting point to board the watercraft.

In choppy water, while in the water, the passenger may hold the watercraft steady to help the operator climb aboard.



The passenger then climbs onto the watercraft while the operator maintains balance by sitting as close as possible to the console.





smo2014-005-078



smo2014-005-079



smo2014-005-080

How to Start Engine

⚠ WARNING

Before starting the engine, the operator and passenger(s) should always:

- Be properly seated on the watercraft
- Have a firm grip on a handhold or hold on to the waist of the person in front of them
- Wear appropriate protective clothing including a PFD approved by local authorities and a wet suit bottom.
- On models with no iBR, the PWC will move forward as soon as engine is started.

NOTICE Ensure there is at least 90 cm (3 ft) of water under the lowest rear portion of the hull when all passengers are aboard prior to starting the engine. Otherwise damage to the propulsion system components may occur.

1. Attach the tether cord clip to your PFD or to the wrist (wrist strap required).
2. Firmly grip the handlebar with your left hand and place both feet on the footboards.
3. Install the tether cord on the engine cut-off switch.
4. Depress the engine START/STOP button to crank the engine.
5. Release engine START/STOP button immediately after engine is started.

⚠ WARNING

The tether cord clip should always be attached to the operators personal flotation device or to the wrist (wrist strap required) when starting or operating the watercraft.

NOTICE Do not hold engine START/STOP button more than 10 seconds to avoid starter overheating. A rest period should be observed between the cranking cycles to allow the starter to cool down.

How to Stop the Engine

Models with iBR

⚠ WARNING

To maintain watercraft directional control, the engine should be running until the watercraft is stopped.

Models Without iBR

⚠ WARNING

The engine must stop running for the watercraft to come to a full stop.

All Models

The engine may be shut off using one of two methods:

- Pressing the engine START/STOP button, or
- Removing the tether cord from the engine cut-off switch.

⚠ WARNING

Never leave the tether cord on the engine cut-off switch when disembarking watercraft to prevent theft, accidental engine starting, and to avoid unauthorized use by children or others.

How to Steer the Watercraft



Turning the handlebar pivots the jet pump nozzle which controls the watercraft direction. Turning the handlebar to the right will turn the watercraft to the right, turning the handlebar to the left turns the watercraft to the left. The throttle should be applied to turn the watercraft.

⚠ WARNING

Throttle should be applied and handlebar turned to change the direction of the watercraft. Steering efficiency will differ depending on the amount of throttle applied, the number of passengers, the load, the water conditions and the environmental factors such as the wind.

Unlike a car, a watercraft needs some throttle to turn. Practice in a safe area applying the throttle and turning away from an imaginary object. This is a good collision avoidance technique.

⚠ WARNING

Directional control is reduced when the throttle is released and lost when the engine is off.

The watercraft behaves differently with a passenger and requires greater skill. The passenger(s) should always grip the seat strap, the molded grab handle, or the waist of the person ahead of them. Reduce speed and avoid sharp turns. Avoid choppy water conditions when carrying a passenger.

Tight Turns and Other Special Maneuvers

Any tight turns or special maneuvers that will cause the air inlet openings to be kept under water for a prolonged time, water will seep into the bilge.

Combustion engines need air to operate; consequently this watercraft cannot be totally watertight.

NOTICE If the air inlet openings are kept under water, such as turning constantly in tight circles, plunging the bow through waves, or capsizing the watercraft, water may seep into the bilge, which may cause severe damage to internal parts of the engine. Refer to the *WARRANTY* section contained in this guide.

O.T.A.S.™ System (If equipped) (Off-Throttle Assisted Steering)

The O.T.A.S. (Off-Throttle Assisted Steering) system provides additional maneuverability in off-throttle situations.

If the driver releases the throttle to idle when initiating a full turn, the O.T.A.S. system will be electronically activated, and will slightly increase engine speed to allow completion of the turn.

When the handlebar is brought back towards its center position, the throttle reverts to idle.

We recommend that you familiarize yourself with this feature during your first ride.

How to Engage Neutral (Models with iBR)

⚠ WARNING

The drive shaft and impeller are always turning when the engine is running, even in neutral position. Keep away from the propulsion system of the watercraft.

When the watercraft is first started, the iBR system automatically sets the neutral position by default.

To engage neutral from forward position, tap the iBR lever.

To engage neutral from reverse position, release the iBR lever and throttle lever.

How to Engage Forward (Models with iBR)

To engage forward from neutral position, tap on the throttle lever. The watercraft will accelerate forward.

To engage forward from reverse position, release the iBR lever, then tap the throttle lever.

To re-engage forward from braking, simultaneously pull in the throttle lever while releasing the iBR lever. The watercraft will accelerate forward after a short delay.

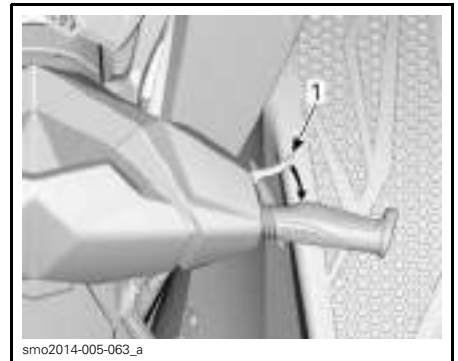

TYPICAL - ENGAGING NEUTRAL
1. Throttle lever

How to Engage and Use Reverse (Models with iBR)

Reverse can only be engaged between idle speed and the threshold forward speed of 7 km/h (4 MPH).

To engage reverse position, the iBR lever on the LH handlebar must be pulled in at least 25% of the lever travel.

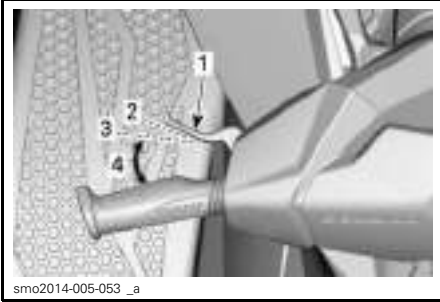

TYPICAL - iBR LEVER

1. iBR lever
2. Lever released position
3. Approximate 25% position
4. Operating range

When operating the iBR lever in reverse mode, the throttle lever can be used to control engine RPM, and thus the amount of reverse thrust produced.

By modulating throttle lever, reverse thrust can be more precisely controlled. Too much RPM will create water turbulence and reduce reverse efficiency.

NOTE: Engine power will be limited whenever the iBR lever position is changed.

Release the iBR lever to end reverse operation.

To stop rearward motion after iBR lever release, apply enough throttle to stop rearward movement.

⚠ WARNING

The brake function has no effect when travelling in reverse.

Available engine power is limited in reverse mode, which limits reverse speed.

⚠ WARNING

Only use reverse at slow speed and for the shortest time possible. Always ensure the path behind is clear of objects, obstacles and people.

When operating in reverse, turn the handlebar in the opposite direction that you want to move the rear of the watercraft.

For example, to steer the rear of the watercraft to port (left), turn the handlebar to starboard (right).



TYPICAL - STEERING DIRECTION REVERSED WHEN BACKING

⚠ CAUTION Steering direction in reverse is opposite of forward. To steer the stern to port (left) in reverse, turn the handlebar to starboard (right). To steer the stern to starboard (right), turn the handlebar to port (left). Reverse operation should be practiced in open waters in order to become fully familiar with the controls and watercraft handling characteristics before operating in close quarters.

How to Engage and Use Braking (Models with iBR)

⚠ WARNING

- The engine must be running to be able to use the brake.
- The brake is only applicable when operating in forward movement, it has no effect on rearward motion.
- The brake cannot prevent your PWC from drifting due to current or wind.

The braking function can only be engaged during forward operation at or above the threshold speed of 7 km/h (4 MPH).

Braking is engaged and controlled when the iBR lever on the LH handlebar is pulled in at least 25% of its travel.

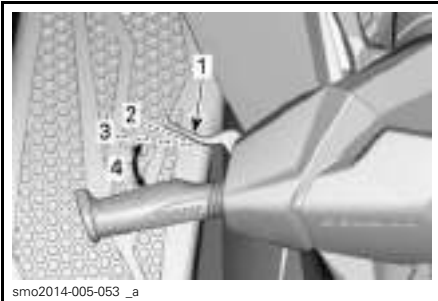

TYPICAL - iBR LEVER

1. iBR lever
2. Lever released position
3. Approximate 25% position
4. Operating range

⚠ WARNING

Braking should be practiced in open waters and at gradually increasing speeds in order to become fully familiar with the controls and watercraft handling characteristics.

When iBR lever is applied, the throttle lever command is overridden and engine throttle control is now dependant

on the iBR lever position. Braking can thus be modulated by using only the iBR lever.

Watercraft deceleration is proportional to the braking force. The more the iBR lever is pulled in, the greater the braking force applied.

NOTE: Be careful to gradually actuate the iBR lever to adjust intensity of the braking force and simultaneously release the throttle lever.

⚠ CAUTION When braking, riders must brace themselves against the deceleration force to prevent from moving forward on the watercraft and losing balance. The operator should always keep both hands on the handlebars, and all passengers should maintain a firm grip of a handhold or the waist of the person in front of them.

⚠ WARNING

Stopping distance will vary depending on initial speed, load, wind, number of riders, water conditions, and the amount of braking power commanded by the operator. Always adjust your riding style accordingly.

When the watercraft slows to less than 7 km/h (4 MPH), braking mode ends and reverse mode is engaged. Release the iBR lever once the watercraft is stopped. Otherwise, a rearward movement will be initiated.

⚠ CAUTION As the watercraft slows to a stop, the wake created by the watercraft will catch up and tend to push the watercraft forward. Ensure there are no obstacles or bathers in the direction of travel.

If the throttle lever is still pulled in when releasing the iBR lever, the watercraft will accelerate forward after a short delay. Acceleration will be proportional to the throttle lever position.

⚠ WARNING

If forward acceleration is not desired when the brake lever is released, release the throttle lever.

When at speed and the brake is first applied, a plume of water will shoot up in the air behind the watercraft which may cause the operator of a following watercraft to momentarily lose sight of your PWC.

⚠ WARNING

- It is important to inform the operator of a watercraft who intends to follow in a convoy formation, of the braking and maneuvering capability of your PWC, what the plume of water indicates, and that a greater distance must be maintained between watercraft.
- Be aware that other boats following or operating in close proximity may not be able to stop as quickly.

Braking in a Turn

Braking can be initiated during a turn using the iBR lever as previously described. Get ready to maintain your balance while the wake is crossing your PWC.

⚠ CAUTION As the watercraft slows to a stop while braking in a turn, the wake created by the watercraft will catch up and tend to push the watercraft sideways. Be prepared to maintain balance as the wake crossed the watercraft.

How to Use the Variable Trim System (VTS)

The variable trim system (VTS) changes the angle of the jet pump nozzle.

When first using the watercraft, the operator should become familiar with the use of the variable trim system (VTS) at various speeds and water conditions. Experience alone will dictate the best trim for the conditions. During the watercraft break-in period, when lower speeds are recommended, it is an excellent opportunity to become familiar with trim adjustment and its effects.

The VTS system allows for manually adjusting the trim position of the nozzle, or selecting two preset trim positions.

Manually Adjusting the VTS

Nine trim positions are available.

With the watercraft operating forward, proceed as follows:

Press and release the VTS UP or VTS Down button to move the VTS of one position.

If the VTS UP or VTS Down button is pressed and held, the pump nozzle will keep moving until the button is released.

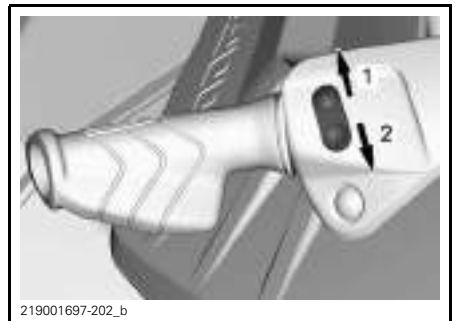

219001697-202_b
VTS CONTROL BUTTON

1. Bow up
2. Bow down

Pressing the VTS button with the engine OFF, will change the indication in the gauge but will not change the jet pump nozzle position. The nozzle will change position next time the engine is started and engaged in forward.

Pressing the VTS button with the engine running in neutral, will change the VTS position, allowing the operator to fine tune the neutral position.

The VTS position is displayed on the multifunction gauge.

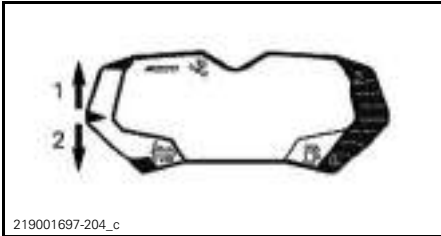

219001697-204_c

1. VTS up display
2. VTS down display

VTS SETTINGS GUIDELINE	
SETTING	USE
Center	Riding at high speeds
Down	Compensate load, obtain neutral attitude, reduce porpoising
Slightly up	Obtain neutral attitude
Up	Purposely raise the bow

⚠ CAUTION Riding at high speeds with the VTS at high settings can affect handling.

Using Preset Trim Positions

Two preset trim positions can be selected (center and full up).

To select the highest trim position, double-click on the VTS UP button.

⚠ CAUTION Riding at high speeds with the VTS at high settings can affect handling.

To select the center trim position, double-click on the VTS DOWN button.

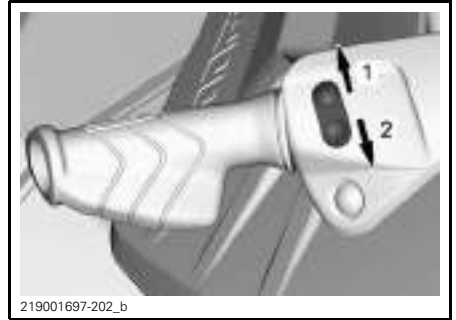

219001697-202_b

DOUBLE-CLICK UP OR DOWN VTS BUTTON TO USE PRESET POSITIONS

1. Highest preset position on UP arrow
2. Center preset position on DOWN arrow

General Operating Recommendations

Rough Water or Poor Visibility Operation

Avoid operation in these conditions. If you must do so, proceed with caution using minimum speed.

Crossing Waves

The operator must grip the handlebar firmly and keep both feet on the footboards.

The passenger must grip the handholds with both hands and keep both feet on the footboards.

Reduce speed.

Always be prepared to steer and maintain your balance as necessary.

When going over waves, raise your body slightly off the seat to absorb the shocks with your legs.

When crossing wakes, always keep a safe distance from watercraft ahead.

⚠ WARNING

When crossing wakes, slow down. Operator and passenger(s) should brace themselves and adopt a semi-standing position to help absorb the bumps. Do not jump waves or wakes.

Stopping/Docking

When the throttle is released, the watercraft is slowed by water drag against the hull. The stopping distance will vary depending on the watercraft size, weight, speed, water surface condition, presence and direction of wind and current.



smo2014-005-083

The operator should practice in open waters at various speeds to become familiar with the stopping distances under different conditions.

Models Without iBR**⚠ WARNING**

The engine must stop running for the watercraft to come to a full stop.

Models with iBR**⚠ WARNING**

Always practice braking in open waters ensuring there are no watercraft or boats in your immediate vicinity, especially astern. Other users of the waterways may not be able to maneuver or stop in time to avoid you should you unexpectedly come to a full stop in front of them.

The iBR system can also be used for slowing down or for stopping the watercraft more quickly, and for increasing maneuverability especially when docking. Stopping using the iBR system in a straight line and in a turn should be practiced extensively to become familiar with the handling characteristics of the watercraft under partial or full braking conditions.

When at speed and the brake is first applied, a plume of water will shoot up in the air behind the watercraft and may cause the operator of a following watercraft to momentarily lose sight of your PWC.

⚠ WARNING

It is important to inform the operator of a watercraft who intends to follow in a convoy formation of the braking and maneuvering capability of your PWC, what the plume of water indicates, and that a greater distance should be maintained between both of you.

The operator should also practice docking with an imaginary dock using the various controls available (iBR lever and throttle lever).

Release the throttle at a sufficient distance before the expected landing area.

Reduce speed to idle.

Maneuver using a combination of the iBR lever and throttle lever, shifting to neutral, reverse, or forward as required.

Remember that when operating in reverse, steering direction is reversed. Turning the handlebars to the left will move the stern to the right when backing up, and vice-versa.

⚠ WARNING

Directional control is reduced when the throttle is released and/or when engine is off. Steering direction is reversed when operating the watercraft in reverse.

Beaching

NOTICE It is not recommended to run the watercraft to the beach.

Drive slowly towards the beach and shut off the engine before the water is less than 90 cm (3 ft) deep under the lowest rear portion of the hull. Then pull the watercraft to the beach.

NOTICE Riding the watercraft in shallow water may result in damage to the propulsion system components. Always shut off the engine before the water is less than 90 cm (3 ft) deep, and never use reverse or braking.



sno2014-005-083

OPERATING MODES (ROTAX 900 HO ACE)

Touring Mode

By default, the watercraft is in TOURING mode of operation when first started.

A TOURING mode indicator is ON in the multifunction gauge to confirm the active mode of operation.

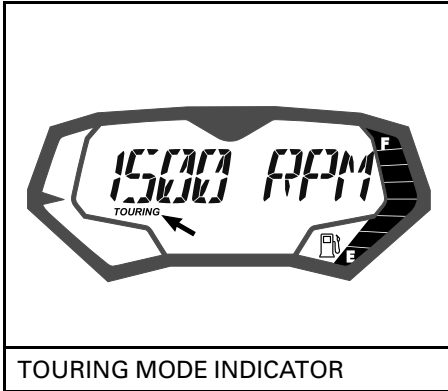

1. Start engine.
2. Depress and hold the MODE button for at least 3/4 of a second.

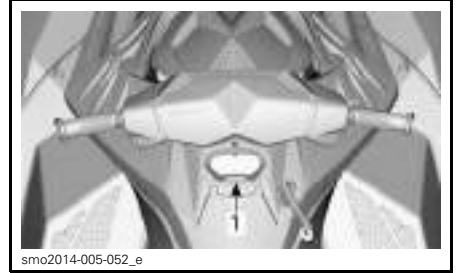

TYPICAL

1. Mode button

Two beeps will be heard and the following message will be displayed in the multifunction gauge:

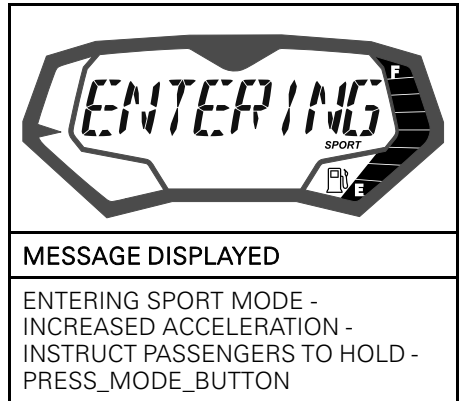

Sport Mode

When selected, SPORT MODE provides for instant throttle response and more rapid accelerations than TOURING MODE.

A SPORT mode indicator is ON in the multifunction gauge to confirm the active mode of operation.

Once activated, SPORT MODE will remain active until it is deactivated by the operator, or the engine is shut down whereby it defaults back to TOURING MODE.

Activating Sport Mode

To activate sport mode, carry out the following:

⚠ WARNING

When activating sport mode, be sure to maintain situational awareness of other watercraft, obstacles, or persons in the water.

⚠ WARNING

Ensure passengers are advised that sport mode provides for increased accelerations and that they are to hold on tightly.

3. Press the MODE button again to acknowledge the message and activate sport mode.

One beep will be heard and a scrolling SPORT MODE ACTIVATED message will momentarily confirm that sport mode has been activated.

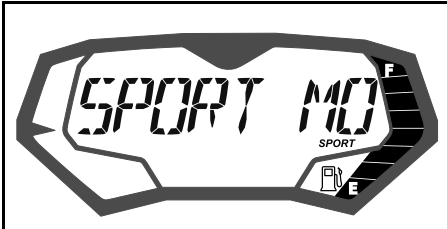

MESSAGE DISPLAYED

SPORT MODE ACTIVATED

NOTE: After a few seconds, the gauge will revert to its normal display.

4. Ensure the SPORT mode indicator is turned on.



SPORT MODE INDICATOR

NOTE: The SPORT mode indicator will come on and stay on as long as sport mode is active. If the throttle is not fully released and the engine is not at idle, SPORT mode cannot be activated. The following message will then appear in the multifunction gauge.

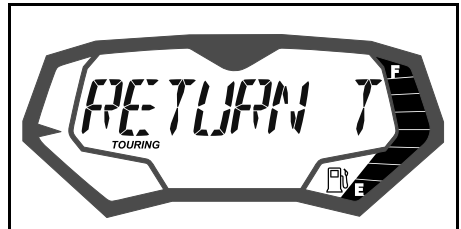

MESSAGE DISPLAYED

SPORT MODE - RETURN TO IDLE TO ACTIVATE

Release the throttle. Once the engine has returned to idle, SPORT mode will be activated.

Deactivating Sport Mode

To deactivate sport mode, carry out the following:

⚠ WARNING

When deactivating sport mode, be sure to maintain situational awareness of other watercraft, obstacles, or persons in the water.

1. Depress and hold the MODE button for 3/4 of a second.

NOTE: The following message will scroll in the multifunction display: SPORT MODE DEACTIVATED.

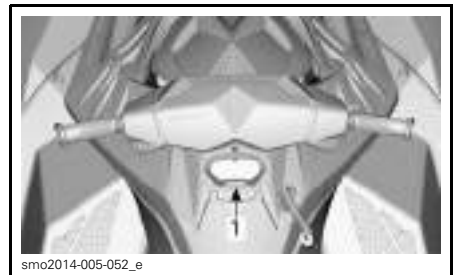

TYPICAL

1. MODE button

NOTE: The following message will scroll in the multifunction display:
SPORT MODE DEACTIVATED.

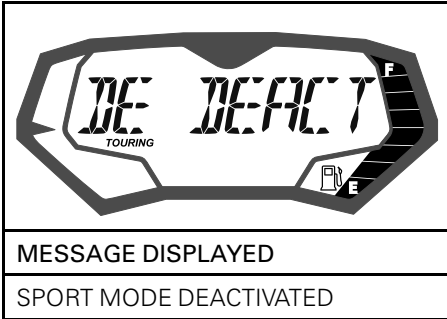

NOTE: After a few seconds, the multifunction gauge will revert to its normal display.

2. Ensure the TOURING mode indicator is on.

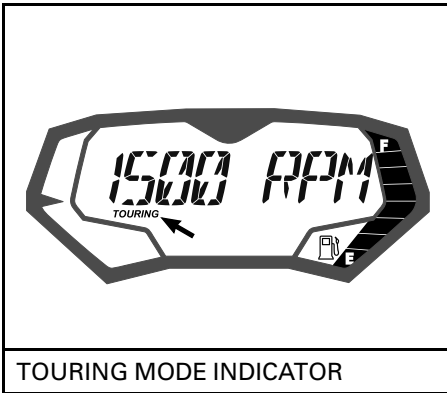

SPECIAL PROCEDURES

Jet Pump Water Intake and Impeller Cleaning

WARNING

Keep away from intake grate while engine is running. Items such as long hair, loose clothing or personal flotation device straps can become entangled in moving parts.

Weeds, shells or debris can get caught on the intake grate, drive shaft and/or impeller. A clogged water intake may cause troubles such as:

- **Cavitation:** Engine speed is high but watercraft moves slowly due to reduced jet thrust, jet pump components may be damaged.
- **Overheating:** Since the jet pump operation controls the flow of water to cool the exhaust system, a clogged intake will cause the exhaust to overheat and damage exhaust components.

A weed clogged area can be cleaned as follows:

WARNING

If it is necessary to reach in to remove any foreign object caught in the propulsion system, the tether cord **MUST BE REMOVED** from the engine cut-off switch.

In-Water Cleaning

Rock the watercraft several times. Most of the time, this should remove the blockage. Start engine and make sure watercraft operates properly.

NOTICE Ensure there is at least 90 cm (3 ft) of water under the lowest rear portion of the hull when all passengers are aboard prior to starting the engine. Otherwise damage to the propulsion system components may occur.

Models with iBR

If the aforementioned method does not work, the following can be performed:

- With engine running and before applying throttle, pull the iBR lever in to select reverse operation and vary throttle quickly several times.
- Repeat procedure if necessary.

All Models

If system is still blocked, move the watercraft out of the water for cleaning. Refer to *ON-BEACH WATER CLEANING*.

On-Beach Water Cleaning

WARNING

The tether cord **MUST BE REMOVED** from the engine cut-off switch to prevent accidental engine starting before cleaning the propulsion system components.

Place a cardboard or a carpet beside the watercraft to prevent scratching when turning the watercraft for cleaning.

Rotate the watercraft to any side for cleaning.



TYPICAL - 2UP MODEL WITHOUT iBR

Clean the water intake area. If the system is still clogged, refer to an authorized Sea-Doo dealer for servicing.

NOTICE Inspect water intake grate for damage. Refer to an authorized Sea-Doo dealer for repair as necessary.

Models with iBR: for ease of access to the propulsion system, move the iBR to the forward position, refer to *iBR OVERRIDE FUNCTION* for detailed instructions.

iBR Override Function (Models Equipped with iBR)

When the iBR override function is activated, it allows the user to electrically move the iBR gate and nozzle through its full range of motion using the VTS control button.

NOTE: The iBR override function is only available when the engine is not running.

⚠ WARNING

When moving the iBR gate using the iBR override function, ensure no-one is near the rear of the watercraft. Movement of the gate may squeeze fingers.

NOTICE An object or tool caught in the iBR system when using the iBR override function may cause damage to the iBR components. Remove all rigid foreign objects that may obstruct the iBR gate travel before moving it.

⚠ WARNING

If it is necessary to reach in to remove any foreign object caught in the propulsion system, strictly observe the following before proceeding:

- Remove tether cord from the engine cut-off switch.
- Wait at least 5 minutes.
- Do not press on START/STOP button. Should the START/STOP button is pressed, wait another 5 minutes.

Activating iBR Override Function

To activate the iBR override function, carry out the following step.

1. Power up the electrical system by pressing the START/STOP button.
2. Install the tether cord on the engine cut-off switch.

NOTE: The tether cord must be installed to ensure the information center will not shut off all indications after its self test function. Electrical power will stay on for approximately 1 hour.

3. Pull in and hold the iBR lever for the entire procedure.

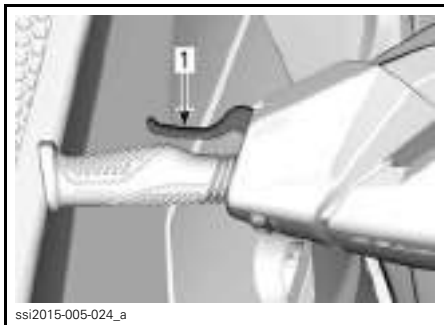

ssi2015-005-024_a

1. iBR lever pulled and held

4. When the following message appears in the multifunction gauge, press the SET button.

MULTIFUNCTION GAUGE MESSAGE

"ENTERING iBR OVERRIDE - PRESS SET BUTTON"

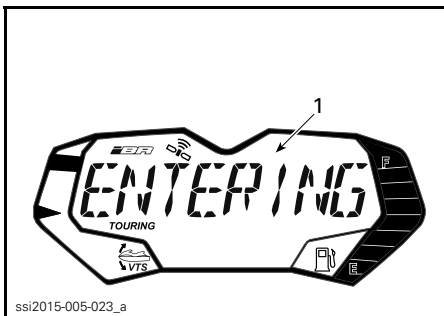

ssi2015-005-023_a

TYPICAL

1. Multifunction gauge message

After a few seconds, the following message will repeatedly scroll across the multifunction gauge.

MULTIFUNCTION GAUGE MESSAGE

"iBR OVERRIDE ON- RELEASE LEVER TO EXIT"

5. While still holding the iBR lever in, press the VTS UP/DOWN button to move the iBR gate to the desired position. Ensure the VTS indication in the multifunction gauge changes

with the iBR gate movement. If the iBR gate moves upwards, the indication moves upwards.

6. Release the iBR lever.
7. Remove the tether cord from the engine cut-off switch.

⚠ WARNING

If it is necessary to reach in to remove any foreign object caught in the propulsion system, strictly observe the following before proceeding:

- Remove tether cord from the engine cut-off switch.
- Wait at least 5 minutes.
- Do not press on START/STOP button. Should the START/STOP button be pressed, wait another 5 minutes.

Deactivating iBR Override Function

To deactivate the iBR override function, release the iBR lever. The iBR OVERRIDE ON- RELEASE LEVER TO EXIT message will cease to scroll in the multifunction gauge.

NOTE: When the engine is started, the iBR gate will move to the neutral position.

⚠ WARNING

When moving the iBR gate using the iBR override function, ensure no-one stands near the rear of the watercraft. Movement of the gate may squeeze fingers.

Capsized Watercraft

The watercraft is designed so that it should not turn over easily. Two sponsons mounted on the side of the hull, assist watercraft stability. If it turns over, it will remain capsized.

⚠ WARNING

When watercraft is capsized, do not attempt to restart the engine. Operator and passengers should always wear approved personal flotation devices.

⚠ CAUTION Heat exchanger in the hull may become very hot. Avoid any contact with the heat exchanger as burns may occur.

To turn the watercraft upright, ensure the engine is off and the tether cord is **NOT** on the engine cut-off switch. Then grab the inlet grate, step on a side bumper rail, and use your weight to rotate the watercraft towards you.

NOTE: A label on the stern near the flushing connector provides instructions on how to turn the watercraft right side up. The label is upside down so that it can be read when the watercraft is overturned.

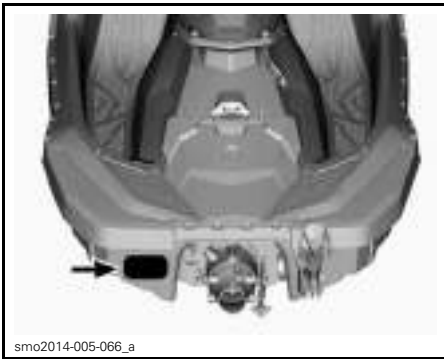

When the watercraft is returned to its normal operating position, the engine can be started normally.

NOTE: It is recommended to ride the vehicle for approximately 5 minutes with engine speed lower than 5000 RPM to evacuate any water that might have been accumulated in the bilge. Never exceed 5000 RPM. If not, water could get inside the engine.

NOTICE If the watercraft has been capsized for more than 5 minutes, do not attempt to crank the engine to avoid water ingestion that would damage the engine. See an authorized Sea-Doo dealer as soon as possible.

NOTICE If the engine does not crank, do not attempt to start it anymore. Otherwise, the engine could be damaged. See an authorized Sea-Doo dealer as soon as possible.

As soon as possible, check for presence of water in the bilge. Drain as necessary when back to the shore.

Submerged Watercraft

To limit damages to the engine, perform the following procedure as soon as possible.

Drain bilge.

If it was submerged in salt water, spray bilge and all components with fresh water using a garden hose to stop the salt corroding effect.

NOTICE Never try to crank or start the engine. Water trapped in intake manifold would flow towards the engine and possibly cause severe engine damage.

Bring the watercraft to an authorized Sea-Doo dealer as soon as possible to have it serviced.

NOTICE The longer the delay before you have the engine serviced, the greater the damage to the engine will be.

Water-Flooded Engine

NOTICE Never try to crank or start the engine. Water trapped in intake manifold would flow towards the engine and possibly cause severe engine damage.

Bring the watercraft to an authorized Sea-Doo dealer as soon as possible to have it serviced.

NOTICE The longer the delay before you have the engine serviced, the greater the damage to the engine will be. Failure to have the engine properly serviced may cause severe engine damage.

Towing the Watercraft in Water

Special precautions should be taken when towing a Sea-Doo watercraft in water.

The maximum recommended towing speed is 21 km/h (13 MPH).

If you have to tow the watercraft, clamp the water supply hose in the engine compartment.

To access the water supply hose, turn the LH access cover knob 1/4 turn clockwise, then pull out to unsnap the rear portion and slide rearward to remove.



LH ACCESS COVER

1. To unlock, turn the knob 1/4 turn clockwise

⚠ WARNING

Some components in the engine compartment may be hot. To avoid injury, wait for engine to cool down.

⚠ CAUTION Make sure the hose is properly clamped before towing the watercraft. If hose is not properly clamped when engine is not running, water will accumulate in the exhaust system, will enter the engine and cause damages.

NOTICE Failure to follow these instructions may result in damage to the engine. If you must tow a stranded watercraft in water, be sure not to exceed the maximum towing speed of 21 km/h (13 MPH).

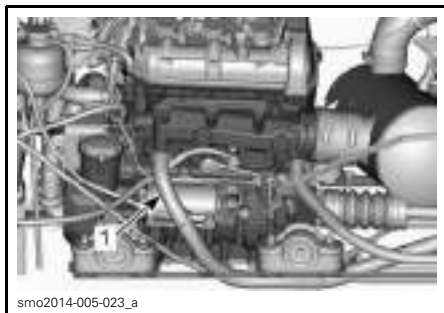

1. Water supply hose

Reinstall the LH access cover in the reverse of the removal procedure and lock the knob by turning it 1/4 turn counterclockwise.



LH ACCESS COVER

1. To lock, turn the knob 1/4 turn counterclockwise

***This page is
intentionally blank***

MAINTENANCE INFORMATION

MAINTENANCE SCHEDULE

Maintenance is very important for keeping the watercraft in a safe operating condition. The watercraft should be serviced as per the maintenance schedule.

A repair shop or person of the owner's choosing may maintain, replace, or repair emission control devices and systems. These instructions do not require components or service by BRP or authorized Sea-Doo dealers. Although an authorized Sea-Doo dealer has an in-depth technical knowledge and tools to service the Sea-Doo personal watercraft, the emission-related warranty is not conditioned on the use of an authorized Sea-Doo dealer or any other establishment with which BRP has a commercial relationship. For emission-related warranty claims, BRP is limiting the diagnosis and repair of emission-related parts to the authorized Sea-Doo dealers. For more information, please refer to the *US EPA EMISSION-RELATED WARRANTY* contained herein. Proper maintenance is the owner's responsibility. A warranty claim may be denied if, among other things, the owner or operator caused the problem through improper maintenance or use.

You must follow the instructions for fuel requirements in the fueling section of this manual. Even if gasoline containing greater than ten volume percent ethanol is readily available, the US EPA issued a prohibition against the use of gasoline containing greater than 10 vol% ethanol that applies to this vehicle. The use of gasoline containing greater than 10 vol% ethanol with this engine may harm the emission control system.

Disregard the information pertaining to the following systems if the watercraft is not equipped with these features:

- iBR (intelligent Brake and Reverse)

Carry out all maintenance as listed in the schedule whenever the hours or time of each column is reached.

NOTE: As an example, at 200 hours or 2 years, complete all items in this column and ALSO in the EVERY 100 hours or 1 year column.

WARNING

Failure to properly maintain the watercraft according to the maintenance schedule and procedures can make it unsafe to operate.

The maintenance schedule does not exempt the pre-ride inspection.

AFTER EACH RIDE IN SALT OR DIRT WATER

Rinse engine compartment with fresh water and drain salt water

Flush the exhaust system

EVERY MONTH IN SALT OR DIRT WATER

Spray an anticorrosion lubricant to metallic components in engine compartment (every 10 hours in salt water use)

Inspect sacrificial anode

EVERY YEAR AT PRESEASON OR 100 HOURS OF OPERATION (WHICHEVER COMES FIRST)
Inspect sacrificial anode
Check for fault codes
Perform all items indicated in the Pre-Ride Inspection and Post-operation Care
Replace engine oil and filter
Inspect engine rubber mounts
Inspect the cooling system (coolant level, hoses and fasteners for leaks)
Visually inspect connection between throttle body and intake manifold
Inspect the air intake for damage on hoses and clamps.
Inspect spark plugs and ignition coils
Inspect electrical connections and fastening (ignition system, starting system, fuel injectors, fuse boxes etc.)
Inspect steering cable and connections
Verify O.T.A.S. operation (if equipped)
Visually inspect impeller and boot
Measure impeller and impeller wear ring clearance
Remove impeller cover and inspect for signs of water intrusion
Visually inspect condition of steering cable and connections
Visually inspect reverse gate bushing for excessive play (If equipped)
Inspect fuel cap, filler neck, fuel tank, fuel tank straps, fuel lines and connections for leaks

EVERY 2 YEARS OR 200 HOURS OF OPERATION (WHICHEVER COMES FIRST)
Replace spark plugs
Inspect flame arrestor
Validate condition of bearing by manually spinning impeller checking for radial shaft play or noise
Verify and lubricate splines of the drive shaft and impeller

EVERY 2 YEARS OR 200 HOURS OF OPERATION
(WHICHEVER COMES FIRST)

Inspect and lubricate drive shaft/PTO splines

The following must be performed every 200 hours (irrespective of the number of years):

Inspect, lubricate PTO sleeve and replace oil seal and both water seals. (Inspect for possible leaks or damages on oil seal or on both water seals, and PTO sleeve surface. Lubricate grease chamber (between the two water seals.) (900 ACE engines)

EVERY 5 YEARS OR 300 HOURS OF OPERATION
(WHICHEVER COMES FIRST)

Replace the coolant

MAINTENANCE PROCEDURES

NOTE: Some vehicle safety labels are not shown on illustrations. For information on vehicle safety labels, refer to *WATERCRAFT SAFETY LABELS*.

This section includes instructions for basic maintenance procedures.

⚠ WARNING

Turn off the engine and follow these maintenance procedures when performing maintenance. If you do not follow proper maintenance procedures you can be injured by hot parts, moving parts, electricity, chemicals or other hazards.

⚠ WARNING

Should removal of a locking device (e.g. lock tabs, self-locking fasteners, etc.) be required, always replace with a new one.

NOTICE Never leave any object, rag, tool, etc., in the engine compartment or in the bilge.

Engine Oil

Recommended Engine Oil

Scandinavia Countries

XPS™ RECOMMENDED ENGINE OIL	
900 ACE	4T 5W40 SYNTHETIC BLEND OIL (EUR) (P/N 779290)
If THE RECOMMENDED XPS ENGINE OIL IS NOT AVAILABLE	
Use a 5W40 4-stroke SAE synthetic engine oil meeting or exceeding the following lubricant industry specifications: <ul style="list-style-type: none">– API service classification SJ, SL, SM or SN Always check the API service label certification on the oil container, it must contain at least one of the indicated standards.	

Rotax® engines were developed and validated using the XPS™ oil. BRP recommends the use of its XPS engine oil or an equivalent at all time. Do not add any additives to the recommended engine oil. Damages caused by the use of an oil not suitable for the engine or by adding of an additives may not be covered by the BRP Limited Warranty.

All Other Countries

XPS™ RECOMMENDED ENGINE OIL	
900 ACE	4T 5W40 SYNTHETIC BLEND OIL (P/N 779133)
If THE RECOMMENDED XPS ENGINE OIL IS NOT AVAILABLE	
<p>Use a 5W40 4-stroke SAE synthetic engine oil meeting or exceeding the following lubricant industry specifications:</p> <ul style="list-style-type: none"> – API service classification SJ, SL, SM or SN <p>Always check the API service label certification on the oil container, it must contain at least one of the indicated standards.</p>	

Rotax® engines were developed and validated using the XPS™ oil. BRP recommends the use of its XPS engine oil or an equivalent at all time. Do not add any additives to the recommended engine oil. Damages caused by the use of an oil not suitable for the engine or by adding of an additives may not be covered by the BRP Limited Warranty.

Engine Oil Level

NOTICE Check level frequently and refill if necessary. Do not overfill. Operating the engine with an improper level may severely damage engine.

CAUTION Many components in the engine compartment may be very hot. Direct contact may result in skin burn.

Oil level can be checked with watercraft either in or out of water.

Out of Water

NOTICE Watercraft must be level.

CAUTION When operating the engine out of water, the heat exchanger may become very hot. Avoid any contact with the heat exchanger as burns may occur.

1. Raise trailer tow pole, then block in position when bumper rail is level.
2. Install a garden hose on the exhaust system flushing connector. Refer to *EXHAUST SYSTEM* in this section and follow the procedure.

CAUTION

- Never run engine without supplying water to the exhaust system. Failure to cool exhaust system may severely damage it.
 - Never run engine longer than 2 minutes. Drive line seal has no cooling when watercraft is out of water. Also, extreme heat will damage engine.
3. With the engine already at normal operating condition, let engine **idle for 30 seconds** then stop engine.
 4. Wait at least 30 seconds for the oil to settle in the engine.

In or Out of Water

5. To check level, remove access cover located on rear of RH side of watercraft by turning counterclockwise.



smo2014-005-024_a

TYPICAL

1. RH access cover

6. Unscrew dipstick, pull it out and wipe clean.

NOTE: Inner side of RH access cover is equipped with an extension to facilitate dipstick unscrewing.



smo2014-005-025_a

1. RH access cover - extension side
2. Dipstick

7. Reinstall dipstick, push in completely.
8. Remove dipstick again and read oil level. It should be between the MAX and MIN marks.

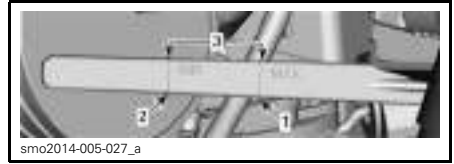

smo2014-005-027_a

1. Maximum
2. Minimum
3. Operating range

9. Add oil to ensure the level is between marks as required.

NOTE: Do not overfill.

To add oil:

- Place a funnel in the oil neck opening.
- Add the recommended oil to the proper level.

NOTE: Every time oil is added in the engine, the complete procedure explained in this section must be carried out again. Otherwise, you will obtain a false oil level reading.

10. Properly reinstall dipstick and RH access cover.

Engine Oil Change and Oil Filter Replacement

The oil change and filter replacement may be performed by an authorized Sea-Doo dealer, repair shop, or person of your own choosing.

Engine Coolant

Recommended Engine Coolant

COUNTRY	RECOMMENDED COOLANT
Scandinavia	EXTENDED LIFE PRE-MIXED COOLANT (EUR) (P/N 779223)
All other countries	EXTENDED LIFE PRE-MIXED COOLANT (P/N 779150)
Alternative, or if not available	If the recommended coolant is not available, use a low silicate, extended life ethylene-glycol premixed coolant (50%-50%) specifically formulated for internal combustion aluminum engines.

NOTICE Always use ethylene-glycol antifreeze containing corrosion inhibitors specifically for internal combustion aluminum engines.

To prevent antifreeze deterioration, always use the same brand and grade. Never mix different brands or grades unless cooling system is completely flushed and refilled.

Engine Coolant Level

⚠ WARNING

Check coolant level with engine cold. Never add coolant in cooling system when engine is hot.

⚠ CAUTION Many components in the engine compartment may be very hot. Direct contact may result in skin burn.

To access the expansion tank, turn the LH access cover knob 1/4 turn clockwise, then pull out to unsnap the rear portion and slide rearward to remove.



LH ACCESS COVER

1. To unlock, turn the knob 1/4 turn clockwise

Locate the expansion tank cap.



1. Expansion tank cap

With watercraft on a level surface, add coolant until it is visible without exceeding the COLD level mark in coolant reservoir when engine is cold.



1. Cold level mark

NOTE: The watercraft is level when it is in water. When on a trailer, raise trailer tow pole and block in this position when bumper rail is level.

Add premixed coolant to adjust coolant level between marks as required. Use a funnel to avoid spillage. Do not over-fill.

Properly reinstall and tighten expansion tank cap, then reinstall the LH access cover in the reverse of removal procedure and lock the knob by turning it 1/4 turn counterclockwise.



LH ACCESS COVER

1. To lock, turn the knob 1/4 turn counterclockwise

NOTE: A cooling system that frequently requires coolant is an indication of leaks or engine problems. See an authorized Sea-Doo dealer.

Engine Coolant Replacement

Coolant replacement should be performed by an authorized Sea-Doo dealer.

Steering Alignment

1. Manually release and remove the LH side knee pad.

NOTE: This area is intended only to access the steering cable assembly. Do not use this area for storage purposes.

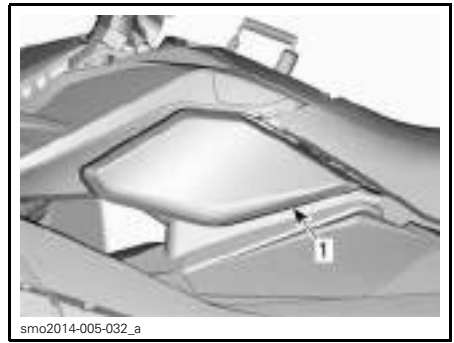

1. LH Side knee pad

2. Unclip the steering cable by pushing the ring up towards the nut.



STEERING CABLE UNCLIPPED

1. Ring
2. Nut
3. Put the jet pump nozzle in straight position.
4. Unscrew nut to turn handlebar to the right.

5. Screw nut to turn handlebar to the left.
6. When steering alignment is complete, clip the steering cable by pushing the ring back down and re-installing the LH side knee pad.

Central Body

Central Body Removal

When necessary, remove the central body as follows:

WARNING

Never attempt to lift the central body alone. Lift only with assistance or use an appropriate lifting device. Lifting alone can cause serious injury.

1. Turn the LH access cover knob 1/4 turn clockwise, then pull out to un-snap the rear portion and slide rearward to remove.



LH ACCESS COVER

1. To unlock, turn the knob 1/4 turn clockwise
2. Disconnect the steering connector.



1. Connector

3. Remove the front trim retaining screw.

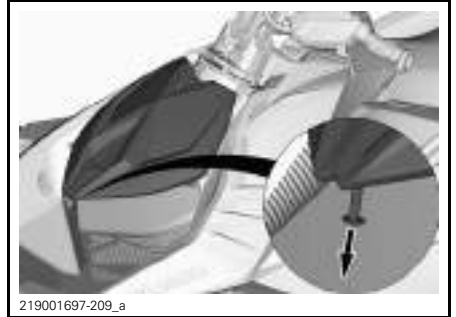

4. Remove the front trim.

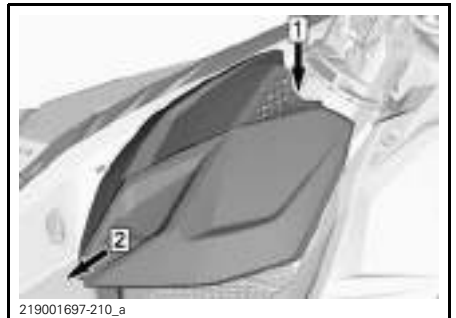

- Step 1: Push tab
Step 2: Slide towards front

5. Disconnect the steering cable.



1. Steering cable retaining bolt



1. Nut and washer
2. Bolt
3. Rod

6. Remove two screws from the cable assembly.

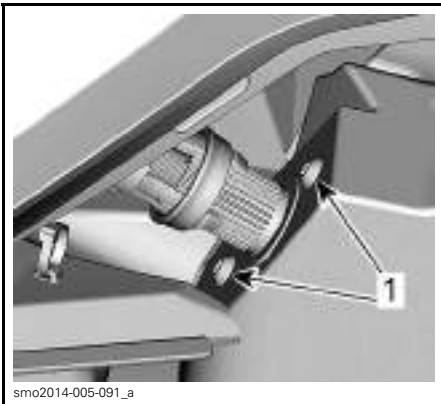

1. Cable assembly screws

7. Remove nut, bolt, and washer to disconnect rod from steering column.

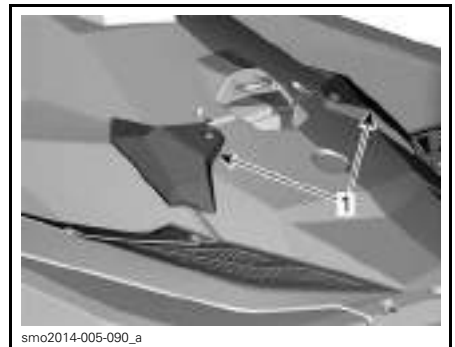

TYPICAL
1. Rear panel trims

Trixx Models

10. Remove both rear footrests.



219001697-212_a

LH SHOWN

1. Footrest

All Models

11. Remove seat. Refer to *SEAT* in *EQUIPMENT*.

12. Remove three self-tapping screws around the fuel cap

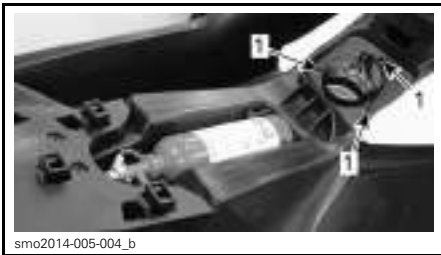

smo2014-005-004_b

1. Screws

13. Remove five (5) self-tapping screws at front of central body.

NOTE: If equipped with a storage bin, open the storage bin first. Refer to *STORAGE BIN*.

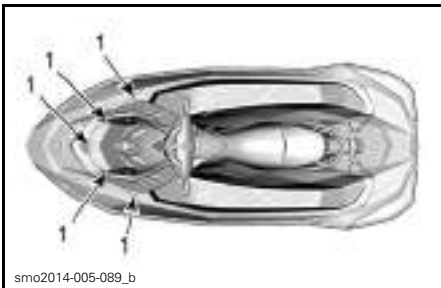

smo2014-005-089_b

1. Self-tapping screws

14. Remove six (6) self-tapping screws at rear of central body.

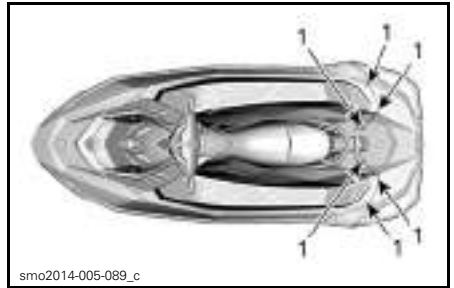

smo2014-005-089_c

1. Self-tapping screws

15. Remove ten (10) M6 nuts and screws from both sides of central body.

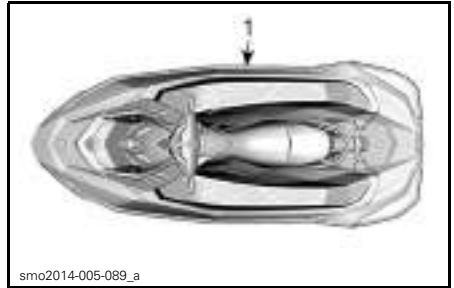

smo2014-005-089_a

1. Nuts and screws

16. Carefully lift the central body off the hull using a lifting belt.

NOTE: When lifting central body, wrap belt around handlebars. Wrapping belt elsewhere on central body to lift it may cause damages.

Central Body Installation

1. Properly place central body alignment tabs on hull.



CENTRAL BODY - STARBOARD SIDE VIEW

1. Grooved alignment tab on central body
2. Rib in hull

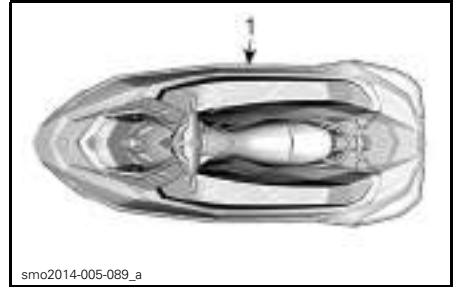

1. Nuts and screws

TIGHTENING TORQUE	
M6 nuts	3.5 N•m ± 0.5 N•m (31 lbf•in ± 4 lbf•in)

5. Install and tighten screws on front and rear of central body to the recommended torque.

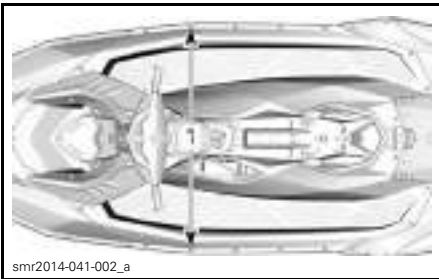

1. Screws adjacent to alignment tabs

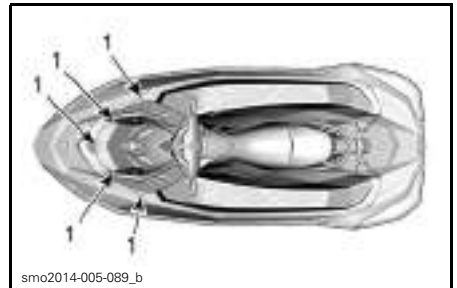

1. Self-tapping screws

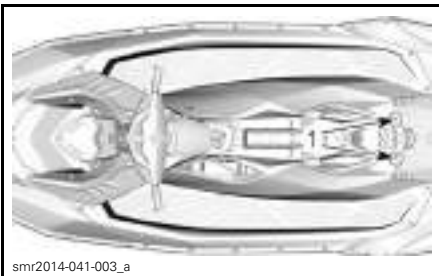

1. Screws on rear support

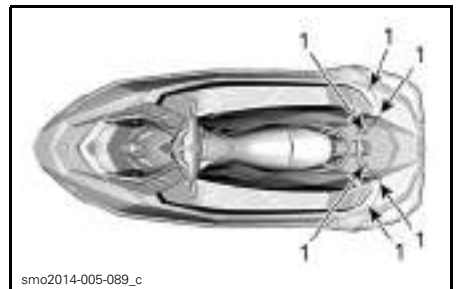

1. Self-tapping screws

TIGHTENING TORQUE	
Self-tapping screw	5.5 N•m ± 0.5 N•m (49 lbf•in ± 4 lbf•in)

2. Install screws adjacent to alignment tabs first to ensure alignment tabs remain properly engaged.

3. Install two screws on rear support.

4. Install screws and tighten nuts on both sides of central body to the recommended torque.

- Install and tighten self-tapping screws around the fuel cap to the recommended torque.



1. Screws

TIGHTENING TORQUE	
Self-tapping screw	4.5 N•m ± 0.5 N•m (40 lbf•in ± 4 lbf•in)

- Reinstall the seat. Refer to *SEAT in EQUIPMENT*.

All Models Except Trixx Models

- Position rear panel trims in place by sliding towards the inside of PWC and install self-tapping screws. Tighten to the recommended torque.



TYPICAL

1. Rear panel trims

Trixx Models

- Install there rear footrests.

All Models

TIGHTENING TORQUE	
Self-tapping screw (footrests or rear panel trims)	5.5 N•m ± 0.5 N•m (49 lbf•in ± 4 lbf•in)

- Connect the steering connector.



1. Connector

- Connect steering cable in reverse of removal procedure.
- Close the LH access cover and lock the knob by turning it 1/4 turn counterclockwise.



LH ACCESS COVER

- To lock, turn the knob 1/4 turn counterclockwise

13. Install the front trim.

TIGHTENING TORQUE	
Front trim retaining screw	3.5 N•m ± 0.5 N•m (31 lbf•in ± 4 lbf•in)

Battery

Battery Access

Turn the LH access cover knob 1/4 turn clockwise, then pull out to unsnap the rear portion and slide rearward to remove.



LH ACCESS COVER

1. To unlock, turn the knob 1/4 turn clockwise

Battery Removal

⚠ WARNING

The BLACK (-) battery cable must always be disconnected first and reconnected last. Never charge or boost battery while installed in watercraft.

1. Disconnect the BLACK (-) battery cable.
2. Slide the RED rubber protector off the RED (+) cable terminal and disconnect it from the battery post.
3. Reinstall bolts to secure retaining nuts during removal.
4. Detach retaining strap.

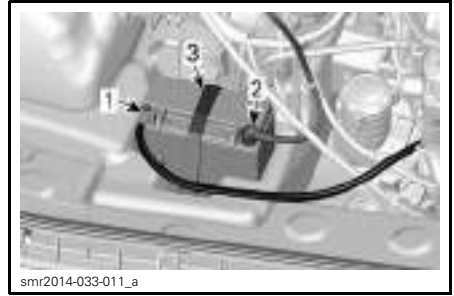

smr2014-033-011_a

CENTRAL BODY REMOVED FOR CLARITY PURPOSE

1. BLACK (-) cable
2. RED (+) cable
3. Retaining strap

5. Remove battery from vehicle.

NOTICE Should any electrolyte spillage occur, immediately wash off area with a solution of baking soda and water, then rinse thoroughly.



smr2014-033-012

Battery Cleaning

Clean the battery casing, cables and battery posts using a solution of baking soda and water.

Remove corrosion from battery cable terminals and battery posts using a firm wire brush.

Battery top should be cleaned with a soft brush and any grease-cutting soap or baking soda solution.

Rinse with clear water then dry well.

Battery Inspection

Visually inspect battery casing for cracks, leaks or other possible damages.

Discoloration, warping or raised top, indicates that the battery has overheated or been overcharged.

If the casing is damaged, replace battery and thoroughly clean battery tray and surrounding area with a water and baking soda solution.

⚠ CAUTION Should the battery casing be damaged, wear a suitable pair of non-absorbent gloves when removing the battery by hand.

Inspect the battery posts for security of mounting.

Battery Storage

NOTICE Battery storage is critical for battery life. Regularly charging the battery during storage will prevent cell sulfation. Keeping the battery in vehicle for storage may lead to contacts degradation/corrosion and case damage if freezing occurs. A discharged battery will freeze and crack in areas where freezing conditions are experienced. Electrolyte leakage will damage surrounding parts. Always remove battery from vehicle for storage and regularly recharge it to keep an optimal condition.

Clean battery terminals and cable connections using a wire brush.

Apply a light coat of dielectric grease on terminals.

Clean battery casing using a solution of baking soda and water.

Rinse battery with clear water and dry well using a clean cloth.

Store battery in a cool dry place. Such conditions reduce self-discharging and keep fluid evaporation to a minimum. Keep battery away from dew, high moisture and direct sunlight.

Recharge frequency depends on battery condition and storage temperature. Maintain battery as per following table.

NOTE: The battery must always be stored in fully a charged state.

AMBIENT TEMPERATURE	CHARGING FREQUENCY
Below 16°C (60°F)	Every month
Above 16°C (60°F)	Every 2 weeks

Charging a Battery

⚠ WARNING
Never charge or boost the battery while installed in the watercraft.

⚠ WARNING
Always wear safety glasses and charge the battery in a ventilated area. Never charge or boost a battery while installed on a vehicle. Do not open the sealed caps during charging. Do not place battery near an open flame.

NOTICE If the battery becomes hot to the touch, stop charging and allow it to cool before continuing.

NOTE: Sealed VRLA batteries have an internal safety valve. If battery pressure increases due to overcharging, the valve opens to release excess pressure, preventing battery damage.

Carry out a battery *UNLOADED VOLT-METER TEST* as described in this section, then proceed as described here.

An automatic charger is the fastest and most convenient way for error-proof charging.

When using a constant current charger, charge battery according to the chart below.

Battery Voltage Below 12.8 V and Above 11.5 V

YTX20L-BS	TIME	CHARGE
STANDARD CHARGING (RECOMMENDED)	4 - 9 hours	2 A
QUICK CHARGING	50 minutes	10 A

Battery Voltage Below 11.5 V

A battery with a voltage below 11.5 V requires a special procedure to recharge. In charging an over discharged battery, its internal resistance may be too high to charge at a normal charging rate.

Set charger to the 10 A charging rate and monitor charging current for approximately 30 minutes. If there is no change in charging current or battery becomes abnormally hot, the battery is most likely at the end of its service life and should be replaced.

Battery Installation

1. Install the battery in the watercraft and secure it using retaining strap.

⚠ WARNING

Always connect battery cables in the specified order, RED (+) cable first, BLACK (-) cable last.

2. Connect RED (+) cable.
3. Connect BLACK (-) cable last.
4. Apply dielectric grease on battery posts.
5. Verify cable routing and attachments.
6. Install remaining removed components.

Battery maintenance

These batteries require little maintenance to perform perfectly. Follow this simple check list for optimum battery performance:

- Check voltage every 3 months using a voltmeter.
- Keep a battery fully charged to 100% (12.8 V or higher after standing 2 hours).
- Check and charge battery if the voltage drops below 12.5 V.
- Keep the battery top free of grime.
- Clean terminals and connectors if necessary.
- For storage, pull battery or disconnect battery cables.

Ignition Coils

Ignition Coil Removal

1. To access the ignition coils, remove the central body. Refer to *CENTRAL BODY REMOVAL* section.

NOTICE Do not remove the ignition coil before disconnecting the input connector or the wires may be damaged. Do not pry up ignition coil with a screwdriver to avoid damage.

2. Disconnect ignition coil connector.
3. Remove ignition coil retaining screw.
4. Remove ignition coil from spark plug by rotating coils side to side as you pull up.



1. Ignition coils

Ignition Coil Installation

1. Align the retaining screw hole of the ignition coil with the threaded hole on the valve cover.
2. Install the ignition coil on the spark plug and push it all the way down until it rests on the valve cover.
3. Install the retaining screw and tighten to specification below.

IGNITION COIL RETAINING SCREW	
Tightening torque	11 N•m (97 lbf•in)

4. Connect ignition coil connector.

Spark Plugs

Spark Plug Removal

1. Disconnect the ignition coil input connector.
2. Remove ignition coil. Refer to *IGNITION COIL REMOVAL*.

⚠ WARNING

Never remove an ignition coil from a spark plug without disconnecting it from the wiring harness. Flammable vapors may be present in the bilge. Should the tether cord be installed on the engine cut-off switch, a spark could be generated at the coil spark plug end which could cause an explosion.

3. Using a spark plug socket, release the torque applied to the spark plug.

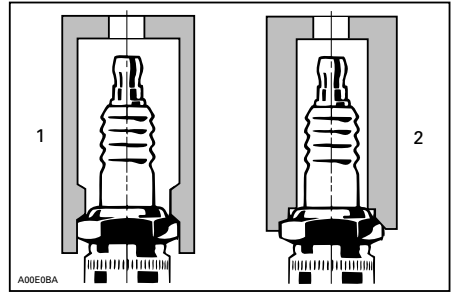

1. Approved socket
2. Improper socket

4. Clean the spark plug and cylinder head with pressurized air.
5. Unscrew spark plug then use the ignition coil to take spark plug out of spark plug hole.

Spark Plug Installation

Prior to installation, ensure the contact surfaces of the cylinder head and spark plug are free of grime.

⚠ WARNING

Do not adjust gap on this type of spark plug. The adjustment could weaken negative electrodes which may lead to electrode breaking and severe engine damage.

1. Using a wire feeler gauge, check electrode gap as specified in *TECHNICAL SPECIFICATIONS*.
2. Apply LOCTITE 767 (ANTISEIZE LUBRICANT) (P/N 293 800 070) over the spark plug threads to prevent possible seizure.
3. Hand screw spark plug into cylinder head. Then, tighten the spark plug clockwise to the specified torque with an approved spark plug socket.

SPARK PLUG	TORQUE
NGK CR8EB (or equivalent)	13 N•m ± 1 N•m (115 lbf•in ± 9 lbf•in)

4. Install ignition coil. Refer to *IGNITION COIL INSTALLATION*.

Reinstall the central body Refer to *CENTRAL BODY INSTALLATION* section.

Exhaust System

Exhaust System Flushing

Flushing the exhaust system with fresh water is essential to neutralize corroding effects of salt or other chemical products present in water. It will help to remove sand, salt, shells or other particles in water jackets and/or hoses.

Flushing should be performed when the watercraft is not expected to be used further the same day or when the watercraft is stored for any extended time.

⚠ WARNING

Perform this operation in a well ventilated area.

Proceed as follows:

Clean propulsion system by spraying water in its inlet and outlet and then apply a coating of XPS Lube or equivalent.

⚠ CAUTION When operating the engine while the watercraft is out of the water, the heat exchanger may become very hot. Avoid any contact with heat exchanger as burns may occur.

Connect a garden hose to the connector located at the rear of watercraft (on the port side of the stern). Do not open water tap at this time.

NOTICE Always run the engine before opening the water tap. If not, water will get inside the engine.

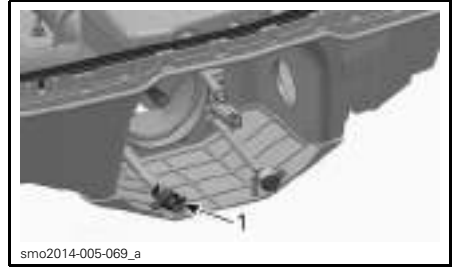

JET NOZZLE REMOVED FOR CLARITY
1. Flushing connector location (with optional hose adapter shown)

NOTE: An optional quick connect hose adapter and hose fitting can be used (P/N 295 500 473). No hose pincher is required to flush engine.

To flush, start engine then immediately open the water tap.

⚠ CAUTION Many components in the engine compartment may be very hot. Direct contact may result in skin burn. Do not touch any electrical parts or propulsion system component when the engine is running.

NOTICE Never flush a hot engine. Always start the engine before opening the water tap. Open water tap immediately after engine is started to prevent overheating.

Run the engine 90 seconds at idle speed.

NOTICE Never run engine without supplying water to the exhaust system when watercraft is out of water.

Ensure water flows out of jet pump while flushing. Otherwise, refer to an authorized Sea-Doo dealer for servicing.

Close the water tap, run the engine at 5000 RPM for 5 seconds and stop the engine.

NOTICE Always close the water tap before stopping the engine. If not, water will get inside the engine.

NOTICE Remove quick connect adapter after flushing operation (if used).

Heat Exchanger and Water Intake Grate

Heat Exchanger and Water Intake Grate Inspection

Inspect heat exchanger and jet pump water intake grate for cracks and other damages. See your Sea-Doo dealer to have any damaged part repaired or replaced.

⚠ WARNING

The tether cord must always be removed from the engine cut-off switch prior to inspecting the intake grate.

NOTE: There is a reinforcement plate on LH side of hull to maintain symmetry so the hydrodynamics of PWC is not affected.

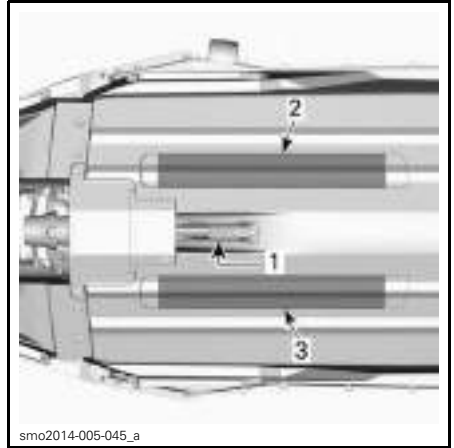

1. Water intake
2. Heat exchanger
3. Reinforcement plate

Sacrificial Anode

Sacrificial Anode Inspection

Check for wear. If worn more than half, replace anode.

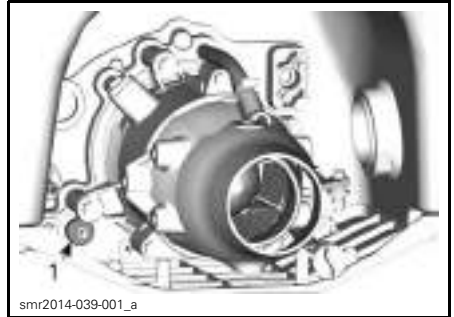

1. Sacrificial anode location

Sacrificial Anode Removal

Unscrew sacrificial anode retaining nut and remove anode.

Sacrificial Anode Installation

Installation is the reverse of the removal procedure.

TIGHTENING TORQUE

8 N•m (71 lbf•in)

Fuses

Fuse Removal and Installation

Use the fuse remover/installer included in the fuse box to ease fuse removal.

Fuse Inspection

If an electrical problem occurs, check the fuses. If a fuse is burnt, replace by one of the same rating.

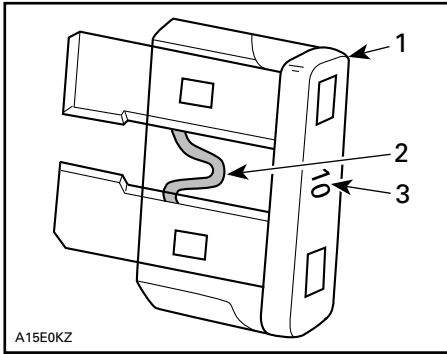

A15E0KZ

1. Fuse
2. Check if melted
3. Ampere rating

⚠ WARNING

Do not use a higher rated fuse as this can cause severe damage. If a fuse has burnt out, the source of the malfunction should be determined and corrected before restarting. See an authorized Sea-Doo dealer for servicing.

Fuse Location

All fuses are located inside a single fuse box.

To access the fuse box, turn the knob 1/4 turn clockwise, then pull out to unsnap the rear portion and slide rearward to remove.



smo2015-005-005_a

LH ACCESS COVER

1. To unlock, turn the knob 1/4 turn clockwise

The fuse box is located to the left of the expansion tank.

To remove the fuse box cover, squeeze and hold locking tabs on both sides of the fuse box and pull the cover off the fuse box.



smo2014-005-002_a

1. Fuse box cover
2. Locking tabs
3. Expansion tank



smo2014-005-041_a

TYPICAL - FUSE BOX COVER REMOVED

1. Fuse box

NOTE: Fuse ratings and positions are illustrated on the fuse box cover.

To reinstall the fuse box cover and the LH access cover, do the reverse of the removal procedure and lock the knob by turning it 1/4 turn counterclockwise.



LH ACCESS COVER

1. To lock, turn the knob 1/4 turn counterclockwise

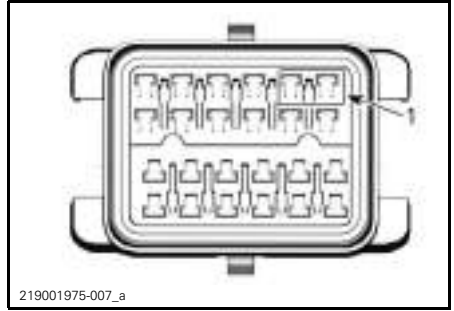

1. Bilge pump fuse location (If equipped)

Fuse Description

FUSE	RATING	DESCRIPTION
1	10 A	ECM, Cluster, Starter Solenoid, O.T.A.S. (if equipped) and CAPS
2	5 A	Engine START/STOP button
3	15 A	Battery
4	30 A	Charge
5	30 A	iBR
*	3 A	Bilge pump (If equipped)

* The bilge pump fuse is located above the #1 ACC (10A) fuse.

WATERCRAFT CARE

Remove the watercraft from the water every day.

Post-Operation Care

Exhaust System Flushing

The exhaust system should be flushed daily when watercraft is used in salt or foul water.

Refer to *MAINTENANCE PROCEDURES*.

Additional Care for Foul Water or Salt Water Operation

When the watercraft is operated in foul water and particularly in salt water, additional care should be taken to protect the watercraft and its components.

Rinse watercraft bilge area with fresh water.

Never use a high pressure washer to clean the bilge. **USE LOW PRESSURE ONLY** (such as a garden hose).

High pressure can cause damages to electrical or mechanical systems.

⚠ CAUTION Allow engine to cool before performing any maintenance.

NOTICE Failure to perform proper care such as: watercraft rinsing, exhaust system flushing and anticorrosion treatment, when watercraft is used in salt water, will result in damage to the watercraft and its components. Never leave the watercraft stored in direct sunlight.

Watercraft Cleaning

Body and Hull

Occasionally, wash the hull and various body components with water and soap (use only mild detergent). Remove any marine organisms from engine and/or hull. Soiled surfaces can be cleaned with XPS WASH AND

WAX (BOAT/PWC) (P/N 219 701 711) or CLEANER AND DEGREASER PRO C1 (P/N 779262), or the equivalent, which does not damage textured plastic.

NOTICE Never clean plastic parts with strong detergent, degreasing agent, paint thinner, acetone, or other strong chemical or petroleum type cleaner, such as XPS SPRAY CLEANER & POLISH (P/N 219 701 706), that can damage textured plastic.

Stains may be removed from the seat using BRP HEAVY DUTY CLEANER (P/N 293 110 001) or the equivalent, which is safe on vinyl and metal surfaces.

NOTICE Never use BRP HEAVY DUTY CLEANER (P/N 293 110 001) on plastic parts. This product can damage textured plastic.

⚠ WARNING

Never apply plastic or vinyl protector on the wet grip floorboard area or seat as the surface will become slippery and the occupants may slip off the watercraft.

Respect the environment by ensuring fuel, oil, coolant or cleaning solutions do not drain into the waterways.

STORAGE AND PRESEASON PREPARATION

Storage

⚠ WARNING

Because fuel and oil are flammable, you should have an authorized Sea-Doo dealer, repair shop, or person of your own choosing to inspect the fuel system integrity as specified in the periodic inspection chart.

It is recommended that the watercraft be serviced by an authorized Sea-Doo dealer, repair shop, or person of your own choosing, however the following operations can be performed by you with a minimum of tools.

NOTE: Carry out the following tasks in the same order as detailed in this section.

NOTICE Do not run the engine during the storage period.

Propulsion System

Jet Pump Cleaning

Clean jet pump by spraying water in its inlet and outlet and then apply a coat of LUB. & ANTI-CORROSIVE (P/N 779168) or equivalent.

⚠ WARNING

Always remove tether cord from the engine cut-off switch to prevent unexpected engine starting before cleaning the propulsion system components. Engine must not be running for this operation.

Jet Pump Inspection

Remove impeller cover and check if jet pump is water contaminated; if so, see your authorized Sea-Doo dealer.

Fuel System

Fuel System Protection

FUEL STABILIZER (P/N 779171) (or equivalent) should be added in the fuel tank to prevent fuel deterioration and fuel system gumming. Follow stabilizer manufacturers' instructions for proper use.

NOTICE It is highly recommended to add fuel stabilizer at storage in order to maintain fuel system in good condition. Fuel stabilizer should be added prior to engine lubrication and fuel tank top up to ensure fuel system components protection against varnish deposits.

Fill up fuel tank completely as explained in *FUELING* section. Make sure there is no water inside fuel tank.

NOTICE Should any water be trapped inside fuel tank, severe internal damage will occur to the fuel injection system.

Engine and Exhaust Systems

Exhaust System Flushing

Perform procedure as described in *MAINTENANCE PROCEDURES*.

Engine Oil and Filter Replacement

The oil change and filter replacement may be performed by an authorized Sea-Doo dealer, repair shop, or person of your own choosing.

Exhaust System Draining

In areas where temperature may freeze, water trapped in the exhaust system must be removed.

Using the flushing connector located on the port (LH) side of the stern, inject pressurized air at 379 kPa (55 PSI) into system until there is no more water flowing from jet pump.



JET NOZZLE REMOVED FOR CLARITY

1. Flushing connector (with optional hose adapter shown)

The following hose can be fabricated to ease draining procedure.



1. Flushing connector adapter (P/N 295 500 473)
2. Hose 12.7 mm (1/2 in)
3. Air hose male adapter

NOTICE Failure to drain the exhaust system may cause severe damage to the exhaust manifold.

Remove special tools.

Engine Internal Lubrication

1. Remove the central body. Refer to *CENTRAL BODY REMOVAL* in *MAINTENANCE PROCEDURES* section.
2. Remove ignition coils, refer to *MAINTENANCE PROCEDURES*.
3. Remove spark plugs, refer to *MAINTENANCE PROCEDURES*.
4. Spray LUB. & ANTI-CORROSIVE (P/N 779168) or equivalent in spark plug holes.
5. To prevent fuel from being injected and to disable the ignition during engine cranking, fully depress throttle lever and HOLD against handlebar.

6. Press the engine START/STOP button to crank the engine a few turns. This will distribute the oil on the cylinder walls.
7. Apply a small amount of anti-seize lubricant on spark plug threads, then reinstall them in the engine. Refer to *MAINTENANCE PROCEDURES*.
8. Install the ignition coils, refer to *MAINTENANCE PROCEDURES*.

Engine Coolant Test

If antifreeze is not replaced, test its density.

The antifreeze replacement and a density test should be performed by an authorized Sea-Doo dealer.

NOTE: Antifreeze should be replaced every 300 hours or every 5 years to prevent antifreeze deterioration.

NOTICE Improper antifreeze density may result in freezing of the liquid in the cooling system if the watercraft is stored in an area where the freezing point is attained. This could seriously damage the engine.

Electrical System

Battery Removal and Charging

Refer to *BATTERY* in *MAINTENANCE PROCEDURES* section.

Engine Compartment

Engine Compartment Cleaning

Clean the bilge using hot water and a mild detergent or with bilge cleaner.

Rinse thoroughly.

Lift front end of watercraft to completely drain bilge through the bilge drain plug.

Anticorrosion Treatment

Wipe off any residual water in the engine compartment.

Spray LUB. & ANTI-CORROSIVE (P/N 779168) or equivalent, or ANTI-CORROSION SPRAY (P/N 219 700 304) or equivalent, only over all metallic components in engine compartment while minimizing overspray.

NOTE: The LH access panel and RH access cover should be left partially open during storage. This will prevent engine compartment condensation and possible corrosion.

Body and Hull

Body and Hull Cleaning

Wash the body with a soap and water solution (use only mild detergent). Rinse thoroughly with fresh water. Remove marine organisms from the hull.

NOTICE Never clean plastic parts with strong detergent, de-greasing agent, paint thinner, acetone, or other strong chemical or petroleum cleaners.

Body and Hull Repair

If any repairs are needed to body components or to the hull, contact your authorized Sea-Doo dealer.

Body and Hull Protection

If the watercraft is to be stored outside, cover it with an opaque tarpaulin to prevent sun rays and grime from affecting the plastic components, watercraft finish, as well as preventing dust accumulation.

NOTICE The watercraft should never be left in water for storage. Never leave the watercraft stored in direct sunlight. Never store watercraft in a plastic bag.

Preseason Preparation

Maintenance preparation must be performed in conjunction with *MAINTENANCE SCHEDULE*.

Ensure to perform all tasks included in the **100 HOURS OR 1 YEAR** column before storage.

Preseason maintenance preparation may be performed by an authorized Sea-Doo dealer, repair shop or person of your own choosing.

NOTE: Though not required, it is recommended that an authorized Sea-Doo dealer perform preseason maintenance preparation at the same time that any safety-related factory campaigns are performed by the authorized Sea-Doo dealer.

WARNING

Only perform procedures as detailed in the *MAINTENANCE SCHEDULE*. It is recommended that the assistance of an authorized Sea-Doo dealer be periodically obtained on other components and systems not covered in this guide.

NOTICE When component conditions seem less than satisfactory, replace using genuine BRP parts, or equivalents.

TECHNICAL INFORMATION

WATERCRAFT IDENTIFICATION

The main components of the watercraft (engine and hull) are identified by different serial numbers. It may sometimes become necessary to locate these numbers for warranty purposes or to trace the watercraft in the event of theft.

Hull Identification Number

The Hull Identification Number (HIN) is engraved on the right hand side of the hull at the rear of watercraft, above the front of the sponson.



TYPICAL

1. Hull Identification Number (HIN)

It is composed of 12 digits:

YDV	12345	L	8	09
				Model year
				Year of production
				Month of production
				Serial number (a letter may also be used as a digit)
				Manufacturer

Engine Identification Number

The Engine Identification Number (EIN) is located under the exhaust manifold, close to cylinder number one.

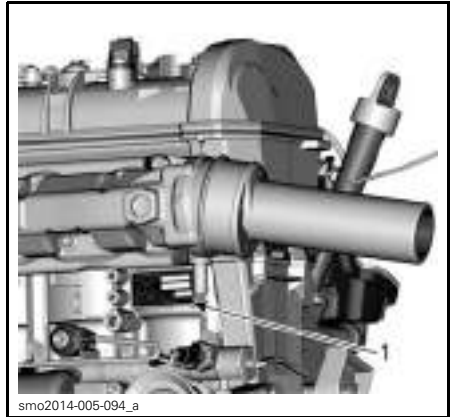

TYPICAL

1. Engine Identification Number (EIN)

Engine Manufacturer Identification

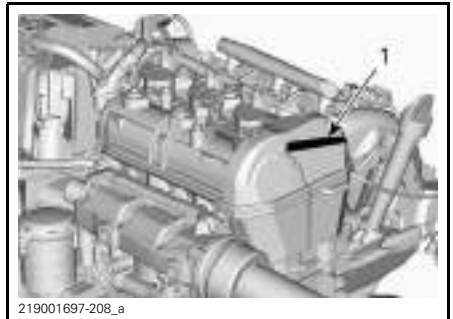

1. Engine Manufacturer Identification



RF D.E.S.S. KEY (IF APPLICABLE)

This device complies with FCC Part 15 and Industry Canada license exempt RSS standard(s).

Operation is subject to the following two conditions: (1) this device may not cause interference, and (2) this device must accept any interference, including interference that may cause undesired operation of the device.

Changes or modifications not expressly approved by the party responsible for compliance could void the user's authority to operate the equipment.

IC Registration Number: 12006A-M01456

FCC ID: 2ACERM01456

We, the party responsible for compliance, declare under our sole responsibility that the device is in conformity with the provisions of the following Council Directive: 2014/53/EU. To which this declaration relates is in conformity with the essential requirements and other relevant requirements. The product is in conformity with the following directives, harmonized standards and regulations:

Radio Equipment Directive (RED) 2014/53/EU and Harmonized Standards:

EN 300 330-2, EN 60950-1

ENGINE EMISSIONS INFORMATION

Manufacturer's Responsibility

Beginning with 1999 model year engines, PWC manufacturers of marine engines must determine the exhaust emission levels for each engine horsepower family and certify these engines with the United States of America Environmental Protection Agency (EPA). An emissions control information label, showing emission levels and engine specifications, must be placed on each watercraft at the time of manufacture.

Dealer's Responsibility

When performing service on all 1999 and more recent Sea-Doo watercraft that carry an emissions control information label, adjustments must be kept within published factory specifications.

Replacement or repair of any emission related component must be executed in a manner that maintains emission levels within the prescribed certification standards.

Dealers are not to modify the engine in any manner that would alter the horsepower or allow emission levels to exceed their predetermined factory specifications.

Exceptions include manufacturer's prescribed changes, such as altitude adjustments for example.

Owner Responsibility

The owner/operator is required to have engine maintenance performed to maintain emission levels within prescribed certification standards.

The owner/operator is not to, and should not allow anyone to modify the engine in any manner that would alter the horsepower or allow emissions levels to exceed their predetermined factory specifications.

EPA Emission Regulations

All 1999 and more recent Sea-Doo watercraft manufactured by BRP are certified to the EPA as conforming to the requirements of the regulations for the control of air pollution from new watercraft engines. This certification is contingent on certain adjustments being set to factory standards. For this reason, the factory procedure for servicing the product must be strictly followed and, whenever practicable, returned to the original intent of the design.

The responsibilities listed above are general and in no way a complete listing of the rules and regulations pertaining to the EPA requirements on exhaust emissions for marine products. For more detailed information on this subject, you may contact:

U.S. Environmental Protection Agency
Certification Division
Gasoline Engine Compliance Center
2000 Traverwood Drive
Ann Arbor MI 48105
USA

EPA INTERNET WEB SITE:
www.epa.gov/otaq

EVAPORATIVE EMISSION CONTROL SYSTEM

Starting with MY2018; personal watercraft sold in the State of California are certified to the California evaporative emissions regulations for spark ignition marine watercraft of the California Air Resources Board (13 CCR 2850 to 2869). These models are equipped with an evaporative emission control system consisting of Low Permeation Fuel Tank (LPFT), Low Permeation Fuel Line (LPFL) and a Pressure Relief Valve (PRV).

SPECIFICATIONS

SPARK		
ENGINE		
Type	Rotax 903	
Model	Rotax 900 ACE, 900 HO ACE	
	4-stroke, Double Over Head Camshaft (DOHC), dry sump, liquid cooled	
Declared Power ⁽¹⁾	Rotax 900 ACE	44.13 kW @ 7000 RPM
	Rotax 900 HO ACE	66.19 kW @ 8000 RPM
Induction	Naturally-aspirated	
Number of cylinders	3	
Number of valves	12 valves (self adjusting hydraulic valve lifters)	
Bore	74 mm (2.9 in)	
Stroke	69.7 mm (2.7 in)	
Displacement	899.31 cm ³ (54.88 in ³)	
Compression ratio	11,0:1	
COOLING SYSTEM		
Type	Closed-loop cooling system (CLCS)	
FUEL SYSTEM		
Fuel injection type	Multipoint fuel injection with iTC (intelligent Throttle Control). Single throttle body (46 mm) with actuator	
ELECTRICAL SYSTEM		
Ignition	IDI (inductive discharge ignition)	
Spark plug	Make and type	NGK CR8EB or equivalent
	Gap	0.70 mm to 0.80 mm (.028 in to .031 in)
Battery	12 V	
PROPULSION		
Propulsion system	Sea-Doo® jet pump	
Jet pump	Type	Axial flow, single stage. Large hub with double row ball bearings

SPECIFICATIONS

SPARK

PROPULSION (cont'd)			
Jet pump (cont'd)	Material	Aluminum	
Impeller		Stainless steel	
Transmission	Type	Direct drive	
DIMENSIONS			
Length	2UP	279 cm (110 in)	
	3UP	305 cm (120 in)	
Width		118 cm (46 in)	
Height	All Except Trixx Models	104 cm (41 in)	
	Trixx Models	107 cm (42 in)	
WEIGHT AND LOADING CAPACITY			
Weight (dry)	Spark 900 ACE	2UP	184 kg (405 lb)
	Spark 900 HO ACE	2UP	190 kg (419 lb)
		3UP	192 kg (423 lb)
	Spark Trixx	2UP	192 kg (423 lb)
		3UP	199 kg (439 lb)
Rider capacity	2UP models		2 (refer to load limit)
	3UP models		3 (refer to load limit)
Storage capacity	Storage bin (Convenience Package)		2.5 kg (5 lb)
	Glove box		1.6 L (.42 U.S. gal.)
	Rear under-seat storage compartment (3UP models)		0.5 L (.13 U.S. gal.)
Load limit (passenger)	2UP models		160 kg (352 lb)
	3UP models		205 kg (450 lb)

SPARK		
FLUIDS		
Fuel	Type	Regular unleaded Refer to <i>FUEL REQUIREMENTS</i>
	Minimum octane	87 Pump Posted AKI (RON+MON)/2 (Inside North America) 92 (RON) E10 (Outside North America)
	Tank capacity	30 L (7.9 U.S. gal.)
Engine oil	Recommended oil	Scandinavia : 4T 5W40 SYNTHETIC BLEND OIL (EUR) (P/N 779290) All other countries : 4T 5W40 SYNTHETIC BLEND OIL (P/N 779133)
	Alternative, or if not available	Use a 5W40 motor oil that meets the requirements for API service classification SJ, SL, SM or SN. Refer to <i>RECOMMENDED ENGINE OIL</i>
	Capacity	2.01 L (2.12 qt (U.S. liq.)) oil change w/filter ⁽²⁾
Cooling system	Scandinavia	EXTENDED LIFE PRE-MIXED COOLANT (EUR) (P/N 779223)
	All other countries	EXTENDED LIFE PRE-MIXED COOLANT (P/N 779150)
	Alternative, or if not available	Use a low silicate, extended life ethylene-glycol premixed coolant (50%-50%) specifically formulated for internal combustion aluminum engines.
	Capacity	3.0 L (3.2 qt (U.S. liq.))

⁽¹⁾ Declared power as per ISO 8665 at propeller-shaft.

⁽²⁾ Quantity required when changing engine oil. Total quantity for a dry engine is 3.4 L (3.6 qt (U.S. liq.)).

NOTE: BRP reserves the right to make changes in design and specifications and/or to make additions to, or improvements in its products without imposing any obligation upon itself to install them on its products previously manufactured.

***This page is
intentionally blank***

TROUBLESHOOTING

TROUBLESHOOTING GUIDELINES

ENGINE WILL NOT START

1. **Burnt fuse: main, electric starter or ECM.**
 - *Check wiring then replace fuse(s).*
2. **ECM does not recognize the D.E.S.S. key (If applicable).**
 - *Refer to an authorized Sea-Doo dealer.*
3. **Discharged battery.**
 - *Charge battery. Refer to CHARGING A BATTERY in BATTERY.*

WARNING

Do not charge or boost the battery while installed on the watercraft. Electrolyte is poisonous and dangerous. Avoid contact with eyes, skin and clothing.

4. **Battery connections, corroded or loose. Bad ground.**
 - *Refer to an authorized Sea-Doo dealer.*
5. **Water-flooded engine.**
 - *Refer to WATER-FLOODED ENGINE in SPECIAL PROCEDURES.*
6. **Faulty sensor or ECM.**
 - *Seek service from an authorized Sea-Doo dealer, repair shop, or person of your own choosing for maintenance, repair, or replacement. Please refer to the US EPA EMISSIONS-RELATED WARRANTY contained herein for information about warranty claims.*
7. **Seized jet pump.**
 - *Try to clean. Otherwise, refer to an authorized Sea-Doo dealer.*

ENGINE CRANKS SLOWLY

1. **Loose battery cable connections.**
 - *Check/clean/tighten.*
2. **Discharged or weak battery.**
 - *Charge battery. Refer to CHARGING A BATTERY in BATTERY.*
3. **Worn starter.**
 - *Refer to an authorized Sea-Doo dealer.*

ENGINE TURNS NORMALLY BUT WILL NOT START

1. **Fuel tank empty or water-contaminated.**
 - *Refill. Siphon and fill with fresh fuel.*
2. **Fouled/defective spark plugs.**
 - *Replace.*
3. **Blown fuse.**
 - *Check wiring then replace fuse(s).*

ENGINE TURNS NORMALLY BUT WILL NOT START (cont'd)

4. Water-flooded engine.

- Refer to *WATER-FLOODED ENGINE* in *SPECIAL PROCEDURES*.

5. Engine management system fault detected (check engine pilot lamp is ON).

- Seek service from an authorized Sea-Doo dealer, repair shop, or person of your own choosing for maintenance, repair, or replacement. Please refer to the *US EPA EMISSIONS-RELATED WARRANTY* contained herein for information about warranty claims.

6. Faulty fuel pump.

- Seek service from an authorized Sea-Doo dealer, repair shop, or person of your own choosing for maintenance, repair, or replacement. Please refer to the *US EPA EMISSIONS-RELATED WARRANTY* contained herein for information about warranty claims.

ENGINE MISFIRES, RUNS IRREGULARLY

1. Fouled/defective/worn spark plugs.

- Replace.

2. Fuel: Level too low, stale or water-contaminated.

- Siphon and/or refill.

3. Faulty ignition coil(s).

- Seek service from an authorized Sea-Doo dealer, repair shop, or person of your own choosing for maintenance, repair, or replacement. Please refer to the *US EPA EMISSIONS-RELATED WARRANTY* contained herein for information about warranty claims.

4. Clogged injectors.

- Seek service from an authorized Sea-Doo dealer, repair shop, or person of your own choosing for maintenance, repair, or replacement. Please refer to the *US EPA EMISSIONS-RELATED WARRANTY* contained herein for information about warranty claims.

5. Engine management system fault detected (check engine pilot lamp is ON).

- Refer to *MONITORING SYSTEM*.

ENGINE SMOKE

1. Oil level too high.

- Seek service from an authorized Sea-Doo dealer, repair shop, or person of your own choosing for maintenance, repair, or replacement. Please refer to the *US EPA EMISSIONS-RELATED WARRANTY* contained herein for information about warranty claims.

2. Water ingestion, coolant leak or damaged cylinder head gasket.

- Seek service from an authorized Sea-Doo dealer, repair shop, or person of your own choosing for maintenance, repair, or replacement. Please refer to the *US EPA EMISSIONS-RELATED WARRANTY* contained herein for information about warranty claims.

ENGINE SMOKE (cont'd)

3. Internal engine damage.

- *Seek service from an authorized Sea-Doo dealer, repair shop, or person of your own choosing for maintenance, repair, or replacement. Please refer to the US EPA EMISSIONS-RELATED WARRANTY contained herein for information about warranty claims.*

ENGINE OVERHEATS

1. Clogged exhaust system.

- *Flush exhaust system.*

2. Engine coolant level too low.

- *Refer to MAINTENANCE PROCEDURES.*

3. Quick connect adapter left in flushing connector.

- *Remove adapter from flushing connector and retry watercraft. If problem persists, seek service from an authorized Sea-Doo dealer, repair shop, or person of your own choosing for maintenance, repair, or replacement. Please refer to the US EPA EMISSIONS-RELATED WARRANTY contained herein for information about warranty claims.*

ENGINE LACKS ACCELERATION OR POWER

1. Not in Sport mode (Rotax® 900 HO ACE).

- *Select Sport mode.*

2. Jet pump water intake clogged.

- *Clean. Refer to JET PUMP WATER INTAKE AND IMPELLER CLEANING in SPECIAL PROCEDURES section.*

3. Damaged impeller or worn-out wear ring.

- *Replace. Refer to an authorized Sea-Doo dealer.*

4. Engine oil level too high.

- *Seek service from an authorized Sea-Doo dealer, repair shop, or person of your own choosing for maintenance, repair, or replacement. Please refer to the US EPA EMISSIONS-RELATED WARRANTY contained herein for information about warranty claims.*

5. Weak spark.

- *Refer to ENGINE MISFIRES, RUNS IRREGULARLY.*

6. Engine management system fault detected (check engine pilot lamp is ON).

- *Refer to MONITORING SYSTEM.*

7. Clogged injectors.

- *Seek service from an authorized Sea-Doo dealer, repair shop, or person of your own choosing for maintenance, repair, or replacement. Please refer to the US EPA EMISSIONS-RELATED WARRANTY contained herein for information about warranty claims.*

ENGINE LACKS ACCELERATION OR POWER (cont'd)

8. Low fuel pressure.

- *Seek service from an authorized Sea-Doo dealer, repair shop, or person of your own choosing for maintenance, repair, or replacement. Please refer to the US EPA EMISSIONS-RELATED WARRANTY contained herein for information about warranty claims.*

9. Water in fuel.

- *Siphon and replace.*

10. Engine damaged by water ingestion.

- *Refer to an authorized Sea-Doo dealer.*

WATERCRAFT CANNOT REACH TOP SPEED

1. Jet pump water intake clogged.

- *Clean. Refer to JET PUMP WATER INTAKE AND IMPELLER CLEANING in SPECIAL PROCEDURES section.*

2. Damaged impeller or worn-out wear ring.

- *Replace. Refer to an authorized Sea-Doo dealer.*

3. Engine management system fault detected (check engine pilot lamp is ON).

- *Refer to MONITORING SYSTEM.*

WATERCRAFT STAYS IN NEUTRAL AFTER OPERATING THE iBR LEVER (MODELS WITH iBR)

1. The iBR gate stays in neutral.

- *Release the throttle to idle RPM.*
- *Refer to an authorized Sea-Doo dealer.*

iBR WILL NOT RETURN TO NEUTRAL POSITION (iBR INDICATOR LIGHT ON) (MODELS WITH iBR)

1. iBR jammed with debris.

- *Clean and check for damage in the iBR gate and nozzle area.*

2. iBR system malfunction.

- *Remove tether cord and wait 5 minutes.*
- *Press engine START/STOP button.*
- *Install tether cord and check iBR light to ensure fault is cleared.*
- *Refer to an authorized Sea-Doo dealer if fault persists or reoccurs frequently.*

iBR WILL NOT RETURN TO NEUTRAL POSITION (iBR FAULT INDICATOR OFF) (MODELS WITH iBR)

1. Throttle lever not fully released during operation.

- *Release throttle lever fully to ensure iBR gate returns to neutral.*

2. Throttle lever does not fully return to null when released.

- *Refer to an authorized Sea-Doo dealer.*

ABNORMAL NOISE FROM PROPULSION SYSTEM

1. **Weeds or debris jammed around impeller.**
 - *Clean. Refer to JET PUMP WATER INTAKE AND IMPELLER CLEANING in SPECIAL PROCEDURES section.*
 - *Check for damage.*
2. **Damaged impeller shaft or drive shaft.**
 - *Refer to an authorized Sea-Doo dealer.*
3. **Water intrusion in jet pump causing bearing seizure.**
 - *Refer to an authorized Sea-Doo dealer.*

WATER FOUND IN BILGE

1. **Bailer system malfunction.**
 - *Have system inspected by an authorized Sea-Doo dealer.*
2. **Exhaust system leak.**
 - *Refer to an authorized Sea-Doo dealer.*
3. **Perimeter seal between hull and deck may have to be replaced.**
 - *Refer to an authorized Sea-Doo dealer.*
4. **Seals between front and center decks and between rear and center decks may have to be replaced.**
 - *Refer to an authorized Sea-Doo dealer.*
5. **Drive shaft bellows damaged or incorrectly installed.**
 - *Refer to an authorized Sea-Doo dealer.*
6. **PTO water seal damaged.**
 - *Refer to an authorized Sea-Doo dealer.*

MONITORING SYSTEM

A system monitors the electronic components of the EMS (engine management system) iBR (models with iBR), and other components of the electrical system. When a fault occurs, it sends visual messages through the multi-function gauge and/or audible signals through a beeper to inform you of a particular condition.

When a minor or transient fault occurs, the fault message and beeper will cease automatically if the condition that caused the fault does not exist anymore.

Releasing the throttle and letting the engine return to idle speed may allow normal operation to return. If this does not work, try removing the tether cord from the engine cut-off switch, waiting 5 minutes, then restarting.

The electronic system will react differently depending on the fault type. If a severe failure occurred, the engine may not be allowed to be started. In other cases, the engine will operate in limp home mode (reduced speed).





When a fault occurs, seek service from an authorized Sea-Doo dealer, repair shop, or person of your own choosing for maintenance, repair, or replacement. Please refer to the *US EPA EMISSIONS-RELATED WARRANTY* contained herein for information about warranty claims.

Fault Indicators and Message Display Information

The fault indicators and messages displayed in the multifunction gauge will inform you of a particular condition or if an anomaly occurs.

If a fault indicator or a fault message comes ON in the multifunction gauge, seek service from an authorized Sea-Doo dealer, repair shop, or person of your own choosing for maintenance, repair, or replacement. Please refer to the *US EPA EMISSIONS-RELATED WARRANTY* contained herein for information about warranty claims.

For information on usual function indicators, refer to *MULTIFUNCTION GAUGE* section as applicable to model.

FAULT INDICATOR (ON)	MESSAGE DISPLAY	DESCRIPTION
	HIGH TEMPERATURE	Engine or exhaust system overheating
	CHECK ENGINE or LIMP HOME MODE	Check engine (minor fault requiring maintenance) or iBR system fault (models with iBR) or LIMP HOME MODE (major engine fault)
	LOW or HIGH BATTERY VOLTAGE	Low/high battery voltage
	LOW OIL PRESSURE	Low engine oil pressure detected
Models with iBR		
	IBR MODULE ERROR_	iBR system fault

MESSAGE DISPLAY INFORMATION	
LOW OIL PRESSURE	Engine low oil pressure detected
HIGH EXHAUST TEMPERATURE	High exhaust temperature detected
HIGH TEMPERATURE	High engine temperature detected
CHECK ENGINE	Engine system malfunction or maintenance required
HIGH BATTERY VOLTAGE	High battery voltage detected
LOW BATTERY VOLTAGE	Low battery voltage detected
LIMP HOME MODE	Major fault detected, engine power limited
FUEL SENSOR DEFECTIVE	Fuel level sensor fault
IBR MODULE ERROR (models with iBR)	iBR system malfunction
CALIBRATION CHECKSUM ERROR	Cluster programming corrupted
MAINTENANCE REQUIRED	Watercraft maintenance required

NOTICE Running engine with low oil pressure may severely damage the engine.

Beeper Code Information

BEEPER CODES	DESCRIPTION
1 long beep (when installing tether cord on engine cut-off switch	Models with D.E.S.S.: Bad D.E.S.S. system connection. Reinstall tether cord correctly on engine cut-off switch.
	Models with D.E.S.S.: Wrong D.E.S.S. key. Use a tether cord that has been programmed for the watercraft.
	Models with D.E.S.S.: Defective D.E.S.S. key. Use another programmed tether cord.
	Defective engine cut-off switch. Seek service from an authorized Sea-Doo dealer, repair shop, or person of your own choosing for maintenance, repair, or replacement. Please refer to the <i>US EPA EMISSIONS-RELATED WARRANTY</i> contained herein for information about warranty claims.
	Improper operation of ECM or defective wiring harness. Refer to an authorized Sea-Doo dealer.
A 2 second beep every 15 minute interval	Engine management system fault. Seek service from an authorized Sea-Doo dealer, repair shop, or person of your own choosing for maintenance, repair, or replacement. Please refer to the <i>US EPA EMISSIONS-RELATED WARRANTY</i> contained herein for information about warranty claims.
A 2 second beep every 5 minute interval	Low fuel level. Refill fuel tank. If problem persists, refer to an authorized Sea-Doo dealer.
	Fuel tank level sensor or circuit malfunction. Refer to an authorized Sea-Doo dealer.
Continuously beeps	High engine coolant temperature. See <i>ENGINE OVERHEATING</i> .
	High exhaust temperature. Seek service from an authorized Sea-Doo dealer, repair shop, or person of your own choosing for maintenance, repair, or replacement. Please refer to the <i>US EPA EMISSIONS-RELATED WARRANTY</i> contained herein for information about warranty claims.
	Low oil pressure. Turn off engine as soon as possible. Check oil level and refill. Seek service from an authorized Sea-Doo dealer, repair shop, or person of your own choosing for maintenance, repair, or replacement. Please refer to the <i>US EPA EMISSIONS-RELATED WARRANTY</i> contained herein for information about warranty claims.

NOTICE If the monitoring beeper continuously sounds, stop engine as soon as possible.

***This page is
intentionally blank***

WARRANTY

BRP LIMITED WARRANTY – USA AND CANADA: 2019 SEA-DOO® PERSONAL WATERCRAFT

1. SCOPE

Bombardier Recreational Products Inc. (“BRP”)* warrants its model-year 2019 Sea-Doo personal watercraft sold by authorized BRP Dealers (as defined below) in the United States of America (“USA”) and in Canada from defects in material or workmanship for the period and under the conditions described below. This limited warranty will become null and void if: (1) the Sea-Doo personal watercraft was used for racing or any other competitive activity, at any point, even by a previous owner; or (2) the Sea-Doo personal watercraft has been altered or modified in such a way so as to adversely affect its operation, performance or durability, or has been altered or modified to change its intended use.

Non-factory installed parts and accessories are not covered under this limited warranty. Please refer to the applicable parts and accessories limited warranty text.

2. LIMITATIONS OF LIABILITY

THIS WARRANTY IS EXPRESSLY GIVEN AND ACCEPTED IN LIEU OF ANY AND ALL OTHER WARRANTIES, EXPRESSED OR IMPLIED, INCLUDING WITHOUT LIMITATION ANY WARRANTY OF MERCHANTABILITY OR FITNESS FOR A PARTICULAR PURPOSE. TO THE EXTENT THAT THEY CANNOT BE DISCLAIMED, THE IMPLIED WARRANTIES ARE LIMITED IN DURATION TO THE LIFE OF THE EXPRESS WARRANTY. INCIDENTAL AND CONSEQUENTIAL DAMAGES ARE EXCLUDED FROM COVERAGE UNDER THIS WARRANTY. SOME STATES/PROVINCES DO NOT ALLOW FOR THE DISCLAIMERS, LIMITATIONS AND EXCLUSIONS IDENTIFIED ABOVE, AS A RESULT, THEY MAY NOT APPLY TO YOU. THIS WARRANTY GIVES YOU SPECIFIC RIGHTS, AND YOU MAY ALSO HAVE OTHER LEGAL RIGHTS WHICH MAY VARY FROM STATE TO STATE, OR PROVINCE TO PROVINCE.

Neither the distributor, any BRP dealer nor any other person has been authorized to make any affirmation, representation or warranty regarding the product, other than those contained in this limited warranty, and if made, shall not be enforceable against BRP. BRP reserves the right to modify this limited warranty at any time, being understood that such modification will not alter the warranty conditions applicable to the products sold while this warranty is in effect.

3. EXCLUSIONS – ARE NOT WARRANTED

The following are not warranted under any circumstances:

- Normal wear and tear;
- Routine maintenance items, tune ups, adjustments;
- Damage caused by failure to provide proper maintenance and/or storage, as described in the Operator’s Guide;
- Damage resulting from removal of parts, improper repairs, service, maintenance, modifications or use of parts not manufactured or approved by BRP or resulting from repairs done by a person that is not an authorized servicing BRP dealer;
- Damage caused by abuse, abnormal use, neglect, or operation of the product in a manner inconsistent with the recommended operation described in the Operator’s Guide;

- Damage resulting from accident, submersion, fire, theft, vandalism or any act of God;
- Operation with fuels, oils or lubricants which are not suitable for use with the product (see the Operator’s Guide);
- Damage from rust, corrosion or exposure to the elements;
- Damage from cooling system or jet pump blockage by foreign material;
- Water damages caused by water ingestion;
- Damages related to gel coat finish including but not limited to cosmetic gel coat finish, blisters or fiberglass delamination caused by blisters, crazing, spider or hairline cracks; and
- Incidental or consequential damages, or damages of any kind including without limitation towing, storage, telephone, rental, taxi, inconvenience, insurance coverage, loan payments, loss of time, loss of income.

4. WARRANTY COVERAGE PERIOD

This limited warranty will be in effect from (1) the date of delivery to the first retail consumer or (2) the date the product is first put into use, whichever occurs first and for the applicable period below:

1. TWELVE (12) CONSECUTIVE MONTHS for private use owners.
2. FOUR (4) CONSECUTIVE MONTHS for commercial use owners. A personal watercraft is used commercially when it is used in connection with generating income or any work or employment during any part of the warranty period. A personal watercraft is also used commercially when, at any point during the warranty period, it has commercial tags or is licensed for commercial use. This is a minimal warranty period which can be extended by any applicable warranty promotional program, as the case may be.
3. For emission-related components; please also refer to the *US EPA EMISSION-RELATED WARRANTY* contained herein.
4. For Sea-Doo personal watercrafts produced by BRP for sale in the State of California or New York that are originally sold to a resident or subsequently warranty registered to a resident in the State of California or New York, please also refer to the applicable California and New York Emissions Control Warranty Statement contained herein.
5. For Sea-Doo personal watercrafts produced by BRP for sale in the State of California that are originally sold to a resident or subsequently warranty registered to a resident in the State of California, please also refer to the CALIFORNIA EVAPORATIVE EMISSIONS CONTROL SYSTEM WARRANTY STATEMENT contained herein.

The repair or replacement of parts or the performance of service under any applicable warranty does not extend the life of such warranty beyond its original expiration date.

5. CONDITIONS REQUIRED FOR WARRANTY COVERAGE

This limited warranty coverage is available **only** if **each** of the following conditions has been fulfilled:

- The 2019 Sea-Doo personal watercraft must be purchased as new and unused by its first owner from a BRP dealer authorized to distribute Sea-Doo personal watercraft in the country in which the sale occurred;
- The BRP specified predelivery inspection process must be completed and documented and signed by the purchaser;
- The 2019 Sea-Doo personal watercraft must have undergone proper registration by an authorized BRP dealer;
- The 2019 Sea-Doo personal watercraft must be purchased in the country in which the purchaser resides; and
- Routine maintenance outlined in the Operator's Guide must be timely performed in order to maintain warranty coverage. BRP reserves the right to make warranty coverage contingent upon proof of proper maintenance.

BRP will not honour this limited warranty to any private use owner or commercial use owner if one of the preceding conditions has not been met. Such limitations are necessary in order to allow BRP to preserve both the safety of its products, and also that of its consumers and the general public.

6. WHAT TO DO TO OBTAIN WARRANTY COVERAGE

The customer must cease using the Sea-Doo personal watercraft upon the appearance of an anomaly. The customer must notify an authorized servicing BRP dealer within three (3) days of the appearance of a defect, and provide it with reasonable access to the product and reasonable opportunity to repair it. The customer must also present to the authorized BRP dealer, proof of purchase of the product and must sign the repair/work order prior to the start of the repair in order to validate the warranty repair. All parts replaced under this limited warranty become the property of BRP.

7. WHAT BRP WILL DO

BRP's obligations under this warranty are limited to, at its sole discretion, repairing parts found defective under normal use, maintenance and service, or replacing such parts with new genuine BRP parts without charge for parts and labor, at any authorized BRP dealer during the applicable warranty coverage period under the conditions described herein. No claim of breach of warranty shall be the cause for cancellation or rescission of the sale of the Sea-Doo personal watercraft to the owner.

In the event that service is required outside of the country of original sale, the owner will bear responsibility for any additional charges due to local practices and conditions, such as, but not limited to freight, insurance, taxes, license fees, import duties, and any and all other financial charges, including those levied by governments, states, territories and their respective agencies.

BRP reserves the right to improve or modify products from time to time without assuming any obligation to modify products previously manufactured.

8. TRANSFER

If the ownership of a product is transferred during the warranty coverage period, this limited warranty, subject to its terms and conditions, shall also be transferred and be valid for the remaining coverage period provided BRP or an authorized Sea-Doo Distributor/Dealer receives a proof that the former owner agreed to the transfer of ownership, in addition to the co-ordinates of the new owner.

9. CONSUMER ASSISTANCE

In the event of a controversy or a dispute in connection with this BRP limited warranty, BRP suggests that you try to resolve the issue at the dealership level. We recommend discussing the issue with the authorized BRP dealer's service manager or owner.

If the matter still remains unresolved, contact BRP by filling out the customer contact form at www.brp.com or contact BRP by mail at one of the addresses listed under the *CONTACT US* section of this guide.

* In the USA, products are distributed and serviced by BRP US Inc.

© 2018 Bombardier Recreational Products Inc. All rights reserved.

® Registered trademark of Bombardier Recreational Products Inc. or its affiliates.

US EPA EMISSION-RELATED WARRANTY

Bombardier Recreational Products Inc. ("BRP")* warrants to the ultimate purchaser and each subsequent purchaser that this new engine, including all parts of its exhaust emission control system and its evaporative emission control system, meets two conditions:

1. It is designed, built, and equipped so it conforms at the time of sale to the ultimate purchaser with the requirements of 40 CFR 1045 and 40 CFR 1060.
2. It is free from defects in materials and workmanship that may keep it from meeting the requirements of 40 CFR 1045 and 40 CFR 1060.

Where a warrantable condition exists, BRP will repair or replace, as it elects, any part or component with a defect in materials or workmanship that would increase the engine's emissions of any regulated pollutant within the stated warranty period at no cost to the owner, including expenses related to diagnosing and repairing or replacing emission-related parts. All defective parts replaced under this warranty become the property of BRP.

For all emission-related warranty claims, BRP is limiting the diagnosis and repair of emission-related parts to the authorized Sea-Doo dealers, unless for emergency repairs as required by item 2 of the following list.

As a certifying manufacturer, BRP will not deny emission-related warranty claims based on any of the following:

1. Maintenance or other service BRP or BRP's authorized facilities performed.
2. Engine/equipment repair work that an operator performed to correct an unsafe, emergency condition attributable to BRP as long as the operator tries to restore the engine/equipment to its proper configuration as soon as possible.
3. Any action or inaction by the operator unrelated to the warranty claim.
4. Maintenance that was performed more frequently than BRP specify.
5. Anything that is BRP fault or responsibility.
6. The use of any fuel that is commonly available where the equipment operates unless BRP written maintenance instructions state that this fuel would harm the equipment's emission control system and operators can readily find the proper fuel. See maintenance information section and fuel requirements of fueling section.

Emission-Related Warranty Period

The emission-related warranty is valid for the following period whichever comes first:

	HOURS	MONTHS
Exhaust emission-related components	175	30
Evaporative emission-related components	N/A	24

Components Covered

The emission-related warranty covers all components whose failure would increase an engine's emissions of any regulated pollutant, including the following listed components:

1. For exhaust emissions, emission-related components include any engine parts related to the following systems:
 - Air-induction system
 - Fuel system
 - Ignition system
 - Exhaust gas recirculation systems
2. The following parts are also considered emission-related components for exhaust emissions:
 - Aftertreatment devices
 - Crankcase ventilation valves
 - Sensors
 - Electronic control units
3. The following parts are considered emission-related components for evaporative emissions:
 - Fuel tank
 - Fuel cap
 - Fuel line
 - Fuel line fittings
 - Clamps*
 - Pressure relief valves*
 - Control valves*
 - Control solenoids*
 - Electronic controls*
 - Vacuum control diaphragms*
 - Control cables*
 - Control linkages*
 - Purge valves
 - Vapor hoses
 - Liquid/vapor separator
 - Carbon canister
 - Canister mounting brackets
 - Carburetor purge port connector
4. Emission-related components also include any other part whose only purpose is to reduce emissions or whose failure will increase emissions without significantly degrading engine/equipment performance.

*As related to the evaporative emission control system

Limited Applicability

As a certifying manufacturer, BRP may deny emission-related warranty claims for failures that have been caused by the owner's or operator's improper maintenance or use, by accidents for which the manufacturer has no responsibility, or by acts of God. For example, an emission-related warranty claim need not be honored for failures that have been directly caused by the operator's abuse of the engine/equipment or the operator's use of the engine/equipment in a manner for which it was not designed and are not attributable to the manufacturer in any way.

If you have any question regarding your warranty rights and responsibility, you should contact Bombardier Recreational Products at 1-888-272-9222.

* In the USA, products are distributed and serviced by BRP US Inc.

CALIFORNIA AND NEW YORK EMISSION CONTROL WARRANTY STATEMENT FOR MODEL YEAR 2019 SEA-DOO® PERSONAL WATERCRAFT

For California, your 2019 Sea-Doo personal watercraft has a special environmental label required by the California Air Resources Board. The label has 1, 2, 3 or 4 stars. A hangtag, provided with your personal watercraft, describes the meaning of the star rating system.

The Star Label Means Cleaner Marine Engines

The Symbol for Cleaner Marine Engines:



F18L3CQ

Cleaner Air and Water

For a healthier lifestyle and environment.

Better Fuel Economy

Burns up to 30 - 40 percent less gas and oil than conventional carbureted two-stroke engines saving money and resources.

Longer Emission Warranty

Protects consumer for worry free operation.

One Star – Low Emission

The one-star label identifies personal watercraft, outboard, stern drive and inboard engines that meet the Air Resources Board's Personal Watercraft and Outboard marine engine 2001 exhaust emission standards. Engines meeting these standards have 75% lower emissions than conventional carbureted two-stroke engines. These engines are equivalent to the U.S. EPA's 2006 standards for marine engines.

Two Stars – Very Low Emission

The two-star label identifies personal watercraft, outboard, stern drive and inboard engines that meet the Air Resources Board's Personal Watercraft and Outboard marine engine 2004 exhaust emission standards. Engines meeting these standards have 20% lower emissions than One Star - Low-Emission engines.

Three Stars – Ultra Low Emission

The three-star label identifies engines that meet the Air Resources Board's Personal Watercraft and Outboard marine engine 2008 exhaust emission standards or the Stern drive and Inboard marine engine 2003 exhaust emission standards. Engines meeting these standards have 65% lower emissions than One Star – Low Emission engines.

Four Stars – Super Ultra Low Emission

The four-star label identifies engines that meet the Air Resources Board's Stern-drive and Inboard marine engine 2012 exhaust emission standards. Personal Watercraft and Outboard marine engines may also comply with these standards. Engines meeting these standards have 90% lower emissions than One Star – Low Emission engines.

For more information: Cleaner Watercraft – Get the Facts
1 800 END-SMOG
www.arb.ca.gov

Your Emission Control Warranty Rights and Obligations

The California Air Resources Board, the New York State Department of Environmental Conservation and Bombardier Recreational Products Inc. ("BRP") are pleased to explain the emission control system warranty on your Model Year 2019 Sea-Doo personal watercraft. In California and New York, new personal watercraft engines must be designed, built and equipped to meet the State's stringent anti-smog standards. BRP must warrant the emission control system on your personal watercraft engine for the period of time listed below provided there has been no abuse, neglect or improper maintenance of your personal watercraft engine.

Your emission control system may include parts such as the fuel injection system, the ignition system and catalytic converter. Also included may be hoses, belts, connectors and other emission related assemblies.

Where a warrantable condition exists, BRP will repair your personal watercraft engine at no cost to you including diagnosis, parts and labor provided that such work is performed by an authorized BRP dealer.

Manufacturer's Limited Warranty Coverage

This emission limited warranty covers Model Year 2019 Sea-Doo personal watercrafts certified and produced by BRP for sale in California or New York, that are originally sold in California or New York to a California or New York resident or subsequently warranty registered to a California or New York resident. The BRP limited warranty conditions for Sea-Doo personal watercrafts are still applicable to these models with the necessary modifications. Select emission control parts of your 2019 Sea-Doo personal watercrafts are warranted from the date of delivery to the first retail consumer for a period of 4 years, or for 250 hours of use, whichever occurs first. However, warranty coverage based on the hourly period is only permitted for personal watercraft equipped with the appropriate hour meters or their equivalent. If any emission-related part on your engine is defective under warranty, the part will be repaired or replaced by BRP.

Parts covered for a Model Year 2019 Sea-Doo® personal watercraft:

Idle bypass valve	Air intake adapter
Throttle position sensor	Spark plugs
Intake manifold air pressure sensor	Ignition coils
Intake manifold air temperature sensor	Air box
Engine temperature sensor	Intake and exhaust valve and seals
Knock sensor	Intake manifold
Engine control module ECM	Crankcase ventilation valve
Throttle body	Throttle body seal
Fuel rail	Intake manifold seal
Fuel injectors	Wire harness and connectors
Fuel pressure regulator	Fuel filter
Fuel pump	Supercharger

The emission warranty covers damage to other engine components that is caused by the failure of a warranted part. The BRP Operator’s Guide provided contains written instructions for the proper maintenance and use of your personal watercraft. All emission warranty parts are warranted by BRP for the entire warranty period of the personal watercraft, unless the part is scheduled for replacement as required maintenance in the Operator’s Guide.

Emission warranty parts that are scheduled for replacement, as required maintenance, are warranted by BRP for the period of time before the first scheduled replacement date for that part. Emission warranty parts that are scheduled for regular inspection, but not regular replacement, are warranted by BRP for the entire warranty period of the personal watercraft. Any emission warranty part repaired or replaced under the terms of this warranty statement is warranted by BRP for the remainder of the warranty period of the original part. All parts replaced under this limited warranty become the property of BRP.

Maintenance receipts and records should be transferred to each subsequent owner of the personal watercraft.

Owner's Warranty Responsibilities

As the owner of a 2019 Sea-Doo personal watercraft, you are responsible for the performance of the required maintenance listed in your Operator's Guide. BRP recommends that you retain all receipts covering maintenance your personal watercraft engine, but BRP cannot deny warranty solely for the lack of receipts or your failure to ensure the performance of all scheduled maintenance.

As the owner of a Sea-Doo® personal watercraft, you should however be aware that BRP may deny you warranty coverage if your engine(s) or a part has failed due to abuse, neglect, improper maintenance or unapproved modifications.

You are responsible for presenting your engine to an authorized BRP Dealer as soon as a problem exists. The warranty repairs will be completed in a reasonable amount of time, not to exceed 30 days.

If you have any questions regarding your warranty rights and responsibilities or for the name and location of the nearest authorized BRP Dealer you should contact the Customer Assistance Center at 1 715 848-4957.

CALIFORNIA EVAPORATIVE EMISSIONS CONTROL SYSTEM WARRANTY STATEMENT

YOUR WARRANTY RIGHTS AND OBLIGATIONS

The California Air Resources Board is pleased to explain the evaporative emissions control system's warranty on your 2019 personal watercraft. In California, new SIMW must be designed, built, and equipped to meet the State's stringent anti-smog standards. Bombardier Recreational Products Inc. must warrant the evaporative emissions control system on your personal watercraft for the period listed below, provided there has been no abuse, neglect or improper maintenance of your SIMW.

Your evaporative emissions control system may include parts such as: canisters, carburetors, clamps, connectors, filters, fuel caps, fuel lines, fuel tanks, valves, vapour hoses, and other associated evaporative emissions control system components.

MANUFACTURER'S WARRANTY COVERAGE:

This evaporative emissions control system is warranted for two years. If any evaporative emission-related part on your SIMW is defective, the part will be repaired or replaced by Bombardier Recreational Products Inc.

PARTS COVERED:

1. Clamp(s)*
2. Fuel Cap
3. Fuel Line
4. Fuel Line Fitting(s)
5. Fuel Tank
6. Pressure Relief Valve(s)*
7. Vapor Hose(s)
8. All other parts not listed that may affect the evaporative emissions control system

*Note: As they relate to the evaporative emissions control system.

OWNER'S WARRANTY RESPONSIBILITIES:

As the personal watercraft owner, you are responsible for performance of the required maintenance listed in your owner's manual. Bombardier Recreational Products Inc. recommends that you retain all receipts covering maintenance on your personal watercraft, but Bombardier Recreational Products Inc. cannot deny warranty solely for the lack of receipts.

As the personal watercraft owner, you should however be aware that Bombardier Recreational Products Inc. may deny you warranty coverage if your personal watercraft or a part has failed due to abuse, neglect, improper maintenance or unapproved modifications.

You are responsible for presenting your personal watercraft to a Bombardier Recreational Products Inc. distribution center or service center as soon as the problem exists. The warranty repairs should be completed in a reasonable

amount of time, not to exceed 30 calendar days. If you have question regarding your warranty coverage, you should contact Bombardier Recreational Products at 1-888-272-9222.

BRP INTERNATIONAL LIMITED WARRANTY: 2019 SEA-DOO® PERSONAL WATERCRAFT

1. SCOPE OF THE LIMITED WARRANTY

Bombardier Recreational Products Inc. ("BRP")* warrants its 2019 SEA-DOO PERSONAL WATERCRAFTS ("personal watercraft") sold by distributors or dealers authorized by BRP to distribute Sea-Doo Personal watercrafts ("Sea-Doo Distributor/Dealer") outside of the fifty United States, Canada, member states of the European Economic Area (which is comprised of the member states of the European Union plus Norway, Iceland and Liechtenstein) ("EEA"), member states of the Commonwealth of the Independent States (including Ukraine and Turkmenistan) ("CIS") and Turkey, from defects in material or workmanship for the period and under the conditions described below.

Non-factory installed parts and accessories are not covered under this limited warranty. Please refer to the applicable parts and accessories limited warranty text.

This limited warranty will become null and void if: (1) the personal watercraft was used for racing or any other competitive activity, at any point, even by a previous owner; or (2) the personal watercraft has been altered or modified in such a way so as to adversely affect its operation, performance or durability or (3) the personal watercraft has been altered or modified to change its intended use.

2. LIMITATIONS OF LIABILITY

TO THE EXTENT PERMITTED BY LAW, THIS WARRANTY IS EXPRESSLY GIVEN AND ACCEPTED IN LIEU OF ANY AND ALL OTHER WARRANTIES, EXPRESSED OR IMPLIED, INCLUDING WITHOUT LIMITATION ANY WARRANTY OF MERCHANTABILITY OR FITNESS FOR A PARTICULAR PURPOSE. TO THE EXTENT THAT THEY CANNOT BE DISCLAIMED, THE IMPLIED WARRANTIES ARE LIMITED IN DURATION TO THE LIFE OF THE EXPRESS WARRANTY. INCIDENTAL AND CONSEQUENTIAL DAMAGES ARE EXCLUDED FROM COVERAGE UNDER THIS WARRANTY. SOME JURISDICTIONS DO NOT ALLOW FOR THE DISCLAIMERS, LIMITATIONS AND EXCLUSIONS IDENTIFIED ABOVE, AS A RESULT, THEY MAY NOT APPLY TO YOU. THIS WARRANTY GIVES YOU SPECIFIC RIGHTS AND YOU MAY ALSO HAVE OTHER LEGAL RIGHTS WHICH MAY VARY FROM COUNTRY TO COUNTRY. (FOR PRODUCTS PURCHASED IN AUSTRALIA SEE CLAUSE 4 BELOW).

Neither the Sea-Doo Distributor/Dealer nor any other person has been authorized to make any affirmation, representation or warranty regarding the product, other than those contained in this limited warranty, and if made, shall not be enforceable against BRP.

BRP reserves the right to modify this warranty at any time, being understood that such modification will not alter the warranty conditions applicable to the products sold while this warranty is in effect.

3. EXCLUSIONS – ARE NOT WARRANTED

The following are not warranted under this limited warranty under any circumstances:

- Replacement of parts due to normal wear and tear;
- Routine maintenance parts and services, including but not limited to tune ups, adjustments, oil, lubricant and coolant changes, spark plug replacement, water pumps and the like;

- Damage caused by negligence or failure to provide proper maintenance and/or storage, as described in the Operator's Guide;
- Damage resulting from removal of parts, improper repairs, service, maintenance, modification or use of parts or accessories not manufactured or approved by BRP which in its reasonable judgment are either incompatible with the product or adversely affect its operation, performance and durability, or resulting from repairs done by a person that is not an authorized servicing Sea-Doo Distributor/Dealer;
- Damage caused by abuse, misuse, abnormal use, neglect, racing, improper operation or operation of the product in a manner inconsistent with the recommended operation described in the Operator's Guide;
- Damage resulting from external damage, accident, submersion, fire, foreign object or water ingestion, theft, vandalism or any act of God;
- Operation with fuels, oils or lubricants which are not suitable for use with the product (see the Operator's Guide);
- Damage resulting from rust, corrosion or exposure to the elements;
- Damages from cooling system or jet pump blockage by foreign material;
- Damages to gel coat finish including but not limited to cosmetic gel coat finish defects, blisters, starring, crazing and fiberglass delamination caused by blisters, crazing, spider or hairline cracks; and
- Incidental or consequential damages, or damages of any kind including without limitation towing, storage, transportation expenses, telephone, rental, taxi, inconvenience, insurance coverage, loan payments, loss of time, loss of income or time missed for downtime experience due to service work.

4. WARRANTY COVERAGE PERIOD

This limited warranty will be in effect from (1) the date of delivery to the first retail consumer or (2) the date the product is first put into use, whichever occurs first and for a period of:

1. TWELVE (12) CONSECUTIVE MONTHS for private, recreational use,
2. FOUR (4) CONSECUTIVE MONTHS for commercial use,
This is a minimal warranty period which can be extended by any applicable warranty promotional program, as the case may be. A personal watercraft is used commercially when it is used in connection with generating income or any work or employment during any part of the warranty period. A personal watercraft is also used commercially when, at any point during the warranty period, it has commercial tags or is licensed for commercial use.

The repair or replacement of parts or the performance of service under this warranty does not extend the life of this warranty beyond its original expiration date.

Note that the duration and any other modalities of the warranty coverage are subject to the applicable national or local legislation in the customer's country.

FOR PRODUCTS SOLD IN AUSTRALIA ONLY

Nothing in these Warranty terms and conditions should be taken to exclude, restrict or modify the application of any condition, warranty, guarantee, right or remedy conferred or implied under the Competition and Consumer Act 2010 (Cth), including the Australian Consumer Law or any other law, where to do so

would contravene that law, or cause any part of these terms and conditions to be void. The benefits given to you under this limited warranty are in addition to other rights and remedies that you have under Australian law.

Our goods come with guarantees that cannot be excluded under the Australian Consumer Law. You are entitled to a replacement or refund for a major failure and for compensation for any other reasonably foreseeable loss or damage. You are also entitled to have the goods repaired or replaced if the goods fail to be of acceptable quality and the failure does not amount to a major failure.

5. CONDITIONS TO HAVE WARRANTY COVERAGE

This warranty coverage is available **only** if **each** of the following conditions has been fulfilled:

- The 2019 Sea-Doo personal watercraft must be purchased as new and unused by its first owner from a Sea-Doo Distributor/Dealer authorized to distribute Sea-Doo personal watercrafts in the country in which the sale occurred;
- The BRP specified pre-delivery inspection process must be completed and documented;
- The 2019 Sea-Doo personal watercraft must have undergone proper registration by an authorized Sea-Doo Distributor/Dealer;
- The 2019 Sea-Doo personal watercraft must have been purchased in the country or union of countries in which the purchaser resides.
- Routine maintenance outlined in the Operator's Guide must be timely performed in order to maintain warranty coverage. BRP reserves the right to make warranty coverage contingent upon proof of proper maintenance.

BRP will not honor this limited warranty to any private use owner or commercial use owner if one of the preceding conditions has not been met. Such limitations are necessary in order to allow BRP to preserve both the safety of its products, and also that of its consumers and the general public.

6. WHAT TO DO TO OBTAIN WARRANTY COVERAGE

The customer must cease using the Sea-Doo personal watercraft upon the appearance of an anomaly. The customer must notify a servicing Sea-Doo Distributor/Dealer within two (2) days of the appearance of a defect, and provide it with reasonable access to the product and reasonable opportunity to repair it. The customer must also present to the authorized Sea-Doo Distributor/Dealer, proof of purchase of the product and must sign the repair/work order prior to starting the repair in order to validate the warranty repair. All parts replaced under this limited warranty become the property of BRP.

Note that the notification period is subject to the applicable national or local legislation in customer's country.

7. WHAT BRP WILL DO

To the extent permitted by law, BRP's obligations under this warranty are limited to, at its sole discretion, repairing parts found defective under normal use, maintenance and service, or replacing such parts with new genuine BRP parts without charge for parts and labor, at any authorized Sea-Doo Distributor/Dealer during the warranty coverage period under the conditions described herein. BRP's responsibility is limited to making the required repairs or replacements of parts.

No claim of breach of warranty shall be cause for cancellation or rescission of the sale of the Sea-Doo personal watercraft to the owner. You may have other legal rights which may vary from country to country.

In the event that service is required outside of the country of original sale, the owner will bear responsibility for any additional charges due to local practices and conditions, such as, but not limited to, freight, insurance, taxes, license fees, import duties, and any and all other financial charges, including those levied by governments, states, territories and their respective agencies.

BRP reserves the right to improve or modify products from time to time without assuming any obligation to modify products previously manufactured.

8. TRANSFER

If the ownership of a product is transferred during the warranty coverage period, this limited warranty, subject to its terms and conditions, shall also be transferred and be valid for the remaining coverage period provided BRP or an authorized Sea-Doo Distributor/Dealer receives a proof that the former owner agreed to the transfer of ownership, in addition to the coordinates of the new owner.

9. CONSUMER ASSISTANCE

In the event of a controversy or a dispute in connection with this limited warranty, BRP suggests that you try to resolve the issue at the Sea-Doo Distributor/Dealer level. We recommend discussing the issue with the authorized Sea-Doo Distributor/Dealer's service manager or owner.

If the matter still remains unresolved, contact BRP by filling out the customer contact form at www.brp.com or contact BRP by mail at one of the addresses listed under the *CONTACT US* section of this guide.

* For the territory covered by this limited warranty, products are distributed and serviced by Bombardier Recreational Products Inc. or its affiliates.

© 2018 Bombardier Recreational Products Inc. All rights reserved.

® Registered trademark of Bombardier Recreational Products Inc.

BRP LIMITED WARRANTY FOR THE EUROPEAN ECONOMIC AREA, THE COMMONWEALTH OF THE INDEPENDENT STATES, TURKEY: 2019 SEA-DOO® PERSONAL WATERCRAFT

1. SCOPE OF THE LIMITED WARRANTY

Bombardier Recreational Products Inc. ("BRP")* warrants its 2019 SEA-DOO PERSONAL WATERCRAFT ("personal watercraft") sold by distributors or dealers authorized by BRP to distribute Sea-Doo personal watercrafts ("Sea-Doo Distributor/Dealer") in member states of the European Economic Area (which is comprised of the member states of the European Union plus Norway, Iceland and Liechtenstein) ("EEA"), in member states of the Commonwealth of the Independent States (including Ukraine and Turkmenistan) ("CIS") and Turkey from defects in material or workmanship for the period and under the conditions described below.

Non-factory installed parts and accessories are not covered under this limited warranty. Please refer to the applicable parts and accessories limited warranty text.

This limited warranty will become null and void if: (1) the personal watercraft was used for racing or any other competitive activity, at any point, even by a previous owner; or (2) the personal watercraft has been altered or modified in such a way so as to adversely affect its operation, performance or durability, or (3) the personal watercraft has been altered or modified to change its intended use.

2. LIMITATIONS OF LIABILITY

TO THE EXTENT PERMITTED BY LAW, THIS WARRANTY IS EXPRESSLY GIVEN AND ACCEPTED IN LIEU OF ANY AND ALL OTHER WARRANTIES, EXPRESSED OR IMPLIED, INCLUDING WITHOUT LIMITATION ANY WARRANTY OF MERCHANTABILITY OR FITNESS FOR A PARTICULAR PURPOSE. TO THE EXTENT THAT THEY CANNOT BE DISCLAIMED, THE IMPLIED WARRANTIES ARE LIMITED IN DURATION TO THE LIFE OF THE EXPRESS WARRANTY. INCIDENTAL AND CONSEQUENTIAL DAMAGES ARE EXCLUDED FROM COVERAGE UNDER THIS WARRANTY. SOME JURISDICTIONS DO NOT ALLOW FOR THE DISCLAIMERS, LIMITATIONS AND EXCLUSIONS IDENTIFIED ABOVE, AS A RESULT, THEY MAY NOT APPLY TO YOU. THIS WARRANTY GIVES YOU SPECIFIC RIGHTS, AND YOU MAY ALSO HAVE OTHER LEGAL RIGHTS WHICH MAY VARY FROM COUNTRY TO COUNTRY.

Neither the Sea-Doo Distributor/Dealer nor any other person has been authorized to make any affirmation, representation or warranty regarding the product, other than those contained in this limited warranty, and if made, shall not be enforceable against BRP.

BRP reserves the right to modify this warranty at any time, being understood that such modification will not alter the warranty conditions applicable to the products sold while this warranty is in effect.

3. EXCLUSIONS – ARE NOT WARRANTED

The following are not warranted under this limited warranty under any circumstances:

- Replacement of parts due to normal wear and tear;

- Routine maintenance parts and services, including but not limited to tune ups, adjustments, oil, lubricant and coolant changes, spark plug replacement, water pumps and the like;
- Damage caused by negligence or failure to provide proper maintenance and/or storage, as described in the Operator's Guide;
- Damage resulting from removal of parts, improper repairs, service, maintenance, modification or use of parts or accessories not manufactured or approved by BRP which in its reasonable judgement are either incompatible with the product or adversely affect its operation, performance and durability, or resulting from repairs done by a person that is not an authorized servicing Sea-Doo Distributor/Dealer;
- Damage caused by abuse, misuse, abnormal use, neglect, racing, improper operation or operation of the product in a manner inconsistent with the recommended operation described in the Operator's Guide;
- Damage resulting from external damage, accident, submersion, fire, foreign object or water ingestion, theft, vandalism or any act of God;
- Operation with fuel, oils or lubricants which are not suitable for use with the product (see the Operator's Guide);
- Damage resulting from rust, corrosion or exposure to the elements;
- Damages from cooling system or jet pump blockage by foreign material;
- Damages to gel coat finish including but not limited to cosmetic gel coat finish defects, blisters, starring, crazing and fiberglass delamination caused by blisters, crazing, spider or hairline cracks; and
- Incidental or consequential damages, or damages of any kind including without limitation towing, storage, transportation expenses, telephone, rental, taxi, inconvenience, insurance coverage, loan payments, loss of time, loss of income; or time missed for downtime experience due to service work.

4. WARRANTY COVERAGE PERIOD

This limited warranty will be in effect from (1) the date of delivery to the first retail consumer or (2) the date the product is first put into use, whichever occurs first and for a period of:

1. Twenty four (24) CONSECUTIVE MONTHS, for private, recreational use,
2. FOUR (4) CONSECUTIVE MONTHS for commercial use,
A personal watercraft is used commercially when it is used in connection with generating income or any work or employment during any part of the warranty period. A personal watercraft is also used commercially when, at any point during the warranty period, it has commercial tags or is licensed for commercial use.

The repair or replacement of parts or the performance of service under this warranty does not extend the life of this warranty beyond its original expiration date.

Note that the duration and any other modalities of the warranty coverage are subject to the applicable national or local legislation in the customer's country.

5. CONDITIONS TO HAVE WARRANTY COVERAGE

This warranty coverage is available **only** if each of the following conditions has been fulfilled:

- The 2019 Sea-Doo personal watercraft must be purchased as new and unused by its first owner from a Sea-Doo Distributor/Dealer authorized to distribute Sea-Doo personal watercrafts in the country in which the sale occurred;
- The BRP specified pre-delivery inspection process must be completed and documented;
- The 2019 Sea-Doo personal watercraft must have undergone proper registration by an authorized Sea-Doo Distributor/Dealer;
- The 2019 Sea-Doo personal watercraft must be purchased within the EEA by an EEA resident, in the CIS for residents of the countries comprised in such area and in Turkey for residents of Turkey; and
- Routine maintenance outlined in the Operator’s Guide must be timely performed in order to maintain warranty coverage. BRP reserves the right to make warranty coverage contingent upon proof of proper maintenance.

BRP will not honor this limited warranty to any private use owner or commercial use owner if one of the preceding conditions has not been met. Such limitations are necessary in order to allow BRP to preserve both the safety of its products, and also that of its consumers and the general public.

6. WHAT TO DO TO OBTAIN WARRANTY COVERAGE

The customer must cease using the Sea-Doo personal watercraft upon the appearance of an anomaly. The customer must notify a servicing Sea-Doo Distributor/Dealer within two (2) months of the appearance of a defect, and provide it with reasonable access to the product and reasonable opportunity to repair it. The customer must also present to the authorized Sea-Doo Distributor/Dealer, proof of purchase of the product and must sign the repair/work order prior to starting the repair in order to validate the warranty repair. All parts replaced under this limited warranty become the property of BRP.

Note that the notification period is subject to the applicable national or local legislation in customer’s country.

7. WHAT BRP WILL DO

To the extent permitted by law, BRP’s obligations under this warranty are limited to, at its sole discretion, repairing parts found defective under normal use, maintenance and service, or replacing such parts with new genuine Sea-Doo parts without charge for parts and labor, at any authorized Sea-Doo Distributor/Dealer during the warranty coverage period under the conditions described herein. BRP’s responsibility is limited to making the required repairs or replacements of parts. No claim of breach of warranty shall be cause for cancellation or rescission of the sale of the Sea-Doo personal watercraft to the owner. You may have other legal rights which may vary from country to country.

In the event that service is required outside of the country of original sale, or for EEA residents, if service is required outside of the EEA, for CIS residents, if service is required outside of the CIS, the owner will bear responsibility for any additional charges due to local practices and conditions, such as, but not limited

to, freight, insurance, taxes, license fees, import duties, and any and all other financial charges, including those levied by governments, states, territories and their respective agencies.

BRP reserves the right to improve or modify products from time to time without assuming any obligation to modify products previously manufactured.

8. TRANSFER

If the ownership of a product is transferred during the warranty coverage period, this warranty shall also be transferred and be valid for the remaining coverage period provided BRP or an authorized Sea-Doo Distributor/Dealer receives a proof that the former owner agreed to the transfer of ownership, in addition to the coordinates of the new owner.

9. CONSUMER ASSISTANCE

In the event of a controversy or a dispute in connection with this limited warranty, BRP suggests that you try to resolve the issue at the Sea-Doo Distributor/Dealer level. We recommend discussing the issue with the authorized Sea-Doo Distributor/Dealer's service manager or owner.

If the matter still remains unresolved, contact BRP by filling out the customer contact form at www.brp.com or contact BRP by mail at one of the addresses listed under the *CONTACT US* section of this guide.

* In the EEA, products are distributed and serviced by BRP European Distribution D.S. and other affiliates or subsidiaries of BRP.

© 2018 Bombardier Recreational Products Inc. All rights reserved.

® Trademark of Bombardier Recreational Products Inc. or its affiliated.

ADDITIONAL TERMS AND CONDITIONS FOR FRANCE ONLY

The following terms and conditions are applicable to products sold in France only:

The seller shall deliver goods that are complying with the contract and shall be responsible for defects existing upon delivery. The seller shall also be responsible for defects resulting from packaging, assembling instructions or the installation when it is its responsibility per the contract or if accomplished under its responsibility. To be compliant with the contract, the good shall:

1. Be fit for normal use for goods similar thereto and, if applicable:
 - Correspond to the description provided by the seller and have the qualities presented to the buyer through sample or model;
 - Have the qualities that a buyer may legitimately expect considering the public declarations of the seller, the manufacturer of its representative, including in advertising or labeling; or
2. Have the characteristics mutually agreed upon as between the parties or be fit for the specific use intended by the buyer and brought to the attention of the seller and which accepted.

The action for failure to comply is prescribed after two years after delivery of the goods. The seller is responsible for the warranty for hidden defects of the good sold if such hidden defects are rendering the good unfit for the intended use, or if they diminish its use in such a way that the buyer would not have acquired the good or would have given a lesser price, had he known. The action for such hidden defects shall be taken by the buyer within 2 years of the discovery of the defect.

***This page is
intentionally blank***

CUSTOMER INFORMATION

PRIVACY INFORMATION

BRP wishes to inform you that your coordinates will be used for safety and warranty related purposes. Furthermore, BRP and its affiliates may use its customer list to distribute marketing and promotional information about BRP and related products.

To exercise your right to consult or correct your data, or to be removed from the addressee-list for direct marketing, please contact BRP.

By E-mail: privacyofficer@brp.com

By mail: BRP
Senior Legal Counsel-Privacy Officer
726 St-Joseph
Valcourt, QC
Canada
J0E 2L0

CONTACT US

www.brp.com

North America

565 de la Montagne Street
Valcourt (Québec) J0E 2L0
Canada

Sturtevant, Wisconsin, U.S.A.
10101 Science Drive
Sturtevant, Wisconsin
53177
U.S.A.

Sa De Cv, Av. Ferrocarril 202
Parque Ind. Querétaro, Lote2-B
76220
Santa Rosa Jáuregui, Qro., Mexico

Europe

Skaldenstraat 125
B-9042 Gent
Belgium

Itterpark 11
D-40724 Hilden
Germany

ARTEPARC Bâtiment B
Route de la côte d'Azur, Le Canet
13590 Meyreuil
France

Ingvald Ystgaardsvei 15
N-7484 Trondeim
Norway

Isoaavantie 7
PL 8040
96101 Rovaniemi

Formvägen 16
S-906 21 Umeå
Sweden

Avenue d'Ouchy 4-6
1006 Lausanne
Switzerland

Oceania

6 Lord Street
Lakes Business Park
Botany, NSW 2019
Australia

South America

Rua James Clerck Maxwell, 230
TechnoPark Campinas SP 13069-380
Brazil

Asia

15/F Parale Mitsui Building,8
Higashida-Cho, Kawasaki-ku
Kawasaki 210-0005
Japan

Room Dubai, level 12, Platinum Tower
233 Tai Cang Road
Xintiandi, Lu Wan District
Shanghai 200020
PR China

CHANGE OF ADDRESS/OWNERSHIP

If your address has changed or if you are the new owner of the watercraft, be sure to notify BRP by either:

- Notifying an authorized Sea-Doo dealer.
- **North America Only:** calling at 1 888 272-9222.
- Mailing one of the change of address cards on the following pages at one of the BRP addresses indicated in the *CONTACT US* section of this guide.

In case of change of ownership, please join a proof that the former owner agreed to the transfer.

Notifying BRP, even after the expiration of the limited warranty, is very important as it enables BRP to reach the watercraft owner if necessary, like when safety recalls are initiated. It is the owner's responsibility to notify BRP.

STOLEN UNITS: In the event that your watercraft is stolen, you should notify your area's distributor warranty department of such. We will ask you to provide your name, address, phone number, Hull Identification Number and date it was stolen.

***This page is
intentionally blank***

CHANGE OF ADDRESS CHANGE OF OWNERSHIP 

VEHICLE IDENTIFICATION NUMBER

Model Number

Vehicle Identification Number (V.I.N.)

OLD ADDRESS
OR PREVIOUS OWNER:

NAME

NO.

STREET

APT

CITY

STATE/PROVINCE

ZIP/POSTAL CODE

COUNTRY

TELEPHONE

NEW ADDRESS
OR NEW OWNER:

NAME

NO.

STREET

APT

CITY

STATE/PROVINCE

ZIP/POSTAL CODE

COUNTRY

TELEPHONE

E-MAIL ADDRESS

V00A2F

CHANGE OF ADDRESS CHANGE OF OWNERSHIP 

VEHICLE IDENTIFICATION NUMBER

Model Number

Vehicle Identification Number (V.I.N.)

OLD ADDRESS
OR PREVIOUS OWNER:

NAME

NO.

STREET

APT

CITY

STATE/PROVINCE

ZIP/POSTAL CODE

COUNTRY

TELEPHONE

NEW ADDRESS
OR NEW OWNER:

NAME

NO.

STREET

APT

CITY

STATE/PROVINCE

ZIP/POSTAL CODE

COUNTRY

TELEPHONE

E-MAIL ADDRESS

V00A2F

***This page is
intentionally blank***

NOTES

WATERCRAFT MODEL No. _____

HULL IDENTIFICATION NUMBER (H.I.N.) _____

ENGINE IDENTIFICATION NUMBER (E.I.N.) _____

Owner: _____
NAME

No. STREET APT

CITY STATE/PROVINCE ZIP/POSTAL CODE

Purchase Date _____
YEAR MONTH DAY

Warranty Expiry Date _____
YEAR MONTH DAY

To be completed by the authorized Sea-Doo dealer at the time of the sale.

DEALER IMPRINT AREA

⚠ WARNING

BEFORE YOU OPERATE THIS VEHICLE, READ THIS OPERATOR'S GUIDE, ALL ON-PRODUCT SAFETY LABELS AND WATCH THE SAFETY VIDEO.



219 001 975
OPERATOR'S GUIDE, SEA-DOO SPARK SERIES / ENGLISH
GUIDE DU CONDUCTEUR, SÉRIE SEA-DOO SPARK / ANGLAIS

FAIT AU / MADE IN CANADA

U/M:P:C