

**SEA-DOO®**



# 2017 OPERATOR'S GUIDE



**SEA-DOO® SAR**  
SERIES

**SEARCH AND RESCUE**

**⚠ WARNING**

Disregarding any of the safety precautions and instructions contained in this Operator's Guide and on-product safety labels could cause injury including the possibility of death!

CALIFORNIA PROPOSITION 65 WARNING

**⚠ WARNING**

This watercraft contains or emits chemicals known to the state of California to cause cancer and birth defects or other reproductive harm.



In Canada, products are distributed by Bombardier Recreational Products Inc. (BRP).

In USA, products are distributed by BRP US Inc.

This is a non-exhaustive list of trademarks that are the property of Bombardier Recreational Products Inc. or its affiliates:

O.T.A.S.™	Rotax®
iTC™	Sea-Doo®
iBR™	4-TEC™
iControl™	Sea-Doo®
T.O.P.S.™	XPST™
VTST™	

# FOREWORD

Deutsch	Dieses Handbuch ist möglicherweise in Ihrer Landessprache verfügbar. Bitte wenden Sie sich an Ihren Händler oder besuchen Sie: <a href="http://www.operatorsguides.brp.com">www.operatorsguides.brp.com</a>
English	This guide may be available in your language. Check with your dealer or go to: <a href="http://www.operatorsguides.brp.com">www.operatorsguides.brp.com</a>
Español	Es posible que este manual esté disponible en su idioma. Consulte a su distribuidor o visite: <a href="http://www.operatorsguides.brp.com">www.operatorsguides.brp.com</a>
Français	Ce guide peut être disponible dans votre langue. Vérifier avec votre concessionnaire ou aller à: <a href="http://www.operatorsguides.brp.com">www.operatorsguides.brp.com</a>
中文	本手册可能有您的语种的翻译版本。请向经销商问询，或者登录 <a href="http://www.operatorsguides.brp.com">www.operatorsguides.brp.com</a> 查询。
日本語	このガイドは、言語によって翻訳版が用意されています。ディーラーに問い合わせるか、次のアドレスでご確認ください： <a href="http://www.operatorsguides.brp.com">www.operatorsguides.brp.com</a>
Nederlands	Deze handleiding kan beschikbaar zijn in uw taal. Vraag het aan uw dealer of ga naar: <a href="http://www.operatorsguides.brp.com">www.operatorsguides.brp.com</a>
Norsk	Denne boken kan finnes tilgjengelig på ditt eget språk. Kontakt din forhandler eller gå til: <a href="http://www.operatorsguides.brp.com">www.operatorsguides.brp.com</a>
Português	Este manual pode estar disponível em seu idioma. Fale com sua concessionária ou visite o site: <a href="http://www.operatorsguides.brp.com">www.operatorsguides.brp.com</a>
Suomi	Käyttöohjekirja voi olla saatavissa omalla kielelläsi. Tarkista jälleenmyyjältä tai käy osoitteessa: <a href="http://www.operatorsguides.brp.com">www.operatorsguides.brp.com</a>
Svenska	Denna bok kan finnas tillgänglig på ditt språk. Kontakta din återförsäljare eller gå till: <a href="http://www.operatorsguides.brp.com">www.operatorsguides.brp.com</a>

Congratulations on your purchase of a new Sea-Doo® SAR (Search and Rescue) personal watercraft (PWC). It is backed by the BRP warranty and a network of authorized Sea-Doo personal watercraft dealers ready to provide the parts, service or accessories you may require.

Your dealer is committed to your satisfaction. He has taken training to perform the initial setup and inspection of your watercraft as well as completed the final adjustment before you took possession. If you need more complete servicing information, please ask your dealer.

At delivery, you were also informed of the warranty coverage and signed the *PREDELIVERY CHECK LIST* to ensure your new watercraft was prepared to your entire satisfaction.

## Know Before you Go

This watercraft is intended for professional rescuers with adequate training and equipment. The users must have followed a safe boating course and advance training for search and rescue operations.

To learn how to reduce the risk of being injured or killed, read the following sections before you operate the watercraft:

- SAFETY INFORMATION
- WATERCRAFT INFORMATION.

Read and understand all safety labels on this watercraft.

Failure to follow the warnings contained in this Operator's Guide can result in serious injury or death.

### WARNING

Get familiar with this PWC; it may exceed the performance of other PWCs you have ridden.

## Safety Messages

This Operator's Guide utilizes the following symbols and words to emphasize particular information:

The safety alert symbol  indicates a potential injury hazard.

### WARNING

Indicates a potential hazard which, if not avoided, could result in serious injury or death.

 **CAUTION** Indicates a potentially hazardous situation which, if not avoided, could result in minor or moderate injury.

**NOTICE** Indicates an instruction which, if not followed, could severely damage watercraft components or other property.

## About this Operator's Guide

This Operator's Guide has been prepared to acquaint the users with this personal watercraft and its various controls, maintenance and safe riding instructions.

Keep this Operator's Guide in the watercraft as you can refer to it for operation, instructing others, maintenance and troubleshooting.

Note that this guide is available in several languages. In the event of any discrepancy, the English version shall prevail.

If you want to view and/or print an extra copy of this Operator's Guide, simply visit the following website [www.operatorsguides.brp.com](http://www.operatorsguides.brp.com).

The information contained in this document is correct at the time of publication. However, BRP maintains a policy of continuous improvement of its products without imposing upon itself any obligation to install them on products previously manufactured. Due to late changes, some differences between the manufactured product and the descriptions and/or specifications in this guide may occur. BRP reserves the right at any time to discontinue or change specifications, designs, features, models or equipment without incurring any obligation upon itself.

Pictures shown throughout this guide are for reference purpose only. Some pictures may show equipment that are not included.

---

# TABLE OF CONTENTS

<b>FOREWORD</b> .....	<b>1</b>
Know Before you Go .....	1
Safety Messages .....	2
About this Operator's Guide .....	2

## ***SAFETY INFORMATION***

<b>GENERAL PRECAUTIONS</b> .....	<b>8</b>
Avoid Carbon Monoxide Poisoning .....	8
Avoid Gasoline Fires and Other Hazards .....	8
Avoid Burns from Hot Parts .....	8
Accessories and Modifications .....	8
<b>SPECIAL SAFETY MESSAGES</b> .....	<b>9</b>
Reminders Regarding Safe Operation .....	9
Hypothermia .....	12
Safe Boating Courses .....	12
<b>ACTIVE TECHNOLOGIES (iCONTROL)</b> .....	<b>13</b>
Introduction .....	13
iTc (intelligent Throttle Control) .....	13
iBR (intelligent Brake and Reverse System) .....	14
<b>SAFETY EQUIPMENT</b> .....	<b>16</b>
Required Safety Equipment .....	16
<b>PRACTICE EXERCISES</b> .....	<b>19</b>
Where to Practice Exercises .....	19
Practice Exercises .....	19
Important Factors Not to Neglect .....	20
<b>NAVIGATION RULES</b> .....	<b>21</b>
Operating Rules .....	21
<b>FUELING</b> .....	<b>23</b>
Fueling Procedure .....	23
Fuel Requirements .....	24
<b>TRAILERING INFORMATION</b> .....	<b>25</b>
<b>IMPORTANT ON-PRODUCT LABELS</b> .....	<b>26</b>
Watercraft Safety Labels .....	26
Product Information Labels .....	30
Compliance Labels .....	31
<b>PRE-RIDE INSPECTION</b> .....	<b>33</b>
What to Do Before Launching the Watercraft .....	33
What to Do After Launching the Watercraft .....	35

## ***WATERCRAFT INFORMATION***

<b>CONTROLS</b> .....	<b>38</b>
1) Handlebar .....	38

<b>CONTROLS</b> (cont'd)	
2) Engine START/STOP Button .....	38
3) Engine Cut-Off Switch .....	39
4) Throttle Lever .....	39
5) iBR Lever (intelligent Brake and Reverse) .....	39
6) MODE/SET Buttons .....	40
7) UP/DOWN Buttons .....	40
8) Cruise Button .....	41
9) Sport Button .....	41
10) ECO Button .....	41
<b>INFORMATION CENTER (GAUGES)</b> .....	<b>42</b>
Multifunction Gauge Features .....	42
Multifunction Gauge Description .....	43
Navigating the Multifunction Display .....	48
Changing Numerical Display Indication .....	51
Resetting Numerical Display Indication .....	51
Multifunction Gauge Setup .....	52
Analog Speedometer Description .....	52
Analog Tachometer Description .....	53
<b>EQUIPMENT</b> .....	<b>54</b>
1) Glove Box .....	54
2) Front Storage Compartment .....	54
3) Seat .....	55
4) Passenger Handhold .....	56
5) Boarding Platform .....	56
6) Boarding Step .....	56
7) Eyelets .....	57
8) Bilge Drain Plugs .....	58
9) Rear Mast .....	58
10) Navigation Lights .....	58
11) Inflatable Sponsons .....	58
12) Ropes .....	59
13) Running Boards .....	59
14) Heavy-Duty Front Bumper .....	59
15) Flip Line .....	59
<b>BREAK-IN PERIOD</b> .....	<b>60</b>
Operation During Break-In Period .....	60
<b>OPERATING INSTRUCTIONS</b> .....	<b>61</b>
Boarding the Watercraft .....	61
How to Start Engine .....	63
How to Stop the Engine .....	64
How to Steer the Watercraft .....	64
How to Engage Neutral .....	65
How to Engage Forward .....	66
How to Engage and Use Reverse .....	66
How to Engage and Use Braking .....	67
How to Use the Variable Trim System (VTS) .....	69

<b>OPERATING INSTRUCTIONS (cont'd)</b>	
General Operating Recommendations .....	72
<b>OPERATING MODES .....</b>	<b>75</b>
Sport Mode .....	75
Touring Mode .....	75
ECO Mode (Fuel Economy Mode) .....	76
Cruise Mode .....	77
Slow Speed Mode .....	79
<b>SPECIAL PROCEDURES .....</b>	<b>82</b>
Jet Pump Water Intake and Impeller Cleaning .....	82
Capsized Watercraft .....	84
Submerged Watercraft .....	85
Water-Flooded Engine .....	85
Towing the Watercraft in Water .....	85

## **MAINTENANCE INFORMATION**

<b>MAINTENANCE SCHEDULE .....</b>	<b>88</b>
<b>MAINTENANCE PROCEDURES .....</b>	<b>92</b>
Engine Compartment .....	92
Engine Oil .....	92
Engine Coolant .....	94
Ignition Coils .....	95
Spark Plugs .....	96
Exhaust System and Heat Exchanger .....	97
Ride Plate and Water Intake Grate .....	98
Sacrificial Anode .....	99
Fuses .....	99
Inflatable Sponsons .....	102
<b>WATERCRAFT CARE .....</b>	<b>106</b>
Post-Operation Care .....	106
Watercraft Cleaning .....	106
Post-Operation Inspection .....	107
<b>STORAGE AND PRESEASON PREPARATION .....</b>	<b>109</b>
Storage .....	109
Preseason Preparation .....	111

## **TECHNICAL INFORMATION**

<b>WATERCRAFT IDENTIFICATION .....</b>	<b>114</b>
Hull Identification Number .....	114
Engine Identification Number .....	114
<b>ENGINE EMISSIONS INFORMATION .....</b>	<b>115</b>
Manufacturer's Responsibility .....	115
Dealer's Responsibility .....	115

**ENGINE EMISSIONS INFORMATION (cont'd)**  
Owner Responsibility ..... 115  
EPA Emission Regulations ..... 115  
**SPECIFICATIONS ..... 116**

***TROUBLESHOOTING***

**TROUBLESHOOTING GUIDELINES ..... 120**  
**MONITORING SYSTEM ..... 125**  
Fault Codes ..... 125  
Fault Indicators and Message Display Information ..... 126  
Beeper Code Information ..... 128

***WARRANTY***

**BRP LIMITED WARRANTY – USA AND CANADA: 2017 SEA-DOO® PERSONAL WATERCRAFT ..... 130**  
**US EPA EMISSION-RELATED WARRANTY ..... 134**  
**CALIFORNIA AND NEW YORK EMISSION CONTROL WARRANTY STATEMENT FOR MODEL YEAR 2017 SEA-DOO® PERSONAL WATERCRAFT ..... 137**  
**BRP INTERNATIONAL LIMITED WARRANTY: 2017 SEA-DOO® PERSONAL WATERCRAFT ..... 141**  
**BRP LIMITED WARRANTY FOR THE EUROPEAN ECONOMIC AREA, THE COMMONWEALTH OF THE INDEPENDENT STATES, TURKEY: 2017 SEA-DOO® PERSONAL WATERCRAFT ..... 146**

***CUSTOMER INFORMATION***

**PRIVACY INFORMATION ..... 152**  
**CONTACT US ..... 153**  
North America ..... 153  
Europe ..... 153  
Oceania ..... 153  
South America ..... 153  
Asia ..... 153  
**CHANGE OF ADDRESS/OWNERSHIP ..... 154**



# ***SAFETY INFORMATION***

---

# GENERAL PRECAUTIONS

## Avoid Carbon Monoxide Poisoning

All engine exhaust contains carbon monoxide, a deadly gas. Breathing carbon monoxide can cause headaches, dizziness, drowsiness, nausea, confusion and eventually death.

Carbon monoxide is a colorless, odorless, tasteless gas that may be present even if you do not see or smell any engine exhaust. Deadly levels of carbon monoxide can collect rapidly, and you can quickly be overcome and unable to save yourself. Also, deadly levels of carbon monoxide can linger for hours or days in enclosed or poorly ventilated areas. If you experience any symptoms of carbon monoxide poisoning, leave the area immediately, get fresh air and seek medical treatment.

To prevent serious injury or death from carbon monoxide:

- Never run the watercraft in poorly ventilated or partially enclosed areas such as seawalls or other boats in close proximity. Even if you try to ventilate engine exhaust, carbon monoxide can rapidly reach dangerous levels.
- Never run the watercraft outdoors where engine exhaust can be drawn into a building through openings such as windows and doors.
- Never stand behind the watercraft while the engine is running. A person standing behind a running engine may inhale high concentrations of exhaust fumes. Inhalation of concentrated exhaust fumes that contain carbon monoxide can result in CO poisoning, serious health problems and death.

## Avoid Gasoline Fires and Other Hazards

Gasoline is extremely flammable and highly explosive. Fuel vapors can spread and be ignited by a spark or

flame many feet away from the engine. To reduce the risk of fire or explosion, follow these instructions:

- Use only an approved red gasoline container to store fuel.
- Strictly adhere to the instructions in *FUELING* subsection.
- Never start watercraft if gasoline or gasoline vapor odors is present in the engine compartment.
- Never start or operate the engine if the fuel cap is not properly secured.
- Do not carry gasoline containers in the front storage compartment or anywhere else on the watercraft.

Gasoline is poisonous and can cause injury or death.

- Never siphon gasoline with your mouth.
- If you swallow gasoline, get any in your eyes, or inhale gasoline vapors, see a doctor immediately.

If gasoline is spilled on you, wash thoroughly with soap and water and change your clothes.

## Avoid Burns from Hot Parts

Certain components may become hot during operation. Avoid contact during and shortly after operation to avoid burns.

## Accessories and Modifications

Do not add accessories or equipment that may adversely affect visibility or alter control of the watercraft.

---

# SPECIAL SAFETY MESSAGES

## Reminders Regarding Safe Operation

The performance of this watercraft may significantly exceed that of other watercraft you may have operated. Make sure you read and understand the content of this Operator's Guide to become completely familiar with the controls and operation of the watercraft before embarking on your first trip, or taking on a passenger(s). If you have not had the opportunity to do so, practice driving solo in a suitable traffic free area to become accustomed to the feel and response of each control. Be fully familiar with all controls before accelerating above idle speed. Do not assume that all PWCs handle identically. Each model differs, often substantially. This model equipped with inflatable sponsons has different turning and handling characteristics.

Always keep in mind that as the throttle lever is returned to the idle position, less directional control is available. To turn the watercraft, both steering and throttle are necessary. Do not release throttle when trying to steer away from objects. Your need throttle to steer. If the engine is shut off, directional control is lost.

Although most watercraft have no means of braking, advancement in technologies now permit us to offer some models that are equipped with a braking system called the iBR™ system. Practice braking maneuvers in a safe traffic-free area to become familiar with handling under braking and with stopping distances under various operating conditions.

### WARNING

Stopping distance will vary depending on initial speed, load, wind, number of riders and water conditions. The amount of braking power commanded by the operator using the iBR lever (Intelligent Brake and Reverse) will also affect stopping distance.

When braking, riders must brace themselves against the deceleration force to prevent from moving forward on the watercraft and losing balance. It is of the utmost importance to brake slowly when someone is on a rescue sled.

When operating an iBR equipped watercraft, be aware that other boats following or operating in close proximity may not be able to stop as quickly.

When at speed and the brake is first applied, a plume of water will shoot up in the air behind the watercraft (except if a rescue sled is installed) which may cause the operator of a following watercraft to momentarily lose sight of your PWC. It is important to inform the operator of a watercraft who intends to follow in a convoy formation, of the braking and maneuvering capability of your PWC, what the plume of water indicates, and that a greater distance should be maintained between watercraft.

When actuating the iBR control lever while the watercraft has some forward speed, the braking mode will engage and generate a deceleration proportional to the iBR lever position. The more you pull in the iBR lever, the greater the braking force becomes. Be careful to gradually actuate the iBR lever to adjust the intensity of the braking force, and to simultaneously release the throttle lever.

The brake feature of the iBR system cannot prevent your PWC from drifting due to current or wind. It has no

braking effect on the rearward motion. Also note that your engine must be running to be able to use the brake.

The personal watercraft jet thrust can cause injury. The jet pump may pick up debris and throw it rearward causing a risk of injuring people, damaging the jet pump, or other property.

Observe the instructions on all safety labels. They are there to help assure that you have a safe and enjoyable outing.

Do not store any objects in areas that are not designed specifically for storage.

Riding with passenger(s) or having an attachment system such as a rescue sled makes the PWC handle differently and requires greater skill.

Combustion engines need air to operate; consequently this PWC cannot be totally watertight. Any maneuvers such as turning constantly in tight circles, plunging the bow through waves, or capsizing the watercraft, that cause the air inlet openings to be under water may cause severe engine problems due to water ingestion. Refer to *OPERATING INSTRUCTIONS* subsection and the *WARRANTY* section contained in this Operator's Guide.

Engine exhaust contains carbon monoxide (CO), which can cause serious health problems or death if inhaled in sufficient quantities. Do not operate the PWC in a confined area or allow CO to accumulate around the PWC, or in enclosed or sheltered areas such as when docked, or when rafting. Be aware of the risk of CO emanations from exhaust of other PWCs.

Know the waters in which the watercraft is to be operated. Current, tides, rapids, hidden obstacles, wakes and waves etc. can affect safe operation.

In shallow water, proceed with caution and at very low speeds. Grounding or abrupt stops may result in injury and

watercraft damage. Debris may also be picked up and thrown rearward by the jet pump onto people or property.

Keep the tether cord attached to the operator's PFD or wrist (wrist strap required) at all times and keep it free from snagging on the handlebars to help ensure the engine stops should the operator fall off. After riding, remove the tether cord from the engine cut-off switch to avoid unauthorized use by children or others. If the operator falls off the watercraft and the tether cord is not attached as recommended, the watercraft engine will not stop.

Ride within your limits and level of riding ability.

Always ride responsibly and safely.

Respect no wake zones, the environment, and the rights of other users of the waterways. As the user of a PWC, you are responsible for damage by the wake of your PWC.

While your watercraft has the capacity of operating at high speeds, it is strongly recommended that high speed operation only be applied when ideal conditions exist and are permitted. Higher speed operation requires a higher degree of skill and increases the risk of severe injuries.

The forces generated on the body of riders while turning, negotiating waves or wakes, operating in choppy waters, or falling off the watercraft, especially at higher speeds, may cause injury including the possibility of broken bones or more serious bodily injuries. Remain flexible and avoid sharp turns.

PWCs are not designed for night-time operation.

### **Before Getting Underway**

For safety reasons and proper care, always perform the pre-ride and post-operation inspections as specified in your Operator's Guide before operating your watercraft.

Do not exceed the payload or passenger capacities for your watercraft. Overloading can affect maneuverability, stability and performance. Also, heavy seas reduce capacity. A payload or person capacity plate is not an excuse for failure to use common sense or good judgment.

Regularly inspect the PWC, hull, inflatable sponsons, engine, safety equipment, and all other boating gear and keep them in safe operating condition.

Be sure you have the minimum required safety equipment, PFDs and any additional gear needed for your outing.

Ensure that all lifesaving equipment, including fire extinguisher, are in safe operating condition and easily accessible. Show all users where this equipment is stored on the PWC, and make sure they know how to use it.

Ensure there is enough fuel on board for the planned outing. Always verify fuel level before use and during the ride. Apply the principle of 1/3 of the fuel to reach your destination, 1/3 to return, and keep 1/3 in reserve. Allow for changes due to adverse weather or other delays.

### **User Awareness**

Read and understand all safety labels on the Sea-Doo PWC, the Operator's Guide, all other safety documents before operating the PWC.

Respect applicable laws. Check local and federal boating laws applicable to the waterways where you intend to use your watercraft. Learn the local navigation rules. Know and understand the applicable navigation system (such as buoys and signs).

Remember that sun, wind, fatigue or illness may impair your judgement and reaction time.

Operation of this PWC by a person under 16 years of age, or a person with a disability that impairs vision, reaction time, judgment, or operation of the controls is NOT recommended.

Always properly use the tether cord when operating the watercraft and ensure that all users are familiar with its use.

Ensure that any operator and all passengers know how to swim and how to reboard the PWC from the water. Boarding in deep water can be strenuous. Practice in chest-deep water before operating or embarking your watercraft in deep water. Ensure that any operator and all passengers wear a PFD at all times.

Never turn handlebar while someone is near the rear of watercraft. Keep away from steering moving parts (nozzle, iBR gate, linkages, etc.).

Do not start the engine or operate the watercraft if anyone is in the water nearby, or near the rear of the watercraft (or at the rear of a rescue sled).

Be aware of the iBR gate movement when starting the engine, shutting down the engine or using the iBR lever. Automatic movement of the gate may squeeze fingers or toes of people taking a hold on the back or your PWC.

The operator and passenger(s) should be properly seated and have a firm grip on a handhold before starting the watercraft, and at all times when the watercraft is in motion. All passenger(s) should be instructed to use the handholds provided, or to hold on to the waist of the person in front of them. When going over waves, passenger(s) may raise their body slightly off the seat to absorb the shocks with their legs.

When braking or decelerating, riders must brace themselves against the deceleration force to prevent from moving forward on the watercraft and losing balance.

When accelerating on a PWC with a passenger(s), whether from a complete stop or while underway, always do so progressively. Fast acceleration may cause your passenger(s) to lose their balance and fall rearward off the watercraft. Make sure that your passenger(s) are aware of or can anticipate any rapid acceleration.

Severe internal injuries can occur if water is forced into body cavities as a result of falling into water or being near a jet thrust nozzle. Consequently, the wearing of a wet suit bottom is highly recommended.

Keep away from the intake grate while the engine is running. Items such as long hair, loose clothing, or PFD straps can become entangled in moving parts.

If the throttle lever is depressed while braking, the iBR system will disable the throttle command by the user. When releasing the iBR lever while the throttle lever is still depressed, the throttle command will regain control and generate an acceleration after a short delay. Release throttle lever if acceleration is not needed.

Before reboarding, make sure engine is off and the tether cord is removed from the engine cut-off switch.

To prevent accidental starting, always remove the tether cord from the engine cut-off switch when someone is boarding, nearby, or during removal of any weeds or debris from the intake grate.

On a PWC, never place your feet and legs in the water to aid turning.

### Drugs and Alcohol

Never use your PWC with drugs or alcohol. Like driving a car, driving a watercraft requires the operator to be sober, attentive and alert. Operating a watercraft while intoxicated or under the influence of drugs is not only dangerous, but it is also a Federal offense carrying a significant penalty. These

laws are vigorously enforced. The use of drugs and alcohol, singly or in combination, decreases reaction time, impedes judgment, impairs vision, and inhibits your ability to safely operate a watercraft.

**⚠ WARNING**

**Alcohol consumption and boating do not mix! Operating with the use of drugs or alcohol endangers the lives of your passengers, other boaters, and yourself. Federal laws prohibit operating a watercraft with the use of drugs or alcohol.**

### Hypothermia

Hypothermia, the loss of body heat resulting in a subnormal body temperature, is a significant cause of death in boating accidents. After an individual has succumbed to hypothermia, he or she will lose consciousness and then drown.

PFDs can increase survival time because of the insulation they provide.

Naturally, the warmer the water, the less insulation one will require. When operating in cold water (below 4°C (40°F)) consideration should be given to using a drysuit, a coat or jacket style PFD as they cover more body area than the vest style PFDs.

### Safe Boating Courses

Many countries recommend or require a boating safety course. Check with your local competent authorities.

Check local and federal boating laws applicable to the waterways where you intend to use your watercraft. Learn the local navigation rules. Know and understand the applicable navigation system (such as buoys and signs).

---

# ACTIVE TECHNOLOGIES (iCONTROL)

## Introduction

iControl™ (intelligent Control systems) provides an environment whereby the operator can control many systems without taking his hands off the handlebars.

All controls are at the operator's finger tips and activated by pressing a button or pulling a lever. The operator's attention can thus remain focused on the water and driving the watercraft.

Each control is electronic and provides a command signal to an electronic module whose function is to assure proper operation of its system within set parameters.

The various systems grouped under iControl are the:

- iTC™ (intelligent Throttle Control)
- iBR (intelligent Brake and Reverse) (models with iBR)
- O.T.A.S. (Off Throttle Assisted Steering).

These systems function together to provide features such as cruise mode, slow speed mode and braking, improved watercraft response to operator inputs, increased maneuverability and control.

It is extremely important for operators to read all information contained in this Operator's Guide so as to become familiar with this watercraft, its systems, controls, capabilities and limitations.

## iTC (intelligent Throttle Control)

The system uses an electronic throttle control (ETC) that provides command signals to the ECM (Engine Control Module). With this system, there is no need for a traditional throttle cable.

The iTC allows the following operating modes:

- Sport mode (default setting)
- Touring mode
- ECO mode

- Cruise mode
- Slow speed mode

The O.T.A.S.™ (Off Throttle Assisted Steering) is also controlled by the iTC.

## Sport Mode

The Sport mode is the default riding mode.

In sport mode, maximum engine power is available throughout the engine operational range.

Refer to *OPERATING MODES* subsection for detailed instructions.

## Touring Mode

In Touring mode, available engine power and acceleration is reduced when accelerating from a complete stop and when operating in the low engine power range under certain conditions.

Refer to *OPERATING MODES* subsection for detailed instructions.

## ECO Mode

When ECO mode is selected (fuel economy mode), engine RPM is limited whereby an optimal cruising speed is maintained in order to reduce fuel consumption.

Refer to *OPERATING MODES* subsection for detailed instructions.

## Cruise Mode

Cruise mode allows the operator to set a desired maximum speed of the watercraft.

Cruise mode limits watercraft speed but does not maintain it. The operator must hold the throttle lever depressed to maintain forward speed, unlike an automotive type cruise control which maintains a constant speed while throttle pedal is released.

As you proceed under a constant cruising speed setting, hold the throttle lever fully depressed in order to keep your full attention to maintaining good situational awareness.

Refer to *OPERATING MODES* subsection for detailed instructions.

### **Slow Speed Mode**

Slow speed mode is a function of cruise mode which allows the operator to adjust and set idle speed corresponding to a watercraft speed of 1.6 km/h to 11 km/h (1 MPH to 7 MPH). The throttle lever should not be depressed while operating in slow speed mode.

Refer to *OPERATING MODES* subsection for detailed instructions.

### **O.T.A.S.™ System (Off-Throttle Assisted Steering)**

The O.T.A.S. (Off-Throttle Assisted Steering) system provides additional maneuverability in off-throttle situations.

The OTAS system is electronically activated when the operator initiates a full turn and releases the throttle at the same time.

#### **Limitations**

The O.T.A.S. system cannot help you maintain control or prevent collisions in all situations.

Refer to *OPERATING INSTRUCTIONS* subsection for details.

### **iBR (intelligent Brake and Reverse System)**

This watercraft uses an electronically controlled braking and reverse system called the iBR system (intelligent Brake and Reverse).

The iBR module controls the position of the iBR gate to provide:

- Forward
- Reverse

- Neutral
- Braking.

The operator commands the position of the iBR gate using either the throttle lever for forward position, or the iBR lever for neutral, reverse, and for the braking function.

**NOTE:** The iBR lever can only be used to command a change in the gate position if the engine is running.

Using the iBR system significantly reduces the stopping distance of this watercraft and can increase its maneuverability as it can be used in a straight line, in a turn, at high or low speeds, or to propel the watercraft in reverse for docking or maneuvering in very close quarters.

Under ideal conditions, experienced operators were consistently able to reduce the stopping distance of a watercraft equipped with an iBR system by approximately 33%, from an initial speed of 80 km/h (50 MPH).

#### **Limitations**

Even when equipped with an iBR system, watercraft do not have the ability of land based vehicles.

Stopping distance will vary notably depending on initial speed, load, wind, current, water conditions and the amount of braking.

The iBR system has no effect on the rearward motion.

It cannot prevent your watercraft from drifting in current or wind.



**⚠ WARNING**

- It is important to inform the operator of a watercraft who intends to follow in a convoy formation, of the braking and maneuvering capability of your PWC, what the plume of water indicates, and that a greater distance must be maintained between watercraft.
- It is also important to inform the person on a rescue sled that this watercraft has braking capabilities. Brake progressively and slowly when someone is on the rescue sled.
- Be aware that other boats following or operating in close proximity may not be able to stop as quickly.

# SAFETY EQUIPMENT

## Required Safety Equipment

The operator and the passenger(s) must wear an approved Personal Flotation Device (PFD) that is suitable for PWC use.

Operator and passenger(s) should have ready access to shatterproof glasses should riding conditions or personal preference warrant.

Wind, water spray and speed may cause a person's eyes to water and create blurred vision.

All required safety equipment should be on board. You should also consider supplying additional equipment as needed for your specific needs.

Safety equipment required by regulations is mandatory. If local regulations require additional equipment, it must be approved by a competent authority. Minimum requirements include the following:

- Personal flotation devices (PFDs)
- A buoyant heaving line of 15 m (50 ft) minimum
- A watertight flashlight or approved flares
- Signaling device
- Sound producing devices (air horn or whistle).

## Recommended Protective Gear

A protective helmet is highly recommended for surf or white water in rescue operations.

The users must wear protective gear, including:

- Wet suit or wet suit bottom (minimum protection) or thick tightly woven and snug fitting clothing that provides equivalent protection

- Dry suit (in cold weather/water operations)
- Footwear, gloves, safety goggles or shatterproof glasses are also recommended. Some type of lightweight, flexible foot protection is recommended. This will help reduce possible injury, should you step on sharp underwater objects.

## **⚠ WARNING**

**Severe internal injuries can occur if water is forced into body cavities as a result of falling in the water or being near jet thrust nozzle without proper protective gear. Normal swimwear does not adequately protect against forceful entry of water into the lower male or female body opening(s).**



### TYPICAL

1. Wet suit / dry suit
2. Helmet
3. Eye protection
4. PFD
5. Gloves
6. Foot protection

## Personal Flotation Devices (PFDs)

Each person on a recreational watercraft must wear a personal flotation device (PFD) at all times. Ensure that these PFDs meet your country's regulations.

A PFD provides buoyancy to help keep the head and face above the water, and to help maintain a satisfactory body position while in the water. Body weight

and age should be considered when selecting a PFD. The buoyancy provided by the PFD should support your weight in water. The size of the PFD should be appropriate for the wearer. Body weight and chest size are common methods used to size PFDs. It is your responsibility to ensure that you have the proper number and types of PFDs on board to comply with federal and local regulations, and that your passengers know where they are and how to use them.

### PFD Types

There are five types of approved PFDs.

**PFD Type I**, Wearable, has the greatest required buoyancy. Its design allows for turning most unconscious persons in the water from face down position to a vertical or slightly backward, face-up position. It can greatly increase the chances of survival. Type I is most effective for all waters, especially offshore when rescue may be delayed. It is also the most effective in rough waters.



**TYPE I — WEARABLE**

**PFD Type II**, Wearable, turns its wearer in the same way as Type I, but not as effectively. The Type II does not turn as many persons under the same conditions as a Type I. You may prefer to use this PFD where there is a probability of quick rescue such as in areas where other people are commonly involved in water activities.

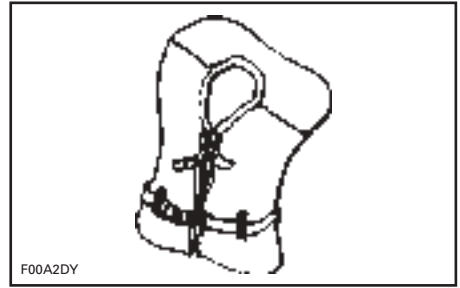

**TYPE II — WEARABLE**

**PFD Type III**, Wearable, allows wearers to place themselves in a vertical or slightly backward position. It does not turn the wearer. It maintains the wearer in a vertical or slightly backward position and has no tendency to turn the wearer face down. It has the same buoyancy as a Type II PFD and may be appropriate in areas where other people are commonly involved in water activities.



**TYPE III — WEARABLE**

**PFD Type V**, Wearable, must be worn. When inflated, it provides buoyancy equivalent to Type I, II or III PFDs. When it is deflated, however, it may not support some people.



TYPE V — WEARABLE

## Helmets

### Some Important Considerations

Helmets are designed to offer some degree of protection in case of impacts to the head. In most motorized sports, the benefits of wearing a helmet clearly outweigh the drawbacks. However, in the case of motorized watersports such as riding personal watercraft, this is not necessarily true as there are some particular risks associated with the water.

### Benefits

A helmet helps to reduce the risk of injury in case of a head impact against a hard surface such as another craft in the case of a collision. Similarly, a helmet with a chin guard might help prevent injuries to the face, jaw or teeth.

### Risks

On the other hand, in some situations when falling off the watercraft, helmets have a tendency to catch the water, like a “bucket”, and put severe stresses on the neck or spine. This could result in choking, severe or permanent neck or spine injury or death.

Helmets may also interfere with peripheral vision and hearing, or increase fatigue which, could contribute to increase the risk of a collision.

## Weighing the Risks vs Benefits

In order to decide whether or not you should wear a helmet, it is best to consider the particular environment you will be riding in, as well as other factors such as personal experience. Will there be a lot of traffic on the water? What is your riding style?

## The Bottom Line

Since each option minimizes some risks, but increases others, before each ride you must decide whether to wear or not wear a helmet based on your particular situation.

If you decide to wear a helmet, you must then decide what type is the most appropriate for the circumstances. Look for helmets that meet DOT or Snell standards.

---

# PRACTICE EXERCISES

It is always a good idea to practice and get familiar with all controls, functions and handling characteristics of this watercraft before venturing on the water.

Always secure the tether cord to the engine cut-off switch and the clip to your PFD or a wrist strap.

## Where to Practice Exercises

Find a suitable area to practice the exercises. Ensure the area meet the following requirements:

- No traffic
- No obstacles
- No swimmers
- No current
- Ample space to maneuver
- Water depth is adequate.

## Practice Exercises

Practice **alone** the following exercises.

### Turning

Practice turning in circles in both directions at slow speed. When comfortable with the exercise, increase difficulty by making some figure 8.

When this is mastered, repeat the above exercises but at increased speed.

### Stopping Distances

Practice stopping the watercraft in a straight line at various speeds and braking force.

Remember that watercraft speed, load, water conditions, current and wind also affect stopping distances.

### Reverse

Practice reverse operation to learn how the watercraft operates in reverse and reacts with steering inputs.

**NOTE:** Always perform this exercise at slow speeds.

## Avoiding an Obstacle

Practice obstacle avoidance (choose a virtual point on the water) by steering the watercraft and maintaining throttle.

Repeat exercise, but this time release throttle while turning.

**NOTE:** With this exercise, you will learn that you need throttle to steer the watercraft in a different direction.

## Docking

Practice docking using the throttle, iBR lever and the steering to become familiar with the response of the PWC, and to develop good control skills.

**NOTE:** Remember that steering direction is reversed when backing.

## Slow Speed Mode and Cruise Mode

If your watercraft has any of these modes, it is also important to understand their operation and to become familiar with these features prior to using them on a ride with other people.

### WARNING

The ski and the cruise modes are not an automatic pilot; they will not drive the watercraft for you.

## Capsized Watercraft

It is important to practice returning a capsized watercraft especially when equipped with the inflatable sponsons. For procedure, refer to *CAPSIZED WATERCRAFT* in *SPECIAL PROCEDURES* subsection.

**NOTE:** It is recommended to have a second person ready to assist for returning the watercraft.

## **Important Factors Not to Neglect**

In addition, always remember that the following conditions have a direct impact on how this watercraft will behave and respond to different inputs:

- Loads
- Currents
- Wind
- Water conditions.

Make sure to be alert to these conditions, and adapt accordingly. If possible, practice further in these conditions.

For delicate maneuvers, the best advice is always to try to reduce your speed to a minimum.

# NAVIGATION RULES

## Operating Rules

Operating a watercraft can be compared with driving on unmarked highways and roads. To prevent collisions or avoid other boaters, a system of operating rules must be followed. It's not only common sense... it's the law!

Generally keep to your right and safely avoid collisions by keeping a safe distance from other watercraft, boats, people and objects.

The following illustration identifies different parts of a boat that are used as directional reference points, the bow being the front of the boat. The port side of boat (left side) is visually identifiable by a RED light off the bow, and the starboard side (right side) by a GREEN light.

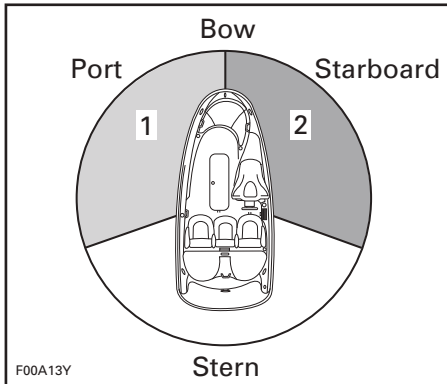

TYPICAL - DIRECTIONAL REFERENCE POINTS

1. RED light
2. GREEN light (yield zone)

## Crossing

Give the right of way to a watercraft ahead and to your right. Never cross in front of a boat, you should see his RED light, he should see your GREEN light (he has the right of way).

Personal watercraft (PWC) do not have these colored lights, but the rule still applies.

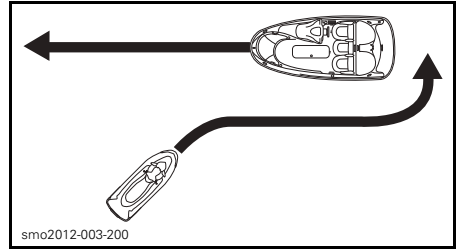

TYPICAL

Like a street traffic light, if you see a RED light, STOP, give the right of way. The other boat is to your right and it has the right of way.

If you see a GREEN light, pass with caution. The other boat is to your left, you have the right of way.

## Meeting Head-On

Keep right.

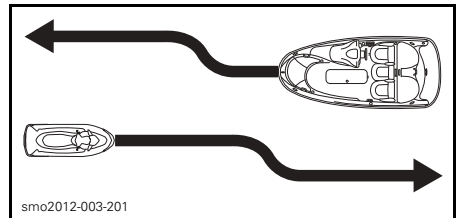

TYPICAL

## Passing

Give the right of way to other crafts and keep clear.

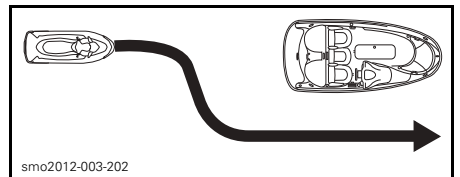

TYPICAL

## Navigation System

Navigational aids, such as signs or buoys, can assist you in identifying safe waters. Buoys will indicate whether you should keep to the right (starboard) or to the left (port) of the

buoy, or to which channel you can continue. They may also indicate whether you are entering a restricted or controlled area such as a no wake or low speed zone. They may also indicate hazards or pertinent boating information. Markers may be located on shore or on the water. They can also indicate speed limits, no power craft or boating, anchorage and other useful information. (The shape of each type of marker will provide assistance).

Make sure you know and understand the navigation system applicable to the waterways where you intend to use the watercraft.

### **Navigation Lights**

Navigation lights are intended to keep other vessels informed of your presence and course in poor visibility operation. On this model, the navigation lights automatically turned on when the engine is started.

**NOTE:** Navigation lights can be activated for approximately 3 minutes without engine running by depressing the start button without the tether cord installed.

### **Collision Avoidance**

Do not release the throttle when trying to steer away from an obstacle. Engine power and jet pump thrust is required to steer the watercraft.

Always keep a constant lookout for other water users, other boats or objects, especially when turning. Be alert for conditions that may limit your visibility or block your vision of others.

Respect the rights of other recreationists and/or bystanders and always keep a safe distance from all other watercraft, boats, people and objects.

Do not wake or wave jump, ride the surf line or attempt to spray or splash others with your watercraft. You may misjudge the ability of the watercraft or your own riding skills and strike a boat, watercraft or person.

This watercraft has the capability of turning more sharply than other boats, however, unless in an emergency, do not negotiate sharp, high speed turns. Such maneuvers make it hard for others to avoid you or understand where you are going. Also, you and/or your passenger(s) could be thrown from the watercraft.

### **Collision Avoidance and the iBR System**

Unlike most other watercraft, this PWC has a braking system (iBR).

When operating an iBR equipped watercraft, be aware that other boats following or operating in close proximity may not be able to stop as quickly.

When at speed and the brake is first applied, a plume of water will shoot up in the air behind the watercraft indicating a braking manoeuvre.

It is important to inform the operator of a watercraft who intends to follow in a convoy formation of the braking and maneuvering capability of your PWC, what the plume of water indicates, and that a greater distance should be maintained between both of you.

Stopping distance will vary depending on initial speed, load, wind and water conditions.

Although the preferable maneuver to avoid an obstacle is to steer away while applying throttle, the iBR can also be used by fully braking and turning in the appropriate direction to avoid the obstacle.



# FUELING

## Fueling Procedure

### **⚠ WARNING**

Fuel is flammable and explosive under certain conditions. Always work in a well ventilated area. Do not smoke or allow open flames or sparks in the vicinity.

1. Turn off engine.

### **⚠ WARNING**

Always stop the engine before refueling.

2. Do not allow anyone to remain on the watercraft.
3. Tie watercraft securely to the fueling pier.
4. Have a fire extinguisher close at hand.
5. Open the front storage compartment cover.
6. Locate fuel tank cap.



TYPICAL - FUEL TANK CAP LOCATION

1. Fuel tank cap (front storage cover open)

7. Slowly unscrew the fuel cap counterclockwise.

### **⚠ WARNING**

Fuel tank may be pressurized, fuel vapors may be released while removing the fuel tank cap.

8. Insert the gas pump spout into the filler neck and fill up the fuel tank.

### **⚠ WARNING**

To prevent fuel back-flow, fill tank slowly so the air can escape from the fuel tank.

9. Stop filling immediately after the release of the gas pump nozzle handle and wait a moment before removing the spout. Do not retract the gas pump nozzle to put more fuel in fuel tank.

### **⚠ WARNING**

Do not overfill or top off the fuel tank and leave the watercraft in the sun. As temperature increases, fuel expands and may overflow.

10. Reinstall fuel tank cap and fully tighten it clockwise.

### **⚠ WARNING**

Always wipe off any fuel spillage from the watercraft.

11. After refueling, always open the seat and ensure there is no gasoline vapor odor inside the engine compartment.

### **⚠ WARNING**

Do not start watercraft if gasoline or gasoline vapor odor is present.

## Fuel Requirements

**NOTICE** Always use fresh gasoline. Gasoline will oxidize; the result is loss of octane, volatile compounds, and the production of gum and varnish deposits which can damage the fuel system.

Alcohol fuel blending varies by country and region. Your vehicle has been designed to operate using the recommended fuels, however, be aware of the following:

- Use of fuel containing alcohol above the percentage specified by government regulations is not recommended and can result in the following problems in the fuel system components:
  - Starting and operating difficulties.
  - Deterioration of rubber or plastic parts.
  - Corrosion of metal parts.
  - Damage to internal engine parts.
- Inspect frequently for the presence of fuel leaks or other fuel system abnormalities if you suspect the presence of alcohol in gasoline exceeds the current government regulations.
- Alcohol blended fuels attract and hold moisture which may lead to fuel phase separation and can result in engine performance problems or engine damage.

### Recommended Fuel

Use common unleaded gasoline with an AKI (RON+MON)/2 octane rating of 87, or an RON octane rating of 91.

**NOTICE** Never experiment with other fuels. Engine or fuel system damages may occur with the use of an inadequate fuel.

**NOTICE** Do NOT use fuel from fuel pumps labeled E85.

Use of fuel labeled E15 is prohibited by U.S. EPA Regulations.

---

# TRAILERING INFORMATION

**NOTICE** The span of the trailer wood bunks including bunk width should be adjusted to provide support throughout the full length of the hull. The ends of both trailer wood bunks should not exceed the length of the watercraft.

Ensure the trailer wheels are positioned so that the center of gravity of the watercraft is slightly ahead of the wheels to properly support the weight of the watercraft.

## WARNING

Never tip this watercraft on end for transporting. We recommend that you carry the watercraft in its normal operating position.

Check the applicable laws and regulations in your area concerning towing a trailer, especially for the following items:

- Brake system
- Tow vehicle weight
- Mirrors.

Take the following precautions when towing the watercraft:

- Respect tow vehicle maximum weight capacity and the tongue weight capacity as recommended by manufacturer.
- Tie the watercraft to both front and transom eyelets so that it is firmly secured on the trailer. Use additional tie-downs if necessary.
- Ensure fuel tank cap, front storage compartment cover, glove box cover and seat are properly latched.
- Observe trailering safety precautions.

**NOTICE** Do not route ropes or tie-downs over the seat or grab handle as they could be permanently damaged. Wrap ropes or tie-downs with rags or similar protectors where they can come into contact with the watercraft body.

## WARNING

Make sure seat is securely latched prior to trailering.

A Sea-Doo cover can protect the watercraft, particularly when driving on dirt roads, to prevent dirt entry through the air inlet openings.

## WARNING

When trailering the watercraft, NEVER leave any equipment on the watercraft.

# IMPORTANT ON-PRODUCT LABELS

## Watercraft Safety Labels

These labels are affixed to the vehicle for the safety of the operator, passenger(s) or bystanders.

The labels illustrated on the following pages are on your watercraft. If missing or damaged, they can be replaced free of charge. See an authorized Sea-Doo dealer.

Please read the following labels carefully before operating this watercraft.

**NOTE:** The first illustration of the watercraft indicates the approximate locations of the various labels. A dotted line indicates that the label is not on the outer surface, and that the seat or a cover of some type must be opened to see the label.

**NOTE:** In the event of any discrepancy between this guide and the vehicle, the safety labels on the vehicle have precedence over the labels in this guide.

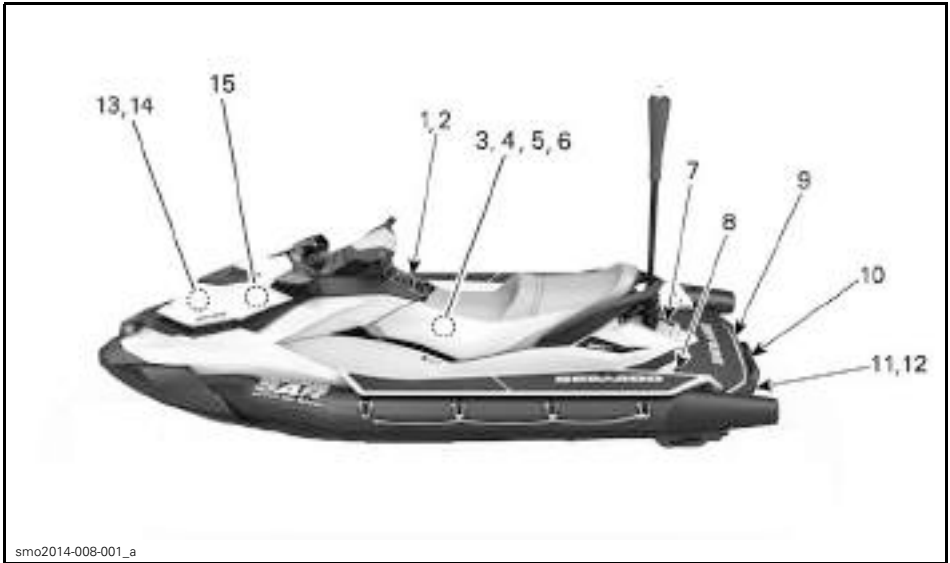

**WARNING**

Collisions result in more **INJURIES AND DEATHS** than any other type of accident for personal watercraft (PWC).

**TO AVOID COLLISIONS:**  
**SCAN CONSTANTLY** for people, objects, and other watercraft. Be alert for conditions that limit your visibility or block your vision of others.  
**OPERATE DEFENSIVELY** at safe speeds and keep a safe distance away from people, objects, and other watercraft.

- Do not follow directly behind PWCs or other boats.
- Do not go near others to spray or splash them with water.
- Avoid sharp turns or other maneuvers that make it hard for others to avoid you or understand where you are going.
- In shallow water, reduce speed and use extra precaution to avoid collision with obstacles or damage to the pump with debris and other boats, do not have brakes.
- TAKE EARLY ACTION** to avoid collisions. Remember, generally PWCs and other boats, do not have brakes.

**DO NOT RELEASE THROTTLE WHEN TRYING TO STEER** away from objects - you need throttle to steer. Always check throttle and steering controls for proper operation before starting PWC. Follow navigation rules and provincial, state and local laws that apply to PWCs. See Operator's Guide for more information. Seating is limited to one operator and two passengers (650 lbs./295 kg.)

**IBR INSTRUCTIONS**

**IBR INTELLIGENT BRAKE AND REVERSE FUNCTIONS:**

**How to brake**

- Squeeze brake lever

**How to reverse**

- Maintain brake lever engaged

**How to go forward**

- Tap throttle lever to engage forward movement from neutral position.
- Squeeze throttle lever to accelerate.

**How to get to neutral**

- Tap brake lever

Refer to the operator's guide for more information.

219904636



219904636

LABEL 1 - MAIN WARNING LH

**WARNING**

To reduce the risk of **SEVERE INJURY DEATH:**  
**WEAR A PERSONAL FLOTATION DEVICE (PFD).**  
 All PFDs must be Coast Guard approved (PFD) that is suitable for personal watercraft (PWC) use.

**WEAR PROTECTIVE CLOTHING.** Severe internal injuries can occur if water is forced into body cavities as a result of falling into water or being thrown from a watercraft. Protective clothing is designed to provide protection against forceful water entry into lower body openings of males or females. All riders must wear a wet suit bottom or clothing that provides equivalent protection. For more information on protective clothing, refer to the Operator's Guide. Footwear, gloves, and goggles/glasses are recommended.

**KNOW BOATING LAWS.** BRP recommends a minimum training requirements for your provincial/state. A boating safety course is recommended and may be required in your provincial/state.

**ATTACH ENGINE SHUT-OFF CORD (LANYARD) to PFD.** After the operator falls off. After riding, remove cord from PWC to avoid unauthorized use by children or others.

**RIDE WITHIN YOUR LIMITS AND AVOID AGGRESSIVE MANEUVERS** to reduce the risk of loss of control, ejection, and collision. This is a high performance boat and is not designed for the risk of backspinal injury (paralysis), facial injuries, and broken legs, ankles, and other bones. Do not jump wakes or waves.



**DO NOT APPLY THROTTLE WHEN ANYONE IS AT REAR SEAT.** The engine is not designed for this use. Excessive throttle and/or debris exiting jet thrust nozzle can cause severe injury.

**KEEP AWAY FROM INTAKE GRATE** while engine is on. Items such as long hair, loose clothing, or PFD straps can become entangled with moving parts resulting in severe injury or drowning.

**NEVER RIDE AFTER CONSUMING DRUGS OR ALCOHOL.**

**READ AND FOLLOW OPERATOR'S GUIDE**

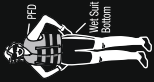
892005616

219903448B

LABEL 2 - MAIN WARNING RH

**CAUTION**

ENGINE OIL AND CERTAIN COMPONENTS IN THE ENGINE COMPARTMENT MAY BE HOT. DIRECT CONTACT MAY RESULT IN SKIN BURN.

CHECKING ENGINE OIL LEVEL

- Make sure engine is at operating temperature.
- Never let engine run out of water without the flush kit connected as it may damage the engine.
- Vehicle must be level to perform verification.
- Let engine running at idle for at least 30 seconds.
- Stop engine and wait at least 30 seconds.
- Check oil level using the dipstick.

219903184A

219903184

LABEL 3

**WARNING / AVERTISSEMENT**

When disconnecting coil from sparkplug, always disconnect coil from main harness first. Never check for engine ignition spark from an open coil and/or sparkplug in the engine compartment as spark may cause fuel vapor to ignite.

Lorsque vous déconnectez la bobine d'allumage de la bougie, toujours déconnecter la bobine d'allumage du harnais principal en premier. Ne jamais vérifier si le circuit d'allumage du moteur produit une étincelle en utilisant la bobine d'allumage et/ou la bougie dans le compartiment moteur car une étincelle pourrait entraîner l'allumage des vapeurs d'essence.

F18L0NY

LABEL 4



LABEL 5

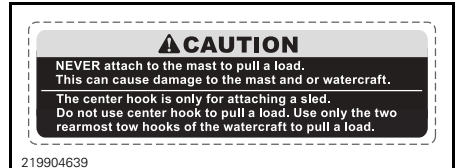

LABEL 7



LABEL 6

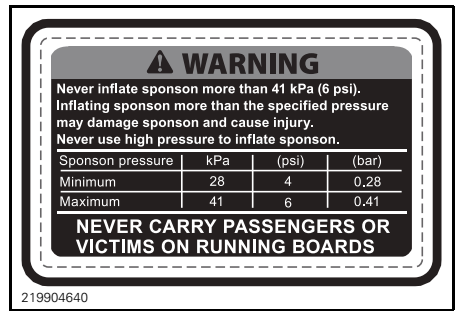

LABEL 8

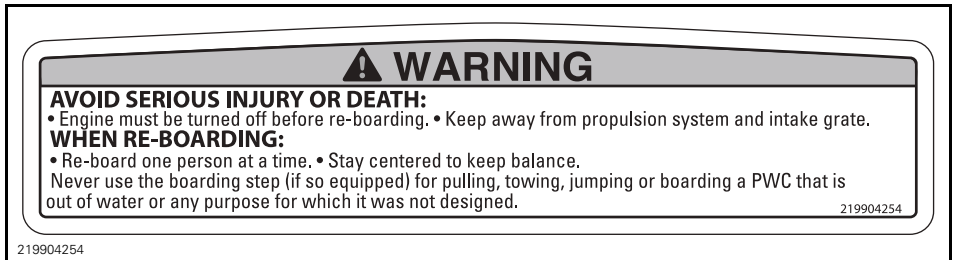

LABEL 9



LABEL 10



LABEL 12



LABEL 11

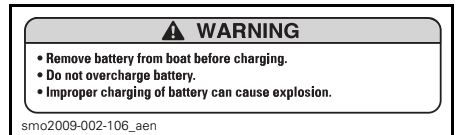

LABEL 13

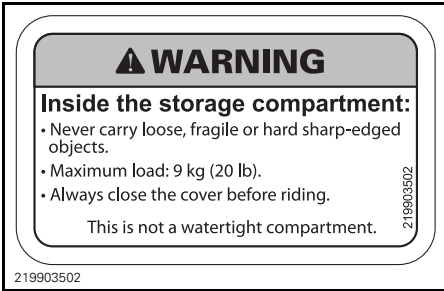

LABEL 14

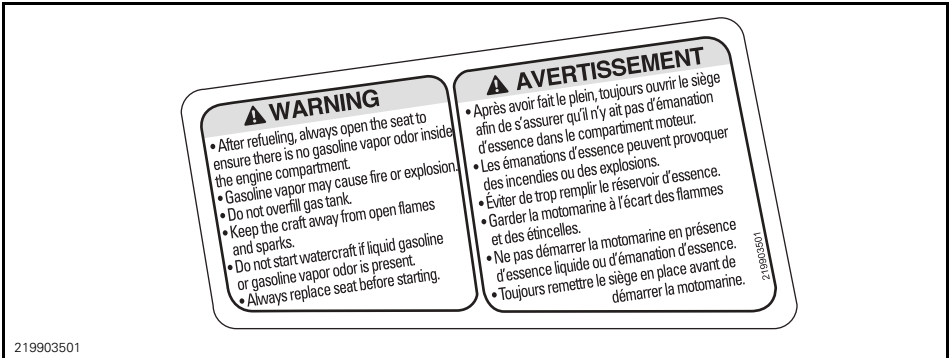

LABEL 15

## Product Information Labels



### NOTICE

- To comply with noise regulations, this engine is designed to operate with an air intake silencer.
- Operation without air intake silencer or with one not properly installed may cause engine damage.

219903177A

219903177

LABEL 1

### NOTICE

It is very important to flush the exhaust system with fresh water (from 1-1/2 to 2 minutes) after each use in salt water or foul water.

219904387

LABEL 2

### NOTICE

Make sure engine is off. Detach one end of flip line from inflatable sponson (Image A). Use flip line and body weight to roll boat.



219904634

219904634

LABEL 3



# Compliance Labels

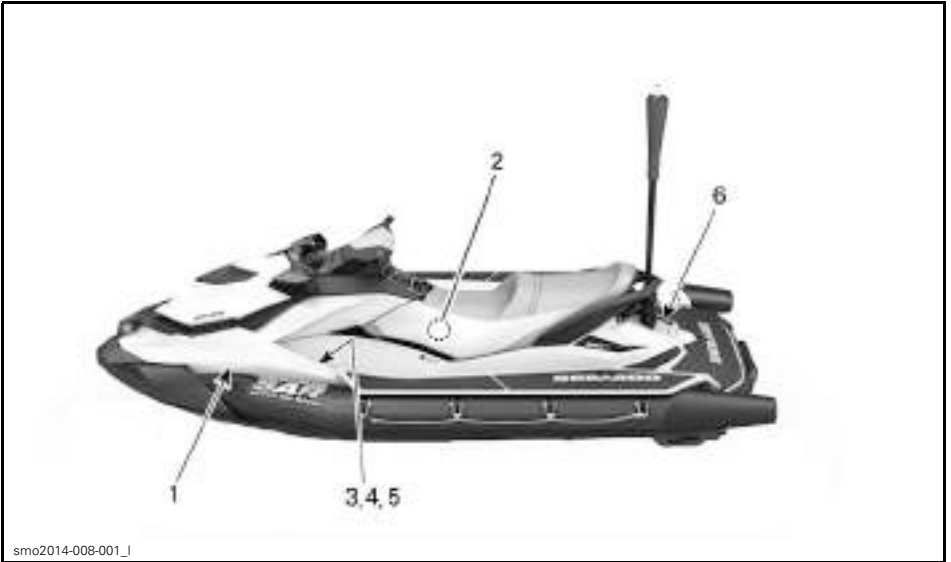

smo2014-008-001\_j

## COMPLIANCE LABEL LOCATION



LABEL 1 - EMISSION CONTROL LABEL

<b>EMISSION CONTROL INFORMATION</b>		
THIS ENGINE IS CERTIFIED TO OPERATE ON UNLEADED GASOLINE AND CONFORMS TO U.S. EPA & CALIFORNIA EMISSION / EVAP REGULATIONS FOR MARINE SI ENGINES.		
ENGINE FAMILY	<input type="text"/>	FAMILLE DE MOTEUR
FEL	<input type="text"/>	LIMITE DES ÉMISSIONS DE LA FAMILLE
ENGINE DISPLACEMENT	<input type="text"/>	CYLINDRÉE
EXHAUST EMISSION CONTROL SYSTEM	<input type="text"/>	SYSTÈME DE CONTRÔLE DES ÉMISSIONS
POWER	<input type="text"/>	PUISSANCE
<b>RENSEIGNEMENTS SUR LE DISPOSITIF ANTIPOLLUTION</b>		
CE MOTEUR EST CERTIFIÉ POUR FONCTIONNER À L'ESSENCE SANS PLOMB ET IL RÉPOND AUX NORMES <input type="checkbox"/> DE L'EPA DES É.-U. & RÉGLEMENTATIONS CALIFORNIENNES POUR LES MOTEURS MARINS À ALLUMAGE COMMANDE.		
SEE OPERATOR'S GUIDE FOR MAINTENANCE SPECIFICATIONS VOIR GUIDE DU CONDUCTEUR POUR LES SPÉCIFICATIONS D'ENTRETIEN		
<b>BOMBARDIER RECREATIONAL PRODUCTS INC.</b>		
219904642		219904642

LABEL 2 - INSIDE NORTH AMERICA ONLY

<b>CANADIAN COMPLIANCE NOTICE</b> <b>AVIS DE CONFORMITÉ CANADIEN</b>	
MAXIMUM RECOMMENDED SAFE LIMITS LIMITES MAXIMALES DE SECURITE RECOMMANDEES	
	<b>295 kg</b> <b>650 lbs/lb</b>
	<b>295 kg</b> <b>650 lbs/lb</b>
CATEGORY / CATEGORIE: C	
MAXIMUM WAVE / VAGUE MAXIMALE	2.0 m
MAXIMUM WIND SPEED / VITESSE DE VENT MAXIMALE	33.0 knots/noeuds
BOMBARDIER RECREATIONAL PRODUCT INC. BOMBARDIER PRODUITS RECREATIF INC. VALCOURT, QUÉBEC, CANADA (YDV)	
MODEL / MODÈLE: 	
<small>THE MANUFACTURER DECLARES THAT THIS PRODUCT COMPLIES WITH THE CONSTRUCTION REQUIREMENTS OF THE SMALL VESSEL REGULATIONS, AS THEY READ ON THE DAY ON WHICH THE CONSTRUCTION OF THE VESSEL WAS STARTED OR ON THE DAY ON WHICH THE VESSEL WAS IMPORTED. LE FABRICANT ATTESTE QUE CE PRODUIT EST CONFORME AUX EXIGENCES DE CONSTRUCTION DU REGLEMENT SUR LES PETITS BATIMENTS EN VIGUEUR A LA DATE DU DEBUT DE SA CONSTRUCTION OU DE SON IMPORTATION.</small>	

219903554\_d

LABEL 3 - CANADIAN COMPLIANCE NOTICE (TYPICAL)

<p><b>THIS BOAT IS NOT REQUIRED TO COMPLY WITH THE FOLLOWING U.S. COAST GUARD SAFETY STANDARDS IN EFFECT ON THE DATE OF CERTIFICATION:</b></p> <ul style="list-style-type: none"> <li>• FUEL SYSTEM</li> <li>• DISPLAY OF CAPACITY INFORMATION</li> <li>• SAFE LOADING</li> <li>• FLOTATION</li> <li>• POWERED VENTILATION</li> </ul> <p><b>AS AUTHORIZED BY U.S. COAST GUARD GRANT OF EXEMPTION (COB 88-001).</b></p> <p>BOMBARDIER RECREATIONAL PRODUCTS INC. 565 DE LA MONTAGNE STREET VALCOURT, QUEBEC CANADA J0E 2L0</p> <p><b>ASSEMBLED IN CANADA</b></p>
---

219903510

LABEL 6 - TYPICAL

<p><b>AUSTRALIAN BUILDERS PLATE</b> Imported by BRP Australia Pty Ltd DATE 2015</p>
<p><b>Max persons 3 = 225 kg</b> <b>Max load = 295 kg</b> <b>Buoyancy Basic Flotation</b></p>
<p><b>WARNING</b></p> <p>Alteration of the boat's hull or permanent fittings may invalidate the particulars on this plate.</p> <p>Information determined - ISO 13590</p>

219904651

LABEL 4 - AUSTRALIAN MODEL ONLY

<p><b>CE 0609</b> </p> <p>BOAT CATEGORY: C</p> <p>Max.  = 3</p> <p>Max.  = 273 kg</p> <p><small>Bombardier Recreational Products Inc. - Canada</small></p>
---

219902637

LABEL 5 - TYPICAL (WATERCRAFT OUTSIDE NORTH AMERICA EXCEPT AUSTRALIA)

# PRE-RIDE INSPECTION

We encourage you to have an Annual Safety Inspection of your vehicle. Please contact an authorized BRP dealer for further details. Though not required, it is recommended that an authorized BRP dealer performs the pre-season preparation of your watercraft. Each visit to your authorized BRP dealer is a great opportunity for your dealer to verify if your watercraft is included in any safety campaign. We also urge you to visit your authorized BRP dealer in a timely manner if you become aware of any safety related campaigns.

## WARNING

Perform a pre-ride inspection before each ride to detect potential problems during operation.. Correct any problems that you discover to reduce the risk of a breakdown or crash. See an authorized Sea-Doo dealer as necessary.

Before performing the pre-ride inspection, read and understand the *CONTROLS* subsection.

## What to Do Before Launching the Watercraft

## WARNING

Engine should be off and the tether cord cap should always be removed from the engine cut-off switch prior to verifying the following points except for the engine start/stop button. Only start watercraft once all items have been checked and operate properly.

Check the items listed in the following table before launching the watercraft.

**NOTE:** After riding the watercraft, refer to *WATERCRAFT CARE* subsection to ensure the watercraft will be ready and in proper condition for the next outing.

ITEM	OPERATION	✓
Drain plugs	Tighten.	
Steering system	Check operation.	
Throttle lever	Check operation.	
iBR lever	Check operation.	
Front storage compartment cover, glove box and seat	Ensure they are closed and latched.	
Inflatable sponsons including running boards	Inspect and adjust pressure of inflatable sponsons.	
Navigation lights (if equipped)	Check operation. Depress start/stop button without tether cord installed on engine cut-off switch. Navigation lights should turn on.	
Engine cut-off switch and engine START/STOP button	Check operation. Do not run engine more than 30 seconds out of the water.	

## Drain Plugs

Secure bilge drain plugs.



TYPICAL - BILGE DRAIN PLUG LOCATIONS

1. Bilge drain plugs
2. Tighten
3. Untighten

### **⚠ WARNING**

Ensure bilge drain plugs are properly secured prior to launching the watercraft in water.

## Steering System

Assisted by another person, check steering operation for free movement.

When the handlebar is horizontal, the jet pump nozzle should be in the straight ahead position. Ensure the jet pump nozzle pivots easily and in the same direction as the handlebar (e.g.: when handlebar is turned to the left, the nozzle opening must point towards the LH side of watercraft).

### **⚠ WARNING**

Check handlebar and corresponding steering nozzle operation before starting. Never turn handlebar while someone is near the rear of the watercraft. Keep away from steering moving parts (nozzle, iBR gate, linkages etc.).

## Throttle Lever

Check the Electronic Throttle Control lever (ETC) for free and smooth operation. It should return to its initial position immediately after it is released.

### **⚠ WARNING**

Check throttle lever operation before starting the engine. If any friction is felt in the throttle lever, refer to an authorized Sea-Doo dealer.

## iBR Lever

Check the iBR lever for free and smooth operation. It should return to its initial position immediately after it is released.

### **⚠ WARNING**

Check iBR lever operation before starting the engine. If any friction is felt in the iBR lever, refer to an authorized Sea-Doo dealer.

## Storage Compartment, Glove Box and Seat

Ensure all required safety and survival equipment and any additional cargo is properly stored in the storage compartment provided.

Ensure the front cover, glove box, and seat are closed and latched.

### **⚠ WARNING**

Ensure the seat, glove box, and front storage compartment cover are securely latched.

## Inflatable Sponsons and Running Boards

Check condition and solidity of the inflatable sponsons and running boards.

Check air pressure in inflatable sponsons. Adjust to specification:

SPONSON PRESSURE	
MINIMUM	MAXIMUM
28 kPa (4 PSI)	41 kPa (6 PSI)

**NOTE:** Exterior air temperature and sun affect air pressure; always readjust accordingly.

**⚠ WARNING**

Never inflate sponson more than 41 kPa (6 PSI). Inflating sponson more than the specified pressure may damage sponson and cause personal injury. Never use high pressure to inflate sponson.

**Rear Mast**

Check condition of the rear mast and its support.

**Navigation Lights**

Ensure all navigation lights are operational.

**Engine Cut-Off Switch and Engine START/STOP Button**

Install the tether cord cap on the engine cut-off switch.

Press the START/STOP button to start the engine, then stop it by pressing the START/STOP button a second time.

Restart the engine, then stop it by removing the tether cord from the engine cut-off switch.

**⚠ WARNING**

Should the tether cord cap be loose or fail to remain on the engine cut-off switch, replace the tether cord immediately in order to avoid unsafe use. If removing the tether cord cap from the engine cut-off switch or pressing the START/STOP button does not stop the engine, do not use the watercraft. See your authorized Sea-Doo dealer.

**What to Do After Launching the Watercraft**

Check the items listed in the following table after launching the watercraft and before going for a ride.

ITEM	OPERATION	✓
Information Center	Check operation	
Intelligent Brake and Reverse System (iBR)	Check operation	
Variable Trim System (VTS)	Check operation	

**Information Center (Gauge)**

1. Press START/STOP button and install the tether cord cap on the engine cut-off switch.
2. As the information center cycles through its self-test function, ensure all indications come on.

**⚠ WARNING**

Always attach the tether cord clip to your PFD or to the wrist (wrist strap required).

**iBR System**

**NOTICE** Ensure there is sufficient space ahead and behind watercraft to safely carry out the iBR system test to avoid a collision. Watercraft will move during test.

1. Remove the moorings securing the watercraft to the dock.
2. Start the engine and ensure the watercraft does not move.
3. On the left handlebar, depress the iBR lever completely in, the watercraft should move slowly backwards.
4. Release the iBR lever, there should not be any reverse thrust.

**⚠ WARNING**

Always ensure proper iBR system operation before taking the watercraft out for a ride.

## **Variable Trim System**

With the engine running in forward position, use the VTS system to move the jet pump nozzle up and down alternately to check VTS operation. Confirm the VTS position indicator movement in the information center.

Refer to *OPERATING INSTRUCTIONS* subsection for detailed instructions.

# ***WATERCRAFT INFORMATION***

# CONTROLS

**NOTE:** Some vehicle safety labels are not shown on illustrations. For information on vehicle safety labels, refer to *WATERCRAFT SAFETY LABELS* subsection.

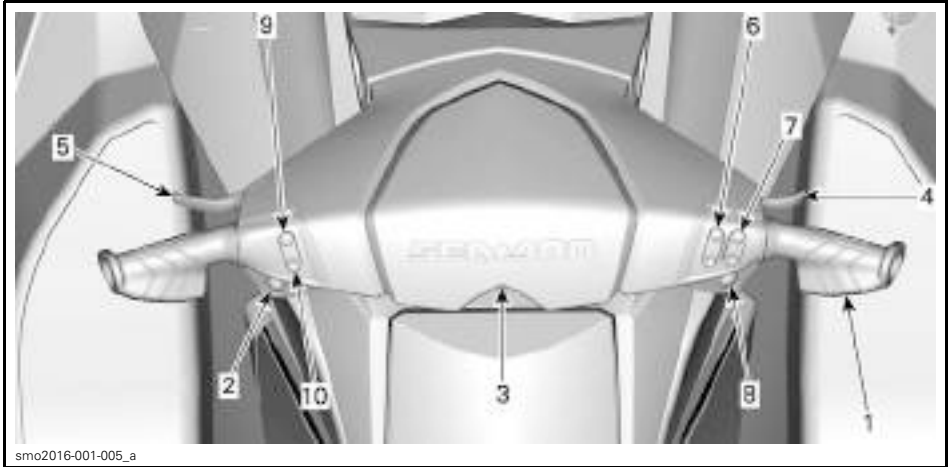

## 1) Handlebar

The handlebar controls the direction of the watercraft. During forward operation, turning the handlebar to the right steers the watercraft to the right and inversely.

### **⚠ WARNING**

Check handlebar and corresponding steering nozzle operation before starting. Never turn handlebar while someone is near the rear of the watercraft. Keep away from the propulsion system.

## 2) Engine START/STOP Button

The engine START/STOP button is located on the LH handlebar.

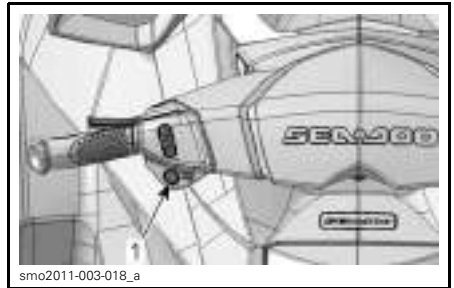

*TYPICAL*

1. START/STOP button

## Engine Starting and Stopping

Refer to *OPERATING INSTRUCTIONS* subsection for detailed instructions.

## Waking Up the Electrical System

Press the START/STOP button once without installing the tether cord on the engine cut-off switch.

This will power up the electrical system; the information center will cycle through a self-test function and will then go blank after a few seconds.

The electrical system will stay powered up for approximately 3 minutes after the START/STOP button was depressed.



**NOTE:** If the START/STOP button is pressed and held without the tether cord installed, the information center displays will stay on as long as the START/STOP button is held.

### 3) Engine Cut-Off Switch

The engine cut-off switch is located in the middle of the handlebar.

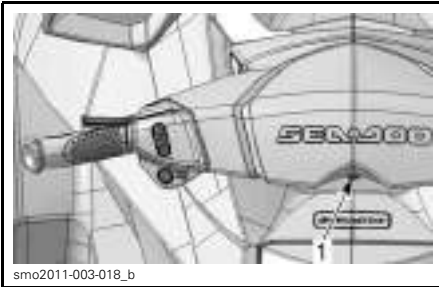

smo2011-003-018\_b

#### TYPICAL

1. Engine cut-off switch

To allow engine starting, the tether cord cap must be securely snapped onto the engine cut-off switch.

### ⚠ WARNING

Always attach the tether cord clip to the operator's personal flotation device (PFD) or wrist (wrist strap required).



smo2014-008-002\_a

#### TYPICAL

1. Tether cord cap on the engine cut-off switch
2. Tether cord clip secured to operator's PFD

To stop engine, pull the tether cord cap from the engine cut-off switch.

### ⚠ WARNING

Should the engine be stopped, the brake function (models with iBR) and watercraft directional control is lost.

### ⚠ WARNING

Always disconnect the tether cord when the watercraft is not in operation in order to prevent accidental engine starting or to avoid unauthorized use by others, children, and to prevent theft.

### 4) Throttle Lever

The throttle lever on the RH handlebar electronically controls the engine speed.

To increase or maintain watercraft speed, pull on the throttle lever with your finger.

To decrease watercraft speed, release the throttle lever.

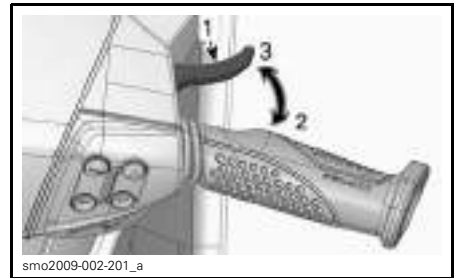

smo2009-002-201\_a

#### TYPICAL

1. Throttle lever
2. To accelerate
3. To decelerate

The throttle lever is spring loaded and should return to rest position (idle) when not pressed.

### 5) iBR Lever (intelligent Brake and Reverse)

The iBR lever on the LH handlebar can electronically command:

- Reverse

- Neutral
- Braking.

**NOTE:** A minimum of 25% lever travel is required to activate iBR functions.

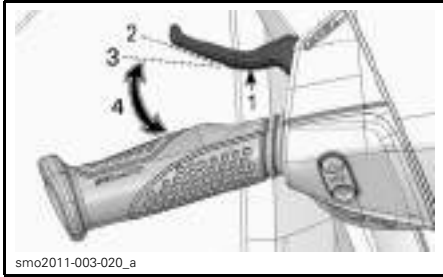

**TYPICAL - iBR LEVER**

1. iBR lever
2. Lever rest position
3. 25% stroke required to activate iBR function
4. Operating range

At speeds below 14 km/h (9 MPH), pulling the iBR lever in will engage reverse.

**NOTE:** If water current is 14 km/h (9 MPH) or above, the reverse can not be engaged as the speed threshold for the reverse is exceeded.

At speeds above 14 km/h (9 MPH), pulling the iBR lever in will engage the brake.

When the iBR lever is released after braking or reverse operation, neutral is engaged.

**⚠ WARNING**

If the throttle lever is still pulled in when releasing the iBR lever, forward movement will be initiated after a short delay. If forward acceleration is not desired, release the throttle lever.

**NOTE:** The neutral position can be fine tuned by trimming the iBR system.

Refer to *OPERATING INSTRUCTIONS* subsection for detailed instructions.

## 6) MODE/SET Buttons

These buttons are located on the RH side of the handlebar.

Press MODE button to scroll through various functions available through the information center.

Press SET button to select the desired function, navigate through a function submenu, or to save any modified setting.



**TYPICAL**

1. MODE
2. SET
3. UP/DOWN button

Refer to *OPERATING INSTRUCTIONS* subsection for detailed instructions.

## 7) UP/DOWN Buttons

These buttons located on the RH side of the handlebar.

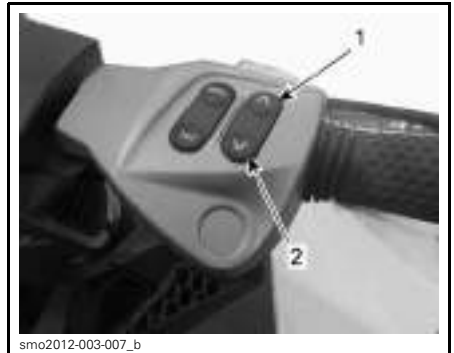

**TYPICAL**

1. Up button
2. Down button

The UP/DOWN buttons are used to make a selection or change a setting through the information center such as:

- Gauge functions
- Cruise mode
- Slow speed mode
- iBR neutral adjustment.

## 8) Cruise Button

The Cruise button is located on the RH side of the handlebar, just below the UP/DOWN buttons.



**TYPICAL**

1. Cruise button

It is used to activate or deactivate CRUISE mode or to engage SLOW SPEED MODE.

Refer to *OPERATING MODES* subsection for detailed instructions.

## 9) Sport Button

The Sport button is located on the LH handlebar.



**TYPICAL**

1. Sport button

It is used to return to SPORT mode after selecting the Touring mode if engine is not stopped.

Refer to *OPERATING MODES* subsection for details.

## 10) ECO Button

The ECO button is located on the LH handlebar.



**TYPICAL**

1. ECO button

It is used to activate or deactivate ECO mode. Refer to *OPERATING MODES* subsection for details.

# INFORMATION CENTER (GAUGES)

## ⚠ WARNING

Do not adjust the display while riding, you could lose control.

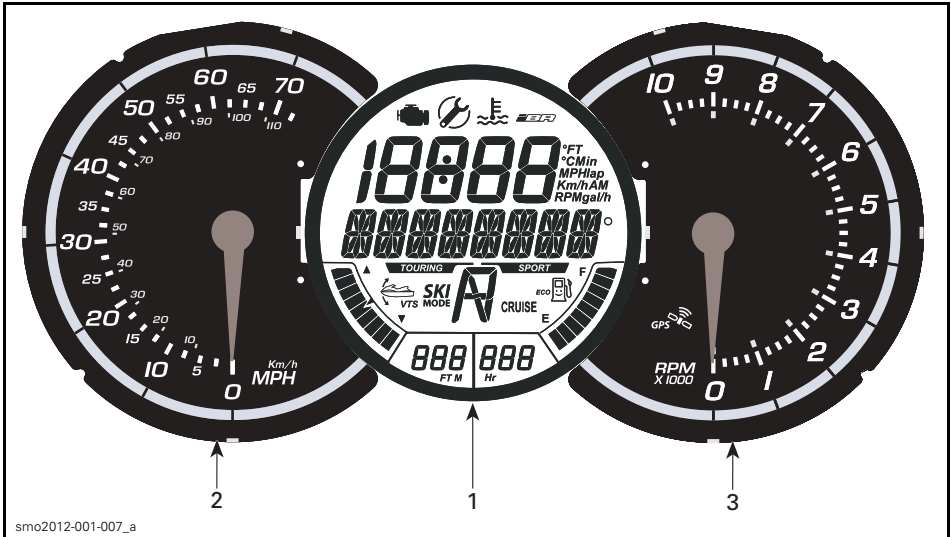

smo2012-001-007\_a

### TYPICAL

1. Multifunction gauge
2. Analog speedometer
3. Analog tachometer

## Multifunction Gauge Features

FEATURE	DISPLAY
Sport mode indicator	X
Touring mode indicator	X
Fuel level indication	X
Hour meter display	X
ECO mode indicator	X
CRUISE mode indicator	X
iBR position indicator	X
SKI mode indicator	N.A.
VTS position indication	X
X = Indicates a <b>standard</b> feature Opt = Indicates a feature available as an <b>option</b> N.A. = Not applicable	

# Multifunction Gauge Description

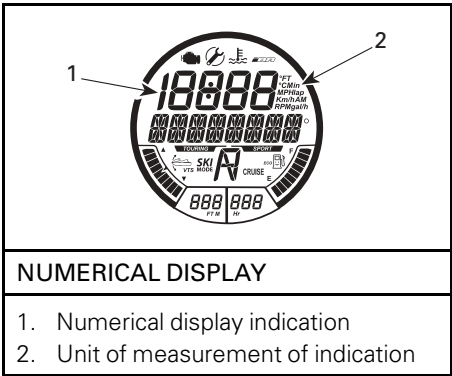
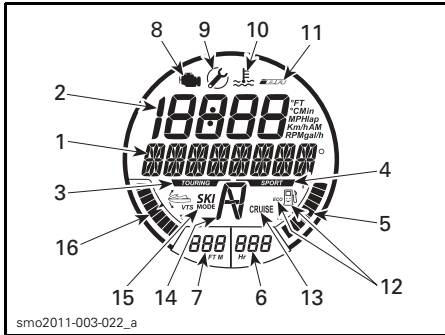

NUMERICAL DISPLAY

1. Numerical display indication
2. Unit of measurement of indication

## 1) Multifunction Display

- The multifunction display is used to:
- Display the WELCOME message on power up
  - Provide various indications as selected by the operator
  - Activating or changing various functions or modes of operation
  - Display scrolling messages of function activation or system faults
  - Display fault codes.

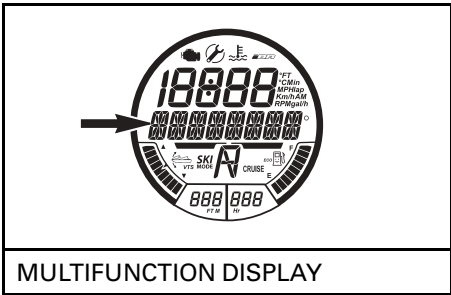

MULTIFUNCTION DISPLAY

**NOTE:** The default indication in the multifunction display is the compass direction.

## 2) Numerical Display

The numerical display is used to provide a variety of indications as selected by the operator using the DISPLAY function in the multifunction display.

AVAILABLE INDICATIONS IN NUMERICAL DISPLAY	
Watercraft speed	Indication by default
Engine RPM	X
Clock	X
CRUISE SPEED setting	X
SLOW SPEED MODE setting	X
VTS preset	-
VTS settings	X
Fuel consumption (instant and average)	X
Fuel autonomy (distance and time to empty)	-
Lap timer	-
Top speed/RPM Average speed/RPM	-
X = An X indicates a <b>standard</b> feature - = See your Sea-Doo dealer for availability.	

When the information center is first powered up, the numerical display defaults to the last selected indication.

### 3) Touring Mode Indicator

When the TOURING mode indicator is ON, the TOURING mode of operation is active.

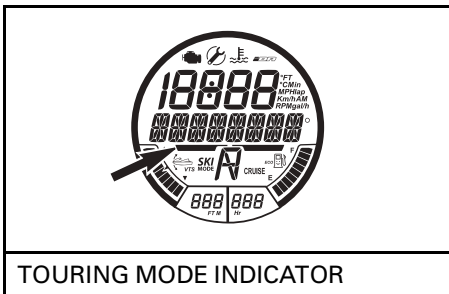

**NOTE:** The TOURING mode is not the default riding mode. To be active, it must be selected after starting the engine.

Refer to *OPERATING MODES* subsection for detailed instructions.

### 4) Sport Mode Indicator

When the SPORT mode indicator is ON, the default SPORT mode of operation is active.

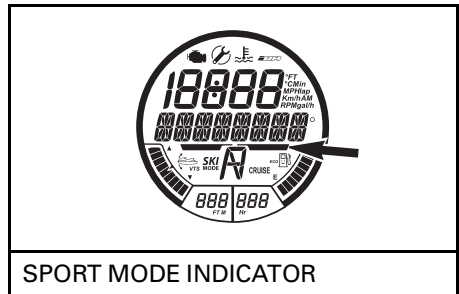

Refer to *OPERATING MODES* subsection for detailed instructions.

### 5) Fuel Level Indication

A bar gauge located in the bottom RH side of the multifunction display continuously indicates the amount of fuel in the fuel tank while riding.

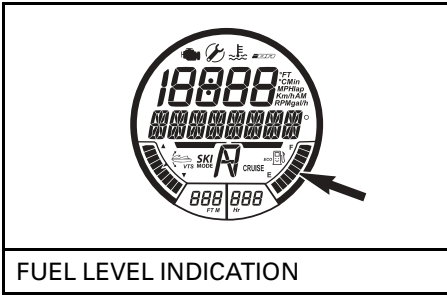

When the fuel tank is full, 8 segments (bars) of the indicator are turned on. The top segment is not used.

### Low Fuel Level Warning

When there is only 2 segments of fuel indicated (approximately 25% fuel tank capacity or 14 L (3.7 U.S. gal.), the following warnings will be ON.

LOW FUEL LEVEL WARNING	
Last 2 fuel gauge segments	Flashing
Fuel tank symbol	
Audible warning (one long beep)	Periodically
Scrolling LOW FUEL WARNING message	

### 6) Hour Meter Display (HR)

Continuously displays the accumulated engine hours.

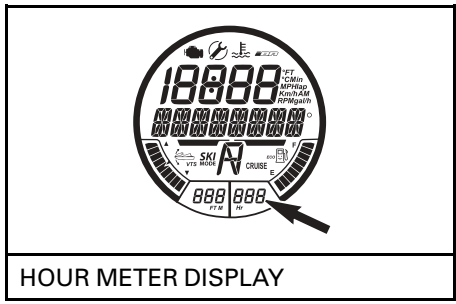

### 7) Water Depth Display

NOTE: This feature is not available on the SAR.

The water depth display provides an indication of the lake water depth.

The system is capable of indicating water depth under the hull in single increments up to 50 m (164 ft).

NOTE: Under certain conditions, the display may stop indicating. The display's ability to provide and indication of the water's depth depends on the conditions of use.

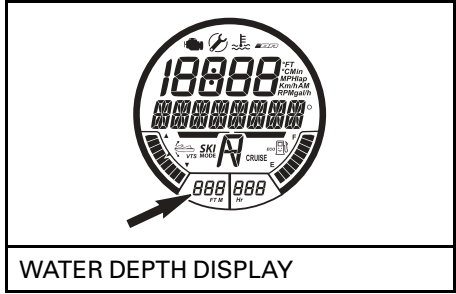

NOTE: The water depth indication is only available when a depth sounder is installed and detected.

**⚠ WARNING**

Never use the depth sounder as a warning device to ride in shallow water.

### 8) Check Engine Light

The check engine light comes ON when a fault is detected by the engine management system.

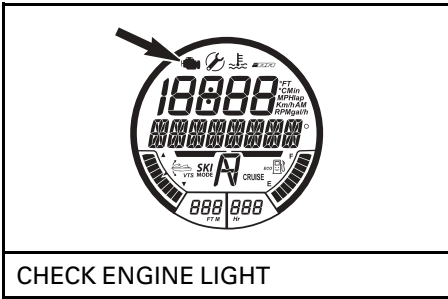

When the check engine light comes on, you may seek service from an authorized Sea-Doo dealer, repair shop, or person of your own choosing for maintenance, repair, or replacement. Please refer to the *US EPA EMISSIONS-RELATED WARRANTY* contained herein for information about warranty claims.

**9) Maintenance Reminder Indicator**

The maintenance reminder indicator comes ON when required maintenance is due.

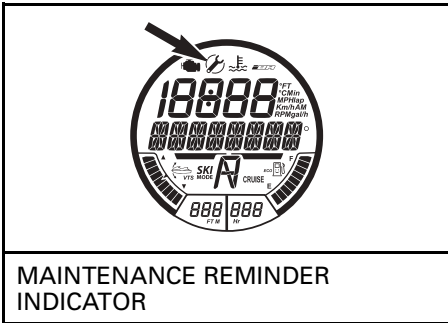

When the maintenance reminder indicator comes on, you may seek service from an authorized Sea-Doo dealer, repair shop, or person of your own choosing for maintenance, repair, or replacement. Please refer to the *US EPA EMISSIONS-RELATED WARRANTY* contained herein for information about warranty claims.

**10) High Temperature Indicator**

The high temperature indicator comes ON when a high engine temperature or a high exhaust system temperature is detected.

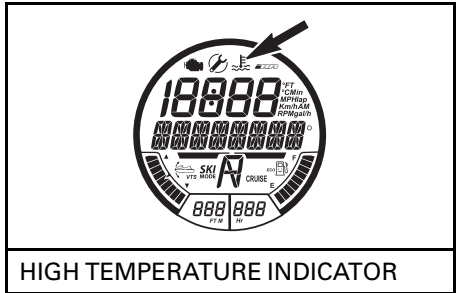

Refer to *TROUBLESHOOTING* sub-section for details.

**11) iBR Fault Indicator**

The iBR fault indicator comes ON when a fault in the iBR system has been detected.

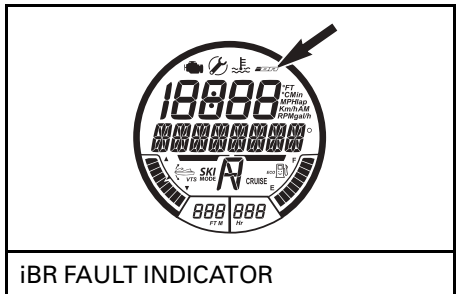

Refer to *TROUBLESHOOTING* sub-section for details.

**12) ECO Indicator**

The ECO indicator and a smile in the fuel tank symbol comes ON when **FUEL ECONOMY MODE** is activated.



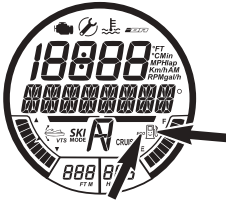

**ECO MODE INDICATOR**  
(Fuel Economy Mode)

Refer to *OPERATING MODES* subsection for detailed instructions.

**13) CRUISE Mode Indicator**

The cruise mode indicator comes ON when:

- CRUISE MODE has been activated.
- SLOW SPEED MODE has been activated.

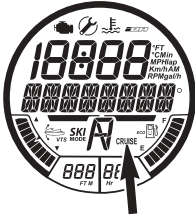

**CRUISE MODE INDICATOR**

Refer to *OPERATING MODES* subsection for detailed instructions.

**14) iBR Position Indicator**

Provides an indication of the iBR gate position.

- N (neutral)
- F (forward)
- R (reverse).



**iBR POSITION INDICATOR**

**15) SKI MODE Indicator**

The ski mode indicator is not active on the SAR model.



**SKI MODE INDICATOR**

**16) VTS Position Indication**

The VTS position indication provides an indication of the pump nozzle position.

A single segment of a bar gauge type indicator is turned on to indicate the relative position of the watercraft bow.

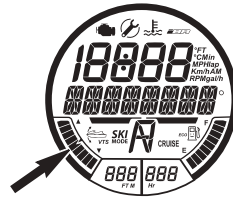

**VTS POSITION INDICATION**

Refer to *OPERATING INSTRUCTIONS* subsection for detailed instructions.

## Navigating the Multifunction Display

### **⚠ WARNING**

Do not adjust display while riding, you could lose control.

### Selecting Functions

When operating at speed, the multifunction display provides an indication of the compass direction and azimuth of the watercraft is traveling by default.

- To select the various functions available through the multifunction display, press the MODE button repeatedly until the desired function is visible:
  - LAP TIMER
  - FUEL ECONOMY MODE
  - FUEL CONSUMPTION
  - VTS MODE
  - DISPLAY
  - FAULT CODES
  - SETTINGS.

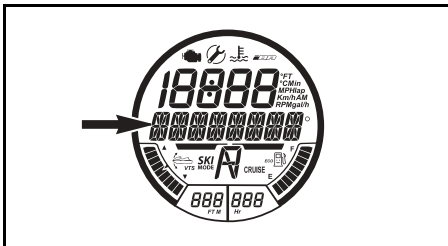

FUNCTION SUBMENU DISPLAYED IN SEQUENCE WHEN MODE BUTTON PRESSED REPEATEDLY

- Then press the SET button to enter that function.

**NOTE:** The available functions and the order in which they appear depends on the watercraft model. The fault code function is only available when there is an active fault. The settings function is only available when the engine is shut off.

## Function Description

### Compass

A GPS incorporated in the information center provides the indication in the multifunction display.

The cardinal points, intermediate cardinal points, as well as the azimuth the watercraft is travelling are displayed in the multifunction display by default when the watercraft is moving.

For a compass indication to be displayed, the GPS must have a good link with the navigation satellites.

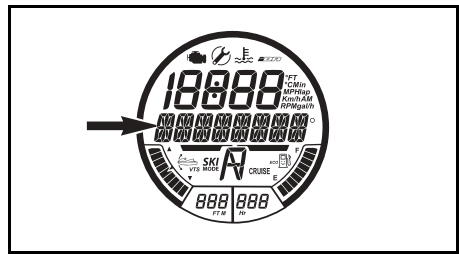

COMPASS DIRECTION DISPLAYED

**NOTE:** The compass indication is only available above 5 km/h (3 MPH).

### **⚠ WARNING**

Use the compass as a guide only. Not to be used for precision navigation purposes.

### Lap Timer

The lap timer can be used to record up to 50 individual lap times.

To activate and use the lap timer, carry out the following:

- Press the MODE button repeatedly until LAP TIME is visible in the multifunction display.

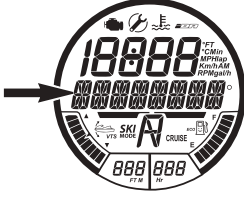

18888

00000000000000000000

888 888

FTM IN

MESSAGE DISPLAYED

LAP TIME

2. Press the SET button to enter the function, the lap timer will be activated and visible in the display.

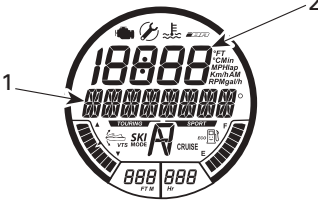

00'00'00

0

888 888

FTM IN

LAP TIMER FUNCTION

1. 00'00'00 lap time displayed here

2. Lap number "0" displayed here

3. To start the timer, press the SET button.

**NOTE:** The timer starts immediately when pressing the SET button.

4. To record each lap time, press the SET button at the start of each lap.

**NOTE:** The lap time will be recorded, the lap counter in the numerical display will count the number of laps recorded, and the timer will continue to run.

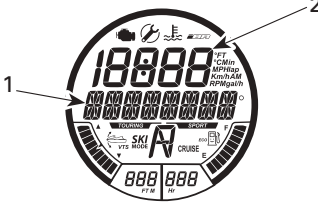

01'02'34

1

888 888

FTM IN

LAP TIMER FUNCTION EXAMPLE

1. 01'02'34 lap time displayed here

2. Lap number "1" displayed here

5. To save the last lap and stop the timer, press the MODE button.

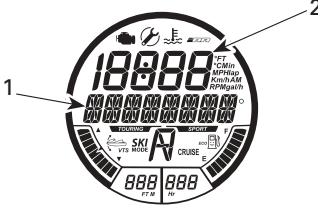

01'21'03

2

888 888

FTM IN

LAP TIMER FUNCTION EXAMPLE

1. 01'21'03 lap time displayed here

2. Lap number "2" displayed here

To view each lap time, use the UP/DOWN button. The lap counter will indicate which lap is indicated.

To view the cumulative lap time of all laps recorded, use the UP/DOWN button until ALL is visible in the lap counter.

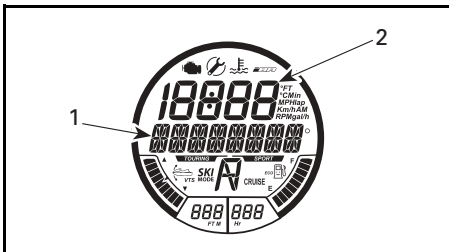

LAP TIMER FUNCTION EXAMPLE

1. Total lap times 02'23'37 displayed here
2. Lap count "ALL" displayed here

To reset the lap timer and lap counter, press and hold the SET button until the timer and counter are reset to 0 (zero).

ECO Mode

ECO mode is a function by which engine fuel consumption is reduced. Refer to *OPERATING MODES* subsection for detailed instructions.

Fuel Consumption

The FUEL CONSUMPTION function is used to display the watercraft fuel consumption four different ways:

- Instant fuel flow per hour (gal/h or L/h)
- Average fuel flow per hour (gal/h or L/h)
- Distance to empty (Mi or Km)
- Time to empty (h or min).

The fuel consumption functions are not continuously active.

The fuel consumption function selected becomes active only when selected as the indication in the numerical display.

When the LOW FUEL indications come on in the multifunction gauge, the "TIME TO EMPTY" and "DISTANCE TO EMPTY" functions will indicate "0" (zero) if they are the selected indication.

To display the watercraft fuel consumption, carry out the following:

1. Press the MODE button repeatedly until FUEL CONSUMPTION is visible in the multifunction display.

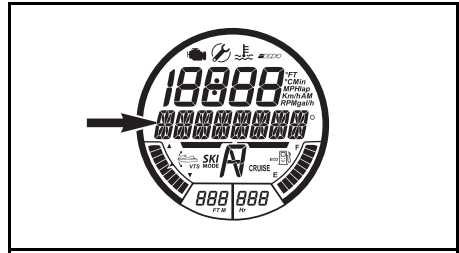

MESSAGE DISPLAYED

FUEL CONSUMPTION

2. Press the UP/DOWN button to toggle to the desired fuel consumption display mode.

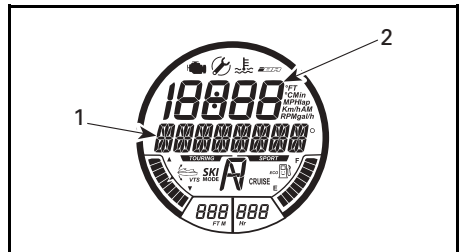

FUEL CONSUMPTION DISPLAY MODE

1. INSTANT FUEL CONSUMPTION message
2. Applicable value

3. Press the SET button to save the setting and return to the main display.

**NOTE:** The fuel consumption value selected will be displayed in the numerical display. Double click the SET button to reset the average fuel consumption indication. The display will momentarily indicate zero (0).

### VTS Mode

The VTS MODE function is used to manually set the VTS or change VTS PRESET settings.

Refer to *OPERATING INSTRUCTIONS* subsection for detailed instructions.

### Display

The DISPLAY function is used to change the indication in the numerical display. Refer to *CHANGING NUMERICAL DISPLAY INDICATION*.

### Fault Codes

The FAULT CODES function is used to display active fault codes.

Refer to *MONITORING SYSTEM* subsection for details.

### Settings

The SETTINGS function is used for:

- Changing the clock setting, refer to *MULTIFUNCTION GAUGE SETUP*.
- Activating the iBR override function, refer to *SPECIAL PROCEDURES*.

## Changing Numerical Display Indication

To change the indication in the numerical display, carry out the following:

1. Press the MODE button on the RH handlebar repeatedly until DISPLAY is visible in the multifunction display.

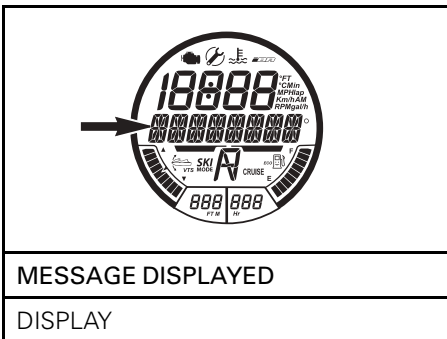

2. Press the SET button to enter the DISPLAY function.

3. Press the UP/DOWN button until the preferred indication is visible in the multifunction display (as applicable to model).

- RPM
- SPEED
- CLOCK
- ENGINE TEMP
- TOP SPEED
- AVG SPEED
- TOP RPM
- AVG RPM.

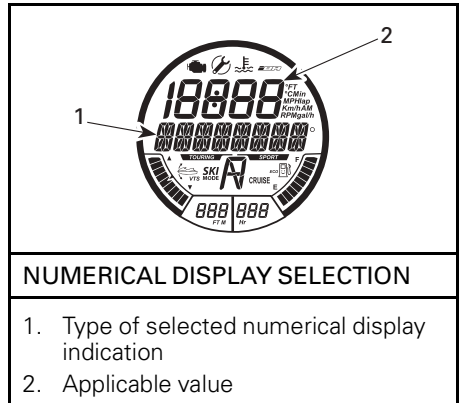

4. Press the SET button to select and save the preferred indication, or wait for the display function to time out. The last indication visible will be automatically saved.

## Resetting Numerical Display Indication

The following numerical display indications can be reset when selected:

- Average fuel consumption
- Top speed
- Average speed
- Top RPM
- Average RPM.

To reset the indication, double click the SET button. The numerical display will momentarily indicate zero (0).

NOTE: Each of these functions become active **ONLY** when selected as the numerical display indication.

## Multifunction Gauge Setup

### Clock Setting

1. Press the MODE button repeatedly until SETTINGS is visible in the multifunction display.

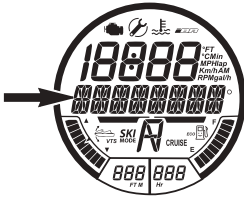

MESSAGE DISPLAYED
SETTINGS

2. Press the UP/DOWN button repeatedly until CLOCK is visible.

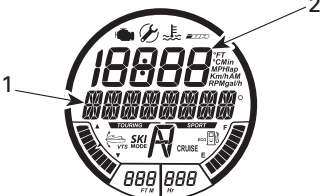

FUNCTION SELECTED - CLOCK
1. CLOCK indication
2. Time

3. Press the SET button to enter the function. CHANGE CLOCK OFFSET message will be displayed.

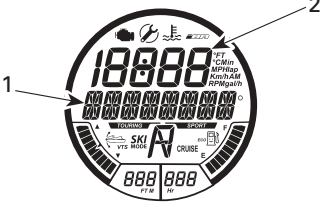

FUNCTION SELECTED - CHANGE CLOCK OFFSET
1. CHANGE CLOCK OFFSET indication
2. Time

4. Press the UP/DOWN button to adjust the clock to the correct local time.
5. Press the SET button to save the setting and return to the main display.

NOTE: The clock uses the GPS signal to maintain the appropriate time referenced to Greenwich Mean Time (GMT). When setting the clock, only the hour indication may be changed.

### Units of Measurement and Language Setting

The multifunction gauge is capable of displaying information in metric or imperial units and in various languages.

To change the units of measurement or to change the language displayed in the multifunction gauge, see your authorized Sea-Doo dealer.

### Analog Speedometer Description

The speedometer, located in the LH side of the information center, provides an analog indication of the speed of the watercraft in miles per hour (MPH) and kilometers per hour (km/h).

The speed indication is based on a GPS (Global Positioning System) incorporated within the information center.

If for some reason the GPS signal is lost, a default mode is used whereby, the speed is calculated using information received from other systems to provide an estimated watercraft speed.

## **Analog Tachometer Description**

The tachometer provides an analog indication of the revolutions per minute (RPM) of the engine. Multiply the indicated number by 1000 to obtain the actual engine RPM.

# EQUIPMENT

**NOTE:** Some vehicle safety labels are not shown on illustrations. For information on vehicle safety labels, refer to *WATERCRAFT SAFETY LABELS* subsection.

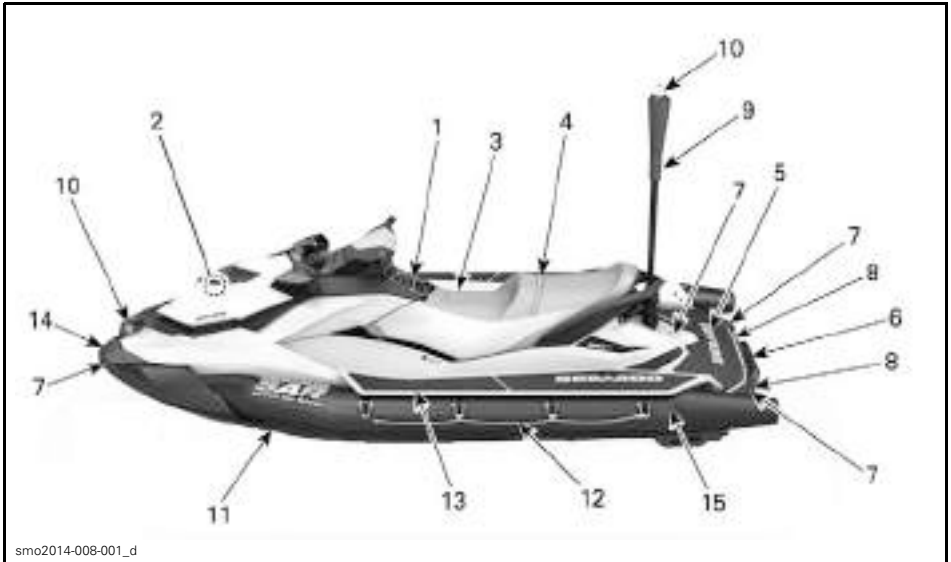

TYPICAL - MODEL WITH NAVIGATION LIGHTS AND INFLATABLE SPONSON SHOWN

## 1) Glove Box

A small, storage compartment for personal articles.

Pull up on cover latch to open glove box.



TYPICAL — GLOVE BOX

1. Cover latch

## 2) Front Storage Compartment

A convenient area to carry personal articles.

The front storage compartment also contains two holders for safety equipment; one for a fire extinguisher and another for the emergency kit (these are not provided).



**FRONT STORAGE COMPARTMENT**

1. Fire extinguisher secured in holder
2. Emergency kit secured in holder

To open the front storage compartment cover, pull the latch lever upward. Always close and latch cover when riding.

**TYPICAL**

1. Front storage compartment cover
2. Latch lever

## ⚠ WARNING

Never carry any loose, heavy, sharp, or breakable objects in the storage compartment. Do not exceed maximum load capacity; 9 kg (20 lb). Never operate the watercraft with the front storage compartment cover open. This is not a watertight compartment.

### 3) Seat

Removing the seat provides access to the engine compartment.

The seat latch is located at the back end of the seat.

To remove the seat, pull up on the latch handle and lift the back end of the seat off the latch pin. Then pull the seat up and backwards to unhook the front of the seat from it's retainer and remove the seat from the watercraft.

**TYPICAL - SEAT LATCH**

1. Seat latch handle
2. Latch pin
3. Pin insertion hole

To install the seat, insert the forward end of the seat in it's retainer.

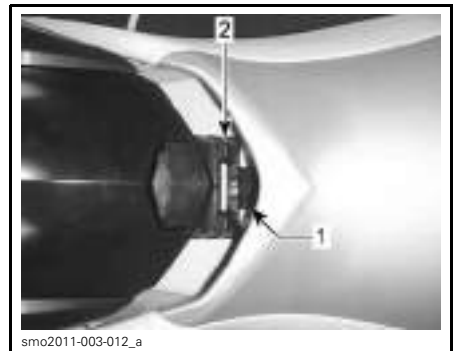

1. Forward seat tab
2. Forward seat retainer

Align the seat latch with the latch pin and firmly press down on the rear portion of the seat to lock it in place.

Pull up on the rear portion of the seat to ensure it is properly latched.

**⚠ CAUTION** Ensure the latch is properly locked onto the pin.

## 4) Passenger Handhold

The seat strap provides a handhold for a passenger to hold on to when riding.

The sides of the molded grab handle at the rear of the seat also provide a handhold for a passenger. The rear portion of the molded grab handle provides a handhold for the spotter or boarding the watercraft from the water.

**NOTICE** Never use the molded grab handle to tow anything or to lift the watercraft.



smo2011-003-013\_a

### TYPICAL - PASSENGER HANDHOLDS

1. Seat strap
2. Molded grab handle

## 5) Boarding Platform

The rear deck area serves as the boarding platform.

The aft portion of the foot wells near the boarding platform are used as foot rests for the rear facing spotter (if applicable).



smo2014-008-010\_a

### TYPICAL

1. Boarding platform
2. Spotter foot rests (each side)

## 6) Boarding Step

A convenient step used for boarding the watercraft from the water.



smo2009-002-132\_a

### TYPICAL

1. Boarding step

## **⚠ WARNING**

The engine must be shut off before attempting to board the watercraft using the boarding step.

Pull down the step with your hand and hold until a foot or a knee is put on the step.



**TYPICAL - BOARDING STEP HELD DOWN FOR BOARDING FROM WATER**

### **NOTICE**

- Never use the step for boarding a watercraft that is out of water.
- Never use the step for pulling, towing, diving or jumping, or any other purpose other than as a boarding step.
- Stay on center of the step.
- Only one person at a time on the step.

**NOTE:** If a rescue sled is attached, the boarding step will not be easily accessible and should not be used.

### **⚠ WARNING**

Be aware of the iBR gate movement when starting the engine, shutting down the engine or using the iBR lever. Automatic movement of the gate may squeeze fingers or toes of people taking a hold on the back or your PWC.

## **7) Eyelets**

### **Front Eyelet**

The front eyelet can be used for:

- Mooring the watercraft
- Towing the watercraft
- Lifting the watercraft
- As a tie-down point when trailering the watercraft.



**TYPICAL**

1. Front eyelet

### **Transom Eyelets**

The transom eyelets can be used for:

- Mooring the watercraft
- Lifting the watercraft
- As a tie-down point for a rescue sled or when trailering the watercraft.



**TYPICAL**

1. Transom eyelets

### **Central Eyelet**

The central eyelet must be used only as a tie-down point for a rescue sled.



smo2014-008-003\_a

**TYPICAL**

1. Central eyelet

**NOTICE** Do not use the central eyelet for towing. Use only for attaching a rescue sled.

## 8) Bilge Drain Plugs

Unscrew drain plugs whenever watercraft is on the trailer. This will allow water accumulated in the bilge to be evacuated and helps to reduce condensation.



smo2009-002-135\_a

**TYPICAL**

1. Drain plugs
2. Tighten
3. Loosen

**NOTICE** Ensure drain plugs are properly secured prior to launching the watercraft in water.

## 9) Rear Mast

The rear mast should be used only as a grabbing support for added stability when the watercraft is stopped.

**CAUTION** Never attach to the mast to pull a load. This can cause damage to the mast and/or watercraft.



smo2014-008-001\_g

1. Rear mast

## 10) Navigation Lights

The navigation lights automatically turn on whenever the electrical system is activated or if the engine is started.



smo2014-008-001\_f

1. Bow lights
2. Stern light

## 11) Inflatable Sponsons

The inflatable sponsons provide more stability and increase the buoyancy of the watercraft.



1. Sponson (on each side)

**NOTICE** Sponsons must be inflated to correct pressure at all times. Refer to *MAINTENANCE* section.

## 12) Ropes

The rope on each side of the sponson provides grip for a person in the water.



1. Rope (on each side)

**CAUTION** Never attach to the rope to pull a load or lift the watercraft. This can cause damage to the rope or inflatable sponson.

## 13) Running Boards

The running boards allow for a safe footing on the sponsons.



1. Running board (on each side)

## 14) Heavy-Duty Front Bumper

The heavy duty front bumper protects the front end of the watercraft.



1. Front bumper

**NOTICE** The front bumper is not intended as a push bumper. Use the transom eyelets to tow if needed.

## 15) Flip Line

The flip line is in a bag located aft of the inflatable sponson on the left side.

**NOTE:** The flip line is used to return a capsized watercraft. Refer to *SPECIAL PROCEDURES* subsection for more details.

---

## BREAK-IN PERIOD

### Operation During Break-In Period

A break-in period of 10 operating hours is required before running the watercraft at sustained full throttle.

During this period, maximum throttle should not exceed 1/2 to 3/4 opening. However, brief full acceleration and speed variations contribute to a good break-in.

**NOTICE** Continued wide open throttle accelerations or operation, prolonged cruising speeds are detrimental during the break-in period.

# OPERATING INSTRUCTIONS

## **⚠ WARNING**

Always perform the *PRE-RIDE INSPECTION* before operating this watercraft. Be sure to read the *SAFETY INFORMATION* and the *WATERCRAFT INFORMATION* sections and be thoroughly familiar with the iControl technology.

Should any control or instruction not be fully understood, refer to an authorized Sea-Doo dealer.

## **Boarding the Watercraft**

As with any watercraft, boarding should be done carefully and engine must not be running.

## **⚠ WARNING**

Engine must be OFF and tether cord must be removed when boarding the watercraft or when using the boarding step. Never use propulsion system components as a supporting point to board the watercraft.

## **Boarding from a Dock**

When boarding from a dock, slowly place one foot on the watercraft footboard (or sponson running board when equipped with) nearest the dock while holding the handlebar, and at the same time, transfer the body weight to the other side in order to balance the watercraft.

Then bring the other foot over the seat and place it on the footboard farthest of the dock. Push the watercraft away from the dock.



TYPICAL

## **Boarding from Water**

The ideal water depth to board the watercraft is 90 cm (3 ft). Take into account that the hull will be lower in the water when all passengers are aboard.

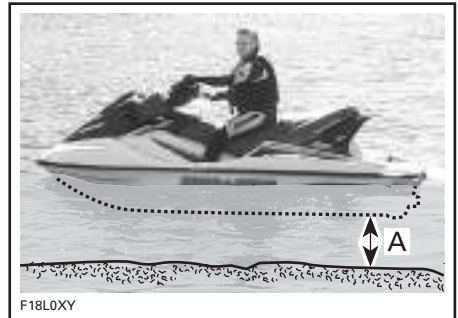

TYPICAL

A. Ideal water depth = 90 cm (3 ft)

If the watercraft must be board in shallower water, special care must be taken to avoid debris from clogging the intake grate or the cooling system and causing premature wear or damage to the propulsion system.

**NOTICE** In shallow water, keep speed to a minimum and avoid hard accelerations. Even though this watercraft is equipped with an anti-debris water intake grate, it is still possible that debris such as rocks, sand or other objects may damage the propulsion system. The hull protection coating may not prevent damages to the hull caused by collisions with obstacles.

**⚠ WARNING**

In shallow water, debris may be picked up and thrown rearward by the jet pump onto people or property.

**Operator Alone**

Using one hand, lower the boarding step.



TYPICAL

Using the other hand, take hold of the edge of the boarding platform, then pull yourself up so that you can knee onto the boarding step.



TYPICAL

**NOTICE**

- Stay on center of the step.
- Only one person at a time on the step.
- Never use propulsion system components to board.

Reach forward with one hand and take hold of the molded handle behind the seat (or the rear mast), then stand on the boarding step.



TYPICAL

With both hands on the handle behind the seat (or the rear mast), step up onto the boarding platform.



TYPICAL



TYPICAL



Take hold of the seat strap to help maintain your balance and step forward onto the footboards on either side of the seat.



smo2009-002-145

TYPICAL

Sit astride the seat.

### Operator with a Passenger

The operator climbs on the watercraft in the same way as explained previously.



smo2009-002-149

TYPICAL



smo2009-002-150

TYPICAL

## **⚠ WARNING**

Engine must be OFF and tether cord must be removed when boarding the watercraft or when using the boarding step. Never use propulsion system components as a supporting point to board the watercraft.

The passenger then climbs onto the watercraft while the operator maintains balance by sitting as close as possible to the console.



smo2009-002-148

TYPICAL

## How to Start Engine

### **⚠ WARNING**

Before starting the engine, the operator and passenger(s) should always:

- Be properly seated on the watercraft
- Have a firm grip on a handhold or hold on to the waist of the person in front of them
- Wear appropriate protective clothing including a PFD approved by local authorities.

**NOTICE** In shallow water, keep engine speed to a minimum and avoid hard accelerations. Even though this watercraft is equipped with an anti-debris water intake grate, it is still possible that debris such as rocks, sand or other objects may damage the propulsion system. The hull protection coating may not prevent damages to the hull caused by collisions with obstacles.

**⚠ WARNING**

In shallow water, debris may be picked up and thrown rearward by the jet pump onto people or property.

1. Attach the tether cord clip to your PFD or to the wrist (wrist strap required).
2. Firmly grip the handlebar with your left hand and place both feet on the footboards.
3. Install the tether cord on the engine cut-off switch.
4. Depress the START/STOP button to crank the engine.
5. Release engine START/STOP button immediately after engine is started.

**⚠ WARNING**

The tether cord clip should always be attached to the operators personal flotation device or to the wrist (wrist strap required) when starting or operating the watercraft.

**NOTICE** Do not hold START/STOP button more than 10 seconds to avoid starter overheating. A rest period should be observed between the cranking cycles to allow the starter to cool down.

**NOTE:** If the engine is stopped using the START/STOP button without removing the tether cord, it can be restarted within 3 minutes. After this delay, remove the tether cord and carry out the engine starting procedure from the beginning.

**How to Stop the Engine****⚠ WARNING**

To maintain watercraft directional control, the engine should be running until the watercraft is stopped.

The engine may be shut off using one of two methods:

- Pressing the engine START/STOP button, or
- Removing the tether cord from the engine cut-off switch.

**⚠ WARNING**

Never leave the tether cord on the engine cut-off switch when disembarking watercraft to prevent theft, accidental engine starting, and to avoid unauthorized use by children or others.

**How to Steer the Watercraft**

Turning the handlebar pivots the jet pump nozzle which controls the watercraft direction. Turning the handlebar to the right will turn the watercraft to the right, turning the handlebar to the left turns the watercraft to the left. The throttle should be applied to turn the watercraft.

**⚠ WARNING**

Throttle should be applied and handlebar turned to change the direction of the watercraft. Steering efficiency will differ depending on the amount of throttle applied, the number of passengers, the load, the water conditions and the environmental factors such as the wind.

Unlike a car, a watercraft needs some throttle to turn. Practice in a safe area applying the throttle and turning away from an imaginary object. This is a good collision avoidance technique.

**⚠ WARNING**

Directional control is reduced when the throttle is released and lost when the engine is off.

The watercraft behaves differently with a passenger and requires greater skill. The passenger(s) should always grip the seat strap, the molded grab handle, or the waist of the person ahead of them. Reduce speed and avoid sharp turns. Avoid choppy water conditions when carrying a passenger.

**Tight Turns and Other Special Maneuvers**

Any tight turns or special maneuvers that will cause the air inlet openings to be kept under water for a prolonged time, water will seep into the bilge.

Combustion engines need air to operate; consequently this watercraft cannot be totally watertight.

**NOTICE** If the air inlet openings are kept under water, such as turning constantly in tight circles, plunging the bow through waves, or capsizing the watercraft, water may seep into the bilge, which may cause severe damage to internal parts of the engine. Refer to the *WARRANTY* section contained in this guide.

**O.T.A.S.™ System  
(Off-Throttle Assisted Steering)**

The O.T.A.S. (Off-Throttle Assisted Steering) system provides additional maneuverability in off-throttle situations.

If the driver releases the throttle to idle when initiating a full turn, the O.T.A.S. system will be electronically activated, and will slightly increase engine speed to allow completion of the turn.

When the handlebar is brought back towards its center position, the throttle reverts to idle.

We recommend that you familiarize yourself with this feature during your first ride.

**How to Engage Neutral****⚠ WARNING**

The drive shaft and impeller are always turning when the engine is running, even in neutral position. Keep away from the propulsion system of the watercraft.

When the watercraft is first started, the iBR system automatically sets the neutral position by default.

To engage neutral from forward position, tap the iBR lever.

To engage neutral from reverse position, release the iBR lever and throttle lever.

**How to Trim the Neutral Position of the iBR**

When in NEUTRAL, if the watercraft creeps forward or backward, the iBR system may be trimmed.

**NOTE:** Movement of the watercraft when operating in neutral may be due to wind or water current.

If the watercraft is moving forwards, momentarily press the DOWN button.

If the watercraft is moving backwards, momentarily press the UP button.



**TYPICAL - TRIMMING THE iBR NEUTRAL POSITION**

1. UP button (to stop rearward movement)
2. DOWN button (to stop forward movement)

**NOTE:** Press the UP/DOWN button repeatedly until proper adjustment of the neutral position is attained and the watercraft stops moving.

## How to Engage Forward

To engage forward from neutral position, tap on the throttle lever. The watercraft will accelerate forward.

To engage forward from reverse position, release the iBR lever, then tap the throttle lever.

To re-engage forward from braking, simultaneously pull in the throttle lever while releasing the iBR lever. The watercraft will accelerate forward after a short delay.

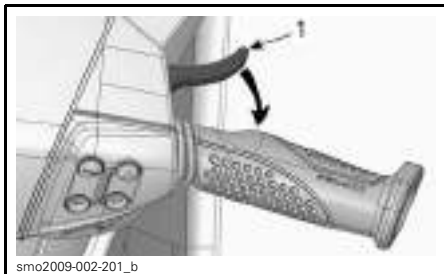

**TYPICAL - ENGAGING NEUTRAL**

1. Throttle lever

## How to Engage and Use Reverse

Reverse can only be engaged between idle speed and the threshold forward speed of 8 km/h (5 MPH).

To engage reverse position, the iBR lever on the LH handlebar must be pulled in at least 25% of the lever travel.

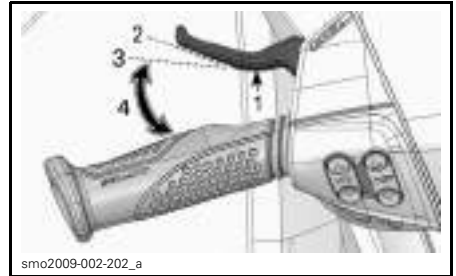

**TYPICAL - iBR LEVER**

1. iBR lever
2. Lever released position
3. Approximate 25% position
4. Operating range

When operating the iBR lever in reverse mode, the throttle lever can be used to control engine RPM, and thus the amount of reverse thrust produced.

By modulating both the iBR and throttle levers simultaneously, reverse thrust can be more precisely controlled. Too much RPM will create water turbulence and reduce reverse efficiency.

**NOTE:** Engine power will be reduced to idle whenever the iBR lever position is changed.

Release the iBR lever to end reverse operation.

To stop rearward motion after iBR lever release, apply enough throttle to stop rearward movement.

### **⚠ WARNING**

The brake function has no effect when travelling in reverse.

Available engine power is limited in reverse mode, which limits reverse speed.

### **⚠ WARNING**

Only use reverse at slow speed and for the shortest time possible. Always ensure the path behind is clear of objects, obstacles and people.

When operating in reverse, turn the handlebar in the opposite direction that you want to move the rear of the watercraft.

For example, to steer the rear of the watercraft to port (left), turn the handlebar to starboard (right).



F18J08Z

**TYPICAL - STEERING DIRECTION REVERSED WHEN BACKING**

**⚠ CAUTION** Steering direction in reverse is opposite of forward. To steer the stern to port (left) in reverse, turn the handlebar to starboard (right). To steer the stern to starboard (right), turn the handlebar to port (left). Reverse operation should be practiced in open waters in order to become fully familiar with the controls and watercraft handling characteristics before operating in close quarters.

## **How to Engage and Use Braking**

### **⚠ WARNING**

- The engine must be running to be able to use the brake.
- The brake is only applicable when operating in forward movement, it has no effect on rearward motion.
- The brake cannot prevent your PWC from drifting due to current or wind.

The braking function can only be engaged during forward operation at or above the threshold speed of 14 km/h (9 MPH).

Braking is engaged and controlled when the iBR lever on the LH handlebar is pulled in at least 25% of its travel.

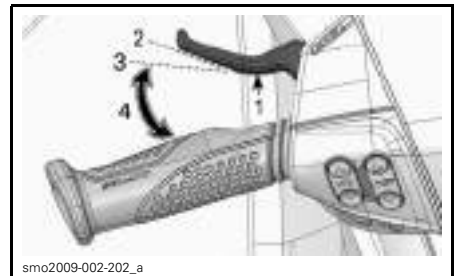

smo2009-002-202\_a

### **TYPICAL - iBR LEVER**

1. iBR lever
2. Lever released position
3. Approximate 25% position
4. Operating range

**⚠ WARNING**

Braking should be practiced in open waters and at gradually increasing speeds in order to become fully familiar with the controls and watercraft handling characteristics.

When iBR lever is applied, the throttle lever command is overridden and engine throttle control is now dependant on the iBR lever position. Braking can thus be modulated by using only the iBR lever.

Watercraft deceleration is proportional to the braking force. The more the iBR lever is pulled in, the greater the braking force applied.

**NOTE:** Be careful to gradually actuate the iBR lever to adjust intensity of the braking force and simultaneously release the throttle lever.

**⚠ CAUTION** When braking, riders must brace themselves against the deceleration force to prevent from moving forward on the watercraft and losing balance. The operator should always keep both hands on the handlebars, and all passengers should maintain a firm grip of a handhold or the waist of the person in front of them.

**⚠ WARNING**

Stopping distance will vary depending on initial speed, load, wind, number of riders, water conditions, and the amount of braking power commanded by the operator. Always adjust your riding style accordingly.

When the watercraft slows to less than 14 km/h (9 MPH), braking mode ends and reverse mode is engaged. Release the iBR lever once the watercraft is stopped. Otherwise, a rearward movement will be initiated.

**⚠ CAUTION** As the watercraft slows to a stop, the wake created by the watercraft will catch up and tend to push the watercraft forward. Ensure there are no obstacles or bathers in the direction of travel.

If the throttle lever is still pulled in when releasing the iBR lever, the watercraft will accelerate forward after a short delay. Acceleration will be proportional to the throttle lever position.

**⚠ WARNING**

If forward acceleration is not desired when the brake lever is released, release the throttle lever.

When at speed and the brake is first applied, a plume of water will shoot up in the air behind the watercraft which may cause the operator of a following watercraft to momentarily lose sight of your PWC.

**⚠ WARNING**

- It is important to inform the operator of a watercraft who intends to follow in a convoy formation, of the braking and maneuvering capability of your PWC, what the plume of water indicates, and that a greater distance must be maintained between watercraft.
- Be aware that other boats following or operating in close proximity may not be able to stop as quickly.

**Braking in a Turn**

Throttle must be applied for turning to ensure directional control. However braking can be initiated during a turn using the iBR lever as previously described. Get ready to maintain your balance while the wake is crossing your PWC.

**⚠ CAUTION** As the watercraft slows to a stop while braking in a turn, the wake created by the watercraft will catch up and tend to push the watercraft sideways. Be prepared to maintain balance as the wake crossed the watercraft.

### How to Use the Variable Trim System (VTS)

The variable trim system (VTS) changes the vertical position of the jet pump nozzle to provide the operator with a fast, effective system to compensate for load, thrust, riding position and water conditions. Correctly adjusted, it can improve handling, reduce porpoising, and position the watercraft at its best riding attitude to attain maximum performance.

When first using the watercraft, the operator should become familiar with the use of the variable trim system (VTS) at varying speeds and water conditions. A mid-range trim is generally used when cruising. Experience alone will dictate the best trim for the conditions. During the watercraft break-in period, when lower speeds are recommended, it is an excellent opportunity to become familiar with trim adjustment and its effects.

When the nozzle is positioned in an upward angle, the water jet directs the bow of the watercraft upward. This position is used to optimize high speed.

When the nozzle is directed downward, the bow is forced downward and increases the watercraft turning capabilities. As with any watercraft, speed and operator body position and movement (body English), will determine the degree and sharpness of the watercraft turn. Porpoising can be reduced or eliminated if the nozzle is downward and speed is adjusted proportionately.

**NOTE:** VTS position is indicated on a bar gauge in the information center.

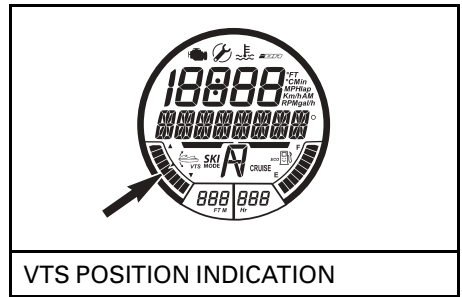

The VTS system allows for manually adjusting the trim position of the nozzle, or selecting two preset trim positions and recording or changing preset trim positions on certain models.

### VTS Trimming Methods

AVAILABLE VTS TRIMMING METHODS	
VTS trim button	N.A.
VTS "Double Click" trimming	N.A.
VTS "Presets"	N.A.
VTS trimming through multifunction gauge	X
X = Indicates a <b>standard</b> feature N.A. = Not Available	

### Trimming the VTS Using the VTS Button (Option)

Five trim positions are available.

With the watercraft operating in forward position, proceed as follows:

1. Press the VTS UP button once to trim the bow of the watercraft up to the next trim position.

**NOTE:** Pressing the VTS trim button without the engine in forward position will only change the indication. The nozzle will move to the selected VTS trim position when forward position is engaged.

2. Press the VTS DOWN button once to trim the bow of the watercraft down to the next trim position.

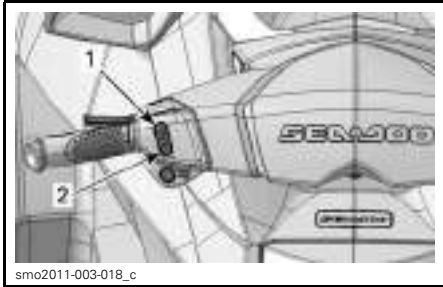

TYPICAL - VTS CONTROL BUTTON

1. Bow up
2. Bow down

**NOTE:** If the VTS UP/Down button is pressed and held, the pump nozzle will keep moving until the button is released at the desired trim attitude, or the maximum trim position (up or down) is reached.

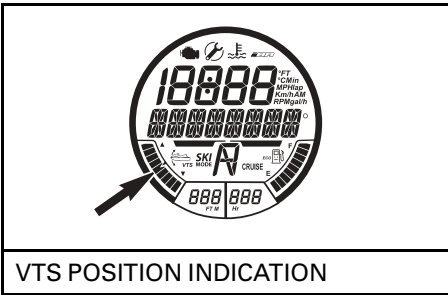

VTS POSITION INDICATION

### Using Preset Trim Positions

Two preset trim positions can be selected.

To select the highest trim position recorded, double-click on the VTS UP button (bow up).

To select the lowest trim position recorded, double-click on the VTS DOWN button (bow down).

**NOTE:** If only one preset trim position is recorded, double-click either UP or DOWN of the VTS button.

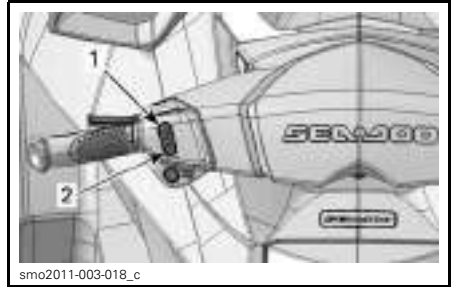

TYPICAL - DOUBLE-CLICK UP OR DOWN VTS BUTTON TO USE PRESET POSITIONS

1. Highest preset position on UP arrow
2. Lowest preset position on DOWN arrow

### Recording Preset Trim Positions

Two different VTS trim positions may be recorded for quickly selecting the preferred watercraft trim attitude.

Both VTS PRESET trim positions are factory set to 3 but may be changed as per operator preference. When the VTS PRESET trim positions are changed by an operator, the new settings will remain recorded in memory even after complete watercraft power down.

To record VTS preset trim positions:

1. Turn ON the electrical power by pressing the START/STOP button once.
2. Install the tether cord on the engine cut-off switch.
3. On the RH handlebar, press the MODE button repeatedly until VTS MODE is displayed.





sdd2009-001-024\_b

**TYPICAL**

1. MODE button
2. SET button
3. UP/DOWN button

6. Press the SET button to save PRE-SET 1 and display PRESET 2.
7. Press the VTS UP/DOWN button to change the PRESET 2 VTS position. Gauge will display setting 1 through 5 in the digital screen above PRE-SET 2.
8. Press the SET button to save the settings and return to the main display.

The VTS system will compare the pre-set trim settings recorded, the highest position will be assigned to the UP arrow (bow up), the lowest to the DOWN arrow (bow down).

If both trim positions are identical, both buttons will have the same trim settings.

**Trimming the VTS Using the Mode/Set Buttons**

With the engine running in forward position, proceed as follows:

1. Press the MODE button to display the VTS function in the multifunction display.
2. On the RH handlebar, press the UP/DOWN button to change the VTS setting.

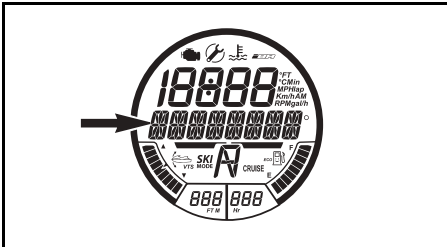

MESSAGE DISPLAYED

VTS MODE

4. On the RH handlebar, press the SET button to display PRESET 1.
5. Press the VTS UP/DOWN button to change the PRESET 1 VTS position. Gauge will display setting 1 through 5 in the digital screen above PRE-SET 1.

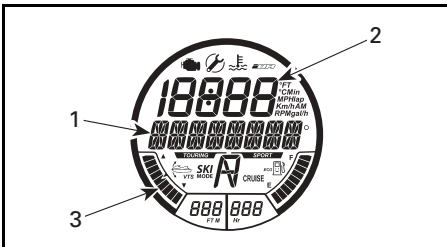

FUNCTION SELECTED - PRESET 1

1. PRESET 1 message
2. VTS setting number
3. VTS position indicator at setting 1 (bow down)

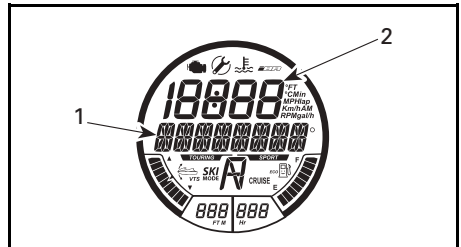

FUNCTION SELECTED - VTS

1. VTS message
2. VTS setting number
3. Confirm VTS operation by looking for the VTS position indicator movement in the digital display.

4. Press the SET button to save the desired setting and return to the main display.

**NOTE:** The available VTS settings are between 1 and 5.

**NOTE:** The VTS system cannot be fully tested without the engine operating in forward position. If the engine is not running in forward position, only the VTS indication will change when the VTS control switches are pressed; the nozzle will not change position.

## General Operating Recommendations

### Rough Water or Poor Visibility Operation

If you must operate in these conditions, proceed with caution using minimum speed.

#### **WARNING**

Ensure all navigation lights are operational in poor visibility operation.

### Shallow Water Operation

In shallow water, reduce speed and use extra precaution to avoid collision with obstacles.

**NOTICE** In shallow water, keep speed to a minimum and avoid hard accelerations. Even though this watercraft is equipped with an anti-debris water intake grate, it is still possible that debris such as rocks, sand or other objects may damage the propulsion system. The hull protection coating may not prevent damages to the hull caused by collisions with obstacles.

Keep in mind that operation in shallow water is much more severe on the propulsion system and will accelerate wear (due to abrasion) to the following parts:

- Seal

- Water intake grate
- Impeller
- Wear ring.

#### **WARNING**

In shallow water, debris may be picked up and thrown rearward by the jet pump onto people or property.

### Crossing Waves

The operator must grip the handlebar firmly and keep both feet on the footboards.

The passenger must grip the handholds with both hands and keep both feet on the footboards.

Reduce speed.

Always be prepared to steer and maintain your balance as necessary.

When going over waves, raise your body slightly off the seat to absorb the shocks with your legs.

When crossing wakes, always keep a safe distance from watercraft ahead.

#### **WARNING**

When crossing wakes, slow down. Operator and passenger(s) should brace themselves and adopt a semi-standing position to help absorb the bumps. Do not jump waves or wakes.

### Stopping/Docking

When the throttle is released, the watercraft is slowed by water drag against the hull. The stopping distance will vary depending on the watercraft size, weight, speed, water surface condition, presence and direction of wind and current.

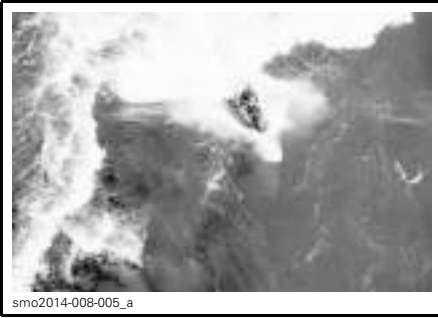

The operator should practice in open waters at various speeds to become familiar with the stopping distances under different conditions.

### **⚠ WARNING**

Always practice braking in open waters ensuring there are no watercraft or boats in your immediate vicinity, especially astern. Other users of the waterways may not be able to maneuver or stop in time to avoid you should you unexpectedly come to a full stop in front of them.

The iBR system can also be used for slowing down or for stopping the watercraft more quickly, and for increasing maneuverability especially when docking. Stopping using the iBR system in a straight line and in a turn should be practiced extensively to become familiar with the handling characteristics of the watercraft under partial or full braking conditions.

When at speed and the brake is first applied, a plume of water will shoot up in the air behind the watercraft and may cause the operator of a following watercraft to momentarily lose sight of your PWC.

### **⚠ WARNING**

It is important to inform the operator of a watercraft who intends to follow in a convoy formation of the braking and maneuvering capability of your PWC, what the plume of water indicates, and that a greater distance should be maintained between both of you.

The operator should also practice docking with an imaginary dock using the various controls available (iBR lever and throttle lever).

Release the throttle at a sufficient distance before the expected landing area.

Reduce speed to idle.

Maneuver using a combination of the iBR lever and throttle lever, shifting to neutral, reverse, or forward as required.

Remember that when operating in reverse, steering direction is reversed. Turning the handlebars to the left will move the stern to the right when backing up, and vice-versa.

### **⚠ WARNING**

Directional control is reduced when the throttle is released and/or when engine is off. Steering direction is reversed when operating the watercraft in reverse.

### **Beaching**

**NOTICE** It is not recommended to run the watercraft to the beach.

Reduce speed and avoid acceleration towards the beach and shut off the engine if possible before the water is less than 90 cm (3 ft) deep under the lowest rear portion of the hull. Then pull the watercraft to the beach.

**NOTICE** Even though this watercraft is equipped with an anti-debris water intake grate, it is still possible that debris such as rocks, sand or other objects may damage the propulsion system in shallower water than 90 cm (3 ft). The hull protection coating may not prevent damages to the hull caused by collisions with obstacles.

# OPERATING MODES

AVAILABLE OPERATING MODES	SAR
Sport mode	X
Touring mode	X
ECO mode	X
Cruise mode	X
Slow speed mode	X

X = Indicates a **standard** feature  
 Opt = Indicates a feature available as an **option**  
 N.A. = Not Applicable

## Sport Mode

By default, the watercraft is in SPORT mode of operation when first started. The SPORT MODE provides instant throttle response and rapid accelerations. A SPORT mode indicator is ON in the multifunction gauge to confirm the active mode of operation.

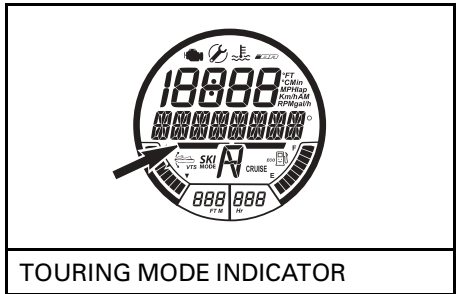

TOURING MODE INDICATOR

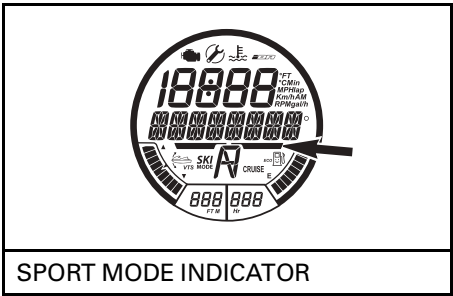

SPORT MODE INDICATOR

## Activating Touring Mode

To activate Touring mode while riding at speed, carry out the following:

1. Depress and hold the Sport button for at least 3 seconds.



TYPICAL  
 1. Sport button

## Touring Mode

When selected, a TOURING mode indicator is ON in the multifunction gauge to confirm the active mode of operation.

**NOTE:** Once activated, the TOURING MODE will remain active until it is deactivated by the operator, or the engine is shut down whereby it defaults back to SPORT MODE.

## Deactivating Touring Mode

To deactivate Touring mode while riding at speed, carry out the following:

### **⚠ WARNING**

When deactivating touring mode, be sure to maintain situational awareness of other watercraft, obstacles, or persons in the water.

1. Depress and hold the Sport button for at least 3 seconds.
2. Ensure the SPORT mode indicator is on.

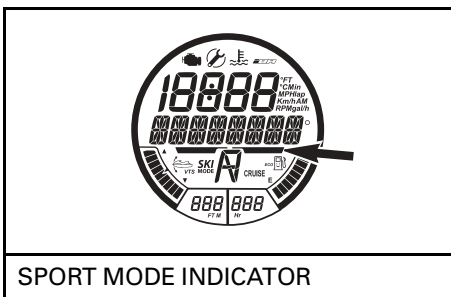

SPORT MODE INDICATOR

## ECO Mode (Fuel Economy Mode)

### How to Activate ECO Mode

1. Depress the Eco button for at least one second.



TYPICAL  
1. ECO button

The following message will be displayed on the multifunction display:

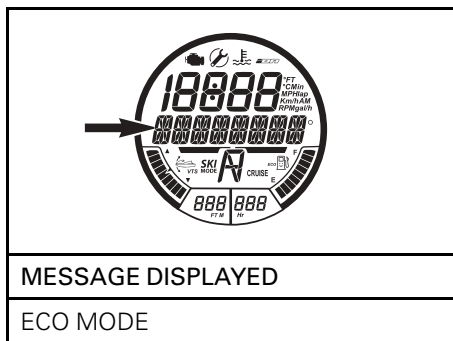

MESSAGE DISPLAYED

ECO MODE

The ECO mode indicator will also be activated.

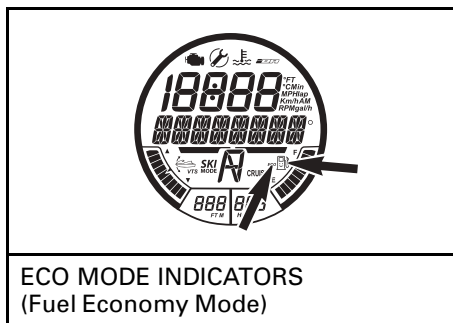

ECO MODE INDICATORS  
(Fuel Economy Mode)

### How to Deactivate ECO Mode

1. Depress the Eco button for at least one second.



TYPICAL  
1. Eco button

The ECO mode indicator will be deactivated.

## Cruise Mode

Cruise mode is a function of iTC (intelligent Throttle Control) system that allows the operator to set the desired maximum watercraft speed.

This is useful when cruising for long distances, operating in limited speed zones or for towing.

Cruise mode only limits forward speed, the operator must keep the throttle depressed to maintain forward speed.

Once the maximum cruise speed is set, the operator can vary the watercraft speed from idle speed up to the set cruise speed using the throttle lever. The set cruise speed will not be exceeded even if the throttle lever is fully depressed.

As you proceed under a constant cruising speed setting, keep your attention level up to maintain good situational awareness.

Slowing down is a matter of releasing the throttle lever further than the set point, or by pulling the iBR lever in.

If the iBR lever is pulled in for braking, CRUISE mode is overridden but **not deactivated**.

Once the iBR lever is released and the throttle is pulled in to engage forward position, the cruise function will reengage to limit the watercraft speed as it was set before.

**NOTE:** Cruise mode is **not** available if slow speed mode is engaged.

### Activating Cruise Mode

#### Cruise Mode Activation at Idle Speed

**NOTE:** This function is available up to approximately 10 km/h (6 MPH).

To activate and preset CRUISE MODE at idle speed, carry out the following:

1. Tap the throttle lever to move the iBR to the forward position.

2. Press and hold the cruise button.

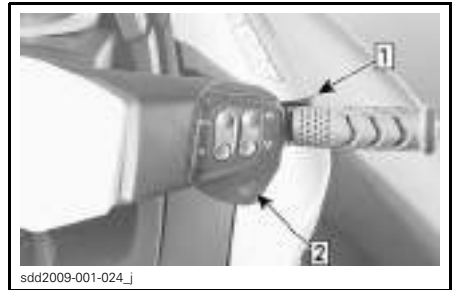

#### TYPICAL - ENGAGING CRUISE AT IDLE

Step 1: Tap throttle to engage FORWARD

Step 2: Press cruise button

The following message will appear in the multifunction display.

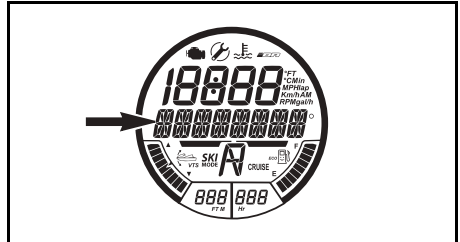

#### MESSAGE DISPLAYED

CRUISE MODE \_ SELECT SPEED \_  
PRESS SET TO ACCEPT OR MODE TO  
EXIT

3. Press the UP button until the desired cruise speed is indicated in the numerical display.

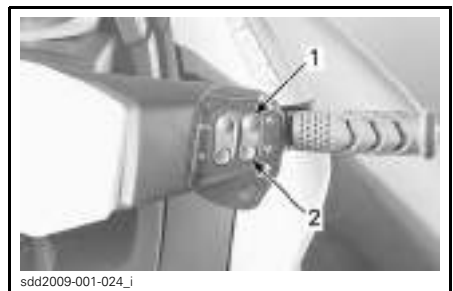

#### TYPICAL

1. UP button
2. DOWN button

## OPERATING MODES

The following will be displayed in the multifunction gauge.

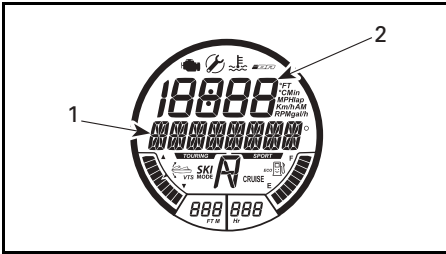

FUNCTION SELECTED - CRUISE MODE

1. CRUISE MODE \_ SPEED ADJUSTING
2. Cruise speed set point indication

4. Press the SET button to save the cruise speed selected and engage cruise mode. The following scrolling message will appear in the multifunction display.

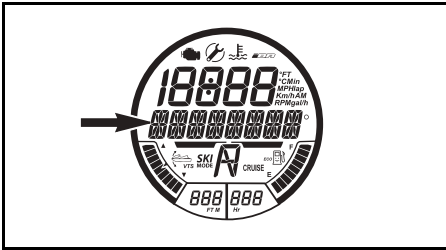

MESSAGE DISPLAYED

CRUISE MODE ACTIVE

A beep indicating that you are now in cruise mode will sound, and a CRUISE indicator will come on in the multifunction gauge.

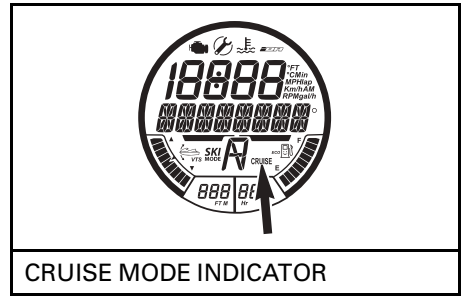

CRUISE MODE INDICATOR

### Cruise Mode Activation Above Idle Speed

To activate cruise mode above idle speed (10 km/h (6 MPH)):

1. Accelerate to the desired watercraft speed and hold throttle lever steady.
2. Press and hold the cruise button for approximately 1 second.

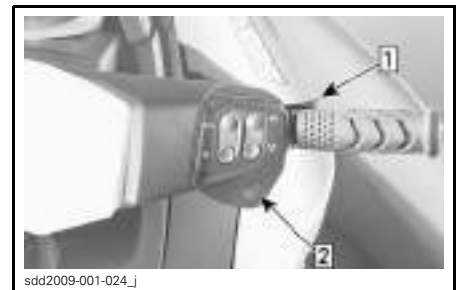

### TYPICAL - ENGAGING CRUISE AT SPEED

Step 1: Accelerate to desired speed and hold throttle steady

Step 2: Press cruise button

A beep indicating that you are now in cruise mode will sound, and a CRUISE indicator will come on in the multifunction gauge.



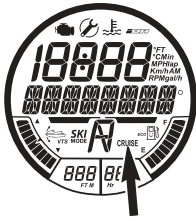

CRUISE MODE INDICATOR

### Changing Set Cruise Speed

To increase or decrease the set cruise speed:

1. Hold the throttle lever all the way in to the handlebar.
2. On the RH handlebar, press UP/DOWN button.



sdd2009-001-024\_h

#### TYPICAL - CHANGING SET CRUISE SPEED

1. Throttle lever
2. UP button
3. DOWN button

While the UP/Down is being pressed to change the speed setting, the following will appear in the multifunction gauge.

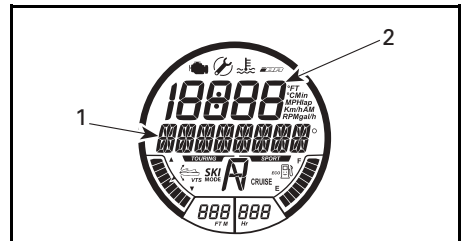

FUNCTION SELECTED - CRUISE MODE

1. CRUISE MODE \_ SPEED ADJUSTING
2. Cruise speed set point indication

**NOTE:** Pressing the UP/DOWN button repeatedly will change the cruise set speed in single increments. Pressing and holding the button will increase or decrease the speed until the button is released.

### Deactivating Cruise Mode

To deactivate cruise mode:

1. Release the throttle lever.
2. Press the cruise button.

Deactivation of cruise mode is indicated by:

- The CRUISE indicator will turn off.
- A BEEP will be heard.

**NOTE:** If the throttle lever is not fully released when the cruise button is pressed to deactivate cruise mode, the BEEP will not be heard and the cruise indicator will remain on. The speed limiting function of cruise mode will stay active until the throttle is fully released, then the BEEP will be heard and the cruise indicator will go out.

### Slow Speed Mode

The Intelligent Throttle Control also allows for a Slow Speed Mode where the driver can adjust and set idle speed. This is useful when operating in slow speed zones where the driver must be especially attentive to possible obstacle avoidance.

The operator can select an idle speed set point (slow speed) between 1 and 5 (1.6 km/h to 11 km/h (1 MPH to 7 MPH)).

If you accelerate above approximately 14 km/h (9 MPH), Slow Speed Mode will be deactivated and the engine will return to its normal idle RPM when the throttle is released.

Should a situation arise where the operator must stop or accelerate quickly away from a hazardous situation, pull in the iBR lever, or pull in on the throttle lever to deactivate slow speed mode and regain normal control of the watercraft.

### Activating Slow Speed Mode

To activate slow speed mode of operation:

1. Release the throttle lever to idle RPM.
2. Pull in and release the iBR lever to engage neutral.
3. Press and hold the cruise button for approximately 1 second.



**TYPICAL**

1. CRUISE button

The CRUISE indicator will come on in the multifunction gauge to indicate cruise activation.

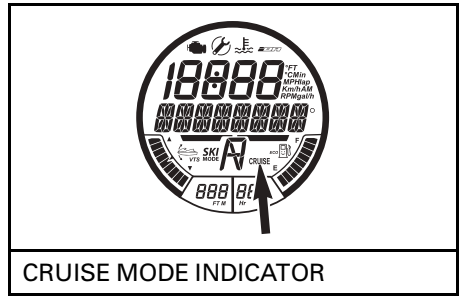

A scrolling message will appear in the multifunction display to specify that you are now in slow speed mode. The default slow speed set point of 1 will also come on for a few seconds in the numerical display.

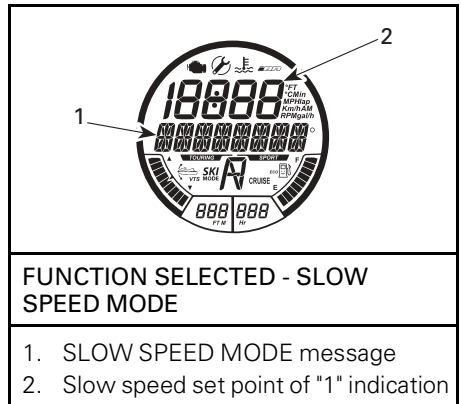

**NOTE:** The scrolling SLOW SPEED MODE message repeats itself as long as slow speed mode is activated. The numerical display reverts back to the previous indication after a few seconds.

### Changing Set Slow Speed

There are 5 slow speed set points available (1 through 5), 1 being the slowest. To **increase** or **decrease** the slow speed set point, press the UP/DOWN button on the RH handlebar once, or repeatedly.



sdd2009-001-024\_i

**TYPICAL**

1. UP button to increase speed
2. DOWN button to decrease speed

While the UP/DOWN is being pressed to change the slow speed set point, the following will appear in the multi-function gauge.

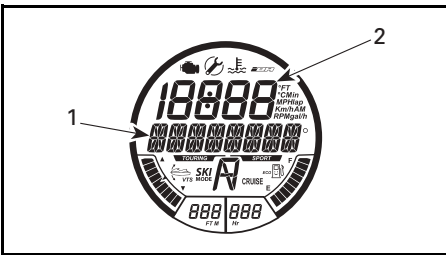

**FUNCTION MODE SELECTED - SLOW SPEED MODE**

1. SLOW SPEED MODE - SPEED ADJUSTING message
2. Slow speed set point indication

The displays will revert back to their previous indication a few seconds after the last activation of the UP/DOWN button.

**NOTE:** As a reminder, the following message will scroll across the multi-function display periodically.

<b>MESSAGE DISPLAYED</b>
<b>SLOW SPEED MODE ACTIVE</b>

**Deactivating Slow Speed Mode**

Slow speed mode can be deactivated using any of the following methods:

- Pressing the cruise button.
- Depressing the iBR lever.
- Accelerating above the highest slow speed that can be set (approximately 14 km/h (9 MPH)).

When deactivating SLOW SPEED MODE:

- By pressing the cruise button, the iBR system maintains forward position.
- By pressing the iBR lever, the iBR system will shift to neutral position.

SLOW SPEED MODE deactivation will be indicated in the following manner:

1. The CRUISE indicator will go out
2. The scrolling SLOW SPEED MODE ACTIVE message will cease.

# SPECIAL PROCEDURES

## Jet Pump Water Intake and Impeller Cleaning

### WARNING

Keep away from intake grate while engine is running. Items such as long hair, loose clothing or personal flotation device straps can become entangled in moving parts.

Weeds, shells or debris can get caught on the intake grate, drive shaft and/or impeller. A clogged water intake may cause troubles such as:

- **Cavitation:** Engine speed is high but watercraft moves slowly due to reduced jet thrust, jet pump components may be damaged.
- **Overheating:** Since the jet pump operation controls the flow of water to cool the engine and exhaust system, a clogged intake will cause the engine to overheat and damage engine internal components.

A clogged area can be cleaned as follows:

### WARNING

If it is necessary to reach in to remove any foreign object caught in the propulsion system, the tether cord **MUST BE REMOVED** from the engine cut-off switch

### In-Water Cleaning

Rock the watercraft several times while repeatedly pressing engine START/STOP button for short periods without starting the engine. Most of the time, this will remove the blockage. Start engine and make sure watercraft operates properly.

**NOTE:** If debris are denser than water, stopping the engine should allow debris to sink and clean the intake grate automatically.

If the aforementioned method does not work, the following can be performed:

- With engine running and before applying throttle, pull the iBR lever in to select reverse operation and vary throttle quickly several times.
- Repeat procedure if necessary.

If system is still blocked, debris could be lighter than water. In this case, cleaning manually the intake grate could be necessary.

### iBR Override Function

When the iBR override function is activated, it allows the user to electrically move the iBR gate and nozzle through its full range of motion using the VTS control button.

**NOTE:** The iBR override function is only available when the engine is not running.

### WARNING

When moving the iBR gate using the iBR override function, ensure no-one is near the rear of the watercraft. Movement of the gate may squeeze fingers.

**NOTICE** An object or tool caught in the iBR system when using the iBR override function may cause damage to the iBR components. Remove all rigid foreign objects that may obstruct the iBR gate travel before moving it.



**NOTE:** Use the UP/DOWN button on the RH handlebar to move the iBR to the desired position once the iBR override function has been activated as described in the previous steps.

- Remove the tether cord from the engine cut-off switch.

### **⚠ WARNING**

If it is necessary to reach in to remove any foreign object caught in the propulsion system, strictly observe the following before proceeding:

- Remove tether cord from the engine cut-off switch.
- Wait at least 5 minutes.
- Do not press on START/STOP button. Should the START/STOP button be pressed, wait another 5 minutes.

### Deactivating iBR Override Function

There are three ways to deactivate the iBR override function:

- Repeat steps in *ACTIVATING iBR OVERRIDE FUNCTION* and press the SET button when OVR OFF is visible.
- Wait for the electrical power to shut off.
- Start the engine.

**NOTE:** When the engine is started, the iBR OVR function is deactivated and the iBR gate will move to the neutral position.

### **⚠ WARNING**

When moving the iBR gate using the iBR override function, ensure no-one stands near the rear of the watercraft. Movement of the gate may squeeze fingers.

## Capsized Watercraft

The watercraft is designed so that it should not turn over easily. Two inflatable sponsons mounted on the side of the hull assist watercraft stability. If it turns over, it will remain capsized.

The 4-TEC™ engine features a tip-over protection system (T.O.P.S.™). When the watercraft tips over, the engine is automatically stopped.

### **⚠ WARNING**

When watercraft is capsized, do not attempt to restart the engine. Operator and passengers should always wear approved personal flotation devices.

### Procedure to Return the Watercraft

**NOTE:** A label on the stern provides instructions on how to turn the watercraft right side up. The label is upside down so that it can be read when the watercraft is overturned.

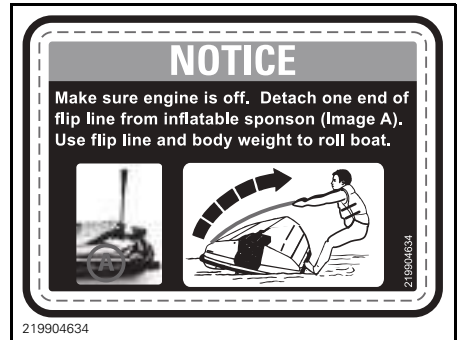

Make sure the tether cord is **NOT** on the engine cut-off switch.

- Detach flip line from inflatable sponson.
- Holding the flip line, board the watercraft from the opposite side.
- Step on the sponson and use your body weight and the flip line to rotate the watercraft towards you.

4. If this method does not work, ask someone to assist you.

**NOTE:** The watercraft can be easily flipped back by a person weighting more than 84 kg (185 lb). However, people lighter than this should plan to do it with another person.

**NOTICE** If the watercraft has been capsized for more than 5 minutes, do not attempt to crank the engine to avoid water ingestion that would damage the engine. See an authorized Sea-Doo dealer as soon as possible.

**NOTICE** If the engine does not crank, do not attempt to start it anymore. Otherwise, the engine could be damaged. See an authorized Sea-Doo dealer as soon as possible.

As soon as possible, check for presence of water in the bilge. Drain as necessary when back to the shore.

## Submerged Watercraft

To limit damages to the engine, perform the following procedure as soon as possible.

Drain bilge.

If it was submerged in salt water, spray bilge and all components with fresh water using a garden hose to stop the salt corroding effect.

**NOTICE** Never try to crank or start the engine. Water trapped in intake manifold would flow towards the engine and possibly cause severe engine damage.

Bring the watercraft to an authorized Sea-Doo dealer as soon as possible to have it serviced.

**NOTICE** The longer the delay before you have the engine serviced, the greater the damage to the engine will be.

## Water-Flooded Engine

**NOTICE** Never try to crank or start the engine. Water trapped in intake manifold would flow towards the engine and possibly cause severe engine damage.

Bring the watercraft to an authorized Sea-Doo dealer as soon as possible to have it serviced.

**NOTICE** The longer the delay before you have the engine serviced, the greater the damage to the engine will be. Failure to have the engine properly serviced may cause severe engine damage.

## Towing the Watercraft in Water

Special precautions should be taken when towing a Sea-Doo watercraft in water.

The maximum recommended towing speed is 21 km/h (13 MPH).

This will prevent the exhaust system from filling with water, which may lead to water being injected into and filling the engine. Without the engine running, there isn't any exhaust pressure to push the water out the exhaust outlet.

**NOTICE** Failure to follow these instructions may result in damage to the engine. If you must tow a stranded watercraft in water, be sure not to exceed the maximum towing speed of 21 km/h (13 MPH).

If you have to tow the watercraft faster than the maximum recommended speed, clamp the cross over hose.



smo2013-001-001\_a

1. *Cross over hose*



# ***MAINTENANCE INFORMATION***

---

## MAINTENANCE SCHEDULE

Maintenance is very important for keeping the watercraft in a safe operating condition. The watercraft should be serviced as per the maintenance schedule.

A repair shop or person of the owner's choosing may maintain, replace, or repair emission control devices and systems. These instructions do not require components or service by BRP or authorized Sea-Doo dealers. Although an authorized Sea-Doo dealer has an in-depth technical knowledge and tools to service the Sea-Doo personal watercraft, the emission-related warranty is not conditioned on the use of an authorized Sea-Doo dealer or any other establishment with which BRP has a commercial relationship. For emission-related warranty claims, BRP is limiting the diagnosis and repair of emission-related parts to the authorized Sea-Doo dealers. For more information, please refer to the *US EPA EMISSION-RELATED WARRANTY* contained herein. Proper maintenance is the owner's responsibility. A warranty claim may be denied if, among other things, the owner or operator caused the problem through improper maintenance or use.

You must follow the instructions for fuel requirements in the fueling section of this manual. Even if gasoline containing greater than ten volume percent ethanol is readily available, the US EPA issued a prohibition against the use of gasoline containing greater than 10 vol% ethanol that applies to this vehicle. The use of gasoline containing greater than 10 vol% ethanol with this engine may harm the emission control system.

Disregard the information pertaining to the following systems if the watercraft is not equipped with these features:

- iBR (intelligent Brake and Reverse)

Carry out all maintenance as listed in the schedule whenever the hours or time of each column is reached.

**NOTE:** As an example, at 200 hours or 2 years, complete all items in this column and ALSO in the EVERY 100 hours or 1 year column.

### **WARNING**

**Failure to properly maintain the watercraft according to the maintenance schedule and procedures can make it unsafe to operate.**

The maintenance schedule does not exempt the pre-ride inspection.

A: ADJUST C: CLEAN I: INSPECT L: LUBRICATE R: REPLACE  O: OPERATOR RS: REPAIR SHOP <b>PART/TASK</b>	FIRST 50 HOURS OR 1 YEAR					<b>NOTE</b>
	EVERY 100 HOURS OR 1 YEAR					
	EVERY 200 HOURS OR 2 YEARS					
	TO BE PERFORMED BY					
<b>ENGINE</b>						
Engine oil and filter	R	R			RS	(1) Every 10 hours in salt water use. (2) Replace at 200 hours, irrespective of the number of years.
Rubber mounts		I			RS	
Corrosion protection (spray an anti-corrosion lubricant to metallic components in engine compartment)			L (1)		O	
Supercharger clutch (215 engines)				R (2)	RS	
<b>EXHAUST SYSTEM</b>						
Exhaust system	I	I, C (3)			O/RS	(3) Daily flushing in salt water or dirty water use.
<b>COOLING SYSTEM</b>						
Hose and fasteners		I	I		RS	(4) Replace at 300 hours or 5 years
Coolant		I	R(4)		RS	
Heat exchanger		I			O	
<b>FUEL SYSTEM</b>						
iTC lever (5)		I, L			O/RS	(5) See NOTE 1 after maintenance schedule.
Fuel cap, filler neck, fuel tank, fuel tank straps, fuel lines and connections	I	I (6)			RS	(6) At storage period or after 100 hours of use whichever comes first.
Fuel system leak test	I	I			RS	
Throttle body	I	I			RS	
<b>AIR INTAKE SYSTEM</b>						
Air intake silencer		I			RS	—
<b>ELECTRONIC MANAGEMENT SYSTEMS</b>						
Fault codes	I	I			RS	—

A: ADJUST C: CLEAN I: INSPECT L: LUBRICATE R: REPLACE  O: OPERATOR RS: REPAIR SHOP  PART/TASK	FIRST 50 HOURS OR 1 YEAR				NOTE
	EVERY 100 HOURS OR 1 YEAR				
	EVERY 200 HOURS OR 2 YEARS				
	TO BE PERFORMED BY				
ELECTRICAL SYSTEM					
Spark plugs	I	I	R	RS	(7) Inspect once a month. It is recommended to replace battery every 6 months.
Ignition coils		I, L		RS	
Electrical connections and fastening (ignition system, starting system, fuel injectors, fuse boxes etc.)	I	I		RS	
Engine cut-off switch	I	I		RS	
Monitoring beeper	I	I		RS	
Bilge pump	I	I		RS	
Battery and fasteners		I, R (7)		RS	
STEERING SYSTEM					
Steering cable and connections	I	I		RS	(8) Inspect operation.
Steering nozzle bushings	I	I		RS	
O.T.A.S. (8)	I	I		RS	
PROPULSION SYSTEM					
Carbon ring and rubber boot (drive shaft) <sup>(10)</sup>	I	I		RS	(6) At storage period or after 100 hours of use whichever comes first. (9) Inspect each month (more often in salt water use) and change when necessary. (10) Inspect more frequently when using PWC in foul/dirty water.
Impeller, impeller boot and wear ring condition	I	I		RS	
Impeller shaft radial play		I		RS	
Jet pump housing inspection		I		RS	
Impeller shaft seal, sleeve, O-ring and impeller cover		I (6)		RS	
Drive shaft/impeller splines		I, L		RS	
Sacrificial anode		I (9)		RS	
Measure impeller and impeller wear ring clearance		I		RS	

A: ADJUST C: CLEAN I: INSPECT L: LUBRICATE R: REPLACE  O: OPERATOR RS: REPAIR SHOP <b>PART/TASK</b>	<b>FIRST 50 HOURS OR 1 YEAR</b>				
	<b>EVERY 100 HOURS OR 1 YEAR</b>				
	<b>EVERY 200 HOURS OR 2 YEARS</b>				
	<b>TO BE PERFORMED BY</b>				
					<b>NOTE</b>
<b>iBR SYSTEM (intelligent Brake and Reverse)</b>					
iBR lever <sup>(5)</sup>		I, L		O/RS	(5) See NOTE 1 after maintenance schedule.
iBR gate backlash	I	I		RS	
iBR, VTS trim ring and iBR gate		I		RS	
iBR protective guard	I	I		RS	
<b>HULL AND BODY</b>					
Hull		I <sup>(11)</sup>		RS	(11) Check for cracks or other damages. Check hull protective coating.
Ride plate and water intake grate		I		O	
Inflatable sponsons	I	I		O	

**NOTE 1:** The iTC and iBR levers should be inspected by depressing and releasing the levers to check for freedom of movement. If any friction is felt, the lever must be taken apart, cleaned, inspected for wear and lubricated, refer to *INTELLIGENT THROTTLE CONTROL (ITC)*, *STEERING* and *O.T.A.S.* subsections.

# MAINTENANCE PROCEDURES

This section includes instructions for basic maintenance procedures.

## **⚠ WARNING**

Turn off the engine and follow these maintenance procedures when performing maintenance. If you do not follow proper maintenance procedures you can be injured by hot parts, moving parts, electricity, chemicals or other hazards.

## **⚠ WARNING**

Should removal of a locking device (e.g. lock tabs, self-locking fasteners, etc.) be required, always replace with a new one.

**NOTICE** Never leave any object, rag, tool, etc., in the engine compartment or in the bilge.

When it is required to lift the watercraft for service or to install it on a stand, use only the front and the transom eyelets of the watercraft.

**NOTICE** Never use the central eyelet, mast or inflatable sponsons to lift the watercraft.

## **Engine Compartment**

### **Engine Compartment Inspection**

Inspect the engine compartment for fuel vapor odor.

## **⚠ WARNING**

Should any leak or gasoline odor be present, do not apply electrical power or start the engine. You should seek service from an authorized Sea-Doo dealer, repair shop, or person of your own choosing for maintenance, repair, or replacement. Please refer to the *US EPA EMISSIONS-RELATED WARRANTY* contained herein for information about warranty claims.

To access the engine compartment, open the seat.



*ENGINE COMPARTMENT, SEAT REMOVED*

## **Engine Oil**

### **Recommended Engine Oil**

Use XPS 4-STROKE SYNTH. BLEND OILXPS 4-STROKE SYNTH. BLEND OIL (SUMMER) (P/N 293 600 121).

If the recommended XPST<sup>™</sup> engine oil is not available, use a 5W40 or 10W40 engine oil meeting the requirements for API service classification SM, SL or SJ. Always check the API service label certification on the oil container, it must contain at least one of the above standards.

## Engine Oil Level

**NOTICE** Check level frequently and refill if necessary. Do not overfill. Operating the engine with an improper level may severely damage engine.

**CAUTION** Certain components in the engine compartment may be very hot. Direct contact may result in skin burn.

Oil level can be checked with watercraft either in or out of water.

### If Watercraft is Out of the Water

**NOTICE** Watercraft must be level.

1. Raise trailer tow pole, then block in position when bumper rail is level.
2. Open the seat.
3. Install a garden hose on the exhaust system flushing connector. Refer to *EXHAUST SYSTEM* in this section and follow the procedure.

**NOTICE**

- Never run engine without supplying water to the exhaust system. Failure to cool exhaust system may severely damage it.
  - Never run engine longer than 2 minutes. Drive line seal has no cooling when watercraft is out of water.
4. With the engine already at normal operating condition, let engine **idle for 30 seconds** then stop engine.
  5. Wait at least 30 seconds for the oil to settle in the engine, then pull dipstick out and wipe clean.

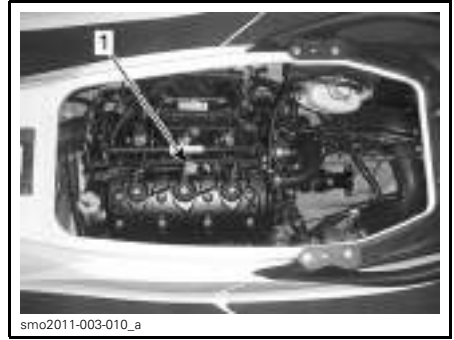

smo2011-003-010\_a

**TYPICAL**

1. Oil dipstick location

6. Reinstall dipstick, push in completely.

7. Remove dipstick again and read oil level. It should be between the **FULL** and **ADD** marks.

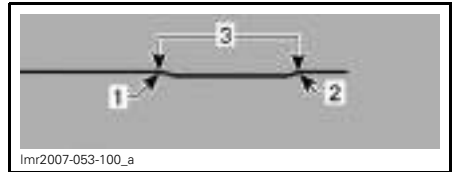

lmr2007-053-100\_a

1. Full
2. Add
3. Operating range

8. Add oil to ensure the level is between marks as required.

To add oil:

- Unscrew oil cap.
- Place a funnel in the oil filler neck opening.
- Add the recommended oil to the proper level.

**NOTE:** Do not overfill.



smo2011-003-010\_b

**TYPICAL**

1. Oil filler cap location

**NOTE:** Every time oil is added in the engine, the complete procedure explained in this section must be carried out again. Otherwise, you will obtain a false oil level reading.

9. Properly reinstall oil cap and dipstick.

**Engine Oil Change and Oil Filter Replacement**

The oil change and filter replacement may be performed by an authorized Sea-Doo dealer, repair shop, or person of your own choosing.

**Engine Coolant**

**Recommended Engine Coolant**

Always use LONG LIFE ANTIFREEZE-LONG LIFE ANTIFREEZE (P/N 219 702 685) or equivalent. If the recommended coolant is not available, use a low silicate, extended life ethylene-glycol premixed coolant (50%-50%) specifically formulated for internal combustion aluminum engines.

To prevent antifreeze deterioration, always use the same brand and grade. Never mix different brands or grades unless cooling system is completely flushed and refilled.

**Engine Coolant Level**

**⚠ WARNING**  
 Check coolant level with engine cold. Never add coolant in cooling system when engine is hot.

**⚠ CAUTION** Certain components in the engine compartment may be very hot. Direct contact may result in skin burn.

Open seat.

Locate the expansion tank cap.



smo2011-003-010\_c

**TYPICAL**

1. Expansion tank cap

With watercraft on a level surface, coolant level should be between MIN. and MAX. marks on coolant reservoir when engine is cold.



**TYPICAL - COOLANT EXPANSION TANK**  
 1. Level between marks when engine is cold



**NOTE:** The watercraft is level when it is in water. When on a trailer, raise trailer tow pole and block in this position when bumper rail is level.

Add coolant, see *RECOMMENDED ENGINE COOLANT* for specification to adjust coolant level between marks as required. Use a funnel to avoid spillage. Do not overfill.

Properly reinstall and tighten filler cap, then reinstall ventilation box and close seat.

**NOTE:** A cooling system that frequently requires coolant is an indication of leaks or engine problems. See an authorized Sea-Doo dealer.

### Engine Coolant Replacement

Coolant replacement should be performed by an authorized Sea-Doo dealer.

## Ignition Coils

### Ignition Coil Removal

1. Open seat.
2. Remove engine cover (as applicable to model).
3. Disconnect ignition coil connector.

**NOTICE** Do not remove the ignition coil before disconnecting the input connector or the wires may be damaged. Do not pry up ignition coil with a screwdriver to avoid damage.

**NOTE:** Twist ignition coil in both directions as you pull it up to ease removal. Remove ignition coil from spark plug.

### Ignition Coil Lubrication

1. Pull rubber seal down.



1. Rubber seal pulled down

2. Apply DOW CORNING 111DOW CORNING 111 (P/N 413 707 000) or an equivalent to rubber seal seat as shown.



1. Apply product here

3. Pull rubber seal back on its seat making sure the tabs on the ignition coil and the slots in the seal properly match together.
4. Leave a ring of grease on top of the seal as shown to act as a water barrier. Wipe off the excess.



1. Correctly shaped excess of product

5. Apply DOW CORNING 111DOW CORNING 111 (P/N 413 707 000) or an equivalent on rubber seal contact area.

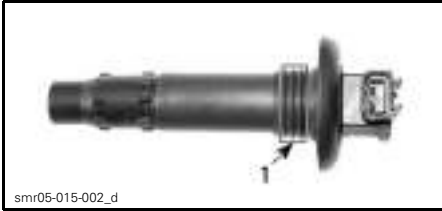

smr05-015-002\_d

1. Apply product here

## Ignition Coil Installation

**NOTE:** Prior to inserting the ignition coil on its spark plug, apply sealant as described in *IGNITION COIL LUBRICATION*.

1. Install coil in cylinder head hole.
2. Push the ignition coil down to securely install it on the spark plug tip.
3. Ensure the seal seats properly with top surface of engine valve cover.

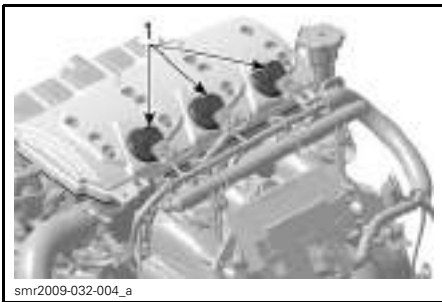

smr2009-032-004\_a

**TYPICAL**

1. Seal properly seated

## Spark Plugs

### Spark Plug Removal

1. Open seat.
2. Disconnect the ignition coil input connector.
3. Remove ignition coil. Refer to *IGNITION COIL REMOVAL*.

**⚠ WARNING**

Never remove an ignition coil from a spark plug without disconnecting it from the wiring harness. Flammable vapors may be present in the bilge. Should the tether cord be installed on the engine cut-off switch, a spark could be generated at the coil spark plug end which could cause an explosion.

4. Using a spark plug socket, release the torque applied to the spark plug.

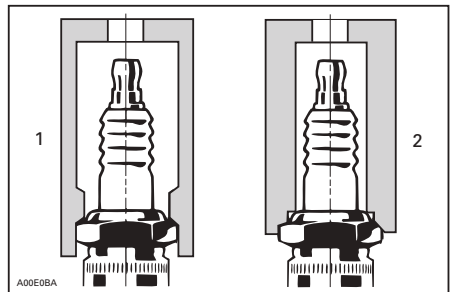

1. Approved socket
2. Improper socket

5. Clean the spark plug and cylinder head with pressurized air.
6. Unscrew spark plug then use the ignition coil to take spark plug out of spark plug hole.

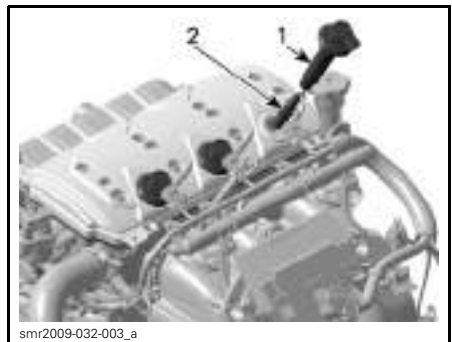

smr2009-032-003\_a

1. Ignition coil
2. Spark plug

## Spark Plug Installation

Prior to installation, ensure the contact surfaces of the cylinder head and spark plug are free of grime.

- Using a wire feeler gauge, set electrode gap as specified in the following chart.

SPARK PLUG	TORQUE	GAP mm (in)
NGK DCPR8E (or equivalent)	Hand tighten + 1/4 turn with a socket	0.75 mm (.03 in)

- Apply anti-seize lubricant over the spark plug threads to prevent possible seizure.
- Hand screw spark plug into cylinder head. Then, tighten the spark plug clockwise an additional 1/4 turn with an approved spark plug socket.
- Install ignition coil. Refer to *IGNITION COIL INSTALLATION*.
- Close seat.

## Exhaust System and Heat Exchanger

### Exhaust System and Heat Exchanger Flushing

Flushing the exhaust system and heat exchanger with fresh water is essential to neutralize corroding effects of salt or other chemical products present in water. It will help to remove sand, salt, shells or other particles in water jackets and/or hoses.

**NOTICE** It is very important to flush the exhaust system and heat exchanger with fresh water (from 1½ to 2 minutes) after each use in salt water or foul water. Otherwise, heat exchanger may corrode and affect the efficiency of the cooling system.

Flushing should be performed when the watercraft is not expected to be used further the same day or when the watercraft is stored for any extended time.

**⚠ WARNING**

Perform this operation in a well ventilated area.

Proceed as follows:

Clean propulsion system by spraying water in its inlet and outlet and then apply a coating of XPS Lube or equivalent.

**⚠ CAUTION** When operating the engine while the watercraft is out of the water, the heat exchanger in the ride plate may become very hot. Avoid any contact with ride plate as burns may occur.

Connect a garden hose to the connector located at the rear of watercraft (on the port side of the stern). Do not open water tap at this time.

**NOTICE** Always run the engine before opening the water tap. If not, water will get inside the engine.



TYPICAL  
1. Flushing connector location

**NOTE:** An optional quick connect hose adapter and hose fitting can be used (P/N 295 500 473) or equivalent. No hose pincher is required to flush engine.



smo2009-002-138  
TYPICAL - QUICK CONNECT HOSE ADAPTER

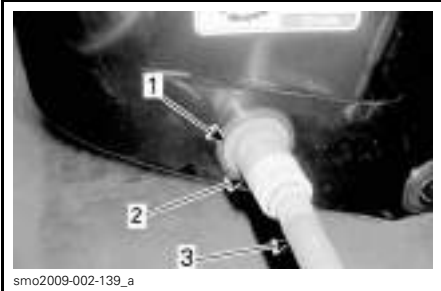

- smo2009-002-139\_a
- TYPICAL
1. Hose adapter (optional, not mandatory)
  2. Quick connect fitting (optional, not mandatory)
  3. Garden hose

To flush, start engine then immediately open the water tap.

**CAUTION** Certain components in the engine compartment may be very hot. Direct contact may result in skin burn. Do not touch any electrical parts or propulsion system component when the engine is running.

**NOTICE** Never flush a hot engine. Always start the engine before opening the water tap. Open water tap immediately after engine is started to prevent overheating.

Run the engine 90 seconds at idle speed.

**NOTICE** Never run engine without supplying water to the exhaust system when watercraft is out of water.

Ensure water flows out of jet pump while flushing. Otherwise, refer to an authorized Sea-Doo dealer for servicing.

**NOTICE** Never run engine longer than 2 minutes. Drive line seal has no cooling when watercraft is out of water.

Close the water tap, run the engine at 5000 RPM for 5 seconds and stop the engine.

**NOTICE** Always close the water tap before stopping the engine. If not, water will get inside the engine.

**NOTICE** Remove quick connect adapter after flushing operation (if used).

## Ride Plate and Water Intake Grate

### Water Intake Grate Cleaning

Remove weeds, shells, debris or anything else that could restrict the flow of water and damage the propulsion system. Clean as necessary. If any obstruction cannot be removed, refer to an authorized Sea-Doo dealer for servicing.

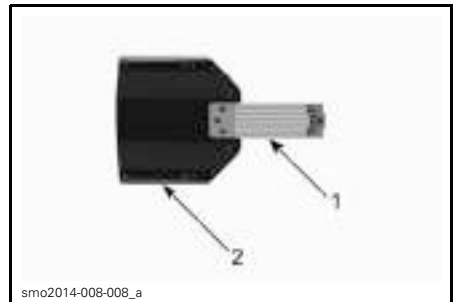

smo2014-008-008\_a  
TYPICAL — CLEAN AS REQUIRED

1. Water intake
2. Ride plate

## Ride Plate and Water Intake Grate Inspection

Inspect ride plate and jet pump water intake grate for damage. See your Sea-Doo dealer to have any damaged part repaired or replaced.

### **⚠ WARNING**

The tether cord must always be removed from the engine cut-off switch prior to inspecting the intake grate.

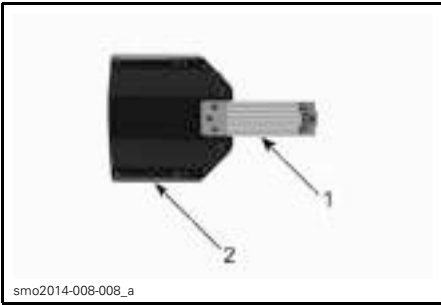

smo2014-008-008\_a

### TYPICAL — INSPECT

1. Water intake
2. Ride plate

## Sacrificial Anode

### Sacrificial Anode Inspection

Check for wear. If worn more than half, see an authorized Sea-Doo dealer for anode replacement.

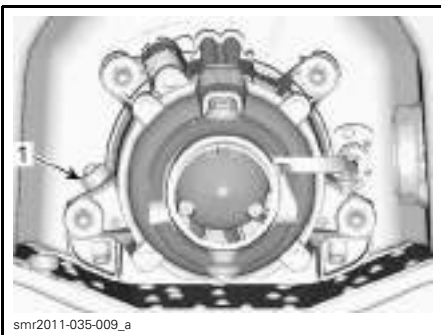

smr2011-035-009\_a

1. Sacrificial anode location

## Fuses

### Fuse Removal and Installation

Use the fuse remover/installer included in the fuse box to ease fuse removal.

### Fuse Inspection

If an electrical problem occurs, check the fuses. If a fuse is burnt, replace by one of the same rating.

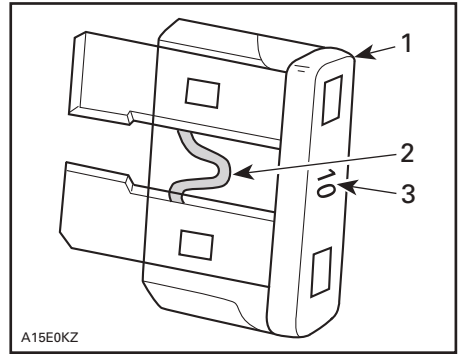

### TYPICAL

1. Fuse
2. Check if melted
3. Ampere rating

### **⚠ WARNING**

Do not use a higher rated fuse as this can cause severe damage. If a fuse has burnt out, the source of the malfunction should be determined and corrected before restarting. See an authorized Sea-Doo dealer for servicing.

### Fuse Location

All fuses are located inside two fuse boxes.

To access fuse boxes, open the front storage cover.

Remove the two plastic rivets and the rubber tie securing the battery access panel at the back of the storage compartment. The fuse boxes are located

ahead of the fuel tank just under the gauge area, attached to the battery holder.



**BATTERY AND FUSE ACCESS, FRONT STORAGE COMPARTMENT**

1. Battery access panel

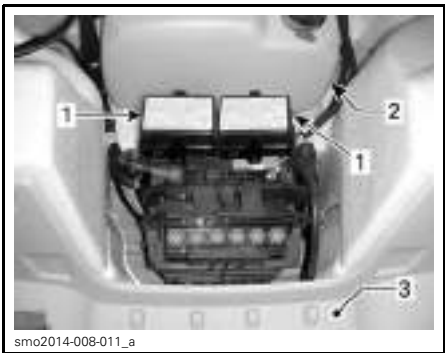

**TYPICAL**

1. Fuse box
2. Fuel tank
3. Front storage compartment (access panel removed)

To remove the fuse box cover, squeeze and hold locking tabs on both sides of the fuse box and pull the cover off the fuse box.

**NOTE:** Fuse ratings and positions are illustrated on the fuse box cover.

**Fuse Box 1 Description**

FUSE	RATING	DESCRIPTION
1	—	Not used
2	15 A	Diagnostic connector
3	3 A	START/STOP button
4	3 A	GPS
5	30 A	iBR
6	30 A	Charge
7	—	Not used
8	30 A	Battery
9	—	Not used
10	—	Not used
11	3 A	Depth sounder (if so equipped)
12	3 A	Gauge, OTAS and CAPS
13	10 A	Cylinder 1 (ignition coil and injection)
14	10 A	Cylinder 2 (ignition coil and injection)
15	10 A	Cylinder 3 (ignition coil and injection)
16	5 A	Starter solenoid
17	5 A	iBR control
18	10 A	Fuel pump
19	15 A	ECM

**Fuse Box 2 Description**

FUSE	RATING	DESCRIPTION
BP1	3 A	Bilge pump
BA	10 A	Auxiliary output
FP-B	3 A	Navigation light (port side)
FP-T	3 A	Navigation light (starboard side)
F360	3 A	Navigation light (stern)

## Inflatable Sponsons

### Important Information on Sponson Inflation

The sponsons must be inflated to the recommended pressure at all times

SPONSON PRESSURE	
MINIMUM	MAXIMUM
28 kPa (4 PSI)	41 kPa (6 PSI)

It is normal to observe changes in air pressure of the sponsons as the following factors have a direct effect:

- Exterior air temperature
- Water temperature.

If there is a change in the above conditions, air pressure must be rechecked.

**NOTE:** Air pressure in sponsons should be rechecked while the watercraft is afloat; adjust if necessary, as the temperature of the water may be different from that of the air, which could result in changes in air pressure.

### Sponson Inflation

Remove valve cap by unscrewing it a quarter of a turn counterclockwise.



1. Valve

Check that the center plunger of the valve is in the upright position

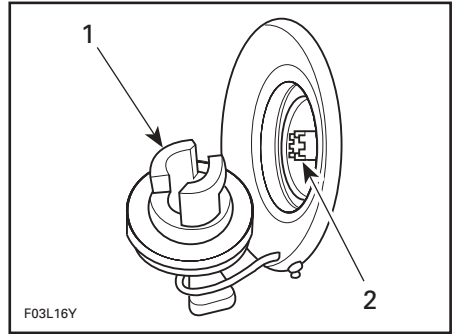

#### TYPICAL

1. Valve cap removed
2. Center plunger in upright position

Using an air pump (not supplied), insert hose end with proper adapter into the valve.

**NOTE:** If required, use the adapter provided with the watercraft to connect the air pump hose to the sponson valve.

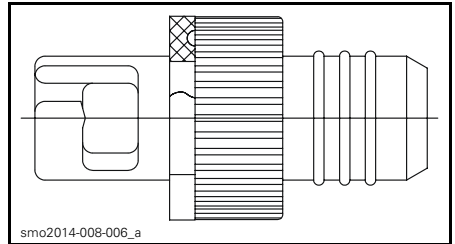

ADAPTER PROVIDED WITH WATERCRAFT

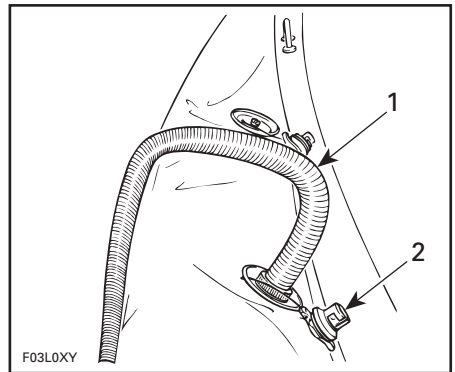

#### TYPICAL

1. Foot pump hose
2. Valve cap removed



Inflate sponson to specification. Verify pressure using the valve adapter and a low pressure gauge (70 kPa (10 PSI)).

**NOTE:** Seat valve adapter as quickly as possible onto valve opening and firmly maintain in position to avoid air loss.

SPONSON PRESSURE	
MINIMUM	MAXIMUM
28 kPa (4 PSI)	41 kPa (6 PSI)

If pressure is too high, reduce it by slightly pushing the center plunger.

**NOTICE** To avoid damage to inflatable sponson: Never use high pressure to inflate sponson. Use ONLY a foot pump. Do not over inflate.

Install valve cap when air pressure is set to specification.

**NOTE:** It is very important to seal the valve with the cap in order to increase air tightness and to keep out unwanted dirt and water.

Proceed with the same procedure for the other sponson.

**Sponson Deflation**

Remove valve cap by unscrewing it a quarter of a turn counterclockwise.

Push and twist the center plunger in either direction to lock it into the open position.

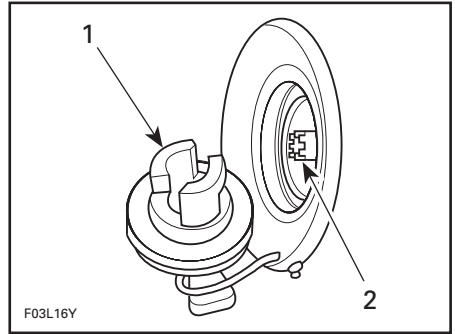

**TYPICAL**

1. Valve cap removed
2. Press on valve button

The sponson will now automatically deflate.

Install valve cap.

Proceed with the same procedure for the other sponson.

**How to Find a Slow Leak**

With valve cap removed, spray soapy water on valve. Check for air bubbles.

**NOTE:** If a leak is found, it is recommended to continue testing as there is a possibility of more than one leak.

If air bubbles are coming out around the valve, retighten valve using pliers.

If plunger is leaking, remove valve after sponson inspection. Check for dirt or damaged seal. Clean or replace valve if necessary.

Spray soapy water on sponson section. Check for air bubbles.

**Inflatable Sponson Repairs**

For best results, repairs should be performed at temperatures ranging from 18°C to 25°C (64°F to 77°F). Avoid carrying out repairs in direct sunlight, rain or in high humidity conditions.

**NOTE:** Any major repairs must be performed by a qualified technician in a specialty shop.

**Tear Repair of Less than 5 cm (2 in)**

Deflate completely sponson to be repaired.

Cut a patch about 75 mm (3 in) larger than the tear in every direction. Always round corners.

Using only a pencil, trace on sponson the patch position.

**NOTICE** Do not use pen or felt-tip pen as ink will permanently mark sponson.

Sand thoroughly sponson area and patch with a 80 grit sandpaper.

**NOTE:** Protect sponson surface in vicinity with masking tape.

Remove masking tape.

Clean the patch and sponson areas with recommended solvent. Allow solvent to completely evaporate.

RECOMMENDED SOLVENT
Acetone / Toluene / Methyl ethyl ketone

Apply a thin layer of recommended adhesive (or equivalent) to the patch and sponson. Allow adhesive to dry so that it is dry to the touch.

RECOMMENDED ADHESIVE
Bostik 2402-A with hardener 2402-B

**NOTE:** Mix Bostik glue and hardener as per instruction on its package.

Apply a second thin layer of adhesive on both parts.

Allow the second coat to dry until tacky to the touch; then, position the patch.

Smooth out the patch using a spoon-shaped tool beginning at center and working outward to remove all excess glue and air bubbles.

Allow 24 hours to dry before inflating.

Clean any glue excess.

**Tear Repair of More than 5 cm (2 in)**

Deflate completely sponson to be repaired.

Cut 2 patches about 75 mm (3 in) larger than the tear in every direction. Always round corners.

Using only a pencil, trace the patch position on sponson.

**NOTICE** Do not use pen or felt-tip pen as ink will permanently mark sponson.

Sand thoroughly sponson areas (inner and outer) with a 80 grit sandpaper.

**NOTE:** Protect the outer surface in vicinity with masking tape.

Remove masking tape.

Clean the patch and sponson areas with recommended solvent. Allow solvent to completely evaporate.

RECOMMENDED SOLVENT
Acetone / Toluene / Methyl ethyl ketone

Apply a thin layer of recommended adhesive (or equivalent) to one patch and to inner section of sponson. Allow adhesive to dry so that it is dry to the touch.

RECOMMENDED ADHESIVE
Bostik 2402-A with hardener 2402-B

**NOTE:** Mix glue and hardener as per instruction on its package.

Apply a second thin layer of adhesive on both parts.

Allow the second coat to dry until tacky to the touch; then, position the patch.

**NOTE:** To ease patch installation, roll it tightly and insert it through the sponson tear.

Smooth out the patch using a spoon-shaped tool beginning at center and working outward to remove all excess glue and air bubbles.

Repeat the same bonding procedure for the outer patch.

Allow 24 hours to dry before inflating.

Clean any glue excess.

# WATERCRAFT CARE

Remove the watercraft from the water every day.

## Post-Operation Care

### Exhaust System and Heat Exchanger Flushing

The exhaust system and the heat exchanger should be flushed daily when watercraft is used in salt or foul water.

Refer to *MAINTENANCE PROCEDURES*.

### Additional Care for Foul Water or Salt Water Operation

When the watercraft is operated in foul water and particularly in salt water, additional care should be taken to protect the watercraft and its components.

Rinse watercraft bilge area with fresh water.

Never use a high pressure washer to clean the bilge. **USE LOW PRESSURE ONLY** (such as a garden hose).

High pressure can cause damages to electrical or mechanical systems.

**⚠ CAUTION** Allow engine to cool before performing any maintenance.

**NOTICE** Failure to perform proper care such as: watercraft rinsing, exhaust system flushing and anticorrosion treatment, when watercraft is used in salt water, will result in damage to the watercraft and its components. Never leave the watercraft stored in direct sunlight.

## Watercraft Cleaning

### Body and Hull

Occasionally, wash the hull and various body components with water and soap (use only mild detergent). Remove any marine organisms from engine and/or hull. Apply non-abrasive wax such as silicone wax.

**NOTICE** Never clean fiberglass and plastic parts with strong detergent, degreasing agent, paint thinner, acetone, or other strong chemical or petroleum type cleaner.

Stains may be removed from the seat and fiberglass using XPS ALL PURPOSE CLEANER/XPS ALL PURPOSE CLEANER (P/N 219 701 709) or the equivalent.

To clean the carpets, use 3M™ Citrus Base Cleaner (24 oz spray can) or an equivalent.

### **⚠ WARNING**

Never apply plastic or vinyl protector on the carpets or seat as the surface will become slippery and the occupants may slip off the watercraft.

Respect the environment by ensuring fuel, oil or cleaning solutions do not drain into the waterways.

### Inflatable Sponsons

When the watercraft is operated in foul water and particularly in salt water, sponsons must be rinsed frequently with fresh water.

Occasionally, wash the sponsons with warm water and soap (only use mild detergent).

Stubborn stains and scuff marks may be removed using methyl ethyl ketone, toluene or acetone.

**NOTICE** Never clean decals or other surfaces of the watercraft with strong detergent, methyl ethyl ketone, toluene or acetone. Limit application of these solvents on sponson joints to avoid glue dilution.

## Post-Operation Inspection

It is important to check the following after riding the watercraft, especially if it was used in shallow water. This will ensure that the watercraft is ready and in proper condition for the next outing.

### WARNING

The post-operation inspection can help you monitor wear and deterioration before they become a problem. Correct any problems that you discover to reduce the risk of a breakdown for the next outing. See an authorized Sea-Doo dealer as necessary.

### WARNING

Engine should be off and the tether cord cap should always be removed from the engine cut-off switch prior to verifying any of the following points.

ITEM	OPERATION	✓
Hull	Inspect hull integrity. Check also condition of the protective coating.	
Jet pump water intake grate	Inspect/clean. Refer to <i>MAINTENANCE PROCEDURES</i> subsection.	
Jet pump	Inspect impeller condition and wear ring clearance (when used in shallow water).	
Fuel tank	Refill. Refer to <i>FUELING</i> subsection.	
Engine compartment	Check for any visible fluid leaks and gasoline vapor odor. Refer to <i>MAINTENANCE PROCEDURES</i> subsection.	
Engine oil level	Check/refill. Refer to <i>MAINTENANCE PROCEDURES</i> subsection.	
Engine coolant level	Check/refill. Refer to <i>MAINTENANCE PROCEDURES</i> subsection.	
Front bumper	Check condition.	

ITEM	OPERATION	✓
Inflatable sponsons including running boards	Check condition of sponsons and running boards. Also: <ul style="list-style-type: none"> <li>– Inspect cords.</li> <li>– Inspect and tighten shackles.</li> </ul>	
Rear mast (if equipped)	Check condition: <ul style="list-style-type: none"> <li>– Make sure mast is properly installed and check for any play. Tighten nuts if required.</li> <li>– Make sure padding is in good condition and properly secured.</li> <li>– Ensure base is secured and in good condition.</li> </ul>	
Battery	Check battery voltage. If below 12.3 VDC, swap with another battery and recharge. We recommend swapping battery with a charged one after every outing if watercraft is used for search and rescue operations.	

# STORAGE AND PRESEASON PREPARATION

## Storage

### WARNING

Because fuel and oil are flammable, you should have an authorized Sea-Doo dealer, repair shop, or person of your own choosing to inspect the fuel system integrity as specified in the periodic inspection chart.

It is recommended that the watercraft be serviced by an authorized Sea-Doo dealer, repair shop, or person of your own choosing for storage, however the following operations can be performed by you with a minimum of tools.

**NOTE:** Carry out the following tasks in the same order as detailed in this section.

**NOTICE** Do not run the engine during the storage period.

## Propulsion System

### Jet Pump Cleaning

Clean jet pump by spraying water in its inlet and outlet and then apply a coat of XPS LUBE (P/N 293 600 016) or equivalent.

### WARNING

Always remove tether cord from the engine cut-off switch to prevent unexpected engine starting before cleaning the propulsion system components. Engine must not be running for this operation.

### Jet Pump Inspection

See your authorized Sea-Doo dealer.

## Fuel System

### Fuel System Protection

XPS FUEL STABILIZER (P/N 413 408 601) (or equivalent) should be added in the fuel tank to prevent fuel deterioration and fuel system gumming. Follow stabilizer manufacturers' instructions for proper use.

**NOTICE** It is highly recommended to add fuel stabilizer at storage in order to maintain fuel system in good condition. Fuel stabilizer should be added prior to engine lubrication and fuel tank top up to ensure fuel system components protection against varnish deposits.

Fill up fuel tank completely as explained in *FUELING* subsection. Make sure there is no water inside fuel tank.

**NOTICE** Should any water be trapped inside fuel tank, severe internal damage will occur to the fuel injection system.

## Engine and Exhaust Systems

### Exhaust System Flushing

Perform procedure as described in *MAINTENANCE PROCEDURES*.

### Engine Oil and Filter Replacement

The oil change and filter replacement may be performed by an authorized Sea-Doo dealer, repair shop, or person of your own choosing.

### Exhaust System Draining

In areas where temperature may freeze, water trapped in the exhaust system must be removed.

Using the flushing connector located on the port (LH) side of the stern, inject pressurized air at 379 kPa (55 PSI) into system until there is no more water flowing from jet pump.



smo2009-002-132\_c

**TYPICAL**

1. Flushing connector

The following hose can be fabricated to ease draining procedure.



smo2009-001-053\_a

**TYPICAL**

1. Flushing connector adapter
2. Hose 12.7 mm (1/2 in)
3. Air hose male adapter

**NOTICE** Failure to drain the exhaust system may cause severe damage to the exhaust manifold.

Remove special tools.

**Engine Internal Lubrication**

1. Open the seat.
2. Remove ignition coils, refer to *MAINTENANCE PROCEDURES*.
3. Remove spark plugs, refer to *MAINTENANCE PROCEDURES*.
4. Spray XPS LUBEXPS LUBE (P/N 293 600 016) or equivalent in spark plug holes.
5. To prevent fuel from being injected and to disable the ignition during engine cranking, fully depress throttle lever and HOLD against handlebar.
6. Press the START/STOP button to crank the engine a few turns. This will distribute the oil on the cylinder walls.

7. Apply anti-seize lubricant on spark plug threads, then reinstall them in the engine. Refer to *MAINTENANCE PROCEDURES*.
8. Install the ignition coils, refer to *MAINTENANCE PROCEDURES*.

**Engine Coolant Test**

If antifreeze is not replaced, test its density.

The antifreeze replacement and a density test should be performed by an authorized Sea-Doo dealer.

**NOTE:** Antifreeze should be replaced every 300 hours or every 5 years to prevent antifreeze deterioration.

**NOTICE** Improper antifreeze density may result in freezing of the liquid in the cooling system if the watercraft is stored in an area where the freezing point is attained. This could seriously damage the engine.

**Electrical System**

**Battery Removal and Charging**

Contact your authorized Sea-Doo dealer.

**⚠ WARNING**

Never charge or boost (jump start) the battery while installed in the watercraft.

**Engine Compartment**

**Engine Compartment Cleaning**

Clean the bilge using hot water and a mild detergent or with bilge cleaner.

Rinse thoroughly.

Lift front end of watercraft to completely drain bilge through the bilge drain plugs.

**Anticorrosion Treatment**

Wipe off any residual water in the engine compartment.



Spray XPS LUBEXPS LUBE (P/N 293 600 016) or an equivalent over all metallic components in engine compartment.

**NOTE:** The seat should be left partially open during storage. This will prevent engine compartment condensation and possible corrosion.

## Body and Hull

### Body and Hull Cleaning

Wash the body with a soap and water solution (use only mild detergent). Rinse thoroughly with fresh water. Remove marine organisms from the hull.

**NOTICE** Never clean fiberglass and plastic parts with strong detergent, de-greasing agent, paint thinner, acetone, or other strong chemical or petroleum cleaners.

### Body and Hull Repair

If any repairs are needed to body components or to the hull, contact your authorized Sea-Doo dealer.

### Body and Hull Protection

Apply a good quality marine wax to the body.

If the watercraft is to be stored outside, cover it with an opaque tarpaulin to prevent sun rays and grime from affecting the plastic components, watercraft finish, as well as preventing dust accumulation.

**NOTICE** The watercraft should never be left in water for storage. Never leave the watercraft stored in direct sunlight. Never store watercraft in a plastic bag.

### Inflatable Sponsons

Wash the sponsons with soap and water solution (use only mild detergent). Rinse thoroughly with fresh water. Remove marine organisms from the sponsons.

**NOTICE** Never sponsons with strong detergent, de-greasing agent, paint thinner, acetone, or other strong chemical or petroleum cleaners.

Do not deflate sponsons for storage.

**NOTICE** Sponsons may deflate during storage. To avoid damages to floorboard, they should be removed.

## Preseason Preparation

Maintenance preparation must be performed in conjunction with *PERIODIC MAINTENANCE CHART*.

Ensure to perform all tasks included in the **100 HOURS OR 1 YEAR** column.

Preseason maintenance preparation may be performed by an authorized Sea-Doo dealer, repair shop or person of your own choosing.

**NOTE:** Though not required, it is recommended that an authorized Sea-Doo dealer perform preseason maintenance preparation at the same time that any safety-related factory campaigns are performed by the authorized Sea-Doo dealer.

### WARNING

Only perform procedures as detailed in the *PERIODIC MAINTENANCE CHART*. It is recommended that the assistance of an authorized Sea-Doo dealer be periodically obtained on other components and systems not covered in this guide.

**NOTICE** When component conditions seem less than satisfactory, replace using genuine BRP parts, or equivalents.

***This page is  
intentionally blank***

# ***TECHNICAL INFORMATION***

# WATERCRAFT IDENTIFICATION

The main components of the watercraft (engine and hull) are identified by different serial numbers. It may sometimes become necessary to locate these numbers for warranty purposes or to trace the watercraft in the event of theft.

## Hull Identification Number

The Hull Identification Number (HIN) is located on the boarding platform at the rear of watercraft.



**TYPICAL**

1. Hull Identification Number (HIN)

It is composed of 12 digits:

YDV	12345	L	8	09	
					Model year
					Year of production
					Month of production
					Serial number (a letter may also be used as a digit)
					Manufacturer

## Engine Identification Number

The Engine Identification Number (EIN) is located on the front end of the engine.



**TYPICAL**

1. Engine Identification Number (EIN)

---

# ENGINE EMISSIONS INFORMATION

## Manufacturer's Responsibility

Beginning with 1999 model year engines, PWC manufacturers of marine engines must determine the exhaust emission levels for each engine horsepower family and certify these engines with the United States of America Environmental Protection Agency (EPA). An emissions control information label, showing emission levels and engine specifications, must be placed on each watercraft at the time of manufacture.

## Dealer's Responsibility

When performing service on all 1999 and more recent Sea-Doo watercraft that carry an emissions control information label, adjustments must be kept within published factory specifications.

Replacement or repair of any emission related component must be executed in a manner that maintains emission levels within the prescribed certification standards.

Dealers are not to modify the engine in any manner that would alter the horsepower or allow emission levels to exceed their predetermined factory specifications.

Exceptions include manufacturer's prescribed changes, such as altitude adjustments for example.

## Owner Responsibility

The owner/operator is required to have engine maintenance performed to maintain emission levels within prescribed certification standards.

The owner/operator is not to, and should not allow anyone to modify the engine in any manner that would alter the horsepower or allow emissions levels to exceed their predetermined factory specifications.

## EPA Emission Regulations

All 1999 and more recent Sea-Doo watercraft manufactured by BRP are certified to the EPA as conforming to the requirements of the regulations for the control of air pollution from new watercraft engines. This certification is contingent on certain adjustments being set to factory standards. For this reason, the factory procedure for servicing the product must be strictly followed and, whenever practicable, returned to the original intent of the design.

The responsibilities listed above are general and in no way a complete listing of the rules and regulations pertaining to the EPA requirements on exhaust emissions for marine products. For more detailed information on this subject, you may contact:

U.S. Environmental Protection Agency  
Office of Transportation and Air Quality  
1200 Pennsylvania Ave. NW  
Mail Code 6403J  
Washington D.C. 20460

**EPA INTERNET WEB SITE:**  
<http://www.epa.gov/otaq>

# SPECIFICATIONS

SEA-DOO SAR		
<b>ENGINE</b>		
Type	Rotax®1503 4-TEC®. Single Over Head Camshaft (SOHC)	
Declared Power <sup>(1)</sup>	106 kW @ 7300 RPM	
Induction	Naturally-aspirated	
Number of cylinders	3	
Number of valves	12 valves (4 per cylinder) with hydraulic lifters (no adjustment)	
Displacement	1 494 cm <sup>3</sup> (91.2 in <sup>3</sup> )	
Bore	100 mm (3.9 in)	
Stroke	63.4 mm (2.5 in)	
Compression ratio	10.6:1	
<b>COOLING SYSTEM</b>		
Type	Closed-loop cooling system (shock protected with internal heat exchanger)	
<b>FUEL SYSTEM</b>		
Fuel injection type	Multipoint fuel injection with iTC (intelligent Throttle Control). Single throttle body (62 mm) with actuator	
<b>ELECTRICAL SYSTEM</b>		
Ignition	IDI (inductive discharge ignition)	
Battery	12 V, 30 A•h. Maintenance-free type	
Spark plug	Make and type	NGK, DCPR8E
	Gap	0.75 mm (.03 in)
<b>PROPULSION</b>		
Propulsion system	Sea-Doo® jet pump with iBR (intelligent brake and reverse)	
Jet pump	Type	Axial flow, single stage. Large hub with 10-vane stator
	Material	Aluminum/stainless steel (wear ring)
Impeller	Stainless steel	
Transmission	Type	Direct drive

SEA-DOO SAR			
PROPULSION (con't)			
VTS	Type	Electronic, gauge interface	
DIMENSIONS			
Length	339 cm (133.4 in)		
Width	170 cm (66.8 in)		
Height (except rear mast)	111.8 cm (44 in)		
WEIGHT AND LOADING CAPACITY			
Weight (dry)	438 kg (965 lb)		
Rider capacity	3 (refer to load limit)		
Storage capacity	116.6 L (30.8 U.S. gal.)		
Load limit (passengers + luggage)	295 kg (650 lb)		
FLUIDS			
Fuel - Refer to <i>FUEL REQUIREMENTS</i>	Type	Regular unleaded	
	Minimum octane	87 Pump Posted AKI (RON+MON)/2	
		91 RON	
Tank capacity	60 L (15.9 U.S. gal.)		
Engine oil	Type	XPS synthetic blend oil. If not available, use SAE 5W40 API service SM motor oil	
	Capacity	3 L (3.2 qt (U.S. liq.)) oil change w/filter	
Cooling system	Coolant type	See <i>ENGINE COOLANT</i> in the <i>MAINTENANCE PROCEDURES</i> sub-section of this guide	
	Capacity	5.5 L (5.8 qt (U.S. liq.))	

(1) Declared power as per ISO 8665 at propeller-shaft.

**NOTE:** BRP reserves the right to make changes in design and specifications and/or to make additions to, or improvements in its products without imposing any obligation upon itself to install them on its products previously manufactured.

***This page is  
intentionally blank***



# ***TROUBLESHOOTING***

---

# TROUBLESHOOTING GUIDELINES

---

## ENGINE WILL NOT START

---

1. Tether cord removed.
  - Properly install tether cord cap on engine cut-off switch .
  - After double “beep”, press START/STOP button to start engine.
2. Burnt fuse: main, electric starter or ECM.
  - Check wiring then replace fuse(s).
3. Discharged battery.
  - Refer to an authorized Sea-Doo dealer.

### **WARNING**

Do not charge or boost (jump start) the battery while installed on the watercraft. Electrolyte is poisonous and dangerous. Avoid contact with eyes, skin and clothing.

4. Battery connections, corroded or loose. Bad ground.
  - Refer to an authorized Sea-Doo dealer.
5. Water-flooded engine.
  - Refer to WATER-FLOODED ENGINE in SPECIAL PROCEDURES.
6. Faulty sensor or ECM.
  - Seek service from an authorized Sea-Doo dealer, repair shop, or person of your own choosing for maintenance, repair, or replacement. Please refer to the US EPA EMISSIONS-RELATED WARRANTY contained herein for information about warranty claims.
7. Seized jet pump.
  - Try to clean. Otherwise, refer to an authorized Sea-Doo dealer.

## ENGINE CRANKS SLOWLY

---

1. Loose battery cable connections.
  - Check/clean/tighten.
2. Discharged or weak battery.
  - Refer to an authorized Sea-Doo dealer.
3. Worn starter.
  - Refer to an authorized Sea-Doo dealer.

## ENGINE TURNS NORMALLY BUT WILL NOT START

---

1. Fuel tank empty or water-contaminated.
  - Refill. Siphon and fill with fresh fuel.
2. Fouled/defective spark plugs.
  - Replace.
3. Blown fuse.
  - Check wiring then replace fuse(s).

---

**ENGINE TURNS NORMALLY BUT WILL NOT START (cont'd)**

---

**4. Water-flooded engine.**

- Refer to *WATER-FLOODED ENGINE* in *SPECIAL PROCEDURES*.

**5. Engine management system fault detected (check engine pilot lamp is ON).**

- Seek service from an authorized Sea-Doo dealer, repair shop, or person of your own choosing for maintenance, repair, or replacement. Please refer to the *US EPA EMISSIONS-RELATED WARRANTY* contained herein for information about warranty claims.

**6. Faulty fuel pump.**

- Seek service from an authorized Sea-Doo dealer, repair shop, or person of your own choosing for maintenance, repair, or replacement. Please refer to the *US EPA EMISSIONS-RELATED WARRANTY* contained herein for information about warranty claims.

---

**ENGINE MISFIRES, RUNS IRREGULARLY**

---

**1. Fouled/defective/worn spark plugs.**

- Replace.

**2. Fuel: Level too low, stale or water-contaminated.**

- Siphon and/or refill.

**3. Faulty ignition coil(s).**

- Seek service from an authorized Sea-Doo dealer, repair shop, or person of your own choosing for maintenance, repair, or replacement. Please refer to the *US EPA EMISSIONS-RELATED WARRANTY* contained herein for information about warranty claims.

**4. Clogged injectors.**

- Seek service from an authorized Sea-Doo dealer, repair shop, or person of your own choosing for maintenance, repair, or replacement. Please refer to the *US EPA EMISSIONS-RELATED WARRANTY* contained herein for information about warranty claims.

**5. Engine management system fault detected (check engine pilot lamp is ON).**

- Refer to *MONITORING SYSTEM*.

---

**ENGINE SMOKE**

---

**1. Oil level too high.**

- Seek service from an authorized Sea-Doo dealer, repair shop, or person of your own choosing for maintenance, repair, or replacement. Please refer to the *US EPA EMISSIONS-RELATED WARRANTY* contained herein for information about warranty claims.

**2. Water ingestion, coolant leak or damaged cylinder head gasket.**

- Seek service from an authorized Sea-Doo dealer, repair shop, or person of your own choosing for maintenance, repair, or replacement. Please refer to the *US EPA EMISSIONS-RELATED WARRANTY* contained herein for information about warranty claims.

## ENGINE SMOKE (cont'd)

---

### 3. Internal engine damage.

- *Seek service from an authorized Sea-Doo dealer, repair shop, or person of your own choosing for maintenance, repair, or replacement. Please refer to the US EPA EMISSIONS-RELATED WARRANTY contained herein for information about warranty claims.*

## ENGINE OVERHEATS

---

### 1. Clogged exhaust system or internal heat exchanger.

- *Flush exhaust system and heat exchanger.*

### 2. Engine coolant level too low.

- *Refer to MAINTENANCE PROCEDURES.*

### 3. Quick connect adapter left in flushing connector.

- *Remove adapter from flushing connector and retry watercraft. If problem persists, seek service from an authorized Sea-Doo dealer, repair shop, or person of your own choosing for maintenance, repair, or replacement. Please refer to the US EPA EMISSIONS-RELATED WARRANTY contained herein for information about warranty claims.*

## ENGINE LACKS ACCELERATION OR POWER

---

### 1. Not in Sport mode.

- *Select Sport mode or restart engine to enable Sport mode.*

### 2. Jet pump water intake clogged.

- *Clean. Refer to JET PUMP WATER INTAKE AND IMPELLER CLEANING in SPECIAL PROCEDURES subsection.*

### 3. Damaged impeller or worn-out wear ring.

- *Replace. Refer to an authorized Sea-Doo dealer.*

### 4. Engine oil level too high.

- *Seek service from an authorized Sea-Doo dealer, repair shop, or person of your own choosing for maintenance, repair, or replacement. Please refer to the US EPA EMISSIONS-RELATED WARRANTY contained herein for information about warranty claims.*

### 5. Weak spark.

- *Refer to ENGINE MISFIRES, RUNS IRREGULARLY.*

### 6. Engine management system fault detected (check engine pilot lamp is ON).

- *Refer to MONITORING SYSTEM.*

### 7. Clogged injectors.

- *Seek service from an authorized Sea-Doo dealer, repair shop, or person of your own choosing for maintenance, repair, or replacement. Please refer to the US EPA EMISSIONS-RELATED WARRANTY contained herein for information about warranty claims.*

---

**ENGINE LACKS ACCELERATION OR POWER (cont'd)**

---

**8. Low fuel pressure.**

- *Seek service from an authorized Sea-Doo dealer, repair shop, or person of your own choosing for maintenance, repair, or replacement. Please refer to the US EPA EMISSIONS-RELATED WARRANTY contained herein for information about warranty claims.*

**9. Water in fuel.**

- *Siphon and replace.*

**10. Engine damaged by water ingestion.**

- *Refer to an authorized Sea-Doo dealer.*

---

**WATERCRAFT CANNOT REACH TOP SPEED**

---

**1. Jet pump water intake clogged.**

- *Clean. Refer to JET PUMP WATER INTAKE AND IMPELLER CLEANING in SPECIAL PROCEDURES subsection.*

**2. Damaged impeller or worn-out wear ring.**

- *Replace. Refer to an authorized Sea-Doo dealer.*

**3. Engine management system fault detected (check engine pilot lamp is ON).**

- *Refer to MONITORING SYSTEM.*

---

**WATERCRAFT STAYS IN NEUTRAL AFTER OPERATING THE iBR LEVER**

---

**1. The iBR gate stays in neutral.**

- *Release the throttle to idle RPM.*
- *Press the CRUISE button to activate the slow speed mode.*
- *Return to shore using the slow speed mode. Refer to an authorized Sea-Doo dealer.*

---

**iBR WILL NOT RETURN TO NEUTRAL POSITION (iBR INDICATOR LIGHT ON)**

---

**1. iBR jammed with debris.**

- *Clean and check for damage in the iBR gate and nozzle area.*

**2. iBR system malfunction.**

- *Remove tether cord and wait 5 minutes.*
- *Press START/STOP button.*
- *Install tether cord and check iBR light to ensure fault is cleared.*
- *Refer to an authorized Sea-Doo dealer if fault persists or reoccurs frequently.*

---

**iBR WILL NOT RETURN TO NEUTRAL POSITION (iBR FAULT INDICATOR OFF)**

---

**1. Throttle lever not fully released during operation.**

- *Release throttle lever fully to ensure iBR gate returns to neutral.*

**2. Throttle lever does not fully return to null when released.**

- *Refer to an authorized Sea-Doo dealer.*

## ABNORMAL NOISE FROM PROPULSION SYSTEM

---

1. **Weeds or debris jammed around impeller.**
  - *Clean. Refer to JET PUMP WATER INTAKE AND IMPELLER CLEANING in SPECIAL PROCEDURES subsection.*
  - *Check for damage.*
2. **Damaged impeller shaft or drive shaft.**
  - *Refer to an authorized Sea-Doo dealer.*
3. **Water intrusion in jet pump causing bearing seizure.**
  - *Refer to an authorized Sea-Doo dealer.*

## WATER FOUND IN BILGE

---

1. **Bilge pump malfunction.**
  - *Refer to an authorized Sea-Doo dealer.*
2. **Bailer system malfunction.**
  - *Have system inspected by an authorized Sea-Doo dealer.*
3. **Exhaust system leak.**
  - *Refer to an authorized Sea-Doo dealer.*
4. **Carbon ring at drive shaft worn.**
  - *Refer to an authorized Sea-Doo dealer.*
5. **Hull damaged.**
  - *Refer to an authorized Sea-Doo dealer.*

# MONITORING SYSTEM

A system monitors the electronic components of the EMS (engine management system), iBR (if equipped), and other components of the electrical system. When a fault occurs, it sends visual messages through the information center and/or audible signals through a beeper to inform you of a particular condition.

A fault code may also be recorded.

When a minor or transient fault occurs, the fault message and beeper will cease automatically if the condition that caused the fault does not exist anymore.

Releasing the throttle and letting the engine return to idle speed may allow normal operation to return. If this does not work, try removing the tether cord from the engine cut-off switch, waiting 5 minutes, then restarting.

The electronic system will react differently depending on the fault type. If a severe failure occurred, the engine may not be allowed to be started. In other cases, the engine will operate in limp home mode (reduced speed).

When a fault occurs, seek service from an authorized Sea-Doo dealer, repair shop, or person of your own choosing for maintenance, repair, or replacement as soon as possible for inspection. Please refer to the *US EPA EMISSIONS-RELATED WARRANTY* contained herein for information about warranty claims.

## Fault Codes

When a fault occurs, a numerical fault code may be recorded depending on the fault type and system.

These fault codes are used by authorized Sea-Doo dealers for troubleshooting the watercraft systems when comparing them to a fault list.

Fault codes can be viewed in the information center multifunction display however, this function is only available if a fault is still active.

If there is an active fault code, it may be viewed by the operator on the multifunction display. The operator may then choose to call his authorized Sea-Doo dealer to pass on the fault code. The dealer will then advise the operator on the steps to take to solve the problem, or to stop using the watercraft and to bring it in to the dealer for repairs.

## Displaying Fault Codes

Press the MODE button repeatedly until the FAULT CODE function is visible in the multifunction display.

Press the SET or the UP/DOWN button to enter the function and display the first fault code, then press the UP/DOWN button repeatedly to display each subsequent code.

**NOTE:** When the last fault code has been displayed and the button is pressed again, the system loops back to the first fault code displayed, and all fault codes can again be displayed. If there was one active fault code when entering the FAULT CODE mode, and it becomes occurred (no longer active), a NO ACTIVE FAULT CODE message will scroll in the display.

To exit the FAULT CODE display function, the MODE or SET button must be pressed once. There is no time out on this function.

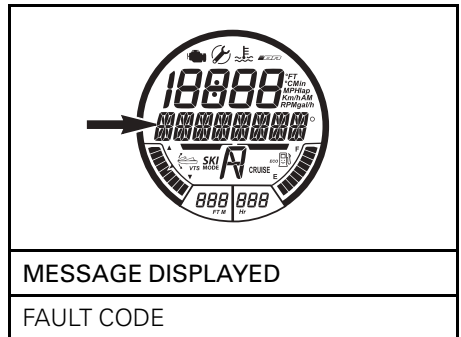

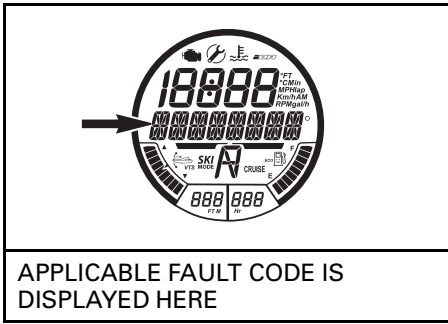

APPLICABLE FAULT CODE IS DISPLAYED HERE

## Fault Indicators and Message Display Information

The fault indicators and messages displayed in the information center will inform you of a particular condition or if an anomaly occurs.

If a fault indicator or a fault message comes ON in the multifunction gauge, seek service from an authorized Sea-Doo dealer, repair shop, or person of your own choosing for maintenance, repair, or replacement. Please refer to the *US EPA EMISSIONS-RELATED WARRANTY* contained herein for information about warranty claims.

For information on usual function indicators, refer to *INFORMATION CENTER (GAUGES)* subsection.

FAULT INDICATOR (ON)	MESSAGE DISPLAY	DESCRIPTION
	HIGH TEMPERATURE	Engine or exhaust system overheating
	CHECK ENGINE or LIMP HOME MODE	Check engine (minor fault requiring maintenance) or LIMP HOME MODE (major engine fault)
	LOW or HIGH BATTERY VOLTAGE	Low/high battery voltage
	LOW OIL PRESSURE	Low engine oil pressure detected
	IBR MODULE ERROR	Models with iBR Light is steady with a buzzer and a check engine light: iBR system fault (refer to an authorized Sea-Doo dealer)
	--	Models with iBR Light is flashing: iBR system fault (refer to an authorized Sea-Doo dealer)
	--	Models with iBR Light is steady with no buzzer: iBR system still functional but needs to be inspected by an authorized Sea-Doo dealer



MESSAGE DISPLAY INFORMATION	
RIGHT KEYPAD ERROR	Gauge control button malfunction
LOW OIL PRESSURE	Engine low oil pressure detected
HIGH EXHAUST TEMPERATURE	High exhaust temperature detected
HIGH TEMPERATURE	High engine temperature detected
CHECK ENGINE	Engine system malfunction or maintenance required
HIGH BATTERY VOLTAGE	High battery voltage detected
LOW BATTERY VOLTAGE	Low battery voltage detected
LIMP HOME MODE	Major fault detected, engine power limited
FUEL SENSOR DEFECTIVE	Fuel level sensor fault
IBR MODULE ERROR	iBR system malfunction (models with iBR)
CALIBRATION CHECKSUM ERROR	Cluster programming corrupted
MAINTENANCE REQUIRED	Watercraft maintenance required

**NOTICE** Running engine with low oil pressure may severely damage the engine.

## Beeper Code Information

BEEPER CODES	DESCRIPTION
1 long beep (when installing tether cord on engine cut-off switch)	<b>Defective engine cut-off switch.</b> Refer to an authorized Sea-Doo dealer.
	<b>Improper operation of ECM or defective wiring harness.</b> Seek service from an authorized Sea-Doo dealer, repair shop, or person of your own choosing for maintenance, repair, or replacement. Please refer to the US EPA Emissions-related warranty contained herein for information about warranty claims.
A 2 second beep every 15 minute interval	<b>Watercraft is upside down.</b> Turn watercraft upright. Refer to <i>SPECIAL PROCEDURES</i> .
	<b>Engine management system fault.</b> Seek service from an authorized Sea-Doo dealer, repair shop, or person of your own choosing for maintenance, repair, or replacement. Please refer to the US EPA Emissions-related warranty contained herein for information about warranty claims.
	<b>iBR system fault.</b> Refer to an authorized Sea-Doo dealer.
A 2 second beep every 5 minute interval	<b>Low fuel level.</b> Refill fuel tank. If problem persists, refer to an authorized Sea-Doo dealer.
	<b>Fuel tank level sensor or circuit malfunction.</b> Refer to an authorized Sea-Doo dealer.
Continuously beeps	<b>High engine coolant temperature.</b> See <i>ENGINE OVERHEATING</i> .
	<b>High exhaust temperature.</b> Seek service from an authorized Sea-Doo dealer, repair shop, or person of your own choosing for maintenance, repair, or replacement. Please refer to the US EPA Emissions-related warranty contained herein for information about warranty claims.
	<b>Low oil pressure.</b> Turn off engine as soon as possible. Check oil level and refill. Refer to an authorized Sea-Doo dealer.

**NOTICE** If the monitoring beeper continuously sounds, stop engine as soon as possible.

# ***WARRANTY***

---

# **BRP LIMITED WARRANTY – USA AND CANADA: 2017 SEA-DOO® PERSONAL WATERCRAFT**

## **1. SCOPE**

Bombardier Recreational Products Inc. (“BRP”)\* warrants its model-year 2017 Sea-Doo personal watercraft sold by authorized BRP Dealers (as defined below) in the United States of America (“USA”) and in Canada from defects in material or workmanship for the period and under the conditions described below. This limited warranty will become null and void if: (1) the Sea-Doo personal watercraft was used for racing or any other competitive activity, at any point, even by a previous owner; or (2) the Sea-Doo personal watercraft has been altered or modified in such a way so as to adversely affect its operation, performance or durability, or has been altered or modified to change its intended use.

## **2. LIMITATIONS OF LIABILITY**

THIS WARRANTY IS EXPRESSLY GIVEN AND ACCEPTED IN LIEU OF ANY AND ALL OTHER WARRANTIES, EXPRESSED OR IMPLIED, INCLUDING WITHOUT LIMITATION ANY WARRANTY OF MERCHANTABILITY OR FITNESS FOR A PARTICULAR PURPOSE. TO THE EXTENT THAT THEY CANNOT BE DISCLAIMED, THE IMPLIED WARRANTIES ARE LIMITED IN DURATION TO THE LIFE OF THE EXPRESS WARRANTY. INCIDENTAL AND CONSEQUENTIAL DAMAGES ARE EXCLUDED FROM COVERAGE UNDER THIS WARRANTY. SOME STATES/PROVINCES DO NOT ALLOW FOR THE DISCLAIMERS, LIMITATIONS AND EXCLUSIONS IDENTIFIED ABOVE, AS A RESULT, THEY MAY NOT APPLY TO YOU. THIS WARRANTY GIVES YOU SPECIFIC RIGHTS, AND YOU MAY ALSO HAVE OTHER LEGAL RIGHTS WHICH MAY VARY FROM STATE TO STATE, OR PROVINCE TO PROVINCE.

Neither the distributor, any BRP dealer nor any other person has been authorized to make any affirmation, representation or warranty regarding the product, other than those contained in this limited warranty, and if made, shall not be enforceable against BRP. BRP reserves the right to modify this warranty at any time, being understood that such modification will not alter the warranty conditions applicable to the products sold while this warranty is in effect.

## **3. EXCLUSIONS – ARE NOT WARRANTED**

The following are not warranted under any circumstances:

- Normal wear and tear;
- Routine maintenance items, tune ups, adjustments;
- Damage caused by failure to provide proper maintenance and/or storage, as described in the Operator’s Guide;
- Damage resulting from removal of parts, improper repairs, service, maintenance, modifications or use of parts not manufactured or approved by BRP or resulting from repairs done by a person that is not an authorized servicing BRP dealer;
- Damage caused by abuse, abnormal use, neglect, or operation of the product in a manner inconsistent with the recommended operation described in the Operator’s Guide;
- Damage resulting from accident, submersion, fire, theft, vandalism or any act of God;

- Operation with fuels, oils or lubricants which are not suitable for use with the product (see the Operator’s Guide);
- Damage from rust, corrosion or exposure to the elements;
- Damage from cooling system or jet pump blockage by foreign material;
- Water damages caused by water ingestion;
- Damages related to gel coat finish including but not limited to cosmetic gel coat finish, blisters or fiberglass delamination caused by blisters, crazing, spider or hairline cracks; and
- Incidental or consequential damages, or damages of any kind including without limitation towing, storage, telephone, rental, taxi, inconvenience, insurance coverage, loan payments, loss of time, loss of income.

#### **4. WARRANTY COVERAGE PERIOD**

This limited warranty will be in effect from (1) the date of delivery to the first retail consumer or (2) the date the product is first put into use, whichever occurs first and for the applicable period below:

1. TWELVE (12) CONSECUTIVE MONTHS for private use owners.
2. FOUR (4) CONSECUTIVE MONTHS for commercial use owners. A personal watercraft is used commercially when it is used in connection with generating income or any work or employment during any part of the warranty period. A personal watercraft is also used commercially when, at any point during the warranty period, it has commercial tags or is licensed for commercial use. This is a minimal warranty period which can be extended by any applicable warranty promotional program, as the case may be.
3. For emission-related components; please also refer to the *US EPA EMISSION-RELATED WARRANTY* contained herein.
4. For Sea-Doo personal watercrafts produced by BRP for sale in the State of California or New York that are originally sold to a resident or subsequently warranty registered to a resident in the State of California or New York, please also refer to the applicable California and New York Emissions Control Warranty Statement contained herein.

The repair or replacement of parts or the performance of service under any applicable warranty does not extend the life of such warranty beyond its original expiration date.

#### **5. CONDITIONS REQUIRED FOR WARRANTY COVERAGE**

This limited warranty coverage is available **only** if **each** of the following conditions has been fulfilled:

- The 2017 Sea-Doo personal watercraft must be purchased as new and unused by its first owner from a BRP dealer authorized to distribute Sea-Doo personal watercraft in the country in which the sale occurred;
- The BRP specified predelivery inspection process must be completed and documented and signed by the purchaser;
- The 2017 Sea-Doo personal watercraft must have undergone proper registration by an authorized BRP dealer;

- The 2017 Sea-Doo personal watercraft must be purchased in the country in which the purchaser resides; and
- Routine maintenance outlined in the Operator's Guide must be timely performed in order to maintain warranty coverage. BRP reserves the right to make warranty coverage contingent upon proof of proper maintenance.

BRP will not honour this limited warranty to any private use owner or commercial use owner if one of the preceding conditions has not been met. Such limitations are necessary in order to allow BRP to preserve both the safety of its products, and also that of its consumers and the general public.

## **6. WHAT TO DO TO OBTAIN WARRANTY COVERAGE**

The customer must cease using the Sea-Doo personal watercraft upon the appearance of an anomaly. The customer must notify an authorized servicing BRP dealer within three (3) days of the appearance of a defect, and provide it with reasonable access to the product and reasonable opportunity to repair it. The customer must also present to the authorized BRP dealer, proof of purchase of the product and must sign the repair/work order prior to the start of the repair in order to validate the warranty repair. All parts replaced under this limited warranty become the property of BRP.

## **7. WHAT BRP WILL DO**

BRP's obligations under this warranty are limited to, at its sole discretion, repairing parts found defective under normal use, maintenance and service, or replacing such parts with new genuine BRP parts without charge for parts and labor, at any authorized BRP dealer during the applicable warranty coverage period under the conditions described herein. No claim of breach of warranty shall be the cause for cancellation or rescission of the sale of the Sea-Doo personal watercraft to the owner.

In the event that service is required outside of the country of original sale, the owner will bear responsibility for any additional charges due to local practices and conditions, such as, but not limited to freight, insurance, taxes, license fees, import duties, and any and all other financial charges, including those levied by governments, states, territories and their respective agencies.

BRP reserves the right to improve or modify products from time to time without assuming any obligation to modify products previously manufactured.

## **8. TRANSFER**

If the ownership of a product is transferred during the warranty coverage period, this warranty shall also be transferred and be valid for the remaining coverage period provided that BRP is notified of such transfer of ownership in the following way:

1. The former owner contacts BRP (at the phone number provided below) or an authorized BRP dealer and gives the coordinates of the new owner; or
2. BRP or an authorized BRP dealer receives a proof that the former owner agreed to the transfer of ownership, in addition to the coordinates of the new owner.

## **9. CONSUMER ASSISTANCE**

In the event of a controversy or a dispute in connection with this BRP limited warranty, BRP suggests that you try to resolve the issue at the dealership level. We recommend discussing the issue with the authorized BRP dealer's service manager or owner.

If the issue has not yet been resolved, please contact us:

<http://www.sea-doo.com/form/contact-us.html>

Tel.: 1-888-272-9222

\* In the USA, products are distributed and serviced by BRP US Inc.  
© 2017 Bombardier Recreational Products Inc. All rights reserved.  
® Registered trademark of Bombardier Recreational Products Inc. or its affiliates.

---

# US EPA EMISSION-RELATED WARRANTY

Bombardier Recreational Products Inc. ("BRP")\* warrants to the ultimate purchaser and each subsequent purchaser that this new engine, including all parts of its exhaust emission control system and its evaporative emission control system, meets two conditions:

1. It is designed, built, and equipped so it conforms at the time of sale to the ultimate purchaser with the requirements of 40 CFR 1045 and 40 CFR 1060.
2. It is free from defects in materials and workmanship that may keep it from meeting the requirements of 40 CFR 1045 and 40 CFR 1060.

Where a warrantable condition exists, BRP will repair or replace, as it elects, any part or component with a defect in materials or workmanship that would increase the engine's emissions of any regulated pollutant within the stated warranty period at no cost to the owner, including expenses related to diagnosing and repairing or replacing emission-related parts. All defective parts replaced under this warranty become the property of BRP.

For all emission-related warranty claims, BRP is limiting the diagnosis and repair of emission-related parts to the authorized Sea-Doo dealers, unless for emergency repairs as required by item 2 of the following list.

As a certifying manufacturer, BRP will not deny emission-related warranty claims based on any of the following:

1. Maintenance or other service BRP or BRP's authorized facilities performed.
2. Engine/equipment repair work that an operator performed to correct an unsafe, emergency condition attributable to BRP as long as the operator tries to restore the engine/equipment to its proper configuration as soon as possible.
3. Any action or inaction by the operator unrelated to the warranty claim.
4. Maintenance that was performed more frequently than BRP specify.
5. Anything that is BRP fault or responsibility.
6. The use of any fuel that is commonly available where the equipment operates unless BRP written maintenance instructions state that this fuel would harm the equipment's emission control system and operators can readily find the proper fuel. See maintenance information section and fuel requirements of fueling section.

## Emission-Related Warranty Period

The emission-related warranty is valid for the following period whichever comes first:

	HOURS	MONTHS
Exhaust emission-related components	175	30
Evaporative emission-related components	N/A	24



## Components Covered

The emission-related warranty covers all components whose failure would increase an engine's emissions of any regulated pollutant, including the following listed components:

1. For exhaust emissions, emission-related components include any engine parts related to the following systems:
  - Air-induction system
  - Fuel system
  - Ignition system
  - Exhaust gas recirculation systems
2. The following parts are also considered emission-related components for exhaust emissions:
  - Aftertreatment devices
  - Crankcase ventilation valves
  - Sensors
  - Electronic control units
3. The following parts are considered emission-related components for evaporative emissions:
  - Fuel tank
  - Fuel cap
  - Fuel line
  - Fuel line fittings
  - Clamps\*
  - Pressure relief valves\*
  - Control valves\*
  - Control solenoids\*
  - Electronic controls\*
  - Vacuum control diaphragms\*
  - Control cables\*
  - Control linkages\*
  - Purge valves
  - Vapor hoses
  - Liquid/vapor separator
  - Carbon canister
  - Canister mounting brackets
  - Carburetor purge port connector
4. Emission-related components also include any other part whose only purpose is to reduce emissions or whose failure will increase emissions without significantly degrading engine/equipment performance.

\*As related to the evaporative emission control system

## **Limited Applicability**

As a certifying manufacturer, BRP may deny emission-related warranty claims for failures that have been caused by the owner's or operator's improper maintenance or use, by accidents for which the manufacturer has no responsibility, or by acts of God. For example, an emission-related warranty claim need not be honored for failures that have been directly caused by the operator's abuse of the engine/equipment or the operator's use of the engine/equipment in a manner for which it was not designed and are not attributable to the manufacturer in any way.

\* In the USA, products are distributed and serviced by BRP US Inc.

---

# CALIFORNIA AND NEW YORK EMISSION CONTROL WARRANTY STATEMENT FOR MODEL YEAR 2017 SEA-DOO® PERSONAL WATERCRAFT

For California and New York, your 2017 Sea-Doo personal watercraft has a special environmental label required by the California Air Resources Board. The label has 1, 2, 3 or 4 stars. A hangtag, provided with your personal watercraft, describes the meaning of the star rating system.

## The Star Label Means Cleaner Marine Engines

The Symbol for Cleaner Marine Engines:



F18L3CQ

## Cleaner Air and Water

For a healthier lifestyle and environment.

## Better Fuel Economy

Burns up to 30 - 40 percent less gas and oil than conventional carbureted two-stroke engines saving money and resources.

## Longer Emission Warranty

Protects consumer for worry free operation.

## One Star – Low Emission

The one-star label identifies personal watercraft, outboard, stern drive and inboard engines that meet the Air Resources Board's Personal Watercraft and Outboard marine engine 2001 exhaust emission standards. Engines meeting these standards have 75% lower emissions than conventional carbureted two-stroke engines. These engines are equivalent to the U.S. EPA's 2006 standards for marine engines.

## Two Stars – Very Low Emission

The two-star label identifies personal watercraft, outboard, stern drive and inboard engines that meet the Air Resources Board's Personal Watercraft and Outboard marine engine 2004 exhaust emission standards. Engines meeting these standards have 20% lower emissions than One Star - Low-Emission engines.

## **Three Stars – Ultra Low Emission**

The three-star label identifies engines that meet the Air Resources Board's Personal Watercraft and Outboard marine engine 2008 exhaust emission standards or the Stern drive and Inboard marine engine 2003 exhaust emission standards. Engines meeting these standards have 65% lower emissions than One Star – Low Emission engines.

## **Four Stars – Super Ultra Low Emission**

The four-star label identifies engines that meet the Air Resources Board's Stern-drive and Inboard marine engine 2012 exhaust emission standards. Personal Watercraft and Outboard marine engines may also comply with these standards. Engines meeting these standards have 90% lower emissions than One Star – Low Emission engines.

For more information: Cleaner Watercraft – Get the Facts  
1 800 END-SMOG  
[www.arb.ca.gov](http://www.arb.ca.gov)

## **Your Emission Control Warranty Rights and Obligations**

The California Air Resources Board, the New York State Department of Environmental Conservation and Bombardier Recreational Products Inc. ("BRP") are pleased to explain the emission control system warranty on your Model Year 2017 Sea-Doo personal watercraft. In California and New York, new personal watercraft engines must be designed, built and equipped to meet the State's stringent anti-smog standards. BRP must warrant the emission control system on your personal watercraft engine for the period of time listed below provided there has been no abuse, neglect or improper maintenance of your personal watercraft engine.

Your emission control system may include parts such as the fuel injection system, the ignition system and catalytic converter. Also included may be hoses, belts, connectors and other emission related assemblies.

Where a warrantable condition exists, BRP will repair your personal watercraft engine at no cost to you including diagnosis, parts and labor provided that such work is performed by an authorized BRP dealer.

## **Manufacturer's Limited Warranty Coverage**

This emission limited warranty covers Model Year 2017 Sea-Doo personal watercrafts certified and produced by BRP for sale in California or New York, that are originally sold in California or New York to a California or New York resident or subsequently warranty registered to a California or New York resident. The BRP limited warranty conditions for Sea-Doo personal watercrafts are still applicable to these models with the necessary modifications. Select emission control parts of your 2017 Sea-Doo personal watercrafts are warranted from the date of delivery to the first retail consumer for a period of 4 years, or for 250 hours of use, whichever occurs first. However, warranty coverage based on the hourly period is only permitted for personal watercraft equipped with the appropriate hour meters or their equivalent. If any emission-related part on your engine is defective under warranty, the part will be repaired or replaced by BRP.

**Parts covered for a Model Year 2017 Sea-Doo® personal watercraft:**

Idle bypass valve	Air intake adapter
Throttle position sensor	Spark plugs
Intake manifold air pressure sensor	Ignition coils
Intake manifold air temperature sensor	Air box
Engine temperature sensor	Intake and exhaust valve and seals
Knock sensor	Intake manifold
Engine control module ECM	Crankcase ventilation valve
Throttle body	Throttle body seal
Fuel rail	Intake manifold seal
Fuel injectors	Wire harness and connectors
Fuel pressure regulator	Fuel filter
Fuel pump	Supercharger

The emission warranty covers damage to other engine components that is caused by the failure of a warranted part. The BRP Operator’s Guide provided contains written instructions for the proper maintenance and use of your personal watercraft. All emission warranty parts are warranted by BRP for the entire warranty period of the personal watercraft, unless the part is scheduled for replacement as required maintenance in the Operator’s Guide.

Emission warranty parts that are scheduled for replacement, as required maintenance, are warranted by BRP for the period of time before the first scheduled replacement date for that part. Emission warranty parts that are scheduled for regular inspection, but not regular replacement, are warranted by BRP for the entire warranty period of the personal watercraft. Any emission warranty part repaired or replaced under the terms of this warranty statement is warranted by BRP for the remainder of the warranty period of the original part. All parts replaced under this limited warranty become the property of BRP.

Maintenance receipts and records should be transferred to each subsequent owner of the personal watercraft.

## **Owner's Warranty Responsibilities**

As the owner of a 2017 Sea-Doo personal watercraft, you are responsible for the performance of the required maintenance listed in your Operator's Guide. BRP recommends that you retain all receipts covering maintenance of your personal watercraft engine, but BRP cannot deny warranty solely for the lack of receipts or your failure to ensure the performance of all scheduled maintenance.

As the owner of a Sea-Doo® personal watercraft, you should however be aware that BRP may deny you warranty coverage if your engine(s) or a part has failed due to abuse, neglect, improper maintenance or unapproved modifications.

You are responsible for presenting your engine to an authorized BRP Dealer as soon as a problem exists. The warranty repairs will be completed in a reasonable amount of time, not to exceed 30 days.

If you have any questions regarding your warranty rights and responsibilities or for the name and location of the nearest authorized BRP Dealer you should contact the Customer Assistance Center at 1 715 848-4957.

---

# **BRP INTERNATIONAL LIMITED WARRANTY: 2017 SEA-DOO® PERSONAL WATERCRAFT**

## **1. SCOPE OF THE LIMITED WARRANTY**

Bombardier Recreational Products Inc. ("BRP")\* warrants its 2017 SEA-DOO PERSONAL WATERCRAFTS ("personal watercraft") sold by distributors or dealers authorized by BRP to distribute Sea-Doo Personal watercrafts ("Sea-Doo Distributor/Dealer") outside of the fifty United States, Canada, member states of the European Economic Area (which is comprised of the member states of the European Union plus Norway, Iceland and Liechtenstein) ("EEA"), member states of the Commonwealth of the Independent States (including Ukraine and Turkmenistan) ("CIS") and Turkey, from defects in material or workmanship for the period and under the conditions described below.

All genuine BRP personal watercraft parts and accessories, installed by an authorized Sea-Doo Distributor/Dealer at the time of delivery of the 2017 Sea-Doo personal watercraft, carry the same warranty as that of the personal watercraft.

This limited warranty will become null and void if: (1) the personal watercraft was used for racing or any other competitive activity, at any point, even by a previous owner; or (2) the personal watercraft has been altered or modified in such a way so as to adversely affect its operation, performance or durability or (3) the personal watercraft has been altered or modified to change its intended use.

## **2. LIMITATIONS OF LIABILITY**

TO THE EXTENT PERMITTED BY LAW, THIS WARRANTY IS EXPRESSLY GIVEN AND ACCEPTED IN LIEU OF ANY AND ALL OTHER WARRANTIES, EXPRESSED OR IMPLIED, INCLUDING WITHOUT LIMITATION ANY WARRANTY OF MERCHANTABILITY OR FITNESS FOR A PARTICULAR PURPOSE. TO THE EXTENT THAT THEY CANNOT BE DISCLAIMED, THE IMPLIED WARRANTIES ARE LIMITED IN DURATION TO THE LIFE OF THE EXPRESS WARRANTY. INCIDENTAL AND CONSEQUENTIAL DAMAGES ARE EXCLUDED FROM COVERAGE UNDER THIS WARRANTY. SOME JURISDICTIONS DO NOT ALLOW FOR THE DISCLAIMERS, LIMITATIONS AND EXCLUSIONS IDENTIFIED ABOVE, AS A RESULT, THEY MAY NOT APPLY TO YOU. THIS WARRANTY GIVES YOU SPECIFIC RIGHTS AND YOU MAY ALSO HAVE OTHER LEGAL RIGHTS WHICH MAY VARY FROM COUNTRY TO COUNTRY. (FOR PRODUCTS PURCHASED IN AUSTRALIA SEE CLAUSE 4 BELOW).

Neither the Sea-Doo Distributor/Dealer nor any other person has been authorized to make any affirmation, representation or warranty regarding the product, other than those contained in this limited warranty, and if made, shall not be enforceable against BRP.

BRP reserves the right to modify this warranty at any time, being understood that such modification will not alter the warranty conditions applicable to the products sold while this warranty is in effect.

## **3. EXCLUSIONS – ARE NOT WARRANTED**

The following are not warranted under this limited warranty under any circumstances:

- Replacement of parts due to normal wear and tear;

- Routine maintenance parts and services, including but not limited to tune ups, adjustments, oil, lubricant and coolant changes, spark plug replacement, water pumps and the like;
- Damage caused by negligence or failure to provide proper maintenance and/or storage, as described in the Operator's Guide;
- Damage resulting from removal of parts, improper repairs, service, maintenance, modification or use of parts or accessories not manufactured or approved by BRP which in its reasonable judgment are either incompatible with the product or adversely affect its operation, performance and durability, or resulting from repairs done by a person that is not an authorized servicing Sea-Doo Distributor/Dealer;
- Damage caused by abuse, misuse, abnormal use, neglect, racing, improper operation or operation of the product in a manner inconsistent with the recommended operation described in the Operator's Guide;
- Damage resulting from external damage, accident, submersion, fire, foreign object or water ingestion, theft, vandalism or any act of God;
- Operation with fuels, oils or lubricants which are not suitable for use with the product (see the Operator's Guide);
- Damage resulting from rust, corrosion or exposure to the elements;
- Damages from cooling system or jet pump blockage by foreign material;
- Damages to gel coat finish including but not limited to cosmetic gel coat finish defects, blisters, starring, crazing and fiberglass delamination caused by blisters, crazing, spider or hairline cracks; and
- Incidental or consequential damages, or damages of any kind including without limitation towing, storage, transportation expenses, telephone, rental, taxi, inconvenience, insurance coverage, loan payments, loss of time, loss of income or time missed for downtime experience due to service work.

#### **4. WARRANTY COVERAGE PERIOD**

This limited warranty will be in effect from (1) the date of delivery to the first retail consumer or (2) the date the product is first put into use, whichever occurs first and for a period of:

1. TWELVE (12) CONSECUTIVE MONTHS for private, recreational use,
2. FOUR (4) CONSECUTIVE MONTHS for commercial use,  
This is a minimal warranty period which can be extended by any applicable warranty promotional program, as the case may be. A personal watercraft is used commercially when it is used in connection with generating income or any work or employment during any part of the warranty period. A personal watercraft is also used commercially when, at any point during the warranty period, it has commercial tags or is licensed for commercial use.

The repair or replacement of parts or the performance of service under this warranty does not extend the life of this warranty beyond its original expiration date.

Note that the duration and any other modalities of the warranty coverage are subject to the applicable national or local legislation in the customer's country.



## **FOR PRODUCTS SOLD IN AUSTRALIA ONLY**

Nothing in these Warranty terms and conditions should be taken to exclude, restrict or modify the application of any condition, warranty, guarantee, right or remedy conferred or implied under the Competition and Consumer Act 2010 (Cth), including the Australian Consumer Law or any other law, where to do so would contravene that law, or cause any part of these terms and conditions to be void. The benefits given to you under this limited warranty are in addition to other rights and remedies that you have under Australian law.

Our goods come with guarantees that cannot be excluded under the Australian Consumer Law. You are entitled to a replacement or refund for a major failure and for compensation for any other reasonably foreseeable loss or damage. You are also entitled to have the goods repaired or replaced if the goods fail to be of acceptable quality and the failure does not amount to a major failure.

## **5. CONDITIONS TO HAVE WARRANTY COVERAGE**

This warranty coverage is available **only** if **each** of the following conditions has been fulfilled:

- The 2017 Sea-Doo personal watercraft must be purchased as new and unused by its first owner from a Sea-Doo Distributor/Dealer authorized to distribute Sea-Doo personal watercrafts in the country in which the sale occurred;
- The BRP specified pre-delivery inspection process must be completed and documented;
- The 2017 Sea-Doo personal watercraft must have undergone proper registration by an authorized Sea-Doo Distributor/Dealer;
- The 2017 Sea-Doo personal watercraft must have been purchased in the country or union of countries in which the purchaser resides.
- Routine maintenance outlined in the Operator's Guide must be timely performed in order to maintain warranty coverage. BRP reserves the right to make warranty coverage contingent upon proof of proper maintenance.

BRP will not honor this limited warranty to any private use owner or commercial use owner if one of the preceding conditions has not been met. Such limitations are necessary in order to allow BRP to preserve both the safety of its products, and also that of its consumers and the general public.

## **6. WHAT TO DO TO OBTAIN WARRANTY COVERAGE UNDER THIS WARRANTY**

The customer must cease using the Sea-Doo personal watercraft upon the appearance of an anomaly. The customer must notify a servicing Sea-Doo Distributor/Dealer within two (2) days of the appearance of a defect, and provide it with reasonable access to the product and reasonable opportunity to repair it. The customer must also present to the authorized Sea-Doo Distributor/Dealer, proof of purchase of the product and must sign the repair/work order prior to starting the repair in order to validate the warranty repair. All parts replaced under this limited warranty become the property of BRP.

Note that the notification period is subject to the applicable national or local legislation in customer's country.

## **7. WHAT BRP WILL DO**

To the extent permitted by law, BRP's obligations under this warranty are limited to, at its sole discretion, repairing parts found defective under normal use, maintenance and service, or replacing such parts with new genuine BRP parts without charge for parts and labor, at any authorized Sea-Doo Distributor/Dealer during the warranty coverage period under the conditions described herein. BRP's responsibility is limited to making the required repairs or replacements of parts. No claim of breach of warranty shall be cause for cancellation or rescission of the sale of the Sea-Doo personal watercraft to the owner. You may have other legal rights which may vary from country to country.

In the event that service is required outside of the country of original sale, the owner will bear responsibility for any additional charges due to local practices and conditions, such as, but not limited to, freight, insurance, taxes, license fees, import duties, and any and all other financial charges, including those levied by governments, states, territories and their respective agencies.

BRP reserves the right to improve or modify products from time to time without assuming any obligation to modify products previously manufactured.

## **8. TRANSFER**

If the ownership of a product is transferred during the limited warranty coverage period, this warranty, subject to its terms and conditions, shall also be transferred and be valid for the remaining coverage period provided BRP or an authorized Sea-Doo Distributor/Dealer receives a proof that the former owner agreed to the transfer of ownership, in addition to the coordinates of the new owner.

## **9. CONSUMER ASSISTANCE**

1. In the event of a controversy or a dispute in connection with this limited warranty, BRP suggests that you try to resolve the issue at the Sea-Doo Distributor/Dealer level. We recommend discussing the issue with the authorized Sea-Doo Distributor/Dealer's service manager or owner.
2. If further assistance is required, the Sea-Doo Distributor/Dealer service department should be contacted in order to resolve the matter.
3. If the matter still remains unresolved then contact BRP by writing at the address listed below.

**For countries within Middle East and Africa, please contact our European office:**

**BRP EUROPE N.V.**

Consumer Assistance Center  
Skaldenstraat 125  
9042 Gent  
Belgium  
Tel.: +32 9 218 26 00

**For all other countries, please contact your local Sea-Doo Distributor/Dealer (visit our website at [www.brp.com](http://www.brp.com) for contact information), or contact our North American office at:**

**BOMBARDIER RECREATIONAL PRODUCTS INC.**

Consumer Assistance Center  
75 J.-A. Bombardier Street  
Sherbrooke QC J1L 1W3  
Tel.: +1 819 566-3366

\* For the territory covered by this limited warranty, products are distributed and serviced by Bombardier Recreational Products Inc. or its affiliates.  
© 2017 Bombardier Recreational Products Inc. All rights reserved.  
® Registered trademark of Bombardier Recreational Products Inc.

---

# **BRP LIMITED WARRANTY FOR THE EUROPEAN ECONOMIC AREA, THE COMMONWEALTH OF THE INDEPENDENT STATES, TURKEY: 2017 SEA-DOO® PERSONAL WATERCRAFT**

## **1. SCOPE OF THE LIMITED WARRANTY**

Bombardier Recreational Products Inc. ("BRP")\* warrants its 2017 SEA-DOO PERSONAL WATERCRAFT ("personal watercraft") sold by distributors or dealers authorized by BRP to distribute Sea-Doo personal watercrafts ("Sea-Doo Distributor/Dealer") in member states of the European Economic Area (which is comprised of the member states of the European Union plus Norway, Iceland and Liechtenstein) ("EEA"), in member states of the Commonwealth of the Independent States (including Ukraine and Turkmenistan) ("CIS") and Turkey from defects in material or workmanship for the period and under the conditions described below.

All genuine BRP personal watercraft parts and accessories, installed by an authorized Sea-Doo Distributors/Dealers at the time of delivery of the 2017 Sea-Doo personal watercraft carry the same warranty as that of the personal watercraft.

This limited warranty will become null and void if: (1) the personal watercraft was used for racing or any other competitive activity, at any point, even by a previous owner; or (2) the personal watercraft has been altered or modified in such a way so as to adversely affect its operation, performance or durability, or (3) the personal watercraft has been altered or modified to change its intended use.

## **2. LIMITATIONS OF LIABILITY**

TO THE EXTENT PERMITTED BY LAW, THIS WARRANTY IS EXPRESSLY GIVEN AND ACCEPTED IN LIEU OF ANY AND ALL OTHER WARRANTIES, EXPRESSED OR IMPLIED, INCLUDING WITHOUT LIMITATION ANY WARRANTY OF MERCHANTABILITY OR FITNESS FOR A PARTICULAR PURPOSE. TO THE EXTENT THAT THEY CANNOT BE DISCLAIMED, THE IMPLIED WARRANTIES ARE LIMITED IN DURATION TO THE LIFE OF THE EXPRESS WARRANTY. INCIDENTAL AND CONSEQUENTIAL DAMAGES ARE EXCLUDED FROM COVERAGE UNDER THIS WARRANTY. SOME JURISDICTIONS DO NOT ALLOW FOR THE DISCLAIMERS, LIMITATIONS AND EXCLUSIONS IDENTIFIED ABOVE, AS A RESULT, THEY MAY NOT APPLY TO YOU. THIS WARRANTY GIVES YOU SPECIFIC RIGHTS, AND YOU MAY ALSO HAVE OTHER LEGAL RIGHTS WHICH MAY VARY FROM COUNTRY TO COUNTRY.

Neither the Sea-Doo Distributor/Dealer nor any other person has been authorized to make any affirmation, representation or warranty regarding the product, other than those contained in this limited warranty, and if made, shall not be enforceable against BRP.

BRP reserves the right to modify this warranty at any time, being understood that such modification will not alter the warranty conditions applicable to the products sold while this warranty is in effect.

## **3. EXCLUSIONS – ARE NOT WARRANTED**

The following are not warranted under this limited warranty under any circumstances:

- Replacement of parts due to normal wear and tear;

- Routine maintenance parts and services, including but not limited to tune ups, adjustments, oil, lubricant and coolant changes, spark plug replacement, water pumps and the like;
- Damage caused by negligence or failure to provide proper maintenance and/or storage, as described in the Operator's Guide;
- Damage resulting from removal of parts, improper repairs, service, maintenance, modification or use of parts or accessories not manufactured or approved by BRP which in its reasonable judgement are either incompatible with the product or adversely affect its operation, performance and durability, or resulting from repairs done by a person that is not an authorized servicing Sea-Doo Distributor/Dealer;
- Damage caused by abuse, misuse, abnormal use, neglect, racing, improper operation or operation of the product in a manner inconsistent with the recommended operation described in the Operator's Guide;
- Damage resulting from external damage, accident, submersion, fire, foreign object or water ingestion, theft, vandalism or any act of God;
- Operation with fuel, oils or lubricants which are not suitable for use with the product (see the Operator's Guide);
- Damage resulting from rust, corrosion or exposure to the elements;
- Damages from cooling system or jet pump blockage by foreign material;
- Damages to gel coat finish including but not limited to cosmetic gel coat finish defects, blisters, starrng, crazing and fiberglass delamination caused by blisters, crazing, spider or hairline cracks; and
- Incidental or consequential damages, or damages of any kind including without limitation towing, storage, transportation expenses, telephone, rental, taxi, inconvenience, insurance coverage, loan payments, loss of time, loss of income; or time missed for downtime experience due to service work.

#### **4. WARRANTY COVERAGE PERIOD**

This limited warranty will be in effect from (1) the date of delivery to the first retail consumer or (2) the date the product is first put into use, whichever occurs first and for a period of:

1. Twenty four (24) CONSECUTIVE MONTHS, for private, recreational use,
2. FOUR (4) CONSECUTIVE MONTHS for commercial use,

A personal watercraft is used commercially when it is used in connection with generating income or any work or employment during any part of the warranty period. A personal watercraft is also used commercially when, at any point during the warranty period, it has commercial tags or is licensed for commercial use.

The repair or replacement of parts or the performance of service under this warranty does not extend the life of this warranty beyond its original expiration date.

Note that the duration and any other modalities of the warranty coverage are subject to the applicable national or local legislation in the customer's country.

## **5. CONDITIONS TO HAVE WARRANTY COVERAGE**

This warranty coverage is available **only** if **each** of the following conditions has been fulfilled:

- The 2017 Sea-Doo personal watercraft must be purchased as new and unused by its first owner from a Sea-Doo Distributor/Dealer authorized to distribute Sea-Doo personal watercrafts in the country in which the sale occurred;
- The BRP specified pre-delivery inspection process must be completed and documented;
- The 2017 Sea-Doo personal watercraft must have undergone proper registration by an authorized Sea-Doo Distributor/Dealer;
- The 2017 Sea-Doo personal watercraft must be purchased within the EEA by an EEA resident, in the CIS for residents of the countries comprised in such area and in Turkey for residents of Turkey; and
- Routine maintenance outlined in the Operator's Guide must be timely performed in order to maintain warranty coverage. BRP reserves the right to make warranty coverage contingent upon proof of proper maintenance.

BRP will not honor this limited warranty to any private use owner or commercial use owner if one of the preceding conditions has not been met. Such limitations are necessary in order to allow BRP to preserve both the safety of its products, and also that of its consumers and the general public.

## **6. WHAT TO DO TO OBTAIN WARRANTY COVERAGE UNDER THIS WARRANTY**

The customer must cease using the Sea-Doo personal watercraft upon the appearance of an anomaly. The customer must notify a servicing Sea-Doo Distributor/Dealer within two (2) months of the appearance of a defect, and provide it with reasonable access to the product and reasonable opportunity to repair it. The customer must also present to the authorized Sea-Doo Distributor/Dealer, proof of purchase of the product and must sign the repair/work order prior to starting the repair in order to validate the warranty repair. All parts replaced under this limited warranty become the property of BRP.

Note that the notification period is subject to the applicable national or local legislation in customer's country.

## **7. WHAT BRP WILL DO**

To the extent permitted by law, BRP's obligations under this warranty are limited to, at its sole discretion, repairing parts found defective under normal use, maintenance and service, or replacing such parts with new genuine Sea-Doo parts without charge for parts and labor, at any authorized Sea-Doo Distributor/Dealer during the warranty coverage period under the conditions described herein. BRP's responsibility is limited to making the required repairs or replacements of parts. No claim of breach of warranty shall be cause for cancellation or rescission of the sale of the Sea-Doo personal watercraft to the owner. You may have other legal rights which may vary from country to country.

In the event that service is required outside of the country of original sale, or for EEA residents, if service is required outside of the EEA, for CIS residents, if service is required outside of the CIS, the owner will bear responsibility for any additional charges due to local practices and conditions, such as, but not limited

to, freight, insurance, taxes, license fees, import duties, and any and all other financial charges, including those levied by governments, states, territories and their respective agencies.

BRP reserves the right to improve or modify products from time to time without assuming any obligation to modify products previously manufactured.

## **8. TRANSFER**

If the ownership of a product is transferred during the warranty coverage period, this warranty shall also be transferred and be valid for the remaining coverage period provided BRP or an authorized Sea-Doo Distributor/Dealer receives a proof that the former owner agreed to the transfer of ownership, in addition to the coordinates of the new owner.

## **9. CONSUMER ASSISTANCE**

1. In the event of a controversy or a dispute in connection with this limited warranty, BRP suggests that you try to resolve the issue at the Sea-Doo Distributor/Dealer level. We recommend discussing the issue with the authorized Sea-Doo Distributor/Dealer's service manager or owner.
2. If further assistance is required, the Sea-Doo Distributor/Dealer service department should be contacted in order to resolve the matter.
3. If the matter still remains unresolved then contact BRP at the address listed below.

**For countries within EEA, CIS or Turkey, except Scandinavian countries please contact our European office:**

**BRP EUROPE N.V.**

Consumer Assistance Center  
Skaldenstraat 125  
9042 Gent  
Belgium  
Tel.: +32 9 218 26 00

**For Scandinavian countries, please contact our Finland office:**

**BRP FINLAND OY**

Service Department  
Isoaavantie 7  
FIN-96320 Rovaniemi  
Finland  
Tel.: +358 163 208 111

You can find your Sea-Doo Distributor/Dealer's coordinates on [www.brp.com](http://www.brp.com).

\* In the EEA, products are distributed and serviced by BRP European Distribution S.A. and other affiliates or subsidiaries of BRP.

© 2017 Bombardier Recreational Products Inc. All rights reserved.

® Registered trademarks of Bombardier Recreational Products Inc.

## **ADDITIONAL TERMS AND CONDITIONS FOR FRANCE ONLY**

The following terms and conditions are applicable to products sold in France only:

The seller shall deliver goods that are complying with the contract and shall be responsible for defects existing upon delivery. The seller shall also be responsible for defects resulting from packaging, assembling instructions or the installation when it is its responsibility per the contract or if accomplished under its responsibility. To be compliant with the contract, the good shall:

1. Be fit for normal use for goods similar thereto and, if applicable:
  - Correspond to the description provided by the seller and have the qualities presented to the buyer through sample or model;
  - Have the qualities that a buyer may legitimately expect considering the public declarations of the seller, the manufacturer of its representative, including in advertising or labeling; or
2. Have the characteristics mutually agreed upon as between the parties or be fit for the specific use intended by the buyer and brought to the attention of the seller and which accepted.

The action for failure to comply is prescribed after two years after delivery of the goods. The seller is responsible for the warranty for hidden defects of the good sold if such hidden defects are rendering the good unfit for the intended use, or if they diminish its use in such a way that the buyer would not have acquired the good or would have given a lesser price, had he known. The action for such hidden defects shall be taken by the buyer within 2 years of the discovery of the defect.



# ***CUSTOMER INFORMATION***

---

## PRIVACY INFORMATION

BRP wishes to inform you that your coordinates will be used for safety and warranty related purposes. Furthermore, BRP and its affiliates may use its customer list to distribute marketing and promotional information about BRP and related products.

To exercise your right to consult or correct your data, or to be removed from the addressee-list for direct marketing, please contact BRP.

By E-mail: **privacyofficer@brp.com**

By mail: BRP  
Senior Legal Counsel-Privacy Officer  
726 St-Joseph  
Valcourt, QC  
Canada  
J0E 2L0

---

# CONTACT US

www.brp.com

## North America

565 de la Montagne Street  
Valcourt (Québec) J0E 2L0  
Canada

Sturtevant, Wisconsin, U.S.A.  
10101 Science Drive  
Sturtevant, Wisconsin  
53177  
U.S.A.

Sa De Cv, Av. Ferrocarril 202  
Parque Ind. Querétaro, Lote2-B  
76220  
Santa Rosa Jáuregui, Qro., Mexico

## Europe

Skaldenstraat 125  
B-9042 Gent  
Belgium

Itterpark 11  
D-40724 Hilden  
Germany

ARTEPARC Bâtiment B  
Route de la côte d'Azur, Le Canet  
13590 Meyreuil  
France

Ingvald Ystgaardsvei 15  
N-7484 Trondeim  
Norway

Isoavantie 7  
PL 8040  
96101 Rovaniemi

Formvägen 16  
S-906 21 Umeå  
Sweden

Avenue d'Ouchy 4-6  
1006 Lausanne  
Switzerland

## Oceania

6 Lord Street  
Lakes Business Park  
Botany, NSW 2019  
Australia

## South America

Rua James Clerck Maxwell, 230  
TechnoPark Campinas SP 13069-380  
Brazil

## Asia

15/F Parale Mitsui Building,8  
Higashida-Cho, Kawasaki-ku  
Kawasaki 210-0005  
Japan

Room Dubai, level 12, Platinum Tower  
233 Tai Cang Road  
Xintiandi, Lu Wan District  
Shanghai 200020  
PR China

---

## CHANGE OF ADDRESS/OWNERSHIP

If your address has changed or if you are the new owner of the watercraft, be sure to notify BRP by either:

- Mailing one of the following card below;
- **North America Only:** calling at 1-888-272-9222;
- Contacting an authorized BRP distributor/dealer.

In case of change of ownership, please join a proof that the former owner agreed to the transfer.

Notifying BRP, even after the expiration of the limited warranty, is very important as it enables BRP to reach the watercraft owner if necessary, like when safety recalls are initiated. It is the owner's responsibility to notify BRP.

**STOLEN UNITS:** In the event that your watercraft is stolen, you should notify your area's distributor warranty department of such. We will ask you to provide your name, address, phone number, Hull Identification Number and date it was stolen.



***This page is  
intentionally blank***



## NOTES





## NOTES

**WATERCRAFT** MODEL No. \_\_\_\_\_

**HULL**  
IDENTIFICATION NUMBER (H.I.N.) \_\_\_\_\_

**ENGINE**  
IDENTIFICATION NUMBER (E.I.N.) \_\_\_\_\_

**Owner:** \_\_\_\_\_  
NAME

No. \_\_\_\_\_ STREET \_\_\_\_\_ APT \_\_\_\_\_

CITY \_\_\_\_\_ STATE/PROVINCE \_\_\_\_\_ ZIP/POSTAL CODE \_\_\_\_\_

**Purchase Date** \_\_\_\_\_  
YEAR MONTH DAY

**Warranty Expiry Date** \_\_\_\_\_  
YEAR MONTH DAY

To be completed by the authorized Sea-Doo dealer at the time of the sale.

DEALER IMPRINT AREA



219 001 882  
OPERATOR'S GUIDE, SEA-DOO SAR SERIES / ENGLISH  
GUIDE DU CONDUCTEUR, SÉRIE SEA-DOO SAR / ANGLAIS

**FAIT AU / MADE IN CANADA**      **U/M:P:C**