

SEA-DOO®



2012

Sea-Doo Boats
**OPERATOR'S
GUIDE**
Includes
SAFETY, VEHICLE
and MAINTENANCE
INFORMATION

180 CHALLENGER* Series

⚠ WARNING

Read this guide thoroughly. It contains important safety information.
Minimum recommended operator's age: 16 years old.
Keep this Operator's Guide in the boat.

<https://www.boat-manuals.com/> 219 000 896

! WARNING

Disregarding any of the safety precautions and instructions contained in this Operator's Guide, *SAFETY DVD* and on-product labels could cause injury including the possibility of death!

! WARNING

This boat may exceed the performance of other boats you may have ridden in the past. Take time to familiarize yourself with your new boat.

CALIFORNIA PROPOSITION 65 WARNING

! WARNING

This product contains or emits chemicals known to the state of California to cause cancer and birth defects or other reproductive harm.

In Canada, products are distributed by Bombardier Recreational Products Inc. (BRP).

In USA, products are distributed by BRP US Inc.

This is a non-exhaustive list of trademarks that are the property of Bombardier Recreational Products Inc. or its affiliates:

4-TEC™ Sea-Doo® XPS™
CHALLENGER* Rotax®

* Trademark of Bombardier Inc. used under license.

Flitz is a registered trademark of Flitz International.
Gelcote is a trademark of Gelcote International.
Spray Nine is a trademark of Spray Nine Corporation.
Slip Streamer is a trademark of Slip Streamer Inc.
303 Protectant is a trademark of 303 Products Inc.
Dawn is a registered trademark of Procter & Gamble.
Ivory is a registered trademark of Procter & Gamble.
Fantastik is a trademark of S.C Johnson & Son Inc.
3M is a trademark of Aircraft Spruce & Specialty Co.

FOREWORD

Congratulations on your purchase of a new Sea-Doo® Boat. It is backed by the BRP limited warranty and a network of authorized Sea-Doo Boats dealers ready to provide the parts, service or accessories you may require.

At delivery, you were informed of the warranty coverage and signed the *PREDELIVERY CHECK LIST* to ensure your new boat was prepared to your entire satisfaction.

Your dealer is committed to your satisfaction. If you need more complete servicing information, please ask your dealer.

Know Before you Go

To learn how to reduce the risk of accident, read the following sections of this guide before you operate the boat:

- SAFETY INFORMATION
- BOAT INFORMATION.

Also, read all safety labels on your boat and watch your *SAFETY DVD*.

We highly recommend that you take a safe boating course. Please check your dealer or local authorities for availability in your area.

In certain areas, an operator competency card is mandatory to operate a pleasure craft.

Failure to follow the warnings contained in this Operator's Guide can result in **SERIOUS INJURY** or **DEATH**.

Safety Messages

The types of safety messages, what they look like and how they are used in this guide are explained as follows:

 DANGER
Indicates a hazardous situation which, if not avoided, will result in serious injury or death.

 WARNING
Indicates a potential hazard which, if not avoided, could result in serious injury or death.

 **CAUTION** Indicates a hazard situation which, if not avoided, could result in minor or moderate injury.

NOTICE Indicates an instruction which, if not followed, could severely damage boat components or other property.

About this Operator's Guide

This Operator's Guide has been prepared to acquaint the owner and the operator of a new boat with the various controls, maintenance and safe operating instructions. It is indispensable for the proper use of the product.

Keep this Operator's Guide in the boat as you can refer to it for things such as maintenance, troubleshooting and instructing others.

Note that this guide is available in several languages. In the event of any discrepancy, the English version shall prevail.

If you want to view and/or print an extra copy of your Operator's Guide, simply visit the following website www.operatorsguide.brp.com.

The informations contained in this document are correct at the time of publication. BRP, however, maintains a policy of continuous improvement of its products without imposing upon itself any obligation to install them on products previously manufactured. Due to late changes, some differences between the manufactured product and the descriptions and/or specifications in this guide may occur. BRP reserves the right at any time to discontinue or

change specifications, designs, features, models or equipment without incurring any obligation upon itself.

This Operator's Guide and the *SAFETY DVD* should remain with the boat when it's sold.

TABLE OF CONTENTS

FOREWORD	1
Know Before you Go	1
Safety Messages	1
About this Operator's Guide	1

SAFETY INFORMATION

SPECIAL SAFETY MESSAGES	10
Reminders Regarding Operation	10
Carbon Monoxide and Boating	11
Water Sports	15
Hypothermia	18
Voluntary Inspections	18
Safe Boating Courses	18
SAFETY EQUIPMENT	19
Mandatory Safety Equipment	19
Additional Recommended Equipment	21
PRACTICE EXERCISES	23
Where to Practice Exercises	23
Practice Exercises	23
Important Factors Not to Neglect	24
SAFE BOATING PRACTICES	25
Drugs and Alcohol	25
Safe Operation	25
NAVIGATION RULES	27
Operating Rules	27
FUELING	29
Recommended Fuel	29
Fueling Procedure	29
TRAILERING INFORMATION	31
LOCATION OF IMPORTANT ON-PRODUCT LABELS	32
Hang Tag	32
Safety Labels	33
Compliance Labels	37
Technical Information Labels	39
PRE-RIDE INSPECTION	40
Pre-Ride Check List When Boat is Trailered to Waterway	41
Pre-Ride Check List When Boat is Moored to a Dock	42

BOAT INFORMATION

CONTROLS	44
1) Steering Wheel	44

CONTROLS (cont'd)

2) Throttle/Shifter Control 44
 3) Engine Cut-Off Switch 45
 4) Ignition Switch 46
 5) Bilge Blower Switch 47
 6) Engine Start/Stop Button 47
 7) Bilge Pump Switch 47
 8) Deck Lights Switch 48
 9) Navigation Lights Switch 49
 10) Horn Button 49

INFORMATION CENTER GAUGE **50**

Speedometer 50
 Tachometer 50
 Fuel Level 50
 Information Display 50
 Message Code 50
 Indicator Lights 51

EQUIPMENT **52**

1) Seats 53
 2) Bow Seats 53
 3) Main Battery Cut-Off Switch 53
 4) Deck Storage Compartment 54
 5) Rear Storage Compartment 54
 6) Glove box 55
 7) Bow Seat Storage Compartments 55
 8) Bow Filler Cushion (SE Model only) 56
 9) Rear Seat Storage Compartments 56
 10) Passenger Storage Compartment 57
 11) Removable Cooler 57
 12) Grab Handles 57
 13) Rear Grab Handles 57
 14) Swim Platform 57
 15) Ladder 57
 16) Bow Lights 58
 17) Stern Light Socket 58
 18) Radio 59
 19) 23) Radio AUX Output 60
 20) Radio Remote Control 60
 21) 12-Volt Power Outlet 60
 22) Deck Drain 61
 23) Bilge Drain Plugs 61
 24) Cup Holders 61
 25) Bow and Stern Eyelets 61
 26) Mooring Cleats 61
 27) Water Sport Towing Attachments 62
 28) Engine Cover 65
 29) Port Bilge Access 66

EQUIPMENT (cont'd)

30) Bimini Top 66

31) Automatic Fire Extinguisher 67

BREAK-IN PERIOD **68**

Operating During Break-In..... 68

OPERATING INSTRUCTIONS **69**

Launching/Loading..... 69

Boarding the Boat 69

Starting the Engine..... 71

Steering Operation..... 72

Throttle/Shifter Control Operation 72

Leaving the Shore 73

Shutting Off the Engine..... 73

General Operating Recommendations 74

OPERATING MODES **75**

Cruise Mode..... 75

Ski Mode..... 76

ECO Mode..... 77

Docking Mode..... 78

SPECIAL PROCEDURES **79**

Jet Pump Water Intake and Impeller Cleaning..... 79

Towing the Boat in Water..... 79

Capsized Boat 80

Submerged Boat and Water-Flooded Engine 80

MAINTENANCE

BREAK-IN INSPECTION **82**

MAINTENANCE SCHEDULE **84**

MAINTENANCE PROCEDURES **87**

Engine Oil 87

Engine Coolant 89

Ignition Coils..... 90

Exhaust System..... 91

Fuses..... 92

Bilge Blower 94

Navigation Lights..... 94

Deck Drain and Scupper Valve 95

Latches and Hinges..... 96

Reverse Gate..... 96

Sacrificial Anodes 96

BOAT CARE..... **98**

Post-Operation Care 98

Boat Cleaning..... 98

Boat Protection..... 100

STORAGE	101
Jet Pump Cleaning	101
Fuel System Protection.....	101
Engine Oil and Filter Replacement.....	101
Intercooler Draining	101
Exhaust System Flushing	102
Exhaust System Protection	102
Engine Internal Lubrication.....	102
Engine Coolant Test.....	103
Battery Removal and Storage	103
Boat Cleaning/Repair	103
Boat Protection.....	103
PRESEASON PREPARATION	105

TECHNICAL INFORMATION

BOAT IDENTIFICATION	108
Hull Identification Number	108
Engine Identification Number	108
ENGINE EMISSIONS INFORMATION	109
Manufacturer's Responsibility	109
Dealer's Responsibility	109
Owner Responsibility	109
EPA Emission Regulations	109
SPECIFICATIONS	110

TROUBLESHOOTING

TROUBLESHOOTING GUIDELINES	116
MONITORING SYSTEM	120
Beeper Code Information	120

WARRANTY

BRP LIMITED WARRANTY FOR MODEL YEAR 2012 SEA-DOO® BOATS SOLD IN THE UNITED STATES AND CANADA	122
CALIFORNIA EMISSION CONTROL WARRANTY STATEMENT FOR MODEL-YEAR 2012 SEA-DOO® BOATS WITH 4-TEC® ENGINES OR 4-TEC® IC ENGINES	126
BRP INTERNATIONAL LIMITED WARRANTY FOR MODEL YEAR 2012 SEA-DOO® BOATS	130

**BRP LIMITED WARRANTY FOR THE EUROPEAN AND THE RUSSIAN
ECONOMIC AREA AND TURKEY: MODEL YEAR 2012 SEA-DOO®
BOATS..... 134**

CUSTOMER INFORMATION

PRIVACY INFORMATION 140
CHANGE OF ADDRESS/OWNERSHIP 141

SAFETY INFORMATION

SPECIAL SAFETY MESSAGES

Reminders Regarding Operation

- Engine exhaust contains carbon monoxide (CO), which can cause injury or death if inhaled in sufficient quantities. Educate all occupants about the risks and symptoms of CO accumulation and CO poisoning. For more information, refer to *CARBON MONOXIDE AND BOATING* section.
- Gasoline vapors can explode, resulting in injury or death. Always use blower for a minimum of 5 minutes before starting engine, then turn it OFF above idle speed. Use of the bilge blower should never replace "smelling" for gasoline vapor odors.
- If at any time, gasoline leaks/odors are found, do not start the engine. Have the boat serviced by an authorized Sea-Doo Boats dealer.
- Always keep in mind that as the throttle lever is returned to the idle position, less directional control is available. To turn the boat, both steering and throttle are necessary.
- This boat has no brake. Stopping distance will vary depending on initial speed, load, wind, and water conditions. Practice stopping and docking in a safe, traffic-free area to have an idea of how long it will take to stop the boat under varying conditions. Do not release the throttle when trying to steer away from objects. You need throttle to steer. Do not use the boat's reverse to stop.
- Do not start or operate the boat if any person is not properly seated in a seat intended for use when underway (refer to boat labels) or if a person is nearby in the water.
- The boat's jet thrust can cause injury. Always accelerate slowly, and decelerate in a controlled fashion.
- Observe the instructions on all safety labels. They are there to help assure that you have a safe and enjoyable outing.
- Riding with passenger(s) or pulling other boats, tubes, a skier or a wake boarder makes the boat handle differently and requires greater skills.
- Certain boats may come equipped with tow eyelets, a ski pole or a wakeboard tower which can be used to attach a tow rope for a skier, tube or wakeboarder. Do not use these attachment points or any other portion of the boat to tow a parasail or another craft. Personal injury or severe damage may occur.
- In shallow water, proceed with caution and at very low speeds. Grounding or abrupt stops may result in injury to you, your passengers or others. The jet pump may pick up debris and throw it rearward causing a risk of injuring people or damaging the jet pump or other property.
- Combustion engines need air to operate; consequently this boat can not be totally watertight. Any maneuvers such as figure eights that cause the upper deck to be under water may cause severe engine problems due to water ingestion. Refer to the *SPECIAL PROCEDURES* and *WARRANTY* sections contained in this Operator's Guide.
- Respect no wake zones, the rights of other water users and the environment. As the "skipper" and owner of a boat, you are responsible for damage to other boats caused by the wake of your boat. Do not let anyone throw refuse overboard.
- Between sunset and sunrise, use the boat's navigation lights and reduce speed. Do not operate the boat in reduced visibility.
- Do not add accessories or equipment that may adversely affect visibility or alter control of the boat.
- The skipper should personally take the helm during storms.

Before Getting Underway

- Always perform the pre-ride inspection as specified in this Operator's Guide.
- Do not exceed the payload or passenger capacities for this boat, which are listed on the capacity plate located directly besides the driver and in the specifications. Overloading can affect maneuverability, stability and performance. Also, heavy seas reduce capacity. A payload or person capacity plate is not an excuse for failure to use common sense or good judgment.
- Regularly inspect the boat, the hull, engine, safety equipment, and all other boating gear and keep them in safe operating condition.
- Be sure you have at least the minimum required safety equipment, PFDs and any additional gear needed for your cruise.
- Check that all lifesaving equipment, including fire extinguisher (not included in boat), is in safe operating condition and easily accessible. Show all passengers where this equipment is, and make sure they know how to use it.
- Keep an eye on the weather. Check local weather broadcasts before departure. Be alert to changing conditions.
- Keep accurate and up-to-date charts of the boating area on board. Before getting underway, check water conditions in the planned boating area.
- Before departure, file a Float Plan with a responsible person ashore.
- Keep enough fuel on board for the planned trip. Always verify fuel level before use and during the ride. Apply the principle of 1/3 of the fuel to reach your destination, 1/3 to return, and keep 1/3 in reserve. Allow for changes due to adverse weather or other delays.

Operators and Passengers Awareness

- Each boat operator has a responsibility to ensure the safety of his/her passenger(s) and of other water users. Please follow all safety instructions and operate your boat with care.
- Never operate a boat while under the influence of drugs or alcohol they slow reaction time and impair judgement. It is also a Federal offense. Allow only qualified drivers to operate your boat.
- Remember that sun, wind, fatigue or illness may impair your judgement and reaction time.
- At least one passenger should be able to operate the boat in case the operator is unexpectedly unable to do so.
- Operation of this boat by a person under 16 years of age or a person with a disability that impairs vision, reaction time, judgment, or operation of the controls is NOT recommended.
- Always use the tether cord when operating the boat and ensure that all passengers are familiar with its use.
- Ensure that any operator and all passengers know how to swim and how to re-board the boat from the water. If a passenger does not know how to swim, ensure that passenger wears a PFD at all times and take extra precautions when boating.

Carbon Monoxide and Boating

Burning a material containing carbon produces carbon monoxide (CO), an odorless and colorless gas. Because CO has a similar density as air, it can spread throughout an enclosed space unnoticed because you cannot see it or smell it. Any device used to burn carbon-based materials on a boat can

be a source of CO. Common sources of CO include internal combustion engines.

CO reacts with the blood to reduce the ability of the blood to carry oxygen. The reduced oxygen supply to body tissues results in death of the tissue. Prolonged exposure can cause brain damage or death. In high concentrations, CO can be fatal within minutes. The effects of CO in lower concentrations are cumulative and can be just as lethal over long periods of time.

Symptoms of CO poisoning include: Itchy and watering eyes, flushed appearance, throbbing temples, inability to think coherently, ringing in the ears, tightness across the chest, headaches, drowsiness, nausea, dizziness, fatigue, vomiting, collapse, and convulsions. If any of these symptoms are evident, begin treatment immediately. Prompt action can make the difference between life and death.

- Evacuate the area and move the victim to fresh air.
- Administer oxygen if available and get medical help.
- Open all canvas enclosures to ventilate the area.
- Investigate the source of CO and take immediate corrective action.
- Be especially aware of other CO sources which may be near boat.

Carbon Monoxide Accumulation

Following are examples of possible situations where CO may accumulate within your boat while docked, anchored, or underway. Become familiar with these examples and their precautions to prevent personal injury or death.

WARNING

Exhaust fumes! Generator or hull exhaust from other vessels while either docked or anchored can emit poisonous CO gas and cause excessive accumulation within cabin and cockpit areas. Be alert for generator exhaust from your vessel or other vessels alongside. Exhaust outlets near a pier, dock, seawall or outlets blocked by any other means can cause excessive accumulation of poisonous CO gas within cockpit area.

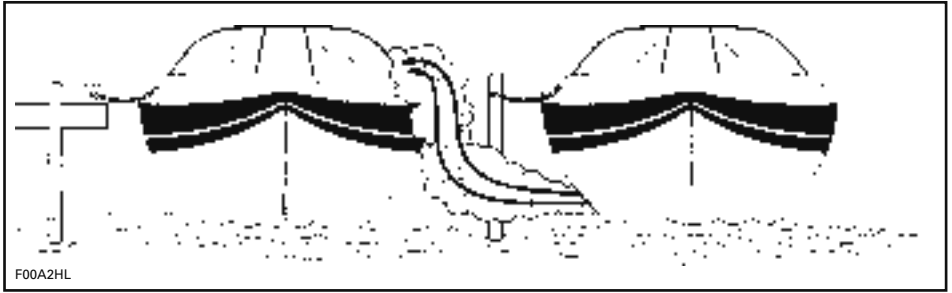

F00A2HL

VESSEL ALONGSIDE

WARNING

Engine exhaust fumes contain carbon monoxide (CO) which can accumulate in and around the boat (under bimini top, in cockpit, etc.). CO can be harmful or fatal if inhaled. Assure there is adequate ventilation whenever running engine(s).

Boat houses, seawalls, and other boats in close proximity or confined areas can contribute to increased CO levels. Operators must be aware that operation, mooring, and anchoring in an area with other boats puts them in jeopardy of CO accumulation from other sources. Likewise, a boat operator must be aware of how exhaust from his boat will affect others. Operation of the engines while moored may cause CO accumulation in your boat and those around you.

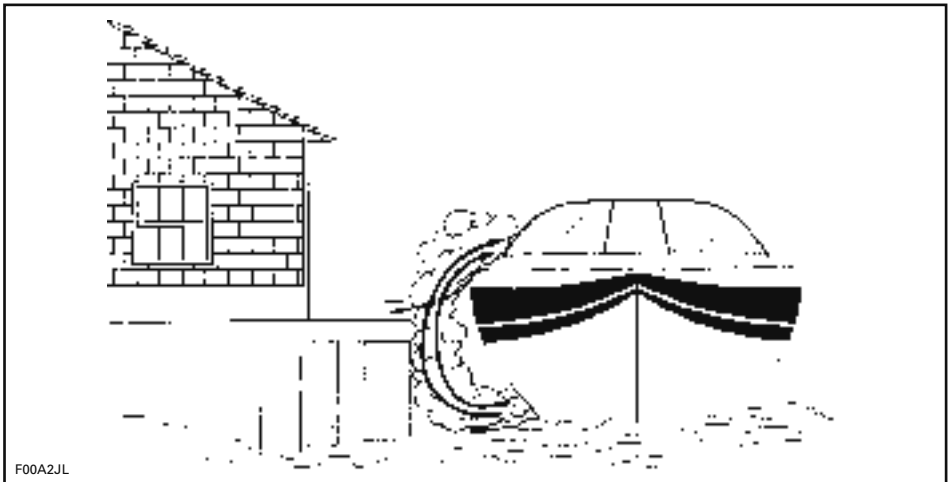

F00A2JL

CONFINED AREAS

Be sure to provide adequate ventilation. If the windshield has vents, open them before getting underway to increase positive air flow and decrease the chances of CO accumulation.

! WARNING

Backdrafting! Under certain conditions, moving air currents can direct poisonous CO fumes into boat. These fumes can accumulate to dangerous levels without proper airflow. Provide adequate ventilation, redistribute the load or bring boat out of high bow angle.

While underway, CO concentrations can increase by backdrafting or “the station wagon effect”. Backdrafting is caused by factors such as relative wind direction, speed, or the bow being too high. To prevent this, open canvas whenever possible to provide positive airflow through the hull.

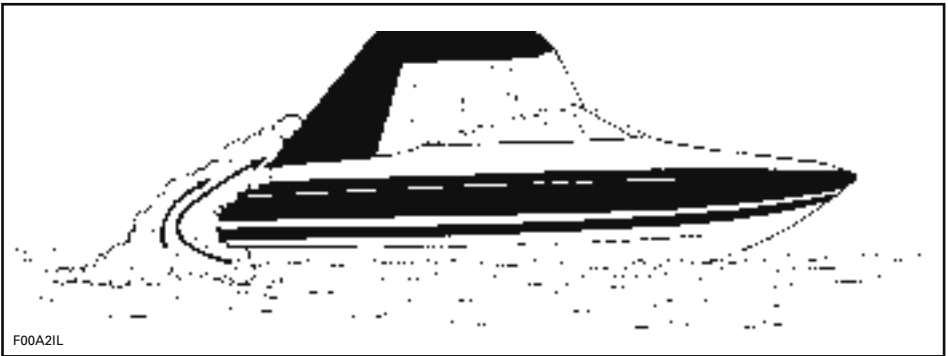

WHILE UNDERWAY (BACKDRAFTING)

Even with the best boat design and construction, CO may still accumulate in enclosed or confined areas under certain conditions. Continually observe passengers for symptoms of CO poisoning.

CO Detector

It is strongly recommended that you have CO detectors installed in boats with canvas enclosures. Monitors are available from your dealer. Monitors should be professionally installed and calibrated.

NOTE: A CO detector is not a gas fuel vapor detector. Gas fuel vapor detectors do not monitor the buildup of CO in an enclosed area.

Do NOT Operate your Boat without Performing the Following Checklist:

Each Boating Day

OPERATION	✓
Make sure you and your passengers know where exhaust outlets are located on the vessel	
Educate all passengers about the symptoms of CO poisoning and where CO may accumulate	
When docked or rafting with another boat, be aware of exhaust emissions from the other boat	
Listen for any change in exhaust sound, which could indicate an exhaust component failure	
Test the operation of each CO alarm by pressing the test button (if applicable)	

Water Sports

WARNING

Avoid personal injury! Your boat is not designed for and should not be used for pulling parasails, kites, gliders, or any device which can become airborne. Use boat only for appropriate water sports.

WARNING

Teak surfing is extremely dangerous to participants due to their proximity to the rear of the boat where direct contact with the exhaust fumes from the boat engine is the highest. Carbon monoxide poisoning can occur and result in mental disorientation, dizziness, drowsiness, and loss of consciousness. The combination of carbon monoxide exposure and non-use of a life jacket (PFD) make this new water recreation activity an incredibly dangerous and potentially deadly sport.

Water skiing, wakeboarding, or riding a towed, inflatable apparatus are some of the more popular water sports. Taking part in any water sport requires increased safety awareness by the participant and the boat operator. If you have never pulled someone behind your boat before, it is a good idea to spend some hours as an observer, working with and learning from an experienced driver. It is also important to be aware of the skill and experience of the person being pulled. Always have a second person on board to observe the person in the water so the driver can concentrate on operating the boat.

Both the boat operator and observer should monitor the location of the towrope when participating in water sports. A slack tow rope can become entangled with person(s) or objects in the boat or in the water, particularly when making a tight turn or circling, and cause serious personal injury.

Everyone participating in a water sport should observe these guidelines:

- Allow only capable swimmers to take part in any water sport.
- Always wear an approved personal flotation device (PFD). Wearing a properly designed PFD helps a stunned or unconscious person stay afloat. A **Type IV** water-ski vest is an approved and practical PFD.
- Have a second person aboard to observe the person being towed and inform the driver about the participant's hand signals. The driver must give full attention to operating the boat and the waters ahead.
- Be considerate to others you share the water with.

- Never allow a person to "teak surf" behind your boat. Do not tow a person in any water sport on a short tow rope such that the person inhales exhaust fumes in concentration. Inhalation of concentrated exhaust fumes, which contain carbon monoxide, can result in CO poisoning, personal injury and death.
- Give immediate attention to a person who has fallen. He or she is vulnerable in the water alone and may not be seen by other boaters.
- Approach a person in the water from the lee side (opposite the direction of the wind). Turn off the motor before coming close to the person.
- Turn off engine and anchor the boat before swimming.
- Participate in water sports only in safe areas. Stay away from other boats, channels, beaches, restricted areas, swimmers, and heavily traveled waterways and underwater obstructions.
- Swim only in areas designated as safe for swimming. These are usually marked with a swim area buoy. Do not swim alone or at night.

- Shut engine off and remove ignition key when anyone is in the water nearby.
- Stay at least 45 m (150 ft) away from areas marked by a diver down float.



DIVER DOWN FLOAT

⚠ WARNING

Avoid personal injury! Do not allow anyone near the jet pump or intake grate, even when the engine is off. Items such as long hair, loose clothing or personal flotation device straps can become entangled in moving parts resulting in serious injury or drowning. In shallow water, shells, sand, pebbles or other objects could be drawn up by the jet pump and be thrown rearward.

NOTE: For more information about water skiing, please contact your local water ski association.



SWIM AREA BUOY

- Do not water ski between sunset and sunrise. It is illegal in most states.
- Do not drive the boat directly behind a water skier, tuber or wakeboarder as the boat may overtake a person who falls in the water.



FASTER -
Palm of one hand pointing
upward.



SLOWER -
Palm pointing down.



SPEED OK -
Arm upraised with thumb and
finger joined to form circle.



RIGHT TURN -
Arm outstretched pointing
to the right.



LEFT TURN -
Arm outstretched pointing
to the left.



RETURN TO DROP-OFF AREA -
Arm at 45 degree from body
pointing down to water and
swinging.



CUT MOTOR -
Finger drawn across
throat.



STOP -
Hand up, palm forward,
policeman style.



**SKIER OK.
AFTER THE FALL -**
Hands clenched
together overhead.



**PICK ME UP
OR FALLEN SKIER,
WATCH OUT -**
One ski extended
vertically out of water.

F00A2NL

SKIING SIGNALS

Hypothermia

Hypothermia, the loss of body heat to the water, is a significant cause of deaths in boating accidents. After an individual been overcome by hypothermia, he or she will lose consciousness and then drown.

PFDs can increase survival time because of the insulation they provide.

Naturally, the warmer the water, the less insulation one will require. When operating in cold water (below 4.4°C (40°F)) consideration should be given to using a coat or jacket style PFD as they cover more of the body than the vest style PFDs.

Some points to remember about hypothermia protection:

1. While afloat in the water, do not attempt to swim unless it is to reach a nearby boat, fellow survivor, or a floating object on which you can lean or climb. Unnecessary swimming increases the rate of body heat loss. In cold water, drown-proof methods that require putting your head in the water are not recommended. Keep your head out of the water. This will greatly lessen heat loss and increase your survival time.
2. Keep a positive attitude about your survival and rescue. This will improve your chances of extending your survival time until rescued. Your will to live does make a difference!
3. If there is more than one person in the water, huddling is recommended while waiting to be rescued. This action tends to reduce the rate of heat loss and thus increase the survival time.
4. Always wear your PFD. It won't help you fight off the effects of hypothermia if you don't have it on when you go into the water.

Voluntary Inspections

Boating officials in many countries or their auxiliaries offer courtesy inspections to check out your boat. They will check for compliance with safety standards and required safety equipment. You may voluntarily consent to one of these inspections, and you are allowed time to make corrections without prosecution. Check with competent authorities for details.

Safe Boating Courses

Many countries recommend or require a boating safety course. Check with your local competent authorities.

SAFETY EQUIPMENT

Mandatory Safety Equipment

As the owner of the boat, you are responsible for ensuring that all mandatory safety equipment is aboard.

Check regulations for the area where the boat is used. Mandatory safety equipment must be approved by a recognized authority under this jurisdiction.

Personal Flotation Devices (PFDs)

In many countries, regulations require that you have at least one approved personal flotation device (PFD) of the correct size for each person in a recreational boat and require that all children under 13 years of age wear a PFD at all times when the boat is underway, except when below deck or in an enclosed cabin. You may not use your boat unless all PFDs are in serviceable condition, readily accessible, legibly marked with the approval number, and of an appropriate size (within the weight range and chest size marked on the PFD) for each person on board.

A PFD provides buoyancy to help keep your head above the water and to help you remain in a satisfactory position while in the water. Body weight and age should be considered when selecting a PFD. The buoyancy provided by the PFD should support your weight in water. The size of the PFD should be appropriate for the wearer. Body weight and chest size are common methods used to size PFDs. It is your responsibility to ensure that you have the proper number and types of PFDs on board to comply with federal and local regulations and that your passengers know where they are and how to use them.

PFD Types

There are five types of approved PFDs.

PFD Type I, Wearable has the greatest required buoyancy. Its design allows for turning most unconscious persons in the water from face down position to a vertical or slightly backward, face-up position. It can greatly increase the chances of survival. Type I is most effective for all waters, especially offshore when rescue may be delayed. It is also the most effective in rough waters.

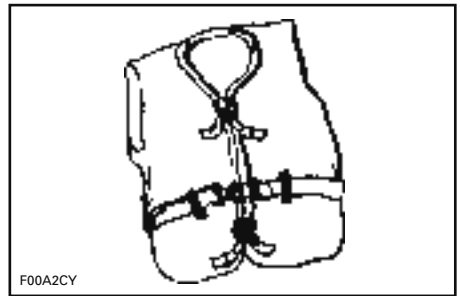

TYPE I — WEARABLE

PFD Type II, Wearable turns its wearer in the same way as Type I, but not as effectively. The Type II does not turn as many persons under the same conditions as a Type I. You may prefer to use this PFD where there is a probability of quick rescue such as in areas where other people are commonly involved in water activities.

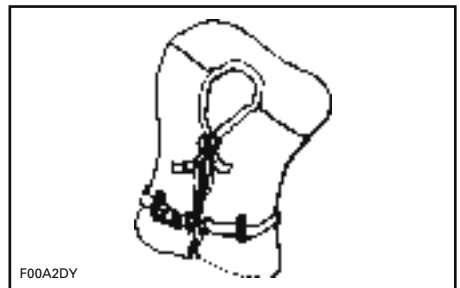

TYPE II — WEARABLE

PFD Type III, Wearable allows wearers to place themselves in a vertical or slightly backward position. It does not turn the wearer. It maintains the

wearer in a vertical or slightly backward position and has no tendency to turn the wearer face down. It has the same buoyancy as a Type II PFD and may be appropriate in areas where other people are commonly involved in water activities.

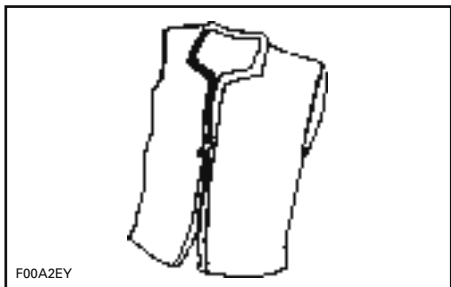

TYPE III — WEARABLE

PFD Type IV, Throwable is required in addition to the PFDs previously discussed. The most common Type IV PFD is a buoyant cushion or ring buoy. It is designed to be thrown to a person in the water, grasped and held by the user until he or she is rescued. A Type IV PFD should always be in serviceable condition and immediately available for use. Grasping this PFD may be difficult if the rescue is delayed or if the user is overcome by hypothermia (loss of body heat).

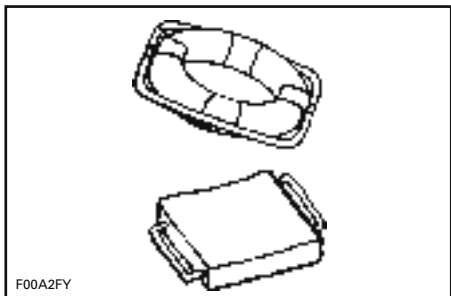

TYPE IV — THROWABLE

PFD Type V, Wearable must be worn. When inflated, it provides buoyancy equivalent to Type I, II or III PFDs. When it is deflated, however, it may not support some people.



TYPE V — WEARABLE

PFD Pointers

The purpose of a PFD is to help save your life. If you want it to support you when you are in the water, it needs to fit, float, and be in good condition.

- Try the PFD on and adjust it until it fits comfortably in and out of the water. Mark your PFD if you are the only wearer.
- To make sure the PFD works, wear it in the water. This will show you how it works and give you confidence when you use it.
- Teach children how to put a PFD on and allow them to try it in the water. That way, they know what the PFD is for and how it works. They will feel more comfortable with it if they suddenly find themselves in the water.
- If the PFD is wet, allow it to dry thoroughly before storing it. Do not dry it in front of a radiator or heater. Store it in a well-ventilated area.
- Keep PFDs away from sharp objects which can tear the fabric or puncture the flotation pads.

- For their own safety and the safety of others, all non-swimmers, poor swimmers, and small children should wear PFD's at all times whether the boat is stationary or moving.
- Check the PFD frequently to make sure that it is not torn, that flotation pads have no leaks, and that all seams and joints are securely sewn.
- If a PFD contains a material which may become waterlogged and lose its buoyancy after the vinyl inserts are punctured, replace immediately if it becomes hard or soaked with water. It may not work when you need it.

Fire Extinguishers

As the owner of the boat, you are responsible for supplying an approved fire extinguisher. Check with the local competent authorities. Boats less than 7.9 m (26 ft) are required to carry one (1) B-1 type hand portable fire extinguisher unless the boat is equipped with a fixed fire extinguishing system in the engine compartment.

Hand-held portable fire extinguishers should be mounted in readily accessible locations away from the engine compartment. All persons aboard should know the location and proper operation of the fire extinguisher(s).

NOTE: Don't test fire extinguishers by squirting small amounts of the extinguishing compound. The extinguisher might not work when you really need it!

WARNING

In case of fire, do not open engine compartment. Turn off engine. Using portable CO₂ fire extinguisher, continuously discharge entire contents at base of fire.

Visual Distress Signal Devices

Visual distress signal equipment may be of the pyrotechnic or non-pyrotechnic type. Regulations prohibit display of visual distress signals on the water under any circumstances except when assistance is required to prevent immediate or potential danger to persons on board a vessel. Check with the local authority to have proper equipment.

The equipment must be approved by the competent authorities, be in serviceable condition, and be stowed in a readily accessible location. Equipment having a date for serviceable life must be within the specified usage date shown.

Careful selection and proper stowage of visual distress equipment is very important if children are aboard.

DAY USE ONLY
Three orange smoke signals (one hand held and two floating) or one orange flag with black square and disk.
NIGHT USE ONLY
One S-O-S electric distress light.
DAY AND NIGHT USE
Three flares of the hand held, meteor or parachute type.

Additional Recommended Equipment

It is recommended that you acquire additional equipment for safe, enjoyable cruising (some could be mandatory by legislation). This list, which is not all inclusive, includes items you should consider acquiring.

BASIC EQUIPMENT	
Flashlight	Oar or paddle
Compass	First aid kit

BASIC EQUIPMENT	
Distress signals	VHF radio
Dock fenders	Boat hook
Electronic Position Indicating Radio Bacon (EPIRB)	Local map
Anchor	Tow line
Mooring lines	Dewatering device (pump or bailer)

TOOLS	
Screwdrivers	Pocket knife
Pliers	Electrician's tape
Adjustable wrench	Duct tape

SPARE PARTS	
Extra bulbs	Extra fuses

RECOMMENDED PERSONAL GEAR AND FOOD	
Extra warm clothing	Cellular phone ⁽²⁾
Sunblock	Emergency supply of drinking water and food
Shatterproof glasses ⁽¹⁾	

⁽¹⁾ Operator and passenger(s) should have ready access to shatterproof glasses should riding conditions or personal preference warrant. Wind, water spray and speed may cause blurred vision.

⁽²⁾ A cellular telephone in a waterproof bag or container has also been found to be beneficial to boaters when in distress or just for contacting someone on shore.

Recommended personal gear and food

To enjoy your boating day and for your own protection, it is recommended to bring the following during your trip:

PRACTICE EXERCISES

It is always a good idea to practice and get familiar with all controls, functions and handling characteristics of your boat before venturing on the water.

Always secure the tether cord to the engine cut-off switch and the clip to your PFD or a wrist strap.

Where to Practice Exercises

Find a suitable area to practice the exercises. Ensure the area meet the following requirements:

- No traffic
- No obstacles
- No swimmers
- No current
- Ample space to maneuver
- Water depth is adequate.

Practice Exercises

Practice **alone** the following exercises.

Turning

Practice turning in circles in both directions at slow speed. When comfortable with the exercise, increase difficulty by making some figure 8.

When this is mastered, repeat the above exercises but at increased speed.

Stopping Distances

Practice stopping the boat in a straight line at different speeds.

Remember, water drag is the main factor which reduces the boat speed and thus the stopping distance.

NOTE: The boat speed, load, current and wind also play an important role in affecting stopping distances.

 WARNING

Do not use the reverse to stop.

Reverse

Practice reverse operation to learn how the boat operates in reverse and reacts with steering inputs.

NOTE: Always perform this exercise at slow speeds.

Avoiding an Obstacle

Practice to avoid an obstacle (choose a virtual point on the water) by steering boat and maintaining throttle.

Repeat exercise, but this time release throttle while turning.

NOTE: With this exercise, you will learn that you need throttle to steer the boat in a different direction.

Docking

If your boat has the Docking Mode, it is also important to understand its operations and get familiar with it prior to using it on a ride with other people.

Practice docking using the throttle and shift lever along with the steering to become familiar with the response of the boat and develop good control skills.

Ski Mode and Cruise Mode

If your boat has the Ski Mode or Cruise mode, it is also important to understand their operation and to become familiar with these features prior to using them on a ride with other people.

 WARNING

These operating modes are not an automatic pilot and are not meant as a replacement for an experienced operator.

Important Factors Not to Neglect

In addition, always remember that the following conditions have a direct impact on how your boat will behave and respond to different inputs:

- Load change
- Currents
- Wind
- Water conditions.

Make sure to be alert to these conditions, and adapt accordingly. If possible, practice further in these conditions.

For delicate maneuvers, the best advice is always to reduce your speed to a minimum.

SAFE BOATING PRACTICES

YOU are responsible for your own safety, the safety of your passengers, and the safety of fellow boaters.

Drugs and Alcohol

Do not use drugs or drink alcohol while operating a boat. Like driving a car, driving a boat requires sober, attentive care. Operating a boat while intoxicated or under the influence of drugs is not only dangerous, but it is also a Federal offense carrying a significant penalty. These laws are vigorously enforced. The use of drugs and alcohol, singly or in combination, decreases reaction time, impedes judgment, impairs vision, and inhibits your ability to safely operate a boat.



WARNING

Alcohol consumption and boating do not mix! Operating under the influence endangers the lives of your passengers and other boaters. Federal laws prohibit operating a boat under the influence of alcohol or drugs.

Safe Operation

For safety reasons and proper care, always perform *PRE-RIDE INSPECTION* as specified in your Operator's Guide before operating your boat. Safe operation means that you do not misuse your boat nor do you allow your passengers to do so. Safe operation means using good judgment at all times. It includes, without limitation, the following actions:

- Load the boat within the limits listed on the capacity plate (located to the right of the driver seat). Balance loads bow to stern and port to starboard.
- Maintain boat speed at or below the local legal limit. Avoid excessive speed or speeds not appropriate for operating conditions.

- Do not use the boat in weather or waterway conditions beyond the skill or experience of the operator or the capability of the boat and comfort of passengers.
- Be sure at least one other passenger is familiar with the operation and safety aspects of the boat in case of an emergency.
- Make sure that passengers and gear do not obstruct the operator's view or ability to move.
- Do not exceed the maximum engine power rating stated on the certification plate attached to the boat.
- Observe all safety signs and warnings both inside the boat and in the immediate boating area.
- While your boat has the capacity of operating at high speeds, it is strongly recommended that high speed operation only be applied when ideal conditions exist and are permitted. Higher speed operation requires a higher degree of skill and increases the risk of severe injuries.
- In shallow water, proceed with caution and at very low speeds. Grounding or abrupt stops may result in injury. Debris may also be picked up and be thrown rearward by the jet pump onto people or property.
- Do not use the boat's reverse to stop. You or your passenger(s) could be violently ejected forward or even off the boat onto the hazard.

Maneuverability of the Boat and Towing

- Always keep in mind that as the throttle lever is returned to idle position, less directional control is available, and when the engine is off, directional control is lost. You need throttle to steer.

- Do not overload the boat or take on more passengers than designated for the particular boat. Overloading can affect maneuverability, stability and performance.
- Avoid adding on accessories or equipment which may alter your control of the boat.
- Riding with a passenger(s) or pulling a tube, skier or wakeboarder makes the boat handle differently and requires greater skill.
- Always respect the safety and comfort of your passenger(s) and person being towed on skis, wakeboard or other towables.
- Always carry an observer when pulling a tube, skier or wakeboarder, proceed with only as much speed as required and follow the observer's instructions. Unless absolutely necessary, do not make tight, sharp turns. Keep a safe distance from the docks, other swimmers, craft or objects.
- Use a tow rope of sufficient length and size and make sure it is adequately secured to your boat. Some boats are equipped or can be fitted with a specially designed towing mechanism. It can become a hazard should someone fall on it.

Passenger Safety

Before getting underway, show all passengers where emergency and safety equipment is stowed, and explain how to use it. Everyone aboard should wear rubber-soled shoes which resist slipping on wet surfaces. While underway, passengers should remain seated inside the deck rails. Don't allow passengers to drag their feet or hands in the water. Always use handholds and other safety hardware to prevent falls. All non-swimmers, poor swimmers, and children should wear a PFD at all times. Federal regulations require that children under 13 years of

age wear a PFD when the boat is underway unless they are in an enclosed cabin or below deck.

- Do not start or operate the boat if anyone is seated on the sun deck or swim platform, or is nearby in the water. Water and/or debris exiting jet thrust nozzle can cause severe injury.
- The operator and passenger(s) should be properly seated before starting or moving the boat. All passenger(s) should be instructed to use the handholds or seat straps provided.
- When accelerating a boat with a passenger(s), whether from a complete stop or while underway, always do so progressively. Fast acceleration may cause your passenger(s) to lose their balance or grip and strike something in the boat or fall out of the boat. Make sure that your passenger(s) know of, or anticipate, any rapid acceleration.

First Aid

As a boat operator, you should be familiar with basic first aid procedures that may be needed while you are far from help. Fish hook accidents or minor cuts and abrasions may be the most serious mishaps on board a boat, but you should also learn the proper procedures and be ready to deal with the truly serious problems like excessive bleeding, hypothermia, and burns. First aid literature and courses are available through most Red Cross chapters.

Operation by Minors

Minors should always be supervised by an adult whenever operating a boat. Many countries have laws regarding the minimum age and licensing requirements of minors. Be sure to contact the state boating authorities for information. BRP recommends a minimum operator age of 16 years old.

NAVIGATION RULES

Operating Rules

Operating a boat can be compared with driving unmarked highways and roads. To prevent collisions or avoid other boaters, a system of operating rules must be followed. It's not only common sense... it's the law!

Check local and federal boating laws applicable to the waterways where you intend to use your boat. Learn the local rules of the waterways. Know and understand the applicable navigation system (such as buoys and signs).

Know the waters in which the boat is to be operated. Current, tides, rapids, hidden obstacles, wakes and waves etc. can affect safe operation. It is not advisable to operate the boat in rough or inclement weather.

Generally keep to your right and safely avoid other craft by keeping a safe distance from other craft, people and objects.

The following illustration identifies different parts of the boat that are used as directional reference points, the bow being the front of the boat. The port side of boat (left side) is visually identifiable by a RED light off the bow, and the starboard side (right side) by a GREEN light.

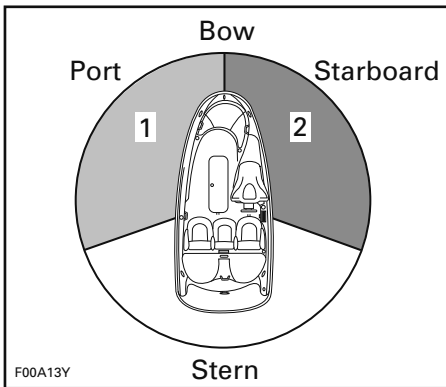

TYPICAL
1. RED light
2. GREEN light (yield zone)

Crossing

Give right of way to craft ahead and to your right. Never cross in front of another craft.

RED light (give way to the other craft).

GREEN light (you have the right of way).

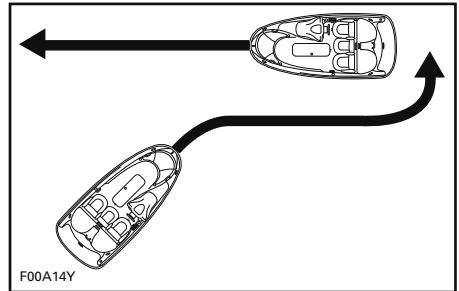

TYPICAL

Meeting Head-On

Keep right.

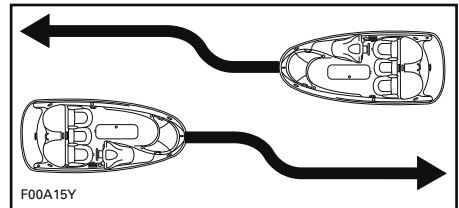

TYPICAL

Passing

Give right of way to other craft and keep clear.

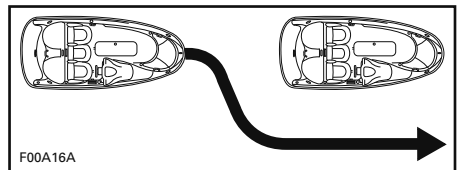

TYPICAL

Navigation System

Navigational aids, such as signs or buoys, can help you identify safe waters. Buoys will indicate whether you should keep to the right (starboard) or to the left (port) of the buoy or to which channel you can continue. They may also indicate whether you are entering a restricted or controlled area such as a no wake or speed zone. They may also indicate hazards or pertinent boating information. Markers may be located on shore or on the water. They can also indicate speed limits, no power craft or boating, anchorage and other useful information. (The shape of each type of marker will provide assistance).

Make sure you know and understand the navigation system applicable to the waterways where you intend to use the boat.

Sound Signaling Devices

NOTE: No single signaling device is appropriate for all purposes. Consider keeping various types of equipment on board.

Boats less than 7.9 m (26 ft) in length are required to carry a hand, mouth, or power operated horn or whistle. It must produce a blast of two second duration and audible at a distance of at least 800 m (1/2 mi).

Following are standard whistle signals:

- One prolonged blast (warning signal)
- One short blast (pass on my port side)
- Two short blasts (pass on my starboard side)
- Three short blasts (engines in reverse)
- Five or more blasts (danger signal).

Navigation Lights

Navigation lights are intended to keep other vessels informed of your presence and course. If you are out on the

water between sunset and sunrise, you are required to display appropriate navigation lights.

Collision Avoidance

- Do not decrease throttle when trying to steer away from objects. You need throttle to steer.
- Always keep a constant lookout for other water users, other craft or objects, especially when turning. Be alert for conditions that may limit your visibility or block your vision of others.
- Respect the rights of other recreationists and/or bystanders and always keep a safe distance from all other craft, people and objects.
- Do not wake or wave jump, ride the surf line or attempt to spray or splash others with your boat. You may misjudge the ability of the boat or your own driving skills and strike a boat or person.
- This boat has the capability of turning more sharply than other boats. However, unless in an emergency, do not negotiate sharp, high speed turns. Such maneuvers make it hard for others to avoid you or understand where you are going. Also, you and/or your passenger(s) could be ejected from the boat.
- This boat has no brake. Stopping distance will vary depending on initial speed, load, wind, and water conditions. Practice stopping and docking in a safe, traffic free area to have an idea of how long it will take to stop the boat under various conditions.
- Maintaining or increasing speed may be necessary to avoid a collision.

FUELING

Recommended Fuel

Use unleaded gasoline or oxygenated fuel containing a maximum total of 10% of ethanol or methanol. The gasoline used must have the following recommended octane rating.

NOTICE Never experiment with other fuels or fuel ratios. The use of inadequate fuel can result in boat performance deterioration and damage to critical parts in the fuel system and engine components.

Inside North America

MINIMUM OCTANE RATING		
87 (RON + MON)/2		
91 (RON + MON)/2		
ENGINE	91	87
215 Engine	X ⁽¹⁾	X
260 Engine	X ⁽¹⁾	X

⁽¹⁾ For optimum engine performance.

Outside North America

MINIMUM OCTANE RATING		
92 RON		
95 RON		
ENGINES	95	92
215 Engine	X ⁽¹⁾	X
260 Engine	X ⁽¹⁾	X

⁽¹⁾ For optimum engine performance.

Fueling Procedure

⚠ WARNING

Fuel is flammable and explosive under certain conditions. Do not smoke or allow open flames or sparks in the vicinity. Always have a fire extinguisher close at hand during fueling procedure.

Be very careful when fueling and adhere to the fueling procedures described below in this Operator's Guide and those given to you by the marina.

Know the capacity of the fuel tank. Avoid fueling at night except under well lighted conditions. Gas spills are not noticeable in the dark. Do not carry spare fuel or flammable liquids in any of the storage or engine compartments.

⚠ WARNING

Follow these safe boating fueling instructions explicitly.

On a Trailer

1. The boat should be level.
2. Ensure engine cover is closed to prevent fumes from entering the engine compartment.
3. Have a fire extinguisher close at hand.
4. Unscrew the cap counterclockwise and remove it slowly.



Imo2011-002-009
TYPICAL - FUEL TANK CAP

5. Insert the gas pump spout into the filler neck and fill up fuel tank.

⚠ WARNING

To prevent fuel back-flow, fill up tank slowly so the air can escape from the fuel tank.

6. Stop filling immediately after the release of the gas pump nozzle handle and wait a moment before removing the spout. Do not retract the gas pump nozzle to put more fuel in fuel tank.

⚠ WARNING

Do not overfill or top off the fuel tank and leave the boat in the sun. As temperature increases, fuel expands and may overflow.

7. Install and fully tighten the fuel tank cap.

⚠ WARNING

Always wipe off any fuel spillage from the boat.

In Water

1. Turn off engine.
2. Tie boat securely to the fueling pier.
3. Do not allow anyone to remain on the boat.
4. Ensure engine cover is closed to prevent fumes from entering the engine compartment.
5. Have a fire extinguisher close at hand.
6. Unscrew the cap counterclockwise and remove it slowly.



TYPICAL - FUEL TANK CAP

7. Insert the gas pump spout into the filler neck and fill up the fuel tank.

⚠ WARNING

To prevent fuel back-flow, fill up tank slowly so the air can escape from the fuel tank.

8. Stop filling immediately after the release of the gas pump nozzle handle and wait a moment before removing the spout. Do not retract the gas pump nozzle to put more fuel in fuel tank.

⚠ WARNING

Do not overfill or top off the fuel tank and leave boat in the sun. As temperature increases, fuel expands and might overflow.

9. Install and fully tighten the fuel tank cap.

⚠ WARNING

Always wipe off any spillage from the boat.

TRAILERING INFORMATION

Refer to the trailer owner's manual for proper capacity, operation, maintenance, accessories and warranty.

Observe trailering safety precautions.

Check the regulations in your area concerning towing a trailer, especially the following rules:

- Brake system
- Tow vehicle weight
- Mirrors.

NOTE: An optional brake system is available for your trailer (if not standard equipment), contact Karavan Trailers at www.karavantrailers.com

Take the following precautions when trailering the boat:

1. Tie the boat to both bow and stern (front/rear) eyelets so that it is firmly retained on the trailer.
2. Remove stern light (if installed).
3. Ensure all storage compartment covers are properly latched.

NOTICE Always ensure rear storage compartment lid is closed and securely fastened **before** trailering.

4. Close bimini top (if so equipped).
5. A Sea-Doo mooring cover can protect the boat, particularly before driving on dirt roads, to prevent dirt entry through the air intake openings.

NOTICE Do not use cockpit cover and bow cover for trailering.

LOCATION OF IMPORTANT ON-PRODUCT LABELS

The labels illustrated on the following pages are on your boat. If missing or damaged, they can be replaced free of charge. See an authorized Sea-Doo boats dealer.

Please read the following labels carefully before operating your boat.

NOTE: The illustration of the boat indicates the approximate locations of the various labels. A dotted line indicates that the label is not on the outer surface, and that the seat or a cover of some type must be opened to see the label.

Hang Tag

The Star Label means Cleaner Marine Engines

This engine has been certified as:



The Symbol for Cleaner Marine Engines:

Cleaner Air and Water

For a healthier lifestyle and environment.

Better Fuel Economy

Burns up to 30-40 percent less gas and oil than conventional carbureted two-stroke engines, saving money and resources.

Longer Emission Warranty

Protects consumer for worry free operation.



One Star-Low emission

The one-star label identifies personal watercraft, outboard, sterndrive and inboard engines that meet the Air Resources Board's Personal Watercraft and Outboard marine engine 2001 exhaust emission standards. Engines meeting these standards have 75% lower emissions than conventional carbureted two-stroke engines. These engines are equivalent to the U.S. EPA's 2006 standards for marine engines.



Two Stars-Very Low emission

The two-star label identifies personal watercraft, outboard, sterndrive and inboard engines that meet the Air Resources Board's Personal Watercraft and Outboard marine engine 2004 exhaust emission standards. Engines meeting these standards have 20% lower emissions than One Star - Low-Emission engines.



Three Stars-Ultra Low emission

The three-star label identifies engines that meet the Air Resources Board's Personal Watercraft and Outboard marine engine 2008 exhaust emission standards or the Sterndrive and Inboard marine engine 2003 exhaust emission standards. Engines meeting these standards have 65% lower emissions than One Star - Low Emission engines.



Four Stars-Super Ultra Low emission

The four-star label identifies engines that meet the Air Resources Board's Sterndrive and Inboard marine engine 2009 exhaust emission standards. Personal Watercraft and Outboard marine engines may also comply with these standards. Engines meeting these standards have 90% lower emissions than One Star - Low Emission engines.

BOMBARDIER RECREATIONAL PRODUCTS INC.
VALCOURT, QUÉBEC, CANADA
 Cleaner Watercraft - Get the facts 1-800-END-SMOG
www.arb.ca.gov

2119002678

219902678

Safety Labels

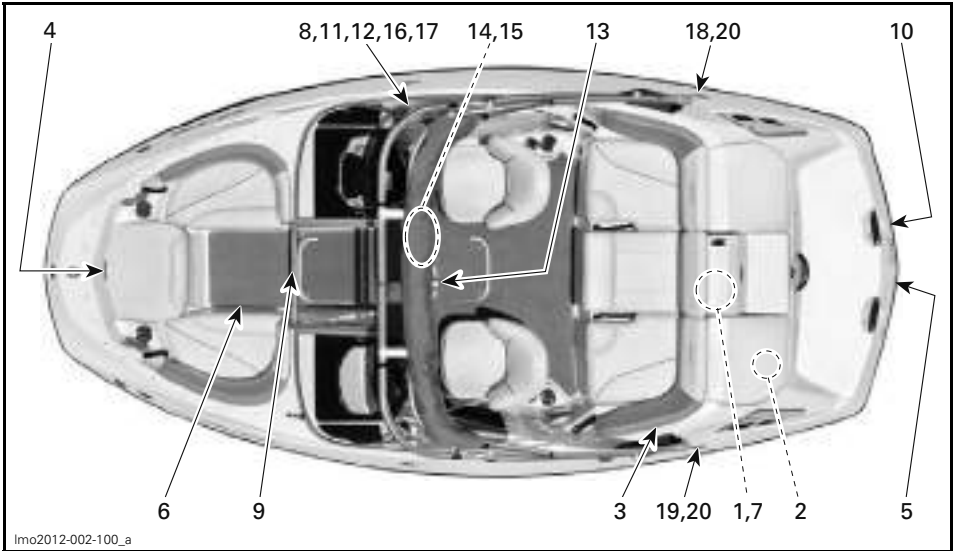

lmo2012-002-100_a

TYPICAL

CAUTION

ENGINE OIL AND CERTAIN COMPONENTS IN THE ENGINE COMPARTMENT MAY BE HOT. DIRECT CONTACT MAY RESULT IN SKIN BURNS. CHECK ENGINE OIL LEVEL.

- Make sure engine is at operating temperature. (Never let the engine run out of water without the flush kit connected as it may damage the engine)
- Boat must be level to perform verification.
- Leave engine running at idle for at least 30 seconds.
- Stop engine and wait at least 30 seconds.
- Check oil level using the dipstick.

PN: 21990003

219904003

LABEL 1

WARNING

- Remove battery from boat before charging.
- Do not overcharge battery.
- Improper charging of battery can cause explosion.

204901330

204901330

LABEL 2

WARNING

Avoid serious injury or death from fire or explosion from leaking fuel or vapors.

- Before fueling, turn off engine.
- Keep the boat level with no one aboard.
- Keep craft away from open flames and sparks.
- Use regular unleaded gasoline 87 pump octane.
- Do not overfill.
- Wipe up spilled gasoline.
- Inspect fuel system for leaks and verify components integrity at each pre-ride inspection.

204 902 065

204902065

LABEL 3

WARNING

Avoid Serious Injury Or Fatal Injury. Do Not Occupy Seat When Engine Is Running.

PN: 219 903 239

219903239

LABEL 4

WARNING

Avoid serious personal injury or death.

- Turn off engines before using the boarding ladder or when swimmers are nearby to avoid carbon monoxide poisoning.
- Keep people, clothing and hair away from jet nozzles or intake grates when engines are running to avoid entanglement and drowning.

PN: 21902992

219903992

LABEL 5

204900359

LABEL 6



LABEL 7

⚠ WARNING

Read and follow safety labels and operator's guide before operation. Severe injury or death can result from ignoring warnings or improper use of this sport boat. The performance of this sport boat may significantly exceed that of other boats you may have operated.

- Check throttle/shifter and steering operation and position before starting engine(s).
- Properly attach safety lanyard to your PFD.
- Directional control is reduced with decreasing speed and lost when engine is off.
- Do not splash others or jump waves or wakes.
- Occupants should always wear approved PFD and recommended protective clothing.
- Do not operate if passengers are not properly seated and using handgrips, or if visibility is obstructed. Do not allow passenger(s) to ride on any portion of the boat not designated in the operator's guide as a seat for use when underway.
- Keep a safe distance from all other water users.
- BRP recommends a minimum operation age of 16 years old supervised by an adult. Be aware of and observe all applicable laws and regulations.

204 902 067

204902067_A

LABEL 8

⚠ CAUTION

Always securely lock windshield door in the opened or closed position before getting underway

219903498

LABEL 9

⚠ DANGER



Carbon monoxide (CO) can cause brain damage or death.

Engine and generator exhaust contains odorless and colorless carbon monoxide gas.

Carbon monoxide will be around the back of the boat when engines or generators are running.

Move to fresh air if you feel nausea, headache, dizziness, or drowsiness.

204901626
204901626

LABEL 10

⚠ WARNING

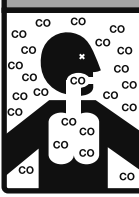

Carbon monoxide (CO) can cause brain damage or death.

Engine and generator exhaust contains odorless and colorless carbon monoxide gas.

Signs of carbon monoxide poisoning include nausea, headache, dizziness, drowsiness, and lack of consciousness.

Get fresh air if anyone shows signs of carbon monoxide poisoning.

See Owner's Manual for information regarding carbon monoxide poisoning.

204901625
204901625

LABEL 11

⚠ WARNING

Gasoline vapor may cause fire or explosion, resulting in serious injury or death.

Inspect fuel system for leaks and verify components integrity at each pre-ride inspection.

Before starting engine(s)

ALWAYS:

- Operate the bilge blower for 5 minutes.
- Open engine cover and check for gasoline vapor odor inside the engine compartment.
- Close the engine cover before starting the engine(s).

NEVER:

- Start the engine(s) if gasoline vapor odor is present in the engine compartment.

219903475
219903475

LABEL 12

⚠ WARNING

Misuse of tower may cause severe injury or death.

- Use tower only for wakeboarding or water skiing.
- Do not allow tow rope to dangle or get entangled with occupants, boat or engine.
- Attach tow rope only at the center attachment point.
- Tow only 1 person at a time.
- Do not climb on, sit on or jump off tower.
- Never add accessories to the tower unless approved by BRP.

204 902 068

204902068

LABEL 13

⚠ DANGER

EXHAUST FUMES FROM ENGINES CONTAIN DEADLY CARBON MONOXIDE GAS (CO). BOATS WITH CANVAS OR POOR VENTILATION ARE MOST LIKELY TO COLLECT FUMES. CO SICKNESS SYMPTOMS INCLUDE HEADACHE, NAUSEA AND DISSINESS. DO NOT MISTAKE FOR SEASICKNESS. VENTILATE BOAT. SEE BOAT OWNER'S MANUAL FOR MORE DETAIL. TH-23

lmo2011-001-014_a

LABEL 14 - IF EQUIPPED WITH BIMINI TOP

⚠ WARNING

TOP SHOULD NOT BE USED WHEN VESSEL SPEED EXCEEDS 35 MPH

lmo2011-001-015_a

LABEL 15 - IF EQUIPPED WITH BIMINI TOP

UNDERWAY SEATING POSITIONS

MAXIMUM PERSONS

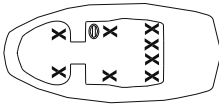

204901451

LABEL 16

BRP US Inc.
451 E. Illinois Ave. Benton, IL 62812

U.S. COAST GUARD

MAXIMUM CAPACITIES

MAX 8 PERSONS OR 627 kg (1383 lbs)

MAX 1 PERSONS + GEAR = 627 kg (1383 lbs)

THIS BOAT COMPLIES WITH U.S. COAST GUARD SAFETY STANDARDS IN EFFECT ON THE DATE OF CERTIFICATION

180 CHALLENGER / SE

CE BOAT DESIGN CATEGORY: C

219904023

219904023

LABEL 17 - TYPICAL

REFER TO THE OPERATOR'S GUIDE FOR FULL OPERATING INSTRUCTIONS

UN-LOCK/ RESET

LOCK

HANDLE MUST BE ROTATED TO RESET POSITION BEFORE RE-LOCKING

ROTATE 3/4 OF A TURN TO RESET

219903499

219903499

LABEL 18

REFER TO THE OPERATOR'S GUIDE FOR FULL OPERATING INSTRUCTIONS

UN-LOCK/ RESET

LOCK

HANDLE MUST BE ROTATED TO RESET POSITION BEFORE RE-LOCKING

ROTATE 3/4 OF A TURN TO RESET

219903500

219903500

LABEL 19

⚠ CAUTION

- To avoid injury never lower or raise tower alone. Ask someone to hold the tower for manipulation.
- Make sure to properly latch both sides of the tower before operating or towing the boat.
- When tower is folded down, always use the holder bracket and do not operate the boat more than 16 km/h (10mph).
- Never tow boat when tower is folded down.

Refer to the operator's guide for more details

269800405

269800405

LABEL 20

Compliance Labels

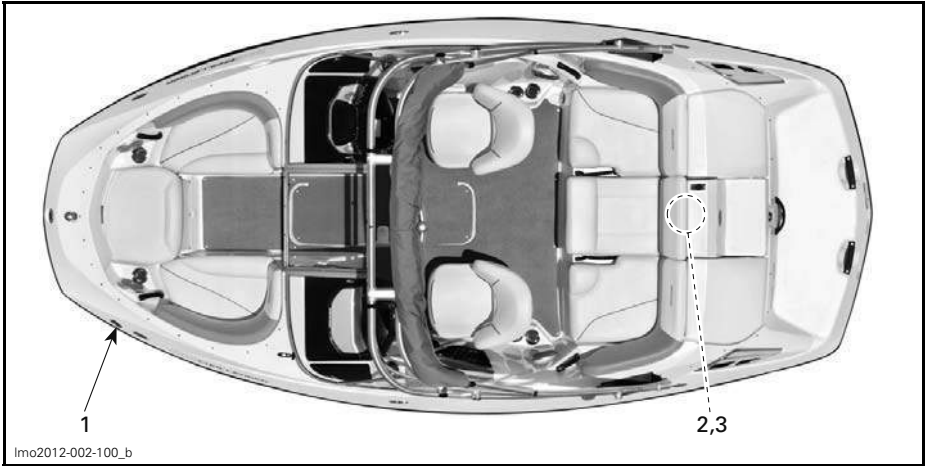

lmo2012-002-100_b

TYPICAL



219902679

LABEL 1 – EMISSION CONTROL



219904027

LABEL 1 – EMISSION CONTROL

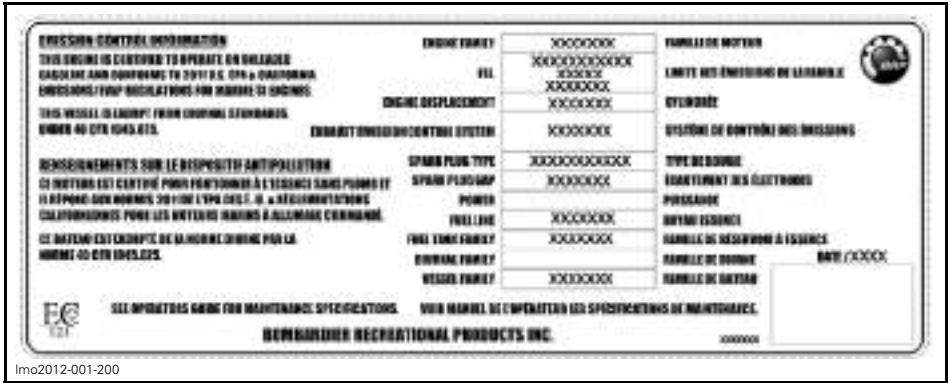

LABEL 2 – TYPICAL EPA COMPLIANCE



LABEL 3 - ISO

Technical Information Labels

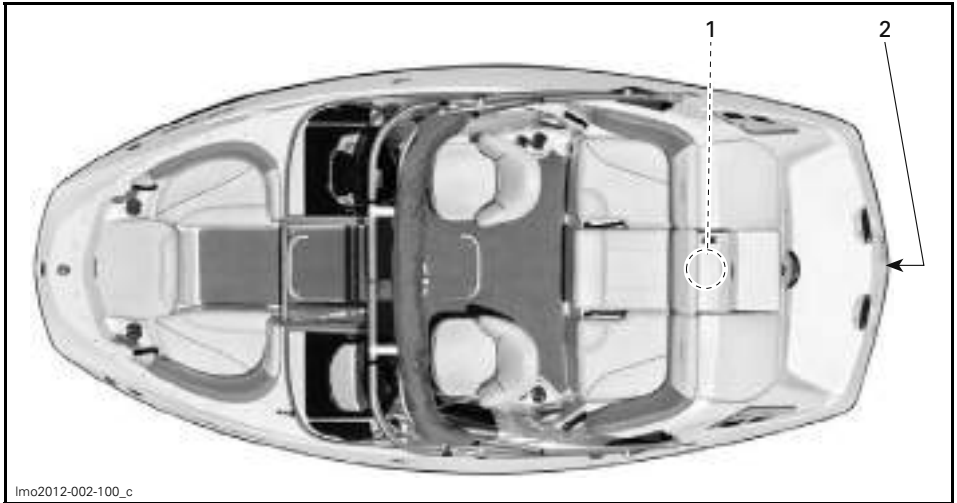

lmo2012-002-100_c

**MAXIMUM ENGINE POWER
CAPACITY RATING
OF THE CRAFT:
179 KW**

219903595

LABEL 1

Product covered by one or more of the following United States copyrights © and patents and their non-U.S. equivalents. / Produit protégé aux États-Unis par ou plusieurs des droits d'auteurs © et brevets tel qu'indiqué ci-après ainsi que par leurs équivalents à l'extérieur des États-Unis.

2009/0293,850 ; 2010/0319,604 ; 6,102,756 ; 6,390,869 ; 6,415,759 ; 6,419,533 ; 6,488,553 ; 6,568,376 ; 6,591,819 ; 6,592,413 ; 6,601,528 ; 6,626,140 ; 6,672,240 ; 6,701,863 ; 6,702,629 ; 6,766,759 ; 6,837,173 ; 6,868,938 ; 6,884,129 ; 6,886,490 ; 6,945,188 ; 6,966,274 ; 7,070,467 ; 7,101,238 ; 7,191,728 ; 7,220,155 ; 7,421,969 ; 7,424,861 ; 7,552,721 ; 7,607,958 ; D489,311 ; D509,469 ; D513,399 ; D583,285 ; D632,631 ; DVH0233(2006) ; DVH0283(2006) ; DVH0461(2010)

BRP, BRP logo, D-SEA-BEL, D.E.S.S., ECO, Fold'n Stow, ISLANDIA, ITC, ROTAX, SEA-DOO, SPEEDSTER, Transat, WAKE, WakeBoost, 4-TEC and associated designs are trademarks of Bombardier Recreational Products Inc. or its affiliates. / et les graphiques y associés sont des marques de commerce de Bombardier Produits Récréatifs Inc. ou de ses sociétés affiliées. BOMBARDIER, CHALLENGER are trademarks of Bombardier Inc. used under license. / sont des marques de commerce de Bombardier Inc. utilisée sous licence..

© 2010-2012 Bombardier Recreational Products Inc. / Bombardier Produits Récréatifs inc.
All rights reserved. / Tous droits réservés.

ACN 097 370 100

219903993

219903993

LABEL 2

PRE-RIDE INSPECTION

WARNING

The pre-ride inspection is very important before operating the boat. Bring all safety equipment required by local laws. Perform a pre-ride inspection before each ride to detect potential problems during operation. The pre-ride inspection can help you monitor wear and deterioration before they become a problem. Correct any problems that you discover to reduce the risk of a breakdown or accident. See an authorized Sea-Doo Boat dealer if necessary.

For more detailed information on these items, refer to the appropriate sections.

WARNING

Engine must be off and the tether cord removed from the engine cut-off switch except where specified otherwise.

Pre-Ride Check List When Boat is Trailered to Waterway

SUMMARY			
	ITEM	OPERATION	✓
BOAT ON TRAILER	Fuel tank	Refill.	
	Hull and deck	Inspect for damage.	
	Jet pump water intake	Inspect/clean.	
	Bilge	Ensure drain plug is properly secured.	
	Engine compartment	Verify for leaks or gasoline vapor odor. Verify fuel system components integrity.	
	Bilge	Check for abnormal water presence in bilge.	
	Throttle lever	Check operation.	
	Shift lever	Check operation.	
	Steering	Check operation.	
	Bilge blower	Turn ON bilge blower for 5 minutes to ventilate bilge.	
	Multifunction gauge cluster	Check operation.	
	Tower (optional)	Check tightness of mounting points fasteners.	
	Bimini top (optional)	Check tightness of mounting points fasteners. Check for canvas damages.	
	Mandatory safety boating equipment	Ensure all required safety equipment is on board.	
	Storage compartment covers	Ensure they are closed and latched.	
	Navigation lights	Check operation.	
	Engines start/stop switch	Check operation for starting and stopping engine.	
	Engine cut-off switch	Check if engine can be stopped by pulling off the tether cord from the engine cut-off switch.	
Removable cushions	Removable cushions securely fastened or stowed		
BOAT IN WATER (engine started)	Throttle lever	Check operation.	
	Shift lever	Check operation.	
	Steering	Check operation.	

Pre-Ride Check List When Boat is Moored to a Dock

SUMMARY			
DOCKED BOAT	ITEM	OPERATION	✓
	Fuel tank	Refill.	
	Bilge	Check for abnormal water presence in bilge.	
	Engine compartment	Verify for leaks or gasoline vapor odor. Verify fuel system components integrity.	
	Throttle lever	Check operation.	
	Shift lever	Check operation.	
	Steering	Check operation.	
	Bilge blower	Turn ON bilge blower for 5 minutes to ventilate bilge.	
	Multifunction gauges cluster	Check operation.	
	Tower (optional)	Check tightness of mounting points fasteners.	
	Bimini top (optional)	Check tightness of mounting points fasteners. Check for canvas damages.	
	Mandatory safety boating equipment	Ensure all required safety equipment is on board.	
	Storage compartment covers	Ensure they are closed and latched.	
	Navigation lights	Check operation.	
	Engine start/stop buttons	Check operation for starting and stopping engines.	
Engine cut-off switch	Check if engine can be stopped by pulling off the tether cord from the engine cut-off switch.		

BOAT INFORMATION

CONTROLS

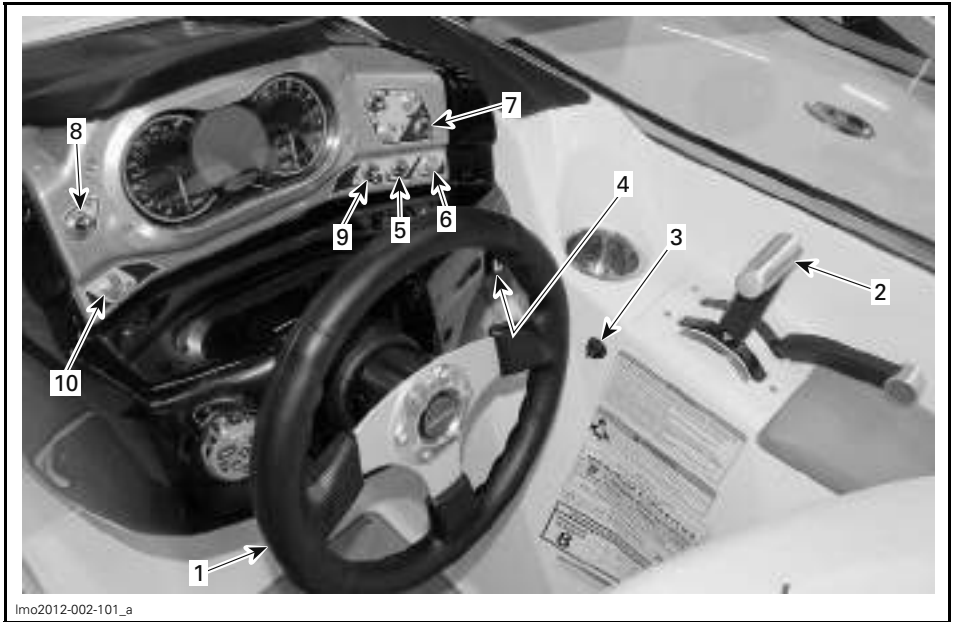

COCKPIT VIEW

1) Steering Wheel

The steering wheel controls the direction of the boat. Turning the steering wheel clockwise steers the boat to the right and inversely.

2) Throttle/Shifter Control

Shift Lever

A 3-position lever:

- Forward
- Neutral
- Reverse.

NOTICE Do not force throttle when shifter is in neutral. Forcing the throttle may result in damage to the shifter/throttle assembly.

In order to shift, throttle lever must be fully pulled back to idle speed position.

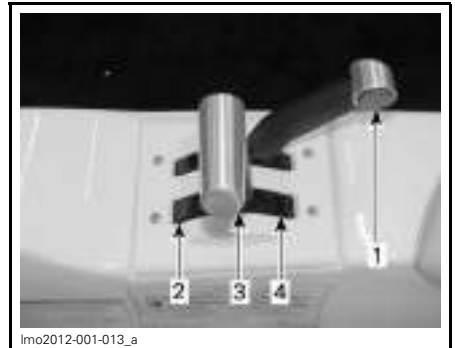

TYPICAL

1. Throttle lever must be fully pulled back (idle speed) to shift
2. Forward
3. Neutral
4. Reverse

⚠ WARNING

Shift lever should only be used when boat is completely stopped.

⚠ WARNING

Always ensure the path behind is clear of people and objects.

Throttle Lever

When pushed forward, the boat accelerates. When fully pulled back, engine returns to idle speed and the boat is gradually stopped by water drag.



lmo2012-001-013_b

TYPICAL

1. Throttle lever in idle speed position
2. Increase speed
3. Decrease speed

3) Engine Cut-Off Switch

The engine cut-off switch is located on starboard side, between throttle lever and driver's console.



lmo2012-001-010_a

1. Engine cut-off switch

⚠ WARNING

Keep the engine cut-off switch free from obstructions that could interfere with its operation. The proper use of the tether cord can prevent a runaway boat situation. Remove the tether cord clip from the switch when stopped to help prevent accidental starting.

The tether cord clip should be securely clipped onto the engine cut-off switch to allow engines starting. Pulling the tether cord clip off the engine cut-off switch shuts the engine OFF.

⚠ WARNING

Should the tether cord clip become loose or fail to remain on the engine cut-off switch, replace it immediately.



lmo2010-003-015_a

1. Tether cord clip (switch side)
2. Tether cord
3. Driver's clip



lmo2010-003-016_a

TYPICAL

1. Tether cord clip secured to engine cut-off switch

⚠ WARNING

Always attach the tether cord to the operator using its Personal Flotation Device (PFD) or a wrist strap before starting the engine.

**TYPICAL**

1. Tether cord
2. Tether cord secured to PFD
3. Tether cord secured to switch

If emergency engine shut off is required, pull tether cord clip off the switch.

⚠ WARNING

Directional control is reduced when throttle is decreased and lost when engine is OFF. Always remove tether cord clip when boat is not in operation.

4) Ignition Switch

The ignition switch is located to the right of steering wheel. It is a 3-position switch.

**TYPICAL - IGNITION SWITCH POSITIONS**

1. OFF
2. ACCESSORIES (lights touchscreen and radio)
3. ON

Insert key in switch and turn to the desired position.

NOTICE If the key does not turn easily, do not force it. Pull it out and reinsert key.

OFF

NOTE: When turning the key to OFF position, the boat electrical system will take a few seconds to shut down.

⚠ WARNING

If you turn the ignition switch to OFF, it shuts off the engine and directional control is lost.

Always turn ignition key to the OFF position after engine has been stopped.

NOTE: While engine can be stopped by turning ignition key to OFF position, we recommend the engine be stopped by pressing the engine stop button.

To remove key, turn key to OFF position then pull it out.

ACCESSORIES

The ACCESSORIES position allows the operation of electrical accessories.

NOTICE Having the accessories ON without the engines running discharges the battery.

ON

The ON position activates the complete electrical system. The ON position allows engines starting.

5) Bilge Blower Switch

This switch is located on driver's console at the right of steering wheel.



lmo2012-002-003_b

1. Bilge blower switch

This is a 2-position OFF/ON switch.

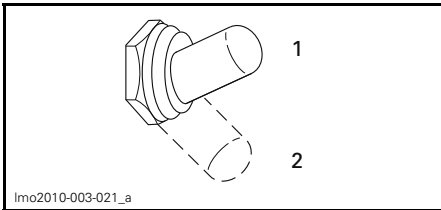

lmo2010-003-021_a

1. ON position
2. OFF position

When turned on, the blower ventilates the engine compartment.

Turn ON bilge blower for a minimum of 5 minutes before starting engine and turn it OFF above idle speed.

! WARNING

Gasoline vapors can explode. Always use bilge blower as specified. Use of the bilge blower should never replace "smelling" for gasoline vapor odors.

! WARNING

If any leaks or gasoline vapor odors are present, do not start the engine. Consult an authorized Sea-Doo boats dealer.

NOTE: Using the bilge blower for a prolonged time when the engine is not running will discharge the battery.

6) Engine Start/Stop Button

The start/stop button is located beside the right analogical indicator.

Dual function push button. Used to start as well as to stop engine.



lmo2012-002-003_c

1. START/STOP button

Engine Starting and Stopping

Refer to *OPERATING INSTRUCTIONS* for complete procedure to start and stop the engine.

7) Bilge Pump Switch

This switch is located on driver's console at the right of steering wheel.



1. Bilge pump switch

This is a 2-position OFF/ON switch.

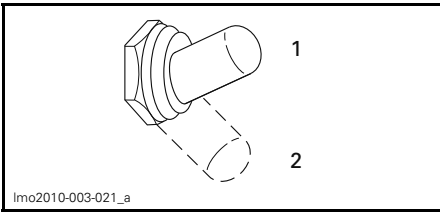

1. ON position
2. OFF position

Turn to ON position when manual operation of the bilge pump is required (after cleaning, storage, etc.).

Turn switch to OFF when finished.

NOTICE Do not operate for prolonged time if the bilge is dry: battery drainage will occur and pump will be damaged.

The bilge pump may be operated without the tether cord on the engine cut-off switch.

NOTICE Always turn pump OFF after water is evacuated or before operating the engine above idle. Bilge pump will then switch to automatic mode.

Bilge Pump Automatic Mode

The bilge pump will evacuate automatically the water from the bilge. A water sensor detects the water, activating the pump. After the water is pumped out, the pump shuts-off automatically.

NOTE: The automatic mode can not be deactivated, even if the main battery cut-off switch is turned OFF.

NOTICE If boat is exposed to prolonged rain without a cover, battery will discharge and bilge pump will quit working. Boat may sink if in water.

8) Deck Lights Switch

This switch is located on driver's console at the left of steering wheel.

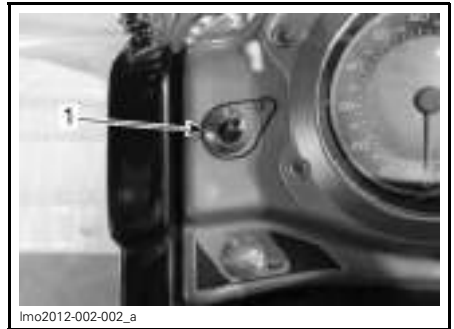

1. Deck light switch

This is a 2-position OFF/ON switch.

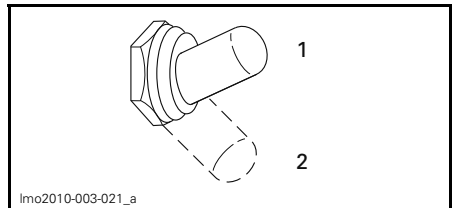

1. ON position
2. OFF position

Raise switch stem to ON position to turn on the deck lights.

Lower switch stem to OFF position to turn off the deck lights.

NOTE: The ignition switch must be in the ACC or ON position to allow lights operation.

NOTICE Using the deck lights for a prolonged time when the engine is not running will discharge the battery.

9) Navigation Lights Switch

A 3-position NAV/OFF/ANC switch.

This switch is located on driver's console at the right of steering wheel.



lmo2012-002-003_a

1. Navigation lights switch

A 3-position NAV/OFF/ANC switch.

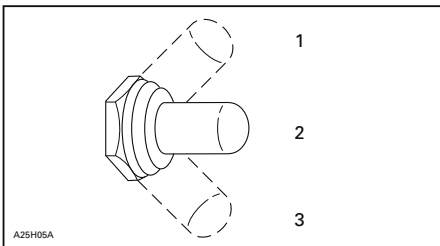

A25H05A

1. NAV
2. OFF
3. ANC

ANC: Turns on the anchorage light (stern light) when the boat is anchored.

OFF: Turns off all lights.

NAV: Turns on both bow and stern lights and illuminates the gauges.

10) Horn Button

This button is located on driver's console at the very left of steering wheel.

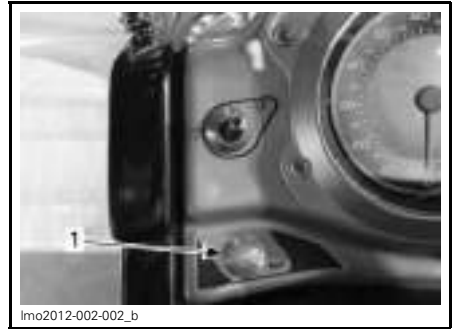

lmo2012-002-002_b

TYPICAL

1. Horn switch

Press the button to activate the horn.

INFORMATION CENTER GAUGE

This is a multifunction gauge that supplies several real time useful information to the driver either in English, French or Spanish. See an authorized Sea-Doo Boats dealer for unit settings.

At start-up, all LCD segments and indicator lights will turn on for 3 seconds each time the information center is activated (when tether cord is installed). This allows the driver to validate they are all working properly.

NOTE: Gauge is illuminated whenever the navigation lights are used.

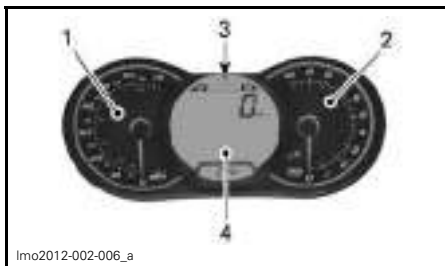

1. Speedometer
2. Tachometer
3. Fuel level
4. Information display
5. Indicator lights
6. Water temperature display

⚠ WARNING

Do not adjust the display while riding. You could lose control.

Speedometer

Speedometer indicates the speed of the boat in miles per hour (MPH) or kilometers per hour (km/h).

Tachometer

Tachometer indicates the revolutions per minute (RPM) of the engine. Multiply by 1000 to obtain the actual revolutions.

Fuel Level

Bar gauge that continuously indicates the amount of fuel left in the fuel tank while riding.

Information Display

Compass

Displays the cardinal points to indicate the orientation of the boat.

⚠ WARNING

Use the compass as a guide only. Not to be used for navigation purposes.

Hourmeter (HR)

Displays the time in hours of the boat usage.

Water Temperature Display

Displays the water temperature of the water surface in degrees Celsius (°C) or Fahrenheit (°F).

Message Code

Displays a message code whenever one of the following circumstances occurs. The abbreviations between parenthesis here are the codes displayed.

(H-TEMP)

Engine or exhaust system overheating.

NOTICE If the monitoring beeper continuously sounds, stop engine as soon as possible.

Turn off engine as soon as possible. Check oil and coolant levels and refill if necessary. Refer to *MAINTENANCE PROCEDURES*.

If engine still overheats, refer to *ENGINE OVERHEATING* in *TROUBLESHOOTING*.

(OIL)

Low or high oil pressure in the engine.

Check oil level as soon as possible.

If lamp remains ON contact an authorized Sea-Doo Boats dealer.

NOTICE Never run engine out of oil. Serious engine damage will occur.

(12 V LOW)

Low battery voltage.

Before the battery becomes too discharged to start the engines, the **low/high battery voltage** indicator light will come on.

When the indicator light is ON, you should discontinue all use of electrical accessories immediately and start the engine in order to recharge the battery.

(12 V HI)

High battery voltage.

See an authorized Sea-Doo Boats dealer.

(FUEL-LOW)

Low fuel level.

Fill up fuel tank as soon as possible.

(MAINT)

Maintenance reminder.

NOTE: When the boat is due for a maintenance inspection, the message MAINT will blink. After servicing, your authorized Sea-Doo Boats dealer will clear it.

(CHK ENG)

Check engine.

NOTE: If a fault occurs, this system generates numbered fault codes (P-XXXX) that are displayed through the information center. In case of a failure, you may call your authorized Sea-Doo Boats dealer and he would be able to assist you to obtain the code descriptions to help troubleshooting.

(SENSOR)

Sensor failure (boat electronic equipment).

See an authorized Sea-Doo Boats dealer.

Additional Information

A beeper will sound and indicator light will blink depending on the fault occurring to catch the driver attention when necessary.

Except for low liquid levels, which can be corrected by refilling, it is recommended to see an authorized Sea-Doo Boats dealer when other messages occur.

Indicator Lights

NOTE: Refer to *MESSAGE CODE* above for additional information regarding messages.



Low oil pressure (OIL)



Check engine (CHK ENG)



Engine or exhaust system overheating (H-TEMP)



Low fuel level (FUEL-LOW)



Low/high battery voltage (12 V LOW/HI)



Maintenance reminder (MAINT)

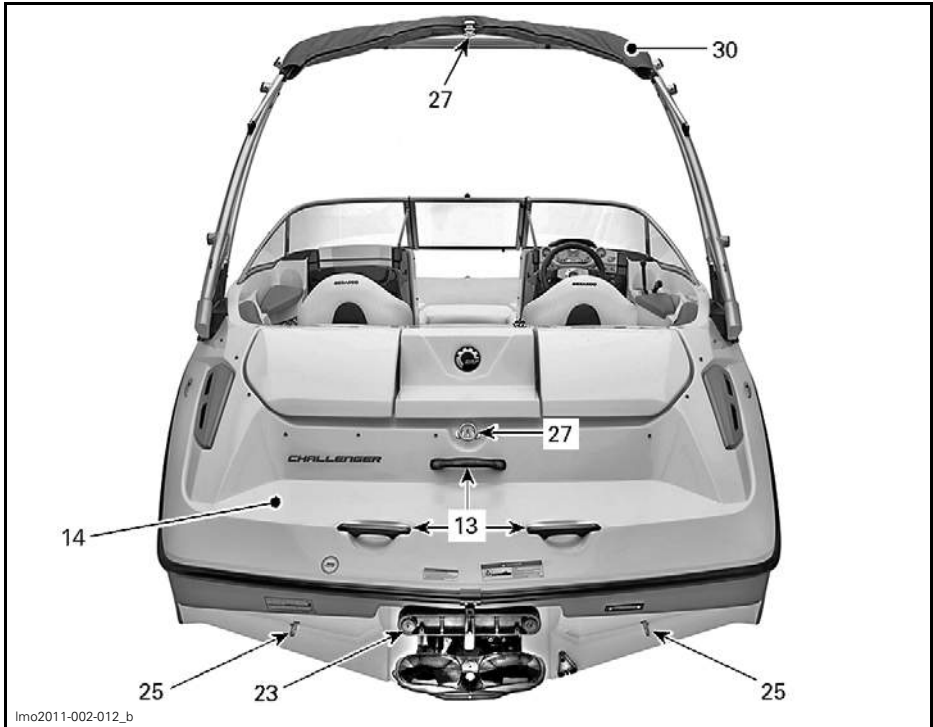

lmo2011-002-012_b

TYPICAL

1) Seats

Each occupant should be seated while underway.

⚠ WARNING

Allow no one to sit on edge of the boat or to stand up while in operation. Seat and grab handles should be used in rough waters.

2) Bow Seats

Located at the front of the boat, they are provided as a sun seat.

⚠ WARNING

No passenger should use the most forward seat in the bow area if it faces backwards unless the boat is stopped or under idle speed.

3) Main Battery Cut-Off Switch

The switch allows a complete power cut-out of the electrical system.

This switch is located in the port bilge access compartment.

When in OFF position, ALL electrical equipment and electronics will be OFF, **except** the bilge pump. The bilge pump will operate automatically with the battery switch in the OFF position.

Switch must be in the ON position to allow the use of electrical components and to start the engine.

NOTICE Stop engine before switching to the OFF position.



TYPICAL — MAIN BATTERY CUT-OFF SWITCH

1. Battery cut-off switch in ON position

It is recommended to set this switch to the OFF position whenever performing maintenance in the engine compartment, on the electrical system, for transportation or during short term storage.

NOTICE When the main battery cut-off switch is turned OFF while boat is moored, the automatic bilge pump will start if water comes up in the bilge.

4) Deck Storage Compartment

The deck storage compartment is a convenient lockable location for water-skis, paddles, anchor and rope, etc. Use the provided key to unlock the compartment if needed.



1. Lock

⚠ WARNING

Never leave any heavy or loose breakable objects in the storage basket. Never operate the boat with the storage compartment cover open.

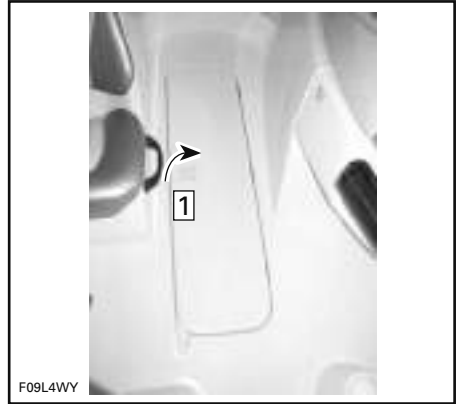

TYPICAL

Step 1: Pull latch and lift cover

Lift the latch ring and open cover gently until the gas assist cylinder is fully extended.

When completely opened, the cover remains in that position on calm water.

To close, gently lower the cover.

Lock if desired.

5) Rear Storage Compartment

Starboard Rear Storage Compartment

Located behind the rear starboard passenger seat.

Pull latch to open storage cover.



1. Lift latch

The gas assist cylinder will hold the storage cover open.

NOTICE Always close cover before getting underway.

6) Glove box

Located on the port console, the glove box provides a convenient, lockable storage space for keys, wallet, etc.



1. Glove box
2. Opening button
3. Radio compartment

To open the glove box:

- Press the button
- Turn the button counterclockwise
- Lift the cover.



GLOVE BOX OPENED

NOTICE Never operate the boat with the glove box cover open.

NOTE: This operator's guide should be kept in a waterproof bag in the glove box and remain with the boat at all times.

7) Bow Seat Storage Compartments



TYPICAL

1. Bow storage compartments

Located under the bow seat cushions, the bow seat storage compartments are provided for securing extra PFD's, rope, etc.

Unsnap and lift bow cushions to access storage areas.

Installation of bow cushions is the reverse of removal.

8) Bow Filler Cushion (SE Model only)

The bow seat filler cushion is located under the front bow seat cushion.

Unsnap the front bow seat cushion and remove.

Pull the bow seat filler cushion from its storage position.

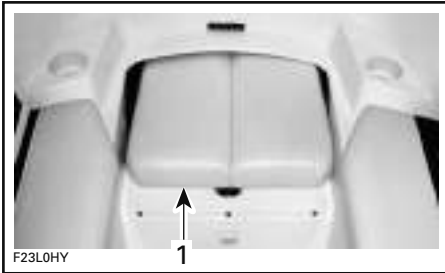

1. Filler cushion

Remove the support bars from their storage position beneath the bow seat filler cushion.

Unsnap the two side bow seat cushions, lift each cushion slightly to position the support bars.

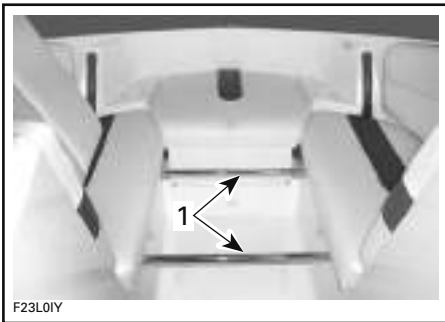

1. Support bars installed

Reposition front bow seat cushion and fasten with the snap.

Position bow seat filler cushion to create a comfortable lounging area while boat is stopped.



TYPICAL

9) Rear Seat Storage Compartments

Located beneath the rear port and starboard seat cushions, these compartments are convenient for storing a cooler, or additional articles.

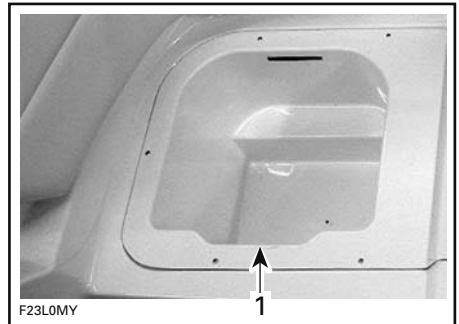

1. Starboard side shown



COOLER

1. Port side shown

10) Passenger Storage Compartment

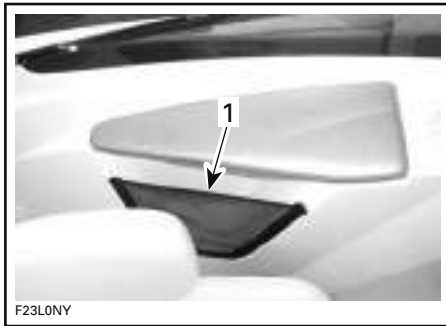

1. Passenger storage area

Located at the port side of the boat next to the front passenger seat, this storage area provides quick, easy access for small articles.

11) Removable Cooler

A 15 L (16 qt (U.S. liq.)) removable cooler is provided for keeping sandwiches and non-alcoholic beverages cold.

It is located in the starboard rear seat storage compartment, and will also fit in the port rear seat storage compartment.



COOLER

1. Port side shown

12) Grab Handles

Grab handles provide a handhold for the passengers.

Although grab handles are provided, never perform maneuvers that place a passenger or the driver at risk for being ejected or thrown out of their seat.

NOTICE Never use the grab handles to pull anything or to lift the boat.

Refer to components location illustrations at the beginning of this section for grab handle locations.

13) Rear Grab Handles

Provide a handhold for boarding when needed.

NOTICE Never use the grab handle to tow anything or to lift the boat.

14) Swim Platform

Provides an anti-skid surface for easy boarding from rear of the boat.

⚠ WARNING

Do not start or operate the boat if a person is seated on the platform. Engine must be off when using swim platform. Keep away from jet or intake grate.

15) Ladder



1. Retractable ladder

Located under the swim platform, the ladder helps in reboarding the boat.

⚠ WARNING

Engine should be OFF when using ladder. Keep limbs away from jet or intake grate. Only one person at a time on the ladder. Never use the ladder for pulling, towing, diving or jumping, boarding a boat that is out of the water or any other purpose other than a ladder.

Pull latch to unlock the ladder.

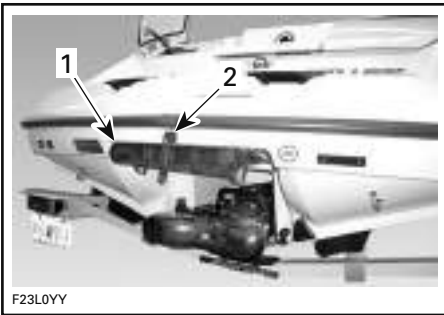

F23L0YY

TYPICAL

1. Retractable ladder
2. Latch

Slide ladder toward rear, then push down.



F23L0ZY

TYPICAL — LADDER LOWERED

To store ladder, lift horizontally, slide toward front and refasten latch.

16) Bow Lights

Mandatory red/green lights. See *NAVIGATION LIGHT SWITCH* as mentioned earlier in this section.

17) Stern Light Socket

The stern light socket is provided for the mandatory white stern light.

It is recommended to keep stern light in ski locker compartment at all times except when needed.

Stern Light Installation

1. Release stern light storage lock as shown.

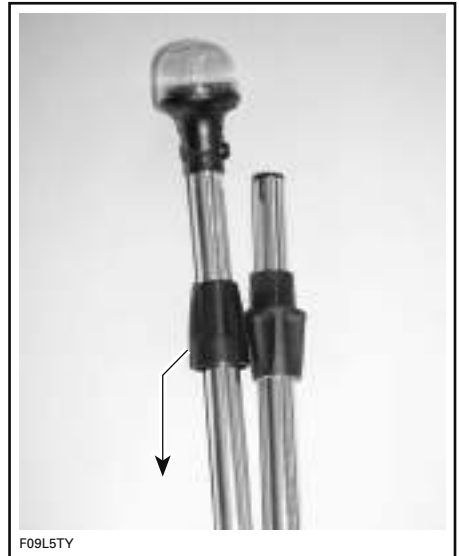

F09L5TY

SLIDE THIS DIRECTION

2. Thread onto folding joint as shown below.

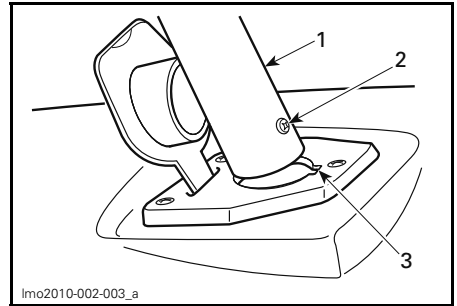
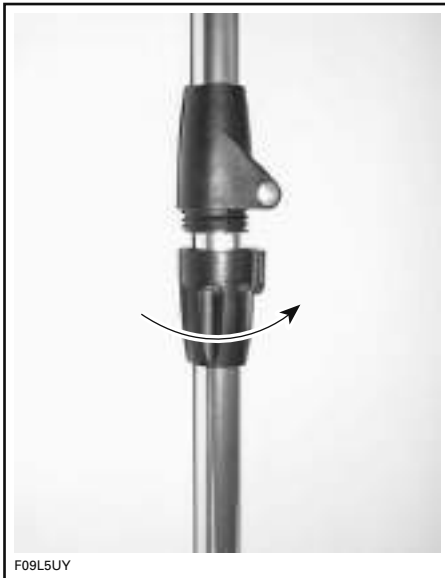

1. Stern light post
2. Post screw head
3. Hole keyway

5. Firmly push downward to engage terminals.
6. Push lock ring downward. Turn until locked. It may be necessary to slightly turn it to allow its insertion in the hole.

3. Lift connector cap.



1. Connector cap

4. Insert post in connector hole. Ensure to align hole keyway with post screw head.

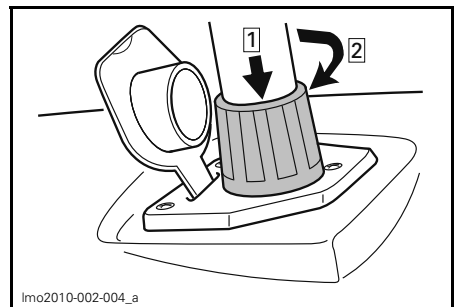

- Step 1: Push downward
Step 2: Turn clockwise to lock

7. Check light operation. See *NAVIGATION LIGHT SWITCH* as mentioned earlier in this section.

Removal and storage of light is the reverse of installation.

18) Radio

The Radio Player is located inside the glove box.

The radio door has a magnetic catch and you just use your finger to overcome the magnetic force to open it



RADIO

NOTICE Always close cover before getting underway.

Refer to *MANUFACTURER'S GUIDE* for complete explanation of features and controls.

NOTICE Using the radio/CD player for a prolonged time without engine running may discharge the battery.

19) 23) Radio AUX Output

These sockets are used to connect portable audio devices.



INSIDE GLOVE BOX

1. Portable audio device sockets

Refer to radio owner manual for operating instruction.

20) Radio Remote Control

SE Models



RADIO REMOTE CONTROL

A remote control for the Radio is included as standard equipment and is located on the dashboard.

Please refer to included *MANUFACTURER'S INSTRUCTION SHEET* for remote control operation.

21) 12-Volt Power Outlet

A 12-volt power outlet is located to the left of the Radio/CD Player. It is provided to power temporary accessories such as a cellular phone or other 12-volt portable devices.



RADIO COMPARTMENT

1. 12-Volt Power Outlet

Lift protective cap to expose jack.

NOTICE Using the accessory jack for a prolonged time without engine running may discharge the battery.

NOTICE Close protective cap when jack is not in use to protect against weather.

22) Deck Drain

Located below the driver's seat, the deck drain provides water drainage from rain, deck washing, water splashing, etc. Keep clean to avoid clogging.

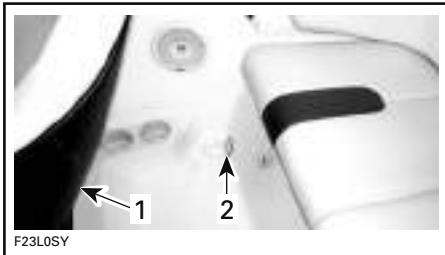

TYPICAL
 1. Driver's seat
 2. Deck drain

23) Bilge Drain Plugs

A drain plug is provided to expel water from the bilge.

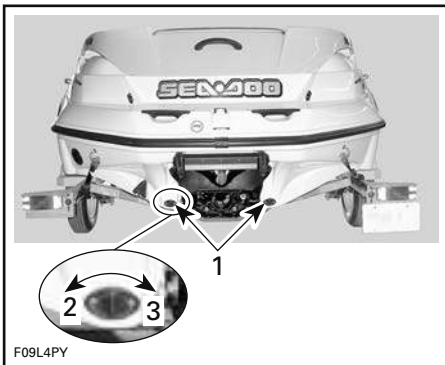

TYPICAL
 1. Drain plugs
 2. Loosen
 3. Tighten

24) Cup Holders

Convenient locations for non-alcoholic beverages.

! WARNING

Never operate boat while under the influence of alcoholic beverages while aboard. Do not keep bottles, cans etc. in cup holders while riding at high speed and/or on rough water.

25) Bow and Stern Eyelets

Eyelets can be used for mooring, towing and as a tie-down point during transportation.



TYPICAL
 1. Stern eyelet
 2. Bow eyelet

26) Mooring Cleats

When mooring to a dock, it is recommended to secure the boat with both front and rear cleats. The use of dock lines with sealed air fenders is recommended to protect your boat.

NOTICE Never use mooring cleats to pull anything or to lift the boat.

SE Model

The SE model is equipped with a "pull-up" cleat type.



PULL-UP CLEAT

27) Water Sport Towing Attachments

Please read and often refer to *WATER SPORTS* information in the *SAFETY INFORMATION* section at the front of this guide.

! WARNING

"Teak Surfing" is extremely dangerous to participants due to their proximity to the rear of the boat where direct contact with the exhaust fumes from the boat engine is the highest. Carbon monoxide poisoning can occur and result in mental disorientation, dizziness, drowsiness, and loss of consciousness. The combination of carbon monoxide exposure and non-use of a life jacket (PFD) make this new water recreation activity an incredibly dangerous and potentially deadly sport.

! WARNING

When pulling a tube, skier or wakeboarder, always have an observer, proceed with only as much speed as required, and follow the observer's instructions.

! WARNING

Pulling a tube, skier or wakeboarder makes the boat handle differently and requires greater skill. Unless absolutely necessary, do not make tight, sharp turns. Keep a safe distance from docks, swimmers, other craft or objects. Be advised that serious injury can result if the tow rope becomes slack during a tight turn or when circling. The rope could become wrapped around the neck or limbs of a person.

Tow Hook

Used to pull skiers and other appropriate water toys.



TYPICAL

1. Tow hook

Towing Tower (Optional)

The towing tower is for skiing or wakeboarding.

NOTICE The tower must be in the upright position and secured when boat is operated or when towed. Check clearance height around docks, shore, overhanging objects, bridges and power lines. The tower must not be used as a tie-down or tie-off point.

Lowering Tower

Lowering tower may be useful for storing the boat or for bridge clearance, on the water, at low speeds.

⚠ CAUTION To avoid injury, never lower the tower alone. Ask someone to hold the tower for manipulation.

To lower the tower, proceed as follows:

1. Have someone to support the tower front section.
2. On LH side of tower, install and turn the handle (provided with boat) 3/4 turn **COUNTERCLOCKWISE** to the unlock position.

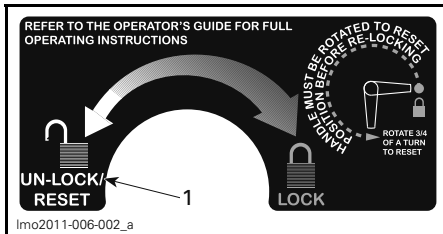

1. UNLOCK/RESET position (port side)



TURN HANDLE 3/4 TURN COUNTERCLOCKWISE (PORT SIDE)

3. Remove handle.

4. On RH side of tower, install and turn the handle 3/4 turn **CLOCKWISE** to the unlock position.

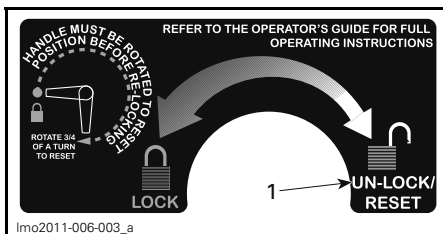

1. UNLOCK/RESET position (starboard side)

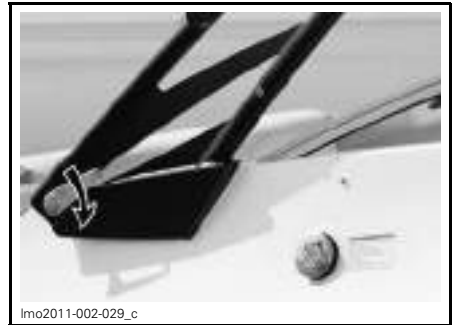

TURN HANDLE 3/4 TURN CLOCKWISE (STARBOARD SIDE)

5. Remove handle and stow in one of the boat compartment.
6. Carefully lower and hold tower.



TYPICAL - LOWERING TOWER

NOTE: Use the holder brackets and knobs (provided with the boat) to secure tower in position.

7. Insert and secure hook end of the holder bracket into the tower mount of the boat.

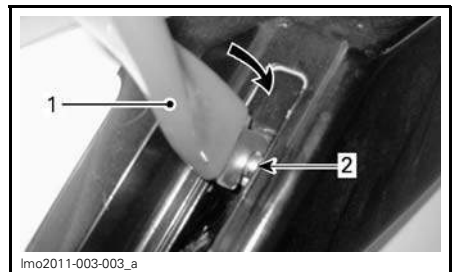

BRACKET HOOK IN TOWER MOUNT

1. Bracket hook
2. Tower mount pin

8. Secure the other end of bracket to tower leg end with the retaining screw.

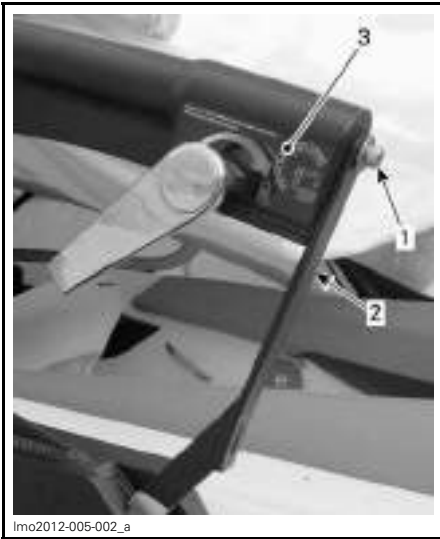

1. Retaining screw
2. Holder bracket (upper end)
3. Tower leg end



HOLDER BRACKET INSTALLED

9. Proceed with the holder bracket installation on the other side.

NOTICE When tower is folded down, always use the holder bracket and do not operate the boat more than 16 km/h (10 MPH). Never tow boat when tower is folded down.

Raising the Tower

The tower must be in the upright position when trailering boat or when riding.

Have someone to support the tower front section

1. Remove tower support brackets from tower.
2. On LH side of tower, install and turn the handle (provided with boat) 3/4 turn **COUNTERCLOCKWISE** to the **RESET** position.

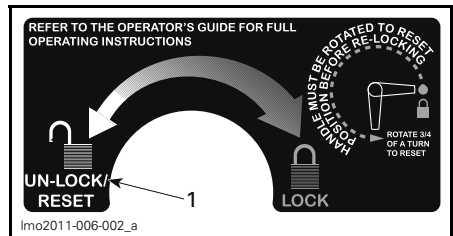

1. UNLOCK/RESET position (port side)



TURN HANDLE 3/4 TURN COUNTERCLOCKWISE (PORT SIDE)

3. Remove handle.
4. On RH side of tower, install and turn the handle 3/4 turn **CLOCKWISE** to the **RESET** position.

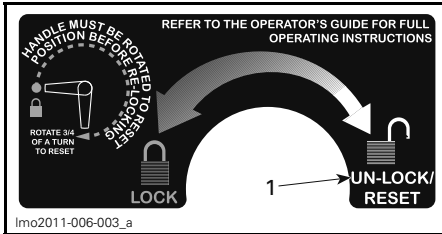

1. UNLOCK/ RESET position (starboard side)

5. Raise the tower to its highest position.



lmo2011-002-022_b

TYPICAL - RAISING TOWER

6. On RH side of tower, turn handle 3/4 of a turn **CLOCKWISE** to the LOCK position.



lmo2011-002-032_b

PORT SIDE - TURN HANDLE 3/4 TURN **CLOCKWISE** TO LOCK

7. On LH side of tower, turn handle 3/4 of a turn **COUNTERCLOCKWISE** to the LOCK position.



lmo2011-002-029_d

STARBOARD SIDE - TURN HANDLE 3/4 TURN **COUNTERCLOCKWISE** TO LOCK

8. Remove handle and stow in one of the boat compartment.

⚠ CAUTION Make sure to latch properly both sides of the tower before operating or towing the boat.

28) Engine Cover

Pull upwards on the latch below the rear center seat cushion and lift engine cover lid.

Remove lower cover to access the engine.

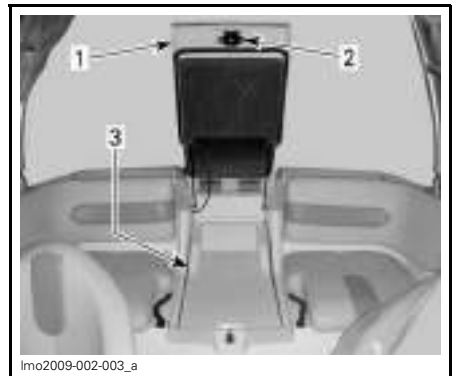

lmo2009-002-003_a

1. Engine upper cover/center cushion
2. Latch
3. Lower cover

The gas assist cylinders will complete the opening and hold the cover open.

29) Port Bilge Access

Located at the port rear of the boat.

This area allows access to the battery, the main battery cut-off switch and various fuses.

Lift latch to open storage cover.

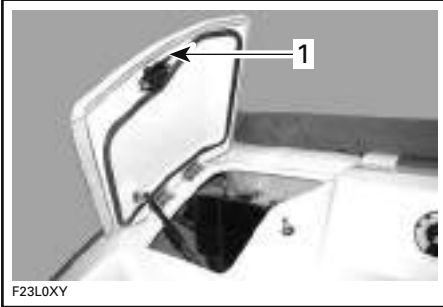

1. Latch

The gas assist cylinder will hold the storage cover open.

! WARNING

Always close cover before getting underway.

Also see *MAINTENANCE INFORMATION* section.

30) Bimini Top

SE Models

The bimini top is convenient for protection against inclement weather or sunshine.

! DANGER

- Exhaust fumes from engines contain deadly carbon monoxide gas (CO).
- Boat with bimini top are most likely to collect fumes.
- CO sickness symptoms include headache, nausea and dizziness. Do not mistake for seasickness.

! WARNING

- Avoid body contact with bimini top.
- Hold down straps are under tension.
- Do not use bimini top as a support.
- Do not use bimini top at speeds exceeding 56 km/h (35 MPH), otherwise top can break or dislodge causing a risk of personal injury or interference with boat operation.

Opening Bimini Top

Unzip and remove cover.

Store cover in a storage area.

Detach straps from bimini top.

Models without Tower

Lift bimini top to vertical position.

Pull front portion of canvas towards the front of the boat and fasten front straps to eyelets.

Pull rear portion of canvas towards the rear of the boat and fasten rear straps to eyelets.

Adjust center structural tubes at the same position on both sides to support center of canvas.

Adjust front structural tubes at the same position on both sides to support front portion of canvas.

Adjust front and rear straps tension as needed.

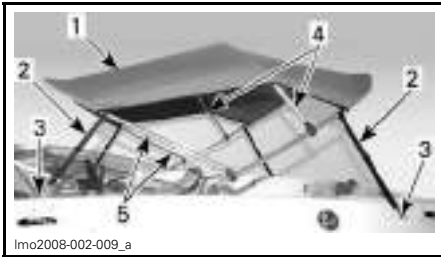

lmo2008-002-009_a

MODELS WITHOUT TOWER

1. Canvas
2. Straps
3. Eyelets
4. Center structural tubes
5. Front structural tubes

Models with Tower

Pull bimini top towards the rear of the boat until canvas is stretched.

Fasten straps to attaching points on tower structure.

Adjust straps tension as needed.

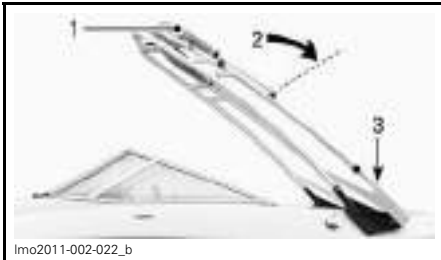

lmo2011-002-022_b

MODELS WITH TOWER

1. Canvas
2. Unfolding canvas
3. Attaching points for straps

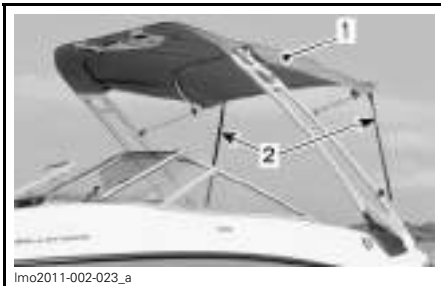

lmo2011-002-023_a

BIMINI TOP UNFOLDED

1. Canvas (stretched)
2. Attaching straps

Closing/Storing Bimini Top

NOTE: If canvas of bimini top has been splashed by salt water, rinse canvas with cold fresh water. At any time when canvas is wet, let dry before installing cover and storage.

Unhook rear straps.

Fold bimini top carefully.

Install protective cover.

Place bimini top straps inside cover and slowly zip while packing canvas inside cover.

31) Automatic Fire Extinguisher**CE Models Only**

This boat is equipped with an automatic fire extinguisher in case a fire starts in the engine compartment.

NOTE: There is an indicator light on the side of the deck.

NOTE: Do not test fire extinguishers by squirting small amounts of the extinguishing compound. The extinguisher might not work when you really need it!

⚠ WARNING

In case of fire, do not open engine compartment. Turn off engine. Activate automatic fire extinguisher, continuously and discharge entire contents at base of fire.

Refer to *MANUFACTURER'S INSTRUCTION MANUAL* additional information.

BREAK-IN PERIOD

Operating During Break-In

NOTICE Carefully follow the instructions of this section. Failure to do so may reduce the engine's life and/or performance.

A break-in period of 10 hours is required before continuous operation at full throttle.

To achieve a good break-in, throttle lever should not be advanced more than 3/4 opening, however, brief acceleration and speed variations contribute to a good break-in.

NOTICE Continued wide open throttle runs and prolonged cruising without speed variations should be avoided. This can cause engine damage during the break-in period.

OPERATING INSTRUCTIONS

⚠ WARNING

Always perform *PRE-RIDE INSPECTION* before operating the boat. Become thoroughly familiar with all controls and the function of each. Should any control or instruction be not fully understood, refer to an authorized Sea-Doo boats dealer.

Launching/Loading

NOTICE Before launching the boat, ensure the main battery cut-off switch is turned ON and the bilge plugs are fully screwed into place.

When finished loading the boat on trailer, turn the main battery cut-off switch to OFF.

Remove bilge plugs to drain bilge when boat is on trailer.

Boarding the Boat

As with any boat, boarding should be done carefully and engines must not be running.

⚠ WARNING

Engines must be OFF when boarding the boat or when using the swim platform.

NOTICE Never use propulsion system as a supporting point to board the boat.

Boarding from a Dock

When boarding from a dock, use the swim platform to climb aboard.

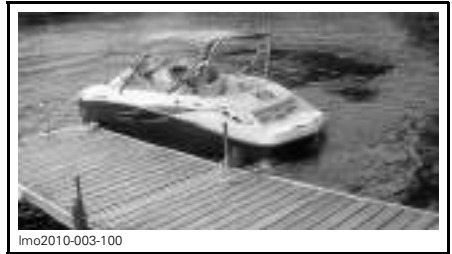

lmo2010-003-100

TYPICAL

NOTICE Although the boat requires only 30 cm (1 ft) of water to float, the engine should be started with at least 90 cm (3 ft) of water below the hull. If the depth of water is less than 90 cm (3 ft) and the engines are running, the impeller is turning and debris can be drawn from the bottom and damage the propulsion system.



lmo2010-005-001_a

TYPICAL

A. 90 cm (3 ft)

Boarding from Shallow Water

In shallow water, board the boat from either the front or the rear using ladders.

Ensure there is at least 90 cm (3 ft) of water underneath the lowest rear portion of the hull.

Take into account that the hull will be lower in the water when all passengers are aboard. Be certain to maintain the specified depth so sand, pebbles and rocks will not be drawn up in the jet pump.



lmo2010-005-001_a

TYPICAL

A. 90 cm (3 ft)

NOTICE Starting the engine or riding the boat in shallower water may damage the impeller or other jet pump components.

Boarding from Deep Water

⚠ WARNING

Inexperienced riders should practice how to get aboard close to shore first before venturing into deep water.

⚠ WARNING

Engine should not be running while boarding. Never use propulsion components as a supporting point to board the boat.

Swim to the rear of the boat.

Release the rubber stays on one-step ladder pulling ladder out and down into boarding position. Grip the grab handle and pull yourself up until your knee can reach the swim platform.



lmo2010-003-101

TYPICAL

When you can reach the engine cover grab handle, grip it and continue to pull yourself upward to place your knee on the swim platform.



lmo2010-003-102

TYPICAL

Continue to climb on engine cover to reach the deck.



lmo2010-003-103

TYPICAL

NOTE: The last boarded person must secure the ladder using the retaining latch prior to reach its seat.

NOTICE Do not leave ladder hanging when operating the boat. Before operating the boat, always fasten the ladder in place using the latch.

⚠ WARNING

Do not start engine until all passengers are properly seated.

Starting the Engine

NOTE: Before starting engine for the first time during the day, perform the complete pre-ride inspection as described in *PRE-RIDE INSPECTION*.

1. Open the engine compartment cover and ensure engine compartment is free of gasoline vapor odors.

⚠ WARNING

If any leaks or gasoline vapor odors are present, **DO NOT** start the engine and communicate with your authorized Sea-Doo boats dealer.

2. Close the engine compartment cover.
3. Turn on bilge blower for 5 minutes then turn bilge blower switch off.

⚠ WARNING

Always activate bilge blower 5 minutes minimum before starting the engine to allow the bilge blower to ventilate the bilge.

4. Attach the tether cord to your PFD or to a wrist strap.

⚠ WARNING

The tether cord must be attached to the operator all the time when engine is running.

5. Install the tether cord on the engine cut-off switch.

NOTE: The tether cord clip must be securely attached to the operator's PFD, clothing, arm, or leg. Be sure to attach the tether cord clip to a place where it is free of obstructions and to something that will move with the operator if he or she leaves the helm station.



lmo2010-003-009_a

TYPICAL

1. Tether cord
 2. Tether cord secured to PFD
 3. Tether cord secured to switch
6. Ensure all passengers are properly seated in accordance with the seating label. Refer to *SAFETY LABELS* section.

⚠ WARNING

Before starting the engine, the operator and passengers should always be properly seated. Do not allow swimmers and passengers to stay close to the propulsion system.

NOTICE Ensure there is at least 90 cm (3ft) of water under the lowest rear portion of the hull when all passengers are aboard prior to starting the engine. Otherwise damage to the propulsion system may occur. Do not accelerate abruptly.

7. Ensure shift lever is in neutral position and throttle lever in idle position.
8. Press and hold the start/stop button to crank the engine. Release immediately after engine is started.

NOTICE To avoid starter motor overheating, the cranking period should not exceed 5 - 10 seconds and a rest period of 30 seconds should be observed between cranking cycles to let the starter cool down and its mechanism disengage.

9. Check tachometer to monitor engine.

Steering Operation

Turning the steering pivots the jet pump nozzle which controls the boat direction. Turning the steering wheel clockwise will turn the boat to the right and inversely.



TYPICAL — RIGHT-HAND TURN

Above idle speed, throttle must be applied to turn the boat.

⚠ WARNING

Throttle must be applied and steering turned to change the direction of the boat at speed. Steering efficiency will differ depending on the number of passengers, load and water conditions.

A jet propelled boat needs some throttle applied in order to turn. Practice in a safe area applying the throttle and turning away from an imaginary object. This is a good collision avoidance practice.

Throttle/Shifter Control Operation

When selecting the neutral or reverse position with the shift lever, the reverse gate moves up or down to the desired position.

Forward

To obtain forward:

1. Press on release button.
2. Push shift lever in the forward position.

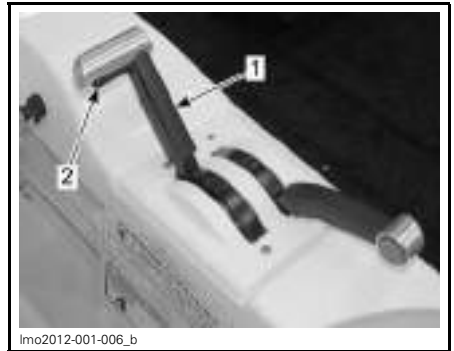

TYPICAL

1. Shift lever in forward position
2. Release button
3. Push the throttle lever forward in order for the boat to advance.

NOTICE Do not force throttle when shifter is in neutral. No warm up feature is offered or needed. Forcing the throttle forward beyond the stop in when shifter is in neutral may result in damage to the shifter/throttle assembly.

Neutral

To obtain neutral, pull shift lever to the upright position. Reverse gate will be in the middle position, directing half of the thrust toward the front of the boat to minimize movement.

⚠ WARNING

When the shift is in neutral position, the impeller is turning.



lmo2012-001-007_b

TYPICAL

1. Shift lever in neutral position
2. Release button

Reverse

To obtain reverse, press on release button and pull shift lever completely to the rear. Reverse gate will be in downward position, directing all the thrust toward the front of the boat.

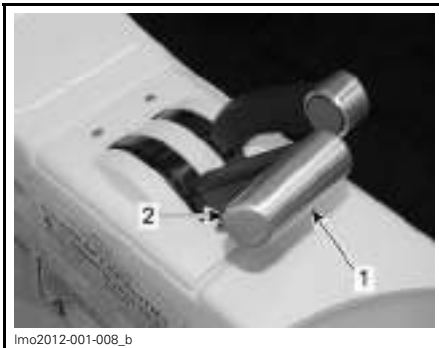

lmo2012-001-008_b

TYPICAL

1. Shift lever in reverse position
2. Release button

NOTE: To obtain maximum efficiency and control from the reverse, increase engine speed to slightly above idle. Too much RPM will create water turbulence and reduce reverse efficiency.

The boat behaves differently when using reverse. At first outing, carefully practice this maneuver away from anything with which you might collide.

⚠ WARNING

Become fully familiar with the reverse operation during your first ride and before carrying passengers.

Leaving the Shore

With throttle lever at idle position, move shift lever to the desired direction.

Slowly accelerate to reach deeper water. Do not apply full throttle until engine is warm.

⚠ WARNING

In shallow water, shells, sand, pebbles or other objects could be drawn up by the jet pump and thrown rearward.

Shutting Off the Engine

To shut off the engine, completely pull back throttle lever then remove the tether cord or press the engine start/stop button.

Always remove the tether cord from the engine cut-off switch.

⚠ WARNING

Should the engine be shut off, boat directional control is not available. Never leave the tether cord connected on the engine cut-off switch when boat is not in operation to avoid unauthorized use by children, theft or others.

General Operating Recommendations

Rough Water or Poor Visibility Operation

Avoid operation in these conditions. If you must do so, proceed with caution and prudence using minimum speed. Turn on navigation lights if necessary.

Night Operation

Between sunset and sunrise, use the navigation lights and reduce speed.

⚠ WARNING

Navigation lights should always be used between sunset and sunrise. Ensure the stern light is installed. See *STERN LIGHT SOCKET* in this section for location and installation.

Crossing Waves

Reduce speed when crossing waves. Always be prepared to steer and balance as necessary.

When crossing wakes, always keep a safe distance from boat ahead.

⚠ WARNING

When crossing wakes, slow down. Operator and passenger(s) can brace themselves by posting. Do not jump waves or wakes.

Stopping/Docking

The boat is slowed by water drag. The stopping distance will vary depending on weight, speed, water surface condition, presence and direction of wind and current.

The operator should become familiar with the stopping distance under different conditions.

Reduce speed to idle. Shift to neutral, reverse or forward as required when approaching a dock then shut off the engine just before coming alongside.

⚠ WARNING

Directional control is reduced when throttle is decreased and lost when engine is off.

Press the start/stop button to stop the engine.

⚠ WARNING

While engine can be stopped by pressing the start/stop button, we strongly recommend the engine be stopped by removing the tether cord. This will install good habits.

Beaching

NOTICE It is not recommended to run the boat onto the beach.

Come slowly to the beach and shut off the engine using the tether cord when water depth is 90 cm (3 ft) under the hull, then pull the boat to the beach. Ensure that all accessories are OFF.



A. 90 cm (3 ft) of water under the hull

⚠ WARNING

In shallow water, shells, sand, pebbles or other objects could be drawn up by the jet pump and thrown rearward.

OPERATING MODES

NOTE: These operating modes do not resume if engine was stopped

Cruise Mode

⚠ WARNING

It is not recommended to use the CRUISE mode when pulling a tube, skier or wakeboarder. Maintain your speed manually or use the SKI MODE.

CRUISE mode is a function of iTC (intelligent Throttle Control) system that allows to maintain a steady speed while riding the boat. It will prevent the boat from going above a set speed limit.

This is useful when cruising for long distances or operating in limited speed zones.

NOTE: The boat speed may vary slightly depending on the weather or water conditions such as the wind or waves.

The CRUISE mode is designed to be used for prolonged drives on open waters.

⚠ WARNING

Improper use of the CRUISE mode can lead the boat to a loss of control.

Cruise Mode Limitations

The CRUISE mode is not an automatic pilot, it will not drive the boat.

The CRUISE mode does not anticipate for obstacles, other users, objects, etc, and will not steer or stop the boat.

Setting the Cruise Mode

NOTE: To use the CRUISE mode, the boat speed must be above approximately 10 km/h (6 MPH).

To activate the CRUISE mode:

1. Using the throttle/shifter lever, bring the boat at the speed you want to maintain.
2. Press MODE button repeatedly until CRUISE mode is displayed.

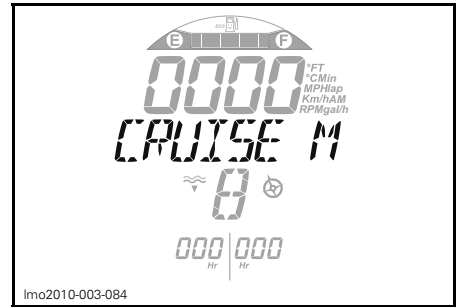

CRUISE MODE

3. Press the SET button once, the following message will be displayed "HOLD SET TO ACTIVATE OR MODE TO EXIT".
4. Hold the SET button until CRUISE mode reappears. At this time, the CRUISE light blinks and you hear one short beep.
5. Slightly move throttle lever forward until CRUISE light turns ON and activate the CRUISE mode.

Deactivating Temporarily the Cruise Mode

All Model

To deactivate the CRUISE mode temporarily, move the throttle/shifter lever backward.

To reactivate the CRUISE mode, push throttle/shifter lever in forward until the light turns ON again.

Cancelling the Cruise Mode

To cancel the CRUISE mode, move the throttle/shifter lever in NEUTRAL position and press the MODE button twice. Two short beeps will be heard.

Ski Mode

180 SP Model

Ski Mode allows the driver to adjust launch intensity and set target speed for different rider skill levels and tow sports while maintaining a constant speed.

The Ski Mode offers five acceleration curves with the slowest at RAMP 1 increasing to setting RAMP 5.

For each RAMP, a predetermined speed range is available.

RAMP	APPROX. SPEED
1	10 km/h to 35 km/h (6 MPH to 22 MPH)
2	15 km/h to 45 km/h (9 MPH to 28 MPH)
3	20 km/h to 55 km/h (12 MPH to 34 MPH)
4	30 km/h to 65 km/h (19 MPH to 40 MPH)
5	40 km/h to 67 km/h (25 MPH to 42 MPH)

Ski Mode Limitations

The Ski Mode is not an automatic pilot, it will not drive the boat.

Always leave your hand on the throttle and keep an eye on the water ahead. Pull back throttle to neutral to stop the boat (the Ski Mode immediately disengage setting boat control on manual).

Setting the Ski Mode

To activate the SKI MODE:

1. Press MODE button until SKI MODE is displayed.



Imo2010-003-085

SKI MODE

2. Press the SET button once to enter SKI MODE. The following indications will be displayed.

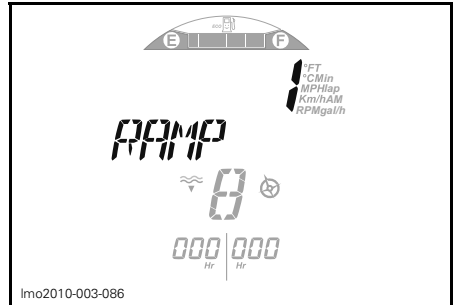

Imo2010-003-086

RAMP

3. Using the UP and DOWN switch, select the appropriate RAMP.
4. Press SET button to accept the selection.
5. Now determine the target speed using UP and DOWN switch.



Imo2010-003-087

TARGET SPEED

- Press SET button to confirm the speed. The indication SKI MODE will be displayed with the determined speed.



SKI MODE

- Press the SET button again to activate the launch sequence. At this time, the SKI MODE light blinks.

NOTE: In the launch sequence mode, the first 95% of throttle/shifter lever travel is used to position the boat and stretch the cord without engaging the SKI MODE.

- When everybody is ready (operator, watcher and skier or wakeboarder), push the throttle/shifter lever in full throttle position. The SKI MODE will be activated and the light turns ON.

Deactivating Temporarily the Ski Mode

To deactivate the SKI MODE temporarily, move the throttle/shifter lever in NEUTRAL position and press the MODE button to return to step 7 of SETTING THE SKI MODE. All of the throttle/shifter lever travel can be used without restriction.

The SKI MODE light will blink again and a beep will be heard every 3 seconds.

To reactivate the SKI MODE, place the throttle/shifter lever in NEUTRAL position and press the SET button to return to step 8 of SETTING THE SKI MODE.

Cancelling the Ski Mode

To cancel the SKI MODE, move the throttle/shifter lever in NEUTRAL position and press the MODE button twice.

ECO Mode

The ECO mode optimizes fuel efficiency by limiting engine torque

To engage the fuel economy mode:

- Press MODE button repeatedly until ECO MODE is displayed.

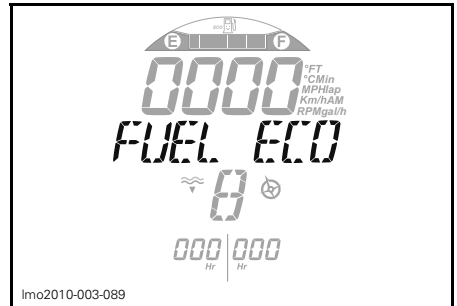

ECO MODE

- Press the SET button once, the following message will be displayed ECO MODE - PRESS SET to activate or MODE to exit.
- Press and hold the SET button until ECO MODE reappears.

To confirm the ECO mode, the symbol ECO is displayed on the LH of the smiling fuel tank.

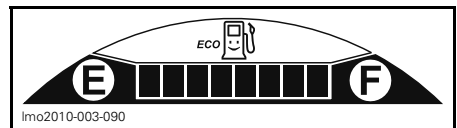

To cancel the fuel economy mode:

- Move throttle/shifter lever in NEUTRAL position.
- Press the MODE button.

Docking Mode

The docking mode limits engine power for increased maneuverability while docking

To select this mode:

1. Reduce throttle speed to idle.
2. Press the MODE button repeatedly until DOCKING is displayed in the information center.

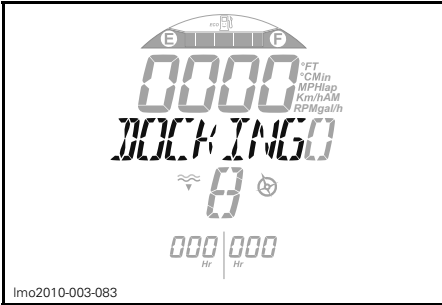

DOCKING

3. Press the SET button once, the following message will be displayed PRESS AND HOLD SET BUTTON.
4. Press and hold the SET button until DOCKING reappears.
5. The docking mode is now activated and the information center returns to main display.

To cancel this mode:

1. Press the MODE button repeatedly until DOCKING is displayed in the information center.
2. Press the SET button once, the following message will be displayed PRESS AND HOLD SET BUTTON.
3. Press the MODE button once. The DOCKING mode will turn OFF right after the throttle/shifter lever will be in NEUTRAL position.

NOTE: This mode is cancelled automatically when engines are turned off.

SPECIAL PROCEDURES

Jet Pump Water Intake and Impeller Cleaning

Water is drawn up by the impeller through this opening. The grate minimizes entry of foreign objects into the propulsion system.

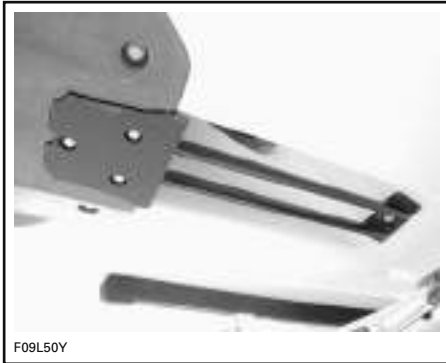

TYPICAL

⚠ WARNING

Keep away from intake grate while engine is on. Items such as long hair, loose clothing or personal flotation device straps can become entangled in moving parts resulting in severe injury or drowning.

Weeds, shells or debris can get caught on the intake grate, drive shaft and/or impeller. A clogged water intake may cause troubles such as:

1. **Cavitation:** Engine speed is high but boat moves slowly due to reduced jet thrust; jet pump components may be damaged.
2. **Overheating:** Since the jet pump operation controls the flow of water to cool the exhaust system, a clogged intake will cause the engine to overheat and damage internal engine components.

The clogged area can be cleaned as follows:

In-water cleaning: Pull the tether cord from engine cut-off switch to stop engine. Let the boat stop by itself. Wait a while to allow weeds or other debris to escape from grate. It may be necessary to repeat the procedure.

In severe conditions if the above method does not work, the following can be performed:

1. With engine running, put shift lever in reverse position and vary throttle setting quickly several times.
2. Try accelerating again.

Most of the time, debris will escape from the propulsion system.

Out of water cleaning: If the system is still clogged, shut off the engine by removing the tether cord.

⚠ WARNING

Always remove the tether cord from the engine cut-off switch to prevent accidental engine starting before cleaning the jet pump area.

From underneath boat, manually clean water intake area. If the system is still clogged, refer to an authorized Sea-Doo boats dealer for servicing.

NOTICE Avoid operation in weeded areas. If unavoidable, vary speed. Weeds tend to entangle more at steady and slow speeds. Inspect water intake grate for damage. Refer to an authorized Sea-Doo boats dealer for repair as necessary.

Towing the Boat in Water

Special precautions should be taken when towing a Sea-Doo boat in water.

Maximum recommended towing speed is 24 km/h (15 MPH).

When towing your boat in water, pinch the exhaust manifold water outlet hose on each engine with a LARGE HOSE PINCHER (P/N 529 032 500).

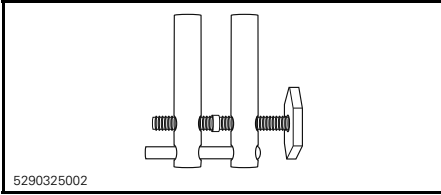

This will prevent the exhaust system from filling which may lead to water being injected into the engine. Without the engine running there isn't any exhaust pressure to carry the water out the exhaust outlet.

NOTICE Failure to do this may result in damage to the engine. If your Sea-Doo boats must be towed in water and you do not have a hose pincher, be sure to stay well below the maximum towing speed of 24 km/h (15 MPH).

Install the hose pincher on the exhaust manifold water outlet hose as shown.



TYPICAL

1. Install hose pincher here

NOTICE When finished towing the boats, hose pincher must be removed before operating it. Failure to do so will result engine damage.

Capsized Boat

This boat is designed so that it should not turn over easily due to its long and wide dimensions. If the boat ever capsizes, remember that it will continue to

float. It is usually best to remain with it, so you will be more easily located by others.

⚠ WARNING

When boat is capsized, do not attempt to restart the engine. Operator and passengers should always wear approved personal flotation devices.

Submerged Boat and Water-Flooded Engine

To limit damages to the engine, perform the following procedure as soon as possible.

Drain bilge.

If it was submerged in salt water, spray bilge and all components with fresh water using a garden hose to stop the salt corrosive effect.

NOTICE Never try to crank or start the engine. Water trapped in intake manifold would flow towards the engine and may cause severe damage to the engine.

Bring the boat to be serviced by an authorized Sea-Doo boats dealer as soon as possible.

NOTICE The longer the delay before you have the engine serviced, the greater the damage will be to the engine. Failure to have the engine properly serviced **will** cause severe engine damage.

MAINTENANCE

BREAK-IN INSPECTION

We suggest that after the first 10 hours of operation, the boat be checked by an authorized Sea-Doo boats dealer. The break-in inspection is very important and must not be neglected.

NOTE: The break-in inspection is at the expense of the boat owner.

We recommend that this inspection be signed by an authorized Sea-Doo boats dealer.

Date of inspection

Authorized dealer signature

Dealer name

BREAK-IN INSPECTION CHART	REPLACE				
	ADJUST				
	LUBRICATE				
	CLEAN				
	INSPECT				
ENGINE					
Engine oil and filter					X
Rubber mounts	X				
Corrosion protection			X		
Supercharger clutch	X				
EXHAUST SYSTEM					
Exhaust system fasteners, hoses and components condition. Also inspect for leaks	X				
COOLING SYSTEM					
Hose and fasteners	X				
Coolant	X				

BREAK-IN INSPECTION CHART	REPLACE				
	ADJUST				
	LUBRICATE				
	CLEAN				
	INSPECT				
FUEL SYSTEM					
Fuel lines, connections and pressure relief valve	X				
Fuel system leak test	X				
Throttle body	X				
Throttle cable	X				
Fuel tank straps	X				
ELECTRICAL SYSTEM					
Spark plugs	X				
Electrical connections and fastening (ignition system, starting system, fuel injectors, fuse boxes etc.)	X				
Engine cut-off switch	X				
Main battery cut-off switch	X				
Battery support	X				
STEERING SYSTEM					
Steering cable and connections	X				
Steering nozzle bushings	X				
PROPULSION SYSTEM					
Shift lever , cable and connections	X				
Carbon ring and rubber boot (drive shaft)	X				
Impeller boot	X				
Impeller and impeller wear ring clearance	X				
HULL and BODY					
Storage compartment cover(s), locks, latch(es) and hinge(s)	X		X		
Windscreen and fasteners	X				
Drain plug (inside bilge). Check for obstruction	X				
Bilge pump. Check for debris around bilge pump area.	X	X			
Ski/wakeboard attachment (tower, ski pole or tow hook) and fasteners	X				

MAINTENANCE SCHEDULE

Maintenance is very important for keeping your boat in safe operating condition. Proper maintenance is the owner's responsibility. The boat should be serviced as per the maintenance schedule.

The maintenance schedule does not exempt the pre-ride inspection.

WARNING

Failure to properly maintain the boat according to the maintenance schedule can make it unsafe to operate.

We encourage you to have an Annual Safety Inspection of your boat.

PART/TASK	EVERY 25 HOURS						TO BE PERFORMED BY
	EVERY 50 HOURS						
PART/TASK	EVERY 100 HOURS OR Preseason						LEGEND
	EVERY 200 HOURS OR 2 YEARS						
ENGINE							
Engine oil and filter			R (1)			D	(1) At storage period or after 100 hours of use whichever comes first. (2) Inspect slipping moment. (3) Every 10 hours in salt water use.
Rubber mounts		I				D	
Supercharger clutch				I (2)		D	
Corrosion protection			L (3)			O	
AIR INTAKE SYSTEM							
Air filter			I (6)			D	(6) Replace if required.
EXHAUST SYSTEM							
Exhaust system fasteners, hoses and components condition	I			I (4)		D	(1) At storage period or after 100 hours of use whichever comes first. (4) Also inspect for leaks.
Exhaust system flushing			(1) (5)			O	(5) Daily flushing in salt water or foul water use.
COOLING SYSTEM							
Hose and fasteners				I		D	—
Coolant					R	D	

A: ADJUST C: CLEAN I: INSPECT L: LUBRICATE R: REPLACE D: DEALER O: OPERATOR	EVERY 25 HOURS										
	EVERY 50 HOURS										
	EVERY 100 HOURS OR Preseason										
	EVERY 200 HOURS OR 2 YEARS										
	TO BE PERFORMED BY										
PART/TASK	LEGEND										
FUEL SYSTEM											
Throttle body				I (3)						D	(3) Every 10 hours in salt water use.
Fuel lines, connections, pressure relief valve and fuel system leak test				I						D	
Fuel tank straps				I						D	
ELECTRICAL SYSTEM											
Spark plugs				I	R					D	(3) Every 10 hours in salt water use.
Ignition coils				I, L (3)						D	
Electrical connections (ignition system, starting system, fuel injectors etc.)				I						D	
ECM connectors (visual inspection without disconnecting)				I (3)						O	
Engine cut-off switch				I						D	
Main battery cut-off switch				I						D	
Battery support				I						D	
Battery				I						D	
Battery posts				L						D	
Stern light connectors				L						O	
STEERING SYSTEM											
Steering cable and connections				I						D	—
Steering nozzle bushings				I						D	

MAINTENANCE SCHEDULE

A: ADJUST C: CLEAN I: INSPECT L: LUBRICATE R: REPLACE D: DEALER O: OPERATOR	EVERY 25 HOURS					PART/TASK	LEGEND
	EVERY 50 HOURS						
	EVERY 100 HOURS OR Preseason						
	EVERY 200 HOURS OR 2 YEARS						
	TO BE PERFORMED BY						
PROPULSION SYSTEM							
			L (3) (7)			Drive shaft	(3) Every 10 hours in salt water use. (7) Lubricate for corrosion protection (8) Inspect each month (every two weeks in salt water) and change when necessary.
		I				Carbon ring and rubber boot (drive shaft)	
			I			Shifter system, cable and connections	
		L (3)				Reverse gate	
			I, L			Drive shaft/impeller splines	
			I			Impeller boot	
			I (3)			Impeller shaft seal, sleeve and O-ring	
			I			Impeller and wear ring clearance	
			(8)			Sacrificial anode	
HULL/BODY							
			I, L (3)			Storage compartment(s) cover lock(s), latch(es) and hinge(s)	(3) Every 10 hours in salt water use. (9) Check for obstructions.
			I			Ride shoe condition	
			I			Deck drains/scupper valve	
			I (9)			Drain plug (inside bilge)	
			I, L (3)			Ski/wakeboard attachment (tower, ski pole or tow hook) and fasteners	

MAINTENANCE PROCEDURES

This section includes instructions for basic maintenance procedures. If you have the necessary mechanical skills and the required tools, you can perform these procedures. If not, see your authorized Sea-Doo boats dealer.

Other important items in the maintenance schedule that are more difficult and require special tools are best performed by your authorized Sea-Doo boats dealer.

⚠ WARNING

Engine must be off and tether cord removed from engine cut-off switch, unless specified otherwise.

⚠ WARNING

Should removal of a locking device be required (e.g. lock tabs, self-locking fasteners, etc.), always replace it with a new one.

⚠ CAUTION Some components in the engine compartment may be very hot.

Engine Oil

Recommended Engine Oil

Use XPS 4-STROKE SYNTH. BLEND OIL (SUMMER) (P/N 293 600 121).

NOTE: This engine has been developed and validated using the XPS™ Synthetic blend oil. BRP strongly recommends the use of its XPS Synthetic blend oil at all times.

If XPS™ engine oil is not available, use a 10W40 mineral engine oil compatible with wet clutches.

NOTICE NEVER use synthetic oil. This would impair the proper operation of the supercharger clutch. Do not add any additives to the recommended oil. Mineral oils (API service SM or SL) may also contain additives (friction modifiers) that may cause inappropriate slippage of the supercharger clutch and eventually lead to premature wear. Damages caused by oil which is not suitable for the engine will not be covered by the BRP limited warranty.

Engine Oil Level

NOTICE Check level frequently and refill if necessary. Operating the engine with an improper oil level may severely damage engine.

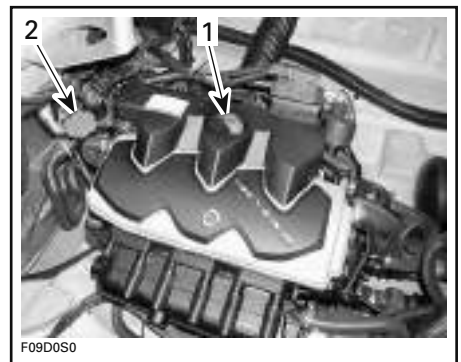

TYPICAL
1. Dipstick
2. Oil cap

Boat must be leveled.

Oil level can be checked either with boat in water or out of water.

If Boat is Out of the Water

If the boat is out of the water and on a trailer, block the wheels and raise the bow slightly with the trailer jack (if so equipped) until the bumper rail is level.

Install a garden hose to the flushing connector. Refer to *EXHAUST SYSTEM FLUSHING* in *MAINTENANCE PROCEDURES* and follow the procedure.

NOTICE Never run engine without supplying water to the exhaust system when boat is out of water. Failure to supply water to the exhaust system may severely damage exhaust system.

NOTICE Never run engine longer than 2 minutes. Drive line seal has no cooling when boat is out of water.

**Procedure Continuation
(Boat Out or In Water)**

It is of the utmost importance to follow this procedure in order to obtain an accurate reading of the engine oil level.

CAUTION Engine oil may be hot. Certain components in the engine compartment may be very hot. Direct contact may result in skin burn.

1. Ensure engine is at normal operating temperature.
2. Let engine idle for 30 seconds before stopping.
3. Stop engine.
4. Wait at least 30 seconds.
5. Pull dipstick out and wipe clean.

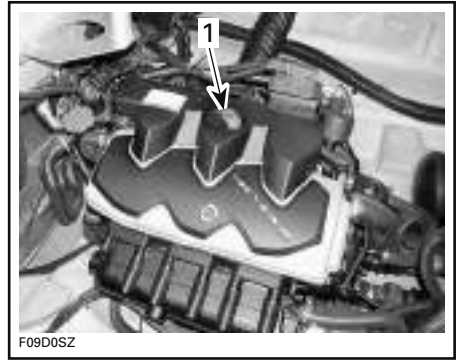

TYPICAL
1. Dipstick

6. Reinstall dipstick, push in completely.
7. Remove dipstick and read oil level. It should be between marks.

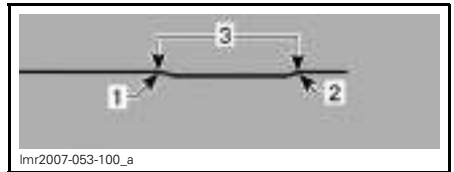

1. Full
2. Add
3. Operating range

8. If needed, add oil up to have the level between marks as required.
 - 8.1 Unscrew oil cap.
 - 8.2 Place a funnel into the opening and add the recommended oil to the proper level.

NOTE: Do not overfill.



TYPICAL
1. Oil cap

NOTE: Every time oil is added in engine, the complete procedure explained above must be done. Otherwise, you will have a false oil level reading.

9. Properly reinstall oil cap and dipstick.
10. Wipe off any oil spillage.

Engine Oil Change and Oil Filter Replacement

The oil change and filter replacement should be performed by an authorized Sea-Doo boats dealer.

Engine Coolant

Recommended Engine Coolant

Always use ethylene-glycol antifreeze containing corrosion inhibitors specifically for internal combustion aluminum engines.

NOTE: When available, it is recommended to use biodegradable antifreeze compatible with internal combustion aluminum engines. This will contribute to protect the environment.

Cooling system must be filled with BRP PREMIXED COOLANT (P/N 219 700 362) or with a water and antifreeze solution (50% distilled water, 50% antifreeze).

To prevent antifreeze deterioration, always use the same brand. Never mix different brands unless cooling system is completely flushed and refilled. Refer to an authorized Sea-Doo boats dealer.

Engine Coolant Level

With boat on a level surface, coolant should be between MIN. and MAX. level marks of coolant reservoir when engine is cold.



1. Level between marks when engine is cold

⚠ WARNING

Check coolant level with cold engine. Never add coolant in cooling system when engine is hot.

NOTE: The boat is considered level when it is in water. When on a trailer, block the wheels and raise the bow slightly with the trailer jack (if so equipped) until the bumper rail is level.

Add coolant to have the level between marks as required. Use a funnel to avoid spillage. **Do not overfill.**

Properly reinstall and tighten filler cap.

NOTE: A cooling system that frequently requires coolant is the indication of leaks or engine problems. See an authorized Sea-Doo boats dealer.

Engine Coolant Replacement

The coolant replacement should be performed by an authorized Sea-Doo boats dealer.

Ignition Coils

Ignition Coil Removal

1. Disconnect ignition coil connector.

NOTICE Do not remove the ignition coil before disconnecting the input connector or the wires may be damaged. Do not pry up ignition coil with a screwdriver to avoid damage.

NOTE: Twist ignition coil in both directions as you pull it up to ease removal.

Remove ignition coil from spark plug.

Ignition Coil Lubrication

1. Pull rubber seal down.



1. Rubber seal pulled down
2. Apply DOW CORNING 111 (P/N 413 707 000) to rubber seal seat as shown.



1. Apply product here
3. Pull rubber seal back on its seat making sure the tabs on the ignition coil and the slots in the seal properly match together.
4. Leave a ring of grease on top of the seal as shown to act as a water barrier. Wipe off the excess.



1. Correctly shaped excess of product
5. Apply DOW CORNING 111 (P/N 413 707 000) on rubber seal contact area.

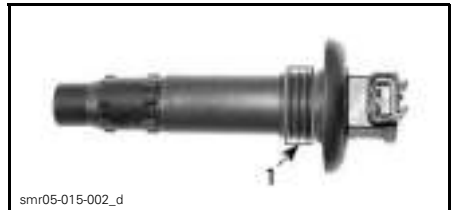

1. Apply product here

Ignition Coil Installation

NOTE: Prior to inserting the ignition coil on its spark plug, apply sealant as described in *IGNITION COIL LUBRICATION*.

1. Install coil in cylinder head hole.
2. Push the ignition coil down to securely install it on the spark plug tip.
3. Ensure the seal seats properly with top surface of engine valve cover.

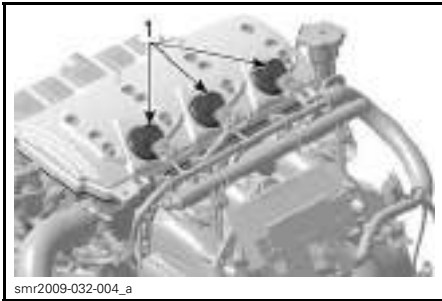

smr2009-032-004_a

TYPICAL

1. Seal properly seated

Exhaust System

Exhaust System Flushing

Flushing the exhaust system and intercooler with fresh water is essential to neutralize corroding effects of salt or other chemical products present in water. It will help to remove sand, salt, shells or other particles in water jackets and/or hoses.

⚠ WARNING

Perform this operation in a well ventilated area.

Proceed as follows:

1. Clean jet pump by spraying water in its inlet and outlet and then apply a coating of XPS LUBE (P/N 293 600 016) or equivalent.

⚠ WARNING

When operating the engine while the boat is out of the water, the heat exchanger in the ride plate may become very hot. Avoid any contact with ride plate as burns may occur.

2. Connect a garden hose to the connector located at the rear of boat on jet pump support. Do not open water tap at this time.



imo2007-001-006_a

TYPICAL

1. Flushing connector

NOTE: Use the optional FLUSHING CONNECTOR ADAPTER (P/N 295 500 473) with a quick connect adapter to ease garden hose installation.

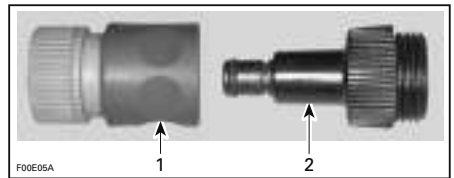

1. Quick connect adapter
2. Flushing connector adapter

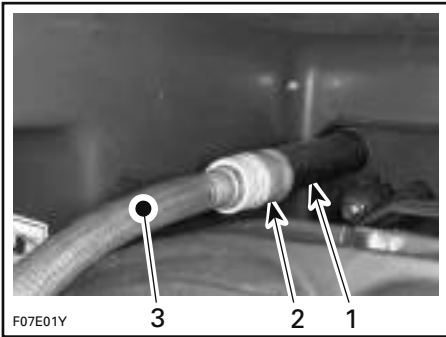

TYPICAL

1. Flushing connector
2. Quick connect adapter and flushing connector adapter (optional, not mandatory)
3. Garden hose

3. To flush, start engine then immediately open the water tap.

CAUTION Certain components in the engine compartment may be very hot. Direct contact may result in skin burn. Do not touch any electrical parts or jet pump area when engine is running.

NOTICE Never flush a hot engine. Always start the engine before opening the water tap. Open water tap immediately after engine is started to prevent overheating.

4. Run the engine about 20 seconds at a fast idle between 4000 - 5000 RPM.

NOTICE Never run engine without supplying water to the exhaust system when boat is out of water.

5. Ensure water flows out of jet pump while flushing. Otherwise, refer to an authorized Sea-Doo boats dealer for servicing.

NOTICE Never run engine longer than 2 minutes. Drive line seal has no cooling when boat is out of water.

6. Close the water tap, then stop the engine.

NOTICE Always close the water tap before stopping the engine.

NOTICE Remove quick connect adapter after flushing operation (if used).

Fuses

Fuse Inspection and Replacement

The electrical system is protected with fuses.

To remove fuse from box or holder, pull fuse out. Check if filament is melted.

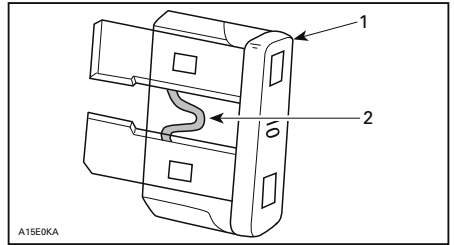

1. Fuse
2. Check if melted

If a fuse is defective, replace by one of the same rating.

NOTE: If the entire electrical system is down, make sure the main battery cut-off switch is properly turned on, refer to *MAIN BATTERY CUT-OFF SWITCH*. If the main battery cut-off switch is ON, check the main breaker. See *MAIN BREAKER* below.

NOTICE Do not use a higher rated fuse as this can cause severe damage. If a fuse has blown, the source of malfunction should be determined and corrected before restarting. See an authorized Sea-Doo boats dealer for servicing.

Fuse Boxes 1 and 2

The fuse box 1 and the fuse box 2 are located in the engine compartment on port side. To access the fuse boxes,

open the port bilge access cover, refer to *CONTROLS, INSTRUMENTS AND EQUIPMENT*.

Refer to the covers decals or the *SPECIFICATIONS* section of this guide for fuses identification.

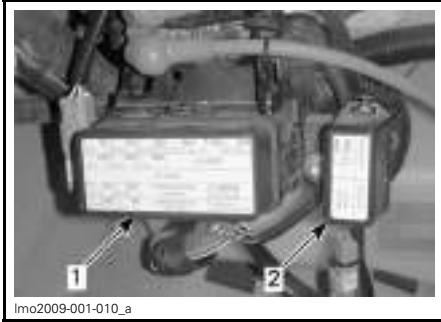

lmo2009-001-010_a

1. Fuse box 1
2. Fuse box 2

To remove a fuse box cover, unlock the tabs and pull cover off.

Circuit Breaker Panel

The circuit breaker panel is located underneath the driver console.

Refer to the inscriptions on the panel for circuit breaker identification.



lmo2012-005-017_a

CIRCUIT BREAKER PANEL LOCATION



lmo2009-006-005

CIRCUIT BREAKER PANEL

Main Breaker

The main breaker protects the entire electrical system except the automatic bilge pump.

The breaker can be manually opened (switched OFF) by depressing the test button.

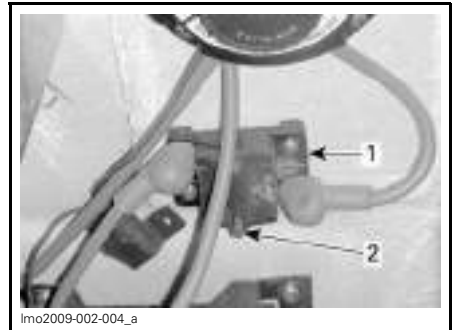

lmo2009-002-004_a

1. Main breaker
2. Test button

If the breaker opens, it cuts the power supply. In that position the reset lever goes out of the breaker housing.

To reset an open breaker, push the reset lever back in.



lmo2009-002-012_a

1. Reset lever in open (OFF) position

Automatic Bilge Pump Fuse

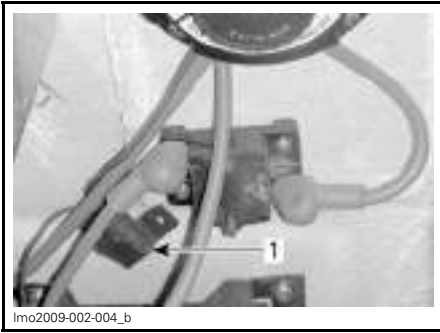

1. Automatic bilge pump fuse

Bilge Blower

Bilge Blower Operation Check

Verify bilge blower for proper operation. It is located beneath starboard ventilation duct in engine compartment.

Make sure that the ventilation ducts are not obstructed.

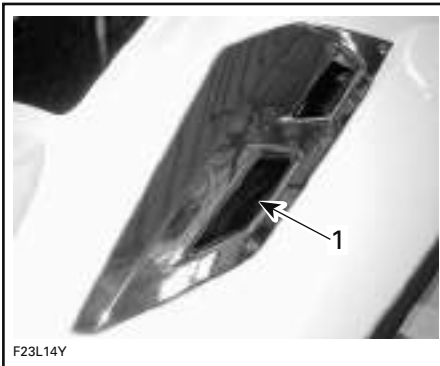

TYPICAL
1. Blower duct

⚠ WARNING

If bilge blower does not operate properly, refer to an authorized Sea-Doo boats dealer before starting the boat.

Navigation Lights

Bow Light Bulb Replacement

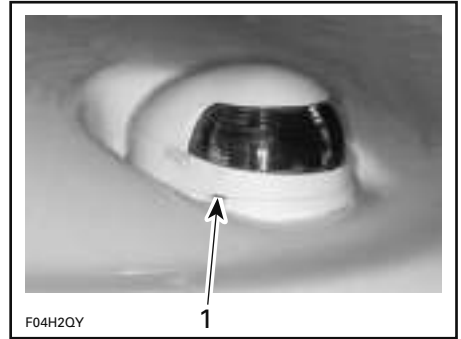

TYPICAL
1. Gently pry here with a screwdriver

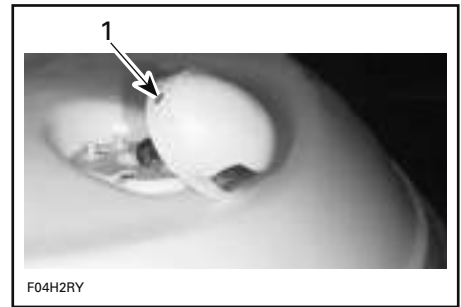

TYPICAL
1. Remove this screw



TYPICAL
1. Pull lens out

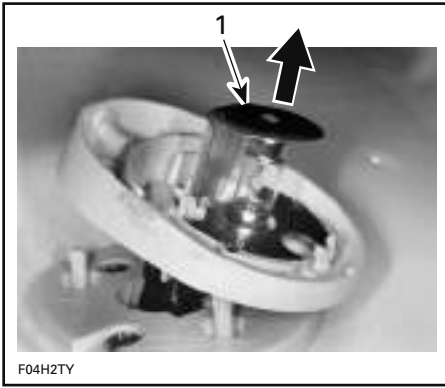

F04H2TY

TYPICAL

1. Lift and remove bulb

The assembly is essentially the reverse of removal procedures. However, pay particular attention to the following:

Apply DIELECTRIC GREASE (P/N 293 550 004) on bulb contact surface.

When installing the bulb under the upper terminal plate, it is possible that the bulb remains loose. The cover will compress the terminal plate against the bulb at reinstallation.

Stern Light Bulb Replacement

Unscrew lens counterclockwise and pull it out.

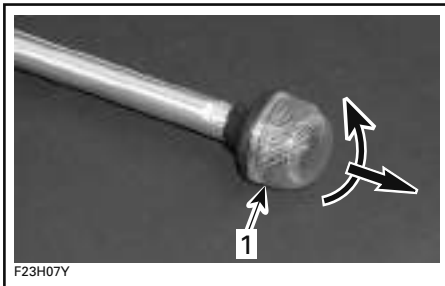

F23H07Y

TYPICAL

1. Unscrew then pull

Pull bulb to remove it.

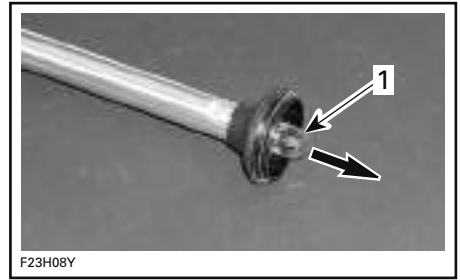

F23H08Y

TYPICAL

1. Pull bulb out

Apply DIELECTRIC GREASE (P/N 293 550 004) on new bulb contact surface.

Assembly is the reverse of removal procedure.

Stern Light Connector Lubrication

Apply DIELECTRIC GREASE (P/N 293 550 004) on stern light connectors as needed.

Deck Drain and Scupper Valve

Deck Drain Cleaning

Remove any obstruction(s) from deck drain outlet.

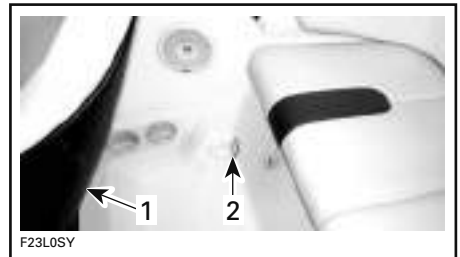

F23L05Y

TYPICAL

1. Driver's seat
2. Deck drain hole

Water drains out though the scupper valve located near the jet pump nozzle.

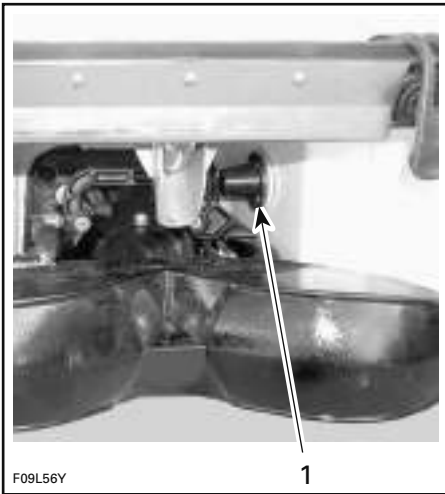

TYPICAL
1. Scupper valve

Keep it clean to avoid clogging.

Latches and Hinges

The application of XPS LUBE (P/N 293 600 016) lubricant will help to prevent corrosion and keep proper operation of moving mechanisms.

Latches and Hinges Lubrication

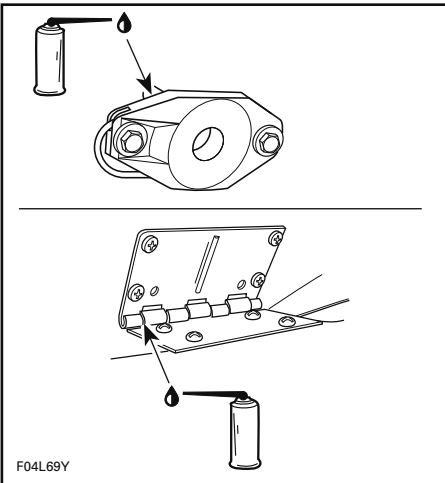

TYPICAL

Reverse Gate

Reverse Gate Lubrication

Lubricate pivot points and mechanism on both sides of reverse gate with XPS LUBE (P/N 293 600 016) lubricant or equivalent.

Sacrificial Anodes

Sacrificial Anodes Inspection

Corrosion of metal parts, especially those exposed to saltwater, is common for boats. Corrosion can be caused by stray electric currents from shore power installations, improperly grounded AC lines and circuits, and poorly insulated DC powered equipment from boats moored nearby. Corrosion is accelerated when electric current is present.

Sacrificial anodes are attached to certain parts of this boat to reduce corrosion. The anode corrodes, rather than the part to which the anode is attached.

Change each anode when 50% of its weight has corroded away.

Anodes are attached at the following locations:

- Ride shoe/cooling plate
- Pump housing
- Reverse gate support
- Steering nozzle
- Reverse gate.

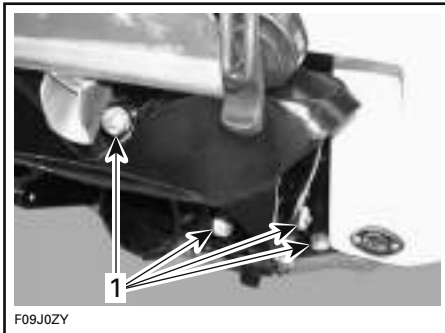
**TYPICAL**

1. Anode installation shown

NOTICE Inspect anodes each time boat is to be launched. Do **NOT** paint anodes or apply protective coatings.

BOAT CARE

Post-Operation Care

Remove the boat from the water every day to prevent growth of marine organisms.

NOTICE Failure to perform proper care such as: boat rinsing, exhaust system flushing and anticorrosion treatment, when used in salt water, will result in damage to the boat and its components.

WARNING

Allow engine to cool before performing any maintenance.

Exhaust System Flushing

The exhaust system should be flushed daily when boat is used in salt or foul water.

Refer to *MAINTENANCE PROCEDURES*.

Anticorrosion Treatment

To prevent corrosion, spray a corrosion inhibitor (salt water resistant) such as XPS LUBE (P/N 293 600 016) or equivalent over metallic components in engine compartment.

NOTE: Engine fogging should be done with XPS LUBE (P/N 293 600 016) whenever the boat is to be stored for few days or a long period.

Apply DIELECTRIC GREASE (P/N 293 550 004) (salt water resistant) on battery posts and cable connectors.

NOTICE Never leave rags or tools in the engine compartment or in the bilge.

Additional Care for Foul Water or Salt Water Use

When the boat is operated in foul water and particularly in salt water, additional care must be taken to protect the boat and its components.

Rinse trailer and boat's hull/bilge area with fresh water.

Never use a high pressure washer to clean the bilge. **USE LOW PRESSURE ONLY (such as a garden hose)**. High pressure can cause damages to electrical or mechanical systems.

In coastal areas, special care should also be taken on stainless steel or chrome parts like grab handles, mooring cleats, fuel cap and navigation lights. Refer to *BOAT CLEANING* for proper care.

Boat Cleaning

Engine compartment Cleaning

The engine compartment should be cleaned with warm water and BRP HEAVY DUTY CLEANER (P/N 293 110 001), as required.

Unscrew the drain plug, block the wheels and raise the bow slightly with the trailer jack (if so equipped) to allow water to drain. Rinse thoroughly. Leave all compartments open to air dry.

Corrosion Protection

Protect engine compartment metallic parts from corrosion using XPS LUBE (P/N 293 600 016) or an equivalent.

Body Cleaning

First rinse with fresh water to remove dried salt water.

Wash the body with soapy water (only use mild detergent). Remove any marine organisms.

NOTICE Never clean fiberglass and plastic parts with strong detergent, degreasing agent, paint thinner, acetone, etc.

Apply a marine wax to protect the finish.

Towing Tower Cleaning

To clean tower, use mineral spirits and a clean soft cloth.

Carpet Cleaning

To clean the carpets, use 3M™ Citrus Base Cleaner or an equivalent. See the manufacturer's instructions.

Windshield Cleaning

Wash with BRP HEAVY DUTY CLEANER (P/N 293 110 001).

Clean only with flannel clothes.

NOTICE It is necessary to use flannel cloths on windshield to avoid damaging surface.

To remove scratches on windshield: Start with "Slip Streamer® Scratch Remover". Finish with "Slip Streamer® Cleaner and Polish".

NOTE: The later product may be used alone if only light scratches are noticeable.

NOTICE Never clean windshield with strong detergent, degreasing agent, paint thinner, acetone, products containing chlorine, etc.

Stainless Steel and Chrome

To clean or polish stainless steel or chrome parts, always use a product specially developed for marine environment such as the Flitz Stainless Steel & Chrome Cleaner.

Vinyl Cleaning

Use XPS MULTI-PURPOSE CLEANER (P/N 219 701 709).

For dirt build up, let cleaner soak for approximately 10 minutes, then gently scrub with a soft bristle brush.

Refer to next table for other products that can also be used for cleaning vinyl.

Do not use any silicone-based protectants. They will extract the plasticizers, leaving the vinyl hard and brittle, and eventually cracking will occur.

CLEANING PRODUCTS
1. XPS MULTI-PURPOSE CLEANER (P/N 219 701 709)
2. Dish soap (Dawn or Ivory) and water
3. Fantastik
4. Spray Nine
5. 3M Citrus Cleaner
6. 303 Protectant

NOTE: Always follow manufacturer's recommendations and instructions.

Vinyl Cleaning Recommendations for Special Stains

TYPE OF STAIN	STEP		
	1	2	3
Ballpoint ink *	E	B	A
Chewing gum	D	A	—
Coffee, tea, chocolate	B	—	—
Pencil	D	B	—
Grease	D	B	—
Household soil	A	B	—
Ketchup	A	B	—
Latex paint	A	B	—
Lipstick	A	B	—
Mildew or wet leaves *	C	B	A
Motor oil	B	—	—
Oil-based paint	D	B	—
Permanent marker *	E	B	C
Spray paint	B	B	—
Suntan lotion	A	B	—
Tar/asphalt	D	B	—
Yellow mustard	A	B	C

RECOMMENDED ACTION	
A	Medium-soft brush, warm soapy water, rinse/dry.
B	XPS MULTI-PURPOSE CLEANER (P/N 219 701 709), rinse/dry.
C	One (1) tablespoon of ammonia, one-fourth (1/4) cup of hydrogen peroxide, three-fourth (3/4) cup of water, rinse/dry.
D	Wipe or scrape off excess (chill gum with ice before hand).
E	Denatured alcohol, rinse/dry.
*	Suntan lotion, tree pollen, wet leaves and some other products can contain dyes that stain permanently.

All cleaning methods must be followed by a thorough rinse with warm water.

Certain household cleaners, powdered abrasives, steel wool and industrial cleaners can cause damage and discoloration and are not recommended. Dry cleaning fluids and lacquer solvents should not be used as they will remove printed pattern and gloss. Waxes should be used with caution as many contain dyes or solvents that can permanently damage the protective coating.

Boat Protection

Protect boat with a cover when not in use.

NOTICE If boat is exposed to prolonged rain without a cover, battery will discharge and bilge pump will quit working. Boat may sink if in water.

STORAGE

It is recommended that the boat be taken to an authorized Sea-Doo boats dealer for proper storage, however you can perform the following operations with a minimum of tools.

NOTE: Leave drain plug(s) out during storage period.

NOTICE Do not run the engine during the storage period.

⚠ WARNING

Because fuel and oil are flammable, have an authorized Sea-Doo boats dealer to pressurize and inspect the fuel and oil systems integrity as specified in the *MAINTENANCE SCHEDULE*.

Jet Pump Cleaning

Clean jet pump by spraying water in its inlet and outlet and then apply a coating of XPS LUBE (P/N 293 600 016) or equivalent.

⚠ WARNING

Always remove tether cord cap from engine cut-off switch to prevent unexpected engine starting before cleaning the jet pump area. Engine must not be running for this operation.

Fuel System Protection

XPS FUEL STABILIZER (P/N 413 408 601) (or equivalent) can be added in fuel tank to prevent fuel deterioration and fuel system gumming. Follow stabilizer manufacturer's instructions for proper use.

NOTICE It is highly recommended to add fuel stabilizer at storage in order to maintain fuel system in good condition.

Engine Oil and Filter Replacement

The oil and oil filter change should be performed by an authorized Sea-Doo boats dealer.

Intercooler Draining

It is important to expel any trapped water that may have accumulated from condensation in the intercooler.

Proceed as follows:

1. Open the engine cover.
2. Ensure there is an alignment line drawn on the intercooler outlet hose. This will ensure the hose is not twisted or kinked on reinstallation.
3. Loosen the clamp retaining the intercooler outlet hose.
4. Remove the intercooler outlet hose from the intercooler.

NOTE: This hose feeds the inlet of the supercharger.



1. Intercooler outlet hose

5. Start and rev the engine up to 4000 RPM several times.

NOTE: Prevent air intake system from aspirating foreign objects which may cause severe engine or damage.

6. Stop engine.
7. Reinstall the intercooler air outlet hose, ensure it is properly aligned as prior to removal to ensure proper engine operation.

Exhaust System Flushing

Perform procedure as described in *MAINTENANCE PROCEDURES* section.

Exhaust System Protection

In areas where temperature may freeze, water trapped in the exhaust system and intercooler must be removed.

Using the flushing connector on jet pump support, inject pressurized air (around 689 kPa (100 PSI)) into system until there is no more water flowing from the jet pump.



smo2008-001-054_a

1. Flushing connector — location may differ

To ease the procedure, a custom hose can be assembled. See the following illustration.



smo2008-001-053_a

TYPICAL

1. Flushing connector adapter (P/N 295 500 473)
2. Hose 13 mm (1/2 in)
3. Air hose male adapter

NOTICE Failure to drain the exhaust system may cause severe damage to exhaust manifold and the intercooler (260 Engine).

Remove the tool.

Engine Internal Lubrication

Pull engine access panel upward to remove it.

Remove dipstick.

Remove engine cover.

Reinstall dipstick.

Expel water from the exhaust system and intercooler as follows:

Remove ignition coils. Refer to *MAINTENANCE PROCEDURES*.

Remove spark plugs.

NOTICE Ensure there is no dirt in coil holes before removing the spark plugs.

NOTE: After loosening the spark plugs, a coil may be used to pull the spark plugs out. Simply bring the coil down to spark plug and “hook” it to then extract spark plug.



smr2006-016-030_a

1. Ignition coil
2. Spark plug

Spray XPS LUBE (P/N 293 600 016) or equivalent, in spark plug holes.

To prevent fuel to be injected and also to cut the ignition at the engine cranking, proceed as follows.

From the engine compartment, have a second person hold throttle bell crank in fully opened position.

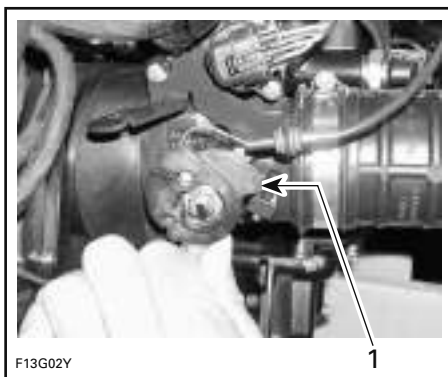
**TYPICAL**

1. Fully-opened position

Crank the engine a few turns to distribute the oil on cylinder wall.

Apply LOCTITE 767 (ANTISEIZE LUBRICANT) (P/N 293 800 070) on spark plug threads then reinstall them.

Lubricate and reinstall ignition coils. Refer to *MAINTENANCE PROCEDURES*.

To reinstall engine cover, remove dipstick, push engine cover downward until it snaps.

Reinstall dipstick.

Engine Coolant Test

If antifreeze is not replaced, test its density.

The antifreeze replacement and a density test should be performed by an authorized Sea-Doo boats dealer.

NOTE: Antifreeze should be replaced every 200 hours or every 2 years to prevent antifreeze deterioration.

NOTICE Improper antifreeze density may allow freezing of the liquid in the cooling system if the boat is stored in an area where the freezing point is attained. This would seriously damage the engine.

Battery Removal and Storage

For battery removal, cleaning and storage, contact your authorized Sea-Doo boats dealer.

Boat Cleaning/Repair

Clean boat. Refer to *BOAT CARE*.

If repairs are needed to the body or to the hull contact your authorized Sea-Doo boats dealer. For paint touch up to mechanical parts use BRP spray paint. For minor Gelcote repairs, a repair kit is available from Gelcote International (www.gelcote.com).

Replace damaged labels and decals.

Boat Protection

Using a flat screwdriver, lift tab as shown below.



TYPICAL — LIFT TAB

Detach cylinder end. Detach other side.

Block and leave engine cover lid open slightly.

This will avoid engine compartment condensation and possible corrosion.

Reattach cylinder ends to engine cover lid before operating boat.

If the boat is to be stored outside, cover it with a vented opaque tarpaulin to prevent UV (ultraviolet) rays and grime from affecting the plastic components, boat finish, as well as preventing dust accumulation.

NOTICE Never leave the boat stored in direct sunlight. UV radiation will dull finishes. The boat must never be left in water for storage.

For the storage period, it is necessary to make certain the drain plugs are unscrewed and unobstructed, then block the wheels and slightly raise the bow with the trailer jack (if so equipped) so drainage can take place.

PRESEASON PREPARATION

Maintenance preparation must be performed in conjunction with *MAINTENANCE SCHEDULE*.

Ensure to perform all tasks included in the **100 HOURS OR 1 YEAR** column.

Since technical skills and special tools are required, some operations should be performed by an authorized Sea-Doo boats dealer.

NOTE: It is highly recommended that an authorized Sea-Doo boats dealer perform factory campaigns in addition to the preseason preparation at the same time.

WARNING

Only perform procedures as detailed in the *MAINTENANCE SCHEDULE*. It is recommended that the assistance of an authorized Sea-Doo boats dealer be periodically obtained on other components and systems not covered in this guide.

NOTICE When component conditions seem less than satisfactory, replace using only genuine BRP parts, or approved equivalents.

***This page is
intentionally blank***

TECHNICAL INFORMATION

BOAT IDENTIFICATION

The main components of the boat (hull and engine) are identified by different serial numbers. It may sometimes become necessary to locate these numbers for warranty purposes or to trace the boat in the event of theft.

Hull Identification Number

The Hull Identification Number (HIN) is located on the right side of the transom.



TYPICAL

1. Hull Identification Number (HIN)

Engine Identification Number

The Engine Identification Number (EIN) is located on the upper crankcase on MAGNETO side.



1. Engine Identification Number (EIN)

ENGINE EMISSIONS INFORMATION

Maintenance, replacement, or repair of the emission control devices and systems may be performed by any marine SI (spark ignition) engine repair establishment or individual.

Manufacturer's Responsibility

Beginning with 1999 model year engines, manufacturers of marine engines must determine the exhaust emission levels for each engine horsepower family and certify these engines with the United States of America Environmental Protection Agency (EPA). An emissions control information label, showing emission levels and engine specifications, must be placed on each boat at the time of manufacture.

Dealer's Responsibility

When performing service on all 1999 and more recent Sea-Doo boats carrying an emissions control information label, adjustments must be kept within published factory specifications.

Replacement or repair of any emission related component must be executed in a manner that maintains emission levels within the prescribed certification standards.

Dealers are not to modify the engine in any manner that would alter the horsepower or allow emission levels to exceed their predetermined factory specifications.

Exceptions include manufacturer's prescribed changes, such as altitude adjustments for example.

Owner Responsibility

The owner/operator is required to have engine maintenance performed to maintain emission levels within prescribed certification standards.

The owner/operator is not to, and should not allow anyone to modify any engine in a manner that would alter the horsepower or allow emission levels to exceed predetermined factory specifications.

EPA Emission Regulations

All new 1999 and more recent Sea-Doo boats manufactured by BRP are certified to the EPA as conforming to the requirements of the regulations for the control of air pollution from new boat engines. This certification is contingent on certain adjustments being set to factory standards. For this reason, the factory procedure for servicing the product must be strictly followed and, whenever practicable, returned to the original intent of the design.

The responsibilities listed above are general and in no way a complete listing of the rules and regulations pertaining to the EPA requirements on exhaust emissions for marine products. For more detailed information on this subject, you may contact the following locations:

MAIL:

U.S. Environmental Protection Agency
Office of Transportation and Air Quality
1200 Pennsylvania Ave. NW
Mail Code 6403J
Washington D.C. 20460

INTERNET WEB SITE:

<http://www.epa.gov/otaq/>

SPECIFICATIONS

MODEL		180 CHALLENGER 215 ENGINE	180 CHALLENGER 260 ENGINE
ENGINE			
Engine type		Rotax 1503 4-TEC, 4-stroke, Single Over Head Camshaft (SOHC)	
Exhaust system		Water cooled/water injected (opened loop). Direct flow from jet pump	
Lubrication	Type	Dry sump (2 oil pumps). Replaceable oil filter. Water-cooled oil cooler	
	Oil type	XPS summer grade oil Refer to <i>MAINTENANCE PROCEDURES</i> section for more information	
Number of cylinders		3	
Displacement		1 493.8 cm ³ (91 in ³)	
Induction type		Supercharger intercooled	supercharged with external intercooled
Maximum HP RPM		8000 ± 50 RPM	
COOLING			
Type		Liquid cooled. Closed-loop system (see also <i>EXHAUST SYSTEM</i>)	
Coolant		Ethylene-glycol and distilled water (50%/50%). Use premix coolant from BRP or a coolant specially formulated for aluminum engines	
ELECTRICAL			
Magneto generator output		360 W @ 6000 RPM	
Ignition system type		DI (Digital Inductive)	
Spark plugs	Make and type	NGK DCPR8E	
	Gap	0.7 mm - 0.8 mm (.028 in - .031 in)	
Starting system		Electric starter	
Engine RPM limiter setting		8000 RPM	
Battery		(1) Not supplied. 12 V group 24, marine starting battery with top-mounted, round taper type battery post	

MODEL		180 CHALLENGER 215 ENGINE	180 CHALLENGER 260 ENGINE
ELECTRICAL (cont'd)			
Fuse box 1	F1: Gauge		3 A
	F2: Beeper		3 A
	F3: Depth sounder		3 A
	F4: Fuel level		3 A
	F5: Unused		-
	F6: Fuel pump		10 A
	F7: Cylinder 1		10 A
	F8: Cylinder 2		10 A
	F9: Cylinder 3		10 A
	F11: Diagnostic tool		15 A
	F13: Starter relay		10 A
	F14: CAPS		3 A
Fuse box 2	F15: Charge		30 A
	F 13: Battery		30 A
Front fuse box	F1: Blower		5 A
	F2: bilge pump		3 A
	F3: Navigation/ anchor light		3 A
	F4: Courtesy lights		3 A
	F5: Stereo		10 A
	F6: 12-Volt power outlet		10 A
	F7: Horn		7.5 A
Automatic Bilge Pump			3 A
Main circuit breaker			35 A

SPECIFICATIONS

MODEL		180 CHALLENGER 215 ENGINE	180 CHALLENGER 260 ENGINE
FUEL SYSTEM			
Fuel injection type		Multipoint Fuel Injection with iTC (intelligent throttle control). Single throttle body (52 mm) with actuator	
Fuel	OCTANE RATING (OPTIMUM PERFORMANCE)		
	Type	Premium unleaded gasoline	
	Minimum octane rating	Inside North America: 91 (RON + MON)/2 Outside North America: 95 RON	
	MINIMUM OCTANE RATING		
	Type	Regular unleaded gasoline	
	Minimum octane rating	Inside North America: 87 (RON + MON)/2 Outside North America: 92 RON	
PROPULSION			
Jet pump type		Axial flow single stage	
Jet pump grease		Jet pump bearing grease (P/N 293 550 032) sold by BRP	
Transmission		Direct drive	
Pivoting angle of direction (nozzle)		20°	
Minimum required water level for jet pump		90 cm (3 ft) underneath the lowest rear portion of hull	
DIMENSIONS			
Overall length		5.36 m (17.6 ft)	
Beam		2.49 m (8.2 ft)	
Draft		30.5 cm (1 ft)	
Dead rise		20°	
DIMENSIONS (ON TRAILER)			
Length (with swing-away tongue folded)		5.36 m (17.6 ft)	
Width		2.49 m (8.2 ft)	
Height	No tower	1.98 m (6.5 ft)	
	Tower down	2.29 m (7.5 ft)	
	Tower up	2.8 m (9.2 ft)	

MODEL		180 CHALLENGER 215 ENGINE	180 CHALLENGER 260 ENGINE
WEIGHT AND LOADING CAPACITY			
Weight	No tower	868 kg (1,913 lb)	
	With tower	884 kg (1,948 lb)	
Seating capacity		8	
Load limit (passengers + luggage) (based on calm water operation)		8 passengers OR 627 kg (1,383 lb)	
Gross weight		1 290 kg (2,843 lb)	1 306 kg (2,878 lb)
CAPACITIES			
Engine oil		3 L (3.2 qt (U.S. liq.)) oil change w/filter	
Cooling system (coolant)		5.5 L (5.8 qt (U.S. liq.)) total	
Fuel tank (including reserve)		112.4 L (29.7 U.S. gal.)	
MATERIALS			
Hull		Composite FRP	
Fuel tank		Polyethylene	
Seat	Base	Polyethylene	
	Foam	Polyethylene	

⁽¹⁾ Recommended: Exide R-24-130, 12 V, 25 A•h (130 minutes reserve) or R-24-160 (160 minutes) or equivalent.

***This page is
intentionally blank***

TROUBLESHOOTING

TROUBLESHOOTING GUIDELINES

The following information is provided to help in diagnosing the probable source of simple troubles. You may be able to solve many of these problems rather quickly, but others may require the skills of a mechanical technician. In such a case, consult an authorized Sea-Doo boats dealer for servicing.

BATTERY IS REGULARLY DISCHARGED

1. **Check battery condition.**
 - *Have the battery charged or replaced by an authorized Sea-Doo boats dealer.*
2. **Loose battery cable connection.**
 - *Check/clean/tighten.*
3. **Check charging system fuse.**
 - *Replace fuse if necessary and have charging system checked by an authorized Sea-Doo boats dealer.*

WARNING

See your authorized Sea-Doo boats dealer to have the battery charged or replaced. Do not charge or boost the battery while installed in the engine compartment. Electrolyte is poisonous and capable of causing severe burns.

NO BEEPS ARE HEARD WHEN INSTALLING THE TETHER CORD ON ENGINE CUT-OFF SWITCH

1. **Main battery cut-off switch is turned OFF.**
 - *Verify and turn ON.*
2. **Battery discharged.**
 - *Have the battery charged or replaced by authorized Sea-Doo boats dealer.*

ENGINE DOES NOT TURN OVER AND THE MONITORING BEEPER SOUNDS

1. Refer to *MONITORING SYSTEM* below.

ENGINE WILL NOT START

1. **Tether cord removed.**
 - *Install tether cord over engine cut-off switch.*
2. **Burnt fuse.**
 - *Check fuse(s). See an authorized Sea-Doo boats dealer if problem is repetitive.*
3. **Discharged battery.**
 - *Have the battery charged or replaced by an authorized Sea-Doo boats dealer.*
4. **Battery connections, corroded or loose.**
 - *Contact an authorized Sea-Doo boats dealer.*
5. **Water flooded engine.**
 - *Contact an authorized Sea-Doo boats dealer.*
6. **Obstructed jet pump.**
 - *Try to clean. Otherwise, refer to an authorized Sea-Doo boats dealer.*

ENGINE WILL NOT START (cont'd)

- 7. Faulty engine management system.**
 - *Refer to an authorized Sea-Doo boats dealer.*

ENGINE TURNS SLOWLY

- 1. Loose battery cable connections.**
 - *Check/clean/tighten.*
- 2. Discharged or weak battery.**
 - *Have the battery charged or replaced by an authorized Sea-Doo boats dealer.*
- 3. Bad ground(s).**
 - *Refer to an authorized Sea-Doo boats dealer.*
- 4. Worn starter or related parts.**
 - *Refer to an authorized Sea-Doo boats dealer.*

ENGINE TURNS NORMALLY BUT WILL NOT START

- 1. Fuel tank empty or water contaminated.**
 - *Refill or siphon and fill with fresh fuel.*
- 2. Fouled/defective spark plugs.**
 - *Replace.*
- 3. Burnt fuse.**
 - *Check fuse(s). See an authorized Sea-Doo boats dealer if problem is repetitive.*
- 4. Water-flooded engine.**
 - *Refer to WATER-FLOODED ENGINE in SPECIAL PROCEDURES.*
- 5. Engine management system fault detected (check if engine pilot lamp is ON).**
 - *Refer to an authorized Sea-Doo boats dealer.*
- 6. Faulty fuel pump.**
 - *Refer to an authorized Sea-Doo boats dealer.*

ENGINE MISFIRES, RUNS IRREGULARLY

- 1. Fouled/defective/worn spark plugs.**
 - *Replace.*
- 2. Faulty ignition coil(s).**
 - *Contact an authorized Sea-Doo boats dealer.*
- 3. Fuel: Level too low, stale or water contaminated.**
 - *Siphon and/or refill.*
- 4. Clogged injectors.**
 - *Refer to an authorized Sea-Doo boats dealer.*
- 5. Engine management system fault detected (check if engine pilot lamp is ON).**
 - *Refer to an authorized Sea-Doo boats dealer.*

ENGINE SMOKE

1. Oil level too high.
 - Refer to an authorized Sea-Doo boats dealer.
2. Water ingestion, coolant leak or damaged cylinder head gasket.
 - Refer to an authorized Sea-Doo boats dealer.
3. Internal engine damage.
 - Refer to an authorized Sea-Doo boats dealer.

ENGINE OR EXHAUST OVERHEATING OR IMPROPER OIL PRESSURE (MONITORING BEEPER EMITS A CONTINUOUS BEEP)

NOTICE If beeper emits a continuous beep, stop engine as soon as possible.

1. Check oil and coolant levels.
 - Refer to MAINTENANCE PROCEDURES. Refill if necessary.
2. Clogged jet pump water intake.
 - Perform the JET PUMP WATER INTAKE AND IMPELLER CLEANING PROCEDURE in SPECIAL PROCEDURES.
3. Clogged exhaust system.
 - Flush exhaust system.

NOTICE If these actions do not correct the problem, discontinue use and contact an authorized Sea-Doo boats dealer.

ENGINE LACKS ACCELERATION OR POWER

1. Jet pump water intake clogged.
 - Clean. Refer to JET PUMP WATER INTAKE AND IMPELLER CLEANING in SPECIAL PROCEDURES section.
2. Damaged impeller or worn-out wear ring.
 - Replace. Refer to an authorized Sea-Doo boats dealer.
3. Faulty supercharger or intercooler (215 and 260 engine).
 - Refer to an authorized Sea-Doo boats dealer.
4. Supercharger clutch slipping.
 - Refer to an authorized Sea-Doo boats dealer.
5. Weak spark.
 - Refer to ENGINE MISFIRES, RUNS IRREGULARLY in this section.
6. Engine management system fault detected (check if engine pilot lamp is ON).
 - Refer to an authorized Sea-Doo boats dealer.
7. Clogged injectors.
 - Refer to an authorized Sea-Doo boats dealer.
8. Low fuel pressure.
 - Refer to an authorized Sea-Doo boats dealer.

ENGINE LACKS ACCELERATION OR POWER (cont'd)

9. Water in fuel.

- *Siphon and replace.*

BOAT CANNOT REACH TOP SPEED

1. Jet pump water intake clogged.

- *Perform the JET PUMP WATER INTAKE AND IMPELLER CLEANING PROCEDURE in SPECIAL PROCEDURES.*

2. Damaged impeller or worn-out wear ring.

- *Contact an authorized Sea-Doo boats dealer.*

3. Faulty supercharger or intercooler (260 engine).

- *Refer to an authorized Sea-Doo boats dealer.*

4. Engine management system fault detected (check if engine pilot lamp is ON).

- *Refer to an authorized Sea-Doo boats dealer.*

ABNORMAL NOISE FROM PROPULSION SYSTEM

1. Weeds or debris jammed around impeller.

- *Perform the JET PUMP WATER INTAKE AND IMPELLER CLEANING PROCEDURE in SPECIAL PROCEDURES.*

2. Damaged impeller shaft or drive shaft.

- *Contact an authorized Sea-Doo boats dealer.*

WATER FOUND IN BILGE

1. Drain plug(s) not tighten.

- *Tighten drain plugs.*

2. Defective scupper valve.

- *Refer to an authorized Sea-Doo boats dealer.*

3. Exhaust system leak.

- *Refer to an authorized Sea-Doo boats dealer.*

4. Carbon ring at drive shaft worn out.

- *Refer to an authorized Sea-Doo boats dealer.*

MONITORING SYSTEM

A system monitors the electronic components of the EMS (engine management system) and other components of the electrical system. When a fault occurs, it sends visual messages through the information center and/or audible signals through a beeper to inform you of a particular condition.

A fault code may also be recorded.

When a minor or transient fault occurs, the fault message and beeper will cease automatically if the condition that caused the fault does not exist anymore.

Releasing the throttle and letting the engine return to idle speed may allow normal operation to come back. If this does not work, try removing and reinstalling the tether cord on the engine cut-off switch.

The electronic system will react differently depending on the fault type. In severe failure, the engine may not be allowed to be started. In other cases, the engine will operate in limp home mode (reduced speed).

When a fault occurs, see an authorized Sea-Doo boats dealer as soon as possible for inspection.

Beeper Code Information

BEEPER CODE ⁽¹⁾	DESCRIPTION
1 Long Beep while installing tether cord on engine cut-off switch or when pressing start/stop button	Shift lever not in Neutral position. Move shift lever to Neutral.
	Unable to read key (wrong installation or dirty key). Remove tether cord, make sure it's clean and reinstall.
4 Short Beeps while pressing start/stop button with tether cord installed	Shift lever is not in Neutral. Move shift lever to Neutral.
1 Short Beep while moving shift lever to neutral	Confirms that shift lever is now in Neutral.
4 Short Beeps at Different Interval	Tether cord has been left on the engine cut-off switch without the engine running. Remove tether cord to prevent battery discharge.
Continuous Beep.	High engine coolant temperature. Refer to <i>ENGINE OVERHEATS</i> in <i>TROUBLESHOOTING GUIDELINES</i> .
	High exhaust temperature. Refer to <i>ENGINE OVERHEATS</i> in <i>TROUBLESHOOTING GUIDELINES</i> .
	Low or high engine oil pressure. Check oil level as soon as possible. If level good, discontinue use and contact an authorized Sea-Doo boats dealer.
⁽¹⁾ Some beeper codes go with messages on the information display, refer to <i>CONTROLS, INSTRUMENTS AND EQUIPMENT</i> for details	

NOTICE If the monitoring beeper emits a continuous beep, stop engine as soon as possible.

WARRANTY

BRP LIMITED WARRANTY FOR MODEL YEAR 2012 SEA-DOO® BOATS SOLD IN THE UNITED STATES AND CANADA

1) SCOPE

BRP US Inc.* ("BRP") warrants its new and unused Model Year 2012 Sea-Doo® Boats ("Boat") sold by authorized BRP dealers (as hereinafter defined) in the fifty United States and Canada ("dealer") from defects in material and workmanship for the period and under the conditions described below. This limited warranty will become null and void if: (1) the Boat was used for racing or any other competitive activity, at any point, even by a previous owner; or (2) the Boat has been altered or modified in such a way so as to adversely affect its operation, performance or durability, or has been altered or modified to change its intended use.

All genuine BRP parts and accessories, installed by an authorized BRP dealer at the time of delivery of the 2012 Sea-Doo® Boat, carry the same warranty as that of the Boat.

2) LIMITATIONS OF LIABILITY

THIS WARRANTY IS EXPRESSLY GIVEN AND ACCEPTED IN LIEU OF ANY AND ALL OTHER WARRANTIES, EXPRESSED OR IMPLIED, INCLUDING WITHOUT LIMITATION ANY WARRANTY OF MERCHANTABILITY OR FITNESS FOR A PARTICULAR PURPOSE. TO THE EXTENT THAT THEY CANNOT BE DISCLAIMED, THE IMPLIED WARRANTIES ARE LIMITED IN DURATION TO THE LIFE OF THE EXPRESS WARRANTY. INCIDENTAL AND CONSEQUENTIAL DAMAGES ARE EXCLUDED FROM COVERAGE UNDER THIS WARRANTY. SOME STATES/PROVINCES DO NOT ALLOW FOR THE DISCLAIMERS, LIMITATIONS AND EXCLUSIONS IDENTIFIED ABOVE, AS A RESULT, THEY MAY NOT APPLY TO YOU. THIS WARRANTY GIVES YOU SPECIFIC RIGHTS, AND YOU MAY ALSO HAVE OTHER LEGAL RIGHTS WHICH MAY VARY FROM STATE TO STATE, OR PROVINCE TO PROVINCE.

NEITHER THE DISTRIBUTOR, ANY BRP DEALER NOR ANY OTHER PERSON HAS BEEN AUTHORIZED TO MAKE ANY AFFIRMATION, REPRESENTATION OR WARRANTY REGARDING THE PRODUCT, OTHER THAN THOSE CONTAINED IN THIS LIMITED WARRANTY, AND IF MADE, SHALL NOT BE ENFORCEABLE AGAINST BRP. BRP RESERVES THE RIGHT TO MODIFY THIS WARRANTY AT ANY TIME, BEING UNDERSTOOD THAT SUCH MODIFICATION WILL NOT ALTER THE WARRANTY CONDITIONS APPLICABLE TO THE PRODUCTS SOLD WHILE THIS WARRANTY IS IN EFFECT.

3) EXCLUSIONS – ARE NOT WARRANTED

The following are not warranted under any circumstances:

- Normal wear and tear;
- Routine maintenance items, tune-ups, adjustments;
- Damage caused by failure to provide proper maintenance and/or storage, as described in the Operator's Guide;
- Damage resulting from removal of parts, improper repairs, service, maintenance, modifications or use of parts not manufactured or approved by BRP or resulting from repairs done by a person that is not an authorized servicing BRP dealer;

- Damage caused by abuse, misuse, abnormal use, neglect, racing, improper operation or operation of the Boat in a manner inconsistent with the recommended operation described in the Operator's Guide;
- Damage resulting from external damage, submersion, water or foreign object ingestion, accident, fire, theft, vandalism or any act of God;
- Operation with fuels, oils or lubricants which are not suitable for the Boat (see Operator's Guide);
- Damage from rust, corrosion or exposure to the elements;
- Damage from cooling system or jet pump blockage by foreign material;
- Damage to gel coat finish including but not limited to cosmetic gel coat finish defects, blisters, starring, crazing; and fiberglass delaminating caused by blisters, crazing, spyder or hairline cracks or exposure to the elements; and
- Incidental or consequential damages, or damages of any kind including without limitation towing, storage, telephone, rental, taxi, inconvenience, insurance coverage, loan payments, loss of time, loss of income.

4) WARRANTY COVERAGE DURATION

This limited warranty will be in effect from the date of delivery to the first retail consumer or the date the Boat is first put into use, whichever occurs first and for a period of:

1. TWELVE (12) CONSECUTIVE MONTHS for private, recreational use, except that the deck and hull fiberglass structure are covered for SIXTY (60) CONSECUTIVE MONTHS.
2. FOUR (4) CONSECUTIVE MONTHS for commercial use, except that the deck and hull fiberglass structure is covered for TWELVE (12) CONSECUTIVE MONTHS. A Boat is used commercially when it is used in connection with generating income or any work or employment during any part of the warranty period. A Boat is also used commercially when, at any point during the warranty period, it has commercial tags or is licensed for commercial use.
3. For Sea-Doo® Boats equipped with engine(s) meeting the Sterndrive/Inboard Standards (Include, but without limitation: models 98CA, 98CB, 98CC, 98CD, 85CA, 85CB, 85CC, 85CD, 85CE, 85CF, 85CG, 85CH); the following emission related warranty period applies:

Emission-related components that are installed on EPA certified Boats registered in the USA are covered for thirty-six (36) consecutive months or 480 hours of engine use whichever occurs first; and evaporative emission related components are warranted for twenty-four (24) consecutive months. If the 480 hours of engine use are reached during the regular warranty coverage period, the emission-related components are still covered by BRP's standard warranty until the end of regular coverage period.

For all other Sea-Doo® Boats; the following emission related warranty period applies: Emission-related components that are installed on EPA certified Boats registered in the USA are covered for thirty (30) consecutive months or 175 hours of engine use whichever occurs first; and evaporative emission related components are warranted for twenty-four (24) consecutive months. If the 175 hours of engine use are reached during the regular warranty coverage period, the emission-related components are still covered by BRP's standard warranty until the end of regular coverage period.

4. The list of the current warranted emission-related components is known by your authorized BRP dealer.
5. For Boats produced by BRP for sale in the state of California, that are originally sold to a resident or subsequently warranty registered to a resident in the state of California, please also refer to the applicable California Emissions Control Warranty Statement.

The repair or replacement of parts or the performance of service under this warranty does not extend the life of this warranty beyond its original expiration date.

For Boats produced by BRP for sale in the states of California, that are originally sold to a resident or subsequently warranty registered to a resident in the state of California, please also refer to the applicable California Emissions Control Warranty Statement.

5) CONDITIONS TO HAVE WARRANTY COVERAGE

This warranty coverage is available **only** if **each** of the following conditions has been fulfilled:

- The 2012 Sea-Doo® Boat must be purchased as new and unused by its first owner from a BRP dealer authorized to distribute Sea-Doo® Boats products in the country in which the sale occurred (“BRP dealer”);
- The BRP specified pre-delivery inspection process must be completed and documented and signed by the purchaser;
- The product must have undergone proper registration by an authorized BRP dealer;
- The 2012 Sea-Doo® Boat must be purchased in the country in which the purchaser resides;
- Routine maintenance outlined in the Operator’s Guide must be timely performed in order to maintain warranty coverage. BRP reserves the right to make warranty coverage contingent upon proof of proper maintenance.

BRP will not honor this limited warranty to any private use owner or commercial use owner if one of the preceding conditions has not been met. Such limitations are necessary in order to allow BRP to preserve both the safety of its products, and also that of its consumers and the general public.

6) WHAT TO DO TO OBTAIN WARRANTY COVERAGE

The customer must cease using the Boat upon the appearance of an anomaly. The customer must notify a servicing BRP dealer within two (2) days of the appearance of a defect, and provide it with reasonable access to the product and reasonable opportunity to repair it. The customer must also present to the authorized BRP dealer, proof of purchase of the product and must sign the repair/work order prior to starting the repair in order to validate the warranty repair. All parts replaced under this limited warranty become the property of BRP.

7) WHAT BRP WILL DO

BRP's obligations under this warranty are limited to, at its sole discretion, repairing parts found defective under normal use, maintenance and service, or replacing such parts with new genuine BRP parts without charge for parts and labor, at any authorized BRP dealer during the warranty coverage period under the conditions described herein. BRP's responsibility is limited to making the required repairs or replacements of parts. No claim of breach of warranty shall be cause for cancellation or rescission of the sale of the Boat to the owner.

In the event that service is required outside of the country of original sale, the owner will bear responsibility for any additional charges due to local practices and conditions, such as, but not limited to, freight, insurance, taxes, license fees, import duties, and any and all other financial charges, including those levied by governments, states, territories and their respective agencies.

BRP reserves the right to improve or modify products from time to time without assuming any obligation to modify products previously manufactured.

8) TRANSFER

If the ownership of a product is transferred during the warranty coverage period, this warranty shall also be transferred and be valid for the remaining coverage period provided that BRP is notified of such transfer of ownership in the following way:

1. The former owner contacts BRP (at the phone number provided below) or an authorized BRP dealer and gives the coordinates of the new owner; or
2. BRP or an authorized BRP dealer receives a proof that the former owner agreed to the transfer of ownership, in addition to the coordinates of the new owner.

9) CONSUMER ASSISTANCE

In the event of a controversy or a dispute in connection with this limited warranty, BRP suggests that you try to resolve the issue at the dealership level. We recommend discussing the issue with the authorized BRP dealer's service manager or owner.

If the issue has not yet been resolved, please submit your complaint in writing or call the appropriate number below:

In Canada

BOMBARDIER RECREATIONAL PRODUCTS INC.
SEA-DOO
Customer Assistance Center
75 J.A. Bombardier street
Sherbrooke QC J1L 1W3
Tel.: 819 566-3366

In USA

BRP US INC.
SEA-DOO
Customer Assistance Center
7575 Bombardier COURT
Wausau WI 54401
Tel.: 715 848-4957

*In Canada, products are distributed and serviced by Bombardier Recreational Products Inc
© 2011 Bombardier Recreational Products Inc. All rights reserved.

® Registered trademark of Bombardier Recreational Products Inc. or its subsidiaries.

‡ is the trademark of its owner.

CALIFORNIA EMISSION CONTROL WARRANTY STATEMENT FOR MODEL-YEAR 2012 SEA-DOO® BOATS WITH 4-TEC® ENGINES OR 4-TEC® IC ENGINES

For California, your 2012 Sea-Doo® Boat ("Boat") has a special environmental label required by the California Air Resources Board. The label has 1, 2, 3 or 4 stars. A hangtag, provided with your Boat, describes the meaning of the star rating system.

The Star Label Means Cleaner Marine Engines

The Symbol for Cleaner Marine Engines:



F18L3CQ



Cleaner Air and Water

For a healthier lifestyle and environment.

Better Fuel Economy

Burns up to 30 - 40 percent less gas and oil than conventional carbureted two-stroke engines, saving money and resources.

Longer Emission Warranty

Protects consumer for worry free operation.

One Star – Low Emission

The one-star label identifies personal watercraft, outboard, stern drive and inboard engines that meet the Air Resources Board's Personal Watercraft and Outboard marine engine 2001 exhaust emission standards. Engines meeting these standards have 75% lower emissions than conventional carbureted two-stroke engines. These engines are equivalent to the U.S. EPA's 2006 standards for marine engines.

Two Stars - Very Low Emission

The two-star label identifies personal watercraft, outboard, stern drive and inboard engines that meet the Air Resources Board's Personal Watercraft and Outboard marine engine 2004 exhaust emission standards. Engines meeting these standards have 20% lower emissions than One Star - Low-Emission engines.

Three Stars - Ultra Low Emission

The three-star label identifies engines that meet the Air Resources Board's Personal Watercraft and Outboard marine engine 2008 exhaust emission standards or the Stern drive and Inboard marine engine 2003 exhaust emission standards. Engines meeting these standards have 65% lower emissions than One Star – Low Emission engines.

Four Stars - Super Ultra Low Emission

The four-star label identifies engines that meet the Air Resources Board's Stern-drive and Inboard marine engine 2009 exhaust emission standards. Personal Watercraft and Outboard marine engines may also comply with these standards. Engines meeting these standards have 90% lower emissions than One Star – Low Emission engines.

For more information: Cleaner Watercraft – Get the Facts
1 800 END-SMOG
www.arb.ca.gov

Your Emission Control Warranty Rights and Obligations

The California Air Resources Board and BRP US Inc. ("BRP") are pleased to explain the emission control system warranty on your Model Year 2012 Sea-Doo® Boat. In California, new Boat engines must be designed, built and equipped to meet the State's stringent anti-smog standards. BRP must warrant the emission control system on your Boat engine for the period of time listed below provided there has been no abuse, neglect or improper maintenance of your Boat engine.

Your emission control system may include parts such as the fuel injection system, the ignition system and catalytic converter. Also included may be hoses, belts, connectors and other emission related assemblies.

Where a warrantable condition exists, BRP will repair your Boat engine at no cost to you including diagnosis, parts and labor provided that such work is performed by an authorized BRP dealer.

Manufacturer's Limited Warranty Coverage

For Sea-Doo® Boats equipped with engine(s) meeting the 3-Star Standards (All models except units equipped with engine(s) meeting the 4-Star Standards); the following emission related warranty period applies:

This emission limited warranty covers Model Year 2012 Sea-Doo® Boats certified and produced by BRP for sale in California, that are originally sold in California to a California resident or subsequently warranty registered to a California resident. The BRP limited warranty conditions for Sea-Doo® Boats are still applicable to these models with the necessary modifications. Select emission control parts of your 2012 Sea-Doo® Boat are warranted from the date of delivery to the first retail consumer for a period of 4 years, or for 250 hours of use, whichever occurs first. However, warranty coverage based on the hourly period is only permitted for Boats equipped with the appropriate hour meters or their equivalent. If any emission-related part on your engine is defective under warranty, the part will be repaired or replaced by BRP.

For Sea-Doo® Boats equipped with engine(s) meeting the 4-Star Standards ; (Include, but without limitation: models 98CA, 98CB, 98CC, 98CD, 85CA, 85CB, 85CC, 85CD, 85CE, 85CF, 85CG, 85CH); the following emission related warranty period applies: This emission limited warranty covers Model Year 2012 Sea-Doo® Boats certified and produced by BRP for sale in California, that are originally sold in California to a California resident or subsequently warranty registered to a California resident. The BRP limited warranty conditions for Sea-Doo® Boats are still applicable to these models with the necessary modifications. Select emission control parts of your 2012 Sea-Doo® Boat are warranted from the date of delivery to the first retail consumer for a period of 36 months, or for 480 hours of use, whichever occurs first. However, warranty coverage based on the hourly period is only permitted for Boats equipped with the appropriate hour meters or their equivalent. If any emission-related part on your engine is defective under warranty, the part will be repaired or replaced by BRP.

Parts Covered for Model Year 2012 Sea-Doo® Boat Equipped with 4-TEC® Engines:

Idle Bypass Valve	Air Intake Adapter
Throttle Position Sensor	Spark Plugs
Intake Manifold Air Pressure Sensor	Ignition Coils
Intake Manifold Air Temperature Sensor	Air Box
Engine Temperature Sensor	Intake and Exhaust Valve and Seals
Knock Sensor	Crankcase Ventilation Valve
Emission Control Module ECM	Throttle Body Seal
Throttle Body	Wire Harness and Connectors
Fuel Rail	Intake Manifold
Fuel Injectors	Intake Manifold Seal
Fuel Pressure Regulator	Fuel Filter
Fuel Pump	Supercharger
Oxygen Sensor	Catalytic Converter

The emission warranty covers damage to other engine components that is caused by the failure of a warranted part. The BRP Operator’s Guide provided contains written instructions for the proper maintenance and use of your Boat. All emission warranty parts are warranted by BRP for the entire warranty period of the Boat, unless the part is scheduled for replacement as required maintenance in the Operator’s Guide.

Emission warranty parts that are scheduled for replacement, as required maintenance, are warranted by BRP for the period of time before the first scheduled replacement date for that part. Emission warranty parts that are scheduled for regular inspection, but not regular replacement, are warranted by BRP for the entire warranty period of the Boat. Any emission warranty part repaired or replaced under the terms of this warranty statement is warranted by BRP for the remainder of the warranty period of the original part. All parts replaced under this limited warranty become the property of BRP. Maintenance receipts and records should be transferred to each subsequent owner of the Boat.

Owner's Warranty Responsibilities

As the owner of a 2012 Sea-Doo® Boat, you are responsible for the performance of the required maintenance listed in your Operator's Guide. BRP recommends that you retain all receipts covering maintenance your Boat engine, but BRP cannot deny warranty solely for the lack of receipts or your failure to ensure the performance of all scheduled maintenance. As the owner of a Sea-Doo® Boat, you should however be aware that BRP may deny you warranty coverage if your engine(s) or a part has failed due to abuse, neglect, improper maintenance or unapproved modifications. You are responsible for presenting your engine to an authorized BRP Dealer as soon as a problem exists. The warranty repairs will be completed in a reasonable amount of time, not to exceed 30 days. If you have any questions regarding your warranty rights and responsibilities or for the name and location of the nearest authorized BRP Dealer you should contact the Customer Assistance Center at 1-715-848-4957.

BRP INTERNATIONAL LIMITED WARRANTY FOR MODEL YEAR 2012 SEA-DOO® BOATS

1) SCOPE

BRP US Inc. ("BRP")* warrants its new and unused Model Year 2012 Sea-Doo® Boats ("Boat") sold by authorized BRP Distributors/Dealers ("Distributor/Dealer") outside of the United States, Canada and states members of the European Economic Area (which is comprised of the states member of the European Union plus Norway, Iceland and Liechtenstein) Turkey, and states members of the Commonwealth of the Independent States ("CIS") (which is comprised of the Russian Federation and ex-members states of the USSR), will be free from defects in material and workmanship for the period and under the conditions below. This limited warranty will become null and void if: (1) the Boat was used for racing or any other competitive activity, at any point, even by a previous owner; or (2) the Boat has been altered or modified in such a way so as to adversely affect its operation, performance or durability, or has been altered or modified to change its intended use.

All genuine BRP parts and accessories, installed by an authorized BRP Distributor/Dealer (as hereinafter defined) at the time of delivery of the 2012 Sea-Doo® Boat, carry the same warranty as that of the Boat.

2) LIMITATIONS OF LIABILITY

THIS WARRANTY IS EXPRESSLY GIVEN AND ACCEPTED IN LIEU OF ANY AND ALL OTHER WARRANTIES, EXPRESSED OR IMPLIED, INCLUDING WITHOUT LIMITATION ANY WARRANTY OF MERCHANTABILITY OR FITNESS FOR A PARTICULAR PURPOSE. TO THE EXTENT THAT THEY CANNOT BE DISCLAIMED, THE IMPLIED WARRANTIES ARE LIMITED IN DURATION TO THE LIFE OF THE EXPRESS WARRANTIES. INCIDENTAL AND CONSEQUENTIAL DAMAGES ARE EXCLUDED FROM COVERAGE UNDER THIS WARRANTY. SOME STATES/PROVINCES DO NOT ALLOW FOR THE DISCLAIMERS, LIMITATIONS AND EXCLUSIONS IDENTIFIED ABOVE, AS A RESULT, THEY MAY NOT APPLY TO YOU. THIS WARRANTY GIVES YOU SPECIFIC RIGHTS, AND YOU MAY ALSO HAVE OTHER LEGAL RIGHTS WHICH MAY VARY FROM COUNTRY TO COUNTRY.

Neither the authorized BRP Distributor/Dealer, nor any other person has been authorized to make any affirmation, representation or warranty regarding the product, other than those contained in this limited warranty, and if made, shall not be enforceable against BRP. BRP reserves the right to modify this warranty at any time, being understood that such modification will not alter the warranty conditions applicable to the products sold while this warranty is in effect.

3) EXCLUSIONS – ARE NOT WARRANTED

The following are not warranted under any circumstances:

- Replacement of parts due to normal wear and tear;
- Routine maintenance parts and services, including but not limited to adjustments, oil, lubricant and coolant changes, spark plug replacement, water pumps and the like;
- Damage caused by improper or lack of maintenance or storage, or failure to follow the procedures and recommendations in the Operator's Guide;

- Damage resulting from removal of parts, improper repairs, service, maintenance, or modification, or use of parts or accessories not manufactured or approved by BRP, which in its reasonable judgment, are either incompatible with Boats or adversely affect its operation, performance, or durability, or resulting from repairs done by a person that is not an authorized BRP Distributor/Dealer;
- Damage caused by abuse, misuse, abnormal use, neglect, racing, improper operation or operation of the Boat in a manner inconsistent with the recommended operation described in the Operator's Guide;
- Damages resulting from external damage, submersion, water or foreign object ingestion, accident, fire, theft, vandalism or any act of God;
- Operation with fuel, oils or lubricants that are not suitable for the Boat (see Operator's Guide);
- Damage from rust, corrosion or exposure to the elements;
- Damage from cooling system or jet pump blockage by foreign material;
- Incidental or consequential damages, or damages of any kind including without limitation towing, storage, telephone, rental, taxi, inconvenience, insurance coverage, loan payments, loss of time, loss of income; and,
- Damage to gel coat finish including but not limited to cosmetic gel coat finish defects, blisters, starring, crazing; and fiberglass delaminating caused by blisters, crazing, spider or hairline cracks or exposure to the elements.

4) WARRANTY COVERAGE DURATION

This limited warranty will be in effect from the date of delivery to the first retail consumer or the date the Boat is first put to use, whichever occurs first, for a period of:

- TWELVE (12) CONSECUTIVE MONTHS for private, recreational use, except for the deck and hull fiberglass structure that are covered for SIXTY (60) CONSECUTIVE MONTHS;
- FOUR (4) CONSECUTIVE MONTHS for commercial use, except for the deck and hull fiberglass structure that are covered for TWELVE (12) CONSECUTIVE MONTHS. A Boat is used commercially when it is used in connection with generating income or any work or employment during any part of the warranty period. A Boat is also used commercially when, at any point during the warranty period, it has commercial tags or is licensed for commercial use.

The repair or replacement of parts or the performance of service to a Boat under this warranty does not extend the life of this limited warranty beyond its original expiration date.

FOR PRODUCTS SOLD IN AUSTRALIA ONLY

"Our goods come with guarantees that cannot be excluded under the Australian Consumer Law. You are entitled to a replacement or refund for a major failure and for compensation for any other reasonably foreseeable loss or damage. You are also entitled to have the goods repaired or replaced if the goods fail to be of acceptable quality and the failure does not amount to a major failure."

5) CONDITIONS TO HAVE WARRANTY COVERAGE

This warranty coverage is available **only** if **each** of the following conditions has been fulfilled:

- The 2012 Sea-Doo® Boats must be purchased as new and unused by its first owner from a BRP Distributor/Dealer authorized to distribute SEA-DOO® BOAT products in the country in which the sale occurred;
- The BRP specified pre-delivery inspection process must be completed and documented;
- The product must have undergone proper registration by an authorized BRP Distributor/Dealer;
- The 2012 Sea-Doo® Boats must be purchased in the country in which the purchaser resides; and,
- Routine maintenance outlined in the Operator's Guide must be timely performed in order to maintain warranty coverage. BRP reserves the right to make warranty coverage contingent upon proof of proper maintenance.

BRP will not honor this limited warranty to any private use owner or commercial use owner if one of the preceding conditions has not been met. Such limitations are necessary in order to allow BRP to preserve both the safety of its products, and that of its consumers and the general public.

6) WHAT TO DO TO OBTAIN WARRANTY COVERAGE

The customer must notify a servicing BRP Distributor/Dealer within two (2) days of the appearance of a defect, and provide it with reasonable access to the product and reasonable opportunity to repair it. The customer must also present to the authorized BRP Distributor/Dealer, proof of purchase of the product and must sign the repair/work order prior to starting the repair in order to validate the warranty repair. All parts replaced under this limited warranty become the property of BRP.

7) WHAT BRP WILL DO

BRP's obligations under this warranty are limited to, at its sole discretion, repairing parts found defective under normal use, maintenance and service, or replacing such parts with new genuine BRP parts without charge for parts and labor, at any authorized BRP Distributor/Dealer during the warranty coverage period under the conditions described herein. BRP's responsibility is limited to making the required repairs or replacements of parts. No claim of breach of warranty shall be cause for cancellation or rescission of the sale of the Boat to the owner.

In the event that service is required outside of the country of original sale, the owner will bear responsibility for any additional charges due to local practices and conditions, such as, but not limited to, freight, insurance, taxes, license fees, import duties, and any and all other financial charges, including those levied by governments, states, territories and their respective agencies.

BRP reserves the right to improve or modify products from time to time without assuming any obligation to modify products previously manufactured.

8) TRANSFER

If the ownership of a Product is transferred during the warranty coverage period, this warranty shall also be transferred and be valid for the remaining coverage period provided that BRP is notified of such transfer of ownership in the following way:

1. The former owner contacts BRP (at the phone number provided below) or an authorized Distributor/Dealer and gives the coordinates of the new owner; or
2. BRP or an authorized Distributor/Dealer receives a proof that the former owner agreed to the transfer of ownership, in addition to the coordinates of the new owner.

9) CONSUMER ASSISTANCE

In the event of a controversy or a dispute in connection with this limited warranty, BRP suggests that you try to resolve the issue at the dealership level.

If further assistance is required, the Distributor's service department should be contacted in order to resolve the matter. You will find your distributor's coordinates on www.brp.com.

If the matter still remains unresolved then contact BRP by writing to us at the address listed below.

For countries within Europe, Middle East and Africa, please contact our European office

BRP EUROPE N.V.

Customer Assistance Center
Skaldenstraat 125
9042 Gent
Belgique
Tel.: +32-9-218-26-00

For all other countries, please contact your local distributor or our North America office

BOMBARDIER RECREATIONAL PRODUCTS INC.

Customer Assistance Center
75 J.A. Bombardier Street
Sherbrooke QC J1L 1W3
Tel.: 1 819 566-3366

© 2011 Bombardier Recreational Products Inc. All rights reserved.

® Registered trademark of Bombardier Recreational Products Inc.

* For the territory covered by this limited warranty, products are distributed and serviced by Bombardier Recreational Products Inc. or its affiliates.

© 2011 Bombardier Recreational Products Inc. All rights reserved.

® Registered trademark of Bombardier Recreational Products Inc. or its affiliates.

BRP LIMITED WARRANTY FOR THE EUROPEAN AND THE RUSSIAN ECONOMIC AREA AND TURKEY: MODEL YEAR 2012 SEA-DOO® BOATS

1) SCOPE OF THE LIMITED WARRANTY

BRP US Inc. ("BRP")* warrants its new and unused model-year 2012 Sea-Doo® Boats sold by authorized BRP distributors/dealers ("Distributors/Dealers") in member states of the European Economic Area ("EEA") (which is comprised of the state members of the European Union plus Norway, Iceland and Liechtenstein), in member states of the Commonwealth of the Independent States ("CIS") (which is comprised of the Russian Federation and ex-members states of the USSR), and Turkey from defects in material or workmanship for the period and under the conditions described below. This limited warranty will become null and void if: (1) the Boat was used for racing or any other competitive activity, at any point, even by a previous owner; or (2) the Boat has been altered or modified in such a way so as to adversely affect its operation, performance or durability, or has been altered or modified to change its intended use.

All genuine SEA-DOO® BOAT parts and accessories, installed by an authorized BRP Distributors/Dealers at the time of delivery of the 2012 Sea-Doo® Boats, carry the same warranty as that of the Boats.

2) LIMITATIONS OF LIABILITY

THIS WARRANTY IS EXPRESSLY GIVEN AND ACCEPTED IN LIEU OF ANY AND ALL OTHER WARRANTIES, EXPRESSED OR IMPLIED, INCLUDING WITHOUT LIMITATION ANY WARRANTY OF MERCHANTABILITY OR FITNESS FOR A PARTICULAR PURPOSE. TO THE EXTENT THAT THEY CANNOT BE DISCLAIMED, THE IMPLIED WARRANTIES ARE LIMITED IN DURATION TO THE LIFE OF THE EXPRESS WARRANTY. INCIDENTAL AND CONSEQUENTIAL DAMAGES ARE EXCLUDED FROM COVERAGE UNDER THIS WARRANTY. SOME JURISDICTIONS DO NOT ALLOW FOR THE DISCLAIMERS, LIMITATIONS AND EXCLUSIONS IDENTIFIED ABOVE, AS A RESULT, THEY MAY NOT APPLY TO YOU. THIS WARRANTY GIVES YOU SPECIFIC RIGHTS, AND YOU MAY ALSO HAVE OTHER LEGAL RIGHTS WHICH MAY VARY FROM COUNTRY TO COUNTRY.

Neither the BRP Distributor/Dealer nor any other person has been authorized to make any affirmation, representation or warranty regarding the product, other than those contained in this limited warranty, and if made, shall not be enforceable against BRP.

BRP reserves the right to modify this warranty at any time, being understood that such modification will not alter the warranty conditions applicable to the products sold while this warranty is in effect.

3) EXCLUSIONS – ARE NOT WARRANTED

The following are not warranted under any circumstances:

- Replacement of parts due to normal wear and tear;
- Routine maintenance parts and services, including but not limited to adjustments, oil, lubricant and coolant changes, spark plug replacement, water pumps and the like;
- Damage caused by improper or lack of maintenance or storage, or failure to follow the procedures and recommendations in the Operator's Guide;

- Damage resulting from removal of parts, improper repairs, service, maintenance, or modification, or use of parts or accessories not manufactured or approved by BRP, which in its reasonable judgment, are either incompatible with Boats or adversely affect its operation, performance, or durability, or resulting from repairs done by a person that is not an authorized BRP Distributor/Dealer;
- Damage caused by abuse, misuse, abnormal use, neglect, racing, improper operation or operation of the Boat in a manner inconsistent with the recommended operation described in the Operator's Guide;
- Damages resulting from external damage, submersion, water or foreign object ingestion, accident, fire, theft, vandalism or any act of God;
- Operation with fuel, oils or lubricants that are not suitable for the Boat (see Operator's Guide);
- Damage from rust, corrosion or exposure to the elements;
- Damage from cooling system or jet pump blockage by foreign material;
- Incidental or consequential damages, or damages of any kind including without limitation towing, storage, telephone, rental, taxi, inconvenience, insurance coverage, loan payments, loss of time, loss of income; and,
- Damage to gel coat finish including but not limited to cosmetic gel coat finish defects, blisters, starring, crazing; and fiberglass delaminating caused by blisters, crazing, spider or hairline cracks or exposure to the elements.

4) WARRANTY COVERAGE PERIOD

This limited warranty will be in effect from the date of delivery to the first retail consumer or the date the product is first put into use, whichever occurs first and for a period of:

TWENTY-FOUR (24) CONSECUTIVE MONTHS for private use owners except for the deck and hull fiberglass structure that are covered for SIXTY (60) CONSECUTIVE MONTHS;

FOUR (4) CONSECUTIVE MONTHS for commercial use owners except for the deck and hull fiberglass structure that are covered for TWELVE (12) CONSECUTIVE MONTHS.

A Boat is used commercially when it is used in connection with generating income or any work or employment during any part of the warranty period. A Boat is also used commercially when, at any point during the warranty period, it has commercial tags or is licensed for commercial use.

The repair or replacement of parts or the performance of service under this warranty does not extend the life of this warranty beyond its original expiration date.

Note that the duration and any other modalities of the warranty coverage are subject to the applicable national or local legislation in your country.

5) CONDITIONS TO HAVE WARRANTY COVERAGE

This warranty coverage is available **only** if **each** of the following conditions has been fulfilled:

- The 2012 Sea-Doo® Boats must be purchased as new and unused by its first owner from a BRP Distributor/Dealer authorized to distribute SEA-DOO® BOAT products in the country in which the sale occurred;

- The BRP specified pre-delivery inspection process must be completed and documented;
- The product must have undergone proper registration by an authorized BRP Distributor/Dealer;
- The 2012 Sea-Doo® Boats must be purchased within the EEA by an EEA resident, in the CIS for residents of the countries comprised in such area and in Turkey for residents of Turkey; and
- Routine maintenance outlined in the Operator's Guide must be timely performed in order to maintain warranty coverage. BRP reserves the right to make warranty coverage contingent upon proof of proper maintenance.

BRP will not honor this limited warranty to any private use owner or commercial use owner if one of the preceding conditions has not been met. Such limitations are necessary in order to allow BRP to preserve both the safety of its products, and also that of its consumers and the general public.

6) WHAT TO DO TO OBTAIN WARRANTY COVERAGE

The customer must notify a servicing BRP Distributor/Dealer within two (2) months of the appearance of a defect, and provide it with reasonable access to the product and reasonable opportunity to repair it. The customer must also present to the authorized BRP Distributor/Dealer, proof of purchase of the product and must sign the repair/work order prior to starting the repair in order to validate the warranty repair. All parts replaced under this limited warranty become the property of BRP.

Note that the notification period is subject to the applicable national or local legislation in your country.

7) WHAT BRP WILL DO

BRP's obligations under this warranty are limited to, at its sole discretion, repairing parts found defective under normal use, maintenance and service, or replacing such parts with new genuine Boat parts without charge for parts and labor, at any authorized BRP Distributor/Dealer during the warranty coverage period under the conditions described herein. BRP's responsibility is limited to making the required repairs or replacements of parts. No claim of breach of warranty shall be cause for cancellation or rescission of the sale of the Boat to the owner.

In the event that service is required outside of the country of original sale, the owner will bear responsibility for any additional charges due to local practices and conditions, such as, but not limited to, freight, insurance, taxes, license fees, import duties, and any and all other financial charges, including those levied by governments, states, territories and their respective agencies.

BRP reserves the right to improve or modify products from time to time without assuming any obligation to modify products previously manufactured.

8) TRANSFER

If the ownership of a Product is transferred during the warranty coverage period, this warranty shall also be transferred and be valid for the remaining coverage period provided that BRP is notified of such transfer of ownership in the following way:

The former owner contacts BRP (at the phone number provided below) or an authorized Distributor/Dealer and gives the coordinates of the new owner; or BRP or an authorized Distributor/Dealer receives proof that the former owner agreed to the transfer of ownership, in addition to the coordinates of the new owner.

9) CONSUMER ASSISTANCE

In the event of a controversy or a dispute in connection with this limited warranty, BRP suggests that you try to resolve the issue at the dealership level. We recommend discussing the issue with the authorized Distributor/Dealer's service manager or owner.

- If further assistance is required, the distributor's service department should be contacted in order to resolve the matter. You will find your distributor's coordinates on www.brp.com.
- If the matter still remains unresolved then contact BRP at the address listed below.

For countries within Europe, to the exception of the Scandinavian countries, and for countries within the CIS and Turkey, please contact our European office at:

BRP EUROPE N.V.

Customer Assistance Center
Skaldenstraat 125
9042 Gent
Belgium
Tel.: +32-9-218-26-00

For Scandinavian countries, please contact our office in Finland at:

BRP FINLAND OY

Service Department
Isoaavantie 7
FIN-96320 Rovaniemi
Finland
Tel.: +358163208111

For all other countries, please contact your local distributor or our North America office:

BOMBARDIER RECREATIONAL PRODUCTS INC.

Customer Assistance Center
75 J.A. Bombardier Street
Sherbrooke QC J1L 1W3
Tel.: 1 819 566-3366

* For the territory covered by this limited warranty, products are distributed and serviced by Bombardier Recreational Products Inc. or its affiliates.

© 2011 Bombardier Recreational Products Inc. All rights reserved.

® Registered trademark of Bombardier Recreational Products Inc.

***This page is
intentionally blank***

CUSTOMER INFORMATION

PRIVACY INFORMATION

BRP wishes to inform you that your coordinates will be used for safety and warranty related purposes. Furthermore, BRP and its affiliates may use its customer list to distribute marketing and promotional information about BRP and related products.

To exercise your right to consult or correct your data, or to be removed from the addressee-list for direct marketing, please contact BRP.

By E-mail: **privacyofficer@brp.com**

By mail: BRP
Senior Legal Counsel-Privacy Officer
726 St-Joseph
Valcourt, QC
Canada
J0E 2L0

CHANGE OF ADDRESS/OWNERSHIP

If your address has changed or if you are the new owner of the boat, be sure to notify BRP by either:

- Mailing one of the following card below;
- **North America only:** calling at 715 848-4957 (USA) or 819 566-3366 (Canada);
- Contacting an authorized BRP distributor/dealer.

In case of change of ownership, please join a proof that the former owner agreed to the transfer.

Notifying BRP, even after the expiration of the limited warranty, is very important as it enables BRP to reach the boat owner if necessary, like when safety recalls are initiated. It is the owner's responsibility to notify BRP.

STOLEN UNITS: In the event that your boat is stolen, you should notify your area's distributor warranty department of such. We will ask you to provide your name, address, phone number, Hull Identification Number and date it was stolen.

In North America

BOMBARDIER RECREATIONAL PRODUCTS INC.

Warranty Department
75, J.-A. Bombardier Street
Sherbrooke QC J1L 1W3
Canada

Scandinavian countries

BRP FINLAND OY

Service Department
Isoaavantie 7
FIN-96320 Rovaniemi
Tel.: + 358 16 3208 111

Other areas in the world except Scandinavian countries

BRP EUROPEAN DISTRIBUTION

Warranty Department
Chemin de Messidor 5-7
1006 Lausanne
Switzerland

***This page is
intentionally blank***

CHANGE OF ADDRESS CHANGE OF OWNERSHIP 

VEHICLE IDENTIFICATION NUMBER

Model Number

Vehicle Identification Number (V.I.N.)

OLD ADDRESS
OR PREVIOUS OWNER:

NAME

NO.

STREET

APT

CITY

STATE/PROVINCE

ZIP/POSTAL CODE

COUNTRY

TELEPHONE

NEW ADDRESS
OR NEW OWNER:

NAME

NO.

STREET

APT

CITY

STATE/PROVINCE

ZIP/POSTAL CODE

COUNTRY

TELEPHONE

E-MAIL ADDRESS

V00A2F

CHANGE OF ADDRESS CHANGE OF OWNERSHIP 

VEHICLE IDENTIFICATION NUMBER

Model Number

Vehicle Identification Number (V.I.N.)

OLD ADDRESS
OR PREVIOUS OWNER:

NAME

NO.

STREET

APT

CITY

STATE/PROVINCE

ZIP/POSTAL CODE

COUNTRY

TELEPHONE

NEW ADDRESS
OR NEW OWNER:

NAME

NO.

STREET

APT

CITY

STATE/PROVINCE

ZIP/POSTAL CODE

COUNTRY

TELEPHONE

E-MAIL ADDRESS

V00A2F

BOAT MODEL No. _____

HULL IDENTIFICATION NUMBER (H.I.N.) _____

ROTAX ENGINE IDENTIFICATION NUMBER (E.I.N.) _____

Owner: _____
NAME

No. _____ STREET _____ APT _____

CITY _____ STATE/PROVINCE _____ ZIP/POSTAL CODE _____

Purchase Date _____
YEAR MONTH DAY

Warranty Expiry Date _____
YEAR MONTH DAY

To be completed by the dealer at the time of the sale.

DEALER IMPRINT AREA

000A36LA

Please verify with your selling dealer to ensure your SEA-DOO boat has been registered with BRP.

219 000 896

CA

OPERATOR'S GUIDE, 180 CHALLENGER SERIES / ENGLISH
GUIDE DU CONDUCTEUR, SÉRIE 180 CHALLENGER / ANGLAIS

FAIT AU / MADE IN CANADA

U/M:P.C.

®™ AND THE BRP LOGO ARE TRADEMARKS OF BOMBARDIER RECREATIONAL PRODUCTS INC. OR ITS AFFILIATES.

* TRADEMARK OF BOMBARDIER INC. USED UNDER LICENSE.

©2011 BOMBARDIER RECREATIONAL PRODUCTS INC. ALL RIGHTS RESERVED. PRINTED IN CANADA.

<https://www.boat-manuals.com/>