



Spearheading the Future of Fishing.

380 LXF

Owner's Manual



Scout Boats Inc.
2531 Hwy 78 West
Summerville, SC 29483

SAFETY INFORMATION	9
BOAT INFORMATION	11
SPECIFICATIONS	12
CERTIFICATIONS & SPECIFICATIONS	13
OWNER'S / OPERATOR'S INFORMATION	15
SCOUT LIMITED WARRANTY.....	17
SCOUT WARRANTY REGISTRATION TRANSFER	19

Chapter 1:

Safety Information

1.1 General	21
1.2 Engine Alarms	21
1.3 Neutral Safety Switch	21
1.4 Engine Stop Switch	21
1.5 Required Safety Equipment	22
1.6 Bilge & Fuel Fires	23
1.7 Carbon Monoxide Monitoring System	24
1.8 First Aid.....	25
1.9 Additional Safety Equipment	26

Chapter 2:

Operation

2.1 General	29
2.2 Rules of the Road	29
2.3 Pre-Cruise Check	32
2.4 Operating Your Boat	33
2.5 Docking, Anchoring & Mooring	34
2.6 Controls, Steering or Propulsion System Failure.....	37
2.7 Collision.....	37
2.8 Grounding, Towing & Rendering Assistance.....	37
2.9 Flooding or Capsizing.....	38
2.10 Fishing.....	38
2.11 Flybridge or Tower Operation	38
2.12 Teak Surfing	39
2.13 Trash Disposal	40
2.14 Yacht Certification Plate.....	40
2.15 Transporting Your Boat.....	40

Chapter 3:

Propulsion System

3.1 General	41
3.2 Drive System Corrosion	41
3.3 Engine Lubrication.....	42
3.4 Engine Cooling System	42
3.5 Propellers	42
3.6 Performance Issues & Propellers	42
3.7 Engine Instrumentation	44

Chapter 4:

Helm Control Systems

4.1 General	47
4.2 Engine Throttle & Shift Controls	47
4.3 Neutral Safety Switch	50
4.4 Engine Power Tilt & Trim	50
4.5 Engine Stop Switch	51
4.6 Steering System	52
4.7 Joystick Controls.....	53
4.8 Trim Tabs.....	54
4.9 Bow Thruster (Optional).....	55
4.10 Control Systems Maintenance	56

Chapter 5:

Fuel System

5.1 General	59
5.2 Outboard Engine Fuel System.....	60
5.3 Diesel Generator Fuel System.....	62
5.4 Fueling Instructions.....	64
5.5 Fuel System Maintenance.....	65

Chapter 6:

Electrical System

6.1 General	67
6.2 12 volt DC System Overview	67
6.3 Batteries and Battery Switches	68
6.4 Battery Switch Panel Circuit Breakers	72
6.5 Other DC Circuit Protection.....	73
6.6 Ignition Switch Panels.....	75
6.7 12 volt Accessory Switch Panels	76
6.8 CZone Digital Control System	83
6.9 Cabin DC Breaker Panel	86
6.10 DC Power Management	89
6.11 120 volt AC Electrical System	90
6.12 Generator.....	96
6.13 Bonding System & Galvanic Isolator.....	97
6.14 Electrical System Maintenance	98
6.15 AC Line Load Estimator	100

Chapter 7:

Fresh Water System

7.1 General	101
7.2 Fresh Water System Operation.....	101
7.3 Water Heater	103
7.4 Fresh Water System Maintenance.....	103

Chapter 8:

Raw Water System

8.1 General	105
8.2 Raw Water System Operation	106
8.3 Baitwell	107
8.4 Air Conditioner Cooling Pump.....	108
8.5 SeaKeeper Cooling Pump	108
8.6 Generator Raw Water Supply	108
8.7 Raw Water System Maintenance.....	109

Chapter 9:

Drainage Systems

9.1 General	111
9.2 Cockpit & Deck Drainage	111
9.3 Hardtop & Tower Drains	112
9.4 Bilge Drainage & Alarm	113
9.5 Cabin Drainage	114
9.6 Drainage System Maintenance	115

Chapter 10:

Ventilation System

10.1 Cabin Ventilation	117
10.2 Windshield Ventilation	117
10.3 Carbon Monoxide & Proper Ventilation	117
10.4 Maintenance	119

Chapter 11:

Exterior Equipment

11.1 Deck	121
11.2 Rope Locker & Windlass	121
11.3 Hull	124
11.4 Cockpit Features	125
11.5 Leaning Post Equipment	135
11.6 Console & Helm	138
11.7 Hardtop	141
11.8 Upper Helm Flybridge	143
11.9 Aftermarket Hardtop or Tower	144

Chapter 12:

Interior Equipment

12.1 Head Compartment	145
12.2 Main Cabin & Galley	149
12.3 Cabin Air Conditioner	153
12.4 Cabin Woodwork	155

Chapter 13:

Routine Maintenance

13.1 Exterior Hull and Deck	157
13.2 Upholstery, Canvas and Enclosures	160
13.3 Interior	162
13.4 Engines & Fuel	162
13.5 Bilge.....	163
13.6 Drainage System.....	163

Chapter 14:

Seasonal Maintenance

14.1 Storage and Lay-up	165
14.2 Freshwater System Winterizing	167
14.3 Raw Water System Winterizing.....	168
14.4 Drainage & Other Water System Winterizing	169
14.5 Winterizing Bilge Components & Engines	170
14.6 Preparing Exterior & Interior Equipment For Winter Storage	170
14.7 Recommissioning	171

Appendix A:

Schematics.....	173
Hull Harness 12V System - 1.....	173
Hull Harness 12V System - 2.....	174
Deck Harness 12V	175
Deck Harness 110V.....	176
Hardtop Harness 12V	177
Freshwater System	178
Raw Water System	179
Drainage System.....	180
Waste System.....	181
Fuel System.....	182
Propulsion System	183
Mercury Steering System.....	184
Yamaha Steering System.....	185

Appendix B:

Glossary Of Terms	187
-------------------------	-----



Appendix C:

Maintenance Log 191

Appendix D:

Boating Accident Report 197

Appendix E:

Float Plan 201

Appendix F:

Troubleshooting Guide..... 203



NOTES

Your Scout manual has been written to include a number of safety instructions to assure the safe operation and maintenance of your boat. These instructions are in the form of **CAUTION**, **WARNING**, **DANGER** and **NOTICE** statements. The following definitions apply:

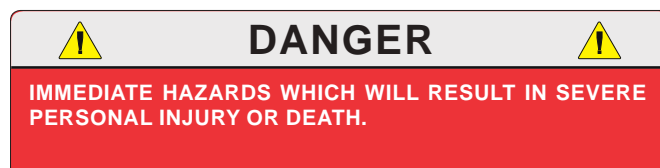

All instructions given in this book are as seen from the stern looking toward the bow, with starboard being to your right, and port to your left. A glossary of boating terms is included.

IMPORTANT NOTE: Your boat uses internal combustion engines and flammable fuel. Every precaution has been taken by Scout to reduce the risks associated with possible injury and damage from fire or explosion, but your own precaution and good maintenance procedures are necessary in order to enjoy safe operation of your boat.

S.O.S SAVE OUR SEAS

Scout Boats has made a commitment to quality since the very beginning. More importantly, we've also made a commitment to saving our natural resources. Our boating and fishing waters are beautiful but often abused and neglected. With care, we can turn the tide in favor of preserving our shining seas for generations to come. At Scout, we're doing our part by using earth-friendly manufacturing techniques and materials, and by choosing suppliers who observe strict environmental controls in making their products. It means more expense and time on our part, but we think it's worth it. You can do your part by being sensitive to our environment. Our marshes are the filter systems of the world. As responsible boaters we must manage our natural resources so our children can enjoy them.



WARNING



A WIDE VARIETY OF COMPONENTS USED ON THIS VESSEL CONTAIN OR EMIT CHEMICALS KNOWN TO THE STATE OF CALIFORNIA TO CAUSE CANCER AND BIRTH DEFECTS AND OTHER REPRODUCTIVE HARM.

EXAMPLES INCLUDE:

- **ENGINE AND GENERATOR EXHAUST.**
- **ENGINE AND GENERATOR FUEL, AND OTHER LIQUIDS SUCH AS COOLANTS AND OIL, ESPECIALLY USED MOTOR OIL.**
- **COOKING FUELS.**
- **CLEANERS, PAINTS, AND SUBSTANCES USED FOR VESSEL REPAIR.**
- **WASTE MATERIALS THAT RESULT FROM WEAR OF VESSEL COMPONENTS.**
- **LEAD FROM BATTERY TERMINALS AND FROM OTHER SOURCES SUCH AS BALLAST OR FISHING SINKERS.**

TO AVOID HARM:

- **KEEP AWAY FROM ENGINE, GENERATOR, AND COOKING FUEL EXHAUST FUMES.**
- **WASH AREAS THOROUGHLY WITH SOAP AND WATER AFTER HANDLING THE SUBSTANCES ABOVE.**

CALIFORNIA HEALTH & SAFETY CODE §§ 25249.5-.13



BOAT INFORMATION

Please fill out the following information section and leave it in your Scout Owner's Manual. This information will be important for you and Scout service personnel to know, if and when you may need to call Scout for technical assistance or service.

BOAT	
MODEL:	HULL SERIAL #:
PURCHASE DATE:	DELIVERY DATE:
IGNITION KEYS #:	REGISTRATION #:
DOOR KEY #:	OTHER KEYS #:
ENGINES	
MAKE:	MODEL:
PORT SERIAL #:	STARBOARD SERIAL #:
PT CTR SERIAL #:	STBD CTR SERIAL #:
TRAILER	
MAKE:	MODEL:
SERIAL #:	GVRW:
TIRE SIZE:	
GENERATOR	
MAKE:	MODEL:
SERIAL #:	KILOWATTS:
PROPELLERS	
MAKE:	BLADES:
RH DIAMETER/PITCH:	LH DIAMETER/PITCH:
AIR CONDITIONERS	
MAKE:	MODEL:
SERIAL #:	BTU OUTPUT:
SERIAL #:	BTU OUTPUT:
ADDITIONAL EQUIPMENT/NOTES	
DEALER	SCOUT
NAME:	REPRESENTATIVE:
DEALER/PHONE:	SCOUT PHONE:
SALESMAN:	ADDRESS:
SERVICE MANAGER:	
ADDRESS:	
DEALER E- MAIL:	SCOUT E- MAIL:

Scout reserves the right to make changes and improvements in equipment, design and vendored equipment items, at any time without notification.



SPECIFICATIONS



Hull Length Overall _____ 38' 6" / 11.7 m

Beam _____ 12' 1" / 3.7 m

Dry Weight _____ 7,164 lbs / 3,250 kg

Dry Weight W/O Engines (approx) _____ 14,500 lbs / 6,577 kg

Dry Weight W/ Triple Yamaha 350'S (approx) _____ 16,870 lbs / 7,652 kg

Dry Weight W/ Quad Yamaha 300'S (approx) _____ 16,820 lbs / 7,629 kg

Dry Weight W/ Triple Mercury 350'S (approx) _____ 16,504 lbs / 7,486 kg

Dry Weight W/ Quad Mercury 300'S (approx) _____ 17,040 lbs / 7,729 kg

Fuel Tank Capacity _____ 404 gal / 1,529 L

Generator Diesel Fuel Tank Capacity _____ 18 gal / 68 L

Fresh Water Capacity _____ 51 gal / 193 L

Waste Tank _____ 16 gal / 61 L

Baitwell _____ 100 gal / 379 L

Deadrise _____ 20°

Maximum Horsepower _____ 1675 HP / 1250 kw

Draft W/ Engines Up (approx) _____ 27" / 0.7 m

Note: Dry weight is the average weight of the base boat without options, fuel, water, waste, batteries or gear.





CERTIFICATIONS & SPECIFICATIONS

*** For Export Only ***

To be in compliance with European directives for recreational boats as published by the International Organization for Standardization (ISO) in effect at the time this boat was manufactured, we are providing the following information.

Manufacturer:

Name: Scout Boats

Address: 2531 Hwy 78 West

Summerville, South Carolina Zip Code: 29483

Identification Numbers:

Hull Identification Number: _____

Port Engine Serial Number: _____

Starboard Engine Serial Number: _____

Intended Design Category:

Ocean: _____ Inshore: _____

Offshore: X Sheltered Waters: _____

Weight and Maximum Capacities:

Unladen Weight: - Kilograms (Pounds) _____

Maximum Load: - Weight - Kilograms (Pounds) _____

Number of People: _____

Maximum Rated Engine Horsepower - Kilowatts (Horsepower) _____

Certifications:

Certifications & Components Covered: _____



NOTES

Warranty and Warranty Registration Cards

The Scout Limited Warranty Statement is included with your boat. It has been written to be clearly stated and easily understood. If you have any questions after reading the warranty, please contact Scout Customer Service.

Scout, Yamaha Motor Corporation, engine manufacturers, and the suppliers of major components maintain their own manufacturer's warranty and service facilities. It is important that you properly complete the warranty registration cards included with your boat and engines and mail them back to the manufacturers to register your ownership. This should be done within 15 days of the date of purchase and before the boat is put into service. A form for recording this information is provided at the beginning of this manual. This information will be important for you and service personnel to know, if and when you may need service or technical information.

The boat warranty registration requires the Hull Identification Number "HIN" which is located on the starboard side of the transom, just below the rubrail. The engine warranty registration requires the engine serial numbers. Please refer to the engine owner's manual for the location of the serial numbers.

IMPORTANT:

All boat manufacturers are required by the Federal Boat Safety Act of 1971 to notify first time owners in the event any defect is discovered "which creates a substantial risk of personal injury to the public." It is essential that we have your warranty registration card complete with your name and mailing address in our files so that we can comply with the law if it should become necessary.

Product Changes

Scout is committed to the continuous improvement of our boats. As a result, some of the equipment described in this manual or pictured in the catalog may change or no longer be available. Scout reserves the right to change standard equipment, optional equipment and specifications without notice or obligation. If you have questions about the equipment on your Scout, please contact Scout Customer Service.



Typical Hull ID Number on Starboard Transom

Service

All warranty repairs must be performed by an authorized Scout Dealer. Should a problem develop that is related to faulty workmanship or materials, as stated in the Limited Warranty, you should contact your Scout dealer to arrange for the necessary repair. If you are not near your dealer or another authorized Scout dealer or the dealer fails to remedy the cause of the problem, then contact the Scout Customer Service Department within 15 days. It is the boat owner's responsibility to deliver the boat to the dealer for warranty service.

Transferring The Warranty

For an administration fee of \$100, Scout will extend warranty coverage to subsequent owners of Scout models for the duration of the original warranty period. The Limited Warranty may be transferred to any subsequent purchaser of the vessel within seven years from the date of delivery to the original purchaser. Please refer to the Limited Warranty Statement for the procedure to transfer the warranty.

To take advantage of this program, notification of the change of ownership, including the new owner's name, address and telephone number together with the appropriate fee, must be sent

to Scout within 10 days of the date of resale. Scout will confirm, in writing, that the transfer of the warranty has taken place. After which, the transferee will be treated as the original purchaser as outlined in the Scout Boats Limited Warranty Statement.

Yamaha Engine Warranty

Yamaha is ready to stand behind your purchase with strong warranty coverage. To be sure you receive all the benefits of warranty for your engines, please take the following steps:

- Be sure your new Yamaha is registered for warranty. Your boat dealer should do this at the time of sale. Make sure your dealer gives you a copy of the completed Yamaha registration card for your records.
- Read the Yamaha Limited Warranty statement. This warranty applies to Yamaha outboard motors sold in the United States, whether purchased separately or when supplied as original equipment by a boat builder.
- If you need warranty repairs, you must take your Yamaha outboard to an authorized Yamaha outboard dealer.
- If you are away from home, or your selling dealer is not an authorized Yamaha dealer, use the following toll-free numbers to find the nearest Yamaha dealer.

United States Dealer Locations:
800-692-6242

Canada Dealer Locations:
800-267-8577

- Your warranty applies specifically to repairs made in the country of purchase.
- If you need any additional information about your Yamaha or warranty coverage which your dealer cannot provide, please contact Yamaha Directly. Refer to your engine owner's manual for the address and phone number to contact Yamaha directly.



2017

3 YEAR STEM TO STERN (LIMITED) WARRANTY

+

10 YEAR TRANSFERRABLE STRUCTURAL HULL WARRANTY

Scout Boats Inc. has a limited transferable warranty that insures to the purchaser that each hull is free from structural defects in materials and workmanship, (under normal care and use), for a period of **ten (10) years** from the original date of purchase. Scout Boats, Inc. agrees to repair or replace, (at our discretion, based on review and/or observation of the hull in question), to the purchaser, any boats(s) that is found to be defective during the applied warranty period. Scout Boats, Inc. also warrants for a period of **three (3) years** to the original purchaser, that each new hull is free from non-structural defects, (i.e. defective materials and/or workmanship). **During this three year period Scout Boats, Inc. will cover the cost of all parts and accessories manufactured or installed by Scout Boats Inc. during the original manufacturing process. Labor associated with these repairs will be covered for a period of twelve months from the original date of purchase. This warranty excludes engines, trolling motors, batteries, generators, air conditioning systems, electronics, and all related components, which will only be covered by their respective warranties.**

In order to receive warranty service, the selling dealer must register the boat on www.dealerscircle.com, and the purchaser must take his/her boat to an authorized Scout Boats, Inc. dealer. Depending on the nature of the claim, Scout Boats, Inc. may require the boat to be returned to our factory at 2531 Highway 78 West, Summerville, SC 29483, in which case all transportation, haul-out, and/or loading charges shall be prepaid and the sole responsibility of the original purchaser. Scout Boats, Inc. will reimburse up to one half of such transportation charges to the original purchaser upon the discovery of a valid and applicable warranty claim that is a direct result of improper manufacturing processes on the part of Scout Boats, Inc. or one of our suppliers. The original purchaser must remove and reinstall, at his/her own expense, all outboard engines, (if directly related to damage in question), as well as any and all personal effects and electronics equipment. The decision to repair, replace or make reimbursement for a particular boat or part shall be at the discretion of Scout Boats, Inc.

Online registration, a bill of sale, or proof-of-purchase demonstrating individual in question as the purchaser, along with a proof of customer's identity, is required before warranty service can be rendered.

Scout Boats, Inc. does not warrant: (1) any Scout Boat which has been powered or loaded in excess of the manufacturer's maximum horsepower or capacity recommendations. The maximum horsepower and capacity recommendations are shown on the certification plate affixed to every boat. (2) Any Scout Boat used in or for racing (of any type, organized or not), commercial fishing, chartering or other commercial use. (3) Any Scout Boat which has been subject to misuse, neglect, or structural alterations. (4) Gelcoat cracking, crazing, bubbling, or blistering. (5) Excessive wear due to unprotected and/or over exposure to the elements. **(6) Any fuses, bulbs, switches or the failure of any electrical component due to corrosion.** (7) Any boat that has been deemed to have been misused neglected or re-powered by anyone other than the original purchaser. (8) Any Scout Boat sold to a customer, (who happens to be the original owner), by anyone other than an authorized Scout Boats, Inc. dealer. (9) Any Scout Boat that has been used on a trailer that does not adequately support the hull or any trailer that may be considered undersized, including any and all roller type trailers. (10) Any Scout Boat with a jack plate installed by anyone other than Scout boats, Inc., or an authorized dealer, or on any hull other than the 191, 201, 221, or 251 models. Any Scout Boat with a jack plate of 8" or greater. (11) Any part or component not manufactured directly by Scout Boats, Inc. after the first three years of this warranty policy, (three years from date of purchase), will only have that particular manufacturer's warranty available.

Scout Boats, Inc. reserves the right to improve its product through changes in design or material without obligation to incorporate such changes on boats built prior to the implementation of respected change(s).



SCOUT LIMITED WARRANTY



This warranty is in lieu of any other warranty implied or expressed. Scout Boats, Inc. accepts no responsibility for any representations, acts, or omissions of its dealer relating to the preparation and/or sale of Scout Boats, Inc. products to original consumer. This warranty is transferable, and to do so the original owner or purchaser must download a copy of the warranty transfer form from www.scoutboats.com from the warranty section of the website and mail it to Scout Boats, Inc. within 10 days of sale of his/her boat to the new owner. A notarized bill of sale and a \$100 administration fee payable to Scout Boats, Inc. must also be included with the notification of customer's intent to re-sell his/her boat.

Please mail to 2531 Hwy. 78 West, Summerville, SC 29483

❖ *By signing below I do hereby agree that I have read this Warranty Policy and do fully understand the terms and procedures listed within. I also attest and agree that my dealer, (listed below), has gone over this policy in full detail and has answered all of my questions regarding this policy and how it applies and has registered my boat online at www.dealerscircle.com.*

Customer _____ Date _____

❖ *By signing below the dealership representative hereby agrees that the status of this boat has been changed to "delivered" on Dealer's Circle, in order for warranty to go into effect.*

Dealership Representative _____ Date _____

You must mail the original signed copy of this agreement to Scout Boats Inc. at 2531 Highway 78 West; Summerville, SC 29483 and log on to www.dealerscircle.com to complete the warranty registration process.

WARRANTY WILL BE NULL AND VOID UNLESS THE BOAT IS REGISTERED ONLINE AT WWW.DEALERSCIRCLE.COM AND THE ORIGINAL SIGNED COPY OF THIS WARRANTY AGREEMENT IS RECEIVED BY SCOUT BOATS INC. WITHIN 30 DAYS OF THE POINT OF SALE!!!

Hull Identification Number: **SLP** _____
(located on the top right side of transom, under the rub rail)

Owner's Name: _____ Date: _____

Address: _____

City: _____ State: _____ Zip: _____

Email: _____ Phone: _____

Date of Purchase: _____

Dealership: _____

Salesman's Name: _____

Dealership Address: _____

Brand of Engine: _____ Horsepower: _____

Scout (white) Customer (yellow) Dealer (pink)





The Power of Innovation

WARRANTY REGISTRATION TRANSFER

DATE _____

HULL IDENTIFICATION NO. SLP _____

DATE OF PURCHASE _____

NEW OWNER'S NAME _____

ADDRESS _____

CITY _____ STATE _____ ZIP _____

EMAIL _____ PHONE _____

BRAND OF ENGINE _____ HORSEPOWER _____

I agree to the warranty terms and conditions pursuant to my particular model year boat.

SIGNATURE

PREVIOUS OWNER'S NAME _____

ADDRESS _____

CITY _____ STATE _____ ZIP _____

EMAIL _____ PHONE _____

ORIGINAL DATE OF PURCHASE _____

DEALER WHERE BOAT WAS ORIGINALLY PURCHASED _____

<p>→ There is a \$100.00 fee payable to Scout Boats. Fee covers official transfer and documentation of the warranty.</p> <p>Send CHECK or MONEY ORDER with a completed copy of this form along with a copy of the notarized BILL OF SALE. All information must be provided in order to transfer the warranty.</p>	<p>SEND PAYMENT & FORM TO:</p> <p>Scout Boats, Inc. Warranty Transfer Dept. 2531 Highway 78 West Summerville SC 29483</p>
<p>PHONE: 843.821.0068</p>	<p>www.scoutboats.com</p>

NOTES

Safety Information

1.1 General

Your boat and outboard engines have been equipped with safety equipment designed to enhance the safe operation of the boat and to meet U.S. Coast Guard safety standards. The Coast Guard or state, county and municipal law enforcement agencies require certain additional accessory safety equipment on each boat. This equipment varies according to length and type of boat and type of propulsion. The accessory equipment typically required by the Coast Guard is described in this chapter. Some local laws require additional equipment. It is important to obtain "Federal Requirements And Safety Tips for Recreational Boats," published by the Coast Guard and copies of state and local laws, to make sure you have the required equipment for your boating area.

Your boat is equipped with engine alarms. The alarm systems are designed to increase your boating safety by alerting you to potentially serious problems in the primary power system. Alarm systems are not intended to lessen or replace good maintenance and pre-cruise procedures.

This chapter also describes safety related equipment that could be installed on your boat. This equipment will vary depending on the type of engines and other options installed by you or your dealer.

1.2 Engine Alarms

Most outboard engines are equipped with an audible alarm system mounted in the helm area that monitors selected critical engine systems. The alarm will sound if one of these systems begins to fail. Refer to the engine owner's manual for information on the alarms installed with your engines.

If the alarm sounds:

- Immediately throttle the engines back to idle.
- Shift the transmissions to neutral.
- Monitor the engine gauges to determine the cause of the problem.



- If necessary, shut off the engine and investigate until the cause of the problem is found.

1.3 Neutral Safety Switch

Every control system has a neutral safety switch incorporated into it. This device prohibits the engines from being started while the shift levers are in any position other than the neutral position. If an engine will not start, slight movement of the shift lever may be necessary to locate the neutral position and disengage the safety cutout switch. Control adjustments may be required to correct this condition should it persist. See your Scout dealer for necessary control adjustments. Refer to the Helm Control Systems chapter for more information on the neutral safety switch.

1.4 Engine Stop Switch

Your boat is equipped with a engine stop switch and lanyard. When the lanyard is pulled it will engage the switch and shut off the engines. We strongly recommend that the lanyard be attached to the driver and stop switch whenever the engines are running. If the engines will not start, it could be because the lanyard is not properly inserted into the engine stop switch. Always make sure the lanyard is properly attached to the engine stop switch before attempting to start the engine.

Notice:

In some states, a lanyard attached to the driver at all times is required by law.

Notice:

You should carry an extra stop switch lanyard and instruct at least one other crew member on the operation of the stop switch and location of the extra lanyard.

1.5 Required Safety Equipment

Besides the equipment installed on your boat by Scout, certain other equipment is required by the U.S. Coast Guard to help ensure passenger safety. Items like a sea anchor, working anchor, extra dock lines, flare pistol, life vests, a line permanently secured to your ring buoy, etc., could at some time save your passengers' lives or save your boat from damage. Refer to the "Federal Requirements And Safety Tips For Recreational Boats" pamphlet for a more detailed description of required equipment. You also can visit the U.S. Coast Guard Boating Safety web site, www.uscgboating.org, for information on boat safety courses and brochures listing the Federal equipment requirements. Also, check your local and state regulations.

The Coast Guard Auxiliary offers a "Courtesy Examination." This inspection will help ensure that your boat is equipped with all of the necessary safety equipment. The following is a list of the accessory equipment required on your boat by the U.S. Coast Guard:

Personal Flotation Devices (PFDs)

PFDs must be Coast Guard approved, in good and serviceable condition and of appropriate size for the intended user. Wearable PFDs must be readily accessible, meaning you must be able to put them on in a reasonable amount of time in an emergency. Though not required, the Coast Guard emphasizes that PFDs should be worn at all times when the vessel is underway. Throwable devices must be immediately available for use. All Scout boats must be equipped with at least one Type I, II or III PFD for each person on board, plus one throwable device (Type IV).

Notice:

Many state laws now require that children 13 years old and under must wear a PFD at all times.

Anyone being towed on skis, wakeboards and other water sports equipment is considered a passenger on the boat and must wear a Coast Guard approved life jacket at all times.



Visual Distress Signals

All boats used on coastal waters, the Great Lakes, territorial seas and those waters connected directly to them, must be equipped with Coast Guard approved visual distress signals. These signals are either Pyrotechnic or Non-Pyrotechnic devices.

Pyrotechnic Visual Distress Signals:

Pyrotechnic visual distress signals must be Coast Guard approved, in serviceable condition and readily accessible. They are marked with a date showing the service life, which must not have expired. A minimum of three are required. Some pyrotechnic signals meet both day and night use requirements. They should be stored in a cool, dry location. They include:

- Pyrotechnic red flares, hand held or aerial.
- Pyrotechnic orange smoke, hand-held or floating.
- Launchers for aerial red meteors or parachute flares.

 **WARNING** 

PYROTECHNICS ARE UNIVERSALLY RECOGNIZED AS EXCELLENT DISTRESS SIGNALS. HOWEVER, THERE IS POTENTIAL FOR INJURY AND PROPERTY DAMAGE IF NOT PROPERLY HANDLED. THESE DEVICES PRODUCE A VERY HOT FLAME AND THE RESIDUE CAN CAUSE BURNS AND IGNITE FLAMMABLE MATERIAL. PISTOL LAUNCHED AND HAND-HELD PARACHUTE FLARES AND METEORS HAVE MANY CHARACTERISTICS OF A FIREARM AND MUST BE HANDLED WITH CAUTION. IN SOME STATES THEY ARE CONSIDERED A FIREARM AND PROHIBITED FROM USE. ALWAYS BE EXTREMELY CAREFUL AND FOLLOW THE MANUFACTURER'S INSTRUCTIONS EXACTLY WHEN USING PYROTECHNIC DISTRESS SIGNALS.

Non-Pyrotechnic Devices

Non-Pyrotechnic visual distress signals must be in serviceable condition, readily accessible and certified by the manufacturer as complying with U.S. Coast Guard requirements. They include:

- Orange Distress Flag (Day use only)
The distress flag is a day signal only. It must be at least 3 x 3 feet with a black square and ball on an orange background. It is most distinctive when attached and waved from a paddle or boat hook.

- Electric Distress Light (Night use only)
The electric distress light is accepted for night use only and must automatically flash the international SOS distress signal. Under "Inland Navigation Rules," a high intensity white light flashing at regular intervals from 50-70 times per minute is considered a distress signal.

Sound Signaling Devices

The navigation rules require sound signals to be made under certain circumstances. Recreational vessels also are required to sound fog signals during periods of reduced visibility. Therefore, you must have some means of making an efficient sound signal.

Navigation Lights

Recreational boats are required to display navigation lights between sunset and sunrise and other periods of reduced visibility (fog, rain, haze, etc.) Navigation lights are intended to keep other vessels informed of your presence and course. Your boat is equipped with navigation lights required by the U.S. Coast Guard at the time of manufacture. It is up to you to make sure they are operational and turned on when required.

Fire Extinguishers

Your boat is required to have two Marine Type USCG approved fire extinguishers. Coast Guard approved fire extinguishers are hand-portable, either B-I or B-II classification and have a specific marine type mounting bracket. It is recommended that the extinguishers be mounted in a readily accessible position.



Fire extinguishers require regular inspections to ensure that:

- Seals & tamper indicators are not broken or missing.
- Pressure gauges or indicators read in the operable range.
- There is no obvious physical damage, corrosion, leakage or clogged nozzles.

Refer to the "Federal Requirements And Safety Tips For Recreational Boats" pamphlet or visit the U.S. Coast Guard Boating Safety web site, www.uscgboating.org, for information on the type and size fire extinguisher required for your boat.

Refer to the information provided by the fire extinguisher manufacturer for instructions on the proper maintenance and use of your fire extinguisher.

	CAUTION	
<p>INFORMATION FOR HALON, AGENT FE-241 AND AGENT FM 200 FIRE EXTINGUISHERS IS PROVIDED BY THE MANUFACTURER. IT IS ESSENTIAL THAT YOU READ THE INFORMATION CAREFULLY AND COMPLETELY UNDERSTAND THE SYSTEM, IN THEORY AND OPERATION, BEFORE USING YOUR BOAT.</p>		

1.6 Bilge & Fuel Fires

Fuel compartment and bilge fires are very dangerous because of the presence of gasoline in the various components of the fuel system and the possibility for explosion. You must make the decision to fight the fire or abandon the boat. If the fire cannot be extinguished quickly or it is too intense to fight, abandoning the boat may be your only option. If you find yourself in this situation, make sure all passengers have a life preserver on and go over the side and swim well upwind of the boat. This will keep you and your passengers well clear of any burning fuel that could be released and spread on the water as the boat burns or in the event of an explosion. When clear of the danger, check about and account for all those who were aboard with you. Give whatever assistance you can to anyone in need or in the water without a buoyant device. Keep everyone together in a group for morale and to aid rescue operations.

	WARNING	
<p>GASOLINE CAN EXPLODE. IN THE EVENT OF A FUEL COMPARTMENT OR BILGE FIRE, YOU MUST MAKE THE DIFFICULT DECISION TO FIGHT THE FIRE OR ABANDON THE BOAT. YOU MUST CONSIDER YOUR SAFETY, THE SAFETY OF YOUR PASSENGERS, THE INTENSITY OF THE FIRE AND THE POSSIBILITY OF AN EXPLOSION IN YOUR DECISION.</p>		

1.7 Carbon Monoxide Monitoring System

DANGER

CARBON MONOXIDE IS COLORLESS, ODORLESS AND DANGEROUS. ALL ENGINES, GENERATORS AND FUEL BURNING APPLIANCES EXHAUST CARBON MONOXIDE (CO). DIRECT AND PROLONGED EXPOSURE TO CO WILL CAUSE BRAIN DAMAGE OR DEATH. SIGNS OF EXPOSURE TO CO INCLUDE NAUSEA, DIZZINESS AND DROWSINESS.

The carbon monoxide (CO) detector is installed in the cabin as standard equipment and warns the occupants of dangerous accumulations of carbon monoxide gas. If excess carbon monoxide fumes are detected, the detector will sound an alarm indicating the presence of the toxic gas.

Should a very high level of carbon monoxide exist, the alarm will sound in a few minutes. However, if small quantities of CO are present or high levels are short-lived, the alarm will accumulate the information and determine when an alarm level has been reached.

The carbon monoxide detector is automatically activated whenever the House battery is connected. The power light on the carbon monoxide detector should be lit to indicate that the carbon monoxide detector is activated.

Always make sure the power light on the carbon monoxide detector is lit whenever the cabin is occupied.

A by-product of combustion, carbon monoxide (CO) is invisible, tasteless, odorless and is produced by all engines, heating and cooking appliances. The most common sources of CO on boats are the engines, auxiliary generators and propane or butane stoves. These produce large amounts of CO and should never be operated while sleeping.

A slight buildup of carbon monoxide over several hours causes headache, nausea and other symptoms that are similar to food poisoning, motion sickness or flu. High concentrations can be fatal within minutes. Many cases of carbon monoxide poisoning indicate that while victims are aware they are not well, they become so disoriented they are unable to save themselves by either exiting the area or calling for help. Also, young children, elderly persons and pets may be the first affected.



Typical Carbon Monoxide Detector

Drug or alcohol use increases the effect of CO exposure. Individuals with cardiac or respiratory conditions are very susceptible to the dangers of carbon monoxide. CO poisoning is especially dangerous during sleep when victims are unaware of any side effects. The following are symptoms which may signal exposure to CO: (1) Headache (2) Tightness of chest or hyperventilation (3) Flushed face (4) Nausea (5) Drowsiness (6) Fatigue or Weakness (7) Inattention or confusion (8) Lack of normal coordination.

Persons who have been exposed to carbon monoxide should be moved into fresh air immediately. Have the victim breathe deeply and seek immediate medical attention. To learn more about CO poisoning, contact your local health authorities.

Low levels of carbon monoxide over an extended period of time can be just as lethal as high doses over a short period. Therefore, low levels of carbon monoxide can cause the alarm to sound before the occupants of the boat notice any symptoms of carbon monoxide poisoning. CO detectors are very reliable and rarely sound false alarms. If the alarm sounds, always assume the hazard is real and move persons who have been exposed



Typical First Aid Kit

to carbon monoxide into fresh air immediately. Never disable the CO detector because you think the alarm may be false. Always contact the detector manufacturer or your local fire department for assistance in finding and correcting the situation.

Remember, carbon monoxide detectors do not guarantee that CO poisoning will not occur. Do not use the CO detector as a replacement for ordinary precautions or periodic inspections of equipment. Never rely on alarm systems to save your life, common sense is still prudent and necessary.

You should read the owner's manual supplied by the CO detector manufacturer and included with this manual for operation instructions and additional information regarding the hazards of carbon monoxide gas. Refer to the Ventilation System chapter for information on ventilating your boat properly while underway and other precautions while at anchor or in a slip. This is especially essential if your boat is equipped with the generator.

Many manufacturers of carbon monoxide detectors offer a testing and recertification program. We recommend that you contact the manufacturer of your carbon monoxide detector and have it tested and recertified periodically.

1.8 First Aid

It is the operator's responsibility to be familiar with the proper first-aid procedures and be able to care for minor injuries or illnesses of your passengers. In an emergency, you could be far from professional medical assistance. We strongly recommend that you be prepared by receiving training in basic first aid and CPR. This can be done through classes given by the Red Cross or your local hospital.

Your boat should also be equipped with at least a simple marine first-aid kit and a first-aid manual. The marine first-aid kit should be designed for the marine environment and be well supplied. It should be accessible and each person on board should be aware of its location. As supplies are used, replace them promptly. Some common drugs and antiseptics may lose their strength or become unstable as they age. Ask a medical professional about the supplies you should carry and the safe shelf life of prescription drugs or other medical supplies that may be in your first-aid kit. Replace questionably old supplies whether they have been used or not.

In many emergency situations, the Coast Guard can provide assistance in obtaining medical advice for treatment of serious injuries or illness. If you are within VHF range of a Coast Guard Station, make the initial contact on channel 16 and follow their instructions.

1.9 Additional Safety Equipment

Besides meeting the legal requirements, prudent boaters carry additional safety equipment. This is particularly important if you operate your boat offshore. You should consider the following items, depending on how you use your boat.

Satellite EPIRBs

EPIRBs (Emergency Position Indicating Radio Beacon) operate as part of a worldwide distress system. When activated, EPIRBs will send distress code homing beacons that allow Coast Guard aircraft to identify and find them quickly. The satellites that receive and relay EPIRB signals are operated by the National Oceanic and Atmospheric Administration (NOAA) in the United States. The EPIRB should be mounted and registered according to the instructions provided with the beacon, so that the beacon's unique distress code can be used to quickly identify the boat and owner.

Marine Radio

A marine radio is the most effective method of receiving information and requesting assistance. VHF marine radios are used near shore and single sideband radios are used for long range communication.

There are specific frequencies to use in an emergency. The VHF emergency channel is 16 in the United States. You should read the owners manual for your radio and know how to use it in an emergency or for normal operation. If you hear a distress call you should assist or monitor the situation until help is provided.

Additional Equipment to Consider:

Cell Phone	Spare Anchor
Fenders	Heaving Line
Mirror	First Aid Kit
Tool Kit	Flashlight & Batteries
Anchor	Search light
Boat Hook	Sunburn Lotion
Mooring Lines	Ring Buoy or Boat Cushion
Binoculars	Whistle or Horn
Extra Clothing	Portable Radio
Chart and Compass	Marine Hardware
Food & Water	Spare Keys
Sunglasses	Spare Parts
Spare Propellers	Spare Propeller Hub Kits

1.10 Caution & Warning Labels

The caution and warning labels shown are examples of the labels that could be on your boat. The actual labels and their location could vary on your boat.

Caution and warning labels must remain legible for the safety of you and your passengers. If a label becomes missing or damaged it must be replaced. Immediately contact your dealer or Scout Customer Service for a replacement.

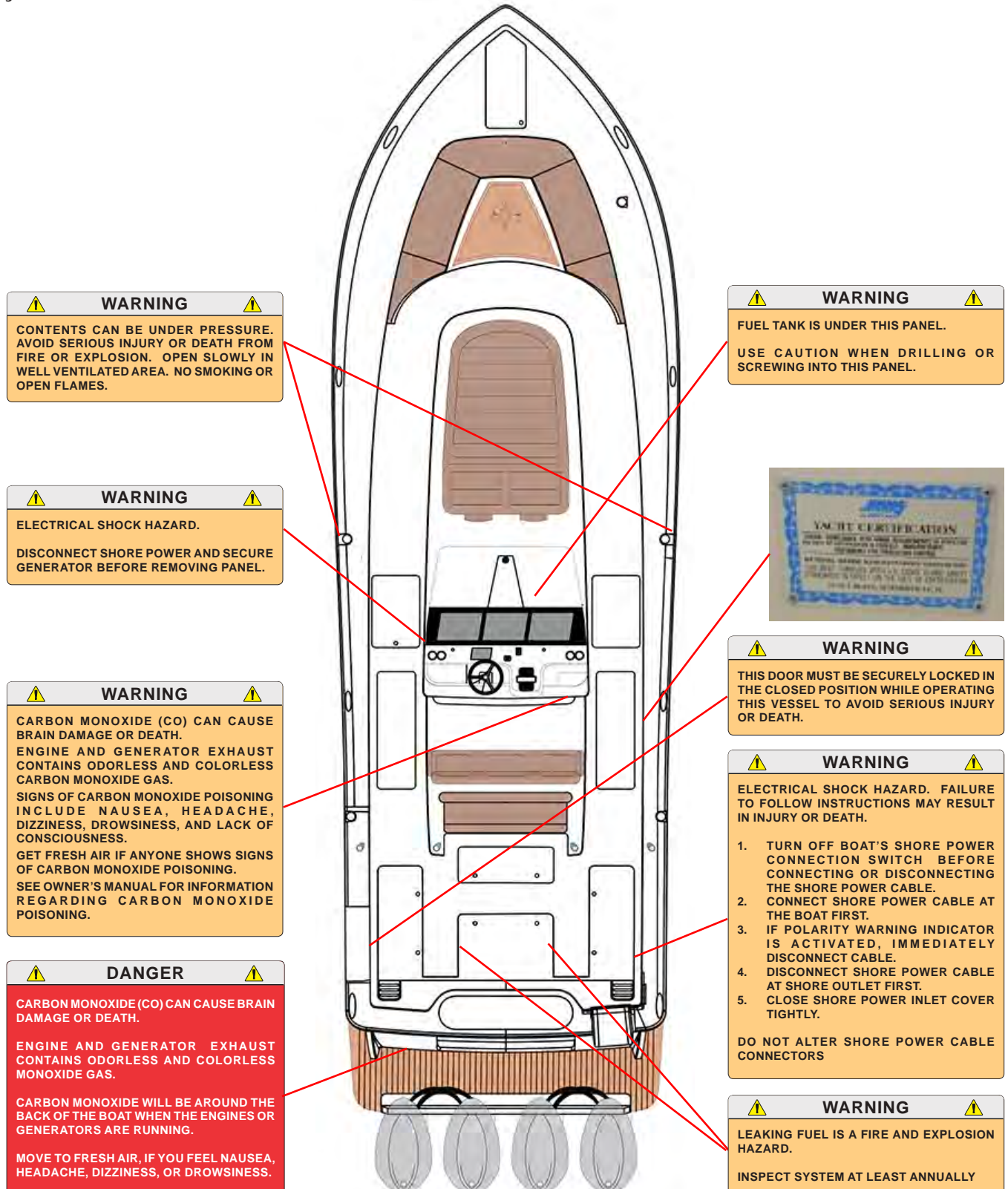

NOTES

2.1 General

Before you start the engines on your Scout, you should have become familiar with the various component systems and their operation and have performed a "Pre-Cruise System Check." A thorough understanding of the component systems and their operation is essential to the proper operation of the boat. This manual and the associated manufacturers' information is provided to enhance your knowledge of your boat. Please read them carefully.

Your boat must have the necessary safety equipment on board and be in compliance with the U.S. Coast Guard, local and state safety regulations. There should be one Personal Flotation Device (PFD) for each person. Non-swimmers and small children should wear PFDs at all times. You should know and understand the "Rules of the Road" and have had an experienced operator brief you on the general operation of your new boat. At least one other person should be instructed on the proper operation of the boat in case the operator is suddenly incapacitated.

The operator is responsible for his safety and the safety of his passengers. When boarding or loading the boat, always step onto the boat, never jump. All passengers should be properly seated whenever the boat is operated above idle speed. Your passengers should not be allowed to sit on the seat backs, gunnels, bows or transoms whenever the boat is underway. The passengers should also be seated to properly balance the load and must not obstruct the operator's view, particularly to the front.

Overloading and improper distribution of weight can cause the boat to become unstable and are significant causes of accidents. Know the weight capacity and horsepower rating of your boat. Do not overload or overpower your boat.

You should be aware of your limitations and the limitations of your boat in different situations or sea conditions. No boat is indestructible, no matter how well it is constructed. Any boat can be severely damaged if it is operated in a manner that exceeds its design limitations. If the ride is hard on you and your passengers, it is hard on the

boat as well. Always modify the boat speed in accordance with the sea conditions, boat traffic and weather conditions.

Remember, it is the operator's responsibility to use good common sense and sound judgement in loading and operating the boat.

2.2 Rules of the Road

As in driving an automobile, there are a few rules you must know for safe boating operation. The following information describes the basic navigation rules and action to be taken by vessels in crossing, meeting or overtaking situations while operating in inland waters. These are basic examples and not intended to teach all the rules of navigation. For further information consult the "Navigation Rules" or contact the Coast Guard, Coast Guard Auxiliary, Department of Natural Resources or your local boat club. These organizations sponsor courses in boat handling, including rules of the road. We strongly recommend such courses. Books or videos on this subject also are available from your local library.

Notice:

Sailboats not under power, paddle boats, vessels unable to maneuver, vessels engaged in commercial fishing and other vessels without power have the right-of-way over motor powered boats. You must stay clear or pass to the stern of these vessels. Sailboats under power are considered motor boats.

Crossing Situations

When two motor boats are crossing, the boat on the right has the right-of-way. The boat with the right-of-way should maintain its course and speed. The other vessel should slow down and permit it to pass. The boats should sound the appropriate signals.

Meeting Head-On or Nearly-So Situations

When two motor boats are approaching each other head-on or nearly head-on, neither boat has the right-of-way. Both boats should reduce their speed and turn to the right so as to pass port side to port side, providing enough clearance for safe passage. The boats should sound the appropriate signals.

Overtaking Situations

When one motor boat is overtaking another motor boat, the boat that is being passed has the right-of-way. The overtaking boat must make the adjustments necessary to provide clearance for a safe passage of the other vessel. The boats should sound the appropriate signals.

The General Prudential Rule

In obeying the Rules of the Road, due regard must be given to all dangers of navigation and collision and to any special circumstances, including the limitations of the vessels, which may justify a departure from the rules that is necessary to avoid immediate danger or a collision.

Night Operation

Recreational boats are required to display navigation lights between sunset and sunrise and other periods of reduced visibility such as fog, rain, haze, etc. When operating your boat at night you should:

- Make sure your navigation lights are on and working properly. Navigation lights warn others of your position and course and the position and course of other vessels.
- All navigation rules apply. If the bow light of another vessel shows red, you should give way to that vessel, if it shows green, you have the right-of-way.
- Slow down and never operate at high speeds when operating at night, stay clear of all boats and use good common sense. Always be ready to slow down or steer clear of other vessels, even if you have the right-of-way.
- Avoid bright lights that can destroy night vision, making it difficult to see navigation lights and the lights of other boats. You and your passengers should keep a sharp lookout for hazards, other boats and navigational aids.

Navigation Aids

Aids to navigation are placed along coasts and navigable waters as guides to mark safe water and to assist mariners in determining their position in relation to land and hidden dangers. Each aid to navigation is used to provide specific information. You should be familiar with these and any other markers used in your boating area.

Notice:

Storms and wave action can cause buoys to move. You should not rely on buoys alone to determine your position.

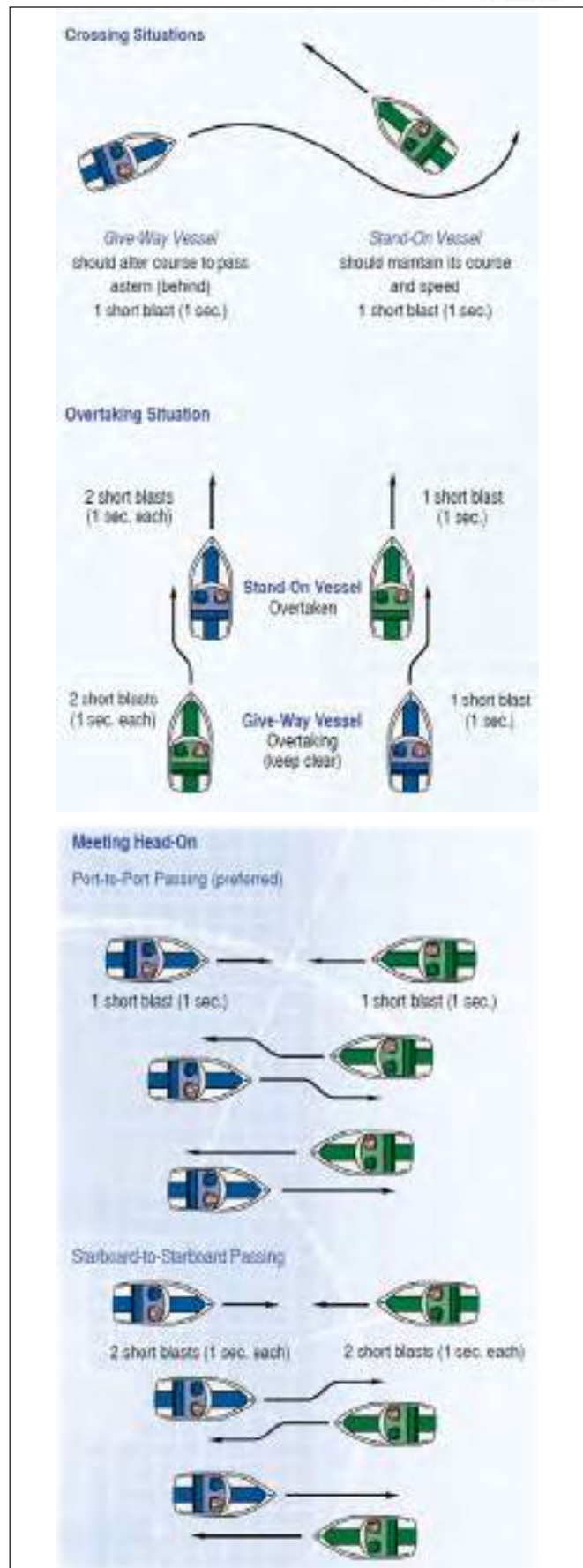

Navigational Aids Chart

REMEMBER THESE RULES

1. OVERTAKING - PASSING: Boat being passed has the right-of-way. KEEP CLEAR.
2. MEETING HEAD ON: Keep to the right.
3. CROSSING: Boat on right has the right-of-way. Slow down and permit boat to pass.

← PORT

Yield right-of-way to boats in your DANGER ZONE!

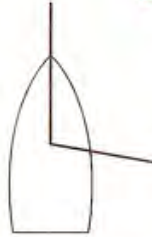

STARBOARD →

DANGER ZONE (Dead ahead to 2 points abeam your starboard beam)

STORM WARNINGS



RED FLAG
Small craft (winds up to 33 knots)



2 RED FLAGS
Gale (winds up to 47 knots)



SQUARE RED FLAG
BLACK BOX (Storm)



2 SQUARE RED FLAGS
BLACK BOX (Hurricane)

WHISTLE SIGNALS

- ONE LONG BLAST: Warning signal (Coming out of slip)
- ONE SHORT BLAST: Pass on my port side
- TWO SHORT BLASTS: Pass on my starboard side
- THREE SHORT BLASTS: Engine(s) in reverse
- FOUR OR MORE BLASTS: Danger signal

BRIDGE SIGNALS

SOUND

- VESSEL: Open
- BRIDGE: OK
- No
- VESSEL: Replies:
- RADIO: VHF CH. 13

VISUAL

- VESSEL: Open
- BRIDGE: OK
- No
- DAY (Flag)
- NIGHT (Lights)
- Same
- or Same

LATERAL AIDS AS SEEN ENTERING FROM SEAWARD

**PORT SIDE
ODD NUMBERED AIDS**

- GREEN LIGHT ONLY
- FLASHING
- OCCULTING
- QUICK FLASHING
- ISOPHASE

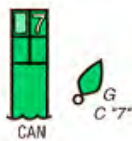

**SAFE WATER MID-CHANNELS OR FAIRWAYS
NO NUMBERS — MAY BE LETTERED**

- WHITE LIGHT ONLY
- MORSE CODE
- Mo (A)

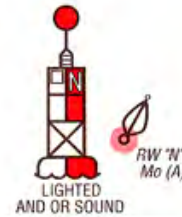

PREFERRED CHANNEL

NO NUMBERS — MAY BE LETTERED

- COMPOSITE GROUP FLASHING (2 + 1)

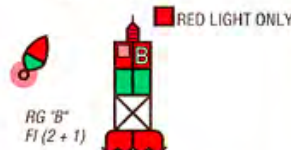
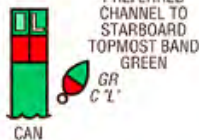
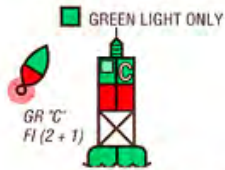

**STARBOARD SIDE
EVEN NUMBERED AIDS**

- RED LIGHT ONLY
- FLASHING
- OCCULTING
- QUICK FLASHING
- ISOPHASE

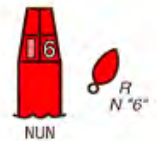
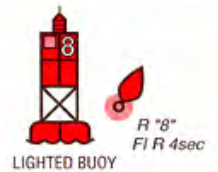

2.3 Pre-Cruise Check

Before Starting the Engines:

- Check the weather forecast and sea conditions before leaving the dock. Decide if the planned cruise can be made safely.
- Be sure all required documents are on board.
- Be sure all necessary safety equipment is on board and operative. This should include items like the running lights, spotlight, life saving devices, etc. Refer to the Safety Equipment chapter for additional information on safety equipment.
- Make sure you have signal kits and flare guns aboard and they are current and in good operating condition.
- Be sure you have sufficient water and other provisions for the planned cruise.
- Leave a written message listing details of your planned cruise with a close friend ashore (Float Plan). The float plan should include a description of your boat, where you intend to cruise and a schedule of when you expect to arrive in the cruising area and when you expect to return. Keep the person informed of any changes in your plan to prevent false alarms. This information will tell authorities where to look and the type of boat to look for in the event you fail to arrive.
- Check the amount of fuel on board. Observe the "Rule of Thirds": one third of the fuel for the trip out, one third to return and one third in reserve. An additional 15% may be consumed in rough seas.
- Check the water separating fuel filters for leaks or corrosion.
- Check the crankcase oil level in each engine.
- Turn the battery switches on.
- Check the bilge water level. Look for other signs of potential problems. Monitor for the scent of fuel fumes.
- Test the automatic and manual bilge pump switches to make sure the systems are working properly. This is particularly important before running offshore.

- Have a tool kit aboard. The kit should include the following basic tools:

Hammer	Electrician's tape
Screwdrivers	Offset screwdrivers
Lubricating oil	Pliers
Jackknife	Adjustable wrench
Basic 3/8" ratchet set	Vise grip pliers
Hex key set	Needle nose pliers
Wire crimping tool	Wire connector Set
End wrench set	Medium slip-joint pliers
Diagonal cutting pliers	DC electrical test light



WARNING



THERE MUST BE AT LEAST ONE PERSONAL FLOTATION DEVICE ON BOARD FOR EVERY PERSON ON BOARD AND ONE THROW-OUT FLOTATION DEVICE. CHECK THE U.S. COAST GUARD STANDARDS FOR THE CORRECT TYPE OF DEVICE FOR YOUR BOAT.

- Have the following spare parts on board:

Extra light bulbs	Spark plugs
Fuses and circuit breakers	Main 12 volt fuses
Assorted stainless screws	Assorted stainless bolts
Flashlight and batteries	Drain plugs
Engine oil	Propellers
Fuel filters	Propeller hub kits
Fuel hose and clamps	Wire ties
Assorted hose clamps	Hydraulic steering fluid
Spare bilge pump	Rags
- Make sure all fire extinguishers are in position and in good operating condition.
- Check the engine and steering controls for smooth and proper operation. Be sure the shift controls are in the neutral position.
- Be sure the emergency stop lanyard is attached to the operator and the stop switch.
- Refer to the engine owner's manual for pre-operation checks specific to your engines.

2.4 Operating Your Boat

After Starting the Engines:

- Visibly check the engines to be sure there are no apparent water, fuel or oil leaks.
- Check the operation of the engine cooling systems by monitoring the water flowing from the bypass ports.
- Check the engine gauges. Make sure they are reading normally.
- Check the controls and steering for smooth and proper operation.
- Make sure all lines, cables, anchors, etc. for securing a boat are on board and in good condition. All lines should be coiled, secured and off the decks when underway.
- Have a safe cruise and enjoy yourself.

Remember:



When you operate a boat, you accept the responsibility for the boat, for the safety of passengers and for others out enjoying the water.

- Alcohol and any drugs can severely reduce your reaction time and affect your better judgement.
- Alcohol severely reduces the ability to react to several different signals at once.
- Alcohol makes it difficult to correctly judge speed and distance or track moving objects.
- Alcohol reduces night vision and the ability to distinguish red from green.

	WARNING	
YOU SHOULD NEVER OPERATE YOUR BOAT WHILE UNDER THE INFLUENCE OF ALCOHOL OR DRUGS.		

- Make sure one other person on the boat is instructed in the operation of the boat.
- Make sure the boat is operated in compliance with all state and local laws governing the use of a boat.

	WARNING	
DO NOT OPERATE THE BOAT UNLESS IT IS COMPLETELY ASSEMBLED. KEEP ALL FASTENERS TIGHT. KEEP ADJUSTMENTS ACCORDING TO SPECIFICATIONS.		

	WARNING	
FAILURE TO FOLLOW THE BREAK-IN PROCEDURE MAY RESULT IN REDUCED ENGINE LIFE OR EVEN SEVERE ENGINE DAMAGE IN YOUR OUTBOARD ENGINES. MAKE SURE YOU FOLLOW THE BREAK-IN PROCEDURE EXACTLY.		

- If equipped, always operate the blower whenever the generator is running to remove fumes and help cool the equipment compartment.
- Avoid sea conditions that are beyond the skill and experience of you and your crew. Learn to understand weather patterns and indications for change. You should monitor NOAA weather broadcasts before leaving port and periodically while boating. If the weather deteriorates or a storm approaches, seek shelter in a safe harbor.
- Use caution during periods of reduced visibility due to weather or operation conditions. Reduce speed and designate a passenger to be a lookout for other boats, obstacles and navigational markers until you reach port or conditions improve.
- Your Scout is a heavy boat that will produce a large wake at certain speeds. You are responsible for damage and injury caused by your boat's wake. Always observe no wake zones and be aware that your wake can endanger small vessels and their passengers. Always be courteous and slow down to reduce your wake when passing smaller boats.
- Before operating the boat for the first time, read the engine break-in procedures. The break-in procedures are found in the owner's manual for the engines. The manual is in the literature packet.

- As different types of engines are used to power the boat, have the dealer describe the operating procedures for your boat. For more instructions on "How To Operate The Boat," make sure you read the instructions given to you in the owner's manual for the engines you have selected.

Notice:

For more instructions on safety, equipment and boat handling, enroll in one of the several free boating courses offered. For information on courses offered in your area go to the U.S. Coast Guard Boating Safety web site at www.uscgboating.org.

Notice:

If the running gear hits an underwater object, stop the engines. Inspect the propulsion system for damage. If the system is damaged, contact your dealer for a complete inspection and repair of the unit.

To stop the boat, follow this procedure:

- Allow the engines to drop to the idle speed.
- Make sure the shifting levers are in the neutral position.

Notice:

If the engines have been run at high speed for a long period of time, allow the engines to cool down by running the engines in the idle position for 3 to 5 minutes.

- Turn the ignitions to the "OFF" position.
- Raise the trim tabs to the full up position.

After Operation:

- If operating in saltwater, wash the boat and all equipment with soap and water. Flush the engines using freshwater. Refer to the engine owner's manual for instructions on flushing your outboard engines.
- Check the bilge area for debris and excess water.
- Fill the fuel tank to near full to reduce condensation. Allow enough room in the tank for the fuel to expand without being forced out through the vent.

- Turn off all electrical equipment except the automatic bilge pumps.
- If you are going to leave the boat for a long period of time, put the battery main switches in the "Off" position and close all seacocks.
- Make sure the boat is securely moored.

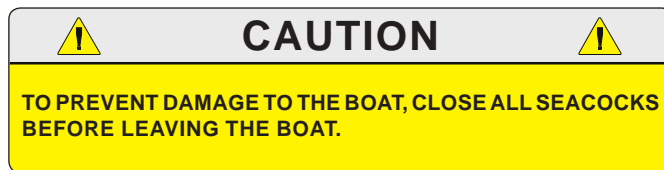

2.5 Docking, Anchoring & Mooring

Docking and Dock Lines

Maneuvering the boat near the dock and securing the boat requires skill and techniques that are unique to the water and wind conditions and the layout of the dock. If possible, position a crew member at the bow and stern to man the lines and assist in docking operations. While maneuvering close to the dock, consideration must be given to the wind and current. You should anticipate the effect these forces will have on the boat and use them to help put the boat where you want it. It is important to practice in open water using an imaginary dock enough to develop a sense for the way your boat handles in a variety of docking scenarios. You must be able to foresee the possibilities and have solutions in mind before problems occur.

Approaching a dock or backing into a slip in high winds or strong currents requires a considerable amount of skill. If you are new to boat handling, you should take lessons from an experienced pilot to learn how to maneuver your boat in tight quarters in less than ideal conditions. You should also practice away from the dock during windy conditions.

Dock lines are generally twisted or braided nylon. Nylon is strong and stretches to absorb shock. It also has a long life and is soft and easy on the hands. The line's size will vary with the size of the boat. Typically a 30 to 40 foot boat will use 5/8-inch line and a 20 to 30 foot boat will use 1/2-inch line. The number of lines and their configuration will vary depending on the dock, the range of the tide and many other factors. Usually a combination of bow, stern and spring lines is used to secure the boat.

Maneuvering to a Dock or Slip

Notice:

Your boat is equipped with triple or quad engines and electronic control systems. Depending on the control system options selected, the following conditions could apply that will affect the handling of your boat as you maneuver to the dock:

If you are using the engine shift and throttle controls to maneuver the boat, we recommend turning the center engine or engines off and using the port and starboard engines to maneuver the boat to the dock or back it into a slip.

If your boat is equipped with a joystick integrated into the engine control system and you are using the joystick to maneuver the boat, you should leave all engines running while using the joystick control to maneuver the boat to the dock or back into the slip.

Note that most joystick controls will be deactivated if either throttle/shift control lever is moved while maneuvering the boat.

Electronic control system and joystick operation is unique to the engines installed on your boat. Operation manuals for the engines and control systems are included with this manual. You should read these manuals thoroughly and understand the control system in theory and operation before operating your boat. Additionally, your dealer should demonstrate the operation of the control system and instruct you in operating the controls properly.

Maneuvering to a Dock

Approach the dock slowly at a 30 to 40 degree angle. Whenever possible, approach against the wind or current. Turn the engines straight & shift to neutral when you feel you have enough momentum to reach the dock. Use reverse on the outboard engine while turning the steering wheel towards the dock to slow the boat and pull the stern toward the dock as the boat approaches. Straighten the engines and use both engines to stop the boat if it is still moving forward against the pilings. If you executed your approach prop-

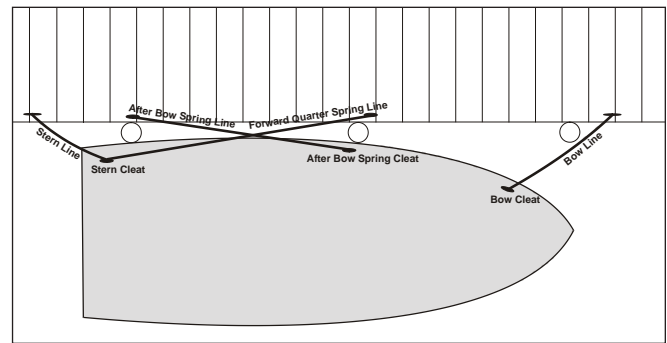

Securing The Boat Along Side A Dock (Typical)

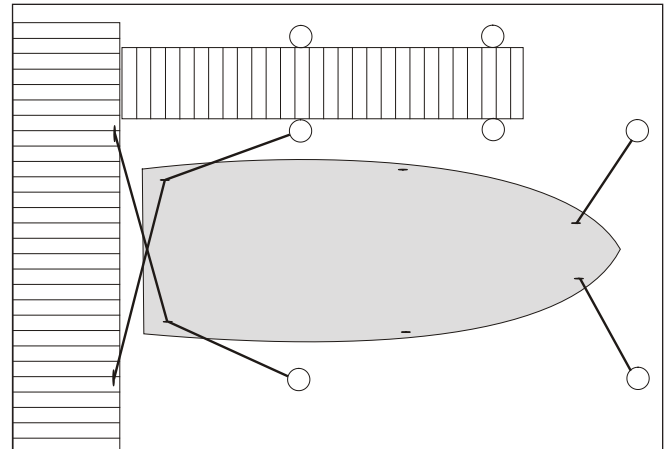

Securing The Boat In A Slip (Typical)

erly, the boat will lightly touch the pilings at the same time the forward momentum is stopped. Have the dock lines ready and secure the boat as soon as it stops. Use fenders to protect the boat while it is docked. Keep the engines running until the lines are secured.

Backing into a Slip

Approach the slip with the stern against the wind or current and the engines straight ahead. Use the engines and turn the steering wheel to maneuver the boat into alignment with the slip. Reverse the engines and slowly back into the slip. Shift from reverse to neutral frequently to prevent the boat from gaining too much speed. Move the stern right and left by shifting the engines in and out of gear or turning the wheel. When nearly in the slip all the way, straighten the engines and shift to forward to stop. Keep the engines running until the lines are secured.

Securing Dock Lines

Securing a boat that is tied along side the dock typically requires a bow and stern line and two spring lines. The bow and stern lines are usually secured to the dock at a 40° angle aft of the stern cleat and forward of the bow cleat. The after bow spring line is secured to the dock at a 40° angle aft of the after bow spring cleat. The forward quarter spring is secured to the dock at a 40° angle forward of the stern cleat. The spring lines keep the boat square to the dock and reduce fore and aft movement while allowing the boat to move up and down with the tide.

Securing a boat in a slip is somewhat different. It typically requires two bow lines secured to pilings on each side of the bow, two stern lines secured to the dock and two spring lines that prevent the boat from hitting the dock. The bow lines are typically secured with enough slack to allow the boat to ride the tide. The stern lines are crossed. One line runs from the port aft boat cleat to the starboard dock cleat and the other line runs from the starboard aft boat cleat to the port cleat on the dock. The stern lines center the boat, control the forward motion and allow the boat to ride the tide. Two forward quarter spring lines typically are secured to the stern cleats and to mid ship pilings or cleats. The spring lines keep the boat from backing into the dock while allowing it to ride the tide.

Leaving the Dock

Always start the engines and let them warm up for several minutes before releasing the lines. Boats steer from the stern and it is important that you achieve enough clearance at the stern to maneuver the boat as quickly as possible. Push the stern off and maneuver such that you get stern clearance quickly. Proceed slowly until well clear of the dock and other boats.

Mooring

Approach the mooring heading into the wind or current. Shift to neutral when you have just enough headway to reach the buoy. Position a crew member on the bow to retrieve the mooring line with a boat hook and secure the line. Keep the engines running until the line is secured.

Leaving a Mooring

Start the engines and let them warm up for several minutes before releasing the mooring line. The boat will already be headed into the wind, so move it forward enough to loosen the line and

untie it. Back the boat away from the mooring until you can see the buoy. Move the boat slowly away from the mooring.

Anchoring

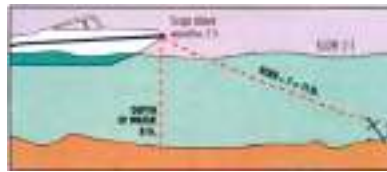

Make sure the bitter end of the anchor line is attached to boat before dropping the anchor. Bring the bow into the wind



or current and put the engines in neutral. When the vessel comes to a stop, lower the anchor over the bow. Pay out anchor line so that it is at least 5 to 7 times the depth of the water and secure the line to a cleat. Use caution to avoid getting your feet or hands tangled in the line. Additional scope of 10 times the depth may be required for storm conditions. Check landmarks on shore or your GPS position to make sure the anchor is not dragging. If it is dragging, you will have to start all over. It is prudent to use two anchors at the bow if you are anchoring overnight or in rough weather.

After the anchor is set, the windlass must not be left to take the entire force from the anchor line. Boats lying to their anchor in a high swell or heavy weather conditions will snub on the line. This can cause slippage or apply excessive loads to the windlass. The line should always be made fast to a bow cleat to relieve the load on the windlass.

Do not set a bow and stern anchor when mooring, only anchor from the bow. The stern anchor will not allow the boat to swing with the current and wind. If you are anchored in a mooring with other boats, your boat will not swing with the other boats in the mooring, creating a potential for contact with another boat when the tide or wind changes. Additionally, having the stern to the wind or tide creates a potentially hazardous situation for the boat and crew.

Releasing the Anchor



Release the anchor by driving the boat slowly to the point where the anchor line becomes vertical. It should release when you pass that point. If the anchor doesn't release right away, stop the boat directly above the anchor and tie the line to the cleat as tight as possible. The up and down movement of the boat will usually loosen the anchor within a minute. Make sure you secure the anchor and properly stow the line before operating the boat.

 WARNING 
<p>NEVER ANCHOR THE BOAT BY THE STERN. THE STERN OF THE BOAT IS VULNERABLE TO SWAMPING FROM WAVE ACTION AND WIND AND CURRENT WILL PUT MORE STRESS ON THE ANCHOR WHEN IT IS ATTACHED TO THE STERN. ONLY ANCHOR THE BOAT BY THE BOW</p>

2.6 Controls, Steering or Propulsion System Failure

If the propulsion, control or steering system fails while you are operating the boat, bring the throttles to idle and shift to neutral. Decide whether you need to put out the anchor to prevent the boat from drifting or to hold the bow into the seas. Investigate and correct the problem if you can. Turn the engine off before opening the engine cowling to make repairs. If you are unable to correct the problem, call for help.

If only one engine has failed, you can usually run home on the other engines. Be careful not to apply too much power to the engines that are running. When one or more engines are not operating on a multi engine boat, the remaining engine or engines are over propped and can be overloaded if too much throttle is applied. You should contact your dealer or the engine manufacturer for the maximum power settings when running without one engine.

 CAUTION 
<p>ENGINE DAMAGE CAN RESULT IF PROPER EMERGENCY PROCEDURES ARE NOT FOLLOWED ON MULTI ENGINE BOATS. THIS IS PARTICULARLY IMPORTANT ON TRIPLE OR QUAD ENGINE BOATS WITH ELECTRONIC STEERING. REFER TO THE ENGINE AND CONTROL SYSTEM MANUALS. ALWAYS FOLLOW THE EMERGENCY PROCEDURES RECOMMENDED BY THE ENGINE MANUFACTURER.</p>

2.7 Collision

If your boat is involved in a collision with another boat, dock, piling or a sandbar, your first priority is to check your passengers for injuries and administer first aid if necessary. Once your passengers situations are stabilized, thoroughly inspect the boat for damage. Check below decks for leaks and the control systems for proper operation. Plug all leaks or make the necessary repairs to the control systems before proceeding slowly and carefully to



port. Request assistance if necessary. Haul the boat and make a thorough inspection of the hull and running gear for damage.



2.8 Grounding, Towing & Rendering Assistance

The law requires the owner or operator of a vessel to render assistance to any individual or vessel in distress, as long as his vessel is not endangered in the process.

If the boat should become disabled or if another craft that is disabled requires assistance, great care must be taken. The stress applied to a boat during towing may become excessive. Excessive stress can damage the structure of the boat and create a safety hazard for those aboard.

Freeing a grounded vessel or towing a boat that is disabled, requires specialized equipment and knowledge. Line failure and structural damage caused by improper towing have resulted in fatal injuries. Because of this, we strongly suggest that these activities be left to those who have the equipment and knowledge, e.g., the U.S. Coast Guard or a commercial towing company, to safely accomplish the towing task.

 DANGER 
<p>THE MOORING CLEATS ON SCOUT BOATS ARE NOT DESIGNED OR INTENDED TO BE USED FOR TOWING PURPOSES. THESE CLEATS ARE SPECIFICALLY DESIGNED AS MOORING CLEATS FOR SECURING THE BOAT TO A DOCK, PIER, ETC. DO NOT USE THESE FITTINGS FOR TOWING OR ATTEMPTING TO FREE A GROUNDED VESSEL.</p>

 WARNING 
<p>WHEN TOWING OPERATIONS ARE UNDERWAY, HAVE EVERYONE ABOARD BOTH VESSELS STAY CLEAR OF THE TOW LINE AND SURROUNDING AREA. A TOW LINE THAT SHOULD BREAK WHILE UNDER STRESS CAN BE VERY DANGEROUS AND COULD CAUSE SERIOUS INJURY OR DEATH.</p>



WARNING



RUNNING AGROUND CAN CAUSE SERIOUS INJURY TO PASSENGERS AND DAMAGE TO A BOAT AND ITS UNDERWATER GEAR. IF YOUR BOAT SHOULD BECOME GROUNDED, DISTRIBUTE PERSONAL FLOTATION DEVICES AND INSPECT THE BOAT FOR POSSIBLE DAMAGE. THOROUGHLY INSPECT THE BILGE AREA FOR SIGNS OF LEAKAGE. AN EXPERIENCED SERVICE FACILITY SHOULD CHECK YOUR UNDERWATER GEAR AT THE FIRST OPPORTUNITY. DO NOT CONTINUE TO USE YOUR BOAT IF THE CONDITION OF THE UNDERWATER EQUIPMENT IS QUESTIONABLE.

2.9 Flooding or Capsizing

Boats can become unstable if they become flooded or completely swamped. You must always be aware of the position of the boat to the seas and the amount of water in the bilge. Water entering the boat through the transom/side doors or over the stern gunnels can usually be corrected by closing the doors and turning the boat into the waves. If the bilge is flooding because of a hole in the hull or a defective hose, you may be able to plug it with rags, close the thru-hull valve or assist the pumps by bailing with buckets. Put a mayday call in to the Coast Guard or nearby boats and distribute life jackets as soon as you discover your boat is in trouble.

If the boat becomes swamped and capsizes, you and your passengers should stay with the boat as long as you can. It is much easier for the Coast Guard, aircraft or other boats to spot, than people in the water. If your boat is equipped with an EPIRB, make sure it is activated. When activated, EPIRBs will send distress code homing beacons that allow Coast Guard aircraft to identify your boat and find you quickly.

2.10 Fishing

Fishing can be very exciting and distracting for the operator when the action gets intense. You must always be conscious of the fact that your primary responsibility is the safe operation of your boat and the safety of your passengers and other boats in the area.

You must always make sure the helm is properly manned and is never left unattended while trolling. If your boat is equipped with a tower, caution and good common sense must be exercised whenever

someone is in the tower. Remember, weight in the tower raises the boat's center of gravity and the boat's motion is greatly exaggerated for the person in a tower.

If you are fishing in an area that is crowded with other fishing boats, it may be difficult to follow the rules of the road. This situation can become especially difficult when most boats are trolling. Being courteous and exercising good common sense is essential. Avoid trying to assert your right-of-way and concentrate on staying clear and preventing tangled or cut lines and other unpleasant encounters with other boats. Also keep in mind that fishing line wrapped around a propeller shaft can damage seals in the engine lower unit.

2.11 Flybridge or Tower Operation

Your boat could be equipped with an optional fabricated aluminum tower or upper helm station. Upper helm stations are normally equipped with full engine controls, trim tab controls, compass, engine alarms, stop and start buttons, emergency stop switch and tachometers. This allows for complete operation of the boat from the tower.

Operation of the Upper Station Controls

The engines should be started at the lower helm. Monitor the gauges to make sure all systems are normal and the engines have been allowed to warm up slightly before proceeding to the tower helm. The ignition or restart switches on the tower are only used to restart an engine in the event it should stall. The shift controls must be in neutral for the start switches to be functional.

Electronic engine controls are equipped with a station transfer button that allows the operator to transfer control from one station to another with the push of a button. Always make sure that you activate the controls as soon as you reach the upper helm station.

Refer to the Control Systems chapter and the electronic engine control owner's manual for more information on the control system operation and selecting the controls on boats with dual stations.

The following is a list of safety precautions for tower operation:

- Do not operate the boat from the tower in rough sea conditions. The boat's motions are exaggerated in the tower and this motion may become excessive in rough seas.
- Be careful when using the trim tabs from the tower. The reaction of the trim tabs will be exaggerated in the tower. Use small tab corrections and wait ten (10) seconds for the tabs to react. Keep making small corrections until the hull is at the desired attitude.
- Do not overload the tower. Most towers are designed to hold the weight of only two average sized people. The Scout flybridge option is designed for a maximum of four average sized people. Weight in the tower raises the boat's center of gravity. Too much weight in the tower could make the boat unstable.
- Do not operate the boat in tight quarters, such as marinas, from the tower. The operator is isolated from the boat while in the tower and will not be able to assist in docking procedures.
- Always pay close attention to your grip and footing on tower ladders. Your ability to achieve a good grip and proper footing is reduced in wet or rough weather. Therefore, the tower should be avoided in these conditions.
- Only operate the boat from the tower in familiar waters or where running aground is not a possibility. Running aground while operating the boat from the tower could result in severe injury.
- Always be alert for waves and boat wakes when operating the boat from the tower. Remember that the boat's motions are exaggerated in the tower.
- Good common sense and judgment must be exercised at all times when operating a boat from the tower.
- If an engine alarm sounds, immediately put the boat in NEUTRAL and shut OFF the engine(s), if safe to do so, until the problem is found and corrected.
- Always put the boat in NEUTRAL before moving to and from the tower helm and cockpit.



WARNING



GOOD COMMON SENSE, JUDGMENT AND EXTREME CAUTION MUST BE EXERCISED WHEN OPERATING A BOAT WITH SOMEONE IN THE TOWER. DO NOT ALLOW ANYONE IN THE TOWER WHEN THE WATER IS ROUGH OR WHEN OPERATING IN UNFAMILIAR WATERS WHERE RUNNING AGROUND IS A POSSIBILITY. REMEMBER, WEIGHT IN THE TOWER RAISES THE BOAT'S CENTER OF GRAVITY AND THE BOAT'S MOTION IS GREATLY EXAGGERATED FOR THE PEOPLE IN THE TOWER.

2.12 Teak Surfing

Teak Surfing is a new and dangerous boating fad that involves an individual holding on to the swim platform of a vessel while a wake builds up then lets go to body surf the wave created by the boat; hence the term "Teak Surfing." This activity puts that individual directly in the path of the boat's exhaust and poisonous carbon monoxide. Because of the multiple dangers associated with teak surfing and the carbon monoxide problem in particular, the Coast Guard has issued a safety alert that strongly advises the public not to engage in teak surfing and warns that teak surfing may cause carbon monoxide poisoning and even fatalities.

Teak surfing not only exposes an individual to potentially fatal concentrations of carbon monoxide from the engine exhaust, it exposes them unnecessarily and dangerously to the boat's propellers. The danger is compounded by the fact that individuals do not usually wear a life jacket when teak surfing.

Teak surfing is an extremely dangerous activity and you should never allow anyone to "Teak Surf" behind your boat or be in the water near the ladder or swim platform while the engine is operating.



WARNING



TEAK SURFING (HOLDING ONTO THE SWIM PLATFORM WHILE BOAT IS UNDERWAY) IS EXTREMELY DANGEROUS AND CAN CAUSE SEVERE INJURY OR DEATH. TEAK SURFING PUTS AN INDIVIDUAL DIRECTLY THE PATH OF THE BOAT'S EXHAUST AND EXPOSES THEM TO POISONOUS LEVELS OF CARBON MONOXIDE. IT ALSO EXPOSES AN INDIVIDUAL TO THE POSSIBILITY OF BEING THROWN INTO THE PROPELLERS. YOU SHOULD NEVER ALLOW ANYONE TO TEAK SURF BEHIND YOUR BOAT OR TO BE IN THE WATER NEAR THE LADDER OR SWIM PLATFORM WHILE THE ENGINE IS RUNNING.

2.13 Trash Disposal

The discharge of plastic trash or trash mixed with plastic is illegal anywhere in the marine environment. U.S. Coast Guard regulations also restrict the dumping of other forms of garbage. Regional, State, and local restrictions on garbage discharges also may apply.

Responsible boaters store refuse in bags and dispose of it properly on shore. You should make sure your passengers are aware of the local waste laws and the trash management procedure on your boat. Refer to the placard mounted on your boat for more specific information regarding solid waste disposal.

Federal law requires that vessels of 26 feet or longer must display in a prominent location, a durable placard at least 4 by 9 inches notifying the crew and passengers of the discharge restrictions (Marpol Treaty). It is the boat owner's responsibility to make sure this placard remains mounted and legible in accordance with the law.

2.14 Yacht Certification Plate

Coast Guard rules require boats less than 20 feet (6 meters) to display a gross weight and person-capacity plate provided by the manufacturer. The person/load capacity is determined by the US Coast Guard.

Boat manufacturers in the National Marine Manufacturers Association (NMMA) program will display a gross weight and person-capacity plate on boats up to 26 feet (7.9 meters). Larger boats, including your boat, will display a Yacht Certification plate indicating compliance with the NMMA and U.S. Coast Guard requirements instead of a capacity plate.

The yacht certification plate is usually located near the helm in clear view of the operator.

2.15 Transporting Your Boat

Your Scout is a large boat and should only be trailered by professionals that have the knowledge and equipment to move large boats without causing damage.

You should contact your dealer or the Scout Boats Customer Service Department if you are planning to transport your boat and have any questions in



Trash Disposal & Discharge Placard



Yacht Certification

regard to the proper equipment and support for the hull.

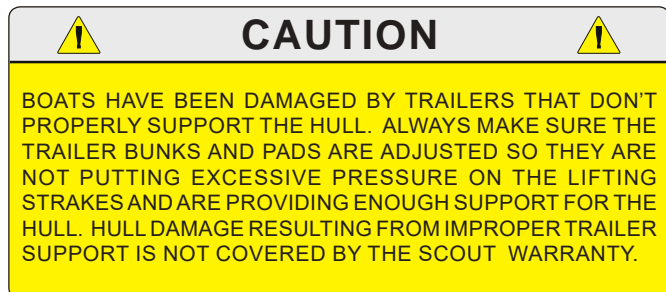

Propulsion System

3.1 General

Your Scout is designed to be powered with 4-cycle outboard motors. Each engine is equipped with an oil sump in the crankcase that must be kept full of the type of oil recommended by the engine manufacturer. The oil must be checked before each use and changed regularly.

Each manufacturer of the various outboard motors provides an owner's information manual with its product. It is important that you read the manual(s) very carefully and become familiar with the proper care and operation of the engines and drive systems. A warranty registration card has been furnished with each new engine and can be located in the engine owner's manual. All information requested on this card should be filled out completely by the dealer and purchaser and then returned to the respective engine manufacturer as soon as possible.



Outboard Engines



WARNING



DO NOT ATTEMPT TO SERVICE ANY ENGINE OR DRIVE COMPONENT WITHOUT BEING TOTALLY FAMILIAR WITH THE SAFE AND PROPER SERVICE PROCEDURES. CERTAIN MOVING PARTS ARE EXPOSED AND CAN BE DANGEROUS TO SOMEONE UNFAMILIAR WITH THE OPERATION AND FUNCTION OF THE EQUIPMENT.



WARNING



DO NOT INHALE EXHAUST FUMES! EXHAUST CONTAINS CARBON MONOXIDE THAT IS COLORLESS AND ODORLESS. CARBON MONOXIDE IS A DANGEROUS GAS THAT IS POTENTIALLY LETHAL.

in saltwater for extended periods of time. Then the main concerns are marine growth and galvanic corrosion.

Marine growth occurs when components are left in the water for extended periods and can cause poor performance or permanent damage to the exposed components. The type of growth and how quickly it occurs is relative to the water conditions in your boating area. Water temperature, pollution, current, etc. can have an effect on marine growth.

3.2 Drive System Corrosion

Each outboard motor is a complete drive system with the gear case being just forward of the propeller and connected to the power head with a vertical drive shaft. All engines require some maintenance. Routine maintenance recommended for your engine is outlined in the engine owner's manual. Routine maintenance is normally the primary concern unless the boat is to be kept

Galvanic corrosion is the corrosion process occurring when different metals are submerged in an electrolyte. Seawater is an electrolyte and submerged engine components must be properly protected. Outboard motors are equipped with sacrificial anodes to prevent galvanic corrosion problems. The anodes must be monitored and replaced as necessary. For locations and maintenance, please refer to the engine owner's manual. When leaving the boat in the water, tilt the mo-

tors as high as possible. This will decrease the risk of marine growth around the cooling inlets, propeller and exhaust ports and damage from galvanic corrosion.

CAUTION

DO NOT PAINT THE OUTBOARD MOTOR WITH ANTI-FOULING PAINTS DESIGNED FOR BOAT HULLS. MANY OF THESE PAINTS CAN CAUSE SEVERE DAMAGE TO THE ENGINE. CONTACT YOUR SCOUT DEALER OR ENGINE MANUFACTURER FOR INFORMATION ON THE PROPER PAINTING PROCEDURES.

CAUTION

NEVER RUN AN OUTBOARD MOTOR WITHOUT WATER FLOWING TO THE WATER PUMP. SERIOUS DAMAGE TO THE WATER IMPELLER OR ENGINE COULD RESULT.

3.3 Engine Lubrication

4-cycle outboard engines incorporate a pressure-type lubrication system with an oil sump in the crankcase that must be kept full of the type and grade of oil recommended by the engine manufacturer. It is normal for 4-cycle engines to consume a small amount of oil. Therefore, the oil must be checked before each use and changed at regular intervals as instructed by the engine owner's manual.

Notice:

Always monitor the oil level in the crankcase and only use the type of oil specified by the engine manufacturer. Yamaha engines specify Yamalube engine oil.

3.4 Engine Cooling System

Outboard engines are raw water (seawater) cooled. Water is pumped through the water inlets, circulated through the engine block and relinquished with the exhaust gases through the propeller hub. The water pump uses a small impeller made of synthetic rubber. The impeller and water pump cannot run dry for more than a few seconds. In most outboard motors, some cooling water is diverted through ports below the engine cowling. This allows the operator to visually check the operation of the cooling system. When the engine is started, always check for a steady stream of water coming out of those ports.

Notice:

If the boat is used in salt or badly polluted water, the engines should be flushed after each use. Refer to the engine owner's manual for the proper engine flushing procedure.

3.5 Propellers

The propellers convert the engine's power into thrust. They come in a variety of styles, diameters and pitches. All boats powered by Yamaha engines are equipped with Yamaha propellers. The propellers that will best suit the needs of your boat will depend somewhat on your application and expected average load. Propeller sizes are identified by two numbers stamped on the prop in sequence. The 1st number in the sequence (example 14" x 21") is the diameter of the propeller and the 2nd number is the pitch. Pitch is the theoretical distance traveled by the propeller in each revolution.

Always repair or replace a propeller immediately if it has been damaged. A damaged and therefore out of balance propeller can cause vibration that can be felt in the boat and could damage the engine gear assembly. Refer to the engine owner's manual for information on propeller removal and installation.

3.6 Performance Issues & Propellers

It is extremely important that the boat is propped to run at or very near the recommended top RPM with an average load. If the top RPM is above or below the recommend range, the propellers must be changed to prevent loss of performance and possible engine damage.

Your boat is equipped from the factory with counter rotating engines that are mounted to achieve quicker planning and optimum performance. Therefore, the left rotation engine is mounted on the port side of the transom and the right rotation engine is mounted on the starboard side. If your boat is equipped with three engines, the center engine is typically a right rotation engine. If your boat is equipped with quad engines, the port center engine is typically a right rotation and the starboard center engine is a left rotation. You should make sure that each propeller matches the rotation of the engine.

Notice:

Before changing propellers to correct boat performance problems, be sure other factors such as engine tuning, bottom and running gear growth, etc. are not the source of performance changes. Always be sure the load conditions are those normally experienced, before changing propellers.

Your boat was shipped with propellers that typically provide optimum performance for your boat. However there are factors that can affect performance and propeller requirements.

Some are as follows:

- You should be sure the load conditions are those normally experienced. If the boat ran in the required RPM range when it was new and you have not added any additional gear or heavy equipment and have not damaged the propellers, there is a good chance the propellers are not the problem.
- The addition of heavy equipment like a tower, life rafts, additional coolers, etc., will cause additional load on the engines. Consequently, different propellers may be required.
- Boats operated at high altitudes (above 2000 feet). Engines operated at high altitudes will not be able to develop as much horsepower as they do at or near sea level. Consequently, different propellers may be required.



Yamaha Propeller

Notice:

Outboard engines can be damaged and the warranty voided if the boat is not propped correctly. Always consult your Scout dealer or authorized engine service dealer when making changes to the propellers or if the boat does not run near the top recommended RPM.



Typical Quad Engine & Propeller Rotation

Note that the engine rotation on your boat may be different, depending on the engines installed.



Yamaha Command Link Plus® / Typical Two Engine Combo Screen For Quad Engines

3.7 Engine Instrumentation

The helm station is equipped with a set of engine instruments and/or alarms. These instruments allow the operator to monitor the operational condition of the engines. Close observation of these instruments allows the operator to operate the engines at the most efficient level and could save them from serious costly damage.

Most Scout boats are equipped with Yamaha engines and Command Link Plus® LCD multifunction display. Triple engine boats typically have one display that monitors all three engines. Quad engine boats typically have 2 displays, one for the port and port center engines and one for the starboard and starboard center engine.

This system can be integrated with the optional electronic navigation equipment installed on your boat and/or the Yamaha Helm Master control system. A brief description of the Command Link Plus® system integrated gauges and their basic functions are listed in this section. Other functions that are dependent on the electronics and control system installed on your boat may be available. Please refer to the Yamaha engine, Command Link Plus® and Helm Master owner's manuals and the

manuals for the electronics installed on your boat for detailed information on the operation of the instruments and additional functions available.

The instrumentation is unique to the type of out-board motors installed on your Scout.

Some or all of the following gauges may be present.

Tachometers

The tachometers display the speed of the engines in revolutions per minute (RPM). This speed is not the boat speed or necessarily the speed of the propeller.

The tachometer display also contains the engine trim meters, oil pressure indicator, water pressure, water temperature, volt meters and the overheat warning indicator.

⚠**CAUTION**⚠

NEVER EXCEED THE MAXIMUM RECOMMENDED OPERATION RPM OF THE ENGINES. MAINTAINING MAXIMUM OR CLOSE TO MAXIMUM RPM FOR EXTENDED PERIODS CAN REDUCE THE LIFE OF THE ENGINES.

Speedometer

Yamaha Command Link Plus® speedometers can indicate boat speed via the engine pickup or an optional GPS or depth sounder triducer, if these options are installed in your boat. Refer to the engine gauge and electronics operating manuals for more information on the speedometer options available for your boat.

Overheat Warning Indicator

The temperature warning indicates that the temperature of the engine is too high. A sudden increase in the temperature could indicate an obstructed water inlet or an impeller failure. On Yamaha engines the overheat warning indicator is built into the LCD display. It will start to blink and sound an alarm if the engine temperature is too high.



Typical Command Link Plus® Triple Engine Combo Display

CAUTION

CONTINUED OPERATION OF AN OVERHEATED ENGINE CAN RESULT IN ENGINE SEIZURE. IF AN UNUSUALLY HIGH TEMPERATURE READING OCCURS, SHUT THE ENGINE OFF IMMEDIATELY. THEN INVESTIGATE AND CORRECT THE PROBLEM

Fuel Gauge

The fuel gauge indicates the amount of fuel in the fuel tanks. On boats equipped with Yamaha Command Link Plus®, the fuel gauge is built into the LCD Display. The fuel indicator on the display will begin to blink if the fuel in the tank drops too low. The system can monitor up to 4 fuel or water tanks.

Voltmeters

The voltmeters display the voltage for the battery and the charging system for each engine. The normal voltage is 11 to 12 volts with the engines off and 13 to 14.5 volts with the engines running. The Yamaha engine voltmeter is built into the LCD display. It will begin to blink if the voltage in the battery drops too low.

Hour Meters

The hour meters keep a record of the operating time for each engine.

Engine Tilt/Trim Gauges

The tilt/trim gauges monitor the position of each outboard engine. The upper range of the gauge indicates the tilt, which is used for trailering and

shallow water operation. The lower range indicates the trim position. This is the range used to adjust the hull angle while operating your boat on plane. The Yamaha engine trim indicator is built into the LCD display. Please refer to the engine and Command Link Plus® owner's manuals for more information on the operation of the outboard power tilt and trim.

Engine Alarms

All outboards are equipped with an audible alarm system mounted in the helm area that monitors selected critical engine systems. The alarm will sound if one of these systems begins to fail. Refer to the engine owner's manual for information on the alarms installed with your engines.

CAUTION

IF THE ENGINE ALARM SOUNDS, IMMEDIATELY SHUT OFF THE ENGINE UNTIL THE PROBLEM IS FOUND AND CORRECTED.

Fuel Management

Fuel management systems are standard equipment with some outboard engines. On Yamaha engines, the fuel management gauge is built into the Command Link Plus® display and can monitor miles per gallon, total gallons used and total gallons remaining.

If you have a fuel management system installed on your boat, refer to the engine or fuel management manual for detailed information on that system.

Compass

All boats are equipped with a compass on the top of the instrument panel. The compass cannot be adjusted accurately at the factory as it must be compensated for the influence of the electrical equipment and electronics unique to your boat. Therefore, the compass should be adjusted by a professional after the electronics and additional electrical accessories are installed and before operating the boat. To adjust the compass for your area, read the instructions on "Compass Compensation" given to you in the literature packet.

Instrument Maintenance

Electrical protection for instruments and ignition circuitry is provided by a set of fuses or circuit breakers located on each engine. The ignition switches should be sprayed periodically with a contact cleaner/lubricant. The ignition switches and all instruments, controls, etc. should be protected from the weather when not in use. Excessive exposure can lead to gauge and ignition switch difficulties.



Compass

Helm Control Systems

4.1 General

The helm controls consist of three systems: the engine throttle and shift controls, the steering system and the trim tab control switches. These systems provide the operator with the ability to control the direction and attitude of the boat from the helm station.

In addition to the primary helm controls, your boat could be equipped with an optional bow thruster that provides the operator additional control of the bow while docking or anchoring the boat in tight quarters or high winds and strong currents.

Each manufacturer of the control components provides an owner's manual with its product. It is important that you read the manuals and become familiar with the proper care and operation of the control systems.

4.2 Engine Throttle & Shift Controls

The shift and throttle controls on your boat may vary depending on the engines used. Refer to the engine or control manuals for specific information on the controls installed on your boat.

Electronic engine controls are standard on large outboard engines. The following control description is typical of most triple and quad engine electronic control systems.

Triple Engine Controls

The helm is designed for a binnacle style control with a single lever for the port and center engines and another single lever for the starboard engine. The electronic control system consists of three major components: the electronic control head, display screens and keypad, control processors and applicable harnesses. The controls are completely electronic and there are no cables.

Each single lever operates as a gearshift and a throttle. General control lever operation will include a position for neutral (straight up and down or slightly aft of vertical), a forward position (the 1st detent forward of neutral) and a reverse position (the 1st detent aft of neutral). Advancing the control lever beyond the shift range advances



Typical Yamaha Triple Engine Electronic Control

the throttle in forward or reverse. Each control is equipped with a means of permitting the engines to be operated at a higher than normal idle RPM while in neutral for cold starting and warm-up purposes. The control levers are equipped with adjustable control head detent and friction settings.

On triple engine boats, an engine selector switch on the binnacle control panel allows the operator to select which engines provide the forward and reverse thrust, for optimum control and handling. LED lights on the control indicate which engines are selected.

Typically, the center engine is disengaged during docking and while maneuvering in tight quarters to improve handling. It can also be disengaged while operating at slow or trolling speeds to save fuel. If an engine fails, the selector switch can

be used to operate the boat on the two remaining engines or just the center engine, if it is available. When only the port and starboard engines are selected, the port lever will control the port engine and starboard lever controls the starboard engine. The center engine will remain in neutral.

When all three engines are selected during normal operations, the center and port engines are controlled by the port control handle. The computer automatically synchronizes the rpm of the center and port engines whenever all three engines are selected. Another engine synchronizer feature built into the control system can be selected to synchronize all three engines.

Quad Engine Controls

The helm is designed for a binnacle style control with a single lever for the port and port center engines and another single lever for the starboard and starboard center engines. The electronic control system consists of three major components: the electronic control head, display screens and keypad, control processors and applicable harnesses. The controls are completely electronic and there are no cables.

Each single lever operates as a gearshift and a throttle. General control lever operation will include a position for neutral (straight up and down or slightly aft of vertical), a forward position (the 1st detent forward of neutral) and a reverse position (the 1st detent aft of neutral). Advancing the control lever beyond the shift range advances the throttle in forward or reverse. Each control is equipped with a means of permitting the engines to be operated at a higher than normal idle RPM while in neutral for cold starting and warm-up purposes. The control levers are equipped with adjustable control head detent and friction settings.

On quad engine boats, an engine selector switch on the binnacle control panel allows the operator to select which engines provide the forward and reverse thrust, for optimum control and handling. LED lights on the control indicate which engines are selected.

Typically, the center engines are disengaged during docking and while maneuvering in tight quarters to improve handling. They can also be disengaged while operating at slow or trolling speeds to save fuel. If an engine fails, the selector switch can be used to operate the boat on



Typical Yamaha Quad Engine Electronic Controls

the remaining engines or any combination of the available engines.

When only the port and starboard engines are selected, the port lever will control the port engine and starboard lever controls the starboard engine. The center engines will remain in neutral.

When all four engines are selected during normal operations, the port and port center engines are controlled by the port control handle and the starboard and starboard center engines are controlled by the starboard control handle. The computer automatically synchronizes the rpm of the port center engine with the port engine and the starboard center engine with the starboard engine whenever all four engines are selected. Another engine synchronizer feature built into the control system can be selected to synchronize all four engines.

Control Functions and Features

Most electronic engine controls and key pad have integrated switches and indicator lights which allow the operator to control all aspects of the boat's propulsion system. LED lights on the control pad indicate that the control is activated and the engines can be started.

The most common features activated or monitored by the keypad are:

- Starter lockout, which prevents the engine from being started in gear.
- Gear lockout, which allows engine RPM to be advanced in neutral safely.
- Battery voltage warning indicator that warns the operator of high or low voltage supplied to the system (audible alarm).
- An engine synchronization feature that automatically keeps all engines at the same RPM while cruising. Refer to Engine Synchronizing in this section and the control systems owner's manual for more information regarding engine synchronization.
- Trolling feature that allows the operator to increase or decrease engine speed in 50 RPM increments while operating at trolling speeds.
- Station selection (a separate button on some controls) that allows the operator to transfer control from one station to another with the push of a button on boats with two helm stations. Each station must be selected by the operator before the controls will operate from that station.

These features and others not mentioned require specific procedures to activate and operate them properly. Some of the procedures and features are unique to the engines and other options installed on your boat. It is essential that you read the owner's manual for the controls and be completely familiar with their operation before using your boat.

! **CAUTION** !

ALWAYS RETURN THE ENGINE THROTTLE LEVER TO THE EXTREME LOW SPEED POSITION AND ALLOW THE ENGINES TO DROP TO IDLE RPM BEFORE SHIFTING. NEVER SHIFT THE UNIT WHILE ENGINE SPEED IS ABOVE IDLE RPM.



Typical Yamaha Triple Engine Station Transfer Button



Yamaha Helm Master Control Key Pad & Station Transfer Button

Engine Synchronizer

During most operations of triple and quad engine powered boats, it is advantageous for all engines to be operated at the same RPM. This reduces noise and vibration and can increase engine efficiency. Setting the throttles so that the engines are running the same RPM (synchronized) can be done by listening to the engine sounds at low RPM and with the automatic synchronizer feature built into the electronic engine controls when the engines are op-

erating above 1000 RPM. Attempting to synchronize the engines solely by using the tachometer readings or control lever placement generally will not work. When the engines are in proper synchronization, the throttle levers may not necessarily be even.

Refer to the engine or control owner's manuals for more information on the engine synchronizer and other features for the electronic controls installed on your boat.

4.3 Neutral Safety Switch

Every control system has a neutral safety switch incorporated into it. This device prohibits an engine from being started while the shift lever is in any position other than the neutral position. If the engine will not start, slight movement of the shift lever may be necessary to locate the neutral position and disengage the safety cutout switch. Control adjustments may be required to correct this condition should it persist. See your Scout dealer for necessary control adjustments.

The neutral safety switches should be tested periodically to ensure that they are operating properly. To test the neutral safety switches, make sure the engines are tilted down and move the shift levers to the forward position.

Make sure the throttle control levers are not advanced past the idle position. Press the Start Button or turn the key just long enough to briefly engage the starter for the engine.

Notice:

Some outboard control systems are equipped with a computer controlled start feature that will keep the starter engaged until the engine starts if the neutral safety switch fails and allows the starter to engage.

The starter should not engage for any engine. Repeat this test with the shift levers in reverse and the engine throttles at idle. Again, the starter should not engage for any engine. If the starter for any engine engages with the shift controls in any position other than the neutral position, then the neutral safety switch is not functioning properly and you should contact your dealer to have the neutral safety switch repaired by a qualified marine mechanic before using the boat. If an engine starts in gear during this test, immediately move the control lever to the neutral position and turn the engine off.



Yamaha Triple Engine Trim Switches

4.4 Engine Power Tilt & Trim

All outboard engines are equipped with a tilt and trim feature. On most outboard boats, tilt/trim switches are built into the engine shift and throttle controls that allow the operator to control the position of the outboards from the helm. Typically, a switch or switches on the port control lever grip activates the tilt/trim for all engines simultaneously. Yamaha engine controls have three switches for triple or quad engines on the cover that activate each engine tilt/trim individually. The maximum tilt angle is usually preset at the factory. If necessary, the maximum tilt angle can be adjusted by your Scout or engine dealer by reprogramming the settings using a computer controlled diagnostic system.

Moving the outboards closer to the boat transom is called trimming "in" or "down." Moving the outboards further away from the boat transom is called trimming "out" or "up." In most cases, the boat will run best with the outboards adjusted so the hull will run at a 3 to 5 degree angle to the water. The term "trim" generally refers to the adjustment



WARNING



IN SOME SITUATIONS, IT MAY BE POSSIBLE TO ACCIDENTALLY START THE ENGINES IN GEAR WITH THE THROTTLES ABOVE IDLE IF THE NEUTRAL SAFETY SWITCH IS NOT OPERATING PROPERLY. THIS WOULD CAUSE THE BOAT TO ACCELERATE UNEXPECTEDLY IN FORWARD OR REVERSE AND COULD RESULT IN LOSS OF CONTROL, DAMAGE TO THE BOAT OR INJURY TO PASSENGERS. ALWAYS TEST THE NEUTRAL SAFETY SWITCH PERIODICALLY AND CORRECT ANY PROBLEMS BEFORE USING THE BOAT.

of the outboards within the first 20° range of travel. This is the range used while operating your boat on plane. The term “tilt” is generally used when referring to adjusting the outboards further up for shallow water operation or trailering.

Some control systems provide a means to set the engine trim angle to automatically adjust according to the engine speed. For information on the proper use and maintenance of the power tilt and trim, please refer to the engine owner’s manual.

CAUTION

THE ENGINE HOSES AND CABLES OR THE TRANSGEL COAT CAN BE DAMAGED BY TILTING THE ENGINES TO THE FULL UP POSITION WITH THE ENGINES TURNED TO THE WRONG POSITION. MOST BOATS REQUIRE THE STEERING WHEEL TO BE TURNED COMPLETELY TO PORT OR STARBOARD BEFORE TILTING THE ENGINES TO THE FULL UP POSITION. YOU SHOULD MONITOR EACH ENGINE AS IT TILTS TO DETERMINE BEST FULL TILT ENGINE POSITION FOR YOUR BOAT.

CAUTION

SOME AUTOPILOTS HAVE ENGINE POSITION SENSORS THAT ARE MOUNTED TO THE HYDRAULIC STEERING CYLINDER. WITH THESE AUTOPILOTS, THE ENGINE POSITION SENSOR BRACKET COULD HIT THE TRANSGEL WHEN THE ENGINES ARE TILTED TO THE FULL UP POSITION AND CAUSE DAMAGE TO THE ENGINE RIGGING, THE AUTOPILOT OR THE TRANSGEL. IF YOU HAVE AN AUTOPILOT INSTALLED ON YOUR BOAT, YOU SHOULD MONITOR THE LOCATION OF THE ENGINE CABLES AND AUTOPILOT BRACKETS AS THE ENGINES ARE TILTED TO DETERMINE THE BEST ENGINE POSITION AND MAXIMUM ENGINE TILT FOR YOUR APPLICATION.



Yamaha Quad Engine Port Control Trim Switch



Yamaha Quad Engine Trim Controls

4.5 Engine Stop Switch

Your boat is equipped with an engine stop switch and lanyard at each helm. When the lanyard is pulled it will engage the switch and shut off the engines. We strongly recommend that the lanyard be attached to the driver whenever the engines are running. If an engine will not start, it could be because the lanyard is not properly inserted into the engine stop switch. Always make sure the lanyard is properly attached to the engine stop switch before attempting to start the engines.

Refer to the engine owner’s manual for more information on the engine stop switch.



Yamaha Engine Stop Switch

4.6 Steering System

Power Assist Hydraulic Steering

Power assisted steering systems on triple engine boats without the joystick option are hydraulic and comprised of two hydraulic circuits: a manual system, which is the control element and a hydraulic power assist pump, which is the working element.

The manual system is hydraulic and made of three main components: the helm assembly, hydraulic hoses and the steering cylinders. The fluid reservoir for the system is built into the power assist pump assembly and the helm acts as a pump. Turning of the steering wheel, pumps fluid through the hydraulic hoses and activates the hydraulic steering cylinders causing the motors to turn. A slight clicking sound may be heard as the wheel is turned. This sound is the opening and closing of valves in the helm pump unit and is normal.

The power system is an electronically controlled, 12 volt hydraulic pump that boosts the fluid pressure being sent from the helm pump to the steering cylinders to provide "Power" for the steering system which results in much easier effort at the steering wheel, even under heavy loads. In the event of a power loss or failure of the hydraulic steering pump, the steering system will automatically revert to a manual hydraulic system. The manual system operates as described previously in this section and will require more effort on the steering wheel to turn the motors.

Steering Cylinders and Tie Bar

Triple outboards with hydraulic steering are coupled near the tiller arms by tie bars that connect the center engine to the port and starboard engines which are equipped with steering cylinders.

The engines must be aligned to provide maximum stability on straight ahead runs and proper tracking through corners. The port and starboard engines on triples are aligned so the engines are towed in slightly (.25" to .5") at the propellers. Engine or steering system damage may require the engines to be realigned.

Triple and Quad Engine Electronic Steering

Triple engine boats that are equipped with the joystick control option are equipped with an electronic steering system that provides precise and responsive steering. The joystick control and electronic steering is standard equipment on boats with quad engines.



Typical Power Assist Steering Unit



Typical Steering Cylinders & Tie Bar

The system is 100% electronic and there are no mechanical connections between the steering wheel and the engines. Each engine is turned independently allowing improved tight quarter maneuvering and the convenience of an optional Joystick control at the helm.



Typical Yamaha Triple Engine Electronic Controlled Steering

For safety and improved tight quarter maneuvering, the controlling software on most systems senses engine speed and adjusts maximum steering angle and steering wheel resistance to preset limits as the engine speed increases or decreases. The steering angles and steering wheel resistance at specific engine speeds are programmed into the system at the factory and are not adjustable.

The steering on each motor is totally independent with full redundancy built into the system. If the steering fails on one engine, the other units will continue to operate. Should a failure in one steering system occur, the controlling software will sense the failure, limit the engine RPM as a safety precaution and alert the operator.

Each steering control system has emergency procedures that are specific to the steering system and type of failure. It is very important to follow the correct procedure to avoid damage to the engine cowlings if a steering system failure occurs.

Refer to the engine manufacturer owner's manuals for specific information on the operation, maintenance and emergency procedures for the steering system installed in your boat.

Tilt Steering Wheel

The steering wheel can be tilted to five different positions by activating the tilt lock lever located on the bottom of the helm station. When the lever is released, it automatically locks the steering wheel at or close to that angle. Refer to the



Typical Tilt Steering Wheel

steering manufacturer owner's manual for specific information on the steering system.

4.7 Joystick Controls

A joystick control system is an option on triple engine boats and standard equipment on quads. The joystick can only be used at slow speeds. It is engaged by moving the shift and throttle controls to the neutral position and pressing the ON/OFF button on the base of the joystick control or the keypad on the main engine controls. Once

activated, the boat moves in the direction the joystick is pushed with the engine speed increasing the further the stick is pushed, up to preset limits. Turning the knob on the top of the joystick rotates the boat in the direction the knob is turned. Another button on the joystick or engine control key pad raises the preset engine speed for maneuvering in high winds and/or strong tides.

When the joystick is released, it automatically returns to center, the engines shift to neutral, rotate to the straight ahead position, and engine speed is reduced to idle. It is deactivated by pressing the ON/OFF button at the base of the joystick or control keypad or by moving the shift and throttle control levers.

All engines on triple and quad engine boats must be running for the joystick control to maneuver boat properly.

Always refer to the engine manufacturer owner's manuals for specific information on the operation and maintenance for the joystick and steering control systems on your boat.



Yamaha Helm Master Joystick

4.8 Trim Tabs

The recessed trim tabs are mounted to the hull below the swim platform and integrated transom engine mounting system. A dual rocker switch is used to control the trim tabs. The switch controls bow up and down movements. It also controls starboard and port up and down movements. Bow up and bow down will control the hull planing attitude, while port and starboard up and down provides control for the hull listing.

A LED indicator built into the switch displays the position of the trim tabs. When one LED is flashing at the top of the display, the tabs are in the "full-up" (bow up) position. When all LED lights are lit from the top to the bottom of the display, the tabs are fully extended (bow down).

The trim tabs are programmed to automatically retract when the engines are shutdown to keep the actuators clean and set the tabs in the full "UP" position when leaving the dock. Refer to the trim tab operating manual for more information on the operation and programming of the trim tabs.

Before leaving the dock, make sure that the tabs are in the full "UP" position. If they are not, press



Trim Tab Switches

and hold the control in the bow up position for ten (10) seconds to fully retract the tabs.

Always establish the intended heading and cruise speed before attempting to adjust the hull attitude with the trim tabs. After stabilizing speed and

direction, move the trim tabs to achieve a level side to side running attitude being careful not to over trim.

After depressing a trim tab switch, always wait a few seconds for the change in the trim plane to take effect. Avoid depressing the switch while awaiting the trim plane reaction. By the time the effect is noticeable the trim tab plane will have moved too far and thus the boat will be in an overcompensated position.

When running at a speed that will result in the boat falling off plane, lowering the tabs slightly, bow down, will improve the running angle and operating efficiency. Too much bow down tabs can reduce operating efficiency and cause substantial steering and handling difficulties.

Be extremely careful when operating in a following sea. The effect of trim tabs is amplified under such conditions. Steering and handling difficulties can result from improper trim tab usage, particularly in a following sea. Always raise the tabs to the full bow up position in these conditions.

When running at high speeds be sure that the tabs are in the full "UP" position. Only enough trim plane action should be used to compensate for any listing. Trim tabs are extremely sensitive at high speeds. Adjust for this and be prepared to slow down if difficulties arise.

When running into a chop, a slight bow down attitude will improve the ride. Be careful not to over trim. Handling difficulties may result.

4.9 Bow Thruster (Optional)

The optional bow thruster provides the operator additional control of the bow while docking or anchoring the boat in tight quarters or high winds and strong currents. The joystick control panel is located in the helm and controls the bow thruster that is mounted to the hull in the bilge near the bow.

The momentary joystick is activated by the pressing both ON buttons simultaneously. Move the joystick in the direction you wish to thrust. The joystick is proportional with the power increasing the further it is pushed, up to preset limits. A one second delay protects the thruster when the direction is changed. Arrows on the panel on each side of the joystick indicate the direction the bow



Typical Bow Thruster Control Panel

will move. The bow thruster will stop when the joystick is released.

Press and hold the OFF button for 5 seconds to deactivate the bow thruster control pad. The bow thruster will power down automatically if it senses no operation for 5 minutes.

The bow thruster circuit is protected by a fuse or circuit breaker and emergency shut off button/battery switch located in the forward cabin bilge compartment below the berth. It is activated automatically when the thruster control panel is switched on and turns off when the panel is deactivated.

Refer to the bow thruster owner's manual for details on operating the bow thruster and using the control.



4.10 Control Systems Maintenance

Control Maintenance

Periodic inspection of the control systems and all connections should be made. Signs of rust, corrosion, wear or other deterioration should immediately be serviced. Generally, periodic lubrication of all moving parts and connections with a light waterproof grease is in order.

Lubrication should be performed as often as necessary to keep the system operating smoothly.

Control system adjustments may become necessary. If adjustments become necessary, see your Scout dealer.

 WARNING 
DO NOT ATTEMPT CONTROL ADJUSTMENTS UNLESS YOU ARE FAMILIAR WITH SERVICING CONTROL SYSTEM PROCEDURES. CONTROL MISADJUSTMENT CAN CAUSE LOSS OF CONTROL AND SEVERE ENGINE OR LOWER UNIT DAMAGE.

Hydraulic Steering System Maintenance

A periodic inspection of all steering hoses, linkage and helm assemblies should be made. Signs of corrosion, cracking, loosening of fastenings, excessive wear or deterioration should be corrected immediately.

The fluid level for the hydraulic steering should be checked frequently and maintained at the proper level. The steering fluid level should be maintained at no less than 1/2" below the bottom of the fill plug hole on the hydraulic power assist pump reservoir located in the mechanical systems compartment. Only use power steering fluid recommended by the steering system manufacturer when adding fluid.

If your boat is equipped with the optional tower, the procedure for checking the steering fluid level and adding fluid may be different. Refer to the steering system manual for instructions on checking and filling the steering system on your boat.

Generally, periodic lubrication of all moving parts and connections with a light waterproof grease is in order. Check the hydraulic hoses and fittings for chaffing, rub marks and leaks. Replace if necessary. Failure to do so could lead to steering system failure that would result in loss of control.



When new or after repairs, hydraulic steering systems may need to have all air purged from the system. Only use hydraulic steering fluid recommended by the steering system manufacturer. Difficult steering and premature seal failure can result if the wrong fluid is used in the steering system. Review the information provided by the steering system manufacturer for proper specifications and details on system service and maintenance.

Electronic Steering and Control Systems Maintenance

Electronic steering and control systems are supplied by the engine manufacturer. The systems have maintenance requirements that are specific to the engines and control options installed in your boat.

You should refer to the engine and controls systems owner's manuals for information and maintenance on the control and steering system installed in your boat. Their recommendations should be followed exactly.

The engine controls and steering systems are fully electronic and activated by micro processors and controlling software in each drive unit. If adjustment becomes necessary do not attempt to address the problem yourself. You should contact your Scout or outboard engine dealer for assistance.

 WARNING 
IMPROPERLY ADJUSTED ELECTRONIC ENGINE CONTROLS CAN CAUSE LOSS OF CONTROL AND SEVERE ENGINE DAMAGE. IF YOUR CONTROLS ARE NOT OPERATING PROPERLY, DO NOT ATTEMPT CONTROL SYSTEM ADJUSTMENTS YOURSELF. CONTACT YOUR SCOUT OR ENGINE DEALER FOR ASSISTANCE AND DO NOT USE THE BOAT UNTIL THE SITUATION IS CORRECTED.

Engine Lubrication

Refer to the engine owner's manual for maintenance and lubrication instructions for the outboard engines.

Trim Tab Maintenance

Marine growth can interfere with the proper operation of the trim tab planes and actuators. To reduce problems due to marine growth, always return the trim tabs to the full "UP" position after operating the boat and periodically inspect

and clean marine growth from the actuators and planes.

There are two trim tab pumps located in the stern mechanical systems compartment. The fluid level should be checked often. Keep the fluid level between the marks on the trim tab pump reservoirs.

The trim tabs are attached to the bonding system and each tab is equipped with an anode to prevent galvanic corrosion when the boat is salt water. Galvanic corrosion is the corrosion process occurring when different metals are submerged in an electrolyte. Seawater is an electrolyte and submerged metal components must be properly protected. The anodes will need to be monitored and changed when they are 75% of their original size. Refer to the Routine Maintenance chapter of this manual for information on maintaining zinc anodes.

To discourage any marine growth on the tabs or actuators, antifouling paint can be applied. Contact your dealer or the trim tab manufacturer for information regarding the correct bottom paint for the trim tabs.

Refer to the trim tab owner's manual for additional maintenance information, specifications, troubleshooting and operating instructions.

Bow Thruster Maintenance (Optional)

The bow thruster is mounted in the forward bilge. Periodically inspect the components inside the hull for leaks and for loose or corroded electrical connections. Signs of leaks and loose or corroded electrical connections should be corrected immediately by a qualified marine technician.

Marine growth, weeds and debris can interfere with the proper operation of the bow thruster so you should inspect the tunnel regularly and clean as necessary. This is particularly important when operating in areas with weeds or if the thruster is not responding normally. You should also check the propellers. If the propellers are damaged or heavily contaminated, they should be replaced. The thruster is protected from galvanic corrosion by an anode on each propeller shaft. The anodes should be inspected regularly and changed when they are 75% of their original size.

If the boat is kept in the water, the anodes should be inspected at least once every 3-4 months. Antifouling paint can be applied to the tunnel and



Typical Trim Tab Pump

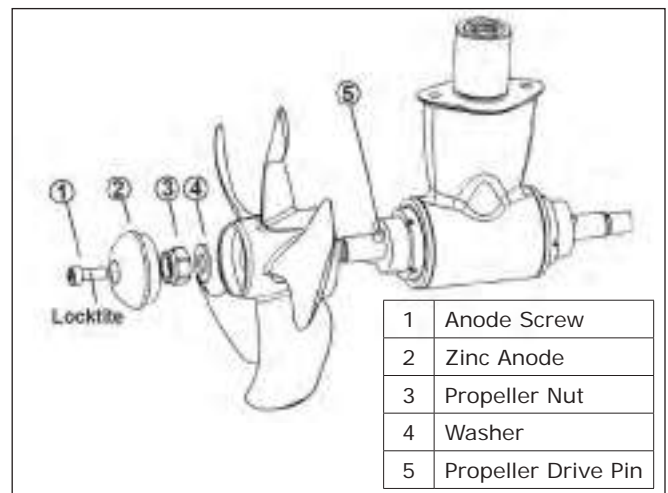

Bow Thruster Anode & Propeller Assembly
Note that there are two propellers & Two Anodes

underwater components to discourage marine growth. Bow thrusters have specific requirements for the type of antifouling paint that can be used and where it can be applied. Applying the wrong paint or paint that is not applied correctly can damage the bow thruster and void the warranty. Contact your authorized Scout dealer or the bow thruster manufacturer for information regarding the correct bottom paint and application.

Refer to the bow thruster owner's manual for additional maintenance information, specifications, troubleshooting and operating instructions.

NOTES

5.1 General

The Gasoline fuel system used in Scout boats is designed to meet or exceed the emission control standards of the Environmental Protection Agency (EPA) and the requirements of the U.S. Coast Guard, the Boating Industry Association and the American Boat and Yacht Council in effect at the time of manufacture.

All gasoline fuel systems have been factory inspected and pressure tested in accordance with regulations in effect at the time of manufacture. This inspection assures that the system is air tight, leak proof and safe. It is the responsibility of the purchaser to maintain it in that condition. Make frequent inspections to assure that no deterioration or loosening of connections is resulting from vibration.

!
DANGER
!

DO NOT LET THE ODOR OF GASOLINE GO UNCHECKED. ANY ODOR OF GASOLINE MUST BE IMMEDIATELY INVESTIGATED AND STEPS TAKEN TO PROTECT THE BOAT AND ITS OCCUPANTS UNTIL THE PROBLEM IS CORRECTED. IF THE ODOR OF GASOLINE IS NOTED, SHUT OFF ALL ENGINES AND ELECTRICAL EQUIPMENT. INVESTIGATE AND CORRECT THE SITUATION IMMEDIATELY. HAVE ALL PASSENGERS PUT ON PERSONAL FLOTATION DEVICES AND KEEP A FIRE EXTINGUISHER READY UNTIL THE SITUATION IS RESOLVED.

Fuel Withdrawal Tubes

The fuel withdrawal tubes are positioned in the fuel tanks to achieve optimum fuel usage, fuel line routing, etc. At certain speeds and hull trim angles, the fuel supply at the withdrawal tank location can increase or decrease accordingly. Be extremely careful when attempting to operate the boat when low on fuel. Though some fuel may be in the tank, the relative trim angle of the boat may cause the fuel to flow away from the withdrawals.

Fuel Gauges

Indicate the amount of fuel in the tanks. Due to the mechanical nature of the fuel senders, variations in readings during various speeds of operation may occur. This system is merely a relative indication of the available fuel supply and not a calibrated instrument.



Typical Hinged Fuel Fill

Fuel Fills

The fuel tanks are vented through the fill fitting and cap. The system is equipped with three "key-less" fuel caps located on each side gunnel that are marked "GAS." The fuel fill caps are designed to seal out water and allow the fuel tank to vent to the atmosphere when the cap is closed.

To comply with EPA emission requirements, your boat could be equipped with spring loaded, hinged fuel fill caps with a push button release system or threaded, ratcheting twist off caps that click when they are tightened to indicate the cap is properly closed.

Hinged Fuel Fill Caps

Hinged fuel fills are opened by pressing the release button on the side of the cap and flipping the cap open. After fueling, make sure to close and press down firmly on the cap until it latches.

Fuel Tank Vent

Each fuel tank is equipped with a fuel tank vent system incorporated into each fuel fill. The fuel fill cap is designed to seal out water and allow the fuel tank to vent to the atmosphere when the cap is closed.

While the tank is being filled, air displaced by the fuel escapes through the vent and fuel fill. When the tank is full, special valves incorporated in the vent and fill hoses close and activate the



Triple Engine Fuel System - Stbd Engine Fuel Filter, Primer Bulbs & Fuel Selector Valve



Triple Engine Fuel System - Port & Center Engine Fuel Filters & Primer Bulbs

automatic shutoff valve on the marina fuel pump nozzle to prevent the tank from being overfilled and/or fuel from being ejected from the fuel fill/vent fitting. You should never attempt to "top off" the tank after the pump shutoff has activated. The shutoff valves will not allow additional fuel to be added after they close and could be damaged by attempts to force additional fuel into the tank.

After fueling, close and latch the fill cap. Then wash spilled fuel from the areas around the fuel fill if necessary. Residual fuel left on the deck and hull sides can be dangerous and will yellow the fiberglass or damage the striping.

5.2 Outboard Engine Fuel System

The fuel system on your Scout has three fuel tanks, port, center and starboard located in the bilge below the cockpit sole. Each tank is equipped with 3 or 4 fuel withdrawal tubes, depending on the engines installed. Each fuel withdrawal line is equipped with an anti-siphon valve where the line attaches to the fuel tank. This valve prevents gasoline from siphoning out of the fuel tank should a line rupture.

The fuel supply to each engine is controlled by labeled selector valves for each engine located in the aft systems room, below the center hatch in the rear of the cockpit. The valves are ON when the lever is pointed toward a labeled fuel tank and parallel with the fuel flow. The valve is OFF when the lever is perpendicular to the flow. All valves can be turned to the OFF position to shutoff the fuel supply when servicing the fuel system.

CAUTION

DO NOT REMOVE THE ANTI-SIPHON VALVES FROM THE SYSTEM. SHOULD THE VALVE BECOME CLOGGED, CLEAN AND REINSTALL OR REPLACE.

A fuel filter for each engine is located on each side of the aft systems room. The filters are the water separator type and should be serviced frequently to assure an adequate supply of clean, dry fuel to the engines. It is recommended that the filters be inspected periodically and the elements changed as needed or recommended by the engine manufacturer. Note that some engines have the fuel filter mounted on the engine and there is no filter in the aft systems room.

There is a primer bulb in each fuel line located near each filter that are used to prime the fuel system after service or as required. See Fuel System Maintenance in this chapter and the engine owner's manual for additional information on the fuel filters and the outboard engine fuel system.

Fuel Management

Proper fuel management is important on all boats. Each fuel tank is equipped with a fuel withdrawal tube for each engine. Labeled valves for each engine allow the operator to select which fuel tank (port, starboard or center) supplies fuel to the engine.

The valves are labeled Starboard Tank and Center Tank, depending on the engine. The labels refer to the tank the valve draws fuel from. If a supply problem should occur in one of the fuel tanks, the engines can be temporarily operated from another fuel tank by turning the valves to select the desired tank.

Triple Engine Fuel Management

During normal operation with triple engines, the port engine should be supplied fuel from the port tank, the starboard engine supplied fuel from the starboard tank and the center engine supplied fuel by the center tank. This configuration will keep the boat properly balanced and reduce the possibility for fuel supply problems. It also ensures that enough fuel will cycle through each tank to reduce the possibility of fuel degradation in one of the tanks.

You should avoid selecting the port/starboard and center engines to be supplied by the port or starboard tank during normal operation. Running two engines from the port or starboard tank will cause the boat to become improperly balanced, which will affect the handling and safe operation of the boat. Only select the port or starboard tank for the center engine when there is a fuel supply problem in the center tank.

If contamination or a fuel delivery problem occurs in one of the tanks and emergency fuel tank selections are necessary, it is important to be conscious of weight and balance and manage the fuel tank selections to keep the boat properly balanced whenever possible.

If a fuel supply problem occurs in the port or starboard tank, all three engines should be switched to the center tank first. When the fuel level in the center tank drops below 1/3, one port or starboard engine can be left on the center tank, depending on the situation, and the center and other port or starboard engines can be switched to the other good tank. The idea is to keep the boat properly balanced as long as possible. If all three engines are run from the center tank and the port or starboard fuel tank, the trim tabs will need to be adjusted as necessary to compensate for listing and maintain a level running attitude as fuel is consumed.



Triple Engine Fuel System - Stbd Engine Fuel Selector Valve



Triple Engine Fuel System - Port & Center Engine Fuel Selector Valves & Filters



CAUTION



WHEN EMERGENCY FUEL TANK SELECTIONS ARE NECESSARY, PAY ATTENTION TO THE FUEL LEVEL IN THE CENTER TANK AND SWITCH ONE PORT/STARBOARD AND THE CENTER ENGINE TO THE OTHER GOOD TANK AND LEAVE ONE PORT/STARBOARD ENGINE ON THE CENTER TANK WHEN THE FUEL LEVEL IN REACHES 1/3. THIS WILL PROVIDE ADDITIONAL RUN TIME FOR THE THE ENGINES. CONSIDER SHUTTING DOWN THE CENTER ENGINE IF THE FUEL SUPPLY BECOMES MARGINAL.

WHEN ENGINES RUN OUT OF FUEL THEY WILL SHUT DOWN SUDDENLY AND YOU WILL LOOSE THE ABILITY TO CONTROL THE POSITION OF THE BOAT FOR SEVERAL MINUTES WHILE THE FUEL SYSTEM IS PRIMED SO THE ENGINES CAN BE RESTARTED. THIS COULD ENDANGER THE BOAT AND CREW IN ROUGH SEAS, AN INLET OR A BUSY WATERWAY. ALWAYS MAKE SURE TO RETURN THE SELECTOR VALVES TO THE NORMAL POSITION WHEN THE FUEL SUPPLY PROBLEM IS CORRECTED.

Notice:

The procedure to prime the fuel system on outboard engines is specific to the type and model of engines on your boat. You should refer to engine manufacturer owner's manual for the priming procedure for your engines.

Quad Engine Fuel Management

During normal operation with quad engines, the port engine should be supplied fuel from the port tank, the starboard engine supplied fuel from the starboard tank. The starboard mid and port mid engines should be supplied fuel by the center tank. This configuration will keep the boat properly balanced and reduce the possibility of fuel supply problems. It also ensures that enough fuel will cycle through each tank to reduce the possibility of fuel degradation in one of the tanks.

You should avoid selecting the port or starboard tank for the center engines during normal operation. If not done correctly for both center engines, this could cause the boat to become improperly balanced, which will affect the handling and safe operation of the boat. Only select the port or starboard tank for the center engines when there is a fuel supply problem in the center tank.

If contamination or a fuel delivery problem occurs in one of the tanks and emergency fuel tank selections are necessary, it is important to be conscious of weight and balance and manage the fuel tank selections to keep the boat properly balanced whenever possible.

If a fuel supply problem occurs in the port or starboard tank, all three engines should be switched to the center tank first. When the fuel level in the center tank drops below 1/3, one port/starboard engine and one center engine can be left on the center tank and the other center engine and port/starboard engine can be switched to the other good tank. The idea is to keep the boat properly balanced as long as possible. If all four engines are run from the center tank and the port or starboard fuel tank, the trim tabs will need to be adjusted as necessary to compensate for listing and maintain a level running attitude as fuel is consumed.



CAUTION



WHEN EMERGENCY FUEL TANK SELECTIONS ARE NECESSARY, PAY ATTENTION TO THE FUEL LEVEL IN THE CENTER TANK AND SWITCH ONE PORT/STARBOARD AND CENTER ENGINE TO THE OTHER GOOD TANK AND LEAVE ONE PORT/STARBOARD AND CENTER ENGINE ON THE CENTER TANK WHEN THE FUEL LEVEL IN REACHES 1/3. THIS WILL PROVIDE ADDITIONAL RUN TIME FOR THE THE ENGINES. CONSIDER SHUTTING DOWN ONE CENTER ENGINE IF THE FUEL SUPPLY BECOMES MARGINAL.

WHEN ENGINES RUN OUT OF FUEL THEY WILL SHUT DOWN SUDDENLY AND YOU WILL LOOSE THE ABILITY TO CONTROL THE POSITION OF THE BOAT FOR SEVERAL MINUTES WHILE THE FUEL SYSTEM IS PRIMED SO THE ENGINES CAN BE RESTARTED. THIS COULD ENDANGER THE BOAT AND CREW IN ROUGH SEAS, AN INLET OR A BUSY WATERWAY. ALWAYS MAKE SURE TO RETURN THE SELECTOR VALVES TO THE NORMAL POSITION WHEN THE FUEL SUPPLY PROBLEM IS CORRECTED.

Notice:

The procedure to prime the fuel system on outboard engines is specific to the type and model of engines on your boat. You should refer to engine manufacturer owner's manual for the priming procedure for your engines.

5.3 Diesel Generator Fuel System

The diesel fuel system for the generator is completely separate from the gasoline system. The diesel fuel tank is located in the stern bilge below the cockpit and is filled from a fuel fill deck plate on the starboard gunnel labeled "Diesel." The diesel fuel system is not equipped with an anti-siphon valve and there is a fuel return line from the engine that returns unused fuel to the fuel tank.

Proper diesel engine operation requires a good supply of clean, dry diesel fuel. Improper marina fuel storage techniques, limited boat usage, etc. can cause the fuel to become contaminated. Periodically, it may be necessary to pump accumulating water and contaminated fuel from the bottom of the fuel tank. If the generator fuel system on your boat becomes contaminated, contact your dealer or Scout Customer Service for assistance.

Algae can grow in the accumulated water in diesel fuel tanks. This condition is most prevalent in warm climates. Periodically adding a high quality diesel fuel additive containing an algicide may be required to control algae in your boating area. You should contact your dealer or the generator manufacturer for additional information regarding fuels and additives.



Diesel Fuel Fill



Diesel Generator Fuel Filter Location Behind Sound Shield Access Panel

Notice:

Do not allow the generator to sit unused for an extended period with the fuel tank less than full. Changes in temperature and weather conditions can cause condensation in diesel fuel tanks that are less than 3/4 full.

Diesel Fuel Filter

A water separator type fuel filter is mounted near the generator in the aft systems room. Another filter is typically installed on the generator inside the sound shield. Replace the filter cartridges as recommended by the generator manufacturer or as needed.

It is particularly important to monitor the condition of the fuel filters frequently because diesel engines circulate much more fuel than they consume. Because of the volume of fuel that flows through the filters, they typically must be changed at least twice a season or more frequently depending on the quality of the fuel and the hours run. Follow the generator manufacturer's instructions for replacing the filters.

Notice:

Diesel fuel systems may need to be primed after servicing. Refer to the generator owner's manual for information on priming the fuel system.



Typical Generator Fuel Filter



Typical Fuel Filter On the Generator

5.4 Fueling Instructions



WARNING



FUEL IS VERY FLAMMABLE. BE CAREFUL WHEN FILLING THE FUEL TANKS. NO SMOKING. NEVER FILL THE TANK WHILE AN ENGINE IS RUNNING. FILL THE FUEL TANKS IN AN OPEN AREA. DO NOT FILL THE TANKS NEAR OPEN FLAMES.



CAUTION



TO PREVENT DAMAGE TO THE FUEL SYSTEM, USE ONLY A GOOD GRADE OF GASOLINE FOR GASOLINE ENGINES OR DIESEL FUEL FOR DIESEL ENGINES. DO NOT USE FUEL THAT CONTAINS HARSH ADDITIVES OR IS AN ALCOHOL BLEND. ANY DAMAGE DONE TO THE FUEL SYSTEM THAT IS THE RESULT OF USE OF AN ALCOHOL BLEND IS NOT COVERED BY THE SCOUT WARRANTY. REFER TO THE ENGINE MANUFACTURER OWNER'S MANUAL REGARDING FUEL REQUIREMENTS FOR YOUR ENGINES.



WARNING



DO NOT CONFUSE THE FUEL FILL DECK PLATES WITH THE WATER OR WASTE PUMP OUT DECK PLATE. THESE PLATES ARE LABELED ACCORDINGLY. THE DIESEL FUEL FILL DECK PLATE IS LOCATED ON THE SAME SIDE OF THE BOAT AS THE WASTE PUMP OUT DECK PLATE AND YOU SHOULD BE CAREFUL NOT TO ACCIDENTALLY PUMP DIESEL FUEL INTO THE WASTE HOLDING TANK. IF GASOLINE OR DIESEL FUEL IS ACCIDENTALLY PUMPED INTO THE WATER OR WASTE TANK, DO NOT ATTEMPT TO PUMP IT OUT YOURSELF. WATER AND WASTE PUMPS ARE NOT DESIGNED TO PUMP FUEL AND A FIRE OR EXPLOSION COULD RESULT. CONTACT YOUR DEALER OR THE SCOUT CUSTOMER SERVICE DEPARTMENT FOR ASSISTANCE IN HAVING THE FUEL PROFESSIONALLY REMOVED.

Preparing The Boat For Fueling

Use the following procedure to prepare the boat for fueling at a marina fuel pump:

- Make sure the boat is securely moored and all engines are off.
- Make sure all switches are in the OFF position.
- Make sure all passengers leave the boat.
- Close all doors and hatches.



WARNING



GASOLINE FUEL VAPORS THAT ACCUMULATE IN THE BILGE, AFT SYSTEMS ROOM, MID EQUIPMENT ROOM OR CABIN WHILE FUELING CAN EXPLODE!! FUEL VAPORS ARE HEAVIER THAN AIR AND CAN ACCUMULATE IF THEY ARE CARRIED BY THE WIND INTO THE BILGE OR CABIN THROUGH OPEN DOORS, HATCHES OR VENTS. ALWAYS CLOSE DOORS AND HATCHES BEFORE FUELING.

- Estimate how much fuel is needed and avoid overfilling the fuel tank.

Fueling The Boat

In order to comply with U.S. EPA emission regulations, boats sold in the United States are equipped with special fuel systems that reduce the flow of fuel vapors from the fuel system to the atmosphere when fueling operations are complete.

These fuel systems meet U.S. EPA emission standards and are designed to maintain a specific air space at the top of the fuel tank that provides proper tank ventilation and protection for emission control components. Special valves in the fuel tank vent and fill systems and a shutoff valve in marina fuel pump nozzles are designed to automatically stop the fuel flow when the tank is full and maintain this air space.

Notice:

When the fuel tank is full, the shutoff valve in the marina fuel pump nozzle will activate and automatically shut off the flow, indicating that the tank is filled to the maximum level. You should stop filling the tank at this point and never attempt to "top off" the tank. Attempting to "top off" the tank could damage fuel level control valves.





WARNING





STATIC ELECTRICITY GENERATED BY FLOWING FUEL CAN CAUSE A FIRE OR EXPLOSION. TO PREVENT STATIC SPARKS WHEN FILLING THE TANK, MAKE SURE THE NOZZLE IS ALWAYS IN CONTACT WITH THE FUEL FILL OPENING

To fill the fuel tank, follow this procedure:

- The fuel caps are hinged and do not require a key. Press the release button on the side of the cap and swing it open.
- Make sure the nozzle is equipped with an automatic shutoff valve. Then put the nozzle in the fuel fill opening and make sure it stays in contact with the fuel fill fitting during the entire fueling operation.
- Fill the tank until the shutoff valve in the pump nozzle clicks and automatically stops the fuel flow.
- Remove the nozzle and close the cap. Make sure to press down firmly until the cap clicks, indicating that it is secure and the system is sealed.

WARNING

FUEL TANK CONTENTS CAN BE UNDER PRESSURE. TO AVOID SERIOUS INJURY OR DEATH FROM FIRE OR EXPLOSION, OPEN FUEL CAP SLOWLY IN A WELL VENTILATED AREA. NO SMOKING OR OPEN FLAMES.

WARNING

SPILLED FUEL CAN CAUSE A FIRE OR AN EXPLOSION. MAKE SURE YOU DO NOT SPILL ANY FUEL. IF A SMALL AMOUNT OF FUEL IS SPILLED ON THE FIBERGLASS, USE A CLOTH TO REMOVE THE FUEL AND PROPERLY DISPOSE OF THE CONTAMINATED CLOTH. IF FUEL IS SPILLED ON THE WATER, EXERCISE EXTREME CAUTION. FUEL FLOATS ON THE SURFACE OF THE WATER AND CAN IGNITE. IF FUEL IS SPILLED INTO THE WATER, IMMEDIATELY EVACUATE THE AREA AND NOTIFY THE MARINA AND THE PROPER OFFICIALS.

Preparing The Boat For Operation

Use the following procedure to prepare the boat for operation when fueling operations are complete:

- Open all hatches, windows and doors.
- Check the fuel compartment and below the deck for fuel odors. If you smell fuel, do not start the engines.

5.5 Fuel System Maintenance

Outboard Gasoline Fuel System

Periodically inspect all primer bulbs, connections, clamps and hoses for leakage, damage or deterioration. Replace as necessary. Spray the valves,

tank fuel gauge senders and ground connections with a metal protector.

Frequently inspect and lubricate the fuel fill cap seal with Teflon or silicone grease. The seal prevents water from entering the fuel system through the fuel fill cap and it should be immediately replaced if there is any sign of damage or deterioration.

Contaminated fuel may cause serious damage to your engines. Fuel filters must be checked for corrosion and deterioration frequently. Fuel filters must be changed at least once a season or more frequently depending on the type of engine and the quality of the fuel. Refer to the engine or fuel filter manufacturer's instructions for information on servicing and replacing the fuel filter.



The age of gasoline can effect engine performance. Chemical changes occur as the gasoline ages that can cause deposits and varnish in the fuel system as well as reduce the octane rating of the fuel. Severely degraded fuel can damage the engines and boat fuel tanks and lines. Therefore, if your boat is not being run enough to require at least one full tank of fresh fuel a month, a fuel stabilizer should be added to the gasoline to protect the fuel from degradation. Your dealer or the engine manufacturer can provide additional information on fuel degradation and fuel stabilizers recommended for your engine.



In many states, most gasoline is blended with ethanol alcohol. Ethanol is a strong solvent and can absorb water during periods of storage. You should refer to the engine operating manual for information regarding alcohol blended fuels and how it affects the operation of your marine engine.



Diesel Generator Fuel System

Algae can grow in the accumulated water in diesel fuel tanks. This condition is most prevalent in warm climates. Periodically adding a high quality diesel fuel additive containing an algaecide may be required to control algae in your boating area. Since algae also can grow in accumulated water in the fuel filters, it is important to run the generator for at least 30 minutes after the algaecide has been added so it will be circulated throughout the fuel system. This is even more important during periods of storage or if the generator is not used enough to require refueling at least once a month.

Severe algae in a diesel fuel system can be extremely difficult and expensive to clean. You should be diligent in monitoring the fuel system by changing the fuel filter as recommended and being alert for signs of algae in fuel that is drained from the filter. Most algae appears as black, carpet like, fibers suspended in fuel and water drained from the filter. Severe cases of algae will produce a black jelly like substance that quickly clogs the filter and starves the engine for fuel.

 WARNING 	
<p>DO NOT DRAIN ANY FUEL INTO THE BILGE WHEN SERVICING THE FUEL SYSTEM. THIS COULD LEAD TO A FIRE OR EXPLOSION.</p>	
<p>AFTER THE FILTER ELEMENTS HAVE BEEN CHANGED, PRIME THE FUEL SYSTEM AND CHECK ALL FITTINGS FOR LEAKS BEFORE AND AFTER STARTING THE ENGINES.</p>	
<p>BEFORE STARTING THE ENGINES, ALWAYS OPEN ALL HATCHES, WINDOWS AND DOORS TO COMPLETELY VENTILATE THE BOAT AFTER SERVICING THE FUEL SYSTEM.</p>	

 WARNING 	
<p>TO REDUCE THE POSSIBILITY OF A FIRE OR EXPLOSION, MAKE SURE ALL ELECTRICAL SWITCHES ARE IN THE "OFF" POSITION BEFORE SERVICING THE FUEL SYSTEM.</p>	

 DANGER 	
<p>AVOID SERIOUS INJURY OR DEATH FROM FIRE OR EXPLOSION RESULTING FROM LEAKING FUEL, INSPECT SYSTEM FOR LEAKS AT LEAST ONCE A YEAR.</p>	

Electrical System

6.1 General

Your Scout is equipped with 120 volt AC and 12 volt DC electrical systems. The AC system can draw current from one of two sources, either shore power outlets at dockside or the generator. The DC system draws current from onboard batteries.

Your boat and engine charging system is designed for 12 volt, absorbed glass mat (AGM) marine batteries. AGM batteries are maintenance free.

All wires in the electrical systems are color coded to make identifying circuits easier. Wiring schematics have been included with this manual to aid in following an individual circuit.

6.2 12 volt DC System Overview

The 12 volt system is a fairly standard marine system. There are five or six batteries, depending on the engine options selected. One for each engine and two in parallel for the house, generator and electronics. There is also a dedicated battery in a forward compartment to power the optional bow thruster. The house battery bank is connected to the engine auxiliary charging circuits.

The engine and house batteries are located in battery boxes on each side of the mid equipment room companionway below the aft facing lounge seat. The battery for the optional bow thruster is mounted in a storage compartment below the forward cockpit sole.

Triple engine battery systems are controlled by five battery switches, one for each engine, one for the house 12 volt accessories and electronics, and one for the generator. Quad engine battery systems are controlled by six battery switches, one for each engine, one for the house 12 volt accessories and electronics, and one for the generator. The engine and house batteries are charged by the engines or the battery chargers when connected to shore power or when the generator is operating.

The bow thruster battery is paralleled to one of the engine batteries and is also charged by the engines or battery charger. The optional bow thruster unit is located in the forward bilge com-

Scout Boats Marine Standard Wiring Code

<u>COLOR</u>	<u>USE</u>
Brown (Br)	Pumps
Orange (O)	Accessory Feed + 12 VDC
Dark Blue	Cabin/Courtesy/Instrument Lighting
Pink (Pk)	Fuel Sender
Dark Gray (Gy)	Navigation Lighting
Black or Yellow	12 VDC Ground
Purple (Pu)	Ignition Instrument Feed + 12 VDC
Green (G)	DC Grounding (Bonding)
Red	+ 12 VDC Power

partment below the cabin berth. It is controlled by a main switch that is activated automatically when the bow thruster is energized. The main switch also provides overload circuit protection for the bow thruster. It is accessed through a hatch below the forward center berth cushion in the cabin.

Most 12 volt power is distributed to the 12 volt accessories through individual circuit breakers located in the cabin DC panel, battery switch panel or by fuses in the CZone control output modules. All circuit breakers and fuses are labeled with the name of the circuit they protect.

Main circuit breakers in the battery switch panel protect the primary circuits for the CZone control modules, continuous (24 hour) power, windlass, hardtop switch panel, electronics, stereo amplifiers, and the main 12 volt power supply. Other main breakers in the panel protect the battery charger circuits for the batteries and additional accessories. The "push to reset" circuit breakers in the panel protect the circuits for the trim tab pumps and switches. Most 12 volt accessories are operated directly by switches in the helm electronics panels, hardtop switch panel or switches in the cabin. Other accessories are controlled directly with the CZone control feature.



Mid Equipment Room Access Hatch Below Leaning Post Aft Facing Bench Seat

Boats equipped with quad or triple Yamaha engines and electronic steering will also be equipped with main circuit breakers mounted in electrical boxes on each side of the aft systems room. These circuit breakers protect the electronic steering and auxiliary engine charging circuits for each engine.

Main breakers or fuses located on each engine protect the ignition systems and gauges. Yamaha and Mercury engine electrical circuits are protected by fuses located in a fuse panel on the side of the engine. The fuse panel is equipped with a spare fuse for each circuit. Always replace fuses used with the fuse specified by the engine manufacturer. Refer to the engine owner's manual for more information on the fuses, fuse panels or circuit breakers on your engines.

	CAUTION	
PROPER FUSE OR BREAKER PROTECTION MUST BE PROVIDED FOR ALL 12 VOLT EQUIPMENT ADDED. DO NOT OVERLOAD THE ACCESSORY CIRCUIT BREAKERS OR OTHER CIRCUITRY THROUGH ADDITIONAL 12 VOLT EQUIPMENT.		

6.3 Batteries and Battery Switches

The DC electrical system on your boat is designed for absorbed glass mat (AGM) marine batteries only. Do not attempt to use gel cell, wet cell or batteries not recommended by the engine manufacturers. The engine charging system and/or the battery chargers may not be able to recharge gel cell batteries



Typical Triple Engine House Batteries



Typical Triple Engine Starting Batteries

properly which could cause unusually short battery life, engine starting problems and damage to the DC charging systems. Since the batteries are side mounted, wet cell batteries will leak battery acid which will damage components in the mid equipment room and bilge. You also should not mix the size or brand of AGM batteries. Always consult your Scout dealer before changing the type of batteries in your boat.

Your boat has provision for five or six batteries in the mid equipment room below the aft facing lounge seat. There is one battery for each engine and two in parallel for the house, generator and electronics circuits. The batteries supplied by Scout are the size and capacity batteries recommended by the engine manufacturer. These specifications should be considered to be the minimum size battery required.

There are 4 or 5 motorized battery switches and three or four parallel switches in the battery switch panel, depending on whether your boat is equipped with triple or quad engines. The battery and parallel switches can be activated by labeled switches in the cabin DC panel, the CZone control feature or on the battery switch panel. They can also be activated manually by rotating the knob on each switch and remotely with the wireless CZone remote control.

Battery switches are identified by red knobs and the parallel switch knobs are yellow. The engine batteries are dedicated to starting and operating the engines. The house battery bank is dedicated to powering DC accessories, generator and the electronics. The engine and house batteries can be temporarily connected in parallel by the PARALLEL switch to provide additional starting current for each engine.



Quad Engine Battery Switch Panel, Motorized Battery Switches, Remote Battery Switches, Parallel Switches & Circuit Breakers

The batteries are automatically charged by the engines whenever they are running. The batteries are also charged by the battery chargers when the AC electrical system is activated.

The motorized battery switches can be controlled remotely, in Auto Mode, by switches in the cabin DC panel and battery switch panel or manually, in Manual Mode, by turning the knob on the battery switches. There are LED lights on both the remote switches and the battery switches that indicate battery switch mode and status. These lights will blink when the switch has been activated and the motor is turning the battery switch ON or OFF. The Parallel switches operate in exactly the same manner as the battery switches.

Press the remote switch once to engage the battery switch. A blue light in the switch will illuminate to indicate that the battery switch is ON. To turn the battery switch OFF, simply press the switch again. The LED light may not turn off immediately or will slowly fade out if there are no loads present on the system. This is normal as the capacitors in the system drain.

To operate the battery switches remotely in Auto Mode, the manual knob on each battery switch

must be set to "AUTO OFF." In this position, each battery switch will move from "AUTO OFF" to "AUTO ON" when the remote switch is turned on and from "AUTO ON" to "AUTO OFF" when the remote switch is turned off. LED lights at the remote switches and on each battery switch will be lit when the battery switches are in the ON position. The LED lights at the remote switches and on the battery switches will be off and the battery switches will indicate "AUTO OFF" when the battery switches are turned off. Remote operation of the battery switches is not possible when they are set to Manual Mode. If auto operation is attempted, the LED lights will flash for 3 seconds, then stop. The knob on the battery switches must be set to "AUTO OFF" before they can be activated remotely.

The remote operation of the battery switches can be overridden at anytime by depressing the control knob on the battery switch and turning it to the "MAN ON" or "MAN OFF" position. The "MAN ON" LED light on the battery switch will be lit whenever the battery switch is activated in Manual Mode. The knob on the battery switch must be returned to the "AUTO OFF" position before the battery switch can be activated remotely. For more information on the motorized battery switches, refer to the switch manufacturer's operation manual.



Cabin DC Panel Remote Battery Switches

When in port or at anchor, the engine battery switches should be off. Only the battery switch that activates the house battery bank should be on. This will keep the engine starting batteries in reserve for starting the engines. If the house batteries become discharged to the point that DC accessories will not operate, the engines can be started to recharge the house batteries.

Notice:

Current is supplied to the high water alarm and automatic switches for the bilge pumps when the batteries are connected and the battery switches are OFF.

The battery chargers are equipped with a switch to select the type of batteries to be charged. The batteries will be damaged if the charger is not set properly. You should refer to the battery charger owner's manual to make sure the charger is set to the type of batteries in your boat and do not mix the size, type or brand of marine batteries. Always consult your dealer before changing the type of batteries.

Parallel Start Switches and Dead Batteries

In the event of a dead starting battery for any engine, the engine and house batteries can be placed in a temporary parallel configuration. This allows you to start any engine from the engine batteries and the house battery bank combined. Make sure the House and all Engine battery switches are on. Press the Parallel remote switch once to activate the Parallel switches, then start the engine with the dead battery

normally. Press and hold the Parallel remote switch for eight seconds to disengage the Parallel switches.

In the event of dead house batteries, there are a several options.

- If at the dock, simply plug in the shore power and operate the battery chargers to recharge the house batteries.
- If at sea, start the engines. Once any engine is running, the alternator circuit will charge the house batteries. The house battery bank will continue to be charged until the engines are shutdown, isolating the house batteries from the engine batteries.
- Use the generator to activate the battery chargers to recharge the batteries. To operate the generator, start the engines and allow them to run for 10 to 15 minutes to charge the house batteries enough to engage the generator starter. Then start the generator and activate the battery chargers to accelerate the charge into the house battery bank.

Notice:

If a battery is fully discharged/dead for a lengthy period it may become permanently damaged and will not be able to hold a charge.

Always consult your dealer before changing the type of batteries in your boat or if you have questions regarding the batteries or charging system.

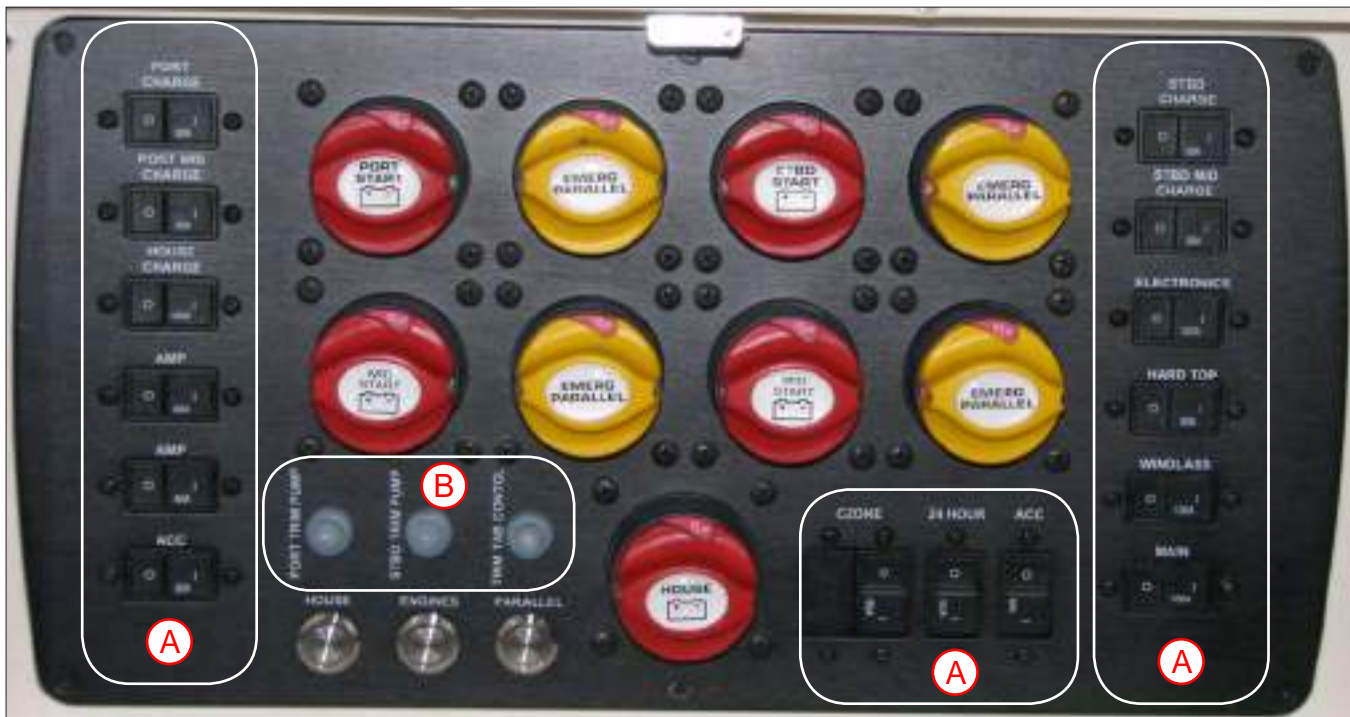

Quad Engine Battery Switch Panel Heavy Duty & "Push to Reset" Circuit Breakers
 A. Heavy Duty Circuit Rocker Style Breakers B. "Push to Reset" Circuit Breakers

6.4 Battery Switch Panel Circuit Breakers

Heavy Duty Rocker Style Circuit Breakers

High amperage, heavy duty, normally ON circuit breakers. These breakers are turned on, off or reset by rocker switches on the face of each breaker.

If a main circuit breaker trips, always make sure the problem that caused the breaker to trip is found and corrected before resetting the breaker.

Port Charge

Provides protection for the battery charger output wire that supplies DC charging current to the port engine battery.

Port Mid Charge

Provides protection for the battery charger output wire that supplies DC charging current to the port center engine battery on quads and the center engine battery on triples.

House

Provides protection for the battery charger output wire that supplies DC charging current to the house batteries.

STBD Charge

Provides protection for the battery charger output wire that supplies DC charging current to the starboard engine battery.

STBD Mid Charge

Provides protection for the battery charger output wire that supplies DC charging current to the starboard center engine battery on quads.

Amp

One of two circuit breakers that provides protection and power for the amplifier for the boat stereo speaker system. This breaker is supplied current when the House battery switch is activated.

Amp

One of two circuit breakers that provides protection and power for the stereo amplifier for the boat stereo speaker system. This breaker is supplied current when the House battery switch is activated.

Electronics

Provides protection and electrical current to the main electronics circuit for the helm. Other fuses in the electronics fuse panels behind the helm and /or in-line fuses protect the individual circuits for the electronic equipment. This breaker is supplied current when the House battery switch is activated.

Hard Top

Provides protection and electrical current to the primary circuit for hardtop accessories. Other "push to reset" breakers in the hardtop switch panel, CZone output modules and in-line fuses or circuit breakers near the accessories protect the individual circuits. This breaker is supplied current when the House battery switch is activated.

Windlass

Provides protection and power for the circuit that powers the windlass relay. This breaker is supplied current when the House battery switch is activated.

Main

Provides protection and electrical current to the primary circuits for helm, cockpit and cabin DC accessories that are not controlled by the CZone system. Other circuit breakers or fuses protect the individual circuits. This breaker is supplied current when the House battery switch is activated.

CZone

Protects the circuit that supplies primary DC power to the CZone output control modules. Other fuses in the CZone control modules protect the individual circuits. This breaker is supplied current when the House battery switch is activated.

24 Hour

Protects the circuit that supplies constant DC power to the continuous power, "push to reset" circuit breakers in the cabin DC panel and continuous power fuses in the CZone control modules. This breaker is always supplied current when the house battery is connected.

ACC (2)

Reserved for additional 12 volt equipment.

"Push TO Reset" Circuit Breakers

Normally ON circuit breakers with a flexible translucent boot on the face. When a breaker trips, the reset button pops out and is visible in the boot. Press the button to reset the breaker.



Typical Electronics Fuse Panel

Trim Tab Control

Protects the circuit that supplies 12 volt electrical current to the trim tab control switches at the helm. This breaker is supplied current when the House battery switch is activated.

Stbd Trim Pump

Protects the circuit that supplies 12 volt electrical current to the starboard trim tab pump when the House battery switch is activated.

Port Trim Pump

Protects the circuit that supplies 12 volt electrical current to the port trim tab pump when the House battery switch is activated.

Underwater LTS

Protects the circuit that supplies 12 volt electrical current to the transom underwater lights when the House battery switch is activated.

6.5 Other DC Circuit Protection

Helm Electronics Fuse Panels

Mounted inside the helm and accessed through a door in the head compartment aft bulkhead.

Individual fuses protect the circuits for electronics and other helm electronic accessories. The fuses are labeled for the accessory circuit they protect.

Blank fuse holders are reserved for additional accessories.

If a fuse blows, it must be replaced with a fuse of the same amperage as the original. The fuses are labeled and color coded. Never try to correct a problem by installing a larger fuse. This could damage sensitive electronic equipment or cause the circuit to overheat, which could result in an electrical fire.

Electrical Box Circuit Breakers Main Circuit Breakers

Boats equipped with quad or triple Yamaha engines and electronic steering will also be equipped with main circuit breakers mounted in electrical boxes on each side of the aft systems room. These circuit breakers protect the electronic steering and auxiliary engine charging circuits for each engine.

“Push to Reset” Circuit Breakers

Normally ON circuit breakers with a flexible translucent boot on the face usually located on the back side of each electrical box. When a breaker trips, the reset button pops out and is visible in the boot. Press the button to reset the breaker.

Vent Fan

Protects the circuit that supplies 12 volt electrical current to the aft systems compartment vent fan when the House battery switch is activated. The fan is activated automatically when the generator is started. It circulates fresh air and removes heat from the aft systems compartment while the generator is operating.

Port Reel (Optional)

Protects the circuit that supplies 12 volt electrical current to the electric reel outlet or switch below the port gunnel when the House battery switch is activated.

Starboard Reel (Optional)

Protects the circuit that supplies 12 volt electrical current to the electric reel outlet or switch below the starboard gunnel when the House battery switch is activated.



Electrical Box & Typical Yamaha Electronic Steering & Auxiliary Engine Charging Circuit Main Breakers



Port Side Electrical Box - Vent Fan & Port Electric Reel Circuit Breakers



Typical Yamaha Helm Master Quad Engine
Radio Frequency ID Key Activated START/STOP & Ignition Switch Panels

6.6 Ignition Switch Panels

Ignition switch panels are unique to each engine manufacturer and the engine control options selected. The information in this section provides a general overview of the most common triple and quad ignition systems for Yamaha outboard engines.

Your dealer will provide you with the proper starting procedure for your boat at the time of delivery. Additional information for the ignition switch system installed in your boat is located in the engine and control system operating manuals included in your information packet.

Yamaha Command Link Plus® Ignition

Most Scout boats equipped with triple Yamaha engines are equipped with Command Link Plus® ignition panels that offer advanced technology and durability. This is a "key" activated ignition panel which energizes the ignition system of multiple outboards with only one key.

The START/STOP panel is used in conjunction with the ignition key panel and features lights which indicate when the engines are running and a START/STOP button for each engine. This system greatly simplifies the starting and stopping process of your engines while providing the simplicity and security of a keyed ignition. For convenience and protection, engines can not be restarted while running.

Starting and stopping procedure:

Make sure the engines are shutdown with the shift levers in the neutral position and your hand is on the control levers. Turn the ignition key to the ON position to activate the ignition and START/STOP buttons for the engines. Press and release the START/STOP button for the port engine. It is not necessary to hold the button, just press it once and release it. The computer will automatically check all engine systems and start the engine.



Typical Yamaha Triple Engine
Key Activated Ignition Switch & START/STOP Buttons

Once the engine stabilizes, repeat the starting procedure for the other engines. Stop the engines by pressing the START/STOP buttons again. Then turn the key switch to OFF and remove the key to deactivate the START/STOP panel and secure the engines.

Helm Master Ignition

Boats equipped with quad Yamaha engines and some triple engine boats include the Helm Master ignition panel that offers the latest technology and security. This is a "keyless" electronic panel which energizes the ignition system of multiple outboards with only one Radio Frequency ID key by touching the panel with the electronic key. The panel features lights which indicate when the engines are running and a START/STOP button for each engine. For convenience and protection, engines can not be restarted while running.



Typical Accessory Switch Panel In Garmin Display



CZone Display Monitoring Screen

Starting And Stopping Procedure

Make sure the engines are shutdown with the shift levers in the neutral position and your hand is on the control levers. Touch the panel with the electronic key fob to unlock and activate the panel. The panel will beep twice to indicate it is unlocked and the buttons are active. Once the panel is activated, press the IGNITION button, then the START/STOP button for the port engine. It is not necessary to hold the button, just press it once and release it. The computer will automatically check all engine systems and start the engine. Once the engine stabilizes, repeat the starting procedure for the other engines. Stop the engines by pressing the START/STOP buttons again. Touch the panel with the electronic key to deactivate and lock the panel. The panel will beep once to indicate that it is locked and the engines and START/STOP buttons are deactivated.

6.7 12 volt Accessory Switch Panels Digital Switch System

Your boat is equipped with a CZone digital switching system that provides reduced complexity and increased switching options for the lights and accessories the switches control. The system consists of the CZone display screens, control output modules, push button digital switch panels and touch screen switches in the helm electronics display panels.

Each circuit is protected by individual spade type fuses located in a fuse panel built into each control output module. The control output modules are where the switching of input and output current load to the selected accessories takes place. The controllers in each module recognize low voltage, digital signals from the switches and activate the correct programmed combination of circuits for each switch function (i.e. the navigation lights switch actually forces the forward navigation lights and the anchor light to be turned on at the same time).

Interior or cockpit light switches may be programmed to activate different colors for multicolored LED lights activated by the switches as well as their ON/OFF status. All switches in the push button switch panels are a "press to activate" and "press to deactivate" design. LED lights in each switch indicate the circuit is activated.

This section provides a general description of the accessories typically activated by the CZone switch panels. CZone switch programming is unique to each boat, depending on optional equipment installed at the factory or by your dealer and display preferences chosen at the time of delivery. Consequently, switch programming on your boat may be different.

Refer to the CZone Control System section in this chapter and the Scout CZone operation manual for additional information on the digital switching system. Your dealer and or Scout representative will also provide you with hands-on instructions at the time of delivery.



Hardtop Switch Panel

Hardtop Accessory Switch Panel

The accessory digital switch panel is located in the hardtop liner above the helm. The following is a description of the accessories controlled by the main accessory switch panel:

Nav/Anchor Lights

Pressing the switch once will activate the navigation lights. Press the switch again to activate the anchor light. Press the switch again to turn the anchor light off.

Forward Spreader

Activates the overhead light at the front of the hardtop that illuminates the forward cockpit.

Aft Spreader

Activates the overhead light at the rear of the hardtop that illuminates the aft cockpit.

Hardtop LTS

Activates the overhead lights above the helm and on the rear of the console, above the footrest. Press the mode switch with the lights ON to change the color.

Map light

Activates the red overhead map lights above the helm. Press the mode switch with the lights ON to change the color.

Notice:

Red lights have less effect on night vision and should be selected if you need to illuminate the helm area while navigating at night.

Fwd Bilge

Manually activates the forward bilge pump located in the bilge below the cabin sole. The pump moves water out through a thru-hull fitting in the hull. The pump is also activated by an automatic switch whenever the batteries are connected. This pump will run



Hard Top Push Button Digital Switch Panel

as needed whenever water in the bilge accumulates high enough to be activated by the automatic switch and turn off when the water is removed.

Aft Bilge

Manually activates the aft bilge pump located in the aft systems room bilge near the transom. The pump moves water out through a thru-hull fitting in the hull. The pump is also activated by an automatic switch whenever the batteries are connected. This pump will run as needed whenever water in the bilge accumulates high enough to be activated by the automatic switch and turn off when the water is removed.

Notice:

The bilge pumps will start automatically when there is sufficient water in the bilge to activate the float switch. Each automatic switch is protected by a labeled fuse located in the CZone control modules or by a circuit breaker in the cabin DC Panel and are always supplied current when the batteries are connected.

Wiper

Activates the windshield wiper.

Wiper Wash

Activates the solenoid that sprays water on the windshield washer from the fresh water system.

Notice:

The fresh water system must be activated for the windshield washers to work.

High Water Alarm

A red LED light illuminates and an alarm sounds if the bilge water level rises above the normal operating range of the bilge pump automatic switches. The alarm automatic switch is connected to the batteries and protected by a fuse located in the CZone control module or a circuit breaker in the cabin DC panel. It remains activated when the battery switches are in the OFF position and the batteries are connected.

Shade In/Shade Out (Optional)

Two momentary switches that control the retractable sunshade integrated into the rear of the hardtop. Press the SHADE OUT switch to extend the sunshade. Press the switch again to stop the sunshade in the current position.

Press the SHADE IN switch to retract the sunshade. Press the switch again to stop the sunshade in the current position.

Limit switches in the electric actuators that extend and retract the sunshade will automatically stop the actuators when the sun shade reaches the fully extended or retracted positions.

Notice:

If your boat is equipped with rocket launcher rod holders on the rear of the hardtop, the rod holders will automatically rotate down to provide clearance for the sunshade when the SHADE OUT button is pressed. The rod holders will automatically rotate to the up position when the sunshade is retracted.

If the retractable sunshade option is not installed, these switches are reserved for additional 12 volt accessories.



Rocket Launcher Rod Holders Rotated Down To Provide Clearance To Extend Sunshade

Windlass In/Windlass Out

Two momentary switches that control the windlass, which is mounted to the deck forward of the rope locker. Press and hold the WINDLASS OUT switch to pay the anchor line out. Press and hold the WINDLASS IN switch to pull the anchor line in.

Mode Switch

The mode switch is a separate momentary switch that changes the color of the LED cockpit or map lights when they are activated. To change the color mode, activate the lights on the main switch panel, then press the mode switch to select the desired color or light color combination.

Horn



Activates the boat horn located on the hardtop.

House Battery Volt Meter

Monitors the voltage in the house battery circuit.

Circuit Breakers

Two "push to reset" circuit breakers on the starboard side of the switch panel provide protection and electrical current to the horn and VHF radio circuits. These circuit breakers are supplied current when the House battery switch is activated.

**CAUTION**

FISHING RODS IN THE HARDTOP ROCKET LAUNCHER ROD HOLDERS WILL ROTATE QUICKLY TO THE HORIZONTAL POSITION WHEN THE SHADE OUT BUTTON IS PRESSED. ROD OR REEL COMPONENTS COULD HIT PASSENGERS STANDING BEHIND THE HARDTOP. TO AVOID INJURY, ALWAYS MAKE SURE NO PASSENGERS ARE STANDING BEHIND THE HARDTOP BEFORE ACTIVATING THE SHADE OUT SWITCH.



Typical Switch Panel In Helm Electronics Touch Screen Display Panel

Typical Helm Electronics Display Panel Switches

Accessory switches are integrated into the electronic display panels at the helm. The switches are typically activated by touching the top of the switch icon to activate the accessory and pressing the bottom of the switch to turn it off. LED lights in each switch icon illuminate to indicate the circuit is activated.

Notice:

Some switches in the hardtop switch panel may be duplicated in the electronics display panel for convenience. Switches can be added or deleted from the panel at the operator's discretion and your boat may be equipped with additional switches not mentioned.

The following is a description of accessory switches typically controlled by touch screen switches in the electronics display panel:

Accent Light Switches

Activates and controls the lights in the cockpit below the gunnels that illuminate the cockpit sole.

Anchor Light

Activates the anchor light.

Nav/Anchor Lights

Activates the navigation lights.

Baitwell Lights

Activates the light in the baitwell.

Baitwell Pump

Activates the pump for the baitwell.

Bilge Light Switches

Activates the light in the aft systems room and mid equipment room.

Storage Light Switches

Activates the lights inside the cockpit storage compartments.

Bilge Pump Aft

Manually activates the aft bilge pump located in the stern bilge near the transom. The pump moves water out through a thru-hull fitting in the hull. The pump is also activated by an automatic float switch that is activated whenever the batteries are connected. This pump will run as needed whenever the water in the bilge accumulates high enough to raise the float switch to the ON position and turn off when the water is removed.

Bilge Pump Forward

Manually activates the forward bilge pump located in the bilge below the cabin sole. The pump moves water out through a thru-hull fitting in the hull. The pump is also activated by an automatic float switch that is activated whenever the batteries are connected. This pump will run as needed whenever the water in the bilge accumulates high enough to raise the float switch to the ON position and turn off when the water is removed.

Bow Table (Optional)

Controls the electric actuator that raises and lowers the bow table pedestal.

Discharge Pump

Activates the waste discharge pump that empties the waste tank. Refer to the Marine Head System in the Interior Equipment chapter for additional information on the operation of the overboard discharge system.

Fishbox Port

Activates the diaphragm pump that drains the port cockpit fishbox. To avoid damage to the pump, always monitor the water level as the pump drains the fishbox and turn it off immediately when draining is complete.

Fishbox Starboard

Activates the diaphragm pump that drains the starboard cockpit fishbox. To avoid damage to the pump, always monitor the water level as the pump drains the fishbox and turn it off immediately when draining is complete.

Flex Light Hardtop

Activates and controls the overhead lights above the helm and on the rear of the console, above the footrest. Press the mode switch with the lights on to change the color.

Fresh Water Pump

Activates the fresh water pump that supplies the fresh water washdown hose connector in the cockpit, marine toilet and the cabin sink. The pump is the pressure demand type. A pressure switch automatically controls the water pump when the system is activated and properly primed.

Raw Water Pump

Activates the raw water washdown pump that supplies the washdown hose in the cockpit. The pump is the pressure demand type. A pressure switch automatically controls the water pump when the system is activated and properly primed.

Map lights

Activates the red overhead map lights above the helm. Press the mode switch with the lights ON to change the color.

Swim Door Light

Activates the light at the swim door.

Transom Door Light

Activates the light at the transom door.

Transom lights

Activates the lights at the transom platform.

Underwater Lights

Activates the LED underwater lights in the stern below the waterline.

Forward Spreader

Activates the overhead light at the front of the hardtop that illuminates the forward cockpit.

Aft Spreader

Activates the overhead light at the rear of the hardtop that illuminates the aft cockpit.

Additional DC Switches and Accessories Trim Tab Switches

Located in the helm. These switches control the trim tab planes located on the transom of the boat. They are protected by circuit breakers located in the battery switch panel. Refer to the Helm Control Systems chapter for detailed information on the operation of the trim tab controls.

Engine Trim and Tilt Switches

Located in the helm. These switches are typically installed in the engine throttle and shift control. They control the trimming and tilting of the engines. Refer to the Helm Control Systems chapter and the engine owner's manual for information regarding the proper use of the tilt and trim switches.

Spot Light (Optional)

Located in the helm. Controls the spot light that is mounted on the hardtop. Refer to the spot light owner's manual for details on operating the control pad.

Bow Thruster (Optional)

The bow thruster switch panel controls the bow thruster when this option is installed. Refer to the Control Systems Chapter and the Bow Thruster owner's manual for additional information on the bow thruster.

Table Control Switch Panel (Optional)

Two momentary switches that control the electric actuator that raises and lowers the bow table pedestal. Press and hold the top switch to raise the table. Press and hold the bottom switch to lower the table. Release the switch to stop the table in the current position. A limit switch in the actuator will automatically stop the pedestal when the table reaches the full UP or Down position.

Shore Power Reel Control Switch (Optional)

A momentary two position rocker switch located in the cockpit. Controls the electric shore power reel in the transom. Press and hold the top of switch to extend the cord. Press and hold the bottom of the switch to retract the cord. Release the switch to stop the reel.

Beach Platform Switch (Optional)

Located in the cockpit near the swim door. Controls the hydroelectric actuators that raise and lower the optional beach platform.



Table Control Switch Panel & Forward Cockpit USB Plug



Marine Head Control Switches

Marine Head Control Switches

Located above the marine toilet in the cabin. They control the filling and flushing operations of the marine toilet. Refer to the Interior Equipment chapter for additional information on the operation of the marine toilet.

Discharge Pump

Accessed by the power control feature in the CZone display or programmed into the electronics display panel. Activates the waste discharge pump that empties the waste tank. Refer to the Marine Head System in the Interior Equipment chapter for additional information on the operation of the overboard discharge system.

Raw Water Pump

Accessed by the power control feature in the CZone display or programmed into the electronics display panel. Activates the raw water washdown pump that supplies the washdown hose in the cockpit. The pump is the pressure demand type. A pressure switch automatically controls the water pump when the system is activated and properly primed.

Water Pressure

Accessed by the power control feature in the CZone display or programmed into the electronics display panel. Activates the fresh water pump that supplies the fresh water system and washdown hoses in the cockpit and anchor locker. The pump is the pressure demand type. A pressure switch automatically controls the water pump when the system is activated and properly primed.

Port Fishbox

Accessed by the power control feature in the CZone display or programmed into the electronics display panel. Activates the diaphragm pump that drains the port cockpit fishbox. To avoid damage to the pump, always monitor the water level as the pump drains the fishbox and turn it off immediately when draining is complete.

Starboard Fishbox

Accessed by the power control feature in the CZone display or programmed into the electronics display panel. Activates the diaphragm pump that drains the starboard cockpit fishbox. To avoid damage to the pump, always monitor the water level as the pump drains the fishbox and turn it off immediately when draining is complete.

Baitwell

Accessed by the power control feature in the CZone display or programmed into the electronics display panel. Activates the pump for the baitwell.

Recirc Pump

Accessed by the power control feature in the CZone display or programmed into the electronics display panel. Activates the pump that recirculates and aerates the water in the baitwell.

Helm Stereo Control Pads

Located in the helm and cockpit. Controls the stereo mounted in the cabin. Refer to the stereo owner's manual for details on operating the stereo control pads.

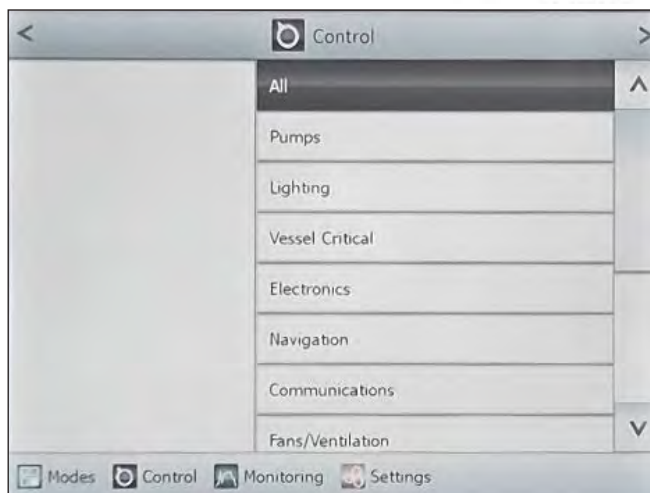

CZone Control Menu



Stereo Remote Control Pad

12 volt Receptacles

Located in the storage compartments at the helm, in the cabin and in the cockpit at the bow. Provides electrical current for portable 12 volt equipment.

MP3/USB Connections

Located in storage compartments at the helm, in the cabin and in cockpit at the bow. Provide an input for MP3 players and USB drives to connect to the boat stereo system. The USB connections will charge cell phones and other portable electronics that are charged by a USB cord.



CZone Switch Display

6.8 CZone Digital Control System

The CZone digital switching system provides reduced complexity and increased switching options at the helm. The system consists of the CZone switch and control screens in the Garmin displays, digital switch panels and DC digital control output modules.

The electrical systems and accessories are monitored by various CZone screens in the Garmin touch screen displays. Specific modes can be activated or deactivated wirelessly using the key fob remote or a smart phone or Ipad application.



CZone Display & Control Features

The CZone display/control screens are the primary interface between the CZone digital switch network and the user. They provide full control of circuits controlled by the digital switch panels as well as the ability to view selected onboard system information, such as tank levels and power levels for DC supplies. Fuses in the control output modules and "push to reset" circuit breakers in the cabin DC and battery switch panels protect the DC circuits activated by the module.

Audio and visual alarms with systems diagnostics are also provided. The display screens are designed with a menu structure that is easy to follow. The 'modes of operation' feature allows the control of multiple circuits with a single push of a button.

The following are some features that can be modified, monitored or controlled with the CZone control features on the Garmin display panels.

Modes of Operation

- Allows user to assign control of multiple DC circuits to a single switch.
- Allows user to dim or brighten selected light circuits.
- Allows users to activate or power down the DC electrical system from the onboard control panels or remotely through the wireless network interface.

Power Control

- Activates and monitors the DC powered sea-water and freshwater pumps.
- Activates and monitors the holding tank DC powered overboard discharge diaphragm pump for the waste tank.

DC Power Meter

- Displays voltages of engine and house batteries. Includes low and high voltage alarms.
- Displays battery capacity in ampere hours and % charge/discharge, includes low ampere hour alarm.
- Displays charge and discharge amps.

Tank Levels

- View tank level information for water and waste tanks.
- View gas and diesel fuel tank level information.

Data

- Displays network information.
- Displays temperature and pressure values.
- Monitors all circuits connected to the CZone network.

Alarms

- CZone network status reporting.
- Indicates alarms for onboard faults in audible and visual form (bilge pump operation, high bilge water level, smoke alarm).

Refer to the Scout CZone operation manual for additional information on the features and operation of the CZone control system.



CZone Mode Screen

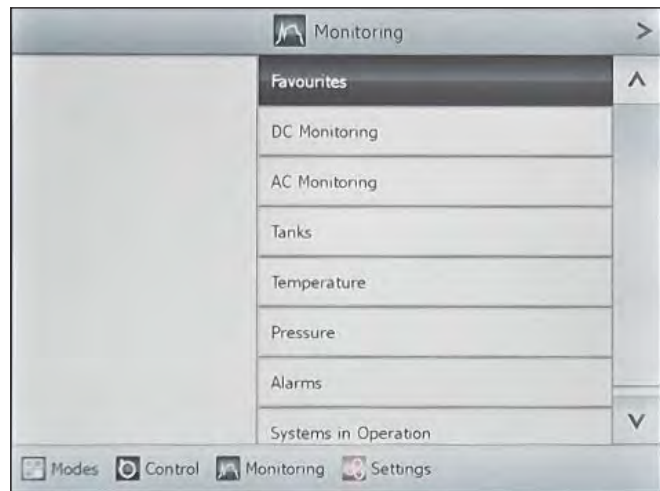

CZone Monitoring Menu



CZone DC Power Monitoring

CZone DC Electrical System Control Output Module Circuit Protection

Accessory circuits activated by the digital switches are protected by spade type fuses located in the CZone output modules. The circuits controlled by each module are numbered and labeled for the accessory activated and protected by the module.

The fuses are color coded to indicate the amperage of the fuse. The amperage rating is also clearly printed on the fuse housing. Never replace a blown fuse with a fuse of a higher amperage and/or a different color.

The fuses are located behind a removable panel on the front face of each module. Refer to the CZone operation manual for instructions to remove the panel and inspect or replace fuses.

In addition to circuit protection, the fuses and fuse panels are equipped with a manual circuit bypass feature that allows any circuit controlled by a CZone output module to be activated manually.

To bypass the controller and activate a circuit manually, remove the protective cover and find the fuse for the circuit to be bypassed. Remove the fuse and reinsert it in the bypass position.

Refer to the Scout CZone operation manual for additional information on the features and operation of the CZone control system.



CZone Control Output Modules



CZone Output Module Fuses



CZone Circuit 3 Fuse In Bypass Position



Cabin DC Breaker Panel, CZone Display & Generator Control Panel

- A. Engine & House Battery Volt Meters
- B. Remote Battery Switches & Parallel Switch
- C. DC Accessory "Push TO Reset" Circuit Breakers
- D. CZone Monitor & Control Panel
- E. Generator Control Panel

6.9 Cabin DC Breaker Panel

DC Power is distributed to the CZone networks and other 12 volt circuits through individual "push to rest" circuit breakers located in the cabin DC panel. Main circuit breakers in the battery switch panel protect the CZone output modules from an overload. Some 12 volt accessories are operated directly by the circuit breaker in the DC panel. Switches fed by the panel breakers or digital switches in the CZone switch panels activate other accessories.

Digital volt meters in the panel continuously monitor DC voltage level in the engine and house batteries. Battery voltage can also be monitored using the monitoring function in the CZone system. Refer to the Scout CZone operation manual for instructions to navigate to the battery monitoring screen and selecting the battery to be monitored.

Proper fuse or breaker protection must be provided for all 12 volt equipment added. Do not overload the accessory circuit breakers or other circuitry through additional 12 volt equipment.

The following is a description of the accessories controlled by switches and circuit breakers in the cabin DC panel:

Battery and Parallel Switches

These switches activate the motorized battery and parallel switches for the engines and House circuits. An LED light in each switch glows when the battery or parallel switch it controls is on. The light may not turn off immediately or will slowly fade out when the switches are turned off.

Generator Control Panel

The generator panel controls the starting, running, and stopping of the generator. Lights in the panel and an LED data screen monitor engine temperature, exhaust temperature, oil pressure, fuel level and other generator functions.

The generator can also be controlled by the CZone control feature or a control panel on the generator. The generator DC circuits are powered by the house battery bank and activated by the generator battery switch in the aft systems room near the generator.

An owner's manual for the generator has been supplied with this manual. Please refer to it and the Scout CZone operation manual for additional instructions for operating the generator.

Cabin Speaker Switch

An ON/OFF switch that activates and deactivates the cabin speakers.

DC Panel "Push TO Reset" Breakers

Normally ON circuit breakers with a flexible translucent boot on the face are located on the DC breaker panel. When a breaker trips, the reset button pops out and is visible in the boot. Press the button to reset the breaker.

Some circuits are activated by the House battery switch and some provide continuous power to the circuits they protect and remain activated when the battery switches are OFF. These breakers are always ON unless tripped by an overload.

The following circuits are supplied power and protected by the "push to reset" circuit breakers:

Auto Bilge FWD

A continuous power circuit breaker that protects the circuit that supplies continuous 12 volt electrical power to the automatic switch for the forward bilge pump. This breaker is always supplied current when the batteries are connected.

Auto Bilge AFT

A continuous power circuit breaker that protects the circuit that supplies continuous 12 volt electrical power to the automatic switch for the aft bilge pump. This breaker is always supplied current when the batteries are connected.

High Water Alarm

A continuous power circuit breaker that protects the circuit that supplies continuous 12 volt electrical power to the automatic float switch in the aft bilge that activates the high water alarm in the hardtop switch panel. This breaker is always supplied current when the batteries are connected.

Sumps

A continuous power circuit breaker that protects the circuit that supplies continuous 12 volt electrical power to the cabin drain and air conditioner sump pumps. This breaker is always supplied current when the house battery is connected.

24 HR NEAMA

A continuous power circuit breaker that protects the circuit that supplies continuous 12 volt electrical power to the CZone network. This breaker is always supplied current when the house battery is connected.

ACCY 1

Reserved for additional 12 volt equipment.

Wireless Remote

A continuous power circuit breaker that protects the circuit that supplies continuous 12 volt electrical power to the CZone controller activated by the key fob wireless remote control. This breaker is always supplied current when the house battery is connected.

Stereo Memory

A continuous power circuit breaker that protects the circuit that supplies continuous 12 volt electrical power to the memory circuit in the stereo and electronics. This breaker is always supplied current when the house battery is connected.

CO Detector

Protects the circuit that supplies 12 volt electrical current to the carbon monoxide detector in the cabin. This breaker is supplied current when the House battery switch is activated.

USB Outlets

Protects the circuit that supplies 12 volt electrical current to the USB power outlet plugs. This breaker is supplied current when the House battery switch is activated.

12V Outlets

Protects the circuit that supplies 12 volt electrical current to the 12 volt accessory plugs. This breaker is supplied current when the House battery switch is activated.

Head

Protects the circuit that supplies 12 volt electrical current to the toilet control switches for the electric head system. This breaker is supplied current when the House battery switch is activated.

NEAMA CZone

A continuous power circuit breaker that protects the circuit that supplies continuous 12 volt electrical power to the CZone system and network. This breaker is always supplied current when the house battery is connected.

NEAMA Garmin

A continuous power circuit breaker that protects the circuit that supplies continuous 12 volt electrical power to the Garmin electronics network. This breaker is always supplied current when the house battery is connected.

Wiper Park

Protects the circuit that supplies 12 volt electrical current to the circuit that parks the windshield wiper to the side of the windshield each time the wiper switch is turned OFF. This breaker is supplied current when the House battery switch is activated.

Stereo

Protects the circuit that supplies 12 volt electrical current to the stereo mounted in the cabin DC panel. This breaker is supplied current when the House battery switch is activated.

DVD Player

Protects the circuit that supplies 12 volt electrical current to the DVD player mounted in the cabin DC panel. This breaker is supplied current when the House battery switch is activated.

Reading Lights

Protects the circuit that supplies 12 volt electrical current to the reading lights above the berth in the cabin. This breaker is supplied current when the House battery switch is activated.

Bow Table (Optional)

Protects the circuit that supplies 12 volt electrical current to the switches that raise and lower the table at the bow cockpit seating area. This breaker is supplied current when the House battery switch is activated.

ACCY 2

Reserved for additional 12 volt equipment.

WIFI (Optional)

A continuous power circuit breaker that protects the circuit that supplies continuous 12 volt electrical power to the wireless network. This breaker is always supplied current when the house battery is connected.

Display

A continuous power circuit breaker that protects the circuit that supplies continuous 12 volt electrical power to the CZone display panel. This breaker is always supplied current when the house battery is connected.

Notice:

The continuous power circuit breakers are always supplied current when the batteries are connected. These circuits are not deactivated when the battery switches are OFF.

6.10 DC Power Management

Modern outboard powered boats are typically equipped with a full array of electronics, fuel injected engines, spreader lights, stereo amplifiers, or other accessories that consume a significant amount of DC electrical power. All outboard engine charging systems are designed to provide maximum electrical output at or above cruising RPM. The electrical output from the charging system is considerably less at idle or trolling speeds.

Depending on the optional equipment and electronics installed on your boat, there may be times when the charging systems on your engines will not be able to meet the DC electrical power demand if too many accessories are activated while the boat is operating at idle or trolling speeds. Consequently, POWER MANAGEMENT PRACTICES may need to be observed at slow speeds.

The house battery system in your Scout is designed to provide several hours of reserve capacity, which is adequate for most situations. However, you should be aware of the load each of your DC accessories draw and make sure you don't overload the capacity of the charging system for

extended periods while operating the boat below cruising speed. Always monitor the volt meters while operating at slow speeds and turn off unnecessary equipment that draw high amperage loads if the volt meters indicate that battery voltage is below 12 volts. If necessary, reduce the electrical load by turning off or alternating the use of high draw DC accessories such as the radar units, refrigeration, stereo, spreader lights, etc.

If the house battery system that powers the electronics and accessories on your boat becomes critically discharged while underway at low speeds or trolling, make sure that you turn off all unnecessary DC equipment and run the engines at an RPM that will provide a reading of at least 13 volts on the volt meters to recharge the house battery. Proper DC power management will prevent low voltage that can cause critical navigation equipment to become erratic or shutdown unexpectedly. Additionally, sound power management practices increase the life of your batteries and engine charging systems. You should contact your dealer if you have any questions regarding DC power management or the DC electrical system on your boat.

6.11 120 volt AC Electrical System

The AC electrical system is supplied 120 & 240 volt, 60 cycle current by a shore power outlet at dockside. It is wired totally separate from the 12 volt DC system and is equipped with an onboard isolation system. Your boat is equipped with one 50 amp shore power cord and an inlet located on the port side of the transom.

A main circuit breaker that protects the circuit from the shore inlet to the main AC panel and an Equipment Leakage Circuit Interrupter (ELCI) are located in the inlet connection panel on the starboard rear side of the cockpit.

The Equipment Leakage Circuit Interrupter provides whole-boat ground fault protection (electrical shock protection from stray current) for the entire AC shore power system. It also protects the system from reverse polarity problems due to an improperly wired shore power supply. Shore power main breakers and individual breakers for each accessory circuit are located in the main AC distribution panel in the cabin.

The AC system can be fed by either the shore power inlets or the generator. Main breakers in the AC panel are used to select the source of power desired, Shore Power or Generator. The AC main breakers must be switched to the OFF position before selecting a different power source. The main panel includes an interlock system that allows only one power source to energize the panel and prevents the activation of the generator and shore power supplies simultaneously.

All AC current is distributed to the AC accessories through individual circuit breakers in the main AC panel. The main breakers protect the system from an overload and a reverse polarity light indicates any faults due to an improper shore power supply. All AC outlets in the cabin and cockpit are protected by ground fault interrupts to protect against electrical shock. While moored dockside, 120 or 240 volt, 60 cycle, AC power should be utilized from dockside power, if available.



Shore Power Inlet Connection or Power Reel Cord Hawse Pipe

⚠ DANGER ⚠

TO REDUCE THE POSSIBILITY OF AN ELECTRICAL SHOCK, IT IS IMPORTANT THAT THE AC GROUND SYSTEM IS FUNCTIONING PROPERLY AND THAT A PROPER CONNECTION EXISTS BETWEEN THE SHORE POWER CORD, THE SHORE POWER INLET, THE BOAT BONDING SYSTEM AND THE OUTLET GROUND CIRCUITS. IF THERE IS ANY DOUBT ABOUT THE INTEGRITY OF THE GROUND CIRCUIT, A QUALIFIED MARINE ELECTRICIAN SHOULD BE CONTACTED IMMEDIATELY AND THE AC POWER SHOULD BE DISCONNECTED UNTIL THE NECESSARY REPAIRS ARE COMPLETED.

⚠ DANGER ⚠

TO REDUCE THE RISK OF ELECTRICAL SHOCK IN WET WEATHER, AVOID MAKING CONTACT WITH THE SHORE CABLE OR MAKING A CONNECTION TO A LIVE SHORE OUTLET. NEVER SPRAY WATER ON ELECTRICAL CABLES WHILE WASHING DOWN DECKS.

Recommended procedure for making a shore connection:

Turn the AC Shore Main breaker and all accessory circuit breakers in the cabin AC panel to the OFF position. If the dockside outlets include a disconnect breakers, turn them to the OFF position also.

If your boat equipped with the optional power cord reel, open the shore power cord inlet cap, then press the bottom of the SHORE POWER REEL rocker switch to extend the desired length of cable.

To avoid strain on the cable make sure it has more slack than the mooring lines. Dress the cable so it cannot be damaged by chafing between the boat and the dock. Make sure the cable doesn't come in contact with the water and connect the cable to the dockside outlet, making sure the connection plug includes a three-prong plug with a ground wire. Tighten the lock ring on the shore connector plug.

Turn the dockside disconnect circuit breaker to the ON position. Then turn the circuit breaker at the boat inlet panel ON and check for proper polarity. If reverse polarity has been achieved, the red indicator in the shore power inlet panel and the red reverse polarity light in the AC main distribution panel will light. If this should happen, turn the inlet breaker and dock power supply breakers OFF. Then disconnect the shore power cord and notify a qualified electrician to check the wiring at the dock outlet. If the red fault and reversed polarity lights do not illuminate and the green, power available light in the shore power inlet panel is lit when power is supplied, the polarity is correct and the Shore Power main circuit breaker on the AC distribution panel can be activated.

⚠
DANGER
⚠

REVERSED POLARITY WILL DAMAGE THE SYSTEM AND EXPOSE PASSENGERS TO ELECTROCUTION HAZARDS. THIS CONDITION COULD ALSO CAUSE A FIRE IN THE ELECTRICAL SYSTEM. DO NOT OPERATE THE AC ELECTRICAL SYSTEM FROM SHORE POWER WITH REVERSED POLARITY.

Check the ELCI lights in the inlet panel for faults. The green "POWER" LED should show steady illumination and the red "FAULT" LED should remain OFF. The ELCI trips and opens the main circuit when there is a ground fault condition. If the red LED is continuously illuminated, the ELCI has tripped due to a ground fault condition. Some faults are self-clearing. Try resetting the ELCI once. If the green LED shows steady illumination and the ELCI does not trip again, the circuit is correct and activated.

If the reversed polarity light is lit or the ELCI continues to trip and the red "FAULT" LED is lit after being reset there is a problem with the AC electrical system and it is unsafe to use. Make sure all AC accessory circuits are OFF and turn the Shore Power main breaker OFF. Then turn the shore power inlet panel and dockside main circuit breakers OFF. Disconnect the shore power supply cord from the dockside outlet and notify a qualified marine electrician to check the wiring and correct the problem.



Shore Inlet Main Breaker & ELCI Panel In Cockpit



ELCI Inlet Panel & TEST/RESET Buttons
Power & Fault LED Lights



WARNING



ELECTRIC SHOCK CAN CAUSE SEVERE INJURY OR EVEN DEATH. DO NOT ATTEMPT TO CORRECT THE WIRING YOURSELF. ALWAYS HAVE A QUALIFIED ELECTRICIAN CHECK WIRING.

KEEP CHILDREN AWAY FROM ANY ELECTRICAL CABLES OR EQUIPMENT AND ALWAYS USE GROUNDED APPLIANCES ON BOARD YOUR BOAT.



WARNING



UNDETECTED FAULTS IN THE AC ELECTRICAL SYSTEM COULD CAUSE THE WATER AROUND THE BOAT TO BECOME ENERGIZED. THIS COULD CAUSE A SEVERE SHOCK OR EVEN DEATH TO SOMEONE IN THE WATER NEAR THE BOAT. NEVER SWIM OR ALLOW SWIMMING AROUND THE BOAT WHEN THE AC SYSTEM IS ACTIVATED BY THE SHORE POWER CONNECTION OR GENERATOR.

Disconnecting procedure for shore power connection:

Deactivate all AC accessory circuits. Turn the Shore Power main breaker at the AC distribution panel OFF, then turn the shore power inlet panel main and the dockside outlet circuit breakers to the OFF position.

Disconnect the cables from the dockside outlets and replace the outlet caps. Disconnect the cables from the boat and close the outlet caps. Store cables.

If your boat is equipped with the optional power cord reel, press the top of the SHORE POWER REEL rocker switch to retract the shore power cord into the inlet hawse pipe. Close and secure the hawse pipe cap.

AC Main Distribution Panel

The AC distribution panel is located in the cabin near the door. The following is a description of the distribution panel equipment and the breakers that protect the accessories.

AC Volt Meters

Phase 1 and Phase 2 volt meters monitor the voltage for each phase when the boat is connected to AC power. The voltage should be checked each time the AC system is activated. The AC system and accessories can be damaged by voltage that is below 105 volts or above 125 volts in either phase. You should monitor the voltage and never

operate your AC electrical system if the voltage is below or above this range.

The amp or current load should be calculated, particularly when operating the air conditioner and optional cockpit cooler/freezer. You should always be aware of the electrical load needed to activate accessories and manage the amperage being supplied so the load can be kept within safe limits. Avoid excessive current load that can overload the circuits or the generator. If you have any questions about managing the power in your boat, contact your authorized Scout dealer.

Shore Power and Generator Main Breakers

These circuit breakers select the power source and protect the general distribution network. There is a main breaker for the shore circuit and the generator. The Shore Power breaker is equipped with a relay that will cause the breaker to trip when reversed polarity current is detected.

The breakers are equipped with a sliding safety cover to prevent activating the breakers for the generator and shore circuits simultaneously. The main breakers must be in the OFF position before the sliding cover can be moved.

These breakers are very sensitive. The resulting power surge that occurs when connecting the dockside cord may cause the main breaker to trip. To avoid this surge, always turn the Shore main breaker to the OFF position before plugging or unplugging the shore power cord and the Generator main breaker to the OFF position when starting the generator.

Care must be taken when operating the AC system from the generator or the shore power supply line. In some situations it may be possible to overload the generator or shore power circuit if too many AC accessory breakers are activated. Too much amperage being supplied through the panel will cause the main breakers to trip and could damage the system. This is particularly important when operating the air conditioner, water heater, electric grill, ice maker, SeaKeeper and other optional accessories that may be on your boat that draw high amperage. You should always be aware of the electrical load needed to activate accessories and manage the amperage being supplied so the load can be kept within safe limits.

The table at the end of this section will assist you in documenting the load AC accessories on your boat require and managing the electrical load



AC Main Distribution Panel

- | | |
|--|--|
| A. Phase 1/Phase 2 Power Supply Voltage | C. Reverse Polarity/AC Power Status LED Indicator Lights |
| B. Shore Power/Generator Main Circuit Breakers | D. Accessory Circuit Breakers |

on the circuit. If you have any questions about managing the power in your boat, contact your authorized Scout dealer.

Reversed Polarity Lights

The red lights indicate reverse polarity current supplied to the panel for each circuit. This situation will cause the red light to remain lit. If reverse

polarity is achieved, immediately turn off all cabin AC breakers and dockside outlet breakers. Disconnect the power cable from the dockside outlet and notify a qualified marine electrician to check the dockside wiring.

Green, Power available lights on the status panel indicate the polarity is correct, there are no de-

tected faults and it is safe to activate the main breakers and AC accessories.

Typical AC Distribution Panel Accessory Circuit Breakers

Cooling Pump (Optional)

Supplies electrical current to the pump that provides cooling water to the optional SeaKeeper system.

Microwave

Supplies 120 volt AC electrical current to the cabin ground fault interrupter (GFI) electrical outlet that activates the Microwave.

TV/Outlets

Supplies 120 volt AC electrical current to the ground fault interrupter (GFI) electrical outlets.

Notice:

All AC electrical outlets are provided with ground fault interrupts to protect against electric shock. These outlets should be tested periodically to ensure proper operation by pressing the TEST/RESET buttons in the center of faceplate. GFI outlets do not protect against short circuits and overloads. This is done by the outlet breaker in the AC panel.



WARNING



GFI OUTLETS DO NOT PROVIDE 100% PROTECTION FROM ELECTRIC SHOCK. EVEN THOUGH GROUND FAULT INTERRUPTERS PROVIDE PROTECTION BY REDUCING EXPOSURE TIME FROM LINE TO GROUND SHOCK HAZARDS, IT IS STILL POSSIBLE TO RECEIVE AN ELECTRIC SHOCK FROM DEFECTIVE APPLIANCES OR POWER TOOLS AND MISUSED ELECTRICAL EQUIPMENT.

Cabin Refrigerator

Supplies 120 volt electrical current directly to the galley refrigerator when AC power is available and chosen over the 12 volt power supply. See the refrigerator manual for more information.

SeaKeeper (Optional)

Supplies electrical current to the optional SeaKeeper stabilizing system mounted to the stringers in the mid equipment room when this option is installed. Refer to the SeaKeeper operation manual for more information.

Cold Plate (Optional)

Supplies electrical current to the cold plate when this option is installed.

Air Conditioner

Supplies electrical current to the air conditioner compressor, cooling pump and control panel located in the cabin.

Notice:

After a certain amount of time without water flow, the air conditioning unit will automatically power down. If this occurs, reset the unit and check for water flow out of the air conditioner thru-hull fitting. See air conditioner owner's manual for more information.

Grill (Optional)

Supplies electrical current to the optional BBQ grill when this option is installed.

Stove

Supplies 120 volt AC electrical current to the stove in the galley.

Battery Charger 1/Battery Charger 2

Supplies electrical current directly to the automatic battery chargers. Battery charger 1 charges the port engine, port center engine on quads or center engine on triples and the house batteries. Battery charger 2 charges the starboard engine, starboard center engine on quads and the house battery. If your boat is equipped with an optional bow thruster, the bow thruster battery is paralleled with the starboard engine battery and will be charged with the starboard engine battery. Each battery charger will charge and maintain the batteries simultaneously when activated. They are fully automatic.

The wires that supply DC charging current to the batteries are protected by an internal fuse in the battery charger and circuit breakers, one for each battery output wire, located in the battery switch panel. The external circuit breakers protect the DC charging circuit from the batteries to the charger. The internal fuses in the charger protect the DC charging circuit from the charger to the batteries. If one of the circuit breakers is tripped by an overload, reset the breaker by pressing the breaker ON button until it resets and locks in the ON position. Refer to the battery charger owner's manual for more information on the features and operation of the battery charger.

The charge to the engine batteries can be monitored by using the DC volt meters in the cabin DC panel,



Quad Engine Battery/Charger Circuit Breakers

the volt meters in the engine gauge display panels, LED lights on the charger, the CZone monitoring screen and volt meters near each charger in the electrical equipment room. To monitor the engine batteries with the volt meters in the engine gauge cluster, activate the chargers and turn the engine battery switches ON. Activate the ignition switch for each engine (DO NOT START THE ENGINES) and read the voltage on the volt meter for each engine. To monitor the house or engine batteries with the DC volt meters in the cabin DC panel, activate the charger and turn the battery switches on. Read the voltage for each battery on the volt meters. To monitor the house or engine batteries with the CZone display screens, activate the charger and turn the battery switches on. Select to read the voltage on the desired battery using the display controls.

If the batteries are in good condition and charging properly, the volt meters will indicate between 12 and 14.5 volts. If the reading is below 12 volts, then the battery is not accepting a charge or the charger is not working properly. When using the engine display panels to check the voltage, always turn the ignition switches off immediately after the monitoring is complete.

Hot Water

Supplies electrical current directly to the water heater circuit. A thermostat in the water heater control panel automatically controls the water temperature. Before operation, you must have water in the water heater. (See the water heater manual for details)

Deck Fridge

Supplies 120 volt electrical current directly to the optional cockpit refrigerator when AC power is available and chosen over the 12 volt power supply. See the refrigerator manual for more information.



Typical Battery Charger & Volt Meter



Typical CZone Monitoring Screen

Ice Maker (Optional)

Supplies 120 volt electrical current directly to the optional cockpit ice maker. Always make sure the freshwater system is activated to supply water to the ice maker. Refer to the ice maker manual for more information.

Fishbox Freezer (Optional)

Supplies electrical current to the freezer compressor for the optional transom fishbox/freezer control in the cockpit when this option is installed.

Fishbox Freezer (Optional)

Supplies electrical current to the freezer compressor for the optional transom fishbox/freezer control in the cockpit when this option is installed.

ACCY

Reserved for additional 120 volt AC equipment.

6.12 Generator

The generator is supplied 12 volt power for the ignition and starter motor by the house battery bank and is located in the aft systems room. The generator oil and coolant should be checked whenever you check the oil in the main engines.

The generator START/STOP button in the cabin breaker panel and the control feature in the CZone display control the starting, running, and stopping of the generator. Digital gauges in the panel monitor engine temperature, exhaust temperature, oil pressure and other generator functions.

The generator can also be operated from a control panel on the generator. The circuit breakers and fuses that protect the generator AC and DC circuits are also on this panel or on the side of the panel control box. An owner operator's manual for the generator has been supplied with this manual. Please refer to it for details on generator operation and circuit protection.

The generator engine uses a closed cooling system with a seawater-cooled heat exchanger. A sacrificial anode in the seawater cooling system protects generator components that are in contact with seawater. There is an expansion tank for the engine coolant mounted to the generator that is accessed by opening the sound shield door. Make sure the fluid level in the expansion tank is kept between the maximum and minimum lines of the tank. You should also check the exhaust port for water flow each time the generator is started. If there



Typical Generator Control Panel



Generator Seawater Supply In Sea Chest

is no discharge within thirty seconds, shut down the generator, then find and correct the problem. The seawater cooling system draws seawater from a dedicated supply fitting in the sea chest located in the aft systems room bilge. Two sea strainers, one on each intake line, prevents debris in the seawater from entering the sea chest and generator cooling pump. It is important to check and clean the strainers regularly to ensure the seawater system can circulate enough water for the closed cooling and exhaust systems on the generator. Refer to the Sea Chest Raw Water Supply section of the Raw Water System chapter for information on cleaning the sea strainers.

The generator diesel fuel system is different than the fuel system for the main engines. Refer to the Fuel System chapter for more information on generator fuel system.

You also should read the generator owner's manual for detailed information on the safe operation and maintenance of the generator.

Notice:



Generators charge the starting battery just enough to compensate for the DC electrical current the engine requires to operate. Therefore, it is important to activate the battery chargers to maintain the batteries whenever the generator is running.

Notice:

The generator used in your boat may not be able to operate all 120 volt accessories at the same time. POWER MANAGEMENT PRACTICES may need to be observed depending on the AC power load.



Sea Chest Inlet Strainer - 1 of 2

	DANGER	
<p>GENERATOR ENGINES PRODUCE CARBON MONOXIDE WHICH IS A LETHAL, TOXIC GAS THAT IS COLORLESS AND ODORLESS. IT IS A DANGEROUS GAS THAT WILL CAUSE DEATH IN CERTAIN LEVELS. ONLY OPERATE THE GENERATOR IN WELL VENTILATED AREAS AND NEVER OPERATE THE GENERATOR WHILE YOU ARE SLEEPING.</p>		

6.13 Bonding System & Galvanic Isolator

Your boat is equipped with a bonding system that interconnects all underwater hardware and thru-hull fittings to ensure that they are of the same electrical potential. Sacrificial anodes are attached to the bonding system at the trim tabs and engines. There is also an anode in the seawater cooling system for the generator and on the bow thruster propeller if this option is installed on your boat.



Thru-Hull Valve Bonding Wires & Connection

The anodes deteriorate before the other metals, thereby protecting the underwater metals from galvanic corrosion or stray electrical current. Since the anodes are sacrificial, it is important to monitor them and replace them when they have deteriorated to 50 - 75% of their original size. The bonding system is connected to the DC ground and the earth ground wire for the AC electrical system. It provides a path for dangerous short circuits in the AC electrical system to the safety earth ground in the event of a fault in the shore earth ground connection and when the boat is away from the dock.



When the boat is connected to shore power at a marina or city dock, all boats connected to shore power are connected to a common shore safety earth ground connection. This circuit provides essential protection against electrical shock from faults or short circuits in AC equipment and, unfortunately, provides a path for low voltage galvanic current to flow between the bonding systems of other boats in the circuit. If one or more of the boats in the circuit has a stray current electrical problem or is not equipped with proper galvanic protection, it will seek protection from your boat's bonding system through the safety ground circuit.

This could cause accelerated deterioration of the sacrificial anodes and/or severe damage to the underwater hardware. To prevent damage from other boats in the circuit, a galvanic isolator is installed in the shore ground circuit that isolates your boat's bonding system from the other boats. It prevents the flow of low voltage galvanic current while still providing a path for dangerous short circuit currents in the AC system to the shore safety ground.

6.14 Electrical System Maintenance

12 volt AC Electrical System Maintenance

At least once a year, spray all exposed electrical components behind the helm, in the transom area and in the plugs with a protector. Removable light fixture lenses should be removed and wiped clean with a damp cloth and reinstalled. Some LED light fixtures are sealed and not serviceable.

 **CAUTION** 

WHEN REPLACING LIGHT BULBS IN MARINE LIGHT FIXTURES, ALWAYS USE A BULB WITH THE SAME RATING AS THE ORIGINAL. USING A DIFFERENT BULB COULD CAUSE THE FIXTURE TO OVERHEAT AND MELT OR SHORT CIRCUIT.

Inspect all wiring for proper support, sound insulation and tight terminals, paying particular attention to portable equipment power cords and plugs.

Check all below deck wiring to be sure it is properly supported, that the insulation is sound, and that there are no loose or corroded terminals. Corroded terminals should be thoroughly cleaned with sandpaper or replaced, tightened securely and sprayed with a metal and electrical protector. Inspect all engine wiring.

Check the electrolyte level in wet cell batteries regularly and add distilled water as necessary. If the batteries are frequently charged by the automatic battery charger, the electrolyte level will have to be checked more often. The correct fluid level in the cells is approximately 1/4 to 1/2 inch above the plates. If fluid is needed, fill to the proper level with distilled water. Do not over fill!



Notice:

AGM and some wet cell batteries are sealed and do not require or allow the inspection of the electrolyte.

Keep the battery tops clean and dry. Dirt and water can conduct electricity from one post to the other causing the battery to discharge.

The battery posts should be kept free of corrosion. Remove the cables and clean the posts and cable clamps with a battery post cleaner or sandpaper as required. Coating the battery posts and cable clamps with petroleum jelly or dielectric silicone grease will protect them and reduce corrosion.

Battery cables, both hot and ground, must be replaced when they show signs of corrosion or fraying. Deteriorated cables cause a considerable voltage loss when high currents are drawn, as for starting the engines.

 **DANGER** 

NEVER USE AN OPEN FLAME IN THE BATTERY STORAGE AREA. AVOID STRIKING SPARKS NEAR THE BATTERY. A BATTERY CAN EXPLODE IF A FLAME OR SPARK IGNITES THE HYDROGEN GAS THE BATTERY EMITS WHILE BEING CHARGED.

AC Electrical System Maintenance

Periodically inspect all wiring for nicks, chafing, brittleness, improper support, etc. Examine the shore power cord closely for cracks in the insulation and corrosion in electrical connectors. Spraying receptacles and electrical connections with an electrical contact cleaner or a metal and electrical protector will reduce corrosion and improve electrical continuity.

Inspect all wiring for proper support, sound insulation and tight terminals, paying particular attention to portable appliance cords and plugs.

The entire AC circuitry, especially the shore power cords, should be seasonally tested for proper continuity by an experienced electrician. This will detect any shorts, open wires, or ground faults.

Ground fault interrupt outlets and ELCI should be tested monthly to ensure proper operation by pressing the test/reset buttons. The reverse polarity system should also be inspected and tested periodically for proper operation.

Generator Maintenance

The engine maintenance required on the generator is similar in many ways to the main 4-stroke outboard engines. The most important factors to the generator's longevity are proper ventilation and maintenance of the fuel system, cooling system, lubrication system and the AC alternator.

The seawater cooling system is equipped with a sacrificial anode and that should be checked whenever the generator is serviced and replaced as necessary. Maintenance schedules and procedures are outlined in your generator owner's manual. They should be followed exactly.



WARNING



CORROSION ALLOWED TO BUILD ON THE ELECTRICAL CONNECTORS CAN CAUSE A POOR CONNECTION RESULTING IN SHORTS, GROUND FAULTS OR POOR GROUND CONNECTIONS. ELECTRICAL CONNECTORS SHOULD BE CHECKED AT LEAST ANNUALLY AND CLEANED AS REQUIRED. DO NOT ALLOW CORROSION TO BUILD ON CONNECTIONS.

ELECTRIC SHOCK CAN CAUSE SEVERE INJURY OR EVEN DEATH. THE AC AND DC ELECTRICAL SYSTEMS ALWAYS SHOULD BE DISCONNECTED FROM THE POWER SOURCE BEFORE INSPECTING OR SERVICING THE SYSTEM. NEVER SERVICE ANY COMPONENT OF AN ELECTRICAL SYSTEM WHILE IT IS ENERGIZED.

Fresh Water System

7.1 General

The fresh water system consists of a potable water tank, distribution lines and two distribution pumps. Each pump is equipped with an automatic pressure switch and is located near the water tank in a compartment below the port side cabin berth.

Shutoff valves on the cold and hot water manifolds near the pumps and water tank enable the operator to turn off individual water lines if necessary.

	CAUTION	
<p>DO NOT FILL SYSTEM WITH ANYTHING OTHER THAN WATER. SHOULD THE SYSTEM BECOME CONTAMINATED WITH FUEL OR OTHER TOXIC FLUIDS, COMPONENT REPLACEMENT MAY BE NECESSARY.</p>		

	WARNING	
<p>DO NOT CONFUSE FUEL FILL DECK PLATES WITH THE WATER OR WASTE FILL DECK PLATES. THESE PLATES ARE LABELED ACCORDINGLY. IF GASOLINE OR DIESEL FUEL IS ACCIDENTALLY PUMPED INTO THE WATER OR WASTE TANK, DO NOT ATTEMPT TO PUMP IT OUT YOURSELF. WATER AND WASTE PUMPS ARE NOT DESIGNED TO PUMP FUEL AND A FIRE OR EXPLOSION COULD RESULT. CONTACT YOUR DEALER OR THE SCOUT CUSTOMER SERVICE DEPARTMENT FOR ASSISTANCE IN HAVING THE FUEL PROFESSIONALLY REMOVED AND COMPONENTS OF THE FRESH WATER SYSTEM REPLACED AS NECESSARY.</p>		



Typical Fresh Water Pump & Valve System

7.2 Fresh Water System Operation

Fill the water supply tank slowly through the labeled deck plate located on the port forward gunnel. After filling the water tank, partially open all faucets. The fresh water pumps should be activated with the CZone control feature. Allow the pumps to run until all of the air is purged from the system and a steady stream of water is flowing from each outlet. Next, turn off the faucets, one by one. As the pressure builds, the pumps will automatically shut off.

When properly primed and activated, the water system will operate much like the water system in a home. Automatic pressure sensors keep the system pressurized. If the system has been re-



Fresh Water Tank Deck Fill Plate

cently filled or has not been used for an extended period, air bubbles may accumulate at the pumps and the system may have to be reprimed.

Whenever the boat is left unattended, the fresh water pumps should be turned OFF using the Czone control feature.

CAUTION

DO NOT ALLOW THE FRESH WATER PUMPS TO RUN DRY. THE FRESH WATER PUMPS WORK ON DEMAND AND WILL NOT SHUT OFF AUTOMATICALLY WHEN THE TANK IS EMPTY. THIS CAN RESULT IN DAMAGE TO THE PUMPS. ALWAYS TURN THE FRESH WATER PUMPS OFF WHEN THE FRESH WATER SYSTEM IS NOT IN USE.



Cold Water Shutoff Valves Near Water Tank

Cockpit Sink (Optional)

The sink in the leaning post is supplied by the fresh water system. The faucet pivots and folds down to allow the hatch to close. To use the sink, open the hatch and rotate the faucet outlet up. Make sure the fresh water system is activated. Open the faucets to supply fresh water to the sink.

Cockpit and Head Compartment Shower Operation

Your boat is equipped with a shower spray head located in the head compartment and could be equipped with an optional shower in a recessed compartment on the port side of the leaning post. Each shower has hot and cold water and a retractable shower head with an ON/OFF valve.



Hot Water Shutoff Valves Near Water Tank

Make sure the fresh water system is activated, then turn the water on. Adjust the hot and cold water faucet until the desired temperature is obtained. Some minor variations in the water temperature may occur as the pressure pump cycles. To conserve water, use the valve on the shower head to turn the water on and off as you shower.

Head compartment shower water is drained by a sump pump system located below the compartment sole. An automatic float switch in the sump controls the pump. The pump is protected by the Sumps circuit breaker in the cabin DC panel. After showering, let the cold water flow for a period of time to flush the drainage system of soap residue. It is essential that the shower drain strainer is cleaned regularly and the sump is inspected periodically for accumulated debris that needs to be removed.



Typical Head Compartment Shower Sump System

Fresh Water Washdown



Fresh water washdown hoses are located on the port side of the hardtop above the leaning post and in the anchor winch compartment. Both hoses are equipped with automatic retracting reels.

To use a washdown hose, make sure the fresh water system is activated. Pull the nozzle and hose out of the fitting to the desired length. When washdown operations are complete, turn OFF the nozzle and pull the hose out slightly to release the reel lock. Keep steady pressure on the hose and allow it to slowly retract until the nozzle seats in the recess.

7.3 Water Heater

The water heater is located behind the starboard berth backrest cushion in the cabin. The 120 volt AC element that heats the water is thermostatically controlled at the heater. It is activated and protected by a circuit breaker located in the AC breaker panel.

A high pressure relief valve protects the system from excessive pressure. To avoid damage to the water heater, always make sure all air is purged from the water heater and lines before activating the water heater. Refer to the water heater owner's manual for additional information.

	CAUTION	
DO NOT SUPPLY CURRENT TO AN EMPTY WATER HEATER. DAMAGE TO THE HEATER WILL RESULT. THE SYSTEM MUST BE FILLED AND PRIMED BEFORE USING THE WATER HEATER.		

7.4 Fresh Water System Maintenance

Information supplied with water system components by the equipment manufacturers is included with this manual. Refer to this information for additional operation and service data.

Routine Maintenance

The following items should be done routinely to maintain your fresh water system:

- Periodically remove and clean the water strainers located near the intake side of each fresh water pump. To clean the strainers, make sure the Fresh Water system is off. Rotate the strainer bowl counterclockwise to release it. Remove and clean the screen with fresh water. Lubricate the O-ring lightly with Teflon or silicone grease and reinstall the strainer bowl.



Cockpit Fresh Water Washdown Hose



Windlass Compartment Washdown Hose



Water Heater

- Remove the filter screens from the faucet spouts and eliminate any accumulation of debris. A build up of debris can cause the pump to cycle excessively.
- Periodically remove the lid on the head compartment drain sump and clean the water strainer for the sump pump and the sump.
- Periodically spray the fresh water pumps and metal components with a metal protectant.
- The batteries must be properly maintained and charged. Operating the pressure pumps from a battery with a low charge could lead to pump failure.
- Add a commercially available potable water conditioner to the water tank to keep it fresh.

Notice:

The fresh water system must be properly winterized prior to winter lay-up. Refer to the section on winterizing for more information.



Typical Fresh Water Pump Strainers

	CAUTION	
THE FRESH WATER SYSTEM SHOULD BE OFF WHENEVER LEAVING THE BOAT UNATTENDED OR WHEN THE FRESH WATER SYSTEM IS NOT IN USE.		

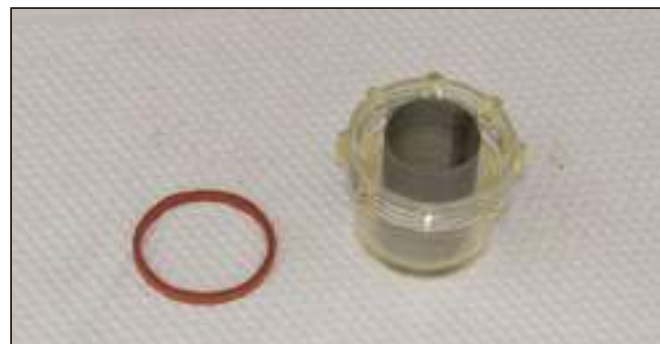

Typical Fresh Water Pump Strainer Removed for Cleaning

Sanitizing the Fresh Water Tank

The fresh water system should be sanitized if it has not been used for a long period or you are unsure of the quality of the water in the system.

The following steps can be used to sanitize the system:

- Activate the system, open all faucets and pump out as much water as you can.
- Make a chlorine solution by mixing two ounces of household chlorine bleach in a gallon of water. This mixture will treat approximately fifteen gallons. If the water tank on your boat is larger or smaller than 15 gallons, then adjust the mixture accordingly. Always mix the chlorine with water in a separate container first and never add straight chlorine to the fresh water tank.
- Fill the water tank half full with fresh water and pour the mixture into the water tank. Top off the tank.

- Activate the system and allow the water to run for about one minute at each faucet. Let the treated water stand for 4-6 hours.
- Drain the system by pumping it dry and flush with several tank fills of fresh water.
- The system should now be sanitized and can be filled with fresh water. If the chlorine smell is still strong, it should be flushed several more times with fresh water.

Notice:

The water quality in marine freshwater systems can be questionable. We recommend that you avoid using water from the freshwater system for drinking and cooking. You should only use bottled water for these purposes.

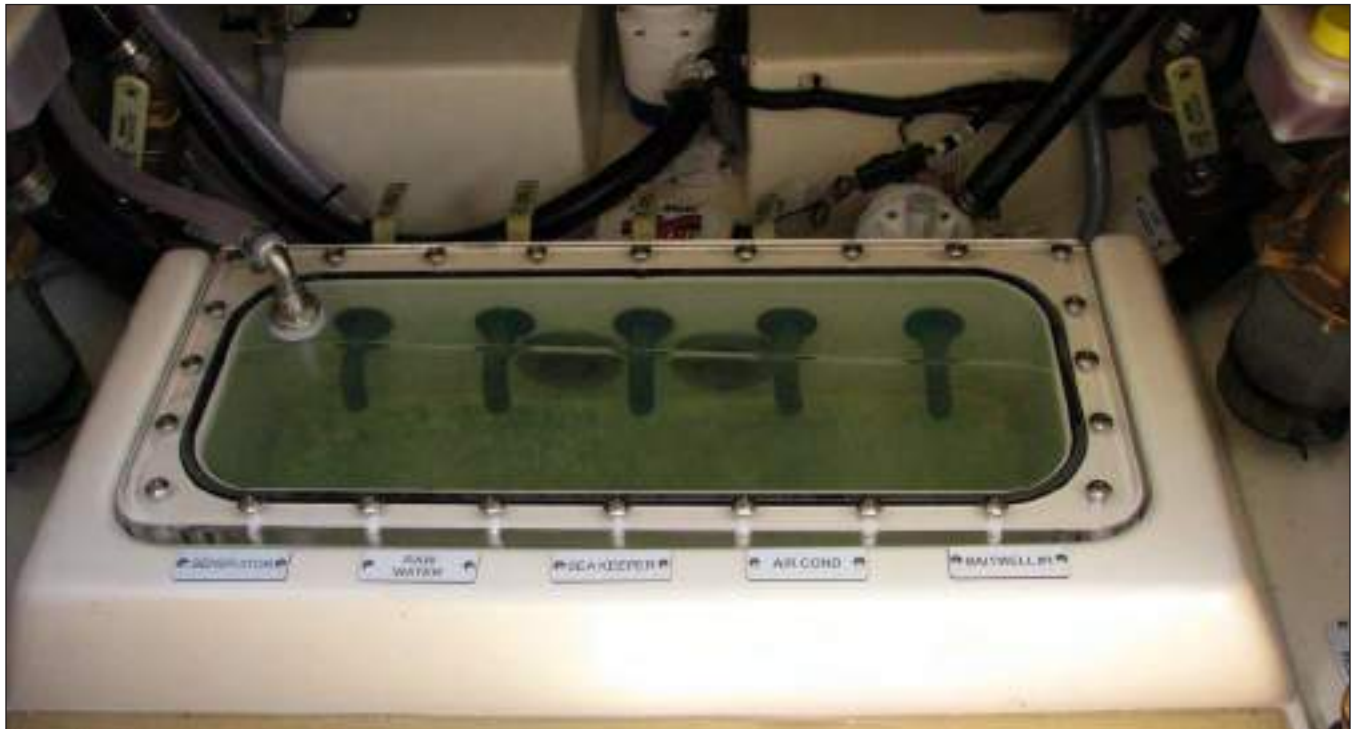

Raw Water System Sea Chest

8.1 General

A sea chest is located in the aft systems room bilge supplies seawater to the raw water pumps. Two intake thru-hull fittings for the sea chest are equipped with ball valves to turn the raw water main supply to the sea chest on or off. Other ball valves at the outlet connections on the sea chest enable the operator to turn the water supply on or off for each individual pump in the system. A sea strainer in each intake supply hose filters debris as seawater flows to the sea chest. The strainers should be checked frequently and cleaned as necessary.

Always make sure all ball valves are open before attempting to operate any component of the raw water system.

Priming the System

Open all sea chest intake and raw water pump supply ball valves. The sea chest is vented to a thru-hull fitting in the hull side to automatically purge air from the sea chest as it fills. Activate the raw water pump systems with the CZone



Sea Chest Intake Thru-Hull Valve & Sea Strainer

control feature. Run the pressure pump by turning on the raw water washdown hose nozzle at the rear of the hardtop until all air is purged from the system. Then turn the hose off. Activate the baitwell pump with the CZone control feature and run the pump until all of the air is purged from the system. Then turn the pump off. Follow the

baitwell pump priming procedure for all other pumps connected to the sea chest.

The sea chest water intake fittings are equipped with scoops that will supply pressurized water to the sea chest and help prime the system while the boat is underway during normal operation. If a pump runs but will not prime, make sure the pump supply valve is open. If the pump still won't prime, it may be air locked. Make sure the sea chest intake valves and the valve for the pump intake hose are open and run the boat at or above 15 MPH. Water pressure from the sea chest will usually force trapped air through the pump and allow it to prime. If this procedure doesn't work, contact your Scout dealer.

Closing the sea chest intake thru-hull valves before the boat is hauled from the water will help to eliminate air locks in raw water systems. The valves should also be closed whenever you leave the boat in the water unattended.

Notice:

It may be necessary to reprime the raw water system if it is not used for an extended period and at the time of launching.

8.2 Raw Water System Operation

The high pressure pump that supplies the raw water washdown hose is located on the starboard side of the aft systems compartment. It is controlled by a pressure sensitive switch and activated with the CZone control feature. When activated, the pressure switch will automatically control the pump.

As the pressure builds in the system, the pump will shut off. When the system is in use and the pressure drops, the pump will turn on.

Whenever the boat is left unattended, the pressure pump should be turned off.

Washdown Hose

The raw water washdown hose is located on the starboard side of the hardtop above the leaning post. The hose is equipped with an automatic retracting reel.

To use a washdown hose, make sure the raw water pressure pump is activated. Pull the nozzle and hose out of the fitting to the desired length. When washdown operations are complete, turn off the



Raw Water Pump & Typical Air Conditioner Or Optional SeaKeeper Cooling Pump



Raw Water Washdown Hose

nozzle and pull the hose out slightly to release the reel lock. Keep steady pressure on the hose and allow it to slowly retract until the nozzle seats in the recess.

	CAUTION	
DO NOT ALLOW THE WATER PUMP TO RUN DRY. THE PUMP WORKS ON DEMAND AND WILL NOT SHUT OFF AUTOMATICALLY IF NO WATER IS AVAILABLE. THIS CAN RESULT IN DAMAGE TO THE PUMP. ALWAYS TURN THE RAW WATER PUMP OFF WITH THE CZONE CONTROL FEATURE WHEN THE SYSTEM IS NOT IN USE.		

8.3 Baitwell

Seawater is provided to the baitwell by a 12 volt centrifugal pump. The pump is not controlled by a pressure sensitive switch and designed to supply a constant flow of water to the well. It is activated with the CZone control feature. There is also an LED light in the baitwell that is activated by the CZone panel.

An overflow built into the drain system automatically controls the water level in the well and adjustable inlet valves control water flow. Always turn the pump off when the well is not in use.

To fill the baitwell, insert the plug into the drain fitting at the bottom of the well. Make sure the ball valves for the sea chest and pump are open. Then activate the pump. When the water level reaches the overflow, it will begin to circulate.

The sea chest water intake fittings are equipped with scoops that will supply pressurized water to the sea chest and the baitwell if the pump should fail. The scoops also help prime the system while the boat is underway during normal operation. To supply water to the baitwell if the pump fails, make sure the sea chest and the baitwell pump intake valves are open and run the boat at a speed above 15 miles per hour. Seawater will circulate through the baitwell and out the overflow.

When the recirculating feature is activated by the Recirc Pump control in the CZone control feature, a separate pump will recirculate and aerate the water that is in the well without drawing additional seawater into the system.

To drain the baitwell, turn off the baitwell pumps and remove the plug in the drain fitting at the bottom of the baitwell. When the baitwell has completely drained, use the washdown hose to flush the baitwell and drain of debris.

The baitwell pump supply valve at the sea chest should be closed whenever the baitwell is not in use. This will prevent water from entering the baitwell while the boat is cruising.





Baitwell



Baitwell Pump & Supply Valve Fitting

Notice:

Do not use a baitwell as a dry storage area when it is not in use. Seawater could accidentally be delivered to the baitwell from the thru-hull fitting and damage equipment stored there.

	CAUTION	
<p>A RUPTURED RAW WATER INTAKE OR PRESSURE LINE COULD CAUSE THE BOAT TO TAKE ON WATER. ALWAYS TURN THE RAW WATER SYSTEMS OFF AND CLOSE THE THRU-HULL SEAWATER SUPPLY VALVES WHEN LEAVING THE BOAT UNATTENDED.</p>		

8.4 Air Conditioner Cooling Pump

The air conditioning unit is self-contained and seawater cooled. A 120 volt AC centrifugal pump supplies seawater that cools the condensing unit as it circulates through the system and is discharged overboard. The air conditioner seawater pump is located in the aft systems compartment near the sea chest. It is protected and supplied current by Air Cond circuit breaker in the AC breaker panel. The pump is activated automatically by the air conditioner control panel whenever the air conditioner is running.

Seawater is supplied to the pump by a ball valve and hose connected to the sea chest. Make sure the valve is open before activating the pump.

You should refer to the air conditioner owner's manual for more information on the operation and maintenance of the air conditioning system and the seawater cooling pump.

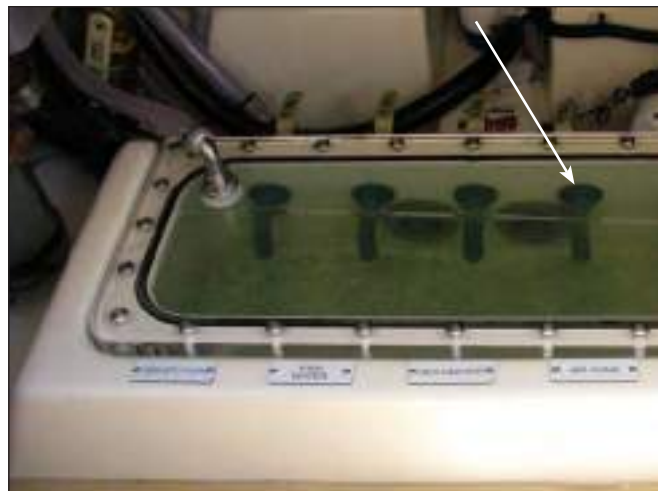

Air Conditioner Cooling Pump Supply Valve Fitting

8.5 SeaKeeper Cooling Pump

The optional SeaKeeper boat stabilizer is self-contained and seawater cooled. A 120 volt AC centrifugal pump supplies seawater that cools specific components in the gyroscope system. The seawater pump is located in the aft systems compartment near the sea chest. It is protected and supplied current by a circuit breaker in the AC breaker panel. The pump is activated automatically whenever the SeaKeeper system is running.

Seawater is supplied to the pump by a ball valve and hose connected to the sea chest. Make sure the valve is open before activating the pump.

You should refer to the SeaKeeper owner's manual for more information on the operation and maintenance of the SeaKeeper cooling system and seawater cooling pump.



Air Conditioner Seawater Cooling Pump

8.6 Generator Raw Water Supply

The generator engine uses a closed cooling system with a seawater-cooled heat exchanger. Seawater circulates through the heat exchanger and is expelled through the generator exhaust system, cooling it as well. Seawater is supplied to the pump by a ball valve and hose connected to the sea chest. Make sure the valve is open before activating the pump. It is important to check and clean the sea chest intake strainers regularly to



Generator Cooling Pump Supply Valve Fitting



Sea Chest Intake Thru-Hull Valve, Sea Strainer & Sea Strainer Cap

ensure the seawater system can circulate enough water to cool the heat exchanger and exhaust system on the generator. Refer to Raw Water System Maintenance in this chapter for information on cleaning the sea strainers.

You should also read the generator owner's manual for detailed information on the safe operation and maintenance of the generator.

8.7 Raw Water System Maintenance

The following items should be done routinely to help maintain your raw water system:

Routine Maintenance

- Check hoses, particularly the seawater supply lines, for signs of deterioration. Tighten fittings and clamps or replace deteriorated hoses and components as necessary.

- Periodically remove and clean the water strainers located in the intake lines for the sea chest. To clean the strainers, make sure the generator and all seawater pump systems are off. Then close the sea chest intake valves. Rotate the strainer cap counterclockwise to release it. Remove the cap and pull the screen out. Thoroughly flush the screen and the inside of the strainer to remove foreign matter. Lubricate the seal with silicon or Teflon grease and reassemble the strainer, making sure that the strainer cap is tightened hand tight. Open the intake valves, activate the pumps and check for leaks.
- Spray pumps and thru-hull valves with a protective oil periodically.
- The fishboxes and baitwell should be drained and cleaned after each use.
- Operate all valves at least once a month to keep them operating properly.



Verifying Generator and Air Conditioner Cooling System Operation After Cleaning Sea Chest Strainers

Generator Cooling System

- Make sure the sea chest and generator cooling pump supply valves are open.
- Start the generator and monitor the exhaust port for proper water flow. If there is no discharge within thirty seconds, shut down the generator and find and correct the problem.
- Allow the generator to operate for several minutes, then check the sea chest and strainers for leaks.

Air Conditioner Cooling System

- Make sure the sea chest and air conditioner cooling pump supply valves are open.
- Activate the air conditioner and monitor the flow of water out of the air conditioner thru-hull fitting in the hull side. If no water is flowing after 30 seconds, shutdown the air conditioner and find and correct the problem.
- Allow the air conditioner to operate for several minutes, then check the sea chest and strainers for leaks.

 **CAUTION** 

SHOULD A HOSE RUPTURE, TURN THE PUMP OFF IMMEDIATELY. ALWAYS CLOSE THE SEA CHEST THRU-HULL VALVES WHEN PERFORMING MAINTENANCE ON A SEAWATER PUMP.

THE BATTERIES MUST BE PROPERLY CHARGED. OPERATING ANY PUMPS FROM A BATTERY WITH A LOW CHARGE MAY LEAD TO A PUMP FAILURE.

THE RAW WATER SYSTEM MUST BE PROPERLY WINTERIZED PRIOR TO WINTER LAY-UP. SEE SECTION ON WINTERIZING.



Port & Starboard Cockpit Scupper Drains

9.1 General

Most water is drained by gravity to overboard thru-hull fittings located in the hull above the water line. It is important to check the drain system frequently to ensure it is free flowing and that the hoses on thru-hull fittings are secure and not leaking.

9.2 Cockpit & Deck Drainage **Cockpit Scupper Drains**

Your Scout has two scupper drains located in the rear of the cockpit that drain the cockpit through fittings in the hull sides above the waterline. A check valve built into each scupper drain fitting reduces the surge of seawater through the scupper and into the cockpit while maneuvering or in rough water.



Scupper Drain Thru-Hull Fittings & Check Valves

Water is channeled away from all hatches by a gutter or drain rail system. The water then drains overboard through the scupper drain system.

Fishboxes and Baitwell Drains

The aft fish boxes below the cockpit sole are drained overboard by a diaphragm pump out system. There is a diaphragm pump and overboard discharge thru-hull valve for each fishbox located in the aft systems room. The pumps are activated with the CZone control feature.

To pump out the fishboxes, make sure the pump out thru-hull valves are open. Activate the pump and monitor the water level as the pump drains the fishbox and turn it off immediately when draining is complete. The pumps could be damaged if they are allowed to run dry for extended periods.

The baitwell and baitwell overflow drains by gravity to a thru-hull fitting in the hull.

Cockpit Storage Compartments and Coolers

The storage compartment below the console lounge seat is drained by gravity to the cockpit through a fitting in the side of the seat base.

The forward storage/cooler compartments below the port and starboard bow seats drain by gravity to thru-hull fittings located in the hull sides above the waterline.

The bow storage compartment below the cockpit sole drains to the bilge.

Rope Locker Drainage

The rope locker drains overboard through a drain fitting located in the hull side at the bottom of the rope locker. It is important to inspect the drain frequently to remove any accumulated debris.

Cup Holder and Storage Compartment Drains

All cup holders in the helm and cockpit areas drain by gravity to the cockpit sole. The console and forward cockpit storage compartments also drain to the cockpit.

Leaning Post Sink

The sink in the leaning post is drained by gravity to a thru-hull fitting in the hull side.



Diaphragm Fishbox Pump



Port Fishbox Pump Out Thru-Hull Fitting & Valve

9.3 Hardtop & Tower Drains

There is a hole drilled in the leg bases on the frame to prevent water from being trapped within the legs. Additional drain holes are drilled in the tubing to drain other areas as required.

Always make sure the leg and tubing drain holes are clear when the boat is laid up for the winter. Water trapped inside the legs could freeze and cause the legs to split.

9.4 Bilge Drainage & Alarm

There are three bilge pumps, aft, forward and emergency. The aft and forward bilge pumps are activated both manually, by switches in the hardtop switch panel or CZone display, and automatically by switches built into each pump that sense the water level at the pump. The automatic switches remain activated when the battery switches are in the OFF position and the batteries are connected. They are protected by "push to reset" circuit breakers in the cabin DC breaker panel. The manual switches are supplied current when the HOUSE battery switch is activated. They are protected by fuses in the CZone output modules. All bilge pumps pump water out of thru-hull fittings located above the waterline in the hull.

The manual bilge pump switches should be activated briefly each time the boat is used. This will ensure that the pumps are operating properly and increase the service life of the pumps.

The automatic switches should be manually activated periodically, by pressing the test button on the side of pump or flooding the bilge with a garden hose to verify operation. This is particularly important before operating the boat offshore.

The emergency bilge pump is located above and to the rear of the aft bilge pump. The pump is fully automatic and will activate at about the same time as the high water alarm if the bilge water level rises above the normal operating range of the bilge pump automatic switches. The automatic switch remains activated when the battery switches are in the OFF position and the batteries are connected. It is protected by a "push to reset" circuit breaker in the cabin DC breaker panel.

The emergency pump should be manually activated periodically, by pressing the test button on the side of pump to verify operation and increase the service life of the pump. This is particularly important before operating the boat offshore.

Notice:

See Electrical Systems for additional information on bilge pump operation.

When the boat is out of the water the bilge can be drained by a garboard drain located in the transom near the bottom of the hull. The plug should be



Aft Bilge Pump With Automatic Switch



Forward Bilge Pump With Automatic Switch

removed whenever the boat is hauled out of the water and installed just prior to launching. It is important to check the drain plug regularly to make sure it is tight.

	CAUTION	
<p>A LOOSE DRAIN PLUG WILL ALLOW SEAWATER TO ENTER THE BILGE AND COULD CAUSE THE BOAT TO TAKE ON ENOUGH WATER TO DAMAGE EQUIPMENT OR SINK THE BOAT. IT IS VERY IMPORTANT TO CHECK THE DRAIN PLUG FREQUENTLY TO ENSURE IT IS PROPERLY TIGHTENED.</p>		

Bilge High Water Alarm

An automatic float switch located in the aft bilge near the bilge pumps will sound an alarm if the bilge water level rises above the normal operating range of the bilge pump automatic switches. The alarm automatic switch is protected by a "push to reset" circuit breaker in the cabin DC panel. It remains activated when the battery switches are in the OFF position and the batteries are connected. This switch should be tested periodically to ensure it is operating properly. If the alarm does not activate, you should find and correct the problem as soon as possible.

Notice:

Any oil spilled in the bilge must be thoroughly removed and properly disposed of before operating the bilge pump. The discharge of oil from the bilge is illegal and subject to a fine. Oil in the bilge may also cause the bilge pump automatic switches to malfunction and not activate the bilge pumps when required.

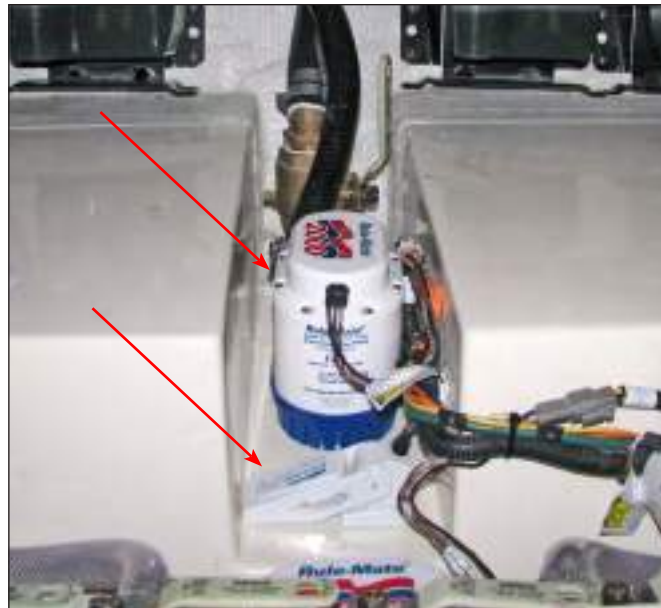

Emergency Bilge Pump With Automatic Switch
High Water Alarm Automatic Float Switch

	CAUTION	
<p>THE FEDERAL WATER POLLUTION CONTROL ACT PROHIBITS THE DISCHARGE OF OIL OR OILY WASTE INTO OR UPON THE NAVIGABLE WATERS OF THE UNITED STATES OR THE WATERS OF THE CONTIGUOUS ZONE IF SUCH DISCHARGE CAUSES A FILM OR SHEEN UPON OR A DISCOLORATION OF THE SURFACE OF THE WATER OR CAUSES A SLUDGE OR EMULSION BENEATH THE SURFACE OF THE WATER. VIOLATORS ARE SUBJECT TO A PENALTY OF \$10,000.</p>		



Typical Shower & Drain Sump Pump System In The Bilge
Below The Head Compartment

9.5 Cabin Drainage

Shower and Drain Sump Pump

The sump system is equipped with a strainer, centrifugal pump and automatic switch. It is activated whenever the house battery is connected and protected by the Sumps circuit breaker in the DC panel. The sump pump automatic switch can be overridden by the CZone control feature which provides a means to manually activate the sump pump when necessary.

After showering, it is important to let the cold water flow for a period of time to flush the drainage system of soap residue. Make sure to inspect the sump system regularly and keep the sump components and pump strainer clean.

The sump pump is located in the forward bilge below a hatch in the head compartment sole.

Cabin Sole

The cabin sole drains by gravity to the bilge through access hatches and other non sealed components in the sole.

Cabin and Head Compartment Sink

The galley and head compartment sinks drain by gravity to thru-hull fittings in the hull side.

Air Conditioner

The cabin air conditioning condensation pan is drained by a hose attached to the pan that drains the water to the air conditioner sump pump system.

The sump system is located below the cabin sole and access through a hatch below the table.

It is activated whenever the house battery is connected and protected by the Sumps circuit breaker in the DC panel. The sump pump automatic switch can be overridden by the CZone control feature which provides a means to manually activate the sump pump when necessary.



9.6 Drainage System Maintenance

It is essential that the following items be done periodically to maintain proper drainage of your boat:

- Clean the cockpit drain rails with a hose to remove debris that can block water drainage.
- Clean the hardtop or tower leg and tubing drain holes. This is especially important just before winter lay-up.
- Clean the bilge pump strainers of debris and check the bilge for foreign material that can cause the automatic switch to malfunction.
- Frequently test the automatic bilge pump switches for proper operation. This is accomplished by pressing the test button on the side of the pumps or using a garden hose to flood the bilge until the water level is high enough to activate the pumps.
- Clean and inspect the sump systems. Remove accumulated debris and flush with fresh water. Frequently test the automatic pump switch for proper operation.
- Flush all gravity drains with fresh water to keep them clean and free flowing.
- Flush the air conditioner condensation pan and drain hose with fresh water at least once each season to remove mold and debris. This is particularly important because mold tends to accumulate in condensation pan drain and, if it is not cleaned regularly, the drain can clog and flood the cabin sole when the air conditioner is operating.
- Clean and flush the fishboxes, baitwell, coolers and storage boxes with soap or a bilge cleaner and fresh water after each use to keep them clean and fresh.
- Operate all thru-hull valves at least once a month to keep them operating properly.

Notice:

All drains and pumps must be properly winterized before winter lay-up.

	CAUTION	
NEVER USE HARSH CHEMICAL DRAIN CLEANERS IN MARINE DRAIN SYSTEMS. PERMANENT DAMAGE TO THE HOSES AND FITTINGS MAY RESULT.		

NOTES

Ventilation System

10.1 Cabin Ventilation

Cabin Windows

Opening tempered glass windows are located on each side of the cabin. The windows are equipped with a screen and secured in the closed position by two cam latches.

To open a side window, release the latches and swing the window open. To close, swing the window to the closed position and secure it with the latches.

Always make sure the windows are closed and secured with the latches whenever the boat is underway. Sea spray could enter the cabin through an open window and damage equipment or items stowed there.



Cabin Window & Latches Closed



10.2 Windshield Ventilation

Ventilation through the windshield is provided by vent panels above the windshield. The vent panes are always open unless closed with optional canvas panels.



Cabin Window & Latches Open

10.3 Carbon Monoxide & Proper Ventilation

	WARNING	
<p>FAILURE TO PROPERLY VENTILATE THE BOAT WHILE THE ENGINES ARE RUNNING MAY PERMIT CARBON MONOXIDE TO ACCUMULATE WITHIN THE CABIN AND OPEN AREAS OF YOUR BOAT. CARBON MONOXIDE IS A COLORLESS AND ODORLESS GAS THAT IS LETHAL WHEN INHALED. CARE MUST BE TAKEN TO PROPERLY VENTILATE THE BOAT AND TO AVOID CARBON MONOXIDE FROM ACCUMULATING IN THE BOAT WHENEVER AN ENGINE IS RUNNING.</p>		

A by-product of combustion, carbon monoxide (CO) is invisible, tasteless, odorless, and is produced by all engines and gas heating and cooking appliances. The most common sources of CO on boats are gasoline and diesel engines, auxiliary generators and propane or butane stoves. These produce large amounts of CO and should never be operated while sleeping. The hazard also may be



Windshield Ventilation

created by a boat nearby whose exhaust fumes are entering your boat. Boats also have a problem due to the "station wagon effect" where engine exhaust fumes are captured in the vacuum or low pressure area, usually the cockpit and cabin, that can be created by the forward speed of the boat.



Boats underway should close all aft facing hatches, windows and doors. The forward facing windshield vent should be open whenever possible to help pressurize the helm area of the boat. No sleeping in the cabin should be permitted while underway. The canvas drop or aft curtain must be removed and the side curtains should be opened or removed to increase air flow and maintain proper ventilation whenever the engines are running. Under no circumstances should the engines be operating with side curtains closed and the aft or drop curtain installed.

Extreme caution must be taken while at anchor or in a slip when an auxiliary power generator is operating. Wind still nights can easily allow exhaust fumes, containing high concentrations of CO, from the generator on your boat or from an adjacent boat's generator to enter the boat.

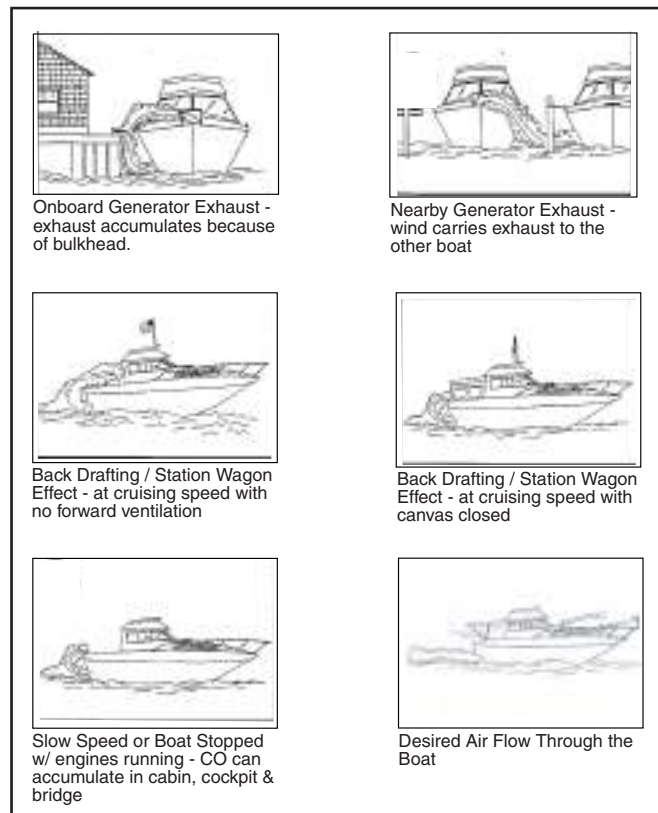
A carbon monoxide detector has been installed in your cabin as standard equipment. While a CO detector enhances your protection from CO poisoning, it does not guarantee it will not occur. Do not use the carbon monoxide detector as a replacement for ordinary precautions or periodic inspections of equipment. Never rely on alarm systems to save your life, common sense is still prudent and necessary. Remember, the operator of the boat carries the ultimate responsibility to make sure the boat is properly ventilated and the passengers are not exposed to dangerous levels of carbon monoxide. You should always be alert to the symptoms and early warning signs of carbon monoxide poisoning. You also should read the "Carbon Monoxide Monitoring System" in the Safety Equipment chapter of this manual and the owner's manual supplied by the CO detector manufacturer for operation instructions and additional information regarding the hazards and symptoms of carbon monoxide poisoning.



Typical Carbon Monoxide Detector & Alarm

 **DANGER** 

ACTIVATION OF THE CARBON MONOXIDE DETECTOR INDICATES THE PRESENCE OF CARBON MONOXIDE (CO) WHICH CAN BE FATAL. EVACUATE THE CABIN IMMEDIATELY. DO A HEAD COUNT TO CHECK THAT ALL PERSONS ARE ACCOUNTED FOR. DO NOT REENTER THE CABIN UNTIL IT HAS BEEN AIRED OUT AND THE PROBLEM FOUND AND CORRECTED.

Periodically test the carbon monoxide detector per the manufacturer's instructions. Please refer to the carbon monoxide detector manual or contact the manufacturer for more information on maintaining and calibrating the detector.

10.4 Maintenance

- Periodically lubricate all hinges and latch assemblies with a light oil.
- Periodically clean and coat gasket materials with silicone to help keep them pliable.

NOTES

Exterior Equipment

11.1 Deck

Rails and Deck Hardware

The rail system and hardware fittings have been selected and installed to perform specific functions. Hand rails are installed to provide a handhold in certain areas of the boat. You should make sure you keep at least one hand on the handholds as you move about the boat.

Your boat is equipped with cleats that are retractable and flush with the deck when not in use. To use the cleats, pull up on the center of the cleat until it locks in the mooring position. Mooring lines should be secured to the cleats and not to rails or stanchions. Be sure a clear lead exists when running dock lines or anchor lines. A line inadvertently run around a stanchion or over the rail could cause damage.

Notice:

All fittings must be inspected periodically for loose fit or wear and damage. Any problems should be corrected immediately.



Stern Mooring Cleat Retracted



Stern Mooring Cleat Up

 WARNING 
<p>SCOUT BOATS ARE NOT EQUIPPED WITH HARDWARE DESIGNED FOR TOWING PURPOSES. THE MOORING CLEATS ARE NOT TO BE USED FOR TOWING ANOTHER VESSEL OR HAVING THIS BOAT TOWED.</p>

11.2 Rope Locker & Windlass

Bow Roller

The bow roller is built into the hull and equipped with hardware that allows the anchor to be operated and stored at the roller. The roller assembly, windlass, anchor line and chain binder are concealed below a hatch in the deck. The anchor line is stored in the rope locker and routed out the windlass, through the roller and connected to the anchor chain. A chain binder is provided between the windlass and the roller to secure the anchor. Always make sure the anchor is properly secured by the chain binder when it is in the stored position on the roller.



Bow Roller & Anchor

The chain binder is accessed by opening the hatch and is designed to connect to a link in the anchor chain when the anchor is hauled in. To release the binder, pull the anchor chain in slightly to relieve the tension on the binder, then release the binder from the chain. To secure the anchor in the up and stored position, raise the anchor until it seats firmly in the roller with the chain snug. Attach the chain binder to a link in the chain. Before getting

underway after hauling the anchor, always make sure the binder is properly attached to the anchor chain link and the hatch is closed and latched.

Rope Locker

The rope locker and anchor line are accessed through a hatch below the center bow cushion. A gas hatch lifter supports the hatch in the open position. The anchor line is always stored in the rope locker and there is an eye fitting to secure the bitter end of the anchor line.

The rope locker is designed for the anchor line and not for storing anchors or additional anchor lines. Do not store anchors or any heavy objects in the locker. Anchors and weights for floating markers will bounce and damage the hull or rope locker if they are stored there. They will also interfere with the operation of the windlass. Always store and secure additional anchors and weights in a storage compartment in the cockpit as far aft as possible.

The rope locker is drained by a fitting in the hull side near the bottom of the locker. It is very important to check the drain frequently to make sure it is clean and free flowing.

Periodically remove the anchor line from the rope locker, rinse it with fresh water and allow it to dry in the sun. Cleaning the anchor line regularly will reduce odors in the rope locker and increase the life of the line.

The line should also be inspected for abrasions or signs of deterioration. Replace the line if it shows any sign of damage or deterioration. It is important to replace the anchor line with a new line of the type recommended or supplied by the windlass manufacturer.

Windlass Compartment

The windlass, chain binder and anchor line cleat are concealed in a compartment below a hatch in the deck. A gas hatch lifter supports the hatch in the open position. A twist latch secures the hatch when it is closed. Always make sure the hatch is closed with the latch in the secured position before operating the boat above idle speed.

The windlass compartment is equipped with a retractable washdown hose plumbed to the fresh water system. After the anchor is hauled in and secured with the chain binder, use the washdown hose to rinse the anchor, chain and hardware. Make sure the freshwater system is activated



Windlass Compartment Hatch In Deck & Foot Switches With Safety Covers Open



Rope Locker Access Hatch Below Center Bow Seat

before using the washdown hose. Rinsing with freshwater each time the anchor is hauled reduces corrosion on the windlass, anchor and hardware.

The anchor is stored on the roller and is raised and lowered by the windlass. The anchor line is stored in the rope locker and routed out through the windlass to the anchor chain.

The anchor is lowered by releasing the anchor from the chain binder and operating the "DOWN" control at the helm or the foot switch at the bow. The windlass control switches are activated and protected by fuses in the CZone modules and a circuit breaker in the battery switch panel. Hinged covers protect the foot switches from being ac-

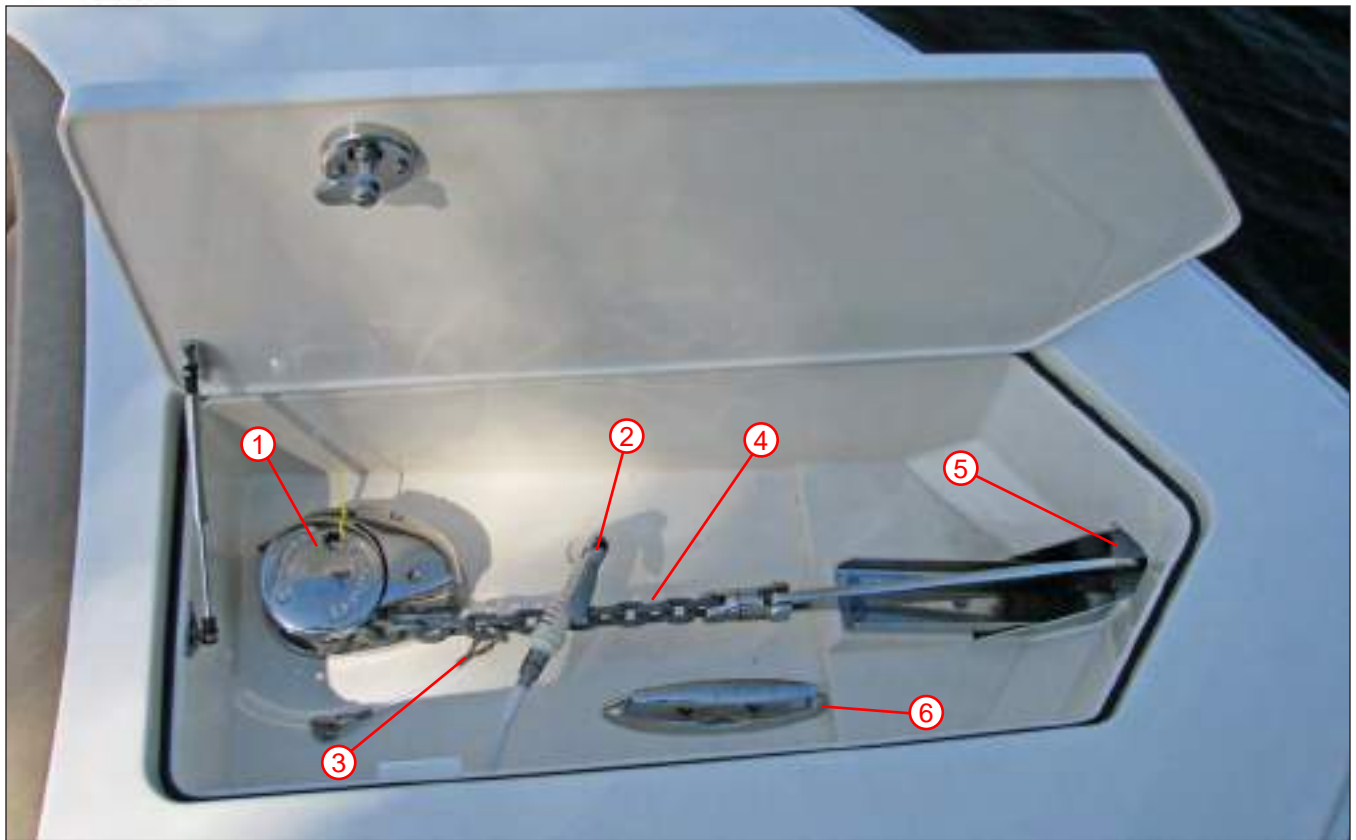

Windlass Compartment

- | | |
|-------------------------|----------------------|
| 1. Windlass | 4. Anchor Chain |
| 2. Fresh Water Washdown | 5. Bow Roller |
| 3. Chain Binder | 6. Anchor Line Cleat |

ciently activated. Make sure to open the covers to expose the switches when using the windlass foot switches and close the covers when done.

After the anchor is set, the windlass must not be left to take the entire force from the anchor line. Boats lying to their anchor in a high swell or heavy weather conditions will snub on the line. This can cause slippage or apply excessive loads to the windlass. The line should be made fast to the cleat provided to relieve the load on the windlass.

The anchor is hauled in by releasing the line from the cleat and operating the "UP" control at the helm or the foot switch on the deck near the windlass. Always start the engines before hauling the anchor and motor up to the anchor as the line is retrieved to relieve the load on the windlass. Once the anchor is retrieved, independently secure the anchor to the chain binder to prevent it from being accidentally released. This is especially important while the boat is under way.

The windlass manufacturer provides an owner's manual with its product. It is extremely important that you read the manual and become familiar with the proper care and operation of the windlass. Refer to the Operation chapter for tips on anchoring your boat.

⚠
WARNING
⚠

A WINDLASS MUST BE USED WITH CARE. IT IS EXTREMELY IMPORTANT THAT YOU READ THE OWNER'S MANUAL AND BECOME FAMILIAR WITH THE SAFETY INSTRUCTIONS AND PROPER OPERATION OF THE WINDLASS BEFORE USING IT WITH YOUR BOAT. ALWAYS ENSURE THAT LIMBS, FINGERS, HAIR AND CLOTHING ARE KEPT CLEAR OF THE WINDLASS AND ANCHOR LINE DURING OPERATION.

A PARTIALLY LOWERED AND LOOSE ANCHOR CAN CAUSE CONSIDERABLE DAMAGE TO THE HULL. DO NOT USE A WINDLASS AS A SOLE MEANS OF SECURING AN ANCHOR IN THE BOW ROLLER. ALWAYS SECURE THE ANCHOR TO A CHAIN BINDER BEFORE OPERATING YOUR BOAT.



Engine Mounting System & Platform

11.3 Hull

Engine Mounting System

Your Scout is equipped with an engine mounting system and platform that is integrated into the hull and stringer system that is designed to distribute the stresses of engine weight and thrust throughout the entire hull.

The engine hoses and cables or transom gel coat can be damaged by tilting the engines to the full up position with the engines turned to the wrong position. You should monitor the engines as they tilt to determine best full tilt engine position for your boat.

Platform Boarding Ladder

A telescoping boarding ladder is recessed into the starboard side of the platform. To use the ladder, make sure the engines are shutdown and lower the platform. Pull the ladder out from the platform and extend it to the full down position. The ladder must be retracted and pushed into the recess before raising the platform.

The platform is equipped with a grab rail to assist in boarding that is retractable and flush with the platform when not in use. To use the grab rail, pull up on the center of the rail until it locks in the deployed position. To retract the rail, push down on the center of the rail until it is flush with the platform.

Unassisted Boarding Situations

When using the swim platform ladder in an unassisted boarding situation in deep water, hold the swim platform and brace your feet against the hull for stability. Then rotate the ladder out of the recess to the down position with your free hand. Hold the side rail of the ladder for stability, then use your free hand and feet to pull the ladder out to the extended position. Use the ladder side rails and platform grab rail for stability while boarding. Remember to retract the ladder and fold it into the recess before starting the engines.

WARNING

MOVING PROPELLERS ARE DANGEROUS. THEY CAN CAUSE DEATH, LOSS OF LIMBS, OR OTHER SEVERE INJURY. DO NOT USE THE SWIM PLATFORM OR BOARDING LADDER WHILE AN ENGINE IS RUNNING. STOP THE ENGINES IF DIVERS OR SWIMMERS ARE ATTEMPTING TO BOARD. ALWAYS RETRACT AND PROPERLY SECURE THE LADDER BEFORE STARTING THE ENGINES.

Trim Tabs

The trim tabs are recessed into the hull below the transom. The trim tabs are an important part of the control systems. Refer to the Helm Control Systems chapter for detailed information on the operation of the trim tabs.

Underwater Lights

The LED underwater lights are mounted in the transom, below the water line. The lights are activated with the CZone control feature or the Underwater Light switch in the helm electronics display. The lights should only be used when the boat is in the water with the lights submerged.

11.4 Cockpit Features

General

Most hatches in the cockpit sole are secured with twist latches and flush mounted handles that store flush in the hatch. Automatic push to close latches secure other cockpit and center console doors and drawers in the closed position. Gas charged springs are used to help raise most hatches and hold them in the open position.

Some hatches in the cockpit sole are secured with special flush mounted, twist lock latches with handles that store flush in the latch. The latch handles can be stored flush in either the open or secured positions. There is a large red dot in the handle that indicates that the latch is in the open position and the hatch is not secure.

Other large hatches in the cockpit sole and deck are secured with flush mounted, twist lock latches with handles that store flush to the hatch only when they are in the latched position. Always make sure that all hatches are closed with the latches in the secured position before operating the boat above idle speed.



Twist Latch Unlatched
Red Dot Showing



Twist Latch latched
Red Dot is Not Showing



Typical push to close Latch

WARNING

IN CERTAIN CONDITIONS, OPEN EXTERIOR DOORS AND HATCHES THAT ARE NOT SECURED PROPERLY CAN SLAM CLOSED UNEXPECTEDLY AND CAUSE INJURY TO PASSENGERS OR DAMAGE TO THE BOAT. SOME DOORS AND HATCHES ARE EQUIPPED WITH SPECIAL FASTENERS, HATCH LIFTERS OR SNAPS AND/OR STRAPS TO SECURE THEM IN THE OPEN POSITION. ALWAYS MAKE SURE THAT THESE HATCHES AND DOORS ARE PROPERLY SECURED WHENEVER THEY ARE IN THE OPEN POSITION.

Transom Door and Gate

A door and gate is incorporated into the starboard side of the transom. The gate is hinged and secured with an automatic push to close latch. It is opened by lifting the starboard side and swinging the gate onto the aft gunnel.

The transom door can be opened when the gate is open or closed. It is secured by a special latch mounted on the inboard side of the door. The door latch has a push button safety pin. When the transom door is closed, make sure the latch is completely engaged and that the safety pin is engaged to prevent the latch from opening accidentally.

The transom door and gate should only be opened when the boat is not underway. The door and gate must be latched in the closed position whenever the boat is underway. Never leave the transom door unlatched.

Notice:



Periodically inspect the transom door and gate fittings for wear, damage or loose fit. Any problems should be inspected and corrected immediately.





Transom Door & Gate Closed



Transom Door Closed & Gate Open

	WARNING	
<p>THE TRANSOM DOOR AND GATE SHOULD BE CLOSED AND PROPERLY LATCHED WHENEVER THE ENGINES ARE RUNNING. NEVER OPEN THE TRANSOM DOOR WHILE UNDERWAY OR IN ROUGH SEA CONDITIONS. IN CERTAIN SITUATIONS, AN OPEN TRANSOM DOOR COULD ALLOW A SUBSTANTIAL AMOUNT OF WATER TO ENTER THE COCKPIT CREATING A POTENTIALLY DANGEROUS CONDITION.</p>		

	WARNING	
<p>OPERATING THE BOAT UNDER POWER WITH THE TRANSOM DOOR AND GATE OPEN MAY ALLOW PERSONS TO FALL OVERBOARD AND INTO BOAT PROPELLERS OR TO BE LOST IN OPEN WATER. ALWAYS CHECK TO MAKE SURE THE TRANSOM DOOR AND GATE ARE PROPERLY CLOSED AND LATCHED BEFORE STARTING THE ENGINES AND NEVER OPERATE THE BOAT UNDER POWER WITH THE TRANSOM DOOR AND GATE OPEN.</p>		



Side Boarding Door & Gate Closed & Latched

Side Boarding Door and Ladder

A side boarding door and gate is incorporated in the port rear hull side. The door provides divers and swimmers easy, unobstructed access to the water and cockpit. It also makes boarding and exiting the boat much easier in many docking situations.

The gate is hinged and opened by releasing the push to close latch at the rear of the gate and swinging it forward onto the gunnel. The side door can be opened when the gate is open or closed. It is secured by a special latch mounted on the in-board side of the door. The door latch has a spring loaded safety button. When the door is closed, make sure the latch is completely engaged and that the safety button is snapped into the latch handle to prevent it from opening accidentally.

A recess in the cockpit side allows the door to open flush against the cockpit when it is open. The door latch must be in the unlatched, vertical position to fit into the recess

The door should only be opened when the boat is not in motion with the engines shutdown. The door must be secured in either the open position to the side of the cockpit or in the closed position with the main latch and safety pin. Never leave the side door unlatched.

Notice:
Periodically inspect the door hinges and hardware for wear, damage or loose fit. Any problems found should be corrected immediately.

Side Boarding Ladder

The side boarding ladder is mounted to special brackets in the side of the cockpit when it is in the stored position. To use the ladder, remove it from the storage clips and slide the studs into the special bracket on the hull side just below the door. The ladder floats and is secured in the ladder bracket by a spring loaded latch that prevents the ladder from floating off the bracket. To remove the ladder, push up on the release lever on the side of the ladder bracket to release the latch, then slide the ladder up and off the bracket.

To prevent damage to the ladder or hull side, the ladder must be removed from the bracket and properly secured in the cockpit storage clips before starting the engines.



Side Boarding Door & Gate Open



Side Boarding Door Latch & Spring Loaded Safety Button

	WARNING	
<p>THE SIDE BOARDING DOOR AND GATE SHOULD BE CLOSED AND PROPERLY LATCHED WHENEVER THE ENGINES ARE RUNNING. NEVER OPEN THE DOOR WHILE UNDERWAY OR IN ROUGH SEA CONDITIONS. IN CERTAIN SITUATIONS, AN OPEN DOOR COULD ALLOW A SUBSTANTIAL AMOUNT OF WATER TO ENTER THE COCKPIT CREATING A POTENTIALLY DANGEROUS CONDITION.</p>		

	WARNING	
<p>OPERATING THE BOAT UNDER POWER WITH THE SIDE BOARDING DOOR AND GATE OPEN MAY ALLOW PERSONS TO FALL OVERBOARD AND INTO BOAT PROPELLERS OR TO BE LOST IN OPEN WATER. ALWAYS CHECK TO MAKE SURE THE DOOR AND GATE ARE PROPERLY CLOSED AND LATCHED BEFORE STARTING THE ENGINES. NEVER OPERATE THE BOAT UNDER POWER WITH THE SIDE BOARDING DOOR AND GATE OPEN.</p>		

Hydraulic Beach Platform (Optional)

A side boarding gate and platform that is incorporated into the port rear side of the cockpit and hull side is an available option. The boarding platform provides divers and swimmers easy, unobstructed access to the water and cockpit.

The gate is hinged and opened by releasing the push to close latch at the rear of the gate and swinging it forward onto the gunnel. The platform can be lowered when the gate is open or closed.

Electrohydraulic actuators controlled by the Beach Platform rocker switch in the cockpit near the side boarding door raise or lower the platform.

To use the platform, open the gate and press the bottom of the Beach Platform momentary switch to lower the platform. Raise the platform by pressing the top of the switch. It will stop when it reaches the up and closed position, then close the gate.

Notice:

Periodically inspect the side door hinges and hardware for wear, damage or loose fit. Any problems found should be corrected immediately.

Beach Platform Boarding Ladder

A telescoping boarding ladder is recessed into the beach platform. To use the ladder, make sure the engines are shutdown and lower the platform. Pull the ladder out from the platform and extend it to the full down position. The ladder must be retracted and pushed into the recess before raising the platform.



Beach Platform Raised & Gate Closed



Beach Platform Lowered & Gate Open



WARNING





THE BEACH PLATFORM SHOULD BE RAISED AND THE GATE CLOSED WHENEVER THE ENGINES ARE RUNNING. NEVER LOWER PLATFORM OR OPEN THE GATE WHILE UNDERWAY OR IN ROUGH SEA CONDITIONS. IN CERTAIN SITUATIONS, A LOWERED PLATFORM COULD ALLOW A SUBSTANTIAL AMOUNT OF WATER TO ENTER THE COCKPIT CREATING A POTENTIALLY DANGEROUS CONDITION. THE PLATFORM COULD ALSO BE DAMAGED BY EXCESSIVE WATER PRESSURE WHILE UNDERWAY OR BY WAVE ACTION IN ROUGH SEAS.



WARNING



OPERATING THE BOAT UNDER POWER WITH THE BEACH PLATFORM LOWERED MAY ALLOW PERSONS TO FALL OVERBOARD AND INTO BOAT PROPELLERS OR TO BE LOST IN OPEN WATER. ALWAYS CHECK TO MAKE SURE THE PLATFORM IS RAISED AND THE GATE IS CLOSED BEFORE STARTING THE ENGINES. NEVER OPERATE THE BOAT UNDER POWER WITH THE GATE OPEN AND/OR THE PLATFORM DOWN.

WARNING

MOVING PROPELLERS ARE DANGEROUS. THEY CAN CAUSE DEATH, LOSS OF LIMBS, OR OTHER SEVERE INJURY. DO NOT USE ANY PLATFORM OR BOARDING LADDER WHILE AN ENGINE IS RUNNING. STOP THE ENGINES IF DIVERS OR SWIMMERS ARE ATTEMPTING TO BOARD. ALWAYS RETRACT ALL LADDERS, RAISE THE BOARDING PLATFORM AND CLOSE ALL TRANSOM AND SIDE DOORS OR GATES BEFORE STARTING THE ENGINES.



Transom Baitwell

Transom Baitwell

The transom baitwell is located in the rear of the cockpit. The hatch is equipped with hatch lifters that hold it in the open position. Flush, twist lock latches secure the hatch when it is closed. There is a large red dot each the handle that indicates that the latch is in the open position and the hatch is not secure. Always make sure the hatch is closed with the latches in the secured position before operating the boat above idle speed.

The baitwell is equipped with lights and drains by gravity to a thru-hull fitting in the hull. A centrifugal pump located in the aft systems room supplies seawater to the baitwell and adjustable inlet valves control water flow. Another pump mounted to the side of the livewell can be activated by the CZone control feature to recirculate and aerate the water in the livewell.

An overflow built into the rear side of the baitwell automatically controls the water level. The baitwell should be drained and rinsed clean with fresh water after each use. Refer to the Raw Water System and Drainage Systems chapters for more information on the operation of the baitwell.



Aft Below Deck Fishbox

Aft Below Deck Fishboxes

Two below deck fishboxes are located on each side of the cockpit. Each fishbox hatch is equipped with a gas hatch lifter that holds the hatch in the open position. Flush, twist lock latches secure the hatches in the closed position. There is a large red dot in the handle that indicates that the latch is in the open position and the hatch is not secure. Always make sure these hatches are closed with the latches in the secured position before operating the boat above idle speed.

Each fishbox is drained by a separate diaphragm pump located in the aft systems room bilge and activated with the CZone control feature or the Fishbox Pump switches in the helm electronics display. Be sure to monitor the water level in the fishbox and turn the pump off as soon as pumping is complete. The pump could be damaged if it is allowed to run dry for extended periods. The fishboxes should be pumped out and cleaned after each use. Refer to the Drainage Systems chapter for more information on the fishbox drainage.

Aft Systems Room Access Hatch

A hatch in the center rear of the cockpit provides access to the fuel valves, fuel filters, pumps, seawater strainers, generator and other equipment in the stern bilge. The fuel supply valves and filters are located on each side of the compartment. The engine control systems, stern bilge pump, emergency bilge pump, fishbox pumps, high water alarm, sea chest, baitwell pump, air conditioner pump are also among the equipment in this compartment.

The hatch is held open by gas hatch lifters and secured closed with rotating latches. There is a large red dot in each latch handle that indicates that the latch is in the open position and the hatch is not secure. Always make sure the hatch is closed with the latches in the secured position before operating the boat above idle speed.

Cockpit Rod Rack

There is a recessed rod storage rack located below the gunnel on the starboard side of the cockpit. The rack is equipped with stretch cords to secure the rods to the rack. Always make sure the rods are properly secured in the storage rack with the rod tips forward.



Aft Systems Room Hatch



Cockpit Rod Rack



Stern Bench Seat Open



Optional Stern Bench Seat Closed

Stern Bench Seat (Optional)

Your boat could be equipped with a forward facing bench seat in the rear of the cockpit. The seat is designed to fold flush against the cockpit when it is not in use.

To use the seat, pull the handle near the top of the seat base out of the recess toward the cockpit. As the seat rotates out, grab the rear and front of the seat cushion and rotate it down to the seat position. The seat automatically stops when the cushion reaches the seating position.

To store the seat, grab the rear and front of the seat cushion and rotate it up until it is almost folded into the recess, then push the seat firmly into the recess. The seat will automatically be secured in the stored position when it is completely folded into the recess.



Port Aft Transom Compartment

Port Aft Transom Compartment

A storage compartment is located behind a hinged door with a push to close latch. Access plates in the bottom and side of the compartment provide access to the port trim tab pump and components for the optional retractable shore power cord and/or electrohydraulic system for the beach platform.

Mid Ship Storage Compartments

Two storage compartments are located below the cockpit sole on each side of the console. The compartments drain to the bilge and can be used to stow lines, fenders or other items that won't be damaged if they get wet. A drain rail around each hatch drains to the overboard drain system and helps prevent water from entering the compartment. Gas hatch lifters support the hatches when they are open.

The hatches are equipped with a flush, twist lock latch that secures the hatches in the closed position. There is a large red dot in the handle of the latch that secures the hatch that indicates that the latch is in the open position and the hatch is not secure. Always make sure the hatch is closed with the latch in the secured position and the handle folded flush to the deck before operating the boat above idle speed.



Mid Ship Storage Compartment

Bow Seats and Storage Compartments

The bow seat cushions are secured to the hatch lids with special friction latches. These latches are equipped with a notched male fitting that seats in a female receiver. These latches require a firm upward pull to release and a firm downward push to latch. The bow seat cushions should be removed and stored when the boat is not being used.

There are two storage/cooler compartments located below the port and starboard bow seats. The rope locker is located below the center bow seat.



Bow Seats

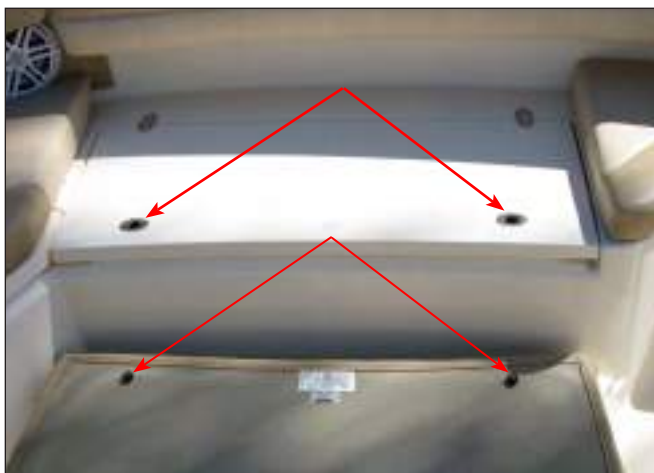

Bow Seat Cushion Friction Latches



Bow Seat Storage Compartments

The compartment access hatches are equipped with gas hatch lifters that hold them in the open or closed position.

The port and starboard compartments are insulated and can be used for dunnage, coolers or fishboxes. They drain overboard by gravity through fittings in the hull sides. Drain plugs can be inserted in each drain fitting to control drainage or isolate the compartments from the seawater. If the compartments are used as fishboxes or coolers, they should be cleaned and flushed thoroughly with fresh water after each use.

Another storage compartment is located below the table and cockpit sole between the bow seats. It is accessed by raising the table, if equipped, to the lounge or table position and provides additional storage for dunnage. If the boat is equipped with an optional bow thruster, the thruster battery will be mounted in this compartment.

The hatch is equipped with a flush, twist lock latch that secures the hatch in the closed position. This compartment is drained by gravity to the forward bilge. There is a large red dot in the handle of the latch that secures the hatch that indicates that the latch is in the open position and the hatch is not secure. Always make sure the hatch is closed with the latch in the secured position and the handle folded flush to the deck before operating the boat above idle speed or lowering the table to the full down position.



Rope Locker Below Forward Bow Seat



Forward Below Deck Storage Compartment



Optional Bow Thruster Battery In Below Deck Storage Compartment



Cockpit Table Up In The Dining Position



Cockpit Table Down

Bow Table and Sun Lounge (Optional)

Your boat could be equipped with a retractable table that converts the bow area into either a sitting area with no table, a sitting area with a table, or a sun lounge/fishing deck. The table is mounted on an electrically actuated pedestal that is controlled by switches in a panel on the side of the cockpit.

Two push button momentary switches control the electric actuator that raises and lowers the bow table pedestal. Press and hold the top switch to raise the table. Press and hold the bottom switch to lower the table. Release the switch to stop the table in the current position. A limit switch in the actuator will automatically stop the pedestal when table reaches the maximum UP or DOWN positions.

To use the bow area for seating without the table, lower the table until it is sitting firmly in the cockpit recess. To use the bow area as a fishing deck, raise the table until it is flush with the bow seat hatches. Install the bow seat cushions and the table filler cushion when the table is flush to the hatches to convert the area to a sun lounge. Remove the filler cushion and raise the table to the full up position to convert the bow area to a sitting area with a table. The filler cushion is stored in the console lounge seat storage compartment when it is not in use.

To avoid damage to the table and pedestal, always make sure the table is down and sitting firmly in the cockpit recess whenever the boat is operating above slow speed. This is particularly important when the boat is being run offshore.



Cockpit Table in Sun Lounge Position



Cockpit Table Switches

11.5 Leaning Post Equipment

The leaning post station is equipped with leaning post/helm seats, rear facing bench seat, refrigerator, and storage drawers for dunnage and/or tackle storage. It could also be equipped with additional optional equipment.

The following is a description of equipment typically installed in the leaning post station. The equipment on your boat could be different, depending on the options selected.

Fresh Water Sink (Optional)

The sink is located below an opening hatch below the rear facing bench seat cushion. The sink faucet is plumbed to the fresh water system and is drained by gravity to a thru-hull fitting in the hull side above the waterline. To use the sink, make sure the fresh water system is activated. Open the hatch and rotate the faucet to the operating position. The faucet works like faucets in your home when the fresh water system is activated. Always lower the faucet to the stored position and close the hatch when the sink is not being used.

Electric Grill (Optional)

An electric, stainless steel grill is located next to the sink below the bench seat cushion/hatch. The grill is recessed into the counter top and operates on 120 volt AC power only. To use the grill, make sure the Grill AC circuit breaker is activated, then use the touch control to activate the burner and control the temperature. After cooking, be sure the burner is turned off and allowed to cool before closing the hatch. Never close the hatch while the grill is hot. Deactivate the Electric Grill circuit whenever the grill is not being used to ensure it is not activated accidentally.

Refer to the grill operating manual for additional information on the proper operation and maintenance of the grill.

Refrigerator

The dual voltage refrigerator will operate on 120 volt AC or 12 volt DC power. The refrigerator switches to 12 volt DC automatically when the AC power is disconnected and the cockpit refrigerator is activated with the CZone control feature. When 120 volt AC current is provided by shore power or the generator, the refrigerator automatically switches to AC power.



Aft Facing Bench Seat & Prep/Entertainment Station



Leaning Post Freshwater Sink & Grill



Leaning Post Refrigerator

Care should be exercised while operating the refrigerator on 12 volt power without the engines running. It draws a substantial amount of current and can severely drain the house batteries through extended use. The refrigerator slide out drawer has a special latch to secure the drawer while under way. Make sure the drawer is properly secured whenever the boat is moving.

Refer to the refrigerator owner's manual for additional operating and maintenance instructions.

Ice Maker (Optional)

An ice maker is a popular option that is usually mounted in the station instead of the refrigerator. The ice maker operates on AC power only. A switch located just below the ice maker door turns the unit on or off. The fresh water system supplies the water for the ice maker. Make sure the freshwater system is activated and there is water in the tank before turning on the ice maker.

The ice maker door has a special latch to secure the door while under way. Make sure the door is properly secured whenever the boat is moving. Refer to the ice maker owner's manual for additional operating and maintenance instructions.

Storage Drawers

Storage drawers on the port side of the leaning post are secured in the closed position with flush mounted, push to close latches. To open, pull the latch handle to release the latch and slide the drawer out. To close, push the drawer in until the latch catches.

Cockpit Fresh Water Shower (Optional)

There could be an optional shower spray head located in a recessed compartment on the port side of the leaning post. It has hot and cold water and a retractable shower head with an ON/OFF valve. Refer to the Fresh Water System chapter for additional information on the cockpit shower.

Aft Facing Bench Seat

A rear facing bench seat is built into the rear of the leaning post station. A slide out storage drawer with a push to close latch is located below the seat. The bench seat cushion is hinged and raises with the sink/grill hatch to convert the sink to a prep/entertainment center.



Tackle/Storage Drawers



Aft Facing Bench Seat & Slide Out Storage Drawer

If your boat is equipped with an optional upper control station, the seat and footrest are used as steps to access the ladder to the upper station from the cockpit.

Mid Equipment Room Hatch

The rear facing bench seat and prep/entertainment station is raised by electrohydraulic actuators to provide clearance to open the hatch in the cockpit sole that provides access to the equipment room below the leaning post. The hydraulic system is controlled by a rocker switch on the starboard side of the leaning post. To raise the station, press and hold the top of the switch until it stops in the raised position.

Once the station is raised, the equipment room hatch can be opened. The hatch provides access to the batteries, battery chargers, volt meters, optional SeaKeeper and other equipment mounted in the mid equipment room.

To lower the station, make sure the access hatch is closed, then press and hold the bottom of the switch until the station stops in the down position.

Helm Seats

The helm and passenger seats are equipped with a flip up bolster to provide more room between the seats and the helm. The bolsters convert the seats to a leaning post style seat with a backrest, allowing the operator and passenger to sit or stand at the helm. To convert each seat to a leaning post, lift the front of the seat cushion to raise the bolster and push it back above the seat cushion.

Arm rests on each side of the seats provide a more comfortable position and swing up into the backrest cushion to make it easier to enter and exit the helm area. A molded in footrest on the rear of the console makes the helm more comfortable when the bolsters are set to the seat position.

Battery Switch Panel

A door with a push to close latch below the helm seats provides access to the battery switches and the CZone control modules and fuse panels.



Battery Switch Panel, CZone Control Modules & Access Door



Mid Equipment Room Hatch



Helm Seats In Leaning Post Position & Battery Switch Panel Access Door



Helm Seats In Seat Position



Typical Helm

11.6 Console & Helm

Helm

The steering, engine controls, engine instruments and switches for exterior equipment, navigation lights and other 12 volt DC accessories are located on the helm station and in the hardtop liner above the helm. Molded-in electronics storage is located forward of the engine controls. The helm is also equipped with molded in cup holders, grab rails and a storage compartment with a 12 volt accessory and MP3 plug.

Air conditioning ducts in the helm provide cooling to the helm station when the cabin air conditioner is operating. Additional ventilation is provided by vent panels above the windshield.

Large hatches and doors in the aft head compartment bulkhead provide access to the back of the helm panel for servicing helm equipment and



Hardtop Switch Panel & Electronics Above Helm

installing electronics or other accessories. There are also fuse panels that provide protection for electronics, helm accessories or other equipment added by you or your dealer.

Windshield

Your boat is equipped with a tinted glass windshield and windshield wiper. The front and side panels are tempered safety glass.

The windshield wiper should only be used when the windshield is wet. Windshield glass can be scratched by activating the wiper when there is dried salt or dirt on the windshield. The windshield washer is supplied by the fresh water system. Always make sure the fresh water system is activated before using the windshield washer.

The windshield/hardtop frame is powder coated aluminum. Powder coated aluminum is very durable and provides excellent resistance to the corrosive effects of saltwater, however, it must be maintained properly and certain precautions must be observed.

The windshield should be washed after each use with soap and water to keep it clean and reduce the corrosive effects of the saltwater. Saltwater allowed to remain on the windshield frame will eventually begin to attack the aluminum, usually around fasteners and hardware mounted to the frame.

Refer to the Routine Maintenance chapter for more information on the care and maintenance of powder coated aluminum.

Cabin Door

The cabin door is on the port side of the console. A lockable, push to close latch secures the door when it is closed.

It is very important that the door is secured properly in the closed position whenever the boat is operated above idle speed. The cabin door is heavy and if the door is not closed and properly latched, it could slam closed when the boat rocks and pinch someone's fingers between the door and cabin or damage the door.



When closing the door, make sure you push the door against the door jam with enough pressure to allow the latch to secure the door.



Windshield & Wiper



Cabin Door

	WARNING	
<p>NEVER LEAVE THE CABIN DOOR UNLATCHED. THE CABIN DOOR IS HEAVY AND SWINGS EASILY. IF THE DOOR IS LEFT UNLATCHED, IT COULD SLAM CLOSED UNEXPECTEDLY AS THE BOAT ROCKS, DAMAGING THE DOOR OR CAUSING AN INJURY TO A PASSENGER. ALWAYS MAKE SURE THE DOOR IS PROPERLY SECURED IN THE CLOSED POSITION.</p>		



DANGER



CARBON MONOXIDE (CO) CAN CAUSE BRAIN DAMAGE OR DEATH. CARBON MONOXIDE CAN BE PRESENT IN THE CABIN. SIGNS OF CARBON MONOXIDE POISONING INCLUDE NAUSEA, HEADACHE, DIZZINESS, DROWSINESS, AND LACK OF CONSCIOUSNESS. GET TO FRESH AIR IF ANYONE SHOWS SIGNS OF CARBON MONOXIDE POISONING. GET TO FRESH AIR IF THE CARBON MONOXIDE DETECTOR ALARM SOUNDS. THE CARBON MONOXIDE DETECTOR MUST BE FUNCTIONING AT ALL TIMES.

Starboard Console Storage Closet

A door on the starboard side of the console provides access to a storage compartment. A lockable, push to close latch secures the door in the closed position.

The storage compartment is equipped with a built-in storage rack designed for boat hooks, gaffs, deck mops, etc. and hooks for storing dock lines. The storage rack is equipped with a stretch cord to secure the stored items.

The fiberglass door is heavy and you should use the same precautions as with the cabin door. Always make sure the door is closed and latched whenever the storage compartment is not being accessed. Never leave the door open.

Console Lounge

A double lounge seat with underside storage is located on the console, forward of the windshield. The lounge will accommodate two people and has arm rests built into each side and a center arm rest with cup holders that fold flush to the backrest.

The forward seat cushion is mounted to a hatch that provides access to a storage compartment below the lounge for dunnage and the sun lounge filler cushions. The compartment drains to the cockpit sole.

The hatch is equipped with gas hatch lifters that hold the hatch in the open or closed position. A twist lock compression latch secures the hatch in the closed position. To prevent the hatch from opening unexpectedly, always make sure the hatch is closed and latched before operating the boat above idle speed.



Starboard Console Storage Closet



Console Lounge Seat



Lounge Seat Storage Compartment



Hardtop

11.7 Hardtop

The hardtop consists of a laminated fiberglass top mounted to a welded, powder coated aluminum frame that is bolted to the console and leaning post station. It is equipped with a switch panel, white/blue/red LED overhead lighting for the helm and a mounting area for a VHF radio and other electronics or accessories. Removable panels in the hardtop liner provide access to wiring and rigging for hardtop and upper station accessories.

The hardtop is designed to accommodate radio antennas, radar and satellite antennas, spreader lights and navigation lights. It can also be equipped with optional outriggers and rocket launcher rod holders. The navigation lights, spreader lights, windshield wiper/washer, hardtop lights, retractable sunshade and other accessories are controlled by switches in the hardtop switch panel.

Hardtops, with or without the optional upper station, are not designed to support the additional weight of heavy items like a life raft. GPS, VHF, and other electronics antennas must be mounted to the top in the proper location. Special mounting pads are provided for a radar antenna, satellite antenna and a spot light. Do not mount any antennas or additional equipment to the brow area forward of the front legs. The hard top frame is

not designed to support the weight of additional accessories in this area and could be damaged. The port and starboard supports on each side of the helm are the wire chase for lights and antennas mounted to the top.

The warranty for the hard top will be void if the top is modified in any way or heavy accessories like life rafts are mounted to the top. Additionally, if items like radar antennas, spotlights and other accessories are mounted in the wrong location, the warranty could be void. If you intend to add equipment or make modifications to the hard top, you should contact Scout Customer Service or your dealer to make sure the equipment you would like to add or the intended modification will not void the warranty on the top.

Retractable Aft Sunshade (Optional)

The optional retractable awing extends to provide shade for the rear cockpit. Electric actuators on each side of the hardtop extend or retract the awing. The actuators are controlled by the Sunshade switch in the hardtop switch panel.

Two momentary switches that control the retractable sunshade. Press the SHADE OUT switch to extend the sunshade. Press the switch again to stop the sunshade in the current position.

Press the SHADE IN switch to retract the sunshade. Press the switch again to stop the sunshade in the current position. Limit switches in the electric actuators that extend and retract the sunshade will automatically stop the actuators when the sun shade reaches the fully extended or retracted positions.

Notice:

If your boat is equipped with rocket launcher rod holders on the rear of the hardtop, the rod holders will automatically rotate down to provide clearance for the sunshade when the SHADE OUT button is pressed. The rod holders will automatically rotate to the up position when the sunshade is retracted.



Sunshade Extended

CAUTION

FISHING RODS IN THE HARDTOP ROCKET LAUNCHER ROD HOLDERS WILL ROTATE QUICKLY TO THE HORIZONTAL POSITION WHEN THE SHADE OUT BUTTON IS PRESSED. ROD OR REEL COMPONENTS COULD HIT PASSENGERS STANDING BEHIND THE HARDTOP. TO AVOID INJURY, ALWAYS MAKE SURE NO PASSENGERS ARE STANDING BEHIND THE HARDTOP BEFORE ACTIVATING THE SHADE OUT SWITCH.

Hardtop Access Hatch and Ladder

A ladder above the leaning post station and a sliding sunroof/access hatch in the hardtop provides access to outside accessories and antennas mounted to the top or to an optional upper helm station.

To open the hatch, push forward on the center of the spring loaded latch release and handle across the rear of the hatch. Latches on each side of the hatch will release and the hatch will slide forward as the handle is pushed. The hatch will automatically lock in the vent or open positions when the handle is released and the latches align with notches in the slide track. To close the hatch, pull and hold the handle down and slide the hatch to the closed position. Release the handle to automatically secure the hatch. Always secure the hatch in the closed position when people are in the upper station.



Rocket Launcher Rod Holders Rotated Down For Sunshade

WARNING

ACCIDENTALLY STEPPING INTO THE HARDTOP/UPPER STATION ACCESS HATCH OPENING CAN CAUSE SEVERE INJURY TO THE OPERATOR OR CREW. ALWAYS MAKE SURE THE ACCESS HATCH IS CLOSED AND LATCHED WHENEVER PEOPLE ARE IN THE UPPER STATION.



Sliding Hatch/Sunroof, Latch Handle & Ladder

11.8 Upper Helm Flybridge

The upper station is a powder coated, welded aluminum frame that is bolted to the topside of the hardtop. It is equipped with a control station that provides full control of the boat from the upper helm and a sunshade.

A ladder built into the center rear of the hardtop provides access to the upper station from the cockpit. The aft facing bench seat and foot rest are incorporated into the upper station access system to provide steps to the ladder. Grab Rails provide hand holds for safety.

The sun roof/access hatch in the hardtop above the ladder and center seat section of the upper helm lounge are opened when accessing the upper station and closed for safety during operation. The seat section is supported in the open position and held down when it is folded to the seat position by a gas spring.



Upper Helm Flybridge

	WARNING	
<p>ACCIDENTALLY STEPPING INTO THE HARDTOP/UPPER STATION ACCESS OPENING CAN CAUSE SEVERE INJURY TO THE OPERATOR OR CREW. ALWAYS MAKE SURE THE ACCESS HATCH IS CLOSED AND LATCHED WHENEVER PEOPLE ARE IN THE UPPER STATION.</p>		
<p>ALWAYS MAKE SURE THE SEAT SECTION AND SUNROOF/ACCESS HATCH ARE CLOSED WHEN THE UPPER HELM IS OCCUPIED.</p>		



Upper Helm Access Ladder, Grab Rails & Sliding Hatch/Sunroof In Hardtop

The upper station lounge seat provides seating for the operator and crew. Do not overload the upper station. It is designed to hold the weight of only four average-sized people. Remember that weight in the upper station raises the boat's center of gravity. Too much weight could make the boat unstable or damage the frame.



Upper Helm Lounge Seat With Center Seat Section Closed



Upper Helm Lounge Seat With Center Seat Section Open For Access

Electronic engine controls are equipped with a station transfer button that allows the operator to transfer control from one station to another with the push of a button. Always make sure that you activate the controls as soon as you reach the upper helm station.

Refer to Flybridge or Tower Operation in chapter 2 for additional information on the safe operation of boats with upper helm stations.

11.9 Aftermarket Hardtop or Tower

Scout does not recommend installing an aftermarket hardtop, upper helm station or tower. An improperly designed or installed fabrication can cause structural damage to the hardtop or deck structure and void the Limited Warranty. Additionally, Scout will not be responsible for any damage resulting from the installation of a fabrication not installed at the Scout factory. If you intend to install an aftermarket hardtop, upper helm station or tower on your boat, please contact your dealer or Scout Customer Service.



Typical Upper Helm

12.1 Head Compartment

The head compartment is equipped with a sink with a hot and cold water faucet. There is also a shower with a removable shower head. The shower head is equipped with a valve that allows the shower water to be turned on and off without affecting the temperature to conserve water while showering. Shower water drains to the cabin sump system which is always activated when the batteries are connected.

There is storage behind the hinged mirror above the vanity. The mirror/door is secured with a dual action, push to lock latch. To open the door, push on the latch knob. The knob is spring loaded and will pop out one inch, providing a finger hold and releasing the locking mechanism on the latch. A slight pull is required to release the friction latch and open the door. The cabinet door will be held closed by the friction latch while at anchor or at the dock. To close and secure, make sure the door is completely closed and push the knob in. The knob will stay in and the locking mechanism will be activated. The knob should be pushed in to activate the positive lock whenever the boat is underway.

Ventilation is provided to the compartment by air conditioning and exhaust blower ducts. There are also 12-volt overhead lights and a 120 volt GFI outlet. The lights and exhaust blower are activated by switches above the vanity counter top.



Head Compartment & Sink



Shower Head



Head Compartment Fan & Light Switches



Helm Access Panels In Head Compartment



Upper Helm Access Panel Open & Helm Fuse Panels

Equipment Access Doors and Hatches

Access doors and a removable panel in the rear head compartment bulkhead provide access to the back of the helm and electronics compartment. Flush mounted, push to close latches secure the doors in the closed position. The removable panel is secured with screws.

A removable hatch in the head compartment sole provides access to the forward bilge pump, cabin drain sump system, and transducers.

Marine Head System

The 12 volt marine toilet is connected to the pressurized fresh water system which results in less odor in the head compartment. It has an automatic pumping device that fills and empties the bowl. Once a button on the control is pressed, the entire cycle is completely automatic. The system uses very little water, approximately 2.27 quarts (2.5 liters) per flush.

To use the toilet, make sure the head and fresh water systems are activated. Then press ADD WATER on the toilet control switch to add a preset amount of water to wet the bowl. After using the toilet, press FLUSH on the control switch to start an automatic flushing cycle that moves the waste to the holding tank and leaves the bowl completely clean and dry in the rest position.



Marine Toilet

The head contains an integrated, high-speed turbine grinding pump that transfers waste to the holding tank where it remains until it is pumped out by a waste dumping station or the overboard diaphragm discharge system.

The fluid level in the waste/holding tank is monitored by the tank level monitoring feature in the CZone display. A lockout system built into the control panel prevents the toilet from flushing when the holding tank is full.

Refer to the toilet manufacturer owner's manual for more information on the operation of the marine head system.

Head System Holding Tank

The holding tank is located in the forward bilge. When the tank is full, the Black Water Tank Sender monitoring feature in the CZone display will indicate the holding tank is full. The tank must either be pumped out by the optional overboard discharge pump or an approved waste dumping station through the waste deck fitting.

A lockout system built into the toilet prevents it from flushing when the holding tank is full. You should not attempt to bypass the lockout and flush the toilet when the tank is full. An overfilled holding tank will force waste into the holding tank vent filter. This will clog the filter and could cause damage to the holding tank. It will also cause unpleasant odors in the cabin and cockpit.

Use the following procedure to pump out the holding tank with the overboard diaphragm discharge pump system:

- Open the waste discharge valve in the forward bilge.
- Use the CZone control feature to activate the overboard diaphragm discharge pump.
- Monitor the pumping operation closely using the CZone Black Water Tank Level monitor as the tank is drained and turn the pump off immediately when draining is complete.
- Close the overboard discharge valve.



Typical Marine Head Control Switch



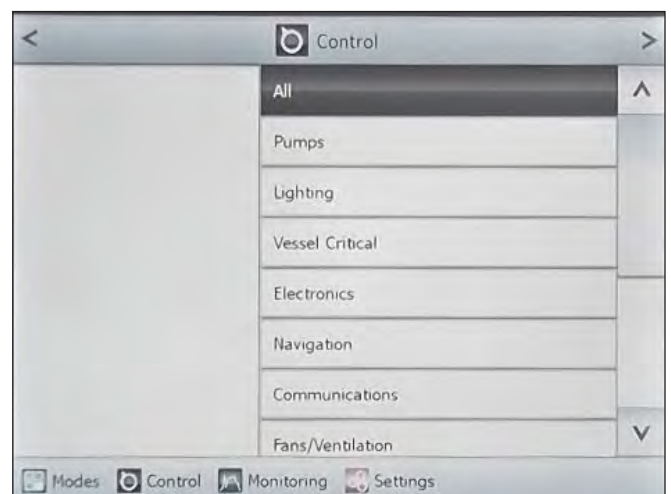

Diaphragm Discharge Pump & Waste Discharge Valve In Forward Cabin Bilge Below Dinette Table



Typical CZone Control Feature Screen

Notice:

In order to comply with current State, Federal and Coast Guard regulations, the Overboard Discharge valve in the forward bilge must be closed whenever the boat is operating in areas in which the discharge of sewage is prohibited.

 **CAUTION** 

IN MANY AREAS IT IS ILLEGAL TO PUMP HEAD WASTE DIRECTLY OVERBOARD. VIOLATION OF THESE POLLUTION LAWS CAN RESULT IN FINES OR IMPRISONMENT. ALWAYS KNOW THE LAW FOR THE AREAS IN WHICH YOU BOAT. NEVER DUMP HEAD OR HOLDING TANK WASTE OVERBOARD ILLEGALLY.

Head System Maintenance

The head should be cleaned and inspected for leaks regularly.

The holding tank should be pumped out and flushed as needed. Periodically add chemical to the holding tank to help control odor and to chemically break down the waste. See the head manufacturer owner's manual for additional operating and maintenance information.

To reduce odor in the cabin, never allow waste to remain in the holding tank for more than one week. Make sure to add fresh water to the holding tank and pump the tank several times to flush it out during pump out operations.

The vent hose for the holding tank is equipped with a charcoal filter to reduce odor from the holding tank. The filter, located behind a removable panel on the starboard side of the cockpit, should be changed once a year or if the holding tank has become overfilled, which will plug the filter and could cause damage to the waste system.

Notice:

The head system must be properly winterized before winter lay-up. Refer to the Seasonal Maintenance chapter and the manufacturer owner's manual for winterizing instructions.

12.2 Main Cabin & Galley

The main cabin is equipped with a galley and dinette that converts to a berth. Natural lighting and fresh air is provided by large opening windows on each side of the cabin. Additional lighting is provided by lights in the cabin headliner. There is also a 120 volt GFI outlet located in the cabinet near the sink.

Storage compartments are located above the galley sink and the stove. Additional storage is located in cabinets near the cabin door below the cabin circuit breaker and switch panel.

The wood cabin floor is made of simulated wood. The top cabin step is hinged and can be rotated up to access a storage compartment.

Cabinet Door and Drawer Latches

The cabinet doors in the cabin are secured with dual action, push to lock latches. To open a cabinet door, push on the latch knob. The knob is spring loaded and will pop out one inch, providing a finger hold and releasing the dead bolt on the latch mechanism. A slight pull is required to release the friction latch and open the door. The cabinet doors will be held closed by the friction latches while at anchor or at the dock. To close and secure, make sure the doors are completely closed and push the knobs in. The knobs will stay in and the locking mechanism will be activated.

The knobs should be pushed in to activate the positive lock dead bolts whenever the boat is underway.

Cabin Lights

All lights in the cabin are powered by the DC electrical system and protected by fuses in the CZone DC output modules. Most of the cabin lights are controlled by switches on the cabin walls. Other lights have switches on the light fixture. Some of the lights are controlled by electronic dimmer switches. Pressing and holding the top of the switch will turn the lights on and make them brighter. Pressing and holding the bottom of the switch will dim the lights or turn them off.



Galley & Storage Cabinets



Cabinet Push To Lock Latches

Galley and Sink

The galley is equipped with storage cabinets and a fresh water sink with hot and cold water faucets. Water is supplied to the sink by 12 volt pumps located in a compartment below the port side of the berth. When activated by the CZone control feature, the system will operate much like the water system in a home. An automatic pressure sensor keeps the system pressurized. The sink drains overboard through a fitting in the hull side. See the Fresh Water System chapter for more information on operating the fresh water system.

The galley counter tops are made of Corian and the microwave oven is built into the cabinet above the sink. Compartments above the counter top and a cabinet below provide storage.



Galley Sink & Stove

Stove

The galley is equipped with a single burner electric stove that is built into the galley counter top. To activate the burner, make sure the Stove circuit breaker in the AC panel is activated and there is nothing but pots or pans on the cook top, then use the touch control to activate the burner and control the temperature.

A manual for the stove is included with your boat. It is extremely important that you read the manual and become familiar with the proper care and operation of the stove before attempting to use it. Always be sure the burner is off and allowed to cool after cooking before placing anything on the cook top.



Typical Stove



WARNING



THE STOVE IS DESIGNED AS AN APPLIANCE FOR COOKING FOOD. DO NOT ATTEMPT TO USE THE STOVE BURNER TO HEAT THE CABIN. USING THE BURNER TO HEAT THE CABIN COULD CAUSE THE STOVE TO OVERHEAT RESULTING IN DAMAGE TO THE STOVE AND COUNTER TOP OR A CABIN FIRE.

Refrigerator (AC/DC)

A dual voltage refrigerator is mounted in the galley below the stove. This unit will operate on 120 volt AC or 12 volt DC power. The refrigerator switches to 12 volt DC automatically when the AC power is disconnected and the refrigerator is activated by the CZone control feature. When 120 volt AC current is provided by the Cabin Fridge circuit breaker in the AC breaker panel, the refrigerator automatically switches to AC power.



Galley Refrigerator

Care should be exercised while operating the refrigerator on 12 volt power without the engines running. It draws a substantial amount of current and can severely drain the house batter bank through extended use. The refrigerator slide out drawer has a special latch to secure the drawer while under way. Make sure the drawer is properly secured whenever the boat is moving. Refer to the refrigerator owner's manual for additional operating and maintenance instructions.

Microwave Oven

A microwave is built into the cabinet above the galley sink. The microwave operates on AC power and is activated and protected by the Microwave circuit breaker in the AC panel. Refer to the manufacturer's operating manual for detailed information on the microwave oven installed in your boat.

Berth and Dinette

A dinette is located in the forward section of the cabin that converts to a berth. There is a hatch below the forward center cushion that provides access to the air conditioner. You should not store dunnage in the forward compartment.

Other hatches below the port and starboard dinette seats and behind the backrest cushions provide storage and access to the hot and cold water system valves, water heater, fresh water pumps and other equipment mounted in the berth area. Another hatch in the cabin sole provides access to the overboard diaphragm discharge pump for the waste tank, thru-hill discharge valve and the sump pump for the air conditioner condensation pan drain.

A table and removable pedestal converts the forward cabin into a dinette or a berth. The pedestal is stowed in special brackets in a storage compartment behind the port dinette backrest cushion.

To convert the dinette to a berth, rotate the table 1/4 turn to release the base from the pedestal. Remove the table and set it down next to the dinette cushion. Rotate the pedestal 1/4 turn to release the pedestal from the base plate and stow the pedestal. Place the table on the supports on each side and front of the dinette. Install the filler cushions on the table to complete the conversion. To convert the berth to a dinette, remove the filler cushions. Install the pedestal on the cabin sole base plate and rotate it 1/4 turn to lock it to the plate. Place the table base plate on the pedestal and rotate the table 1/4 turn to lock the table to the pedestal. Store the cushions.



Dinette Seat Cushions



Dinette Converted To Berth



Table Pedestal In Storage Brackets

To avoid damage to the table and pedestal, always make sure the table is in the berth position whenever the boat is operating above slow speed. This is particularly important when the boat is being run offshore.



Cabin AC/DC Panel, Generator Control Panel & CZone Control Panel

Cabin Breaker and Switch Panel

The cabin AC/DC breaker panel is built into the cabinet near the cabin door. The parallel and battery remote switches and DC volt meters are located near the top of the panel. "Push to Reset" circuit breakers for DC continuous power circuits and other accessory circuits not protected by fuses in the CZone output modules are located below the volt meters. The speaker control switch and CZone and generator control panels are also in the upper section of the panel.

The 120 volt AC selector switches, volt meters and circuit breakers are in the lower section of the panel.

Refer to the Electrical Systems chapter for more information on the operation of the components and circuit breakers in the cabin breaker panel.

Stereo and CD/DVD Player

The stereo and CD/DVD player is located in the



Stereo & CD/DVD Player

compartment below the galley counter top. They are supplied power and protected by the stereo breaker in the DC electrical panel. If your boat

is equipped with a stereo amplifier or amplifiers, they are mounted in the mid equipment room and protected by circuit breakers in the battery switch panel. Key pads and displays in the helm and near the bow seats allows the stereo to be controlled remotely from the helm or cockpit. Refer to the stereo and DVD player owner's manuals for detailed information on the operation of the stereo and DVD player.

Carbon Monoxide Detector

A carbon monoxide (CO) detector is installed in the cabin. If excess carbon monoxide fumes are detected, an audible beeping will sound indicating the presence of the toxic gas. This detector is always activated when the house batteries are connected. A green light on the detector indicates that it is activated. Always make sure the green light is on whenever the cabin is occupied.

A by-product of combustion, carbon monoxide is invisible, tasteless, odorless, and is produced by all engines and some heating and cooking appliances. The most common sources of CO on boats are the engines, auxiliary generators and propane or butane stoves. These produce large amounts of CO and should never be operated while sleeping.

You should read the owner's manual supplied by the detector manufacturer for operation instructions and additional information regarding the hazards of carbon monoxide gas. Also read more about carbon monoxide, carbon monoxide detectors and proper ventilation in the Ventilation System and Safety Equipment chapters in this manual. This is especially essential if your boat is equipped with a generator. If you did not receive a manual for your carbon monoxide detector, please contact the Scout Customer Service Department.



Typical Carbon Monoxide Detector

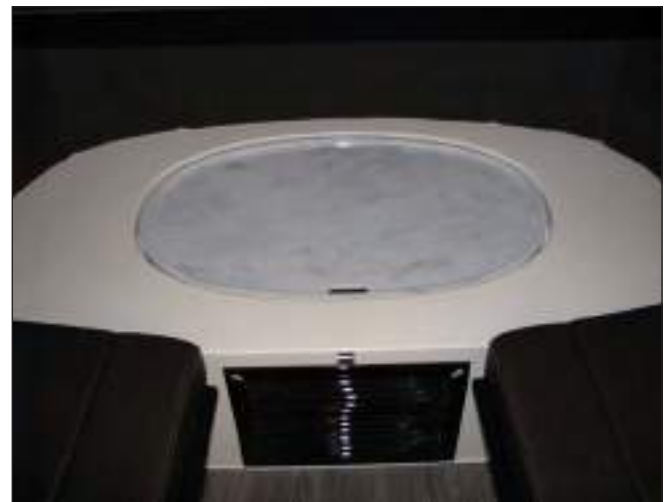

Air Conditioner Compartment
Below Forward Dinette Cushion

	WARNING	
<p>ACTIVATION OF THE CARBON MONOXIDE DETECTOR INDICATES THE PRESENCE OF CARBON MONOXIDE (CO) WHICH CAN BE FATAL. EVACUATE THE CABIN IMMEDIATELY. DO A HEAD COUNT TO CHECK THAT ALL PERSONS ARE ACCOUNTED FOR. DO NOT REENTER THE CABIN UNTIL IT HAS BEEN AIRED OUT AND THE PROBLEM FOUND AND CORRECTED.</p>		

12.3 Cabin Air Conditioner

The air conditioning unit operates on AC power. It is equipped with reverse cycle heat and can be operated as a cooling or heating unit. There is

one air conditioner with ducts for the main cabin, head compartment and helm. It is protected by a circuit breaker in the cabin AC panel and controlled by the air conditioner control panel in the cabin.

To operate the air conditioner, make sure the thru-hull valves for the sea chest and air conditioner sea water supply pump, located in the aft systems room, are open. Turn the Air Cond circuit breaker in the AC panel on to activate the air conditioning 120 volt circuit. The air conditioning or heat will then be controlled by the control panel. When activated, water should continuously flow from the overboard thru-hull in the port hull side.

The air conditioning system produces heat when it is operated in the reverse cycle mode. The ability of the unit to produce heat is affected by the temperature of the seawater. As the seawater temperature lowers, the air conditioner's ability to produce warm air decreases. When the seawater temperature drops below 40 - 45 degrees F, the air conditioner will not be able to produce heat. You should not operate the air conditioner to produce heat when the water temperature is below 40 degrees.

The air conditioning unit creates condensation that drips into the pan at the base of the unit. A hose attached to the pan drains the water to the air conditioner sump system below the dinette. The sump system is activated whenever the house battery is connected and must be operating properly when the air conditioner is operating. It is normal for some water to be in the pan whenever the air conditioner has been used. The condensation pan should be checked periodically to make sure it is draining properly.

The drain hoses, condensation pan and sump should be flushed clean if they become restricted by mold or debris. If the drain becomes plugged, the condensation pan will overflow onto the cabin sole.

You should always keep the cabin door closed when operating the air conditioner. If the cabin door is left open, it could cause the air conditioner unit to run continuously and not cycle enough to defrost the condenser coils. This could cause the coils to develop enough ice to reduce the unit's ability to cool the boat.

There is a filter in the return air duct on the side of the air conditioner compartment. The filter should be removed and cleaned periodically to ensure proper air flow when the unit is operating.

The intake lines for the sea chest are equipped with sea strainers that must be checked for debris frequently and cleaned as necessary.

Refer to the Raw Water System chapter and for information on the air conditioning pump and cleaning the sea strainers. You also should refer to the air conditioner owner's manual for additional operating and maintenance instructions.



Air Conditioner Unit



Air Conditioner Return Air Duct & Filter

Notice:

Air conditioners use seawater as a cooling medium. The boat must be in the water and the raw water supply system must be properly activated prior to use. Operation without proper cooling will cause the air conditioning unit to automatically power down and could result in system damage. Always check for proper water flow out of the air conditioning pump discharge thru-hull fitting when the air conditioner is operating.

12.4 Cabin Woodwork

Cabin Floor

The cabin floor is made of simulated wood. Synthetic wood floors can be vacuumed then washed with a mixture of water and household cleaner. Wipe the floor dry with a clean towel.

Walls, Cabinets and Trim

The hardwood used for the cabinet trim moldings is finished with a high quality urethane varnish. The galley cabinets are made of a laminated, simulated wood that requires no maintenance. The walls and molding can be routinely cleaned with a damp cloth. For heavy duty cleaning, use a mixture of water and Murphy's Oil Soap or white vinegar and water to clean the wood or laminate and wipe it dry with a clean towel. Apply a furniture polish to add luster and help to preserve the finish.



Cabin Floor

NOTES

Routine Maintenance

13.1 Exterior Hull and Deck

Hull Cleaning-Below The Water Line

When the boat is removed from the water, clean the outer bottom surface immediately. Algae, grass, dirt and other marine growth is easier to remove while the hull is still wet. Use a pressure cleaner or a hard bristle brush to clean the surface.

Bottom Painting

If the boat is to be left in saltwater for extended periods, the hull must be protected from marine growth by antifouling paint. Because of variations in water temperature, marine growth, and pollution in different regions, a qualified boat yard in your area should be consulted when deciding what bottom paint system to apply to your hull. This is extremely important as pollution and marine growth can damage fiberglass hulls.

Use only standard antifouling paints and fiberglass wax removers and primers recommended by the antifouling paint manufacturer when preparing the hull for bottom paint. Light sanding, just enough to scuff the gel coat or a skip sand primer system can be used to prepare the hull for bottom paint. The use of a coating other than standard antifouling paint or epoxy barrier coatings are not recommended and will void the hull blister warranty.

Do not allow the hull antifouling paint to contact the outboard motors. Most antifouling paints designed for hull bottoms contain copper and can cause severe galvanic corrosion damage to the motors. Always leave at least a 1/2" barrier between the hull bottom paint and outboard motors.

Most bottom paints require some maintenance. Proper maintenance is especially important when the boat is in saltwater and not used for extended periods or after dry storage. If the hull bottom has been painted with antifouling paint, contact your dealer or local boat yard for the recommended maintenance procedures.

Anodes

Sacrificial anodes are installed on the outboard motors, engine brackets and trim tabs. The anodes are less noble than copper based alloys, stainless steel and aluminum. They will deteriorate first, protecting the more noble underwater hardware against galvanic corrosion. Anodes provide protection against galvanic corrosion for the engines, thru-hull fittings, trim tabs and other underwater hardware that is bonded.

They must be monitored if the boat is to be left in the water. Anodes should be checked monthly and changed when they are 75% of their original size. When replacing the anodes, make sure the contact surfaces are clean, shiny metal and free of paint and corrosion. Never paint over the anode.

Boats stored in saltwater will normally need to have the anodes replaced every 6 months to one year. Anodes requiring replacement more frequently may indicate a stray current problem within the boat or at the slip or marina. Anodes that do not need to be replaced after one year may not be providing the proper protection. Loose or low quality anodes could be the problem.

There are multiple anodes on outboard engines. You should refer to the outboard engine owner's manual for the location of the anodes on your engines. Only use replacement anodes recommended by the engine manufacturer.

Contact your engine dealer or Scout Customer Service for the proper size and type of anodes to be used and the specific installation procedure.

Fiberglass Gel Coat

Normal maintenance requires only washing with mild soap and water. A stiff brush can be used on the nonskid areas. Kerosene or commercially prepared products will remove oil and tar, which could be a problem on trailered boats. Harsh abrasive and chemical cleaners are not recommended because they can damage or dull the gel coat, reducing its life and making it more susceptible to stains. When the boat is used in saltwater, it should be washed thoroughly with soap and water after each use.

At least once a season, wash and wax all exposed fiberglass surfaces. Use a high quality automotive or boat wax. Follow the procedure recommended by the wax manufacturer. The washing and waxing of your boat will have the same beneficial

effects as they have on an automobile finish. The wax will fill minute scratches and pores thus helping to prevent soiling and will extend the life of the gel coat or paint.



After the boat is exposed to the direct sunlight for a period of time, the gel coat or painted surfaces tend to fade, dull or chalk. A heavier buffing is required to bring the finish back to its original luster. For power cleaning use a light cleaner. To clean the boat by hand, use a heavier automotive cleaner. Before cleaning the surfaces, read the instructions given with the cleaner. After cleaning the surfaces, apply wax and polish all fiberglass surfaces except the nonskid areas.

Avoid the following on gelcoat surfaces:

- Do not use plastic or other nonporous (non-breathable) materials to cover gelcoat surfaces. Trapped moisture from condensation can cause gelcoat damage. Shrink wrap storage covers must be properly ventilated, including hull sides.
- Do not use abrasives, bleaches, ammonia, acids or harsh detergents. See your dealer for special marine formulations. Harsh abrasive and chemical cleaners are not recommended because they can damage or dull the gelcoat, reducing its life and making it more susceptible to stains.
- NEVER apply wax or buffing compound to a gelcoat surface in direct sunlight.

Chalking, stains and minor scratches can be removed in most cases with careful rubbing and polishing with appropriate compounds or chemicals and is best done by a professional - see your dealer.

If the fiberglass should become damaged and need repair, contact your dealer or Scout Customer Service for assistance in finding an authorized repair person to make the repairs.

 **CAUTION** 

DO NOT WAX NONSKID AREAS AS THIS COULD MAKE THEM SLIPPERY AND CONSEQUENTLY INCREASE THE POSSIBILITY OF INJURY.

Stainless Steel Hardware



When using the boat in saltwater, the hardware should be washed with soap and water after each use. When your boat is used in a corrosive environment such as saltwater, water with a high sulfur content or polluted water, the stainless steel will periodically develop surface rust stains. This is perfectly normal under these conditions.

The following guidelines will help keep stainless steel looking good for many years.

- Clean stainless steel frequently (daily in salt or polluted environments) with mild soap and plenty of water. Any cleaner safe for use on glass is usually safe for stainless.
- Remove rust spots (especially around welds) immediately with a brass, silver or chrome cleaner. Irreversible pitting will develop under rust allowed to remain on stainless for any period of time.
- Remove rust stains on gelcoat. See dealer for recommended product.
- Stainless Steel can normally be cleaned and protected by using a high quality boat or automotive wax or a commercial metal cleaner and protectant.

Never do the following on Stainless Steel.

- Do not use coarse abrasives like sandpaper or steel wool which may actually cause rusting.
- Do not use acids or bleaches which may etch the naturally occurring protective coating.
- Do not leave stainless steel in contact with iron, steel or other metals which cause contamination leading to rust or corrosion.

 **CAUTION** 



UNDER NO CIRCUMSTANCES SHOULD ANY ABRASIVE MATERIALS SUCH AS SANDPAPER, BRONZE WOOL OR STEEL WOOL BE USED ON STAINLESS STEEL. DAMAGE TO THE HARDWARE WILL RESULT.

Anodized Aluminum Surfaces

Anodized aluminum should be washed periodically with soap and water to keep it clean. If the boat is used in saltwater or polluted water, the aluminum should be washed with soap and water after each use. Saltwater allowed to remain on

anodized aluminum will penetrate the anodized coating and attack the aluminum.

Pay special attention to the area just below the top. This area is subject to salt build up from salty condensation and sea spray. It is also frequently overlooked when the boat is washed and will not be rinsed by the rain. Consequently, the aluminum just below the top is more likely to become pitted than the exposed aluminum on the structure. Make sure the aluminum in this area is washed frequently with soap and water and rinsed thoroughly. Pay particular attention to places where the top material or lacing contact the frame. Once a month coat the entire frame with a metal protector made for anodized aluminum to protect against pitting and corrosion caused by the harsh effects of saltwater. Do not use automotive or boat wax designed for paint or gel coat on anodized aluminum. The wax can contaminate the aluminum and damage the anodized surface.

CAUTION

ONE DRAWBACK TO METAL PROTECTORS IS THAT THEY CAN MAKE THE METAL SLIPPERY. THEREFORE, THEY SHOULD BE NOT BE USED ON TOWER LADDERS, STEERING WHEELS AND OTHER AREAS WHERE A GOOD GRIP AND SURE FOOTING IS IMPORTANT.

Stains can be removed with a metal polish or fine polishing compound. To minimize corrosion, use only high quality stainless steel fasteners on aluminum fabrications. Isolate the fasteners from the aluminum by using fiber washers and caulking compound or Tef Gel to bed hardware and fasteners mounted to aluminum fabrications. If the anodized coating is badly scratched, it will require special attention and more frequent cleaning to the damaged area. With proper care, anodized aluminum will provide many years of service.

Powder Coated Aluminum

Powder coated aluminum should be washed periodically with soap and water to keep it clean. If the boat is used in saltwater or polluted water, the aluminum should be washed with soap and water after each use. Saltwater allowed to remain on powder coated aluminum will penetrate the coating and attack the aluminum, usually around fasteners and hardware mounted to the aluminum.

Pay special attention to the area just below the top. This area is subject to salt buildup from salty condensation and sea spray. It is also frequently

overlooked when the boat is washed and will not be rinsed by the rain. Consequently, the powder coating near fasteners and hardware mounted just below the top is more likely to be attacked by the salt and become corroded than the exposed areas on the structure. Make sure the aluminum in this area is washed frequently with soap and water and rinsed thoroughly. Pay particular attention to places where the top material and lacing contact the frame.

Once a month check the entire frame for damaged powder coating and corrosion around fasteners and hardware. Nicked or badly scratched powder coating can be sanded and touched up with enamel paint. Corrosion around fasteners will have to be sanded, then touched up with paint. The fasteners will require fiber washers and sealing with caulk or Tef Gel to isolate the fastener from the aluminum and prevent damage to the paint or powder coating when the fastener is installed. Periodically applying automotive or boat wax to the powder coating will provide additional protection from the harsh effects of saltwater.

Always repair scratches, nicks and corroded areas in powder coating as soon as possible. Corrosion left unaddressed will lift the powder coating allowing moisture to travel between the powder coating and the aluminum causing the corrosion to spread below the coating and damage the aluminum.

If excessive chipping and peeling occurs, it could be an indication of an electrical fault in the boat or aluminum fabrication. You should contact a qualified marine electrician to inspect your boat immediately and correct the problem if you suspect that your boat may have a fault in the aluminum frame. You should also contact Scout Customer Service.

Notice:

Boats that are towed behind larger vessels require special attention to the aluminum hardware. The salt spray, salty steam, and chemicals in exhaust gases are particularly corrosive and will damage the surface of anodized or powder coated aluminum. It is imperative that the boat and the aluminum are cleaned thoroughly at the completion of each trip or at the end of each day on long cruises to reduce accelerated deterioration of the anodizing or powder coating and premature corrosion to the aluminum.

Notice:

You should contact Scout Customer Service before making any modifications to aluminum fabrications. Unauthorized modifications can void the warranty.

Chrome Hardware

Use a good chrome cleaner and polish on all chrome hardware.

Acrylic Plastic Glass

Acrylic glass scratches easily. Never use a dry cloth or glass cleaning solutions on acrylic. Use a soft cloth and mild soap and water for routine cleaning. Solvents and products containing ammonia can permanently damage acrylic plastic glass.

Fine scratches can be removed with a fine automotive clear coat polishing compound. A coat of automotive or boat wax is beneficial to protect the surface. Do not use the following on acrylic glass:

Abrasive cleaners	Acetone
Solvents	Alcohol
Cleaners containing ammonia	Glass cleaners

13.2 Upholstery, Canvas and Enclosures

Vinyl Upholstery

The vinyl upholstery used on the seats, cushions, bolsters, and for the headliner in some cabins, should be cleaned periodically with mild soap and water. Any stain, spill or soiling should be cleaned up promptly to prevent the possibility of permanent staining. When cleaning, always rub gently. Avoid using products containing ammonia, powdered abrasive cleaners, steel wool, ink, strong solvents, acetone and lacquer solvents or other harsh chemicals as they can cause permanent damage or shorten the life of vinyl. Never use steam heat, heat guns or hair dryers on vinyl.

Stronger cleaners, detergents and solvents may be effective in stain removal, but can cause either immediate damage or slow deterioration. Lotions, sun tan oil, waxes and polishes, etc., contain oils and dyes that can cause stiffening and staining of vinyls.

- Dry soil, dust and dirt - Remove with a soft cloth.

- Dried on dirt - Wash with a soft cloth dampened with water.
- Variations in surface gloss - Wipe with a water dampened soft cloth and allow to air dry.
- Stubborn dirt - Wash with a soft cloth dampened with Ivory Flakes® and water. Rinse with clean water.
- Stubborn spots and stains - Spray with either Fantastik Cleaner® or Tannery Car Care Cleaner® and rub with a soft cloth. Rinse with clean water.
- Liquid spills - Wipe immediately with a clean absorbent cloth. Rinse with clean water.
- Food grease and oily stains - Spray immediately using either Fantastik Cleaner® or Tannery Car Care Cleaner®, wiping with a soft cloth. Take care not to extend the area of contamination beyond its original boundary. Rinse with clean water.

Acrylic Canvas (Sunbrella)

Modern, bright colored canvas tops are usually fabricated from acrylic fabrics with the trade names like Sunbrella®, Argonaut®, etc. Acrylic fabrics look similar to cotton canvas but are much more durable and color fast.

Acrylic canvas can be cleaned by using Ivory Flakes, Ivory Liquid or another mild soap and water. Scrub lightly and rinse thoroughly to remove the soap. Do not use detergents, as they will deteriorate the waterproofing in the fabric. The underside can be brushed with a soft brush and sprayed with a disinfectant to prevent the accumulation of dirt and mildew. The top or accessories should never be folded or stored wet.

In fresh water areas, the top and curtains should be washed weekly. This is particularly important if the boat is stored near a highway, airport or in a large city. Residue from jet fuel, exhaust fumes and industrial pollution can shorten the life of tops and enclosures.

In saltwater areas, the top and curtains should be rinsed with fresh water after each use and at least weekly if it is stored outside. Saltwater attracts moisture and dirt that can shorten the life of fabric tops and enclosures. The salt is also abrasive and can cause premature wear in the fabric and stitching.

After several years, the acrylic canvas may lose some of its ability to shed water. If this occurs, wash the fabric and let it dry thoroughly. Then treat the outside surface with a commercially available waterproofing designed for this purpose. Waterproofing is available in bulk at most canvas shops. One-gallon garden sprayers are excellent for applying waterproofing.

Notice:

Some leakage at the seams is normal and unavoidable with acrylic enclosures.

Laminated Vinyl Tops

Laminated vinyl top material is a lamination of two plies of specially formulated vinyl with an inner reinforcing core fabric. The most common trade name for this fabric is Weblon.® It is not unusual for the interior ply to be a different color than the exterior. There is a greater tendency for this type of fabric to leak at the seams than with acrylic or vinyl coated polyester. Paraffin wax that matches the top can be used to seal the seams if necessary.

Laminated vinyl fabrics should be cleaned periodically by using Ivory Flakes, Ivory Liquid or another mild soap and water. Scrub lightly and rinse thoroughly to remove the soap. Do not use detergents, or harsh cleaners like bleach and ammonia. They will attack the vinyl in the fabric and shorten its life. The top or accessories should never be folded or stored wet.

In fresh water areas, the top and curtains should be washed weekly. This is particularly important if the boat is stored near a highway, airport or in a large city. Residue from jet fuel, exhaust fumes and industrial pollution can shorten the life of tops and enclosures.

In saltwater areas, the top and curtains should be rinsed with fresh water after each use and at least weekly if it is stored outside. Saltwater attracts moisture and dirt that can shorten the life of fabric tops and enclosures. The salt is also abrasive and can cause premature wear in the stitching.

Clear Curtains and Connectors

Side curtains and clear connectors can be cleaned with mild soap and water. They should not be allowed to become badly soiled. Dirt, oil, mildew, and cleaning agents containing ammonia, will shorten the life of the vinyl that is used for clear

curtains. After cleaning the curtains and allowing them to dry, apply a non-lemon furniture polish or an acrylic glass and clear plastic protector to extend the life of the curtains.

Vinyl curtains should be stored either rolled or flat, without folds or creases. Folding the curtains will make permanent creases that could cause the vinyl to crack.

Notice:

Do not use any polish containing lemon scents or lemon. The lemon juice will attack the vinyl and shorten its life.

Snaps should be lubricated periodically with petroleum jelly, silicone grease or a lubricant designed for snaps. Zippers should be lubricated with silicone spray, paraffin or silicone stick.

Strataglass

Strataglass® is a special coated vinyl that could be used in the curtains for the hardtop enclosure. The coating protects the vinyl glass and resists scratching. Waxes and Plexiglas polishing compounds should not be used on strataglass as the protective coating prevents them from penetrating into the vinyl and they will build up on the surface. These products will create a hazy, greasy appearance that will affect the clarity of the strataglass. Products that repel water, like Rainex®, should not be used as they will not take well to the surface and could appear spotty and may also yellow or dull the Strataglass over time.

Strataglass can be cleaned by rinsing off dirt or salt deposits with fresh water, then washing with a clean cloth and mild soap. Chamois dry to remove water spots and improve clarity. If a polish is accidentally used, use Windex® or its equivalent to remove it. While window cleaners will destroy the standard vinyl normally used in side curtains and clear connectors, it will not harm strataglass. Always roll down the curtains and snap in place at the end of each day so the curtains will maintain their shape and to minimize fold distortions.

Depending upon usage, it is recommended that an occasional application of Aquatech Strataglass Cleaner be done. Treat this like a polish, as opposed to a cleaner - wash and dry curtains first, then apply Aquatech Strataglass Cleaner, actually buffing the surface to a beautiful sheen. This is not just a wipe on/ wipe off product...it needs to be buffed to perform.

Remember, the coating on strataglass is scratch resistant and not scratch proof. Always handle the curtains with care and never roll up curtains that are salty or dirty. If you have any questions about the clear curtains used on your boat, please contact the Scout Customer Service Department.

Hardtop enclosures must be removed when trailering. Canvas enclosures are not designed to withstand the extreme wind pressure encountered while trailering and will be damaged. Always remove and properly store the enclosure before trailering your boat.

13.3 Interior

The cabin or head interior can be cleaned just like you would clean a home interior. To preserve woodwork, use teak oil. To maintain carpeting, use a vacuum cleaner. Because air and sunlight are very good cleansers, periodically put cushions, sleeping bags, etc. on deck, in the sun and fresh air, to dry and air out. If cushions or equipment get wet with saltwater, remove and use clean, fresh water to rinse off the salt crystals. Salt retains moisture and will cause damage. Dry thoroughly and reinstall.

Vinyl headliner material should be cleaned periodically as explained in the previous section. Avoid using products containing ammonia, bleach, or harsh chemicals as they can shorten the life of vinyl. Fiberglass headliners should be wiped down with a damp towel as necessary to remove dust and dirt.

If you leave the boat for a long period of time, put all cushions on their sides, open all interior cabin and locker doors, and hang a commercially available mildew protector in the cabin.

Notice:

Always read the label carefully on mildew protectors. Remove the protector and allow the cabin to ventilate completely before using the cabin.

Counter Tops - Corian Surfaces

A mild liquid detergent and water or ammonia-based cleaners will remove most dirt and stains from Corian. For heavy cleaning, oil, and grease, use Fantastik spray cleaner. Rinse with a clean cloth moistened with fresh water. Wipe dry with a clean cloth.

In most cases, Corian can be repaired if accidentally damaged. Minor damage, including scratches, general or chemical stains, scorches or burns, and minor impact marks, can be repaired with a light abrasive cleanser and a Scotch-Brite® pad. For heavier damage, light sanding and machine buffing may be necessary so contact your dealer or a professional.

- Avoid exposing Corian to strong chemicals, such as paint removers, oven cleaners, etc. If contact occurs, quickly flush the surface with water.
- Remove nail polish with a non acetone-based polish remover and flush with water.
- Do not cut directly on Corian counter tops.

Interior Woodwork

Oiled and varnished woodwork or laminated, simulated wood can be cleaned with a damp cloth. For heavy duty cleaning, use a mixture of water and Murphy's Oil Soap or a solution of 10% white vinegar and water to clean the wood and wipe it dry with a clean towel. Apply a furniture polish to add luster and help to preserve the finish.

13.4 Engines & Fuel

Proper engine maintenance is essential to the proper performance and reliability of your outboard engines. Maintenance schedules and procedures are outlined in your engine owner's manual. They should be followed exactly.

If the boat is used in saltwater, flush the cooling systems after each daily use. To flush the systems when the boat is out of the water, follow the procedure outlined in your engine owner's manual.

Proper engine operation requires a good supply of clean, dry fuel. Improper marina fuel storage techniques, limited boat usage, etc. can cause the fuel to become contaminated.

The age of fuel can affect engine performance. Chemical changes occur as the fuel ages that can cause deposits and reduce the octane rating of the fuel. Severely degraded fuel can damage the engines and boat fuel tank and lines. Therefore, if your boat is not being run enough to require at least one full tank of fresh fuel a month, a fuel additive should be added to protect it from degradation. Your dealer or the engine manufacturer can

provide additional information on fuel degradation and fuel stabilizers recommended for your engine.

In many states, most gasoline is blended with ethanol alcohol. Ethanol is a strong solvent and can absorb water during periods of storage. You should refer to the engine operating manual for information regarding alcohol blended fuels and how it affects the operation of your marine engine.

13.5 Bilge

To keep the bilge clean and fresh, it is recommended that you use a commercial bilge cleaner on a regular basis. Follow the directions carefully. All exposed pumps and metal components in the bilge should be sprayed periodically with a protector to reduce the corrosive effects of the high humidity always present in these areas.

Periodically check the bilge pumps and alarms for proper operation and clean debris from the strainers and float switches. Inspect all hoses, clamps and thru-hulls for leaks and tightness on a regular basis and operate all thru-hull valves at least once a month to keep them operating properly.

Frequently test the automatic switches for the bilge pumps and alarms for proper operation. This is accomplished by lifting the float switch or pressing the "Push to Test" button on the side of the pump until the pump or alarm is activated. You can also use a garden hose to flood the bilge until the water level is high enough to activate the pump or alarm.

Generator

The engine maintenance required on the generator is similar in many ways to any 4-cycle marine engine. The engine incorporates a pressure-type lubrication system and a fresh water cooled engine block which is thermostatically controlled. The seawater cooling system on the generator is equipped with a sacrificial anode to protect cooling system components from galvanic corrosion. The anode should be inspected when the generator is serviced and replaced when it is 75% of its original size or at least once each year.

The most important factors to the generator's longevity are proper ventilation and maintenance of the fuel system, ignition system, cooling system, lubrication system and the AC alternator. Maintenance schedules and procedures are outlined in

your generator owner's manual. They should be followed exactly.

Proper generator operation requires a good supply of clean, dry fuel. Algae can grow in the accumulated water in the diesel fuel tank. This condition is most prevalent in warm climates. Periodically adding a high quality diesel fuel additive containing an algaecide may be required to control algae in your boating area. This is particularly important if your generator is not being run enough to require at least one full tank of fresh fuel each month.

13.6 Drainage System

It is essential that the following items be done periodically to maintain proper drainage of your boat:

- Clean the cockpit drains with a hose to remove debris that can block water drainage.
- Clean the hardtop leg drain holes. This is especially important just before winter lay-up.
- Flush all gravity drains with fresh water to keep them clean and free flowing.
- Clean and inspect the shower and cabin drain sump system. Remove accumulated debris and flush with fresh water. Frequently test the automatic pump switch for proper operation.
- Flush the air conditioner condensation pan and drain hose with fresh water at least once each season to remove mold and debris. This is particularly important because mold tends to accumulate in condensation pan drain and, if it is not cleaned regularly, the drain can clog and flood the cabin sole when the air conditioner is operating.
- Clean and flush the fishbox, baitwell, coolers and storage boxes with soap or a bilge cleaner and fresh water after each use to keep them clean and fresh.
- Operate the thru-hull valves once a month and service as required.
- Run all overboard pumps briefly at least once a month to keep them operating properly.

Notice:

All drains and pumps must be properly winterized before winter lay-up.

NOTES

Seasonal Maintenance

14.1 Storage and Lay-up

Before Hauling:

- Pump out the head holding tank. Flush the holding tank using clean water, soap and a deodorizer. Pump out the cleaning solution.
- The fuel tanks should be left nearly full to reduce condensation that can accumulate in each tank. Allow enough room in the tanks for the fuel to expand without leaking out the vents. Moisture from condensation in the fuel tank can reach such concentrations that it becomes heavy enough to settle out of the fuel to the bottom of the tank. Since fuel pickup tubes are located near the bottom of the tank, this accumulated moisture can cause the engines to run poorly or not at all after extended storage.

Chemical changes also occur as the gasoline ages that can cause deposits and varnish in the fuel system as well as reduce the octane rating of the fuel. Severely degraded fuel can damage the engines and boat fuel tank and

lines. Therefore, if your boat is not being run enough to require at least one full tank of fresh fuel a month or during winter storage, a fuel stabilizer should be added to the gasoline to help protect the fuel system from these problems. Operate the boat for at least 15 minutes after adding the stabilizer to allow the treated fuel to reach the engines.

Bacteria, commonly called algae, can grow in the accumulated water in the diesel fuel tank for the generator. This condition is most prevalent in warm climates. Periods of storage or limited use allow the bacteria to accumulate, making the situation worse. Adding a high quality diesel fuel conditioner containing a biocide may be required to control bacteria in your boating area.

Your dealer or the engine manufacturer can provide additional information on fuel degradation and fuel stabilizers recommended for your engines. For more recommendations for your specific area, check with your local Scout dealer.





380 LXF Sling Locations

- Drain water from the fresh water system.
- Consult the engine owner's manual for detailed information on preparing the engines for storage.
- Make sure the hitch is properly supported.
- Check the tires once each season. Add enough air for the correct amount of inflation for the tires as necessary.

Lifting

It is essential that care be used when lifting your boat. Make sure the spreader bar at each sling is at least as long as the distance across the widest point of the boat that the sling will surround. Put the slings in position. Refer to the sling locations drawing for the correct position of the lifting slings. The fore and aft slings should be tied together to prevent the slings from sliding on the hull.

 **CAUTION** 

BOATS CAN BE DAMAGED FROM IMPROPER LIFTING AND TRANSPORTING WITH FORK LIFTS. CARE AND CAUTION MUST BE EXERCISED WHEN TRANSPORTING A BOAT WITH A FORK LIFT. NEVER HOIST THE BOAT WITH A SUBSTANTIAL AMOUNT OF WATER IN THE BILGE.

SEVERE GEL COAT CRACKING OR MORE SERIOUS HULL DAMAGE CAN OCCUR DURING HAULING AND LAUNCHING IF PRESSURE IS CREATED ON THE GUNWALES (SHEER) BY THE SLINGS. FLAT, WIDE BELTING SLINGS AND SPREADERS LONG ENOUGH TO KEEP PRESSURE FROM THE GUNWALES ARE ESSENTIAL. DO NOT ALLOW ANYONE TO HAUL YOUR BOAT WHEN THE SPREADERS ON THE LIFT ARE NOT WIDE ENOUGH TO TAKE THE PRESSURE OFF THE GUNWALES.

Notice:



Read the owner's manual for the trailer for the correct amount of inflation for the tires.

When storing the boat on a lift or cradle:

- The cradle must be specifically for boat storage.
- Make sure the cradle or lift is well supported with the bow high enough to provide proper drainage of the bilge and cockpit.
- Make sure the engines are in the full down position.
- The cradle or lift must be in the proper fore and aft position to properly support the hull. When the cradle or lift is in the correct location, the bunks should match the bottom of hull and should not be putting pressure on the lifting strakes.

Supporting The Boat For Storage

A trailer, elevating lift, well-made cradle or proper blocking is the best support for your boat during storage.

 **CAUTION** 

BOATS HAVE BEEN DAMAGED BY TRAILERS, LIFTS, AND CRADLES THAT DON'T PROPERLY SUPPORT THE HULL. ALWAYS MAKE SURE THE BUNKS AND ROLLERS ARE ADJUSTED SO THEY ARE NOT PUTTING PRESSURE ON THE LIFTING STRAKES AND ARE PROVIDING ENOUGH SUPPORT FOR THE HULL. HULL DAMAGE RESULTING FROM IMPROPER CRADLE OR TRAILER SUPPORT IS NOT COVERED BY THE SCOUT WARRANTY.

When storing the boat on a trailer for a long period:

- Make sure the trailer is large enough to properly support your boat and that it is rated to support the weight.
- Make sure the trailer is on a level surface and the bow is high enough so that water will drain from the bilge and cockpit.
- Make sure the engines are in the full down position.
- The trailer must properly support the hull. The bunks and rollers should match the bottom of the hull and should not be putting pressure on the lifting strakes.

When supporting the boat with blocking:

- Make sure the boat is blocked on a level surface and the bow is high enough so that water will drain from the bilge and cockpit.
- Make sure the keel is supported with large, solid wood blocks in at least four points.
- Use at least three heavy duty jacks on each side of the hull and make sure the boat is level from side to side. The jacks must be on a solid surface like packed gravel, concrete or pavement. All of the supports must be set up properly to prevent the boat from shifting while it is in storage.

Preparing The Boat For Storage:

- Remove the bilge drain plug(s), if installed. (Some boats do not have bilge drain plugs)
- Thoroughly wash the fiberglass exterior, especially the antifouling portion of the bottom. Remove as much marine growth as possible. Lightly wax the exterior fiberglass components.
- Remove all oxidation from the exterior hardware and apply a light film of moisture displacing lubricant, wax or a metal protector.
- Remove propellers and grease the propeller shafts using light waterproof grease.
- Remove the batteries and store in a cool place. Clean using clear, clean water. Be sure the batteries have sufficient water and clean terminals. Keep the batteries charged and safe from freezing throughout the storage period.

Notice:

Refer to the Electrical System chapter, for information on the maintenance of the AC and DC electrical systems.

- Coat all faucets and exposed electrical components in the cabin and cockpit with a protecting oil.
- Clean out, totally drain and completely dry the fishboxes, coolers, sinks and baitwells.
- Thoroughly clean the interior of the boat. Vacuum all carpets and dry clean drapes and upholstery.
- Remove cushions and open as many locker doors as possible. Leaving as many of these areas open as possible will improve the boat's ventilation during the storage period.

Notice:

It is recommended that a mildew preventer be hung in the cabin before it is closed for storage.

- Clean the exterior upholstery with a good vinyl cleaner and dry thoroughly. Spray the weather covers and boat upholstery with a spray disinfectant. Enclosed areas such as the shower basin, storage locker areas, etc. should also be sprayed with this disinfectant.

14.2 Freshwater System Winterizing

The entire fresh water system must be completely drained and winterized using the following procedure.

Draining the freshwater system

- Make sure the water heater, filters and fresh water tank are completely drained.
- Disconnect all hoses, check valves, etc. Open all faucets and washdown hose nozzles and blow all the water from the system. Use only very low air pressure when doing this to prevent possible system damage.
- Because of the check valve mechanism built in the pumps, blowing the lines will not remove the water from the fresh water pumps. Remove the inlet and outlet hoses on the pumps. Activate the pumps and allow them to pump out any remaining water....about a cupful.

Using antifreeze - alternative option

A recommended alternative to the above-mentioned procedure is the use of commercially available non toxic, fresh water system antifreeze.

- After draining the fresh water tank, lines, filters and water heater, pour 10 gallons of potable water antifreeze into the fresh water tank.
- Prime and operate the pumps until antifreeze flows from all fresh water faucets. Be sure to open all hot and cold water faucets, including the fresh water shower in the head compartment, anchor locker and cockpit washdown hose nozzles, cockpit shower, leaning post sink and windshield washers.
- Activate the marine toilet flush cycle several times to properly winterize the freshwater supply line at the toilet. Make sure to repeat the flush cycle as necessary until antifreeze is flowing to the toilet bowl.
- Make sure antifreeze has flowed through all of the fresh water drains.

Ice Maker (Optional)

If your boat is equipped with an optional ice maker, it will have specific lay up and winterizing procedures. Refer to their owner's manuals and your Scout dealer for recommended winterizing procedures.

14.3 Raw Water System Winterizing

The raw water washdown and seawater supply pumps and systems must be completely drained and winterized using the following procedure.

Sea Chest & Sea Water Supply Systems

The sea chest and raw water systems supplied by the sea chest require the following procedure to be properly winterized.

Sea Chest and Boat Sea Water Pumps

1. Remove and clean the screens for both sea strainers on the intake lines for the sea chest. Reassemble the strainers.
2. Close all pump supply valves on the sea chest and open both inlet valves.
3. Remove the vent hose from the sea chest and use compressed air at very low pressure to blow the water from the sea chest.
4. Remove the drain plugs in both sea strainer bowls and use compressed air in the sea chest to blow all water from the intake lines and both sea strainers.
5. Replace the strainer drain plugs and close the intake valves.
6. Disconnect the inlet and outlet water lines from the raw water washdown pump at the pump. Open the nozzle on the cockpit washdown hose and use very low pressure to blow as much water from the pressure line and hose as possible.
7. Open the raw water supply valve on the sea chest and use compressed air to blow the water from the raw water pump intake line.
8. Because of the check valve mechanism built into the raw water washdown pump, blowing the lines will not remove the water from the raw water pump. Make sure the inlet and outlet lines are disconnected from the pump. Turn the pump on and allow it to pump out any remaining water...about a cupful.
9. Reconnect the lines to the pump and remove the lid for the sea chest. Thoroughly clean the inside of the lid and seal.
10. Fill the sea chest with potable water antifreeze and reinstall the lid.

11. Connect one end of a five foot length of hose to the vent fitting on the sea chest and place the other end in a 5 gallon bucket filled with potable water antifreeze. Have another five gallon bucket of antifreeze available to fill the supply bucket as necessary.
12. Open the raw water pump supply valve and the nozzles on the washdown hoses. Make sure the hose connected to the sea chest vent fitting is at the bottom of the bucket of antifreeze and activate pump. The pump will create a vacuum and draw the antifreeze from the bucket into the sea chest. Add antifreeze to the bucket as necessary and allow the pump to run until antifreeze is flowing from the washdown hose nozzle. Then shut off the pump and close the hose nozzles and supply valve.
13. Run the other pumps connected to the sea chest one at a time until the antifreeze solution is visible at all raw water outlets and discharge fittings. Be sure antifreeze has flowed through all of the raw water drain thru-hull fittings.

Generator Raw Water Cooling System

Drain the heat exchanger and raw water supply and discharge lines for the generator seawater cooling pump. If the generator muffler is equipped with a drain plug, remove the plug and drain the muffler. Reinstall the drain plugs when draining is complete. Use the following procedure to fill the generator seawater cooling system with antifreeze.

1. Make sure the sea chest and raw water system has been winterized as previously described in this section.
2. Make sure the bucket and sea chest are full of antifreeze and open the generator supply valve. All other valves on the sea chest should be closed.
3. Start the generator. The generator seawater cooling pump will draw antifreeze from the sea chest and pump it through the seawater cooling system. The pump will create a vacuum and draw the antifreeze from the bucket into the sea chest.
4. Monitor the exhaust and add antifreeze to the supply bucket as necessary until antifreeze is flowing from the exhaust port, then shutdown the generator and close the supply valve.

You should refer to the generator owner's manual or contact your dealer for specific instructions on winterizing your generator.

Notice:

Properly winterize the generator engine and fuel system by following the generator manufacturer's winterizing procedures located in generator owner's manual or contact your Scout dealer.

Air Conditioner Raw Water Cooling System

Make sure the sea chest and raw water systems have been winterized as previously described in this section. Then use the following procedure to fill the air conditioner seawater cooling system with antifreeze.

1. Make sure the bucket and sea chest are full of antifreeze and open the air conditioner supply valve. All other valves on the sea chest should be closed.
2. Activate the air conditioner. The seawater cooling pump will draw antifreeze from the sea chest and pump it through the air conditioner cooling system.
3. Monitor the air conditioner discharge thru-hull fitting on the hull side and add antifreeze to the supply bucket as necessary until antifreeze is flowing from the fitting, then shutdown the air conditioner and close the supply valve.

The air conditioning condensation drain system must also be properly winterized. Refer to the Cabin Drain Sump Systems in the next section for instructions to winterize the condensation drain sump system.

Notice

The sea water cooling system and all other air conditioner components must be properly winterized by following additional winterizing instructions in the manufacturer's owner's manual.

SeaKeeper Raw Water Cooling System.

If your boat is equipped with an optional SeaKeeper stabilizer system, it will have specific lay up and winterizing procedures. Refer to the SeaKeeper's manual and/or contact your Scout dealer for recommended winterizing procedures.

Notice:

When winterizing operations are complete on all raw water systems supplied by the sea chest, remove the antifreeze supply hose and bucket. Then reconnect the vent hose to the sea chest.

Notice:

Refer to the Raw Water System chapter for additional information on the raw water system.

14.4 Drainage & Other Water System Winterizing

Cabin and Cockpit Drains

Use very low pressure compressed air to blow the water from all cabin, storage compartment and cockpit drains. Make sure to blow out the scupper and cockpit drain rail drains. Pour potable water antifreeze into each drain until it flows from the thru-hull fitting.

Dry the self-bailing cockpit troughs. Water freezing in these areas could cause damage.

Cabin Drain Sump Systems

The air conditioning system and head compartment shower drain use different sump systems that must be winterized. The air conditioner condensation sump system is in the forward cabin bilge below the table. The shower drain sump is in the bilge below the head compartment. Make sure both systems are filled with enough antifreeze to activate the pump and that antifreeze flows from the discharge thru-hull fitting when winterizing the systems.

Air Conditioner Drain Sump System

Clean debris from the drain and flush with fresh clean water. After the system is clean, pump the drain sump as dry as possible. Then pour potable water antifreeze into the drain pan until the sump pump is activated and antifreeze has been pumped through the system and is visible at the discharge thru-hull fitting in the hull side.

Shower Drain Sump System

The shower/cabin drain sump system must be properly winterized. Clean debris from the drain and sump and flush for several minutes with fresh clean water. After the system is clean, pump the drain sump as dry as possible. Then pour a potable water antifreeze mixture into the head

compartment drain fittings until antifreeze has been pumped through the entire system and out of the thru-hull fitting in the hull side.

Fishbox Pump out System

Open the thru-hull valves for the fishbox pumps and run each fishbox diaphragm pump until all the water is removed from the fishboxes and the pumps. Then pour potable water antifreeze in each fishbox and activate the diaphragm pumps until antifreeze is visible at the discharge thru-hull fittings. To avoid damage to the pumps, be careful not to run either pump dry for extended periods.

Baitwell and Recirculation System

Install the baitwell drain plug and pour potable water antifreeze in the baitwell until it covers the intake for the recirculation pump. Then activate the recirculation pump until antifreeze is visible at the discharge fitting. Remove the drain plugs and wipe down the inside of the wells.

Marine Toilet and Waste Overboard Discharge System

Drain the discharge hoses completely using low air pressure if necessary. The waste holding tank and diaphragm discharge pump must be pumped dry and two gallons of potable water antifreeze poured into the tank through the deck waste pump out fitting. After the antifreeze has been added to the holding tank, open the overboard discharge valve and activate the diaphragm pump until the antifreeze solution is visible at the discharge thru-hull.

The marine toilet must be properly winterized by following the manufacturer's winterizing instructions in the marine toilet owner's manual.

Notice:

Make sure you follow the marine toilet manufacturer's winterizing instructions exactly.

The freshwater supply line to the toilet must be properly winterized when winterizing the fresh water system.

14.5 Winterizing Bilge Components & Engines

Bilge

Coat all metal components, wire busses, pumps and connector plugs in the bilge with a protecting oil. It is also important to protect all strainers, seacocks and steering components.

The bilge pumps and discharge hoses must be completely free of water and dried out when the boat is laid-up for the winter in climates where freezing occurs. Compartments and areas in the bilge that will not drain completely should be pumped out and then sponged until completely free of water. Water freezing in these areas could cause damage.

Notice:

The optional bow thruster and steering systems have specific lay up requirements. Refer to their owner's manuals for recommended winterizing procedures.

Outboard Engines

The engines should be flushed with fresh water for at least 15 minutes prior to winter storage. This will remove salt, sand and other contaminants that can damage the engine. It is also important to "Fog" the cylinders, change the gear and crankcase oil, coat each engine with a protector, wax the exterior and properly store and charge the batteries. You should refer to the engine owner's manual or contact your dealer for specific instructions on winterizing your engines.

Generator Raw Water System

Refer to winterizing the generator seawater cooling system in the Raw Water System Winterizing section of this chapter. Once this is accomplished, you should refer to the generator owner's manual or contact your dealer for additional instructions on winterizing your generator.

14.6 Preparing Exterior & Interior Equipment For Winter Storage

Hardtop



It is imperative that all drain holes in the legs are open and that the legs are completely free of water. Remove canvas and thoroughly clean and store in a safe, dry place. Remove all electronics. Coat all wire connectors and bus bars in the helm compartment with a protecting oil.

Clean the aluminum frame with soap and water and dry thoroughly. Apply an aluminum metal protector to the entire frame on anodized aluminum to reduce corrosion and pitting. Apply an automotive or boat wax to powder coated aluminum to protect it during storage periods.

Flybridge and Towers

It is imperative that all drain holes in the tower and hardtop legs are open and completely free of water. Tower basket drains should be checked and clear of debris. Remove the tower or flybridge sun shade, if installed, and belly band or removable cushions. Then thoroughly clean and store in a safe, dry place. Remove all electronics. Coat all wire connectors and bus bars in the helm compartment with a protecting oil. Cover the tower basket or flybridge with a tarp or custom canvas storage enclosure and secure it properly.

Clean the aluminum frame with soap and water and dry thoroughly. Apply an aluminum metal protector to anodized aluminum to reduce corrosion and pitting. Apply an automotive or boat wax to powder coated aluminum to protect it during storage periods.



	CAUTION	
<p>ALWAYS MAKE SURE THE LEG DRAIN HOLES ARE CLEAR WHEN THE BOAT IS LAID UP FOR THE WINTER. WATER TRAPPED INSIDE THE HARDTOP OR TOWER LEGS COULD FREEZE AND CAUSE THE LEGS TO SPLIT.</p>		

Special Notes Prior To Winter Storage

If the boat will be in outside storage, properly support a storage cover and secure it over the boat. It is best to have a frame built over the boat to support the canvas. It should be a few inches wider than the boat so the canvas will clear the rails and allow passage of air. If this cover is fastened too tightly there will be inadequate ventilation and this can lead to mildew, moisture accumulation, etc. It is essential to fasten the canvas down securely so that the wind cannot remove it or cause chafing of the hull superstructure. Do not store the boat in a damp storage enclosure. Excessive dampness can cause electrical problems, corrosion, and excessive mildew.

Whenever possible, do not use a sun shade or other boat canvas in place of a winter storage cover. The life of these canvases may be sig-

nificantly shortened if exposed to harsh weather elements for long periods.

	CAUTION	
<p>PLACING AN ELECTRIC OR FUEL BURNING HEATING UNIT IN THE BILGE AREA CAN BE POTENTIALLY HAZARDOUS AND IS NOT RECOMMENDED.</p>		

Proper storage is very important to prevent serious damage to the boat. If the boat is to be stored indoors, make sure the building has enough ventilation. It is very important that there is enough ventilation both inside the boat and around the boat.

Notice:



If the boat is to be stored indoors or outdoors, open all interior drawers, clothes lockers, cabinets, and doors a little. If possible, remove the upholstery, mattresses, clothing, and drugs. Then hang a commercially available mildew protector in the interior compartments.

14.7 Recommissioning

	WARNING	
<p>DO NOT OPERATE THE BOAT UNLESS IT IS COMPLETELY ASSEMBLED. KEEP ALL FASTENERS TIGHT. KEEP ADJUSTMENTS ACCORDING TO SPECIFICATIONS.</p>		

Notice:

It is important and recommended that the fitting out procedure for the marine gear be done by a qualified service person. Read the engine owner's manual for the recommended procedure.

	CAUTION	
<p>BEFORE LAUNCHING THE BOAT, MAKE SURE THE HULL DRAIN PLUG IS INSTALLED.</p>		



WARNING



MAKE SURE THE GENERATOR MUFFLER HAS NOT BEEN DAMAGED DURING WINTER STORAGE AND THAT THE DRAIN PLUG IS INSTALLED AND PROPERLY TIGHTENED. LOOSE OR MISSING DRAIN PLUGS AND DAMAGED OR LEAKING MUFFLERS OR EXHAUST HOSES WILL ALLOW CARBON MONOXIDE, ENGINE GASES AND WATER INTO THE BILGE CREATING A POTENTIALLY HAZARDOUS CONDITION.

Notice:

Not all generator mufflers are equipped with drain plugs.

Reactivating The Boat After Storage:

- Charge and install the batteries.
- Install the drain plug(s) in the hull.
- Check the engines for damage and follow the manufacturer's instructions for recommissioning.
- Check the mounting bolts for the engines to make sure they are tight.
- Perform all routine maintenance.
- Check all hose clamps for tightness.
- Pump the antifreeze from the fresh and raw water systems and flush several times with fresh water. Make sure all antifreeze is flushed from the water heater and it is filled with fresh water before it is activated.
- Check and lubricate the steering system.
- Clean and wash the boat.
- Install all upholstery, cushions and canvas.

After Launching:

- Carefully inspect the engine bolts and other transom mounted equipment for leaks.
- Open the sea chest inlet valves and carefully check the sea chest and all water systems for leaks. Operate each system one at a time checking for leaks and proper operation.

- Check the bilge pump manual and automatic switches.
- Check the high water alarm.
- When each engine starts, check the cooling system port below the engine cowling for a strong stream of water. This ensures that the cooling pump is operating.
- Carefully monitor the gauges and check for leakage and abnormal noises.
- Operate the boat at slow speeds until the engine temperature stabilizes and all systems are operating normally.
- Start the generator and monitor the exhaust port for a steady stream of water. It may take 20 or 30 seconds for the muffler to fill and for water to appear at the port. This ensures that the cooling pump is operating. Carefully inspect the generator and all hoses for leaks, paying particular attention to the muffler and exhaust hoses. Any leak, no matter how minor must be corrected immediately.
- Once the generator is started and operating normally, activate the air conditioner and monitor the discharge thru-hull fitting for a steady stream of water. It may take 20 or 30 seconds for the system to fill water to appear at the fitting. This ensures that the cooling pump is properly primed and operating. Carefully inspect all hoses for leaks, paying particular attention to the hoses below the waterline and those connected to the air conditioning unit.
- If the air conditioner sea water pump runs but no water is visible at the outlet port after 45 seconds the pump may be air locked. The sea chest water intake fittings are equipped with scoops that will supply pressurized water to the sea chest and help prime the system while the boat is underway. Make sure the sea chest intake valves and the valve for the pump intake hose are open. Then operate the boat at or above 15 MPH. Water pressure from the sea chest will usually force the trapped air through the pump and allow it to prime. If this procedure doesn't work, contact your Scout dealer.

Hull Harness 12 V System

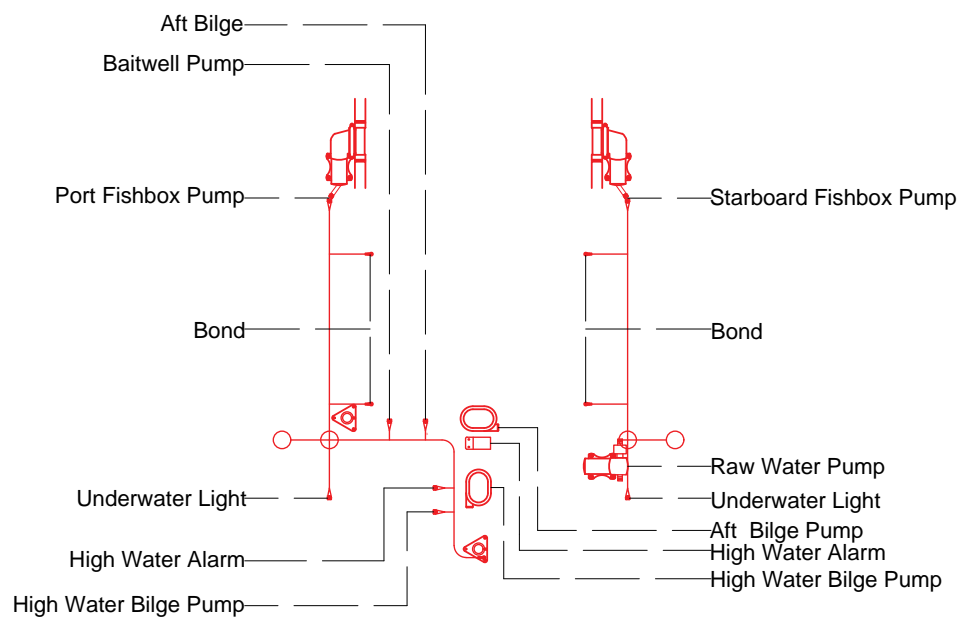
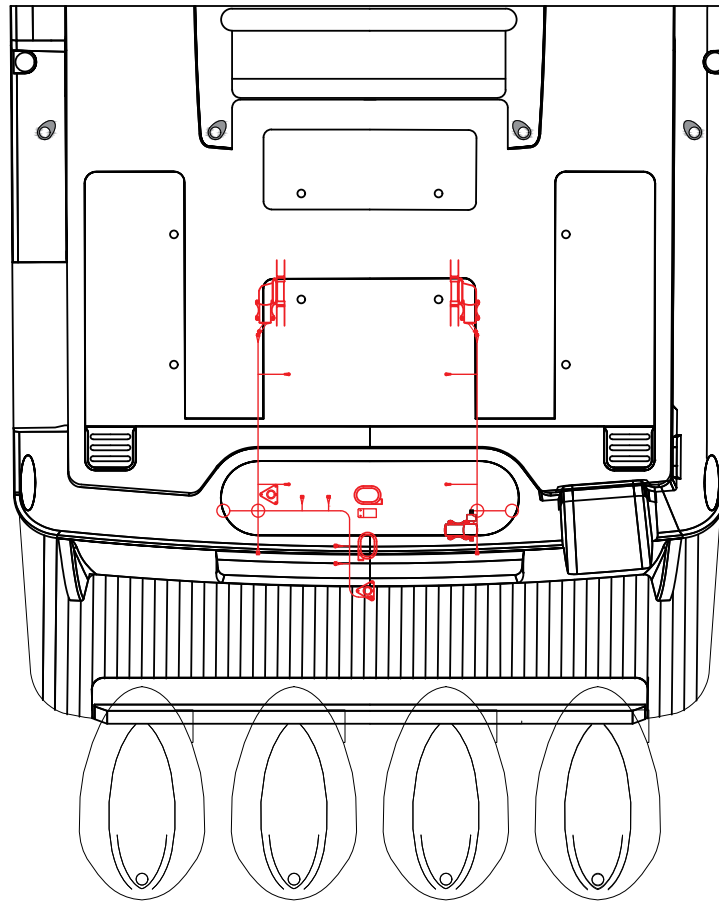

Hull Harness 12V System - 1

12V Hull Harness

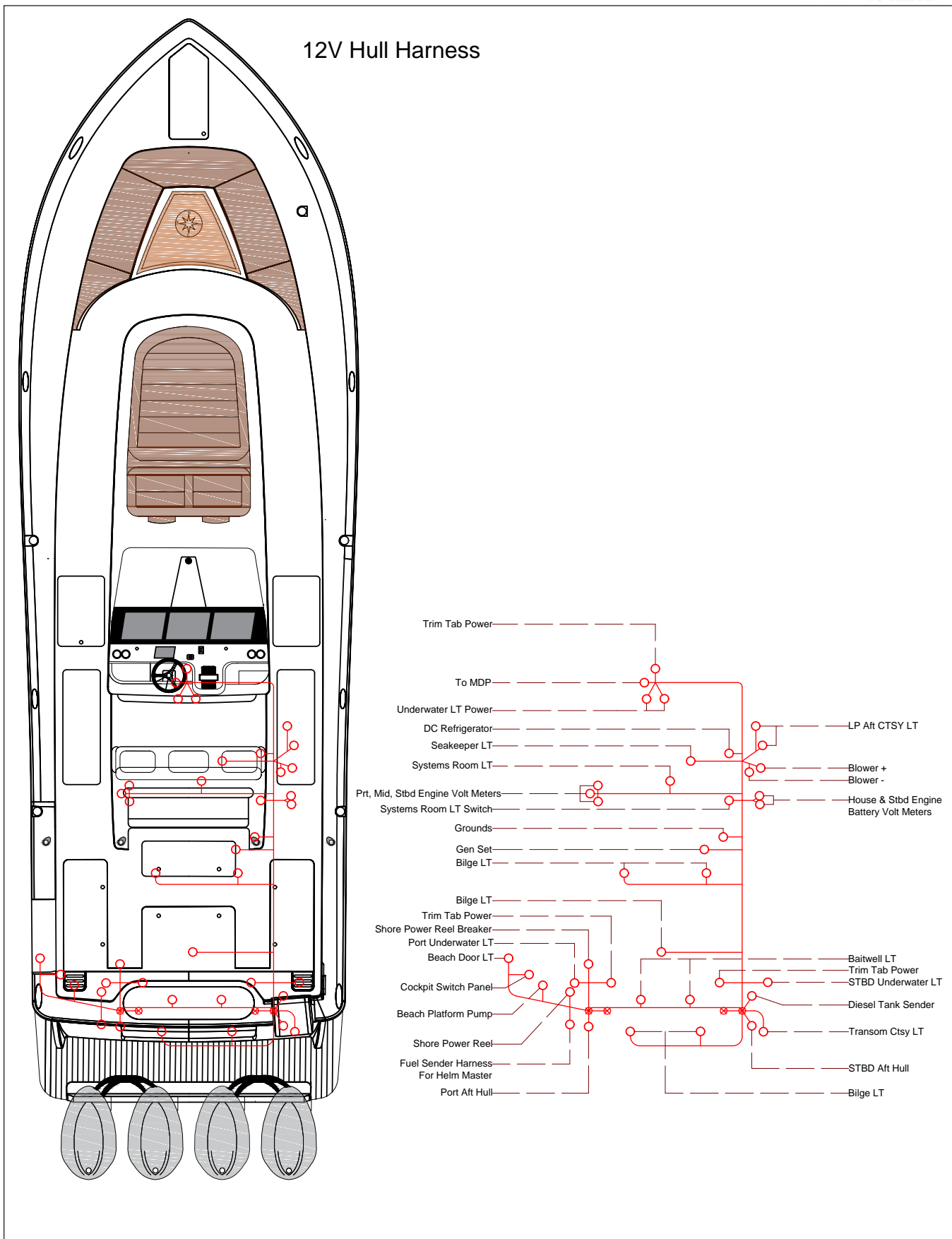

Hull Harness 12V System - 2

Deck Harness

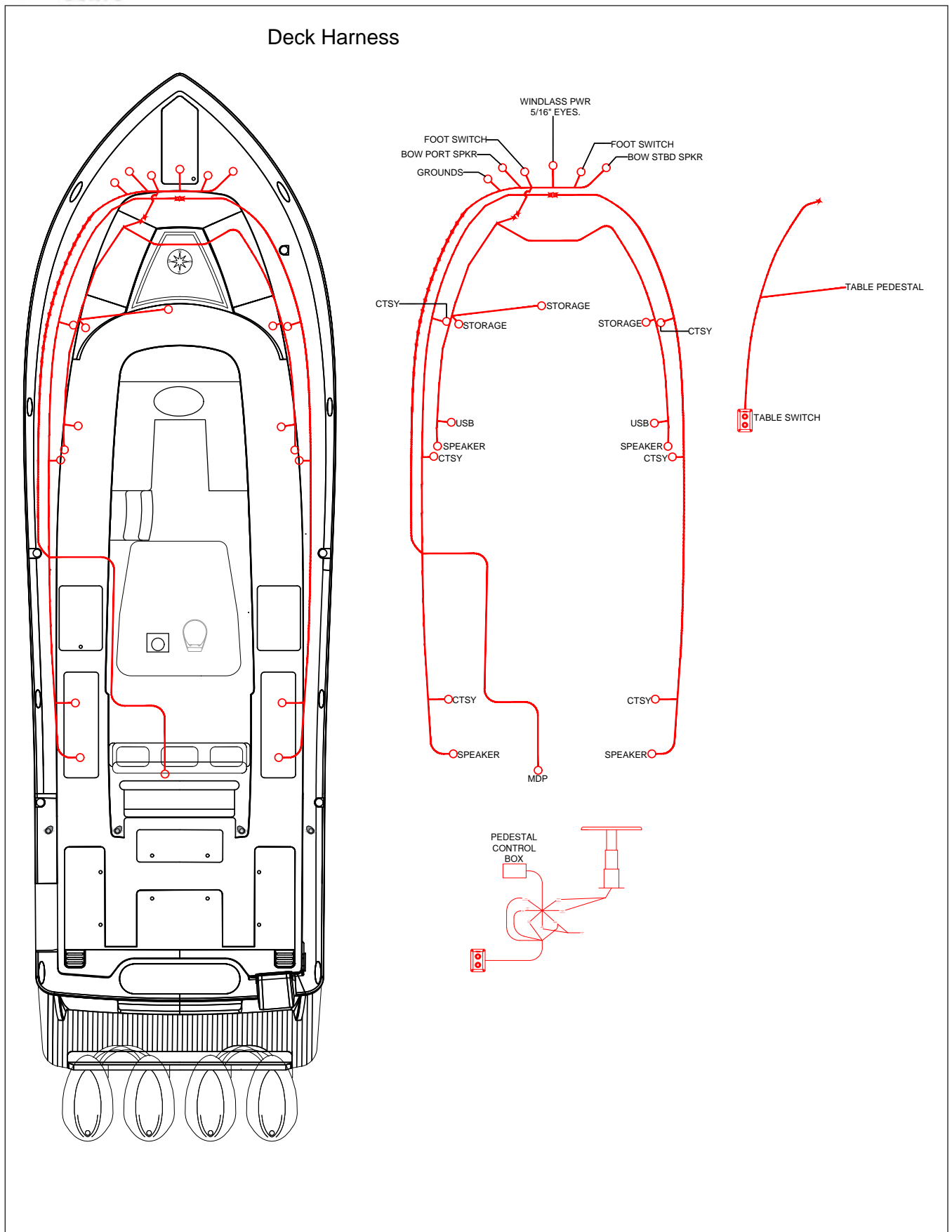

Deck Harness 12V

Deck Harness 110 Volt System

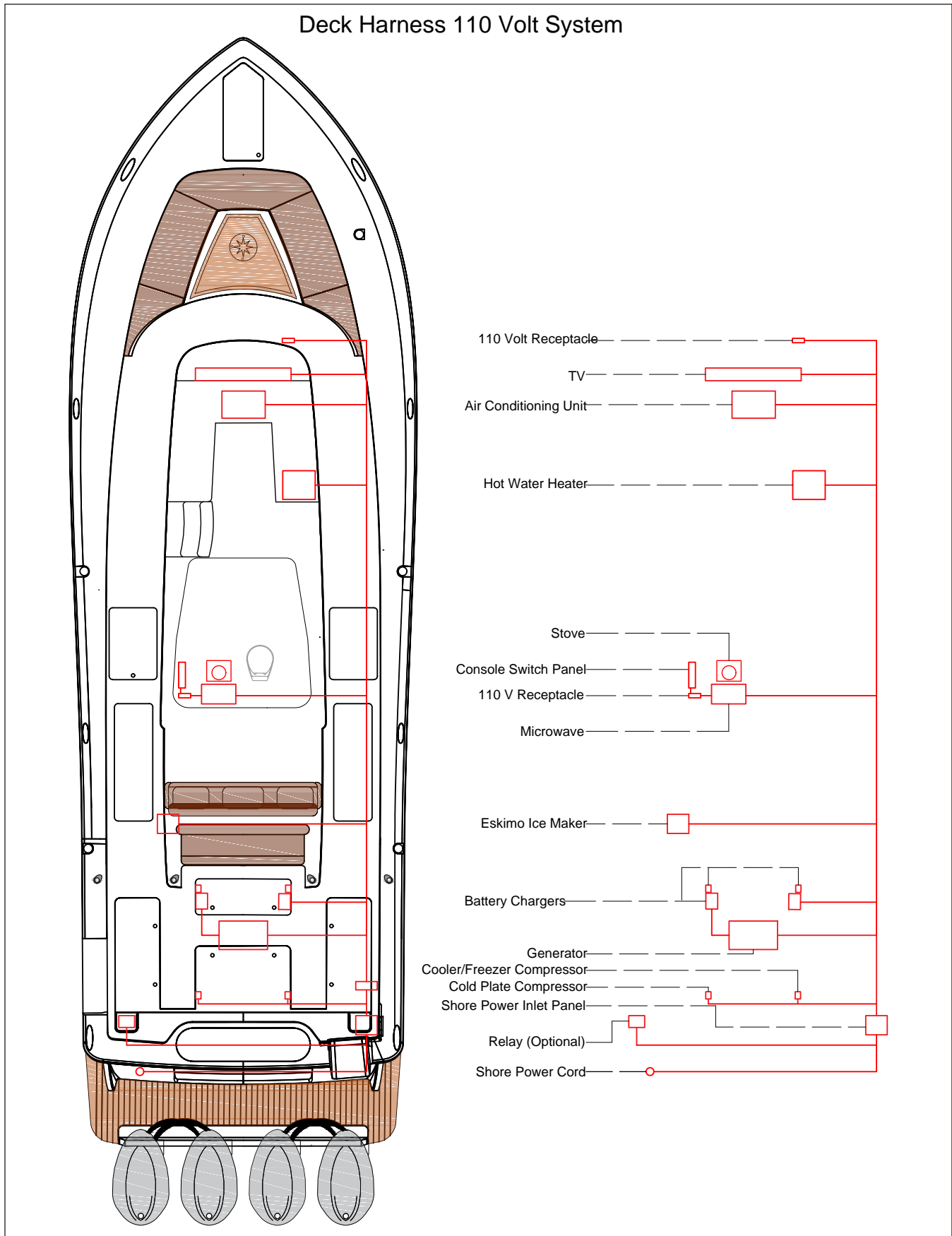

Deck Harness 110V

Hardtop Harness 12V

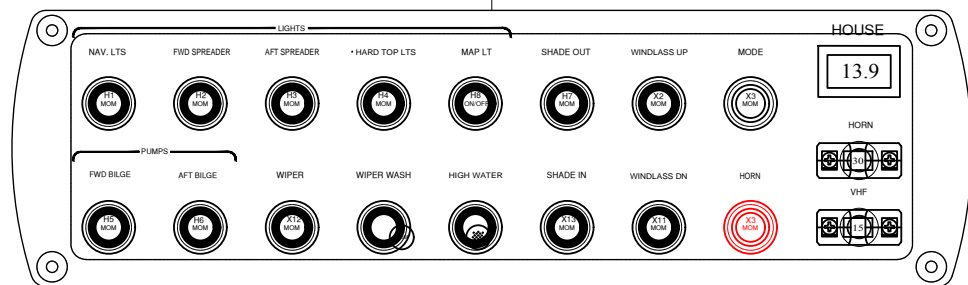
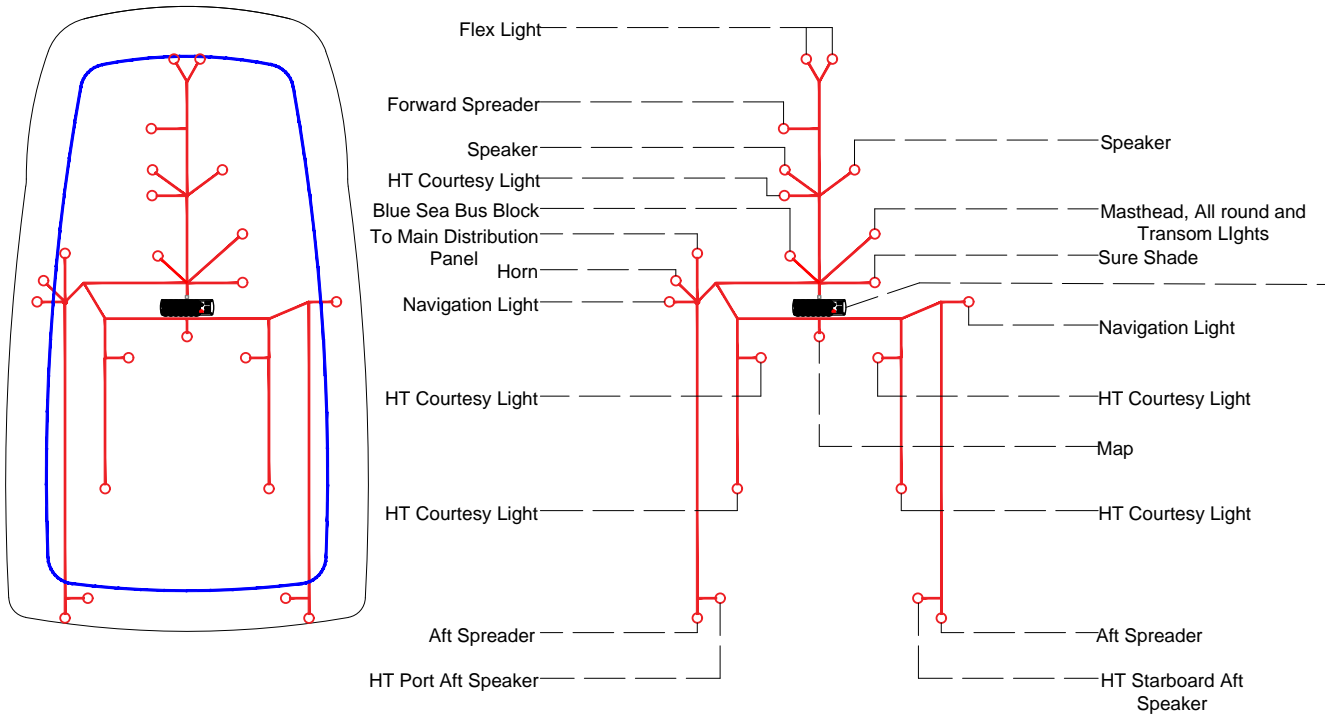

Hardtop Harness 12V

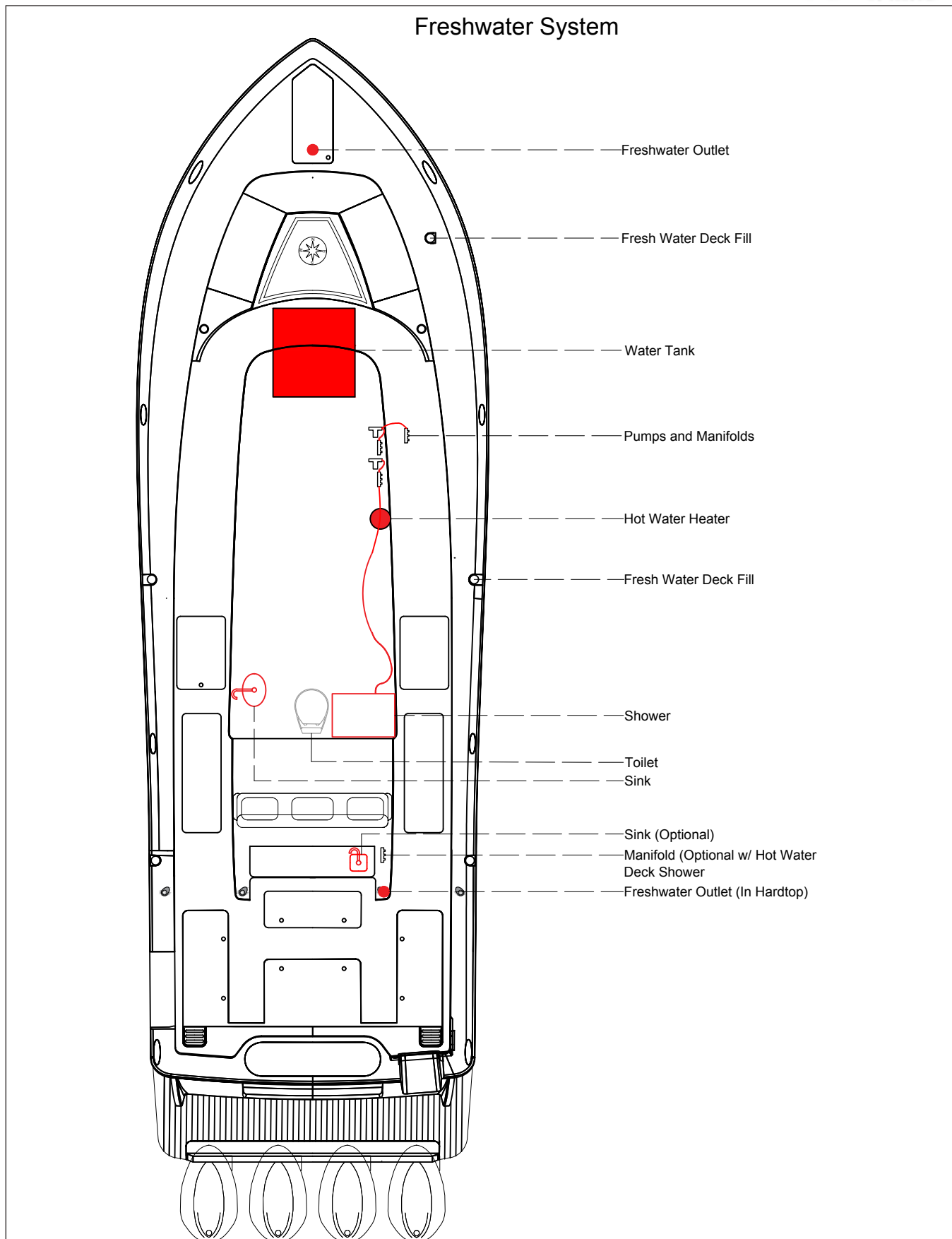

Freshwater System

Freshwater System

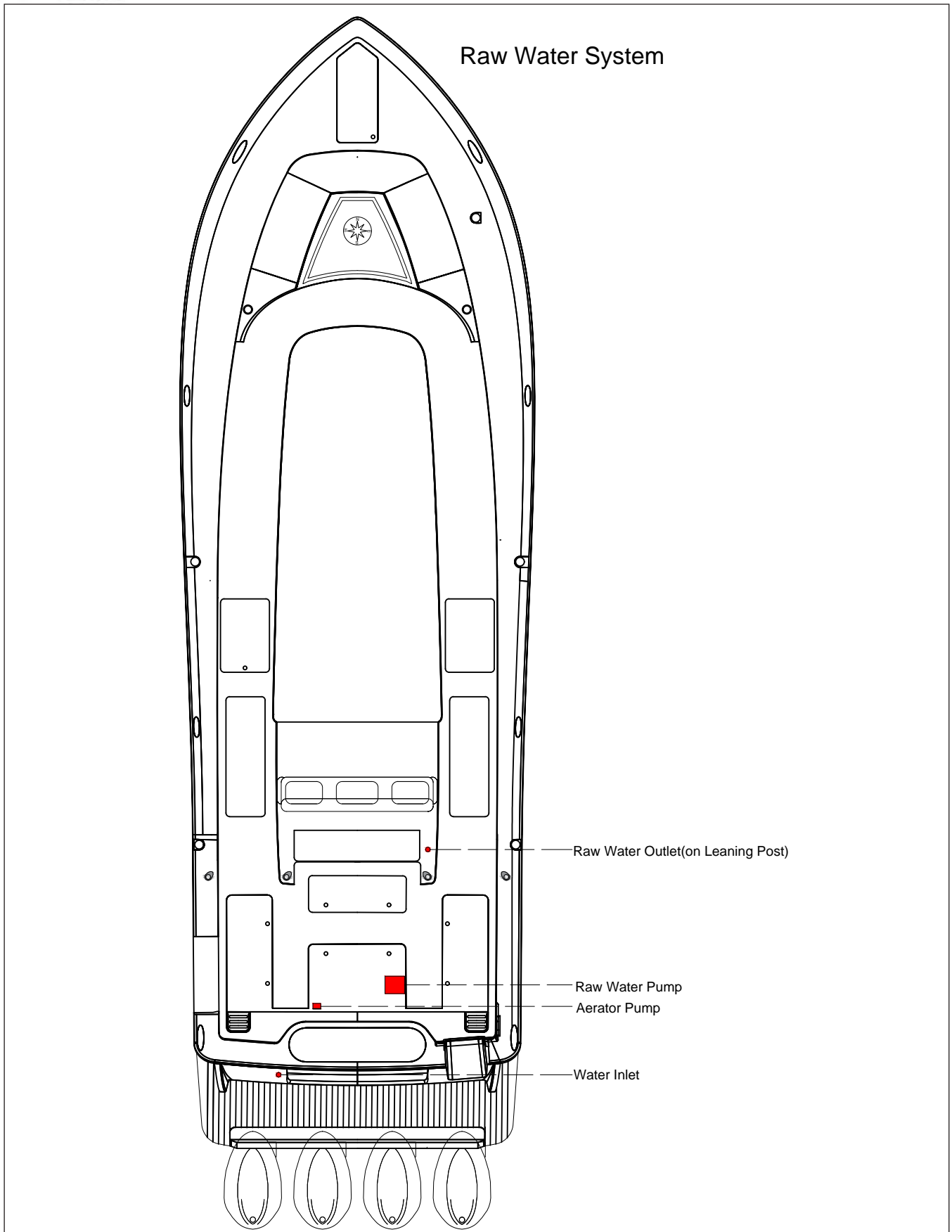

Raw Water System

Drainage System

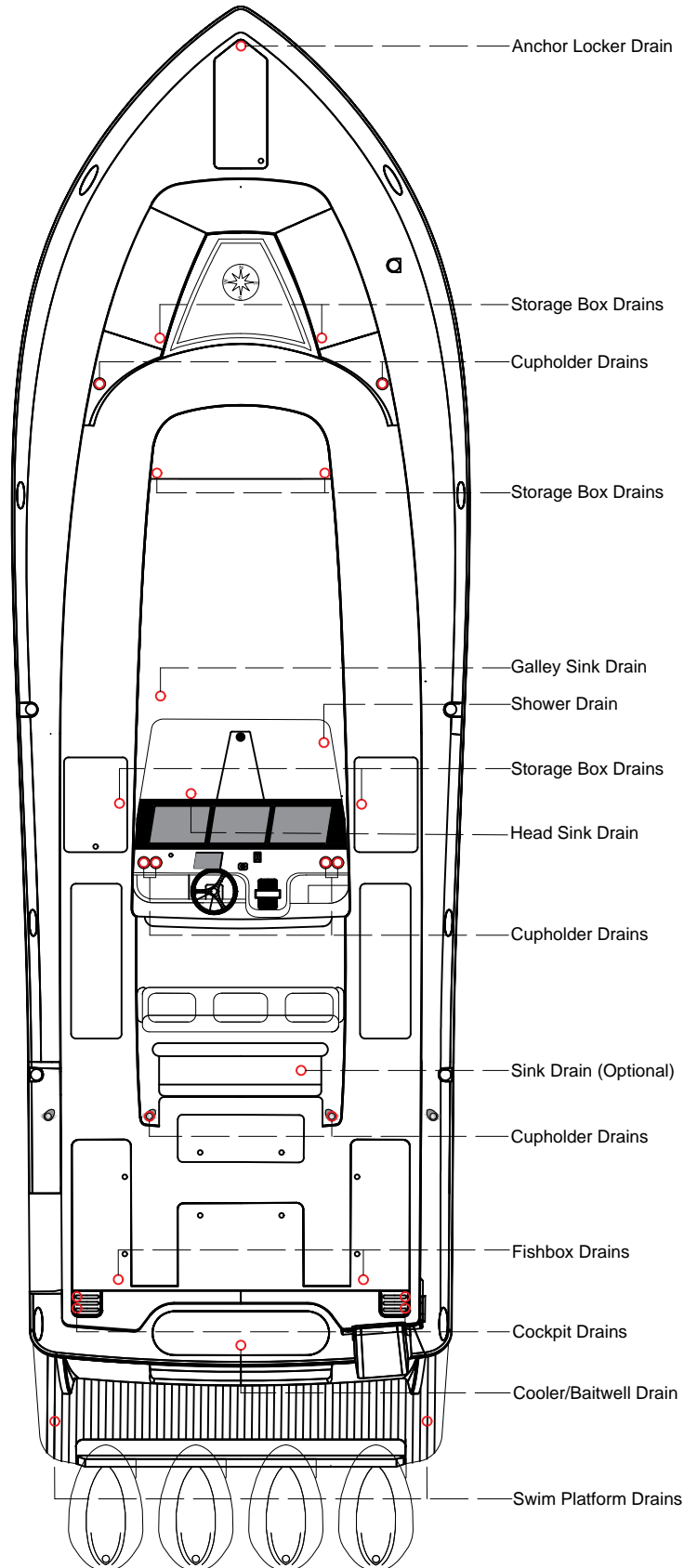

Drainage System

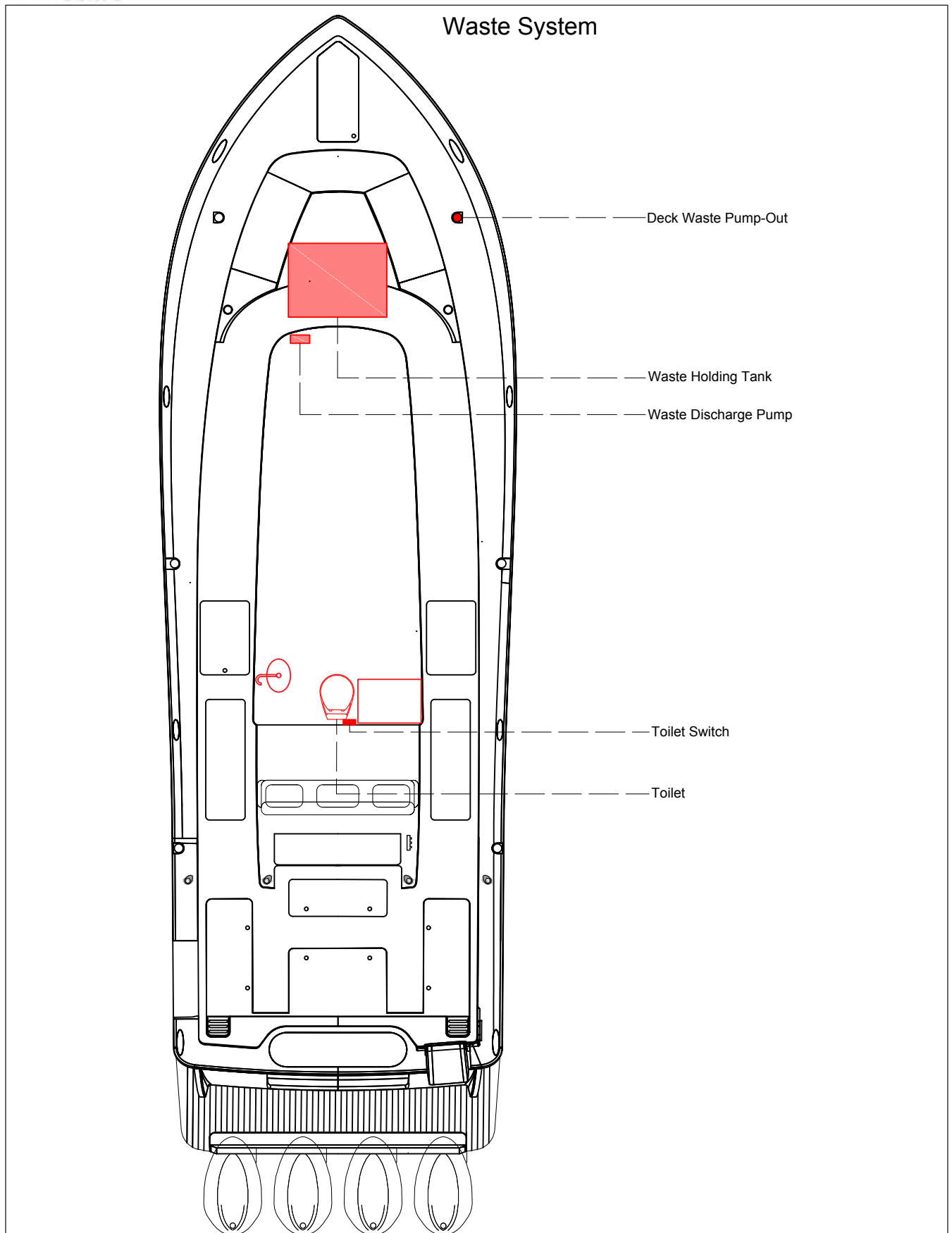

Waste System

Fuel System

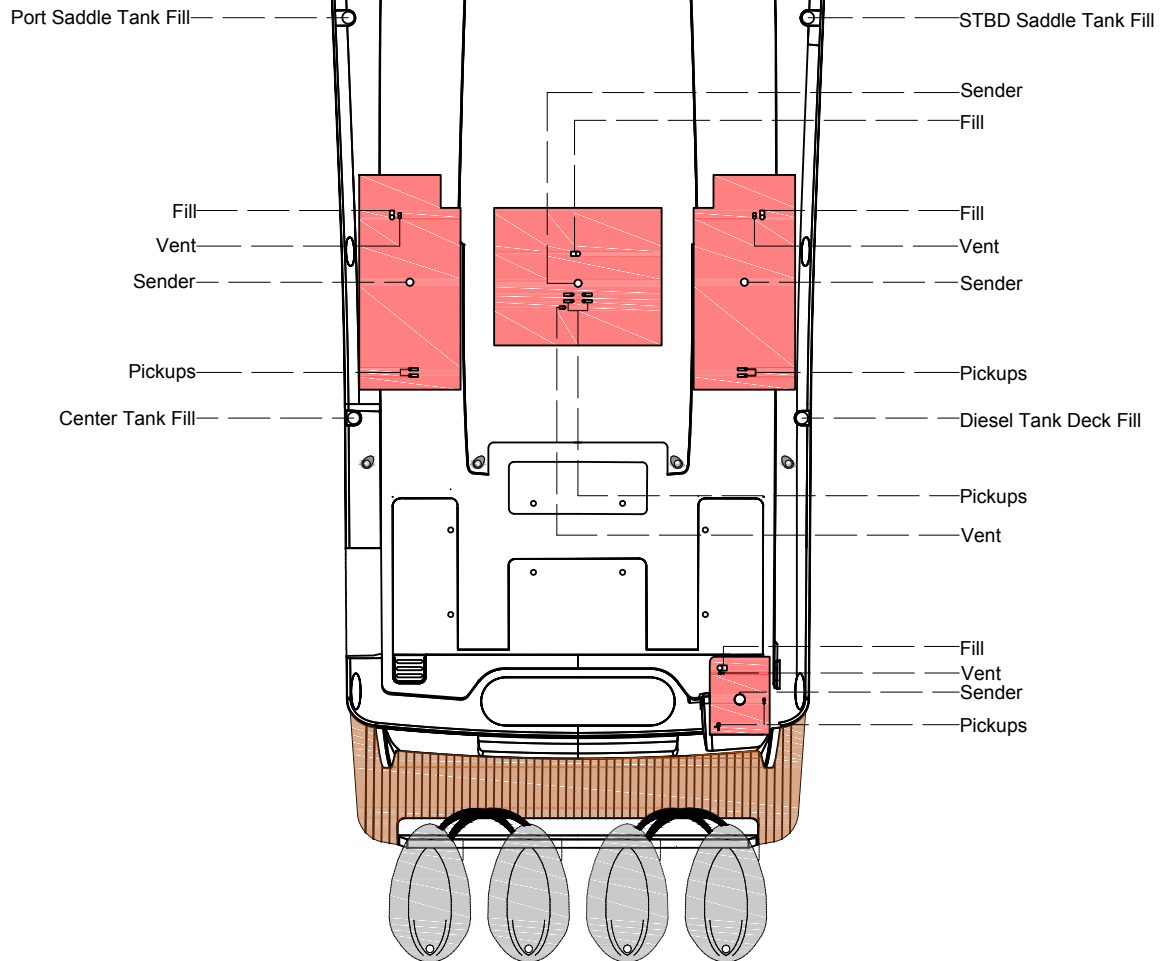

Fuel System

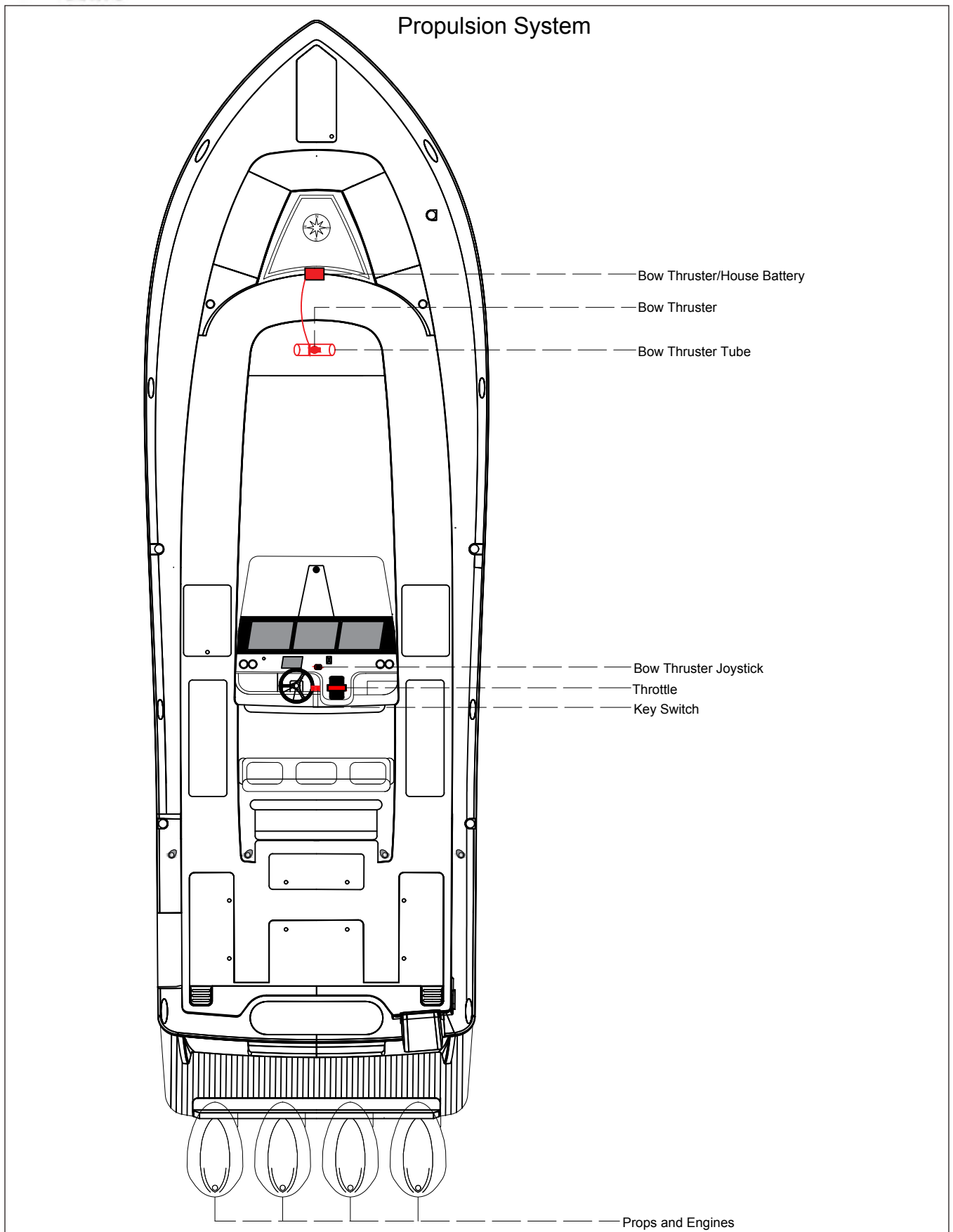

Propulsion System

Mercury Steering System

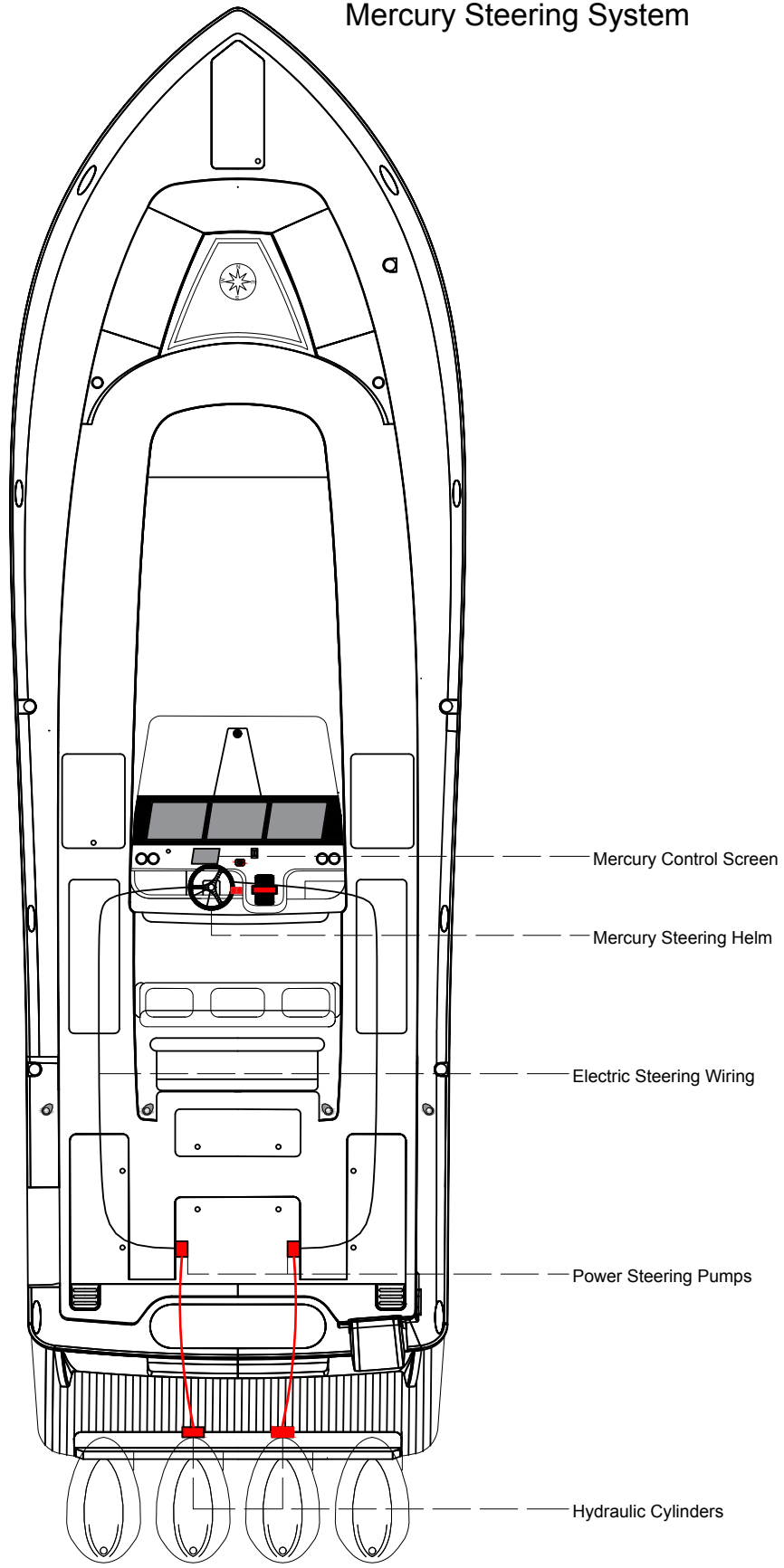

Mercury Steering System

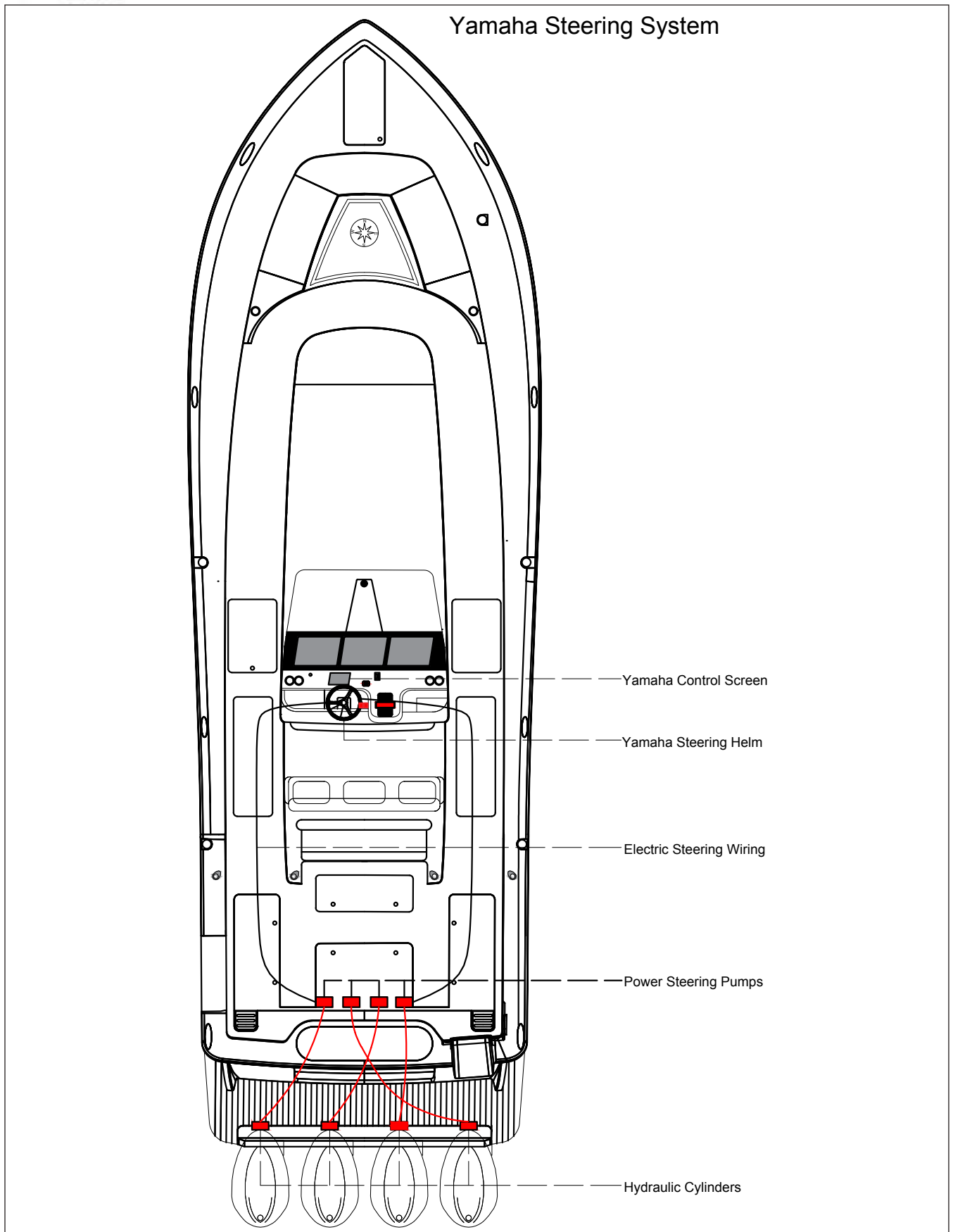

Yamaha Steering System

NOTES

Glossary Of Terms

Aft: In, near, or toward the stern of a boat.

Aground: A boat stuck on the bottom.

Amidships: In or toward the part of a boat midway between the bow and stern.

Anchor: A specially shaped heavy metal device designed to dig efficiently into the bottom under a body of water and hold a boat in place.

Anchorage: An area specifically designated by governmental authorities in which boats may anchor.

Ashore: On shore.

Astern: Behind the boat, to move backwards.

Athwartship: At right angles to the center line of the boat.

Barnacles: Small, hard-shelled marine animals which are found in salt water attached to pilings, docks and bottoms of boats.

Beam: The breadth of a boat usually measured at its widest part.

Bearing: The direction of an object from the boat, either relative to the boat's direction or to compass degrees.

Berth: A bunk or a bed on a boat.

Bilge: The bottom of the boat below the flooring.

Bilge Pump: A pump that removes water that collects in the bilge.

Boarding: Entering or climbing into a boat.

Boarding Ladder: Set of steps temporarily fitted over the side of a boat to assist persons coming aboard.

Boat Hook: Short shaft of wood or metal with a hook fitting at one end shaped to aid in extending one's reach from the side of the boat.

Bow: The front end of a boat's hull

Bow Line: A line that leads forward from the bow of the boat.

Bow Rail: Knee high rails of solid tubing to aid in preventing people from falling overboard.

Bridge: The area from which a boat is steered and controlled.

Bridge Deck: A deck forward and usually above the cockpit deck.

Broach: When the boat is sideways to the seas and in danger of capsizing; a very dangerous situation that should be avoided.

Bulkhead: Vertical partition or wall separating compartments of a boat.

Cabin: Enclosed superstructure above the main deck level.

Capsize: When a boat lays on its side or turns over.

Chock: A deck fitting, usually of metal, with inward curving arms through which mooring or anchor lines are passed so as to lead them in the proper direction both on board and off the boat.

Cleat: A deck fitting, usually of metal with projecting arms used for securing anchor and mooring lines.

Closed Cooling System: A separate supply of fresh water that is used to cool the engine and circulates only within the engine.

Coaming: A vertical piece around the edges of cockpit, hatches, etc. to stop water on deck from running below.

Cockpit: An open space, usually in the aft deck, outside of the cabin.

Companionway: Opening in the deck of a boat to provide access below.

Compartment: The interior of a boat divided off by bulkheads.

Cradle: A framework designed to support a boat as she is hauled out or stored.

Cutlass Bearing: A rubber bearing in the strut that supports the propeller shaft.

Deck: The floor-like platform of a boat that covers the hull.

Displacement: The volume of water displaced by the hull. The displacement weight is the weight of this volume of water.

Draft: The depth of water a boat needs to float.

Dry Rot: A fungus attack on wood areas.

Dry-dock: A dock that can be pumped dry during boat construction or repair.

Electrical Ground: A connection between an electrical connector and the earth.

Engine Beds: Sturdy structural members running fore and aft on which the inboard engines are mounted.

EPIRB: Emergency Position Indicating Radio Beacon. Operates as a part of a worldwide satellite distress system.

Even Keel: When a boat floats properly as designed.

Fathom: A measure of depth. One Fathom = 6 feet.

Fender: A soft object of rubber or plastic used to protect the topsides from scarring and rubbing against a dock or another vessel.

Fend off: To push or hold the boat off from the dock or another boat.

Flying Bridge: A control station above the level of the deck or cabin.

Flukes: The broad portions of an anchor which dig into the ground.

Fore: Applies to the forward portions of a boat near the bow.

Foundering: When a boat fills with water and sinks.

Freeboard: The height from the waterline to the lowest part of the deck.

Galley: The kitchen of a boat.

Grab Rail: Hand-hold fittings mounted on cabin tops or sides for personal safety when moving around the boat, both on deck and below.

Ground Tackle: A general term including anchors, lines, and other gear used in anchoring.

Grounds: A boat touches the bottom.

Gunwale: The upper edge of a boat's side.

Hand Rail: Rail mounted on the boat, for grabbing with your hand, to steady you while walking about the boat.

Harbor: An anchorage which provides reasonably good protection for a boat, with shelter from wind and sea.

Hatch: An opening in the deck with a door or lid to allow for access down into a compartment of a boat.

Head: A toilet on a boat.

Heat Exchanger: Used to transfer the heat that is picked up by the closed cooling system to the raw cooling water.

Helm: The steering and control area of a boat.

Hull: The part of the boat from the deck down.

Inboard: A boat with the engine mounted within the hull of the boat. Also refers to the center of the boat away from the sides.

Inboard/outboard: Also stern drive or I/O. A boat with an inboard engine attached to an outboard drive unit.

Keel: A plate or timber plate running lengthwise along the center of the bottom of a boat.

Knot: Unit of speed indicating nautical miles per hour. 1 knot = 1 nautical mile per hour (1.15 miles per hour). A nautical mile is equal to one minute of latitude: 6076 feet. Knots times 1.15 equals miles per hour. Miles per hour times .87 equals knots.

Lay-up: To decommission a boat for the winter (usually in northern climates).

Leeward: The direction toward which the wind is blowing.

Length On The Waterline (l.w.l.): A length measurement of a boat at the waterline from the stern to where the hull breaks the water near the bow.

Limber Hole: A passage cut into the lower edges of floors and frames next to the keel to allow bilge water to flow to the lowest point of the hull where it can be pumped overboard.

Line: The term used to describe a rope when it is on a boat.

Lists: A boat that inclines to port or starboard while afloat.

L.O.A.: Boat length overall.

Locker: A closet, chest or box aboard a boat.

Loran: An electronic navigational instrument which monitors the boat's position using signals emitted from pairs of transmitting stations.

Lunch hook: A small light weight anchor typically used instead of the working anchor. Normally used in calm waters with the boat attended.

Midships: The center of the boat.

Marina: A protected facility primarily for recreational small craft.

Marine Ways or Railways: Inclined planes at the water's edge onto which boats are hauled.

Moored: A boat secured with cables, lines or anchors.

Mooring: An anchor permanently embedded in the bottom of a harbor that is used to secure a boat.

Nautical Mile: A unit of measure equal to one minute of latitude. (6076 feet)

Nun Buoy: A red or red-striped buoy of conical shape.

Outboard: A boat designed for an engine to be mounted on the transom. Also a term that refers to objects away from the center line or beyond the hull sides of a boat.

Pad Eye: A deck fitting consisting of a metal eye permanently secured to the boat.

Pier: A structure which projects out from the shoreline.

Pile or Piling: A long column driven into the bottom to which a boat can be tied.

Pitching: The fore and aft rocking motion of a boat as the bow rises and falls.

Pitch: The measure of the angle of a propeller blade. Refers to the theoretical distance the boat travels with each revolution of the propeller.

P.F.D: Personal Flotation Device.

Port: The left side of the boat when facing the bow.

Porthole (port): The opening in the side of a boat to allow the admittance of light and air.

Propeller: A device having two or more blades that is attached to the engine and used for propelling a boat.

Propeller Shaft: Shaft which runs from the back of the engine gear box, aft, through the stuffing box, shaft log, struts, and onto which the propeller is attached.

Pyrotechnic Distress Signals: Distress signals that resemble the brilliant display of flares or fireworks.

Raw Water Cooled: Refers to an engine cooling system that draws seawater in through a hull fitting or engine drive unit, circulates the water in the engine, and then discharges it overboard.

Reduction Gear: Often combined with the reverse gear so that the propeller turns at a slower rate than the engine.

Reverse Gear: Changes the direction of rotation of the propeller to provide thrust in the opposite direction for stopping the boat or giving it sternway.

Roll: A boat's sideways rotational motion in rough water.

Rope Locker: A locker, usually located in the bow of a boat, used for stowing the anchor line or chain.

Rubrail: Railing (often rubber or hard plastic) that runs along the boat's sheer to protect the hull when coming alongside docks, piers, or other boats.

Rudder: A moveable flat surface that is attached vertically at or near the stern for steering.

Sea anchor: An anchor that does not touch the bottom. Provides drag to hold the bow in the most favorable position in heavy seas.

Scupper: An opening in the hull side or transom of the boat through which water on deck or in the cockpit is drained overboard.

Seacock: Safety valves installed just inside the thru-hull fittings and ahead of the piping or hose running from the fittings.

Shaft Log: Pipe through which the propeller shaft passes.

Sheer: The uppermost edge of the hull.

Sling: A strap which will hold the boat securely while being lifted, lowered, or carried.

Slip: A boat's berth between two pilings or piers.

Sole: The deck of a cockpit or interior cabin.

Spring Line: A line that leads from the bow aft or from the stern forward to prevent the boat from moving ahead or astern.

Starboard: The right side of a boat when facing the bow.

Steerageway: Sufficient speed to keep the boat responding to the rudder or drive unit.

Stem: The vertical portion of the hull at the bow.

Stern: The rear end of a boat.

Stow: To pack away neatly.

Stringer: Longitudinal members fastened inside the hull for additional structural strength.

Strut: Mounted to the hull which supports the propeller shaft in place.

Strut Bearing: See "cutlass bearing."

Stuffing Box: Prevents water from entering at the point where the propeller shaft passes through the shaft log.

Superstructure: Something built above the main deck level.

Swamps: When a boat fills with water from over the side.

Swimming Ladder: Much the same as the boarding ladder except that it extends down into the water.

Taffrail: Rail around the rear of the cockpit.

Thru-hull: A fitting used to pass fluids (usually water) through the hull surface, either above or below the waterline.

Topsides: The side skin of a boat between the waterline or chine and deck.

Transom: A flat stern at right angles to the keel.

Travel Lift: A machine used at boat yards to hoist boats out of and back into the water.

Trim: Refers to the boat's angle or the way it is balanced.

Trough: The area of water between the crests of waves and parallel to them.

Twin-Screw Craft: A boat with two propellers on two separate shafts.

Underway: When a boat moves through the water.

Wake: Disrupted water that a boat leaves astern as a result of its motion.

Wash: The flow of water that results from the action of the propeller or propellers.

Waterline: The plane of a boat where the surface of the water touches the hull when it is afloat on even keel.

Watertight Bulkhead: Bulkheads secured so tightly so as not to let water pass.

Wharf: A structure generally parallel to the shore.

Working Anchor: An anchor carried on a boat for most normal uses. Refers to the anchor used in typical anchoring situations.

Windlass: A winch used to raise and lower the anchor.

Windward: Toward the direction from which the wind is coming.

Yacht Basin: A protected facility primarily for recreational small craft.

Yaw: When a boat runs off her course to either side.



DEPARTMENT OF TRANSPORTATION U.S. COAST GUARD CG-3865 (Rev. 9/95)	BOATING ACCIDENT REPORT	FORM APPROVED OMB NO. 2115-0010
STATE ASSIGNED CASE NO. _____		

THE OPERATOR/OWNER OF A VESSEL USED FOR RECREATIONAL PURPOSES IS REQUIRED TO FILE A REPORT IN WRITING WHENEVER AN ACCIDENT RESULTS IN: LOSS OF LIFE OR DISAPPEARANCE FROM A VESSEL; AN INJURY WHICH REQUIRES MEDICAL TREATMENT BEYOND FIRST AID; OR PROPERTY DAMAGE IN EXCESS OF \$2000 OR COMPLETE LOSS OF THE VESSEL. REPORTS IN DEATH AND INJURY CASES MUST BE SUBMITTED WITHIN 48 HOURS. REPORTS IN OTHER CASES MUST BE SUBMITTED WITHIN 10 DAYS. REPORTS MUST BE SUBMITTED TO THE REPORTING AUTHORITY IN THE STATE WHERE THE ACCIDENT OCCURRED. THIS FORM IS PROVIDED TO ASSIST THE OPERATOR IN FILING THE REQUIRED WRITTEN REPORT.

COMPLETE ALL BLOCKS (INDICATE THOSE NOT APPLICABLE BY "NA")

ACCIDENT DATA

DATE OF ACCIDENT	TIME	AM PM	NAME OF BODY OF WATER	LOCATION (GIVE LOCATION PRECISELY)
NUMBER OF VESSELS INVOLVED	NEAREST CITY OR TOWN		COUNTY	STATE
WEATHER (CHECK ALL APPLICABLE) [] CLEAR [] RAIN [] CLOUDY [] SNOW [] FOG [] HAZY	WATER CONDITIONS [] CALM (WAVES LESS THAN 6") [] CHOPPY (WAVES 6" TO 2') [] ROUGH (WAVES 2' TO 6') [] VERY ROUGH (GREATER THAN 6') [] STRONG CURRENT		TEMPERATURE (ESTIMATE) AIR _____ °F WATER _____ °F	WIND [] NONE [] LIGHT (0-6 MPH) [] MODERATE (7-14 MPH) [] STRONG (15-25 MPH) [] STORM (OVER 25 MPH)
	VISIBILITY DAY NIGHT [] GOOD [] [] FAIR [] [] POOR []		NAME OF OPERATOR	
OPERATOR TELEPHONE NUMBER ()		DATE OF BIRTH MO DAY YR	OPERATOR'S EXPERIENCE [] NONE [] UNDER 100 HOURS [] > 100 HOURS	INSTRUCTION IN BOATING SAFETY [] STATE COURSE [] U.S. POWER SQUADRON [] USCG AUXILIARY [] AMERICAN RED CROSS [] NONE
NAME OF OWNER		OWNER ADDRESS		
OWNER TELEPHONE NUMBER ()	NUMBER OF PEOPLE ON BOARD	NUMBER OF PEOPLE BEING TOWED	RENTED BOAT? [] YES [] NO	

BOAT NO. 1 (THIS VESSEL)

BOAT REGISTRATION OR DOCUMENTATION NUMBER	STATE	HULL IDENTIFICATION NUMBER	BOAT NAME
BOAT MANUFACTURER	LENGTH	MODEL	YEAR BUILT
TYPE OF BOAT [] OPEN MOTORBOAT [] CABIN MOTORBOAT [] AUXILIARY SAIL [] SAIL (ONLY) [] ROWBOAT [] CANOE/KAYAK [] PERSONAL WATERCRAFT [] PONTOON BOAT [] HOUSEBOAT [] OTHER (SPECIFY)	HULL MATERIAL [] WOOD [] ALUMINUM [] STEEL [] FIBERGLASS [] RUBBER/VINYL/CANVAS [] RIGID HULL INFLATABLE [] OTHER (SPECIFY)	ENGINE [] OUTBOARD [] INBOARD [] INBOARD-STERNDRIVE (I/O) [] AIRBOAT	PROPULSION [] PROPELLER [] WATER JET [] AIR THRUST [] MANUAL [] SAIL
		FUEL [] GASOLINE [] DIESEL [] ELECTRIC	NUMBER OF ENGINES TOTAL HORSEPOWER
OPERATION AT TIME OF ACCIDENT (CHECK ALL APPLICABLE) [] CRUISING [] CHANGING DIRECTION [] CHANGING SPEED [] DRIFTING [] TOWING [] BEING TOWED [] ROWING/PADDLING [] SAILING [] LAUNCHING [] DOCKING/UNDOCKING [] AT ANCHOR [] TIED TO DOCK/MOORED [] OTHER (SPECIFY)	ACTIVITY AT TIME OF ACCIDENT (CHECK ANY IF APPLICABLE) [] FISHING [] TOURNAMENT [] HUNTING [] SWIMMING/DIVING [] MAKING REPAIRS [] WATERSKIING/TUBING/ETC. [] RACING [] WHITEWATER SPORTS [] FUELING [] STARTING ENGINE [] NON-RECREATIONAL [] OTHER (SPECIFY)	TYPE OF ACCIDENT [] GROUNDING [] CAPSIZING [] FLOODING/SWAMPING [] SINKING [] FIRE OR EXPLOSION (FUEL) [] FIRE OR EXPLOSION (OTHER) [] SKIER MISHAP [] COLLISION WITH VESSEL [] COLLISION WITH FIXED OBJECT [] COLLISION WITH FLOATING OBJ. [] FALLS OVERBOARD [] FALLS IN BOAT [] STRUCK BY BOAT [] STRUCK BY MOTOR/PROPELLER [] STRUCK SUBMERGED OBJECT [] OTHER (SPECIFY)	FIRE EXTINGUISHERS ON BOARD? [] YES [] NO USED? [] YES [] NO WHAT CONTRIBUTED TO ACCIDENT? (CHECK ALL APPLICABLE) [] WEATHER [] EXCESSIVE SPEED [] IMPROPER LOOKOUT [] RESTRICTED VISION [] OVERLOADING [] IMPROPER LOADING [] HAZARDOUS WATERS [] ALCOHOL USE [] DRUG USE [] HULL FAILURE [] MACHINERY FAILURE [] EQUIPMENT FAILURE [] OPERATOR INEXPERIENCE [] OPERATOR INATTENTION [] CONGESTED WATERS [] PASSENGER/SKIER BEHAVIOR [] DAM/LOCK [] OTHER (SPECIFY)
ESTIMATED SPEED [] NONE [] UNDER 10 MPH [] 10 - 20 MPH [] 21 - 40 MPH [] OVER 40 MPH	[] HIT AND RUN		



Boating Accident Report



DECEASED (IF MORE THAN 2 FATALITIES, ATTACH ADDITIONAL FORMS)			
NAME OF VICTIM		ADDRESS OF VICTIM	
DATE OF BIRTH		DEATH CAUSED BY	
[] MALE [] FEMALE	[] DROWNING [] OTHER	[] DISAPPEARANCE	
WAS PFD WORN? [] YES [] NO			
NAME OF VICTIM		ADDRESS OF VICTIM	
DATE OF BIRTH		DEATH CAUSED BY	
[] MALE [] FEMALE	[] DROWNING [] OTHER	[] DISAPPEARANCE	
WAS PFD WORN? [] YES [] NO			
INJURED (IF MORE THAN 2 INJURIES, ATTACH ADDITIONAL FORMS)			
NAME OF VICTIM		ADDRESS OF VICTIM	
DATE OF BIRTH	MEDICAL TREATMENT BEYOND FIRST AID? [] YES [] NO	DESCRIBE INJURY	
	ADMITTED TO HOSPITAL? [] YES [] NO		
WAS PFD WORN? [] YES [] NO		PRIOR TO ACCIDENT? [] YES [] NO	
AS A RESULT OF ACCIDENT? [] YES [] NO		AS A RESULT OF ACCIDENT? [] YES [] NO	
WAS IT INFLATABLE? [] YES [] NO			
NAME OF VICTIM		ADDRESS OF VICTIM	
DATE OF BIRTH	MEDICAL TREATMENT BEYOND FIRST AID? [] YES [] NO	DESCRIBE INJURY	
	ADMITTED TO HOSPITAL? [] YES [] NO		
WAS PFD WORN? [] YES [] NO		PRIOR TO ACCIDENT? [] YES [] NO	
AS A RESULT OF ACCIDENT? [] YES [] NO		AS A RESULT OF ACCIDENT? [] YES [] NO	
WAS IT INFLATABLE? [] YES [] NO			
OTHER PEOPLE ABOARD THIS BOAT (IF MORE THAN 2 PEOPLE, ATTACH ADDITIONAL FORMS)			
NAME		ADDRESS	
DATE OF BIRTH	WAS PFD WORN? [] YES [] NO	PRIOR TO ACCIDENT? [] YES [] NO	
	AS A RESULT OF ACCIDENT? [] YES [] NO	WAS IT INFLATABLE? [] YES [] NO	
NAME		ADDRESS	
DATE OF BIRTH	WAS PFD WORN? [] YES [] NO	PRIOR TO ACCIDENT? [] YES [] NO	
	AS A RESULT OF ACCIDENT? [] YES [] NO	WAS IT INFLATABLE? [] YES [] NO	
BOAT NO. 2 (IF MORE THAN 2 VESSELS, ATTACH ADDITIONAL IDENTIFYING INFORMATION)			
NAME OF OPERATOR		OPERATOR ADDRESS	
OPERATOR TELEPHONE NUMBER ()		BOAT REGISTRATION OR DOCUMENTATION NUMBER STATE	
NAME OF OWNER		OWNER ADDRESS	
OWNER TELEPHONE NUMBER ()			
PROPERTY DAMAGE			
ESTIMATED AMOUNT: THIS BOAT AND CONTENTS: \$		OTHER BOAT(S) AND CONTENTS: \$	
DESCRIBE PROPERTY DAMAGED		OTHER PROPERTY: \$	
WITNESSES NOT ON THIS VESSEL			
NAME		ADDRESS	TELEPHONE NUMBER ()
NAME		ADDRESS	TELEPHONE NUMBER ()
PERSON COMPLETING REPORT			
NAME		ADDRESS	TELEPHONE NUMBER ()
SIGNATURE		QUALIFICATION [] OPERATOR [] OWNER [] INVESTIGATOR [] OTHER	DATE SUBMITTED
FOR AGENCY USE ONLY			
CAUSES BASED ON (CHECK ONE): [] THIS REPORT [] INVESTIGATION [] INVESTIGATION AND THIS REPORT [] OTHER			
NAME OF REVIEWING OFFICE		DATE RECEIVED	RECREATIONAL [] NON-REPORTABLE [] COMMERCIAL []
PRIMARY CAUSE		SECONDARY CAUSE	

Call the Coast Guard Infoline 1-800-368-5647 for information on **Federal Requirements for Recreational Boats**



ACCIDENT DESCRIPTION

DESCRIBE WHAT HAPPENED (SEQUENCE OF EVENTS. INCLUDE FAILURE OF EQUIPMENT. INCLUDE A DIAGRAM IF NEEDED. CONTINUE ON ADDITIONAL SHEETS IF NECESSARY. INCLUDE ANY INFORMATION REGARDING THE INVOLVEMENT OF ALCOHOL AN/OR DRUGS IN CAUSING OR CONTRIBUTING TO THE ACCIDENT. INCLUDE ANY DESCRIPTIVE INFORMATION ABOUT THE USE OF PFD'S.)

An agency may not conduct or sponsor and a person is not required to respond to an information collection, unless it displays a currently valid OMB Control Number. The Coast Guard estimates that the average burden for this report form is 30 minutes. You may submit any comments concerning the accuracy of this burden estimate or any suggestions for reducing the burden to: Commandant (G-OPB-1), U.S. Coast Guard, Washington, DC 20593-0001 or Office of Management and Budget, Paperwork Reduction Project (2115-0010), Washington, DC 20503.

NOTES

Float Plan

Float Plan

Scout recommends filling out a float plan each time you use your boat for an offshore day trip or a long cruise. Leave this information with a responsible person ashore, like a close friend or relative that you know well.

1. Name of person reporting and telephone number.

2. Description of boat.
 Type _____ Color _____ Trim _____
 Registration No. _____ Length _____
 Name _____ Make _____ Other Info _____

3. Engine type _____ H.P. _____
 No. of Engines _____ Fuel Capacity _____

4. Survival equipment: (Check as appropriate)

<input type="checkbox"/> PFDS	<input type="checkbox"/> Flares	<input type="checkbox"/> Mirror
<input type="checkbox"/> Smoke Signals	<input type="checkbox"/> Flashlight	<input type="checkbox"/> Food
<input type="checkbox"/> Paddles	<input type="checkbox"/> Water	<input type="checkbox"/> Others
<input type="checkbox"/> Anchor	<input type="checkbox"/> Raft or Dinghy	<input type="checkbox"/> EPIRB

5. Radio Yes No Type _____

6. Automobile license _____
 Type _____ Trailer License _____
 Color _____ and make of auto _____

7. Persons aboard _____
 Name _____ Age _____ Address & telephone No. _____

8. Do any of the persons aboard have a medical problem?
 Yes No If yes, what? _____

9. Trip Expectations: Leave at _____
 From _____ Going to _____
 Expect to return by _____ (time)
 and no later than _____

10. Any other pertinent info. _____

11. If not returned by _____ (time)
 call the COAST GUARD, or (Local authority) _____

12. Telephone Numbers.

NOTES

Troubleshooting Guide

PROBLEM	CAUSE AND SOLUTION
CONTROL SYSTEMS	
Hydraulic steering is slow to respond & erratic and/or the steering wheel feels bumpy.	<ul style="list-style-type: none"> • Steering system is low on fluid. Fill and bleed system. • Steering system has air in it. Fill and bleed system. • A component in the steering system is binding. Check and adjust or repair binding component. • Engine steering spindle is binding. Grease spindles.
The boat wanders and will not hold a course at cruise speeds with hydraulic steering.	<ul style="list-style-type: none"> • There could be air in the steering system. Fill & bleed the system. • The engines are not aligned properly. Align engines. • Engine steering spindle is binding. Grease spindles.
Hydraulic steering is unusually hard.	<ul style="list-style-type: none"> • The fuse for the power steering circuit has blown. Replace the fuse. • An internal fuse in the power steering pump system has blown. Refer to the steering owners manual for fuse location and replace the fuse or contact your dealer for assistance. • A steering line is kinked or collapsed. Replace kinked or collapsed line.
An engine will not start with the shift control lever in neutral.	<ul style="list-style-type: none"> • The shift control lever is not in the neutral detent. Try moving the shift lever slightly. • There is a loose wire on the neutral safety switch in the control. Inspect wires and repair loose connections. • The starter or ignition switch is bad. • There is a problem with the electronic control system at the helm control, module or at the engine. Have the system serviced by a qualified marine technician.
PERFORMANCE PROBLEMS	
Boat is sluggish and has lost speed & RPM.	<ul style="list-style-type: none"> • The boat may be need to have marine growth cleaned from hull and running gear. • Propellers may be damaged & need repair. • Weeds or line around the propellers. Clean propellers. • Boat is overloaded. Reduce load. • Check for excessive water in the bilge. Pump out bilge & find & correct the problem. • One of the throttles is not responding properly and the engine is not getting full throttle. Have the throttle control system checked by a qualified marine technician.
The boat vibrates at cruising speeds.	<ul style="list-style-type: none"> • Propellers may be damaged & need repair. • A propeller or propeller shaft is bent. Repair or replace damaged components. • The running gear is fouled by marine growth or rope. Clean running gear. • The engines are not trimmed properly. Trim engines.

PROBLEM	CAUSE AND SOLUTION
ENGINE PROBLEMS	
<p>An engine is running too hot.</p>	<ul style="list-style-type: none"> • The engine raw water pick up strainer is clogged with marine growth. Clean pick up. • The engine raw water pump impeller is worn or damaged. Repair the pump. • The engine thermostat is faulty and needs to be replaced.
<p>An engine alternator is not charging properly.</p>	<ul style="list-style-type: none"> • The battery cable is loose or corroded. Clean and tighten battery cables. • The alternator is not charging and must be replaced. • The battery is defective. Replace the battery.
<p>An engine suddenly will not operate over 2000 RPM.</p>	<ul style="list-style-type: none"> • The engine emergency system has been activated. The on board computer has sensed a problem and has limited the RPM to protect the engine. Find & correct the problem. • The tachometer is bad and needs to be replaced. • A throttle control is not responding properly. Have the throttle setting checked by a qualified technician.
<p>An engine is loosing RPM. The boat is not overloaded and the hull bottom and running gear are clean and in good condition.</p>	<ul style="list-style-type: none"> • The engine may be having a problem with a sticky Anti-siphon valve, located in the fuel line near the fuel tank, that is restricting the fuel flow. Remove & clean or replace the Anti-siphon valve. • The remote gasoline fuel filter could be dirty. Inspect and replace the fuel filter. • The primary fuel filter on the engine may be dirty. Inspect and replace the fuel filter. • The electronic engine control system on the engine is malfunctioning. Repair the engine control system. • The fuel injection system on the engine is malfunctioning. Repair the fuel injection system.

PROBLEM	CAUSE AND SOLUTION
ACCESSORY PROBLEMS	
The baitwell pump runs, but does not pump water.	<ul style="list-style-type: none"> • The sea chest supply valve is not open. Open valve. • The sea chest intake strainers are clogged with weeds or debris. Clean the intake sea strainers. • There is an air lock in the system. Prime the system.
The fresh water pumps run, but will not pump water.	<ul style="list-style-type: none"> • The water tank is empty. Fill the tank. • The water pump strainers are clogged. Clean strainers. • The intake hose is damaged and sucking air. Replace or repair the hose. • The pump is defective. Repair or replace the pump.
The fresh water pumps fail to turn off after all outlets are closed.	<ul style="list-style-type: none"> • There is a leak in a pressure line or outlet. Repair the leak. • There is an air leak in the intake line. Repair the air leak. • The pressure switch is defective. Replace the pressure switch. • The voltage to the pump is low. Check for corroded or loose wiring connections or low battery. • The strainer is clogged. Clean strainer. • A pump is defective. Repair or replace the pump.
The washdown pump runs, but will not pump water.	<ul style="list-style-type: none"> • The sea chest supply valve is not open. Open valve. • There is an air leak in the intake line. Repair the air leak. • The sea chest intake strainers are clogged with weeds or debris. Clean the sea strainers
The washdown pump fails to turn off after all nozzles are closed.	<ul style="list-style-type: none"> • The intake hose is damaged and sucking air. Replace hose. • The pump is defective. Repair or replace the pump. • There is a leak in a pressure line or outlet. Repair the leak. • There is an air leak in the intake line. Repair the air leak. • The pressure switch is defective. Replace the pressure switch. • The voltage to the pump is low. Check for corroded or loose wiring connections or low battery.
Reduction in water flow from the bilge pump.	<ul style="list-style-type: none"> • The pump strainer is clogged. Clean strainer. • The pump is defective. Repair or replace the pump. • The discharge hose is pinched or clogged. Check discharge hose and clean or repair. • Low voltage to the pump. Check the battery and wire connections.

PROBLEM	CAUSE AND SOLUTION
ACCESSORY PROBLEMS	
<p>The automatic switch on the bilge pump does not activate the pump .</p>	<ul style="list-style-type: none"> • The fuse or circuit breaker for the automatic switch has tripped or blown. Replace the fuse or reset the circuit breaker. • The battery is dead. Charge or replace the battery. • The pump impeller is jammed by debris. Clean pump impeller housing. • The pump automatic switch has sensed excessive oil the bilge and shut the pump down. Clean the bilge and follow the pump manufacturer's instructions to clean and reset the pump. • The wire connections in the bilge have corroded. Replace connectors and secure above the bilge waterline. • The automatic switch is defective. Replace the switch. • The pump is defective. Replace pump.
<p>The bilge pump will not run when the manual switch is activated.</p>	<ul style="list-style-type: none"> • The circuit breaker or fuses supplying the switch has tripped or blown. Reset the circuit breaker or replace the fuse. • The battery switch is off. Turn on the battery switch. • The pump impeller is jammed by debris. Clean pump impeller housing. • The wire connections in the bilge have corroded. Replace connectors and secure above the bilge waterline. • The switch is defective. Replace the switch. • The pump is defective. Replace pump.
<p>Head will not flush.</p>	<ul style="list-style-type: none"> • The fuse or circuit breaker for the head circuit is blown. Replace the fuse or reset the breaker. • The holding tank is full. Pump out the holding tank. • There is bad connection at the head pump or the switch. Repair the connection. • The switch is defective. Replace the switch. • The head pump is defective. Replace the pump.
<p>Excessive odor from marine head.</p>	<ul style="list-style-type: none"> • Back pressure in the holding tank. Pump out holding tank and clean the vent and vent hose or replace the in-line filter. • No deodorizer in the holding tank. Add deodorizer to the holding tank each time it is pumped out. • The waste in the tank is over two weeks old. Pump the holding tank if it has contained waste for two weeks or more.
<p>Holding tank will not empty.</p>	<ul style="list-style-type: none"> • Holding tank vent is clogged. Clean the vent and vent hose. • There is a vacuum leak in the hose from the holding tank to the deck pump out fitting. Tighten loose fittings or replace damaged hoses.

PROBLEM	CAUSE AND SOLUTION
ACCESSORY PROBLEMS	
The air conditioner runs for a short time & then cuts out.	<ul style="list-style-type: none"> • The intake strainers for the sea chest are clogged with weeds or debris. Clean the sea strainers. • The air conditioner pump raw water supply valve is closed. Open the valve. • The air conditioner seawater pump is air-bound. Make sure the sea chest inlet and air conditioner supply valves are open and run the boat above 15 m.p.h. The scoops on the thru hull fittings will pressurize the sea chest and force the air lock through the pump. • The air conditioner raw water pump is not pumping and needs to be repaired or replaced.
The cabin or cockpit refrigerator compressor runs frequently and the house battery life seems shorter than it should be when the refrigerators are operating on DC power.	<ul style="list-style-type: none"> • The thermostat in the refrigerator is set too cold. Check the temperature in the refrigerator and set the thermostat to a warmer setting if necessary. • The door gasket is dirty or moldy and not sealing properly. Clean or replace the door seal. • The house battery is weak and not providing the proper voltage to the refrigerator compressor. Replace the battery. • The refrigerator is defective. Replace the refrigerator.
The carbon monoxide detector sounds the alarm when the engines or generator are running.	<ul style="list-style-type: none"> • The boat is operating at slow speed and the wind is on the stern pushing CO into the cockpit and cabin. Increase boat speed or change heading if possible. • The carbon monoxide detector is defective and needs to be calibrated by the manufacturer or replaced. Have the boat checked by a professional before condemning the CO monitor.
No AC power to the cabin AC panel and shore cord is properly connected.	<ul style="list-style-type: none"> • The breaker at the shore outlet is off. Activate breaker. • The shore power cord is damaged or defective. Replace the cord. • The ELCI at the inlet connection has detected a fault in the electrical system and the breaker has tripped. Contact a qualified marine electrician to find and correct the problem.
The Main Breaker for the cabin AC panel trips when activating the system from shore power.	<ul style="list-style-type: none"> • The AC accessory breakers on the distribution panel are on and the power surge is tripping the breaker. Turn off all AC accessory circuits and reactivate distribution panel. • The main breaker is defective. Contact a qualified marine electrician to replace the breaker.
The AC main breaker activates the panel but trips while using accessories.	<ul style="list-style-type: none"> • There are too many AC accessories activated causing excess amperage draw. Manage AC accessory use to reduce excess amperage draw. • Voltage supplied from the shore outlet is low or high. Check the voltage. Contact the marina operator or qualified marine electrician to correct the problem. • The main breaker is defective. Contact a qualified marine electrician to replace the breaker.

PROBLEM	CAUSE AND SOLUTION
ACCESSORY PROBLEMS	
<p>No AC power at outlets</p>	<ul style="list-style-type: none"> • Outlet breaker in AC panel is off. Activate breaker. • Ground fault interrupter on the GFI outlet has tripped. Push reset button on outlet to reset. • Accessory powered by the outlet has a fault that is tripping the interrupter. Turn the circuit in the distribution panel off and contact a qualified marine electrician to repair the defective accessory. Replace defective accessory. • The GFI outlet is defective. Contact a qualified marine electrician to replace the outlet.
<p>The generator will not start.</p>	<ul style="list-style-type: none"> • The battery switch in the systems room near the generator is off. Turn on the battery switch. • House battery is not charged. Charge or replace battery. • The generator fuel supply valve is off. Turn on fuel supply valve. • The fuel level is too low in the fuel tank. Fill the fuel tank.
<p>The generator runs for a short time and shuts down.</p>	<ul style="list-style-type: none"> • There is a problem with the generator and the emergency shut down system has activated to shut down the generator. Find and correct the problem, then restart the generator. • The fuel level is too low in the fuel tank that supplies the generator. Fill the fuel tank. • The generator is overloaded. Manage AC accessory use to reduce excess amperage draw.



Spearheading the Future of Fishing.

Scout Boats Inc.
2531 Hwy 78 West
Summerville, SC 29483