



Spearheading the Future of Fishing.

## 350 LXF

*Owner's Manual*



Scout Boats Inc.  
2531 Hwy 78 West  
Summerville, SC 29483

<https://www.boat-manuals.com/>



Your Scout manual has been written to include a number of safety instructions to assure the safe operation and maintenance of your boat. These instructions are in the form of **CAUTION**, **WARNING**, **DANGER** and **NOTICE** statements. The following definitions apply:

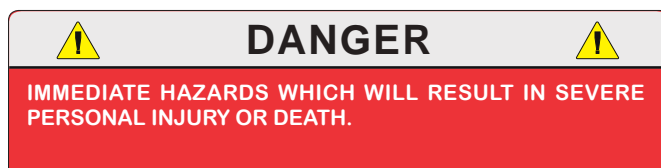

All instructions given in this book are as seen from the stern looking toward the bow, with starboard being to your right, and port to your left. A glossary of boating terms is included.

**IMPORTANT NOTE:** Your boat uses internal combustion engines and flammable fuel. Every precaution has been taken by Scout to reduce the risks associated with possible injury and damage from fire or explosion, but your own precaution and good maintenance procedures are necessary in order to enjoy safe operation of your boat.

THIS PAGE WAS LEFT BLANK  
INTENTIONALLY

# BOAT INFORMATION



Please fill out the following information section and leave it in your Scout Owner's Manual. This information will be important for you and Scout service personnel to know, if and when you may need to call Scout for technical assistance or service.

BOAT			
MODEL:		HULL SERIAL #:	
PURCHASE DATE:		DELIVERY DATE:	
IGNITION KEYS #:		REGISTRATION #:	
WEIGHT:	DRAFT:	BEAM:	VERTICAL CLEARANCE:
DOOR KEYS #:			
ENGINES			
MAKE:		MODEL:	
PORT SERIAL #:		STARBOARD SERIAL #:	
TRAILER			
MAKE:		MODEL:	
SERIAL #:		GVRW:	
TIRE SIZE:			
GENERATOR			
MAKE:		MODEL:	
SERIAL #:		KILOWATTS:	
PROPELLERS			
MAKE:		BLADES:	
DIAMETER/PITCH:		SHAFT:	
AIR CONDITIONERS			
MAKE:		MODEL:	
CABIN AC SERIAL #:		BTU OUTPUT:	
HELM AC SERIAL #:		BTU OUTPUT:	
DEALER		SCOUT BOATS	
NAME:		PHONE:	
DEALER/PHONE:		REPRESENTATIVE:	
SALESMAN:		ADDRESS:	
SERVICE MANAGER:			
ADDRESS:			
DEALER E-MAIL:		SCOUT E-MAIL:	

Scout reserves the right to make changes and improvements in equipment, design and vendored equipment items, at any time without notification.



# SPECIFICATIONS



HULL LENGTH OVERALL \_\_\_\_\_ 34' 11" / 10.6 m

BEAM \_\_\_\_\_ 10'9" / 3.2 m

DRY WEIGHT \_\_\_\_\_ 9,100 lbs / 4,127.7kg

DRY WEIGHT W/ TWIN YAMAHA 300'S \_\_\_\_\_ 10,300 lbs / 4,672kg

DRY WEIGHT W/ TWIN YAMAHA F350'S \_\_\_\_\_ 10,800;bs/ 4,898.8kg

FUEL CAPACITY \_\_\_\_\_ 330 gal / 1,249 ltr

WATER CAPACITY \_\_\_\_\_ 30 gal / 113.5 ltr

HOLDING TANK \_\_\_\_\_ 10 gal / 37.8 ltr

GENERATOR DIESEL TANK CAPACITY \_\_\_\_\_ 10 gal / 37.8 ltr

DEADRISE (approx) \_\_\_\_\_ 22 °

MAXIMUM HORSEPOWER \_\_\_\_\_ 700 HP / 522 kw

DRAFT W/ ENGINES UP (approx) \_\_\_\_\_ 27" / 0.69 m

DRAFT W/ ENGINES DOWN \_\_\_\_\_ 36" / .8 m

OUTBOARD SHAFT \_\_\_\_\_ 25" / 0.6 m

BRIDGE CLEARANCE WITH STANDARD OPTIONS & T-TOP \_\_\_\_\_ 8' 3" / 2.52 m

**Note: Dry weight is the average weight of the base boat without options, fuel, water, waste, batteries or gear.**



# CERTIFICATIONS & SPECIFICATIONS



\*\*\* For Export Only \*\*\*

To be in compliance with European directives for recreational boats as published by the International Organization for Standardization (ISO) in effect at the time this boat was manufactured, we are providing the following information.

## Manufacturer:

Name: Scout Boats

Address: 2531 Hwy 78 West

Summerville, South Carolina Zip Code: 29483

## Identification Numbers:

Hull Identification Number: \_\_\_\_\_

Port Engine Serial Number: \_\_\_\_\_

Starboard Engine Serial Number: \_\_\_\_\_

## Intended Design Category:

Ocean: \_\_\_\_\_ Inshore: \_\_\_\_\_

Offshore: X Sheltered Waters: \_\_\_\_\_

## Weight and Maximum Capacities:

Unladen Weight: - Kilograms (Pounds) \_\_\_\_\_

Maximum Load: - Weight - Kilograms (Pounds) \_\_\_\_\_

Number of People: \_\_\_\_\_

Maximum Rated Engine Horsepower - Kilowatts (Horsepower) \_\_\_\_\_

## Certifications:

Certifications & Components Covered: \_\_\_\_\_

\_\_\_\_\_

\_\_\_\_\_

\_\_\_\_\_



THIS PAGE WAS LEFT BLANK  
INTENTIONALLY



## Warranty and Warranty Registration Cards

The Scout Limited Warranty Statement is included with your boat. It has been written to be clearly stated and easily understood. If you have any questions after reading the warranty, please contact Scout Customer Service.

Scout, Yamaha Motor Corporation, engine manufacturers, and the suppliers of major components maintain their own manufacturer's warranty and service facilities. It is important that you properly complete the warranty registration cards included with your boat and engines and mail them back to the manufacturers to register your ownership. This should be done within 15 days of the date of purchase and before the boat is put into service. A form for recording this information is provided at the beginning of this manual. This information will be important for you and service personnel to know, if and when you may need service or technical information.

The boat warranty registration requires the Hull Identification Number "HIN" which is located on the starboard side of the transom, just below the rubrail. The engine warranty registration requires the engine serial numbers. Please refer to the engine owner's manual for the location of the serial numbers.

### IMPORTANT:

All boat manufacturers are required by the Federal Boat Safety Act of 1971 to notify first time owners in the event any defect is discovered "which creates a substantial risk of personal injury to the public." It is essential that we have your warranty registration card complete with your name and mailing address in our files so that we can comply with the law if it should become necessary.

## Product Changes

Scout is committed to the continuous improvement of our boats. As a result, some of the equipment described in this manual or pictured in the catalog may change or no longer be available. Scout reserves the right to change standard equipment, optional equipment and specifications without notice or obligation. If you have questions about the equipment on your Scout, please contact Scout Customer Service.



*Hull ID Number on Starboard Transom*

## Service

All warranty repairs must be performed by an authorized Scout Dealer. Should a problem develop that is related to faulty workmanship or materials, as stated in the Limited Warranty, you should contact your Scout dealer to arrange for the necessary repair. If you are not near your dealer or another authorized Scout dealer or the dealer fails to remedy the cause of the problem, then contact the Scout Customer Service Department within 15 days. It is the boat owner's responsibility to deliver the boat to the dealer for warranty service.

## Transferring The Warranty

For an administration fee of \$100, Scout will extend warranty coverage to subsequent owners of Scout models for the duration of the original warranty period. The Limited Warranty may be transferred to any subsequent purchaser of the vessel within seven years from the date of delivery to the original purchaser. Please refer to the Limited Warranty Statement for the procedure to transfer the warranty.

To take advantage of this program, notification of the change of ownership, including the new owner's name, address and telephone number together with the appropriate fee, must be sent

to Scout within 10 days of the date of resale. Scout will confirm, in writing, that the transfer of the warranty has taken place. After which, the transferee will be treated as the original purchaser as outlined in the Scout Boats Limited Warranty Statement.

## Yamaha Engine Warranty

Yamaha is ready to stand behind your purchase with strong warranty coverage. To be sure you receive all the benefits of warranty for your engines, please take the following steps:

- Be sure your new Yamaha is registered for warranty. Your boat dealer should do this at the time of sale. Make sure your dealer gives you a copy of the completed Yamaha registration card for your records.
- Read the Yamaha Limited Warranty statement. This warranty applies to Yamaha outboard motors sold in the United States, whether purchased separately or when supplied as original equipment by a boat builder.
- If you need warranty repairs, you must take your Yamaha outboard to an authorized Yamaha outboard dealer.
- If you are away from home, or your selling dealer is not an authorized Yamaha dealer, use the following toll-free numbers to find the nearest Yamaha dealer.

United States Dealer Locations:  
800-692-6242

Canada Dealer Locations:  
800-267-8577

- Your warranty applies specifically to repairs made in the country of purchase.
- If you need any additional information about your Yamaha or warranty coverage which your dealer cannot provide, please contact Yamaha Directly. Refer to your engine owner's manual for the address and phone number to contact Yamaha directly.

## TABLE OF CONTENTS

SAFETY INFORMATION .....	3
BOAT INFORMATION.....	5
SPECIFICATIONS.....	6
CERTIFICATIONS & SPECIFICATIONS.....	7
OWNER'S / OPERATOR'S INFORMATION .....	9

### **Chapter 1:** **PROPULSION SYSTEM**

1.1 General .....	15
1.2 Drive System Corrosion .....	15
1.3 Engine Lubrication.....	16
1.4 Engine Cooling System .....	16
1.5 Propellers .....	16
1.6 Performance Issues and Propellers .....	16
1.7 Engine Instrumentation .....	17

### **Chapter 2:** **HELM CONTROL SYSTEMS**

2.1 General .....	21
2.2 Engine Throttle and Shift Controls .....	21
2.3 Neutral Safety Switch .....	22
2.4 Engine Power Tilt and Trim.....	23
2.5 Engine Stop Switch .....	23
2.6 Steering System .....	24
2.7 Trim Tabs .....	24
2.8 Bow Thruster (Optional).....	25
2.9 Control Systems Maintenance.....	26

### **Chapter 3:** **FUEL SYSTEM**

3.1 General .....	29
3.2 Outboard Fuel System .....	30
3.3 Diesel Generator Fuel System.....	31
3.4 Fueling Instructions.....	32
3.5 Fuel System Maintenance.....	33

### **Chapter 4:** **ELECTRICAL SYSTEM**

4.1 General .....	35
4.2 12-Volt DC System.....	35
4.3 DC Power Management.....	45
4.4 120-Volt AC Electrical System .....	46
4.5 Generator .....	50
4.6 Bonding System and Galvanic Isolator .....	51
4.7 Electrical System Maintenance .....	51
4.8 AC Line Load Estimator.....	53

## **Chapter 5:**

### **FRESH WATER SYSTEM**

5.1 General .....	55
5.2 Fresh Water System Operation .....	55
5.3 Fresh Water System Maintenance.....	56

## **Chapter 6:**

### **RAW WATER SYSTEM**

6.1 General .....	59
6.2 Raw Water System Operation .....	60
6.3 Baitwell .....	60
6.4 Air Conditioning and Freezer Pump.....	61
6.5 Generator Raw Water Supply.....	61
6.6 Raw Water System Maintenance .....	62

## **Chapter 7:**

### **DRAINAGE SYSTEMS**

7.1 General .....	65
7.2 Hardtop Drains .....	65
7.3 Bilge Drainage.....	65
7.4 Cockpit and Deck Drainage.....	66
7.5 Console Cabin Drains.....	67
7.6 Drainage System Maintenance .....	67

## **Chapter 8:**

### **VENTILATION SYSTEM**

8.1 Cabin Ventilation.....	69
8.2 Windshield Ventilation .....	69
8.3 Carbon Monoxide and Proper Ventilation .....	70
8.4 Maintenance.....	71

## **Chapter 9:**

### **EXTERIOR EQUIPMENT**

9.1 Deck .....	73
9.2 Hull.....	75
9.3 Cockpit Features .....	77
9.4 Center Console and Cabin .....	81
9.5 Aftermarket Hardtop or Tower .....	86

## **Chapter 10:**

### **INTERIOR EQUIPMENT**

10.1 Inner Console Cabin .....	87
10.2 Marine Head System .....	90
10.3 Cabin Air Conditioner (Optional).....	92
10.4 Cabin Woodwork .....	93

## **Chapter 11:**

### **SAFETY EQUIPMENT**

11.1 General.....	95
11.2 Engine Alarms.....	95
11.3 Neutral Safety Switch .....	95
11.4 Engine Stop Switch.....	95
11.5 Required Safety Equipment.....	96
11.6 Carbon Monoxide Monitoring System .....	98
11.7 First Aid.....	99
11.8 Additional Safety Equipment.....	99
11.9 Caution and Warning Labels.....	100

## **Chapter 12:**

### **OPERATION**

12.1 General.....	101
12.2 Rules of the Road.....	101
12.3 Pre-Cruise Check.....	104
12.4 Operating Your Boat .....	105
12.5 Docking, Anchoring and Mooring .....	106
12.6 Controls, Steering, or Propulsion System Failure: .....	109
12.7 Collision.....	109
12.8 Grounding, Towing and Rendering Assistance.....	109
12.9 Flooding or Capsizing.....	109
12.10 Fishing.....	110
12.11 Man Overboard .....	110
12.12 Tower Operation.....	110
12.13 Trash Disposal .....	112
12.14 Transporting Your Boat.....	112

## **Chapter 13:**

### **ROUTINE MAINTENANCE**

13.1 Exterior Hull and Deck .....	115
13.2 Upholstery, Canvas and Enclosures.....	118
13.3 Interior .....	120
13.4 Bilge.....	120
13.5 Drainage System.....	121

## **Chapter 14:**

### **SEASONAL MAINTENANCE**

14.1 Storage and Lay-up.....	123
14.2 Winterizing.....	125
14.3 Recommissioning .....	128

## **Appendix A:**

### **SCHEMATICS**

<i>AC/DC Electrical Panel</i> .....	129
<i>Battery Selector Switch Panel</i> .....	130
<i>Console Harness</i> .....	131
<i>Deck Wire Harness 12V</i> .....	132
<i>Deck Wire Harness 110V</i> .....	133
<i>Hull Harness 12V</i> .....	134
<i>Hard Top Harness 12V</i> .....	135
<i>Drainage System</i> .....	136
<i>Freshwater System</i> .....	137
<i>Fuel System</i> .....	138
<i>Propulsion System</i> .....	139
<i>Raw Water System</i> .....	140
<i>Hydraulic Steering System</i> .....	141
<i>Waste System</i> .....	142

## **Appendix B:**

<i>GLOSSARY OF TERMS</i> .....	143
--------------------------------	-----

## **Appendix C:**

<i>MAINTENANCE SCHEDULE AND LOG</i> .....	147
---	-----

## **Appendix D:**

<i>BOATING ACCIDENT REPORT</i> .....	153
--------------------------------------	-----

## **Appendix E:**

<i>FLOAT PLAN</i> .....	157
-------------------------	-----

## **Appendix F:**

<i>TROUBLESHOOTING GUIDE</i> .....	159
------------------------------------	-----

## PROPULSION SYSTEM

### 1.1 General

Your Scout is designed to be powered with 4-cycle outboard motors. 4-cycle outboard engines do not use an oil injection system and are not equipped with remote oil tanks. They have an oil sump in the crankcase that must be kept full of the type of oil recommended by the engine manufacturer. The oil must be checked before each use and changed regularly.

Each manufacturer of the various outboard motors provides an owner's information manual with its product. It is important that you read the manual(s) very carefully and become familiar with the proper care and operation of the engines and drive systems. A warranty registration card has been furnished with each new engine and can be located in the engine owner's manual. All information requested on this card should be filled out completely by the dealer and purchaser and then returned to the respective engine manufacturer as soon as possible.



*Outboard Engines*

	<b>CAUTION</b>	
<p>DO NOT ATTEMPT TO SERVICE ANY ENGINE OR DRIVE COMPONENT WITHOUT BEING TOTALLY FAMILIAR WITH THE SAFE AND PROPER SERVICE PROCEDURES. CERTAIN MOVING PARTS ARE EXPOSED AND CAN BE DANGEROUS TO SOMEONE UNFAMILIAR WITH THE OPERATION AND FUNCTION OF THE EQUIPMENT.</p>		

	<b>WARNING</b>	
<p>DO NOT INHALE EXHAUST FUMES! EXHAUST CONTAINS CARBON MONOXIDE THAT IS COLORLESS AND ODORLESS. CARBON MONOXIDE IS A DANGEROUS GAS THAT IS POTENTIALLY LETHAL.</p>		

### 1.2 Drive System Corrosion

Each outboard motor is a complete drive system with the gear case being just forward of the propeller and connected to the power head with a vertical drive shaft. All engines require some maintenance. Routine maintenance recommend-

ed for your engine is outlined in the engine owner's manual. Routine maintenance is normally the primary concern unless the boat is to be kept in saltwater for extended periods of time. Then the main concerns are marine growth and galvanic corrosion.

Marine growth occurs when components are left in the water for extended periods and can cause poor performance or permanent damage to the exposed components. The type of growth and how quickly it occurs is relative to the water conditions in your boating area. Water temperature, pollution, current, etc. can have an effect on marine growth.

Galvanic corrosion is the corrosion process occurring when different metals are submerged in an electrolyte. Seawater is an electrolyte and submerged engine components must be properly protected. Outboard motors are equipped with sacrificial anodes to prevent galvanic corrosion problems. The anodes must be monitored and replaced as necessary. For locations and maintenance, please refer to the engine owner's manual.

When leaving the boat in the water, tilt the motors as high as possible. This will decrease the risk of marine growth around the cooling inlets, propeller and exhaust ports and damage from galvanic corrosion.



## CAUTION



DO NOT PAINT THE OUTBOARD MOTOR WITH ANTIFOULING PAINTS DESIGNED FOR BOAT HULLS. MANY OF THESE PAINTS CAN CAUSE SEVERE DAMAGE TO THE ENGINE. CONTACT YOUR SCOUT DEALER OR ENGINE MANUFACTURER FOR INFORMATION ON THE PROPER PAINTING PROCEDURES.

### 1.3 Engine Lubrication

4-cycle outboard engines incorporate a pressure-type lubrication system with an oil sump in the crankcase that must be kept full of the type and grade of oil recommended by the engine manufacturer. It is normal for 4-cycle engines to consume a small amount of oil. Therefore, the oil must be checked before each use and changed at regular intervals as instructed by the engine owner's manual.

#### NOTICE:

**Always monitor the oil level in the crankcase and only use the type of oil specified by the engine manufacturer. Yamaha engines specify Yamalube engine oil.**

### 1.4 Engine Cooling System

Outboard engines are raw water (seawater) cooled. Water is pumped through the water inlets, circulated through the engine block, and relinquished with the exhaust gases through the propeller hub. The water pump uses a small impeller made of synthetic rubber. The impeller and water pump cannot run dry for more than a few seconds. In most outboard motors, some cooling water is diverted through ports below the engine cowling. This allows the operator to visually check the operation of the cooling system. When the engine is started, always check for a steady stream of water coming out of those ports.

#### NOTICE:

**If the boat is used in salt or badly polluted water, the engines should be flushed after each use. Refer to the engine owner's manual for the proper engine flushing procedure.**



## CAUTION



NEVER RUN AN OUTBOARD MOTOR WITHOUT WATER FLOWING TO THE WATER PUMP. SERIOUS DAMAGE TO THE WATER IMPELLER OR ENGINE COULD RESULT.



*Yamaha Saltwater Series Propeller*

### 1.5 Propellers

The propellers convert the engine's power into thrust. They come in a variety of styles, diameters and pitches. All boats powered by Yamaha engines are equipped with Yamaha propellers. The one that will best suit the needs of your boat will depend somewhat on your application and expected average load. Propeller sizes are identified by two numbers stamped on the prop in sequence. The 1st number in the sequence (example 14" x 21") is the diameter of the propeller, and the 2nd number is the pitch. Pitch is the theoretical distance traveled by the propeller in each revolution.

Always repair or replace a propeller immediately if it has been damaged. A damaged and therefore out of balance propeller can cause vibration that can be felt in the boat and could damage the engine gear assembly. Refer to the engine owner's manual for information on propeller removal and installation.

### 1.6 Performance Issues and Propellers

It is extremely important that the boat is propped to run at or very near the recommended top RPM with an average load. If the top RPM is above or below the recommend range, the propellers must be changed to prevent loss of performance and possible engine damage.



Your boat is equipped from the factory with counter rotating engines that are mounted to achieve quicker planing and optimum performance. Therefore, the left rotation engine is mounted on the port side of the transom and the right rotation engine is mounted on the starboard side. You should make sure that each propeller matches the rotation of the engine.

**NOTICE:**

**Before changing propellers to correct boat performance problems, be sure other factors such as engine tuning, bottom and running gear growth, etc. are not the source of performance changes. Always be sure the load conditions are those normally experienced, before changing propellers.**

Your boat was shipped with propellers that typically provide optimum performance for your boat. However there are factors that can affect performance and propeller requirements.

**Some are as follows:**

- You should be sure the load conditions are those normally experienced. If the boat ran in the required RPM range when it was new and you have not added any additional gear or heavy equipment and have not damaged the propellers, there is a good chance the propellers are not the problem.
- The addition of heavy equipment like a tower, life rafts, additional coolers, etc., will cause additional load on the engines. Consequently, different propellers may be required.
- Boats operated at high altitudes (above 2000 feet). Engines operated at high altitudes will not be able to develop as much horsepower as they do at or near sea level. Consequently, different propellers may be required.

**NOTICE:**

**Outboard engines can be damaged and the warranty void if the boat is not propped correctly. Always consult your Scout dealer or authorized engine service dealer when making changes to the propellers or if the boat does not run near the top recommended RPM.**



*Yamaha Command Link Plus Display*

## 1.7 Engine Instrumentation

The helm station is equipped with a set of engine instruments and/or alarms. These instruments allow the operator to monitor the operational condition of the engines. Close observation of these instruments allows the operator to operate the engines at the most efficient level and could save them from serious costly damage.

Most Scout boats are equipped with Yamaha engines and Command Link® multifunction instruments. These instruments can be integrated with the optional electronic navigation equipment installed on your boat. A brief description of those instruments and their basic functions are listed in this section. Other functions that are dependent on the electronics installed on your boat may be available. Please refer to the Yamaha engine and Command Link® owner's manuals and the manuals for the electronics installed on your boat for detailed information on the operation of the instruments and additional functions available. The instrumentation is unique to the type of outboard motors installed on your Scout.

**Some or all of the following gauges may be present.**

### Tachometers

The tachometers display the speed of the engines in revolutions per minute (RPM). This speed is not the boat speed or necessarily the speed of the propeller. Analog tachometers may not register zero with the key in the OFF position.

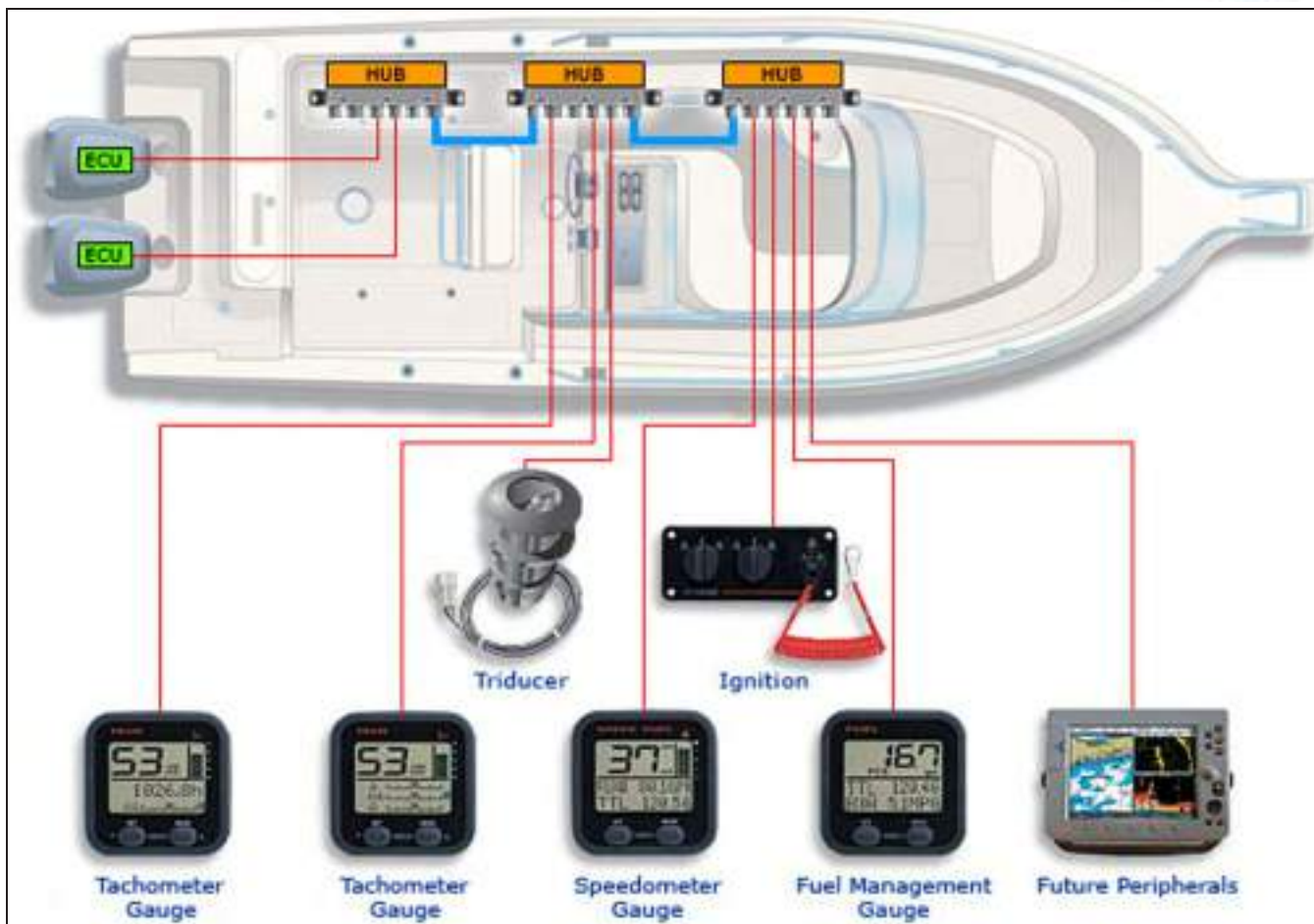

Yamaha Command Link® Instruments and Optional Peripherals Integration

Yamaha tachometers also contain the engine trim meter, oil level (2-cycle engines) or oil pressure indicator (4 stroke engines), water pressure and the overheat warning indicator.

low fuel warning light, a trip meter, a clock and a voltmeter.

**CAUTION**

**NEVER EXCEED THE MAXIMUM RECOMMENDED OPERATION RPM OF THE ENGINES. MAINTAINING MAXIMUM, OR CLOSE TO MAXIMUM RPM FOR EXTENDED PERIODS CAN REDUCE THE LIFE OF THE ENGINES.**

Yamaha Command Link® speedometers can indicate boat speed via the engine pickup or an optional GPS or depth sounder triducer, if these options are installed in your boat. Refer to the engine gauge and electronics operating manuals for more information on the speedometer options available for your boat.

## Speedometer

The speedometer indicates the speed of the boat in miles per hour. Most speedometers measure the water pressure against a small hole in a pickup tube located in the engine lower unit or mounted on the bottom of the transom. Yamaha speedometers also contain the fuel meters and

## Overheat Warning Indicator

The temperature warning indicates that the temperature of the engine is too high. A sudden increase in the temperature could indicate an obstructed water inlet or an impeller failure. On Yamaha engines the overheat warning indicator is built into each tachometer and will start to blink if the engine temperature is too high.

**CAUTION**

CONTINUED OPERATION OF AN OVERHEATED ENGINE CAN RESULT IN ENGINE SEIZURE. IF AN UNUSUALLY HIGH TEMPERATURE READING OCCURS, SHUT THE ENGINE OFF IMMEDIATELY. THEN INVESTIGATE AND CORRECT THE PROBLEM

## Fuel Gauge

The fuel gauge indicates the amount of fuel in the fuel tanks.

On boats equipped with Yamaha engines, the fuel gauge is built into the Yamaha speedometer multi-gauge. The fuel indicator on the Yamaha gauge will begin to blink if the fuel in the tank drops too low.

## Voltmeters

The voltmeters display the voltage for the battery and the charging system for each engine. The normal voltage is 11 to 12-volts with the engines off, and 13 to 14.5 volts with the engines running. The Yamaha engine voltmeter is built into the speedometer. It will begin to blink if the voltage in the battery drops too low.

## Hour Meters

The hour meters keep a record of the operating time for each engine.

## Engine Tilt/Trim Gauges

The tilt/trim gauges monitor the position of each outboard engine. The upper range of the gauge indicates the tilt, which is used for trailering and shallow water operation. The lower range indicates the trim position. This is the range used to adjust the hull angle while operating your boat on plane. The Yamaha engine trim indicator is built into the tachometers. Please refer to the engine owner's manual for more information on the operation of the outboard power tilt and trim.

## Engine Alarms

All outboards are equipped with an audible alarm system mounted in the helm area that monitors selected critical engine systems. The alarm will sound if one of these systems begins to fail. Refer to the engine owner's manual for information on the alarms installed with your engines.



Compass

**CAUTION**

IF THE ENGINE ALARM SOUNDS, IMMEDIATELY SHUT OFF THE ENGINE UNTIL THE PROBLEM IS FOUND AND CORRECTED.

## Fuel Management

Fuel management systems are standard equipment with some outboard engines. On Yamaha® engines, the fuel management gauge is a multi-function gauge used to monitor the gallons per hour, miles per gallon, total gallons used, total gallons remaining and engine synchronization.

If you have a fuel management system installed on your boat, please refer to the engine or fuel management manual for detailed information on that system.

## Depth Gauge (Optional)

The depth gauge indicates the depth of the water below the bottom of the boat.

## Compass

All boats are equipped with a compass on the top of the instrument panel. The compass cannot be adjusted accurately at the factory as it must be compensated for the influence of the electrical equipment and electronics unique to your boat. Therefore, the compass should be adjusted by a professional after the electronics and additional electrical accessories are installed and before operating the boat. To adjust the compass for your area, read the instructions on "Compass Compensation" given to you in the literature packet.

## Instrument Maintenance

Electrical protection for instruments and ignition circuitry is provided by a set of fuses or circuit breakers located on each engine. The ignition switches should be sprayed periodically with a contact cleaner/lubricant. The ignition switches and all instruments, controls, etc. should be protected from the weather when not in use. Excessive exposure can lead to gauge and ignition switch difficulties.

# HELM CONTROL SYSTEMS

## 2.1 General

The helm controls consist of three systems: the engine throttle and shift controls, the steering system, and the trim tab control switches. These systems provide the operator with the ability to control the direction and attitude of the boat from the helm station.

In addition to the primary helm controls, your boat could be equipped with an optional bow thruster that provides the operator additional control of the bow while docking or anchoring the boat in tight quarters or high winds and strong currents.

Each manufacturer of the control components provides an owner's manual with its product. It is important that you read the manuals and become familiar with the proper care and operation of the control systems.

## 2.2 Engine Throttle and Shift Controls

### Electronic Engine Controls

Electronic engine controls are standard on the Yamaha F300 and F350 engines. The following control description is typical of most electronic control installations.

The helm is designed for a binnacle style control with a single lever for each engine. The electronic control system consists of three major components: the electronic control head, Command Link instruments and keypad, the control processors and applicable harnesses. The controls are completely electronic and there are no cables.

The controls have a single lever for each engine that operates as a gearshift and a throttle. General operation will include a position for neutral (straight up and down or slightly aft of vertical), a forward position (the 1st detent forward of neutral), and a reverse position (the 1st detent aft of neutral). Advancing the control lever beyond the shift range advances the throttle in forward or reverse. Each control is equipped with a means of permitting the engine to be operated at a higher than idle RPM while in neutral for cold starting and warm-up purposes. The control levers are



*Yamaha Engine Controls*

equipped with adjustable control head detent and friction settings.



The engine controls and Command Link key pads have integrated switches and indicator lights which allow the operator to control all aspects of the boat's propulsion system. LED lights on the control pad indicate that the control is activated and the engines can be started.

### **The most common features activated or monitored by the keypad are:**

- Starter lockout, which prevents the engine from being started in gear.
- Gear lockout, which allows the engine RPM to be advanced in neutral safely.
- Battery voltage warning indicator that warns the operator of high or low voltage supplied to the system (audible alarm)

- An engine synchronization feature that automatically keeps both engines at the same RPM while cruising. Refer to Engine Synchronizing in this section and the control systems owner's manual for more information regarding engine synchronization.
- Trolling feature that allows the operator to increase the engine speed in 50 RPM increments while operating at trolling speeds between 600 - 1000 RPM.
- Station transfer that allows the operator to transfer control from one station to another with the push of a button on boats with two helm stations. Each station must be selected before the controls will operate from that station.

These features and others not mentioned require specific procedures to activate and operate them properly. Some of the procedures and features are unique to the engines and other options installed on your boat. It is essential that you read the owner's manual for the controls and be completely familiar with their operation before using your boat.

	<b>CAUTION</b>	
<b>ALWAYS RETURN THE ENGINE THROTTLE LEVER TO THE EXTREME LOW SPEED POSITION BEFORE SHIFTING. NEVER SHIFT THE UNIT WHILE ENGINE SPEED IS ABOVE IDLE RPM.</b>		

## Engine Synchronizer

During most operations of a twin engine boat, it is advantageous for both engines to be operated at the same RPM. This reduces noise and vibration and can increase engine efficiency. Setting the throttles so that the engines are running the same RPM (synchronized) can be done by listening to the engine sounds at low RPM and with the automatic synchronizer feature built into the electronic engine controls when the engines are operating above 1000 RPM. Attempting to synchronize the engines solely by using the tachometer readings or control lever placement generally will not work. When the engines are in proper synchronization, the throttle levers may not necessarily be even.



Please refer to the engine or control owner's manuals for more information on the engine synchronizer and other features for the electronic controls installed on your boat.

## 2.3 Neutral Safety Switch

Every control system has a neutral safety switch incorporated into it. This device prohibits the engine from being started while the shift lever is in any position other than the neutral position. If the engine will not start, slight movement of the shift lever may be necessary to locate the neutral position and disengage the safety cutout switch. Control or cable adjustments may be required to correct this condition should it persist. See your Scout dealer for necessary control and cable adjustments.

The neutral safety switches should be tested periodically to ensure that they are operating properly. To test the neutral safety switches, make sure the engines are tilted down and move the shift levers to the forward position.

Make sure the throttle control levers are not advanced past the idle position. Turn the ignition key to the start position just long enough to briefly engage the starter for the engine. Do not hold the key in the start position long enough to start the engine. The starter should not engage for either engine. Repeat this test with the shift levers in reverse and the engine throttles at idle. Again, the starter should not engage for either engine. If the starter for either engine engages with the shift controls in any position other than the neutral position, then the neutral safety switch is not functioning properly and you should contact your dealer to have the neutral safety switch repaired by a qualified marine mechanic before using the boat. If an engine starts in gear during this test, immediately move the control lever to the neutral position and turn the engine off.

	<b>WARNING</b>	
<b>IN SOME SITUATIONS, IT MAY BE POSSIBLE TO ACCIDENTALLY START THE ENGINES IN GEAR WITH THE THROTTLES ABOVE IDLE IF THE NEUTRAL SAFETY SWITCH IS NOT OPERATING PROPERLY. THIS WOULD CAUSE THE BOAT TO ACCELERATE UNEXPECTEDLY IN FORWARD OR REVERSE AND COULD RESULT IN LOSS OF CONTROL, DAMAGE TO THE BOAT, OR INJURY TO PASSENGERS. ALWAYS TEST THE NEUTRAL SAFETY SWITCH PERIODICALLY AND CORRECT ANY PROBLEMS BEFORE USING THE BOAT.</b>		

## 2.4 Engine Power Tilt and Trim

All outboard engines have a tilt and trim feature. Most outboard engines have tilt/trim switches built into the engine shift and throttle controls that allow the operator to control the position of the outboards from the helm. Typically, a switch or switches on the port control lever grip activates the tilt/trim for the engines. Yamaha engine controls have two switches on the cover that activate each engine tilt/trim individually. The maximum tilt angle on the Yamaha F350 engines is preset at the factory. If necessary, the maximum tilt angle can be adjusted by your Scout or Yamaha dealer by reprogramming the settings using the Yamaha engine diagnostic system.

Moving the outboard closer to the boat transom is called trimming "in" or "down." Moving the outboard further away from the boat transom is called trimming "out" or "up." In most cases, the boat will run best with the outboard adjusted so the hull will run at a 3 to 5 degree angle to the water.

The term "trim" generally refers to the adjustment of the outboard within the first 20° range of travel. This is the range used while operating your boat on plane. The term "tilt" is generally used when referring to adjusting the outboard further up for shallow water operation or trailering. For information on the proper use and maintenance of the power tilt and trim, please refer to the engine owner's manual.



Helm



Yamaha Key Switch, Start/Stop Buttons and Engine Stop Switch

**CAUTION**

THE ENGINE HOSES AND CABLES OR THE TRANSOM GEL COAT CAN BE DAMAGED BY TILTING THE ENGINES TO THE FULL UP POSITION WITH THE ENGINES TURNED TO THE WRONG POSITION. MOST BOATS REQUIRE THE STEERING WHEEL TO BE TURNED COMPLETELY TO STARBOARD BEFORE TILTING THE ENGINES TO THE FULL UP POSITION. YOU SHOULD MONITOR EACH ENGINE AS IT TILTS TO DETERMINE BEST FULL TILT ENGINE POSITION FOR YOUR BOAT.

**CAUTION**

SOME AUTOPILOTS HAVE ENGINE POSITION SENSORS THAT ARE MOUNTED TO THE HYDRAULIC STEERING CYLINDER. WITH THESE AUTOPILOTS, THE ENGINE POSITION SENSOR BRACKET COULD HIT THE TRANSOM WHEN THE ENGINES ARE TILTED TO THE FULL UP POSITION AND CAUSE DAMAGE TO THE ENGINE RIGGING, THE AUTOPILOT OR THE TRANSOM. IF YOU HAVE AN AUTOPILOT INSTALLED ON YOUR BOAT, YOU SHOULD MONITOR THE LOCATION OF THE ENGINE CABLES AND AUTOPILOT BRACKETS AS THE ENGINES ARE TILTED TO DETERMINE THE BEST ENGINE POSITION AND MAXIMUM ENGINE TILT FOR YOUR APPLICATION.

## 2.5 Engine Stop Switch

Your boat is equipped with an engine stop switch and lanyard. When the lanyard is pulled it will engage the switch and shut off the engines. We strongly recommend that the lanyard be attached to the driver whenever the engines are running. If an engine will not start, it could be because the lanyard is not properly inserted into the engine stop switch. Always make sure the lanyard is properly attached to the engine stop switch before attempting to start the engines.

Refer to the engine owner's manual for more information on the engine stop switch.

## 2.6 Steering System

### Power Assist Hydraulic Steering

The steering system on your boat is power assisted and comprised of two circuits: a manual system, which is the control element, and a hydraulic power pump, which is the working element.

The manual system is hydraulic and made of three main components: the helm assembly, hydraulic hoses and a hydraulic steering cylinder. The helm unit acts as both a fluid reservoir and pump. Turning of the helm, or steering wheel, pumps the fluid in the hydraulic hoses and activates the hydraulic cylinder causing the motors to turn. A slight clicking sound may be heard as the wheel is turned. This sound is the opening and closing of valves in the helm unit and is normal.

The power system is an electronically controlled, 12-volt hydraulic pump that boosts the fluid pressure being sent from the helm pump to the steering cylinder to provide "Power" for the steering system which results in much easier effort at the steering wheel, even under heavy loads. In the event of a power loss or failure of the steering pump, the steering system will automatically revert to a manual hydraulic system.

### Steering Cylinders and Tie Bar

Dual outboards are coupled near the tiller arms by a tie bar and controlled by two steering cylinders. There is one cylinder on the port engine and one on the starboard engine. The engines must be aligned to provide maximum stability on straight ahead runs and proper tracking through corners. Dual outboards are aligned so the engines are towed in slightly (.25" to .5") at the propellers. Engine or steering system damage may require the engines to be realigned.

## 2.7 Trim Tabs

The trim tabs are mounted below the swim platform and integrated transom engine mounting system. The trim tabs can be activated manually or automatically with a system called Auto Glide. The Auto Glide system can be set to control your trim tabs from the time you leave the dock until you come home again. It uses engine data and GPS data to drive your boat to the most efficient running angle by adjusting the trim tabs as needed. The running angle is optimized and programmed into the system during the set up process by your dealer.



*Steering Wheel*



*Steering Cylinders and Tie Bar*

The Auto Glide has 3 automatic operational modes, 4 automatic settings, and 2 manual operational modes. Although most operators will run with Auto Glide in automatic mode, you may immediately convert to manual mode simply by pressing one of the 4 up/down buttons on the key pad. The trim tabs can be programmed to automatically retract when the engine are shutdown to keep the actuators clean and set the tabs in the full "UP" position when leaving the dock. Refer to the trim tab operating manual for more information on the operation and programming of the trim tabs.

The following procedure should be followed when operating the trim tabs in manual mode. Before leaving the dock, make sure that the tabs are in the full "UP" position. Always establish the intended heading and cruise speed before attempting to manually adjust the hull attitude with the trim tabs. After stabilizing speed and direction, move the trim tabs to achieve a level side to side running attitude being careful not to over trim.



After depressing a trim tab switch, always wait a few seconds for the change in the trim plane to take effect. Avoid depressing the switch while awaiting the trim plane reaction. By the time the effect is noticeable the trim tab plane will have moved too far and thus the boat will be in an overcompensated position.

When running at a speed that will result in the boat falling off plane, lowering the tabs slightly, bow down, will improve the running angle and operating efficiency. Too much bow down tabs can reduce operating efficiency and cause substantial steering and handling difficulties.

Be extremely careful when operating in a following sea. The effect of trim tabs is amplified under such conditions. Steering and handling difficulties can result from improper trim tab usage, particularly in a following sea. Always raise the tabs to the full bow up position in these conditions.

When running at high speeds be sure that the tabs are in the full "UP" position. Only enough trim plane action should be used to compensate for any listing. Trim tabs are extremely sensitive at high speeds. Adjust for this and be prepared to slow down if difficulties arise.

When running into a chop, a slight bow down attitude will improve the ride. Be careful not to over trim. Handling difficulties may result.

## 2.8 Bow Thruster (Optional)

The optional bow thruster provides the operator additional control of the bow while docking or anchoring the boat in tight quarters or high winds and strong currents. The control Joystick/touch pad is located in the helm and controls the bow thruster that is mounted to the hull in the bilge below the V-berth.

The momentary touch pad buttons and Joystick are activated by the pressing and holding the power button in the touch pad for 1 second. Press the button or move the joystick for the direction you wish to thrust. Press the opposite button or move joystick to change direction. A 1 second delay protects the thruster when the direction is changed. The arrow on each button indicates the direction the bow will move when it is pressed. The bow thruster will stop when the button or joystick is released.



*Lenco Auto Glide Trim Tab Switch*



*Bow Thruster Touch Pad and Joystick*

Press and hold the power button for 1 second to deactivate the bow thruster control pad. The bow thruster will power down automatically if it is operated constantly for 3 minutes or senses no operation for 15 minutes.

The bow thruster circuit is protected by a fuse and emergency shut off button/battery switch located in the forward bilge compartment below the v-berth. It is activated automatically when the thruster control panel is switched on and turns off when the panel is deactivated. It can also be activated manually with the red knob on the switch.

Refer to the bow thruster owner's manual for details on operating the bow thruster and using the control pad.



## 2.9 Control Systems Maintenance

### Control Maintenance

Periodic inspection of the control systems and all connections should be made. Signs of rust, corrosion, wear, or other deterioration should immediately be serviced. Generally, periodic lubrication of all moving parts and connections with a light waterproof grease is in order.

Lubrication should be performed as often as necessary to keep the system operating smoothly.

Control system adjustments may become necessary. If adjustments become necessary, see your Scout dealer.

 **WARNING** 

**DO NOT ATTEMPT CONTROL ADJUSTMENTS UNLESS YOU ARE FAMILIAR WITH SERVICING CONTROL SYSTEM PROCEDURES. CONTROL MISADJUSTMENT CAN CAUSE LOSS OF CONTROL AND SEVERE ENGINE OR LOWER UNIT DAMAGE.**

### Steering System Maintenance

A periodic inspection of all steering hoses, linkage and helm assemblies should be made. Signs of corrosion, cracking, loosening of fastenings, excessive wear, or deterioration should be immediately corrected. Failure to do so could lead to steering system failure that would result in loss of control.

When new, or after repairs, hydraulic steering systems may need to have all air purged from the system. Check the steering fluid level in the helm, it should be maintained at no less than 1/2" below the bottom of the filler cap threads.

When new, or after repairs, hydraulic steering systems may need to have all air purged from the system. If your boat is equipped with a tower and two helms, the bottom helm fill plug is sealed and the steering fluid is checked and filled at the top helm.

Remove, clean and grease the engine support tube and rod annually with quality marine grease. Refer to the hydraulic steering manufacturer owner's manual for proper specifications and details on system service and maintenance.

### Trim Tab Maintenance

The trim tab actuators are electric and require no routine maintenance except to periodically inspect the tab actuators for corrosion or marine growth and test the system to ensure that it is operating properly.

Marine growth can interfere with the proper operation of the trim tab planes and actuators. To reduce problems due to marine growth, always return the trim tabs to the full "UP" position after operating the boat and periodically inspect and clean marine growth from the actuators and planes.

If the boat is kept in the water, the trim tabs must be equipped with a zinc anode to prevent galvanic corrosion. Galvanic corrosion is the corrosion process occurring when different metals are submerged in an electrolyte. Seawater is an electrolyte and submerged metal components must be properly protected. The anodes will need to be changed when they are 75% of their original size. Refer to the Routine Maintenance chapter of this manual for information on maintaining zinc anodes.

To discourage any marine growth on the tabs or actuators, antifouling paint can be applied. When applying paint to the actuator, make sure it is fully retracted. Do not paint the stainless ram above the area that is exposed when retracted. The bottom paint will damage the O-ring seals when the ram is retracted and allow seawater to enter the actuator motor. Contact your dealer or the trim tab manufacturer for information regarding the correct bottom paint for the trim tabs.

Refer to the trim tab owner's manual for additional maintenance information, specifications, troubleshooting and operating instructions.

## Bow Thruster (Optional)

The bow thruster is mounted in the forward bilge below the V-berth. Periodically inspect the components inside the hull for leaks and for loose or corroded electrical connections. Signs of leaks and loose or corroded electrical connections should be corrected immediately by a qualified marine technician.

Marine growth, weeds and debris can interfere with the proper operation of the bow thruster so it is necessary to check the tunnel regularly and clean as necessary. This is particularly important when operating in areas with weeds or if the thruster is not responding normally. You should also check the propeller. If the propeller is damaged or heavily contaminated, it should be replaced.

The thruster is protected from galvanic corrosion by an anode on the propeller shaft. The anode should be inspected regularly and changed when it is 75% of its original size.

If the boat is kept in the water, the anode should be inspected at least once every 3-4 months. Antifouling paint can be applied to the tunnel and underwater components to discourage marine growth. Bow thrusters have specific requirements for the type of antifouling paint that can be used and where it can be applied. Applying the wrong paint or paint that is not applied correctly can damage the bow thruster and void the warranty. Contact your authorized Scout dealer or the bow thruster manufacturer for information regarding the correct bottom paint and application.

Refer to the bow thruster owner's manual for additional maintenance information, specifications, troubleshooting and operating instructions.

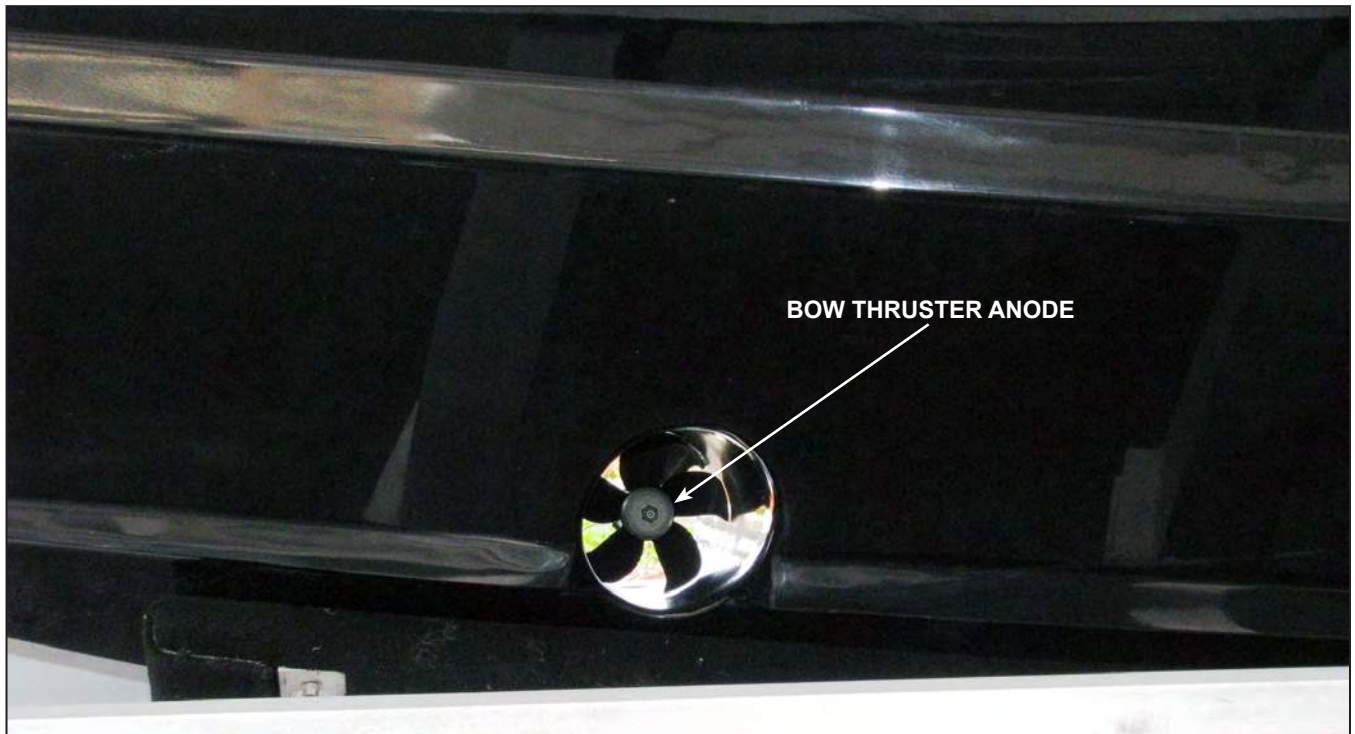

*Optional Bow Thruster and Anode*

THIS PAGE WAS LEFT BLANK  
INTENTIONALLY

# FUEL SYSTEM

## 3.1 General

The gasoline fuel system used in Scout boats is designed to meet or exceed the requirements of the U.S. Coast Guard, the Boating Industry Association, and The American Boat and Yacht Council in effect at the time of manufacture.

All gasoline fuel systems have been factory inspected and pressure tested in accordance with regulations in effect at the time of manufacture. This inspection assures that the system is air tight, leak proof and safe. It is the responsibility of the purchaser to maintain it in that condition. Make frequent inspections to assure that no deterioration or loosening of connections is resulting from vibration.



### DANGER



**DO NOT LET THE ODOR OF GASOLINE GO UNCHECKED. ANY ODOR OF GASOLINE MUST BE IMMEDIATELY INVESTIGATED AND STEPS TAKEN TO PROTECT THE BOAT AND ITS OCCUPANTS UNTIL THE PROBLEM IS CORRECTED. IF THE ODOR OF GASOLINE IS NOTED, SHUT OFF ALL ENGINES AND ELECTRICAL EQUIPMENT. INVESTIGATE AND CORRECT THE SITUATION IMMEDIATELY. HAVE ALL PASSENGERS PUT ON PERSONAL FLOTATION DEVICES AND KEEP A FIRE EXTINGUISHER READY UNTIL THE SITUATION IS RESOLVED.**

### Fuel Withdrawal Tubes

The fuel withdrawal tubes are positioned in the fuel tanks to achieve optimum fuel usage, fuel line routing, etc. At certain speeds and hull trim angles, the fuel supply at the withdrawal tank location can increase or decrease accordingly. Be extremely careful when attempting to operate the boat when low on fuel. Though some fuel may be in the tank, the relative trim angle of the boat may cause the fuel to flow away from the withdrawals.

The reserve fuel withdrawal tubes are longer than the main tubes. This provides approximately 50 gallons of reserved fuel.

### Fuel Gauges

Indicate the amount of fuel in the tanks. Due to the mechanical nature of the fuel senders, varia-



Fuel Fill

tions in readings during various speeds of operation may occur. This system is merely a relative indication of the available fuel supply and not a calibrated instrument.

### Fuel Fill

Fuel fill deck plate is located on the port gunnel and is marked "GAS." The fuel fill is opened by turning it counter clockwise with a special key. Be sure to use the proper type and grade fuel. Refer to the engine owner's manual for additional information on the fuel requirements for your engines. Boats equipped with the optional generator will have another fuel fill on the starboard gunnel marked "Diesel."

### NOTICE:

**Do not overtighten the fuel caps. If the cap is overtightened, the O-ring seal could be damaged allowing water to contaminate the fuel system.**

### Fuel Tank Vents

There is a vent fitting for each gasoline fuel tank on the port side of the hull. While the tank is being filled, the air displaced by the fuel escapes through the vent. When the tank is full, fuel will be ejected from the fuel vent. Boats equipped with the generator will have another fuel vent

fitting on the starboard side of the hull for the diesel fuel tank.

After fueling, replace the fill cap, and wash the areas around the fuel fill plate and below the fuel vent. Residual fuel left on the deck and hull sides can be dangerous and will yellow the fiberglass or damage the striping.

## 3.2 Outboard Fuel System

The fuel system on your Scout has one fuel tank located in the center of the bilge below the cockpit sole. The tank is equipped with two main and two reserve fuel withdrawal tubes controlled by valves located in the aft systems station. Each fuel withdrawal line is equipped with an anti-siphon valve where the line attaches to the fuel tank. This valve prevents gasoline from siphoning out of the fuel tank should a line rupture.



Fuel Valves



Starboard Engine Fuel Filter and Selector Valves in Stern Bilge

	<b>CAUTION</b>	
<b>DO NOT REMOVE THE ANTI-SIPHON VALVES FROM THE SYSTEM. SHOULD THE VALVE BECOME CLOGGED, CLEAN AND REINSTALL OR REPLACE.</b>		

A fuel filter for each engine and the fuel selector valves are installed on the forward bulkhead in the aft systems station. They are accessed through the center hatch at the rear of the cockpit. The filters are the water separator type and should be serviced frequently to assure an adequate supply of clean, dry fuel to the engines. It is recommended that the filters are inspected periodically and the elements changed as needed.

There is a primer bulb in each fuel line located near the fuel filter that is used to prime the fuel system after service or as required. See Fuel System Maintenance and the engine owner's manual for additional information on the fuel filters and the outboard engine fuel system.

The fuel tank is designed with a main and reserve fuel supply. The forward tubes are the main fuel supply and the rear withdrawal tubes are the reserve. Selector valves in the stern bilge near the fuel filters allow the operator to select between the main fuel tank, for normal operation, and the reserve fuel supply. The valves also have an off position for servicing the fuel system.

## Fuel Management

Proper fuel management is important on all boats. The main fuel supply should be selected the majority of the time. However, it is important that some fuel from the reserve fuel supply is consumed for at least 15 minutes once each month to keep the fuel in the reserve system fresh and prevent damage to lines and anti-siphon valves from degraded fuel.

The fuel valves should be set to the MAIN position when you begin each trip. Never select RESERVE for normal operation to ensure reserve fuel is available if and when you need it.

Pay attention to the fuel level and select the RESERVE fuel supply when the fuel level in the tank reaches 1/4 tank. This will prevent the engines from running out of fuel before selecting the reserve fuel supply. When engines run out of fuel they will shut down suddenly and you will lose the ability to control the position of the boat for

several minutes while the fuel system is primed so the engines can be restarted. This could endanger the boat and crew in rough seas, an inlet or a busy waterway. Always make sure to return the selector valves to the main position when you fill the tank.

**NOTICE:**

**The procedure to prime the fuel system on outboard engines is specific to the type and model of engines on your boat. You should refer to engine manufacturer owner's manual for the priming procedure for your engines.**

### 3.3 Diesel Generator Fuel System

The diesel fuel system for the generator is completely separate from the gas system. The diesel fuel tank is located in the bilge below the starboard side of the cockpit and is filled from a fuel fill deck plate on the starboard gunnel labeled "Diesel." The diesel fuel system is not equipped with an anti-siphon valve and there is a fuel return line for the engine that returns unused fuel to the fuel tank. A separate fuel pump mounted near the diesel fuel filter in the aft systems station supplies fuel from the tank to the generator.

Proper diesel engine operation requires a good supply of clean, dry diesel fuel. Improper marina fuel storage techniques, limited boat usage, etc. can cause the fuel to become contaminated. Periodically, it may be necessary to pump accumulating water and contaminated fuel from the bottom of the fuel tank. If the generator fuel system on your boat becomes contaminated, contact your dealer or Scout Customer Service for assistance.

Algae can grow in the accumulated water in diesel fuel tanks. This condition is most prevalent in warm climates. Periodically adding a high quality diesel fuel additive containing an algicide may be required to control algae in your boating area. You should contact your dealer or the generator manufacturer for additional information regarding fuels and additives.

**NOTICE:**

**Do not allow the generator to sit unused for an extended period with the fuel tank less than full. Changes in temperature and weather conditions can cause condensation in diesel fuel tanks that are less than 3/4 full.**



*Primary Generator Diesel Fuel Filter, Coolant Recovery Tank, Sea Strainer and Intake Valve*

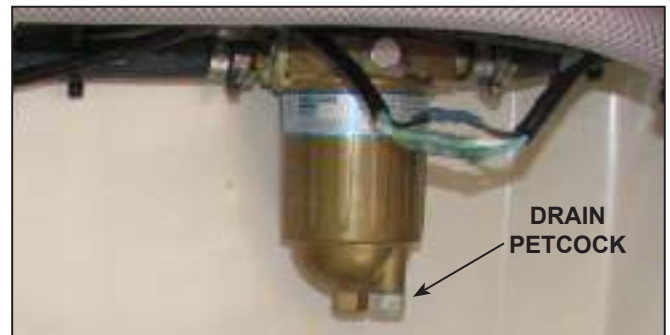

*Generator Fuel Filter*

### Diesel Fuel Filter

The diesel fuel filter is installed near the generator in the port side of the aft systems station. Check the primary filter for water periodically and replace the filter cartridge as needed.

Water is drained from the primary filter by placing a cup under the filter and draining through the petcock at the bottom of the filter until clean fuel flows. It is particularly important to monitor the condition of the fuel filter frequently because diesel engines circulate much more fuel than they consume. Because of the volume of fuel that flows through the filter, the element must be changed at least twice a season or more frequently depending on the quality of the fuel and the hours run. Follow the filter or generator manufacturer's instructions for cleaning and replacing the filter element.

**NOTICE:**

**Diesel fuel systems may need to be primed after servicing. Refer to the generator owner's manual for information on priming the fuel system.**

## 3.4 Fueling Instructions



### WARNING



FUEL IS VERY FLAMMABLE. BE CAREFUL WHEN FILLING THE FUEL TANKS. NO SMOKING. NEVER FILL THE TANK WHILE AN ENGINE IS RUNNING. FILL THE FUEL TANKS IN AN OPEN AREA. DO NOT FILL THE TANKS NEAR OPEN FLAMES.



### CAUTION



TO PREVENT DAMAGE TO THE FUEL SYSTEM, USE ONLY A GOOD GRADE OF GASOLINE FOR GASOLINE ENGINES OR DIESEL FUEL FOR DIESEL ENGINES. DO NOT USE FUEL THAT CONTAINS HARSH ADDITIVES OR IS AN ALCOHOL BLEND. ANY DAMAGE DONE TO THE FUEL SYSTEM THAT IS THE RESULT OF USE OF AN ALCOHOL BLEND IS NOT COVERED BY THE SCOUT WARRANTY. REFER TO THE ENGINE MANUFACTURER OWNER'S MANUAL REGARDING FUEL REQUIREMENTS FOR YOUR ENGINES.



### WARNING



DO NOT CONFUSE THE FUEL FILL DECK PLATES WITH THE WATER OR WASTE PUMP OUT DECK PLATE. THESE PLATES ARE LABELED ACCORDINGLY. THE DIESEL FUEL FILL DECK PLATE IS LOCATED CLOSE TO WASTE PUMP OUT DECK PLATE AND YOU SHOULD BE CAREFUL NOT TO ACCIDENTLY PUMP DIESEL FUEL INTO THE WASTE HOLDING TANK. IF GASOLINE OR DIESEL FUEL IS ACCIDENTALLY PUMPED INTO THE WATER OR WASTE TANK, DO NOT ATTEMPT TO PUMP IT OUT YOURSELF. WATER AND WASTE PUMPS ARE NOT DESIGNED TO PUMP FUEL AND A FIRE OR EXPLOSION COULD RESULT. CONTACT YOUR DEALER OR THE SCOUT CUSTOMER SERVICE DEPARTMENT FOR ASSISTANCE IN HAVING THE FUEL PROFESSIONALLY REMOVED.

5. A special key to open the fuel cap is supplied.
6. Turn the key counter clockwise to open the cap.
7. Remove the cap.
8. Put the nozzle in the fuel opening.



### WARNING



STATIC ELECTRICITY CAN BE GENERATED WHILE FUELING AND CAN CAUSE A FIRE OR EXPLOSION. TO PREVENT STATIC SPARKS WHEN FILLING THE TANK, MAKE SURE THE NOZZLE IS IN CONTACT WITH THE FUEL OPENING.



### WARNING



SPILLED FUEL IS DANGEROUS AND CAN YELLOW FIBERGLASS OR IGNITE. MAKE SURE YOU DO NOT SPILL ANY FUEL. IF FUEL IS SPILLED ON THE DECK, USE A CLOTH TO REMOVE THE FUEL AND PROPERLY DISPOSE OF THE CLOTH ON SHORE. IF FUEL IS SPILLED ON THE WATER, EXERCISE EXTREME CAUTION. FUEL FLOATS ON TOP OF THE WATER AND CAN IGNITE. IF EXCESS FUEL IS SPILLED INTO THE WATER, IMMEDIATELY EVACUATE THE AREA AND NOTIFY THE MARINA AND THE PROPER OFFICIALS.

9. Fill the fuel tank slightly less than the rated capacity to allow for expansion to avoid spilling fuel out of the vents and fuel fills.
10. Remove the nozzle.
11. Install and tighten the fuel cap. Be careful not to overtighten the cap.
12. Check the fuel compartment and below the deck for fuel odors. If you smell fuel, do not start the engines.



### WARNING



TO REDUCE THE RISK OF A FIRE AND/OR EXPLOSION, DO NOT START THE ENGINES WHEN FUEL FUMES ARE PRESENT. FUEL FUMES ARE DANGEROUS AND HARMFUL TO YOUR HEALTH.

MAKE SURE ALL GASOLINE ODORS ARE INVESTIGATED IMMEDIATELY.

### To fill the fuel tank at a marina, follow this procedure:

1. Make sure all switches are in the OFF position.
2. Make sure the boat is securely moored.
3. Make sure all passengers leave the boat.
4. Estimate how much fuel is needed and avoid over filling the tank.

### NOTICE:

When the fuel tank is full, fuel will come out through the fuel vent. The fuel vents are located on the side of the hull.



## 3.5 Fuel System Maintenance

Periodically inspect all primer bulbs, connections, clamps and hoses for leakage, damage or deterioration. Replace as necessary. Spray the valves, tank fuel gauge senders and ground connections with a metal protector.

Frequently inspect and lubricate the fuel fill cap O-ring seal with Teflon or silicone grease. The O-ring seal prevents water from entering the fuel system through the fuel fill cap and it should be immediately replaced if there is any sign of damage or deterioration.

The fuel vent screen should be clear and free from corrosion and salt buildup. The screen will prevent insects and other foreign matter from contaminating the fuel and fuel system. The fuel vent should be replaced if the vent or screen is damaged or badly corroded. Fuel vent screens that are clogged will prevent the fuel tank from venting properly and make filling the fuel tank difficult or cause fuel supply problems to the engines.

Contaminated fuel may cause serious damage to your engines. The filters must be checked for water and other contamination frequently. The filter elements must be changed at least once a season or more frequently depending on the type of engines and the quality of the fuel. Please refer to the engine or fuel filter manufacturer's instructions for information on servicing and replacing the fuel filter elements.

The age of gasoline can effect engine performance. Chemical changes occur as the gasoline ages that can cause deposits and varnish in the fuel system as well as reduce the octane rating of the fuel. Severely degraded fuel can damage the engines, boat fuel tanks and lines. Therefore, if your boat is not being run enough to require at least one full tank of fresh fuel a month, a fuel stabilizer should be added to the gasoline to protect the fuel from degradation. Your dealer or the engine manufacturer can provide additional information on fuel degradation and fuel stabilizers recommended for your engine.

Avoid using gasoline with alcohol additives. Gasoline that is an alcohol blend will absorb moisture from the air which can reach such concentrations that "phase separation" can occur whereby the water and alcohol mixture becomes heavy enough to settle out of the gasoline to the bottom of the tank. Since the fuel pick up tubes are very near

the bottom of the tanks, phase separation can cause the engines to run very poorly or not at all. This condition is more severe with methyl alcohol and will worsen as the alcohol content increases. Water or a jelly like substance in the fuel filters are an indication of phase separation from the use of alcohol blended fuels.

Algae can grow in the accumulated water in diesel fuel tanks. This condition is most prevalent in warm climates. Periodically adding a high quality diesel fuel additive containing an algacide may be required to control algae in your boating area. Since algae also can grow in accumulated water in the fuel filters, it is important to run the generator for at least 30 minutes after the algacide has been added so it will be circulated throughout the fuel system. This is even more important during periods of storage or if the generator is not used enough to require refueling at least once a month.

Severe algae in a diesel fuel system can be extremely difficult and expensive to clean. You should be diligent in monitoring the fuel system by checking the filter for water frequently and being alert for signs of algae in fuel that is drained from the filter. Most algae appears as black, carpet like, fibers suspended in fuel and water drained from the filter. Severe cases of algae will produce a black jelly like substance that quickly clogs the filters and starves the engine for fuel.



### WARNING



**DO NOT DRAIN ANY FUEL INTO THE BILGE WHEN SERVICING THE FUEL SYSTEM. THIS COULD LEAD TO A FIRE OR EXPLOSION.**

**AFTER THE FILTER ELEMENTS HAVE BEEN CHANGED, PRIME THE FUEL SYSTEM AND CHECK ALL FITTINGS FOR LEAKS BEFORE AND AFTER STARTING THE ENGINES.**



### WARNING



**BEFORE STARTING THE ENGINES, ALWAYS OPEN ALL HATCHES, WINDOWS, AND DOORS TO COMPLETELY VENTILATE THE BOAT AFTER SERVICING THE FUEL SYSTEM.**

THIS PAGE WAS LEFT BLANK  
INTENTIONALLY

## ELECTRICAL SYSTEM

### 4.1 General

Your Scout is equipped with 120-volt AC and 12-volt DC electrical systems. The AC system can draw current from one of two sources, either shore power outlets at dockside or an optional generator. The DC system draws current from on board batteries.

Your boat and engine charging system is designed for 12-volt, lead acid wet cell marine batteries. They will require similar maintenance as those found in automobiles.

All wires in the electrical systems are color coded to make identifying circuits easier. Wiring schematics have been included with this manual to aid in following an individual circuit of the boat.

### 4.2 12-Volt DC System

The 12-volt system is a fairly standard marine system. There are five batteries, one for the starboard engine, one for the port engine and three for the house and electronics. If your boat is equipped with the optional generator and bow thruster, they will be operated by the house battery bank.

The batteries for the engines, house and electronics are located in a compartment in the leaning post below the helm seats and in a battery tray mounted in a storage compartment below the forward cockpit sole. They are controlled by three battery switches, one for the port engine, one for the starboard engine and one for the house 12-volt accessories and the electronics. The optional bow thruster is located below the forward storage hatch in the cabin and is controlled by a main switch that is activated automatically when the bow thruster is energized. The optional generator is started by the house batteries. The batteries themselves can be charged by the engines or by the battery charger when connected to shore power or when the optional generator is operating.

Most 12-volt power is distributed to the 12-volt accessories through individual circuit breakers located in the 12-volt switch and breaker panels. All circuit breakers are labeled by the name of the

#### Scout Boats Marine Standard Wiring Code

<u>COLOR</u>	<u>USE</u>
Brown (Br)	Pumps
Orange (O)	Accessory Feed + 12 VDC
Dark Blue	Cabin/Courtesy/Instrument Lighting
Pink (Pk)	Fuel Sender
Dark Gray (Gy)	Navigation Lighting
Black or Yellow	12 VDC Ground
Purple (Pu)	Ignition Instrument Feed + 12 VDC
Green (G)	DC Grounding (Bonding)
Red	+ 12 VDC Power

circuit they protect. Main circuit breakers in the battery switch panel protect the primary circuits for the DC main, windlass, continuous hot and generator control panel. Additional "push to reset" breakers in the battery switch panel protect the circuits for the remote starboard engine battery switch, remote port engine battery switch, remote house battery switch and the generator starting circuit. Most 12-volt accessories are operated directly by switches in the helm switch panel, hardtop switch panel, cabin and circuit breakers in the cabin DC panel.

Main breakers or fuses located on each engine protect the ignition systems and gauges. Yamaha engine electrical circuits are protected by fuses located in a fuse panel on the side of the engine. The fuse panel is equipped with a spare fuse for each circuit. Always replace fuses used with the fuse specified by Yamaha or your engine manufacturer. Refer to the engine owner's manual for more information on the fuses, fuse panels or circuit breakers on your engines.



#### CAUTION



**PROPER FUSE OR BREAKER PROTECTION MUST BE PROVIDED FOR ALL 12-VOLT EQUIPMENT ADDED. DO NOT OVERLOAD THE ACCESSORY CIRCUIT BREAKERS OR OTHER CIRCUITRY THROUGH ADDITIONAL 12-VOLT EQUIPMENT.**

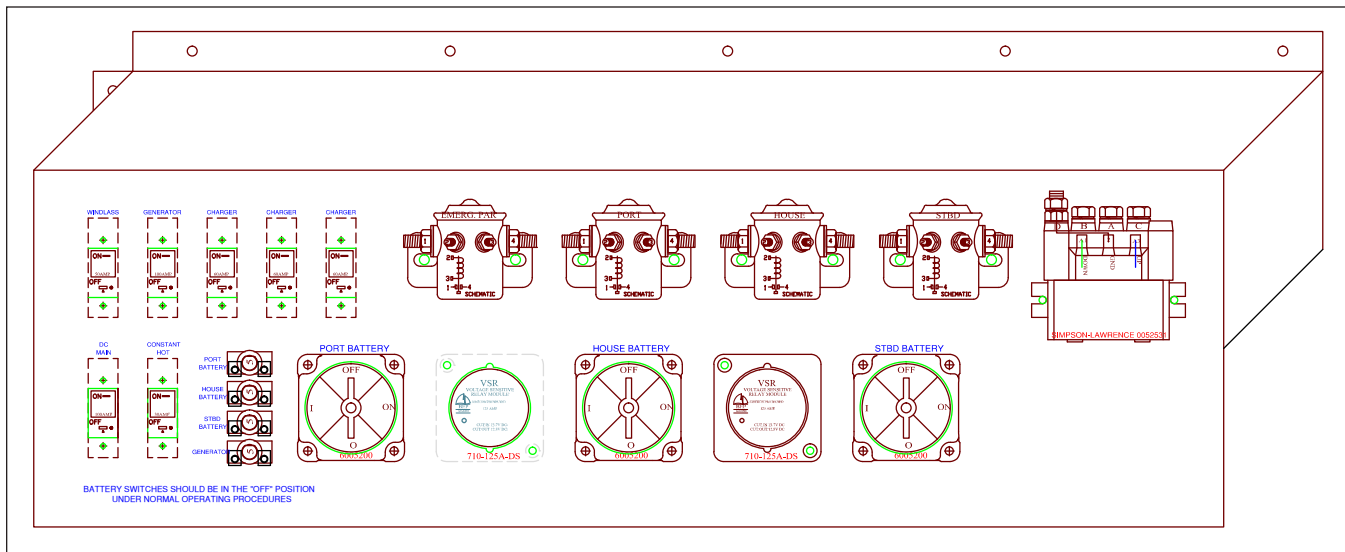

Battery Switch Panel, Manual Battery Switches and Circuit Breakers

## Batteries and Battery Switches

The DC electrical system on your boat is designed for wet cell, marine batteries. Do not attempt to use gel cell, absorbed wet mat or other non wet cell batteries. The engine charging system and the battery charger are not designed to recharge these batteries which could cause unusually short battery life, engine starting problems and damage to the DC charging systems. You also should not mix the size or brand of the wet cell batteries. Always consult your Scout dealer before changing the type of batteries in your boat.

Your boat has provision for four batteries in the battery compartment below the leaning post helm seats. Another house battery is located in a bow storage compartment. There is one battery for each engine and three wired in parallel for the house and electronics circuits. The batteries supplied by Scout are the largest size and capacity lead acid batteries that will fit in your boat. These specifications should be considered to be the minimum size battery required.

There are three manual battery switches and three remotely activated battery switches located in the battery compartment. The remote switches are

located behind the battery switch panel and activated by switches in cabin DC panel. The manual switches are mounted on the battery switch panel and activated by a removable handle on each switch. There is a manual battery switch for each engine and for the house and electronics circuits. The manual battery switches are normally left in the OFF position and used only to bypass a remote switch in the event the remote switch fails to activate the circuit. The handles for the manual switches should be removed and stored in the cabin for increased security.

### NOTICE:

**The manual battery switches completely bypass the remote switches when they are activated. The circuits cannot be turned off using the remote battery switches on the DC panel if the circuits have been activated by the manual battery switches.**

To operate the remote battery switches, the knob on each manual battery switch in the battery compartment must be set to OFF. With the manual switches in this position, each circuit can be activated when the remote switch on the cabin DC breaker panel is turned ON and deactivated

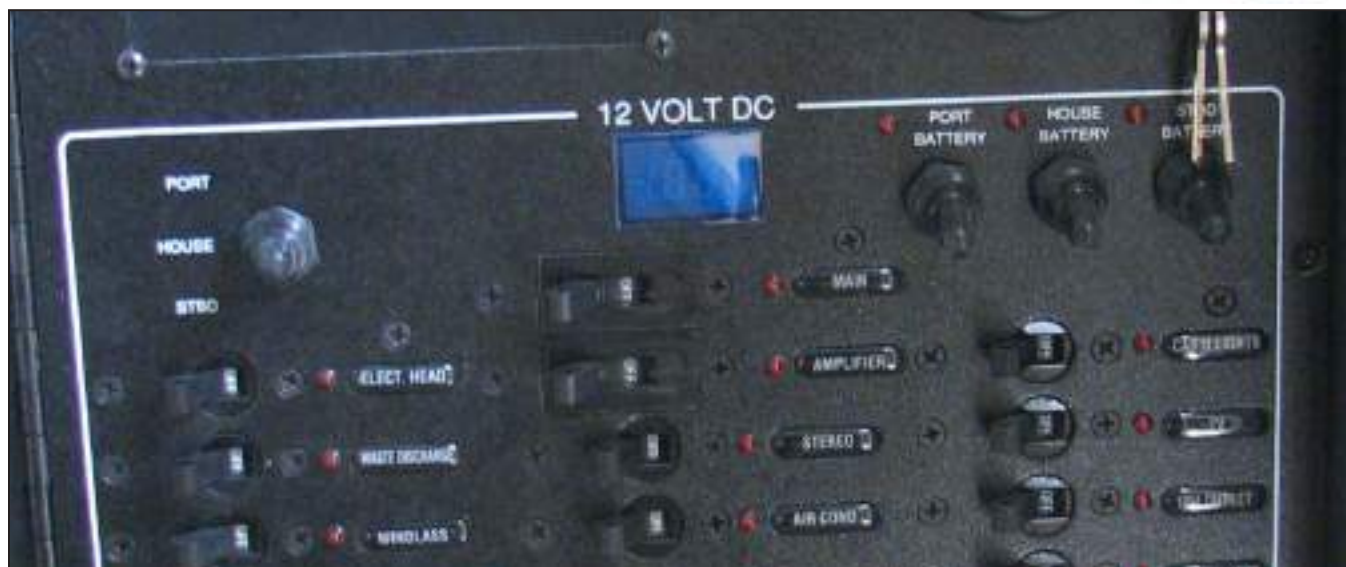

*Remote Battery Switches, DC Volt Meter and Battery Bank Monitor Switch*

when the remote switch is turned OFF. LED lights on each remote switch will be lit when the battery switch is in ON and the circuit is activated. The LED light will not be lit when the battery switch is turned OFF.

The battery switches have two positions, OFF and ON. When the House battery switch is on, current flows from the house battery bank to the house accessory circuits, cockpit accessory circuits and electronics. When the engine battery switches are on, the engine circuits are activated and current flows from the port start battery to the port engine and from the starboard start battery to the starboard engine.

The optional bow thruster battery switch is located near the house battery in the forward storage compartment below the cockpit sole. It is activated automatically when the thruster control panel is switched on and turns off when the thruster control panel is deactivated. It also can be activated manually with the red knob on the battery switch.

Each engine charges the battery that feeds it and the house and electronics batteries through a VSR (voltage sensitive relay) battery isolator system. Additional charging current is supplied to the house battery bank by the engine onboard isolator charging circuits. Two 50 amp circuit breakers on each side of the stern systems station near the transom protect the engine isolator charg-

ing circuits. Refer to the engine owner's manual for more information on the engine isolator and charging system.

The engine and boat battery isolator systems manage the charging current for the 12-volt system whenever the engines are running. The systems automatically sense the condition of each battery and direct the available current to the batteries that require charging. When one or both engines is started, the engine alternator(s) start to recharge the batteries. This charging current passes through the battery isolator sensing circuits. The circuits sense the charge and it is split between the batteries, with the lowest battery receiving the most charge. When the engines are turned off, the charging stops and the sensing circuit turns off each VSR and the engine isolators, disconnecting the batteries from the charging circuit, thereby automatically isolating the batteries from one another.

When in port or at anchor, the battery switches for each engine should be off. This will keep the engine starting batteries in reserve for starting the engines. All battery switches should be in the OFF position when leaving the boat unattended.

**NOTICE:**  
**Current is supplied to the automatic float switches for the bilge pumps and high water alarm when the batteries are connected, even if the battery switches are off.**



*Helm Switch Panels, Bow Thruster Switch, Freezer Control Panel, and Trim Tab Switches*

## **12-Volt Helm Accessory Switch Panel**

The main accessory switch panel is located at the helm. Most of the circuit breakers that protect the accessories are located in the cabin DC panel. An LED light built into the toggle switches indicate that the circuit is activated.

The following is a description of the accessories controlled by the main accessory switch panel:

### **Horn**

Activates the boat horn located on the hardtop.

### **Nav/Anchor Lights**

The switch is a three-position switch. The middle position is OFF. Moving the switch in one direction will activate the navigation lights. Moving the switch in the opposite direction activates the anchor light.

### **Courtesy Lights**

A three-position switch that activates the lights below the gunnels that illuminate the cockpit sole. Move the switch up to activate the aft cockpit lights only. Move the switch down to activate both the forward and aft cockpit lights.

### **Transom Lights**

Activates the transom lights below the rubrail.

### **Bilge Light**

**Activates the lights in the stern bilge.**

### **Storage Box Lights**

Activates the lights in the console forward storage box and inside leaning post battery Compartment.

### **Bait Light**

Activates the light in the transom fish box/freezer/baitwell and the baitwell below the rear facing bench seat.

### **Battery Parallel**

A momentary switch that activates the circuit that connects both engine starting batteries in parallel for extra battery power while starting the engines. When the switch is pressed, a relay is engaged that connects both engine starting batteries, when the switch is released, the relay is deactivated and the batteries are isolated.

## Underwater Lights

Activates the lights in the transom below the waterline.

## Fwd Bilge

Manually activates the forward bilge pump located in the bilge below the cabin sole. The pump moves water out through a thru-hull fitting in the hull. The pump is also activated by an automatic float switch that is activated whenever the batteries are connected. This pump will run as needed whenever the water in the bilge accumulates high enough to raise the float switch to the ON position and turn off when the water is removed.

## Aft Bilge

Manually activates the aft bilge pump located in the stern bilge near the transom. The pump moves water out through a thru-hull fitting in the hull. The pump is also activated by an automatic float switch that is activated whenever the batteries are connected. This pump will run as needed whenever the water in the bilge accumulates high enough to raise the float switch to the ON position and turn off when the water is removed.

## NOTICE:

**The bilge pumps will start automatically when there is sufficient water in the bilge to activate the float switch. Each float switch is protected by a circuit breaker located in the cabin DC panel and is always supplied current when the batteries are connected.**

## Fresh Water

Activates the fresh water pump that supplies the fresh water washdown hose connector in the cockpit, marine toilet and the cabin sink. The pump is the pressure demand type. A pressure switch automatically controls the water pump when the system is activated and properly primed.

## Raw Water

Activates the raw water washdown pump that supplies the washdown hose connector in the cockpit. The pump is the pressure demand type. A pressure switch automatically controls the water pump when the system is activated and properly primed.

## Fish box

Activates the diaphragm pump that drains the port cockpit fish box. To avoid damage to the pump, always monitor the water level as the pump drains the fish box and turn it off immediately when draining is complete.

## Fish box

Activates the diaphragm pump that drains the starboard cockpit fish box. To avoid damage to the pump, always monitor the water level as the pump drains the fish box and turn it off immediately when draining is complete.

## Baitwell 1

Activates the pump for the baitwell below the aft facing bench seat.

## Baitwell 2

Activates the pump for the optional transom baitwell.

## Windlass Switch

This switch controls the windlass which is mounted to the deck forward of the rope locker. It is protected by a circuit breaker of the type and rating recommended by the windlass manufacturer that is located near the battery switches. Another circuit breaker on the DC panel protects the circuit for the windlass switch.

The switch is a three-position switch. The middle position is "OFF." Moving the switch in one direction will pay the anchor line out. Moving the switch in the opposite direction will pull the anchor line in.

## 12-Volt Receptacle

Provides electrical current for portable 12-volt equipment. The receptacle is located in the storage compartment on the starboard side of the helm.

## High Water Indicator

A red LED light near the bilge pump switches illuminates and an alarm sounds if the bilge water level rises above the normal operating range of the bilge pump automatic switches. The alarm automatic switch is connected to the batteries and protected by a "push to reset" circuit breaker located in the cabin circuit breaker panel. It remains activated when the battery switches are in the OFF position and the batteries are connected.

## Hardtop Accessory Switch Panel

The hardtop accessory switch panel is located in the hardtop above the helm. These switches activate the overhead lights on the hardtop and other DC accessories. The circuit breakers that protect the accessories are located in the panel near the switches or in the cabin DC panel. LED lights built into the switches indicate that the circuit is activated.



*Hardtop Switch Panel*

### **Forward Spreader**

Activates the overhead light at the front of the hardtop that illuminates the forward cockpit.

### **Aft Spreader**

Activates the overhead light at the rear of the hardtop that illuminates the aft cockpit.

### **Hardtop Light**

Activates the blue overhead lights above the helm and on the rear of the console, above the footrest.

### **Map light**

Activates the red overhead map lights above the helm.

**Note: Red lights have less effect on night vision and should be selected if you need to illuminate the bridge deck while navigating at night.**

### **Wiper**

Reserved for additional 12 volt accessories.

### **Washer**

Reserved for additional 12 volt accessories.

### **Windshield Vent**

A momentary, three-position switch that activates the electric ram to open and close the center windshield vent panel that provides ventilation for the helm area. The center position is OFF. Move the switch in one direction to open the vent. Move the switch in the opposite direction to close the vent. The switch returns to the OFF position when it is released.

### **Additional DC Switches and Monitors Trim Tab Switch**

Located in the helm. This switch controls the trim tab planes located on the transom of the boat. It is protected by a circuit breaker located in the cabin DC breaker panel. Please refer to the Helm Control Systems chapter for detailed information on the operation of the trim tab controls.

### **Engine Trim and Tilt Switches**

Located in the helm. These switches are typically installed in the engine throttle and shift control. They control the trimming and tilting of the engines. Please refer to the Helm Control Systems chapter and the engine owner's manual for information regarding the proper use of the tilt and trim switches.

### **Bow Thruster Control Switch Panel (Optional)**

This panel is located in the helm and controls the bow thruster that provides the operator additional control of the bow while docking or anchoring the boat in tight quarters or high winds and strong currents. It is protected by a circuit breaker located in the battery switch panel.

The momentary joy stick controls port and starboard movement of the bow. The joystick panel features a one second press-and-hold safety ON switch, auto shut-off after 3 minutes of continuous use or after 15 minutes of continuous inactivity. To prevent damage to electric motor, the panel has a one-second delay from Port to Starboard (and Starboard to Port).



Please refer to the Helm Control Systems chapter and the bow thruster owner's manual for more information regarding the proper use and maintenance of the bow thruster.

## Cockpit Sunshade Switch (Optional)

A programmable switch that controls the optional electric fiberglass sunshade. The switch has six buttons that control the sunshade. The buttons with the arrow indicators are preset to extend or retract the sunshade when they are pressed. The sunshade will stop whenever the arrow button is released. Limit switches automatically stop the sunshade when it is fully extended or retracted. Buttons one through four are programmable and can be set to fully extend or retract the sunshade or to automatically stop at any partially extended position.

Buttons one through four were pre-programmed at the factory. Button 4 fully extends the sunshade. This setting should only be used when the boat is operating below cruising speed. Always use setting 1, 2, or 3 whenever operating the boat at or above cruise speed. Refer to the operating manual for the sunshade switch panel for instructions on using and programming the sunshade switch panel.

## Freezer Control Switch (Optional)

Located inside the console when the optional transom fish box freezer is installed. This panel activates the transom freezer and controls the temperature. An LED screen indicates the selected temperature and push button switches allow the operator to raise or lower the temperature as desired. Refer to the freezer operator's manual for more information on the operation of the freezer.

## Cabin DC Accessory Breaker Panel

Power is distributed to most of the 12-volt accessories in the cabin through individual circuit breakers located in the cabin DC breaker panel. A main circuit breaker located in the battery switch panel protects the system from an overload. Some 12-volt accessories are operated directly by the circuit breaker in the panel. Switches fed by the panel breakers activate other accessories.

A DC volt meter located in the panel monitors the voltage level in the batteries. A labeled switch next to the voltage meter selects the battery to be monitored.



*Bow Thruster Switch and Joystick*



*Optional Rear Sunshade Switch*



*Optional Freezer Control*

CAUTION

**PROPER FUSE OR BREAKER PROTECTION MUST BE PROVIDED FOR ALL 12-VOLT EQUIPMENT ADDED. DO NOT OVERLOAD THE ACCESSORY CIRCUIT BREAKERS OR OTHER CIRCUITRY THROUGH ADDITIONAL 12-VOLT EQUIPMENT.**

The following are descriptions of the accessories controlled by the cabin DC breaker panel:

### Battery Switches

These switches activate the remote battery switches for the Starboard Engine, Port Engine, and House circuits. A red LED light in each switch glows when the battery switch it controls is on. The red light may not turn off immediately or will slowly fade out when the switches are turned off.

### Waste Discharge Switch

A key activated switch located in the cabin DC panel that controls the overboard diaphragm discharge pump system for the holding tank and marine head system. Monitor the waste level in the tank while pumping and turn the waste discharge switch OFF immediately when pumping is complete.

The key must be removed from the switch whenever the discharge pump is not being operated.

### Level Monitor

Monitors the fluid level in the diesel fuel, waste and water tanks. A three-position toggle switch next to the gauge is used to select which tank is monitored.

### Toggle Accessory Breakers

#### DC Main

Protects the circuit that supplies power to the 12-volt DC panel accessory breakers and protects the panel from an overload.

#### Electric Head

Protects the circuit that supplies 12-volt electrical current to the switch panel above the head that controls the toilet. The Fresh Water switch at the helm must be on before using the toilet.

#### Waste Discharge

Protects the circuit that supplies 12-volt electrical current to the Waste Discharge key switch that controls the waste tank diaphragm discharge

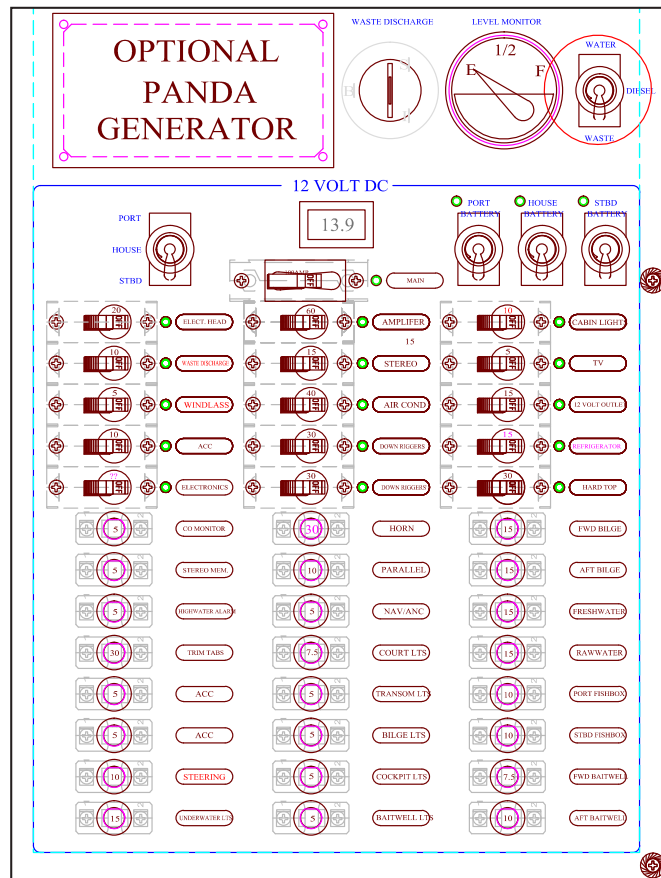

Cabin DC Panel

pump. The key switch is located in the DC panel next to the tank Level Monitor.

### Windlass

Protects the circuit that supplies 12-volt electrical current windlass.

### ACC

Reserved for additional 12-volt DC electrical equipment.

### Electronics

Protects the circuit that supplies 12-volt current to the electronics. This circuit is deactivated when the house battery switch is off.

### Amplifier

Protects the circuit that supplies 12-volt current to the amplifier for the stereo.

### Stereo

Protects the circuit that supplies 12-volt electrical current to the stereo.

## **Air Cond**

Protects the circuit that supplies electrical current to the 12-volt air conditioner compressor and control panel located in the cabin when this option is installed. This breaker is wired in reserve if your boat is not equipped with 12-volt air conditioning.

## **Down Riggers**

Protects the circuit that supplies electrical current to the 12-volt down rigger located in the port stern gunnel when this option is installed. This breaker is wired in reserve if your boat is not equipped with down riggers.

## **Down Riggers**

Protects the circuit that supplies electrical current to the 12-volt down rigger located in the starboard stern gunnel when this option is installed. This breaker is wired in reserve if your boat is not equipped with downriggers.

## **Cabin Lights**

Protects the circuit that supplies 12-volt electrical current to the cabin light switches.

## **TV**

Protects the circuit that supplies 12-volt electrical current to the accessory outlet for the TV.

## **12 Volt Outlet**

Protects the circuit that supplies 12-volt electrical current to the accessory outlet.

## **Refrigerator**

Protects the circuit that supplies 12-volt electrical current to the accessory outlets in the cabin and the helm.

## **Hard Top**

Protects the circuit that supplies 12-volt electrical current to the underwater light switch in the helm switch panel.

## **“Push to Reset” circuit breakers**

These breakers are located in the DC panel below the toggle breakers. Some are activated by the battery switches and some provide continuous power to the circuits they protect and remain activated when the battery switches are OFF.

## **CO Monitor**

A continuous power circuit breaker that supplies the circuit for the carbon monoxide monitor in the cabin.

## **Stereo Mem**

A continuous power circuit breaker that supplies the circuit that supplies continuous 12-volt electrical current to the memory circuit in the stereo and electronics.

## **High Water**

A continuous power circuit breaker that supplies the circuit for the automatic switch that activates high water alarm.

## **Trim Tabs**

Protects the circuit that supplies 12-volt electrical current to the trim tab circuit whenever the house battery switch is on.

## **ACC**

Reserved for additional 12-volt DC electrical equipment.

## **ACC**

Reserved for additional 12-volt DC electrical equipment.

## **Steering**

Protects the 12-volt electrical circuit for the sensors that activate the power assisted steering system.

## **Underwater Lights**

Protects the 12-volt electrical circuit from the Underwater Light switch to the underwater lights.

## **Horn**

Protects the circuit that supplies 12-volt electrical current to the Horn switch in the helm switch panel.

## **Parallel**

Protects the circuit that supplies 12-volt electrical current to the Parallel switch in the helm switch panel.

## **Nav/Anc**

Protects the circuit that supplies 12-volt electrical current to the Nav/Anc switch in the helm switch panel.

## **Courtesy Lights**

Protects the circuit that supplies 12-volt electrical current to the Courtesy Lights switch in the hardtop switch panel.

## **Transom Lights**

Protects the circuit that supplies 12-volt electrical current to the Spreader Light switches in the helm switch panel.

## Bilge Lights

Protects the circuit that supplies 12-volt electrical current to the Bilge Light switch in the helm switch panel.

## Cockpit Lights

Protects the circuit that supplies 12-volt electrical current to the Cockpit Lights switch in the helm switch panel.

## Baitwell Lights

Protects the circuit that supplies 12-volt electrical current to the Bait Light switch in the helm switch panel.

## Fwd Bilge

A continuous power circuit breaker that supplies the circuit for the automatic float switch that activates the bilge pump located in bilge below the aft berth in the cabin.

## Aft Bilge

A continuous power circuit breaker that protects the circuit for the automatic float switch that activates the aft bilge pump located in bilge near the transom.

## Fresh Water

Supplies 12-volt electrical current to the fresh water switch located in the helm switch panel. A pressure switch on the pump automatically controls the water pump when the system is activated and properly primed.

## Raw Water

Supplies 12-volt electrical current to the Raw Water switch located in the helm switch panel. A pressure switch on the automatically controls the water pump when the system is activated and properly primed.

## Port Fishbox

Protects the circuit that supplies 12-volt electrical current to the Fish box switch that controls the diaphragm discharge pump for the port aft floor fish box.

## Starboard Fishbox

Protects the circuit that supplies 12-volt electrical current to the Fish box switch that controls the diaphragm discharge pump for the starboard aft floor fish box.

## Fwd Baitwell

Protects the circuit that supplies 12-volt electrical current to the Baitwell 1 switch that controls

the baitwell pump for the baitwell below the aft facing stern seat.

## Aft Baitwell

Protects the circuit that supplies 12-volt electrical current to the Baitwell 2 switch that controls the baitwell pump for the transom baitwell, if this option is installed. Otherwise, it is wired in reserve.

## Battery Switch Panel and Circuit Breakers

DC Power is distributed to the cabin DC breaker panel, electronics and other main circuits through heavy duty, "push to reset," circuit breakers in the battery switch panel located in the compartment below the helm seats. These main circuits are deactivated when the house battery switch is OFF.

Some 12-volt accessories are operated directly by circuit breakers in the panels while others are operated by switches fed by the panel breakers. Each breaker is labeled for the accessory it protects. The engine and house battery switches are also located on this panel.

### NOTICE:

**Some of the main circuit breakers are high amperage, heavy duty (usually red) breakers and will require a firm push to reset them if they trip. Always make sure the problem that caused the breaker to trip is found and corrected before resetting the breaker.**

**The following are the main circuits supplied and protected by heavy duty circuit breakers:**

### DC Main

Protects the circuit that supplies 12-volt current to the Cabin DC Panel. This circuit is deactivated when the house battery switch is off.

### Windlass (Optional)

Protects the circuit that supplies 12-volt current to the windlass control switch and main circuit battery switch relay located near the forward battery.

### Generator

Protects the circuit for the generator control panel and the starting circuit.

### Constant Hot

Protects the circuit for the constant hot "Push to Reset" circuit breakers in the cabin DC panel. This circuit is always supplied current when the house batteries are connected.

**Additional “Push to Reset” circuit breakers in this panel provide continuous power and protect the circuits for the following accessories:**

### **Port Battery**

Protects the circuit for the Port Battery remote main switch in the cabin DC panel. This circuit is always supplied current when the port engine battery is connected.

### **Starboard Battery**

Protects the circuit for the Starboard Battery remote main switch in the cabin DC panel. This circuit is always supplied current when the starboard engine battery is connected.

### **House Battery**

Protects the circuit for the House Battery remote main switch in the cabin DC panel. This circuit is always supplied current when the house battery bank is connected.

### **Generator**

Protects the circuit for the generator starter circuit. This circuit is always supplied current when the optional generator battery is connected.

### **NOTICE:**

**The continuous power circuit breakers are always supplied current when the batteries are connected. These circuits are not deactivated when the battery switches are off.**

## **4.3 DC Power Management**

Large modern outboard powered boats are typically equipped with a full array of electronics, fuel injected engines, stereo amplifier, DC air conditioning systems, spreader lights and other accessories that consume a significant amount of DC electrical power. All outboard engine charging systems are designed to provide maximum electrical output at or above cruising RPM. The electrical output from the charging system is considerably less at idle or trolling speeds.

Depending on the optional equipment and electronics installed on your boat, there may be times when the charging systems on your engines will not be able to meet the DC electrical power demand if too many accessories are activated while the boat is operating at idle or trolling speeds. Consequently, POWER MANAGEMENT PRACTICES may need to be observed at slow speeds, particularly if your boat is equipped with a full electronics package and the optional DC air conditioning system.

The house battery system in your Scout is designed to provide several hours of reserve capacity, which is adequate for most situations. However, you should be aware of the load each of your DC accessories draw and make sure you don't overload the capacity of the charging system for extended periods while operating the boat below cruising speed. Always monitor the volt meters while operating at slow speeds and turn off unnecessary equipment that draw high amperage loads if the volt meters indicate that the voltage in the batteries is below 12 volts. If necessary, reduce the electrical load by turning off or alternating the use of high draw DC accessories such as the DC air conditioner, radar units, stereo, spreader lights, etc.

If the house battery system that powers the electronics and accessories on your boat becomes critically discharged while underway at low speeds or trolling, make sure that you turn off all unnecessary DC equipment and run the boat engines at an RPM that will provide a reading of at least 13 volts on the volt meters to recharge the house batteries. Proper DC power management will prevent low voltage that can cause critical navigation equipment to become erratic or shutdown unexpectedly. Additionally, sound power management practices increase the life of your batteries and engine charging systems. You should contact your dealer if you have any questions regarding DC power management or the DC electrical system on your boat.

## 4.4 120-Volt AC Electrical System

The AC electrical system is supplied 120-volt, 60 cycle current by a shore power outlet at dockside. It is wired totally separate from the 12-volt DC system and is equipped with an onboard isolation system. Your boat is equipped with one 30 amp shore power cord and an inlet located below the gunnel on the starboard side of the cockpit near the transom door. A main circuit breaker located in the shore inlet panel protects the circuit from the shore inlet to the cabin AC panel. An Equipment Leakage Circuit Interrupter (ELCI), located near the inlet panel provides additional whole-boat ground fault protection (electrical shock protection from stray current) for the entire AC shore power system. Another main circuit breaker and breakers for each accessory circuit are located in the cabin AC panel.

The AC system can be fed by either the shore power inlet or by the optional generator. The main breakers in the AC panel are used to select the source of power desired, Shore Power or Generator. The AC main breakers must be switched to the OFF position before selecting a different power source.

All AC current is distributed to the AC accessories through individual circuit breakers located in the cabin AC panel. The main breakers protect the system from an overload and the reverse polarity lights indicate any problems due to an improper shore power supply. All AC outlets in the cabin and cockpit are protected by ground fault interrupts to protect against electrical shock. While moored dockside, 120-volt, 60 cycle, AC power should be utilized from dockside power, if available.



*Boat AC Inlet, Main Circuit Breaker and ELCI  
Power Available Light and AC GFI Outlet*



### DANGER



**TO REDUCE THE RISK OF ELECTRICAL SHOCK IN WET WEATHER, AVOID MAKING CONTACT WITH THE SHORE CABLE OR MAKING A CONNECTION TO A LIVE SHORE OUTLET. NEVER SPRAY WATER ON ELECTRICAL CABLES WHILE WASHING DOWN DECKS.**

**⚠ DANGER ⚠**

TO REDUCE THE POSSIBILITY OF AN ELECTRICAL SHOCK, IT IS IMPORTANT THAT THE AC GROUND SYSTEM IS FUNCTIONING PROPERLY AND THAT A PROPER CONNECTION EXISTS BETWEEN THE SHORE POWER CORD, THE SHORE POWER INLET, THE BOAT BONDING SYSTEM AND THE OUTLET GROUND CIRCUITS. IF THERE IS ANY DOUBT ABOUT THE INTEGRITY OF THE GROUND CIRCUIT, A QUALIFIED MARINE ELECTRICIAN SHOULD BE CONTACTED IMMEDIATELY AND THE AC POWER SHOULD BE DISCONNECTED UNTIL THE NECESSARY REPAIRS ARE COMPLETED.

### Recommended procedure for making a shore connection:

Turn the AC main breakers to the OFF position. If the dockside outlet includes a disconnect switch, turn it to the OFF position also.

To avoid strain on the cable make sure it has more slack than the mooring lines. Dress the cable so it cannot be damaged by chafing between the boat and the dock. Make sure the cable doesn't come in contact with the water and connect the cable to the boat plug inlet and then to the dockside outlet, making sure the connection plugs include a three-prong plug with a ground wire. Tighten the lock rings on both the shore and the boat connector plugs.

Turn the dockside disconnect switch or circuit breaker to the ON position. Then turn the circuit breaker at the boat inlet plug on and check for proper polarity. If reverse polarity has been achieved, the red reversed polarity indicators in the shore power inlet panel and cabin 120-volt AC panel will light. If this should happen, make sure the main breakers on the AC panel are in the OFF position and turn the inlet breaker and dock power switch or breaker off. Special relays attached to the main breakers in the cabin AC panel will automatically turn the main breakers off whenever reverse polarity is achieved. Notify a qualified electrician to check the wiring at the dock outlet. If the red reversed polarity lights do not illuminate and the green, power available light in the shore power inlet panel is lit when power is supplied, the polarity is correct and the AC main switches can be moved to the ON position.

**⚠ DANGER ⚠**

REVERSED POLARITY WILL DAMAGE THE SYSTEM AND EXPOSE PASSENGERS TO ELECTROCUTION HAZARDS. THIS CONDITION COULD ALSO CAUSE A FIRE IN THE ELECTRICAL SYSTEM. DO NOT OPERATE THE AC ELECTRICAL SYSTEM FROM SHORE POWER WITH REVERSED POLARITY.

**⚠ WARNING ⚠**

ELECTRIC SHOCK CAN CAUSE SEVERE INJURY OR EVEN DEATH. DO NOT ATTEMPT TO CORRECT THE WIRING YOURSELF. ALWAYS HAVE A QUALIFIED ELECTRICIAN CHECK WIRING.

**⚠ WARNING ⚠**

KEEP CHILDREN AWAY FROM ANY ELECTRICAL CABLES OR EQUIPMENT AND ALWAYS USE GROUNDED APPLIANCES ON BOARD YOUR BOAT.

**⚠ WARNING ⚠**

UNDETECTED FAULTS IN THE AC ELECTRICAL SYSTEM COULD CAUSE THE WATER AROUND THE BOAT TO BECOME ENERGIZED. THIS COULD CAUSE A SEVERE SHOCK OR EVEN DEATH TO SOMEONE IN THE WATER NEAR THE BOAT. NEVER SWIM OR ALLOW SWIMMING AROUND THE BOAT WHEN THE AC SYSTEM IS ACTIVATED BY THE SHORE POWER CONNECTION OR GENERATOR.

### Disconnecting procedure for shore power connection:

Turn the main breakers on the cabin AC panel and shore power inlet panel to the OFF position. Turn the disconnect breaker on the dockside outlet to the OFF position.

Disconnect the cable from the dockside outlet and replace the outlet caps. Disconnect the cable from the boat and replace the outlet cap. Store cable.

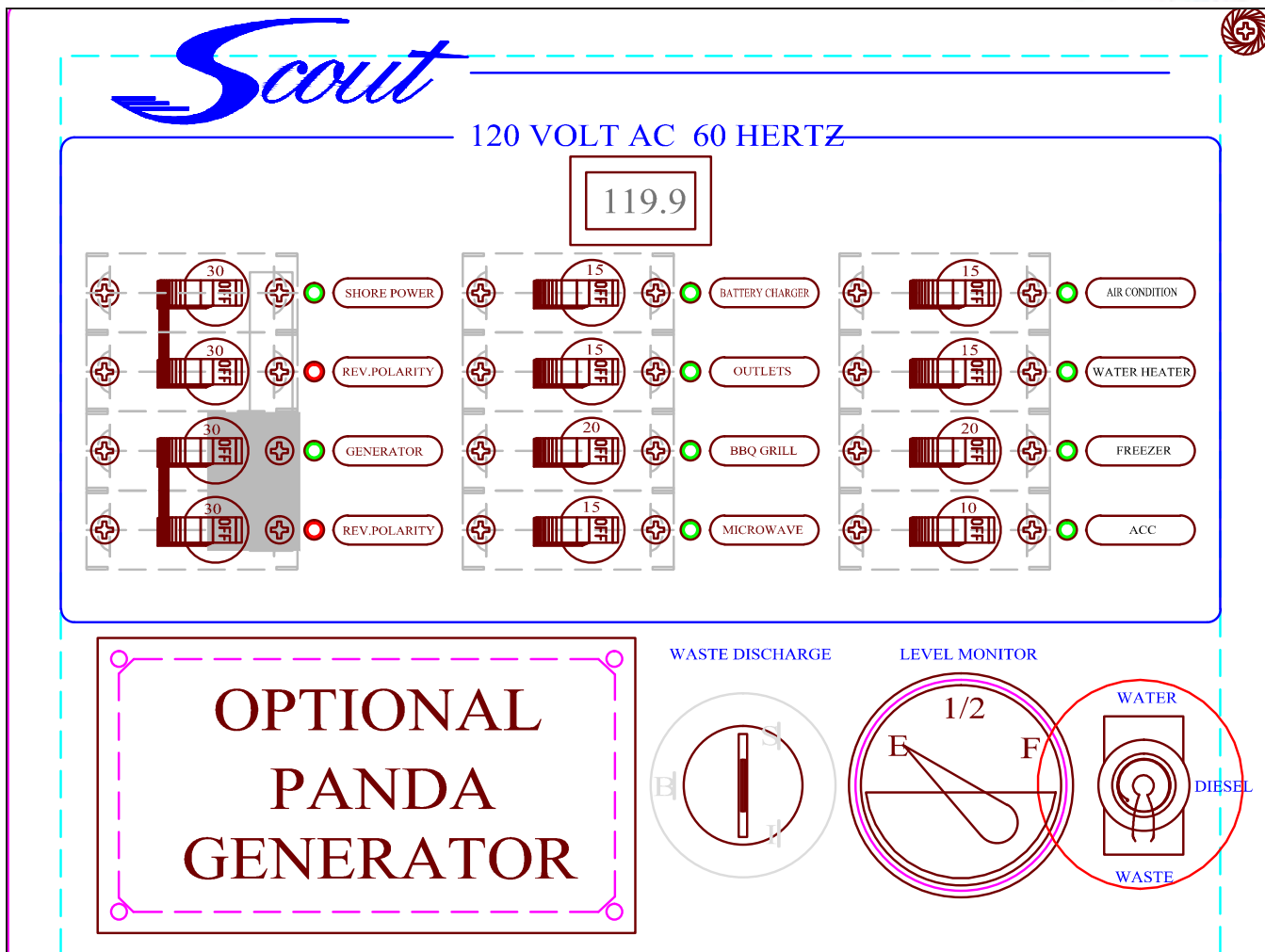

AC Panel

## 120-volt Cabin AC Circuit Breaker Panel

The AC panel is located in the cabin near the cabin door. The following is a description of the AC panel equipment and the breakers that protect the accessories:

### AC Volt Meter

The meter located in the cabin breaker panel monitors the voltage when the boat is connected to AC power. The voltage should be checked each time the AC system is activated. The AC system and accessories can be damaged by voltage that is below 105 volts or above 125 volts. You should monitor the voltage and never operate your AC electrical system if the voltage is below or above this range.

The amp or current load should be calculated, particularly when operating the air conditioner and optional cockpit cooler/freezer. You should

always be aware of the electrical load needed to activate accessories and manage the amperage being supplied so the load can be kept within safe limits. Avoid excessive current load that can overload the circuits or the generator. If you have any questions about managing the power in your boat, contact your authorized Scout dealer.

### Shore Power and Generator Main Breakers

These breakers protect the general distribution network. There is a main breaker for the shore circuit and for the generator. A sliding safety cover on the main breakers prevent activating circuits for the generator and shore circuit simultaneously. These breakers are very sensitive. The resulting power surge that occurs when connecting the dockside cord may cause the main breaker to trip. To avoid this surge, always turn the Shore Power main breakers to the OFF position before plugging or unplugging the shore power cord and



the Generator main breaker to the OFF position when starting the generator. The Shore Power breaker is equipped with a relay that will cause the breaker to trip when reversed polarity current is detected.

Care must be taken when operating the AC system from the generator or the shore power supply line. On some boats it may be possible to overload the generator or shore power circuit if too many AC accessory breakers are activated. Too much amperage being supplied through the panel will cause the Shore Power or Generator breaker to trip and could damage the system. This is particularly important when operating the air conditioner and/or the fish box freezer. You should always be aware of the electrical load needed to activate accessories and manage the amperage being supplied so the load can be kept within safe limits. If you have any questions about managing the power in your boat, contact your authorized Scout dealer.

## Reversed Polarity Lights

The red Reversed Polarity lights indicate that reversed polarity current is being supplied to the shore power inlet or cabin AC panels. This situation will cause the red lights to remain lit. Additionally, a special relay attached to the Shore Power main breaker will automatically turn the main breaker off whenever reverse polarity is achieved. If reverse polarity is achieved, immediately turn off all cabin AC breakers, the shore power inlet breaker and dockside outlet breakers. Disconnect the power cable from the dockside outlet and notify a qualified electrician to check the dockside wiring.

A green, Shore Power available light on the shore power inlet panel indicates the polarity is correct and it is safe to activate the main inlet breaker, the main breaker on the cabin AC panel and AC accessory breakers. Power available lights on the cabin AC panel indicate the power source and correct polarity at the cabin panel.

## Battery Charger

Supplies electrical current directly to the automatic battery charger. The battery charger will charge and maintain the 12-volt batteries simultaneously when activated. It is fully automatic.

The wires that supply DC charging current to the batteries are protected by an internal fuse in the battery charger and circuit breakers, one for each battery output wire, located in the battery switch

panel. The external circuit breakers protect the DC charging circuit from the batteries to the charger. The internal fuses in the charger protect the DC charging circuit from the charger to the batteries. Refer to the battery charger owner's manual for more information on the features and operation of the battery charger.

If one of the inline, heavy duty circuit breakers is tripped by an overload, a yellow lever near the center of the breaker will point to the "Off". Reset the breaker by pushing the lever until it resets and locks in the "On" position.

The charge to the engine batteries can be monitored by using the DC volt meter in the cabin DC panel, the volt meters in the engine gauge cluster or the LED lights on the charger. To monitor the engine batteries with the volt meters in the engine gauge cluster, activate the charger and turn the engine battery switches on. Turn the ignition key switch for each engine to the ON position (DO NOT START THE ENGINES) and read the voltage on the volt meter for each engine. To monitor the house or engine batteries with the DC volt meter in the cabin DC panel, activate the charger and turn the battery switches on. Select to read the voltage on the desired battery using the switch near the meter. If the batteries are in good condition and charging properly, the volt meters will indicate between 12 and 14.5 volts. If the reading is below 12 volts, then the battery is not accepting a charge or the charger is not working properly. Always turn the ignition switches off immediately after the monitoring is complete when using the voltmeters in the engine gauge cluster.

## Outlets

Supplies electrical current to the cabin and cockpit electrical outlets.

### NOTICE:

**All AC electrical outlets are provided with ground fault interrupts to protect against electric shock. These outlets should be tested periodically to ensure proper operation by pressing the test/reset buttons in the center of faceplate. GFI outlets do not protect against short circuits and overloads. This is done by the outlet breaker in the AC panel.**



## WARNING



GFI OUTLETS DO NOT PROVIDE 100% PROTECTION FROM ELECTRIC SHOCK. EVEN THOUGH GROUND FAULT INTERRUPTERS PROVIDE PROTECTION BY REDUCING EXPOSURE TIME FROM LINE TO GROUND SHOCK HAZARDS, IT IS STILL POSSIBLE TO RECEIVE AN ELECTRIC SHOCK FROM DEFECTIVE APPLIANCES OR POWER TOOLS AND MISUSED ELECTRICAL EQUIPMENT.



Typical Generator Control Panel

### BBQ Grill

Supplies electrical current to the optional BBQ grill when this option is installed. Otherwise the breaker is wired in reserve.

### Microwave

Supplies electrical current to the microwave.

### Air Conditioner

Supplies electrical current to the air conditioner compressor and control panel located in the cabin.

### NOTICE:

**After a certain amount of time without water flow, the air conditioning unit will automatically power down. If this occurs, reset the unit and check for water flow out of the air conditioning thru-hull. See air conditioner owner's manual for more information.**

### Water Heater

Reserved for additional 120-volt AC equipment.

### Freezer

**Supplies electrical current to the freezer compressor for the transom fish box/freezer control in the cockpit when this option is installed. Otherwise the breaker is wired in reserve.**

### Acc

Reserved for additional 120-volt AC equipment.

## 4.5 Generator

The generator is activated by the house battery and the generator control panel in the cabin breaker panel. The oil and coolant in the generator should be checked regularly or whenever you check the oil in the main engines.

The generator panel controls the starting, running, and stopping of the generator. Lights in the panel

monitor engine temperature, exhaust temperature and oil pressure. An owner's manual for the generator has been supplied with this manual. Please refer to it for details on the generator operation.

The generator engine uses a closed cooling system with a seawater-cooled heat exchanger. A sacrificial anode in the seawater cooling system protects generator components that are in contact with seawater. There is an expansion tank for the engine coolant mounted in the bilge near the generator. Make sure the fluid level in the expansion tank is kept between the maximum and minimum lines of the tank. You should also check the exhaust port for water flow each time the generator is started. If there is no discharge within thirty seconds, shut down the generator, then find and correct the problem.

The seawater cooling system includes a strainer that prevents debris in the seawater from entering the cooling pump. The strainer is located in the stern bilge compartment. It is important to check and clean the strainer regularly to ensure the seawater system can circulate enough water to provide cooling for the closed cooling and exhaust systems on the generator. Refer to the Generator Raw Water Supply section of the Raw Water System chapter for information on cleaning the sea strainer.

The generator diesel fuel system is different than the fuel system for the main engines. Please refer to the Fuel System chapter for more information on generator fuel system.



You also should read the generator owner's manual for detailed information on the safe operation and maintenance of the generator.

**NOTICE:**

Generators charge the battery just enough to compensate for the DC electrical current the engine requires to operate. Therefore, it is important to activate the battery charger to maintain the batteries whenever the generator is running.

**NOTICE:**

The generator used in your boat may not be able to operate all 120-volt accessories at the same time. **POWER MANAGEMENT PRACTICES** may need to be observed depending on the AC power load.

 **DANGER** 

**GENERATOR ENGINES PRODUCE CARBON MONOXIDE WHICH IS A LETHAL, TOXIC GAS THAT IS COLORLESS AND ODORLESS. IT IS A DANGEROUS GAS THAT WILL CAUSE DEATH IN CERTAIN LEVELS. ONLY OPERATE THE GENERATOR IN WELL VENTILATED AREAS AND NEVER OPERATE THE GENERATOR WHILE YOU ARE SLEEPING.**

## 4.6 Bonding System and Galvanic Isolator

Your boat is equipped with a bonding system that interconnects all underwater hardware and thru-hull fittings to ensure that they are of the same electrical potential. Anodes are attached to the bonding system at the trim tabs and engines. There is also an anode in the seawater cooling system for the generator and on the bow thruster propeller if these options are installed on your boat. The anodes deteriorate before the other metals, thereby protecting the underwater metals from galvanic corrosion or stray electrical current. Since the anodes are sacrificial, it is important to monitor them and replace them when they have deteriorated to 50 - 75% of their original size. The bonding system is connected to the DC ground and the earth ground wire for the AC electrical system. It provides a path for dangerous short circuits in the AC electrical system to the safety earth ground in the event of a fault in the shore earth ground connection and when the boat is away from the dock.



When the boat is connected to shore power at a marina or city dock, all boats connected to shore power are connected to a common shore safety

earth ground connection. This circuit provides essential protection against electrical shock from faults or short circuits in AC equipment and, unfortunately, provides a path for low voltage galvanic current to flow between the bonding system of other boats in the circuit. If one or more of the boats in the circuit has a stray current electrical problem or is not equipped with proper galvanic protection, it will seek protection from your boat's bonding system through the safety ground circuit. This could cause accelerated deterioration of the anodes and/or severe damage to the underwater hardware. To prevent damage from other boats in the circuit, a galvanic isolator is installed in the shore ground circuit that isolates your boat's bonding system from the other boats. It prevents the flow of low voltage galvanic current while still providing a path for dangerous short circuit currents in the AC system to the shore safety ground.

## 4.7 Electrical System Maintenance

### 12-Volt AC Electrical System Maintenance

At least once a year, spray all exposed electrical components behind the helm and in the plugs, with a protector. Exterior light fixture bulbs should be removed and the metal contact areas coated with a non-water soluble lubricant like petroleum jelly or silicone grease. The sockets should be sprayed with a protector. Care must be taken not to get any oil or grease on the glass portion of the bulbs as this will cause the bulb to overheat and burn out. Note that LED lights are sealed and cannot be serviced.

 **CAUTION** 

**WHEN REPLACING LIGHT BULBS IN MARINE LIGHT FIXTURES, ALWAYS USE A BULB WITH THE SAME RATING AS THE ORIGINAL. USING A DIFFERENT BULB COULD CAUSE THE FIXTURE TO OVERHEAT AND MELT OR SHORT CIRCUIT.**

Inspect all wiring for proper support, sound insulation, and tight terminals, paying particular attention to portable appliance cords and plugs.

Check all below deck wiring to be sure it is properly supported, that the insulation is sound, and that there are no loose or corroded terminals. Corroded terminals should be thoroughly cleaned with sandpaper or replaced, tightened securely and sprayed with a metal and electrical protector. Inspect all engine wiring.

Check the electrolyte level in the batteries regularly and add distilled water as necessary. If the batteries are frequently charged by the automatic battery charger, the electrolyte level will have to be checked more often. The correct fluid level in the cells is usually approximately 1/4 to 1/2 inch above the plates. If fluid is needed, fill to the proper level with distilled water. Do not over fill!

**NOTICE:**

**Some batteries are sealed and do not require or allow the inspection of the electrolyte.**

Keep the battery tops clean and dry. Dirt and water can conduct electricity from one post to the other causing the battery to discharge.

The battery posts should be kept free of corrosion. Remove the cables and clean the posts and cable clamps with a battery post cleaner or sandpaper as required. Coating the battery posts and cable clamps with petroleum jelly or silicone grease will protect them and reduce corrosion.

Battery cables, both hot and ground, must be replaced when they show signs of corrosion or fraying. Deteriorated cables cause a considerable voltage loss when high currents are drawn, as for starting the engine or operating the bow thruster.



Inspect all wiring for proper support, sound insulation and tight terminals, paying particular attention to portable appliance cords and plugs.

The entire AC circuitry, especially the shore power cords, should be seasonally tested for proper continuity by an experienced electrician. This will detect any shorts, open wires, or ground faults. Ground fault interrupts should be tested periodically to ensure proper operation by pressing the test/reset buttons in the center of the face plate. The polarity indicator system also should be inspected for proper operation.



**Generator Maintenance**

The engine maintenance required on the generator is similar in many ways to main 4-stroke outboard engines. The most important factors to the generator's longevity are proper ventilation and maintenance of the fuel system, cooling system, lubrication system and the AC alternator.

The seawater cooling system is equipped with a sacrificial anode and that should be checked whenever the generator is serviced and replaced as necessary. Maintenance schedules and procedures are outlined in your generator owner's manual. They should be followed exactly.

 **DANGER** 



**NEVER USE AN OPEN FLAME IN THE BATTERY STORAGE AREA. AVOID STRIKING SPARKS NEAR THE BATTERY. A BATTERY CAN EXPLODE IF A FLAME OR SPARK IGNITES THE HYDROGEN GAS THE BATTERY EMITS WHILE BEING CHARGED.**

 **WARNING** 

**CORROSION ALLOWED TO BUILD ON THE ELECTRICAL CONNECTORS CAN CAUSE A POOR CONNECTION RESULTING IN SHORTS, GROUND FAULTS OR POOR GROUND CONNECTIONS. ELECTRICAL CONNECTORS SHOULD BE CHECKED AT LEAST ANNUALLY AND CLEANED AS REQUIRED. DO NOT ALLOW CORROSION TO BUILD ON CONNECTIONS.**

**AC Electrical System Maintenance**

Periodically inspect all wiring for nicks, chafing, brittleness, improper support, etc. Examine the shore power cord closely for cracks in the insulation and corrosion in electrical connectors. Spraying receptacles and electrical connections with an electrical contact cleaner or a metal and electrical protector will reduce corrosion and improve electrical continuity.

 **WARNING** 

**ELECTRIC SHOCK CAN CAUSE SEVERE INJURY OR EVEN DEATH. THE AC AND DC ELECTRICAL SYSTEMS ALWAYS SHOULD BE DISCONNECTED FROM THE POWER SOURCE BEFORE INSPECTING OR SERVICING THE SYSTEM. NEVER SERVICE ANY COMPONENT OF AN ELECTRICAL SYSTEM WHILE IT IS ENERGIZED.**



THIS PAGE WAS LEFT BLANK  
INTENTIONALLY

## FRESH WATER SYSTEM

### 5.1 General

The fresh water system consists of a potable water tank, distribution lines and a distribution pump. The pump is equipped with an automatic pressure switch. The tank is in the bilge below the berth in the cabin. A gauge in the cabin AC/DC panel monitors the water level in the tank when "Water" is selected with the Waste/Water selector switch on the panel.

	<b>CAUTION</b>	
<p><b>DO NOT FILL SYSTEM WITH ANYTHING OTHER THAN WATER. SHOULD THE SYSTEM BECOME CONTAMINATED WITH FUEL OR OTHER TOXIC FLUIDS, COMPONENT REPLACEMENT MAY BE NECESSARY.</b></p>		



*Fresh Water Pump in the Stern Systems Station*

	<b>WARNING</b>	
<p><b>DO NOT CONFUSE FUEL FILL DECK PLATES WITH THE WATER OR WASTE FILL DECK PLATES. THESE PLATES ALSO ARE LABELED ACCORDINGLY. IF FUEL IS ACCIDENTALLY PUMPED INTO THE WATER OR WASTE TANK, DO NOT ATTEMPT TO PUMP IT OUT YOURSELF. WATER AND WASTE PUMPS ARE NOT DESIGNED TO PUMP FUEL AND A FIRE OR EXPLOSION COULD RESULT. CONTACT YOUR DEALER OR THE SCOUT CUSTOMER SERVICE DEPARTMENT FOR ASSISTANCE IN HAVING THE FUEL PROFESSIONALLY REMOVED AND COMPONENTS OF THE FRESH WATER SYSTEM REPLACED AS NECESSARY.</b></p>		



*Fresh Water Deck Fill Plate*

### 5.2 Fresh Water System Operation

Fill the water supply tank slowly through the labeled deck plate on the port gunnel. After filling the water tank, partially open all faucets. The Fresh Water switch on the helm switch panel should be on. Allow the pump to run until all of the air is purged from the system and a steady stream of water is flowing from each outlet, including the fresh water washdown. Next, turn off the faucets one by one. As the pressure builds, the pump will automatically shut off.

When properly primed and activated, the water system will operate much like the water system in a home. An automatic pressure sensor keeps the system pressurized. If the system has been re-

cently filled or has not been used for an extended period, air bubbles may accumulate at the pump and the system may have to be reprimed.

Whenever the boat is left unattended, the Fresh Water switch should be placed in the OFF position.



## CAUTION



DO NOT ALLOW THE FRESH WATER PUMP TO RUN DRY. THE FRESH WATER PUMP WORKS ON DEMAND AND WILL NOT SHUT OFF AUTOMATICALLY WHEN THE TANK IS EMPTY. THIS CAN RESULT IN DAMAGE TO THE PUMP. ALWAYS TURN THE FRESH WATER SWITCH OFF WHEN THE FRESH WATER SYSTEM IS NOT IN USE.

### Fresh Water Washdown Hose Connection

The cockpit fresh water washdown hose connection is located on the port side of the cockpit and uses a standard garden hose connection. It is equipped with a valve that allows the flow of water to be turned on or off at the hose connection.

Make sure the Fresh Water switch in the helm switch panel is on before using the washdown hose and that the washdown faucet valve or hose spray nozzles are off when the fresh water system is activated.

### 5.3 Fresh Water System Maintenance

Information supplied with water system components by the equipment manufacturers is included with this manual. Refer to this information for additional operation and service data.

#### Routine Maintenance

The following items should be done routinely to maintain your fresh water system:

- Remove the filter screens from the faucet spouts and eliminate any accumulation of debris. A build up of debris can cause the pump to cycle excessively.
- Periodically spray the pump and metal components with a metal protectant.
- The batteries must be properly maintained and charged. Operating the pressure pump from a battery with a low charge could lead to pump failure.
- Add a commercially available potable water conditioner to the water tank to keep it fresh.



*Cockpit Fresh Water Washdown Hose and Faucet*

### Sanitizing the Fresh Water Tank

The fresh water system should be sanitized if it has not been used for a long period or you are unsure of the quality of the water in the system.

The following steps can be used to sanitize the system:



- Activate the system, open all faucets and pump out as much water as you can.
- Make a chlorine solution by mixing two ounces of household chlorine bleach in a gallon of water. This mixture will treat approximately fifteen gallons. If the water tank on your boat is larger or smaller than 15 gallons, then adjust the mixture accordingly. Always mix the chlorine with water in a separate container first and never add straight chlorine to the fresh water tank.
- Fill the water tank half full with fresh water and pour the mixture into the water tank. Top off the tank.
- Activate the system and allow the water to run for about one minute at each faucet. Let the treated water stand for 4-6 hours.
- Drain the system by pumping it dry and flush with several tank fulls of fresh water.





# Fresh Water System



- The system should now be sanitized and can be filled with fresh water. If the chlorine smell is still strong, it should be flushed several more times with fresh water.

 **CAUTION** 

THE FRESH WATER SYSTEM MUST BE PROPERLY WINTERIZED PRIOR TO WINTER LAY-UP. REFER TO THE SECTION ON WINTERIZING FOR MORE INFORMATION.

 **CAUTION** 

THE WATER SYSTEM BREAKER SHOULD BE PLACED IN THE OFF POSITION WHENEVER LEAVING THE BOAT UNATTENDED OR WHEN THE FRESH WATER SYSTEM IS NOT IN USE.

**NOTICE:**

The quality of the water in marine fresh water systems can be questionable. We recommend that you avoid using the water from the fresh water system for drinking and cooking. You should only use bottled water for these purposes.

THIS PAGE WAS LEFT BLANK  
INTENTIONALLY

## RAW WATER SYSTEM



*Stern Systems Station and Bilge*

(A) Stern Bilge Pump  
(B) Baitwell Pump and Valve

(C) Fish box Overboard Diaphragm Discharge Pumps  
(D) Fish box Overboard Discharge Thru-Hull Fittings and Valves

### 6.1 General

In the raw or seawater systems, the baitwell water pump is mounted to a seacock on the thru-hull fitting located in the stern systems station. The water system pressure pump, air conditioner pump and generator cooling pump are connected to individual thru-hull valves. Always make sure the ball valves are open before attempting to operate any component of the raw water system.

#### Priming the System

Make sure the seacock valves are open and the Raw Water switch in the helm switch panel is on. Run the pressure pump by turning on the raw water washdown hose until all of the air is purged from the system and then turn the hose off. Turn the Baitwell switch to the on position and run the baitwell pump until all of the air is purged from the system and turn the pump off.

If your boat is equipped with the optional air conditioning system and shore power is connected and activated, turn on the cabin air conditioner. Monitor the discharge fitting for the air conditioning in the hull side. Water should begin to flow from the discharge fitting within 30 seconds. If water does not flow, the system may have an air lock or debris in the strainer restricting the water flow and causing the unit to automatically shut down. Investigate and correct the problem, then restart the air conditioner.

The intakes for the air conditioner and baitwell centrifugal pumps are equipped with a scoop and ball valve. If a pump runs but will not prime after cleaning the air conditioner sea strainer or at the time of launching, make sure the valve is open. If the pump still won't prime, it may be air locked. Make sure the valve is open and run the boat at

or above 15 M.P.H. The water pressure from the scoop will force the trapped air through the pump and allow it to prime. If this procedure doesn't work, contact your Scout dealer.

Closing the thru-hull valves before the boat is hauled from the water will help to eliminate air locks in raw water systems. The valves should also be closed whenever you leave the boat unattended.

**NOTICE:**

**It may be necessary to reprime the raw water system if it is not used for an extended period and at the time of launching.**



*Raw Water Washdown and Air Conditioning/Freezer Circulating Pump*

## 6.2 Raw Water System Operation

A high pressure pump, controlled by a pressure sensor, is activated by the Raw Water switch located in the helm switch panel. When activated, the pressure switch will automatically control the pump that supplies the raw water hose connector.

As the pressure builds in the system, the pump will shut off. When the system is in use and the pressure drops, the pump will turn on. The water system is equipped with sea strainers on the intake side of the pump and near the thru-hull fitting. The strainers should be checked frequently and cleaned as necessary.

Whenever the boat is left unattended, the Raw Water switch should be placed in the OFF position.

### Washdown Hose Connector

The raw water washdown hose connection is located on the starboard side of the cockpit below the gunnel and uses a standard garden hose connector. It is equipped with a valve that allows the flow of water to be turned on or off.





*Seawater Intake Strainer for the Air Conditioning/Freezer Circulating and Raw Water Washdown Pumps*

## 6.3 Baitwell

Seawater is provided to the baitwell by a 12-volt circulation pump. The pump is designed to carry a constant flow of water to the baitwell. The pump does not have a pressure sensor and is activated by the Baitwell 1 or Baitwell 2 switch in the helm switch panel. There is also a light in the baitwell that is activated by the Bait Light switch. Typically, the Baitwell 1 switch activates the standard baitwell below the aft facing seat. The Baitwell 2 switch activates the optional transom baitwell when your boat is equipped with this option.

An overflow standpipe in the baitwell drain automatically controls the water level. Always turn the pump off at the switch panel when the baitwell is not in use.

	<b>CAUTION</b>	
<p><b>DO NOT ALLOW THE WATER PUMP TO RUN DRY. THE PUMP WORKS ON DEMAND AND WILL NOT SHUT OFF AUTOMATICALLY IF NO WATER IS AVAILABLE. THIS CAN RESULT IN DAMAGE TO THE PUMP. ALWAYS TURN THE RAW WATER SWITCH OFF WHEN THE RAW WATER SYSTEM IS NOT IN USE.</b></p>		

To fill the baitwell, insert the standpipe into the drain fitting at the bottom of the baitwell. Make sure the seacock is open and activate the baitwell supply/aerator pump. When the water level reaches the overflow, it will begin to circulate.

The baitwell raw water intake is equipped with a scoop that will supply water to the baitwell if the pump should fail and helps prime the system during normal operation. To supply water to the baitwell using the scoop, make sure the seacock valve is open and run the boat at a speed above 15 miles per hour. Water will circulate through the baitwell and out the overflow.

To drain the baitwell, turn off the baitwell pump and remove the standpipe in the drain fitting at the bottom of the baitwell. When the baitwell has completely drained, use the washdown hose to flush the baitwell and drain of debris.

The baitwell seacock valve should be closed whenever the baitwell is not in use. This will prevent water from entering the baitwell while the boat is cruising.

**NOTICE:**

**Do not use a baitwell as a dry storage area when it is not in use. Seawater could accidentally be delivered to the baitwell from the thru-hull fitting and damage equipment stored there.**



*Standard Baitwell*

Seawater is supplied to the pump from a thru hull fitting located in the stern bilge. A sea strainer between the pump and thru hull fitting protects the system from contaminants that could damage the pump or the air conditioning system. Make sure the pump receives adequate seawater by periodically cleaning the sea strainer basket. Refer to the maintenance section of this chapter for instructions on cleaning the sea strainer.

You should refer to the air conditioner and refrigerator owner's manual for more information on the operation and maintenance of the seawater pump.

	<b>CAUTION</b>	
<b>A RUPTURED RAW WATER INTAKE OR PRESSURE LINE COULD CAUSE THE BOAT TO TAKE ON WATER AND SINK. ALWAYS TURN THE RAW WATER SYSTEMS OFF AND CLOSE THE THRU-VALVES WHEN LEAVING THE BOAT UNATTENDED.</b>		

## 6.4 Air Conditioning and Freezer Pump

Air conditioner and freezer units are self-contained and seawater cooled. A 12-volt and/or 120-volt AC centrifugal raw water pump, depending on the options selected for your boat, supplies seawater that cools the condensing units as it circulates through the system and is discharged overboard. The seawater pump for the air conditioner and/or freezer is located in the stern systems station and runs whenever an air conditioner or the freezer is activated.

## 6.5 Generator Raw Water Supply

The generator engine uses a closed cooling system with a seawater cooled heat exchanger. The seawater circulates through the heat exchanger and is expelled through the generator exhaust system, cooling it as well. It includes a strainer that prevents debris in the seawater from entering the cooling pump. The strainer is located in the stern systems station and supplied seawater by a thru-hull fitting and valve near the strainer. It is important to check and clean the strainer regularly to ensure the seawater system can circulate enough water to cool the heat exchanger and exhaust system on the generator. Refer to the maintenance section of this chapter for instructions on cleaning the sea strainer.

You also should read the generator owner's manual for detailed information on the safe operation and maintenance of the generator.

## 6.6 Raw Water System Maintenance

The following items should be done routinely to help maintain your raw water system:

- Check hoses, particularly the seawater supply lines, for signs of deterioration. Tighten fittings or replace deteriorated hoses and components as necessary.
- Periodically remove and clean the screens in the water strainers located at the intake side of the generator and air conditioning/freezer seawater pumps. To clean the strainer, make sure the generator or air conditioners and freezer are off and close the valve at the seawater intake thru-hull fitting. Open the top of the strainer and remove the screen. Thoroughly flush the screen and the inside of the strainer to remove foreign matter. Then lubricate the seal with silicon or Teflon grease and reassemble the strainer, making sure that all fastens are tight. Open the intake valve, activate the pump and check for leaks.
- Periodically remove and clean the water strainer located near the intake side of the washdown pump. To clean the strainer, make sure the Raw Water switch is off and close the valve at the thru-hull fitting. Rotate the strainer bowl counterclockwise to release it. Remove and clean the screen with fresh water. Lubricate the O-ring lightly with silicon or Teflon grease and reinstall the strainer bowl.
- Spray pumps and thru-hull valves with a protective oil periodically.
- The fish boxes and baitwells should be drained and cleaned after each use.
- Operate all seacock valves at least once a month to keep them operating properly.
- Periodically remove and clean the seawater strainers for the optional generator and air conditioner or fish box freezer. The strainers are located near the intake thru-hull fittings.

### Cleaning the generator or air conditioner/freezer seawater strainer:

1. Turn off the generator.
2. Close the generator water intake valve.



Generator Sea Strainer and Thru-Hull Valve



Raw Water Washdown Pump and Strainer

# Raw Water System

3. Open the top of the strainer and remove the screen.
4. Thoroughly flush the screen and the inside of the strainer to remove foreign matter.
5. Lubricate the seal.
6. Reassemble the strainer making sure that all fasteners are tight.
7. Open the intake valve.
8. Start the generator or air conditioner/freezer and inspect the strainer for leaks.

	<b>CAUTION</b>	
<b>SHOULD A HOSE RUPTURE, TURN THE PUMP OFF IMMEDIATELY. ALWAYS CLOSE THE THRU-HULL VALVE WHEN PERFORMING MAINTENANCE ON A SEAWATER PUMP.</b>		
<b>THE BATTERIES MUST BE PROPERLY CHARGED. OPERATING ANY PUMPS FROM A BATTERY WITH A LOW CHARGE MAY LEAD TO A PUMP FAILURE.</b>		
<b>THE RAW WATER SYSTEM MUST BE PROPERLY WINTERIZED PRIOR TO WINTER LAY-UP. SEE SECTION ON WINTERIZING.</b>		



*Generator or Air Conditioner/Freezer Sea Strainer and Thru-Hull Intake Fitting and Valve*

THIS PAGE WAS LEFT BLANK  
INTENTIONALLY



# DRAINAGE SYSTEMS

## 7.1 General

All water is drained by gravity or pumped to overboard thru hull fittings located in the hull. It is important to check the drain system frequently to ensure it is free flowing and that the hoses on the thru hull fittings are secure and not leaking. Please review the drainage schematic to become familiar with the location of the drain thru hull fittings.

## 7.2 Hardtop Drains

There is a hole drilled in the center leg bases to prevent water from being trapped within the leg and provide a wire chase for accessories. A small hole is drilled in the tubing at the base of the other legs, which are not drilled for a wire chase, that allows water to drain.

### NOTICE:

**Always make sure the leg drain holes are clear when the boat is laid up for the winter. Water trapped inside the legs could freeze and cause the legs to split.**

## 7.3 Bilge Drainage

The aft and forward bilge pumps are activated both manually, by a switch in the helm switch panel and automatically, by a float switch built into the pump. The automatic float switches are connected to the batteries. They are protected by "push to reset" circuit breakers located in the cabin DC panel. They remain activated when the battery switches are in the OFF position and the batteries are connected. The manual switches in the helm are supplied current when the battery switches are activated. LED lights in the manual switches indicate when a bilge pump is operating. All bilge pumps pump water to thru-hull fittings located above the waterline in the hull sides.

The manual bilge pumps should be activated briefly each time the boat is used. This will ensure that they are operating properly and increase the service life of the pumps. The automatic switches should be manually activated periodically to verify operation. This is particularly important before operating your boat offshore.



*Transom Drain Fittings*



*Stern Bilge Pump*

Refer to the Electrical Systems chapter for additional information on bilge pump operation.



### **Bilge High Water Alarm**

An additional electronic sensor switch, located in the aft bilge, will sound an alarm if the bilge water level rises above the normal operating range of the bilge pump automatic switches. The alarm electronic switch is connected to the batteries. It is protected by a "push to reset" circuit breaker located in the cabin DC panel. It remains activated when the battery switches are in the OFF position and the batteries are connected. This

switch should be tested periodically to ensure it is operating properly. If the alarm does not activate, you should find and correct the problem as soon as possible. Refer to the alarm manual for information on testing the electronic switch.

**NOTICE:**

**Any oil spilled in the bilge must be thoroughly removed and properly disposed of before operating the bilge pump. The discharge of oil from the bilge is illegal and subject to a fine.**

	<b>CAUTION</b>	
<p>THE FEDERAL WATER POLLUTION CONTROL ACT PROHIBITS THE DISCHARGE OF OIL OR OILY WASTE INTO OR UPON THE NAVIGABLE WATERS OF THE UNITED STATES OR THE WATERS OF THE CONTIGUOUS ZONE IF SUCH DISCHARGE CAUSES A FILM OR SHEEN UPON, OR A DISCOLORATION OF THE SURFACE OF THE WATER, OR CAUSES A SLUDGE OR EMULSION BENEATH THE SURFACE OF THE WATER. VIOLATORS ARE SUBJECT TO A PENALTY OF \$10,000.</p> <p>CERTAIN BULKHEAD AREAS ARE SEALED IN ACCORDANCE WITH U.S. COAST GUARD REGULATIONS THAT WERE IN EFFECT AT THE DATE OF MANUFACTURE OF THE BOAT. ANY MODIFICATIONS TO THESE BULKHEADS SHOULD BE IN ACCORDANCE WITH THE U.S. COAST GUARD REGULATIONS.</p>		



*Port Side Cockpit Scupper*



*Rope Locker Drain*

## 7.4 Cockpit and Deck Drainage

Your Scout has two scupper drains located in the rear of the cockpit that drain the cockpit through fittings in the hull sides above the waterline. A flap built into each scupper drain fitting reduces the surge of seawater through the scupper and into the cockpit while maneuvering or in rough water.

Water is channeled away from all hatches by a gutter or drain rail system. The water then drains overboard through the scupper drain system.

### Fish boxes, Coolers and Baitwell Drains

The aft fish boxes below the cockpit sole are drained overboard by a diaphragm pump out system. There is a diaphragm pump for each fish box located in the stern bilge that are activated by the Fish box switches in the helm switch panel. Monitor the water level as the pump drains the fish box and turn it off immediately when draining is complete. The pumps could be damaged if they are allowed to run dry for extended periods.

The baitwell, baitwell overflow and transom freezer/cooler are drained by gravity to thru-hull fittings in the hull.

The storage compartment below the sundeck lounge is drained by gravity to the cockpit. The forward storage/cooler compartments below the bow seats drain by gravity to thru-hull fittings located in the hull sides above the waterline. The bow storage compartment below the cockpit sole drains to the bilge.

### Rope Locker Drainage

The rope locker drains overboard through a drain fitting located in the hull side at the bottom of the rope locker. It is important to inspect the drain frequently to remove any accumulated debris.

## Cup Holder and Helm Storage Compartment Drains

All cup holders in the helm and cockpit areas drain by gravity to the cockpit sole. Helm seat and console storage compartments also drain to the cockpit.

## 7.5 Console Cabin Drains

The cabin sink drains to a thru-hull fitting in the hull side and the top loading cooler drains to the forward bilge. The cabin sole drains to the bilge at the access hatch in the sole near the head and cabin step.



The optional cabin air conditioning condensation pan drains by gravity to the aft bilge.

## 7.6 Drainage System Maintenance

It is essential that the following items be done periodically to maintain proper drainage of your boat:

- Clean the cockpit drain rails with a hose to remove debris that can block water drainage.
- Clean the hardtop or optional tower leg drain holes. This is especially important just before winter lay-up.
- Clean the bilge pump strainers of debris and check the bilge for foreign material that can cause the automatic switch to malfunction.

- Frequently test the automatic bilge pump and high water alarm switches for proper operation. This is accomplished by lifting the float switch until the pump is activated. You can also use a garden hose to flood the bilge until the water level is high enough to activate the pump.
- Flush all gravity drains with fresh water to keep them clean and free flowing.
- Flush the air conditioner condensation pan drains with fresh water at least once each season to remove mold and debris. This is particularly important because mold tends to accumulate in condensation pan drain and if it is not cleaned regularly, the drains can clog and flood the cabin sole when the air conditioner operates.
- Clean and flush the fish boxes and cooler/storage boxes with soap or a bilge cleaner and fresh water after each use to keep them clean and fresh.
- Operate the thru hull valves once a month and service as required.

 <b>CAUTION</b> 
<b>NEVER USE HARSH CHEMICAL DRAIN CLEANERS IN MARINE DRAIN SYSTEMS. PERMANENT DAMAGE TO THE HOSES AND FITTINGS MAY RESULT.</b>
<b>ALL DRAINS AND PUMPS MUST BE PROPERLY WINTERIZED BEFORE WINTER LAY-UP.</b>

THIS PAGE WAS LEFT BLANK  
INTENTIONALLY

# VENTILATION SYSTEM

## 8.1 Cabin Ventilation

Ventilation to the cabin area is provided by the cabin door. The door is held in the open or closed position by a gas spring.

When the door is opened to the full open position, the gas spring will automatically hold the door open. When the door is closed part way, the gas spring will automatically close the door and hold it in the closed position. Make sure the door is fully latched in the closed position before operating the boat above idle speed.

## 8.2 Windshield Ventilation

Ventilation through the windshield is provided by an opening panel above the windshield. The vent panel is opened and closed by an electric actuator controlled by the Windshield Vent switch in the hardtop switch panel. To open the vent, press the switch and open the panel to the desired position. To close the panel, press the switch until the panel is completely closed. Always release the switch immediately when vent panel reaches the full open or closed position.



*Cabin Door*



*Windshield Vent Actuator*



*Windshield Vent Open*

## 8.3 Carbon Monoxide and Proper Ventilation



### WARNING



FAILURE TO PROPERLY VENTILATE THE BOAT WHILE THE ENGINES ARE RUNNING MAY PERMIT CARBON MONOXIDE TO ACCUMULATE WITHIN THE CABIN AND OPEN AREAS OF YOUR BOAT. CARBON MONOXIDE IS A COLORLESS AND ODORLESS GAS THAT IS LETHAL WHEN INHALED. CARE MUST BE TAKEN TO PROPERLY VENTILATE THE BOAT AND TO AVOID CARBON MONOXIDE FROM ACCUMULATING IN THE BOAT WHENEVER AN ENGINE IS RUNNING.

A by-product of combustion, carbon monoxide (CO) is invisible, tasteless, odorless, and is produced by all engines and gas heating and cooking appliances. The most common sources of CO on boats are gasoline and diesel engines, auxiliary generators and propane or butane stoves. These produce large amounts of CO and should never be operated while sleeping. The hazard also may be created by a boat nearby whose exhaust fumes are entering your boat. Boats also have a problem due to the "station wagon effect" where engine exhaust fumes are captured in the vacuum or low pressure area, usually the cockpit and cabin, that can be created by the forward speed of the boat.



Boats underway should close all aft facing hatches, windows and doors. The forward facing windshield vent should be open whenever possible to help pressurize the helm area of the boat. No sleeping in the cabin should be permitted while underway. The canvas drop or aft curtain must be removed and the side curtains should be opened or removed to increase air flow and maintain proper ventilation whenever the engines are running. Under no circumstances should the engines be operating with side curtains closed and the aft or drop curtain installed.

Extreme caution must be taken while at anchor or in a slip when an auxiliary power generator is operating. Wind still nights can easily allow exhaust fumes, containing high concentrations of CO, from the generator on your boat or from an adjacent boat's generator to enter the boat.

A carbon monoxide detector has been installed in your cabin as standard equipment. While a CO detector enhances your protection from CO poisoning, it does not guarantee it will not occur. Do not use the carbon monoxide detector as a replacement for ordinary precautions or periodic

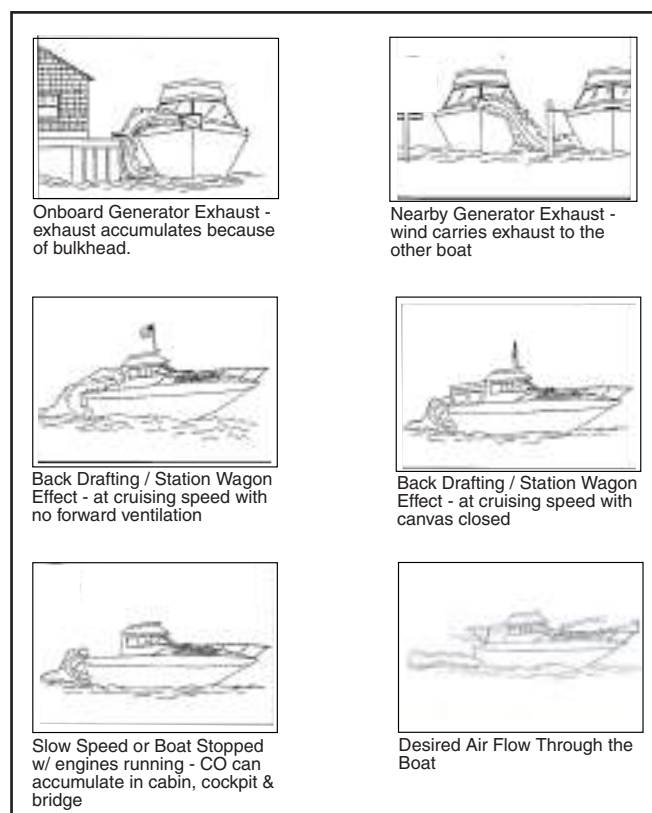
inspections of equipment. Never rely on alarm systems to save your life, common sense is still prudent and necessary. Remember, the operator of the boat carries the ultimate responsibility to make sure the boat is properly ventilated and the passengers are not exposed to dangerous levels of carbon monoxide. You should always be alert to the symptoms and early warning signs of carbon monoxide poisoning. You also should read the "Carbon Monoxide Monitoring System" in the Safety Equipment chapter of this manual and the owner's manual supplied by the CO detector manufacturer for operation instructions and additional information regarding the hazards and symptoms of carbon monoxide poisoning.



 **DANGER** 

**ACTIVATION OF THE CARBON MONOXIDE DETECTOR INDICATES THE PRESENCE OF CARBON MONOXIDE (CO) WHICH CAN BE FATAL. EVACUATE THE CABIN IMMEDIATELY. DO A HEAD COUNT TO CHECK THAT ALL PERSONS ARE ACCOUNTED FOR. DO NOT REENTER THE CABIN UNTIL IT HAS BEEN AIRED OUT AND THE PROBLEM FOUND AND CORRECTED.**

## 8.4 Maintenance

- Periodically lubricate all hinges and latch assemblies with a light oil.
- Periodically clean and coat gasket materials with silicone to help keep them pliable.

Periodically test the carbon monoxide detector per the manufacturer's instructions. Please refer to the carbon monoxide detector manual or contact the manufacturer for more information on maintaining and calibrating the detector.

THIS PAGE WAS LEFT BLANK  
INTENTIONALLY



## EXTERIOR EQUIPMENT

### 9.1 Deck

#### Rails and Deck Hardware

The rail system and hardware fittings have been selected and installed to perform specific functions. Hand rails are installed to provide a handhold in certain areas of the boat. You should make sure you keep at least one hand on the handholds as you move about the boat.

Your boat is equipped with cleats that are retractable and flush with the deck when not in use. To use the cleats, pull up on the center of the cleat until it locks in the mooring position. Mooring lines should be secured to the cleats and not to rails or stanchions. Be sure a clear lead exists when running dock lines or anchor lines. A line inadvertently run around a stanchion or over the rail could cause damage.

**NOTICE:**  
**All fittings must be inspected periodically for loose fit or wear and damage. Any problems should be corrected immediately.**



*Stern Mooring Cleat Up*



*Stern Mooring Cleat Retracted*

	<b>WARNING</b>	
<p>SCOUT BOATS ARE NOT EQUIPPED WITH HARDWARE DESIGNED FOR TOWING PURPOSES. THE MOORING CLEATS ARE NOT TO BE USED FOR TOWING ANOTHER VESSEL OR HAVING THIS BOAT TOWED.</p>		



*Anchor Roller and Delta Plow Anchor*

#### Bow Roller

The bow roller assembly is built into the hull and allows the anchor to be operated and stored at the roller. The windlass, roller assembly, anchor line and chain binder are concealed below a hatch in the bow at deck level. A gas spring hatch support holds the hatch in the open position. A twist latch secures the hatch when it is closed. The latch handle can be stored flush in the open or secured position. There is a large red dot in the handle that indicates that the latch is in the open position and the hatch is not secure. Always make sure the hatch is closed with the latch in the secured position before operating the boat above idle speed.

The anchor line is stored in the rope locker and routed out the windlass, through the roller and connected to the anchor chain. The bow roller is designed for a Delta plow anchor. A chain binder is provided near the windlass to secure the anchor. Always make sure the anchor is properly secured with the chain binder when it is in the stored position on the bow roller.

## Anchor Rope Locker

The anchor rope locker is in the bow of the boat below the windlass and accessed through a hatch forward of the bow seats. The anchor line is always stored in the locker. The rope locker is drained by a thru-hull fitting in the hull side near the bottom of the locker. It is very important to check the drain frequently to make sure it is clean and free flowing.

After the anchor is hauled in and secured with the chain binder, the anchor, anchor line, windlass and all hardware should be rinsed with fresh water using the fresh water washdown hose. Rinsing with fresh water will reduce odors in the rope locker and reduce corrosion on the hardware, anchor and windlass. Make sure the Fresh Water switch in the helm switch panel is on before using the washdown hose.

The locker is designed for the anchor line and not for storing anchors or additional anchor lines. Do not store anchors or any heavy objects in the anchor locker. Anchors and weights for floating markers will bounce and damage the hull or anchor locker if they are stored there. They will also interfere with the operation of the windlass. Always store and secure additional anchors and weights in a storage compartment in the cockpit, as far aft as possible.

Periodically remove the anchor line from the rope locker, rinse it with fresh water and allow it to dry in the sun. Cleaning the anchor line regularly will reduce odors in the anchor locker and increase the life of the line.

The line should also be inspected for abrasions or signs of deterioration. Replace the line if it shows any sign of damage or deterioration. It is important to replace the anchor line with a new line of the type recommended or supplied by the windlass manufacturer.

## Windlass

The windlass is mounted to the deck below a hatch at the bow. The anchor is stored on the bow roller and is raised and lowered by the windlass. The anchor line is stored in the rope locker and routed out through the windlass to the anchor chain.

The anchor is lowered by releasing the anchor from the chain binder and operating a "DOWN" control at the helm or the foot switch at the bow. The windlass control switches are activated and



*Rope Locker*



*Windlass, Deck Foot Switch, Bow Roller and Chain Binder*

protected by a circuit breaker in the cabin DC panel. Hinged covers protect the foot switches from being accidentally activated. Make sure to open the covers to expose the switches when using the windlass foot switches and close the covers when done.

After the anchor is set, the windlass must not be left to take the entire force from the anchor line. Boats lying to their anchor in a high swell or heavy weather conditions will snub on the line. This can cause slippage or apply excessive loads to the windlass. The line should be made fast to the cleat provided to relieve the load on the windlass.

The anchor is hauled in by releasing the line from the cleat and operating the "UP" control at the helm or the foot switch on the deck near the windlass. Always start the engines before hauling the anchor and motor up to the anchor as the line is retrieved to relieve the load on the windlass. Once the anchor is retrieved, independently secure the anchor to the chain binder to prevent it from being accidentally released. This is especially important while the boat is under way.

The windlass manufacturer provides an owner's manual with its product. It is extremely important that you read the manual and become familiar with the proper care and operation of the windlass. Refer to the Operation chapter for tips on anchoring your boat.



Windlass Foot Switches and Safety Covers

	<b>WARNING</b>	
<p>A WINDLASS MUST BE USED WITH CARE. IT IS EXTREMELY IMPORTANT THAT YOU READ THE OWNER'S MANUAL AND BECOME FAMILIAR WITH THE SAFETY INSTRUCTIONS AND PROPER OPERATION OF THE WINDLASS BEFORE USING IT WITH YOUR BOAT. ALWAYS ENSURE THAT LIMBS, FINGERS, HAIR AND CLOTHING ARE KEPT CLEAR OF THE WINDLASS AND ANCHOR LINE DURING OPERATION.</p>		

	<b>WARNING</b>	
<p>A PARTIALLY LOWERED AND LOOSE ANCHOR CAN CAUSE CONSIDERABLE DAMAGE TO THE HULL. DO NOT USE A WINDLASS AS A SOLE MEANS OF SECURING AN ANCHOR IN THE BOW PULPIT. ALWAYS SECURE THE ANCHOR LINE TO A CLEAT OR CHAIN BINDER BEFORE OPERATING YOUR BOAT.</p>		



Engine Mounting System and Swim Platform

A swim platform built into the engine mounting system is standard on your boat. Teak covering boards are optional.

## 9.2 Hull

### Engine Mounting System and Swim Platform

Your Scout is equipped with an engine mounting system that is integrated into the hull and stringer system and designed to equally distribute the stresses of engine weight and thrust throughout the entire hull.

The engine hoses and cables or the transom gel coat can be damaged by tilting the engines to the full up position with the engines turned to the wrong position. You should monitor the engines as they tilt to determine best full tilt engine position for your boat.

### Boarding/Dive Ladder

The boarding ladder is stored below the sundeck lounge when it is not being used. To use the ladder, insert the top studs into the special bracket on the starboard swim platform and rotate the ladder to lock the studs in the top, horizontal slot. The ladder floats and will remain on top of the water until a person begins to board. The weight of the person will cause the ladder to swing down to the boarding position, setting the lower studs firmly against the bracket. Make sure people boarding keep their hands clear of the bracket so their fingers don't get pinched between the ladder and bracket as the ladder swings from floating to the boarding position.

The bracket is designed so the ladder can be rotated out of the water to a near vertical position. As the ladder nears the vertical position, the top studs will align to the vertical slots in the bracket allowing the ladder to slide down and lock in the up position. This position is convenient for moving short distances without removing and storing the ladder.

For normal cruising or fishing, the ladder should be removed and stored. To remove the ladder, rotate it to the up position. Lift the ladder so the studs slide up to the horizontal slot in the ladder bracket and rotate the ladder 90 degrees to release the studs from the bracket. Secure the ladder in the sundeck lounge storage compartment.

Refer to the ladder manufacturer's instructions included with this manual for more information on the use and maintenance of the ladder and hardware.

**NOTICE:**

The swing design of the ladder and bracket allows it to swing up in the event that the boat is operated without removing the ladder. This helps to prevent damage to the ladder and bracket.



*Boarding Ladder Bracket*



*Underwater Lights*

	<b>WARNING</b>	
<p>MOVING PROPELLERS ARE DANGEROUS. THEY CAN CAUSE DEATH, LOSS OF LIMBS, OR OTHER SEVERE INJURY. DO NOT USE THE SWIM PLATFORM OR BOARDING LADDER WHILE AN ENGINE IS RUNNING. STOP THE ENGINES IF DIVERS OR SWIMMERS ARE ATTEMPTING TO BOARD. ALWAYS REMOVE AND PROPERLY STORE THE LADDER BEFORE STARTING THE ENGINES.</p>		

	<b>WARNING</b>	
<p>DO NOT OPERATE LIGHTS OUT OF THE WATER. OPERATING THE LIGHTS WHEN THE BOAT IS OUT OF THE WATER CAN CAUSE EXCESSIVE TEMPERATURE BUILDUP IN THE FIXTURE RESULTING IN DAMAGE TO SEALS OR POSSIBLE FAILURE OF THE SEAL BETWEEN THE LIGHT HOUSING AND HULL.</p>		

### Underwater Lights (Optional)

Your boat may be equipped with optional underwater lights mounted in the transom. The underwater lights are activated by a switch in the helm switch panel and should only be used when the boat is in the water and the lights are submerged.

### Trim Tabs

The trim tabs are located on the transom below the swim platform. The trim tabs are an important part of the control systems. Please refer to the Helm Control Systems chapter for detailed information on the trim tabs.

## 9.3 Cockpit Features

### General

The hatches in the cockpit sole are secured with twist latches and flush mounted handles that store flush in the hatch. Automatic push to close latches secure other cockpit and center console doors and drawers in the closed position. Gas charged springs are used to help raise most hatches and hold them in the open position.

The hatches in the cockpit sole are secured with special flush mounted, twist lock latches with handles that store flush in the latch. The latch handles can be stored flush in either the open or secured positions. There is a large red dot in the handle that indicates that the latch is in the open position and the hatch is not secure. Always make sure these hatches are closed with the latches in the secured position before operating the boat above idle speed.



*Twist Latch Unlatched  
Red Dot Showing*



*Twist Latch latched  
Red Dot is Not Showing*

	<b>WARNING</b>	
<p>IN CERTAIN CONDITIONS, OPEN EXTERIOR DOORS AND HATCHES THAT ARE NOT SECURED PROPERLY CAN SLAM CLOSED UNEXPECTEDLY AND CAUSE INJURY TO PASSENGERS OR DAMAGE TO THE BOAT. SOME DOORS AND HATCHES ARE EQUIPPED WITH SPECIAL FASTENERS, HATCH LIFTERS OR SNAPS AND/OR STRAPS TO SECURE THEM IN THE OPEN POSITION. ALWAYS MAKE SURE THAT THESE HATCHES AND DOORS ARE PROPERLY SECURED WHENEVER THEY ARE IN THE OPEN POSITION.</p>		



*Shore Power Inlet, Transom Door and Gate*

### Transom Door and Gate

A transom door and gate is incorporated into the transom. The gate is hinged and can be opened by releasing the exterior latch and lifting the starboard side. The transom door can be opened when the gate is open or closed. It is secured by a special latch mounted on the inboard side of the door. The door latch has a magnetic safety pin. When the transom door is closed, make sure the latch is completely closed and that the safety pin is snapped into place to prevent the latch from opening accidentally.

The transom door and gate should only be opened when the boat is not underway. The door and gate must be latched in the full CLOSED position whenever the boat is underway. Never leave the transom door unlatched.



*Transom Door and Latch*

## NOTICE:

Periodically inspect the transom door and gate fittings for wear, damage or loose fit. Any problems should be inspected and corrected immediately.



## WARNING



THE TRANSOM DOOR AND GATE SHOULD BE CLOSED AND PROPERLY LATCHED WHENEVER THE ENGINES ARE RUNNING. NEVER OPEN THE TRANSOM DOOR WHILE UNDERWAY OR IN ROUGH SEA CONDITIONS. IN CERTAIN SITUATIONS, AN OPEN TRANSOM DOOR COULD ALLOW A SUBSTANTIAL AMOUNT OF WATER TO ENTER THE COCKPIT CREATING A POTENTIALLY DANGEROUS CONDITION.



*Transom Cooler with Optional Freezer*



## WARNING



OPERATING THE BOAT UNDER POWER WITH THE TRANSOM DOOR AND GATE OPEN MAY ALLOW PERSONS TO FALL OVERBOARD AND INTO BOAT PROPELLERS OR TO BE LOST IN OPEN WATER. ALWAYS CHECK TO MAKE SURE THE TRANSOM DOOR AND GATE IS PROPERLY CLOSED AND LATCHED BEFORE STARTING THE ENGINES AND NEVER OPERATE THE BOAT UNDER POWER WITH THE TRANSOM DOOR AND GATE OPEN.



*Cockpit Below Deck Fishbox*

## Transom Fish box/Baitwell/Freezer Box

An insulated cooler/fish box unit is located in the transom at the rear of the cockpit. The hatch is equipped with a gas charged hatch lifter that holds the hatch in the open or closed position. The cooler or optional freezer is equipped with sliding, removable trays to hold prepped bait in the upper portion of the box.

Flush, twist lock latches secure the hatch in the closed position. There is a large red dot in the handle that indicates that the latch is in the open position and the hatch is not secure. Always make sure the hatch is closed with the latches in the secured position before operating the boat above idle speed.

The fishbox can be converted to an optional baitwell or freezer. If the baitwell option is installed on your boat, it will be equipped with a removable overflow standpipe for the drain fitting and operate much like the standard baitwell below the aft facing bench seat. It is activated by the baitwell 2 switch in the helm switch panel.

If the transom fishbox is equipped with the optional freezer, the freezer unit is located in the transom storage compartment next to the fishbox. The freezer unit is activated by the AC electrical system. The temperature of the box is controlled by a thermostat in the freezer and a digital control panel inside the console above the head.

The box drains by gravity to a thru-hull fitting in the hull above the waterline. Refer to the freezer unit owner's manual for information on the operation and maintenance for the freezer unit.

## Rod Racks

There are recessed rod storage racks located below the gunnel on each side of the cockpit. They are equipped with stretch cords to secure the rods to the racks. Always make sure the rods are properly secured in the storage racks with the rod tips forward.

## Aft below Deck Fish boxes

Two below deck fish boxes are located on each side of the cockpit. Each fish box hatch is equipped

with a hatch lifter that holds the hatch in the open position. Flush, twist lock latches secure the hatches in the closed position. There is a large red dot in the handle that indicates that the latch is in the open position and the hatch is not secure. Always make sure these hatches are closed with the latches in the secured position before operating the boat above idle speed.

Each fish box is drained by a separate diaphragm pump located in the bilge and activated by a switch in the helm switch panel. Be sure to monitor the water level in the fish box and turn the pump off as soon as pumping is complete. The pump could be damaged if it is allowed to run dry for extended periods. The fish boxes should be pumped out and cleaned after each use. Refer to the Drainage Systems chapter for more information on the fish box drainage.

## Aft Systems Compartment Access Hatch

A hatch in the rear of the cockpit provides access to the fuel valves, fuel filters, pumps, strainers, optional generator and other equipment in the stern bilge. The fuel valves are located on the forward side of the compartment. The stern bilge pump, fishbox pumps, high water alarm, baitwell pump, fresh water pump, raw water pump, optional generator and sea strainers for the air conditioner and generator are among the equipment in this compartment. The hatch is held open by a gas hatch lifter and secured closed with a rotating latch. There is a large red dot in the handle that indicates that the latch is in the open position and the hatch is not secure. Always make sure the hatch is closed with the latches in the secured position before operating the boat above idle speed.

## Bow Seats and Storage Compartments

There are 2 storage/cooler compartments located in the bow below the seats and another hatch that provides access to the rope locker. The bow seat cushions are secured to the hatches with snaps and should be removed and stored when the boat is not being used. The bow seat hatches are equipped with gas hatch springs that hold the hatches in the open or closed position. These compartments are insulated and can be used for dunnage, coolers or fishboxes. They drain overboard by gravity through fittings in the hull sides. If the compartments are used as fishboxes or coolers, they should be cleaned and flushed thoroughly with fresh water after each use.



*Aft Under Deck Systems Compartment*



*Bow Seats and Storage Compartments*



*Below Deck Bow Storage Compartment and Optional Bow Thruster Battery*

The center compartment forward of the bow seats is the anchor rope locker. The hatch is equipped with a hatch lifter that holds it in the open or closed position. A flush, twist lock latch secures the hatch in the closed position. The rope locker drains overboard by gravity through a fitting in the hull side.

Another storage compartment is located below the cockpit sole between the bow seats. It provides additional storage for dunnage and is the mounting location for the battery and automatic switch for the optional bow thruster. The hatch is equipped with a hatch lifter that holds it in the open or closed position and a flush, twist lock latch that secures the hatch in the closed position. This compartment is drained by gravity to the forward bilge.

There is a large red dot in the handle of the latches that secure the rope locker and below deck hatch that indicates that the latch is in the open position and the hatch is not secure. Always make sure these hatches are closed with the latches in the secured position and the handles folded flush to the deck before operating the boat above idle speed.

## Helm Seat Base and Aft Facing Seat

The helm seat base is equipped with an aft facing bench seat, baitwell and tackle storage. It has four large aft facing drawers and three drawers on the starboard side for tackle storage that are secured with locking, push to close latches. A door on the port side provides access to the battery switches and the engine and house battery banks.

The aft facing bench seat is hinged to provide access to the baitwell and tackle prep area. It is equipped with gas charged hatch lifters that hold the seat in the open or closed position. The insulated baitwell below the seat is equipped with a light and is supplied by a raw water circulating pump. The baitwell drains overboard by gravity to a fitting in the hull. Refer to the Raw Water System chapter for additional information on the baitwell system.

## Helm and Passenger Seats

The helm and passenger seats are equipped with a flip up bolster to provide more room between the seats and the helm. The bolster converts the seat to a leaning post style seat with a backrest, allowing the operator and passenger to sit or stand



*Helm Seat Base and Aft Facing Bench Seat*



*Standard Baitwell and Bait Prep Area*



*Helm and Passenger Seat*



at the helm. To convert each seat to a leaning post, lift the front of the seat cushion to raise the bolster and push it back above the seat cushion.

There is a lever on the side of each seat base. Pulling the lever out allows the seat to be adjusted fore and aft. Releasing the lever automatically locks the seat in that position. Arm rests on each side provide a more comfortable driving position and swing up into the backrest cushion to make it easier to enter and exit the helm area. The center armrest is equipped with drink holders and a storage compartment that drain by gravity to the cockpit sole.

A molded in footrest on the rear of the console makes the helm more comfortable when the bolsters are set to the seat position.



*Helm and Passenger Seats in the Leaning Post Configuration*

## 9.4 Center Console and Cabin

### Helm

The steering, engine controls, engine instruments and switches for exterior equipment and navigation lights are located on the helm station. Molded-in electronics storage is located forward of the engine controls. Air conditioning ducts in the helm provides cooling to helm station when the cabin air conditioner option is installed and operating. Additional ventilation is provided by an opening vent panel above the windshield.

A molded in storage compartment for small items is located on the starboard side of the helm station. A 12-volt accessory plug is also located in this compartment.

A molded in footrest and stereo speakers are located below the steering wheel.

### Windshield

Your boat is equipped with a tinted glass windshield. The front and side panels are tempered safety glass. If your boat is equipped with an optional windshield wiper, it should only be used when the windshield is wet. The windshield glass can be scratched by activating the wiper when there is dried salt or dirt on the windshield.

Ventilation through the windshield is provided by an opening vent panel that is opened and closed by an electric actuator controlled by the Windshield Vent switch in the hardtop switch panel above the helm. Refer to the Ventilation chapter for instructions on operating the windshield vent.



*Helm, Controls, Switch Panels and Electronics*

The windshield/hardtop frame is powder coated aluminum. Powder coated aluminum is very durable and provides excellent resistance to the corrosive effects of saltwater, however, it must be maintained properly and certain precautions must be observed when mounting snaps or hardware to the windshield frame.

The windshield should be washed after each use with soap water to keep it clean and reduce the corrosive effects of the saltwater. Saltwater allowed to remain on the windshield frame will eventually begin to attack the aluminum, usually around fasteners and hardware mounted to the frame. Snaps or any hardware mounted to the windshield/hardtop frame must be properly sealed and isolated with caulk or a Teflon sealer to prevent salty moisture and galvanic corrosion from damaging the frame. Poor maintenance or improperly mounted hardware and snaps can void the warranty on the windshield/hardtop frame.



*Windshield and Opening Vent Panel*

Refer to the Routine Maintenance chapter for more information on the care and maintenance of powder coated aluminum.

## Cabin Door

The cabin door on the port side of the console is made of fiberglass and equipped with a gas spring that automatically holds the door in the full open or closed positions. A lockable, push to close latch secures the door in the closed position.



*Cabin Door*

It is very important that the cabin door is secured properly in the closed position whenever the boat is operated above idle speed. The cabin door is heavy and if the door is not properly latched, it could slam shut when the boat rocks and pinch someone's fingers between the door and cabin or damage the door.

When the door is open to the full open position, the gas spring will automatically hold it open. As the door is closed, the gas spring will automatically close the door and hold it in the closed position.

When closing the door, make sure you push the door against the door jam with enough pressure to allow the latch to secure the door. The gas spring does not have enough force to hold the door open or closed while the boat is underway.



*Cabin Door Secured Open with Adjuster*

	<b>CAUTION</b>	
<p><b>NEVER LEAVE THE CABIN DOOR UNLATCHED. THE CABIN DOOR IS HEAVY SWINGS EASILY. IF THE DOOR IS LEFT UNLATCHED, IT COULD SLAM UNEXPECTEDLY AS THE BOAT ROCKS, DAMAGING THE DOOR OR CAUSING AN INJURY TO A PASSENGER. ALWAYS MAKE SURE THE DOOR IS PROPERLY SECURED IN THE OPEN OR CLOSED POSITION.</b></p>		

**DANGER**

CARBON MONOXIDE (CO) CAN CAUSE BRAIN DAMAGE OR DEATH. CARBON MONOXIDE CAN BE PRESENT IN THE CABIN. SIGNS OF CARBON MONOXIDE POISONING INCLUDE NAUSEA, HEADACHE, DIZZINESS, DROWSINESS, AND LACK OF CONSCIOUSNESS. GET TO FRESH AIR IF ANYONE SHOWS SIGNS OF CARBON MONOXIDE POISONING. GET TO FRESH AIR IF CARBON MONOXIDE DETECTOR ALARM SOUNDS. CARBON MONOXIDE DETECTOR MUST BE FUNCTIONING AT ALL TIMES."

## Starboard Console Storage Closet

A door on the starboard side of the console provides access to a storage compartment. A lockable, push to close latch secures the door in the closed position.



*Starboard Console Storage Closet*

The storage compartment is equipped with a built-in storage rack designed for boat hooks, gaffs, deck mops, etc. and hooks for storing dock lines. The storage rack is equipped with a stretch cord to secure the stored items.

The fiberglass door is heavy and you should use the same precautions as with the cabin door. Always make sure the door is closed and latched whenever the storage compartment is not being accessed. Never leave the door open.

## Console Sundeck Lounge

A double lounge seat with underside storage is located on the console, forward of the windshield. The lounge seat cushion will accommodate two people and has arm rests built into each side that fold flush to the backrest. The seat cushion is mounted to a hatch that provides access to a large compartment below the lounge that is equipped with storage areas for dunnage, the boarding ladder and the shore power cord. The compartment drains to the cockpit sole.



*Console Sundeck Lounge*

The hatch is equipped with gas hatch springs that hold the hatch in the open or closed position. A locking twist lock latch secures the hatch in the closed position. The latch handle can be folded flush to the hatch in the open or secured position. A large red dot in the handle indicates that the latch is in the open position and the hatch is not secure. To prevent the hatch from opening unexpectedly, always make sure the hatch is closed with the latch in the secured position and the handle folded flush to the deck before operating the boat above idle speed.



*Console Sundeck Hatch Open*

## Hardtop

The standard hardtop consists of a laminated fiberglass top mounted to a welded powder coated aluminum frame that is bolted to the console and helm seat base. It is equipped with a switch panel, LED overhead lighting for the helm and a mounting area for a VHF radio. There is also lockable storage compartments and stereo speakers in the rear of the hardtop liner, above the helm and passenger seats.

The outside of the top is designed to accommodate radio antennas, radar antennas, forward and aft spreader lights, navigation lights and rod holders. It could also be equipped with optional outriggers and an electric cockpit sunshade. The spreader lights, windshield wiper/washer, hardtop lights, windshield vent and the optional electric sunshade are activated by switches in the hardtop switch panel.

The hardtop is not designed to support the additional weight of items like a life raft. Radar and electronics antennas must be mounted to the top between the front and rear legs. Do not mount any antennas or equipment to the brow area forward of the front legs. The hardtop frame is not designed to support the weight of accessories in this area and could be damaged. The port center leg is the wire chase for lights and antennas mounted to the top.

The warranty for the hardtop will be void if the top is modified in any way or heavy accessories like life rafts are mounted to the top. Additionally, if items like radar antennas, spotlights and other accessories are mounted in the wrong location, the warranty could be void. If you intend to add equipment or make modifications to the hardtop, you should contact Scout Customer Service to make sure the equipment you would like to add or the intended modification will not void the warranty on the top.



*Hardtop*



*Rear of Hardtop and Rear Rod Holders*



*Rear Hardtop Storage Compartments*

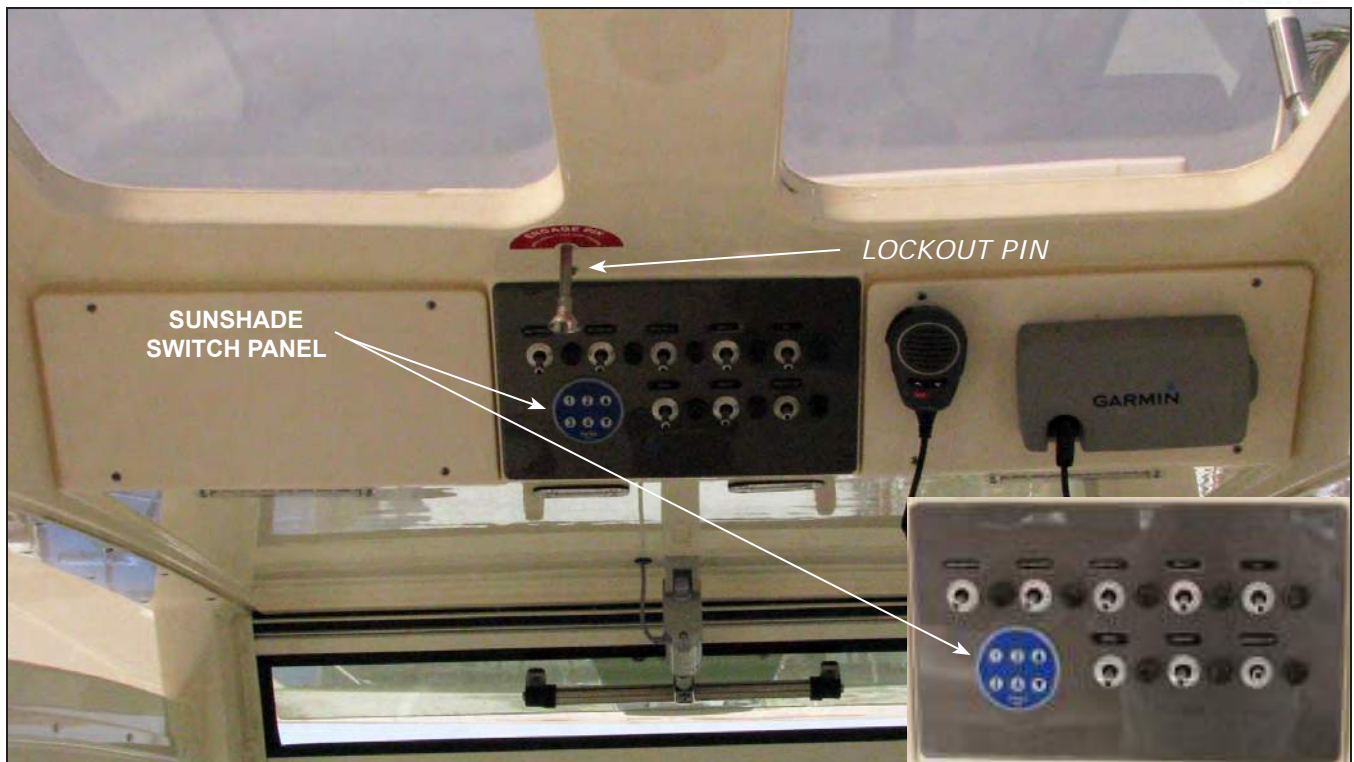

*Hardtop Switch Panel and Sunshade Control Switch*

## Fiberglass Cockpit Sunshade

The optional fiberglass sunshade extends to provide shade for the aft cockpit. An electric actuator controlled by a programmable switch panel in the hardtop extends and retracts the sunshade. A removable lockout pin near the sunshade switch prevents it from extending when there are rods in the rod holders at the rear of the hardtop.

The pin should be engaged whenever the sunshade is fully retracted to ensure the sunshade is not accidentally extended with rods in the rod holders. Always remember to remove the pin before extending the sunshade.



*Hardtop and Rod Holders with Optional Sunshade Retracted*

There are six buttons in the switch Panel that control the sunshade. The buttons with the arrow indicators are preset to extend or retract the sunshade when they are pressed. The sunshade will stop whenever the arrow button is released. Limit switches automatically stop the sunshade when it is fully extended or retracted. Buttons one through four are programmable and are pre-programmed by Scout as follows:

1. Out
2. In
3. Rough water position
4. In



*Hardtop with Optional Sunshade Extended*

Refer to the operating manual for the sunshade switch panel for instructions on using and programming the sunshade switch panel.

**CAUTION**

ALWAYS MAKE SURE TO REMOVE ALL FISHING RODS FROM THE HARDTOP ROD HOLDERS BEFORE EXTENDING THE SUNSHADE. RODS LEFT IN THE ROD HOLDERS WILL PREVENT THE SUNSHADE FROM EXTENDING AND WILL BE DAMAGED OR CAUSE DAMAGE TO THE HARDTOP IF THE SUNSHADE IS EXTENDED WITH RODS IN THE ROD HOLDERS.

THE SUNSHADE ACTUATOR CAN BE DAMAGED IF THE LOCKOUT PIN IS PARTIALLY ENGAGED AND THE SUNSHADE IS EXTENDED. YOU SHOULD ALWAYS MAKE SURE THE PIN IS FULLY ENGAGED WHEN THE SUNSHADE IS RETRACTED AND NEVER ATTEMPT TO EXTEND THE SUNSHADE WITHOUT REMOVING THE PIN.



Sunshade Lockout Pin

## Canvas Enclosure (Optional)

Because the aluminum frames vary slightly, the optional side curtains and drop curtain are custom made to each boat at the factory. To install the curtains, slide the side curtains into the slide tracks on the sides of the top and attach them to the snaps on the center and rear hardtop legs, console and helm seat base. The side curtains will have to be stretched slightly to pull out the wrinkles and reach the snaps.

If you have an optional drop curtain, slide it into the slide track on the back of the hardtop and attach it to the zipper on the rear of the side curtains. Snap the drop curtain to the snaps near the bottom of the helm seat base. To avoid damage to the drop curtain, be sure to remove the curtain before extending the sunshade, if your boat is equipped with this option.

### NOTICE:

**Cold weather can make the clear vinyl material on the curtains stiff and difficult to stretch to the snaps. This can be particularly difficult with new canvas that has been stored off the boat. Laying the curtains in the sun for 30 minutes during the heat of the day will make installing them much easier in cold weather.**

Do not operate engines or fuel consuming heaters with the canvas enclosures closed. The cockpit must be open for legal ventilation and to prevent

the possible accumulation of carbon monoxide fumes, which could be lethal.

**WARNING**

CARBON MONOXIDE IS A LETHAL, TOXIC GAS THAT IS COLORLESS AND ODORLESS. IT IS A DANGEROUS GAS THAT WILL CAUSE DEATH IN CERTAIN LEVELS.

## 9.5 Aftermarket Hardtop or Tower

Scout does not recommend installing an aftermarket hardtop or tower. An improperly designed or installed fabrication can cause structural damage to the deck and void the Scout Limited Warranty. Additionally, Scout will not be responsible for any damage resulting from the installation of a fabrication not installed at the Scout factory. If you intend to install an aftermarket hardtop or tower on your boat, please contact your authorized Scout dealer or Scout Customer Service.

Refer to the Routine Maintenance section for more information on maintaining aluminum fabrications and precautions for adding additional equipment and fasteners.

## INTERIOR EQUIPMENT

### 10.1 Inner Console Cabin

The cabin is equipped with a fresh water sink, marine head and double berth that converts to a dinette. Natural lighting is provided by large windows on each side of the cabin. Fresh air is provided by the cabin door. Additional lighting is provided by lights in the cabin headliner and at the rear of the berth that are controlled by switches on the light fixtures. There is also a 120-volt GFI outlet located in the cabinet near the microwave.

Storage cabinets are located above the sink and the top loading cooler. Additional storage is located below the berth cushions.

The cabin sole is made from cherry and maple and the step is wood made from teak. The step is hinged and can be rotated flush with the side of the cabin to provide more floor space in the galley and head area. Always make sure to rotate the step to the horizontal position when entering or exiting the cabin.

#### Cabin Lights

All lights in the cabin are powered by the DC electrical system and protected by a circuit breaker in the cabin DC breaker panel. The overhead cabin lights are controlled by ON/OFF switches on each light fixture. The reading light fixtures at the aft end of the berth are equipped with dimmer switches on the light base. Rotating the knob on the switch clockwise turns the lights on and makes them brighter. Rotate the knob counter clockwise to dim the lights or turn them off.

#### Galley and Sink

The galley is equipped with storage, a fresh water sink, and microwave oven. Water is supplied to the sink by a 12-volt pump located in the aft systems station. When activated by the Fresh Water switch in the helm switch panel, the system will operate much like the water system in a home. An automatic pressure sensor keeps the system pressurized. The sink drains overboard through a fitting in the hull side. See the Fresh Water System chapter for more information on operating the fresh water system.



*Overhead Light and Switch*



*Galley Sink*



*Top Loading Storage Compartment*

A top loading cooler is built into the counter below the microwave. The cooler is insulated drains to the forward bilge.

The galley counter tops are made of Corian and the microwave oven is built into the cabinet above the cooler. Cabinets above the sink and below the microwave provide additional storage.

## Microwave Oven

A microwave oven is standard equipment. The microwave operates on AC power and is activated and protected by the Microwave circuit breaker in the AC breaker panel. Please refer to the manufacturer's operating manual for detailed information on the microwave oven installed in your boat.



*Microwave Oven, GFI Outlet and Storage Compartment*

## Double Berth and Dinette

A double berth is located in forward section of the cabin that converts to a dinette. There is storage below the port, starboard and forward berth cushions. If your boat is equipped with the optional bow thruster, it will be located in the compartment below the forward Berth cushion. You should not store dunnage in the forward compartment if the bow thruster is installed in your boat.

The center cushion support at the aft end of the berth is hinged and converts to a dinette table. To convert the berth to a dinette, remove the center cushion and raise the rear of the cushion support to the vertical position. Then secure it with the special rotating latch in the cabin headliner. The table is attached to the bottom of the cushion support and hinged at the lower end. Hold the table against the support and release the latch at the top of the table that secures it to the support. Carefully lower the table until it stops in the horizontal position. Reverse the process to convert the dinette and table back to a double berth.



*Double Berth*



*Rotating Latch in Headliner for Dinette Table*



*Berth Converted to a Dinette*



## Rod Racks

Rod racks on the wall above each side of the berth provide storage for 4 rods. They are equipped with stretch cords to secure the rods to the racks. Always make sure the rods are properly secured in the storage racks with the rod tips forward.

## AC/DC breaker Panel

The cabin AC/DC breaker panel is built into the cabinet near the cabin door. The remote battery switches for the engine and house battery banks, generator control panel, water and waste tank level gauge and volt meters are located in the panel. Refer to the Electrical Systems chapter for more information on the operation of the components in the cabin breaker panel.

## Equipment Access Doors

A door and removable panel in the rear cabin bulkhead near the cabin breaker panel provide access to the back of the helm and electronics compartment. Flush mounted, push to close latches secure the door and removable panel in the closed position.

A removable hatch in the cabin sole provides access to the forward bilge pump, transducers and the overboard discharge diaphragm pump and thru-hull valve for the waste tank pump out system.

## Stereo

The stereo is located in the cabin and activated by the stereo breaker in the DC electrical panel. The stereo amplifier is mounted in the electronics compartment. A key pad and display in the helm allows the stereo to be controlled from the helm. Refer to the stereo owner's manual for detailed information on the operation of the stereo.



Cabin AC/DC Circuit Breaker Panel



Cabin Breaker Panel and Helm Access Door



Cabin Sole Access Hatch



Access Door to the electronics Compartment, Cabin Step and Marine Toilet

## Carbon Monoxide Detector

A carbon monoxide (CO) detector is installed in the cabin below the galley sink. If excess carbon monoxide fumes are detected, an audible beeping will sound indicating the presence of the toxic gas. This detector is always activated when the house batteries are connected. A green light on the detector indicates that it is activated. Always make sure the green light is on whenever the cabin is occupied.

A by-product of combustion, carbon monoxide is invisible, tasteless, odorless, and is produced by all engines and some heating and cooking appliances. The most common sources of CO on boats are the engines, auxiliary generators and propane or butane stoves. These produce large amounts of CO and should never be operated while sleeping.

You should read the owner's manual supplied by the detector manufacturer for operation instructions and additional information regarding the hazards of carbon monoxide gas. Also read more about carbon monoxide, carbon monoxide detectors and proper ventilation in the Ventilation System and Safety Equipment chapters in this manual. This is especially essential if your boat is equipped with a generator. If you did not receive a manual for your carbon monoxide detector, please contact the Scout Customer Service Department.



Carbon Monoxide Detector



Marine Toilet

**⚠ WARNING ⚠**

**ACTIVATION OF THE CARBON MONOXIDE DETECTOR INDICATES THE PRESENCE OF CARBON MONOXIDE (CO) WHICH CAN BE FATAL. EVACUATE THE CABIN IMMEDIATELY. DO A HEAD COUNT TO CHECK THAT ALL PERSONS ARE ACCOUNTED FOR. DO NOT REENTER THE CABIN UNTIL IT HAS BEEN AIRED OUT AND THE PROBLEM FOUND AND CORRECTED.**

## 10.2 Marine Head System

Your boat is equipped with a 12-volt Tecma ceramic marine head system as standard equipment. The toilet is connected to the pressurized fresh water system which results in less odor in the cabin. It has an automatic pumping system that fills and empties the bowl. Once a button on the control is pressed, the entire cycle is completely automatic. Additionally, the system uses very little water, approximately 2.27 quarts (2.5 liters) per flush.



Marine Toilet Switch Panel

To use the toilet, make sure the Electric Head circuit breaker in the DC panel and the Fresh Water switch in the helm switch panel are on. Then press the "Add Water" button on toilet control panel to add a preset amount of water to wet the bowl which prevents organic residues from dirtying the ceramic sides. After using the toilet, pressing the "Flush" button starts an automatic flushing cycle that moves the waste to the holding tank and leaves the bowl completely clean and dry in the rest position. A warning light in the control panel illuminates when the holding tank is full and flushing is not recommended.

The Tecma head contains an integrated, high-speed turbine grinding pump that transfers waste to the holding tank where it remains until it is pumped out by a waste dumping station or the overboard diaphragm discharge system.

Please refer to the toilet manufacturer owner's manual for more information on the operation of the marine head system.

### Holding Tank and Overboard Discharge Pump

The holding tank is located in the bilge below the cockpit. When the tank is full, the light on the toilet control panel will be lit, indicating that flushing is not recommended. The tank must either be pumped out by an approved waste dumping station through the waste deck fitting or be pumped overboard with the diaphragm discharge pump, when legal to do so.

To pump out the holding tank with the overboard diaphragm discharge system, activate the Macerator circuit breaker and turn the key lockout, Waste Discharge switch in the cabin breaker panel clockwise to activate the pump. The momentary key switch must be held in the discharge position to activate the pump. Turn the key and the Macerator breaker to the OFF position when pumping is complete.

### NOTICE:

**Monitor the pumping operation as the overboard discharge drains the holding tank and turn the pump off immediately when draining is complete.**



Waste Tank Gauge and Overboard Macerator Key Switch

### NOTICE:

**In order to comply with current State, Federal and Coast Guard regulations, the Overboard Discharge lockout key switch and the Macerator circuit breaker must be OFF and the key removed whenever the boat is operating in areas in which the discharge of sewage is prohibited.**

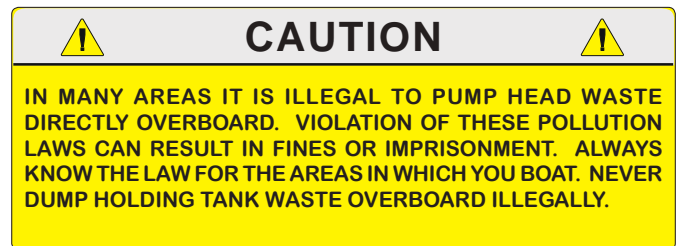

### Maintenance

The toilet should be cleaned and inspected for leaks regularly.

The holding tank should be pumped out and flushed as needed. Periodically add chemical to the holding tank through the toilet to help control odor and to chemically break down the waste. See the manufacturer owner's manual for additional operating and maintenance information.

## 10.3 Cabin Air Conditioner (Optional)

The cabin air conditioner will operate on either 120-volt AC or 12-volt DC power, depending on the unit selected for your boat. The AC powered unit is equipped with reverse cycle heat and can be operated as a cooling or heating unit. The DC powered unit cools only and will not function as a heating unit.

You should always keep the cabin door closed when operating the air conditioner. If the cabin door is left open, it could cause the air conditioner unit to run continuously and not cycle enough to defrost the coiling condenser. This could cause the coils to develop enough ice to reduce the unit's ability to cool the boat. With DC powered units, leaving the cabin door open will significantly reduce the available operating time while operating the air conditioning on battery power.

The air conditioner is located in the helm access compartment in the aft cabin bulkhead. The unit creates condensation that drips into the pan at the base of the unit. A hose attached to the pan drains the water to the forward bilge and where it is pumped out by the forward bilge pump. You should monitor the operation of the bilge pump and make sure it is operating properly whenever the cabin air conditioner is activated. The air conditioner can produce enough condensation to flood the forward bilge and cabin sole if it is allowed to run for extended periods without the bilge pump operating properly.

It is normal for some water to be in the pan whenever the air conditioner has been used. The condensation pan should be checked periodically to make sure it is draining properly. The drain hoses, condensation pan and sump should be flushed clean if they become restricted by mold or debris.

The intake line for the seawater pump in the stern bilge is equipped with a sea strainer that must be checked for debris frequently and cleaned as necessary. Refer to the Raw Water System chapter for information on the air conditioning pump and cleaning the sea strainers.

You should also refer to the air conditioner owner's manual for additional operating and maintenance instructions.



Cabin Air Conditioning Control Panel



Cabin Air Conditioning Unit and Condensation Pan Drain

### NOTICE:

**Air conditioners use surface water as a cooling medium. The boat must be in the water and the raw water supply system must be properly activated prior to use. Operation without proper cooling could cause the air conditioning unit to shut down and could cause system damage. Always check for proper water flow out of the air conditioning pump discharge thru-hull when the air conditioner is operating.**

### 120-volt AC Air Conditioner Operation

The 120-volt AC air conditioning unit is activated and protected by the Air Cond breaker in the AC breaker panel. It requires 120-volt AC current from shore power or the optional generator. To operate the system, make sure the thru-hull valve for the air conditioner seawater supply pump is on. The pump, valve and sea strainer are located

in the stern bilge. Turn the Air Cond breaker in the AC breaker panel ON. The air conditioning or heat then will be controlled by the electronic control panel in the cabin. When activated, water should continuously flow from the overboard drain thru-hull.

The air conditioning system produces heat when it is operated in the reverse cycle mode. The ability of the unit to produce heat is affected by the temperature of the seawater. As the seawater temperature lowers, the air conditioner's ability to produce warm air decreases. When the seawater temperature drops below 40 - 45 degrees, the unit will not be able to produce heat. You should not operate the air conditioner to produce heat when the water temperature is below 40 degrees.

## 12-volt DC Air Conditioner Operation

The 12-volt DC air conditioning unit is activated and protected by the Air Cond breaker in the DC breaker panel. It draws 12-volt DC current from the house battery bank. The DC air conditioning unit draws a significant amount of current (approx 30 amps) while operating. To avoid draining the house batteries when operating the system at dockside, make sure the 120-volt AC system is connected to shore power and the battery charger is activated to maintain the batteries.

When operating the system away from the dock, the voltage in the house battery bank must be monitored closely to avoid draining the batteries when the engines or optional generator are not running. If the house batteries are in good condition and no other DC equipment is operating, the DC air conditioner can typically operate approximately 3 to 5 hours before the batteries become drained. If the stereo, cabin and/or cockpit lights, electronics or other DC electrical equipment is being used, the operating time available for the air conditioner will be significantly less.

While underway at cruise speed, the engine charging systems will provide enough current to maintain the batteries with the DC air conditioner operating. The engines will not provide enough current at idle or trolling speeds to maintain the batteries with the air conditioner operating, particularly with the stereo and electronics activated. If your boat is equipped with the optional generator, it should be operating with the battery charger activated to maintain the batteries when-

ever the air conditioner is activated. Remember that generator engines produce carbon monoxide and should never be operating while the crew is sleeping.

To operate the system, make sure the thru-hull valve for the air conditioner seawater supply pump is on. The pump, valve and sea strainer are located in the stern bilge. Turn the Air Cond breaker in the cabin DC breaker panel on. The air conditioning then will be controlled by the electronic control panel in the cabin. When activated, water should continuously flow from the overboard drain thru-hull.

## 10.4 Cabin Woodwork

### Floors and Steps

The wood cabin floor is made of simulated wood. The step is made of teak. The step is finished with a high quality urethane finish that will provide years of protection with proper care and treatment. It is important to avoid tracking sand and dirt on the cabin floor and step. Sand and dirt acts like sand paper and will eventually sand off the finish in the traffic areas. The wood step can be sanded and refinished as necessary.

Use caution when varnishing wood steps. The wood grain is a natural nonskid and too much varnish or polyurethane will fill the grain and make the wood slippery. You should use a satin or flat varnish and only apply one or two coats. A nonskid material mixed with the varnish may be required to keep cabin steps from becoming slippery when they are refinished.

The synthetic wood floors can be vacuumed then washed with a mixture of water and household cleaner. Wipe the floor dry with a clean towel.



*Synthetic Wood Cabin Sole and Teak Step*

THIS PAGE WAS LEFT BLANK  
INTENTIONALLY

# SAFETY EQUIPMENT

## 11.1 General

Your boat and outboard engines have been equipped with safety equipment designed to enhance the safe operation of the boat and to meet U.S. Coast Guard safety standards. The Coast Guard or state, county, and municipal law enforcement agencies require certain additional accessory safety equipment on each boat. This equipment varies according to length and type of boat and type of propulsion. The accessory equipment required by the Coast Guard is described in this chapter. Some local laws require additional equipment. It is important to obtain "Federal Requirements And Safety Tips for Recreational Boats," published by the Coast Guard, and copies of state and local laws, to make sure you have the required equipment for your boating area.

Your boat is equipped with engine alarms. The alarms are designed to increase your boating safety by alerting you to potentially serious problems in the primary power systems. Alarm systems are not intended to lessen or replace regular maintenance and pre-cruise procedures.

This chapter also describes safety related equipment that could be installed on your boat. This equipment will vary depending on the type of engines and other options installed by you or your dealer.

## 11.2 Engine Alarms

Most outboards are equipped with an audible alarm system mounted in the helm area that monitors selected critical engine systems. The alarm will sound if one of these systems begins to fail. Refer to the engine owner's manual for information on the alarms installed with your engines.

### If the alarms sounds:

- Immediately throttle the engine back to idle.
- Shift to neutral.
- Monitor the engine gauges to determine the cause of the problem.



- If necessary, shut off the engine and investigate until the cause of the problem is found.

## 11.3 Neutral Safety Switch

Every control system has a neutral safety switch incorporated into it. This device prohibits the engine from being started while the shift lever is in any position other than the neutral position and should be inspected and tested periodically to ensure the switch is working. If an engine will not start, slight movement of the shift levers may be necessary to locate the neutral position and disengage the safety cutout switch. Control or cable adjustments may be required to correct this condition should it persist. See your Scout dealer for necessary control and cable adjustments. Please refer to the Helm Control Systems chapter for more information on the neutral safety switch.

## 11.4 Engine Stop Switch

Your Scout is equipped with a engine stop switch and lanyard. When the lanyard is pulled it will engage the switch and shut off the engines. We strongly recommend that the lanyard be attached to the driver and the stop switch whenever the engines are running. If the engines will not start, it could be because the lanyard is not properly inserted into the engine stop switch. Always make sure the lanyard is properly attached to the engine stop switch before attempting to start the engines.

## NOTICE:

**You should carry an extra stop switch lanyard and instruct at least one other crew member on the operation of the stop switch and location of the extra lanyard.**

## 11.5 Required Safety Equipment

Besides the equipment installed on your boat by Scout, certain other equipment is required by the U.S. Coast Guard to help ensure passenger safety. Items like a sea anchor, working anchor, extra dock lines, flare pistol, life vests, a line permanently secured to your ring buoy, etc. could at some time save your passengers' lives or save your boat from damage. Refer to the "Federal Requirements And Safety Tips For Recreational Boats" pamphlet for a more detailed description of the required equipment. You can also contact the U.S. Coast Guard Boating Safety Hotline, 800-368-5647 or 800-336-2628 and 800-245-2628 in Virginia, for information on boat safety courses and brochures listing the Federal equipment requirements. Also, check your local and state regulations.

The Coast Guard Auxiliary offers a "Courtesy Examination." This inspection will help ensure that your boat is equipped with all of the necessary safety equipment.

The following is a list of the accessory equipment required on your boat by the U.S. Coast Guard:

### Personal Flotation Devices (PFDs)

PFDs must be Coast Guard approved, in good and serviceable condition, and of appropriate size for the intended user. Wearable PFDs must be readily accessible, meaning you must be able to put them on in a reasonable amount of time in an emergency. Though not required, the Coast Guard emphasizes that PFDs should be worn at all times when the vessel is underway. Throwable devices must be immediately available for use. All Scout boats must be equipped with at least one Type I, II or III PFD for each person on board, plus one throwable device (Type IV).

Please note that most state laws now require that children 13 years old and under must wear a PFD at all times.

### Visual Distress Signals



All Scout boats used on coastal waters, the Great Lakes, territorial seas, and those waters connected directly to them, must be equipped with Coast

Guard approved visual distress signals. These signals are either Pyrotechnic or Non-Pyrotechnic devices.

### Pyrotechnic Visual Distress Signals

Pyrotechnic visual distress signals must be Coast Guard approved, in serviceable condition, and readily accessible. They are marked with a date showing the service life, which must not have expired. A minimum of three are required. Some pyrotechnic signals meet both day and night use requirements. They should be stored in a cool, dry location. They include:

- Pyrotechnic red flares, hand held or aerial.
- Pyrotechnic orange smoke, hand-held or floating.
- Launchers for aerial red meteors or parachute flares.

 **WARNING** 

**PYROTECHNICS ARE UNIVERSALLY RECOGNIZED AS EXCELLENT DISTRESS SIGNALS. HOWEVER, THERE IS POTENTIAL FOR INJURY AND PROPERTY DAMAGE IF NOT PROPERLY HANDLED. THESE DEVICES PRODUCE A VERY HOT FLAME AND THE RESIDUE CAN CAUSE BURNS AND IGNITE FLAMMABLE MATERIAL. PISTOL LAUNCHED AND HAND-HELD PARACHUTE FLARES AND METEORS HAVE MANY CHARACTERISTICS OF A FIREARM AND MUST BE HANDLED WITH CAUTION. IN SOME STATES THEY ARE CONSIDERED A FIREARM AND PROHIBITED FROM USE. ALWAYS BE EXTREMELY CAREFUL AND FOLLOW THE MANUFACTURER'S INSTRUCTIONS EXACTLY WHEN USING PYROTECHNIC DISTRESS SIGNALS.**

### Non-Pyrotechnic Devices

Non-Pyrotechnic visual distress signals must be in serviceable condition, readily accessible, and certified by the manufacturer as complying with U.S. Coast Guard requirements. They include:

- Orange Distress Flag. (Day use only)  
The distress flag is a day signal only. It must be at least 3 x 3 feet with a black square and ball on an orange background. It is most distinctive when attached and waved from a paddle or boat hook.



- **Electric Distress Light.** (Night use only)  
The electric distress light is accepted for night use only and must automatically flash the international SOS distress signal. Under Inland Navigation Rules, a high intensity white light flashing at regular intervals from 50-70 times per minute is considered a distress signal.

## Fire Extinguishers

Your boat is required to have two Marine Type USCG approved fire extinguishers. Coast Guard approved fire extinguishers are hand-portable, either B-I or B-II classification and have a specific marine type mounting bracket. It is recommended that the extinguishers be mounted in a readily accessible position.

Fire extinguishers require regular inspections to ensure that:

- Seals and tamper indicators are not broken or missing.
- Pressure gauges or indicators read in the operable range.
- There is no obvious physical damage, corrosion, leakage or clogged nozzles.



Refer to the "Federal Requirements And Safety Tips For Recreational Boats" pamphlet or Contact the U.S. Coast Guard Boating Safety Hotline, 1-800-368-5647, for information on the type and size fire extinguisher required for your boat.

Please refer to the information provided by the fire extinguisher manufacturer for instructions on the proper maintenance and use of your fire extinguisher.

**WARNING**

INFORMATION FOR HALON AGENT FE-241 AND AGENT FM 200 FIRE EXTINGUISHERS IS PROVIDED BY THE MANUFACTURER. IT IS ESSENTIAL THAT YOU READ THE INFORMATION CAREFULLY AND COMPLETELY UNDERSTAND THE SYSTEM, IN THEORY AND OPERATION, BEFORE USING YOUR BOAT.

## Bilge and Fuel Fires

Fuel compartment and bilge fires are very dangerous because of the presence of gasoline and/or diesel fuel in the various components of the fuel system and the possibility for explosion. You must make the decision to fight the fire or abandon the boat. If the fire cannot be extinguished quickly or it is too intense to fight, abandoning the boat may be your only option. If you find yourself in this situation, make sure all passengers have a life preserver on and go over the side and swim well upwind of the boat. This will keep you and your passengers well clear of any burning fuel that could be released and spread on the water as the boat burns or in the event of an explosion. When clear of the danger, check about and account for all those who were aboard with you. Give whatever assistance you can to anyone in need or in the water without a buoyant device. Keep everyone together in a group for morale and to aid rescue operations.

**WARNING**

GASOLINE CAN EXPLODE. IN THE EVENT OF A FUEL COMPARTMENT OR BILGE FIRE, YOU MUST MAKE THE DIFFICULT DECISION TO FIGHT THE FIRE OR ABANDON THE BOAT. YOU MUST CONSIDER YOUR SAFETY, THE SAFETY OF YOUR PASSENGERS, THE INTENSITY OF THE FIRE AND THE POSSIBILITY OF AN EXPLOSION IN YOUR DECISION.



## Sound Signaling Devices

The navigation rules require sound signals to be made under certain circumstances. Recreational vessels are also required to sound fog signals during periods of reduced visibility. Therefore, you must have some means of making an efficient sound signal that is audible for .5 nautical miles.

## Navigation Lights

Recreational boats are required to display navigation lights between sunset and sunrise and other periods of reduced visibility (fog, rain, haze, etc.) Navigation lights are intended to keep other vessels informed of your presence and course. Your Scout is equipped with the navigation lights required by the U.S. Coast Guard at the time of manufacture. It is up to you to make sure they are operational and turned on when required.

## 11.6 Carbon Monoxide Monitoring System

**DANGER**

CARBON MONOXIDE IS COLORLESS, ODORLESS AND DANGEROUS. ALL ENGINES, GENERATORS AND FUEL BURNING APPLIANCES EXHAUST CARBON MONOXIDE (CO). DIRECT AND PROLONGED EXPOSURE TO CO WILL CAUSE BRAIN DAMAGE OR DEATH. SIGNS OF EXPOSURE TO CO INCLUDE NAUSEA, DIZZINESS AND DROWSINESS.

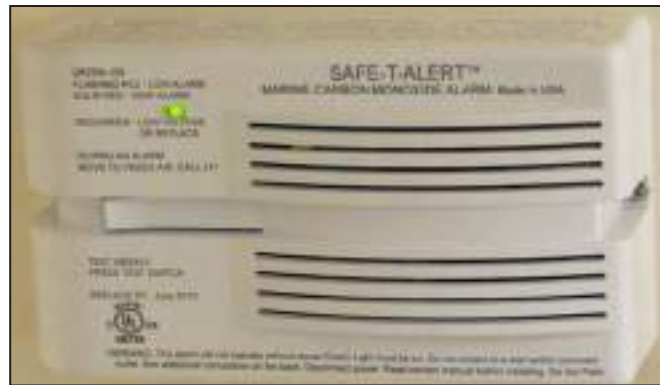

Typical Carbon Monoxide Detector

The carbon monoxide (CO) detector is installed in the cabin as standard equipment and warns the occupants of dangerous accumulations of carbon monoxide gas. If excess carbon monoxide fumes are detected, the detector will sound an alarm indicating the presence of the toxic gas.

Should a very high level of carbon monoxide exist, the alarm will sound in a few minutes. However, if small quantities of CO are present or high levels are short-lived, the alarm will accumulate the information and determine when an alarm level has been reached. The carbon monoxide detector is automatically activated whenever the House battery switch is ON. The power light on the carbon monoxide detector should be lit to indicate that the carbon monoxide detector is activated. Always make sure the House battery switch is ON and the power light on the carbon monoxide detector is lit whenever the cabin is occupied.

A by-product of combustion, carbon monoxide (CO) is invisible, tasteless, odorless, and is produced by all engines, heating and cooking appliances. The most common sources of CO on boats are the engines, auxiliary generators and propane or butane stoves. These produce large amounts of CO and should never be operated while sleeping.

A slight buildup of carbon monoxide over several hours causes headache, nausea and other symptoms that are similar to food poisoning, motion sickness or flu. High concentrations can be fatal within minutes. Many cases of carbon monoxide poisoning indicate that while victims are aware they are not well, they become so disoriented they are unable to save themselves by either exiting the area or calling for help. Also, young children, elderly persons, and pets may be the first affected.

Drug or alcohol use increases the effect of CO exposure. Individuals with cardiac or respiratory conditions are very susceptible to the dangers of carbon monoxide. CO poisoning is especially dangerous during sleep when victims are unaware of any side effects. The following are symptoms which may signal exposure to CO: (1) Headache (2) Tightness of chest or hyperventilation (3) Flushed face (4) Nausea (5) Drowsiness (6) Fatigue or Weakness (7) Inattention or confusion (8) Lack of normal coordination.

Persons who have been exposed to carbon monoxide should be moved into fresh air immediately. Have the victim breath deeply and seek immediate medical attention. To learn more about CO poisoning, contact your local health authorities.



Low levels of carbon monoxide over an extended period of time can be just as lethal as high doses over a short period. Therefore, low levels of carbon monoxide can cause the alarm to sound before the occupants of the boat notice any symptoms of carbon monoxide poisoning. CO detectors are very reliable and rarely sound false alarms. If the alarm sounds, always assume the hazard is real and move persons who have been exposed to carbon monoxide into fresh air immediately. Never disable the CO detector because you think the alarm may be false. Always contact the detector manufacturer or your local fire department for assistance in finding and correcting the situation.

Remember, carbon monoxide detectors do not guarantee that CO poisoning will not occur. Do not use the CO detector as a replacement for ordinary

precautions or periodic inspections of equipment. Never rely on alarm systems to save your life, common sense is still prudent and necessary.

Please read the owner's manual supplied by the CO detector manufacturer and included with this manual for operation instructions and additional information regarding the hazards of carbon monoxide gas. Refer to the Ventilation System chapter for information on ventilating your boat properly while underway and other precautions while at anchor or in a slip. This is especially essential if your boat is equipped with the optional generator.

Many manufacturers of carbon monoxide detectors offer a testing and recertification program. We recommend that you contact the manufacturer of your carbon monoxide detector and have it tested and recertified periodically.

 **DANGER** 

**ACTUATION OF THE CARBON MONOXIDE DETECTOR INDICATES THE PRESENCE OF CARBON MONOXIDE (CO) WHICH CAN BE FATAL. EVACUATE THE CABIN IMMEDIATELY. DO A HEAD COUNT TO CHECK THAT ALL PERSONS ARE ACCOUNTED FOR. DO NOT REENTER THE CABIN UNTIL IT HAS BEEN AIRED OUT AND THE PROBLEM FOUND AND CORRECTED.**

## 11.7 First Aid

It is the operator's responsibility to be familiar with the proper first-aid procedures and be able to care for minor injuries or illnesses of your passengers. In an emergency, you could be far from professional medical assistance. We strongly recommend that you be prepared by receiving training in basic first aid and CPR. This can be done through classes given by the Red Cross or your local hospital.

Your boat should also be equipped with at least a simple marine first-aid kit and a first-aid manual. The marine first-aid kit should be designed for the marine environment and be well supplied. It should be accessible and each person on board should be aware of its location. As supplies are used, replace them promptly. Some common drugs and antiseptics may lose their strength or become unstable as they age. Ask a medical

professional about the supplies you should carry and the safe shelf life of prescription drugs or other medical supplies that may be in your first-aid kit. Replace questionably old supplies whether they have been used or not.

In many emergency situations, the Coast Guard can provide assistance in obtaining medical advice for treatment of serious injuries or illness. If you are within VHF range of a Coast Guard Station, make the initial contact on channel 16 and follow their instructions.

## 11.8 Additional Safety Equipment

Besides meeting the legal requirements, prudent boaters carry additional safety equipment. This is particularly important if you operate your boat offshore. You should consider the following items, depending on how you use your boat.

### Satellite EPIRBs

EPIRBs (Emergency Position Indicating Radio Beacon) operate as part of a worldwide distress system. When activated, EPIRBs will send distress code homing beacons that allow Coast Guard aircraft to identify and find them quickly. The satellites that receive and relay EPIRB signals are operated by the National Oceanic and Atmospheric Administration (NOAA) in the United States. The EPIRB should be mounted and registered according to the instructions provided with the beacon, so that the beacon's unique distress code can be used to quickly identify the boat and owner.

### Additional Equipment to Consider

VHF Radio	Life Raft
Spare Anchor	Fenders
Heaving Line	Mirror
First Aid Kit	Tool Kit
Flashlight & Batteries	Searchlight
Boat Hook	Sunburn Lotion
Mooring Lines	Ring Buoy
Binoculars	Extra Clothing
Whistle or Horn	Portable Radio
Chart and Compass	Marine Hardware
Food & Water	Spare Keys
Sunglasses	Spare Parts
Spare Propeller	

## 11.9 Caution and Warning Labels

"Yacht Certification"  
Located on the helm.



Warning  
"Leaking fuel is a fire and explosion hazard"  
Located between the fuel filters in the systems room.



Caution  
"Shut motor off before using swim platform"  
Located on the starboard inside wall of the cockpit.



Caution  
"Prior to Operating the generator"  
Located on the optional generator in the aft systems station.



"Marine Standard Wiring Code"  
Located in the aft systems station.



# OPERATION

## 12.1 General

Before you start the engines on your Scout, you should have become familiar with the various component systems and their operation, and have performed a "Pre-Cruise System Check." A thorough understanding of the component systems and their operation is essential to the proper operation of the boat. This manual and the associated manufacturers' information is provided to enhance your knowledge of your boat. Please read them carefully.

Your boat must have the necessary safety equipment on board and be in compliance with the U.S. Coast Guard, local and state safety regulations. There should be one Personal Floatation Device (PFD) for each person. Nonswimmers and small children should wear PFDs at all times. You should know and understand the "Rules of the Road" and have had an experienced operator brief you on the general operation of your new boat. At least one other person should be instructed on the proper operation of the boat in case the operator is suddenly incapacitated.

The operator is responsible for his safety and the safety of his passengers. When boarding or loading the boat, always step onto the boat, never jump. All passengers should be properly seated whenever the boat is operated above idle speed. Your passengers should not be allowed to sit on the seat backs, gunnels, bows, transoms or on fishing seats whenever the boat is underway. The passengers should also be seated to properly balance the load and must not obstruct the operator's view, particularly to the front.

Overloading and improper distribution of weight can cause the boat to become unstable and are significant causes of accidents. Know the weight capacity and horsepower rating of your boat. Do not overload or overpower your boat.

You should be aware of your limitations and the limitations of your boat in different situations or sea conditions. No boat is indestructible, no matter how well it is constructed. Any boat can be severely damaged if it is operated in a manner that exceeds its design limitations. If the ride is hard on you and your passengers, it is hard on

the boat as well. Always modify the boat speed in accordance with the sea conditions, boat traffic and weather conditions.

Remember, it is the operator's responsibility to use good common sense and sound judgement in loading and operating the boat.

## 12.2 Rules of the Road

As in driving an automobile, there are a few rules you must know for safe boating operation. The following information describes the basic navigation rules and action to be taken by vessels in a crossing, meeting or overtaking situations while operating in inland waters. These are basic examples and not intended to teach all the rules of navigation. For further information consult the "Navigation Rules" or contact the Coast Guard, Coast Guard Auxiliary, Department of Natural Resources, or your local boat club. These organizations sponsor courses in boat handling, including rules of the road. We strongly recommend such courses. Books on this subject are also available from your local library.

### NOTICE:

**Sailboats not under power, paddle boats, vessels unable to maneuver, vessels engaged in commercial fishing and other vessels without power have the right of way over motor powered boats. You must stay clear or pass to the stern of these vessels. Sailboats under power are considered motor boats**

### Crossing Situations

When two motor boats are crossing, the boat on the right has the right of way. The boat with the right of way should maintain its course and speed. The other vessels should slow down and permit it to pass. The boats should sound the appropriate signals.

### Meeting Head-On or Nearly-So Situations

When two motor boats are approaching each other head-on or nearly head-on, neither boat has the right of way. Both boats should reduce their speed and turn to the right so as to pass port side to port side, providing enough clearance for safe passage. The boats should sound the appropriate signals.

## Overtaking Situations

When one motor boat is overtaking another motor boat, the boat that is being passed has the right of way. The overtaking boat must make the adjustments necessary to provide clearance for a safe passage of the other vessel. The boats should sound the appropriate signals.

## The General Prudential Rule

In obeying the Rules of the Road, due regard must be given to all dangers of navigation and collision, and to any special circumstances, including the limitations of the vessels, which may justify a departure from the rules that is necessary to avoid immediate danger or a collision.

## Night Operation

Recreational boats are required to display navigation lights between sunset and sunrise and other periods of reduced visibility such as fog, rain, haze, etc. When operating your boat at night you should:

- Make sure your navigation lights are on and working properly. Navigation lights warn others of your position and course and the position and course of other vessels.
- All navigation rules apply. If the bow light of another vessel shows red, you should give way to that vessel, if it shows green, you have the right of way.
- Slow down and never operate at high speeds when operating at night, stay clear of all boats and use good common sense. Always be ready to slow down or steer clear of other vessels, even if you have the right-of-way.
- Avoid bright lights that can destroy night vision, making it difficult to see navigation lights and the lights of other boats. You and your passengers should keep a sharp lookout for hazards, other boats and navigational aids.

## Navigation Aids

Aids to navigation are placed along coasts and navigable waters as guides to mark safe water and to assist mariners in determining their position in relation to land and hidden dangers. Each aid to navigation is used to provide specific information. You should be familiar with these and any other markers used in your boating area.

### NOTICE:

**Storms and wave action can cause buoys to move. You should not rely on buoys alone to determine your position.**

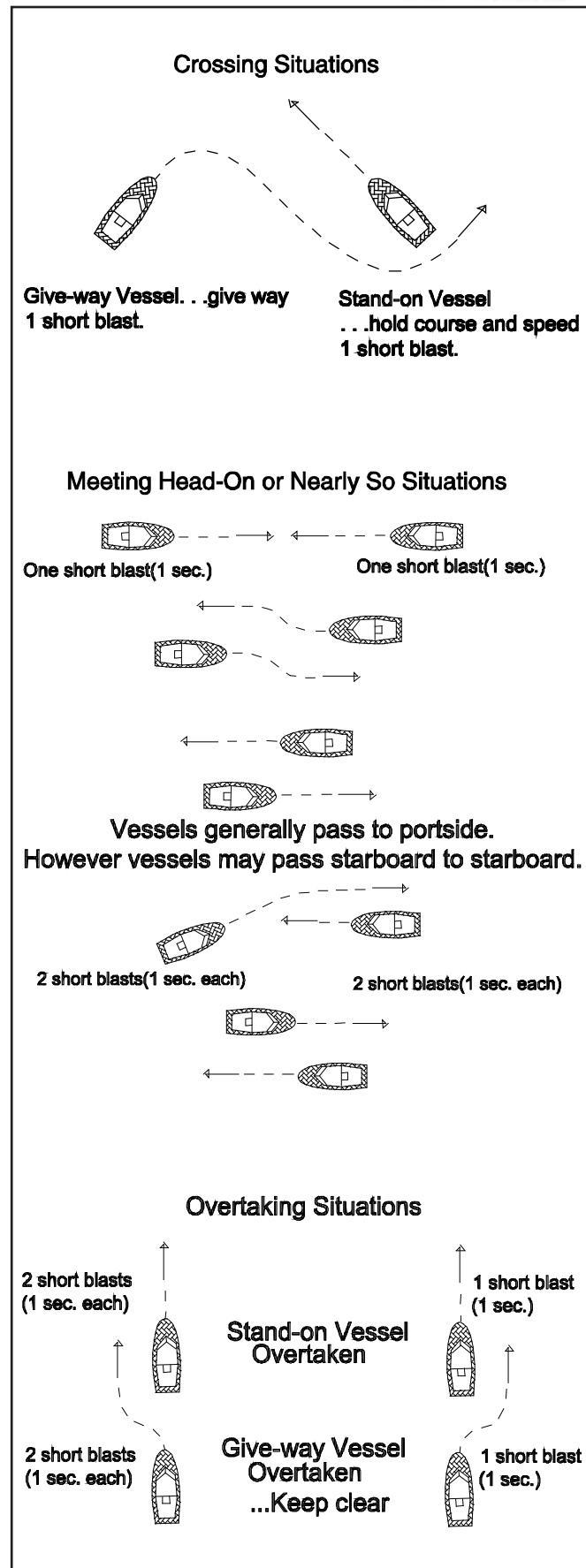

## Navigational Aids Chart

### REMEMBER THESE RULES

1. OVERTAKING - PASSING: Boat being passed has the right-of-way. KEEP CLEAR.
2. MEETING HEAD ON: Keep to the right.
3. CROSSING: Boat on right has the right-of-way. Slow down and permit boat to pass.

### ← PORT

Yield right-of-way to boats in your DANGER ZONE!

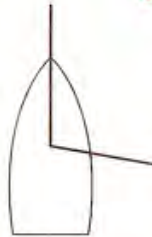

### STARBOARD →

DANGER ZONE (Dead ahead to 2 points abaft your starboard beam)

### STORM WARNINGS



RED FLAG  
Small craft (winds up to 33 knots)



2 RED FLAGS  
Gale (winds up to 47 knots)



SQUARE RED FLAG  
BLACK BOX (Storm)



2 SQUARE RED FLAGS  
BLACK BOX (Hurricane)

### WHISTLE SIGNALS

- ONE LONG BLAST: Warning signal (Coming out of slip)
- ONE SHORT BLAST: Pass on my port side
- TWO SHORT BLASTS: Pass on my starboard side
- THREE SHORT BLASTS: Engine(s) in reverse
- FOUR OR MORE BLASTS: Danger signal

### BRIDGE SIGNALS

#### SOUND

- VESSEL: Open
- BRIDGE: OK
- No
- VESSEL: Replies:
- RADIO: VHF CH. 13

#### VISUAL

- VESSEL: Open
- BRIDGE: OK
- No
- DAY (Flag)
- NIGHT (Lights)

### LATERAL AIDS AS SEEN ENTERING FROM SEAWARD

#### PORT SIDE ODD NUMBERED AIDS

GREEN LIGHT ONLY

FLASHING

OCCULTING

QUICK FLASHING

ISOPHASE

LIGHTED BUOY   
G "9"  
Fl G 4sec

#### SAFE WATER MID-CHANNELS OR FAIRWAYS NO NUMBERS — MAY BE LETTERED

WHITE LIGHT ONLY MORSE CODE

Mo (A)

SPHERICAL   
RW  
SP "G"

MR   
RW  
"A"

LIGHTED AND OR SOUND   
RW "N"  
Mo (A)

#### STARBOARD SIDE EVEN NUMBERED AIDS

RED LIGHT ONLY

FLASHING

OCCULTING

QUICK FLASHING

ISOPHASE

LIGHTED BUOY   
R "8"  
Fl R 4sec

#### PREFERRED CHANNEL NO NUMBERS — MAY BE LETTERED

COMPOSITE GROUP FLASHING (2 + 1)

GREEN LIGHT ONLY RED LIGHT ONLY

GR "C"  
Fl (2 + 1)

RG "B"  
Fl (2 + 1)

LIGHTED

PREFERRED CHANNEL TO STARBOARD  
TOPMOST BAND GREEN  
GR "C" 1"

PREFERRED CHANNEL TO PORT  
TOPMOST BAND RED  
RG "N" "W"

CAN   
CAN   
NUN   
NUN   
JG   
JR   
GR "A"  
RG "B"

CAN   
G  
C "7"

SG   
DAYMARK   
G  
"1"

NUN   
R  
N "6"



DAYMARK   
TR  
R  
"2"

## 12.3 Pre-Cruise Check

### Before Starting the Engines

- Check the weather forecast. Decide if the planned cruise can be made safely.
- Be sure all required documents are on board.
- Be sure all necessary safety equipment is on board and operative. This should include items like the running lights, spotlight, life saving devices, fire extinguishers, etc. Please refer to the Safety Equipment chapter for additional information on safety equipment.
- Make sure you have signal kits and flare guns aboard, and they are current and in good operating condition.
- Be sure you have sufficient water and other provisions for the planned cruise.
- Leave a written message listing details of your planned cruise with a close friend ashore (Float Plan). The float plan should include a description of your boat, where you intend to cruise, and a schedule of when you expect to arrive in the cruising area and when you expect to return. Keep the person informed of any changes in your plan to prevent false alarms. This information will tell authorities where to look and the type of boat to look for in the event you fail to arrive. A float plan form is located in the Appendix section of this manual.
- Check the amount of fuel on board. Observe the "one third rule" by using: one third of the fuel for the trip out, one third to return and one third in reserve. An additional 15% may be consumed in rough seas.
- Check the water separating fuel filters for water and leaks.
- Check the oil in the engine oil tanks (2-cycle engines) or the crankcase oil level (4-cycle engines).
- Turn the battery switches to the ON position.
- Check the bilge water level. Look for other signs of potential problems. Monitor for the scent of fuel fumes.

- Test the automatic and manual bilge pump switches to make sure the system is working properly.

 **CAUTION** 

**THERE MUST BE AT LEAST ONE PERSONAL FLOTATION DEVICE ON BOARD FOR EVERY PERSON ON BOARD AND ONE THROW-OUT FLOTATION DEVICE. CHECK THE U.S. COAST GUARD STANDARDS FOR THE CORRECT TYPE OF DEVICE FOR YOUR BOAT.**

- Have a tool kit aboard. The kit should include the following basic tools:

Spark plug wrench	Hammer
Spark plug gap gauge	Electrician's tape
Screwdrivers	Offset screwdrivers
Lubricating oil	Pliers
Jackknife	Adjustable wrench
Basic 3/8" ratchet set	Vise grip pliers
Hex key set	Needle nose pliers
Wire crimping tool	End wrench set
Medium slip-joint pliers	Diagonal cutting pliers
DC electrical test light	



- Have the following spare parts on board:

Extra light bulbs	Spark plugs
Fuses and circuit breakers	Main engine fuses
Assorted stainless screws	Propellers
Assorted stainless bolts	Drain plugs
Flashlight and batteries	Engine oil
Fuel filters	Propeller nuts
Fuel hose and clamps	Wire ties
Wire connector set	Hydraulic steering oil
Assorted hose clamps	Rags
Steering fluid	

- Make sure all fire extinguishers are in position and in good operating condition.
- Check the engine and steering controls for smooth and proper operation. Be sure the shift controls are in the neutral position.
- Be sure the emergency stop lanyard is attached to the operator and the stop switch.
- Refer to the engine owner's manual for pre-operation checks specific to your engine.



## 12.4 Operating Your Boat

 **WARNING** 

TO REDUCE THE RISK OF A FIRE OR EXPLOSION, DO NOT START THE ENGINES WHEN FUEL FUMES ARE PRESENT. FUEL FUMES ARE DANGEROUS AND HARMFUL TO YOUR HEALTH.

### After Starting the Engines

- Visibly check the engines to be sure there are no apparent water, fuel or oil leaks.
- Check the operation of the engine cooling systems.
- Check the engine gauges. Make sure they are reading normally.
- Check the controls and steering for smooth and proper operation.
- Make sure all lines, cables, anchors, etc. for securing a boat are on board and in good condition. All lines should be coiled, secured and off the decks when underway.
- Have a safe cruise and enjoy yourself.



### Remember:

When you operate a boat, you accept the responsibility for the boat, for the safety of passengers and for others out enjoying the water.

- Avoid sea conditions that are beyond the skill and experience of you and your crew.
- Alcohol and any drugs can severely reduce your reaction time and affect your better judgment.
- Alcohol severely reduces the ability to react to several different signals at once.
- Alcohol makes it difficult to correctly judge speed and distance, or track moving objects.
- Alcohol reduces night vision, and the ability to distinguish red from green.

 **WARNING** 



YOU SHOULD NEVER OPERATE YOUR BOAT WHILE UNDER THE INFLUENCE OF ALCOHOL AND DRUGS.

 **WARNING** 

MAKE SURE ONE OTHER PERSON ON THE BOAT IS INSTRUCTED IN THE OPERATION OF THE BOAT AND ALWAYS OPERATE THE BOAT IN COMPLIANCE WITH ALL STATE AND LOCAL LAWS GOVERNING THE USE OF A BOAT.

DO NOT OPERATE THE BOAT UNLESS IT IS COMPLETELY ASSEMBLED. KEEP ALL FASTENERS TIGHT. KEEP ADJUSTMENTS ACCORDING TO SPECIFICATIONS.

Before operating the boat for the first time, read the engine break-in procedures. The Yamaha break-in procedures are found in the owner's manual for the engines. The manual is in the literature packet. Correct break-in operation is critical to ensure proper performance and longer engine life.

 **CAUTION** 

FAILURE TO FOLLOW THE BREAK-IN PROCEDURE MAY RESULT IN REDUCED ENGINE LIFE OR EVEN SEVERE ENGINE DAMAGE. MAKE SURE YOU FOLLOW THE BREAK-IN PROCEDURE EXACTLY.

As different types of engines are used to power the boat, have the dealer describe the operating procedures for your boat. For more instructions on "How To Operate The Boat," make sure you read the instructions given to you in the owner's manual for the engine you have selected.

### NOTICE:

For more instructions on safety, equipment and boat handling, enroll in one of the several free boating courses offered. For information on the courses offered in your area, call the "Boating Safety Hotline," 800-368-5647, or the "Boat U.S. Foundation Course Hotline," 1-800-336-2628, for further information on boating safety courses.

### NOTICE:

If the drive unit hits an underwater object, stop the engines. Inspect the drive unit for damage. If the unit is damaged, contact your dealer for a complete inspection and repair of the unit.

## To stop the boat, follow this procedure:

- Allow the engines to drop to the idle speed.
- Make sure the shifting levers are in the neutral position.

### NOTICE:

**If the engines have been run at high speed for a long period of time, allow them to cool down by running the engines in the idle position for 3 to 5 minutes.**

- Turn the ignition keys to the OFF position.
- Raise the trim tabs to the full up position.

### After Operation

- If operating in saltwater, wash the boat and all equipment with soap and water. Flush the engines using fresh water. Refer to the engine owner's manual for instructions on flushing your outboard engines.
- Check the bilge area for debris and excess water.
- Fill the fuel tank to near full to reduce condensation. Allow enough room in the tank for the fuel to expand without being forced out through the vent.
- Turn off all electrical equipment except the automatic bilge pumps.
- If you are going to leave the boat for a long period of time, put the battery main switches in the OFF position and close all seacocks.
- Make sure the boat is securely moored.



## CAUTION



**TO PREVENT DAMAGE TO THE BOAT, CLOSE ALL SEACOCKS BEFORE LEAVING THE BOAT.**

## 12.5 Docking, Anchoring and Mooring

### Docking and Dock Lines

Maneuvering the boat near the dock and securing the boat require skill and techniques that are unique to the water, wind conditions and the layout of the dock. If possible, position a crew member

at the bow and stern to man the lines and assist in docking operations. While maneuvering close to the dock consideration must be giving to the wind and current. You should anticipate the effect these forces will have on the boat and use them to help put the boat where you want it. It is important to practice in open water using an imaginary dock enough to develop a sense for the way your boat handles in a variety of docking scenarios. You must be able to foresee the possibilities and have solutions in mind before problems occur.

Approaching a dock or backing into a slip in high winds or strong currents requires a considerable amount of skill. If you are new to boat handling, you should take lessons from an experienced pilot to learn how to maneuver your boat in tight quarters in less than ideal conditions. You should also practice away from the dock during windy conditions.

Dock lines are generally twisted or braided nylon. Nylon is strong and stretches to absorb shock. It also has a long life and is soft and easy on the hands. The line's size will vary with the size of the boat. Typically a 30 to 40 foot boat will use 5/8-inch line and a 20 to 30 foot boat will use 1/2-inch line. The number of lines and their configuration will vary depending on the dock, the range of the tide, and many other factors. Usually a combination of bow, stern and spring lines is used to secure the boat.

### Maneuvering to the Dock

Approach the dock slowly at a 30 to 40 degree angle. Whenever possible, approach against the wind or current. Turn the engines straight & shift to neutral when you feel you have enough momentum to reach the dock. Use reverse on the outboard engine while turning the steering wheel towards the dock to slow the boat and pull the stern toward the dock as the boat approaches. Straighten the engines and use both engines to stop the boat if it is still moving forward against the pilings. If you executed your approach properly, the boat will lightly touch the pilings at the same time the forward momentum is stopped. Have the dock lines ready and secure the boat as soon as it stops. Use fenders to protect the boat while it is docked. Keep the engines running until the lines are secured.

### Backing into a Slip

Approach the slip with the stern against the wind or current and the engines straight ahead. Use the

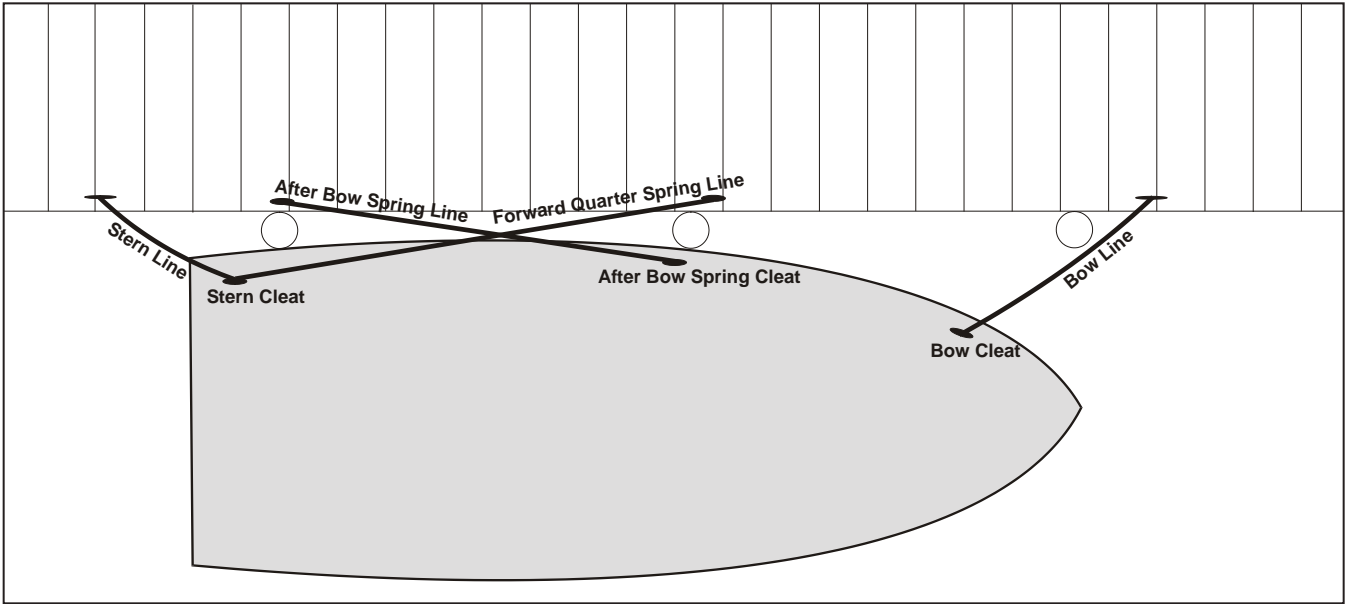

Securing The Boat Along Side A Dock (Typical)

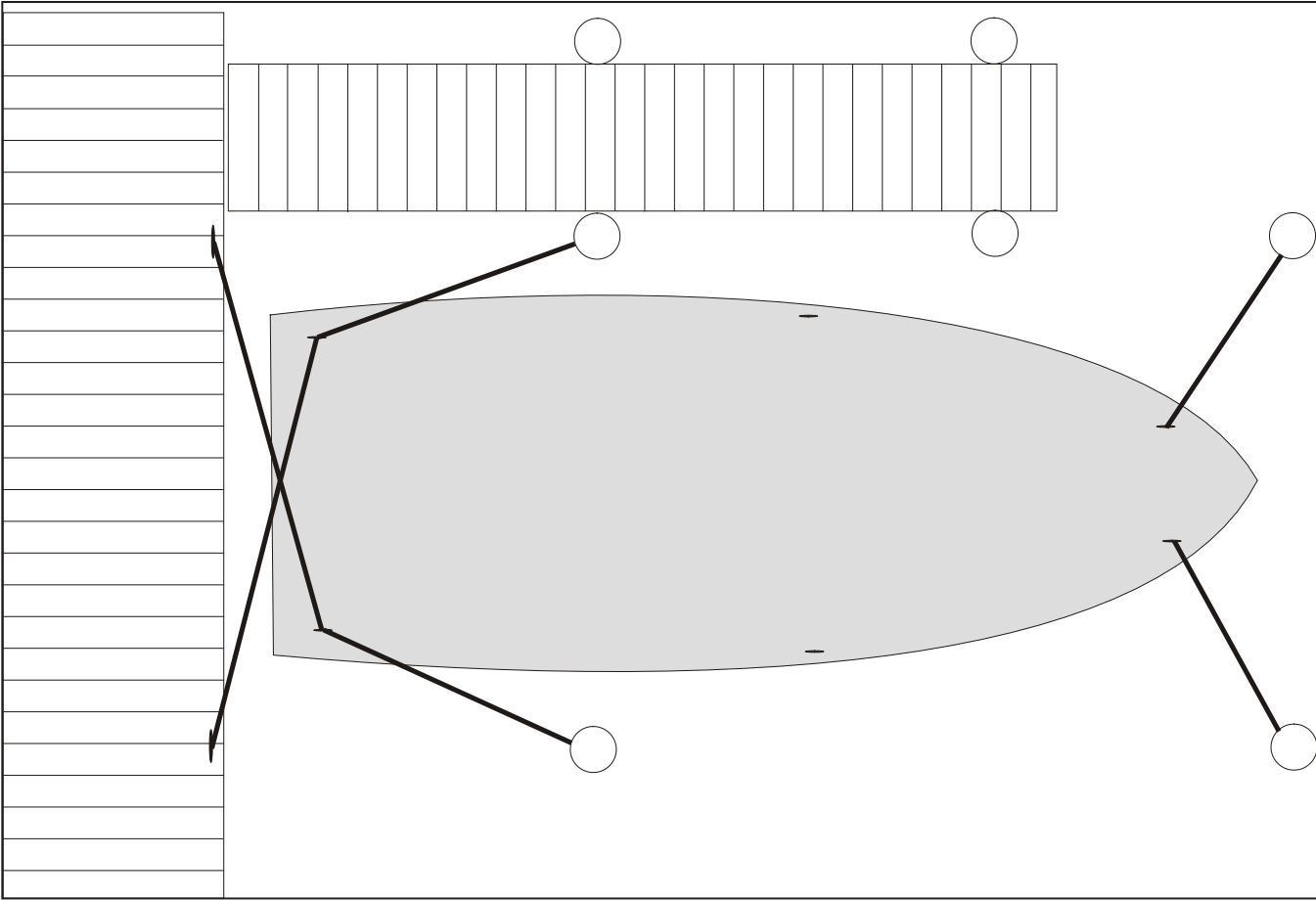

Securing The Boat In A Slip (Typical)

engines and turn the steering wheel to maneuver the boat into alignment with the slip. Reverse the engines and slowly back into the slip. Shift from reverse to neutral frequently to prevent the boat from gaining too much speed. Move the stern right and left by shifting the engines in and out of gear or turning the wheel. When nearly in the slip all the way, straighten the engines and shift to forward to stop. Keep the engines running until the lines are secured.

## Securing Dock Lines

Securing a boat that is tied along side the dock typically requires a bow and stern line and two spring lines. The bow and stern lines are usually secured to the dock at a 40° angle aft of the stern cleat and forward of the bow cleat. The after bow spring line is secured to the dock at a 40° angle aft of the after bow spring cleat. The forward quarter spring is secured to the dock at a 40° angle forward of the stern cleat. The spring lines keep the boat square to the dock and reduce fore and aft movement while allowing the boat to move up and down with the tide.

Securing a boat in a slip is somewhat different. It typically requires two bow lines secured to pilings on each side of the bow, two stern lines secured to the dock and two spring lines that prevent the boat from hitting the dock. The bow lines are typically secured with enough slack to allow the boat to ride the tide. The stern lines are crossed. One line runs from the port aft boat cleat to the starboard dock cleat and the other line runs from the starboard aft boat cleat to the port cleat on the dock. The stern lines center the boat, control the forward motion, and allow the boat to ride the tide. Two forward quarter spring lines typically are secured to the stern cleats and to mid ship pilings or cleats. The spring lines keep the boat from backing into the dock while allowing it to ride the tide.

## Leaving the Dock

Always start the engines and let them warm up for several minutes before releasing the lines. Boats steer from the stern and it is important that you achieve enough clearance at the stern to maneuver the boat as quickly as possible. Push the stern off and maneuver such that you get stern clearance quickly. Proceed slowly until well clear of the dock and other boats.

## Mooring

Approach the mooring heading into the wind or

current. Shift to neutral when you have just enough headway to reach the buoy. Position a crew member on the bow to retrieve the mooring with a boat hook and secure the line. Keep the engines running until the line is secured.

## Leaving a Mooring

Start the engines and let them warm up for several minutes before releasing the mooring line. The boat will already be headed into the wind, so move it forward enough to loosen the line and untie it. Back the boat away from the mooring until you can see the buoy. Move the boat slowly away from the mooring.

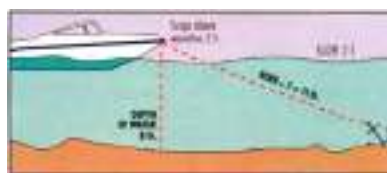

## Anchoring

Make sure the bitter end of the anchor line is attached to boat before dropping the anchor. Bring the bow into the wind or current and put the engines in neutral. When the vessel comes to a stop, lower the anchor over the bow. Pay out anchor line so that it is at least 5 to 7 times the depth of the water and secure the line to a cleat. Use caution to avoid getting your feet or hands tangled in the line. Additional scope of 10 times the depth may be required for storm conditions. Check landmarks on shore or your GPS position to make sure the anchor is not dragging. If it is dragging, you will have to start all over. It is prudent to use two anchors if you are anchoring overnight or in rough weather.

## Releasing the Anchor

Release the anchor by driving the boat slowly to the point where the anchor line becomes vertical. It should release when you pass that point. If the anchor doesn't release right away, stop the boat directly above the anchor and tie the line to the cleat as tight as possible. The up and down movement of the boat will usually loosen the anchor within a minute. Make sure you secure the anchor and properly stow the line before operating the boat.



## WARNING



**NEVER ANCHOR THE BOAT BY THE STERN. THE STERN OF THE BOAT IS VULNERABLE TO SWAMPING FROM WAVE ACTION AND WIND AND CURRENT WILL PUT MORE STRESS ON THE ANCHOR WHEN IT IS ATTACHED TO THE STERN. ONLY ANCHOR THE BOAT BY THE BOW**

## 12.6 Controls, Steering, or Propulsion System Failure:

If the propulsion, control or steering system fails while you are operating the boat, bring the throttles to idle and shift to neutral. Decide whether you need to put out the anchor to prevent the boat from drifting or to hold the bow into the seas. Investigate and correct the problem if you can. Turn the engine off before opening the engine cowling to make repairs. If you are unable to correct the problem, call for help.

If only one engine has failed, you can usually run home on the other engine. Be careful not to apply too much power to the engine that is running. When only one engine is used to power a twin engine boat, that engine is over propped and can be overloaded if too much throttle is applied. You should contact your dealer or the engine manufacturer for the maximum power settings when running without one engine.

## 12.7 Collision

If your boat is involved in a collision with another boat, dock, piling or a sandbar, your first priority is to check your passengers for injuries and administer first aid if necessary. Once your passenger's situations are stabilized, thoroughly inspect the boat for damage. Check below decks for leaks and the control systems for proper operation. Plug all leaks or make the necessary repairs to the control systems before proceeding slowly and carefully to port. Request assistance if necessary. Haul the boat and make a thorough inspection of the hull and running gear for damage.



## 12.8 Grounding, Towing and Rendering Assistance

The law requires the owner or operator of a vessel to render assistance to any individual or vessel in distress, as long as his vessel is not endangered in the process.

If the boat should become disabled, or if another craft that is disabled requires assistance, great care must be taken. The stress applied to a boat during towing may become excessive. Excessive stress can damage the structure of the boat and create a safety hazard for those aboard.



Freeing a grounded vessel or towing a boat that is disabled requires specialized equipment and

knowledge. Line failure and structural damage caused by improper towing have resulted in fatal injuries. Because of this, we strongly suggest that these activities be left to those who have the equipment and knowledge, e.g., the U.S. Coast Guard or a commercial towing company, to safely accomplish the towing task.

 **DANGER** 

**THE MOORING CLEATS ON SCOUT BOATS ARE NOT DESIGNED OR INTENDED TO BE USED FOR TOWING PURPOSES. THESE CLEATS ARE SPECIFICALLY DESIGNED AS MOORING CLEATS FOR SECURING THE BOAT TO A DOCK, PIER, ETC. DO NOT USE THESE FITTINGS FOR TOWING OR ATTEMPTING TO FREE A GROUNDING VESSEL.**

**WHEN TOWING OPERATIONS ARE UNDERWAY, HAVE EVERYONE ABOARD BOTH VESSELS STAY CLEAR OF THE TOW LINE AND SURROUNDING AREA. A TOW LINE THAT SHOULD BREAK WHILE UNDER STRESS CAN BE VERY DANGEROUS, AND COULD CAUSE SERIOUS INJURY OR DEATH.**

 **WARNING** 

**RUNNING AGROUND CAN CAUSE SERIOUS INJURY TO PASSENGERS AND DAMAGE TO A BOAT AND ITS UNDERWATER GEAR. IF YOUR BOAT SHOULD BECOME GROUNDING, DISTRIBUTE PERSONAL FLOTATION DEVICES AND INSPECT THE BOAT FOR POSSIBLE DAMAGE. THOROUGHLY INSPECT THE BILGE AREA FOR SIGNS OF LEAKAGE. AN EXPERIENCED SERVICE FACILITY SHOULD CHECK YOUR UNDERWATER GEAR AT THE FIRST OPPORTUNITY. DO NOT CONTINUE TO USE YOUR BOAT IF THE CONDITION OF THE UNDERWATER EQUIPMENT IS QUESTIONABLE.**

## 12.9 Flooding or Capsizing

Boats can become unstable if they become flooded or completely swamped. You must always be aware of the position of the boat to the seas and the amount of water in the bilge. Water entering the boat over the transom can usually be corrected by turning the boat into the waves. If the bilge is flooding because of a hole in the hull or a defective hose, you may be able to plug it with rags, close the thru-hull valve or assist the pumps by bailing with buckets. Put a mayday call in to the Coast Guard or nearby boats and distribute life jackets as soon as you discover your boat is in trouble.

If the boat becomes swamped and capsizes, you and your passengers should stay with the boat as long as you can. It is much easier for the Coast

Guard, aircraft, or other boats to spot, than people in the water.

## 12.10 Fishing

Fishing can be very exciting and distracting for the operator when the action gets intense. You must always be conscious of the fact that your primary responsibility is the safe operation of your boat and the safety of your passengers and other boats in the area.

You must always make sure the helm is properly manned and is never left unattended while trolling. If your boat is equipped with a tower, caution and good common sense must be exercised whenever someone is in the tower. Most towers are designed for two average-sized people. Remember, weight in the tower raises the boat's center of gravity and the boat's motion is greatly exaggerated for the people in a tower.



If you are fishing in an area that is crowded with other fishing boats, it may be difficult to follow the rules of the road. This situation can become especially difficult when most boats are trolling. Being courteous and exercising good common sense is essential. Avoid trying to assert your right of way and concentrate on staying clear and preventing tangled or cut lines and other unpleasant encounters with other boats. Also keep in mind that fishing line wrapped around a propeller shaft can damage seals in the engine lower unit.

## 12.11 Man Overboard

If someone falls overboard, you must be prepared to react quickly, particularly when you are offshore. The following procedures will help you in recovering a person that has fallen overboard.

- Immediately stop the boat and sound a man overboard alarm and have all passengers point to the person in the water.
- Circle around quickly and throw a cushion or life jacket to the person, if possible, and another to use as a marker.
- Keep the person on the driver side of the boat so you can keep him in sight at all times.

- Make sure to approach the person from the downwind side and maneuver the boat so the propeller is well clear of the person in the water.
- Turn off the engines when the person is alongside and use a ring buoy or a boat cushion with a line attached, a paddle or boathook to assist him to the boat. Make sure you don't hit him with the ring buoy or the boat.
- Pull the person to the boat and assist him on board.
- Check the person for injuries and administer first aid if necessary. If the injuries are serious, call for help. Refer to the Safety Equipment chapter for more information on first aid and requesting emergency medical assistance.

 **WARNING** 

**MOVING PROPELLERS ARE DANGEROUS. THEY CAN CAUSE DEATH, LOSS OF LIMBS, OR OTHER SEVERE INJURY. DO NOT USE THE SWIM PLATFORM OR SWIM LADDER WHILE THE ENGINES ARE RUNNING. STOP THE ENGINES IF DIVERS OR SWIMMERS ARE ATTEMPTING TO BOARD. ALWAYS PROPERLY STORE THE LADDER BEFORE STARTING THE ENGINES.**

## 12.12 Tower Operation

If your boat is equipped with an aftermarket fabricated aluminum tower you should exercise caution and use good common sense when operating the boat from the tower. Towers are normally equipped with full engine controls, trim tab controls, compass, engine alarms, restart buttons and tachometers. This allows for complete operation of the boat from the tower.

### Operation of the Tower Controls

The engines should be started at the lower helm. Monitor the gauges to make sure all systems are normal and the engines have been allowed to warm up slightly before proceeding to the tower helm. The ignition or restart switches on the tower are only used to restart an engine in the event it should stall. The shift controls must be in neutral for the start switches to be functional.

Electronic engine controls are equipped with a station transfer button that allows the operator to transfer control from one station to another with the push of a button. Always make sure that you activate the controls as soon as you reach the helm in the tower.

Refer to the Control Systems chapter and the electronic engine control owner's manual for more information on the control system operation and selecting the controls on boats with dual stations.

**The following is a list of safety precautions for tower operation:**

- Do not operate the boat from the tower in rough sea conditions. The boat's motions are exaggerated in the tower and this motion may become excessive in rough seas.
- Be careful when using the trim tabs from the tower. The reaction of the trim tabs will be exaggerated in the tower. Use small tab corrections and wait ten (10) seconds for the tabs to react. Keep making small corrections until the hull is at the desired attitude.
- Do not overload the tower. Most towers are designed to hold the weight of only two or three average sized people. Weight in the tower raises the boat's center of gravity. Too much weight in the tower could make the boat unstable.
- Do not operate the boat in tight quarters, such as marinas, from the tower. The operator is isolated from the boat while in the tower and will not be able to assist in docking procedures.
- Always pay close attention to your grip and footing on the tower ladders. Your ability to achieve a good grip and proper footing is reduced in wet or rough weather. Therefore, the tower should be avoided in those conditions.
- Only operate the boat from the tower in familiar waters or where running aground is not a possibility. Running aground while operating the boat from the tower could result in severe injury.
- Always be alert for waves and boat wakes when operating the boat from the tower. Remember that the boat's motions are exaggerated in the tower.
- Good common sense and judgment must be exercised at all times when operating a boat from the tower.
- If an engine alarm sounds, immediately put the boat in NEUTRAL and shut OFF the engine(s), if safe to do so, until the problem is found and corrected.
- Always put the boat in NEUTRAL before moving to and from the tower helm and cockpit.

Good common sense, judgment and extreme caution must be exercised when operating a boat with someone in the tower. Do not allow anyone in the tower when the water is rough or when operating in unfamiliar waters where running aground is a possibility. Remember, weight in the tower raises the boat's center of gravity and the boat's motion is greatly exaggerated for the people in the tower.

## 12.13 Trash Disposal

The discharge of plastic trash or trash mixed with plastic is illegal anywhere in the marine environment. U.S. Coast Guard regulations also restrict the dumping of other forms of garbage. Regional, State, and local restrictions on garbage discharges also may apply.

Responsible boaters store refuse in bags and dispose of it properly on shore. You should make sure your passengers are aware of the local waste laws and the trash management procedure on your boat. Refer to the placard mounted on your boat for more specific information regarding solid waste disposal.

Federal law requires that vessels of 26 feet or longer must display in a prominent location, a durable placard at least 4 by 9 inches notifying the crew and passengers of the discharge restrictions (Marpol Treaty). It is the boat owner's responsibility to make sure this placard remains mounted and legible in accordance with the law.

## 12.14 Transporting Your Boat

If you trailer your boat, make sure that your tow vehicle is capable of towing the weight of the trailer, boat and equipment and the weight of the passengers and equipment inside the vehicle. This may require that the tow vehicle be specially equipped with a larger engine, transmission, brakes and trailer tow package.

The boat trailer is an important part of your boating package. The trailer should be matched to your boat's weight and hull. Using a trailer with a capacity too low will be unsafe on the road and cause abnormal wear. A trailer with a capacity too high, can damage the boat. Contact your trailer dealer to evaluate your towing vehicle and hitch, and to make sure you have the correct trailer for your boat.

### NOTICE:

**Your Scout is a heavy boat and care must be taken when selecting the trailer. We recommend that you use a bunk style trailer that incorporates a combination of heavy duty rollers, to support the keel and long bunks**

**running under and parallel to the stringers to support the hull. Avoid using a full roller trailer that does not have bunks. Roller trailers have a tendency to put extreme pressure points on the hull, especially on the lifting strakes, and have damaged boats. The situation is worse during launching and haul out. Damage resulting from improper trailer support or the use of a full roller trailer will not be covered by the Scout Warranty.**

### NOTICE:

**Contact your trailer dealer to evaluate your towing vehicle and hitch, and to make sure you have the correct trailer for your boat.**

- Make sure the trailer is a match for your boat's weight and hull design. More damage can be done to a boat by the stresses of road travel than by normal water operation. A boat hull is designed to be supported evenly by water. So, when it is transported on a trailer it should be supported structurally as evenly across the hull as possible allowing for even distribution of the weight of the hull, engines and equipment.
- Make sure the trailer bunks and rollers properly support the hull and do not put pressure on the lifting strakes. The rollers and bunks must be kept in good condition to prevent scratching and gouging of the hull.
- The capacity rating of the trailer should be greater than the combined weight of the boat, motor, and equipment. The gross vehicle weight rating must be shown on the trailer. Make sure the weight of the boat, engine, gear and trailer is not more than the gross vehicle weight rating.
- Make sure the boat is securely fastened on the trailer to prevent movement between the boat and trailer. The bow eye on the boat should be secured with a rope, chain or turnbuckle in addition to the winch cable. Additional straps may be required across the beam of the boat.

### NOTICE:

**Your trailer dealer will give instructions on how to load, fasten and launch your boat.**



**CAUTION**

**BOATS HAVE BEEN DAMAGED BY TRAILERS THAT DO NOT PROPERLY SUPPORT THE HULL. ALWAYS MAKE SURE THE TRAILER BUNKS AND ROLLERS ARE ADJUSTED SO THEY ARE NOT PUTTING EXCESSIVE PRESSURE ON THE LIFTING STRAKES AND ARE PROVIDING ENOUGH SUPPORT FOR THE HULL. HULL DAMAGE RESULTING FROM IMPROPER TRAILER SUPPORT IS NOT COVERED BY THE SCOUT WARRANTY.**

**Before Going Out On The Highway:**

- SIDE CURTAINS, CLEAR CONNECTOR, BACK DROP and AFT CURTAIN must be removed when trailering. Canvas enclosures are not designed to withstand the extreme wind pressure encountered while trailering and will be damaged. Always remove and properly store the enclosure before trailering your boat.
- Make sure the tow BALL and TRAILER COUPLER are the same size and bolts and nuts are tightly secured.
- The COUPLER MUST BE COMPLETELY OVER THE BALL and the LATCHING MECHANISM LOCKED DOWN.
- Make sure the TRAILER IS LOADED EVENLY from front to rear as well as side to side and has the correct weight on the hitch. Too much weight on the hitch will cause the rear of the tow vehicle to drag and may make steering more difficult. Too little weight on the hitch will cause the rig to fishtail and will make controlling the tow vehicle difficult. Contact your trailer manufacturer or dealer for the correct weight on the hitch for your trailer.
- The SAFETY CHAINS must be attached crisscrossing under the coupler to the frame of the tow vehicle. If the ball was to break, the trailer would follow in a straight line and prevent the coupler from dragging on the road. Make sure the trailer emergency brake cable or chain is also installed to the tow vehicle frame.

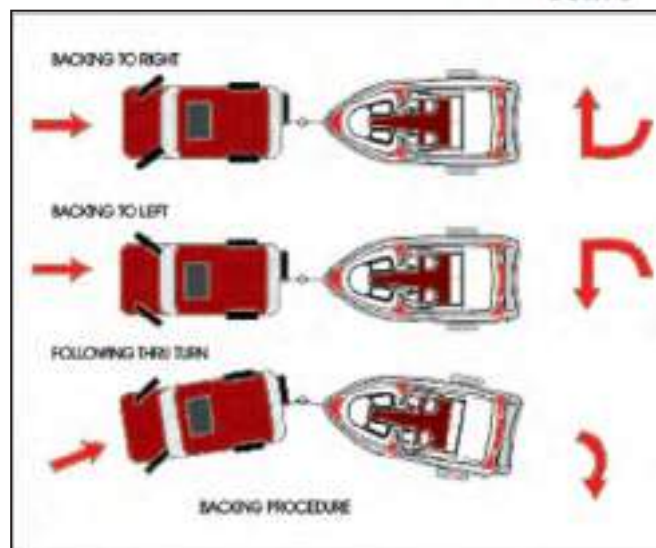

- Make sure the LIGHTS on the trailer function properly.
- CHECK THE BRAKES. On a level parking area roll forward and apply the brakes several times at increasing speeds to determine if the brakes on the tow vehicle and trailer are working properly.
- Make sure the tow vehicle has SIDE VIEW MIRRORS that are large enough to provide an unobstructed rear view on both sides of the vehicle.
- CHECK THE TIRES and WHEEL BEARINGS.

**NOTICE:**  
**Make sure your towing vehicle and trailer are in compliance with all state and local laws. Contact your state motor vehicle bureau for laws governing the towing of trailers.**

THIS PAGE WAS LEFT BLANK  
INTENTIONALLY

# ROUTINE MAINTENANCE

## 13.1 Exterior Hull and Deck

### Hull Cleaning-Below The Water Line

When the boat is removed from the water, clean the outer bottom surface immediately. Algae, grass, dirt and other marine growth is easier to remove while the hull is still wet. Use a pressure cleaner or a hard bristle brush to clean the surface.

### Bottom Painting

If the boat is to be left in saltwater for extended periods, the hull must be protected from marine growth by antifouling paint. Because of variations in water temperature, marine growth, and pollution in different regions, a qualified boat yard in your area should be consulted when deciding what bottom paint system to apply to your hull. This is extremely important as pollution and marine growth can damage fiberglass hulls.

Use only standard antifouling paints and fiberglass wax removers and primers recommended by the antifouling paint manufacturer when preparing the hull for bottom paint. Light sanding, just enough to scuff the gel coat or a skip sand primer system can be used to prepare the hull for bottom paint. The use of a coating other than standard antifouling paint or epoxy barrier coatings are not recommended and will void the hull blister warranty.

Do not allow the hull antifouling paint to contact the outboard motors. Most antifouling paints designed for hull bottoms contain copper and can cause severe galvanic corrosion damage to the motors. Always leave at least a 1/2" barrier between the hull bottom paint and outboard motors.

Most bottom paints require some maintenance. Proper maintenance is especially important when the boat is in saltwater and not used for extended periods or after dry storage. If the hull bottom has been painted with antifouling paint, contact your dealer or local boat yard for the recommended maintenance procedures.

### Anodes

Sacrificial anodes are installed on the outboard

motors, engine brackets and trim tabs. The anodes are less noble than copper based alloys, stainless steel and aluminum. They will deteriorate first, protecting the more noble underwater hardware against galvanic corrosion.

They must be monitored if the boat is to be left in the water. Anodes should be checked monthly and changed when they are 75% of their original size. When replacing the anodes, make sure the contact surfaces are clean, shiny metal and free of paint and corrosion. Never paint over the anode.

Boats stored in saltwater will normally need to have the anodes replaced every 6 months to one year. Anodes requiring replacement more frequently may indicate a stray current problem within the boat or at the slip or marina. Anodes that do not need to be replaced after one year may not be providing the proper protection. Loose or low quality anodes could be the problem. Contact your engine dealer or Scout Customer Service for the proper size and type of anodes to be used and the specific installation procedure.

There are 2 anodes on Yamaha engines. There is a large anode on the bottom of the clamp bracket and another anode on the anti-cavitation plate, above the propeller.

### Fiberglass Gel coat



Normal maintenance requires only washing with mild soap and water. A stiff brush can be used on the nonskid areas. Kerosene or commercially prepared products will remove oil and tar which could be a problem on trailered boats. Harsh abrasive and chemical cleaners are not recommended because they can damage or dull the gel coat, reducing its life and making it more susceptible to stains. When the boat is used in saltwater, it should be washed thoroughly with soap and water after each use.

At least once a season, wash and wax all exposed fiberglass surfaces. Use a high quality automotive or boat wax. Follow the procedure recommended by the wax manufacturer. The washing and waxing of your boat will have the same beneficial effects as they have on an automobile finish. The wax will fill minute scratches and pores thus

helping to prevent soiling and will extend the life of the gel coat or paint.



After the boat is exposed to the direct sunlight for a period of time, the gel coat or painted surfaces tend to fade, dull or chalk. A heavier buffing is required to bring the finish back to its original luster. For power cleaning use a light cleaner. To clean the boat by hand, use a heavier automotive cleaner. Before cleaning the surfaces, read the instructions given with the cleaner. After cleaning the surfaces, apply wax and polish all fiberglass surfaces except the nonskid areas.

If the fiberglass should become damaged and need repair, contact your dealer or Scout Customer Service for assistance in finding an authorized repair person to make the repairs.

	<b>CAUTION</b>	
<p><b>DO NOT WAX NONSKID AREAS AS THIS COULD MAKE THEM SLIPPERY AND CONSEQUENTLY INCREASE THE POSSIBILITY OF INJURY.</b></p>		

## Stainless Steel Hardware



When using the boat in saltwater, the hardware should be washed with soap and water after each use. When your boat is used in a corrosive environment such as saltwater, water with a high sulfur content, or polluted water, the stainless steel will periodically develop surface rust stains. This is perfectly normal under these conditions. The stainless can normally be cleaned and protected by using a high quality boat or automotive wax or a commercial metal cleaner and protectant.

	<b>CAUTION</b>	
<p><b>UNDER NO CIRCUMSTANCES SHOULD ANY ABRASIVE MATERIALS SUCH AS SANDPAPER, BRONZE WOOL, OR STEEL WOOL BE USED ON STAINLESS STEEL. DAMAGE TO THE HARDWARE WILL RESULT.</b></p>		

## Anodized Aluminum Surfaces

Anodized aluminum should be washed periodically with soap and water to keep it clean. If the boat is used in saltwater or polluted water, the aluminum should be washed with soap and water after each use. Saltwater allowed to remain on anodized aluminum will penetrate the anodized coating and attack the aluminum.

Hardtops, bimini tops or T-tops with canvas and/or fiberglass tops require special attention to the anodized aluminum just below the top. This area is subject to salt build up from salty condensation and sea spray. It is also frequently overlooked when the boat is washed and will not be rinsed by the rain. Consequently, the aluminum just below the top is more likely to become pitted than the exposed aluminum on the structure. Make sure the aluminum in this area is washed frequently with soap and water and rinsed thoroughly. Pay particular attention to places where the top material or lacing contact the frame. Once a month coat the entire frame with a metal protector made for anodized aluminum to protect against pitting and corrosion caused by the harsh effects of saltwater. Do not use automotive or boat wax designed for paint or gel coat on anodized aluminum. The wax can contaminate the aluminum and damage the anodized surface.

	<b>CAUTION</b>	
<p><b>ONE DRAWBACK TO METAL PROTECTORS IS THAT THEY CAN MAKE THE METAL SLIPPERY. THEREFORE, THEY SHOULD BE NOT BE USED ON TOWER LADDERS, STEERING WHEELS AND OTHER AREAS WHERE A GOOD GRIP AND SURE FOOTING IS IMPORTANT.</b></p>		

Stains can be removed with a metal polish or fine polishing compound. To minimize corrosion, use only high quality stainless steel fasteners on aluminum fabrications. Isolate the fasteners from the aluminum by using fiber washers and caulking compound or Tef Gel to bed hardware and fasteners mounted to aluminum fabrications. If the anodized coating is badly scratched, it will require special attention and more frequent cleaning to the damaged area. With proper care, anodized aluminum will provide many years of service.

## Powder Coated Aluminum

Powder coated aluminum should be washed periodically with soap and water to keep it clean. If the boat is used in saltwater or polluted water, the aluminum should be washed with soap and water after each use. Saltwater allowed to remain on powder coated aluminum will penetrate the coating and attack the aluminum, usually around fasteners and hardware mounted to the aluminum.

Pay special attention to the area just below the top. This area is subject to salt buildup from salty condensation and sea spray. It is also frequently

overlooked when the boat is washed and will not be rinsed by the rain. Consequently, the powder coating near fasteners and hardware mounted just below the top is more likely to be attacked by the salt and become corroded than the exposed areas on the structure. Make sure the aluminum in this area is washed frequently with soap and water and rinsed thoroughly. Pay particular attention to places where the top material and lacing contact the frame.

Once a month check the entire frame for damaged powder coating and corrosion around fasteners and hardware. Nicked or badly scratched powder coating can be sanded and touched up with enamel paint. Corrosion around fasteners will have to be sanded, then touched up with paint. The fasteners will require fiber washers and sealing with caulk or Tef Gel to isolate the fastener from the aluminum and prevent damage to the paint or powder coating when the fastener is installed. Periodically applying automotive or boat wax to the powder coating will provide additional protection from the harsh effects of saltwater.

Always repair scratches, nicks and corroded areas in powder coating as soon as possible. Corrosion left unaddressed will lift the powder coating allowing moisture to travel between the powder coating and the aluminum causing the corrosion to spread below the coating and damage the aluminum.

If excessive chipping and peeling occurs, it could be an indication of an electrical fault in the boat or aluminum fabrication. You should contact a qualified marine electrician to inspect your boat immediately and correct the problem if you suspect that your boat may have a fault in the aluminum frame. You should also contact Scout Customer Service.

#### **NOTICE:**

**Boats that are towed behind larger vessels require special attention to the aluminum hardware. The salt spray, salty steam, and chemicals in exhaust gases are particularly corrosive and will damage the surface of anodized or powder coated aluminum. It is imperative that the boat and the aluminum are cleaned thoroughly at the completion of each trip or at the end of each day on long cruises to reduce accelerated deterioration of the anodizing or powder coating and premature corrosion to the aluminum.**

#### **NOTICE:**

**You should contact Scout Customer Service before making any modifications to aluminum fabrications. Unauthorized modifications can void the warranty.**

#### **Chrome Hardware**

Use a good chrome cleaner and polish on all chrome hardware.

#### **Acrylic Plastic Glass**

Acrylic glass scratches easily. Never use a dry cloth or glass cleaning solutions on acrylic. Use a soft cloth and mild soap and water for routine cleaning. Solvents and products containing ammonia can permanently damage acrylic plastic glass.

Fine scratches can be removed with a fine automotive clear coat polishing compound. A coat of automotive or boat wax is beneficial to protect the surface. Do not use the following on acrylic glass:

Abrasive cleaners	Acetone
Solvents	Alcohol
Cleaners containing ammonia	Glass cleaners

#### **Engines and Fuel**

Proper engine maintenance is essential to the proper performance and reliability of your outboard engines. Maintenance schedules and procedures are outlined in your engine owner's manual. They should be followed exactly.

If the boat is used in saltwater, flush the cooling system after each daily use. To flush the systems when the boat is out of the water, follow the procedure outlined in your engine owner's manual.

The age of gasoline can affect engine performance. Chemical changes occur as the gasoline ages that can cause deposits and varnish in the fuel system as well as reduce the octane rating of the fuel. Severely degraded fuel can damage the engines and boat fuel tank and lines. Therefore, if your boat is not being run enough to require at least one full tank of fresh fuel a month, a fuel stabilizer should be added to the gasoline to protect the fuel from degradation. Your dealer or the engine manufacturer can provide additional information on fuel degradation and fuel stabilizers recommended for your engines.

Avoid using fuels with alcohol additives. Gasoline that is an alcohol blend will absorb moisture from the air which can reach such concentrations that "phase separation" can occur whereby the water and alcohol mixture becomes heavy enough to settle out of the gasoline to the bottom of the tank. Since the fuel pick up tubes are very near the bottom of the tank, phase separation can cause the engines to run very poorly or not at all. This condition is more severe with methyl alcohol and will worsen as the alcohol content increases. Water or a jelly like substance in the fuel filters are an indication of possible phase separation from the use of alcohol blended fuels.

## 13.2 Upholstery, Canvas and Enclosures Vinyl Upholstery

The vinyl upholstery used on the seats, cushions, bolsters, and for the headliner in some cabins, should be cleaned periodically with mild soap and water. Any stain, spill or soiling should be cleaned up promptly to prevent the possibility of permanent staining. When cleaning, always rub gently. Avoid using products containing ammonia, powdered abrasive cleaners, steel wool, ink, strong solvents, acetone and lacquer solvents or other harsh chemicals as they can cause permanent damage or shorten the life of vinyl. Never use steam heat, heat guns or hair dryers on vinyl.

Stronger cleaners, detergents and solvents may be effective in stain removal, but can cause either immediate damage or slow deterioration. Lotions, sun tan oil, waxes and polishes, etc., contain oils and dyes that can cause stiffening and staining of vinyls.

- Dry soil, dust and dirt - Remove with a soft cloth.
- Dried on dirt - Wash with a soft cloth dampened with water.
- Variations in surface gloss - Wipe with a water dampened soft cloth and allow to air dry.
- Stubborn dirt - Wash with a soft cloth dampened with Ivory Flakes® and water. Rinse with clean water.
- Stubborn spots and stains - Spray with either Fantastik Cleaner® or Tannery Car Care Cleaner® and rub with a soft cloth. Rinse with clean water.

- Liquid spills - Wipe immediately with a clean absorbent cloth. Rinse with clean water.
- Food grease and oily stains - Spray immediately using either Fantastik Cleaner® or Tannery Car Care Cleaner®, wiping with a soft cloth. Take care not to extend the area of contamination beyond its original boundary. Rinse with clean water.

### Acrylic Canvas (Sunbrella)

Modern, bright colored canvas tops are usually fabricated from acrylic fabrics with the trade names like Sunbrella®, Argonaut®, etc. Acrylic fabrics look similar to cotton canvas but are much more durable and color fast.

Acrylic canvas can be cleaned by using Ivory Flakes, Ivory Liquid or another mild soap and water. Scrub lightly and rinse thoroughly to remove the soap. Do not use detergents, as they will deteriorate the waterproofing in the fabric. The underside can be brushed with a soft brush and sprayed with a disinfectant to prevent the accumulation of dirt and mildew. The top or accessories should never be folded or stored wet.

In fresh water areas, the top and curtains should be washed weekly. This is particularly important if the boat is stored near a highway, airport or in a large city. Residue from jet fuel, exhaust fumes and industrial pollution can shorten the life of tops and enclosures.

In saltwater areas, the top and curtains should be rinsed with fresh water after each use and at least weekly if it is stored outside. Saltwater attracts moisture and dirt can shorten the life of fabric tops and enclosures. The salt is also abrasive and can cause premature wear in the fabric and stitching.

After several years, the acrylic canvas may lose some of its ability to shed water. If this occurs, wash the fabric and let it dry thoroughly. Then treat the outside surface with a commercially available waterproofing designed for this purpose. Waterproofing is available in bulk at most canvas shops. One-gallon garden sprayers are excellent for applying waterproofing.

### NOTICE:

**Some leakage at the seams is normal and unavoidable with acrylic enclosures.**

## Laminated Vinyl Tops

Laminated vinyl top material is a lamination of two plies of specially formulated vinyl with an inner reinforcing core fabric. The most common trade name for this fabric is Weblon.® It is not unusual for the interior ply to be a different color than the exterior. There is a greater tendency for this type of fabric to leak at the seams than with acrylic or vinyl coated polyester. Paraffin wax that matches the top can be used to seal the seams if necessary.

Laminated vinyl fabrics should be cleaned periodically by using Ivory Flakes, Ivory Liquid or another mild soap and water. Scrub lightly and rinse thoroughly to remove the soap. Do not use detergents, or harsh cleaners like bleach and ammonia. They will attack the vinyl in the fabric and shorten its life. The top or accessories should never be folded or stored wet.

In fresh water areas, the top and curtains should be washed weekly. This is particularly important if the boat is stored near a highway, airport or in a large city. Residue from jet fuel, exhaust fumes and industrial pollution can shorten the life of tops and enclosures.

In saltwater areas, the top and curtains should be rinsed with fresh water after each use and at least weekly if it is stored outside. Saltwater attracts moisture and dirt can shorten the life of fabric tops and enclosures. The salt is also abrasive and can cause premature wear in the stitching.

## Clear Curtains and Connectors

Side curtains and clear connectors can be cleaned with mild soap and water. They should not be allowed to become badly soiled. Dirt, oil, mildew, and cleaning agents containing ammonia, will shorten the life of the vinyl that is used for clear curtains. After cleaning the curtains and allowing them to dry, apply a non-lemon furniture polish or an acrylic glass and clear plastic protector to extend the life of the curtains.

Vinyl curtains should be stored either rolled or flat, without folds or creases. Folding the curtains will make permanent creases that could cause the vinyl to crack.

### NOTICE:

**Do not use any polish containing lemon scents or lemon. The lemon juice will attack the vinyl and shorten its life.**

Snaps should be lubricated periodically with petroleum jelly, silicone grease or a lubricant designed for snaps. Zippers should be lubricated with silicone spray, paraffin or silicone stick.

## Strataglass

Strataglass® is a special coated vinyl that could be used in the curtains for the hardtop enclosure. The coating protects the vinyl glass and resists scratching. Waxes and Plexiglas polishing compounds should not be used on strataglass as the protective coating prevents them from penetrating into the vinyl and they will build up on the surface. These products will create a hazy, greasy appearance that will affect the clarity of the strataglass. Products that repel water, like Rainex®, should not be used as they will not take well to the surface and could appear spotty and may also yellow or dull the Strataglass over time.

Strataglass can be cleaned by rinsing off dirt or salt deposits with fresh water, then washing with a clean cloth and mild soap. Chamois dry to remove water spots and improve clarity. If a polish is accidentally used, use Windex® or its equivalent to remove it. While window cleaners will destroy the standard vinyl normally used in side curtains and clear connectors, it will not harm strataglass. Always roll down the curtains and snap in place at the end of each day so the curtains will maintain their shape and to minimize fold distortions.

Depending upon usage, it is recommended that an occasional application of Aquatech Strataglass Cleaner be done. Treat this like a polish, as opposed to a cleaner - wash and dry curtains first, then apply Aquatech Strataglass Cleaner, actually buffing the surface to a beautiful sheen. This is not just a wipe on/ wipe off product...it needs to be buffed to perform.

Remember, the coating on strataglass is scratch resistant and not scratch proof. Always handle the curtains with care and never roll up curtains that are salty or dirty. If you have any questions about the clear curtains used on your boat, please contact the Scout Customer Service Department.

Hardtop enclosures must be removed when trailering. Canvas enclosures are not designed to withstand the extreme wind pressure encountered while trailering and will be damaged. Always remove and properly store the enclosure before trailering your boat.

## 13.3 Interior

The cabin or head interior can be cleaned just like you would clean a home interior. To preserve woodwork, use teak oil. To maintain carpeting, use a vacuum cleaner. Because air and sunlight are very good cleansers, periodically put cushions, sleeping bags, etc. on deck, in the sun and fresh air, to dry and air out. If cushions or equipment get wet with saltwater, remove and use clean, fresh water to rinse off the salt crystals. Salt retains moisture and will cause damage. Dry thoroughly and reinstall.

Vinyl headliner material should be cleaned periodically as explained in the previous section. Avoid using products containing ammonia, bleach, or harsh chemicals as they can shorten the life of vinyl. Fiberglass headliners should be wiped down with a damp towel as necessary to remove dust and dirt.

If you leave the boat for a long period of time, put all cushions on their sides, open all interior cabin and locker doors, and hang a commercially available mildew protector in the cabin.

### NOTICE:

**Always read the label carefully on mildew protectors. Remove the protector and allow the cabin to ventilate completely before using the cabin.**

## Counter Tops - Corian Surfaces

A mild liquid detergent and water or ammonia-based cleaners will remove most dirt and stains from Corian. For heavy cleaning, oil, and grease, use Fantastik spray cleaner. Rinse with a clean cloth moistened with fresh water. Wipe dry with a clean cloth.

In most cases, Corian can be repaired if accidentally damaged. Minor damage, including scratches, general or chemical stains, scorching or burns, and minor impact marks, can be repaired with a light abrasive cleanser and a Scotch-Brite® pad. For heavier damage, light sanding and machine buffing may be necessary so contact your dealer or a professional.

- Avoid exposing Corian to strong chemicals, such as paint removers, oven cleaners, etc. If contact occurs, quickly flush the surface with water.

- Remove nail polish with a non acetone-based polish remover and flush with water.
- Do not cut directly on Corian counter tops.

## Interior Woodwork

Oiled and varnished woodwork or laminated, simulated wood can be cleaned with a damp cloth. For heavy duty cleaning, use a mixture of water and Murphy's Oil Soap or a solution of 10% white vinegar and water to clean the wood and wipe it dry with a clean towel. Apply a furniture polish to add luster and help to preserve the finish.

## 13.4 Bilge

To keep the bilge clean and fresh, it is recommended that you use a commercial bilge cleaner on a regular basis. Follow the directions carefully. All exposed pumps and metal components in the bilge should be sprayed periodically with a protector to reduce the corrosive effects of the high humidity always present in these areas.

Periodically check the bilge pumps and alarms for proper operation and clean debris from the strainers and float switches. Inspect all hoses, clamps and thru-hulls for leaks and tightness on a regular basis and operate all thru-hull valves at least once a month to keep them operating properly.

Frequently test the automatic switches for the bilge pumps and alarms for proper operation. This is accomplished by lifting the float switch until the pump is activated. You can also use a garden hose to flood the bilge until the water level is high enough to activate the pump.

## Generator

The engine maintenance required on the generator is similar in many ways to any 4-cycle marine engine. The engine incorporates a pressure-type lubrication system and a fresh water cooled engine block which is thermostatically controlled. The seawater cooling system on the generator is equipped with a sacrificial anode to protect cooling system components from galvanic corrosion. The anode should be inspected when the generator is serviced and replaced when it is 75% of its original size or at least once each year.

The most important factors to the generator's longevity are proper ventilation and maintenance of



---

the fuel system, ignition system, cooling system, lubrication system and the AC alternator. Maintenance schedules and procedures are outlined in your generator owner's manual. They should be followed exactly.

Proper generator operation requires a good supply of clean, dry fuel. Algae can grow in the accumulated water in the diesel fuel tank. This condition is most prevalent in warm climates. Periodically adding a high quality diesel fuel additive containing an algaecide may be required to control algae in your boating area. This is particularly important if your generator is not being run enough to require at least one full tank of fresh fuel each month.

### **13.5 Drainage System**

It is essential that the following items be done periodically to maintain proper drainage of your boat:

- Clean the cockpit drains with a hose to remove debris that can block water drainage.
- Clean the hardtop leg drain holes. This is especially important just before winter lay-up.
- Flush all gravity drains with fresh water to keep them clean and free flowing.
- Operate the thru-hull valves once a month and service as required.
- Run all overboard pumps briefly at least once a month to keep them operating properly.

**Notice:**

**All drains and pumps must be properly winterized before winter lay-up.**

THIS PAGE WAS LEFT BLANK  
INTENTIONALLY

## SEASONAL MAINTENANCE

### 14.1 Storage and Lay-up

#### Before Hauling:

- Pump out the head holding tank. Flush the holding tank using clean water, soap and a deodorizer. Pump out the cleaning solution.
- The fuel tank should be left nearly full to reduce condensation that can accumulate in the tank. Allow enough room in each tank for the fuel to expand without leaking out the vents. Moisture from condensation in the fuel tank can reach such concentrations that it becomes heavy enough to settle out of the fuel to the bottom of the tank. Since fuel pickup tubes are located near the bottom of the tank, this accumulated moisture can cause the engines to run poorly or not at all after extended storage.

Chemical changes also occur as the gasoline ages that can cause deposits and varnish in the fuel system as well as reduce the octane rating of the fuel. Severely degraded fuel can damage the engines and boat fuel tank and

lines. Therefore, if your boat is not being run enough to require at least one full tank of fresh fuel a month or during winter storage, a fuel stabilizer should be added to the gasoline to help protect the fuel system from these problems. Operate the boat for at least 15 minutes after adding the stabilizer to allow the treated fuel to reach the engines. Yamaha recommends using Yamaha Fuel Conditioner and Stabilizer for their engines.

Bacteria, commonly called algae, can grow in the accumulated water in diesel fuel tank for the generator. This condition is most prevalent in warm climates. Periods of storage or limited use allow the bacteria to accumulate, making the situation worse. Adding a high quality diesel fuel conditioner containing a biocide may be required to control bacteria in your boating area.

Your dealer or the engine manufacturer can provide additional information on fuel degradation and fuel stabilizers recommended

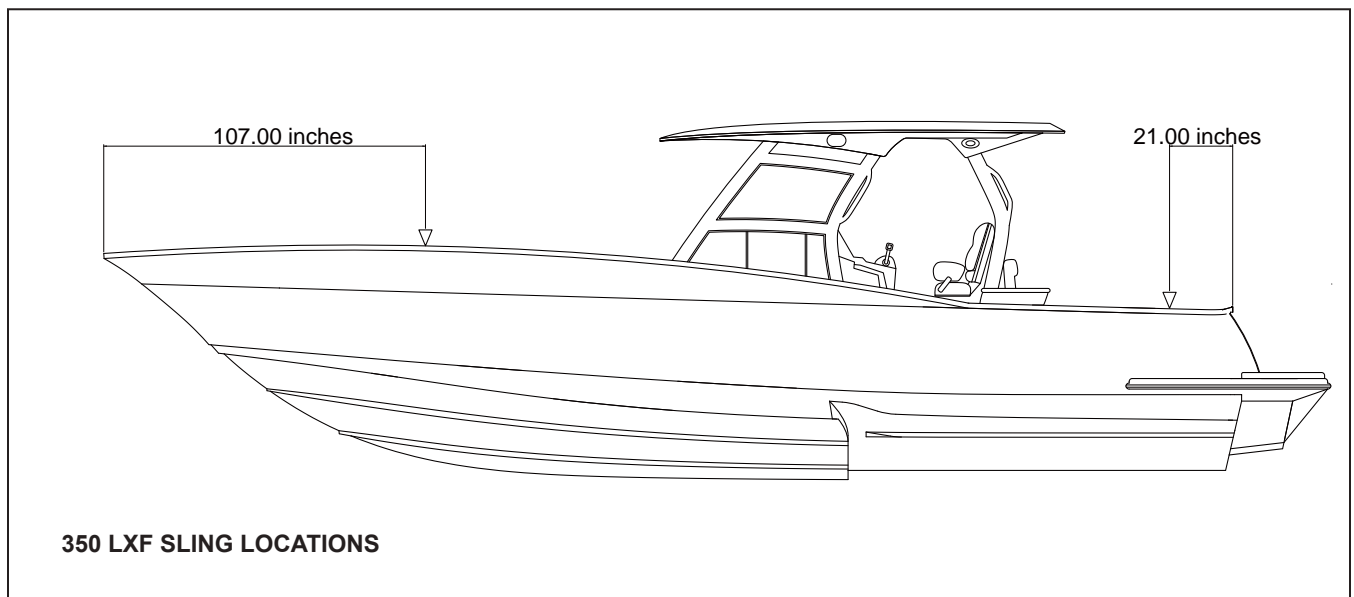



for your engines. For more recommendations for your specific area, check with your local Scout dealer.

- Drain water from the fresh water system.
- Consult the engine owner's manual for detailed information on preparing the engines for storage.

## Lifting

It is essential that care be used when lifting your boat. Make sure the spreader bar at each sling is at least as long as the distance across the widest point of the boat that the sling will surround. Put the slings in position. Refer to the sling locations drawing for the correct position of the lifting slings. The fore and aft slings should be tied together to prevent the slings from sliding on the hull.

**CAUTION**

**BOATS CAN BE DAMAGED FROM IMPROPER LIFTING AND TRANSPORTING WITH FORK LIFTS. CARE AND CAUTION MUST BE EXERCISED WHEN TRANSPORTING A BOAT WITH A FORK LIFT. NEVER HOIST THE BOAT WITH A SUBSTANTIAL AMOUNT OF WATER IN THE BILGE.**

**SEVERE GEL COAT CRACKING OR MORE SERIOUS HULL DAMAGE CAN OCCUR DURING HAULING AND LAUNCHING IF PRESSURE IS CREATED ON THE GUNWALES (SHEER) BY THE SLINGS. FLAT, WIDE BELTING SLINGS AND SPREADERS LONG ENOUGH TO KEEP PRESSURE FROM THE GUNWALES ARE ESSENTIAL. DO NOT ALLOW ANYONE TO HAUL YOUR BOAT WHEN THE SPREADERS ON THE LIFT ARE NOT WIDE ENOUGH TO TAKE THE PRESSURE OFF THE GUNWALES.**

- The trailer must properly support the hull. The bunks and rollers should match the bottom of the hull and should not be putting pressure on the lifting strakes.
- Make sure the hitch is properly supported.
- Check the tires once each season. Add enough air for the correct amount of inflation for the tires as necessary.

## NOTICE:

**Read the owner's manual for the trailer for the correct amount of inflation for the tires.**

## When storing the boat on a lift or cradle:



- The cradle must be specifically for boat storage.
- Make sure the cradle or lift is well supported with the bow high enough to provide proper drainage of the bilge and cockpit.
- Make sure the engines are in the down position.
- The cradle or lift must be in the proper fore and aft position to properly support the hull. When the cradle or lift is in the correct location, the bunks should match the bottom of hull and should not be putting pressure on the lifting strakes.

## Supporting The Boat For Storage

A trailer, elevating lift, well-made cradle or proper blocking is the best support for your boat during storage.

## When storing the boat on a trailer for a long period:

- Make sure the trailer is large enough to properly support your boat and that it is rated to support the weight.
- Make sure the trailer is on a level surface and the bow is high enough so that water will drain from the bilge and cockpit.
- Make sure the engines are in the down position.

**CAUTION**

**BOATS HAVE BEEN DAMAGED BY TRAILERS, LIFTS, AND CRADLES THAT DON'T PROPERLY SUPPORT THE HULL. ALWAYS MAKE SURE THE BUNKS AND ROLLERS ARE ADJUSTED SO THEY ARE NOT PUTTING PRESSURE ON THE LIFTING STRAKES AND ARE PROVIDING ENOUGH SUPPORT FOR THE HULL. HULL DAMAGE RESULTING FROM IMPROPER CRADLE OR TRAILER SUPPORT IS NOT COVERED BY THE SCOUT WARRANTY.**

## When supporting the boat with blocking:

- Make sure the boat is blocked on a level surface and the bow is high enough so that water will drain from the bilge and cockpit.
- Make sure the keel is supported with large, solid wood blocks in at least three points.

- Use at least three heavy duty jacks on each side of the hull and make sure the boat is level from side to side. The jacks must be on a solid surface like packed gravel, concrete or pavement. All of the supports must be set up properly to prevent the boat from shifting while it is in storage.
- Clean the exterior upholstery with a good vinyl cleaner and dry thoroughly. Spray the weather covers and boat upholstery with a spray disinfectant. Enclosed areas such as the shower basin, storage locker areas, etc. should also be sprayed with this disinfectant.

## Preparing The Boat For Storage:

- Remove the bilge drain plug(s), if installed. (Some boats do not have bilge drain plugs)
- Thoroughly wash the fiberglass exterior, especially the antifouling portion of the bottom. Remove as much marine growth as possible. Lightly wax the exterior fiberglass components.
- Remove all oxidation from the exterior hardware and apply a light film of moisture displacing lubricant, wax or a metal protector.
- Remove propellers and grease the propeller shafts using light waterproof grease.
- Remove the batteries and store in a cool place. Clean using clear, clean water. Be sure the batteries have sufficient water and clean terminals. Keep the batteries charged and safe from freezing throughout the storage period.

### NOTICE:

**Refer to the Electrical System chapter, for information on the maintenance of the AC and DC electrical systems.**

- Coat all faucets and exposed electrical components in the cabin and cockpit with a protecting oil.
- Clean out, totally drain and completely dry the fish boxes, coolers, sinks and baitwells.
- Thoroughly clean the interior of the boat. Vacuum all carpets and dry clean drapes and upholstery.
- Remove cushions and open as many locker doors as possible. Leaving as many of these areas open as possible will improve the boat's ventilation during the storage period.

### NOTICE:

**It is recommended that a mildew preventer be hung in the cabin before it is closed for storage.**

## 14.2 Winterizing

### Fresh Water System

The entire fresh water system must be completely drained. Disconnect all hoses, check valves, etc. and blow all the water from the system. Make sure the filters and fresh water tank are completely drained. Use only very low air pressure when doing this to prevent possible system damage. Because of the check valve mechanism built in the pump, blowing the lines will not remove the water from the fresh water pump. Remove the inlet and outlet hoses on the pump. Turn the pump on and allow it to pump out any remaining water...about a cupful. A recommended alternative to the above-mentioned procedure is the use of commercially available non toxic, fresh water system antifreeze. After draining the fresh water tank, lines and filters, pour the antifreeze mixture into the fresh water tank, prime and operate the pump until the mixture flows from all fresh water faucets. Be sure to open all water faucets, including the fresh water washdown hose. Make sure antifreeze has flowed through all of the fresh water drains.

For additional information refer to the Fresh Water System and Drainage System chapters.

### Raw Water System

Completely drain the raw water systems including the sea strainers in the stern bilge. Disconnect all hoses and blow the water from the system. Use only very low air pressure when doing this to prevent possible system damage. Because of the check valve mechanism built in the raw water washdown pump, blowing the lines will not remove the water from the raw water pump. Remove the inlet and outlet hoses on the pump. Turn the pump on and allow it to pump out any remaining water...about a cupful.

A recommended alternative to the above-mentioned procedure is the use of commercially available nontoxic, potable water system antifreeze. If potable water antifreeze is used, pour the mixture into a pail and put the raw water intake lines into the solution. Run the pumps one at a time until

the antifreeze solution is visible at all raw water faucets and discharge fittings and drains. Be sure antifreeze has flowed through all of the raw water drains.

Make sure to run the fish box diaphragm pumps until all the water is removed from the fish boxes and the pump. Then pour potable water antifreeze in each fish box and activate the diaphragm pumps until antifreeze is visible at the discharge thru-hull fittings. To avoid damage to the pump, be careful not to run the pump dry for more than a few seconds.

Refer to the Raw Water System chapter for additional information on the raw water system.

## Marine Toilet

The marine toilet must be properly winterized by following the manufacturer's winterizing instructions in the marine toilet owner's manual. Drain the intake and discharge hoses completely using low air pressure if necessary. The head holding tank and diaphragm discharge pump must be pumped dry and one gallon of potable water antifreeze poured into the tank through the deck waste pump out fitting. After the antifreeze has been added to the holding tank, open the overboard discharge valve and activate the diaphragm pump until the antifreeze solution is visible at the discharge thru-hull.

### NOTICE:

**Make sure you follow the marine toilet manufacturer's winterizing instructions exactly.**

## Bilge

Coat all metal components, wire busses, and connector plugs in the bilge with a protecting oil. It is also important to protect all strainers, sea-cocks and steering components. The bilge pumps and bilge pump lines must be completely free of water and dried out when the boat is laid-up for the winter in climates where freezing occurs. Compartments in the bilge that will not drain completely should be pumped out and then sponged until completely free of water. Dry the hull bilge and self-bailing cockpit troughs. Water freezing in these areas could cause damage.

## Optional Air Conditioner and Freezer Plates

Disconnect and drain the seawater pump intake and discharge hoses. Remove all water from the sea strainer and thru-hull fitting. Allow all water to drain from the system. The air conditioner

components must be properly winterized by following winterizing procedure in the manufacturer's owner's manual.

The air conditioning condensation drain system must be properly winterized. Clean debris from the drain and flush for several minutes with fresh clean water. After the system is clean, pour a potable water antifreeze mixture into each drain pan until antifreeze is visible in the bilge.

### NOTICE:

**The air conditioning, freezer plates, marine head, and steering systems have specific lay up requirements. Please refer to their owner's manuals for recommended winterizing procedures.**

## Yamaha Engines

The engines should be flushed with fresh water for at least 15 minutes prior to winter storage. This will remove salt, sand and other contaminants that can damage the engine. It is also important to "Fog" the cylinders, change the gear oil, fill the oil tanks (2-cycle engines) or change the oil in 4-cycle engines, coat each engine with a protector, wax the exterior and properly store and charge the batteries. You should refer to the Yamaha engine owner's manual or contact your dealer for specific instructions on winterizing your engines.

## Generator Raw Water Systems

Drain the sea strainer, heat exchanger and raw water supply and discharge lines for the generator seawater supply pump. Make sure all seawater has drained from the exhaust system. Some, but not all, engine mufflers could have a drain plug that must be removed to properly drain the muffler. Once this is accomplished, pour a non toxic marine engine antifreeze mixture into a large pail and put the sea water intake line into the solution. Run the generator until the antifreeze solution is visible at the exhaust port, then shut the engine off. You should refer to the generator owner's manual or contact your dealer for specific instructions on winterizing your generator.

### NOTICE:

**Properly winterize the engines, generator and fuel system by following the engine manufacturer's winterizing procedures located in your engine and generator owner's manuals or contact a Scout dealer.**

## Hardtop



It is imperative that all drain holes in the legs are open and that the legs are completely free of water. Remove the canvas and thoroughly clean and store in a safe, dry place. Remove all electronics. Coat all wire connectors and bus bars in the helm compartment with a protecting oil.

Clean the aluminum frame with soap and water and dry thoroughly. Apply an aluminum metal protector to the entire frame on anodized aluminum to reduce corrosion and pitting. Apply an automotive or boat wax to powder coated aluminum to protect it during storage periods.

## Towers

It is imperative that all drain holes in the tower and hardtop legs are open and completely free of water. Tower basket drains should be checked and clear of debris. Remove the tower sun shade, if installed, and belly band or removable cushions. Then thoroughly clean and store in a safe, dry place. Remove all electronics. Coat all wire connectors and bus bars in the helm compartment with a protecting oil. Cover the tower basket with a tarp and secure it properly.



Clean the aluminum frame with soap and water and dry thoroughly. Apply an aluminum metal protector to anodized aluminum to reduce corrosion and pitting. Apply an automotive or boat wax to powder coated aluminum to protect it during storage periods.

	<b>CAUTION</b>	
<b>ALWAYS MAKE SURE THE LEG DRAIN HOLES ARE CLEAR WHEN THE BOAT IS LAID UP FOR THE WINTER. WATER TRAPPED INSIDE THE HARDTOP OR TOWER LEGS COULD FREEZE AND CAUSE THE LEGS TO SPLIT.</b>		

## Special Notes Prior To Winter Storage

If the boat will be in outside storage, properly support a storage cover and secure it over the boat. It is best to have a frame built over the boat to support the canvas. It should be a few inches wider than the boat so the canvas will clear the rails and allow passage of air. If this cover is fastened too tightly there will be inadequate ventilation and this can lead to mildew, moisture accumulation, etc. It is essential to fasten the canvas down securely so that the wind cannot remove it or cause chafing of the hull superstructure. Do not store the boat in a damp storage enclosure. Excessive dampness can cause electrical problems, corrosion, and excessive mildew.

Whenever possible, do not use the bimini top or convertible top canvas in place of the winter storage cover. The life of these canvases may be significantly shortened if exposed to harsh weather elements for long periods.

	<b>CAUTION</b>	
<b>PLACING AN ELECTRIC OR FUEL BURNING HEATING UNIT IN THE BILGE AREA CAN BE POTENTIALLY HAZARDOUS AND IS NOT RECOMMENDED.</b>		

Proper storage is very important to prevent serious damage to the boat. If the boat is to be stored indoors, make sure the building has enough ventilation. It is very important that there is enough ventilation both inside the boat and around the boat.

## NOTICE:

**If the boat is to be stored indoors or outdoors, open all interior drawers, clothes lockers, cabinets, and doors a little. If possible, remove the upholstery, mattresses, clothing, and rugs. Then hang a commercially available mildew protector in the interior compartments.**

## 14.3 Recommissioning



### WARNING



DO NOT OPERATE THE BOAT UNLESS IT IS COMPLETELY ASSEMBLED. KEEP ALL FASTENERS TIGHT. KEEP ADJUSTMENTS ACCORDING TO SPECIFICATIONS.

#### NOTICE:

It is important and recommended that the **fitting out procedure for the marine gear be done by a qualified service person. Read the engine owner's manual for the recommended procedure.**



### CAUTION



BEFORE LAUNCHING THE BOAT, MAKE SURE THE HULL DRAIN PLUG IS INSTALLED.



### WARNING



MAKE SURE THE GENERATOR MUFFLER HAS NOT BEEN DAMAGED DURING WINTER STORAGE AND THAT THE DRAIN PLUG IS INSTALLED AND PROPERLY TIGHTENED. LOOSE OR MISSING DRAIN PLUGS AND DAMAGED OR LEAKING MUFFLERS OR EXHAUST HOSES WILL ALLOW CARBON MONOXIDE, ENGINE GASES, AND WATER INTO THE BILGE CREATING A POTENTIALLY HAZARDOUS CONDITION.

#### NOTICE:

**Not all mufflers are equipped with drain plugs.**

#### Reactivating The Boat After Storage:

- Charge and install the batteries.
- Install the drain plug in the hull. (Not all boats are equipped with drain plugs)
- Check the engines for damage and follow the manufacturer's instructions for recommissioning.
- Check the mounting bolts for the engines to make sure they are tight.

- Perform all routine maintenance.
- Check all hose clamps for tightness.
- Pump the antifreeze from the fresh and raw water systems and flush several times with fresh water.
- Check and lubricate the steering system.
- Clean and wash the boat.
- Install all upholstery, cushions and canvas.

#### After Launching:

- Carefully check all water systems and the engine bolts for leaks. Operate each system one at a time checking for leaks and proper operation.
- Check the bilge pump manual and automatic switches.
- Check the bilge high water alarm automatic switch.
- When each engine starts, check the cooling system port below the engine cowling for a strong stream of water. This ensures that the cooling pump is operating.
- Carefully monitor the gauges and check for leakage and abnormal noises.
- Operate the boat at slow speeds until the engine temperature stabilizes and all systems are operating normally.
- Start the optional generator and monitor the exhaust port for a steady stream of water. It may take 20 or 30 seconds for the muffler to fill and for water to appear at the port. This ensures that the cooling pump is operating. Carefully inspect the generator and all hoses for leaks, paying particular attention to the muffler and exhaust hoses. Any leak, no matter how minor must be corrected immediately.



## SCHEMATICS

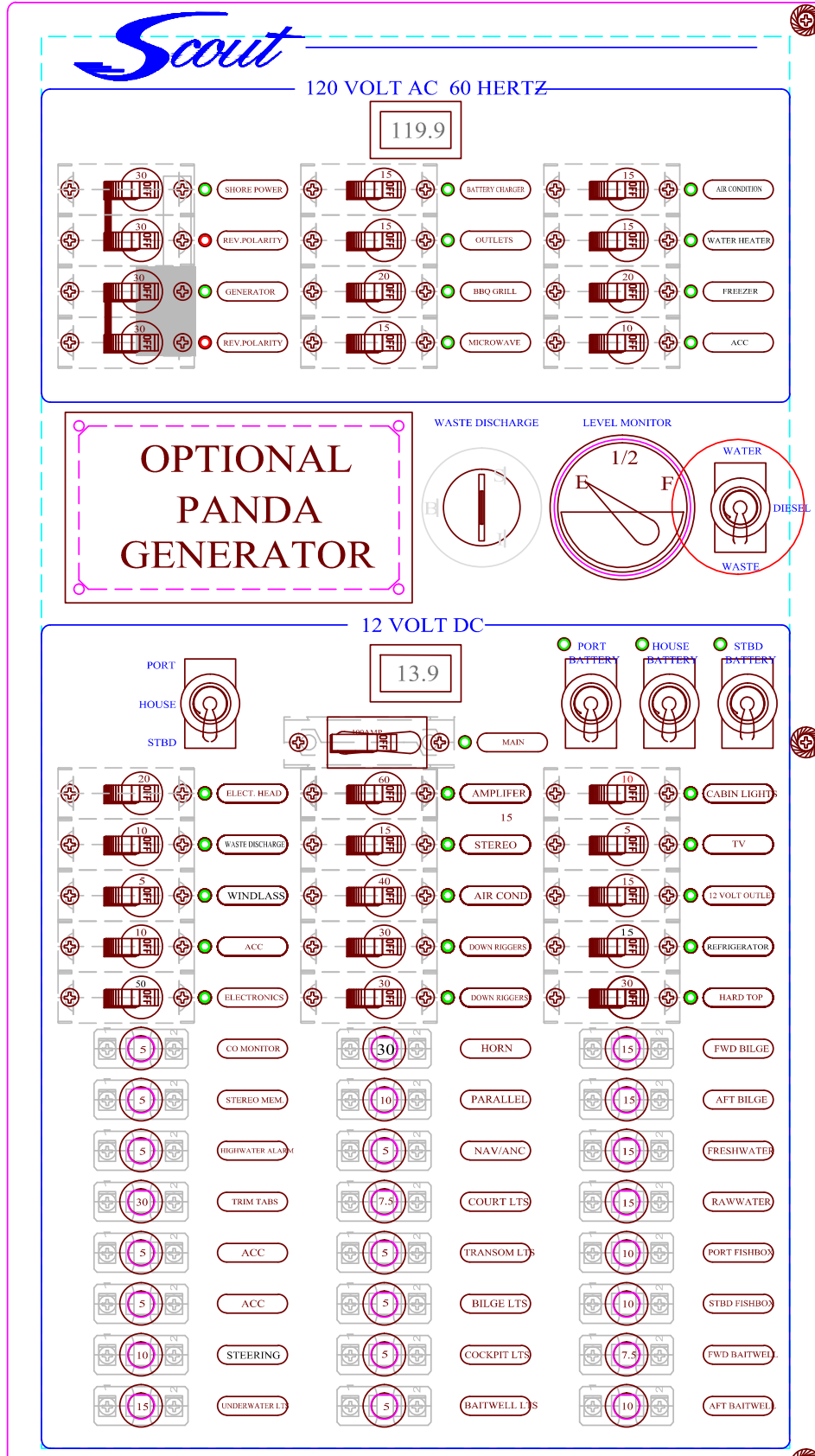

AC/DC Electrical Panel

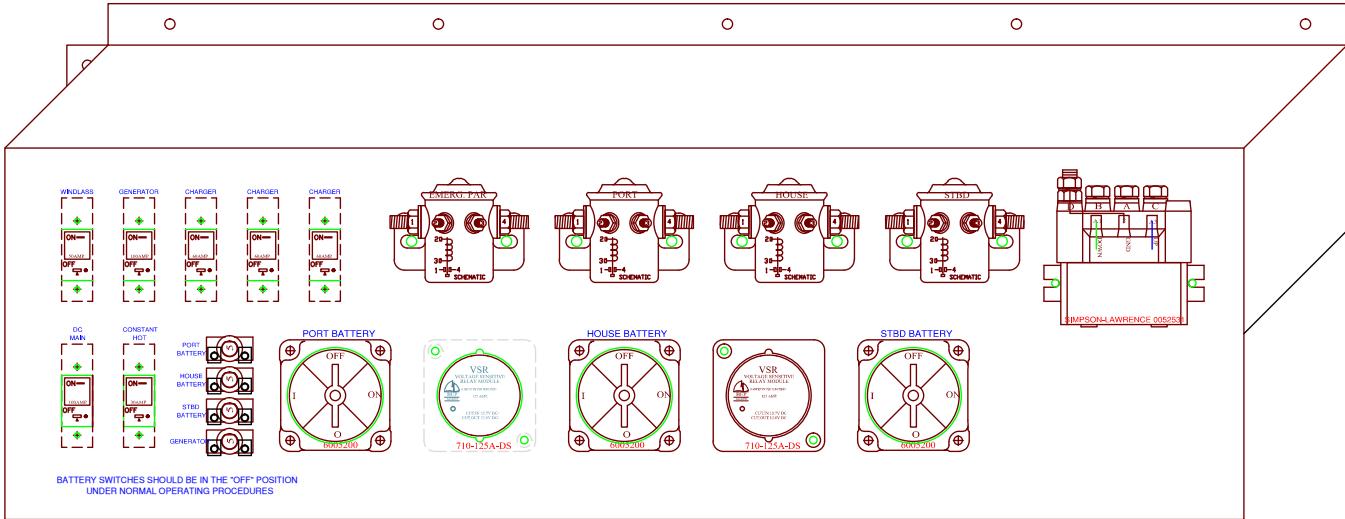

*Battery Selector Switch Panel*

## Console Harness 12 V

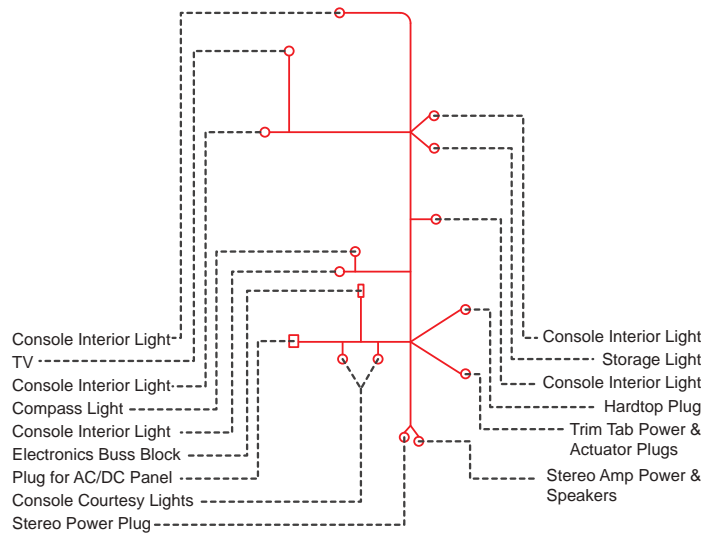
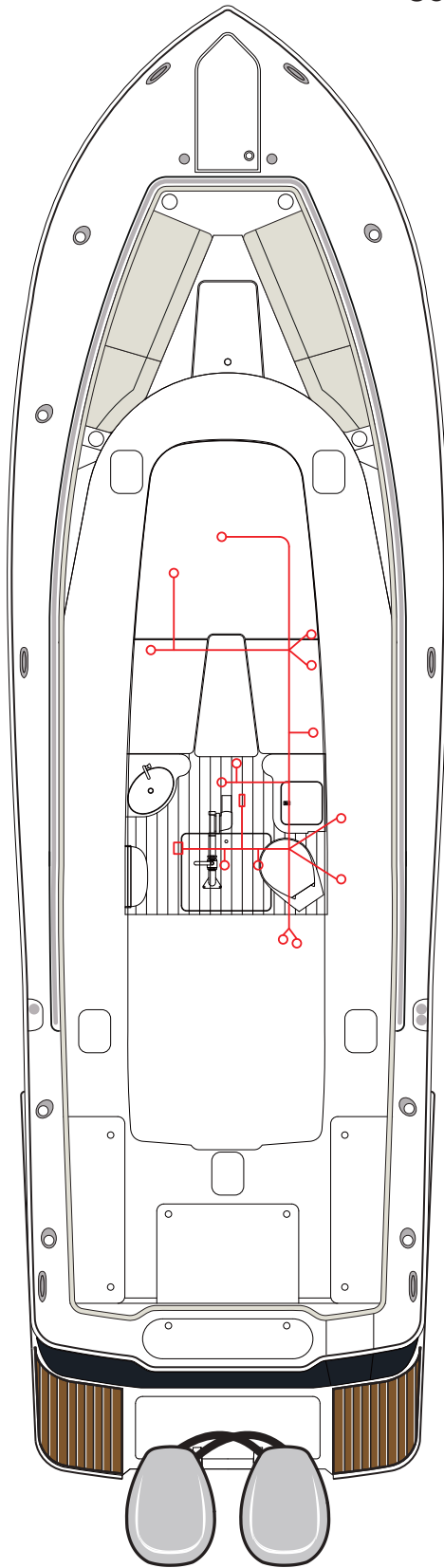

*Console Harness*

## Deck Harness 12 V

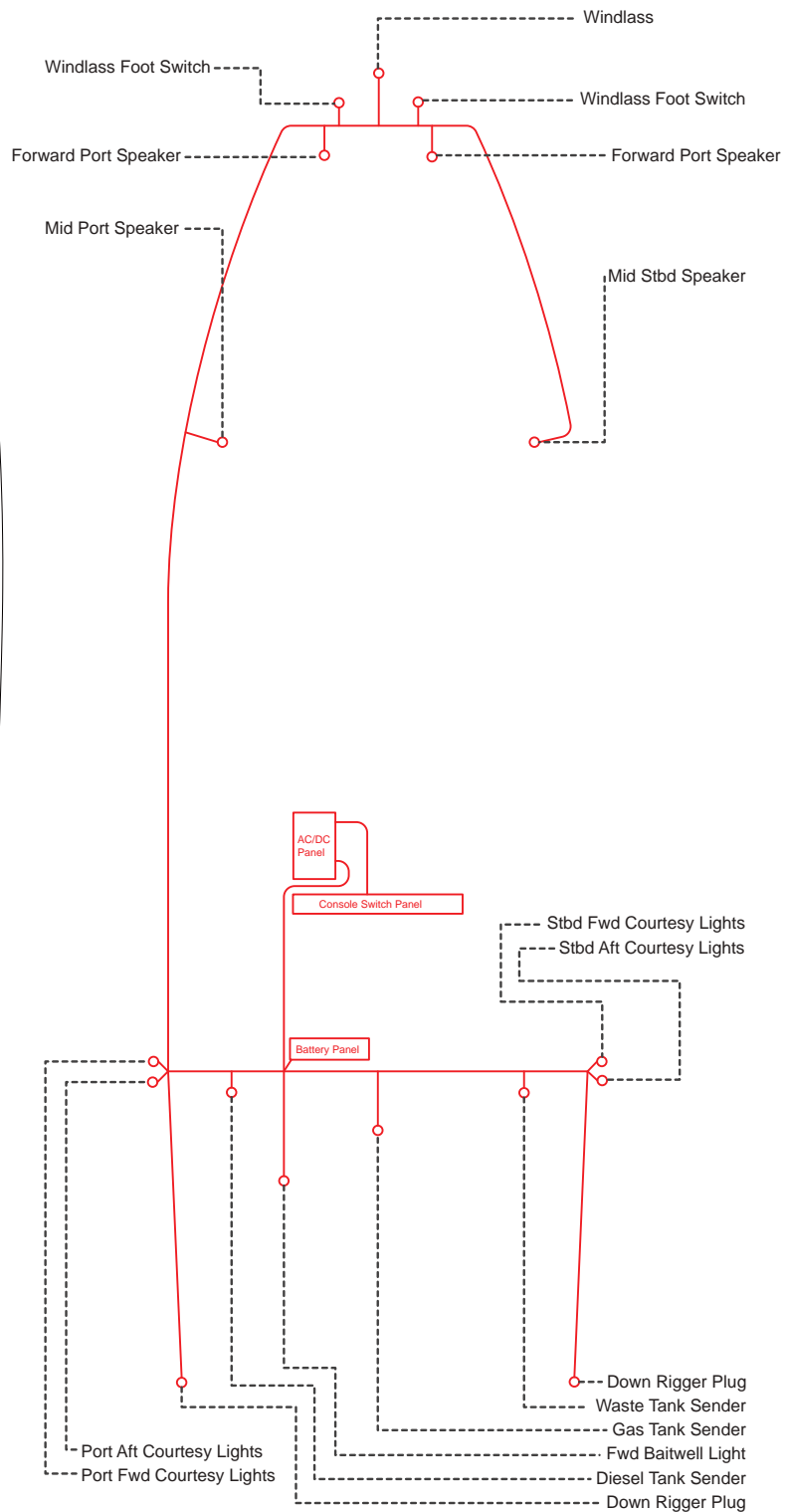
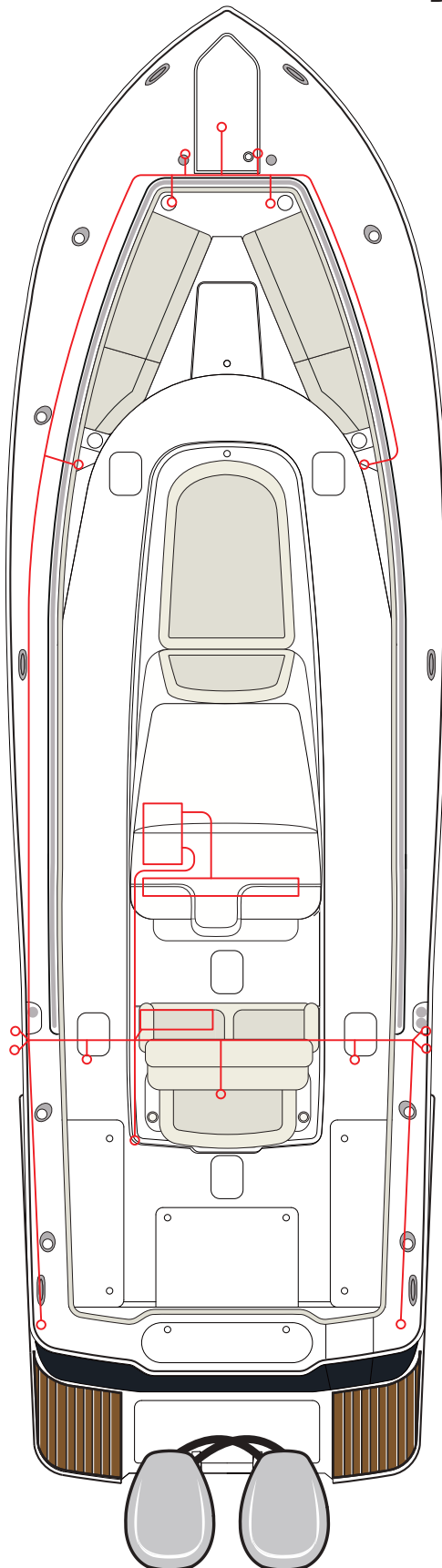

Deck Wire Harness 12V

## Deck Harness 110 V

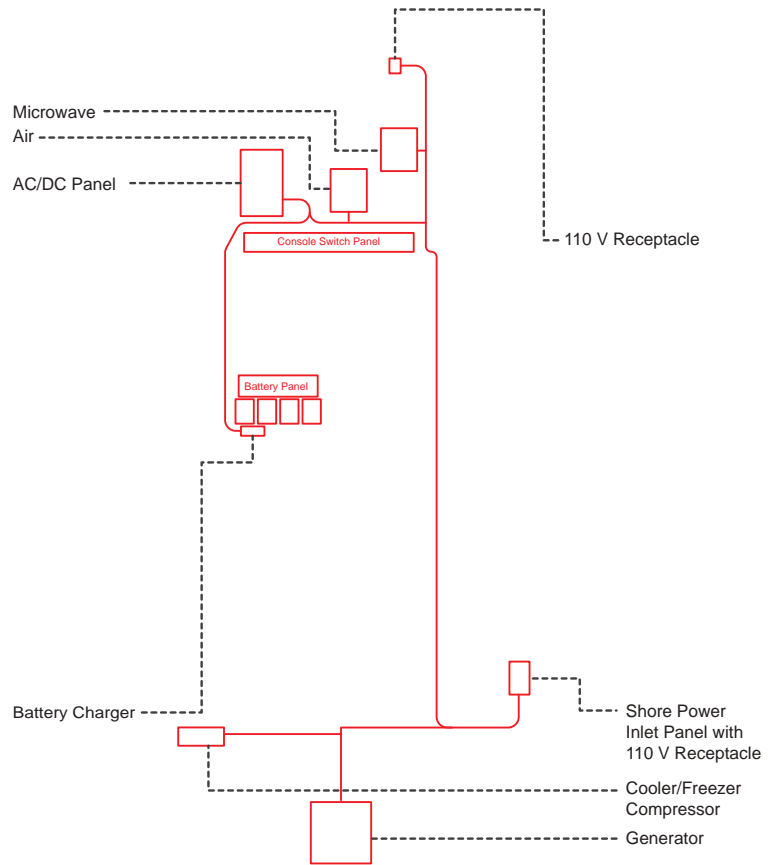
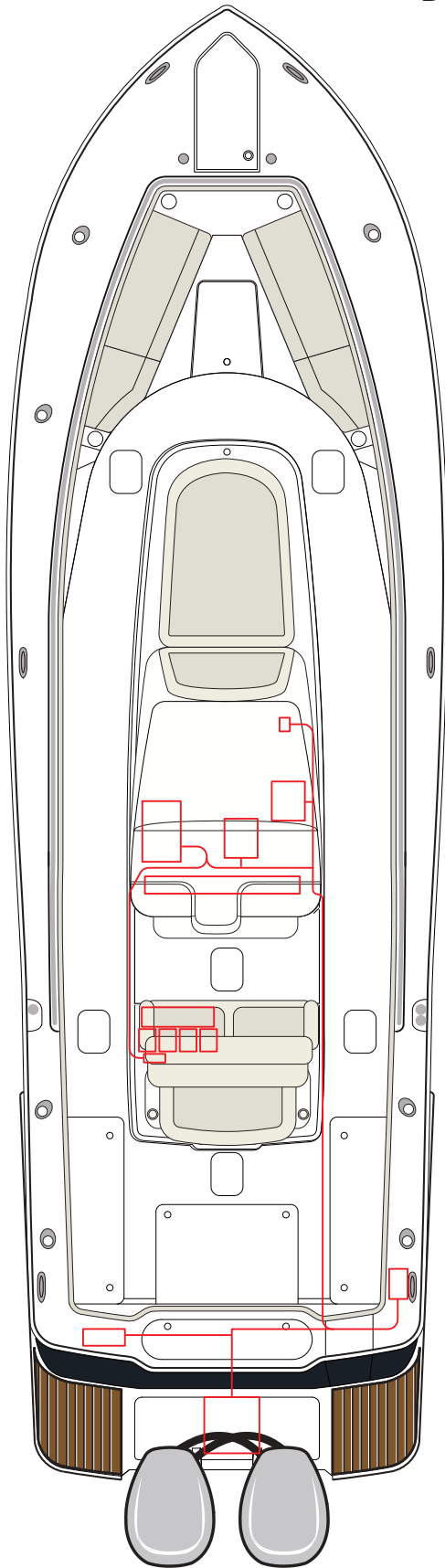

*Deck Wire Harness 110V*

## Hull Harness 12 V

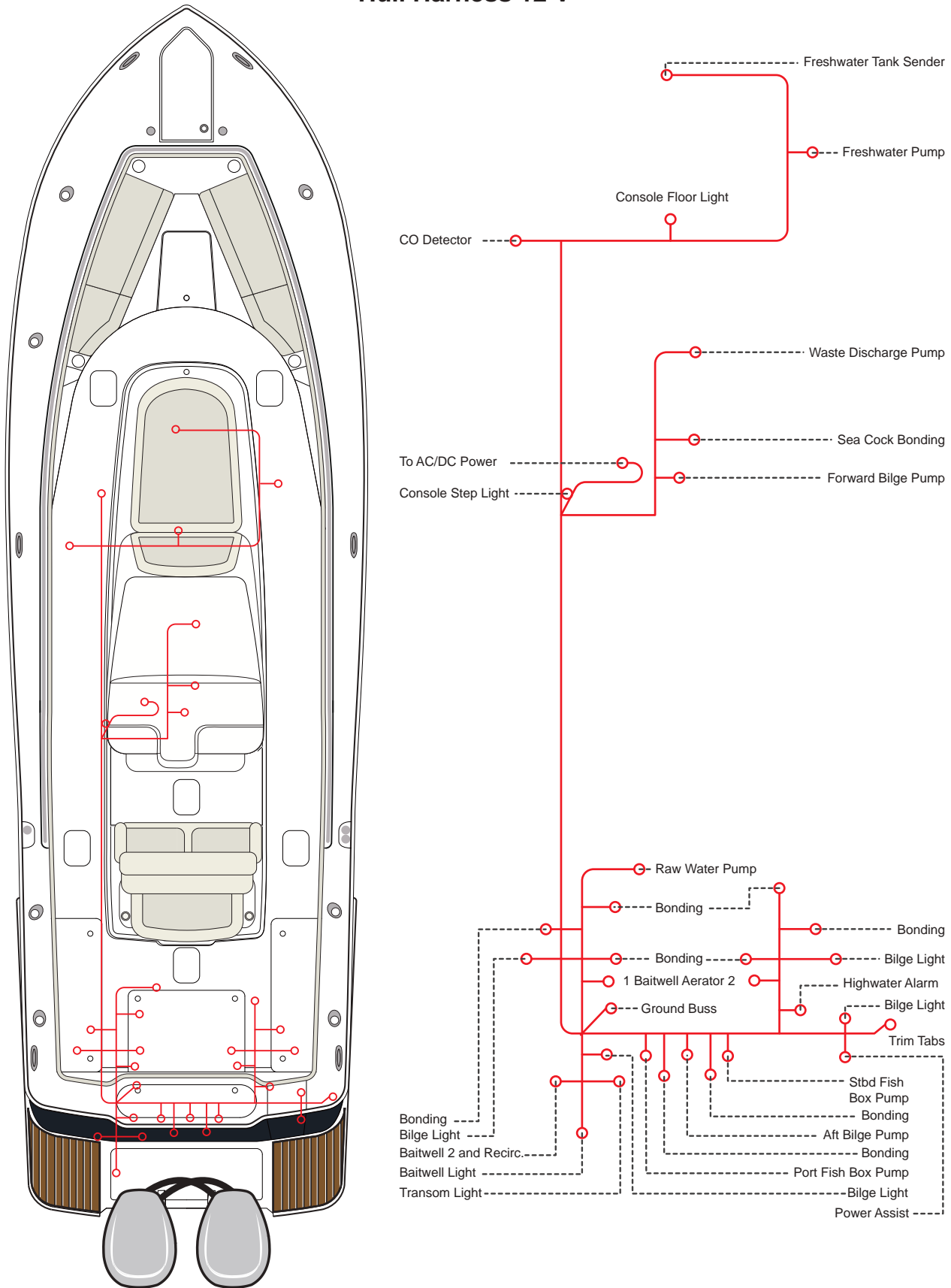

*Hull Harness 12V*

## Hardtop Harness 12V

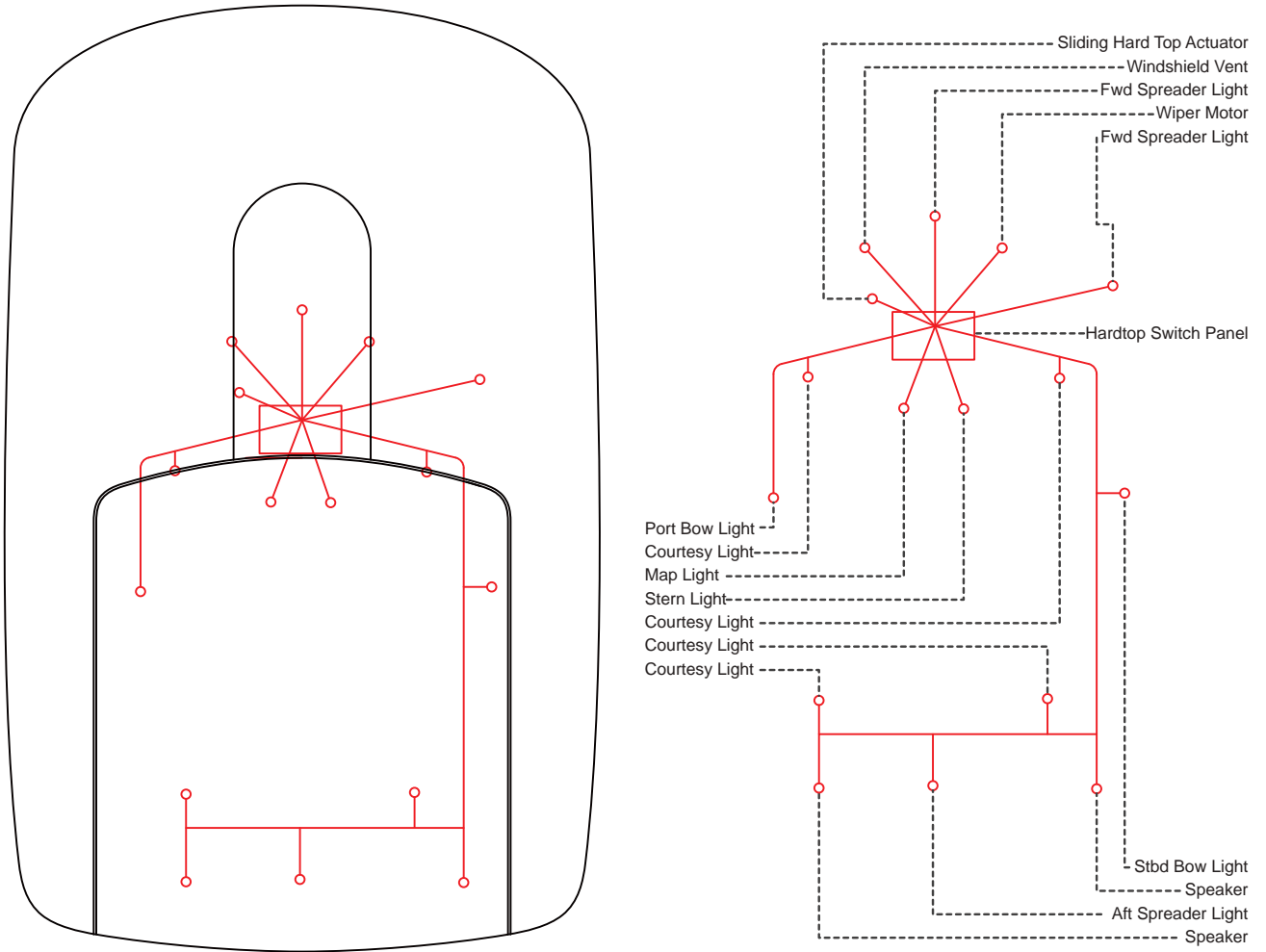

Hard Top Harness 12V

## Drainage System

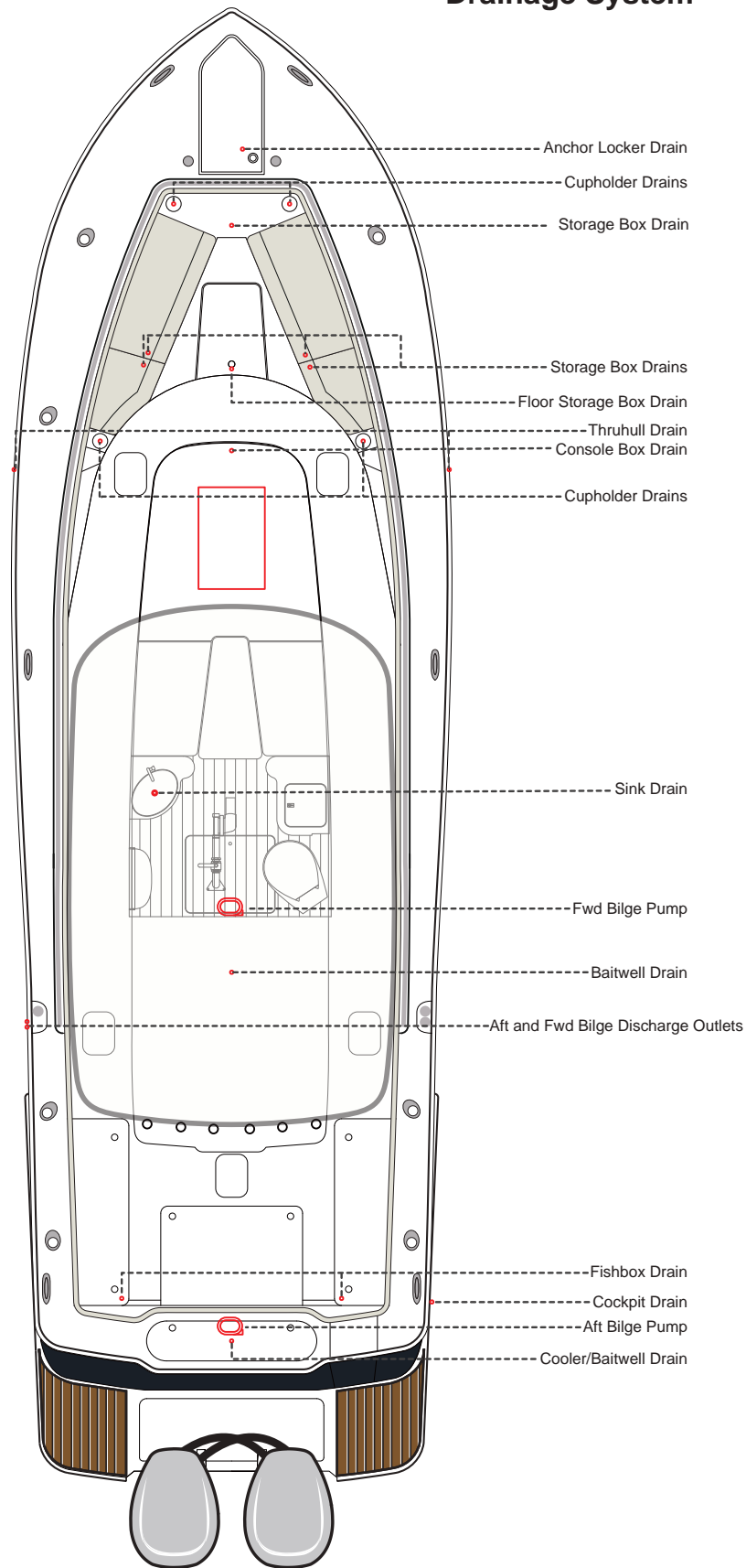

*Drainage System*



Freshwater System

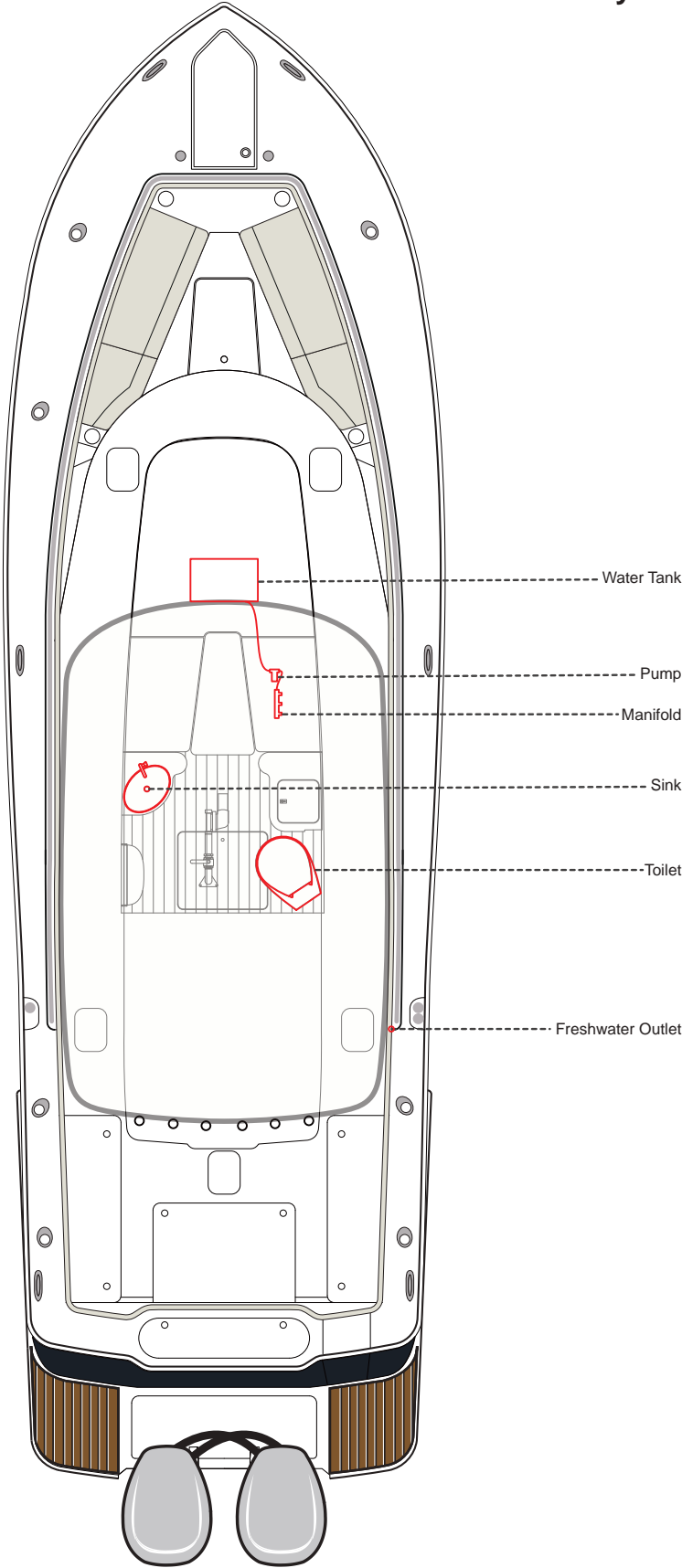

Freshwater System

Fuel System

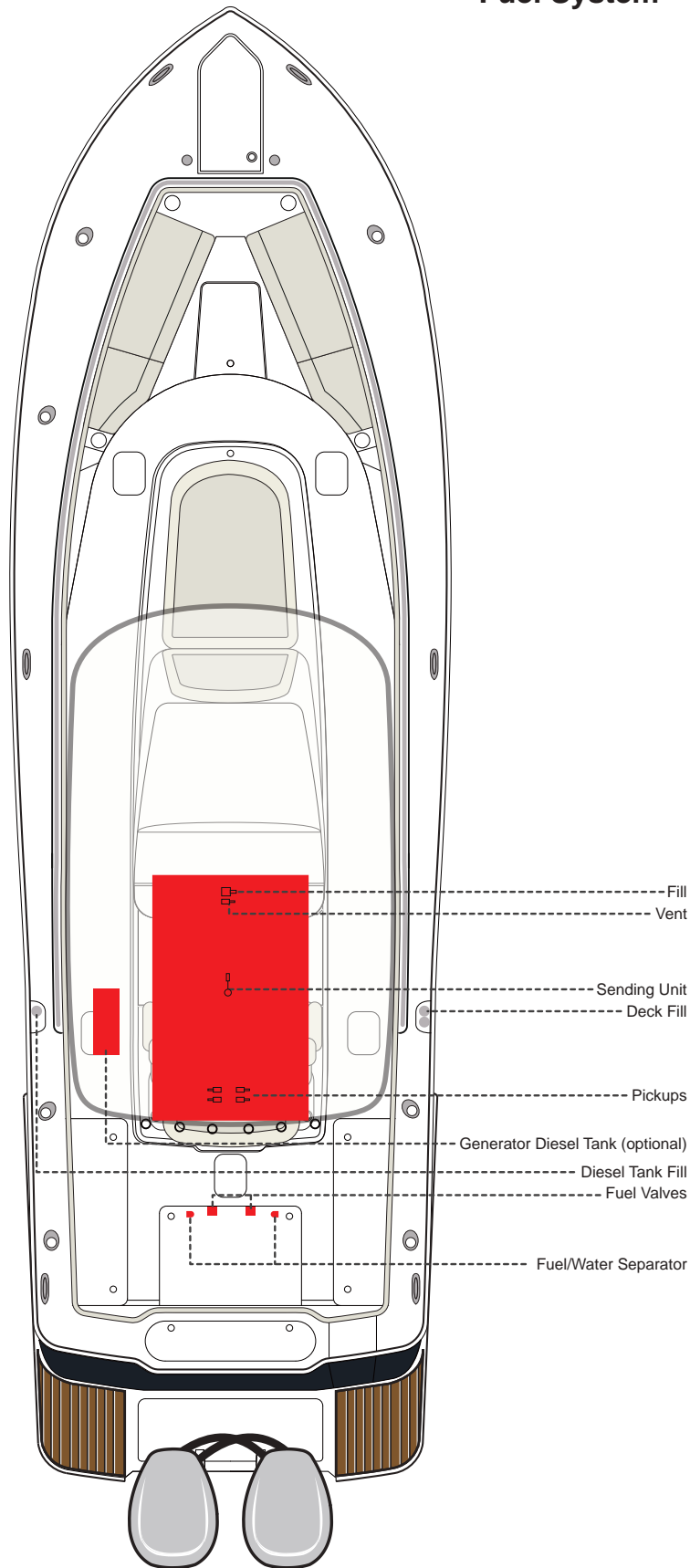

Fuel System

Propulsion System

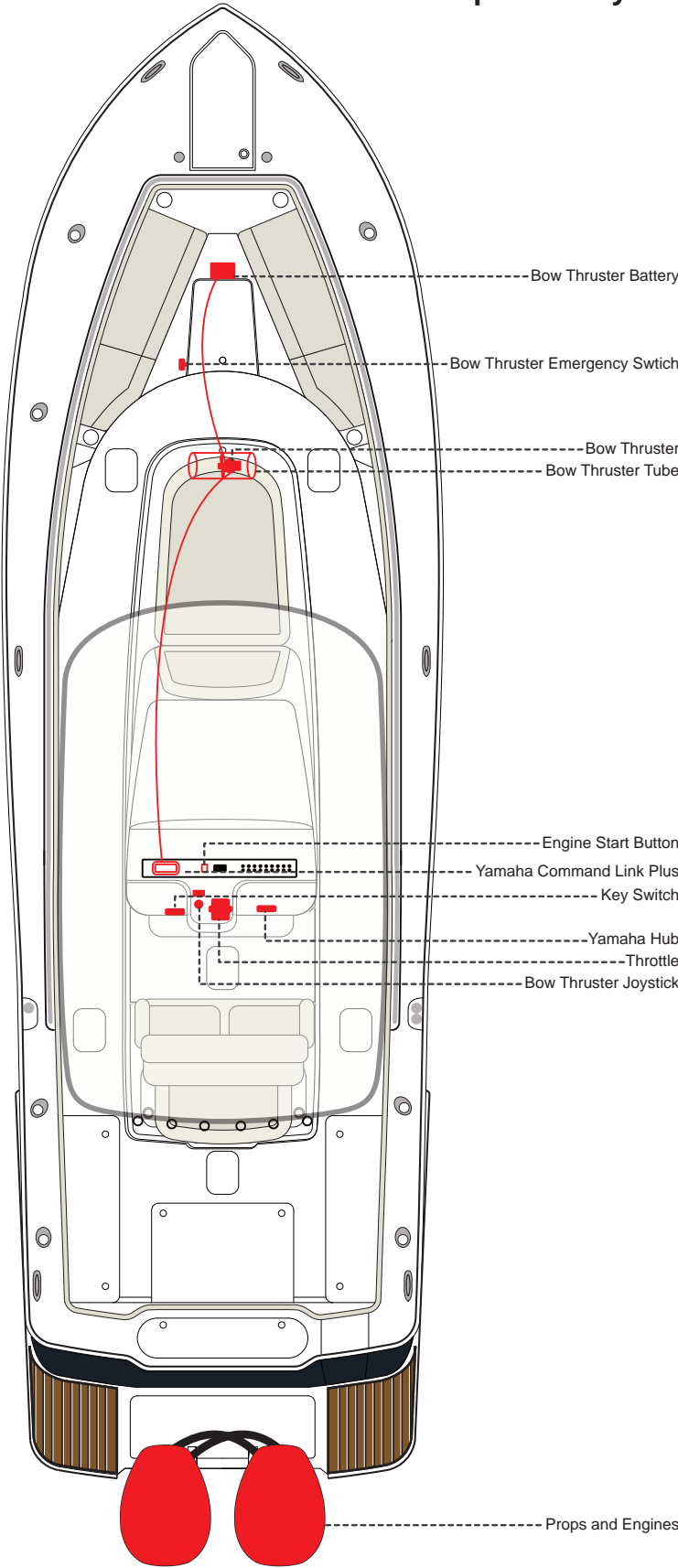

Propulsion System

Raw Water System

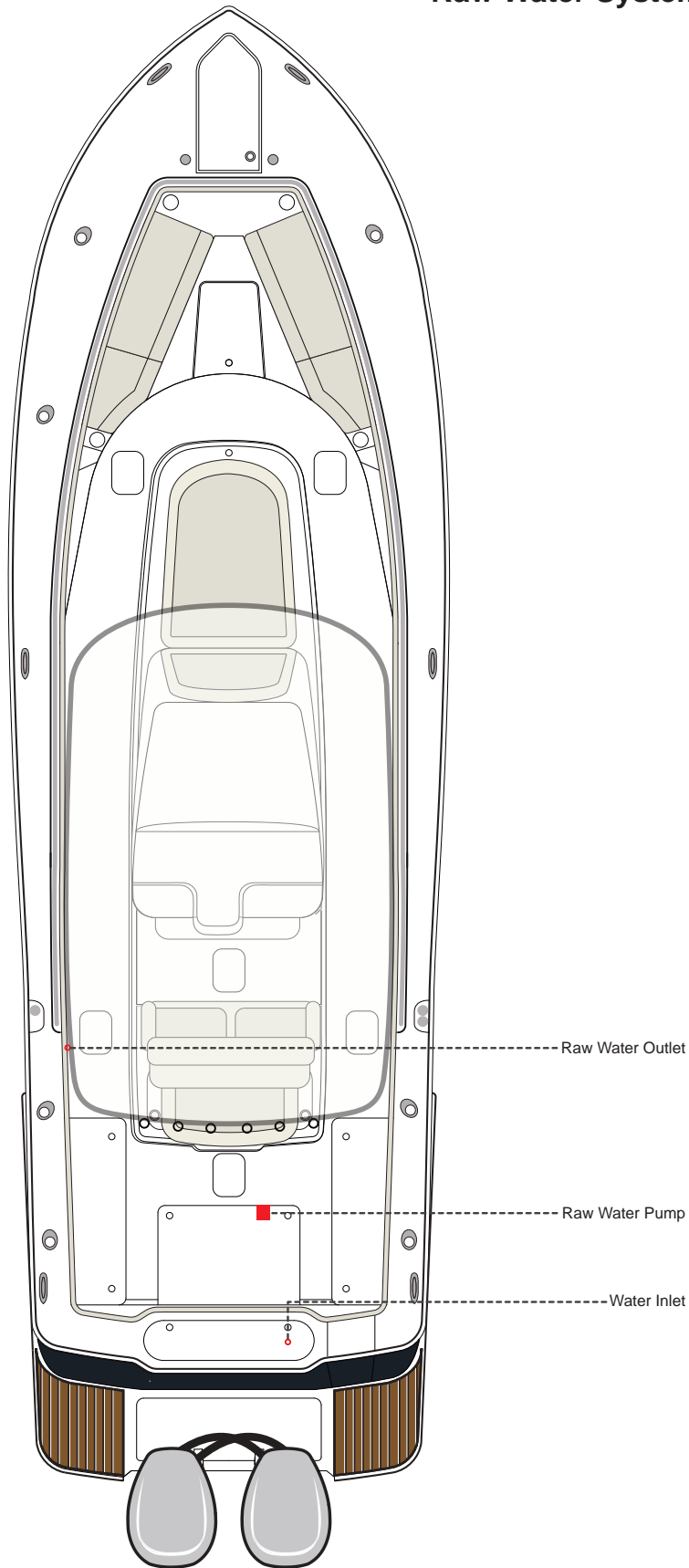

*Raw Water System*

Steering System

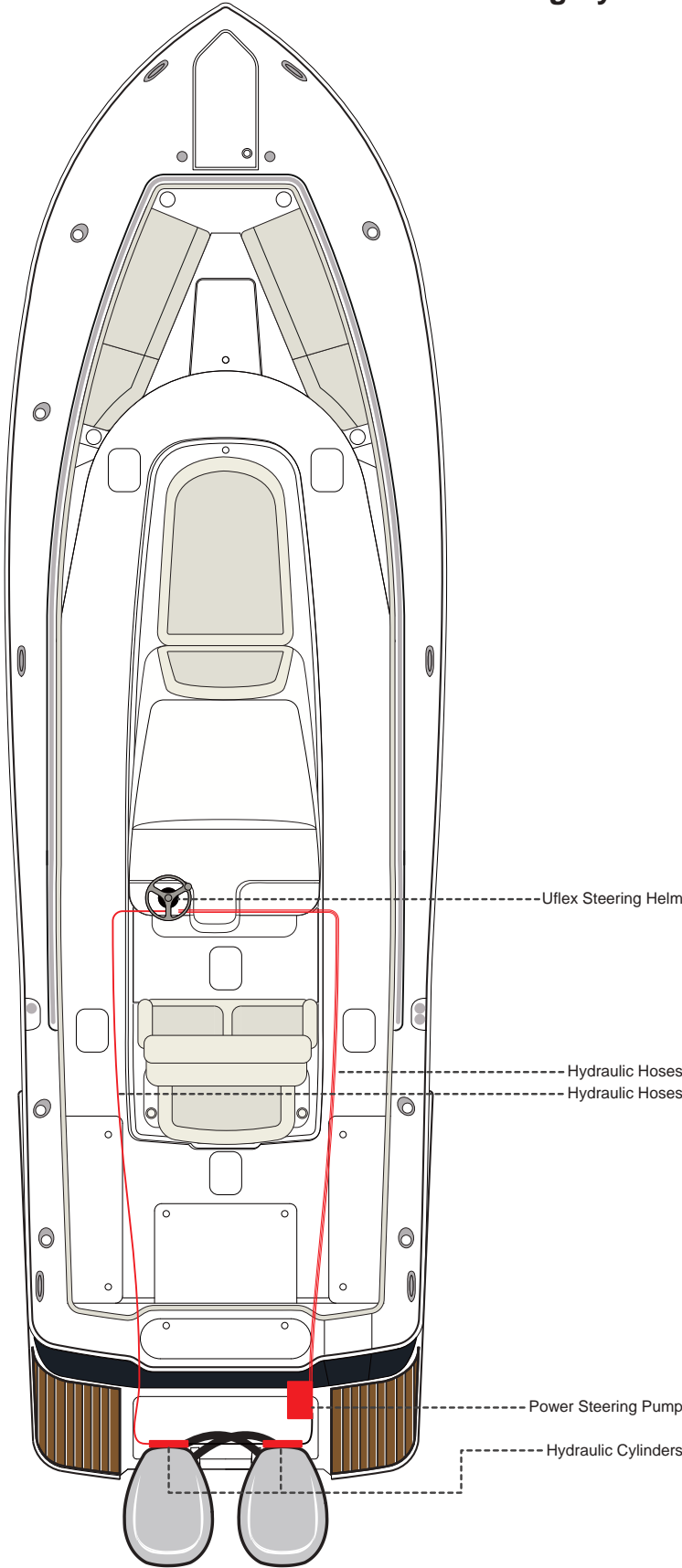

*Hydraulic Steering System*

Waste System

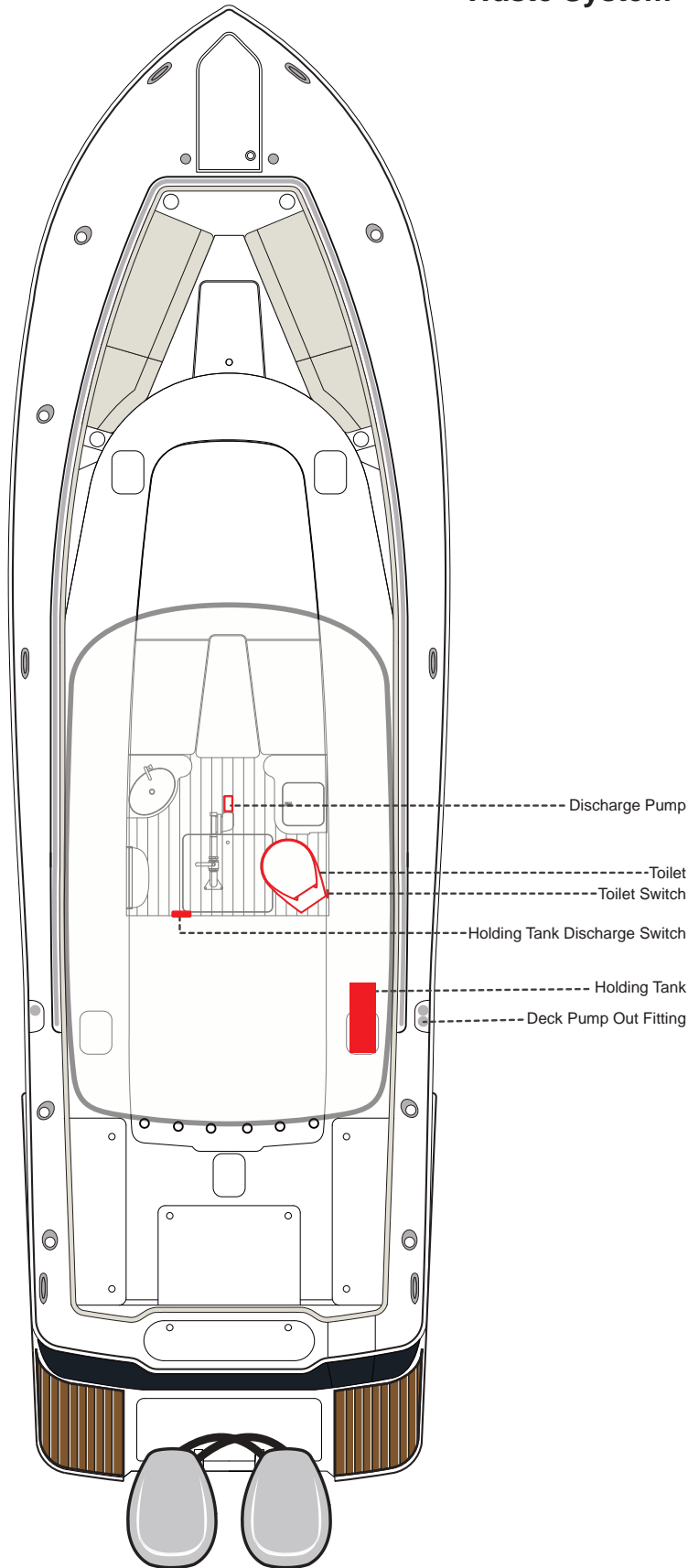

Waste System

# GLOSSARY OF TERMS

**Aft:** In, near, or toward the stern of a boat.

**Aground:** A boat stuck on the bottom.

**Amidships:** In or toward the part of a boat midway between the bow and stern.

**Anchor:** A specially shaped heavy metal device designed to dig efficiently into the bottom under a body of water and hold a boat in place.

**Anchorage:** An area specifically designated by governmental authorities in which boats may anchor.

**Ashore:** On shore.

**Astern:** Behind the boat, to move backwards.

**Athwartship:** At right angles to the center line of the boat.

**Barnacles:** Small, hard-shelled marine animals which are found in salt water attached to pilings, docks and bottoms of boats.

**Beam:** The breadth of a boat usually measured at its widest part.

**Bearing:** The direction of an object from the boat, either relative to the boat's direction or to compass degrees.

**Berth:** A bunk or a bed on a boat.

**Bilge:** The bottom of the boat below the flooring.

**Bilge Pump:** A pump that removes water that collects in the bilge.

**Boarding:** Entering or climbing into a boat.

**Boarding Ladder:** Set of steps temporarily fitted over the side of a boat to assist persons coming aboard.

**Boat Hook:** Short shaft of wood or metal with a hook fitting at one end shaped to aid in extending one's reach from the side of the boat.

**Bow:** The front end of a boat's hull

**Bow Line:** A line that leads forward from the bow of the boat.

**Bow Rail:** Knee high rails of solid tubing to aid in preventing people from falling overboard.

**Bridge:** The area from which a boat is steered and controlled.

**Bridge Deck:** A deck forward and usually above the cockpit deck.

**Broach:** When the boat is sideways to the seas and in danger of capsizing; a very dangerous situation that should be avoided.

**Bulkhead:** Vertical partition or wall separating compartments of a boat.

**Cabin:** Enclosed superstructure above the main deck level.

**Capsize:** When a boat lays on its side or turns over.

**Chock:** A deck fitting, usually of metal, with inward curving arms through which mooring or anchor lines are passed so as to lead them in the proper direction both on board and off the boat.

**Cleat:** A deck fitting, usually of metal with projecting arms used for securing anchor and mooring lines.

**Closed Cooling System:** A separate supply of fresh water that is used to cool the engine and circulates only within the engine.

**Coaming:** A vertical piece around the edges of cockpit, hatches, etc. to stop water on deck from running below.

**Cockpit:** An open space, usually in the aft deck, outside of the cabin.

**Companionway:** Opening in the deck of a boat to provide access below.

**Compartment:** The interior of a boat divided off by bulkheads.

**Cradle:** A framework designed to support a boat as she is hauled out or stored.

**Cutlass Bearing:** A rubber bearing in the strut that supports the propeller shaft.

**Deck:** The floor-like platform of a boat that covers the hull.

**Displacement:** The volume of water displaced by the hull. The displacement weight is the weight of this volume of water.

**Draft:** The depth of water a boat needs to float.

**Dry Rot:** A fungus attack on wood areas.

**Dry-dock:** A dock that can be pumped dry during boat construction or repair.

**Electrical Ground:** A connection between an electrical connector and the earth.

**Engine Beds:** Sturdy structural members running fore and aft on which the inboard engines are mounted.

**EPIRB:** Emergency Position Indicating Radio Beacon. Operates as a part of a worldwide satellite distress system.

**Even Keel:** When a boat floats properly as designed.

**Fathom:** A measure of depth. One Fathom = 6 feet.

**Fender:** A soft object of rubber or plastic used to protect the topsides from scarring and rubbing against a dock or another vessel.

**Fend off:** To push or hold the boat off from the dock or another boat.

**Flying Bridge:** A control station above the level of the deck or cabin.

**Flukes:** The broad portions of an anchor which dig into the ground.

**Fore:** Applies to the forward portions of a boat near the bow.

**Foundering:** When a boat fills with water and sinks.

**Freeboard:** The height from the waterline to the lowest part of the deck.

**Galley:** The kitchen of a boat.

**Grab Rail:** Hand-hold fittings mounted on cabin tops or sides for personal safety when moving around the boat, both on deck and below.

**Ground Tackle:** A general term including anchors, lines, and other gear used in anchoring.

**Grounds:** A boat touches the bottom.

**Gunwale:** The upper edge of a boat's side.

**Hand Rail:** Rail mounted on the boat, for grabbing with your hand, to steady you while walking about the boat.

**Harbor:** An anchorage which provides reasonably good protection for a boat, with shelter from wind and sea.

**Hatch:** An opening in the deck with a door or lid to allow for access down into a compartment of a boat.

**Head:** A toilet on a boat.

**Heat Exchanger:** Used to transfer the heat that is picked up by the closed cooling system to the raw cooling water.

**Helm:** The steering and control area of a boat.

**Hull:** The part of the boat from the deck down.

**Inboard:** A boat with the engine mounted within the hull of the boat. Also refers to the center of the boat away from the sides.

**Inboard/outboard:** Also stern drive or I/O. A boat with an inboard engine attached to an outboard drive unit.

**Keel:** A plate or timber plate running lengthwise along the center of the bottom of a boat.

**Knot:** Unit of speed indicating nautical miles per hour. 1 knot = 1 nautical mile per hour (1.15 miles per hour). A nautical mile is equal to one minute of latitude: 6076 feet. Knots times 1.15 equals miles per hour. Miles per hour times .87 equals knots.

**Lay-up:** To decommission a boat for the winter (usually in northern climates).

**Leeward:** The direction toward which the wind is blowing.

**Length On The Waterline (l.w.l.):** A length measurement of a boat at the waterline from the stern to where the hull breaks the water near the bow.



**Limber Hole:** A passage cut into the lower edges of floors and frames next to the keel to allow bilge water to flow to the lowest point of the hull where it can be pumped overboard.

**Line:** The term used to describe a rope when it is on a boat.

**Lists:** A boat that inclines to port or starboard while afloat.

**L.O.A.:** Boat length overall.

**Locker:** A closet, chest or box aboard a boat.

**Loran:** An electronic navigational instrument which monitors the boat's position using signals emitted from pairs of transmitting stations.

**Lunch hook:** A small light weight anchor typically used instead of the working anchor. Normally used in calm waters with the boat attended.

**Midships:** The center of the boat.

**Marina:** A protected facility primarily for recreational small craft.

**Marine Ways or Railways:** Inclined planes at the water's edge onto which boats are hauled.

**Moored:** A boat secured with cables, lines or anchors.

**Mooring:** An anchor permanently embedded in the bottom of a harbor that is used to secure a boat.

**Nautical Mile:** A unit of measure equal to one minute of latitude. (6076 feet)

**Nun Buoy:** A red or red-striped buoy of conical shape.

**Outboard:** A boat designed for an engine to be mounted on the transom. Also a term that refers to objects away from the center line or beyond the hull sides of a boat.

**Pad Eye:** A deck fitting consisting of a metal eye permanently secured to the boat.

**Pier:** A structure which projects out from the shoreline.

**Pile or Piling:** A long column driven into the bottom to which a boat can be tied.

**Pitching:** The fore and aft rocking motion of a boat as the bow rises and falls.

**Pitch:** The measure of the angle of a propeller blade. Refers to the theoretical distance the boat travels with each revolution of the propeller.

**P.F.D:** Personal Flotation Device.

**Port:** The left side of the boat when facing the bow.

**Porthole (port):** The opening in the side of a boat to allow the admittance of light and air.

**Propeller:** A device having two or more blades that is attached to the engine and used for propelling a boat.

**Propeller Shaft:** Shaft which runs from the back of the engine gear box, aft, through the stuffing box, shaft log, struts, and onto which the propeller is attached.

**Pyrotechnic Distress Signals:** Distress signals that resemble the brilliant display of flares or fireworks.

**Raw Water Cooled:** Refers to an engine cooling system that draws seawater in through a hull fitting or engine drive unit, circulates the water in the engine, and then discharges it overboard.

**Reduction Gear:** Often combined with the reverse gear so that the propeller turns at a slower rate than the engine.

**Reverse Gear:** Changes the direction of rotation of the propeller to provide thrust in the opposite direction for stopping the boat or giving it sternway.

**Roll:** A boat's sideways rotational motion in rough water.

**Rope Locker:** A locker, usually located in the bow of a boat, used for stowing the anchor line or chain.

**Rubrail:** Railing (often rubber or hard plastic) that runs along the boat's sheer to protect the hull when coming alongside docks, piers, or other boats.

**Rudder:** A moveable flat surface that is attached vertically at or near the stern for steering.

**Sea anchor:** An anchor that does not touch the bottom. Provides drag to hold the bow in the most favorable position in heavy seas.

**Scupper:** An opening in the hull side or transom of the boat through which water on deck or in the cockpit is drained overboard.

**Seacock:** Safety valves installed just inside the thru-hull fittings and ahead of the piping or hose running from the fittings.

**Shaft Log:** Pipe through which the propeller shaft passes.

**Sheer:** The uppermost edge of the hull.

**Sling:** A strap which will hold the boat securely while being lifted, lowered, or carried.

**Slip:** A boat's berth between two pilings or piers.

**Sole:** The deck of a cockpit or interior cabin.

**Spring Line:** A line that leads from the bow aft or from the stern forward to prevent the boat from moving ahead or astern.

**Starboard:** The right side of a boat when facing the bow.

**Steerageway:** Sufficient speed to keep the boat responding to the rudder or drive unit.

**Stem:** The vertical portion of the hull at the bow.

**Stern:** The rear end of a boat.

**Stow:** To pack away neatly.

**Stringer:** Longitudinal members fastened inside the hull for additional structural strength.

**Strut:** Mounted to the hull which supports the propeller shaft in place.

**Strut Bearing:** See "cutlass bearing."

**Stuffing Box:** Prevents water from entering at the point where the propeller shaft passes through the shaft log.

**Superstructure:** Something built above the main deck level.

**Swamps:** When a boat fills with water from over the side.

**Swimming Ladder:** Much the same as the boarding ladder except that it extends down into the water.

**Taffrail:** Rail around the rear of the cockpit.

**Thru-hull:** A fitting used to pass fluids (usually water) through the hull surface, either above or below the waterline.

**Topsides:** The side skin of a boat between the waterline or chine and deck.

**Transom:** A flat stern at right angles to the keel.

**Travel Lift:** A machine used at boat yards to hoist boats out of and back into the water.

**Trim:** Refers to the boat's angle or the way it is balanced.

**Trough:** The area of water between the crests of waves and parallel to them.

**Twin-Screw Craft:** A boat with two propellers on two separate shafts.

**Underway:** When a boat moves through the water.

**Wake:** Disrupted water that a boat leaves astern as a result of its motion.

**Wash:** The flow of water that results from the action of the propeller or propellers.

**Waterline:** The plane of a boat where the surface of the water touches the hull when it is afloat on even keel.

**Watertight Bulkhead:** Bulkheads secured so tightly so as not to let water pass.

**Wharf:** A structure generally parallel to the shore.

**Working Anchor:** An anchor carried on a boat for most normal uses. Refers to the anchor used in typical anchoring situations.

**Windlass:** A winch used to raise and lower the anchor.

**Windward:** Toward the direction from which the wind is coming.

**Yacht Basin:** A protected facility primarily for recreational small craft.

**Yaw:** When a boat runs off her course to either side.

## MAINTENANCE SCHEDULE AND LOG

MAINTENANCE	Each Use	Weekly	Monthly	Each Season	Yearly	As Needed
Clean hull below the waterline				X		
Bottom paint hull					X	X
Check sacrificial anodes			X			
Replace sacrificial anodes					X	X
Wash boat canvas & hardware	X		X			
Wax exterior gelcoat				X		X
Clean & protect hardware						X
Polish & protect plastic glass				X		X
Clean exterior upholstery	X					X
Clean cabin & interior upholstery						X
Flush engines with fresh water	X					
Spray metal components in bilge with a protector			X			
Clean bilge				X		X
Check bilge for leaks	X		X			
Inspect & operate thru-hull valves			X			
Inspect steering & control systems	X					
Service steering & control systems				X		
Inspect fuel system for leaks	X					
Inspect & service fuel system				X		
Inspect fuel tank vents & screens					X	
Replace fuel filters					X	
Lubricate fuel fill O-rings			X			
Inspect fire extinguisher			X			
Test bilge pump auto switches			X			
Inspect & protect electrical components, wire & battery connections						
Check battery electrolyte & service			X			
Test and inspect AC electrical system & shore power cord				X		













<b>DEPARTMENT OF TRANSPORTATION U.S. COAST GUARD CG-3865 (Rev. 9/95)</b>		<b>BOATING ACCIDENT REPORT</b>		FORM APPROVED OMB NO. 2115-0010	
STATE ASSIGNED CASE NO. _____					
THE OPERATOR/OWNER OF A VESSEL USED FOR RECREATIONAL PURPOSES IS REQUIRED TO FILE A REPORT IN WRITING WHENEVER AN ACCIDENT RESULTS IN: LOSS OF LIFE OR DISAPPEARANCE FROM A VESSEL; AN INJURY WHICH REQUIRES MEDICAL TREATMENT BEYOND FIRST AID; OR PROPERTY DAMAGE IN EXCESS OF \$2000 OR COMPLETE LOSS OF THE VESSEL. REPORTS IN DEATH AND INJURY CASES MUST BE SUBMITTED WITHIN 48 HOURS. REPORTS IN OTHER CASES MUST BE SUBMITTED WITHIN 10 DAYS. REPORTS MUST BE SUBMITTED TO THE REPORTING AUTHORITY IN THE STATE WHERE THE ACCIDENT OCCURRED. THIS FORM IS PROVIDED TO ASSIST THE OPERATOR IN FILING THE REQUIRED WRITTEN REPORT.					
<b>COMPLETE ALL BLOCKS (INDICATE THOSE NOT APPLICABLE BY "NA")</b>					
<b>ACCIDENT DATA</b>					
DATE OF ACCIDENT		TIME AM PM	NAME OF BODY OF WATER		LOCATION (GIVE LOCATION PRECISELY)
NUMBER OF VESSELS INVOLVED		NEAREST CITY OR TOWN		COUNTY	STATE ZIP CODE
WEATHER (CHECK ALL APPLICABLE) [ ] CLEAR [ ] RAIN [ ] CLOUDY [ ] SNOW [ ] FOG [ ] HAZY		WATER CONDITIONS [ ] CALM (WAVES LESS THAN 6") [ ] CHOPPY (WAVES 6" TO 2') [ ] ROUGH (WAVES 2' TO 6') [ ] VERY ROUGH (GREATER THAN 6') [ ] STRONG CURRENT		TEMPERATURE (ESTIMATE) AIR _____ °F WATER _____ °F	WIND [ ] NONE [ ] LIGHT (0-6 MPH) [ ] MODERATE (7-14 MPH) [ ] STRONG (15-25 MPH) [ ] STORM (OVER 25 MPH)
NAME OF OPERATOR			OPERATOR ADDRESS		
OPERATOR TELEPHONE NUMBER ( )		DATE OF BIRTH MO DAY YR		OPERATOR'S EXPERIENCE [ ] NONE [ ] UNDER 100 HOURS [ ] > 100 HOURS	
[ ] MALE [ ] FEMALE		INSTRUCTION IN BOATING SAFETY [ ] STATE COURSE [ ] U.S. POWER SQUADRON [ ] USCG AUXILIARY [ ] AMERICAN RED CROSS [ ] NONE			
NAME OF OWNER			OWNER ADDRESS		
OWNER TELEPHONE NUMBER ( )		NUMBER OF PEOPLE ON BOARD		NUMBER OF PEOPLE BEING TOWED	
RENTED BOAT? [ ] YES [ ] NO					
<b>BOAT NO. 1 (THIS VESSEL)</b>					
BOAT REGISTRATION OR DOCUMENTATION NUMBER			STATE	HULL IDENTIFICATION NUMBER	
BOAT NAME					
BOAT MANUFACTURER			LENGTH	MODEL	
YEAR BUILT					
TYPE OF BOAT [ ] OPEN MOTORBOAT [ ] CABIN MOTORBOAT [ ] AUXILIARY SAIL [ ] SAIL (ONLY) [ ] ROWBOAT [ ] CANOE/KAYAK [ ] PERSONAL WATERCRAFT [ ] PONTOON BOAT [ ] HOUSEBOAT [ ] OTHER (SPECIFY)		HULL MATERIAL [ ] WOOD [ ] ALUMINUM [ ] STEEL [ ] FIBERGLASS [ ] RUBBER/VINYL/CANVAS [ ] RIGID HULL INFLATABLE [ ] OTHER (SPECIFY)		ENGINE [ ] OUTBOARD [ ] INBOARD [ ] INBOARD-STERNDRIVE (I/O) [ ] AIRBOAT	
				PROPULSION [ ] PROPELLER [ ] WATER JET [ ] AIR THRUST [ ] MANUAL [ ] SAIL	
				PERSONAL FLOTATION DEVICES (PFDS): WAS BOAT ADEQUATELY EQUIPPED WITH COAST GUARD APPROVED PFDS? [ ] YES [ ] NO WERE PFDS ACCESSIBLE? [ ] YES [ ] NO	
				FUEL [ ] GASOLINE [ ] DIESEL [ ] ELECTRIC	
				NUMBER OF ENGINES TOTAL HORSEPOWER	
				FIRE EXTINGUISHERS ON BOARD? [ ] YES [ ] NO USED? [ ] YES [ ] NO	
				WHAT CONTRIBUTED TO ACCIDENT? (CHECK ALL APPLICABLE)	
OPERATION AT TIME OF ACCIDENT (CHECK ALL APPLICABLE) [ ] CRUISING [ ] CHANGING DIRECTION [ ] CHANGING SPEED [ ] DRIFTING [ ] TOWING [ ] BEING TOWED [ ] ROWING/PADDLING [ ] SAILING [ ] LAUNCHING [ ] DOCKING/UNDOCKING [ ] AT ANCHOR [ ] TIED TO DOCK/MOORED [ ] OTHER (SPECIFY)		ACTIVITY AT TIME OF ACCIDENT (CHECK ANY IF APPLICABLE) [ ] FISHING [ ] TOURNAMENT [ ] HUNTING [ ] SWIMMING/DIVING [ ] MAKING REPAIRS [ ] WATERSKIING/TUBING/ETC. [ ] RACING [ ] WHITEWATER SPORTS [ ] FUELING [ ] STARTING ENGINE [ ] NON-RECREATIONAL [ ] OTHER (SPECIFY)		TYPE OF ACCIDENT [ ] GROUNDING [ ] CAPSIZING [ ] FLOODING/SWAMPING [ ] SINKING [ ] FIRE OR EXPLOSION (FUEL) [ ] FIRE OR EXPLOSION (OTHER) [ ] SKIER MISHAP [ ] COLLISION WITH VESSEL [ ] COLLISION WITH FIXED OBJECT [ ] COLLISION WITH FLOATING OBJ. [ ] FALLS OVERBOARD [ ] FALLS IN BOAT [ ] STRUCK BY BOAT [ ] STRUCK BY MOTOR/PROPELLER [ ] STRUCK SUBMERGED OBJECT [ ] OTHER (SPECIFY)	
ESTIMATED SPEED [ ] NONE [ ] UNDER 10 MPH [ ] 10 - 20 MPH [ ] 21 - 40 MPH [ ] OVER 40 MPH				[ ] HIT AND RUN	
[ ] WEATHER [ ] EXCESSIVE SPEED [ ] IMPROPER LOOKOUT [ ] RESTRICTED VISION [ ] OVERLOADING [ ] IMPROPER LOADING [ ] HAZARDOUS WATERS [ ] ALCOHOL USE [ ] DRUG USE [ ] HULL FAILURE [ ] MACHINERY FAILURE [ ] EQUIPMENT FAILURE [ ] OPERATOR INEXPERIENCE [ ] OPERATOR INATTENTION [ ] CONGESTED WATERS [ ] PASSENGER/SKIER BEHAVIOR [ ] DAM/LOCK [ ] OTHER (SPECIFY)					

# Boating Accident Report



DECEASED (IF MORE THAN 2 FATALITIES, ATTACH ADDITIONAL FORMS)			
NAME OF VICTIM		ADDRESS OF VICTIM	
DATE OF BIRTH	[ ] MALE [ ] FEMALE	DEATH CAUSED BY [ ] DROWNING [ ] OTHER	WAS PFD WORN? [ ] YES [ ] NO
NAME OF VICTIM		ADDRESS OF VICTIM	
DATE OF BIRTH	[ ] MALE [ ] FEMALE	DEATH CAUSED BY [ ] DROWNING [ ] OTHER	WAS PFD WORN? [ ] YES [ ] NO
INJURED (IF MORE THAN 2 INJURIES, ATTACH ADDITIONAL FORMS)			
NAME OF VICTIM		ADDRESS OF VICTIM	
DATE OF BIRTH	MEDICAL TREATMENT BEYOND FIRST AID? [ ] YES [ ] NO ADMITTED TO HOSPITAL? [ ] YES [ ] NO	DESCRIBE INJURY	
WAS PFD WORN? [ ] YES [ ] NO	PRIOR TO ACCIDENT? [ ] YES [ ] NO	AS A RESULT OF ACCIDENT? [ ] YES [ ] NO	
NAME OF VICTIM		ADDRESS OF VICTIM	
DATE OF BIRTH	MEDICAL TREATMENT BEYOND FIRST AID? [ ] YES [ ] NO ADMITTED TO HOSPITAL? [ ] YES [ ] NO	DESCRIBE INJURY	
WAS PFD WORN? [ ] YES [ ] NO	PRIOR TO ACCIDENT? [ ] YES [ ] NO	AS A RESULT OF ACCIDENT? [ ] YES [ ] NO	
OTHER PEOPLE ABOARD THIS BOAT (IF MORE THAN 2 PEOPLE, ATTACH ADDITIONAL FORMS)			
NAME		ADDRESS	
DATE OF BIRTH	WAS PFD WORN? [ ] YES [ ] NO AS A RESULT OF ACCIDENT [ ] YES [ ] NO	PRIOR TO ACCIDENT? [ ] YES [ ] NO	WAS IT INFLATABLE? [ ] YES [ ] NO
NAME		ADDRESS	
DATE OF BIRTH	WAS PFD WORN? [ ] YES [ ] NO AS A RESULT OF ACCIDENT [ ] YES [ ] NO	PRIOR TO ACCIDENT? [ ] YES [ ] NO	WAS IT INFLATABLE? [ ] YES [ ] NO
BOAT NO. 2 (IF MORE THAN 2 VESSELS, ATTACH ADDITIONAL IDENTIFYING INFORMATION)			
NAME OF OPERATOR		OPERATOR ADDRESS	
OPERATOR TELEPHONE NUMBER ( )		BOAT REGISTRATION OR DOCUMENTATION NUMBER	STATE
NAME OF OWNER		OWNER ADDRESS	
OWNER TELEPHONE NUMBER ( )			
PROPERTY DAMAGE			
ESTIMATED AMOUNT: THIS BOAT AND CONTENTS:	OTHER BOAT(S) AND CONTENTS:	OTHER PROPERTY:	
\$	\$	\$	
DESCRIBE PROPERTY DAMAGED			
WITNESSES NOT ON THIS VESSEL			
NAME	ADDRESS	TELEPHONE NUMBER ( )	
NAME	ADDRESS	TELEPHONE NUMBER ( )	
PERSON COMPLETING REPORT			
NAME	ADDRESS	TELEPHONE NUMBER ( )	
SIGNATURE	QUALIFICATION [ ] OPERATOR [ ] OWNER [ ] INVESTIGATOR [ ] OTHER	DATE SUBMITTED	
FOR AGENCY USE ONLY			
CAUSES BASED ON (CHECK ONE): [ ] THIS REPORT [ ] INVESTIGATION [ ] INVESTIGATION AND THIS REPORT [ ] OTHER			
NAME OF REVIEWING OFFICE	DATE RECEIVED	RECREATIONAL [ ]	NON-REPORTABLE [ ]
PRIMARY CAUSE	COMMERCIAL [ ] SECONDARY CAUSE		

Call the Coast Guard Infoline 1-800-368-5647 for information on **Federal Requirements for Recreational Boats**



## ACCIDENT DESCRIPTION

DESCRIBE WHAT HAPPENED (SEQUENCE OF EVENTS. INCLUDE FAILURE OF EQUIPMENT. INCLUDE A DIAGRAM IF NEEDED. CONTINUE ON ADDITIONAL SHEETS IF NECESSARY. INCLUDE ANY INFORMATION REGARDING THE INVOLVEMENT OF ALCOHOL AN/OR DRUGS IN CAUSING OR CONTRIBUTING TO THE ACCIDENT. INCLUDE ANY DESCRIPTIVE INFORMATION ABOUT THE USE OF PFD'S.)

An agency may not conduct or sponsor and a person is not required to respond to an information collection, unless it displays a currently valid OMB Control Number. The Coast Guard estimates that the average burden for this report form is 30 minutes. You may submit any comments concerning the accuracy of this burden estimate or any suggestions for reducing the burden to: Commandant (G-OPB-1), U.S. Coast Guard, Washington, DC 20593-0001 or Office of Management and Budget, Paperwork Reduction Project (2115-0010), Washington, DC 20503.

THIS PAGE WAS LEFT BLANK  
INTENTIONALLY

## FLOAT PLAN

Scout recommends filling out a float plan each time you use your boat for an offshore day trip or a long cruise. Leave this information with a responsible person ashore, like a close friend or relative that you know well.

1. Name of person reporting and telephone number.

\_\_\_\_\_

2. Description of boat.

Type \_\_\_\_\_ Color \_\_\_\_\_ Trim \_\_\_\_\_

Registration No. \_\_\_\_\_ Length \_\_\_\_\_

Name \_\_\_\_\_ Make \_\_\_\_\_ Other Info \_\_\_\_\_

3. Engine type \_\_\_\_\_ H.P. \_\_\_\_\_

No. of Engines \_\_\_\_\_ Fuel Capacity \_\_\_\_\_

4. Survival equipment: (Check as appropriate)

<input type="checkbox"/> PFDS	<input type="checkbox"/> Flares	<input type="checkbox"/> Mirror
<input type="checkbox"/> Smoke Signals	<input type="checkbox"/> Flashlight	<input type="checkbox"/> Food
<input type="checkbox"/> Paddles	<input type="checkbox"/> Water	<input type="checkbox"/> Others
<input type="checkbox"/> Anchor	<input type="checkbox"/> Raft or Dinghy	<input type="checkbox"/> EPIRB

5. Radio  Yes  No Type \_\_\_\_\_

6. Automobile license \_\_\_\_\_

Type \_\_\_\_\_ Trailer License \_\_\_\_\_

Color \_\_\_\_\_ and make of auto \_\_\_\_\_

7. Persons aboard \_\_\_\_\_

Name \_\_\_\_\_ Age \_\_\_\_\_ Address & telephone No. \_\_\_\_\_

\_\_\_\_\_  
 \_\_\_\_\_  
 \_\_\_\_\_

8. Do any of the persons aboard have a medical problem?

Yes  No If yes, what? \_\_\_\_\_

9. Trip Expectations: Leave at \_\_\_\_\_

From \_\_\_\_\_ Going to \_\_\_\_\_

Expect to return by \_\_\_\_\_ (time)

and no later than \_\_\_\_\_

10. Any other pertinent info. \_\_\_\_\_

11. If not returned by \_\_\_\_\_ (time)

call the COAST GUARD, or (Local authority) \_\_\_\_\_

12. Telephone Numbers.

\_\_\_\_\_  
 \_\_\_\_\_  
 \_\_\_\_\_  
 \_\_\_\_\_

THIS PAGE WAS LEFT BLANK  
INTENTIONALLY

# TROUBLESHOOTING GUIDE

PROBLEM	CAUSE AND SOLUTION
<b>CONTROL SYSTEMS</b>	
Hydraulic Steering is slow to respond & erratic.	<ul style="list-style-type: none"> <li>Steering system is low on fluid. Fill and bleed system.</li> <li>Steering system has air in it. Fill and bleed system.</li> <li>A component in the steering system is binding. Check and adjust or repair binding component.</li> <li>Engine steering spindle is binding. Grease spindle.</li> </ul>
The boat wanders and will not hold a course at cruise speeds.	<ul style="list-style-type: none"> <li>There could be air in the steering system. Fill &amp; bleed the system.</li> <li>The engine steering tab is corroded or out of adjustment. Replace or adjust steering tab.</li> <li>Engine steering spindle is binding. Grease spindle.</li> </ul>
An engine will not start with the shift control lever in neutral.	<ul style="list-style-type: none"> <li>The control cable is out of adjustment &amp; not activating the neutral safety cut out switch.</li> <li>The shift control lever is not in the neutral detent. Try moving the shift lever slightly.</li> <li>There is a loose wire on the neutral safety switch on the control. Inspect wires and repair loose connections.</li> <li>The starter or ignition switch is bad.</li> <li>There is a problem with the electronic control system at the helm control, module or at the engine. Have the system serviced by a qualified marine technician.</li> </ul>

<b>PERFORMANCE PROBLEMS</b>	
Boat is sluggish and has lost speed & RPM.	<ul style="list-style-type: none"> <li>The boat may need to have marine growth cleaned from hull and running gear.</li> <li>Propellers may be damaged &amp; need repair.</li> <li>Weeds or line around the propellers. Clean propellers.</li> <li>Boat is overloaded. Reduce load.</li> <li>Check for excessive water in the bilge. Pump out bilge &amp; find &amp; correct the problem.</li> <li>The throttle adjustment has changed and the engine is not getting full throttle. Adjust the throttle cable.</li> <li>One of the throttle is not responding properly and the engine is not getting full throttle. Have the throttle control checked by a qualified marine technician.</li> </ul>
The boat vibrates at cruising speeds.	<ul style="list-style-type: none"> <li>Propellers may be damaged &amp; need repair.</li> <li>A propeller or propeller shaft is bent. Repair or replace damaged components.</li> <li>The running gear is fouled by marine growth or rope. Clean running gear.</li> <li>The engines are not trimmed properly. Trim engines.</li> </ul>

PROBLEM	CAUSE AND SOLUTION
<b>ENGINE PROBLEMS</b>	

**An engine is running too hot.**

- The engine raw water pick up strainer is clogged with marine growth. Clean pick up.
- The engine raw water pump impeller is worn or damaged. Repair the pump.
- The engine thermostat is faulty and needs to be replaced.

**An engine alternator is not charging properly.**

- The battery cable is loose or corroded. Clean and tighten battery cables.
- The alternator is not charging and must be replaced.
- The battery is defective. Replace the battery.

**An engine suddenly will not operate over 2000 RPM.**

- The engine emergency system has been activated. The on board computer has sensed a problem and has limited the RPM to protect the engine. Find & correct the problem.
- The tachometer is bad and needs to be replaced.
- The oil tank on 2-cycle engines is low on oil. Fill the engine oil tank. Refer to the engine owner's manual.
- A throttle control is not responding properly. Have the throttle setting checked by a qualified technician.

**An engine is loosing RPM. The boat is not overloaded and the hull bottom and running gear are clean and in good condition.**

- The engine may be having a problem with a sticky Anti-siphon valve, located in the fuel line near the fuel tank, that is restricting the fuel flow. Remove & clean or replace the Anti-siphon valve.
- The remote gasoline fuel filter could be dirty. Inspect and replace the fuel filter.
- The primary fuel filter on the engine may be dirty. Inspect and replace the fuel filter.
- The electronic engine control system on the engine is malfunctioning. Repair the engine control system.
- The fuel injection system on the engine is malfunctioning. Repair the fuel injection system.



## PROBLEM

## CAUSE AND SOLUTION

### ACCESSORY PROBLEMS

**The air conditioner runs for a short time & then cuts out.**

- The air conditioner pump sea strainer is clogged. Clean the strainer.
- The raw water supply thru hull valve is closed. Open the valve.
- The raw water system is air-bound. Make sure the thru hull valve is open and run the boat above 15 m.p.h. The speed scoop on the thru hull fitting will force the air lock out of the system.
- The air conditioner raw water pump is not pumping and needs to be repaired or replaced.

**The carbon monoxide detector sounds the alarm when the engines are running.**

- The canvas curtains are up and none of the forward facing vents are open, allowing carbon monoxide to accumulate in the cockpit and cabin. Open the deck hatch, clear connector, and side curtains to provide proper ventilation.
- The boat is operating at slow speed and the wind is on the stern pushing CO into the cockpit and cabin. Increase boat speed or change heading if possible.
- The carbon monoxide detector is defective and needs to be calibrated by the manufacturer or replaced. Have the boat checked by a professional before condemning the CO monitor.

**The baitwell pump runs, but does not pump water.**

- The strainer on the intake scoop is clogged preventing the water from getting to the pump. Put the boat in reverse to clean the strainer.
- There is an air lock in the system. Prime the system.
- The thru-hull valve is not open. Open valve.

**The fresh water pump runs, but will not pump water.**

- The water tank is empty. Fill the tank.
- The intake hose is damaged and sucking air. Replace or repair the hose.
- The pump is defective. Repair or replace the pump.

**The fresh water pump fails to turn off after all outlets are closed.**

- There is a leak in a pressure line or outlet. Repair the leak.
- There is an air leak in the intake line. Repair the air leak.
- The pressure switch is defective. Replace the pressure switch.
- The voltage to the pump is low. Check for corroded or loose wiring connections or low battery.
- The strainer is clogged. Clean strainer.
- The pump is defective. Repair or replace the pump.

**The washdown pump runs, but the pump will not pump water.**

- The thru-hull valve is not open. Open valve.
- The in-line sea strainer for the pump is clogged. Clean the sea strainer.
- The intake hose is damaged and sucking air. Replace hose.
- The pump is defective. Repair or replace the pump.

## PROBLEM

## CAUSE AND SOLUTION

### ACCESSORY PROBLEMS

**The washdown or fresh water pump fails to turn off after all outlets are closed.**

- There is a leak in a pressure line or outlet. Repair the leak.
- There is an air leak in the intake line. Repair the air leak.
- The pressure switch is defective. Replace the pressure switch.
- The voltage to the pump is low. Check for corroded or loose wiring connections or low battery.
- The strainer is clogged. Clean strainer.
- The pump is defective. Repair or replace the pump.

**Reduction in water flow from the bilge pump.**

- Impeller screen plugged with debris. Clean screen at the base of the pump.
- The discharge hose is pinched or clogged. Check discharge hose and clean or repair.
- Low voltage to the pump. Check the battery and wire connections.

**The automatic float switch on the bilge pump raises but does not activate the pump .**

- The circuit breaker for the automatic switch has tripped. Reset the circuit breaker.
- The battery is dead. Charge or replace the battery.
- The pump impeller is jammed by debris. Clean pump impeller housing.
- The wire connections in the bilge have corroded. Replace connectors and secure above the bilge waterline.
- The automatic switch is defective. Replace the switch.
- The pump is defective. Replace pump.

**The bilge pump will not run when the manual switch is activated.**

- The circuit breaker supplying the switch has tripped. Reset the circuit breaker. Replace if defective.
- The battery switch is off. Turn on the battery switch.
- The pump impeller is jammed by debris. Clean pump impeller housing.
- The wire connections in the bilge have corroded. Replace connectors and secure above the bilge waterline.
- The switch is defective. Replace the switch.
- The pump is defective. Replace pump.

**Head will not flush.**

- Toilet breaker is not activated. Turn on breaker.
- The holding tank is full. Pump out the holding tank.
- There is bad connection at the pump or the switch. Repair the connection.
- The pump in the head is defective. Replace the pump.

PROBLEM	CAUSE AND SOLUTION
---------	--------------------

ACCESSORY PROBLEMS	
--------------------	--

**Holding tank will not empty.**

- Holding tank vent is clogged. Clean the vent and vent hose.
- There is a vacuum leak in the hose from the holding tank to the deck pump out fitting. Tighten loose fittings or replace damaged hoses.

**Excessive odor from marine head.**

- Back pressure in the holding tank. Pump out holding tank and clean the vent and vent hose.
- Waste is in the discharge hose. Flush enough to move waste to the holding tank, particularly at the end of each day.
- No deodorizer in the holding tank. Add deodorizer to the holding tank each time it is pumped out.
- The waste in the tank is over two weeks old. Pump the holding tank if it has contained waste for two weeks or more.

**The refrigerator or freezer compressor runs frequently and doesn't cool properly.**

- The drawer gasket is dirty or moldy and not sealing properly. Clean or replace the door seal..
- The refrigerator or freezer is defective. Replace the refrigerator or freezer.

**The optional generator will not start.**

- House battery is not charged. Charge or replace battery.
- The generator fuel supply valve is off. Turn on fuel supply valve.
- The fuel level is too low in the fuel tank that supplies the generator. Fill the fuel tank.

**The generator runs for a short time and shuts down.**

- There is a problem with the generator and the emergency shut down system has activated to shut down the generator. Find and correct the problem, then restart the generator.
- The fuel level is too low in the fuel tank that supplies the generator. Fill the fuel tank.
- The generator is overloaded. Manage AC accessory use to reduce excess amperage draw.

**No AC power to cabin breaker panel and shore cord is properly connected.**

- The breaker at the shore outlet is off. Activate breaker.
- The shore power cord is damaged or defective. Replace the cord.

**The cabin Main Breaker for AC Power trips when activating from shore power.**

- The polarity at the shore outlet is reversed. Check for red reverse polarity light. If lit, turn off all AC breakers on the boat and at the shore outlet. Contact a qualified marine electrician to correct the wiring.
- The AC accessory breakers are on and the power surge is tripping the breaker. Turn off all AC accessory breakers and reactivate main breaker.
- The main breaker is defective. Contact a qualified marine electrician to replace the breaker.

## PROBLEM

## CAUSE AND SOLUTION

### ACCESSORY PROBLEMS

**The cabin AC main breaker activates the panel but trips while using accessories.**

- There are too many AC accessories activated causing excess amperage draw. Manage AC accessory use to reduce excess amperage draw.
- Voltage supplied from the shore outlet is low or high. Check the voltage. Contact the marina operator or qualified marine electrician to correct the problem.
- The main breaker is defective. Contact a qualified marine electrician to replace the breaker.

**No AC power at cabin outlets**

- Outlet breaker in cabin AC panel is off. Activate breaker.
- Ground fault interrupter has tripped. Push reset button on outlet to reset.
- Accessory powered by the outlet has a fault that is tripping the interrupter. Turn the breaker in the cabin AC panel off and contact a qualified marine electrician to repair the defective accessory. Replace defective accessory.
- The GFI outlet is defective. Contact a qualified marine electrician to replace the outlet.





Spearheading the Future of Fishing.

Scout Boats Inc.  
2531 Hwy 78 West  
Summerville, SC 29483