



The Power of Innovation

275 LXF

Owner's Manual



Scout Boats Inc.
2531 Hwy 78 West
Summerville, SC 29483

SAFETY INFORMATION

Your Scout manual has been written to include a number of safety instructions to assure the safe operation and maintenance of your boat. These instructions are in the form of **DANGER, WARNING, CAUTION, and NOTICE** statements. The following definitions apply:

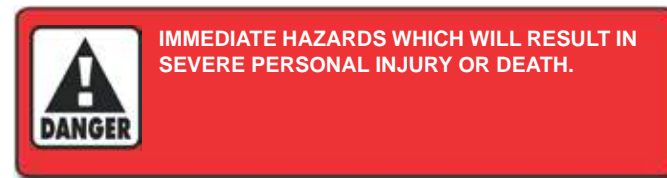
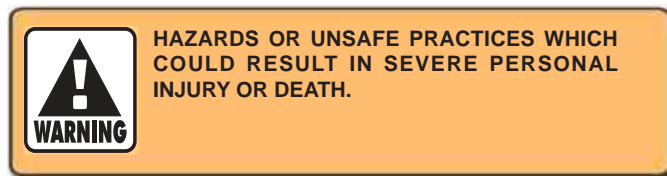
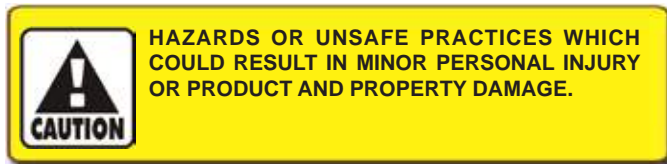

All instructions given in this book are as seen from the stern looking toward the bow, with starboard being to your right, and port to your left. A glossary of boating terms is included.

IMPORTANT NOTE: Your boat uses internal combustion engines and flammable fuel. Every precaution has been taken by Scout to reduce the risks associated with possible injury and damage from fire or explosion, but your own precaution and good maintenance procedures are necessary in order to enjoy safe operation of your boat.

275 LXF Specification Sheet

LENGTH:

27' 6" / 8.38 m

DRAFT (APRX):

16" / 0.4 m

BEAM:

9' / 2.74 m

BRIDGE CLEARANCE (APRX TO T-TOP):

8' / 2.44 m

DRY WEIGHT W/O ENGINES
(APRX):

5,300 lbs / 2,404 kg

TRANSOM BAIT WELL:

20 gal / 76 L

FUEL CAPACITY:

164 gal / 621 L

CONSOLE HEADROOM:

5' 8" / 1.72 m

FRESH WATER CAPACITY:

15 gal / 57 L

OUTBOARD SHAFT:

25" / 0.63 m

HOLDING TANK CAPACITY

9.5 gal / 36 L

FISH BOX:

100 qrts / 95 L

DEADRISE:

22 degrees

CONSOLE COOLER:

100 qrts / 95 L

MAX HP (YAMAHA OUTBOARDS):

400 HP / 298 kW



BOAT INFORMATION

Please fill out the following information section and leave it in your Scout Owner's Manual. This information will be important for you and Scout service personnel to know, if and when you may need to call Scout for technical assistance or service.

BOAT	
MODEL:	HULL SERIAL #:
PURCHASE DATE:	DELIVERY DATE:
IGNITION KEYS #:	REGISTRATION #:
DRAFT:	WEIGHT:
BRIDGE CLEARANCE:	
ENGINES	
MAKE:	MODEL:
PORT SERIAL #:	STARBOARD SERIAL #:
OPTIONS	
PROPELLERS	
MAKE:	NUMBER OF BLADES:
DIAMETER/PITCH:	MODEL:
PORT PART #:	STBD PART #:
TRAILER	
MAKE:	MODEL:
SERIAL #:	GVRW:
DEALER	SCOUT
NAME:	PHONE:
PHONE:	REPRESENTATIVE:
SALESMAN:	ADDRESS:
SERVICE MANAGER:	
ADDRESS:	

Scout reserves the right to make changes and improvements in equipment, design and vendored equipment items, at any time without notification.

THIS PAGE WAS LEFT BLANK
INTENTIONALLY

CERTIFICATIONS & SPECIFICATIONS ***** For Export Only *****

To be in compliance with European directives for recreational boats as published by the International Organization for Standardization (ISO) in effect at the time this boat was manufactured, we are providing the following information.

Manufacturer:

Name: Scout Boats

Address: 2531 Hwy 78 West

Summerville, South Carolina Zip Code: 29483

Identification Numbers:

Hull Identification Number: _____

Port Engine Serial Number: _____

Starboard Engine Serial Number: _____

Intended Design Category:

Ocean: _____ Inshore: _____

Offshore: X Sheltered Waters: _____

Weight and Maximum Capacities:

Unladen Weight: - Kilograms (Pounds) _____

Maximum Load: - Weight - Kilograms (Pounds) _____

Number of People: _____

Maximum Rated Engine Horsepower - Kilowatts (Horsepower) _____

Certifications:

Certifications & Components Covered: _____



2017

3 YEAR STEM TO STERN WARRANTY

+

10 YEAR TRANSFERRABLE STRUCTURAL HULL WARRANTY

Scout Boats Inc. has a limited transferable warranty that insures to the purchaser that each hull is free from structural defects in materials and workmanship, (under normal care and use), for a period of **ten (10) years** from the original date of purchase. Scout Boats, Inc. agrees to repair or replace, (at our discretion, based on review and/or observation of the hull in question), to the purchaser, any boats(s) that is found to be defective during the applied warranty period. Scout Boats, Inc. also warrants for a period of **three (3) years** to the original purchaser, that each new hull is free from non-structural defects, (i.e. defective materials and/or workmanship). During this three year period Scout Boats, Inc. will cover the cost of replacing the part (both part(s) and labor), excluding engines, which will only be covered by their respective warranties.

In order to receive warranty service, the selling dealer must register the boat on www.dealerscircle.com, and the purchaser must take his/her boat to an authorized Scout Boats, Inc. dealer. Depending on the nature of the claim, Scout Boats, Inc. may require the boat to be returned to our factory at 2531 Highway 78 West, Summerville, SC 29483, in which case all transportation, haul-out, and/or loading charges shall be prepaid and the sole responsibility of the original purchaser. Scout Boats, Inc. will reimburse up to one half of such transportation charges to the original purchaser upon the discover of a valid and applicable warranty claim that is a direct result of improper manufacturing processes on the part of Scout Boats, Inc. or one of our suppliers. The original purchaser must remove and reinstall, at his/her own expense, all outboard engines, (if directly related to damage in question), as well as any and all personal effects and electronics equipment. The decision to repair, replace or make reimbursement for a particular boat or part shall be at the discretion of Scout Boats, Inc.

Online registration, a bill of sale, or proof-of-purchase demonstrating individual in question as the purchaser, along with a proof of customer's identity, is required before warranty service can be rendered.

Scout Boats, Inc. does not warrant: (1) any Scout Boat which has been powered or loaded in excess of the manufacturer's maximum horsepower or capacity recommendations. The maximum horsepower and capacity recommendations are shown on the certification plate affixed to every boat. (2) Any Scout Boat used in or for racing (of any type, organized or not), commercial fishing, chartering or other commercial use. (3) Any Scout Boat which has been subject to misuse, neglect, or structural alterations. (4) Gelcoat cracking, crazing, bubbling, or blistering. (5) Excessive wear due to unprotected and/or over exposure to the elements. (6) Any boat that has been deemed to have been misused neglected or re-powered by anyone other than the original purchaser. (7) Any Scout Boat sold to a customer, (who happens to be the original owner), by anyone other than an authorized Scout Boats, Inc. dealer. (8) Any Scout Boat that has been used on a trailer that does not adequately support the hull or any trailer that may be considered undersized, including any and all roller type trailers. (9) Any Scout Boat with a jack plate installed by anyone other than Scout boats, Inc., or an authorized dealer, or on any hull other than the 160, 170, 180, 190, 200, 220, or 240 models. Any Scout Boat with a jack plate of 8" or greater. (10) Any part or component not manufactured directly by Scout Boats, Inc. after the first three years of this warranty policy, (three years from date of purchase), will only have that particular manufacturer's warranty available.

Scout Boats, Inc. reserves the right to improve its product through changes in design or material without obligation to incorporate such changes on boats built prior to the implementation of respected change(s).

This warranty is in lieu of any other warranty implied or expressed. Scout Boats, Inc. accepts no responsibility for any representations, acts, or omissions of its dealer relating to the preparation and/or sale of Scout Boats, Inc. products to original consumer. This warranty is transferable, and to do so the original owner or purchaser must download a copy of the warranty transfer form from www.scoutboats.com from the warranty section of the website and mail it to Scout Boats, Inc. within 10 days of sale of his/her boat to the new owner. A notarized bill of sale and a \$100 administration fee payable to Scout Boats, Inc. must also be included with the notification of customer's intent to re-sell his/her boat.

Please mail to 2531 Hwy. 78 West, Summerville, SC 29483

◆ *By signing below I do hereby agree that I have read this Warranty Policy and do fully understand the terms and procedures listed within. I also attest and agree that my dealer, (listed below), has gone over this policy in full detail and has answered all of my questions regarding this policy and how it applies and has registered my boat online at www.dealerscircle.com*

Customer

Date

◆ *By signing below the dealership representative hereby agrees that the status of this boat has been changed to "delivered" on Dealer's Circle, in order for warranty to go into effect.*

Dealership Representative

Date

Log on to www.dealerscircle.com to complete the warranty registration process. Paper copies are for the dealer and customer records only. Please do not send Scout Boats, Inc. a copy of this agreement

◆ **WARRANTY WILL BE NULL AND VOID UNLESS THE BOAT IS REGISTERED ONLINE AT WWW.DEALERSCIRCLE.COM AT THE POINT OF SALE!!!**

Hull Identification Number: **SLP** _____
(located on the top right side of transom, under the rub rail)

Owner's Name: _____ Date: _____

Address: _____

City: _____ State: _____ Zip: _____

Date of Purchase: _____

Dealership: _____

Salesman's Name: _____

Dealership Address: _____

Brand of Engine: _____ Horsepower: _____

THIS PAGE WAS LEFT BLANK
INTENTIONALLY

OWNER'S / OPERATOR'S INFORMATION

Warranty and Warranty Registration Cards

The Scout Limited Warranty Statement is included with your boat. It has been written to be clearly stated and easily understood. If you have any questions after reading the warranty, please contact Scout Customer Service.

Scout, Yamaha Motor Corporation, engine manufacturers, and the suppliers of major components maintain their own manufacturer's warranty and service facilities. It is important that you properly complete the warranty registration cards included with your boat and engine(s) and mail them back to the manufacturers to register your ownership. This should be done within 15 days of the date of purchase and before the boat is put into service. A form for recording this information is provided at the beginning of this manual. This information will be important for you and service personnel to know, if and when you may need service or technical information.

The boat warranty registration requires the **Hull Identification Number "HIN"** which is located on the starboard side of the transom, just below the rubrail. The engine warranty registration requires the engine serial number(s). Please refer to the engine owner's manual for the location of the serial number(s).

IMPORTANT:

All boat manufacturers are required by the Federal Boat Safety Act of 1971 to notify first time owners in the event any defect is discovered "which creates a substantial risk of personal injury to the public." *It is essential that we have your warranty registration card complete with your name and mailing address in our files so that we can comply with the law if it should become necessary.*

Product Changes

Scout is committed to the continuous improvement of our boats. As a result, some of the equipment described in this manual or pictured in the catalog may change or no longer be available. *Scout reserves the right to change standard equipment, optional equipment and specifications without notice or obligation.* If you have questions about the equipment on your Scout, please contact Scout Customer Service.

Service

All warranty repairs must be performed by an authorized Scout Dealer. Should a problem develop that is related to



Hull ID Number on Starboard Transom

faulty workmanship or materials, as stated in the Limited Warranty, you should contact your Scout dealer to arrange for the necessary repair. If you are not near your dealer or another authorized Scout dealer or the dealer fails to remedy the cause of the problem, then contact the Scout Customer Service Department within 15 days. *It is the boat owner's responsibility to deliver the boat to the dealer for warranty service.*

Transferring The Warranty

For an administration fee of \$100, Scout will extend warranty coverage to subsequent owners of Scout models for the duration of the original warranty period. The Limited Warranty may be transferred to any subsequent purchaser of the vessel within seven years from the date of delivery to the original purchaser. Please refer to the Limited Warranty Statement for the procedure to transfer the warranty.

To take advantage of this program, notification of the change of ownership, including the new owner's name, address and telephone number together with the appropriate fee, must be sent to Scout within 10 days of the date of resale. Scout will confirm, in writing, that the transfer of the warranty has taken place. After which, the transferee will be treated as the original purchaser as outlined in the Scout Boats

Limited Warranty Statement.

Yamaha Engine Warranty

Yamaha is ready to stand behind your purchase with strong warranty coverage. To be sure you receive all the benefits of warranty for your engines, please take the following steps:

- Be sure your new Yamaha is registered for warranty. Your boat dealer should do this at the time of sale. Make sure your dealer gives you a copy of the completed Yamaha registration card for your records.
- Read the Yamaha Limited Warranty statement. This warranty applies to Yamaha outboard motors sold in the United States, whether purchased separately or when supplied as original equipment by a boat builder.
- If you need warranty repairs, you must take your Yamaha

outboard to an authorized Yamaha outboard dealer.

- If you are away from home, or your selling dealer is not an authorized Yamaha dealer, use the following toll-free numbers to find the nearest Yamaha dealer.

United States Dealer Locations: 1-800-692-6242

Canada Dealer Locations: 1-800-267-8577

- Your warranty applies specifically to repairs made in the country of purchase.
- If you need any additional information about your Yamaha or warranty coverage which your dealer cannot provide, please contact Yamaha Directly. Refer to your engine owner's manual for the address and phone number to contact Yamaha directly.

TABLE OF CONTENTS

Chapter 1:

PROPULSION SYSTEM

1.1 General	17
1.2 Drive System Corrosion	17
1.3 Engine Lubrication	18
1.4 Engine Cooling System	18
1.5 Propellers	18
1.6 Performance Issues and Propellers	18
1.7 Engine Instrumentation	19

Chapter 2:

HELM CONTROL SYSTEMS

2.1 General	21
2.2 Engine Throttle and Shift Control	21
2.3 Neutral Safety Switch	21
2.4 Engine Power Tilt and Trim	22
2.5 Engine Stop Switch	22
2.6 Steering System	23
2.7 Trim Tabs	23
2.8 Control Systems Maintenance	24

Chapter 3:

FUEL SYSTEM

3.1 General	25
3.2 Outboard Fuel System	26
3.3 Fueling Instructions	26
3.4 Fuel System Maintenance	27

Chapter 4:

ELECTRICAL SYSTEM

4.1 General	29
4.2 12-Volt System	29
4.3 AC System	32
4.4 Electrical System Maintenance	33

Chapter 5:

FRESH WATER SYSTEM

5.1 General	35
5.2 Fresh Water System Operation	35
5.3 Fresh Water System Maintenance	36

TABLE OF CONTENTS

Chapter 6:

RAW WATER SYSTEM

6.1 General	37
6.2 Raw Water System Operation	37
6.3 Livewell	38
6.4 Raw Water System Maintenance	39

Chapter 7:

DRAINAGE SYSTEMS

7.1 General	41
7.2 Cockpit Drains	41
7.3 T-Top and Hardtop Drains	41
7.4 Bilge Drainage	41
7.5 Fishboxes, Cooler and Storage Compartment Drains	42
7.6 Water System Drains	42
7.7 Rope Locker Drains	42
7.8 Drainage System Maintenance	42

Chapter 8:

VENTILATION SYSTEM

8.1 Head Compartment Ventilation	43
8.2 Maintenance	43

Chapter 9:

EXTERIOR EQUIPMENT

9.1 Deck	45
9.2 Hull	46
9.3 Cockpit Features	47

Chapter 10:

INTERIOR EQUIPMENT

10.1 Head Compartment	51
10.2 Marine Head System	51

Chapter 11:

SAFETY EQUIPMENT

11.1 General	55
11.2 Engine Alarms	55
11.3 Neutral Safety Switch	55
11.4 Engine Stop Switch	55
11.5 Required Safety Equipment	56
11.6 First Aid	57
11.7 Additional Safety Equipment	57
11.8 Caution and Warning Labels	58

TABLE OF CONTENTS

Chapter 12:

OPERATION

12.1 General	59
12.2 Rules of the Road	59
12.3 Pre-Cruise Check.....	61
12.4 Operating Your Boat.....	62
12.5 Docking, Anchoring and Mooring	63
12.6 Controls, Steering, or Propulsion System Failure:.....	65
12.7 Collision.....	65
12.8 Grounding, Towing and Rendering Assistance.....	65
12.9 Flooding or Capsizing.....	65
12.10 Fishing	65
12.11 Man Overboard.....	66
12.12 Trash Disposal.....	66
12.13 Trailering Your Boat	66

Chapter 13:

ROUTINE MAINTENANCE

13.1 Exterior Hull and Deck.....	69
13.2 Upholstery, Canvas and Enclosures	71
13.3 Interior	73
13.4 Bilge.....	73
13.5 Drainage System.....	73

Chapter 14:

SEASONAL MAINTENANCE

14.1 Storage and Lay-up.....	75
14.2 Winterizing	76
14.3 Recommissioning	78

Appendix A:

SCHEMATICS	79
------------------	----

Appendix B:

GLOSSARY OF TERMS	92
-------------------------	----

Appendix C:

MAINTENANCE SCHEDULE AND LOG	96
------------------------------------	----

Appendix D:

BOATING ACCIDENT REPORT	102
-------------------------------	-----

TABLE OF CONTENTS

Appendix E:
FLOAT PLAN 104

Appendix F:
TROUBLESHOOTING GUIDE 106

Chapter 1: PROPULSION SYSTEM

1.1 General

Your Scout is designed to be powered with 2-cycle or 4-cycle outboard motors. 4-cycle outboard engines do not use an oil injection system and are not equipped with remote oil tanks. They have an oil sump in the crankcase that must be kept full of the type of oil recommended by the engine manufacturer. The oil must be checked before each use and changed regularly.

Each manufacturer of the various outboard motors provides an owner's information manual with its product. It is important that you read the manual(s) very carefully and become familiar with the proper care and operation of the engines and drive systems. A warranty registration card has been furnished with each new engine and can be located in the engine owner's manual. All information requested on this card should be filled out completely by the dealer and purchaser and then returned to the respective engine manufacturer as soon as possible.



Outboard Engine



DO NOT ATTEMPT TO SERVICE ANY ENGINE OR DRIVE COMPONENT WITHOUT BEING TOTALLY FAMILIAR WITH THE SAFE AND PROPER SERVICE PROCEDURES. CERTAIN MOVING PARTS ARE EXPOSED AND CAN BE DANGEROUS TO SOMEONE UNFAMILIAR WITH THE OPERATION AND FUNCTION OF THE EQUIPMENT.



DO NOT INHALE EXHAUST FUMES! EXHAUST CONTAINS CARBON MONOXIDE THAT IS COLORLESS AND ODORLESS. CARBON MONOXIDE IS A DANGEROUS GAS THAT IS POTENTIALLY LETHAL.

1.2 Drive System Corrosion

Each outboard motor is a complete drive system with the gear case being just forward of the propeller and connected to the power head with a vertical drive shaft. All engines require some maintenance. Routine maintenance recommended for your engine is outlined in the engine owner's manual. Routine maintenance is normally the primary concern unless the boat is to be kept in saltwater for extended periods of time. Then the main concerns are marine growth and galvanic corrosion.

Marine growth occurs when components are left in the water for extended periods and can cause poor performance or permanent damage to the exposed components. The

type of growth and how quickly it occurs is relative to the water conditions in your boating area. Water temperature, pollution, current, etc. can have an effect on marine growth.

Galvanic corrosion is the corrosion process occurring when different metals are submerged in an electrolyte. Seawater is an electrolyte and submerged engine components must be properly protected. Outboard motors are equipped with sacrificial anodes to prevent galvanic corrosion problems. The anodes must be monitored and replaced as necessary. For locations and maintenance, please refer to the engine owner's manual.

When leaving the boat in the water, tilt the motors as high as possible. This will decrease the risk of marine growth around the cooling inlets, propeller and exhaust ports and damage from galvanic corrosion.



DO NOT PAINT THE OUTBOARD MOTOR WITH ANTI-FOULING PAINTS DESIGNED FOR BOAT HULLS. MANY OF THESE PAINTS CAN CAUSE SEVERE DAMAGE TO THE ENGINE. CONTACT YOUR SCOUT DEALER OR ENGINE MANUFACTURER FOR INFORMATION ON THE PROPER PAINTING PROCEDURES.

1.3 Engine Lubrication

2-cycle outboard motors are lubricated by a variable ratio oil injection system. The oil tanks are mounted below the cockpit floor near the transom.

Always monitor the oil level before each cruise by checking the gauge or indicator lights in the helm (not available on all engine installations) or visually checking the oil level using the reference marks on the tank.

When additional oil is needed, use only the type of oil specified by the engine manufacturer. Refer to the engine owner's manual for oil specifications and additional information on the oil injection system.

Note: Always monitor the oil level in the tank and only use the type of oil specified by the engine manufacturer. Yamaha engines specify Yamalube engine oil.

4-cycle outboard engines have an oil sump in the crankcase that must be kept full of the type and grade of oil recommended by the engine manufacturer. It is normal for 4-cycle engines to consume a small amount of oil. Therefore, the oil must be checked before each use and changed at regular intervals as instructed by the engine owner's manual. As with 2-cycle engines, use only the type of oil specified by the engine manufacturer.

1.4 Engine Cooling System

Outboard engines are raw water (seawater) cooled. Water is pumped through the water inlets, circulated through the engine block, and relinquished with the exhaust gases through the propeller hub. The water pump uses a small impeller made of synthetic rubber. The impeller and water pump cannot run dry for more than a few seconds. In most outboard motors, some cooling water is diverted through ports below the engine cowling. This allows the operator to visually check the operation of the cooling system. When the engine is started, always check for a steady stream of water coming out of those ports.

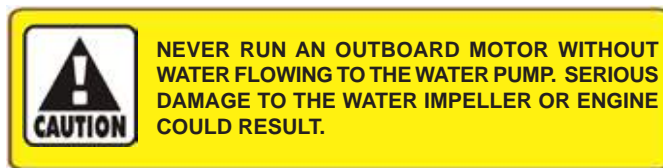

Typical Engine Oil Tank

Note: If the boat is used in salt or badly polluted water, the engines should be flushed after each use. Refer to the engine owner's manual for the proper engine flushing procedure.

1.5 Propellers

The propellers convert the engine's power into thrust. They come in a variety of styles, diameters and pitches. All boats powered by Yamaha engines are equipped with Yamaha "Salt-water Series" propellers. The one that will best suit the needs of your boat will depend somewhat on your application and expected average load. Propeller sizes are identified by two numbers stamped on the prop in sequence. The 1st number in the sequence (example 14" x 21") is the diameter of the propeller, and the 2nd number is the pitch. Pitch is the theoretical distance traveled by the propeller in each revolution.

Always repair or replace a propeller immediately if it has been damaged. A damaged and therefore out of balance propeller can cause vibration that can be felt in the boat and could damage the engine gear assembly. Refer to the engine owner's manual for information on propeller removal and installation.

1.6 Performance Issues and Propellers

It is extremely important that the boat is propped to run at or very near the recommended top RPM with an average load. If the top RPM is above or below the recommend range, the propellers must be changed to prevent loss of performance and possible engine damage.

Your boat is equipped from the factory with counter rotating

engines that are mounted to achieve quicker planing and optimum performance. Therefore, the left rotation engine is mounted on the port side of the transom and the right rotation engine is mounted on the starboard side. You should make sure that each propeller matches the rotation of the engine.

Note: Before changing propellers to correct boat performance problems, be sure other factors such as engine tuning, bottom and running gear growth, etc. are not the source of performance changes. Always be sure the load conditions are those normally experienced, before changing propellers.

Your boat was shipped with propellers that typically provide optimum performance for your boat. However there are factors that can affect performance and propeller requirements. Some are as follows:

- You should be sure the load conditions are those normally experienced. If the boat ran in the required RPM range when it was new and you have not added any additional gear or heavy equipment and have not damaged the propellers, there is a good chance the propellers are not the problem.
- The addition of heavy equipment like life rafts, additional coolers, etc., will cause additional load on the engines. Consequently, different propellers may be required.
- Outboard engines can be damaged and the warranty void if the boat is not propped correctly. Always consult your Scout dealer or authorized engine service dealer when making changes to the propellers or if the boat does not run near the top recommended RPM.
- Boats operated at high altitudes (above 2000 feet). Engines operated at high altitudes will not be able to develop as much horsepower as they do at or near sea level. Consequently, different propellers may be required.



Yamaha Saltwater Series Propeller



Command Link Engine Instrumentation

1.7 Engine Instrumentation

The helm station is equipped with a set of engine instruments and/or alarms. These instruments allow the operator to monitor the operational condition of the engines. Close observation of these instruments allows the operator to operate the engines at the most efficient level and could save them from serious costly damage. The instrumentation is unique to the type of outboard motors installed on your Scout. Some or all of the following gauges may be present.

Note: Most Scout boats are equipped with Yamaha engines and multifunction instruments. A brief description of those instruments and their function is listed in this section. Please refer to the Yamaha engine owner's manual for detailed information on the operation of the instruments.

Tachometer

The tachometer displays the speed of the engine in revolutions per minute (RPM). This speed is not the boat speed or necessarily the speed of the propeller. The tachometer may not register zero with the key in the "OFF" position.

Yamaha tachometers also contain the engine trim meter, oil

level indicator and the overheat warning indicator.

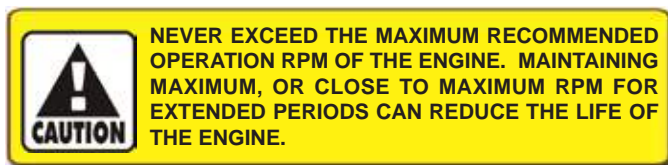

Speedometer

The speedometer indicates the speed of the boat in miles per hour. Most speedometers measure the water pressure against a small hole in a pickup tube located in the engine lower unit or mounted on the bottom of the transom. Yamaha speedometers also contain the fuel meter and low fuel warning light, a trip meter, a clock, and a voltmeter.

Overheat Warning Indicator

The temperature warning indicates that the temperature of the engine is too high. A sudden increase in the temperature could indicate an obstructed water inlet or an impeller failure. On Yamaha engines the overheat warning indicator is built into each tachometer and will start to blink if the engine temperature is too high.

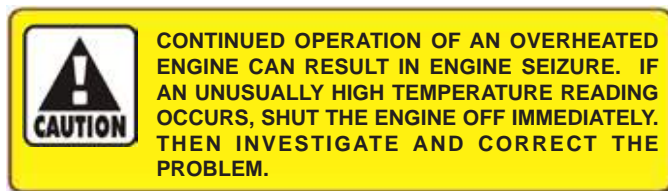

Fuel Gauges

The fuel gauge indicates the amount of fuel in the fuel tanks. On boats equipped with Yamaha engines, the fuel gauge is built into the Yamaha speedometer multi-gauge. The fuel indicator on the Yamaha gauge will begin to blink if the fuel in the monitored tank drops too low.

Voltmeter

The voltmeter displays the voltage for the battery and the charging system. The normal voltage is 11 to 12-volts with the engines off, and 13 to 14.5 volts with the engines running. The Yamaha engine voltmeter is built into the speedometer. It will begin to blink if the voltage in the battery drops too low.

Hour Meter

The hour meter keeps a record of the operating time for the engine.

Engine Tilt/Trim Gauge

The tilt/trim gauge monitors the position of the outboard engine. The upper range of the gauge indicates the tilt, which is used for trailering and shallow water operation. The lower range indicates the trim position. This is the range used to adjust the hull angle while operating your boat on plane. The Yamaha engine trim indicator is built into the tachometer. Please refer the engine owner's manual for more information on the operation of the outboard power tilt and trim.

Engine Alarms

All outboards are equipped with an audible alarm system mounted in the helm area that monitors selected critical engine systems. The alarm will sound if one of these systems begins to fail. Refer to the engine owner's manual for information on the alarms installed with your engines.

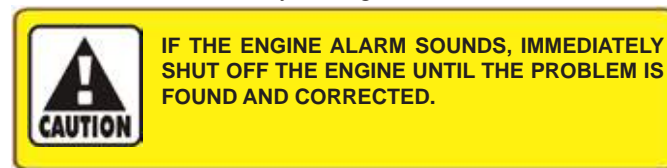

Fuel Management

Fuel management systems are standard equipment with some outboard engines. On Yamaha® engines, the fuel management gauge is a multifunction gauge used to monitor the gallons per hour, miles per gallon, total gallons used and engine synchronization.

If you have a fuel management system installed on your boat, please refer to the engine or fuel management manual for detailed information on that system.

Depth Gauge (Optional)

The depth gauge indicates the depth of the water below the bottom of the boat.

Compass

All boats are equipped with a compass on the top of the instrument panel. The compass cannot be adjusted accurately at the factory as it must be compensated for the influence of the electrical equipment and electronics unique to your boat. Therefore, the compass should be adjusted by a professional after the electronics and additional electrical accessories are installed and before operating the boat. To adjust the compass for your area, read the instructions on "Compass Compensation" given to you in the literature packet.

Instrument Maintenance

Electrical protection for instruments and ignition circuitry is provided by a set of fuses or circuit breakers located on each engine. The ignition switches should be sprayed periodically with a contact cleaner/lubricant. The ignition switches and all instruments, controls, etc. should be protected from the weather when not in use. Excessive exposure can lead to gauge and ignition switch difficulties.

Chapter 2: HELM CONTROL SYSTEMS

2.1 General

The helm controls consist of three systems: the engine throttle and shift controls, the steering system, and the trim tab control switches. These systems provide the operator with the ability to control the direction and attitude of the boat from the helm station.

Each manufacturer of the control components provides an owner's manual with its product. It is important that you read the manuals and become familiar with the proper care and operation of the control systems.

2.2 Engine Throttle and Shift Control

The shift and throttle controls on your boat may vary depending on the engines used. The following control description is typical of most outboard remote controls. Refer to the engine or control manuals for specific information on the controls installed on your boat.

The engine throttle and shift control systems consist of three major components: the control handles, the throttle cable and the shift cable. The cables are all the push-pull type. Two cables are required for each engine. One cable connects the remote throttle control to the carburetor or fuel injectors and the other connects the remote shift control to the engine shift rod linkage.

The helm on your Scout is designed for a binnacle style control with a single lever for each engine that operates as a gear shift and a throttle. General operation will include a position for neutral (straight up and down), a forward position (the 1st detent forward of neutral), and a reverse position (the 1st detent aft of neutral). Advancing the control lever beyond the shift range advances the throttle in forward or reverse. Each control is equipped with a means of permitting the engine to be operated at a higher than idle RPM while in neutral for cold starting and warm-up purposes.

The handles of dual lever controls may not always align with each other at all RPM settings due to variations in control cable routing, cable length and adjustments at the engine. Usually the alignment of the handles can be optimized at a chosen RPM, but may vary at other settings.



Yamaha Engine Controls

2.3 Neutral Safety Switch

Every control system has a neutral safety switch incorporated into it. This device prohibits the engine from being started while the shift lever is in any position other than the neutral position. If the engine will not start, slight movement of the shift lever may be necessary to locate the neutral position and disengage the safety cutout switch. Control or cable adjustments may be required to correct this condition should it persist. See your Scout dealer for necessary control and cable adjustments.

The neutral safety switches should be tested periodically to ensure that they are operating properly. To test the neutral safety switches, make sure the engines are tilted down and move the shift levers to the forward position.

Make sure the throttle control levers are not advanced past the idle position. Turn the ignition key to the start position just long enough to briefly engage the starter for the engine.

Do not hold the key in the start position long enough to start the engine. The starter should not engage for either engine. Repeat this test with the shift levers in reverse and the engine throttles at idle. Again, the starter should not engage for either engine. If the starter for either engine engages with the shift controls in any position other than the neutral position, then the neutral safety switch is not functioning properly and you should contact your dealer to have the neutral safety switch repaired by a qualified marine mechanic before using the boat. If an engine starts in gear during this test, immediately move the control lever to the neutral position and turn the engine off.



IN SOME SITUATIONS, IT MAY BE POSSIBLE TO ACCIDENTALLY START THE ENGINES IN GEAR WITH THE THROTTLES ABOVE IDLE IF THE NEUTRAL SAFETY SWITCH IS NOT OPERATING PROPERLY. THIS WOULD CAUSE THE BOAT TO ACCELERATE UNEXPECTEDLY IN FORWARD OR REVERSE AND COULD RESULT IN LOSS OF CONTROL, DAMAGE TO THE BOAT, OR INJURY TO PASSENGERS. ALWAYS TEST THE NEUTRAL SAFETY SWITCH PERIODICALLY AND CORRECT ANY PROBLEMS BEFORE USING THE BOAT.



THE ENGINE HOSES AND CABLES OR THE TRANSOM GEL COAT CAN BE DAMAGED BY TILTING THE ENGINES TO THE FULL UP POSITION WITH THE ENGINES TURNED TO THE WRONG POSITION. MOST BOATS REQUIRE THE STEERING WHEEL TO BE TURNED COMPLETELY TO STARBOARD BEFORE TILTING THE ENGINES TO THE FULL UP POSITION. YOU SHOULD MONITOR EACH ENGINE AS IT TILTS TO DETERMINE BEST FULL TILT ENGINE POSITION FOR YOUR BOAT.



SOME AUTOPILOTS HAVE ENGINE POSITION SENSORS THAT ARE MOUNTED TO THE HYDRAULIC STEERING CYLINDER. WITH THESE AUTOPILOTS, THE ENGINE POSITION SENSOR BRACKET COULD HIT THE TRANSOM WHEN THE ENGINES ARE TILTED TO THE FULL UP POSITION AND CAUSE DAMAGE TO THE ENGINE RIGGING, THE AUTOPILOT OR THE TRANSOM. IF YOU HAVE AN AUTOPILOT INSTALLED ON YOUR BOAT, YOU SHOULD MONITOR THE LOCATION OF THE ENGINE CABLES AND AUTOPILOT BRACKETS AS THE ENGINES ARE TILTED TO DETERMINE THE BEST ENGINE POSITION AND MAXIMUM ENGINE TILT FOR YOUR APPLICATION.

2.4 Engine Power Tilt and Trim

All outboard engines have a tilt and trim feature. Most outboard engines have tilt/trim switches built into the engine shift and throttle controls that allow the operator to control the position of the outboards from the helm. Typically, a switch or switches on the port control lever grip activates the tilt/trim for the engines. Some engine controls have two switches on the control cover to activate each engine individually.

Moving the outboard closer to the boat transom is called trimming “in” or “down.” Moving the outboard further away from the boat transom is called trimming “out” or “up.” In most cases, the boat will run best with the outboard adjusted so the hull will run at a 3 to 5 degree angle to the water.

The term “trim” generally refers to the adjustment of the outboard within the first 20° range of travel. This is the range used while operating your boat on plane. The term “tilt” is generally used when referring to adjusting the outboard further up for shallow water operation or trailering. For information on the proper use and maintenance of the power tilt and trim, please refer to the engine owner’s manual.

2.5 Engine Stop Switch

Your boat is equipped with an engine stop switch and lanyard. When the lanyard is pulled it will engage the switch and shut off the engines. We strongly recommend that the lanyard be attached to the driver whenever the engines are running. If an engine will not start, it could be because the lanyard is not properly inserted into the engine stop switch. Always make sure the lanyard is properly attached to the engine stop switch before attempting to start the engines.

Refer to the engine owner’s manual for more information on the engine stop switch.

2.6 Steering System

The steering system is hydraulic and made of three main components: the helm assembly, hydraulic hoses



Engine Stop Switch

and a hydraulic steering cylinder. The helm unit acts as both a fluid reservoir and pump. Turning of the helm, or steering wheel, pumps the fluid in the hydraulic hoses and activates the hydraulic cylinder causing the motors to turn. A slight clicking sound may be heard as the wheel is turned. This sound is the opening and closing of valves in the helm unit and is normal.

The steering wheel can be tilted to five different positions by activating the tilt lock lever located on the bottom side of the helm station. When the lever is released, it automatically locks the steering wheel at or close to that angle. Refer to the steering manufacturer owner's manual for specific information on the steering system.

Dual outboards are coupled at the tiller arms by a tie bar and controlled by the steering cylinder. The engines must be aligned to provide maximum stability on straight ahead runs and proper tracking through corners. Dual outboards are aligned so the engines are towed out slightly (.25" to .5") at the propellers. Engine or steering system damage may require the engines to be realigned.



Helm

2.7 Trim Tabs

The trim tabs are recessed below the swim platform and integrated transom engine mounting system. A dual rocker switch is used to control the trim tabs. The switch controls bow up and down movements. It also controls starboard and port up and down movements. Bow up and bow down will control the hull planing attitude, while port and starboard up and down provides control for the hull listing.

Before leaving the dock, make sure that the tabs are in the full "UP" position by holding the control in the bow up position for ten (10) seconds.

Always establish the intended heading and cruise speed before attempting to adjust the hull attitude with the trim tabs. After stabilizing speed and direction, move the trim tabs to achieve a level side to side running attitude being careful not to over trim.

After depressing a trim tab switch, always wait a few seconds for the change in the trim plane to take effect. **Avoid depressing the switch while awaiting the trim plane reaction.** By the time the effect is noticeable the trim tab plane will have moved too far and thus the boat will be in an overcompensated position.

When running at a speed that will result in the boat falling off plane, lowering the tabs slightly, bow down, will improve the running angle and operating efficiency. Too much bow down tabs can reduce operating efficiency and cause substantial steering and handling difficulties.



Trim Tab Switch with Optional Indicators

Be extremely careful when operating in a following sea. The effect of trim tabs is amplified under such conditions. Steering and handling difficulties can result from improper trim tab usage, particularly in a following sea. Always raise the tabs to the full bow up position in these conditions.

When running at high speeds be sure that the tabs are in the full "UP" position. Only enough trim plane action should be used to compensate for any listing. Trim tabs are extremely sensitive at high speeds. Adjust for this and be prepared to slow down if difficulties arise.

When running into a chop, a slight bow down attitude will improve the ride. Be careful not to over trim. Handling difficulties may result.

2.8 Control Systems Maintenance

Control Maintenance

Periodic inspection of the control systems and all connections should be made. Signs of rust, corrosion, wear, or other deterioration should immediately be serviced. Generally, periodic lubrication of all moving parts and connections with a light waterproof grease is in order.

Lubrication should be performed as often as necessary to keep the system operating smoothly.

Control system adjustments may become necessary. If adjustments become necessary, see your Scout dealer.

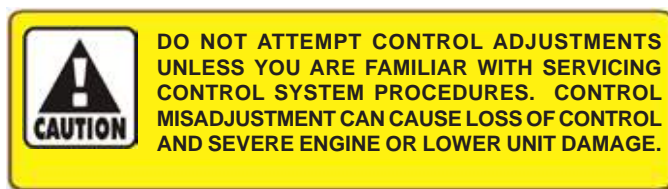

Steering System Maintenance

A periodic inspection of all steering hoses, linkage and helm assemblies should be made. Signs of corrosion, cracking, loosening of fastenings, excessive wear, or deterioration should be immediately corrected. Failure to do so could lead to steering system failure that would result in loss of control.

When new, or after repairs, hydraulic steering systems may need to have all air purged from the system. Check the steering fluid level in the helm, it should be maintained at no less than 1/2" below the bottom of the filler cap threads. The steering system is hydraulic and made of two main components: the helm assembly and the hydraulic cylinder. The helm unit acts as both a fluid reservoir and pump. Turning of the helm, or steering wheel, pumps the fluid in the hydraulic hoses and activates the hydraulic cylinder causing the motors to turn. A slight clicking sound may be heard as the wheel is turned. This sound is the opening and closing of valves in the helm unit and is normal. Refer to the steering manufacturer owner's manual for specific information on the steering system.

When new, or after repairs, hydraulic steering systems may need to have all air purged from the system. If your boat is equipped with a tower and two helms, the bottom helm fill plug is sealed and the steering fluid is checked and filled at the top helm.

Remove, clean and grease the engine support tube and rod annually with quality marine grease. Refer to the hydraulic



Helm Filler Cap

steering manufacturer owner's manual for proper specifications and details on system service and maintenance.

Trim Tab Maintenance

The trim tab actuators are electric and require no routine maintenance except to periodically inspect the tab actuators for corrosion or marine growth and test the system to ensure that it is operating properly.

Marine growth can interfere with the proper operation of the trim tab planes and actuators. To reduce problems due to marine growth, always return the trim tabs to the full "UP" position after operating the boat and periodically inspect and clean marine growth from the actuators and planes.

If the boat is kept in the water, the trim tabs must be equipped with a zinc anode to prevent galvanic corrosion. Galvanic corrosion is the corrosion process occurring when different metals are submerged in an electrolyte. Seawater is an electrolyte and submerged metal components must be properly protected. The anodes will need to be changed when they are 75% of their original size. Refer to the Routine Maintenance chapter of this manual for information on maintaining zinc anodes.

To discourage any marine growth on tab or actuator, antifouling paint can be applied. When applying paint to the actuator, make sure it is fully retracted. **Do not paint the stainless ram above the area that is exposed when retracted. The bottom paint will damage the O-ring seals when the ram is retracted and allow sea water to enter the actuator motor.** Contact your dealer or the trim tab manufacturer for information regarding the correct bottom paint for the trim tabs.

Refer to the trim tab owner's manual for additional maintenance information, specifications, troubleshooting and operating instructions.

Chapter 3:

FUEL SYSTEM

3.1 General

The gasoline fuel system used in Scout boats is designed to meet or exceed the requirements of the U.S. Coast Guard, the Boating Industry Association, and The American Boat and Yacht Council in effect at the time of manufacture.

All gasoline fuel systems have been factory inspected and pressure tested in accordance with regulations in effect at the time of manufacture. This inspection assures that the system is air tight, leak proof and safe. It is the responsibility of the purchaser to maintain it in that condition. Make frequent inspections to assure that no deterioration or loosening of connections is resulting from vibration.



DO NOT LET THE ODOR OF GASOLINE GO UNCHECKED. ANY ODOR OF GASOLINE MUST BE IMMEDIATELY INVESTIGATED AND STEPS TAKEN TO PROTECT THE BOAT AND ITS OCCUPANTS UNTIL THE PROBLEM IS CORRECTED. IF THE ODOR OF GASOLINE IS NOTED, SHUT OFF ALL ENGINES AND ELECTRICAL EQUIPMENT. INVESTIGATE AND CORRECT THE SITUATION IMMEDIATELY. HAVE ALL PASSENGERS PUT ON PERSONAL FLOTATION DEVICES AND KEEP A FIRE EXTINGUISHER READY UNTIL THE SITUATION IS RESOLVED.



Fuel Fill

turn the center of the cap clockwise to lock it in the closed position.

Be sure to use the proper type and grade fuel. Refer to the engine owner's manual for additional information.

Note: Do not overtighten the fuel cap. If the cap is overtightened, the O-ring seal could be damaged allowing water to contaminate the fuel system.

Fuel Withdrawal Tubes

The fuel withdrawal tubes are positioned in the fuel tank to achieve optimum fuel usage, fuel line routing, etc. At certain speeds and hull trim angles, the fuel supply at the withdrawal tank location can increase or decrease accordingly. Be extremely careful when attempting to operate the boat when low on fuel. Though some fuel may be in the tank, the relative trim angle of the boat may cause the fuel to flow away from the withdrawals.

Fuel Gauge

This indicates the amount of fuel in the tank. Due to the mechanical nature of the fuel sender, variations in readings during various speeds of operation may occur. This system is merely a relative indication of the available fuel supply and not a calibrated instrument.

Fuel Fill

A "keyless" fuel fill deck plate is located on the port gunnel that is marked "GAS." After fueling, install the fuel cap and tighten. Once the cap is tight, simultaneously press down and

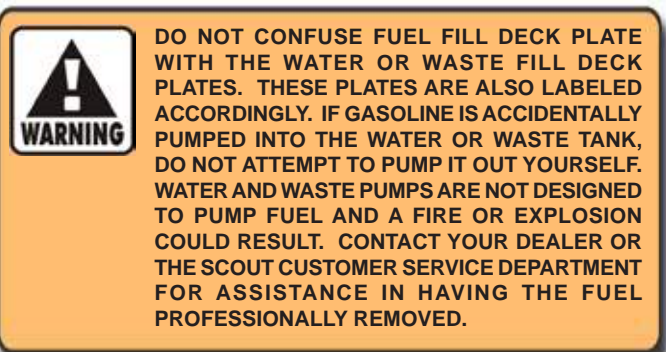

Fuel Tank Vent

There is a fuel tank vent fitting on the port side of the hull. While the tank is being filled, the air displaced by the fuel escapes through the vent. When the tank is full, fuel will be ejected from the fuel vent.

After fueling, replace the fill cap, and wash the areas around the fuel fill plate and below the fuel vent. Residual fuel left on the deck and hull sides can be dangerous, and will yellow the fiberglass or damage the striping.

3.2 Outboard Fuel System

The fuel system on the Scout has one fuel tank. Each fuel withdrawal line is equipped with an anti-siphon valve where the line attaches to the fuel tank. This valve prevents gasoline from siphoning out of the fuel tank should a line rupture.



DO NOT REMOVE THE ANTI-SIPHON VALVES FROM THE SYSTEM. SHOULD THE VALVE BECOME CLOGGED, CLEAN AND REINSTALL OR REPLACE.

The fuel filters are installed in the stern bilge of the boat. They are accessed through the center stern hatch. The filters are the water separator type and should be serviced frequently to assure an adequate supply of clean, dry fuel to the engines. It is recommended that the filters are inspected periodically and the elements changed as needed.

There is a primer bulb in each fuel line located near the fuel filter that is used to prime the fuel system after service or as required. See Fuel System Maintenance and the engine owner's manual for additional information on the fuel filters and the outboard engine fuel system..



Typical Fuel Filter

3.3 Fueling Instructions



FUEL IS VERY FLAMMABLE. BE CAREFUL WHEN FILLING THE FUEL TANK. NO SMOKING. NEVER FILL THE TANK WHILE THE ENGINE IS RUNNING. FILL THE FUEL TANK IN AN OPEN AREA. DO NOT FILL THE TANK NEAR OPEN FLAMES.



TO PREVENT DAMAGE TO THE FUEL SYSTEM, USE ONLY A GOOD GRADE OF GASOLINE FOR OUTBOARD ENGINES. DO NOT USE A FUEL THAT CONTAINS HARSH ADDITIVES OR IS AN ALCOHOL BLEND. ANY DAMAGE DONE TO THE FUEL SYSTEM THAT IS THE RESULT OF USE OF AN ALCOHOL BLEND, IS NOT COVERED BY THE SCOUT WARRANTY. REFER TO THE ENGINE MANUFACTURER OWNER'S MANUAL FOR THE FUEL REQUIREMENTS FOR YOUR ENGINES.

To fill the fuel tank at a marina, follow this procedure:

1. Make sure all switches are in the "Off" position.
2. Make sure the boat is securely moored.
3. Make sure all passengers leave the boat.
4. Estimate how much fuel is needed and avoid over filling the tank.

Note: When the fuel tank is full, fuel will come out through the fuel vent. The fuel vent is located on the port side of the boat.

5. A special keyless fuel cap is supplied.
6. Turn the cap counterclockwise to open the fuel fill.
7. Remove the cap.
8. Put the nozzle in the fuel opening.



STATIC ELECTRICITY CAN BE GENERATED WHILE FUELING AND CAN CAUSE A FIRE OR EXPLOSION. TO PREVENT STATIC SPARKS WHEN FILLING THE TANK, MAKE SURE THE NOZZLE IS IN CONTACT WITH THE FUEL OPENING.



SPILLED FUEL IS DANGEROUS AND CAN YELLOW FIBERGLASS OR IGNITE. MAKE SURE YOU DO NOT SPILL ANY FUEL. IF FUEL IS SPILLED ON THE DECK, USE A CLOTH TO REMOVE THE FUEL AND PROPERLY DISPOSE OF THE CLOTH ON SHORE. IF FUEL IS SPILLED ON THE WATER, EXERCISE EXTREME CAUTION. FUEL FLOATS ON TOP OF THE WATER AND CAN IGNITE. IF EXCESS FUEL IS SPILLED INTO THE WATER, IMMEDIATELY EVACUATE THE AREA AND NOTIFY THE MARINA AND THE PROPER OFFICIALS.

9. Fill the fuel tank slightly less than the rated capacity to allow for expansion to avoid spilling fuel out of the vents and fuel fills.
10. Remove the nozzle.
11. Install and tighten the fuel cap. Be careful not to over-tighten the cap. Once the cap is tight, simultaneously press down and turn the center of the cap clockwise to lock it in the closed position.
12. Check the fuel compartment and below the deck for fuel odors. If you smell fuel, do not start the engine.



TO REDUCE THE RISK OF A FIRE AND/OR EXPLOSION, DO NOT START THE ENGINE WHEN FUEL FUMES ARE PRESENT. FUEL FUMES ARE DANGEROUS AND HARMFUL TO YOUR HEALTH. MAKE SURE ALL GASOLINE ODORS ARE INVESTIGATED IMMEDIATELY.

3.4 Fuel System Maintenance

Periodically inspect all primer bulbs, connections, clamps and hoses for leakage and damage or deterioration. Replace as necessary. Spray the valves, tank fuel gauge sender and ground connections with a metal protector.

Frequently inspect and lubricate the fuel fill cap O-ring seal with petroleum jelly or silicone grease. The O-ring seal prevents water from entering the fuel system through the fuel fill cap and it should be immediately replaced if there is any sign of damage or deterioration.

The fuel vent screen should be clear and free from corrosion and salt buildup. The screen will prevent insects and other foreign matter from contaminating the fuel and fuel system. Fuel vent should be replaced if the vent or screen are damaged or badly corroded. Fuel vent screens that are clogged

will prevent the fuel tank from venting properly and make filling the fuel tank difficult or cause fuel supply problems to the engine.

Contaminated fuel may cause serious damage to your engines. The filters must be checked for water and other contamination frequently. The filter elements must be changed at least once a season or more frequently depending on the type of engines and the quality of the fuel. Please refer to the engine or fuel filter manufacturer's instructions for information on servicing and replacing the fuel filter elements.

The age of gasoline can effect engine performance. Chemical changes occur as the gasoline ages that can cause deposits and varnish in the fuel system as well as reduce the octane rating of the fuel. Severely degraded fuel can damage the engine and boat fuel tank and lines. Therefore, if your boat is not being run enough to require at least one full tank of fresh fuel a month, a fuel stabilizer should be added to the gasoline to protect the fuel from degradation. Your dealer or the engine manufacturer can provide additional information on fuel degradation and fuel stabilizers recommended for your engine.

Avoid using fuels with alcohol additives. Gasoline that is an alcohol blend will absorb moisture from the air which can reach such concentrations that "phase separation" can occur whereby the water and alcohol mixture becomes heavy enough to settle out of the gasoline to the bottom of the tank. Since the fuel pick up tube is very near the bottom of the tank, phase separation can cause the engine to run very poorly or not at all. This condition is more severe with methyl alcohol and will worsen as the alcohol content increases. Water or a jelly like substance in the fuel filters are an indication of phase separation from the use of alcohol blended fuels.



DO NOT DRAIN ANY FUEL INTO THE BILGE WHEN SERVICING THE FUEL SYSTEM. THIS COULD LEAD TO A FIRE OR EXPLOSION.

AFTER THE FILTER ELEMENT HAS BEEN CHANGED, PRIME THE FUEL SYSTEM AND CHECK ALL FITTINGS FOR LEAKS BEFORE AND AFTER STARTING THE ENGINES.

BEFORE STARTING THE ENGINES, ALWAYS OPEN ALL HATCHES, WINDOWS, AND DOORS TO COMPLETELY VENTILATE THE BOAT AFTER SERVICING THE FUEL SYSTEM.

THIS PAGE WAS LEFT BLANK
INTENTIONALLY

Chapter 4: ELECTRICAL SYSTEM

4.1 General

Your Scout is equipped with a 12-volt DC electrical system and a standard onboard charging system. The battery charger draws current from a stand-alone plug that is plugged into a standard 110-volt outlet or through the optional shore power system when plugged in at a dock. The DC system draws current from the house battery bank which consists of 2 batteries hooked in parallel.

Your boat and engine charging system is designed for 12-volt, lead acid wet cell marine batteries. They will require similar maintenance as those found in automobiles.

All wires in the electrical systems are color coded to make identifying circuits easier. Wiring schematics have been included with this manual to aid in following an individual circuit of the boat.

4.2 12-Volt System

The 12-volt system is a fairly standard system. There are (4) batteries, one for the starboard engine, one for the port engine, and two for the house, windlass and 12-volt accessories. The batteries are located behind the aft hatch in the head compartment. They are controlled by (2) battery switches, one for the port and starboard engines and one for the house and accessories. The batteries themselves can be charged by the engines or by the battery charger when hooked to shore power.

All 12-volt power is distributed to the 12-volt accessories through individual circuit breakers located in the 12-volt switch panels. A main helm circuit breaker, located near the battery switches, protects the system from an overload. Other circuit breakers, located near the battery switches, protect the circuit for the trim tabs, the automatic float switches for the bilge pumps and the stereo and electronics memory. Most 12-volt accessories are operated directly by switches in the helm accessory switch panel or separate accessory switch panels.

Main breakers or fuses located on the engine protect the ignition systems and gauges. Yamaha engine electrical circuits are protected by fuses located in a fuse panel on the side of the engine. The fuse panel is equipped with a spare fuse for each circuit. Always replace fuses used with the fuse specified by Yamaha or your engine manufacturer. Refer to the engine owner's manual for more information on the fuses, fuse panels or circuit breakers on your engines.



Battery Switches (red)

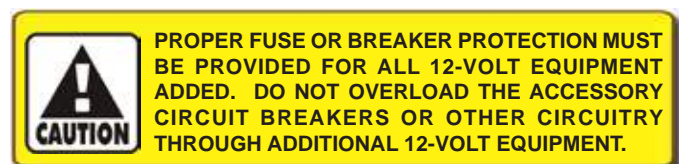

Batteries and Battery Switches

The DC electrical systems and the engines on your boat are designed for wet cell, marine batteries. Do not attempt to use gel cell or absorbed wet mat batteries. The engine charging system is not designed to recharge these batteries which could cause unusually short battery life or engine starting problems. You also should not mix the size or brand of the batteries. Always consult your Scout dealer before changing the type of batteries in your boat.

Your boat has provisions for 4 batteries, 1 for the port engine, 1 for the starboard engine and 2 that are hooked in parallel for all other 12-volt accessories or electronics (house battery bank). If the batteries are changed the house batteries should stay at the same size and capacity or consider increasing the capacity if you will be trolling, drift fishing or have extensive electronics on board. Larger batteries will give you additional capacity to operate the bait well, wash down and electronics at low speed when the charging system output of the engines is minimal. The engine batteries should be of size and capacity recommended by the manufacturer of your engine. See the engine owner's manual.

There are (2) battery switches located on the main distribution panel inside the console. One battery switch feeds the port and starboard engine and the second switch activates the house and 12-volt accessory circuits.

Each engine charges the battery that feeds it. Each engine also charges the house bank through a VSR (voltage sensitive relay) battery isolator system and through the engine isolator charging circuit. The VSR and the engine isolator charging circuit manage the charging current for the 12-volt system whenever the engines are running. These systems automatically sense the condition of each battery and direct the available current to the batteries that require charging. When one or both engines are started, the engine alternator(s) start to recharge the batteries. This charging current passes through the VSR and the engine isolator charging circuit. These circuits sense the charge and it is split between the batteries, with the lowest battery receiving the most charge. When the engines are turned off all charging stops and all sensing circuits turn off thereby automatically isolating the batteries from one another. The engine isolator charging circuits from each engine have a 50 amp breaker which is located on the port and starboard walls of the aft bilge. It is recommended to check these breakers periodically and make sure they are not tripped.

When in port or at anchor the switch that supplies the engines should be off. This will keep the engine starting batteries in reserve for starting the engines. Both battery switches should be in the "OFF" position when leaving the boat unattended.

Note: Current is supplied to the automatic float switches for the bilge pumps when the batteries are connected, even if the battery switch is off.



Helm Gauges and Switch Panel

12-Volt Accessory Switch Panel

The main accessory switch panel is located at the helm. The circuit breakers that protect the accessories are located in the panel near the switches.

The following is a description of the accessories controlled by the main accessory switch panel:

Horn

Activates the boat horn.

Aft Bilge

Manually activates the aft bilge pump located in the stern bilge near the transom. The pump moves water out through a thru-hull fitting in the hull. The pump is also activated by an automatic float switch that is activated whenever the batteries are connected. This pump will run as needed whenever the water in the bilge accumulates high enough to raise the float switch to the "ON" position and turn off when the water is removed.

Fwd Bilge

Manually activates the forward bilge pump located in the forward bilge below the floor grate in the head compartment. The pump moves water out through a thru-hull fitting in the hull. The pump is also activated by an automatic float switch that is activated whenever the batteries are connected. This pump will run as needed whenever the water in the bilge accumulates high enough to raise the float switch to the "ON" position and turn off when the water is removed.

Note: The bilge pumps will start automatically when there is sufficient water in the bilge to activate the float switch. Each float switch is protected by a circuit breaker located near the battery switches and is always supplied current when the batteries are connected.

Running Lights

The switch is a three-position switch. The middle position is "OFF." Moving the switch in one direction will activate the navigation lights. Moving the switch in the opposite direction activates the anchor light.

Interior Lights

Activates the lighting in the head compartment. Also activates the light in the battery compartment which is located behind a hatch in the head compartment. The light in the head can be switched on and off with the switch on the light fixture once it is activated by the interior light switch.

Courtesy Lights

Activates the lights that illuminate the cockpit and helm area.

12-Volt Receptacle

Provides electrical current for portable 12-volt equipment.

Aerator

Activates the livewell circulating pump that supplies water to the standard livewell.

Livewell Light

Activates the lights in the livewell, the forward console cooler, and the light in the optional leaning post livewell.

Leaning Post Recirculating Pump_____

Activates the livewell circulating pump that supplies water to the optional leaning post livewell.

Leaning Post Aerator

Activates the livewell circulating pump that aerates the optional leaning post livewell.

Washdown

Activates the raw or fresh water washdown pump. The pump is the pressure demand type. The pressure switch automatically controls the water pump when the system is activated and properly primed.

Note: Please refer to the **Fresh and Raw Water System chapters for more information on the livewell and washdown systems.**

Accessory Switch (1)

This switch is supplied to protect additional equipment that may have been installed by Scout or your Scout dealer. If no accessories are activated by this switch, it remains wired in the panel in reserve.

Additional DC Switch Panels

Trim Tab Switch

Located in the helm. This switch controls the trim tab planes located on the transom of the boat. It is protected by a circuit breaker located in the 12-volt helm switch panel. Please refer to the Helm Control Systems chapter for detailed information on the operation of the trim tab controls.

Hidaway Door Switch

Located in the helm. Opens and closes the electrically activated panel that covers the instruments and electronics. It is protected by a circuit breaker in the panel below the switch.

Engine Trim and Tilt Switches

Located in the helm. These switches may be installed in the engine control handle or on the helm console, depending on the engines or controls installed in your boat. They control the trimming and tilting of the engines. Please refer to the Helm Control Systems chapter and the engine owner's manual for information regarding the proper use of the tilt and trim switches.

Windlass Switch (Optional)

Located in the helm. This switch controls the optional windlass which is mounted to the deck directly above the rope locker. It is protected by a circuit breaker of the type and rating recommended by the windlass manufacturer that is located near the battery switches.

Spreader Lights

Located on the side of the electronics locker. There are 2 switches. One switch activates the aft spreader light and one switch activates the fwd spreader light.

Console Courtesy and Map Light

Located on the switch panel with the spreader light switches. Moving the switch up activates the courtesy light over the helm and moving the switch down activates the map light. The switch is off in the center position.

Holding Tank Discharge

Activates the overboard diaphragm discharge system for the holding tank and marine head.

4.3 AC System

AC Battery Charger

The battery charging system is fed 120-volt AC current by a power cable connected to a shore side outlet and the shore power inlet located in the cockpit. It is wired totally separate from the 12-volt DC system and charges all batteries simultaneously when connected.

Note: The power cord used for the battery charger is not equipped with lock rings on the shore side or boat connector plugs. The battery charger has built in reverse polarity protection and the circuit is not equipped with a reverse polarity light.



TO REDUCE THE RISK OF ELECTRICAL SHOCK IN WET WEATHER, AVOID MAKING CONTACT WITH THE SHORE CABLE OR MAKING A CONNECTION TO A LIVE SHORE OUTLET. NEVER SPRAY WATER ON ELECTRICAL CABLES WHILE WASHING DOWN DECKS.

TO REDUCE THE POSSIBILITY OF AN ELECTRICAL SHOCK, IT IS IMPORTANT THAT THE AC GROUND SYSTEM IS FUNCTIONING PROPERLY AND THAT A PROPER CONNECTION EXISTS BETWEEN THE SHORE POWER CORD AND THE SHORE POWER INLET AND THE OUTLET GROUND CIRCUITS. IF THERE IS ANY DOUBT ABOUT THE INTEGRITY OF THE GROUND CIRCUIT, A QUALIFIED MARINE ELECTRICIAN SHOULD BE CONTACTED IMMEDIATELY AND THE AC SHOULD BE DISCONNECTED UNTIL THE NECESSARY REPAIRS ARE COMPLETED.



120-Volt Power Inlet



UNDETECTED FAULTS IN THE AC BATTERY CHARGING SYSTEM COULD CAUSE THE WATER AROUND THE BOAT TO BECOME ENERGIZED. THIS COULD CAUSE A SEVERE SHOCK OR EVEN DEATH TO SOMEONE IN THE WATER NEAR THE BOAT. NEVER SWIM OR ALLOW SWIMMING AROUND THE BOAT WHEN THE BATTERY CHARGING SYSTEM IS ACTIVATED BY THE SHORE POWER CONNECTION.

Recommended Procedure For Making a Shore Connection

If the dockside outlet includes a disconnect switch, turn it to the “OFF” position. To avoid strain on the cable make sure it has more slack than the mooring lines. Dress the cable so that it cannot be damaged by chafing between the boat and the dock. Make sure the cable does not come in contact with the water. Then connect the cable in the plug inlet making sure the connection plug includes a three-prong plug with a ground wire. Turn the dock side disconnect switch or circuit breaker to the “ON” position and check that the battery charger is operating properly. If the battery charger is not working, turn off the shore disconnect switch and remove the cable. Contact your dealer or a qualified electrician to find and correct the problem.



DO NOT ATTEMPT TO CORRECT THE WIRING YOURSELF. ELECTRIC SHOCK CAN CAUSE SEVERE INJURY OR EVEN DEATH. ALWAYS HAVE A QUALIFIED ELECTRICIAN CHECK WIRING.

KEEP CHILDREN AWAY FROM ANY ELECTRICAL CABLES OR EQUIPMENT.

Disconnecting procedure for shore power connection

Turn the disconnect switch on the dockside outlet to the “OFF” position.

Disconnect the cable from the dockside outlet and replace the outlet caps. Disconnect the cable from the boat and replace the inlet cap. Store cable.

Battery Charger Operation

AC electrical current is supplied directly to the automatic battery charger which is on the side of the head compartment. The battery charger automatically charges and maintains the 12-volt batteries simultaneously when activated. It is fully automatic and equipped with LED lights to indicate the state of charge for each battery.

Charging for the engine batteries also can be monitored by using the voltmeter in the engine gauge cluster. With the charger activated, turn the ignition key switch that activates the volt meter to the “ON” position. **DO NOT START THE ENGINE.** Then select the batteries one at a time and read the voltage on the volt meter. If the batteries are in good condition and charging properly, the voltmeter will indicate between

12 and 14.5 volts. If the reading is below 12 volts, then the battery is not accepting a charge or the charger is not working properly. Always turn the ignition switch off immediately after the monitoring is complete.

The wires that supply DC charging current to the batteries are protected by an internal fuse in the battery charger. The internal fuses in the charger protect the DC charging circuit from the charger to the batteries. See the battery charger manual for more information.

4.4 Electrical System Maintenance

12-Volt DC Electrical System Maintenance

At least once a year, spray all exposed electrical components behind the helm, in the transom area and in the plugs, with a protector. Exterior light fixture bulbs should be removed and the metal contact areas coated with a non-water soluble lubricant like petroleum jelly or silicone grease. The sockets should be sprayed with a protector. Care must be taken not to get any oil or petroleum jelly on the glass portion of the bulbs as this will cause the bulb to overheat and burn out.

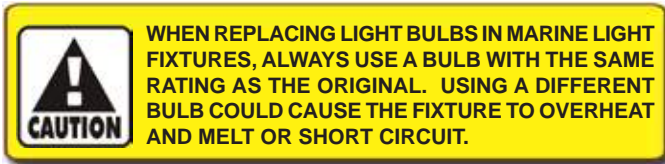

Check all below deck wiring to be sure it is properly supported, that the insulation is sound, and that there are no loose or corroded terminals. Corroded terminals should be thoroughly cleaned with sandpaper, or replaced, tightened securely and sprayed with a metal and electrical protector. Inspect all engine wiring.

Please note that Scout Boats are factory equipped with premium, maintenance free batteries that are sealed and the cells do not require inspection or service. However, if you or your dealer replace the original equipment batteries with the standard wet cell type that are not maintenance free, they will require the following inspection and service:

Check the electrolyte level in the batteries regularly and add distilled water as necessary. If the batteries are frequently charged by the automatic battery charger, the electrolyte level will have to be checked more often. The correct fluid level in the cells is usually approximately 1/4 to 1/2 inch



Battery Charger

above the plates. If fluid is needed, fill to the proper level with distilled water. **Do not over fill and only use distilled water!**

Keep the battery tops clean and dry. Dirt and water can conduct electricity from one post to the other causing the battery to discharge.

The battery posts should be kept free of corrosion. Remove the cables and clean the posts and cable clamps with a battery post cleaner or sandpaper as required. Coating the battery posts and cable clamps with petroleum jelly or silicone grease will protect them and reduce corrosion. Battery cables, both hot and ground, must be replaced when they show signs of corrosion or fraying. Deteriorated cables cause a considerable voltage loss when high currents are drawn, as for starting the engine.



NEVER USE AN OPEN FLAME IN THE BATTERY STORAGE AREA. AVOID STRIKING SPARKS NEAR THE BATTERY. A BATTERY CAN EXPLODE IF A FLAME OR SPARK IGNITES THE HYDROGEN GAS THE BATTERY EMITS WHILE BEING CHARGED.

AC Electrical System Maintenance

Periodically inspect all wiring for nicks, chafing, brittleness, improper support, etc. Examine the shore power cord closely for cracks in the insulation and corrosion in electrical connectors. Spraying receptacles and electrical connections with an electrical contact cleaner or a metal and electrical protector will reduce corrosion and improve electrical continuity.

Inspect all wiring for proper support, sound insulation, and tight terminals, paying particular attention to portable appliance cords and plugs.

The entire AC circuitry, especially the shore power cord, should be seasonally tested for proper continuity by an experienced electrician. This will detect any shorts, open wires, or ground faults.



CORROSION ALLOWED TO BUILD ON THE ELECTRICAL CONNECTORS CAN CAUSE A POOR CONNECTION RESULTING IN SHORTS, GROUND FAULTS OR POOR GROUND CONNECTIONS. ELECTRICAL CONNECTORS SHOULD BE CHECKED AT LEAST ANNUALLY AND CLEANED AS REQUIRED. DO NOT ALLOW CORROSION TO BUILD ON CONNECTIONS.

THE AC AND DC ELECTRICAL SYSTEMS ALWAYS SHOULD BE DISCONNECTED FROM THE POWER SOURCE BEFORE INSPECTING OR SERVICING THE SYSTEM. NEVER SERVICE ANY COMPONENT OF AN ELECTRICAL SYSTEM WHILE IT IS ENERGIZED.

Chapter 5:

FRESH WATER SYSTEM

5.1 General

The fresh water system consists of a potable water tank, distribution lines and a distribution pump. The pump is equipped with an automatic pressure switch and is located behind a panel in the head compartment. The pump's on/off toggle switch is located on the dash panel. The tank is filled through a labeled deck plate located in the head compartment.

The raw water and fresh water systems have separate pressure pumps.

Water Fill

A "keyless" fill deck plate is marked "WATER." The water fill is opened by pressing down on the cap and turning it counter clockwise 1/4 turn. The center of the cap will pop up providing a hand grip. Continue turning the cap counter clockwise until it can be removed. After filling, install the fill cap and tighten. Once the cap is tight, simultaneously press down and turn the center of the cap clockwise to lock it in the closed position.



Freshwater Washdown Quick Connect



DO NOT FILL SYSTEM WITH ANYTHING OTHER THAN WATER. SHOULD THE SYSTEM BECOME CONTAMINATED WITH FUEL OR OTHER TOXIC FLUIDS, COMPONENT REPLACEMENT MAY BE NECESSARY.



DO NOT CONFUSE FUEL FILL DECK PLATE WITH THE WATER OR WASTE FILL DECK PLATES. THESE PLATES ARE ALSO LABELED ACCORDINGLY. IF GASOLINE OR DIESEL FUEL IS ACCIDENTALLY PUMPED INTO THE WATER OR WASTE TANK, DO NOT ATTEMPT TO PUMP IT OUT YOURSELF. WATER AND WASTE PUMPS ARE NOT DESIGNED TO PUMP FUEL AND A FIRE OR EXPLOSION COULD RESULT. CONTACT YOUR DEALER OR THE SCOUT CUSTOMER SERVICE DEPARTMENT FOR ASSISTANCE IN HAVING THE FUEL PROFESSIONALLY REMOVED.

5.2 Fresh Water System Operation

Fill the water supply tank slowly through the labeled deck plate. After filling the water tank, partially open the sink faucet. The Washdown switch in the helm switch panel should be on. Allow the pump to run until all of the air is purged from the system and a steady stream of water is flowing from faucet. Turn off the faucet. As the pressure builds the pump will automatically shut off.

When properly primed and activated, the water system will operate much like the water system in a home. An automatic pressure sensor keeps the system pressurized. If the system has been recently filled or has not been used for an extended period, air bubbles may accumulate at the pump and the system may have to be re-primed.

The water system is equipped with a sea strainer on the intake side of the pump. The strainer should be checked frequently and cleaned as necessary.

Whenever the boat is left unattended, the Washdown

switch should be placed in the “OFF” position.

The Fresh Water and Raw Water Washdown Hose

The fresh water washdown hose is located on the side of the console. The raw water washdown hose is located in the stern splashwell.

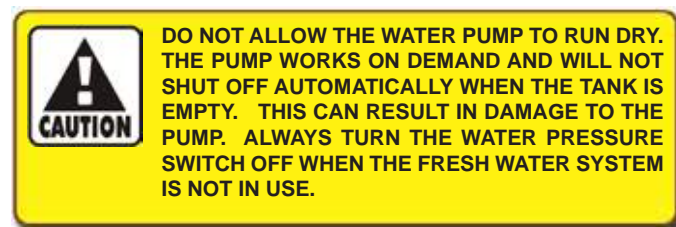

5.3 Fresh Water System Maintenance

Information supplied with water system components by the equipment manufacturers is included with this manual. Refer to this information for additional operation and service data.

The following items should be done routinely to maintain your fresh water system:

- Periodically remove and clean the water strainer located at the intake side of the pressure pump. To clean the strainer, make sure the raw water accessories are off and close the valve at the thru-hull fitting. Rotate the strainer bowl counterclockwise to release it. Remove and clean the screen with freshwater. Lubricate the O-ring lightly with Teflon or silicon grease and reinstall the screen and strainer bowl.
- Remove the filter screens from the faucet spouts and eliminate any accumulation of debris. A build up of debris can cause the pump to cycle excessively.
- Periodically spray the pump and metal components with a metal protector.
- The batteries must be properly maintained and charged. Operating the pressure pump from a battery with a low charge could lead to pump failure.
- Add a commercially available potable water conditioner to the water tank to keep it fresh.

Sanitizing the Fresh Water Tank

The freshwater system should be sanitized if it has not been used for a long period or you are unsure of the quality of the water in the system.

The following steps can be used to sanitize the system:

- Activate the system, open all faucets and pump out as much water as you can.
- Make a chlorine solution by mixing two ounces of household chlorine bleach in a gallon of water. This mixture will treat approximately fifteen gallons. If the water tank on your boat is larger or smaller than 15 gallons, then adjust the mixture accordingly. Always mix the chlorine with water in a separate container first and never add straight chlorine to the fresh water tank.
- Fill the water tank half full with freshwater and pour the mixture into the water tank. Top off the tank.
- Activate the system and allow the water to run for about one minute at each faucet. Let the treated water stand for 4-6 hours.
- Drain the system by pumping it dry and flush with several tank fills of freshwater.
- The system should now be sanitized and can be filled with freshwater. If the chlorine smell is still strong, it should be flushed several more times with freshwater.

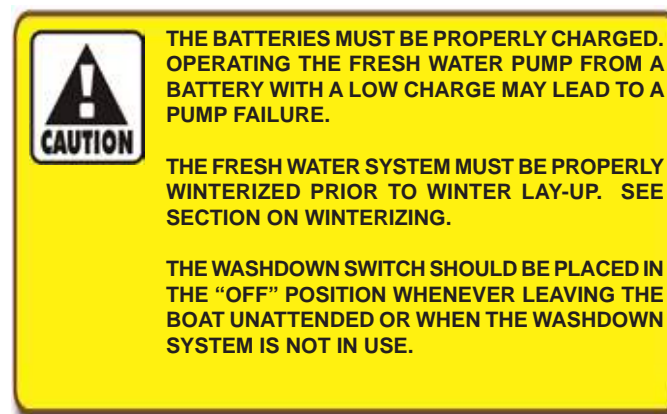

Chapter 6:

RAW WATER SYSTEM

6.1 General

In the raw or sea water systems, the livewell water pump is mounted to a sea cock on the thru-hull fitting located in the stern bilge compartment and the water system pressure pump is connected to an auxiliary fitting on the aerator. Always make sure the ball valve is open before attempting to operate any component of the raw water system.

Priming the System

Make sure the sea cock valve is open and the Washdown switch in the helm switch panel is on. Turn the aerator switch to the “ON” position. Then run the livewell pump until all of the air is purged from the system and turn the pump off. If your boat is equipped with the optional leaning post livewell, activate the leaning post recirculation pump switch until all of the air is purged from the system and turn the pump off.

If the livewell pump runs but does not prime, it may have an air lock at the pump. Activate the raw water washdown pump and reprime the system. This will remove the air lock in the livewell pump, allowing the livewell pump to prime. Closing the thru-hull sea cock valves before the boat is hauled from the water will help to eliminate air locks in raw water systems.

Note: It may be necessary to reprime the raw water system if the system is not used for an extended period and at the time of launching.

6.2 Raw Water System Operation

A high pressure pump, controlled by a pressure sensor, supplies raw water to the washdown hose located on the console or leaning post and the bait prep sink faucet. The pump is activated by the Washdown switch located in the helm switch panel. The water system pressure pump is used to supply fresh or raw water to the tackle station sink or the washdown.

The Washdown switch should be turned to the “ON” position just before using the washdown or sink and be turned to the “OFF” position when the washdown or sink is not in use.

When activated, the pressure switch will automatically control the pump. As the pressure builds in the system, the pump will shut off. When the system is in use and the pressure drops, the pump will turn on.



Raw Water Quick Disconnect in Splashwell

The water system is equipped with a sea strainer on the intake side of the pump. The strainer should be checked frequently and cleaned as necessary.

Whenever the boat is left unattended, the Washdown switch should be placed in the “OFF” position.

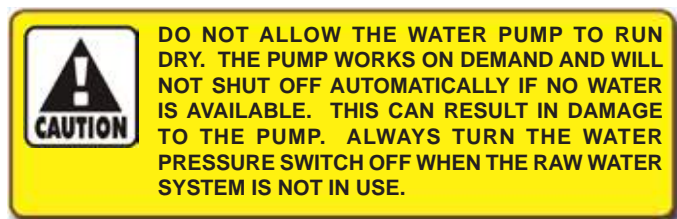

6.3 Livewell

Standard Livewell

Sea water is provided to the standard livewell by a 12-volt circulation pump. Each pump is designed to carry a constant flow of water to the livewell. The pump does not have a pressure sensor and is activated by the Aerator switch in the 12-volt switch panel. There is also a light in the livewell that is activated by the Livewell Light switch in the helm switch panel.

An overflow thru-hull built into the livewell automatically controls the water level in the livewell. Always turn the pump off at the switch panel when the livewell is not in use.

To fill the livewell, insert the plug into the drain fitting at the bottom of the livewell. Make sure the sea cock is open. Then activate the Aerator switch. When the water level reaches the overflow, it will begin to circulate.

The livewell raw water intake is equipped with a scoop that will supply water to the livewell if the pump should fail and helps prime the system during normal operation. To supply water to the livewell using the scoop, make sure the sea cock valve is open and run the boat at a speed above 15 miles per hour. Water will circulate through the livewell and out the overflow.

To drain the livewell, turn off the livewell pump and remove the plug in the drain fitting at the bottom of the livewell. When the livewell has completely drained, use the washdown hose to flush the livewell and drain of debris.

The livewell sea cock valve should be closed whenever the livewell is not in use. This will prevent water from entering the livewell while the boat is cruising. Make sure the valve is opened before operating the raw water washdown.

6.4 Raw Water System Maintenance

The following items should be done routinely to help maintain your raw water system:

- Check hoses, particularly the sea water supply lines, for signs of deterioration.
- Remove and clean the sea water strainer for the washdown pump, as needed. Refer to the Fresh Water System maintenance section for instructions on cleaning the pump strainer.
- Spray pumps and thru-hull valves with a protective oil periodically.
- The fishboxes and livewells should be drained and cleaned after each use.



Baitwell and Bilge Pumps in Stern Bilge



Standard Baitwell

- Operate all sea cock valves at least once a month to keep them operating properly.

6.4 Raw Water System Maintenance

The following items should be done routinely to help maintain your raw water system:

- Check hoses, particularly the sea water supply lines, for signs of deterioration.
- Remove and clean the sea water strainer for the washdown pump, as needed. Refer to the Fresh Water System maintenance section for instructions on cleaning the pump strainer.
- Spray pumps and thru-hull valves with a protective oil periodically.
- The fishboxes and livewells should be drained and cleaned after each use.
- Operate all sea cock valves at least once a month to keep them operating properly.



SHOULD A HOSE RUPTURE, TURN THE PUMP OFF IMMEDIATELY. ALWAYS CLOSE THE THRU-HULL VALVE WHEN PERFORMING MAINTENANCE ON A SEA WATER PUMP.



THE BATTERIES MUST BE PROPERLY CHARGED. OPERATING ANY PUMPS FROM A BATTERY WITH A LOW CHARGE MAY LEAD TO A PUMP FAILURE.



THE RAW WATER SYSTEM MUST BE PROPERLY WINTERIZED PRIOR TO WINTER LAY-UP. SEE SECTION ON WINTERIZING.



Note: Do not use a livewell as a dry storage area when it is not in use. Sea water could accidentally be delivered to the livewell from the thru-hull fitting and damage equipment stored there.

THIS PAGE WAS LEFT BLANK
INTENTIONALLY

Chapter 7: DRAINAGE SYSTEMS

7.1 General

All water is drained by gravity to overboard thru-hull fittings located in the hull above the water line. It is important to check the drain system frequently to insure it is free flowing and that the hoses on the thru-hull fittings are secure and not leaking. Please review the drainage schematic to become familiar with the location of the drain thru-hull fittings.

7.2 Cockpit Drains

Your Scout has two scupper drains located in the rear of the cockpit.

Water is channeled away from all hatches by a gutter or drain rail system. The water then drains overboard through the scupper drain system.

7.3 T-Top and Hardtop Drains

There is a hole drilled in the rear leg bases on T-tops to prevent water from being trapped within the legs and provide a wire chase for accessories. A small hole is drilled in the tubing at the base of the other legs, which are not drilled for a wire chase, that allows water to drain. Additional drain holes are drilled in the tubing to drain other areas as required.

Always make sure the leg drain holes are clear when the boat is laid up for the winter. Water trapped inside the legs could freeze and cause the legs to split.

7.4 Bilge Drainage

The stern and forward bilge pumps are activated both manually, by a switch in the helm switch panel and automatically, by a float switch built into the pump in the bilge. The automatic float switches remain activated when the battery switch is in the "OFF" position and the batteries are connected. All bilge pumps pump water out of thru-hulls located above the water-line in the hull.

Note: See **Electrical Systems** for additional information on bilge pump operation.

When the boat is out of the water the bilge can be drained by a garboard drain located in the transom near the bottom of the hull. The plug should be removed whenever the boat is hauled out of the water and installed just prior to launching. It is important to check the drain plug regularly to make sure it is tight.



Scupper Drains



Bilge Pump and Baitwell Pumps



A LOOSE DRAIN PLUG WILL ALLOW SEA WATER TO ENTER THE BILGE AND COULD CAUSE THE BOAT TO SINK. IT IS VERY IMPORTANT TO CHECK THE DRAIN PLUG FREQUENTLY TO INSURE IT IS PROPERLY TIGHTENED.

Important: Any oil spilled in the bilge must be thoroughly removed and properly disposed of before operating the bilge pump. The discharge of oil from the bilge is illegal and subject to a fine.

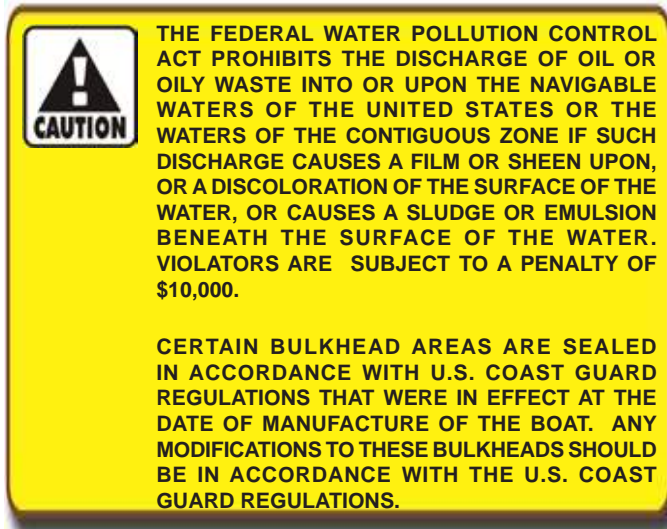

7.5 Fishboxes, Cooler and Storage Compartment Drains

A large insulated fishbox is located in the port rear of the cockpit. The fishboxes are drained overboard by diaphragm pumps through a drain sleeve out the side of the hull. The fishbox should be flushed out and cleaned after each use.

The console cooler is drained by gravity overboard. The cooler is insulated and should be flushed out and cleaned after each use.

The fishboxes and storage compartment in the bow are insulated and drained by gravity to a thru-hull fitting located in the hull side above the waterline.

7.6 Water System Drains

The bait sink and livewells are drained by gravity to a thru-hull fitting in the transom. The overflows in each livewell drain into the overboard drain system.

7.7 Rope Locker Drains

The rope locker drains overboard through a small drain hole in the bottom of the locker. It is important to inspect the drain frequently to remove any accumulated debris.

7.8 Drainage System Maintenance

It is essential that the following items be done periodically to maintain proper drainage of your boat:

- Clean the cockpit drain rails with a hose to remove debris that can block water drainage.
- Clean the T-top leg drain holes. This is especially important just before winter lay-up.
- Clean the bilge pump strainers of debris and check the bilge for foreign material that can cause the automatic switch to malfunction.
- Frequently test the automatic bilge pump switches for proper operation.
- Flush all gravity drains with fresh water to keep them clean and free flowing.
- Clean and flush the fishboxes, coolers and storage boxes with soap or a bilge cleaner and fresh water after each use to keep them clean and fresh.

Note: All drains and pumps must be properly winterized before winter lay-up.

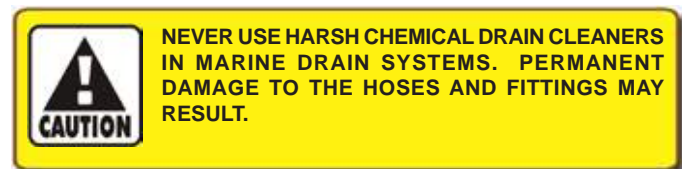

Chapter 8:

VENTILATION SYSTEM

8.1 Head Compartment Ventilation

Ventilation to the head compartment area is provided by an opening port window and a vent in the door.

Port Window

An opening port window is located in the side of the head compartment. The port window is equipped with a screen and is secured in the closed position by three twist action locks. The locks should be adjusted so they are tight enough to seal the window in the closed position, but not so tight that they break the plastic.

Always make sure the window is closed and secured with the cam levers whenever the boat is underway. Sea spray could enter the head compartment through an open window and damage equipment or items stored in there.



Head Compartment Window

8.2 Maintenance

- Periodically lubricate all hinges and latch assemblies with a light oil.
- Periodically clean and coat gasket materials with silicone to help keep them pliable.
- The opening port window and the cabin door are made of acrylic plastic glass. Acrylic glass scratches easily. Never use a dry cloth or glass cleaning solutions on acrylic glass.
- Use a soft cloth and mild soap and water for routine cleaning. Solvents and products containing ammonia can permanently damage acrylic glass. Please refer to the Routine Maintenance chapter for more information on the proper maintenance for acrylic plastic glass.

THIS PAGE WAS LEFT BLANK
INTENTIONALLY

Chapter 9: EXTERIOR EQUIPMENT

9.1 Deck

Rails and Deck Hardware

The rail system and hardware fittings have been selected and installed to perform specific functions. Hand rails are installed to provide a handhold in certain areas of the boat. You should make sure you keep at least one hand on the handholds as you move about the boat.

Fenders or mooring lines should be secured to the cleats and not to rails or stanchions. The cleats on your boat are retractable and flush with the deck when not in use. To use the cleats, pull up on the center of the cleat until it locks in the mooring position. Be sure a clear lead exists when running dock lines or anchor lines. A line inadvertently run around a stanchion or over the rail could cause damage.

Important: All fittings must be periodically inspected for loose fit or wear and damage. Any problems should be corrected immediately.

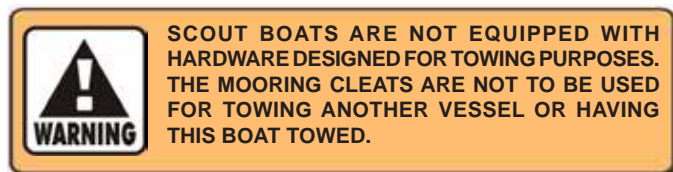

Anchor/Rope Locker

The anchor locker is in the bow of the boat and accessed through a hatch in the deck and another hatch forward of the bow storage compartments.

The anchor line is always stored in the locker. If the anchor is stored in the anchor locker, it must be properly secured to prevent it from bouncing in the locker and causing damage to the hull or anchor locker. The anchor locker has a molded cradle designed to secure a fluke style anchor.

The anchor locker is designed for one fluke style anchor that is properly secured in the cradle. Do not store additional anchors or any heavy object in the anchor locker. Launch hooks and weights for floating markers will bounce and damage the hull or rope locker if they are stored in the anchor locker. Always store and secure additional anchors and weights in a storage



Anchor Locker Deck Hatch

compartment in the cockpit, as far aft as possible.

The anchor locker is drained by a thru-hull fitting in the hull side near the bottom of the locker. It is very important to check the drain frequently to make sure it is clean and free flowing.

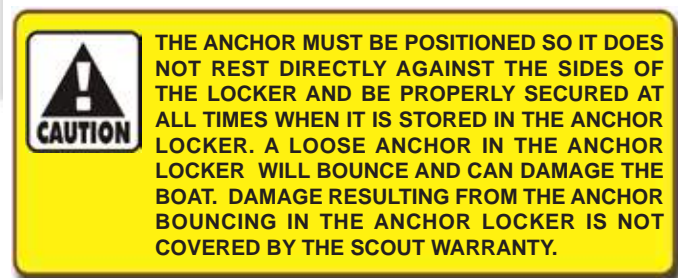

Windlass (Optional)

The optional windlass is mounted to the deck near the rear of the pulpit above the rope locker. The anchor is stored on the pulpit and is raised and lowered by the windlass. The anchor line is stored in the rope locker and routed out through the windlass to the anchor chain.

The anchor is lowered by releasing the anchor from the cleat or chain binder on the pulpit and operating a “DOWN” control at the helm. After the anchor is set, the windlass must not be left to take the entire force from the anchor line. Boats lying to their anchor in a high swell or heavy weather conditions will snub on the line. This can cause slippage or apply excessive

loads to the windlass. The line should be made fast to a bow cleat to relieve the load on the windlass.

The anchor is hauled in by releasing the line from the bow cleat and operating the “UP” control at the helm. Once the anchor is retrieved, independently secure the anchor to the chain binder or a cleat to prevent it from being accidentally released. This is especially important while the boat is under way.

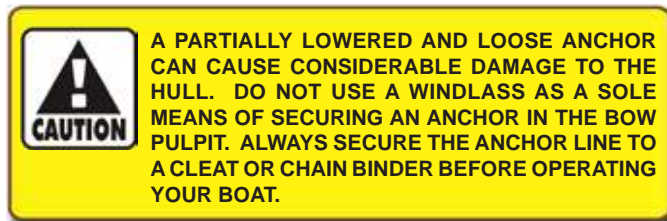
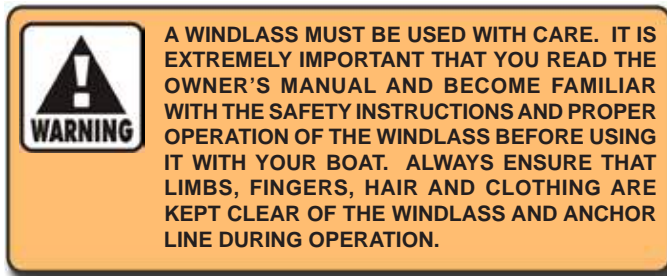

Ladder Storage

on the 275 XSF.

Boarding Ladder

A telescopic boarding ladder is recessed into the swim platform. To use the ladder, rotate it out of the recess to the down position. Then pull the ladder out to the open position. The ladder must be retracted and folded into the recess before starting the engines.

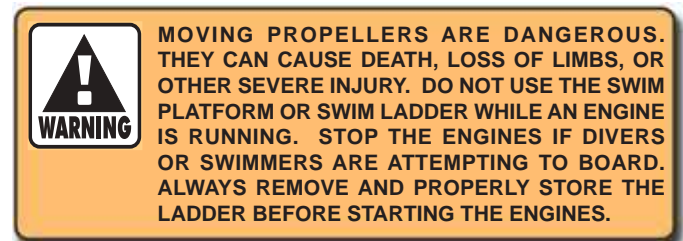

9.2 Hull

Engine Mounting System and Swim Platform

Your Scout is equipped with an engine mounting system that is integrated into the hull and stringer system and designed to equally distribute the stresses of engine weight and thrust throughout the entire hull.

The design of the engine mounting system requires the wave gate/stern seat to be in the folded or down position before tilting the engines to the full up or trailering position. If the wave gate/stern seat is in the up position when the engines are tilted, the cowlings will hit the seat causing damage to the engine cowlings and to the wave gate and seat. Always make sure the wave gate/stern seat is down before tilting the engines and returned to the up position before operating the boat.

A swim platform on the engine mounting system is standard

Trim Tabs

The trim tabs are located on the transom below the swim platform. The trim tabs are an important part of the control systems. Please refer to the Helm Control Systems chapter for detailed information on the trim tabs.

9.3 Cockpit Features

General

Most hatches and doors in the cockpit are secured with special cam action, draw or automatic slam latches. Gas charged springs are used on most hatches above the cockpit sole that help raise the hatches and hold them in the open position.

Always make sure the hatches are closed with the latches in the secured position before operating the boat above idle speed.



IN CERTAIN CONDITIONS, OPEN EXTERIOR DOORS AND HATCHES THAT ARE NOT SECURED PROPERLY CAN SLAM CLOSED UNEXPECTEDLY AND CAUSE INJURY TO PASSENGERS OR DAMAGE TO THE BOAT. SOME DOORS AND HATCHES ARE EQUIPPED WITH SPECIAL FASTENERS, HATCH LIFTERS, OR SNAPS AND/OR STRAPS, TO SECURE THEM IN THE OPEN POSITION. ALWAYS MAKE SURE THAT THESE HATCHES AND DOORS ARE PROPERLY SECURED WHENEVER THEY ARE IN THE OPEN POSITION.

Leaning Post Bait Station

The leaning post bait station is equipped with a sink and is supplied by a fresh water circulating pump. It is equipped with an overflow that controls the water level and drains overboard. Refer to the Raw Water System chapter for additional information on the livewell.

Storage for fishing tackle is provided by two drawers below the sink.



Bait Prep Station

Port and Starboard Fishboxes

The fishboxes are located in the floor on the aft port and starboard sides of the cockpit. A gas spring holds the hatch in the open and closed position. The fishbox is drained by gravity through a drain sleeve out the side of the hull. Always make sure the hatch is properly closed before operating the boat and clean the fishbox after each use.



Starboard Fishbox

Stern Bilge Access

There is an access hatch below the stern seat that provides access to the fuel filter, aft bilge pump, automatic switch for the bilge pump, and other equipment mounted in the stern bilge.

Stern Seat

The seat cushion and backrest is hinged and can be folded to provide clearance for the engines when they are tilted to the full up position or to provide access to the stern of the boat. The backrest is also a wave gate and should always be folded down before tilting the engines and returned to the up position before operating the boat above idle speed. Never leave the transom access open when the boat is underway.

The bottom seat cushion is mounted to a slotted hinge that allows it to drop in front of the stern seat base where it is secure and to allow the backrest to fold down. It can also be removed.

To fold the seat, lift the front of the bottom seat cushion and pull it toward the bow of the boat. The retaining pins at the rear of seat will clear the receivers as the seat moves forward in the slotted hinges. Then lower the cushion until it

is vertical. Pull forward on the wave gate/backrest to release the friction latches. It is hinged and will lower to rest flat on the seat base, securing the bottom seat cushion and providing a standing platform.

To raise the seat, make sure the engines are down and raise the wave gate/backrest to the full up position. Push firmly to secure it with the friction latches. Then lift the front of the bottom seat cushion until it is horizontal, then push it towards the stern. As the cushion slides back in the slotted hinges, align the retaining pins at the rear of the seat with the receivers. Push the front of seat towards the stern and down to fully seat the retaining pins and secure the seat cushion.

To remove the seat, lift the front of the bottom seat cushion and pull it toward the bow of the boat until the retaining pins at the rear clear the receiver. Then lower the cushion until it is almost vertical. Align the hinge pin with the top slot in the in the port slotted hinge. Lift the port side of the cushion until the pin clears the hinge and remove the seat.

Note: Periodically inspect the folding seat fittings for

wear, damage, or loose fit. Any problems should be inspected and corrected immediately.



OPERATING THE BOAT UNDER POWER WITH THE WAVE GATE AND TRANSOM ACCESS OPEN MAY ALLOW PERSONS TO FALL OVERBOARD AND INTO THE BOAT PROPELLER OR TO BE LOST IN OPEN WATER. ALWAYS CHECK TO MAKE SURE THE WAVE GATE IS PROPERLY CLOSED BEFORE STARTING THE ENGINES AND NEVER OPERATE THE BOAT UNDER POWER WITH THE WAVE GATE DOWN.

Bow Storage Compartments

There are three large storage compartments located in the bow below the step and the casting platform. The hatches are equipped with gas hatch springs and draw latches to secure the hatches in the closed position. These compartments are insulated and can be used for dunnage and as coolers. Another hatch provides access to the anchor rope locker.

Seat cushions are secured to the hatches with snaps.

Port and starboard bow compartments and the anchor locker drain overboard to a thru-hull fitting in the hull side. The center storage box drains into the bilge. Always make sure the hatches are closed and properly latched before operating the boat.

Deluxe Fiberglass Leaning Post

The standard leaning post is equipped with storage below the seat cushion that drains to the cockpit sole, cup holders, rod holders and a grab bar. The base contains storage, a waste basket, a tackle station, as well as a sink and bait prep station. An optional grill and refrigerator are available.

Helm and Electronics Locker

The helm and engine controls are located on the rear of the center console. Molded-in electronics storage is located forward of the helm and engine controls. A small compartment starboard of the engine controls provides convenient storage for small items and cup holders. An accessory plug provides electrical current for portable 12-volt accessories. The electronics are protected with an electrically activated acrylic door that can be opened or closed by a switch in the helm.

The console is also equipped with a glass windshield and a foot rest. The footrest is equipped with an opening hatch and a small storage area that can be used to store the shore power cord or other gear. The cockpit courtesy lights are located on the side of the console.

Windshield

The 275 XSF is equipped with a glass windshield mounted to



Stern Seat Folded



Stern Seat Up



Storage Compartment

the t-top frame. A windshield wiper is available as an option.

Head Compartment

The head compartment is located in the center console. A fiberglass door in the port side of the console provides access to the head. An access hatch in the rear bulkhead provides access to service electronics and helm equipment. Other hatches provide access to the center bilge, batteries, electronics and bilge pumps. A porcelain head is standard equipment. Refer to the Interior Equipment chapter for additional information on the head compartment.

Console Cooler

A molded insulated cooler is installed under the front seat of the console. The cooler drains to the bilge and should be cleaned thoroughly after each use.



Helm



Console Cooler



Windshield

T-Top

The Scout T-top is made of welded anodized or powder coated

aluminum and is designed to accommodate radio antennas, radar antennas, outriggers and navigation lights. It is equipped with an electronics box and a courtesy light activated by a switch in the helm. It could also be equipped with optional Taco outriggers, and/or rod holders, spreader lights or the optional hard top.

The T-top is not designed to support the additional weight of items like a life raft. Radar and electronics antennas must be mounted near the center section of the T-top in the area above the legs. Do not mount any antennas or equipment to the brow area forward of the front legs or to the rear of the top. The T-top is not designed to support the weight of accessories in these areas.

The warranty for the T-top will be void if the top is modified in any way or heavy accessories like life rafts are mounted to the top. Additionally, if items like radar antennas, spotlights and other accessories are mounted in the wrong location, the warranty could be void. If you intend to add equipment or make modifications to the T-top, you should contact Scout Customer Service to make sure the equipment you would like to add or the intended modification will not void the warranty on the T-top.

Aftermarket T-top

If an after-market T-top is installed, it must be designed with four legs that are bolted to the cockpit sole near the front and rear sides of the center console. The cockpit floor is designed to support the T-top leg bases in these areas. Both front and rear legs should also have brackets that are thru bolted to the console to provide additional stiffening for the T-top. Avoid a T-top that is designed to mount only on the center console because it will cause excessive flexing to the console and cockpit sole which will result in stress cracks and fractures in the fiberglass. If you have any questions about installing a T-top on your boat, please contact your dealer or Scout Customer Service.

An improperly designed or installed fabrication can cause structural damage to the deck structure and void the Scout Boats Limited Warranty. Additionally, Scout Boats will not be responsible for any damage resulting from the installation of a fabrication not installed at the Scout factory. If you intend to install an after-market T-top on your boat, please contact your dealer or Scout Customer Service.

Refer to the Routine Maintenance section for more information on maintaining aluminum fabrications and precautions for adding additional equipment and fasteners.



Sportfish T-top



T-top front

Chapter 10: INTERIOR EQUIPMENT

10.1 Head Compartment

The head compartment is equipped with compartments for the batteries, battery charger and storage. Additional compartments provide access to mounting areas and service access for helm accessories, control systems and electronics. The access panel for the electronics is secured with screws that must be removed to open the panel for service or installing electronics.

Daylight and ventilation is provided by an opening port window and vents in the cabin door. The cabin door is lockable and held in the open position by tension hinges. There are 12-volt lights in the head and battery compartments.

The batteries are located in a compartment in the forward bulkhead of the head compartment. The fresh water tank fill and vent is located on the gunnel.

The forward bilge pump is located below the floor in the head compartment and accessed through a removable panel in the floor. The panel is secured with screws that must be removed to open the pane and access the pump.

10.2 Marine Head System

Porcelain Marine Head

The flush water is supplied by the fresh water system.

Before using, depress the foot peddle on the side of the toilet to wet the inside of the bowl. After use, press the foot peddle all the way down to flush and rinse the bowl. The waste is discharged to holding tank below the toilet. Once the waste is discharged, the toilet should be drained dry by opening the discharge valve part way without activating the fresh water valve.

Holding Tank

The holding tank is located below the toilet. When the tank is full it must either be pumped out by an approved waste dumping station through the waste deck fitting or pumped overboard by the optional waste discharge pump, when legal to do so. The overboard discharge pump is in the stern bilge and discharges waste to a thru-hull fitting in the transom at the waterline.

To operate the overboard discharge pump, make sure the thru-hull valve is open and turn the key lockout switch in the head control switch panel to Overboard Discharge. Turn the



Head Compartment Door



Porcelain Marine Head and Holding Tank

key lockout switch and the thru-hull valve off when pumping is complete.

Note: Monitor the waste level in the holding tank as the overboard discharge drains the tank and turn the pump off immediately when draining is complete.

Note: In order to comply with current State, Federal and Coast Guard regulations, the Overboard Discharge lockout key switch must be off and the key removed whenever the boat is operating in areas in which the discharge of sewage is prohibited.

Note: In many areas it is illegal to flush head waste directly overboard. Violation of these pollution laws can result in fines or imprisonment. Always know the law for the areas in which you boat. Never dump head or holding tank waste overboard illegally.

Maintenance

The head should be cleaned and inspected for leaks regularly.

The holding tank should be pumped out and flushed as needed. Always add chemical to the holding tank to help control odor and to chemically break down the waste. See the head manufacturer owner's manual for additional operating and maintenance information.

Important: The head system must be properly winterized before winter lay-up. Please refer to the Seasonal Maintenance chapter and the manufacturer owner's manual for winterizing instructions.



Overboard Discharge Pump Lockout Switch



Overboard Discharge Pump in Stern Bilge

THIS PAGE WAS LEFT BLANK
INTENTIONALLY

Chapter 11:

SAFETY EQUIPMENT

11.1 General

Your boat and outboard engines have been equipped with safety equipment designed to enhance the safe operation of the boat and to meet U.S. Coast Guard safety standards. The Coast Guard or state, county, and municipal law enforcement agencies require certain additional accessory safety equipment on each boat. This equipment varies according to length and type of boat and type of propulsion. The accessory equipment required by the Coast Guard is described in this chapter. Some local laws require additional equipment. It is important to obtain “Federal Requirements And Safety Tips for Recreational Boats,” published by the Coast Guard, and copies of state and local laws, to make sure you have the required equipment for your boating area.

Your boat is equipped with engine alarms. The alarms are designed to increase your boating safety by alerting you to potentially serious problems in the primary power systems. Alarm systems are not intended to lessen or replace regular maintenance and precruise procedures.

This chapter also describes safety related equipment that could be installed on your boat. This equipment will vary depending on the type of engines and other options installed by you or your dealer.

11.2 Engine Alarms

Most outboards are equipped with an audible alarm system mounted in the helm area that monitors selected critical engine systems. The alarm will sound if one of these systems begins to fail. Refer to the engine owner’s manual for information on the alarms installed with your engines.

If the alarms sounds:

- Immediately throttle the engine back to idle.
- Shift to neutral.
- Monitor the engine gauges to determine the cause of the problem.
- If necessary, shut off the engine and investigate until the cause of the problem is found.



11.3 Neutral Safety Switch

Every control system has a neutral safety switch incorporated into it. This device prohibits the engine from being started while the shift lever is in any position other than the neutral position and should be inspected and tested periodically to ensure the switch is working. If an engine will not start, slight movement of the shift levers may be necessary to locate the neutral position and disengage the safety cutout switch. Control or cable adjustments may be required to correct this condition should it persist. See your Scout dealer for necessary control and cable adjustments. Please refer to the Helm Control Systems chapter for more information on the neutral safety switch.

11.4 Engine Stop Switch

Your Scout is equipped with an engine stop switch and lanyard. When the lanyard is pulled it will engage the switch and shut off the engines. We strongly recommend that the lanyard be attached to the driver and the stop switch whenever the engines are running. If the engines will not start, it could be because the lanyard is not properly inserted into the engine stop switch. Always make sure the lanyard is properly attached to the engine stop switch before attempting to start the engines.

Note: You should carry an extra stop switch lanyard and instruct at least one other crew member on the operation of the stop switch and location of the extra lanyard.

11.5 Required Safety Equipment

Besides the equipment installed on your boat by Scout, certain other equipment is required by the U.S. Coast Guard to help ensure passenger safety. Items like a sea anchor, working anchor, extra dock lines, flare pistol, life vests, a line permanently secured to your ring buoy, etc. could at some time save your passengers' lives, or save your boat from damage. Refer to the "Federal Requirements And Safety Tips For Recreational Boats" pamphlet for a more detailed description of the required equipment. You can also contact the U.S. Coast Guard Boating Safety Hotline, 800-368-5647 or 800-336-2628 and 800-245-2628 in Virginia, for information on boat safety courses and brochures listing the Federal equipment requirements. Also, check your local and state regulations.

The Coast Guard Auxiliary offers a "Courtesy Examination." This inspection will help ensure that your boat is equipped with all of the necessary safety equipment.

The following is a list of the accessory equipment required on your boat by the U.S. Coast Guard:

Personal Flotation Devices (PFDs)

PFDs must be Coast Guard approved, in good and serviceable condition, and of appropriate size for the intended user. Wearable PFDs must be readily accessible, meaning you must be able to put them on in a reasonable amount of time in an emergency. Though not required, the Coast Guard emphasizes that PFDs should be worn at all times when the vessel is underway. Throwable devices must be immediately available for use. All Scout boats must be equipped with at least one Type I, II or III PFD for each person on board, plus one throwable device (Type IV).

Visual Distress Signals

All Scout boats used on coastal waters, the Great Lakes, territorial seas, and those waters connected directly to them, must be equipped with Coast Guard approved visual distress signals. These signals are either Pyrotechnic or Non-Pyrotechnic devices.

Pyrotechnic Visual Distress Signals

Pyrotechnic visual distress signals must be Coast Guard approved, in serviceable condition, and readily accessible. They are marked with a date showing the service life, which must not have expired. A minimum of three are required. Some pyrotechnic signals meet both day and night use requirements. They should be stored in a cool, dry location. They include:

- Pyrotechnic red flares, hand held or aerial.
- Pyrotechnic orange smoke, hand-held or floating.
- Launchers for aerial red meteors or parachute flares.

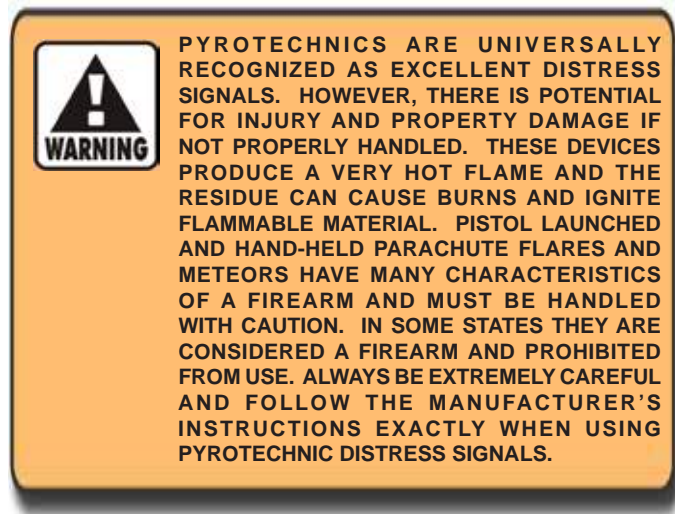

Non-Pyrotechnic Devices

Non-Pyrotechnic visual distress signals must be in serviceable condition, readily accessible, and certified by the manufacturer as complying with U.S. Coast Guard requirements. They include:

- **Orange Distress Flag. (Day use only)**
The distress flag is a day signal only. It must be at least 3 x 3 feet with a black square and ball on an orange background. It is most distinctive when attached and waved from a paddle or boat hook.
- **Electric Distress Light. (Night use only)**
The electric distress light is accepted for night use only and must automatically flash the international SOS distress signal. Under Inland Navigation Rules, a high intensity white light flashing at regular intervals from 50-70 times per minute is considered a distress signal.

Fire Extinguishers

At least one fire extinguisher is required on all Scout boats. Coast Guard approved fire extinguishers are hand-portable, either B-I or B-II classification and have a specific marine type mounting bracket. It is recommended that the extinguishers be mounted in a readily accessible position.

Fire extinguishers require regular inspections to ensure that:

- Seals & tamper indicators are not broken or missing.
- Pressure gauges or indicators read in the operable range.



- There is no obvious physical damage, corrosion, leakage or clogged nozzles.

Refer to the “Federal Requirements And Safety Tips For Recreational Boats” pamphlet or Contact the U.S. Coast Guard Boating Safety Hotline, 1-800-368-5647, for information on the type and size fire extinguisher required for your boat.

Please refer to the information provided by the fire extinguisher manufacturer for instructions on the proper maintenance and use of your fire extinguisher.

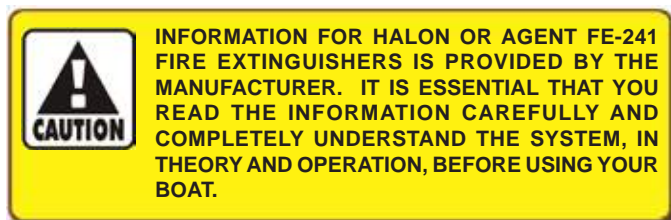

Bilge and Fuel Fires

Fuel compartment and bilge fires are very dangerous because of the presence of gasoline in the various components of the fuel system and the possibility for explosion. You must make the decision to fight the fire or abandon the boat. If the fire cannot be extinguished quickly or it is too intense to fight, abandoning the boat may be your only option. If you find yourself in this situation, make sure all passengers have a life preserver on and go over the side and swim well upwind of the boat. This will keep you and your passengers well clear of any burning fuel that could be released and spread on the water as the boat burns or in the event of an explosion. When clear of the danger, check about and account for all those who were aboard with you. Give whatever assistance you can to anyone in need or in the water without a buoyant device. Keep everyone together in a group for morale and to aid rescue operations.

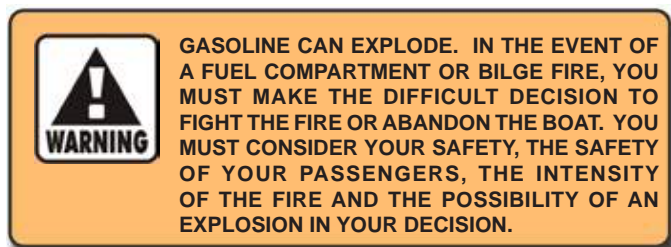

Sound Signaling Devices

The navigation rules require sound signals to be made under certain circumstances. Recreational vessels are also required to sound fog signals during periods of reduced visibility. Therefore, you must have some means of making an efficient sound signal that is audible for .5 nautical miles.

Navigation Lights

Recreational boats are required to display navigation lights between sunset and sunrise and other periods of reduced visibility (fog, rain, haze, etc.) Navigation lights are intended to keep other vessels informed of your presence and course. Your Scout is equipped with the navigation lights required by the U.S. Coast Guard at the time of manufacture. It is up to you to make sure they are operational and turned on when required.

11.6 First Aid

It is the operator’s responsibility to be familiar with the proper first-aid procedures and be able to care for minor injuries or illnesses of your passengers. In an emergency, you could be far from professional medical assistance. We strongly recommend that you be prepared by receiving training in basic first aid and CPR. This can be done through classes given by the Red Cross or your local hospital.

Your boat should also be equipped with at least a simple marine first-aid kit and a first-aid manual. The marine first-aid kit should be designed for the marine environment and be well supplied. It should be accessible and each person on board should be aware of its location. As supplies are used, replace them promptly. Some common drugs and antiseptics may lose their strength or become unstable as they age. Ask a medical professional about the supplies you should carry and the safe shelf life of prescription drugs or other medical supplies that may be in your first-aid kit. Replace questionably old supplies whether they have been used or not.

In many emergency situations, the Coast Guard can provide assistance in obtaining medical advice for treatment of serious injuries or illness. If you are within VHF range of a Coast Guard Station, make the initial contact on channel 16 and follow their instructions.

11.7 Additional Safety Equipment

Besides meeting the legal requirements, prudent boaters carry additional safety equipment. This is particularly important if you operate your boat offshore. You should consider the following items, depending on how you use your boat.

Satellite EPIRBs

EPIRBs (Emergency Position Indicating Radio Beacon) operate as part of a worldwide distress system. When activated, EPIRBs will send distress code homing beacons that allow Coast Guard aircraft to identify and find them quickly. The satellites that receive and relay EPIRB signals are operated by the National Oceanic and Atmospheric Administration (NOAA) in the United States. The EPIRB should be mounted and registered according to the instructions provided with the beacon, so that the beacon’s unique distress code can be used to quickly identify the boat and owner.

Additional Equipment to Consider

VHF Radio	Life Raft
Spare Anchor	Fenders
Heaving Line	Mirror
First Aid Kit	Tool Kit
Flashlight & Batteries	Anchor
Searchlight	Boat Hook
Sunburn Lotion	Mooring Lines
Ring Buoy	Binoculars
Whistle or Horn	Extra Clothing
Portable Radio	Chart and Compass
Marine Hardware	Food & Water
Spare Keys	Sunglasses
Spare Parts	Spare Propeller

11.8 Caution and Warning Labels

275 XSF Designator is on the port & stbd sides of the windshield



Warning - "Using boarding ladder while engine is running can result in severe personal injury. Turn off engine before using ladder."



Caution - "Shut motor off before using swim platform sticker" is on the port inside wall below the fish box lid.



Warning - "Carbon monoxide (CO) can cause brain damage or death. Engine and generator exhaust contains odorless and colorless carbon monoxide gas. Carbon monoxide will be around the back of the boat when engines or generators are on. Move to fresh air, if you feel nausea, headache, dizziness, or drowsiness." Sticker is on the port side of the transom.



Chapter 12: OPERATION

12.1 General

Before you start the engines on your Scout, you should have become familiar with the various component systems and their operation, and have performed a “Pre-Cruise System Check.” A thorough understanding of the component systems and their operation is essential to the proper operation of the boat. This manual and the associated manufacturers’ information is provided to enhance your knowledge of your boat. Please read them carefully.

Your boat must have the necessary safety equipment on board and be in compliance with the U.S. Coast Guard, local and state safety regulations. There should be one Personal Floatation Device (PFD) for each person. Nonswimmers and small children should wear PFDs at all times. You should know and understand the “Rules of the Road” and have had an experienced operator brief you on the general operation of your new boat. At least one other person should be instructed on the proper operation of the boat in case the operator is suddenly incapacitated.

The operator is responsible for his safety and the safety of his passengers. When boarding or loading the boat, always step onto the boat, never jump. All passengers should be properly seated whenever the boat is operated above idle speed. Your passengers should not be allowed to sit on the seat backs, gunnels, bows, transoms or on fishing seats whenever the boat is underway. The passengers should also be seated to properly balance the load and must not obstruct the operator’s view, particularly to the front.

Overloading and improper distribution of weight can cause the boat to become unstable and are significant causes of accidents. Know the weight capacity and horsepower rating of your boat. Do not overload or overpower your boat.

You should be aware of your limitations and the limitations of your boat in different situations or sea conditions. No boat is indestructible, no matter how well it is constructed. Any boat can be severely damaged if it is operated in a manner that exceeds its design limitations. If the ride is hard on you and your passengers, it is hard on the boat as well. Always modify the boat speed in accordance with the sea conditions, boat traffic and weather conditions.

Remember, it is the operator’s responsibility to use good common sense and sound judgement in loading and operating the boat.

12.2 Rules of the Road

As in driving an automobile, there are a few rules you must know for safe boating operation. The following information describes the basic navigation rules and action to be taken by vessels in a crossing, meeting or overtaking situations while operating in inland waters. These are basic examples and not intended to teach all the rules of navigation. For further information consult the “Navigation Rules” or contact the Coast Guard, Coast Guard Auxiliary, Department of Natural Resources, or your local boat club. These organizations sponsor courses in boat handling, including rules of the road. We strongly recommend such courses. Books on this subject are also available from your local library.

Note: **Sailboats not under power, paddle boats, vessels unable to maneuver, vessels engaged in commercial fishing and other vessels without power have the right of way over motor powered boats. You must stay clear or pass to the stern of these vessels. Sailboats under power are considered motor boats**

Crossing Situations

When two motor boats are crossing, the boat on the right has the right of way. The boat with the right of way should maintain its course and speed. The other vessels should slow down and permit it to pass. The boats should sound the appropriate signals.

Meeting Head-On or Nearly-So Situations

When two motor boats are approaching each other head-on or nearly head-on, neither boat has the right of way. Both boats should reduce their speed and turn to the right so as to pass port side to port side, providing enough clearance for safe passage. The boats should sound the appropriate signals.

Overtaking Situations

When one motor boat is overtaking another motor boat, the boat that is being passed has the right of way. The overtaking boat must make the adjustments necessary to provide clearance for a safe passage of the other vessel. The boats should sound the appropriate signals.

The General Prudential Rule

In obeying the Rules of the Road, due regard must be given to all dangers of navigation and collision, and to any special circumstances, including the limitations of the vessels, which may justify a departure from the rules that is necessary to avoid immediate danger or a collision.

Night Operation

Recreational boats are required to display navigation lights between sunset and sunrise and other periods of reduced visibility such as fog, rain, haze, etc. When operating your boat at night you should:

- Make sure your navigation lights are on and working properly. Navigation lights warn others of your position and course and the position and course of other vessels.
- All navigation rules apply. If the bow light of another vessel shows red, you should give way to that vessel, if it shows green, you have the right of way.
- Slow down and never operate at high speeds when operating at night, stay clear of all boats and use good common sense. Always be ready to slow down or steer clear of other vessels, even if you have the right-of-way.
- Avoid bright lights that can destroy night vision, making it difficult to see navigation lights and the lights of other boats. You and your passengers should keep a sharp lookout for hazards, other boats and navigational aids.

Navigation Aids

Aids to navigation are placed along coasts and navigable waters as guides to mark safe water and to assist mariners in determining their position in relation to land and hidden dangers. Each aid to navigation is used to provide specific information. You should be familiar with these and any other markers used in your boating area.

Note: Storms and wave action can cause buoys to move. You should not rely on buoys alone to determine your position.

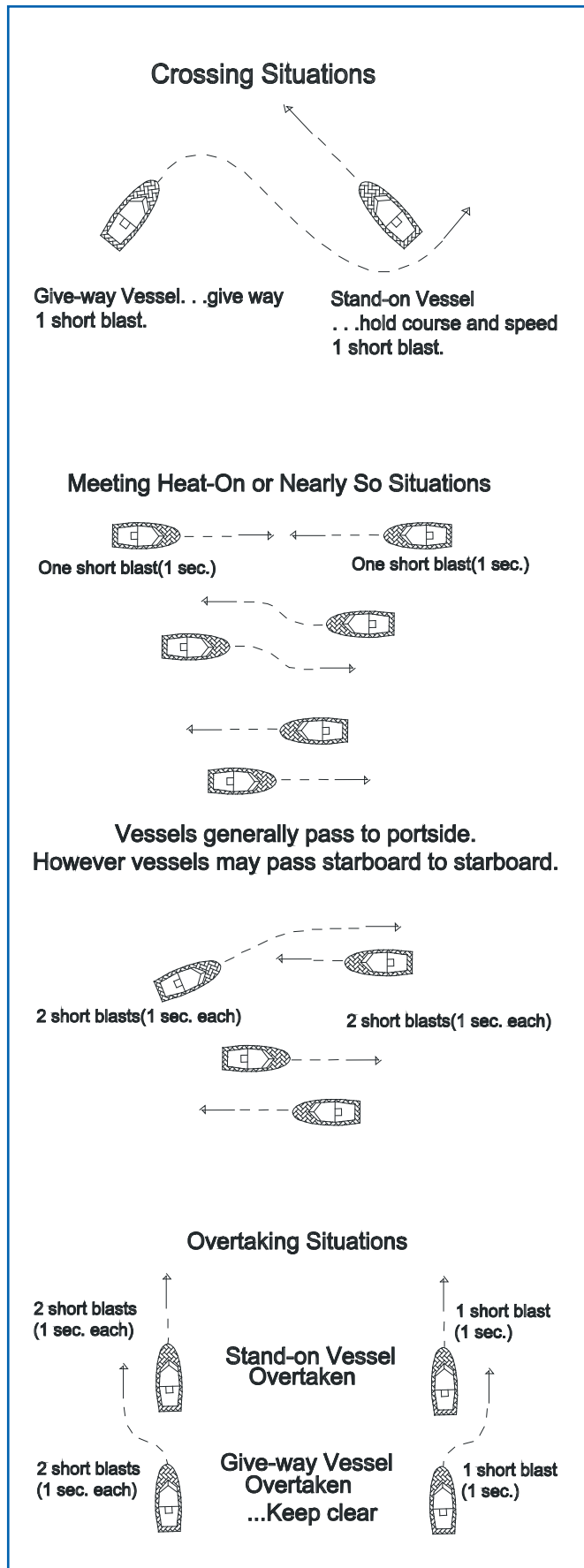
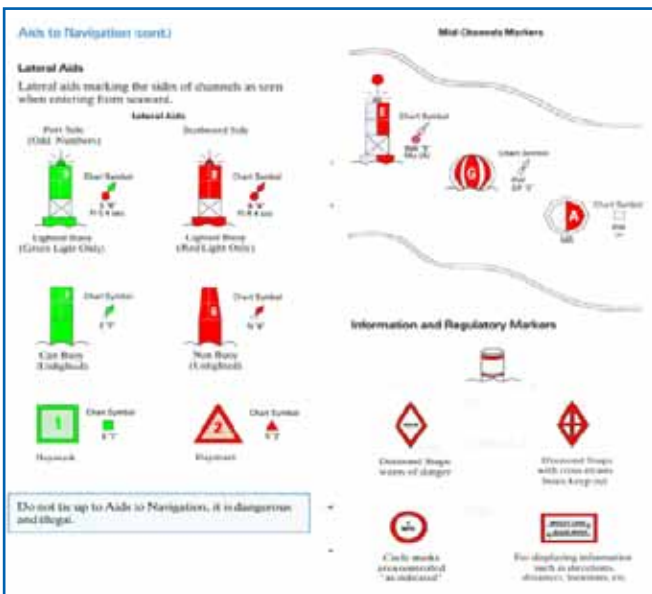

12.3 Pre-Cruise Check

Before Starting the Engines

- Check the weather forecast. Decide if the planned cruise can be made safely.
- Be sure all required documents are on board.
- Be sure all necessary safety equipment is on board and operative. This should include items like the running lights, spotlight, life saving devices, fire extinguishers, etc. Please refer to the Safety Equipment chapter for additional information on safety equipment.
- Make sure you have signal kits and flare guns aboard, and they are current and in good operating condition.
- Be sure you have sufficient water and other provisions for the planned cruise.
- Leave a written message listing details of your planned cruise with a close friend ashore (Float Plan). The float plan should include a description of your boat, where you intend to cruise, and a schedule of when you expect to arrive in the cruising area and when you expect to return. Keep the person informed of any changes in your plan to prevent false alarms. This information will tell authorities where to look and the type of boat to look for in the event you fail to arrive. A float plan form is located in the Appendix section of this manual.
- Check the amount of fuel on board. Observe the “one third rule” by using: one third of the fuel for the trip out, one third to return and one third in reserve. An additional 15% may be consumed in rough seas.
- Check the water separating fuel filters for water and leaks.
- Check the oil in the engine oil tanks (2-cycle engine) or the crankcase oil level (4-cycle engine).
- Turn the battery switches to the “ON” position.
- Check the bilge water level. Look for other signs of potential problems. Monitor for the scent of fuel fumes.
- Test the automatic and manual bilge pump switches to make sure the system is working properly.



- Have a tool kit aboard. The kit should include the following basic tools:

Spark plug wrench	Hammer
Spark plug gap gauge	Electrician's tape
Screwdrivers	Offset screwdrivers
Lubricating oil	Pliers
Jackknife	Adjustable wrench_____
Basic 3/8" ratchet set	Vise grip pliers
Hex key set	Needle nose pliers
Wire crimping tool	End wrench set
Medium slip-joint pliers	Diagonal cutting pliers
DC electrical test light	

- Have the following spare parts on board:

Extra light bulbs	Spark plugs
Fuses and circuit breakers	Main engine fuses
Assorted stainless screws	Assorted stainless bolts
Flashlight and batteries	Drain plugs
Engine oil	Propellers
Fuel filters	Propeller nuts
Fuel hose and clamps	Wire ties
Wire connector set	Hydraulic steering oil
Assorted hose clamps	Rags
Steering fluid	

- Make sure all fire extinguishers are in position and in good operating condition.
- Check the engine and steering controls for smooth and proper operation. Be sure the shift controls are in the neutral position.
- Be sure the emergency stop lanyard is attached to the operator and the stop switch.
- Refer to the Yamaha engine owner's manual for pre-operation checks specific to your engine.

12.4 Operating Your Boat



TO REDUCE THE RISK OF A FIRE OR EXPLOSION, DO NOT START THE ENGINE WHEN FUEL FUMES ARE PRESENT. FUEL FUMES ARE DANGEROUS AND HARMFUL TO YOUR HEALTH.

After Starting the Engines

- Visibly check the engines to be sure there are no apparent water, fuel or oil leaks.
- Check the operation of the engine cooling systems.
- Check the engine gauges. Make sure they are reading normally.
- Check the controls and steering for smooth and proper operation.
- Make sure all lines, cables, anchors, etc. for securing a boat are on board and in good condition. All lines should be coiled, secured and off the decks when underway.
- Have a safe cruise and enjoy yourself.

Remember:

When you operate a boat, you accept the responsibility for the boat, for the safety of passengers and for others out enjoying the water.

- Avoid sea conditions that are beyond the skill and experience of you and your crew.
- Alcohol and any drugs can severely reduce your reaction time and affect your better judgment.
- Alcohol severely reduces the ability to react to several different signals at once.
- Alcohol makes it difficult to correctly judge speed and distance, or track moving objects.
- Alcohol reduces night vision, and the ability to distinguish red from green.



YOU SHOULD NEVER OPERATE YOUR BOAT WHILE UNDER THE INFLUENCE OF ALCOHOL AND DRUGS.

MAKE SURE ONE OTHER PERSON ON THE BOAT IS INSTRUCTED IN THE OPERATION OF THE BOAT AND ALWAYS OPERATE THE BOAT IN COMPLIANCE WITH ALL STATE AND LOCAL LAWS GOVERNING THE USE OF A BOAT.

DO NOT OPERATE THE BOAT UNLESS IT IS COMPLETELY ASSEMBLED. KEEP ALL FASTENERS TIGHT. KEEP ADJUSTMENTS ACCORDING TO SPECIFICATIONS.

Before operating the boat for the first time, read the engine break-in procedures. The Yamaha break-in procedures are found in the owner's manual for the engine. The manual is in the literature packet. Correct break-in operation is critical to ensure proper performance and longer engine life.



FAILURE TO FOLLOW THE BREAK-IN PROCEDURE MAY RESULT IN REDUCED ENGINE LIFE OR EVEN SEVERE ENGINE DAMAGE IN YAMAHA ENGINE. MAKE SURE YOU FOLLOW THE BREAK-IN PROCEDURE EXACTLY.

As different types of engines are used to power the boat, have the dealer describe the operating procedures for your boat. For more instructions on "How To Operate The Boat," make sure you read the instructions given to you in the owner's manual for the engine you have selected.

Note: For more instructions on safety, equipment and boat handling, enroll in one of the several free boating courses offered. For information on the courses offered in your area, call the "Boating Safety Hotline," 800-368-5647, or the "Boat U.S. Foundation Course Hotline," 1-800-336-2628, for further information on boating safety courses.

Note: If the drive unit hits an underwater object, stop the engines. Inspect the drive unit for damage. If the unit is damaged, contact your dealer for a complete inspection and repair of the unit.

To stop the boat, follow this procedure:

- Allow the engines to drop to the idle speed.
- Make sure the shifting levers are in the neutral position.

Note: If the engines have been run at high speed for a long period of time, allow them to cool down by running the engines in the idle position for 3 to 5 minutes.

- Turn the ignition keys to the “Off” position.
- Raise the trim tabs to the full up position.

After Operation

- If operating in saltwater, wash the boat and all equipment with soap and water. Flush the engines using freshwater. Refer to the engine owner’s manual for instructions on flushing your outboard engines.
- Check the bilge area for debris and excess water.
- Fill the fuel tank to near full to reduce condensation. Allow enough room in the tank for the fuel to expand without being forced out through the vent.
- Turn off all electrical equipment except the automatic bilge pumps.
- If you are going to leave the boat for a long period of time, put the battery main switches in the “Off” position and close all seacocks.
- Make sure the boat is securely moored.

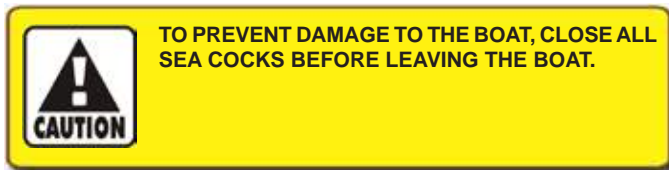

12.5 Docking, Anchoring and Mooring

Docking and Dock Lines

Maneuvering the boat near the dock and securing the boat require skill and techniques that are unique to the water, wind conditions and the layout of the dock. If possible, position a crew member at the bow and stern to man the lines and assist in docking operations. While maneuvering close to the dock consideration must be giving to the wind and current. You should anticipate the effect these forces will have on the boat and use them to help put the boat where you want it. It is important to practice in open water using an imaginary dock enough to develop a sense for the way your boat handles in a variety of docking scenarios. You must be able to foresee the possibilities and have solutions in mind before problems occur.

Approaching a dock or backing into a slip in high winds or strong currents requires a considerable amount of skill. If you are new to boat handling, you should take lessons from an experienced pilot to learn how to maneuver your boat in tight quarters in less than ideal conditions. You should also practice away from the dock during windy conditions.

Dock lines are generally twisted or braided nylon. Nylon is strong and stretches to absorb shock. It also has a long life and is soft and easy on the hands. The line’s size will vary with the size of the boat. Typically a 30 to 40 foot boat will use 5/8-inch line and a 20 to 30 foot boat will use 1/2-inch line. The number of lines and their configuration will vary depending on the dock, the range of the tide, and many other factors. Usually a combination of bow, stern and spring lines is used to secure the boat.

Maneuvering to the Dock

Approach the dock slowly at a 30 to 40 degree angle. Whenever possible, approach against the wind or current. Turn the engines straight & shift to neutral when you feel you have enough momentum to reach the dock. Use reverse on the outboard engine while turning the steering wheel towards the dock to slow the boat and pull the stern toward the dock as the boat approaches. Straighten the engines and use both engines to stop the boat if it is still moving forward against the pilings. If you executed your approach properly, the boat will lightly touch the pilings at the same time the forward momentum is stopped. Have the dock lines ready and secure the boat as soon as it stops. Use fenders to protect the boat while it is docked. Keep the engines running until the lines are secured.

Backing into a Slip

Approach the slip with the stern against the wind or current and the engines straight ahead. Use the engines and turn the steering wheel to maneuver the boat into alignment with the slip. Reverse the engines and slowly back into the slip. Shift from reverse to neutral frequently to prevent the boat from gaining too much speed. Move the stern right and left by shifting the engines in and out of gear or turning the wheel. When nearly in the slip all the way, straighten the engines and shift to forward to stop. Keep the engines running until the lines are secured.

Securing Dock Lines

Securing a boat that is tied along side the dock typically requires a bow and stern line and two spring lines. The bow and stern lines are usually secured to the dock at a 40° angle aft of the stern cleat and forward of the bow cleat. The after bow spring line is secured to the dock at a 40° angle aft of the after bow spring cleat. The forward quarter spring is secured to the dock at a 40° angle forward of the stern cleat. The spring lines keep the boat square to the dock and reduce fore and aft movement while allowing the boat to move up and down with the tide.

Securing a boat in a slip is somewhat different. It typically

requires two bow lines secured to pilings on each side of the bow, two stern lines secured to the dock and two spring lines that prevent the boat from hitting the dock. The bow lines are typically secured with enough slack to allow the boat to ride the tide. The stern lines are crossed. One line runs from the port aft boat cleat to the starboard dock cleat and the other line runs from the starboard aft boat cleat to the port cleat on the dock. The stern lines center the boat, control the forward motion, and allow the boat to ride the tide. Two forward quarter spring lines typically are secured to the stern cleats and to mid ship pilings or cleats. The spring lines keep the boat from backing into the dock while allowing it to ride the tide.

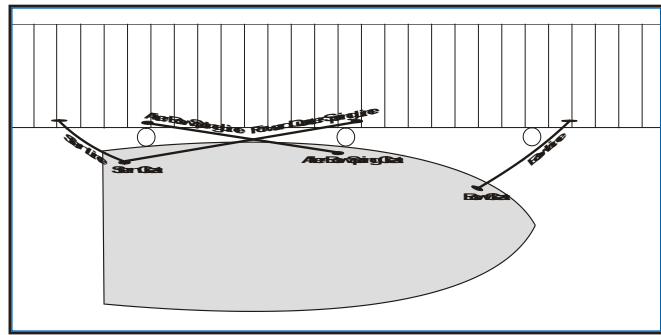

Securing The Boat Along Side A Dock (Typical)

Leaving the Dock

Always start the engines and let them warm up for several minutes before releasing the lines. Boats steer from the stern and it is important that you achieve enough clearance at the stern to maneuver the boat as quickly as possible. Push the stern off and maneuver such that you get stern clearance quickly. Proceed slowly until well clear of the dock and other boats.

Mooring

Approach the mooring heading into the wind or current. Shift to neutral when you have just enough headway to reach the buoy. Position a crew member on the bow to retrieve the mooring with a boat hook and secure the line. Keep the engines running until the line is secured.

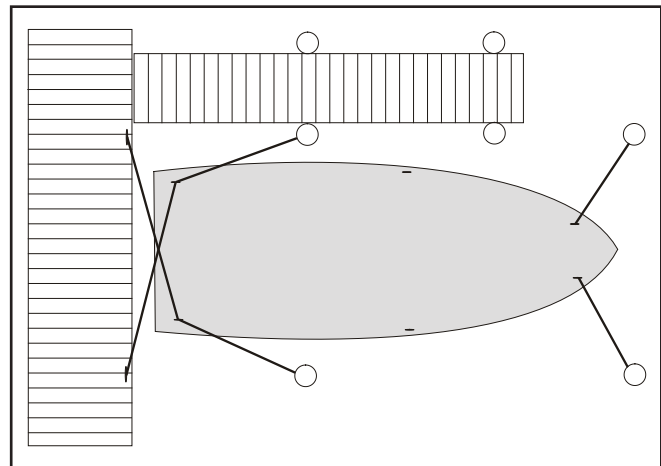

Securing The Boat In A Slip (Typical)

Leaving a Mooring

Start the engines and let them warm up for several minutes before releasing the mooring line. The boat will already be headed into the wind, so move it forward enough to loosen the line and untie it. Back the boat away from the mooring until you can see the buoy. Move the boat slowly away from the mooring.

Anchoring

Make sure the bitter end of the anchor line is attached to boat before dropping the anchor. Bring the bow into the wind or current and put the engines in neutral. When the vessel comes to a stop, lower the anchor over the bow. Pay out anchor line so that it is at least 5 to 7 times the depth of the water and secure the line to a cleat. Use caution to avoid getting your feet or hands tangled in the line. Additional scope of 10 times the depth may be required for storm conditions. Check landmarks on shore or your GPS position to make sure the anchor is not dragging. If it is dragging, you will have to start all over. It is prudent to use two anchors if you are anchoring overnight or in rough weather.

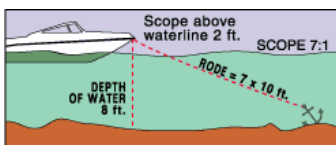

Releasing the Anchor

Release the anchor by driving the boat slowly to the point where the anchor line becomes vertical. It should release when you pass that point. If the anchor doesn't release right away, stop the boat directly above the anchor and tie the line to the cleat as tight as possible. The up and down movement of the boat will usually loosen the anchor within a minute. Make sure you secure the anchor and properly stow the line before operating the boat.

NEVER ANCHOR THE BOAT BY THE STERN. THE STERN OF THE BOAT IS VULNERABLE TO SWAMPING FROM WAVE ACTION AND WIND AND CURRENT WILL PUT MORE STRESS ON THE ANCHOR WHEN IT IS ATTACHED TO THE STERN. ONLY ANCHOR THE BOAT BY THE BOW

12.6 Controls, Steering, or Propulsion System Failure:

If the propulsion, control or steering system fails while you are operating the boat, bring the throttles to idle and shift to neutral. Decide whether you need to put out the anchor to prevent the boat from drifting or to hold the bow into the seas. Investigate and correct the problem if you can. Turn the engine off before opening the engine cowling to make repairs. If you are unable to correct the problem, call for help.

If only one engine has failed, you can usually run home on the other engine. Be careful not to apply too much power to the engine that is running. When only one engine is used to power a twin engine boat, that engine is over propped and can be overloaded if too much throttle is applied. You should contact your dealer or the engine manufacturer for the maximum power settings when running without one engine.

12.7 Collision

If your boat is involved in a collision with another boat, dock, piling or a sandbar, your first priority is to check your passengers for injuries and administer first aid if necessary. Once your passenger's situations are stabilized, thoroughly inspect the boat for damage. Check below decks for leaks and the control systems for proper operation. Plug all leaks or make the necessary repairs to the control systems before proceeding slowly and carefully to port. Request assistance if necessary. Haul the boat and make a thorough inspection of the hull and running gear for damage.

12.8 Grounding, Towing and Rendering Assistance

The law requires the owner or operator of a vessel to render assistance to any individual or vessel in distress, as long as his vessel is not endangered in the process.

If the boat should become disabled, or if another craft that is disabled requires assistance, great care must be taken. The stress applied to a boat during towing may become excessive. Excessive stress can damage the structure of the boat and create a safety hazard for those aboard.

Freeing a grounded vessel or towing a boat that is disabled requires specialized equipment and knowledge. Line failure and structural damage caused by improper towing have resulted in fatal injuries. Because of this, we strongly suggest that these activities be left to those who have the equipment and knowledge, e.g., the U.S. Coast Guard or a commercial towing company, to safely accomplish the towing task.



THE MOORING CLEATS ON SCOUT BOATS ARE NOT DESIGNED OR INTENDED TO BE USED FOR TOWING PURPOSES. THESE CLEATS ARE SPECIFICALLY DESIGNED AS MOORING CLEATS FOR SECURING THE BOAT TO A DOCK, PIER, ETC. DO NOT USE THESE FITTINGS FOR TOWING OR ATTEMPTING TO FREE A GROUNDED VESSEL.

WHEN TOWING OPERATIONS ARE UNDERWAY, HAVE EVERYONE ABOARD BOTH VESSELS STAY CLEAR OF THE TOW LINE AND SURROUNDING AREA. A TOW LINE THAT SHOULD BREAK WHILE UNDER STRESS CAN BE VERY DANGEROUS, AND COULD CAUSE SERIOUS INJURY OR DEATH.



RUNNING AGROUND CAN CAUSE SERIOUS INJURY TO PASSENGERS AND DAMAGE TO A BOAT AND ITS UNDERWATER GEAR. IF YOUR BOAT SHOULD BECOME GROUNDED, DISTRIBUTE PERSONAL FLOTATION DEVICES AND INSPECT THE BOAT FOR POSSIBLE DAMAGE. THOROUGHLY INSPECT THE BILGE AREA FOR SIGNS OF LEAKAGE. AN EXPERIENCED SERVICE FACILITY SHOULD CHECK YOUR UNDERWATER GEAR AT THE FIRST OPPORTUNITY. DO NOT CONTINUE TO USE YOUR BOAT IF THE CONDITION OF THE UNDERWATER EQUIPMENT IS QUESTIONABLE.

12.9 Flooding or Capsizing

Boats can become unstable if they become flooded or completely swamped. You must always be aware of the position of the boat to the seas and the amount of water in the bilge. Water entering the boat over the transom can usually be corrected by turning the boat into the waves. If the bilge is flooding because of a hole in the hull or a defective hose, you may be able to plug it with rags, close the thru-hull valve or assist the pumps by bailing with buckets. Put a mayday call in to the Coast Guard or nearby boats and distribute life jackets as soon as you discover your boat is in trouble.

If the boat becomes swamped and capsizes, you and your passengers should stay with the boat as long as you can. It is much easier for the Coast Guard, aircraft, or other boats to spot, than people in the water.

12.10 Fishing

Fishing can be very exciting and distracting for the operator when the action gets intense. You must always be conscious of the fact that your primary responsibility is the safe operation of your boat and the safety of your passengers and other boats in the area.

You must always make sure the helm is properly manned and is never left unattended while trolling. If your boat is equipped with a tower, caution and good common sense must be exercised whenever someone is in the tower. Most towers are designed for two average-sized people. Remember, weight in the tower raises the boat's center of gravity and the boat's motion is greatly exaggerated for the people in a tower.

If you are fishing in an area that is crowded with other fishing boats, it may be difficult to follow the rules of the road. This situation can become especially difficult when most boats are trolling. Being courteous and exercising good common sense is essential. Avoid trying to assert your right of way and concentrate on staying clear and preventing tangled or cut lines and other unpleasant encounters with other boats. Also keep in mind that fishing line wrapped around a propeller shaft can damage seals in the engine lower unit.

12.11 Man Overboard

If someone falls overboard, you must be prepared to react quickly, particularly when you are offshore. The following procedures will help you in recovering a person that has fallen overboard.

- Immediately stop the boat and sound a man overboard alarm and have all passengers point to the person in the water.
- Circle around quickly and throw a cushion or life jacket to the person, if possible, and another to use as a marker.
- Keep the person on the driver side of the boat so you can keep him in sight at all times.
- Make sure to approach the person from the downwind side and maneuver the boat so the propeller is well clear of the person in the water.
- Turn off the engines when the person is alongside and use a ring buoy or a boat cushion with a line attached, a paddle or boathook to assist him to the boat. Make sure you don't hit him with the ring buoy or the boat.
- Pull the person to the boat and assist him on board.
- Check the person for injuries and administer first aid if necessary. If the injuries are serious, call for help. Refer to the Safety Equipment chapter for more information on first aid and requesting emergency medical assistance.



MOVING PROPELLERS ARE DANGEROUS. THEY CAN CAUSE DEATH, LOSS OF LIMBS, OR OTHER SEVERE INJURY. DO NOT USE THE SWIM PLATFORM OR SWIM LADDER WHILE THE ENGINES ARE RUNNING. STOP THE ENGINES IF DIVERS OR SWIMMERS ARE ATTEMPTING TO BOARD. ALWAYS PROPERLY STORE THE LADDER BEFORE STARTING THE ENGINES.

12.12 Trash Disposal

The discharge of plastic trash or trash mixed with plastic is illegal anywhere in the marine environment. U.S. Coast Guard regulations also restrict the dumping of other forms of garbage. Regional, State, and local restrictions on garbage discharges also may apply.

Responsible boaters store refuse in bags and dispose of it properly on shore. You should make sure your passengers are aware of the local waste laws and the trash management procedure on your boat. Refer to the placard mounted on your boat for more specific information regarding solid waste disposal.

Federal law requires that vessels of 26 feet or longer must display in a prominent location, a durable placard at least 4 by 9 inches notifying the crew and passengers of the discharge restrictions (Marpol Treaty). It is the boat owner's responsibility to make sure this placard remains mounted and legible in accordance with the law.

12.13 Trailering Your Boat

If you trailer your boat, make sure that your tow vehicle is capable of towing the weight of the trailer, boat and equipment and the weight of the passengers and equipment inside the vehicle. This may require that the tow vehicle be specially equipped with a larger engine, transmission, brakes and trailer tow package.

The boat trailer is an important part of your boating package. The trailer should be matched to your boat's weight and hull. Using a trailer with a capacity too low will be unsafe on the road and cause abnormal wear. A trailer with a capacity too high, can damage the boat. Contact your trailer dealer to evaluate your towing vehicle and hitch, and to make sure you have the correct trailer for your boat.

Important Note:

Your Scout is a heavy boat and care must be taken when selecting the trailer. We recommend that you use a bunk style trailer that incorporates a combination of heavy duty rollers, to support the keel and long bunks running under and parallel to the stringers to support the hull. Avoid using a full roller trailer that does not have bunks. Roller trailers have a tendency to put extreme pressure points on the hull, especially on the lifting strakes, and have damaged boats. The situation is worse during launching and haul out. Damage resulting from improper trailer support or the use of a full roller trailer will not be covered by the Scout Warranty.

Note: Contact your trailer dealer to evaluate your towing vehicle and hitch, and to make sure you have the correct trailer for your boat.

- Make sure the trailer is a match for your boat's weight and hull design. More damage can be done to a boat by the stresses of road travel than by normal water operation. A boat hull is designed to be supported evenly by water. So, when it is transported on a trailer it should be supported structurally as evenly across the hull as possible allowing for even distribution of the weight of the hull, engine and equipment.
- Make sure the trailer bunks and rollers properly support the hull and do not put pressure on the lifting strakes. The rollers and bunks must be kept in good condition to prevent scratching and gouging of the hull.
- The capacity rating of the trailer should be greater than the combined weight of the boat, motor, and equipment. The gross vehicle weight rating must be shown on the trailer. Make sure the weight of the boat, engine, gear and trailer is not more than the gross vehicle weight rating.
- Make sure the boat is securely fastened on the trailer to prevent movement between the boat and trailer. The bow eye on the boat should be secured with a rope, chain or turnbuckle in addition to the winch cable. Additional straps may be required across the beam of the boat.

Note: Your trailer dealer will give instructions on how to load, fasten and launch your boat.

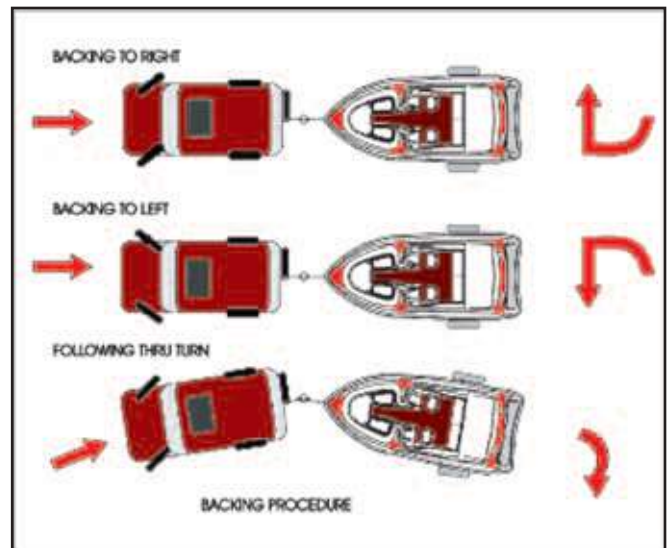

CAUTION

BOATS HAVE BEEN DAMAGED BY TRAILERS THAT DO NOT PROPERLY SUPPORT THE HULL. ALWAYS MAKE SURE THE TRAILER BUNKS AND ROLLERS ARE ADJUSTED SO THEY ARE NOT PUTTING EXCESSIVE PRESSURE ON THE LIFTING STRAKES AND ARE PROVIDING ENOUGH SUPPORT FOR THE HULL. HULL DAMAGE RESULTING FROM IMPROPER TRAILER SUPPORT IS NOT COVERED BY THE SCOUT WARRANTY.

Before Going Out On The Highway:

- SIDE CURTAINS, CLEAR CONNECTOR, BACK DROP and AFT CURTAIN must be removed when trailering. Canvas enclosures are not designed to withstand the extreme wind pressure encountered while trailering and will be damaged. Always remove and properly store the enclosure before trailering your boat.
- Make sure the tow BALL and TRAILER COUPLER are the same size and bolts and nuts are tightly secured.
- The COUPLER MUST BE COMPLETELY OVER THE BALL and the LATCHING MECHANISM LOCKED DOWN.

- Make sure the TRAILER IS LOADED EVENLY from front to rear as well as side to side and has the correct weight on the hitch. Too much weight on the hitch will cause the rear of the tow vehicle to drag and may make steering more difficult. Too little weight on the hitch will cause the rig to fishtail and will make controlling the tow vehicle difficult. Contact your trailer manufacturer or dealer for the correct weight on the hitch for your trailer.
- The SAFETY CHAINS must be attached crisscrossing under the coupler to the frame of the tow vehicle. If the ball was to break, the trailer would follow in a straight line and prevent the coupler from dragging on the road. Make sure the trailer emergency brake cable or chain is also installed to the tow vehicle frame.
- Make sure the LIGHTS on the trailer function properly.
- CHECK THE BRAKES. On a level parking area roll forward and apply the brakes several times at increasing speeds to determine if the brakes on the tow vehicle and trailer are working properly.
- Make sure the tow vehicle has SIDE VIEW MIRRORS that are large enough to provide an unobstructed rear view on both sides of the vehicle.
- CHECK THE TIRES and WHEEL BEARINGS.

Note: Make sure your towing vehicle and trailer are in compliance with all state and local laws. Contact your state motor vehicle bureau for laws governing the towing of trailers.

Chapter 13:

ROUTINE MAINTENANCE

13.1 Exterior Hull and Deck

Hull Cleaning-Below The Water Line

When the boat is removed from the water, clean the outer bottom surface immediately. Algae, grass, dirt and other marine growth is easier to remove while the hull is still wet. Use a pressure cleaner or a hard bristle brush to clean the surface.

Bottom Painting

If the boat is to be left in saltwater for extended periods, the hull must be protected from marine growth by antifouling paint. Because of variations in water temperature, marine growth, and pollution in different regions, a qualified boat yard in your area should be consulted when deciding what bottom paint system to apply to your hull. This is extremely important as pollution and marine growth can damage fiberglass hulls.

Use only standard antifouling paints and fiberglass wax removers and primers recommended by the antifouling paint manufacturer when preparing the hull for bottom paint. Light sanding, just enough to scuff the gel coat or a skip sand primer system can be used to prepare the hull for bottom paint. The use of a coating other than standard antifouling paint or epoxy barrier coatings are not recommended and will void the hull blister warranty.

Do not allow the hull antifouling paint to contact the outboard motors. Most antifouling paints designed for hull bottoms contain copper and can cause severe galvanic corrosion damage to the motors. Always leave a 1/2" barrier between the hull bottom paint and outboard motors.

Most bottom paints require some maintenance. Proper maintenance is especially important when the boat is in saltwater and not used for extended periods or after dry storage. If the hull bottom has been painted with antifouling paint, contact your local boat yard for the recommended maintenance procedures.

Anodes

Sacrificial anodes are installed on the outboard motors, engine brackets and trim tabs. The anodes are less noble than copper based alloys, stainless steel and aluminum. They will deteriorate first, protecting the more noble underwater hardware against galvanic corrosion.

They must be monitored if the boat is to be left in the water. Anodes should be checked monthly and changed when they are

75% of their original size. When replacing the anodes, make sure the contact surfaces are clean, shiny metal and free of paint and corrosion. Never paint over the anode.

Boats stored in saltwater will normally need to have the anodes replaced every 6 months to one year. Anodes requiring replacement more frequently may indicate a stray current problem within the boat or at the slip or marina. Anodes that do not need to be replaced after one year may not be providing the proper protection. Loose or low quality anodes could be the problem. Contact your engine dealer or Scout Customer Service for the proper size and type of anodes to be used and the specific installation procedure.

There are 2 anodes on Yamaha engines. There is a large anode on the bottom of the clamp bracket and another anode on the anti-cavitation plate, above the propeller.

Fiberglass Gel coat

Normal maintenance requires only washing with mild soap and water. A stiff brush can be used on the nonskid areas. Kerosene or commercially prepared products will remove oil and tar which could be a problem on trailered boats. Harsh abrasive and chemical cleaners are not recommended because they can damage or dull the gel coat, reducing its life and making it more susceptible to stains. When the boat is used in saltwater, it should be washed thoroughly with soap and water after each use.

At least once a season, wash and wax all exposed fiberglass surfaces. Use a high quality automotive or boat wax. Follow the procedure recommended by the wax manufacturer. The washing and waxing of your boat will have the same beneficial effects as they have on an automobile finish. The wax will fill minute scratches and pores thus helping to prevent soiling and will extend the life of the gel coat or paint.

After the boat is exposed to the direct sunlight for a period of time, the gel coat or painted surfaces tend to fade, dull or chalk. A heavier buffing is required to bring the finish back to its original luster. For power cleaning use a light cleaner. To clean the boat by hand, use a heavier automotive cleaner. Before cleaning the surfaces, read the instructions given with the cleaner. After cleaning the surfaces, apply wax and polish all fiberglass surfaces except the nonskid areas.

If the fiberglass should become damaged and need repair, contact your dealer or Scout Customer Service for assistance in finding an authorized repair person to make the repairs.

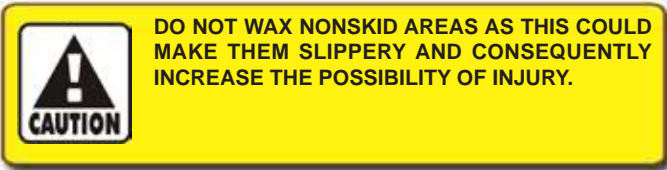

Stainless Steel Hardware

When using the boat in saltwater, the hardware should be washed with soap and water after each use. When your boat is used in a corrosive environment such as saltwater, water with a high sulfur content, or polluted water, the stainless steel will periodically develop surface rust stains. This is perfectly normal under these conditions. The stainless can normally be cleaned and protected by using a high quality boat or automotive wax or a commercial metal cleaner and protectant.

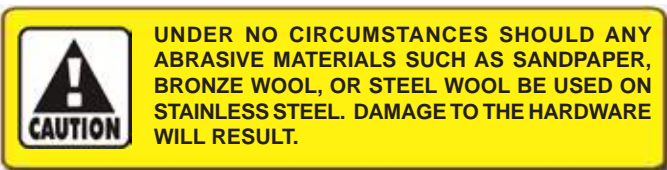

Anodized Aluminum Surfaces

Anodized aluminum should be washed periodically with soap and water to keep it clean. If the boat is used in saltwater or polluted water, the aluminum should be washed with soap and water after each use. Saltwater allowed to remain on anodized aluminum will penetrate the anodized coating and attack the aluminum.

Hard tops, bimini tops or T-tops with canvas and/or fiberglass tops require special attention to the anodized aluminum just below the top. This area is subject to salt build up from salty condensation and sea spray. It is also frequently overlooked when the boat is washed and will not be rinsed by the rain. Consequently, the aluminum just below the top is more likely to become pitted than the exposed aluminum on the structure. Make sure the aluminum in this area is washed frequently with soap and water and rinsed thoroughly. Pay particular attention to places where the top material or lacing contact the frame. Once a month coat the entire frame with a metal protector made for anodized aluminum to protect against pitting and corrosion caused by the harsh effects of saltwater. Do not use automotive or boat wax designed for paint or gel coat on anodized aluminum. The wax can contaminate the aluminum and damage the anodized surface.

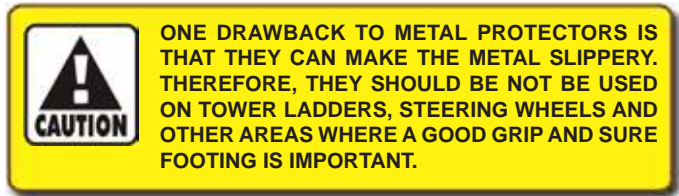

Stains can be removed with a metal polish or fine polishing compound. To minimize corrosion, use only high quality stainless steel fasteners on aluminum fabrications. Isolate the fasteners from the aluminum by using fiber washers and caulking compound or Tef gel to bed hardware and fasteners mounted to aluminum fabrications. If the anodized coating is badly scratched, it will require special attention and more frequent cleaning to the damaged area. With proper care, anodized aluminum will provide many years of service.

Powder Coated Aluminum

Powder coated aluminum should be washed periodically with soap and water to keep it clean. If the boat is used in saltwater or polluted water, the aluminum should be washed with soap and water after each use. Saltwater allowed to remain on powder coated aluminum will penetrate the coating and attack the aluminum, usually around fasteners and hardware mounted to the aluminum.

Pay special attention to the area just below the top. This area is subject to salt buildup from salty condensation and sea spray. It is also frequently overlooked when the boat is washed and will not be rinsed by the rain. Consequently, the powder coating near fasteners and hardware mounted just below the top is more likely to be attacked by the salt and become corroded than the exposed areas on the structure. Make sure the aluminum in this area is washed frequently with soap and water and rinsed thoroughly. Pay particular attention to places where the top material and lacing contact the frame.

Once a month check the entire frame for damaged powder coating and corrosion around fasteners and hardware. Nicked or badly scratched powder coating can be sanded and touched up with enamel paint. Corrosion around fasteners will have to be sanded, then touched up with paint. The fasteners will require fiber washers and sealing with caulk or tef gel to isolate the fastener from the aluminum and prevent damage to the paint or powder coating when the fastener is installed. Periodically applying automotive or boat wax to the powder coating will provide additional protection from the harsh effects of saltwater.

Always repair scratches, nicks and corroded areas in powder coating as soon as possible. Corrosion left unaddressed will lift the powder coating allowing moisture to travel between the power coating and the aluminum causing the corrosion to spread below the coating and damage the aluminum.

If excessive chipping and peeling occurs, it could be an indication of an electrical fault in the boat or aluminum fabrication. You should contact a qualified marine electrician to inspect your boat immediately and correct the problem if you suspect that your boat may have a fault in the aluminum frame. You should also contact Scout Customer Service.

Note: Boats that are towed behind larger vessels require special attention to the aluminum hardware. The salt spray, salty steam, and chemicals in exhaust gases are particularly corrosive and will damage the surface of anodized or powder coated aluminum. It is imperative that the boat and the aluminum are cleaned thoroughly at the completion of each trip or at the end of each day on long cruises to reduce accelerated deterioration of the anodizing or powder coating and premature corrosion to the aluminum.

Note: You should contact Scout Customer Service before making any modifications to aluminum fabrications. Unauthorized modifications can void the warranty.

Chrome Hardware

Use a good chrome cleaner and polish on all chrome hardware.

Acrylic Plastic Glass

Acrylic glass scratches easily. Never use a dry cloth or glass cleaning solutions on acrylic. Use a soft cloth and mild soap and water for routine cleaning. Solvents and products containing ammonia can permanently damage acrylic plastic glass.

Fine scratches can be removed with a fine automotive clear coat polishing compound. A coat of automotive or boat wax is beneficial to protect the surface. Do not use the following on acrylic glass:

Abrasive cleaners	Acetone
Solvents	Alcohol
Glass cleaners	Cleaners containing ammonia

Engine and Fuel

Proper engine maintenance is essential to the proper performance and reliability of your outboard engines. Maintenance schedules and procedures are outlined in your engine owner's manual. They should be followed exactly.

If the boat is used in saltwater, flush the cooling system after each daily use. To flush the systems when the boat is out of the water, follow the procedure outlined in your engine owner's manual.

The age of gasoline can effect engine performance. Chemical changes occur as the gasoline ages that can cause deposits and varnish in the fuel system as well as reduce the octane rating of the fuel. Severely degraded fuel can damage the engines and boat fuel tank and lines. Therefore, if your boat is not being run enough to require at least one full tank of fresh fuel a month, a fuel stabilizer should be added to the gasoline to protect the fuel from degradation. Your dealer or the engine manufacturer can provide additional information on fuel degradation and fuel stabilizers recommended for your engines.

Avoid using fuels with alcohol additives. Gasoline that is an alcohol blend will absorb moisture from the air which can reach such concentrations that "phase separation" can occur whereby the water and alcohol mixture becomes heavy enough to settle out of the gasoline to the bottom of the tank. Since the fuel pickup tubes are very near the bottom of the tank, phase separation can cause the engines to run very poorly or not at all. This condition is more severe with methyl alcohol and will worsen as the alcohol content increases. Water or a jelly like substance in the fuel filters are an indication of possible phase separation from the use of alcohol blended fuels.

13.2 Upholstery, Canvas and Enclosures

Vinyl Upholstery

The vinyl upholstery used on the seats, cushions, bolsters, and for the headliner in some cabins, should be cleaned periodically with mild soap and water. Any stain, spill or soiling should be cleaned up promptly to prevent the possibility of permanent staining. When cleaning, always rub gently. Avoid using products containing ammonia, powdered abrasive cleaners, steel wool, ink, strong solvents, acetone and lacquer solvents or other harsh chemicals as they can cause permanent damage or shorten the life of vinyl. Never use steam heat, heat guns or hair dryers on vinyl.

Stronger cleaners, detergents and solvents may be effective in stain removal, but can cause either immediate damage or slow deterioration. Lotions, sun tan oil, waxes and polishes, etc., contain oils and dyes that can cause stiffening and staining of vinyls.

- Dry soil, dust and dirt - Remove with a soft cloth.
- Dried on dirt - Wash with a soft cloth dampened with water.
- Variations in surface gloss - Wipe with a water dampened soft cloth and allow to air dry.

- Stubborn dirt - Wash with a soft cloth dampened with Ivory Flakes® and water. Rinse with clean water.
- Stubborn spots and stains - Spray with either Fantastik Cleaner® or Tannery Car Care Cleaner® and rub with a soft cloth. Rinse with clean water.
- Liquid spills - Wipe immediately with a clean absorbent cloth. Rinse with clean water.
- Food grease and oily stains - Spray immediately using either Fantastik Cleaner® or Tannery Car Care Cleaner®, wiping with a soft cloth. Take care not to extend the area of contamination beyond its original boundary. Rinse with clean water.

Acrylic Canvas (Sunbrella)

Modern, bright colored canvas tops are usually fabricated from acrylic fabrics with the trade names like Sunbrella®, Argonaut®, etc. Acrylic fabrics look similar to cotton canvas but are much more durable and color fast.

Acrylic canvas can be cleaned by using Ivory Flakes, Ivory Liquid or another mild soap and water. Scrub lightly and rinse thoroughly to remove the soap. Do not use detergents, as they will deteriorate the waterproofing in the fabric. The underside can be brushed with a soft brush and sprayed with a disinfectant to prevent the accumulation of dirt and mildew. The top or accessories should never be folded or stored wet.

In fresh water areas, the top and curtains should be washed weekly. This is particularly important if the boat is stored near a highway, airport or in a large city. Residue from jet fuel, exhaust fumes and industrial pollution can shorten the life of tops and enclosures.

In saltwater areas, the top and curtains should be rinsed with freshwater after each use and at least weekly if it is stored outside. Saltwater attracts moisture and dirt can shorten the life of fabric tops and enclosures. The salt is also abrasive and can cause premature wear in the fabric and stitching.

After several years, the acrylic canvas may lose some of its ability to shed water. If this occurs, wash the fabric and let it dry thoroughly. Then treat the outside surface with a commercially available waterproofing designed for this purpose. Waterproofing is available in bulk at most canvas shops. One-gallon garden sprayers are excellent for applying waterproofing.

Note: Some leakage at the seams is normal and unavoidable with acrylic enclosures.

Laminated Vinyl Tops

Laminated vinyl top material is a lamination of two plies of

specially formulated vinyl with an inner reinforcing core fabric. The most common trade name for this fabric is Weblon.® It is not unusual for the interior ply to be a different color than the exterior. There is a greater tendency for this type of fabric to leak at the seams than with acrylic or vinyl coated polyester. Paraffin wax that matches the top can be used to seal the seams if necessary.

Laminated vinyl fabrics should be cleaned periodically by using Ivory Flakes, Ivory Liquid or another mild soap and water. Scrub lightly and rinse thoroughly to remove the soap. Do not use detergents, or harsh cleaners like bleach and ammonia. They will attack the vinyl in the fabric and shorten its life. The top or accessories should never be folded or stored wet.

In fresh water areas, the top and curtains should be washed weekly. This is particularly important if the boat is stored near a highway, airport or in a large city. Residue from jet fuel, exhaust fumes and industrial pollution can shorten the life of tops and enclosures.

In saltwater areas, the top and curtains should be rinsed with freshwater after each use and at least weekly if it is stored outside. Saltwater attracts moisture and dirt can shorten the life of fabric tops and enclosures. The salt is also abrasive and can cause premature wear in the stitching.

Clear Curtains and Connectors

Side curtains and clear connectors can be cleaned with mild soap and water. They should not be allowed to become badly soiled. Dirt, oil, mildew, and cleaning agents containing ammonia, will shorten the life of the vinyl that is used for clear curtains. After cleaning the curtains and allowing them to dry, apply a non-lemon furniture polish or an acrylic glass and clear plastic protector to extend the life of the curtains.

Vinyl curtains should be stored either rolled or flat, without folds or creases. Folding the curtains will make permanent creases that could cause the vinyl to crack.

Note: Do not use any polish containing lemon scents or lemon. The lemon juice will attack the vinyl and shorten its life.

Snaps should be lubricated periodically with petroleum jelly, silicone grease or a lubricant designed for snaps. Zippers should be lubricated with silicone spray, paraffin or silicone stick.

Strataglass

Strataglass® is a special coated vinyl that could be used in the curtains for the T-top enclosure. The coating protects the vinyl glass and resists scratching. Waxes and Plexiglas polishing compounds should not be used on strataglass as the protective

coating prevents them from penetrating into the vinyl and they will build up on the surface. These products will create a hazy, greasy appearance that will affect the clarity of the strataglass. Products that repel water, like Rainex®, should not be used as they will not take well to the surface and could appear spotty and may also yellow or dull the Strataglass over time.

Strataglass can be cleaned by rinsing off dirt or salt deposits with fresh water, then washing with a clean cloth and mild soap. Chamois dry to remove water spots and improve clarity. If a polish is accidentally used, use Windex® or its equivalent to remove it. While window cleaners will destroy the standard vinyl normally used in side curtains and clear connectors, it will not harm strataglass. Always roll down the curtains and snap in place at the end of each day so the curtains will maintain their shape and to minimize fold distortions.

Depending upon usage, it is recommended that an occasional application of Aquatech Strataglass Cleaner be done. Treat this like a polish, as opposed to a cleaner - wash and dry curtains first, **then** apply Aquatech Strataglass Cleaner, actually buffing the surface to a beautiful sheen. This is not just a wipe on/ wipe off product...it needs to be buffed to perform.

Remember, the coating on strataglass is scratch resistant and not scratch proof. Always handle the curtains with care and never roll up curtains that are salty or dirty. If you have any questions about the clear curtains used on your boat, please contact the Scout Customer Service Department.

The T-top enclosure must be removed when trailering. Canvas enclosures are not designed to withstand the extreme wind pressure encountered while trailering and will be damaged. Always remove and properly store the enclosure before trailering your boat.

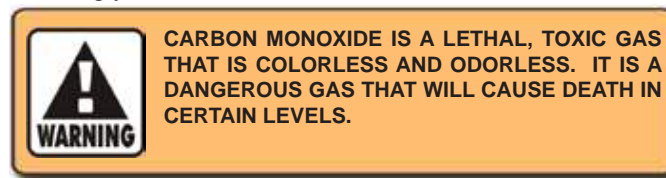

13.3 Interior

The cabin or head interior can be cleaned just like you would clean a home interior. To preserve woodwork, use teak oil. To maintain carpeting, use a vacuum cleaner. Because air and sunlight are very good cleansers, periodically put cushions, sleeping bags, etc. on deck, in the sun and fresh air, to dry and air out. If cushions or equipment get wet with saltwater, remove and use clean, fresh water to rinse off the salt crystals. Salt retains moisture and will cause damage. Dry thoroughly and reinstall.

Vinyl headliner material should be cleaned periodically as explained in the previous section. Avoid using products containing ammonia, bleach, or harsh chemicals as they can shorten the life of vinyl.



If you leave the boat for a long period of time, put all cushions on their sides, open all interior cabin and locker doors, and hang a commercially available mildew protector in the cabin.

Note: Always read the label carefully on mildew protectors. Remove the protector and allow the cabin to ventilate completely before using the cabin.

Interior Woodwork

Oiled and varnished woodwork can be cleaned with a damp cloth. For heavy duty cleaning, use a mixture of water and Murphy's Oil Soap or a solution of 10% white vinegar and water to clean the wood and wipe it dry with a clean towel. Apply a furniture polish to add luster and help to preserve the finish.

13.4 Bilge

To keep the bilge clean and fresh, it is recommended that you use a commercial bilge cleaner on a regular basis. Follow the directions carefully. All exposed pumps and metal components in the bilge should be sprayed periodically with a protector to reduce the corrosive effects of the high humidity always present in these areas.

Periodically check the bilge pumps and alarms for proper operation and clean debris from the strainers and float switches. Inspect all hoses, clamps and thru-hulls for leaks and tightness on a regular basis and operate all thru hull valves at least once a month to keep them operating properly.

Frequently test the automatic switches for the bilge pumps and alarms for proper operation. This is accomplished by lifting the float switch until the pump is activated. You can also use a garden hose to flood the bilge until the water level is high enough to activate the pump.

13.5 Drainage System

It is essential that the following items be done periodically to maintain proper drainage of your boat:

- Clean the cockpit drains with a hose to remove debris that can block water drainage.
- Clean the hardtop or T-top leg drain holes. This is especially important just before winter lay-up.
- Flush all gravity drains with freshwater to keep them clean and free flowing.
- Operate the thru-hull valves once a month and service as required.

Note: All drains and pumps must be properly winterized before winter lay-up.

THIS PAGE WAS LEFT BLANK
INTENTIONALLY

Chapter 14:

SEASONAL MAINTENANCE

14.1 Storage and Lay-up

Before Hauling:

- Pump out the head holding tank. Flush the holding tank using clean soap, water and a deodorizer. Pump out the cleaning solution.
- The fuel tank should be left nearly full to reduce condensation that can accumulate in the tank. Allow enough room in the tank for the fuel to expand without leaking out the vents. Moisture from condensation in the fuel tank can reach such concentrations that it becomes heavy enough to settle out of the gasoline to the bottom of the tank. Since fuel pickup tubes are located near the bottom of the tank, this accumulated moisture can cause the engines to run poorly or not at all after extended storage.

Chemical changes also occur as the gasoline ages that can cause deposits and varnish in the fuel system as well as reduce the octane rating of the fuel. Severely degraded fuel can damage the engine and boat fuel tank and lines. Therefore, if your boat is not being run enough to require at least one full tank of fresh fuel a month or during winter storage, a fuel stabilizer should be added to the gasoline to help protect the fuel system from these problems. Operate the boat for at least 15 minutes after adding the stabilizer to allow the treated fuel to reach the engine. Yamaha recommends using Yamaha Fuel Conditioner and Stabilizer for their engines.

Your dealer or the engine manufacturer can provide additional information on fuel degradation and fuel stabilizers recommended for your engine. For more recommendations for your specific area, check with your local Scout dealer.

- Drain water from the freshwater system.
- Consult the engine owner's manual for detailed information on preparing the engines for storage.

Lifting

It is essential that care be used when lifting your boat. Make sure the spreader bar at each sling is at least as long as the distance across the widest point of the boat that the sling will surround. Put the slings in position. Refer to the sling loca-

tions drawing for the correct position of the lifting slings. The fore and aft slings should be tied together to prevent the slings from sliding on the hull.

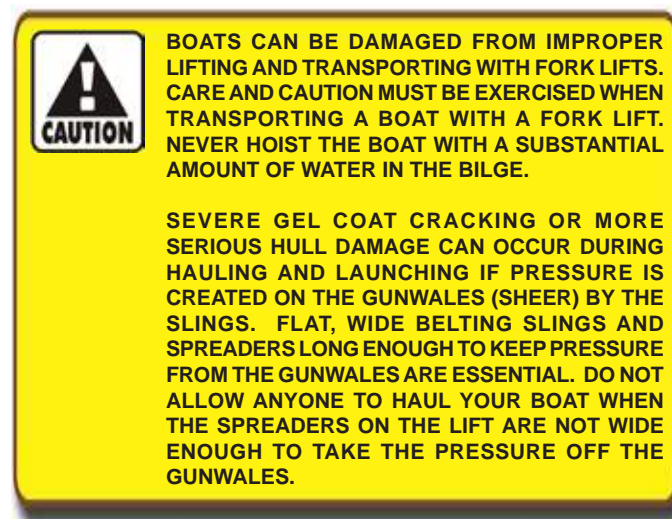

Supporting The Boat For Storage

A trailer, elevating lift, or a well-made cradle is the best support for your boat during storage.

When storing the boat on a trailer for a long period:

- Make sure the trailer is on a level surface and the bow is high enough so that water will drain from the bilge and cockpit.
- Make sure the engines are in the down position.
- The trailer must properly support the hull. The bunks and rollers should match the bottom of the hull and should not be putting pressure on the lifting strakes.
- Make sure the hitch is properly supported.
- Check the tires once each season. Add enough air for the correct amount of inflation for the tires as necessary.

Note: Read the owner's manual for the trailer for the correct amount of inflation for the tires.

When storing the boat on a lift or cradle:

- The cradle must be specifically for boat storage.
- Make sure the cradle or lift is well supported with the bow high enough to provide proper drainage of the bilge.
- Make sure the engines are in the down position.
- The cradle or lift must be in the proper fore and aft position to properly support the hull. When the cradle or lift is in the correct location, the bunks should match the bottom of hull and should not be putting pressure on the lifting strakes.

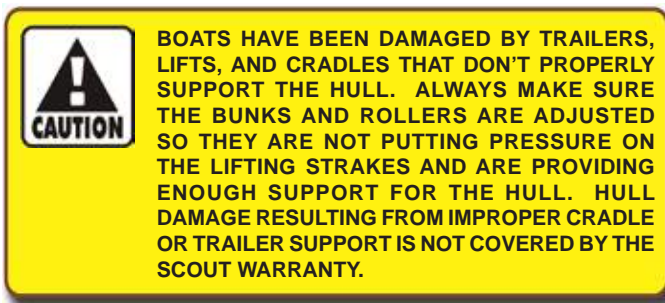

Preparing The Boat For Storage:

- Remove the bilge drain plug(s), if installed.
- Thoroughly wash the fiberglass exterior, especially the antifouling portion of the bottom. Remove as much marine growth as possible. Lightly wax the exterior fiberglass components.
- Remove all oxidation from the exterior hardware, and apply a light film of moisture displacing lubricant, wax or a metal protector.
- Remove propellers and grease the propeller shafts using light waterproof grease.
- Remove the batteries and store in a cool place. Clean using clear, clean water. Be sure the batteries have sufficient water and clean terminals. Keep the batteries charged and safe from freezing throughout the storage period.

Note: Refer to the Electrical System chapter, for information on the maintenance of the AC and DC electrical systems.

- Coat all faucets and exposed electrical components in the cabin and cockpit with a protecting oil.
- Clean out, totally drain and completely dry the fishboxes, sinks and livewells.
- Thoroughly clean the interior of the boat. Vacuum all carpets and dry clean drapes and upholstery.
- Remove cushions, open as many locker doors as possible. Leaving as many of these areas open as possible will improve the boat's ventilation during the storage period.

Note: It is recommended that a mildew preventer be hung in the head compartment or cabin before it is closed for storage.

- Clean the exterior upholstery with a good vinyl cleaner and dry thoroughly. Spray the weather covers and boat upholstery with a spray disinfectant. Enclosed areas such as the shower basin, storage locker areas, etc. should also be sprayed with this disinfectant.

14.2 Winterizing

Freshwater System

The entire freshwater system must be completely drained. Disconnect all hoses, check valves, etc. and blow all the water from the system. Make sure the freshwater tank is completely drained. Use only very low air pressure when doing this to prevent possible system damage. Because of the check valve mechanism built in the pump, blowing the lines will not remove the water from the freshwater pump. Remove the outlet hose on the pump. Turn the pump on and allow it to pump out any remaining water...about a cupful.

A recommended alternative to the above-mentioned procedure is the use of commercially available nontoxic, freshwater system antifreeze. After draining the potable water tank and lines, pour the antifreeze mixture into the freshwater tank, prime and operate the pump until the mixture flows from all freshwater faucets. Make sure antifreeze has flowed through all of the freshwater drains.

For additional information please refer to the Freshwater System chapter.

Raw Water System

Completely drain the raw water systems. Disconnect all hoses and blow the water from the system. Use only very low air pressure when doing this to prevent possible system damage. Because of the check valve mechanism built in the raw water washdown pump, blowing the lines will not remove the water

from the raw water pump. Remove the inlet and outlet hoses on the pump. Turn the pump on and allow it to pump out any remaining water....about a cupful.

A recommended alternative to the above-mentioned procedure is the use of commercially available nontoxic, potable water system antifreeze. If potable water antifreeze is used, pour the mixture into a pail and put the raw water intake lines into the solution. Run the pumps one at a time until the antifreeze solution is visible at all raw water faucets and discharge fittings and drains. Be sure antifreeze has flowed through all of the raw water drains.

Make sure to run the stern fishbox macerator pump until all the water is removed from the fishbox and the pump. To avoid damage to the pump, be careful not to run the pump dry for more than 10 seconds.

Portable Head

The portable head must be properly winterized by following the manufacturer's winterizing instructions in the portable head owner's manual.

Marine Toilet

The marine toilet must be properly winterized by following the manufacturer's winterizing instructions in the marine toilet owner's manual. Drain the intake and discharge hoses completely using low air pressure if necessary. The head holding tank and macerator discharge pump must be pumped dry and one gallon of potable water antifreeze poured into the tank through the deck waste pump out fitting. After the antifreeze has been added to the holding tank, open the overboard discharge valve and activate the macerator pump until the antifreeze solution is visible at the discharge thru hull.

Note: Make sure you follow the marine toilet manufacturer's winterizing instructions exactly.

Bilge

Coat all metal components, wire busses, and connector plugs, in the bilge with a protecting oil. It is also important to protect all strainers, seacocks and steering components. The bilge pumps and bilge pump lines must be completely free of water and dried out when the boat is laid-up for the winter in climates where freezing occurs. Compartments in the bilge that will not drain completely should be pumped out and then sponged until completely free of water. Dry the hull bilge and self-bailing cockpit troughs. Water freezing in these areas could cause damage.

Yamaha Engines

The engines should be flushed with freshwater for at least 15 minutes prior to winter storage. This will remove salt, sand and other contaminants that can damage the engine. It is also important to "Fog" the cylinders, change the gear oil, fill the oil tanks (2-cycle engines) or change the oil in 4-cycle engines,

coat the engine with a protector, wax the exterior and properly store and charge the battery. You should refer to the Yamaha engine owner's manual or contact your dealer for specific instructions on winterizing your engines.

T-Top and Hardtops

It is imperative that all drain holes in the legs are open and that the legs are completely free of water. Remove the canvas and thoroughly clean and store in a safe, dry place. Remove all electronics. Coat all wire connectors and bus bars in the helm compartment with a protecting oil.

Clean the aluminum frame with soap and water and dry thoroughly. Apply an aluminum metal protector to the entire frame on anodized aluminum to reduce corrosion and pitting.

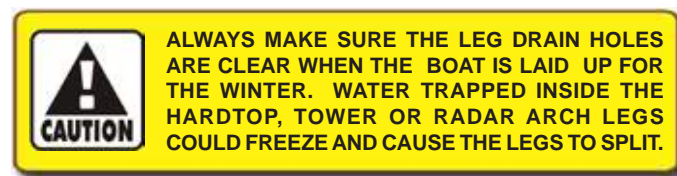

Special Notes Prior To Winter Storage

If the boat will be in outside storage, properly support a storage cover and secure it over the boat. It is best to have a frame built over the boat to support the canvas. It should be a few inches wider than the boat so the canvas will clear the rails and allow passage of air. If this cover is fastened too tightly there will be inadequate ventilation and this can lead to mildew, moisture accumulation, etc. It is essential to fasten the canvas down securely so that the winds cannot remove it or cause chafing of the hull superstructure. Do not store the boat in a damp storage enclosure. Excessive dampness can cause electrical problems, corrosion, and excessive mildew.

Whenever possible, do not use the bimini top or convertible top canvas in place of the winter storage cover. The life of these canvases may be significantly shortened if exposed to harsh weather elements for long periods.

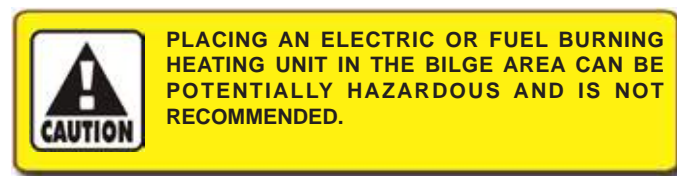

Proper storage is very important to prevent serious damage to the boat. If the boat is to be stored indoors, make sure the building has enough ventilation. It is very important that there is enough ventilation both inside the boat and around the boat.

Note: If the boat is to be stored indoors or outdoors, open all interior drawers, clothes lockers, cabinets, and doors a little. If possible, remove the upholstery, mattresses, clothing, and rugs. Then hang a commercially available mildew protector in the interior compartments.

14.3 Recommissioning

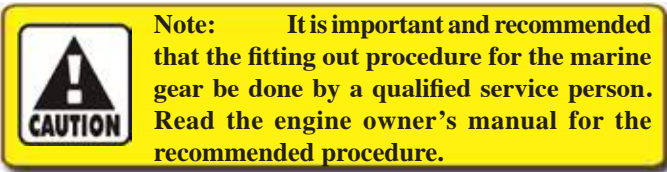
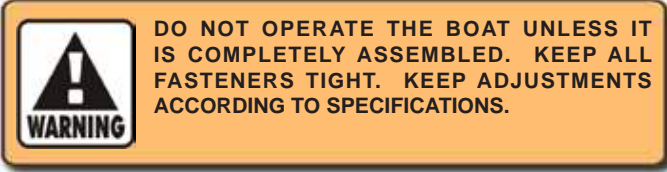

BEFORE LAUNCHING THE BOAT, MAKE SURE THE HULL DRAIN PLUG IS INSTALLED.

- Check and lubricate the steering system.
- Clean and wash the boat.
- Install all upholstery, cushions and canvas.

After Launching:

- Carefully check all water systems and the engine bolts for leaks. Operate each system one at a time checking for leaks and proper operation.
- Check the bilge pump manual and automatic switches.
- Check the bilge alarm automatic switch.
- When each engine starts, check the cooling system port below the engine cowling for a strong stream of water. This ensures that the cooling pump is operating.
- Carefully monitor the gauges and check for leakage and abnormal noises.
- Operate the boat at slow speeds until the engine temperature stabilizes and all systems are operating normally.

Reactivating The Boat After Storage:

- Charge and install the batteries.
- Install the drain plug in the hull.
- Check the engines for damage and follow the manufacturer's instructions for recommissioning.
- Check the mounting bolts for the engines to make sure they are tight.
- Perform all routine maintenance.
- Check all hose clamps for tightness.
- Pump the antifreeze from the freshwater and raw water systems and flush several times with freshwater. Make sure all antifreeze is flushed from the head before it is activated.

Appendix A: SCHEMATICS

12 Volt Harness

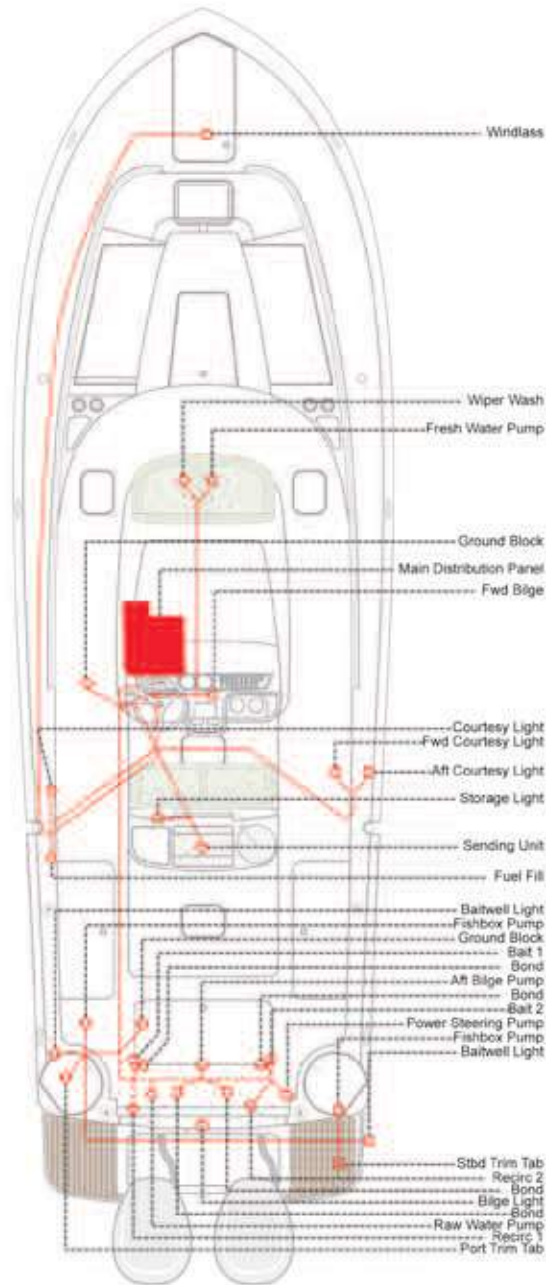

Waste

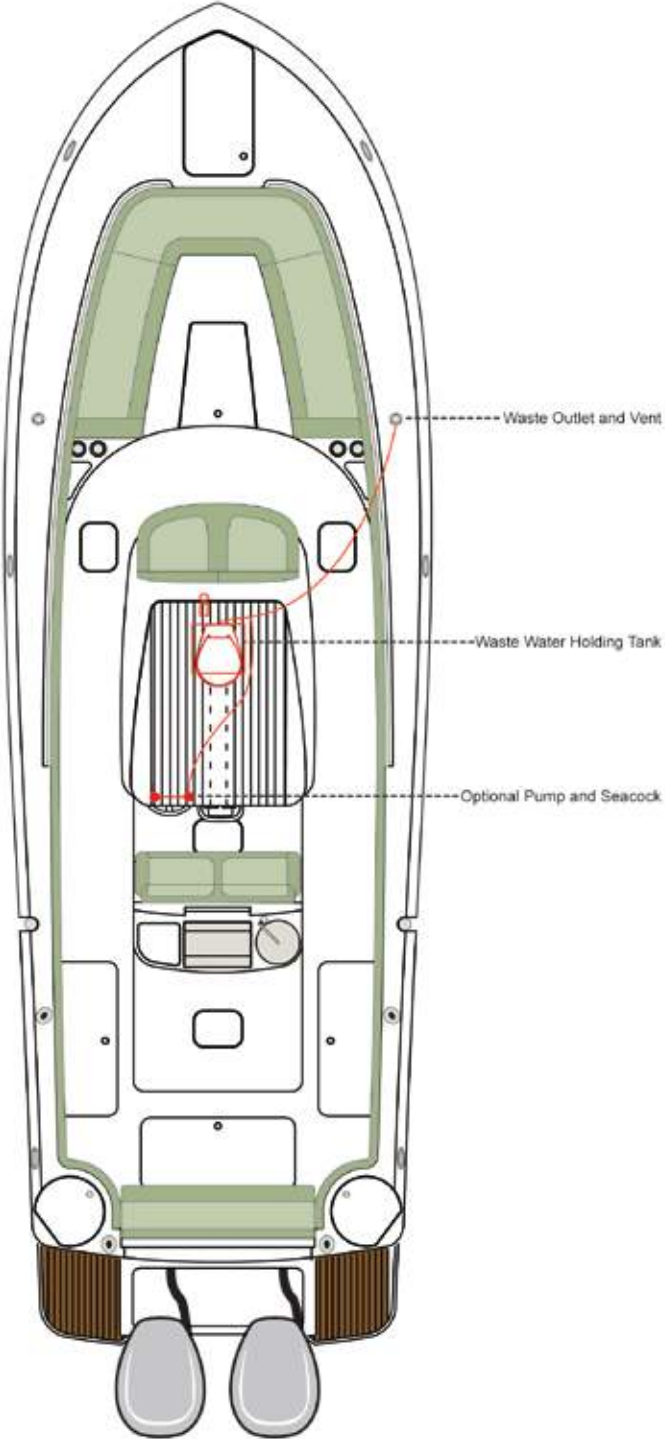

Raw Water

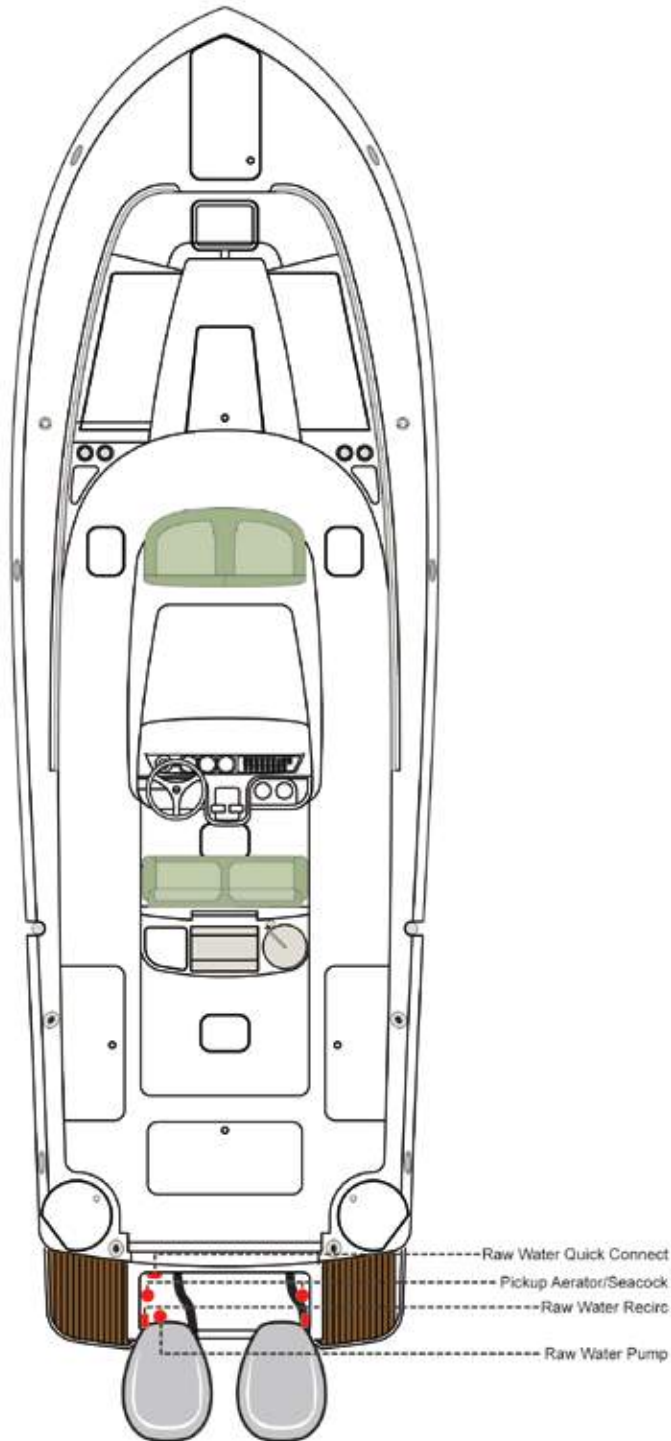

Fresh Water

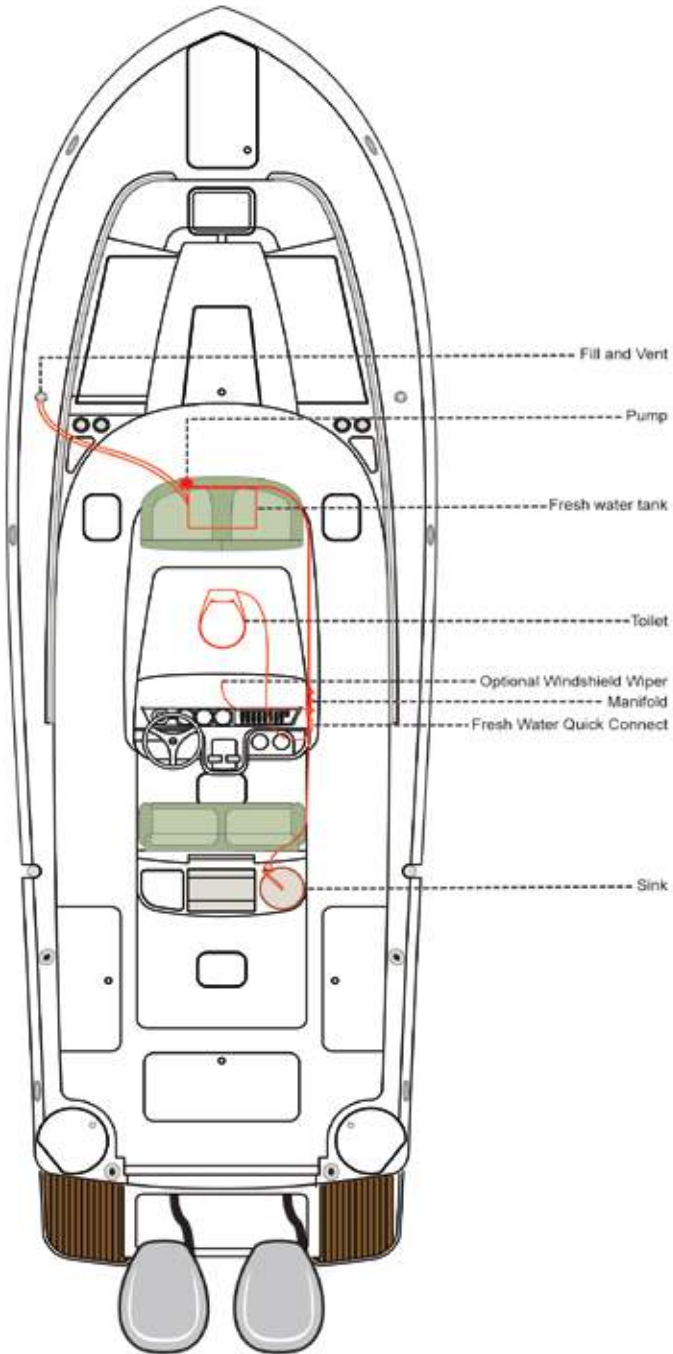

Drainage

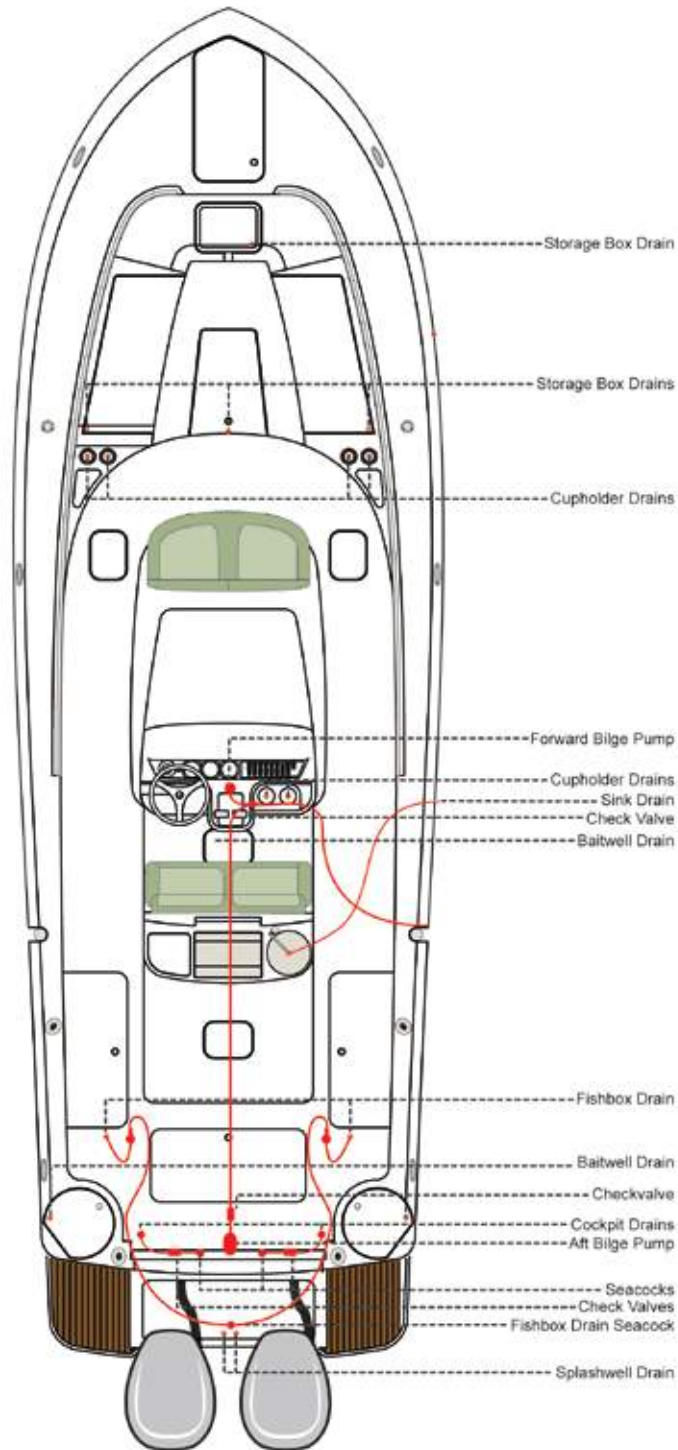

Propulsion

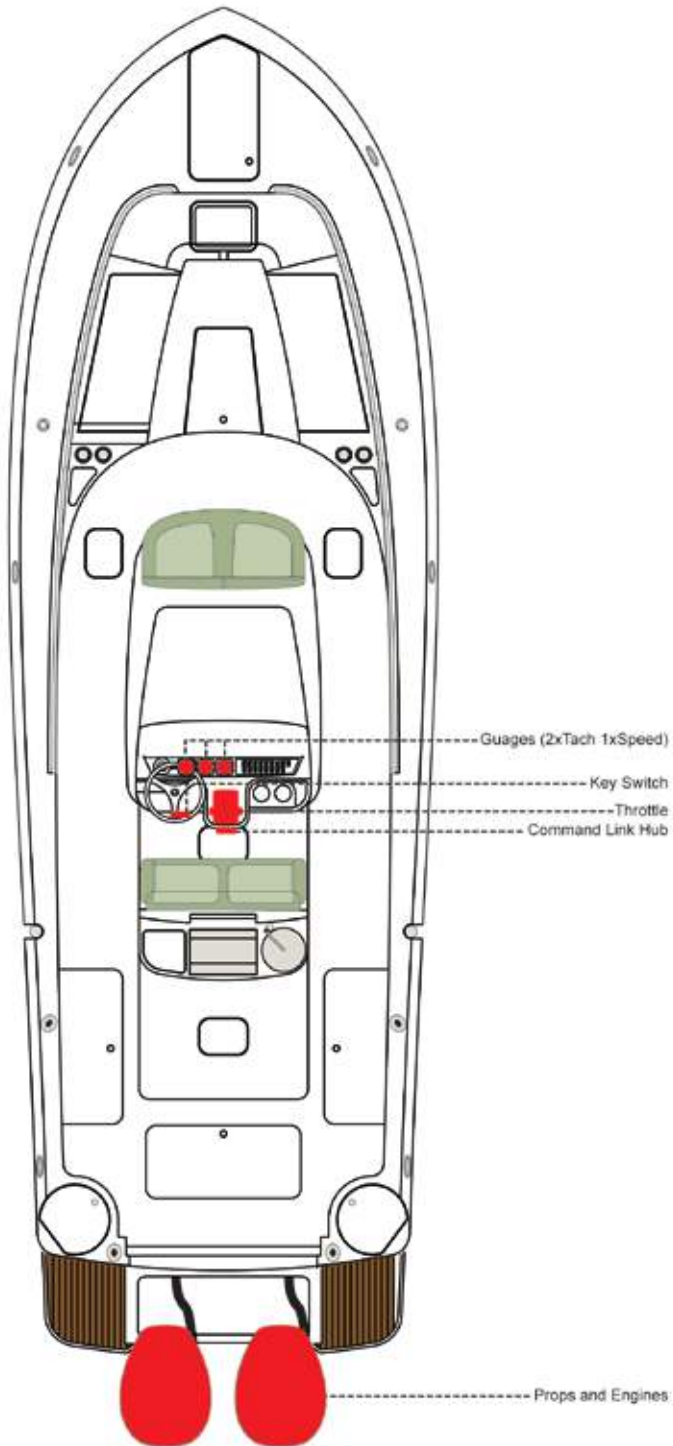

Steering

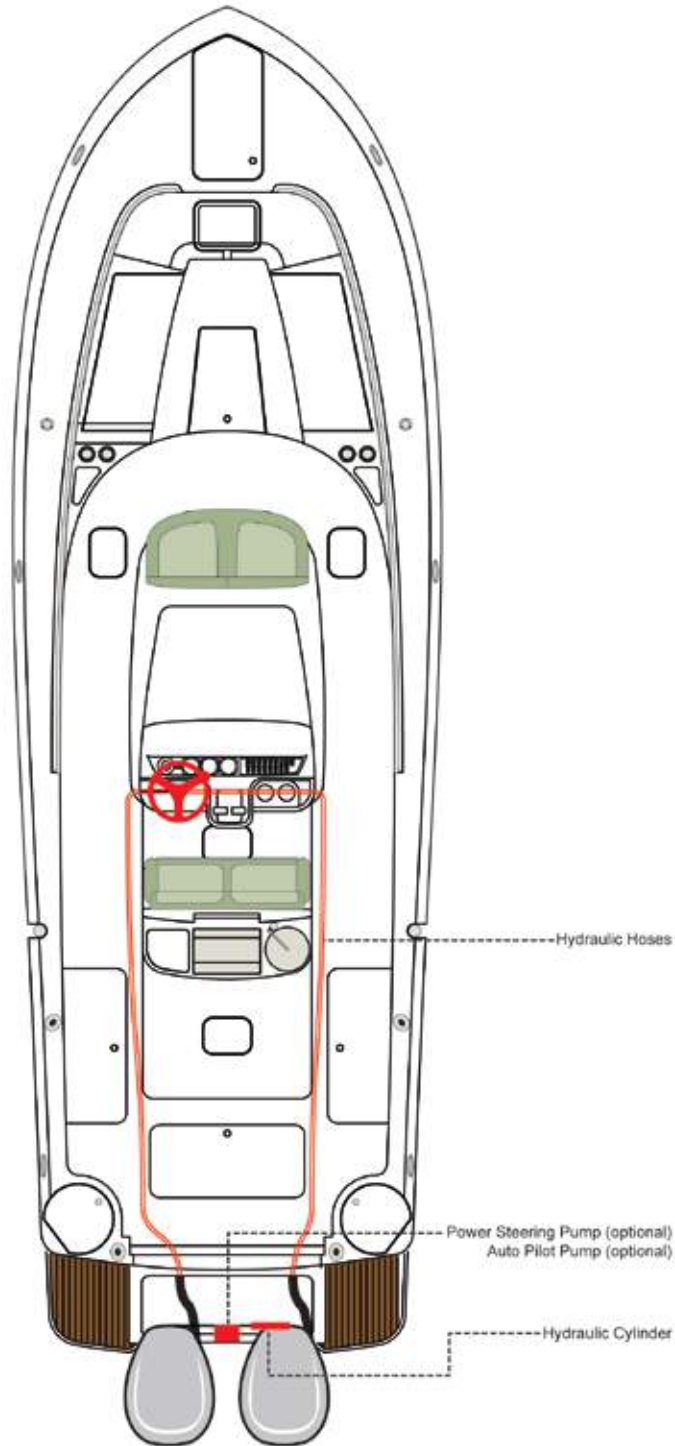

Stereo

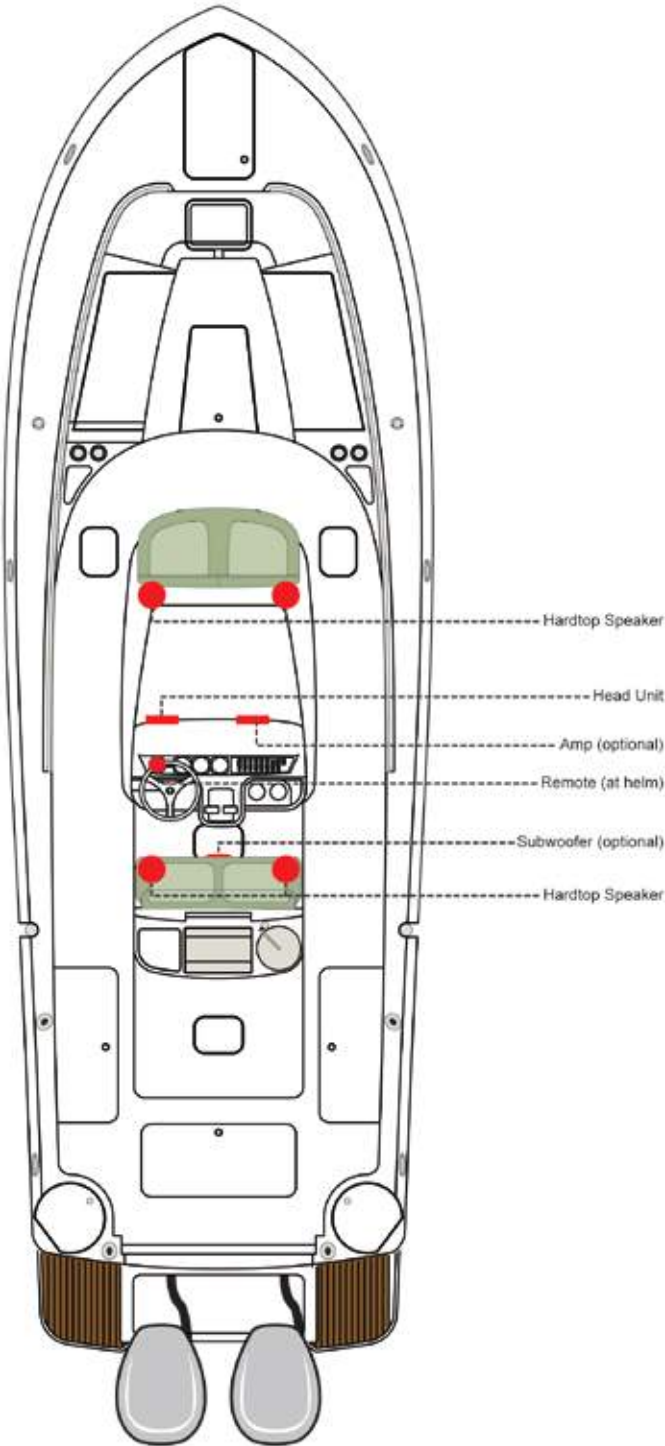

Hard Top Harness

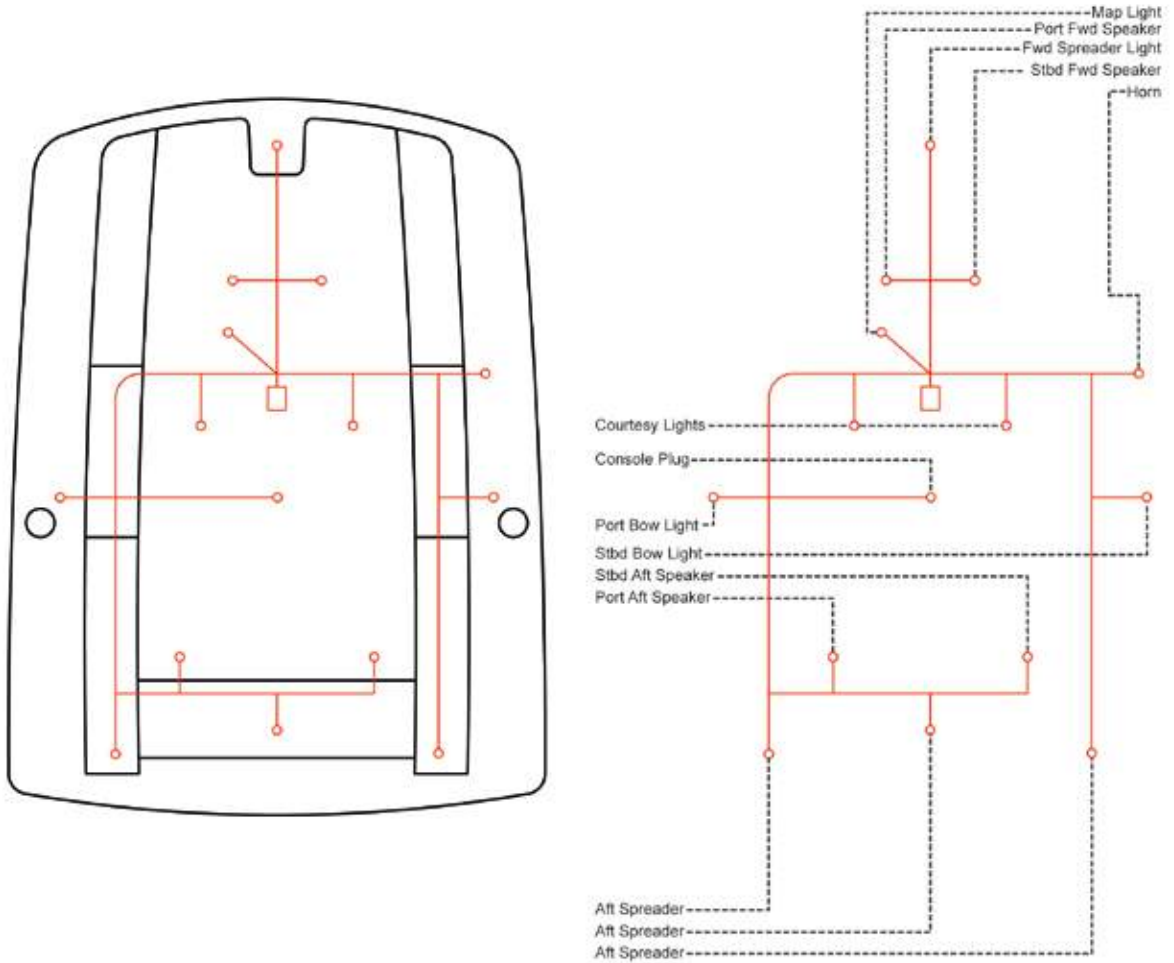

Fuel System

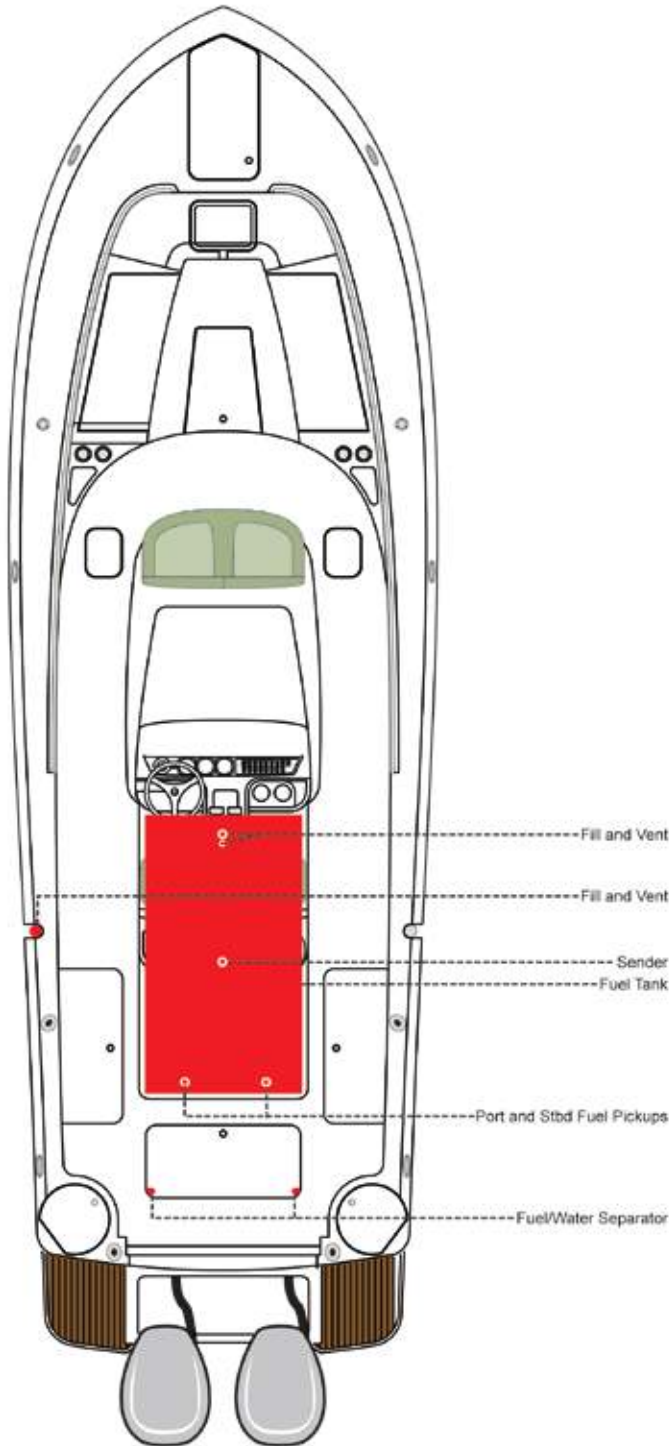

Console Harness

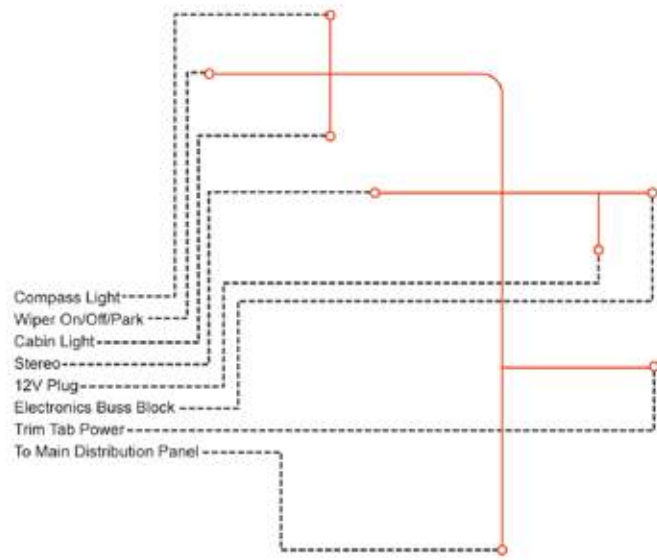
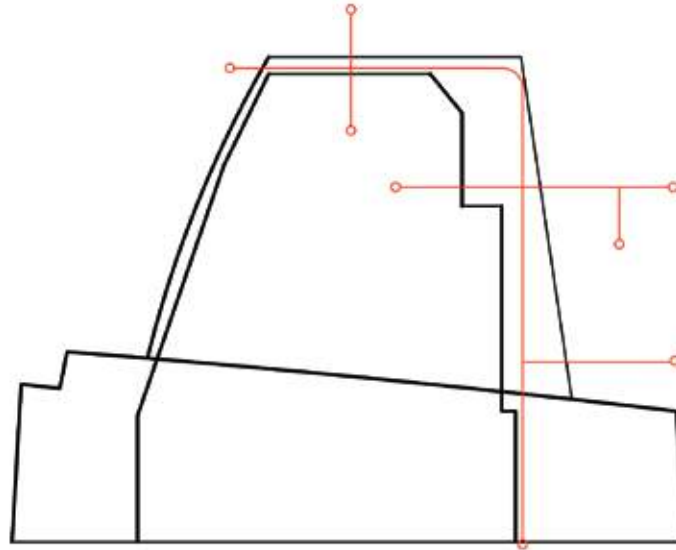

DC Electrical

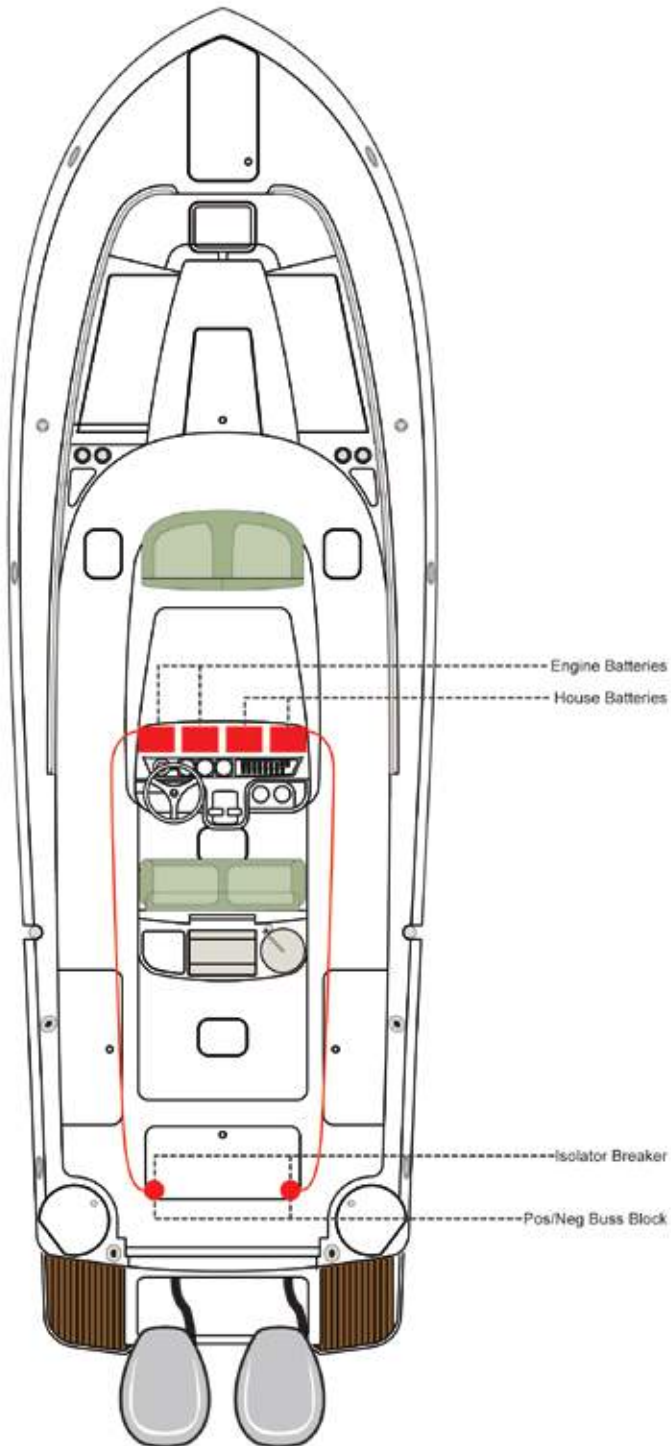

THIS PAGE WAS LEFT BLANK
INTENTIONALLY

Appendix B:

GLOSSARY OF TERMS

Aft: In, near, or toward the stern of a boat.

Aground: A boat stuck on the bottom.

Amidships: In or toward the part of a boat midway between the bow and stern.

Anchor: A specially shaped heavy metal device designed to dig efficiently into the bottom under a body of water and hold a boat in place.

Anchorage: An area specifically designated by governmental authorities in which boats may anchor.

Ashore: On shore.

Astern: Behind the boat, to move backwards.

Athwartship: At right angles to the center line of the boat.

Barnacles: Small, hard-shelled marine animals which are found in salt water attached to pilings, docks and bottoms of boats.

Beam: The breadth of a boat usually measured at its widest part.

Bearing: The direction of an object from the boat, either relative to the boat's direction or to compass degrees.

Berth: A bunk or a bed on a boat.

Bilge: The bottom of the boat below the flooring.

Bilge Pump: A pump that removes water that collects in the bilge.

Boarding: Entering or climbing into a boat.

Boarding Ladder: Set of steps temporarily fitted over the side of a boat to assist persons coming aboard.

Boat Hook: Short shaft of wood or metal with a hook fitting at one end shaped to aid in extending one's reach from the side of the boat.

Bow: The front end of a boat's hull

Bow Line: A line that leads forward from the bow of the boat.

Bow Rail: Knee high rails of solid tubing to aid in preventing people from falling overboard.

Bridge: The area from which a boat is steered and controlled.

Bridge Deck: A deck forward and usually above the cockpit deck.

Broach: When the boat is sideways to the seas and in danger of capsizing; a very dangerous situation that should be avoided.

Bulkhead: Vertical partition or wall separating compartments of a boat.

Cabin: Enclosed superstructure above the main deck level.

Capsize: When a boat lays on its side or turns over.

Chock: A deck fitting, usually of metal, with inward curving arms through which mooring or anchor lines are passed so as to lead them in the proper direction both on board and off the boat.

Cleat: A deck fitting, usually of metal with projecting arms used for securing anchor and mooring lines.

Closed Cooling System: A separate supply of fresh water that is used to cool the engine and circulates only within the engine.

Coaming: A vertical piece around the edges of cockpit, hatches, etc. to stop water on deck from running below.

Cockpit: An open space, usually in the aft deck, outside of the cabin.

Companionway: Opening in the deck of a boat to provide access below.

Compartment: The interior of a boat divided off by bulkheads.

Cradle: A framework designed to support a boat as she is hauled out or stored.

Cutlass Bearing: A rubber bearing in the strut that supports the propeller shaft.

D**eck:** The floor-like platform of a boat that covers the hull.

Displacement: The volume of water displaced by the hull. The displacement weight is the weight of this volume of water.

Draft: The depth of water a boat needs to float.

Dry Rot: A fungus attack on wood areas.

Dry-dock: A dock that can be pumped dry during boat construction or repair.

E**lectrical Ground:** A connection between an electrical connector and the earth.

Engine Beds: Sturdy structural members running fore and aft on which the inboard engines are mounted.

EPIRB: Emergency Position Indicating Radio Beacon. Operates as a part of a worldwide satellite distress system.

Even Keel: When a boat floats properly as designed.

F**athom:** A measure of depth. One Fathom = 6 feet.

Fender: A soft object of rubber or plastic used to protect the topsides from scarring and rubbing against a dock or another vessel.

Fend off: To push or hold the boat off from the dock or another boat.

Flying Bridge: A control station above the level of the deck or cabin.

Flukes: The broad portions of an anchor which dig into the ground.

Fore: Applies to the forward portions of a boat near the bow.

Foundering: When a boat fills with water and sinks.

Freeboard: The height from the waterline to the lowest part of the deck.

G**alley:** The kitchen of a boat.

Grab Rail: Hand-hold fittings mounted on cabin tops or sides for personal safety when moving around the boat, both on deck and below.

Ground Tackle: A general term including anchors, lines, and

other gear used in anchoring.

Grounds: A boat touches the bottom.

Gunwale: The upper edge of a boat's side.

H**and Rail:** Rail mounted on the boat, for grabbing with your hand, to steady you while walking about the boat.

Harbor: An anchorage which provides reasonably good protection for a boat, with shelter from wind and sea.

Hatch: An opening in the deck with a door or lid to allow for access down into a compartment of a boat.

Head: A toilet on a boat.

Heat Exchanger: Used to transfer the heat that is picked up by the closed cooling system to the raw cooling water.

Helm: The steering and control area of a boat.

Hull: The part of the boat from the deck down.

I**nboard:** A boat with the engine mounted within the hull of the boat. Also refers to the center of the boat away from the sides.

Inboard/outboard: Also stern drive or I/O. A boat with an inboard engine attached to an outboard drive unit.

K**eel:** A plate or timber plate running lengthwise along the center of the bottom of a boat.

Knot: Unit of speed indicating nautical miles per hour. 1 knot = 1 nautical mile per hour (1.15 miles per hour). A nautical mile is equal to one minute of latitude: 6076 feet. Knots times 1.15 equals miles per hour. Miles per hour times .87 equals knots.

L**ay-up:** To decommission a boat for the winter (usually in northern climates).

Leeward: The direction toward which the wind is blowing.

Length On The Waterline (l.w.l.): A length measurement of a boat at the waterline from the stern to where the hull breaks the water near the bow.

Limber Hole: A passage cut into the lower edges of floors and frames next to the keel to allow bilge water to flow to the lowest point of the hull where it can be pumped overboard.

Line: The term used to describe a rope when it is on a boat.

Lists: A boat that inclines to port or starboard while afloat.

L.O.A.: Boat length overall.

Locker: A closet, chest or box aboard a boat.

Loran: An electronic navigational instrument which monitors the boat's position using signals emitted from pairs of transmitting stations.

Lunch hook: A small light weight anchor typically used instead of the working anchor. Normally used in calm waters with the boat attended.

Midships: The center of the boat.

Marina: A protected facility primarily for recreational small craft.

Marine Ways or Railways: Inclined planes at the water's edge onto which boats are hauled.

Moored: A boat secured with cables, lines or anchors.

Mooring: An anchor permanently embedded in the bottom of a harbor that is used to secure a boat.

Nautical Mile: A unit of measure equal to one minute of latitude. (6076 feet)

Nun Buoy: A red or red-striped buoy of conical shape.

Outboard: A boat designed for an engine to be mounted on the transom. Also a term that refers to objects away from the center line or beyond the hull sides of a boat.

Pad Eye: A deck fitting consisting of a metal eye permanently secured to the boat.

Pier: A structure which projects out from the shoreline.

Pile or Piling: A long column driven into the bottom to which a boat can be tied.

Pitching: The fore and aft rocking motion of a boat as the bow rises and falls.

Pitch: The measure of the angle of a propeller blade. Refers to the theoretical distance the boat travels with each revolution of the propeller.

P.F.D: Personal Flotation Device.

Port: The left side of the boat when facing the bow.

Porthole (port): The opening in the side of a boat to allow the admittance of light and air.

Propeller: A device having two or more blades that is attached to the engine and used for propelling a boat.

Propeller Shaft: Shaft which runs from the back of the engine gear box, aft, through the stuffing box, shaft log, struts, and onto which the propeller is attached.

Pyrotechnic Distress Signals: Distress signals that resemble the brilliant display of flares or fireworks.

Raw Water Cooled: Refers to an engine cooling system that draws seawater in through a hull fitting or engine drive unit, circulates the water in the engine, and then discharges it overboard.

Reduction Gear: Often combined with the reverse gear so that the propeller turns at a slower rate than the engine.

Reverse Gear: Changes the direction of rotation of the propeller to provide thrust in the opposite direction for stopping the boat or giving it sternway.

Roll: A boat's sideways rotational motion in rough water.

Rope Locker: A locker, usually located in the bow of a boat, used for stowing the anchor line or chain.

Rubrail: Railing (often rubber or hard plastic) that runs along the boat's sheer to protect the hull when coming alongside docks, piers, or other boats.

Rudder: A moveable flat surface that is attached vertically at or near the stern for steering.

Sea anchor: An anchor that does not touch the bottom. Provides drag to hold the bow in the most favorable position in heavy seas.

Scupper: An opening in the hull side or transom of the boat through which water on deck or in the cockpit is drained overboard.

Seacock: Safety valves installed just inside the thru-hull fittings and ahead of the piping or hose running from the fittings.

Shaft Log: Pipe through which the propeller shaft passes.

Sheer: The uppermost edge of the hull.

Sling: A strap which will hold the boat securely while being lifted, lowered, or carried.

Slip: A boat's berth between two pilings or piers.

Sole: The deck of a cockpit or interior cabin.

Spring Line: A line that leads from the bow aft or from the stern forward to prevent the boat from moving ahead or astern.

Starboard: The right side of a boat when facing the bow.

Steerageway: Sufficient speed to keep the boat responding to the rudder or drive unit.

Stem: The vertical portion of the hull at the bow.

Stern: The rear end of a boat.

Stow: To pack away neatly.

Stringer: Longitudinal members fastened inside the hull for additional structural strength.

Strut: Mounted to the hull which supports the propeller shaft in place.

Strut Bearing: See "cutlass bearing."

Stuffing Box: Prevents water from entering at the point where the propeller shaft passes through the shaft log.

Superstructure: Something built above the main deck level.

Swamps: When a boat fills with water from over the side.

Swimming Ladder: Much the same as the boarding ladder except that it extends down into the water.

Taffrail: Rail around the rear of the cockpit.

Thru-hull: A fitting used to pass fluids (usually water) through the hull surface, either above or below the waterline.

Topsides: The side skin of a boat between the waterline or chine and deck.

Transom: A flat stern at right angles to the keel.

Travel Lift: A machine used at boat yards to hoist boats out of and back into the water.

Trim: Refers to the boat's angle or the way it is balanced.

Trough: The area of water between the crests of waves and parallel to them.

Twin-Screw Craft: A boat with two propellers on two separate shafts.

Underway: When a boat moves through the water.

Wake: Disrupted water that a boat leaves astern as a result of its motion.

Wash: The flow of water that results from the action of the propeller or propellers.

Waterline: The plane of a boat where the surface of the water touches the hull when it is afloat on even keel.

Watertight Bulkhead: Bulkheads secured so tightly so as not to let water pass.

Wharf: A structure generally parallel to the shore.

Working Anchor: An anchor carried on a boat for most normal uses. Refers to the anchor used in typical anchoring situations.

Windlass: A winch used to raise and lower the anchor.

Windward: Toward the direction from which the wind is coming.

Yacht Basin: A protected facility primarily for recreational small craft.

Yaw: When a boat runs off her course to either side.

Appendix C:

MAINTENANCE SCHEDULE AND LOG

MAINTENANCE	Each Use	Weekly	Monthly	Each Season	Yearly	As Needed
Clean hull below the waterline				X		
Bottom paint hull					X	X
Check sacrificial anodes			X			
Replace sacrificial anodes					X	X
Wash boat canvas & hardware	X		X			
Wax exterior gelcoat				X		X
Clean & protect hardware						X
Polish & protect plastic glass				X		X
Clean exterior upholstery	X					X
Clean cabin & interior upholstery						X
Flush engines with fresh water	X					
Spray metal components in bilge with a protector			X			
Clean bilge				X		X
Check bilge for leaks	X		X			
Inspect & operate thru-hull valves			X			
Inspect steering & control systems	X					
Service steering & control systems				X		
Inspect fuel system for leaks	X					
Inspect & service fuel system				X		
Inspect fuel tank vents & screens					X	
Replace fuel filters					X	
Lubricate fuel fill O-rings			X			
Inspect fire extinguisher			X			
Test bilge pump auto switches			X			
Inspect & protect electrical components, wire & battery connections						

MAINTENANCE LOG

Date	Hours	Dealer	Service/Repairs

MAINTENANCE LOG

Date	Hours	Dealer	Service/Repairs



MAINTENANCE LOG

Date	Hours	Dealer	Service/Repairs

MAINTENANCE LOG

Date	Hours	Dealer	Service/Repairs



BOATING ACCIDENT REPORT

If more than 3 fatalities and/or injuries, attach additional form(s)					
DECEASED					
NAME	ADDRESS	DATE OF BIRTH	WAS VICTIM? <input type="checkbox"/> Swimmer <input type="checkbox"/> Non Swimmer	DEATH CAUSED BY <input type="checkbox"/> Drowning <input type="checkbox"/> Other <input type="checkbox"/> DISAPPEARANCE	WAS PFD WORN? <input type="checkbox"/> Yes <input type="checkbox"/> No What Type?
NAME	ADDRESS	DATE OF BIRTH	WAS VICTIM? <input type="checkbox"/> Swimmer <input type="checkbox"/> Non Swimmer	DEATH CAUSED BY <input type="checkbox"/> Drowning <input type="checkbox"/> Other <input type="checkbox"/> DISAPPEARANCE	WAS PFD WORN? <input type="checkbox"/> Yes <input type="checkbox"/> No What Type?
NAME	ADDRESS	DATE OF BIRTH	WAS VICTIM? <input type="checkbox"/> Swimmer <input type="checkbox"/> Non Swimmer	DEATH CAUSED BY <input type="checkbox"/> Drowning <input type="checkbox"/> Other <input type="checkbox"/> DISAPPEARANCE	WAS PFD WORN? <input type="checkbox"/> Yes <input type="checkbox"/> No What Type?
INJURED					
NAME	ADDRESS	DATE OF BIRTH	NATURE OF INJURY	MEDICAL TREATMENT	
NAME	ADDRESS	DATE OF BIRTH	NATURE OF INJURY	MEDICAL TREATMENT	
NAME	ADDRESS	DATE OF BIRTH	NATURE OF INJURY	MEDICAL TREATMENT	
ACCIDENT DESCRIPTION					
DESCRIBE WHAT HAPPENED (Sequence of events. Include Failure of Equipment. If diagram is needed, attach separately. Continue on additional sheets if necessary. Include any information regarding the involvement of alcohol and/or drugs in causing or contributing to the accident. Include any descriptive information about the use of PFD's.)					
VESSEL NO. 2 (if more than 2 vessels, attach additional form (s))					
Name of Operator	Address		Boat Number		
Telephone Number			Boat Name		
Name of Owner	Address				
WITNESSES					
Name	Address		Telephone Number		
Name	Address		Telephone Number		
Name	Address		Telephone Number		
WITNESSES					
SIGNATURE		Address		Telephone Number	
QUALIFICATION (Check One) <input type="checkbox"/> Operator <input type="checkbox"/> Owner <input type="checkbox"/> Investigator <input type="checkbox"/> Other				Date Submitted	
(do not use) - FOR REPORTING AUTHORITY REVIEW (use agency date stamp)					
Causes based on (check one) <input type="checkbox"/> This report <input type="checkbox"/> Investigation and this report <input type="checkbox"/> Investigation <input type="checkbox"/> Could not be determined		Name of Reviewing Office		Date Received	
Primary Cause of Accident		Secondary Cause of Accident		Reviewed By	

Appendix E:

FLOAT PLAN

Scout recommends filling out a float plan each time you use your boat for an offshore day trip or a long cruise. Leave this information with a responsible person ashore, like a close friend or relative that you know well.

1. Name of person reporting and telephone number.

2. Description of boat.

Type _____ Color _____ Trim _____

Registration No. _____ Length _____

Name _____ Make _____ Other Info _____

3. Engine type _____ H.P. _____

No. of Engines _____ Fuel Capacity _____

4. Survival equipment: (Check as appropriate)

PFDS

Flares

Mirror

Smoke Signals

Flashlight

Food

Paddles

Water

Others

Anchor

Raft or Dinghy

EPIRB

5. Radio Yes No Type _____

6. Automobile license _____

Type _____ Trailer License _____

Color _____ and make of auto _____

7. Persons aboard _____

Name _____ Age _____ Address & telephone No. _____

8. Do any of the persons aboard have a medical problem?

Yes

No

If yes, what? _____

9. Trip Expectations: Leave at _____

From _____ Going to _____

Expect to return by _____ (time)

and no later than _____

10. Any other pertinent info. _____

11. If not returned by _____ (time)

call the COAST GUARD, or (Local authority) _____

12. Telephone Numbers.

THIS PAGE WAS LEFT BLANK
INTENTIONALLY

Appendix F:

TROUBLESHOOTING GUIDE

PROBLEM	CAUSE AND SOLUTION
CONTROL SYSTEMS	

<p>Hydraulic Steering is slow to respond & erratic.</p>	<ul style="list-style-type: none"> • Steering system is low on fluid. Fill and bleed system. • Steering system has air in it. Fill and bleed system. • A component in the steering system is binding. Check and adjust or repair binding component. • Engine steering spindle is binding. Grease spindle.
<p>The boat wanders and will not hold a course at cruise speeds.</p>	<ul style="list-style-type: none"> • There could be air in the steering system. Fill & bleed the system. • The engine steering tab is corroded or out of adjustment. Replace or adjust steering tab. • Engine steering spindle is binding. Grease spindle.
<p>An engine will not start with the shift control lever in neutral.</p>	<ul style="list-style-type: none"> • The control cable is out of adjustment & not activating the neutral safety cut out switch. • The shift control lever is not in the neutral detent. Try moving the shift lever slightly. • There is a loose wire on the neutral safety switch on the control. Inspect wires and repair loose connections. • The starter or ignition switch is bad.

PERFORMANCE PROBLEMS	
-----------------------------	--

<p>Boat is sluggish and has lost speed & RPM.</p>	<ul style="list-style-type: none"> • The boat may need to have marine growth cleaned from hull and running gear. • Propeller may be damaged & need repair. • Weeds or line around the propeller. Clean propeller. • Boat is overloaded. Reduce load. • Check for excessive water in the bilge. Pump out bilge & find & correct the problem. • The throttle adjustment has changed and the engine is not getting full throttle. Adjust the throttle cable.
<p>The boat vibrates at cruising speeds.</p>	<ul style="list-style-type: none"> • Propeller may be damaged & need repair. • The propeller or propeller shaft is bent. Repair or replace damaged components. • The running gear is fouled by marine growth or rope. Clean running gear. • The engine is not trimmed properly. Trim engine.

Troubleshooting Guide

PROBLEM	CAUSE AND SOLUTION
ENGINE PROBLEMS	
The engine is running too hot.	<ul style="list-style-type: none">• The engine raw water pick up strainer is clogged with marine growth. Clean pick up.• The engine raw water pump impeller is worn or damaged. Repair the pump.• The engine thermostat is faulty and needs to be replaced.
The engine alternator is not charging properly.	<ul style="list-style-type: none">• The battery cable is loose or corroded. Clean and tighten battery cables.• The alternator is not charging and must be replaced.• The battery is defective. Replace the battery.
The engine suddenly will not operate over 2000 RPM.	<ul style="list-style-type: none">• The engine emergency system has been activated. The on board computer has sensed a problem and has limited the RPM to protect the engine. Find & correct the problem.• The tachometer is bad and needs to be replaced.• The oil tank on the 2-cycle engine is low on oil. Fill the engine oil tank. Refer to the engine owner's manual.
The engine is loosing RPM. The boat is not overloaded and the hull bottom and running gear are clean and in good condition.	<ul style="list-style-type: none">• The engine may be having a problem with a sticky Anti-siphon valve, located in the fuel line near the fuel tank, that is restricting the fuel flow. Remove & clean or replace the Anti-siphon valve.• The remote gasoline fuel filter could be dirty. Inspect and replace the fuel filter.• The primary fuel filter on the engine may be dirty. Inspect and replace the fuel filter.• The electronic engine control system on the engine is malfunctioning. Repair the engine control system.• The fuel injection system on the engine is malfunctioning. Repair the fuel injection system.

Troubleshooting Guide

PROBLEM	CAUSE AND SOLUTION
ACCESSORY PROBLEMS	
The livewell pump runs, but does not pump water.	<ul style="list-style-type: none">• The strainer on the intake scoop is clogged preventing the water from getting to the pump. Put the boat in reverse to clean the strainer.• There is an air lock in the system. Prime the system.• The thru-hull valve is not open. Open valve.
The automatic float switch for the bilge pump raises but does not activate the pump.	<ul style="list-style-type: none">• The in-line fuse near the battery switch has blown. Replace the fuse.• The pump impeller is jammed by debris. Clean pump impeller housing.• The pump is defective. Replace pump.• The automatic float switch is defective. Replace switch.• There is a bad connection in the bilge pump wiring. Repair the connection.
The freshwater pump runs, but will not pump water.	<ul style="list-style-type: none">• The water tank is empty. Fill the tank.• The intake hose is damaged and sucking air. Replace or repair the hose.• The pump is defective. Repair or replace the pump.
The washdown pump runs, but the pump will not pump water.	<ul style="list-style-type: none">• The thru-hull valve is not open. Open valve.• The in-line sea strainer for the pump is clogged. Clean the sea strainer.• The intake hose is damaged and sucking air. Replace hose.• The pump is defective. Repair or replace the pump.

THIS PAGE WAS LEFT BLANK
INTENTIONALLY



Spearheading the Future of Fishing.

Scout Boats Inc.
2531 Hwy 78 West
Summerville, SC 29483