

Wireless function:

Button 1

Pressing button 1 will turn on engine and house batteries.

Button 2

Pressing button 2 will turn off engine and house batteries.

Button 3

When the batteries are turned on press button 3 and all of the lights will turn on press button 3 again and the lights will shut off.

Button 4

Pressing button 4 will energize the lights used for night time running and shut off lights not used for operating the boat at night.



Helm Mode Button on Dash Panel:

Pressing the mode switch will cycle thru several different modes. The first mode turns on all of the lights. The second mode puts the boat into night running mode. The third press is the Mood lighting mode. The fourth press will shut off all of the lights.



Console Button at DC Panel:

Press the house or engine button to turn on or off the house or engine battery switch.



Motorized Battery Switch:

The Motorized Battery Switch has two modes of operation. Auto and Manual. There is a LED located on the battery switch indicating Battery Switch status.

Manual Operation:

The automatic operation of the battery switch can be overridden at any time by *depressing the control knob* and turning clockwise towards the “Man On” position or counter clockwise towards the “Man Off” position. During the time that the Battery switch is in “Man On” mode, the “Man On” LED is illuminated.

Auto Operation:

The battery switch moves from a state of “Auto Off” to “Auto On” when either the wireless remote button 1 is pressed or the button at the DC panel is pressed. During the time that the battery switch is in “Auto On” mode, the “Auto On” LED is illuminated. Auto operation of the Battery Switch is not possible while in manual mode. If auto operation is attempted, the LED will flash for 3 seconds then stop. Knob must be returned to “Auto Off” before normal auto operation can continue.

Auto Mode LED Indications:

LED OFF: Battery switch is off

LED ON: Battery switch is on

LED FLASHING: LED flashes whilst moving between auto on and auto off.

LED Rapid Flash: On 0.1 sec & Off 0.1 Sec:

Voltage is outside specification i.e. Less than 8 Volts or greater than 30 Volts

Manual Mode LED Indications:

LED OFF: Battery Switch is off

LED ON: Battery Switch is on



!WARNING: Depress knob while turning or the switch motor could be damaged

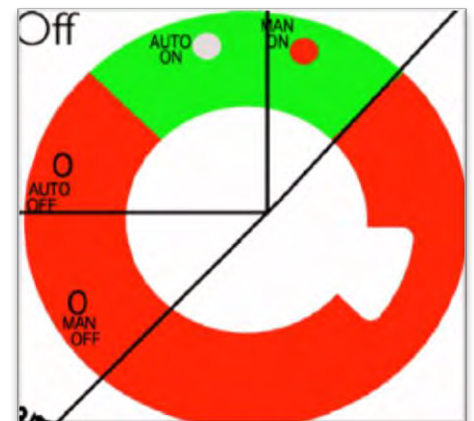



Display Interface (DI)

Product description:

The CZone Display module (DI) is the CZone systems user interface, it has the ability to control DC circuits, display important on board systems information and can be used to set all Zone parameters both for initial installation and future systems maintenance

Suitable to use as the main systems controller/display at the helm or nav station or as a secondary display in an owners cabin or engine room
Simple connection, power and NMEA

DI features:

- 3.5" Transflective QVGA LCD
- IpX7
- Rotary Knob for easy menu navigation
- Simple UI
- Power consumption @12V: 180mA (standby 130mA)

Dimensions:

H 105mm (4"3/32) x W165mm (6"7/16) x D 62mm (2"13/32)

Weight:

374g

Inputs:

Network, NMEA 2000
5 – 35V DC

DC Power Meter:

- Displays Voltages of multiple battery banks includes low and high voltage alarms
- Displays charge and discharge (amps) of multiple battery banks
- Displays battery capacity in ampere hours and % charge/discharge, includes low ampere hour alarm

AC Power Meter:

- Displays multiple line voltages (230 and 110V), includes high and low voltage alarm
- Displays AC line frequencies, includes High and low frequency alarm
- Displays AC power consumption in kW (calculation uses power factor for true RMS)

Fluid level display:

- Displays multiple tank levels and multiple fluid types
- Fuel (Diesel and Gas)
- Fresh water
- Black water
- Grey water

Switching thresholds can be set for tank levels to raise alarms or to control an output i.e. a ballast pump can be automatically controlled via the ballast water level

Switching channel control:

All DC control circuits can be toggled on or off

Systems in operation:

- Displays operation of circuits of interest ie Bilge pumps, engine room lights etc
- Displays systems faults and alarm conditions (programmable)
- Repeater for other NMEA 2000 broadcasted data

EMC ratings:

- IEC EN 60945
- IEC EN 61000
- FCC Class B
- ISO 7637 - 1 (12V Passenger cars and light commercial vehicles with nominal 12 V supply voltage - Electrical transient conduction along supply lines only)
- ISO 7637 - 2 (24V Commercial vehicles with nominal 24 V supply voltage - Electrical transient conduction along supply lines only)
- IEC Standards for indirect lighting strikes



Operation



Main Screen



Monitoring Page

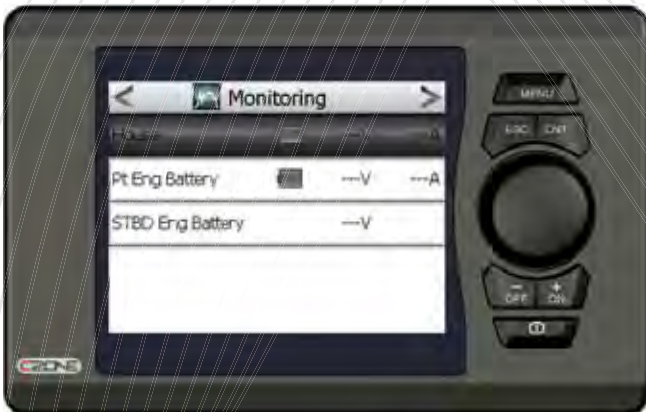

DC Monitoring



Tank Monitoring



AC Monitoring



Main Control Page



Operation



Control Page



Detailed Control Page



Settings Menu



Alarms Page



Connections

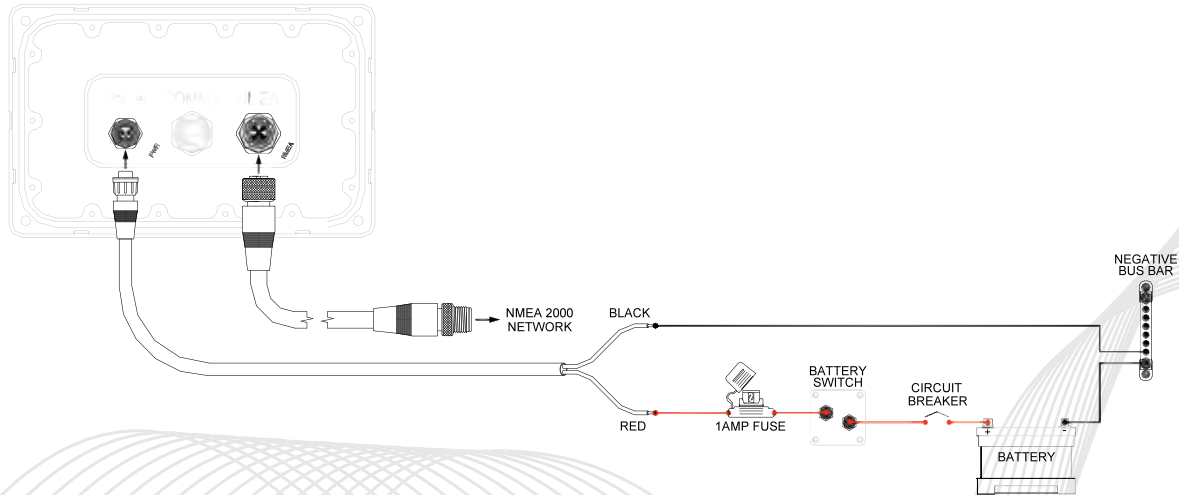

Pictorial Overview



Main Menu page

- **Menu** – returns user to main menu page (as shown below)
- **ESC** – Escape key, returns to previous screen
- **Ent** – Enter key, navigates to next screen or confirms prompt
- **Rotary Knob** – Scrolls cursor bar up and down through menu lists, used to navigate alpha numeric lists in configuration pages
- **Off (-)** – Turns circuit off, decreases values in set up screens such as backlighting level
- **ON (+)** – Turns circuits on, Increases values in set up screens such as backlighting level
- **Power Key** – Turns display off and on

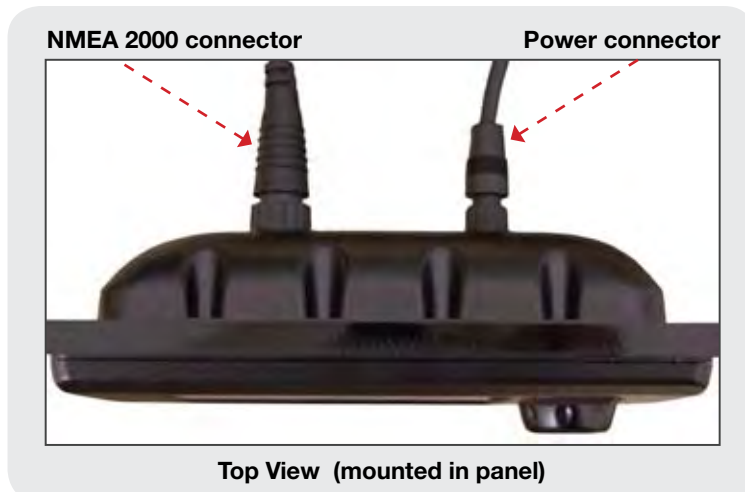

Top View (mounted in panel)

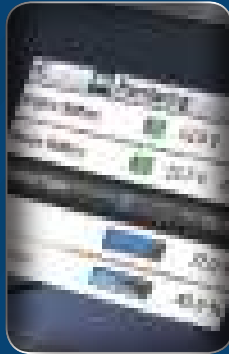

Display Interface Operation Manual



..... LEADING BY DESIGN

<https://www.boat-manuals.com/>

IMPORTANT

BEP Marine strives to ensure all information is correct at the time of printing. However, BEP Marine reserves the right to change any features and specifications of either the operation of the device, or the documentation of the device, without notice.

Translations: In the event that there is a difference between a translation of this manual and the English version, the English version should be considered the official version.

FCC Statement: This device complies with the limits for a Class B digital device, pursuant to part 15 of FCC rules. These rules pertain to reasonable protection from harmful interference in a normal installation. This equipment generates extremely low levels of radio frequency energy which should not interfere with normal radio equipment if installed properly. If interference is detected and attributed to this device, you could try to:

- » Re-orient or relocate the receiving antenna
- » Separate the equipment and the receiver
- » Isolate circuit output between the device and the radio
- » Contact an experienced technician or dealer to help

It is the owner's sole responsibility to install and operate the device in a manner that will not cause accidents, personal injury or property damage.

Copyright: This document is copyright 2008 under the Creative Commons agreement. Rights are granted to research and reproduce elements of this document for non-commercial purposes on the condition that "BEP Marine" is credited as the source. Electronic re-distribution of the document in any format is restricted, to maintain quality and version control.

Contents

1.	Overview	5
	<i>Display Interface</i>	6
	<i>Powering the DI</i>	7
	<i>Screen Features</i>	7
2.	Navigation Conventions	9
	<i>'Spin box' Data Entry</i>	9
3.	Directory Tree	10
	<i>MONITORING</i>	10
	<i>CONTROL</i>	11
	<i>MODES</i>	11
	<i>SETTINGS</i>	12
4.	Specifications.	17
5.	Contact Addresses	18

1. Overview

A CZONE network is an NMEA 2000-compliant CAN-based system. With a maximum of 40 possible reporting interfaces in a single 'backbone' network, the size of the network you want is virtually limitless: for vessels with larger electrical systems extra backbones can be attached.

Because there is no centralized processing facility, a CZONE network is not crippled with the collapse of any one unit.

Your main connection with each CZONE interface throughout your vessel is the Display Interface, or DI. All other interfaces are normally configured at the time of installation, and re-configured very occasionally in your vessel's life. Once installed, your DI becomes the main way you can oversee and configure the entire system. But like any other interface, removing the DI from the network does not cripple the network: all other interfaces work with each other normally.

This manual is aimed at the intermediate and experienced skippers. It is assumed you have basic knowledge of how your vessel already operates, basic electrical knowledge, and have had some basic experience with the conventions of computer equipment.

Display Interface



- MENU** Jumps to the Main Menu
- ESC** Returns to last screen viewed.
- ENT** Moves to the screen selected.
- Dial** Primarily used for menu navigation; sometimes used in configuration screens for quickly selecting from a large set of values.
- /OFF** Decrease a value; disable an interface channel.
- +/ON** Increase a value; enable an interface channel.
- POWER** Activates/Deactivates the DI.

NOTE 

The POWER Button has no effect on the network. Its only use is to activate and deactivate the DI's screen power.

Powering the DI

- » Press **POWER**.
- » Press **MENU**.

Screen Features

Each screen contains one of several features:

A menu selection to more specific controls.



The status of a group of CZONE measurements.



The status of a specific CZONE measurement.



A list of checkboxes.



A 'spin box' of multiple variables. (The **Dial** is used to change values.)



2. Navigation Conventions

The use and operation of the DI for your CZONE network is extremely easy. For the vast majority of use:

- » Use the **Dial** to select an on-screen option.
- » Press **ENT** to open the selected option. Repeat the **Dial - ENT** operation until you reach your target screen.
- » Press **ESC** to step back to the last screen.
- » Press **MENU** to return to the main menu.
- » Use **- OFF / + ON** to decrease or increase values.

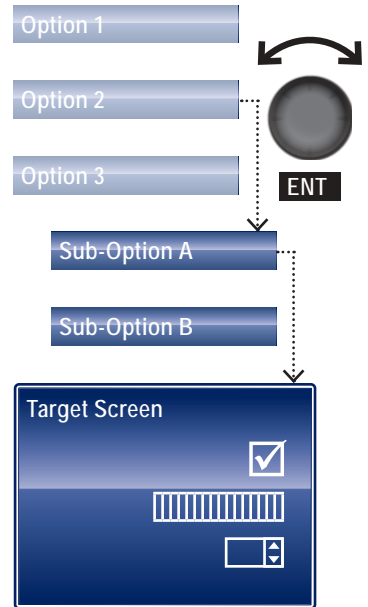

'Spin box' Data Entry

In some system configurations, the **Dial** is used for 'spin box' entry, either to select an item from a long list of values, or text entry.

- » If a target screen has a spinbox field, rolling the **Dial** cycles through the values available, or the alphabet of the currently active character.
- » If the currently active character is part of a preset text value, the value is filled in.
- » **- OFF** moves the text cursor left one space.
- » **+ ON** moves the text cursor right one space.
- » **ENT** sets the entry and shows the next screen.

Back (-) Forward (+)

Power Available

Spin boxes

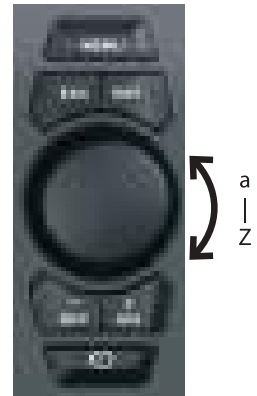

3. Directory Tree

MONITORING

The Monitoring section of the DI provides quick reference general and detailed views of circuit status, tank levels, AC and DC voltages and many other parameters throughout the vessel.

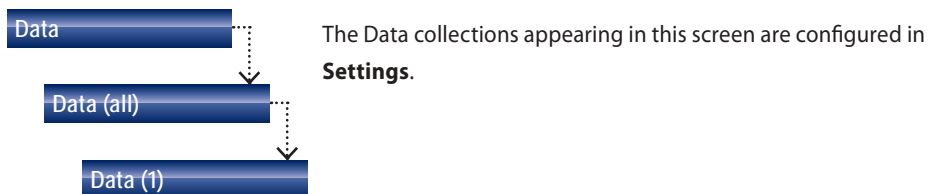
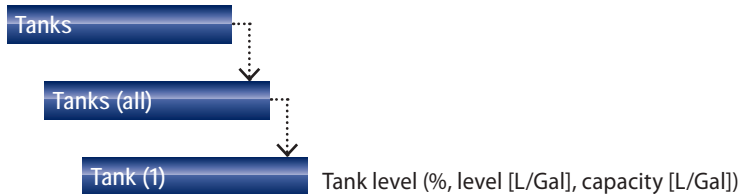
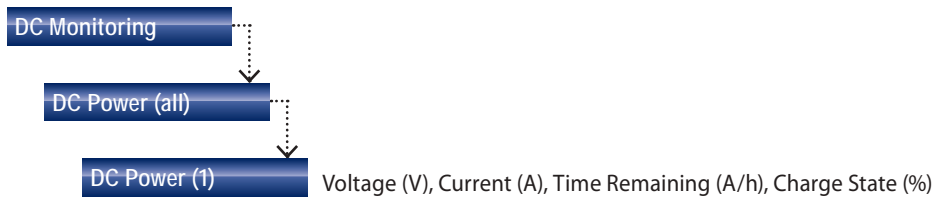
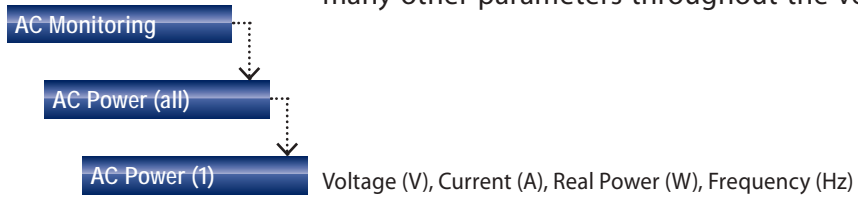

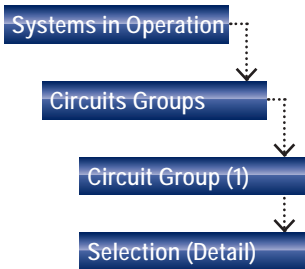

Systems in Operation displays lists of all circuits that are active at that moment.

The list appearing in this screen is configured during the initial set up.

Pressing **ENT** displays circuit-relevant info.

CONTROL

The Control section of the DI allows you to turn circuits on and off, or in the case of certain lights, dim them to different levels.

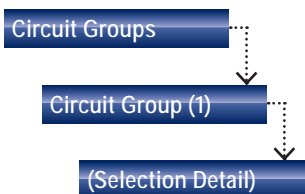

The groups appearing in this screen are configured during the initial set up.

Each item in this screen's list can be selected with the **Dial**, then adjusted with the **- OFF/+ ON** keys.

Pressing **ENT** displays circuit-relevant info.



MODES

The Modes function allows multiple circuits to be turned on at once according to certain predetermined modes. For example you walk onto your boat and activate the Cruise mode, turning on all the circuits required for complete operation of the boat. When you leave the boat you can then select System Off mode which shuts down all non 24Hr circuits.

Alternatively you can select Dock mode which once again turns all non-24hr circuits off except for the refrigeration circuits. (These are just examples; user-specific modes can be configured by a technician.)

SETTINGS

The Settings section is where you set all operating tolerances, calibration, preferences and alarm triggers.

WARNING • • •

Changing calibration or dimensional values may compromise the safety and efficiency of your vessel. Please ensure your alterations do not misrepresent your vessel's operational limits.

Your CZONE network is normally installed with default settings for you. However, customizing your network to suit how you operate your vessel is all part of the flexibility and identity of A CZONE network.

About

Displays software version installed on the DI and dipswitch setting

Backlight

Level

Hold – **OFF** / + **ON** to adjust DI's backlight level.

Key Beeps

On/Off/Tick On

Press + **ON** to set functionality.

Units

Volume

Select between Liters and US Gallons.

Text Size

Choose a text size for your DI.

Rotary Direction

Choose a direction for which way the dial will increase values.

Calibration

The Calibration subsection allows you to set certain parameters for your CZONE system.

DC Monitoring

Voltage (V), Current (A)

(User batteries)

Each battery may be defined, calibrated or reset to defaults.

Set Battery Full

Yes sets the battery level to Full

Custom Data

Allows you to select what parameters are displayed in the **Monitoring - Data** page

Monitoring Parameters

Press - **OFF** / + **ON** to select if that parameter is displayed.

Network

Displays a list of all configured modules showing their state (Online or Offline) and dispswitch setting.

System Config

By entering a password the parameters of your CZONE system can be adjusted to allow additions or modifications. Only trained technicians should carry out this work.

4. Specifications

Display Interface

Dimensions: H x W x D - 105 x 165 x 62 mm

$4 \frac{3}{32} \times 6 \frac{7}{16} \times 2 \frac{13}{32}$ in

Weight: 374 g

DC Power Meter:

Displays voltages of multiple battery banks with low and high voltage alarms; charge and discharge (amps) of multiple battery banks; battery capacity in ampere hours and % charge/discharge; includes low ampere hour alarm.

AC Power Meter:

Displays multiple line voltages (230 and 110 V with low and high voltage alarms); AC line frequencies (includes high and low frequency alarm for each); AC power consumption in kW (calculation uses power factor for true RMS).

Fluid level display:

Displays multiple tank levels/multiple fluid types such as Diesel/Gas/Fresh water/Black water/Grey water; switching thresholds can be set for tank levels to raise alarms or to control an output i.e. a ballast pump can be automatically controlled via the ballast water level.

Switching channel control:

All DC control circuits can be toggled on or off, dimmed or motors reversed.

Systems in operation:

Displays operation of circuits of interest ie Bilge pumps, engine room lights etc; systems faults and alarm conditions (programmable); Repeater for other NMEA 2000 broadcasted data.

Inputs:

Network, NMEA 2000, 5 – 35 V DC

EMC ratings:

IEC EN 60945, IEC EN 61000, FCC Class B.

ISO 7637 - 1 (12 V Passenger cars and light commercial vehicles with nominal 12 V supply voltage - Electrical transient conduction along supply lines only).

ISO 7637 - 2 (24 V Commercial vehicles with nominal 24 V supply voltage - Electrical transient conduction along supply lines only).

IEC Standards for indirect lightning strikes.



Meter Interface (MI)

Product description:

The Meter Interface is designed to accept multiple inputs from AC current and voltage transformers as well as DC voltage inputs and current inputs from shunts. The MI processes the information from these inputs and broadcasts it onto the CZone bus.

MI features:

AC

- 3 x AC voltage inputs (multi voltage)
- 2 x AC current inputs
- Calculates true RMS power
- Ignition protected
- IPX5 water ingress protection

DC

- 3 x DC voltage inputs (multi voltage)
- 2 x DC current inputs
- Calculates battery capacity as Ampere hours and percentage charge remaining
- Resolution for current metering down to 0.1A

Dimensions:

H 100mm (3"29/32) x W156mm (6"3/32) x D 42mm (1"5/8)

Weight:

281g

Note:

High and low alarm levels can be set for all inputs

EMC ratings:

- IEC EN 60945
- IEC EN 61000
- FCC Class B
- ISO 7637 - 1 (12V Passenger cars and light commercial vehicles with nominal 12 V supply voltage - Electrical transient conduction along supply lines only)
- ISO 7637 - 2 (24V Commercial vehicles with nominal 24 V supply voltage - Electrical transient conduction along supply lines only)
- IEC Standards for indirect lightning strikes





LED Flash Codes

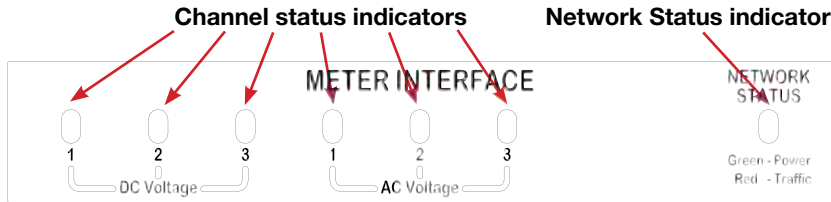

Network Status Indicator

- **Extinguished** = Network power disconnected
- **Green** = Network power connected
- **Red** = Network traffic

Channel Status Indicators

- Red solid on *SCI — Output on
- Red slow flash *SCI — Output in timer mode
- Gn solid on SI/MI — Valid input signal
- 1 x RED SCI/SI/MI — Channel not configured
- 2 x RED SCI/SI/MI — Configuration conflict
- 3 x RED SCI/SI/MI — Dip switch conflict
- 4 x RED SCI/SI/MI — Memory comms failure
- 5 x RED SCI/SI/MI — No modules detected
- 6 x RED SCI/SI — Fault on output
- 7 x RED SCI/SI — Output not detected
- 8 x RED SI/MI — Invalid input signal



Connections

Electrical Connections DC

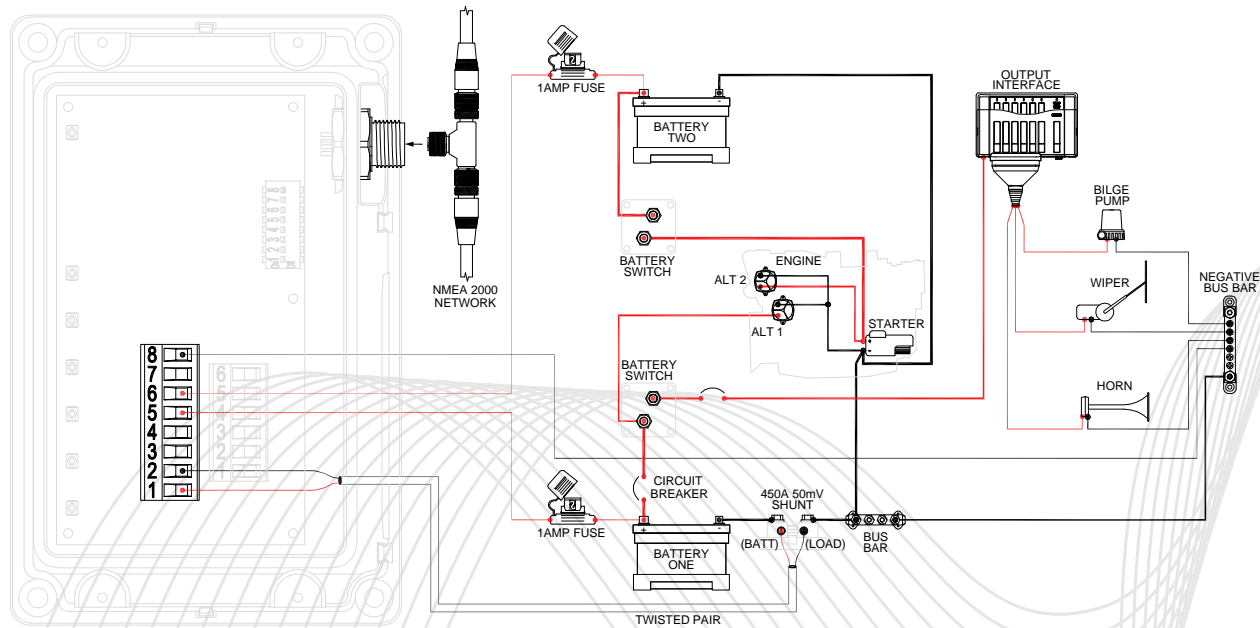

8 Way, DC

8	DC Negative
7	DC voltage positive input 3
6	DC voltage positive input 2
5	DC voltage positive input 1
4	DC current 2 Shunt input 2 (LOAD)
3	DC current 2 Shunt input 1 (BATT)
2	DC current 1 Shunt input 2 (LOAD)
1	DC current 1 Shunt input 1 (BATT)

Electrical Connections AC

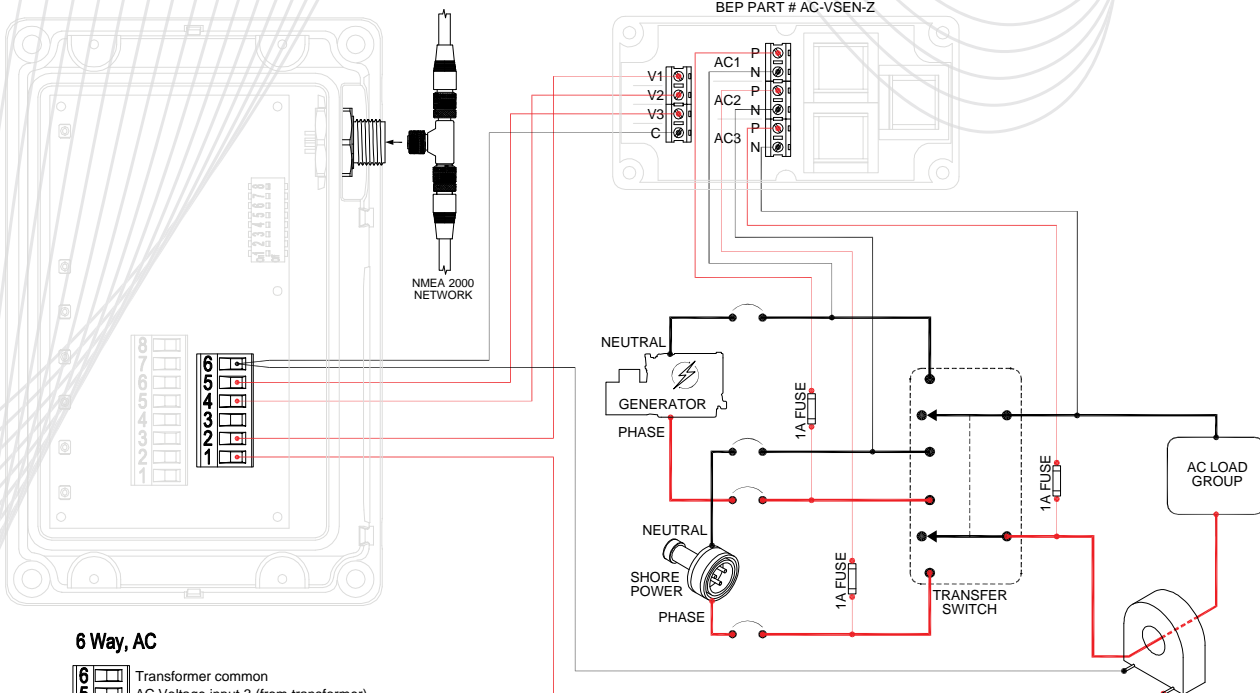

6 Way, AC

6	Transformer common
5	AC Voltage input 3 (from transformer)
4	AC Voltage input 2 (from transformer)
3	AC Current input 2 (from transformer)
2	AC Voltage input 1 (from transformer)
1	AC Current input 1 (from transformer)



Labelling

Connections/LED flash code label

This label is located on the inside of the front lid of the unit, it shows the LED codes and electrical connections to the unit

LED Codes/Module:	Fault Description:
Red solid on *SCI	Output on
Red slow flash *SCI	Output in timer mode
Gn solid on SI/MI	Valid input signal
1 x RED SCI/SI/MI	Channel not configured
2 x RED SCI/SI/MI	Configuration conflict
3 x RED SCI/SI/MI	Dip switch conflict
4 x RED SCI/SI/MI	Memory comms failure
5 x RED SCI/SI/MI	No modules detected
6 x RED SCI/SI	Fault on output
7 x RED SCI/SI	Output not detected
8 x RED SI/MI	Invalid input signal

*SCI LEDS are located on SCI control switches

SI 8 Way

SCI 8 way

MI 8 Way

MI 6 Way

Module Identification and Dipswitch label

OI	SI	MI	XX				
MOI	SCI	DI					
DIP 1	2	3	4	5	6	7	8

These labels allow easy identification of each module whilst recording the dipswitch setting. These labels are to be fitted to the cover and to the module (this prevents covers being swapped). To record the module type and dipswitch settings use a permanent marker and strike through the applicable boxes (a strike through on a dipswitch box indicates that switch is on).



Output Interface (OI)/Motor Output Interface (MOI)

Product descriptions:

Output Interface (OI):

The Output Interface module is where the circuit control and protection takes place, these modules have been designed to be mounted in many locations around the vessel to bring the circuit control and protection closer to the load

Motor Output Interface (MOI)

The Motor Output Interface is designed for loads such as trim tabs and hatch lifters where a polarity reversal is required to change the direction of the motor, it also has two standard output channels

OI/MOI Features:

- 6x 20A circuits per module (OI)
- 2x 20A Circuits per module (MOI)
- 1x 20A "H Bridge" output for controlling direction of DC motors through polarity change (MOI)
- Each circuit channel is programmable to offer circuit protection with settable break currents ranging from 200mA to 20Amps
- Multiple channels can be bridged together to offer higher current switching
- Selectable fusing characteristics to cater for various load types ie Slow and fast blow, characteristics found in traditional mechanical fuses and circuit breakers
- LED indication for individual circuit and network status (see LED Flash codes below)

Robust, reliable electronic design

- Each FET is rated to 75A
- Isolated ground giving electronics protection from ground loops
- Manual Systems override, In case of mechanical failure to network a mechanical override is provided on the OI for each circuit in the form of an ATC fuse. Remove the fuse and place into the bypass position to bypass the OI control

4 levels of fusing

- Mechanical fuse
- Hardware short circuit protection
- Software short circuit protection
- Software over current protection
- IPX5 water ingress and Ignition protection

Dimensions:

H 128mm (5") x W200mm (7"29/32) x D 45mm (1"3/4)

Power consumption: @12V: 85mA (standby 60mA)

Weights:

OI = 659g

MOI = 609g

Pulse width modulation (Current Control)

- Dimming control of lighting circuits
- Smooth start effect for turning lighting on gradually
- Soft start for prolonging the life of halogen bulbs through limiting the shock on the filament by high inrush currents found during normal cold switch on. Can also be used to reduce large inrush currents on motors.
- Timer functionality
- Plug and play configuration
- Inputs
- Network, NMEA 2000
- 5 – 35V DC

EMC ratings:

- IEC EN 60945
- IEC EN 61000
- FCC Class B
- ISO 7637 - 1 (12V Passenger cars and light commercial vehicles with nominal 12 V supply voltage - Electrical transient conduction along supply lines only)
- ISO 7637 - 2 (24V Commercial vehicles with nominal 24 V supply voltage - Electrical transient conduction along supply lines only)
- IEC Standards for indirect lighting strikes



LED Flash Codes

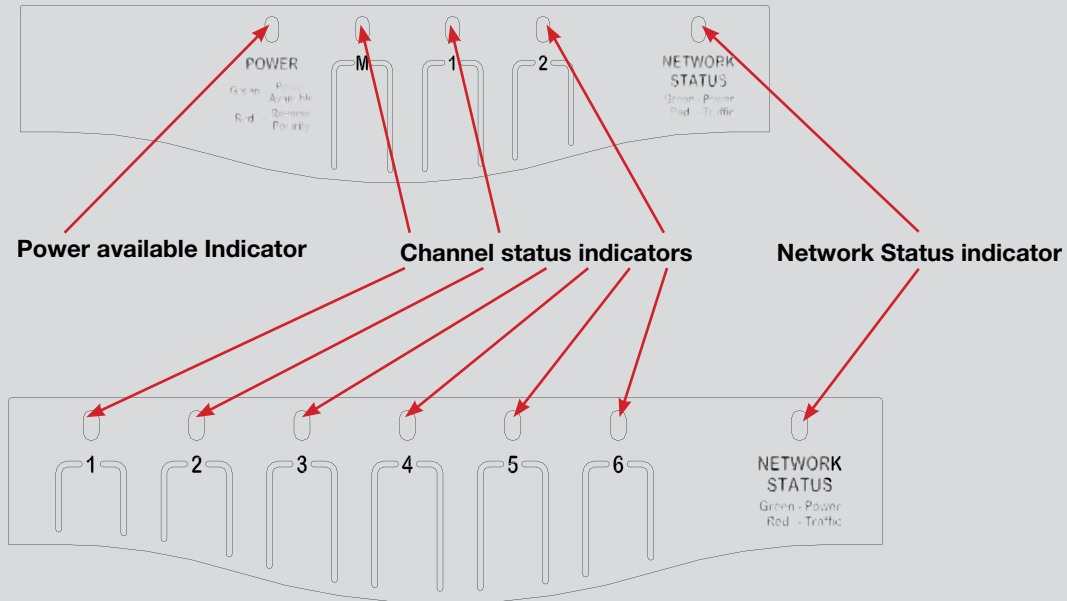

Power available Indicator MOI only

- **Extinguished** = No input power connected
- **Green** = Input power available
- **Red** = Input power reverse polarity

Network Status Indicator

- **Extinguished** = Network power disconnected
- **Green** = Network power connected
- **Red** = Network traffic

Channel Status Indicators

- Gn solid on — Channel on
- Gn slow flash — Channel in timer mode
- 1 x RED — Channel not configured
- 2 x RED — Configuration conflict
- 3 x RED — Dip switch conflict
- 4 x RED — Memory comms failure
- 5 x RED — No modules detected
- 6 x RED — Low Run Current
- 7 x RED — Over current
- 8 x RED — Short circuit
- 9 x RED — Missing commander
- 10 x RED — Reverse current
- 11 x RED — Current calibration



Connections

Electrical Connections OI:

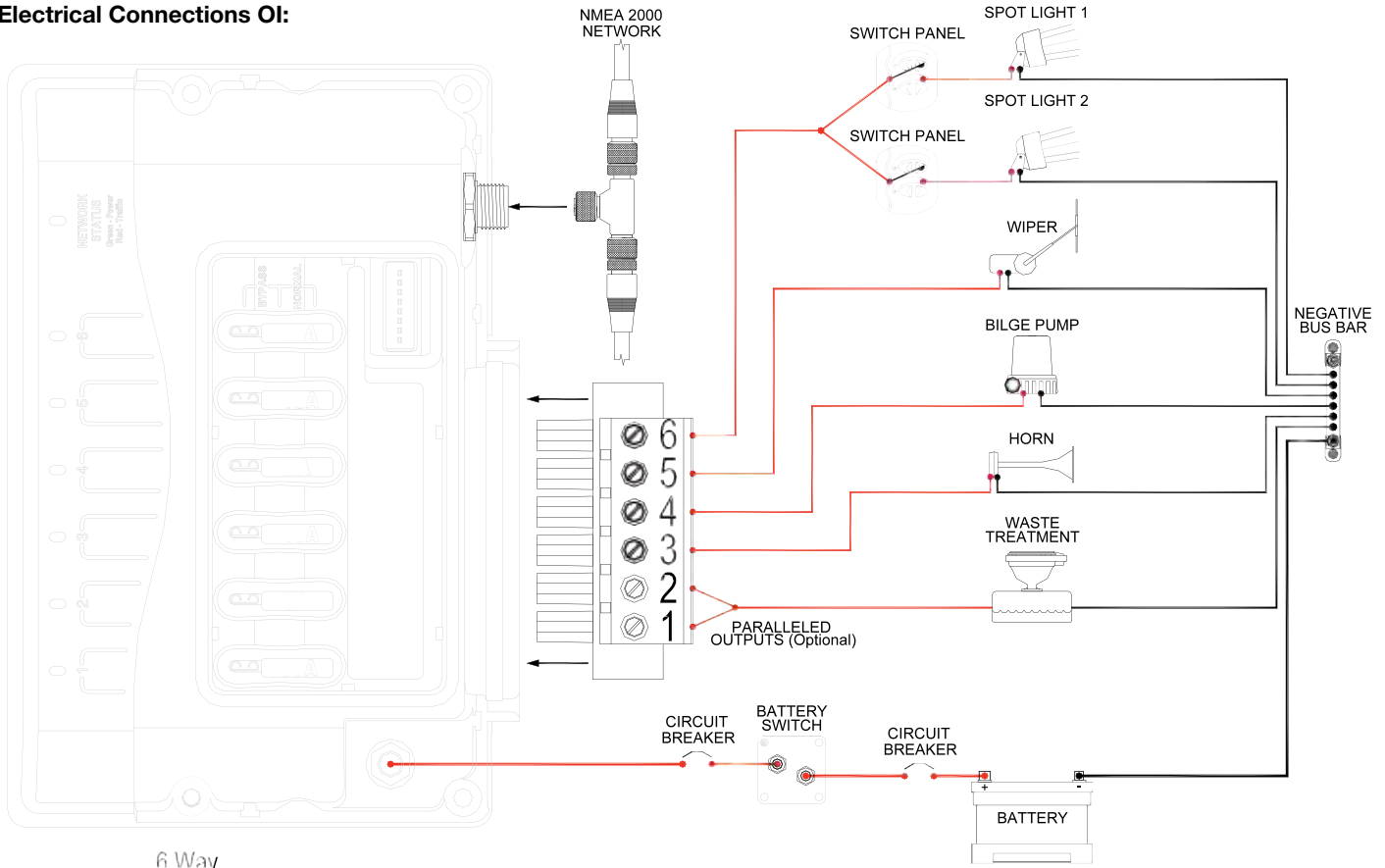

6 Wav

Electrical Connections MOI:

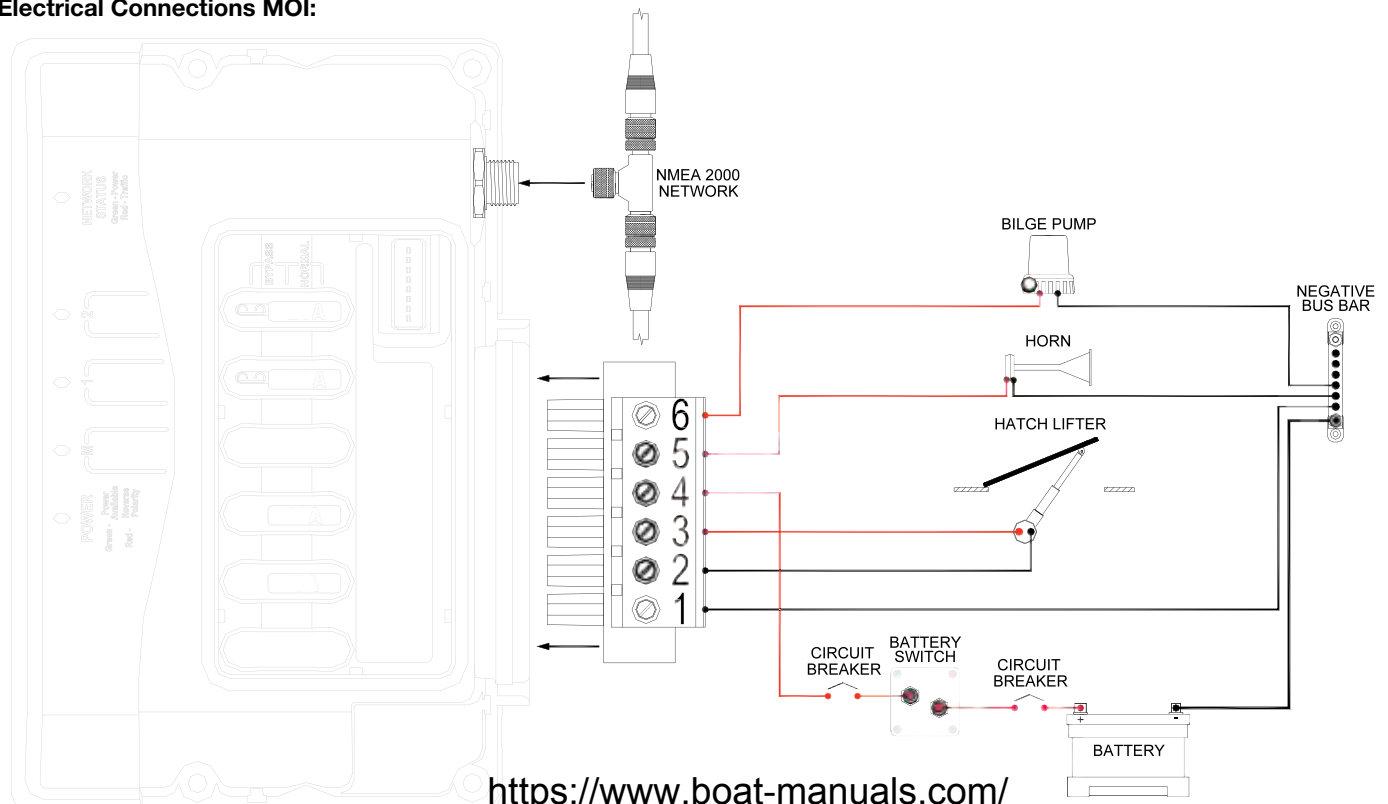



Labelling

Connections label

This label is located between the output connection and the bypass fuses, it gives the field user or installer an indication of the connections without the need to refer to a manual

OI

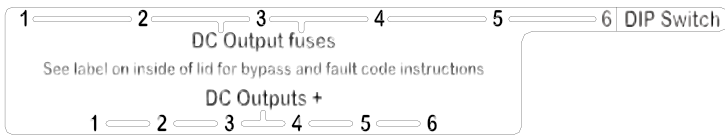

MOI

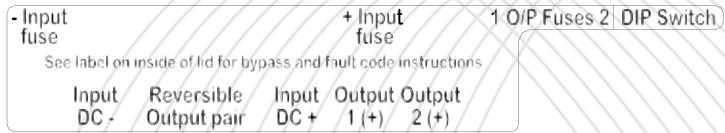

Circuit Identification labels

Standard BEP circuit breaker panel labels are used to indicate the circuit name for each output

OI

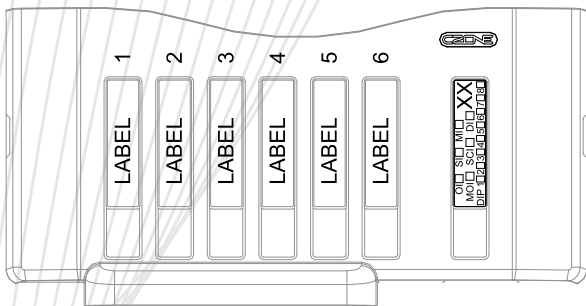

MOI

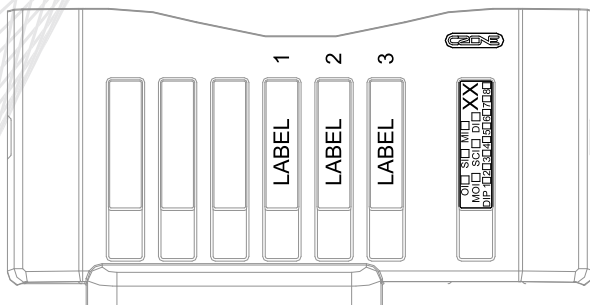

LED flash code label

This label is located on the inside of the front lid of the unit, it shows the LED codes and an instruction on how to manually bypass the circuits

LED Flash Codes	Fault Description:	Manual Bypass:
Gn solid on	Channel on	Remove fuse from "normal" (lower) position and place into "bypass" (upper) position Ignition Danger! Ensure area is free of explosive gases before removing or replacing fuse!
Gn slow flash	Channel in timer mode	
1 x RED	Channel not configured	
2 x RED	Configuration conflict	
3 x RED	Dip switch conflict	
4 x RED	Memory comms failure	
5 x RED	No modules detected	
6 x RED	Low Run Current	
7 x RED	Over current	
8 x RED	Short circuit	
9 x RED	Missing commander	
10 x RED	Reverse current	Fuse in bypass position
11 x RED	Current calibration	

Module Identification and Dipswitch label

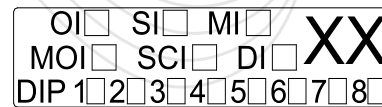

These labels allow easy identification of each module whilst recording the dipswitch setting. These labels are to be fitted to the cover and to the module (this prevents covers being swapped). To record the module type and dipswitch settings use a permanent marker and strike through the applicable boxes (a strike through on a dipswitch box indicates that switch is on).



Pictorial Overview

OI with cover removed

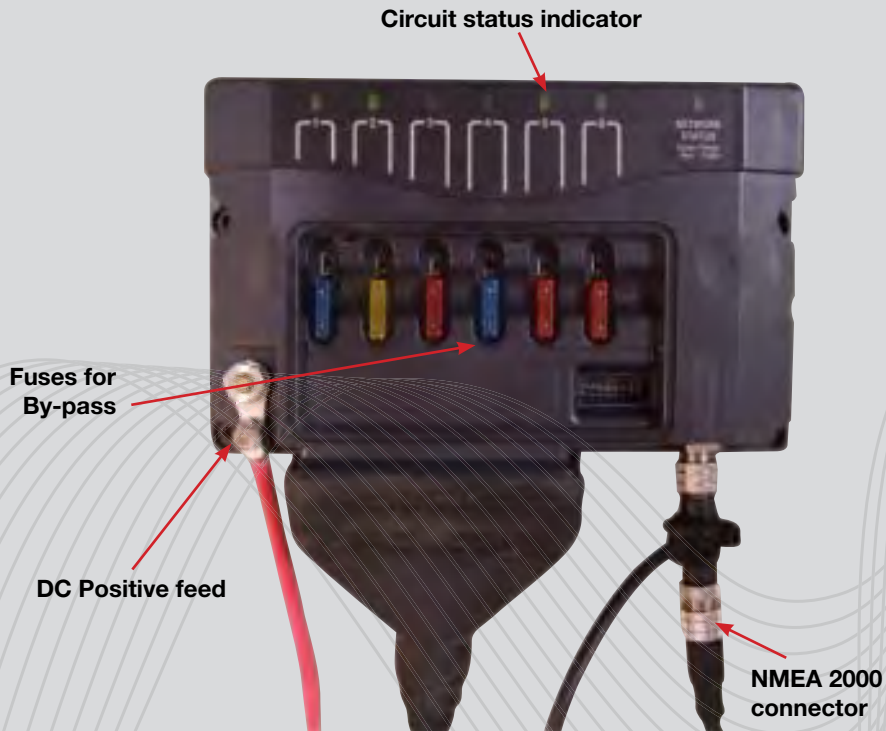

OI with cover Fitted

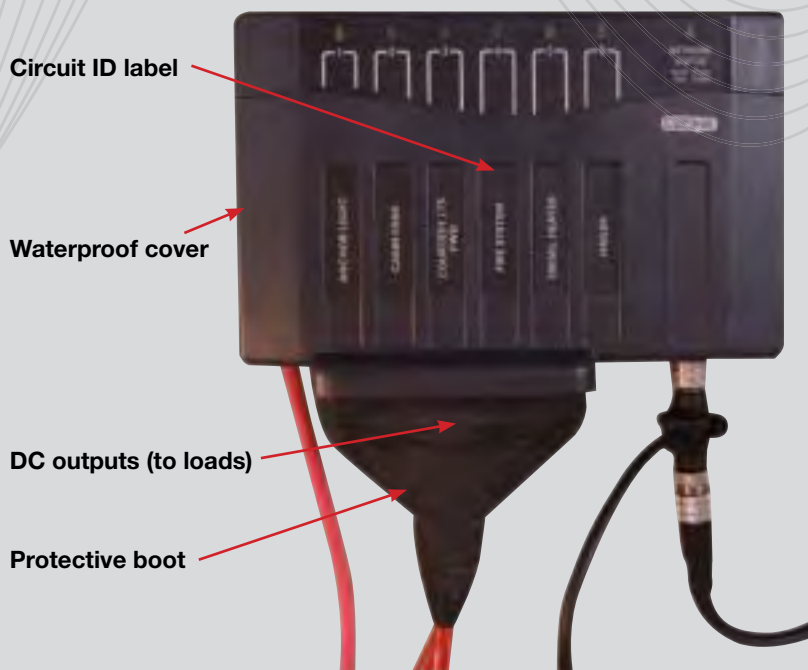



Signal Interface (SI)

Product description:

The Signal Interface is the interface between sensors and switches, external to the CZone system, and the CZone network

SI features:

6 inputs

- Inputs from traditional switch types being used to control outputs (Negative, Open circuit, 0-35V DC)
- Inputs from switches to trigger alarm i.e. high water float switch (Negative, Open circuit, 0-35V DC)
- LED status indicators for each input
- Tank level senders (compatible with industry standard sender outputs, 0-5V, 10-180 Ohm, 240-330Ohm)
- General voltaic or resistive signals can be used for controlling outputs or to display a physical position ie show a hatch is partially open

Inputs

- Network, NMEA 2000

Dimensions: H 100mm (3"29/32) x W156mm (6"3/32) x D 42mm (1"5/8)

Weight: 281g

EMC ratings:

- IEC EN 60945
- IEC EN 61000
- FCC Class B
- ISO 7637 - 1 (12V Passenger cars and light commercial vehicles with nominal 12 V supply voltage - Electrical transient conduction along supply lines only)
- ISO 7637 - 2 (24V Commercial vehicles with nominal 24 V supply voltage - Electrical transient conduction along supply lines only)
- IEC Standards for indirect lighting strikes





LED Flash Codes

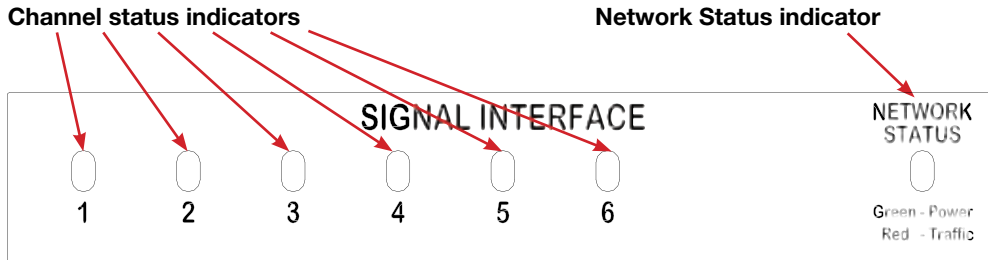

Network Status Indicator

- **Extinguished** = Network power disconnected
- **Green** = Network power connected
- **Red** = Network traffic

- Red solid on *SCI — Output on
- Red slow flash *SCI — Output in timer mode
- Gn solid on SI/MI — Valid input signal
- 1 x RED SCI/SI/MI — Channel not configured
- 2 x RED SCI/SI/MI — Configuration conflict
- 3 x RED SCI/SI/MI — Dip switch conflict
- 4 x RED SCI/SI/MI — Memory comms failure
- 5 x RED SCI/SI/MI — No modules detected
- 6 x RED SCI/SI — Fault on output
- 7 x RED SCI/SI — Output not detected
- 8 x RED SI/MI — Invalid input signal



Labelling

Connections/LED flash code label

This label is located on the inside of the front lid of the unit, it shows the LED codes and electrical connections to the unit

Module Identification and Dipswitch label

OI	<input type="checkbox"/>	SI	<input type="checkbox"/>	MI	<input type="checkbox"/>	XX									
MOI	<input type="checkbox"/>	SCI	<input type="checkbox"/>	DI	<input type="checkbox"/>										
DIP 1	<input type="checkbox"/>	2	<input type="checkbox"/>	3	<input type="checkbox"/>		4	<input type="checkbox"/>	5	<input type="checkbox"/>	6	<input type="checkbox"/>	7	<input type="checkbox"/>	8

These labels allow easy identification of each module whilst recording the dipswitch setting. These labels are to be fitted to the cover and to the module (this prevents covers being swapped). To record the module type and dipswitch settings use a permanent marker and strike through the applicable boxes (a strike through on a dipswitch box indicates that switch is on).

LED Codes/Module:	Fault Description:
Red solid on *SCI	Output on
Red slow flash *SCI	Output in timer mode
Gn solid on SI/MI	Valid input signal
1 x RED SCI/SI/MI	Channel not configured
2 x RED SCI/SI/MI	Configuration conflict
3 x RED SCI/SI/MI	Dip switch conflict
4 x RED SCI/SI/MI	Memory comms failure
5 x RED SCI/SI/MI	No modules detected
6 x RED SCI/SI	Fault on output
7 x RED SCI/SI	Output not detected
8 x RED SI/MI	Invalid input signal

*SCI LEDS are located on SCI control switches

SI 8 Way

DC-	NC	I/P 6	I/P 5	I/P 4	I/P 3	I/P 2	I/P 1
8	7	6	5	4	3	2	1

SCI 8 way

1	3	5	7
2	4	6	8

MI 8 Way

DC-	DC V 3+	DC V 2+	DC V 1+	Shunt 2 (L)	Shunt 2 (B)	Shunt 1 (L)	Shunt 1 (B)
8	7	6	5	4	3	2	1

MI 6 Way

TXFM common	AC V 3 (TXFM)	AC V 2 (TXFM)	AC I 2 (TXFM)	AC V 1 (TXFM)	AC I 1 (TXFM)
6	5	4	3	2	1



Switch Control Interface (SCI)

Product description:

The Switch Control Interface (SCI) is a module which converts signals from traditional mechanical switches and converts them into a CAN signal to control loads via channels on output interface modules

SCI features:

- 8 switch channels per module (sixteen switch points)
- Single switch position can control multiple OI channels
- Multiple SCI switches can control single OI channel
- Output for backlighting of switch labels (dimmable)
- Outputs systems on and function/fault codes to systems on LED of switches (dimmable)
- Programmable switch types
 - Normally open
 - Normally closed
 - Momentary open or closed
 - Dimmer
 - Timer
 - Interlocking

EMC ratings:

- IEC EN 60945
- IEC EN 61000
- FCC Class B
- ISO 7637 - 1 (12V Passenger cars and light commercial vehicles with nominal 12V supply voltage - Electrical transient conduction along supply lines only)
- ISO 7637 - 2 (24V Commercial vehicles with nominal 24 V supply voltage - Electrical transient conduction along supply lines only)
- IEC Standards for indirect lighting strikes

Dimensions:

H 100mm (3"29/32) x W156mm (6"3/32) x D 42mm (1"5/8)

- IPX5 water ingress rated

Weight: 281g





LED Flash Codes

Network Status indicator

SWITCH CONTROL INTERFACE

NETWORK STATUS



Green - Power
Red - Traffic

Network Status Indicator

- **Extinguished** = Network power disconnected
- **Green** = Network power connected
- **Red** = Network traffic

Channel Status Indicators

In the Case of the SCI module the LED channel status indicator flashes are displayed on the Carling switches that are connected to the SCI (Systems in operation window)

- Red solid on *SCI — Output on
- Red slow flash *SCI — Output in timer mode
- Gn solid on SI/MI — Valid input signal
- 1 x RED SCI/SI/MI — Channel not configured
- 2 x RED SCI/SI/MI — Configuration conflict
- 3 x RED SCI/SI/MI — Dip switch conflict
- 4 x RED SCI/SI/MI — Memory comms failure
- 5 x RED SCI/SI/MI — No modules detected
- 6 x RED SCI/SI — Fault on output
- 7 x RED SCI/SI — Output not detected
- 8 x RED SI/MI — Invalid input signal



Connections

SCI - 8 Way connector housing

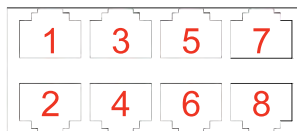
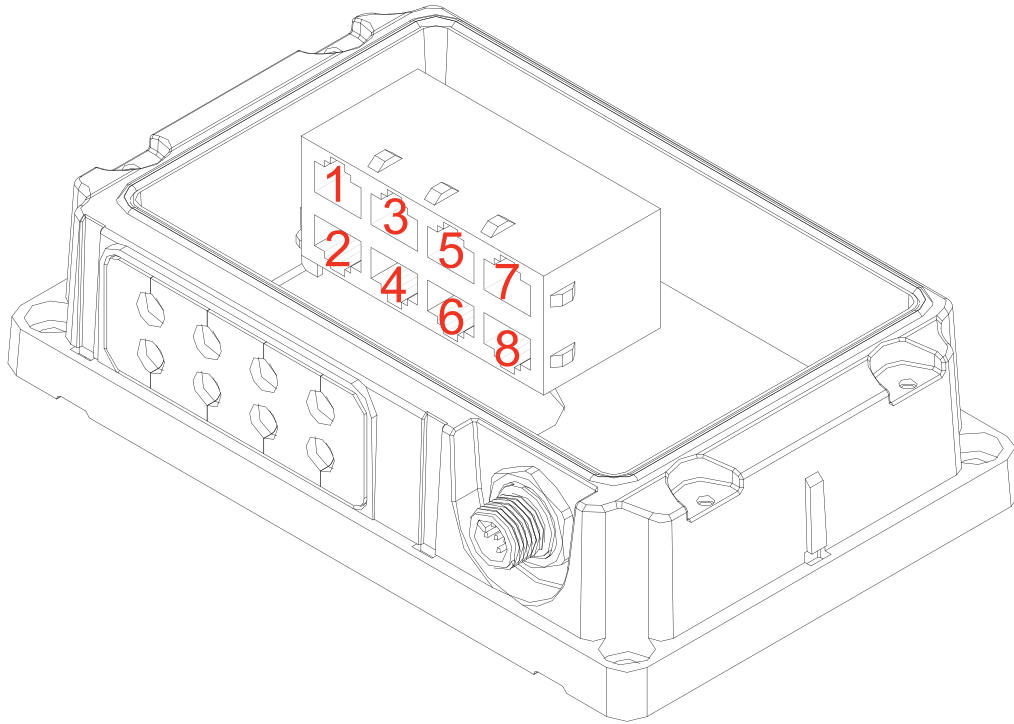

Front View

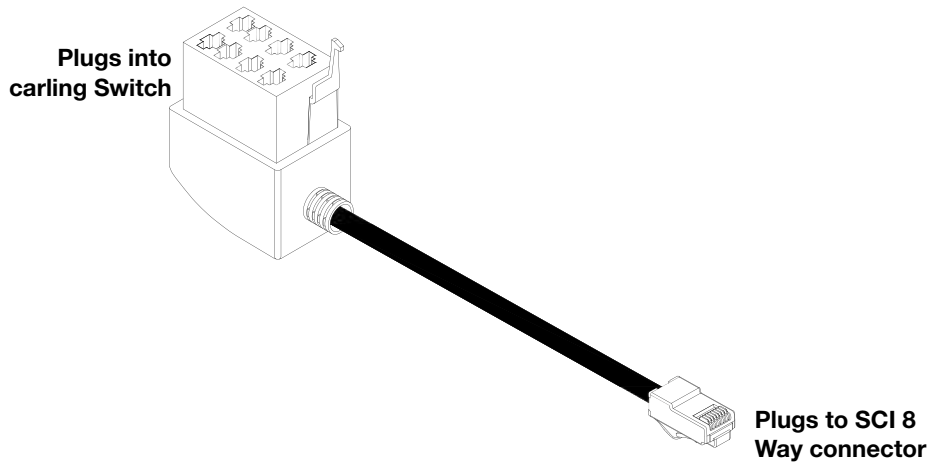



Connections

Internal SCI Conductor connections

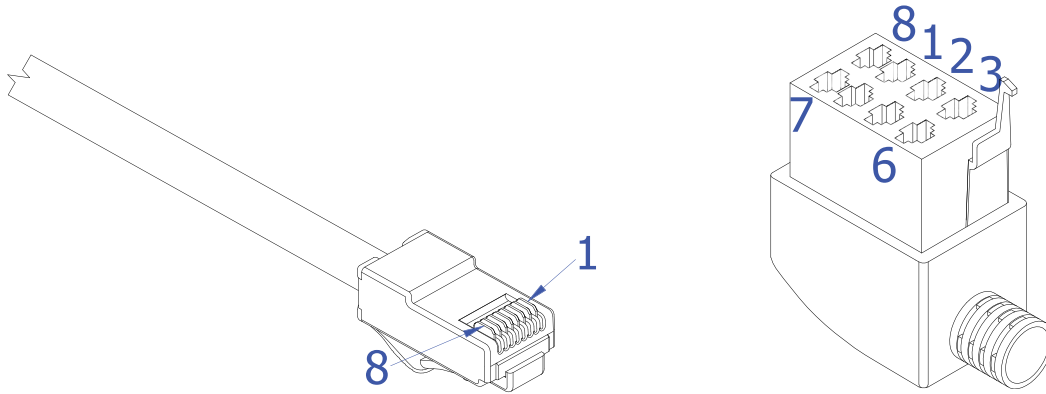

SCI Cable Connections

RJ45	Conductor Colour	Carling terminal Housing	Conductor Designation (in relation to SCI)
1	Green/White	8	Backlighting + 2V
2		NC	
3		NC	
4	Brown/White	3	Switch O/P Position 1
5	Green	1	Switch O/P Position 2
6	Blue	7	NEG
7	Orange		Systems on + 2V
8	Brown	2	Switch I/P centre position



Labelling

Connections/LED flash code label

This label is located on the inside of the front lid of the unit, it shows the LED codes and electrical connections to the unit

LED Codes/Module:	Fault Description:
Red solid on *SCI	Output on
Red slow flash *SCI	Output in timer mode
Gn solid on SI/MI	Valid input signal
1 x RED SCI/SI/MI	Channel not configured
2 x RED SCI/SI/MI	Configuration conflict
3 x RED SCI/SI/MI	Dip switch conflict
4 x RED SCI/SI/MI	Memory comms failure
5 x RED SCI/SI/MI	No modules detected
6 x RED SCI/SI	Fault on output
7 x RED SCI/SI	Output not detected
8 x RED SI/MI	Invalid input signal

Channel Status LED indicator

SI 8 Way							
DC -	NC	I/P 6	I/P 5	I/P 4	I/P 3	I/P 2	I/P 1
8	7	6	5	4	3	2	1

SCI 8 way							
1	3	5	7	2	4	6	8

MI 8 Way				MI 6 Way			
DC -	DC V 3 +	DC V 2 +	DC V 1 +	Shunt 2 (L)	Shunt 2 (B)	Shunt 1 (L)	Shunt 1 (B)
8	7	6	5	4	3	2	1
				TXFM common			
				AC V 3 (TXFM)			
				AC V 2 (TXFM)			
				AC I 2 (TXFM)			
				AC V 1 (TXFM)			
				AC I 1 (TXFM)			
6	5	4	3	2	1		

*SCI LEDS are located on SCI control switches



Pictorial Overview

