

# 2019 ROBALO WALKAROUNDS

---

# ROBALO

**OWNER'S/OPERATORS MANUAL**

**P.O. DRAWER 928**

**300 INDUSTRIAL PARK BLVD.**

**NASHVILLE, GA 31639**

**PHONE: (229) 686-7481 FAX (229) 686-3660**

This manual has been compiled to help you operate your boat with safety and pleasure. It contains details of the craft; typical equipment supplied or fitted its systems and information on its operation and maintenance. Please read it carefully and familiarize yourself with your boat before using it.

If this is your first boat, or you are changing to a new type, for your own comfort and safety please ensure that you obtain handling and operating experience before “assuming command” of the boat. Your dealer or national sailing federation or yacht club will be pleased to advise you of local sea schools or competent instructors.

**Please keep this manual in a secure place and hand it over to the new owner when you sell the craft**

For a complete list of standard and optional features and equipment, consult your local Robalo dealer. Due to a policy of continual product improvement, specifications are subject to change without notice. The weights and volumes shown are estimated and can vary from boat to boat because of equipment, etc.

Robalo boats meet or exceed both NMMA and U.S. Coast Guard standards.

**REV: APRIL 2018**

# 2019 ROBALO WALKAROUNDS

---

## **Model Information**

This manual contains information on the following models:

- R305

ROBALO

The information refers to standards and options available for the 2019 model year.

**Thank you for selecting a Robalo Walkaround!**

# 2019 ROBALO WALKAROUNDS

## Table of Contents

<b>Model Information</b> .....	<b>i</b>	Power Trim .....	43
<b>(1) Introduction</b> .....	<b>1</b>	Stove.....	43
Welcome Aboard .....	1	Water Heater .....	44
About This Manual.....	1	Refrigerator.....	44
Construction and Standards .....	2	Microwave Oven .....	44
Responsibilities.....	4	Bilge Pump .....	45
Laws and Regulations.....	5	Running and Navigation Lights.....	45
Owner's Logs and Records .....	6	Docking Lights .....	45
Warranty Policy Transfer .....	6	Underwater Lights .....	45
Customer Satisfaction.....	7	Stereo Sound System w/ Bluetooth .....	45
Boat Data Record.....	8	Television w/ Dockside Cable/DVD Player .....	46
Fuel Usage Chart.....	9	Generator .....	46
Travel Plan Log.....	10	Air Conditioner .....	47
<b>(2) Boating Safety</b> .....	<b>11</b>	Transom Shower.....	48
Hazard Communication .....	15	Sump Pump.....	48
Safety Recommendations.....	15	Fire Extinguishers .....	48
Safety Equipment .....	18	High Water Alarm.....	48
Running and Navigation Lights .....	19	<b>(5) Underway</b> .....	<b>49</b>
Safety Afloat.....	19	Transporting Your Boat.....	49
Checklist.....	25	Launching and Loading.....	50
Water Sports.....	26	Boarding Your Boat .....	52
<b>(3) Systems</b> .....	<b>29</b>	Fueling.....	54
Electrical Systems .....	29	Operating Your Boat.....	55
Fuel Systems.....	35	Trim Tabs.....	58
Freshwater Shower .....	36	Anchoring Your Boat.....	59
Marine Sanitation Devices.....	37	Mooring Your Boat.....	61
<b>(4) Components</b> .....	<b>41</b>	Shutting Down the Engine .....	61
Dashboard and Instrument Panel.....	41	<b>(6) Preventive Maintenance and Repair</b> .....	<b>62</b>
Windlass System.....	42	Engine.....	62
Hydraulic Steering System .....	42	Tune Up .....	63
Multifunction Navigation Display System.....	43	Fuel System.....	63
Throttle.....	43	Monthly Inspection .....	63
Controls .....	43	Outboard Drive Unit.....	63

# 2019 ROBALO WALKAROUNDS

---

Propeller .....	63
Steering System.....	64
Bilge .....	64
<b>(7) Interior and Exterior Care .....</b>	<b>65</b>
Fiberglass and Gelcoat .....	65
Hull Bottom Maintenance .....	65
Bottom Paint (Anti-Fouling) .....	66
Hardware and Fittings .....	66
Windshield and Portholes .....	66
Seat Coverings and Vinyl.....	67
Canvas (Weather Coverings) .....	67
<b>(8) Winterizing and Storage .....</b>	<b>68</b>
Lifting the Boat.....	68
Dry Storage Preparation.....	68
Systems and Components .....	69
Engine .....	69
Fuel System.....	69
Battery .....	69
Recommissioning .....	70
<b>(9) Warranty.....</b>	<b>71</b>

## INTRODUCTION

### WELCOME ABOARD

#### **Congratulations!....**

on your wise decision to purchase a Robalo boat. We welcome you to the family of thousands of other Robalo boat owners. Since your boat is a substantial investment, we are sure you selected your Robalo because of its value, style, comfort, and performance. This manual contains valuable information concerning your boat's operation, maintenance, and care, plus tips on boating safety and seamanship.

### ABOUT THIS MANUAL

More and more people are joining the ranks of boat owners. This manual is written for the first-time boat owner or operator. Even if you are an experienced boater, you will find much valuable information regarding the safe operation and maintenance of your new Robalo boat. Keep this manual on your boat for ready reference.

Due to our policy of continuous product improvement, the illustrations used in this manual may not be identical to the components, controls, gauges, etc. on your boat, as they are intended to be representative reference views. Some controls, indicators, or information may be optional and not included on your boat model.

The precautions in this manual cannot and do not cover every boating situation. If a specific method or procedure is not covered, you must make sure that what you do is safe for you and others. Always use common sense when boating! Remember, too, that every safe boating excursion is a happy experience.

This manual is part of your boat's equipment. Print a copy and keep it on board the boat at all times. If you transfer ownership of this boat to someone else, be sure to give this manual to the new owner.

Your owner's packet contains the manual for the boat selected. Also, in this packet are instruction manuals from the suppliers of standard and optional equipment for your boat. Examples of these manuals include the engine, electrical equipment, pumps, and cabin amenities. The suppliers of these products maintain their own manufacturer's warranty and service facilities. Be sure to fill out each warranty card and mail it to the manufacturer to validate the warrant. Record all information regarding these products on the "Boat Data Record." A copy of this form is near the end of this chapter under Logs and Records.

**Important: keep the complete Boat Data Record in a safe place at home. Do not keep it aboard the boat.**

Read this manual as well as the manuals for the systems and components on your Robalo boat. They provide the information needed for safe operation and proper maintenance. The information in the manuals provided by the manufacturers takes precedence over any information in this manual if there is a conflict.

Following are summaries of each chapter in this manual:

#### **1. Introduction**

Included in this chapter is a summary of the manual plus general information about construction and standards, dealer and owner responsibilities, laws and regulations, logs and records, and the warranty for your boat.

#### **2. Boating Safety**

This chapter discusses potential hazards associated with boating, safety recommendations, safety information and practices, and water sports safety. It also discusses safety equipment needed to provide a safe operating system.

# 2019 ROBALO WALKAROUNDS

---

**Note:** For your safety, this manual has specific safety warnings and comments where appropriate. Be sure to read the entire manual.

## 3. Systems

Here you will find detailed information about the electrical and fuel systems needed to operate your boat. This chapter discusses the fresh water system and marine sanitation devices which make your boating experience more comfortable.

## 4. Components

Standard features and optional equipment for your Robalo boat are discussed in this chapter. In general, these pertain to equipment and amenities which make your boat a “home away from home.”

## 5. Underway

The intent of this chapter is to explain what you need to do before, during, and after your boating excursion to make it an enjoyable and safe experience.

## 6. Preventive Maintenance and Repairs

Preventive maintenance is the key to trouble-free operation and helps protect your investment. This chapter explains what you should do to maintain your boat and how to make adjustments and repairs.

## 7. Interior and Exterior Care

This chapter tells you how to inspect, clean, and maintain your boat’s interior and exterior.

## 8. Winterizing and Storage

What do you do when you need to winterize or store your boat for extended periods of time? This chapter provides the necessary information.

## **CONSTRUCTION AND STANDARDS**

All Robalo boats meet or exceed the construction standards set by the U.S. Coast Guard, the National Marine Manufacturers Association (NMMA), and the American Boat and Yacht Council (ABYC) concerning

- Navigation Lights
- Factory installed fuel systems
- Engine and fuel tank compartment ventilation
- Flotation
- Steering systems
- Backfire flame arresters
- Wiring specifications

NMMA certification means that the boat complies with applicable federal regulations set forth by the U.S. Coast Guard. These regulations are based on American Boat and Yacht Council (ABYC) standards and recommended practices.

Most Robalo models can be certified to carry the CE mark. The CE mark certifies that the boat meets relevant parts of the European Directive for Recreational Craft 94/25/EC of the European Parliament, including the International Organization for Standards (ISO) and Recreational Marine Agreement Group (RMAG) guidelines in effect at the time of manufacture.

We recommend that you see your dealer if you wish to modify factory-installed equipment or add new equipment. Your dealer is qualified to make such modifications or additions without placing the safety or design integrity of your boat at risk and without invalidating the warranty. Robalo builds exceptionally high quality boats. We offer numerous extras you won’t see at a boat show. We’ve created a list for your review.

# 2019 ROBALO WALKAROUNDS

---

## **Gelcoat**

The advanced technology polyester we use offers superior weathering resistance to surface yellowing and chalking. It will also help protect and maintain the original glossy luster of your boat's finish. Robalo uses a premium quality gelcoat which offers improved flexibility over other gelcoats, minimizing the potential for cracking.

## **Resin**

It's an age-old problem. Water penetrates the gelcoat and blisters the bottom. The key is the resin. To cut costs, most use a general purpose resin. Robalo uses a premium quality resin in the hull skin coat of every boat in our line because of its superior bonding characteristics and exceptional flex.

## **Loom Wrap Wiring**

Attention to rigging detail is a Robalo hallmark. Instead of routing the engine wiring harness haphazardly in the bilge in black tape, we rely on automotive style flexguard loom that not only keeps things neat but also protects against abrasion.

## **Through Bolted Stainless Steel Cleats**

It's one of the most often used components on your boat, but most people think a cleat is a cleat, right? Wrong. Robalo's cleats are stainless steel so they won't corrode and so they won't twist. Also, ours are big enough to accept a full-sized looped line.

## **Heavy Duty Rub Rail**

A rub rail is supposed to protect your boat. Robalo uses a heavy-duty PVC rub rail with stainless steel insert that absorbs far more impact without denting.

## **Acrylic Tops**

Ours are acrylic because it's a superior material that won't crack, peel, or mildew. Further, our acrylic tops won't shrink or expand, which means they look and fit better in all weather conditions.

## **Stain Resistant Fabrics**

Accidents happen. Spilled drinks, wet bathing suits and soggy towels are a fact of life on a boat. All our cabin fabrics are stain resistant. Buyers can choose from a wide variety of colors. When it comes to interior fabrics, we have the one that's right for you.

## **Superior Plastics vs. Wood**

Robalo prides itself on building seats that are not only comfortable, but durable. We use plastic seats because they hold their shape and don't retain water, reducing the potential for foam deterioration.

## **Flotation Requirements**

All Robalo boats meet or exceed U.S. Coast Guard requirements for flotation.

## **Additional Requirements**

All Robalo boats also meet or exceed U.S. Coast Guard requirements for the following:

- Engine and Fuel Tank Compartment Ventilation (requirements for flame arresting devices)
- Factory-Installed Fuel Systems
- Navigation Lights
- Steering System
- Wiring Specifications

# 2019 ROBALO WALKAROUNDS

---

## **RESPONSIBILITIES**

Robalo's quality service does not end when you buy one of our boats. Through our dealer network we do everything possible to ensure that you are satisfied with your purchase. Every Robalo dealer has a responsibility to you, the boater.

### **Dealer**

Dealer responsibilities include the following:

1. Discuss with you the terms of all warranties and stress the importance of registering warranties with the appropriate manufacturers.
2. Explain how you can obtain warranty service.
3. Complete new boat and pre-delivery inspection procedures. Sign the form to certify that all items were completed.

Your Robalo dealer can provide you with thorough instruction in the operation of your boat. Please feel free to ask for assistance.

### **Boat Owner**

Your responsibilities include the following:

1. Read this manual as well as all other manuals and information included in your owner's packet.
2. Schedule an appointment with your dealer to go over all warranties. Keep a record of the hull number for future reference.
3. Inspect the boat at the time of delivery to make sure all systems and components are operating properly. Robalo recommends that you refer to your engine warranty for initial inspection and service requirements.

The new boat and pre-delivery inspection form (found towards the back of this chapter) will help you as you inspect your new boat. After completing your inspection, sign the form to certify you have inspected the boat with your dealer.

4. Schedule an appointment with your dealer to go over the pre-delivery engine service record. Sign this record to indicate your dealer has explained this record to you.
5. Operate all equipment in accordance with the manufacturer's instructions.
6. Become familiar with all federal, state, and local laws affecting your boat and its operation.
7. Perform or provide for the appropriate periodic maintenance outlined in the manuals and service guides.



# 2019 ROBALO WALKAROUNDS

## **LAWS AND REGULATIONS**

This section of the manual includes general information about government regulations. You, the boater, are responsible for complying with the requirements of federal, state, and local laws. If you have any questions, contact the U.S. Coast Guard or other appropriate authority.

### **Boat Registration**

Federal and state laws require that every boat having propulsion machinery of any type must be registered in the main state of usage. Registration numbers and validation stickers must be displayed on the boat according to regulations. The registration certificate must be carried on board when the boat is in use.

### **Safety Equipment**

The following equipment is required on all boats:

- Display of Registration Numbers
- Fire extinguishers
- Personal flotation devices (PFD's)
- Navigation lights
- Visual distress signal
- Sound signaling device

See Chapter 2 for more information about safety equipment.

### **Discharge of Oil**

The Federal Water Pollution Control Act prohibits the discharge of oil or oily waste into or upon the navigable water of the United States or the waters of the contiguous zone if such discharge cause a film or sheen upon, or a discoloration of, the surface of the water or causes a sludge or emulsion beneath the surface of the water. Violators are subject to a penalty.

### **Disposal of Plastics and Other Garbage**

Plastic refuse dumped in the water can kill fish and marine wildlife and can foul vessel propellers and cooling water intakes. Other forms of waterborne garbage can litter beaches and cause illness. U.S. Coast Guard regulations therefore strictly prohibit dumping plastic refuse or other garbage mixed with plastic into the water anywhere. Further, the regulations restrict the dumping of other forms of garbage within 12 miles from shore on the east coast, and 9 miles from shore on the west coast.

Within 3 miles of shore and in U.S. lakes, rivers, bays, and sounds, it is illegal to dump plastic, dunnage, lining, and packing materials that float; and any garbage except dishwater, gray water, and fresh fish parts.

Between 3 and 12 miles it is illegal to dump plastic, dunnage, lining, and packing materials that float; and any garbage not ground to less than one square inch.

Between 12 and 25 miles it is illegal to dump plastic, dunnage, lining, and packing materials that float.

Beyond 25 miles it is illegal to dump plastic.

The U.S. Coast Guard has issued these regulations to implement Annex of the International Convention for the Prevention of Pollution from Ships, 1973, commonly known as Annex V of the MARPOL (Marine Pollution) Treaty 73/78. They apply to all U.S. vessels wherever they operate (except waters under the exclusive jurisdiction of a state), and foreign vessels operating in U.S. waters out to and including the Exclusive Economic Zone (200 miles).

If your boat is 26 feet or more in length, the regulations require U.S. recreational boaters attach one or more Coast Guard Trash dumping Restrictions placards to your boat. The placard warns against the discharge of plastic and other garbage with U.S. navigable waters and specifies discharge restrictions beyond the territorial sea (generally within 3 or more nautical miles of shore).

# 2019 ROBALO WALKAROUNDS

---

The placard must also contain the warning that a person violating these requirements is liable for civil and criminal penalties. The placard must also state that local regulations may further restrict the discharge of garbage. You may purchase these placards from local marinas, boat dealers, or marine equipment suppliers.

The U.S. Coast Guard has also issued regulations requiring boats to have sanitation system on board to control pollution. Wastes are to be stored in a holding tank or other device, such as Porta-Potti, until the device can be pumped out or otherwise disposed of at a shore facility. Discharging this waste overboard is in most cases prohibited. Check with the Coast Guard regarding regulations in your area.

## **OWNER'S LOGS AND RECORDS**

At the end of this chapter are three (3) forms which you will find very helpful.

Use the **Boat Data Record** to record all important information about your boat and the major components installed. Print a copy and after you have entered all the data, store it in a safe place. **Do not keep this form aboard your boat.**

The **Travel Plan Log** provides a record of your destination, departure and return times, boat description, passenger list, and other information about the trip you have planned. At the bottom of the form is space for listing emergency telephone numbers in case your return is delayed past the expected time. It also has space for indicating information about the person filling this report. Leave the completed form ashore with a responsible person. We recommend you print several copies of this form each boating season to ensure an ample supply.

The **Fuel Usage Chart** is a handy way to record information covering engine hours, fuel consumption, miles traveled, as well as RPM (revolutions per minute), Average MPH (miles per hour), and GPH (gallons per hour).

## **WARRANTY POLICY TRANSFER**

Your Robalo boat is backed by a Limited Express Warranty. It is important that you are aware of its terms. If a problem arises with your Robalo boat as a result of workmanship or materials, contact your dealer as soon as possible to determine whether correcting the problem may be covered by the warranty. Please have your hull identification number and necessary model numbers on hand for the items that may need service or repair. Your hull identification number is below the rub rail on the starboard aft corner of your boat.

The Robalo Limited Warranty Policy may be transferred to subsequent owner(s) providing the Ownership Transfer Record (OTR) is completed and returned to the Robalo Customer Service Office. The OTR is located after the Robalo Limited Warranty Policy in Section 11. Subsequent owner(s) will receive the balance of warranty available subject to a \$100.00 deductible per occurrence for claims filed in accordance with the Robalo Limited Warranty Policy. The Ownership Transfer fee varies depending on the boat model and size. See the Robalo Ownership Transfer Record for details and associated fees. YOU are responsible for your safety and your boat, as well as the safety of passengers and other boaters.

# 2019 ROBALO WALKAROUNDS



## CUSTOMER SATISFACTION NEW BOAT AND PRE-DELIVERY OPERATION RECORD (PDOR)

Boat ID Number:

Boat Model:  Date of Sale:

Dealer Name:  City:  State:

Owner Name:  Delivery Person Dealer's:  Sales Person:

### CHECK, INSPECT AND PERFORM THE FOLLOWING OPERATIONS

OK  
 NEEDS CORRECTION  
 COMPLETED

OK  
 NEEDS CORRECTION  
 COMPLETED

#### Boat

- Boat gel coat and wiring
- Upholstery clean and free of stains
- Start/stop system operation
- Water/WP alignment
- Cruise PI
- Lower unit trim/water/lake steps
- Check cabin floor, hatch, coxins and food boxes, all doors work smoothly (Caddy, Grasser, PVC)
- Check all thru hull fittings, vent, thru, plate, drain, and/or seal (oil/water, gear, plug-in), (Yacht, Power, Bow) and

#### Engine

- |   |  |  |
|---|--|--|
| <input type="checkbox"/> T/W/D  | <input type="checkbox"/> Oil/Water                     | <input type="checkbox"/> Air/Water       |
| <input type="checkbox"/> Fuel/Deliver/FC  | <input type="checkbox"/> VHF Radio                     | <input type="checkbox"/> Trim/Tilt       |
| <input type="checkbox"/> Running Light  | <input type="checkbox"/> Day Light                     | <input type="checkbox"/> Day/Bow         |
| <input type="checkbox"/> Out/Light  | <input type="checkbox"/> Day/Furc                      | <input type="checkbox"/> Tarp/cover      |
| <input type="checkbox"/> Mast/Light   | <input type="checkbox"/> Horn                          | <input type="checkbox"/> VHF/air         |
| <input type="checkbox"/> Tilt/W/switch  | <input type="checkbox"/> Sport/Control                 | <input type="checkbox"/> Door/door Power |
| <input type="checkbox"/> Show   | <input type="checkbox"/> Motor/door                    | <input type="checkbox"/> Air conditioner |
| <input type="checkbox"/> Bow/Inboard  | <input type="checkbox"/> Electronics                   | <input type="checkbox"/> Seating         |
| <input type="checkbox"/> Edge/Bow   | <input type="checkbox"/> Tackle/Lake                   | <input type="checkbox"/> Aft/High Seat   |
| <input type="checkbox"/> Bow/Trailer  | <input type="checkbox"/> Cabin/Microclimate Controller |  |
| <input type="checkbox"/> Check water/fuel/water   |  |  |
| <input type="checkbox"/> Water pressure system switches (all pressure must be in tank to use if pump is used) |  |  |

#### Engine

- Check fuel system for leaks
- Check engine compartment for components which may be loose, hot, or (oil/fuel) leakage (leak or electrical circuit or sound for any other meaning or disassembled components)
- Check fuel pump or engine fuel, engine coolant
- Primary steering system complete operational check
- Post-cocks crank on engine
- Thrust control/cable, trim and steering lockers
- Shift/control cable, lower and steering lockers
- Safety/cruise control, engine will not start in gear (D/C)
- Engine shut off (C/W)

JUSTOMER COPY (YELLOW)

#### After Starting Engine (at 900 RPM)

- Oil pressure
- 1st gear/1st gear
- Check fuel/water connectors/fittings
- No engine water or oil leaks
- Idle speed set within 1/10th range (in engine)
- Gear shift works properly (forward, reverse, neutral)
- Indicators register properly
- Control/locks
- Check trim on full gear for leaks

#### Running Water Test

- Good performance
- Port engine performance
- Starboard engine performance
- Steering operates freely
- Trim/Water/Tilt
- Indicators register properly
- To 100 rpm with stop throttle for operation after warm-up
- Port \_\_\_\_\_ RPM \_\_\_\_\_

#### After engine

Revised by: \_\_\_\_\_ Date: \_\_\_\_\_

#### PRE-DELIVERY FINAL CHECK

- All necessary safety proof complete
- Carpets and traps installed
- All boat, engine, and accessory hardware and manuals ready
- Owner has been told with operation and safety policy
- Warranty card completed and posted by dealer
- Boat properly cleaned, shined and waxed

After service referred by: \_\_\_\_\_ Date: \_\_\_\_\_

Under comments (write in check by item): \_\_\_\_\_

Customer Signature: \_\_\_\_\_

License #: \_\_\_\_\_

# 2019 ROBALO WALKAROUNDS

## Boat Data Record

Purchase Dealership		Service Dealership	
Name _____	Sales Manager _____	Name _____	Service Manager _____
Address _____	Phone _____	Address _____	Phone _____
_____	Fax _____	_____	Fax _____

General	Drive Unit	Notes
_____ Model Name                      State of Registration	_____ Serial Number	
_____ Hull Identification Number	<b>Fuel System</b> _____ Tank Capacity	
_____ Boat Name	<b>Fresh Water</b> _____ Tank Capacity	
_____ Hull Color(s)	<b>Propeller</b> _____ Manufacturer                      Pitch	
_____ Length                      Beam                      Weight	_____ Model Number	
_____ Draft (Drive Down)                      Draft (Drive Up)	<b>Battery</b> _____ Manufacturer	
<b>Engine</b> _____ Manufacturer                      Model Name/Number	_____ Model Number	
_____ Oil Type/SAE                      Quarts                      Filter Type	_____ Model Number	
_____ Serial Number                      Transom Plate Serial Number		

# 2019 ROBALO WALKAROUNDS

FUEL USAGE CHART

Date	RunTime (In Hours)	Fuel Used (In Gallons)	Distance Traveled (In Miles)	RPM	Average Miles per Hour	Gallons per Hour

Date	RunTime (In Hours)	Fuel Used (In Gallons)	Distance Traveled (In Miles)	RPM	Average Miles per Hour	Gallons per Hour

# 2019 ROBALO WALKAROUNDS

## TRAVEL PLAN LOG

The boat listed below should return by:  
 \_\_\_\_\_ at the latest.  
 Date Time

If it has not, please call the emergency numbers listed at the right.

Police \_\_\_\_\_  
 Coast Guard \_\_\_\_\_  
 Other Authority \_\_\_\_\_  
 Personal \_\_\_\_\_

### Trip Information

Departure Date/Time \_\_\_\_\_ Departure Location \_\_\_\_\_  
 Return Date/Time \_\_\_\_\_ Return Location \_\_\_\_\_

### Boat Description

Boat Name \_\_\_\_\_ Type \_\_\_\_\_  
 Registration Number \_\_\_\_\_ Manufacturer \_\_\_\_\_  
 Length \_\_\_\_\_  
 Hull Color \_\_\_\_\_ Deck Color \_\_\_\_\_  
 Cabin Color \_\_\_\_\_ Trim Color \_\_\_\_\_

Other Physical Characteristics \_\_\_\_\_

### Engine

Type \_\_\_\_\_ Horsepower \_\_\_\_\_  
 Fuel Type \_\_\_\_\_ Fuel Capacity \_\_\_\_\_

### Safety & Emergency Equipment YES/NO & NUMBER

Life Jackets \_\_\_\_\_ Cushions \_\_\_\_\_ Distress Light \_\_\_\_\_  
 Flares \_\_\_\_\_ Smoke Signals \_\_\_\_\_ Flash Light \_\_\_\_\_  
 Mirror \_\_\_\_\_ Paddles \_\_\_\_\_ Anchor \_\_\_\_\_  
 Food \_\_\_\_\_ Water \_\_\_\_\_ Life Raft \_\_\_\_\_

### Radio

Onboard (Yes/No) \_\_\_\_\_ Type \_\_\_\_\_

Frequencies usually used or monitored, \_\_\_\_\_

### Passenger List (Use another sheet if necessary)

Full Name \_\_\_\_\_  
 Age/Sex \_\_\_\_\_ Phone Number \_\_\_\_\_  
 Complete Address \_\_\_\_\_

Full Name \_\_\_\_\_  
 Age/Sex \_\_\_\_\_ Phone Number \_\_\_\_\_  
 Complete Address \_\_\_\_\_

Full Name \_\_\_\_\_  
 Age/Sex \_\_\_\_\_ Phone Number \_\_\_\_\_  
 Complete Address \_\_\_\_\_

Full Name \_\_\_\_\_  
 Age/Sex \_\_\_\_\_ Phone Number \_\_\_\_\_  
 Complete Address \_\_\_\_\_

**ALWAYS FILL THIS SHEET OUT COMPLETELY—IN AN EMERGENCY ALL INFORMATION MAY BE HELPFUL**

### **Safety Label Information**

The following pages include *general* label information found on the boat.

# 2019 ROBALO WALKAROUNDS

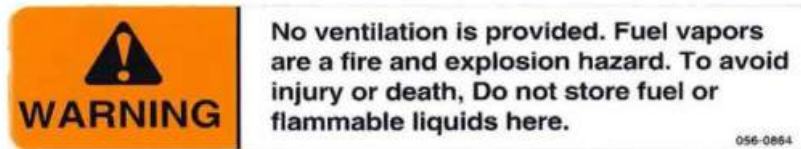



# 2019 ROBALO WALKAROUNDS

**⚠ DANGER ⚠**

CARBON MONOXIDE IS PRODUCED BY ALL GASOLINE ENGINES AND GENERATOR SETS. AVOID BRAIN DAMAGE OR DEATH FROM CARBON MONOXIDE. KEEP COCKPIT AND CABIN AREAS WELL VENTILATED. AVOID BLOCKAGE OF EXHAUST OUTLETS. SIGNS OF EXPOSURE INCLUDE NAUSEA, DIZZINESS, AND DROWSINESS. SEE BOAT OWNER'S MANUAL FOR MORE DETAILS.

USING SWIM PLATFORM WHILE ENGINE IS RUNNING CAN RESULT IN SEVERE PERSONAL INJURY. TURN OFF ENGINE BEFORE USING LADDER OR PLATFORM.

**⚠ WARNING ⚠**

THE OPERATOR OF THIS VESSEL IS RESPONSIBLE FOR THE ACTIONS OF PERSONS IN AND AROUND THIS VESSEL. SAFETY IS THE OPERATOR'S RESPONSIBILITY.

USING SWIM PLATFORM, FORWARD DECK, OR SUN DECK WHILE BOAT IS UNDERWAY COULD RESULT IN SEVERE PERSONAL INJURY. STOP BOAT AND TURN OFF ENGINES BEFORE USING.

AVOID SERIOUS OR FATAL INJURY DUE TO ROTATION OF SEAT. LOCK SWIVEL WHEN SPEED EXCEEDS 5 M.P.H.

INTERRUPT SWITCH MUST BE ATTACHED TO OPERATOR WHILE ENGINE IS RUNNING. QUALIFIED OPERATOR MUST BE IN CONTROL AT ALL TIMES. READ OWNER'S MANUAL BEFORE USE.

## BOATMAN'S CHECK LIST

- For maximum enjoyment and safety, check each of these items BEFORE you start your engine:
- ✓ DRAIN PLUG (Securely in place?)
  - ✓ LIFE-SAVING DEVICES (One for every person on board?)
  - ✓ STEERING SYSTEM (Working smoothly and properly?)
  - ✓ FUEL SYSTEM (Adequate fuel? Leaks? Fumes?)
  - ✓ BATTERY (Fully charged? Cable terminals clean and tight?)
  - ✓ ENGINE (In neutral?)
  - ✓ CAPACITY PLATE (Are you overloaded or overpowered?)
  - ✓ WEATHER CONDITIONS (Safe to go out?)
  - ✓ ELECTRICAL EQUIPMENT (Lights, horn, pump, etc.?)
  - ✓ EMERGENCY GEAR (Fire extinguisher, bailer, paddle, anchor & line, signaling device, tool kit, etc.?)

## ⚠ WARNING

Boat motion can be erratic.  
 You can fall overboard or be injured by hitting something in or on the boat.  
 All persons must be in cockpit area or cabin and be prepared for sudden boat movement.  
 Use front or bow deck area only during anchoring, mooring or emergencies.

**⚠ DANGER**



**Carbon monoxide (CO) can cause brain damage or death.**  
 Engine and generator exhaust contains odorless and colorless carbon monoxide gas.  
 Carbon monoxide will be around the back of the boat when engines or generators are running.  
 Move to fresh air, if you feel nausea, headache, dizziness, or drowsiness.

18V-206-15

**⚠ WARNING**

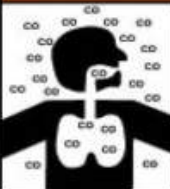

**Carbon monoxide (CO) can cause brain damage or death.**  
 Engine and generator exhaust contains odorless and colorless carbon monoxide gas.  
 Get fresh air if anyone shows signs of carbon monoxide poisoning.  
 Signs of carbon monoxide poisoning include nausea, headache, dizziness, drowsiness, and lack of consciousness.  
 See Owner's Manual for information regarding carbon monoxide poisoning.

## ⚠ WARNING

Wet decks are slippery.  
 You can be seriously injured if you slip and fall.  
 Wear slip resistant footwear secured to your feet and hold on to rails or boat structure.

# 2019 ROBALO WALKAROUNDS

## International Symbols

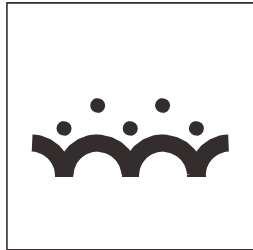

Waste Water Sewage



Fresh Water

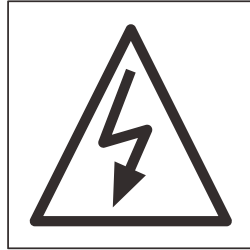

Electrical Hazard

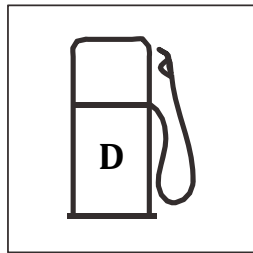

Diesel

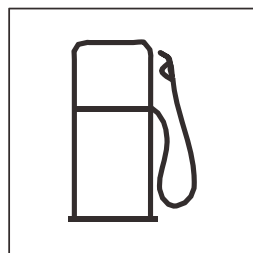

Fuel



**NMMA**

NW-502-17

### **WARNING**

Operating, servicing and maintaining a recreational marine vessel can expose you to chemicals including engine exhaust, carbon monoxide, phthalates, and lead, which are known to the State of California to cause cancer and birth defects or other reproductive harm. To minimize exposure, avoid breathing exhaust, service your vessel in a well-ventilated area and wear gloves or wash your hands frequently when servicing this vessel. For more information go to [www.P65warnings.ca.gov/marine](http://www.P65warnings.ca.gov/marine).

# 2019 ROBALO WALKAROUNDS

## HAZARD COMMUNICATION

As you read this manual, please note the hazard warnings which alert you to safety precautions related to unsafe conditions or operating procedures. We have included these warnings because we are concerned about your safety and the safety of your passengers. Hazard statements generally have five (5) parts:

1. The Hazard Symbol
2. A signal word which indicates the severity of the hazard
3. A concise description of the hazard
4. The results of ignoring the hazard
5. Steps for avoiding the hazard

The three (3) signal words indicating the severity of the hazard are danger, warning, and caution. The meanings they convey are as follows:



**DANGER:** calls attention to immediate hazards that WILL result in severe personal injury or death.



**WARNING:** identifies hazards or unsafe practices that COULD result in severe personal injury or death.



**CAUTION:** indicates hazards or unsafe practices that COULD result in minor personal injury or product or property damage.

**NOTE: This is a general advisory statement relating to equipment operation and maintenance procedures. Its intent is to call attention to information more important than normal text.**

## SAFETY RECOMMENDATIONS

The popularity of boating and other water sports has grown tremendously in the past few years. Boating safety and the safety of your passengers are your responsibilities. You should fully understand and become familiar with the operating procedures and safety precautions in this manual and the other manuals in the owner's packet before you launch your Robalo boat.

Remember that along with the freedom and exhilaration of boating comes the responsibility that you have for the safety of your passengers and the other boaters who share the water with you. Throughout this manual, specific precautions and symbols identify safety-related information. Be sure to pay close attention to them.

### **Safe Operation**

- Keep your boat and equipment in safe operating condition. Inspect the hull, engine(s), safety equipment, and all boating gear regularly.
- Be very careful when fueling your boat. Be sure you know the capacity of your boat's fuel tank and the amount of fuel you use when operating at frequently used engine speeds (RPMs). Ask your Robalo dealer about the capacity of your boat's fuel tank.
- Make sure you have enough fuel on board for anticipated cruising requirements. In general, use 1/3 of your supply to reach your destination and use 1/3 to return. Keep 1/3 in reserve for changes in your plans due to weather or other circumstances.

# 2019 ROBALO WALKAROUNDS

- Be sure lifesaving and fire extinguishing equipment is on board. This equipment must meet regulatory standards and it should be noticeable, accessible, and in safe operating condition. Your passengers should know where this equipment is and how to use it.
- Keep an eye on the weather. Be aware of possible changing conditions by checking local weather reports before your departure. Monitor strong winds and electrical storms closely.
- Always keep accurate, updated charts of the area on board your boat.
- Before you leave the port harbor, file a Travel Plan with a family member, relative, friend, or other responsible person ashore.
- Always operate your boat with care, courtesy, and common sense.
- Instruct at least one other passenger aboard in the basic operating procedures in handling your boat. This person can take over if you unexpectedly become unable to do so.
- Do not allow passengers to ride on parts of your boat other than designated areas.
- Asked all passengers to remain seated while on the boat is in motion.
- Do not use the swim platform or boarding ladder while the engine(s) are running.
- Understand and obey the “Rules of the Road.” Always maintain complete control of your boat.
- Do not overload or improperly load your boat.

The information on your boat’s capacity plate does not override your responsibility for using common sense or sound judgment. Turbulent water and unfavorable weather conditions reduce the capacity of your boat.

## Swimming

1. Swim only in areas designated as safe for swimming. These are usually marked with a swim area buoy (see figure left). Do not swim alone or at night.
2. Do not allow anyone near the propeller(s), even when the engine is off. Propeller blades can be sharp and can continue to turn even after the engine is off. Stay well away from areas marked by a diver down float (see figure right).



## Safe Boating Courses

Your local U.S. Coast Guard Auxiliary and the U.S. Power Squadrons offer comprehensive safe boating classes several times a year. You may contact the Boat/U.S. Foundation at 1-800-336 BOAT (2628), or in Virginia 1-800-245 BOAT (2628). For a course schedule in your area you may also contact your local U.S. Coast Guard Auxiliary or Power Squadron Flotilla for the time and place for their next scheduled class.

U.S. Coast Guard Website: [www.uscg.mil](http://www.uscg.mil)

Power Squadron Website: [www.usps.org](http://www.usps.org)



# 2019 ROBALO WALKAROUNDS

---

## Voluntary Inspections

State boating officials in many states or the U.S. Coast Guard Auxiliaries offer courtesy inspections to check out your craft. They will check your boat for compliance with safety standards and required safety equipment. You may voluntarily consent to one of these inspections and you are allowed time to make corrections without prosecution. Check with the appropriate state agency or the Coast Guard Auxiliary for details.

## Rules of the Road

All responsible boaters comply with the “Rules of the Road,” the marine traffic laws enforced by the U.S. Coast Guard. There are two sets of rules: The United States Inland Navigational Rules and the International Rules. The United States Inland Rules apply to all vessels inside the demarcation lines separating inland and international waters. The Coast Guard publishes the “Rules of the Road” in its publication “Navigational Rules, International-Inland.” You can get a copy from your local U.S. Coast Guard Unit or the United States Coast Guard Headquarters, 1300 E. Street NW, Washington, D.C. 20226.

Other helpful publications available from the U.S. Coast Guard include “Aids to Navigation” (U.S. Coast Guard pamphlet #123), which explains the significance of various lights and buoys; the Boating Safety Training Manual”, and “Federal Requirements for Recreational Boats.” Check with your local Coast Guard station, your Robalo dealer, or a local marina about navigational aids unique to your area.

U.S. Coast Guard Website: [www.uscg.mil](http://www.uscg.mil)

Power Squadron Website [www.usps.org](http://www.usps.org)

If you have a marine radio telephone, heed storm warnings and answer any distress calls from other boats. The word “MAYDAY” spoken three (3) times is the international signal of distress. Monitor marine radio channel 16 which is reserved for emergency and safety messages.

You can also use this channel to contact the Coast Guard or other boaters if you have trouble.

**Important: Never send a “MAYDAY” message unless there is a serious emergency and you are in need of immediate assistance.**

## Warning Markers

Always check with local authorities concerning regional hazardous areas and how they are marked. Other considerations include:

- Boat operators must be able to recognize marine flag designs and respond accordingly.
- Caution should always be exercised relative to swimmers. Swimming areas may not always be marked.
- Navigation markers identify navigable routes and indicate water hazards. Boat operators should familiarize themselves with these important navigational tools and operate their boats accordingly.
- Be prepared to assist anyone flying a ‘distress’ flag as they are requesting immediate assistance.

## Drugs and Alcohol

Drugs and alcohol affect a person’s ability to make sound judgments and react quickly. A responsible boater refrains from using drugs or alcohol while operating their boat. Operation of motorized vessels while under the influence carries a significant penalty. Drugs and alcohol decrease your reaction time, impair your judgment, and inhibit your ability to safely operate your boat.

# 2019 ROBALO WALKAROUNDS

## **SAFETY EQUIPMENT**

Important: Federal law requires you to provide and maintain safety equipment on your Robalo boat. As the boat owner, you are responsible for supplying all required safety equipment. Consult your Coast Guard, state, and local regulations to ensure your boat has all required safety equipment on board. Additional equipment may be recommended for your safety and that of your passengers. Make yourself aware of its availability and use.

### **Personal Flotation Devices (PFDs)**

There must be one United States Coast Guard approved wearable personal flotation device of Type I, II, or III for each person on board or being towed on water skis, water sports tubes, kneeboards, etc. and one Type IV throwable device on board. The PFDs must be of a suitable size for each person aboard and must be in serviceable condition and readily accessible.

**PFD Type I, Wearable:** This off-shore life jacket has the greatest buoyancy. It is most effective for all waters where rescue may be delayed. Its design allows for turning most unconscious persons in the water from a face down position to a vertical or face-up position.

**PFD Type II, Wearable:** This near-shore buoyant vest provides less buoyancy than a Type I PFD. It is intended for calm inland water or waters where there is a chance of quick rescue. It turns its wearer to a face-up position as does the Type I PFD, but the turning action is not as pronounced as the Type I, and it will not turn as many persons under the same conditions as a Type I.

**PFD Type III, Wearable:** Classified as a flotation aid, this PFD allows wearers to place themselves in a vertical or face-up position in the water. Type III has the same minimum buoyancy as a Type II PFD. It has little or no turning ability. People participating in water sports often prefer this PFD because it intended for use in waters where quick rescue is possible and it is generally the most comfortable for continuous wear.

**PFD Type IV, Throwable:** You must also have aboard at least one throwable PFD Type IV device. The Type IV device can be thrown to a person in the water and grasped and held by the user until rescued. The design does not allow it to be worn. The most common Type IV PFDs are buoyant cushions or ring buoys. This PFD must be immediately available for use and in serviceable condition.

**PFD Type V:** Must be worn to be effective. When inflated, it provides buoyancy equivalent to Type I, II, or III PFDs.

### **Fire Extinguishers**

As the boat owner, you are responsible for making sure you have the required number of fire extinguishers. Fire extinguishers must be approved by the U.S. Coast Guard.

Boats longer than 26 feet and shorter than 40 feet: Two Type B-1 or at least one Type B-2 portable hand extinguishers. If your boat has a fixed fire extinguishing system approved by the U.S. Coast Guard, one Type B-1 extinguisher is required.

Boats longer than 16 feet and shorter than 26 feet: At least one portable hand Type B-I fire extinguisher.

All fire extinguishers should be mounted in a readily accessible location away from the engine compartment. Everyone on board should know where the fire extinguishers are and how to operate them.

If your fire extinguisher has a charge indicator gauge, cold or hot weather may affect the gauge reading. Consult the instruction manual supplied with the fire extinguisher to determine the accuracy of the gauge.

### **Visual Distress Signals**

The U.S. Coast Guard requires all boats operating on U.S. coastal waters have visual distress signal equipment on board. In general, coastal waters include all waters except rivers, streams, and inland lakes. The Great Lakes are considered coastal waters as is a river mouth more than two miles wide. Boats owned in the United States and operating on the high seas must also carry visual distress signal equipment.

# 2019 ROBALO WALKAROUNDS

---

Visual distress equipment must be in serviceable condition and stowed in a readily accessible location. Equipment having a date showing useful service life must be within the specified usage date shown. Both pyrotechnic and non-pyrotechnic equipment must be U.S. Coast Guard approved.

Pyrotechnic U.S. Coast Guard approved visual distress signals and associated equipment includes:

- Red flares, hand-held, or aerial
- Orange smoke, hand-held or floating
- Launchers for aerial red meteors or parachute flares.

Non-pyrotechnic equipment includes an orange distress flag and an S-O- S electric distress light.

No single signaling device is ideal under all conditions for all purposes. Consider carrying various types of equipment. Careful selection and proper stowage of visual distress equipment are very important. If young children are frequently aboard, you should select devices with packages which children, but not adults, will find difficult to open.

## **Sound Signaling Device**

Your Robalo boat must have a device that can produce a sound signal when conditions require. For boats over 26 feet, the device must be able to produce a two-second blast which can be heard a mile away. For boats less than 26 feet, it must be able to produce a two-second blast which can be heard one-half mile away. It can be a hand, mouth or power operated horn or whistle. Refer to the U.S. Coast Guard's publication "Navigational Rules, International-Inland" for details about the appropriate signals.

## **RUNNING AND NAVIGATION LIGHTS**

Your boat must have running and navigation lights for safe operation after dark. Observe all navigation rules for meeting and passing. Do not run at high speeds during night operation. Always use common sense and good judgment.

## **SAFETY AFLOAT**

Once your boat is launched and your excursion is underway, you need to be aware of your surroundings and how they may affect your safety and that of your passengers. There is no substitute for good judgment and common sense.

### **Weather**

Storms rarely appear without advance notice. Check the weather forecast before you begin a day of boating. Be aware, however, that weather conditions can change rapidly. If you have a marine radio, listen to the weather reports issued by the U.S. Coast Guard and others. If you have a portable radio, keep it tuned to a station broadcasting frequent weather reports. Many boating clubs fly weather signals. Learn to recognize these signals and listen to your local forecasts before leaving port.

Your surroundings can also be a good indicator of changing weather conditions. Watch for changes in wind direction or cloud formations. There is no substitute for a good understanding of weather conditions and what to do when the weather takes a turn for the worse.

### **Fog**

Fog is a result of either warm-surface or cold-surface conditions. You can judge the likelihood of fog formation by periodically measuring the air temperature and dew point temperature. If the difference between these two temperatures is small, fog is likely to develop. Remember the following guidelines:

- Turn on running lights.
- Unless your boat is well equipped with charts, head for shore at the first sign of fog and wait until conditions improve. If you have charts on board, take bearings as fog sets in, mark your position, and continue to log your course and speed.
- Make sure all persons on board have put on their personal floatation devices.
- If your boat has sounding equipment, take soundings regularly and match them with depths shown on your charts.

# 2019 ROBALO WALKAROUNDS

---

- Station a person forward in the boat as a lookout.
- Reduce your speed. From time to time, stop engine(s) and listen for other fog signals.
- Sound the horn or fog bell intermittently to warn others.
- If there is any doubt in continuing your excursion, anchor. Listen for other fog signals while continuing to sound your fog horn or bell.

## Storms

The present and forecasted weather conditions are a primary consideration, and the possibility of storms should always be a concern. If storms are a possibility, keep a watch on the horizon, especially to the west, for approaching storms. Monitor the weather forecast on a marine channel or local weather station. The best possible situation is to return to a safe port if time allows.

Other steps to follow to weather the storm include:

- Close and secure port holes. Stow all loose gear below deck and tie down any gear on deck.
- Reduce speed as the seas build. Make sure all persons on board have put on their personal floatation devices.
- Trail a sea anchor from the bow. If you do not have a sea anchor aboard, use a canvas bucket, tackle box, or other object that will work like a sea anchor.
- Radar reflectors (if installed on your boat) should be 18 inches diagonally. They should be placed as far above waterline as possible. Other- wise, a boat with radar may have trouble “seeing” your boat.

## Man Overboard

Should someone in the boat fall overboard:

- Act quickly—treat every situation as an emergency.
- Move throttle to idle position and yell “Man Overboard”.
- Immediately throw a Type IV PFD to the person in the water.
- Have someone in the boat assume responsibility for watching the person in the water and keep them in sight while the boat maneuvers back to them.
- Approach the person into the wind and waves. When alongside, put the engine in neutral and throw them a Type IV PFD with a line attached or extend an oar or boat hook.

## Fire

***Important: A fire aboard your boat is a serious emergency. You must act immediately!***

Every boater should develop a fire response plan to determine what kind of fire (fuel, electrical, etc.) might break out, where it might break out, and the best way to react. Having a plan and assigning responsibilities to others results in quicker decisions and quicker reactions.

***Important: Everyone on board should know where fire extinguishers are and how to operate them.***

Any fire requires stopping the engine(s) immediately. Then:

- If equipped, the fire extinguisher system will discharge in the event of a fire. The heat sensitive automatic head will release the extinguishant as a vapor, totally flooding the compartment in fire-killing concentrations. The system indicator light is wired to the ignition and is turned on when the ignition is turned on. The indicator light, located at the dash panel, indicates to the helmsman when the unit has discharged.



# 2019 ROBALO WALKAROUNDS

Under normal operation, the indicator light is lit. If the unit discharges, the charge light will go out.

- Do not open the hatch to the rigging compartment! The fire will flare up if the fresh air supply increases suddenly.
- Keep the fire downwind if possible. If the fire is aft, head into the wind.
- Have all persons on board put on their personal floatation devices.
- If you can get at the fire, aim the fire extinguisher at the base of the flames and use a sweeping action to put out the fire.
- If the fire gets out of control, make a distress signal, and call for help on the radio.

Deciding whether to stay with the boat or abandon ship will be difficult. If the decision is to abandon ship, all persons on board should jump over- board and swim a safe distance away from the burning boat.

## Guidelines for Fire Prevention



**Warning:** Smoking, poor maintenance, or carelessness when refueling can cause hazardous conditions. Always follow proper refueling procedures for your boat.

- Check the bilge for fuel leaks
- Check cleaning products for flammability
- Ventilate when cleaning or painting
- Disconnect electrical system from power source when performing any type of maintenance
- Use extra caution when using exposed flame around urethane foam
- Extinguish smoking materials carefully
- Ensure ventilation systems are not obstructed
- Use only approved marine cooking and heating systems

- Open flames demand constant attention
- Keep flammable materials in approved containers
- Replace circuit breaker fuse with one of the same amperage
- Electrical appliances must be with rated amperage of boat circuits
- A qualified marine electrician should service the electrical system

## Flooding, Swamping or Capsized Boat

Flooding or swamping is usually caused by the actions of an inattentive boat operator, or by hazardous weather or water conditions. To prevent boat flooding:

- Install drain plug before launching.
- Ensure proper bilge pump operation.
- Do not overload boat.
- Adjust boat speed and trim to match sea and weather conditions
- Close all cabin hatches, door, etc. while underway to prevent flooding due to heavy seas or rain. Ensure proper ventilation to avoid carbon monoxide poisoning. See carbon monoxide hazard information later in this chapter.
- When only using one anchor, it should be attached to the bow of the boat.
- When slowing down or moving in reverse do not allow wake or following seas to flood cockpit.

If your boat becomes swamped or capsizes, put on a PFD immediately and set off a distress signal. Chances are good that a capsized boat will stay afloat. For this reason, stay with the boat. Do not leave the boat or try to swim to shore except under extreme conditions. A capsized boat is easier to see than a swimmer, and the shore may be farther away than it appears.

# 2019 ROBALO WALKAROUNDS

More often than not, boats sink while docked. Any number of factors may contribute to these sinkings. There may have been a mechanical failure such as a failed bilge pump or an electrical problem such as a dead battery or tripped circuit breaker. Check your boat regularly if it is docked for an extended period of time to make sure everything is in order.

## Hypothermia

Water Temperature (°F)	Exhaustion Unconsciousness	Expected Time of Survival
32.5	Under 15 min	Under 15-45 min
32.5-40	15-30 min	30-90 min
40-50	30-60 min	1-3 HR
50-60	1-2 HR	1-6 HR
60-70	2-7 HR	2-40 HR
70-80	3-12 HR	3 HR – Indefinite
Over 80	Indefinite	Indefinite

If a person falls overboard, hypothermia may be an immediate concern. Hypothermia means a person's body loses heat to the water faster than the body can replace it. If not rescued, the person will become exhausted or likely drown. In general, the colder the water, the shorter the time for survival. PFDs will increase survival time because they provide insulation.

## Collision

If a serious collision occurs, first check the persons on board for injuries. Then inspect the boat to determine the extent of damage.

- Prepare to help the other craft unless it places your passengers or boat in danger.
- If the bow of the other boat penetrated your boat's hull, prepare to plug the fracture once the boats are separated.

- Shore up the hole inside your boat with a spare life jacket or cushion.
- While plugging the hole, shift weight to get the hole above the water level.
- If your boat is in danger of sinking, have all persons put on their personal floatation devices.
- If your boat has a radio, contact the U.S. Coast Guard or other rescue authorities immediately (VHF Channel 16 or 22 CB radio).

## Running Around

If you run aground check everyone for injury and inspect damage to the boat and propeller(s). If possible, shift weight of passengers or gear to heel the boat while reversing engine(s). If towing becomes necessary, do not attach tow line to deck cleats. These are not designed to take full load of the boat. Robalo recommends using a commercial towing service.



**WARNING:** When towing another boat or having your boat towed, make sure the tow line is fastened securely to the bow or transom towing eyes. Never attach tow line to deck cleat or anchor windlass. Cleat or windlass may pull free from deck and cause serious personal injury or property damage.

# 2019 ROBALO WALKAROUNDS

## Carbon Monoxide Hazard During Operation

Carbon monoxide (CO) in the engine exhaust is a poisonous gas which is odorless, colorless, and heavier than air. Direct prolonged exposure can result in carbon monoxide poisoning which can be harmful and may be fatal.

Indications of excessive exposure to carbon monoxide concentrations may include nausea, dizziness and drowsiness. Carbon monoxide poisoning requires the operator's special and immediate attention! To prevent excess exposure and reduce the possibility of carbon monoxide accumulation in the cabin of the boat, ensure adequate ventilation by opening cabin hatches, cabin doors, cabin windows, and side windshield vents to increase air movement.

Some Robalo models are equipped with a CO detector. Follow the operating instructions supplied with the CO detector and test the unit to verify that it is functioning properly every time you use your boat. Refer to the information provided by the manufacturer in your owner's packet to determine replacement interval for your CO detector.

The following illustrations show how carbon monoxide can possibly accumulate in your boat while at the dock or underway. Become familiar with these examples and their precautions to prevent dangerous accidents from occurring on your boat.

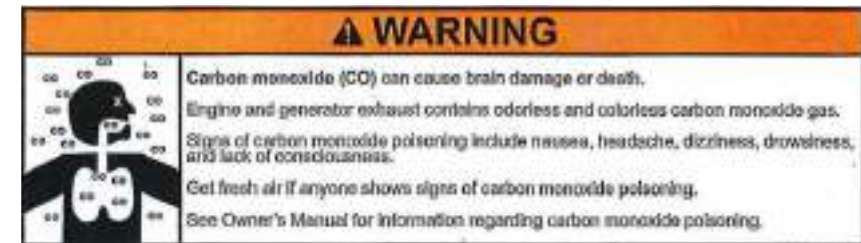

# 2019 ROBALO WALKAROUNDS



**DANGER:** Blocked hull exhaust outlets near a pier, dock, sea wall bulkhead or any other means can cause excessive accumulation of poisonous carbon monoxide gas within the cabin areas. Make sure hull exhaust outlets are not blocked. (Figure 2.1)

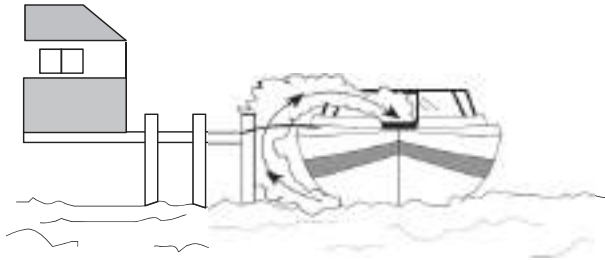

Figure 2.1 - Running engine or generator in confined areas



**DANGER:** Generator or hull exhaust from other vessels alongside your boat, while docked or anchored, can emit carbon monoxide and cause excessive accumulation within the cabin and cockpit areas. Be alert for generator exhaust from other vessels alongside. (Figure 2.2)



Figure 2.2 - Exhaust fumes from vessel alongside



**DANGER:** Engine exhaust from your boat while underway can cause excessive accumulation of carbon monoxide within the cabin and cockpit areas when using protective weather coverings. Provide adequate ventilation when the canvas top, side curtains, and/or back curtains are closed. (Figure 2.3)

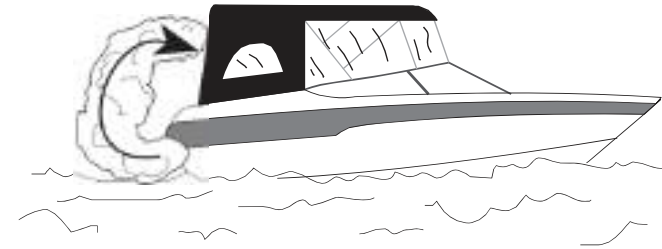

Figure 2.3 - Exhaust accumulations while canvas is in place

Ensure proper ventilation aboard your boat and be aware of the possibility of carbon monoxide poisoning (Figure 2.4). Keep your boat in safe operating condition. Periodically inspect the hull, engine and engine compartment, and all other equipment.

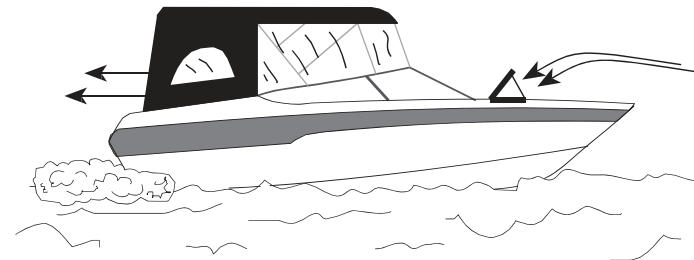

Figure 2.4 - Desired ventilation through the boat

# 2019 ROBALO WALKAROUNDS

## **Checklist**

### **Each Trip**

1. Make sure all the exhaust clamps are in place and secure.
2. Look for exhaust leaking from the exhaust system components evidenced by rust and/or black streaking, water leaks, or corrosion or cracked fittings.
3. Inspect rubber exhaust hoses for burned or cracked sections. All rubber hoses should be pliable and free of kinks.
4. Confirm that water flows from the exhaust outlet when the engines and generator are started.
5. Listen for any change in exhaust sound which could indicate a failure of an exhaust component.
6. Test the operator of each carbon monoxide detector by pressing the test button.

**NOTE: Do not operate the vessel if any of these problems exist.**

### **At Least Annually (performed by a qualified technician)**

1. Replace exhaust hoses if any evidence of cracking, charring or deterioration is found.
2. Replace each water pump impeller and inspect the condition of the water pump housing. Replace if worn. (Refer to the engine manual for further information.)
3. Inspect each of the metallic exhaust components for cracking, rusting, leaking or looseness. Pay particular attention to the cylinder head, exhaust manifold, water injections elbow, and the threaded adapter nipple between the manifold and the elbow.

## **Fuel System**

Everyone who owns or operates a boat must practice fire safety. Each year, boat fires and explosions injure hundreds of individuals and cause millions of dollars in property damage. Many of these accidents can be prevented.

Be alert for damage to your boat's fuel system. Over time, fuel fittings and fuel hoses wear out. Inspect these fittings and hoses regularly,

especially near the engine where engine heat and vibration can accelerate deterioration.

### **What to do**

1. Schedule regular engine and exhaust system maintenance inspections by experienced and trained technicians.
2. Inspect fuel systems annually, particularly hoses, connections and tank surfaces. Use only USCG-approved fuel hoses.
3. Before fueling, shut down engines and auxiliary equipment and all electrical equipment. Also close all hatches and doors on board.
4. Do not allow equipment or gear to contact fuel-system components.  
Monitor side storage areas where fill and vent hoses are often located.
5. Do not store portable fuel tanks in enclosed areas, including the engine room compartment (even though it may be "ventilated").
6. Take a boating safety course and learn the correct type and use of a fire extinguisher aboard a boat.

### **Each Trip**

- Before starting the engine "sniff" your bilges. Getting down on your hand and knees and using your nose is the best fuel/vapor detector.
- Make sure all passengers know where to find your fire extinguishers and how to operate them.
- Before refueling, close all hatches, ports and other openings; shut off engines, motors, pumps and blowers; and DO NOT SMOKE. Fill all portable tanks on the dock.
- After refueling, wipe up or wash off any excess or spilled fuel; open all hatches and ports; and let the boat air out. "Sniff" your bilges.

***Important: Do not operate your boat until the source of a fuel leak is identified. Have a qualified service technician correct the condition. NEVER USE A MATCH TO INSPECT FOR LEAKS.***



# 2019 ROBALO WALKAROUNDS

## At Least Annually:

(Performed by a qualified marine technician)

- Replace fuel system components if any evidence of cracking, corrosion or deterioration is found.
- Inspect fuel tanks annually. Pay particular attention to bottom surfaces that may have contacted bilge water. Also, check to see if any part of the tank is corroded or damaged from rubbing and abrasion. Permanently installed fuel tanks must be vented to the atmosphere outside the boat. Closed compartments that contain fuel tanks and engines or non-ignition protected electrical components must be ventilated.
- Be sure the fill pipe is securely mounted, grounded and located where spilled fuel is directed overboard. Dry and cracked or soft and mushy fuel fill hoses should be replaced immediately.
- If your boat is equipped with bilge blowers, ensure they are working properly.
- Ensure cooking appliances on board are secured and operate properly. Refer to the appliance owner's manual.
- Ensure flammable items are stowed safely and cannot contact cooking appliances or hot engine parts.
- Ensure fire extinguishers are USCG-approved and in good working order (i.e., gauges register and nozzles are clear)
- Repair all bare wires and loose electrical connections that might cause a short in your boat's electrical system and start a fire.
- Do not store disposable propane cylinders or charcoal lighting fluid on board the boat.
- When replacing starters or other electrical equipment use only ignition- protected parts. Do not use automotive parts.

## Navigational Aids Chart

The Navigational Aids Chart (located at the end of this section) contains information about various signals, buoys, and warnings. Robalo recommends you participate in a safe boating course to learn more about navigating your boat safely.

## WATER SPORTS

Water skiing and other water sports, such as knee boarding and riding on inflatable towable devices, require increased safety awareness by all the people involved.



**WARNING:** Death or serious poisoning can result from exposure to carbon monoxide from engine exhaust. Turn off gasoline-powered generators that exhaust at or near the water level when the swim platform on the stern is in use. Swimmers should not enter the cavity beneath the swim platform.

***Important: Remember that three people — not two — are required for safe water skiing: the boat operator, the skier, and an observer on the boat facing the skier. The observer relays signals from the skier to the operator. The operator can therefore give full attention to the operation of the boat and the waters ahead.***

Figure 2.6 shows a set of hand signals recommended by the American Water Ski Association (AWSA). The skier, the observer, and the boat operator should know and understand these 7 simple signals.

Following these guidelines helps make water skiing a safe and enjoyable experience:

1. Water ski only in safe areas away from other boats and swimmers, out of channels, and in water free of underwater obstructions.
2. Make sure anyone who water skis is a competent swimmer.
3. Be sure the skier is wearing a proper flotation device. A properly designed ski vest will keep a stunned or unconscious person afloat.

# 2019 ROBALO WALKAROUNDS

4. Approach a skier in the water from the lee side, and be certain to stop your motor before coming close to the skier.
5. Give immediate attention to a fallen skier. He or she is vulnerable in the water alone and is difficult to see by other boaters.

For more information about water skiing, Please contact the American Water Ski Association, 799 Overlook Drive, Winter Haven, Florida 33884 (1-800-533-2972) or [www.usawaterski.org](http://www.usawaterski.org).



**WARNING:** Serious injury may result from para-sailing, kiting, or similar water sports. Robalo Boats are not designed for towing para-sails, kites, or any other device designed to become airborne when towed behind a boat.

## Additional Equipment

You should consider having additional equipment on board to help make your boating experience safer and more enjoyable. Some examples include the following:

- Anchor and line
- Boat hook
- Bucket and sponge
- Commonly used spare parts
- Compass, navigation charts
- Distress signal kit
- Docking and towing lines
- Engine and accessory manuals

- Extra keys
- Fenders
- First aid kit
- Flashlight and extra batteries
- Fuses
- Manually operated bilge pump
- Owner's manual
- Paddle
- Replacement light bulbs
- Ship-to-shore radio
- Spare fuel and oil
- Spare propeller with fastening hardware
- Spare set of spark plugs and ignition parts
- Tool kit

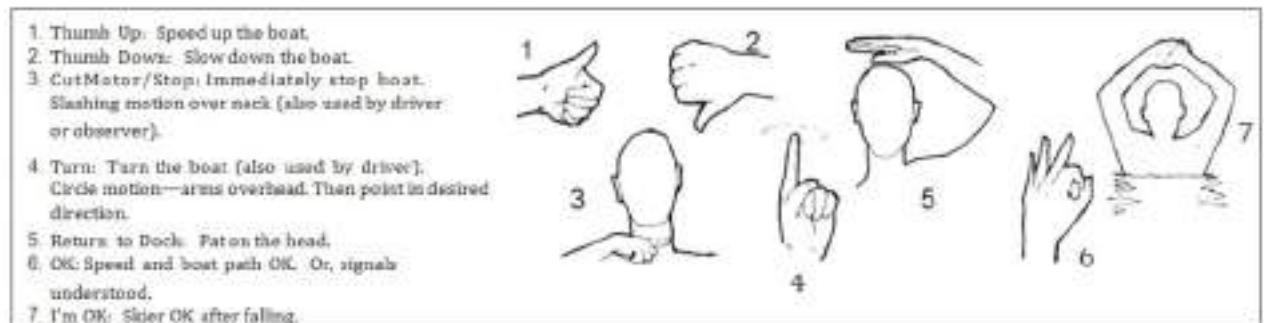

Figure 2.6 AWSA Water Skiing Signals

# 2019 ROBALO WALKAROUNDS

## NAVIGATIONAL AIDS CHART

### REMEMBER THESE RULES

- OVERTAKING- PASSING:** Boat being passed has the right-of-way. KEEP CLEAR.
- MEETING HEAD ON:** Keep to the right.
- CROSSING:** Boat on right has the right-of-way. Slow down and permit boat to pass.

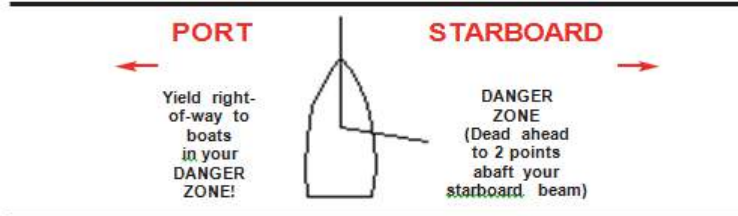

### WHISTLE SIGNALS

- ONE LONG BLAST:** Warning signal (Coming out of slip)
- ONE SHORT BLAST:** Pass on my port side
- TWO SHORT BLASTS:** Pass on my starboard side
- THREE SHORT BLASTS:** Engine(s) in reverse
- FOUR OR MORE BLASTS:** Danger signal

### BRIDGE SIGNALS

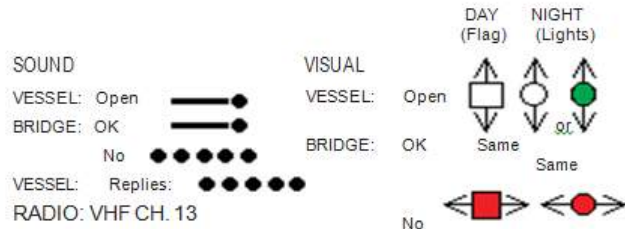

### STORM WARNINGS

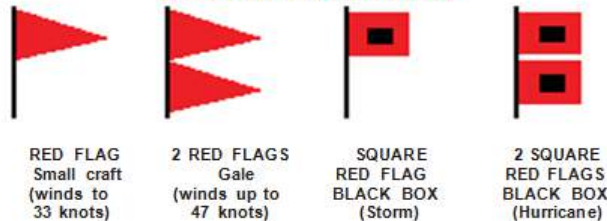

### LATERAL AIDS AS SEEN ENTERING FROM SEAWARD

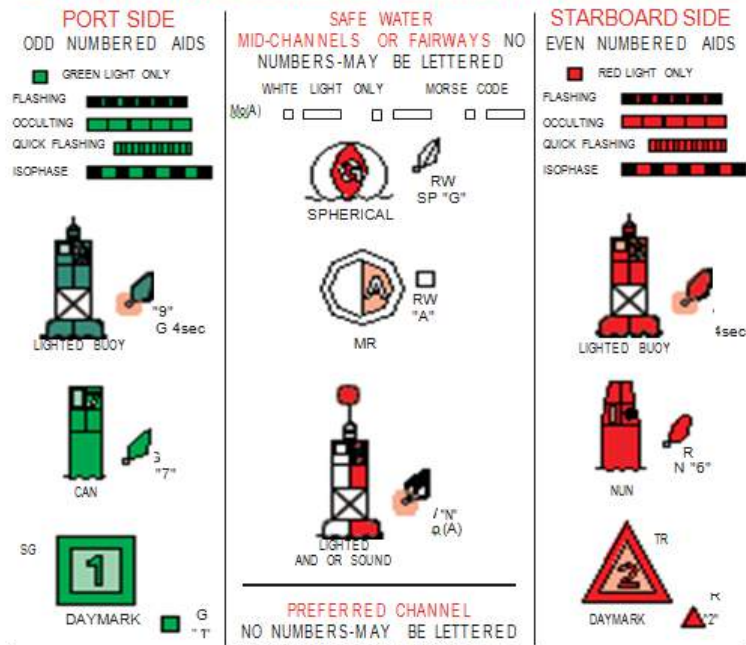

PREFERRED CHANNEL  
NO NUMBERS-MAY BE LETTERED  
COMPOSITE GROUP FLASHING (2+1)

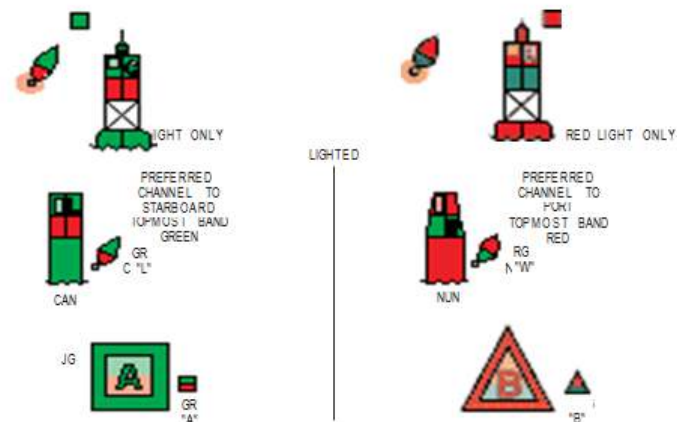

United States Coast Guard Website: [www.uscg.mil](http://www.uscg.mil)



The drawings at the end of this chapter show the typical locations of system equipment.

**NOTE:** For location of items listed in this chapter, refer to the respective drawing. Depending on how your boat is equipped, the location of some items may be different than shown in the illustration.

### Electrical Systems

Your Robalo boat has a 12 volt, direct current (DC) battery system.

#### **Safety Precautions**

Follow these precautions when working with or on electrical systems or electrically powered equipment:

1. Shut off power supply before starting work.
2. Use insulated mats to prevent accidental grounding.
3. Make sure clothing is dry. Keep skin dry.
4. Remove all metal jewelry.

#### **12 Volt DC Power**

Batteries are the source of power for the 12 volt DC (direct current) electrical system. The batteries are charged through the engine-driven alternator. The voltmeter on the instrument panel in the dash shows the battery charging rate when the engine is running.

The negative terminal of each battery is connected to the grounding studs of the main engine(s). This type of negative ground system is the approved system for marine DC electrical systems. If you add additional equipment to your boat it must be adaptable to the negative ground system.

**NOTE:** A fuse block near the helm has been provided with additional accessory hookups. Consult your Robalo dealer for additional DC power needs on your boat.

**Note:** The appropriate fuse or circuit breaker must be used. Consult a qualified technician for proper fuse size.



**CAUTION:** When adding electrical equipment, be careful not to overload the fuse block.



**WARNING:** Considerable care has been taken to design a safe electrical system to protect you from hazardous shocks. Always have a qualified technician make any modifications to the system.



**DANGER:** Do Not disconnect or reconnect battery cables if gasoline fumes are present!

# 2019 ROBALO WALKAROUNDS

## Battery

The battery installed in your boat by your Robalo dealer supplies your boat with DC current for lights, engine starting, and accessories. When the engine is running, the alternator supplies the power needed to keep the batteries charged. Lights and accessories draw power from the batteries.

## Battery Selector Switch

All models have a battery selector switch as standard equipment. If your boat has a battery selector switch, you will find it in the aft rigging area or in the console.

## Four Selector Switches with Three Batteries and Twin Engines

Each of the four battery switches has two positions:

All switches off: Power supplied to automatic bilge pump, CO detector, high water alarm, stereo memory, and mercathode system.

STBD switch on: Use on STBD (main engine) battery.

PORT switch on: Use only PORT (main engine) battery.

House switch on: Use on HOUSE battery(s).

STBD, PORT, House switches on: Use STBD (main engine) and PORT (main engine) batteries. Emergency parallel switch off.

## Recommended settings are as follows:

1. All switches off: When boat is not in use or power is not required, turn all switches to OFF. The only power supplied at this setting is the automatic bilge pump, carbon monoxide detector, stereo memory, high water alarm, and mercathode system.
2. STBD switch on: To start the engine, place switch in ON position. With this setting, power will now be supplied to your boat from the STBD (main engine) battery.

3. PORT switch on: For cabin or accessory power, place the switch in the ON position. Power will now be supplied to your boat from the PORT battery.
4. House switch on: For cabin or accessory power, place the switch in the ON position. Power will now be supplied to your boat from the HOUSE battery.

**Note: Robalo does not recommend leaving all three switches on when the engine is off. This will drain both batteries and you not have a starting battery.**

5. STBD, PORT, Parallel switches on: If the batteries are low, you still have the option of starting the engines by combining the output from both batteries.

**Note: When recharging a low battery, be sure to run the engine for a sufficient amount of time to fully recharge the battery.**

**Note: Robalo does not recommend any other settings than mentioned because of possible damage to batteries or engine alternator.**

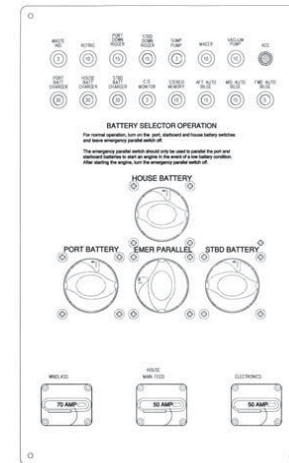

**Figure 3.1 Four Selector Switches with Three Batteries and Twin Engines**

# 2019 ROBALO WALKAROUNDS

## Three Selector Switches with Two Batteries and Twin Engines

Each of the three battery switches has two positions:

All switches off: Power supplied to automatic bilge pump, CO detector, and stereo memory

STBD switch on: Use on STBD (main engine) battery.

PORT switch on: Use only PORT (main engine/House) battery.

House switch on: Use on HOUSE battery(s).

STBD, PORT, Parallel switches on: Use only STBD (main engine) and PORT (main engine/House) batteries.

### Recommended settings are as follows:

1. All switches off: When boat is not in use or power is not required, turn all switches to OFF. The only power supplied at this setting is the automatic bilge pump, carbon monoxide detector (if equipped), and stereo memory.
2. STBD switch on: To start the engine, place switch in ON position. With this setting, power will now be supplied to your boat from the STBD (main engine) battery. This will allow the engine alternator to charge only the starboard main battery.
3. PORT switch on: To start the engine, place switch in ON position. With this setting, power will now be supplied to your boat from the PORT (main engine/House) battery. Having this switch in the ON position will also supply cabin or accessory power. This will allow the engine alternator to charge only the port main battery.

**Note: Robalo does not recommend leaving all three switches on when the engine is off. This will drain both batteries and you will not have a starting battery.**

4. STBD, PORT, Parallel switches on: If the batteries are low, you still have the option of starting the engines by combining the output from both batteries. This position is also used to charge both the main and house batteries from one engine if the boat is not equipped with a battery isolator.

**Note: When recharging a low battery, be sure to run the engine for a sufficient amount of time to fully recharge the battery.**

**Note: Robalo does not recommend any other settings than mentioned because of possible damage to batteries or engine alternator.**

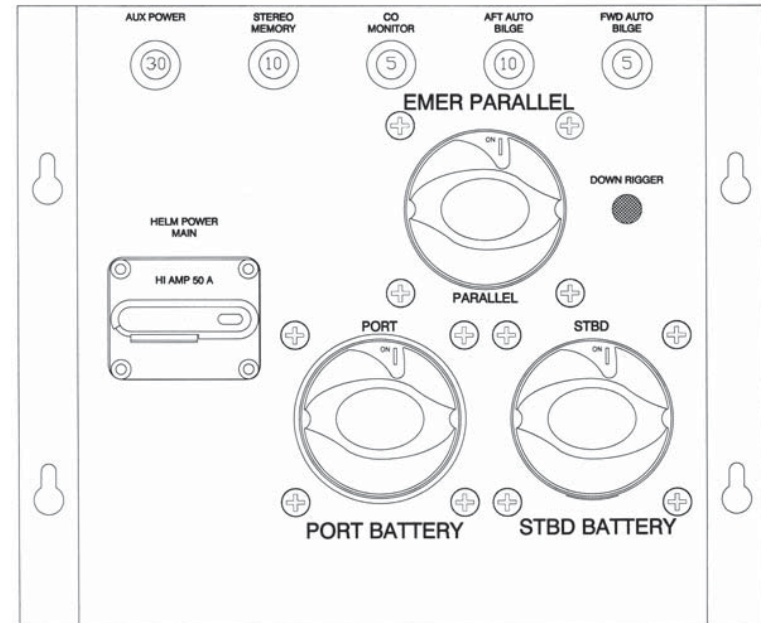

Figure 3.2 Three Selector Switches with Two Batteries and Twin Engines

# 2019 ROBALO WALKAROUNDS

## Three Selector Switches with Two Batteries and Single Engine

Each of the three battery switches has two positions:

All switches off: Power supplied to automatic bilge pump, CO detector (if so equipped), and stereo memory.

STBD Switch ON: Use only STBD (Main Engine) battery.

PORT Switch ON: Use only PORT (House) battery.

STBD, PORT, and Parallel Switches ON: Use STBD (main engine) and PORT (House) batteries in combination.

### Recommended settings are as follows:

1. All Switches off: When boat is not in use or power is not required, turn all switches to OFF. The only power supplied at this setting is the automatic bilge pumps, carbon monoxide detector (if equipped), and stereo memory.
2. STBD Switch on: To start the engine, place switch in ON position. With this setting, power will now be supplied to your boat from the STBD (Main Engine) battery. This will allow the engine alternator to charge on the main battery.
3. PORT Switch on: For cabin or accessory power, place the switch in the ON position. Power will now be supplied to your boat from the House battery.

**Note: Robalo does not recommend leaving all three switches on when the engine is off. This will drain both batteries and you will not have a starting battery.**

4. STBD, PORT, and Parallel Switches on: If both batteries are low, you still have the option of starting the engine by combining the output from both batteries. This position is also used to charge both the main and house batteries if the boat is not equipped with a battery isolator.

**Note: When recharging a low battery, be sure to run the engine for a sufficient amount of time to fully recharge the battery.**

**Note: Robalo does not recommend any other settings than mentioned because of possible damage to batteries or engine alternator.**

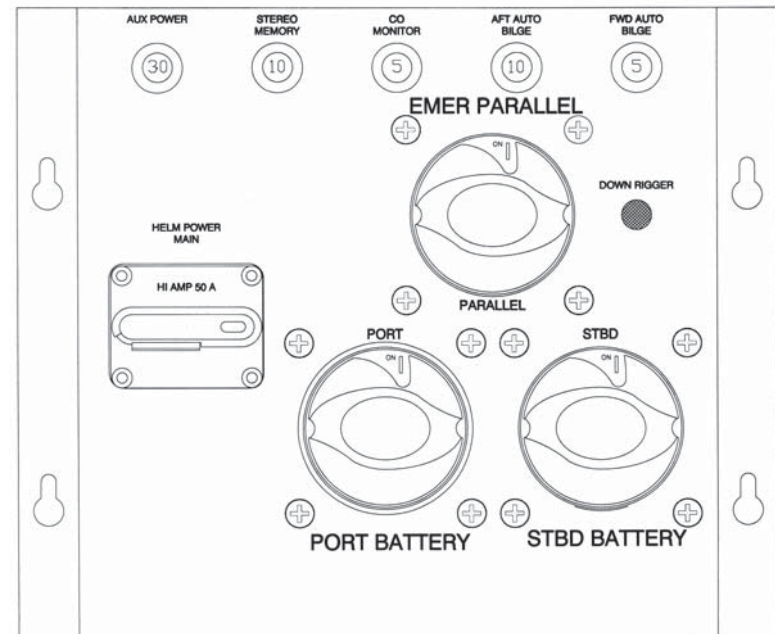

Figure 3.3 Three Selector Switches with Two Batteries and Single Engine

# 2019 ROBALO WALKAROUNDS

## AC/DC Converter and Battery Charger

Your Robalo boat may have an optional battery charging system which operates off 120 or 220 volt AC power from shore power system. Turn the charger on at the main cabin electrical panel whenever your boat is connected to shore power to keep batteries fully charged. The AC-to-DC converting and charging system is fully automatic and permanently wired into the 12 volt DC system. If the monitored battery level drops under the full charge range, the charger automatically turns ON and restores the battery to FULL charge status. If the battery is deeply discharged, the charger will deliver full output. Output automatically decreases as the battery is charged. If the battery is fully charged, the charger provides a trickle charge as needed.

## 120 or 220 Volt AC Power

The alternating current (AC) electrical system operates of a standard 30 amp 120 or 220 volt, 50 or 60 cycle shower power system. The main distribution panel is in the cabin area.

## Shore Power

Your Robalo boat has a single male receptacle outside on the deck for shore power connection. When not in use, a water-resistant cover protects the receptacle.



**CAUTION: To prevent damage to electrical system, never operate power system at low voltage.**

Before you connect your boat to shore power, turn off the main cabin circuit breakers. Attach the shore power cord to the boat first and turn clockwise to lock. Thread the locking ring on the inlet to secure the cord. Connecting the cord to the boat first will prevent dropping a "hot" cord into the water. (When you leave the dock, remove the cord from the dockside shore outlet first.) If you have any questions, contact your Robalo dealer.

Always be sure when using a Y-adapter or connecting two power cords that any connections are clear of water standing on the dock from rain or the pedestal water outlet.

Make sure the dockside shore power breaker is OFF, then plug in the cord. Turn the dockside shore power breaker on. Immediately check the polarity light(s) on the main panel. If the REVERSED POLARITY light on the main cabin panel illuminates, **do not turn on the main cabin breaker.**

Turn off the dockside shore power breaker and disconnect your shore power cord. Inform the marina manager of the problem. If the reverse polarity light does not illuminate, push the test button next to the light. If the light is functioning properly it will illuminate during this test and you are now assured that the polarity of your shore power connection is correct. At this point, turn on the main cabin AC circuit breaker(s). You may now use AC powered components on your boat.



**CAUTION: Electric shock is possible if you turn on main cabin breaker when reversed polarity is present.**

**Important: Some equipment will not work or may be damaged if polarity is reversed. Damage caused by reversed polarity is not covered under your warranty. Be sure polarity is correct when you connect your boat to shore power.**

## Shore Power Connection

**To connect:** Instructions for models that have shore power connectivity.

- Make sure all shore power cords and adapters are clean and dry before use. If cords are dropped overboard, rinse with fresh water and completely dry, and then check cords by a qualified marine electrician. Keep shore power inlet covers tightly closed when not in use.



# 2019 ROBALO WALKAROUNDS

- Get permission from the marina before connecting to a dock receptacle and ask if the “polarity” and ground are correct and when they were last checked.
- Make certain there are no swimmers in the water around your slip.
- Shut off each individual breaker, the boat’s main AC circuit breaker, and dock breaker before connecting the shore power cord.
- Connect the shore power cord to the boat first, and then ensure dockside breaker is off. Connect the cord to the dock receptacle and turn on the dock breaker.
- Thread the locking ring on the outlet to secure cable and prevent accidental unplugging and turn the dock breaker on the dock to the on position.
- Check the boat’s polarity alarm or light (if it has one) on the AC panel as soon as the dock breaker is turned on. If the polarity is incorrect, shut the dock breaker off and disconnect the dock end of the shore power cord immediately. Report the problem to the marina. The marina should contact a qualified electrician to make corrections.
- Turn on the AC main shore power breaker (if it has one). Individual AC breaker and switches can now be energized.

## To disconnect:

- Shut off each individual breaker first then shut off the boat’s main AC circuit breaker.
- Turn off the dock breaker.
- Disconnect the dock end of the shore power cord first.
- Clean and dry the shower power cord. Store it in a dry location on board the boat.

You are now disconnected to shore power.

## Ground Fault Interrupter Outlet

The ground fault interrupter outlet provides protection against currents which can be dangerous even though they do not overload circuit breakers. These outlets which have a test and reset switch in the middle of the faceplate provide ground fault protection to the head and galley outlets on the boat. If there is a difference of more than 5 milliamperes, a safety switch trips in the outlet and interrupts the circuit. This protects the person who is operating the electrical equipment from serious electric shock or loss of life. The outlet may not eliminate the feeling of an electric shock, but it does open the circuit quickly enough to prevent injury to a person of normal health.

When the outlet’s circuit breaker is tripped, you must push the RESET button. Check this outlet periodically by pushing the TEST button. Pushing the TEST button cuts power to the 120 and 220 volt outlets.

Robalo recommends replacing GFCI outlets once a year by a qualified electrician.

## General Electrical System Information

Electrical panel and shore power inlet wire connections may possibly loosen over time. Robalo recommends having your dealer check these connections at least annually, or if you are having any electrical system problem. Due to potential electrical shock hazard, do not attempt this service procedure yourself. Your dealer is trained to properly diagnose and correct electrical problems safely.

## Lighting

Lighting operates off the 12 volt DC system. Turn lights on or off at the main electrical panel in the cabin or at the light fixture. See your Robalo dealer for information regarding bulb replacement.

## Electrolysis and Sacrificial Anodes

Many boaters are unaware of the problems associated with electrolysis and how to properly address corrosion issues. Electrolysis is a reaction between metal and electrical energy. Electrolysis occurs when electrical current is “leaking” into the water, and can come from a variety of things such as ship to shore power, sharing electrical wires, old electrical devices in contact with the water, batteries in boats, etc.

# 2019 ROBALO WALKAROUNDS

Electrolysis can also be caused by “stray currents” due to a fault in an electrical item, even though correctly grounded.

Electrolysis/corrosion is a very real issue and expense for any boater and boat owners must be aware of the proper protection and maintenance. Corrosion will directly affect the performance of your boat within a very short period of time.

It is the boat owner’s responsibility to check for and replace damaged parts due to galvanic deterioration. Refer to your Robalo dealer to investigate the source of stray corrosive currents.

Sacrificial anodes are installed on the outdrive and trim tabs to protect underwater hardware on your boat. Metals used in sacrificial anodes are less noble than the copper-based alloys and aluminum used in underwater fittings; therefore, the anodes will deteriorate first and protect the more noble parts. Metals commonly used in sacrificial anodes include aluminum, magnesium, and zinc.



**CAUTION:** Replace sacrificial anodes if they are corroded 50% or more.

The type of metal needed for your boat’s sacrificial anodes will depend on your use of the boat. For instance, the type of water where you commonly go boating is a major factor in determining your need. Robalo recommends you consult your dealer and your engine manufacturer’s owner’s manual to determine the proper metal needed in your sacrificial anodes.

Zinc anodes generally require replacement about once a year, but may need to be replaced every six months in salt water areas. The need to replace anodes more frequently may indicate a stray current problem within the boat or at the slip or mooring. If zinc anodes are not replaced annually, they may not be providing the necessary protection.

**Note: Do not paint between the zinc and any metal it touches. Do not paint over the zinc.**

Placing a zinc in the water bonded to the metal outlet box on the dock will reduce zinc loss on the boat. Do not connect this zinc to the boat’s ground system.

***Important: All electrically operated DC equipment and accessories must be wired so that the ground polarity of each device is the same as that of the battery. Robalo boats have a negative ground system, which is recommended practice throughout the marine industry. All metal items (fuel tanks, underwater hardware) in the boat are connected to the zinc anode by the green bonding wire.***

## **Once a year**

(Performed by a qualified marine technician)

Inspect boat receptacles for any signs of deterioration, including cord wear, loose connections, and signs of sparking or overheating and bent or pitted blades. If there are any such signs, examine, correct, and test the equipment or replace it.

## **Fuel System**



The internal fuel system on your Robalo boat meets all current Federal requirements.

Fuel lines, filters, and all fuel system components should be checked at the start of each season and periodically thereafter, particularly after any work has been done aboard the boat which might have affected any part of the system. Be certain that all are in proper condition and that the entire system is fuel tight.

The fuel tank is located under the cockpit floor. The fuel tank fill pipe is located on the outside deck. Some models have a dual fuel system, providing convenience and flexibility of refilling your tank from either

# 2019 ROBALO WALKAROUNDS

The fuel tank vent allows air to escape as the tank is being filled and helps equalize tank pressure as temperatures change. The tank has an anti-siphon valve which keeps fuel from leaking into the boat in case of fuel line breaks.

Periodically, check the condition of the fuel tank components. Fuel tank fittings are accessible through the inspection plate of the cockpit floor.

## Fuel Recommendations

The quality of the fuel is very important for satisfactory engine performance and long engine life. Fuel should be clean and free of contamination. Your fuel tanks should be kept full of fuel whenever possible. This will reduce the amount of water condensation and reduce the possibility of contamination. Robalo recommends not using fuel containing more than 10% alcohol by volume.

Ethanol-infused gasoline is widely available to today's boater. However, it may have harmful effects on marine engines and fuel delivery systems. Please refer to your engine manufacturer's owner's manual to find the recommended type and grade of fuel for your engine as well as a better understanding of the effects of ethanol on your engine.



## Freshwater Shower

Some models have a non-pressurized water system as standard equipment and a pressurized system as optional. The fresh water system provides water from an onboard storage tank.

On some models, the fresh water tank is filled through the fill plate on the side of the deck. The vent allows air to enter and escape as water levels change. Fill the tank only with potable water. Using and refilling the tank frequently keeps drinking water fresh and clean.

## Sanitizing the Fresh Water System

Sanitize the fresh water system before you use it the first time, when you recommission your boat after winter storage, or when the system has not been in use for an extended period of time.

**Note: Fresh water tank must be empty before beginning sanitizing process. Empty tank, if necessary.**



**CAUTION:** Bleach causes eye and skin irritation. Notify all persons on board the fresh water system is being sanitized. Do not allow anyone to drink water from fresh water system while it is being sanitized. In case of body contact, follow directions on bleach container.

## To Sanitize the Tank

1. Pour 10 ounces of household bleach for every 10 gallons of capacity into the water tank.
2. Fill the water tank with clean fresh water.
3. Manually pump water throughout the system.
4. When a steady stream of water is coming from the faucet, all air is out of the system. Turn switch OFF after closing faucets.
5. Allow treated water solution to remain in tank for 3 to 4 hours.
6. Turn on water pump switch and pump all treated water solution from tank and lines through all faucets.
7. Refill tank with fresh water and turn on pump to thoroughly flush entire system with fresh water after each sanitizing.

**Note: If fresh water tastes like chlorine after sanitizing, pour a solution of 1 quart vinegar and 5 gallons of fresh water into the tank and allow solution to stand in tank for several days. Then drain entire system and flush with fresh water. Fill tank with fresh water.**

## Initial Start-Up

1. Fill fresh water system.
2. Manually pump water faucet until water is coming out of the faucet or if optional pressure water system, turn on water pump breaker.
3. Open galley faucet to allow air to escape.
4. Close faucet when steady flow of water appears.



# 2019 ROBALO WALKAROUNDS

## Optional Water Pump and Filter

Once the water pump switch is ON, the water pump supplies water under pressure to the fresh water system. The filter keeps particles from entering the pump reservoir. Check the filter periodically and clean if necessary. A clogged filter may result in low water pressure to the system.

Before servicing the filter, turn the water system breaker OFF and release pressure on the system by opening all faucets. To clean the filter, remove screen and rinse with clean water. Replace and make sure the O-ring is seated properly when installing the cover.

**Note: Refer to the water pump manual for detailed operation and maintenance procedures.**

## Livewell Pump, Raw Water Pump, and Filter

Once the water pump switch is ON, the water pump supplies water under pressure to the raw water system. The filter keeps particles from entering the pump reservoir. Check the filter periodically and clean if necessary. A clogged filter may result in low water pressure to the system.

Before servicing the filter, turn the water system switch OFF. To clean the filter, remove screen and rinse with clean water. Replace and make sure the O-ring is seated properly when installing the cover.

**Note: Refer to the water pump manual for detailed operation and maintenance procedures.**

## Marine Sanitation Devices

Standard and optional sanitation equipment varies with the boat model. These options include a Porta-Potti (Figure 3.4), and a VacuFlush® system with holding tank and optional macerator (Figure 3.5).

The marine sanitation device (MSD), or head, installed on your Robalo boat stores the waste in an onboard holding tank. The preferred method to empty the tank is by using a dockside pump out station designed for sanitary removal of the waste.

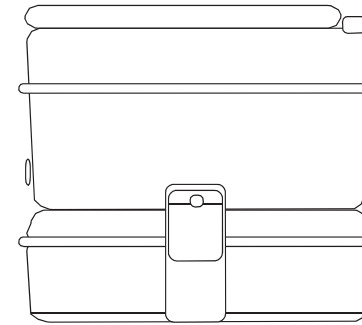

**Figure 3.1 Porta-Potti**

If you empty the holding tank overboard, the optional macerator grinds waste material into small particles as it empties the holding tank. The only time you will use the macerator is when you empty the holding tank overboard.

**Note: See the owner's manual supplied by the manufacturer for safety precautions and for detailed operation, maintenance, and winterizing procedures. The manual is in your owner's packet.**

The U.S. Coast Guard has also issued regulations requiring boats to have a sanitation system on board to control pollution. Wastes are to be stored in a holding tank or other device, such as a Porta-Potti, until the device can be pumped out and disposed of at a shore facility. Discharging this waste overboard is prohibited in most jurisdictions. Check with the Coast Guard regarding regulations in your area.

If your boat is equipped with the Vacuflush® head, your waste system is actuated by a HEAD or TOILET SYSTEM switch in the head. It uses fresh water to minimize odor problems. To add water to the bowl, raise flush lever until desired water level is reached. Add deodorizer before using the head. The pedal at the base of the head evacuates waste and a vacuum forces the waste to the holding tank.

# 2019 ROBALO WALKAROUNDS

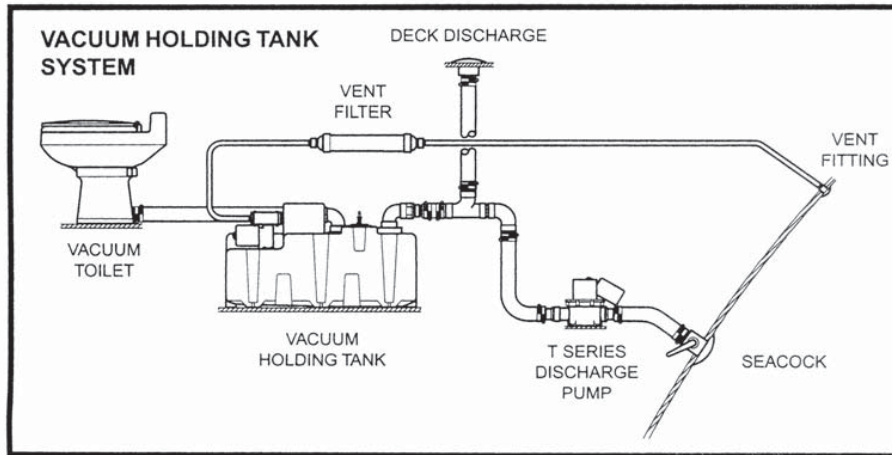

**VacuFlush Head**

To flush, press flush lever sharply to floor until contents clear bowl. A sharp popping noise is normal when the vacuum seal is broken. Hold flush lever down for three seconds. If flush lever is accidentally released before waste clears bowl, do not attempt to flush toilet again until vacuum pumps stops running. A small amount of water should remain in the bowl for flushing. Do not dispose of sanitary napkins or other insoluble items in toilet. Do not leave VacuFlush® power on for extended periods when away from the boat as this can cause damaging over-cycling if the bowl is not sealed.

Make sure all guests understand the operation of the VacuFlush® system and that the instruction label is easy to read and in plain sight.

Refer to your VacuFlush® manual for complete information about the operation of the system.

## Overboard Discharge

**Important: Overboard discharge of untreated sewage within 12 miles of shore on the east coast and within 9 miles of shore on the west coast is prohibited by law. Check with the local authorities for proper discharge procedures in your area. If your boat is going to be used on inland waters, have your dealer seal the overboard discharge portion of your waste system.**

If regulations permit, the macerator can be used to pump waste from the holding tank overboard. The MACERATOR circuit breaker at the battery selector switch panel protects the power supply to the macerator. The macerator pulls the waste from the holding tank, grinds the waste into small particles, and pumps the waste overboard through a hull discharge fitting above the water line.

Follow these procedures to operate the macerator:

1. Switch on the MACERATOR switch in the head compartment.
2. Allow the macerator to run until the holding tank is empty, but not longer. **Running the macerator when the tank is empty will cause damage to the pump.**
3. When you hear the pump speed up (indicates tank is empty), immediately turn the switch off.

**Note: If the macerator won't turn on, check the circuit breaker at the battery switch panel. If resetting the breaker doesn't allow the macerator to turn on, see your dealer to determine the cause of the problem.**

# 2019 ROBALO WALKAROUNDS

1. Aft Bilge Pump and Float
2. Mid Bilge Pump and Float
3. Fwd Bilge Pump and Float
4. Battery Selector Switch
5. Batteries (3 each)
6. Livewell / Raw water seacock and Air Conditioner (Optional)  
Sea Strainer for Livewell / Raw Water and Air Conditioner (Optional)
7. Generator (Optional)
8. Air Conditioner Sea Pump (Optional)
9. Air Conditioner (Optional)
10. Vacuflush Holding Tank
11. Vacuflush Overboard Discharge Pump (Optional)
12. Livewell Pump Forward Raw Water Washdown Pump
13. Livewell Pump Aft Water Pump and Filter
14. Generator Seacock (Optional)
15. Steering Helm
16. Fuel Tank, Main
17. Water Tank



- A - Strong points for anchoring or docking
- B - Sling Locations
- C - Trawling Eye

**Robalo 305**

# 2019 ROBALO WALKAROUNDS

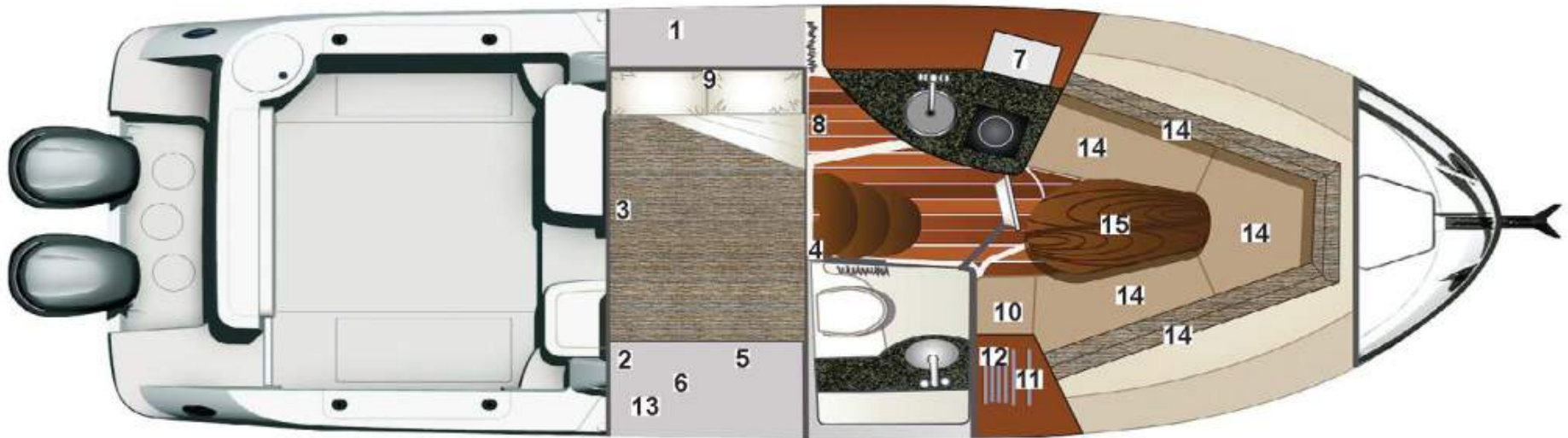

1. Water Tank
2. Air Conditioner (Optional)
3. Fwd Bilge Pump and Float
4. Sump Pump for Head
5. Vacuflush Holding Tank
6. Vacuflush Overboard Discharge Pump (Optional)
7. Microwave
8. LCD Television (Optional)
9. DVD Player (Optional)
10. Stereo, AM/FM/CD
11. Air Conditioner Control
12. CO Monitor
13. Power Steering Pump
14. Storage Areas
15. Bow Thruster (Optional)

## Robalo 305 Cabin



This chapter describes standard and optional components factory installed on our pleasure boats. Depending on how your boat is equipped, it may or may not have all of the equipment described in this chapter.

Be sure to read all operation, maintenance, and safety information contained in each component's manual before operation. The manuals are in your owner's packet.

**Important: Adhere to all safety precautions in the manufacturer's literature when operating the components.**



**WARNING:** When using electrical components, observe safety precautions to reduce the risk of fire, electrical shock, personal injury or damage to your boat and/or component.

### Dashboard and Instrument Panel

Instruments on the dashboard are important for monitoring the performance of your boat and alerting you to possible problems or causes of problems.

All Robalo boats are equipped with a Yamaha Instrument Operation. Please refer to the quick reference information at the end of this section for set up and usage instructions. For boats equipped with the Command Link Plus system, please see the component owner's manual for Command Link Plus provided by Yamaha.

The **fuel gauge** indicates the approximate amount of fuel in your fuel tank. The reading is most accurate when your boat is operating at idle speed. Be aware that you should compare gauge readings with hours of use versus known fuel consumption because the gauge is only an approximate reading of the amount of fuel in your boat's tank.

The **voltmeter** indicates battery voltage. When the engine is running, the meter should read between 12 and 15 volts. A significantly lower reading may indicate a battery or alternator problem or a heavy drain on the battery. If the voltmeter needle moves back and forth in wide swings, the alternator may not be charging properly.

The **tachometer** indicates the operating speed of the engine in revolutions per minute (RPM). It does not indicate the speed of your boat moving through the water. Do not exceed the maximum full throttle RPMs stated in the engine operator's manual.

The **speedometer** indicates the speed your boat is crossing the water in miles per hour. Water pressure from a water pickup at the boat's stern is measured and converted into a reading on the speedometer.

The **compass** indicates the direction or heading in which your boat is traveling. Have the compass calibrated by an experienced technician. See the manufacturer's instructions manual for details about proper operation and maintenance.



**CAUTION:** Compass reading may be erroneous if compensator is not properly adjusted. Always make a deviation table and use it when navigating with a compass.

# 2019 ROBALO WALKAROUNDS

## VHF Radio

Some models are equipped with a VHF radio. Refer to owner's manual packet for instructions and warranty information.

## Windlass System

Some models come equipped with a windlass option. Your anchor can be raised and lowered with the windlass by a toggle switch located at the helm or by two separate foot switches located at the bow of the boat. It is important to remember to use the anchor safety lanyard on the anchor chain when anchor is in fully retracted position. By attaching the lanyard clasp to one of the chain links, you are protecting your boat from any incidental damage from a swinging anchor. **(Figure 4.1)**

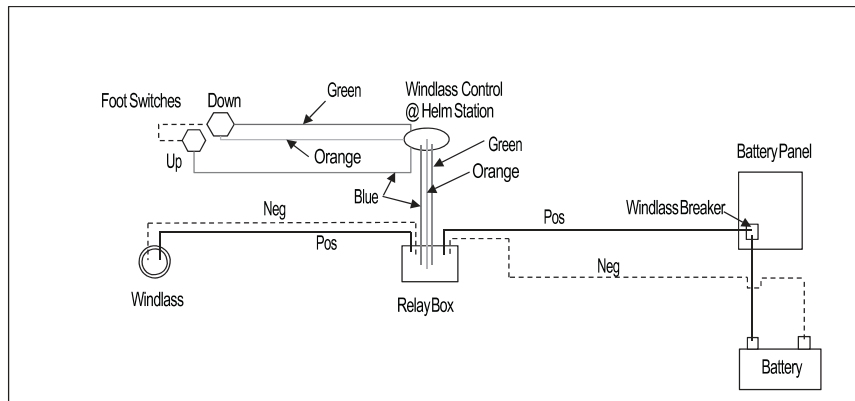

Figure 4.1 Windlass Schematic

**Note:** When anchor is in the up position and locked in slot, be sure to secure the anchor to the deck before getting underway.



**Warning:** Moving parts may cut or crush. Read instructions before use.

## Windlass Safety Tips:

- Always tie off rode while at anchor
- Always secure rode/anchor when under way
- Always look before deploying your anchor
- Always motor up to anchor while retrieving
- Never use your windlass to pull or tow boat
- Never stick fingers in or around gypsy while operating
- Always shut off breaker when working on windlass
- Always shut off breaker when windlass is not in use
- Keep all loose clothing and hair away from windlass when operating
- Never use windlass to lift a person

Refer to the owner's manual packet for instructions and warranty information.

## Hydraulic Steering System

Your boat has a hydraulic steering system. This system has two basic elements: helm pump and cylinder. The steering wheel is mounted to the shaft of the helm pump. Turning the steering wheel pumps hydraulic fluid to the steering cylinder. Extra hydraulic fluid prevents air from entering the system. A relief valve protects both the mechanical portion of the rudder (in case the rudder strikes a hard object) and the hydraulic system. This is a manual system, not a power steering system. The effort required to turn the wheel will increase as the system is called on to exert more force on the engines. At no time, should anyone expect this system to turn as easily as a car's power steering.

Check the level of hydraulic fluid in the helm regularly and replenish, if necessary. All other maintenance should be performed by your dealer.

# 2019 ROBALO WALKAROUNDS

## Multifunction Navigation Display System

An optional high performance multifunction display is available on select models. Robalo provides one of the most powerful multi-function navigational display systems, packed with power and performance features. Boat owners will have access to 3D chart-plotting, HD Digital technology, Sirius Satellite Weather and more.

## Throttle



**Caution:** Acceleration at full throttle is not recommended for certain periods of the engine “break-in period.” Refer to the engine owner’s manual for more details.

The throttle controls the boat’s speed and the direction the boat travels. If the throttle is in its center neutral position, the boat will not move forward or aft with the engine running. Moving the throttle forward from center moves the boat forward. Moving the throttle aft moves the boat backward. The speed at which the boat moves is directly related to how far the operator pushes the throttle.

**Note:** The throttle must be in its center neutral position before the engine will start. See your engine manufacturer’s owner’s manual for specific starting instructions.

## Controls

### Steering

Other than the common sense and good judgment of the operator, the steering system is the most important safety system on your boat. Factors requiring operator attention for safe steering include engine torque, trim tab settings, waves and speed.

## Power Trim

The power trim system allows the operator to raise and lower the outboard to adjust the drive angle while underway. It also allows the operator to raise and lower the drive for trailering, beaching, and operation in shallow water. Control your trim setting with the trim switch on the control handle. Section 5 discusses the importance of proper trim while operating your boat.

**Note:** Refer to your engine manufacturer’s owner’s manual for information concerning maintenance and operation.

## Stove

**Note:** Some boats may have an optional or standard electric or butane stove. Please refer to your stove manual for proper usage, maintenance and caution statements. The electric stove operates off the shore power system or onboard generator, and has a circuit breaker labeled “range” on the main electrical control panel.

**Important:** The operator’s manual and safety instructions explain special safety precautions, maintenance, safety and proper operating procedures. Robalo Boats cannot overemphasize the importance of operating your stove safely. **CAREFULLY READ** and understand the instructions before operating the stove



**Warning:** Stove flame consumes oxygen. Suffocation is possible, Ventilate cabin when using stove.



# 2019 ROBALO WALKAROUNDS



**Warning:** Alcohol flame is invisible in sunlight. Fueling ignited burner can cause explosion. Do not light burner unless flame is extinguished and burner is cool. Carefully follow all instructions in stove owner's manual.

## Water Heater

The water heater, which runs on 120 or 220 volt AC power, has an ON/OFF switch at the main panel in the cabin area. A check valve in the water heater piping prevents hot water from washing back into the cold water source. A pressure relief valve prevents damage if pressure or temperature gets higher than safe settings. The thermostat on the water heater is preset and is not adjustable.



**Warning:** Hydrogen gas may develop if you have not used heater for two weeks or more. Hydrogen gas is extremely flammable. Open hot water faucet at galley sink before you use any appliance connected to hot water system. Do not smoke or have open flame near open faucet.

**Note: Refer to the water heater instruction manual for safety precautions and for detailed operation, maintenance, and winterizing instructions. In areas where frost is possible, the heater tank must be drained to prevent possible damage during winter storage.**

Before turning on power to the water heater, be sure tank is full and water is covering the heating element. The heater tank must be kept full of water to avoid damage to the heating elements.

## Refrigerator

The refrigerator/freezer is designed to operate on 120 or 220 volt AC and/ or 12 volt DC power. When the 120 or 220 volt system is not operating, the refrigerator operates on 12 volts. A built-in relay automatically switches to the correct power. The AC control is an OFF/ON breaker switch at the main panel in the cabin. The unit also has a 10 amp direct current (DC) breaker on the battery switch panel in the engine compartment.

The power needed by the refrigerator exerts a continuous drain on the battery when it is powered by the 12 volt DC system. It can draw a 100 amp battery dead in a short period of time. To avoid excessive battery drain, keep the temperature control at a medium setting when air temperatures are in the 70° to 90° F range. If you plan an overnight trip and shore power is not available, run the generator or the engine occasionally to ensure your battery is charged.

**Note: Refer to the refrigerator instruction manual for safety precautions and for detailed operation and maintenance instructions. The manual is in your owner's packet.**

## Microwave Oven

The microwave oven is controlled by an electronic touch control panel. The breaker at the main panel must be on in order to use the microwave. For a detailed description of the microwave oven features see the owner's manual supplied by the manufacturer



**Caution:** To reduce the risk of burns, electric shock, fire, injury to persons or exposure to excessive microwave energy, read ALL instructions before using the microwave oven. Be sure to secure turntable while underway to prevent damage to the unit.

# 2019 ROBALO WALKAROUNDS

---

## **Bilge Pump**

**Note: All models come equipped with an automatic bilge pump that will activate when water accumulates in the bilge. There is also a switch at the helm for manual activation.**

The electric bilge pump removes water from the bilge area. If the pump motor runs but does not remove any water, the pump may be clogged. If there is no visible debris clogging the pump and water is still not being removed, check the discharge hose for kinks or obstruction.

**Note: The Federal Water Pollution Act prohibits the discharge of oil or oily waste into or upon the navigable waters and contiguous zones of the United States if such discharge causes a film or sheen upon, or discoloration of, the surface of the water, or causes a sludge or emulsion beneath the surface of the water. Violators are subject to a penalty.**

## **Running and Navigation Lights**

If you operate your boat at night, the law requires you to turn your boat's running lights ON. Your Robalo boat has one white, one red (port), and one green (starboard) light. Check running lights periodically for proper operation. Check them before heading out after dusk.

There are various running light combinations for the types of vessels you may encounter while boating. You should learn to identify what these combinations are and the type of vessel they are associated with. Robalo recommends participation in a "safe boating" course to learn more about the various light combinations.

The running/navigation lights are controlled at the helm station by a three position rocker switch. This allows for selection of the mast (white) light ON when anchored or moored, or to have the mast (white), port (red) and starboard (green) lights all ON while underway.

## **Docking Lights**

Docking lights are available on select models. Halogen docking lights are used for safe night time docking, and are glare-free because they mount below the deckline. If your boat is equipped with docking lights, they are powered by a switch at the helm.

## **Underwater Lights**

Underwater lights provide boating enthusiasts with the latest enhancement for their boat, insuring a memorable experience and creating a unique signature visible from shore or other boats. If your boat is equipped with LED underwater lights, they are powered by a toggle switch at the helm.

It is the boat owner's responsibility to manage battery voltage while using this feature, to ensure battery(s) are not drained to a point where engine will not start.

Refer to owner's manual packet for instructions and warranty information.

## **Stereo Sound System w/ Bluetooth**

The stereo in your boat is equipped with an AM/FM radio, MP3 Jack, and premium water resistant speakers. Our sound systems are Sirius Satellite Ready and Bluetooth capable. The stereo will turn off when motor is cranked. This is normal operation. The stereo memory has power at all times.

**Note: It is the boat owner's responsibility to manage battery voltage while using this feature to ensure battery/batteries are not drained to a point where engine will not start.**

Refer to owner's packet for instructions and warranty information.

# 2019 ROBALO WALKAROUNDS

## **Television with Dockside Cable Inlet & DVD Player**

Some models come with a television with a dockside cable inlet. Refer to owner's manual packet for instructions and warranty information.

**Note:** An A/B switch located in the galley will change television from dockside cable inlet to antenna.

## **Generator**

The optional onboard generator provides AC power to your boat's electrical system. If your boat has a generator, it is mounted in the engine compartment. Depending on the generator selected, AC power output ranges from 3.0 kilowatts (kW) to 4.2 kW or for Euro 3.0 kW to 4.2 kW.



**Warning:** Accidentally starting the generator can cause severe personal injury or death. Stop generator and disable by disconnecting battery cables (negative [-] cable first) when maintenance or repairs are made to the engine, controls, or generator. Do not disconnect cables if gas fumes are present.



**Caution:** Prior to starting generator, check for proper operation of carbon monoxide detector.

**Note:** For further information on carbon monoxide hazards, refer to Section 2 pages 8, 9 and 10. Please refer to your owner's manual for specific instructions concerning proper operation of carbon monoxide detector.

**Note:** Follow all generator instructions in the operator's manual. The manual includes detailed information of specifications and procedures for safe operation, maintenance, and winterizing. It also explains how you can obtain service for the generator. The manual is in your Owner's Packet.



**Warning:** Never assume that operating the blower removes all explosive fumes from engine compartment. If you smell any fuel, immediately stop the engine and turn off all electrical components. Extinguish all smoking materials. Determine source of smell immediately.



**Warning:** Gasoline vapors can explode if present while starting generator. Check engine compartment for gasoline or vapors. Operate blower for four (4) minutes. Run blower while generator is running.

1. Run bilge blower for four minutes before starting generator. Run blower while generator is operating.
2. Make sure seawater intake valve (seacock) is open. Seacock must remain open at all times when generator is operating. Seawater strainer must be free of debris to prevent clogging intake. Inspect seawater strainer frequently.

**Note:** Robalo recommends not using the generator when underway. When underway and not using the generator, the seacock should be closed.

# 2019 ROBALO WALKAROUNDS

3. Press GENSET START switch on main panel in cabin. When starting generator, never operate starter for more than 30 seconds. Wait at least 30 seconds before each attempted start.

The generator may also be started using the switch on the generator. Please refer to generator manufacturer's owner's manual for more information.

4. Look over side of boat and check for water flowing from discharge port. If water is not flowing, stop the generator. Check for the following: blocked water intake, air in line, clogged sea strainer, or closed seacock that should be open. Correct the problem before restarting the generator.
5. Before stopping, run generator at no load for three to five minutes to allow lubricating oil and engine cooling water to carry heat away from combustion chamber.

## **Air Conditioners**

Electrical control for the unit is at the main electrical panel in the cabin. Refer to Section 3 for additional information about this panel. The air conditioner runs on 120 or 220 volt AC power from either the onboard generator or shore power. You can control heating and cooling from the air conditioner control panel.

General instructions for operating the air conditioner are as follows:

1. Make sure the sea water inlet seacock is open and strainer is free of debris.
2. Make sure the sump pump is on when you operate the air conditioner. Condensation from the air conditioner drains to the sump pump.
3. Make sure 120 or 220 volt AC switch for air conditioner is on.
4. Set temperature on display. Select either heating or cooling.
5. Turn switch to ON. Fan, water pump, and compressor will start.

6. Look over side of boat and check for water flowing from discharge port. If water is not flowing, stop air conditioner. Check for the following: blocked water intake, air in line, clogged sea strainer, or closed seacock that should be open. Correct the problem before restarting the air conditioner.

Follow these procedures to operate the air conditioner on shore power:

1. Make sure the air conditioner breaker in the cabin is off.
2. Plug AC shore power cord into the receptacle on the boat and turn clockwise to lock. Thread the locking ring on the inlet to secure the cord. Connecting the cord to the boat first will prevent dropping a "hot" cord into water.
3. Make sure dockside power is off. Then, plug in the cord. Turn the dockside shore breaker on.
4. Immediately check the polarity light on the main cabin panel. If the reversed polarity light on the main panel illuminates, do not turn on the cabin main breaker. Turn off the dockside shore power breaker and disconnect the power cord. Inform marina manager of the problem.
5. Make sure the sea water inlet seacock is open and strainer is free of debris.
6. Make sure the sump pump is on when you operate the air conditioner. Condensate from the air conditioner drains to the sump pump.
7. Make sure 120 or 220 volt AC switch for air conditioner is on.
8. Set temperature on display. Select either heating or cooling.
9. Turn selector switch to ON. Fan, water pump, and compressor will start.
10. Look over side of boat and check for water flowing from discharge port. If water is not flowing, stop air conditioner. Check for the following: blocked water intake, air in line, clogged sea strainer, or closed seacock that should be open. Correct the problem before restarting the air conditioner.

# 2019 ROBALO WALKAROUNDS

---

**Note: On some Robalo models, there is an optional 12V air conditioner. Power supplied to the optional 12V air conditioner comes from two additional batteries located in the engine compartment. These batteries are recharged when docked and connected to shore power with the battery charger breaker on. Batteries are also recharged by the engine alternator when the boat is underway.**

**Note: The manufacturer's operation manual covers detailed information for operating the air conditioner including temperature setting, display and calibration, and fan speed and calibration. Also provided are technical data and troubleshooting information to help you keep the unit in safe and proper operating condition.**

## **Transom Shower**

Nothing is more luxurious than being able to rinse yourself off with fresh water after swimming or water skiing in salt water. An optional or standard transom shower, depending on model, is located at the transom and has pressurized water. Most showers have a push button shower head. Pressure water switch is located at helm.

## **Sump Pump**

If your boat is equipped with a sump pump, all your drained water from the air conditioner condensation pan, head floor drains, and some sinks will go to the sump unit to be drained overboard. A float unit located in the sump tank will be activated as the water level raises, which will turn on the pump to discharge the water overboard. Failure to have the sump unit on will cause the sump to overflow into the bilge compartment.

## **Fire Extinguishers**

As the boat owner, you are responsible for making sure you have the required number of fire Extinguishers. Fire Extinguishers must be approved by the U.S. Coast Guard.

Boats longer than 26 feet and shorter than 40 feet: Two Type B-1 or at least one Type B-2 portable hand Extinguishers. If your boat has a fixed fire extinguishing system approved by the U.S. Coast Guard, one Type B-11 extinguisher is required.

Boats longer than 16 feet and shorter than 26 feet: At least one portable hand Type B-1 fire extinguisher.

All fire Extinguishers should be mounted in a readily accessible location away from the engine compartment. Everyone on board should know where the fire Extinguishers are and how to operate them.

If your fire extinguisher has a charge indicator gauge, cold or hot weather may affect the gauge reading. Consult the instruction manual supplied with the fire extinguisher to determine the accuracy of the gauge.

## **High Water Alarm**

Your cabin boat may be equipped with a high water alarm. To determine if your boat has a high water alarm, contact your dealer. A horn under the dash will sound if the water level in the bilge is excessive. Periodically test the system by activating the float unit mounted on a sidewall or on the transom in the aft bilge area. If the warning horn activates, immediately put on your life jacket and seek safety. If conditions allow, determine the cause of the high water and make needed repairs.



This chapter discusses the operation of your boat from the beginning of a boating excursion to its end. We'd like to remind you to be kind to our environment while you're boating. Don't throw garbage and other refuse overboard. And do your best to keep harmful compounds like gasoline and antifreeze out of the water.

**Note: The term "engine" in this chapter means one or two engines depending on how your boat is equipped.**

**Note: If your boat is equipped with a carbon monoxide detector, it should be tested to determine that it is functioning properly every time you use your boat.**

### Transporting your Boat

A correctly selected trailer supports your boat properly, makes towing safer, and makes unloading and loading in varying weather conditions easier.

*Important: Improper trailering is one of the major causes for damage to the hull. The warranty does not cover damage of this type.*

**Note: Ensure all snap-in carpet has been rolled up and secured prior to moving to prevent carpet damage.**

The type and size of the side supports, or pads, are very important. Side supports run lengthwise to the boat and parallel to the keel. Side supports should only be tight enough to keep the boat from leaning side to side. Any unnecessary pressure will damage the hull. Newer trailers have self-adjusting side supports and a bow pad that can be easily adjusted. These eliminate the need for manually adjusting side supports and keel rollers every time you load your boat. Your Robalo dealer can help you select the best trailer for your boat.

Inspect your trailer regularly to make sure the side supports are in good working condition. Check bolts securing rollers and supports from time to time to make sure they are tight.

The trailer should be designed and built to carry the full weight of your boat, engine, and gear while providing support for the hull. Be sure not to overload your trailer by loading the boat with excess baggage, camping equipment, etc. Check the certification label on the frame of the trailer. It is required to show the gross vehicle weight rating. Be sure the total weight of your boat, engine, fuel, gear, and trailer does not exceed this rating. Make sure your towing vehicle has a hitch appropriate for the rating.

Distributing the weight on the trailer is important. Place the heaviest items at the bottom of the boat over a roller or chock, and secure them to keep them from shifting.

Balancing the load on the trailer is also important. If too much weight rests on the hitch, the towing vehicle will over steer, a condition that causes the front end of the vehicle to sway. Conversely, too little weight on the hitch causes the trailer to fishtail. In both cases, the vehicle will be difficult to handle and at higher speeds the swaying or fishtailing can become uncontrollable and result in personal injury and damage to the boat, trailer, or towing vehicle.

Weight on the hitch, or tongue weight, should be 5% to 10% of the total weight of the loaded trailer to avoid overloading the tow vehicle and to provide adequate pressure on the hitch ball. If the weight of the loaded trailer is 2000 pounds, the weight on the tongue should be between 100 and 200 pounds. A weight distributing hitch transfers portions of tongue weight to a point between the front and rear wheels of the towing vehicle and to the trailer wheels.



# 2019 ROBALO WALKAROUNDS

**Important: Bumper hitches are not safe and are illegal in many states.**

## **DISCLAIMER:**

**TOWING REGULATIONS REGARDING GROSS VEHICLE WEIGHT RATINGS VARY BY STATE AS WELL AS REQUIREMENTS FOR BRAKES. CHECK YOUR STATE REGULATIONS TO DETERMINE THE BRAKE REQUIREMENTS FOR YOUR BOAT, MOTOR AND TRAILER PACKAGE.**

**ROBALO ASSUMES NO LIABILITY FOR THE TRAILER REQUIREMENTS SPECIFIC TO YOUR STATE.**



**WARNING:** Improper towing can result in an accident causing personal injury and equipment damage. Become familiar with towing instructions in owner's manual and with warnings supplied with your trailer and towing vehicle. Ensure all snap-in carpet is stowed during trailering to avoid damage to carpets.

The brake system is usually completely self-contained on the trailer and no hook-up is required to the towing vehicle. Brakes are either drum or disc type. They work the same way as the brakes on a standard passenger vehicle, but the method of applying the brakes is different. Your Robalo or trailer dealer can explain how the brakes on your trailer work.

Make sure your boat is secure before towing it.

- Close all windows, hatches, and doors.
- Store equipment to keep it from shifting or falling.
- Remove and store convertible top if your boat is so equipped.

- Use a second safety chain to secure your boat's bow to the trailer tongue. Tie down the stern to the trailer.

Towing a boat requires extra caution by the vehicle's driver. Allow extra distance between vehicles. Obey speed limits. Some states have lower speed limits for vehicles with trailers. If you are traveling slower than other traffic, pull over when it is safe to do so and allow traffic to pass. As with all other aspects of owning and operating your boat, use common sense and good judgment.

If you do not have experience backing a trailer, practice before you get into a confined public or private launch site. Take your trailer to an open area and get accustomed to using it. If possible, take someone with you who knows how to back a trailer.

Steering a trailer while backing it up works the opposite of steering a car. If the trailer needs to go to the right, turn the steering wheel to the left and vice versa. Inexperienced backers tend to turn the wheel too far. Do not over steer. Turn the wheel gradually until you get the feel of safe backing.

## **Launching and Loading**

The handling of your boat and trailer at the ramp requires practice, skill and patience. With care and attention to the following tips, you can launch and relaunch your boat with relative ease.

**Important: Typically a beam of 8 feet 6 inches allows you to tow without a special permit in most places. These boats are considered "trailerable" for this reason. Other boats have wider beams and are still "trailerable," but, in most cases you need a permit to do so. Check with your state on permit requirements before towing.**

## **Roller Trailers – Launching and Loading**

# 2019 ROBALO WALKAROUNDS

**Robalo recommends you follow the trailer manufacturer's guidelines for launching and loading your boat.**



**WARNING:** If the winch handle slips out of your hand, let it spin. DO NOT try to stop it

## **Bunk or Custom Trailers – Launching**

Here are some tips to remember when you are putting your Robalo boat in the water:

***Important: Before launching your boat, make sure the transom drain plug is installed. If it is not installed, the bilge could fill with water quickly.***

1. Always prepare the boat for launching before you get to the ramp. Stop in a launching prep area near the ramp that doesn't block traffic and remove your tie-downs, tilt up your engine or drive unit, replace your transom drain plugs, etc.
2. Have someone at the ramp to give you directions. Slowly back the trailer down the ramp to the water. If there isn't a ramp available, use a solid area of ground to the shore, with a slope if possible. Avoid wet, soft sand. Always remember to launch your boat at a right angle to the shore.
3. Back the trailer down the ramp until there is enough water to make the boat float. Because the bunks generate more friction than rollers, you need to back the trailer further into the water.
4. Tie a mooring line to the boat so you will have control once it is floating.
5. Unfasten the boat bow safety chain. Hold the winch handle securely, reverse the winch lock and begin unwinding the line. Unwind it slowly and carefully.

6. On an average grade, the bunks on your trailer will allow your boat to gently slip back and float into the water. If your boat doesn't immediately move, try unwinding about six inches of line, lock your winch and give the boat a push. Then unlock the winch and try again. If this doesn't work, you might try backing the trailer deeper, if possible.
7. Care should be given when launching from trailers with bunks that are equipped with plastic-like materials. These materials make the bunk surfaces very slippery, and the boat may begin to unload as soon as tension is released on the winch cable/strap.

## **Bunk or Custom Trailers – Loading**

When loading, always prepare for the procedure prior to reaching the ramp. If the ramp is busy, preparation will shorten the time it takes for you to get your boat out of the water.

You probably won't have to back the trailer into the water as far to load the boat as you did to launch it. In fact, the easiest way is to back your trailer up until the rear of the bunks are in the water. By not putting your trailer too deep in the water, your boat will actually center itself on the bunks about 1/3 to 1/2 the distance onto the trailer.

Connect the winch cable/strap to the bow eye of the boat. Lock your winch before attempting to wind the cable/strap in. Once your boat is aligned and is pulled firmly against the winch stand roller or Vee block and your winch is in the locked position, connect the boat bow safety chain and you are ready to drive to the loading/preparation area near the ramp to connect all other tie-downs, lighting or electric brake connections, etc.

## **Common Cause of Boat Misalignment**

# 2019 ROBALO WALKAROUNDS

If your boat doesn't sit level in the water or your bunks or rollers are not adjusted properly, you may have misalignment problems with your boat when loading. Basic correction procedures are as follows:

## Correction Procedures

Re-measure all roller assemblies that set in a line across from each other. Make sure the distance to each roller from the centerline of the trailer is equal. In other words, the left side of your trailer should be exactly the same as the right side. This is true of bunk or roller trailers.

If your boat keeps going to the port (left) side, remove the boat and loosen the U-bolts and/or the through bolts that clamp the roller assemblies on the stern (back) section of the trailer. Force each assembly to the right as if you were trying to turn the handlebars of a bicycle. Hold each assembly in this turned position and retighten the U-bolts and/or through bolts.

This repositioning of the roller assemblies should correct the misalignment of the boat on your trailer. If your boat goes toward the starboard (right) side, reverse the procedure.

Another common reason for boats not centering themselves is putting the trailer too deep in the water, which does not allow the trailer adequate time to center the boat. This is especially true on roller style trailers.

**Note: Make sure your trailer is not too deep in the water or the boat will float over the rollers and be difficult to load and center.**

## Boarding Your Boat

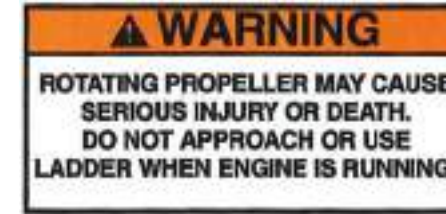

Larger pleasure boats remain stable under most operating conditions because of their beam, draft, and weight displacement. However, the U.S. Coast Guard does require that a capacity plate be affixed to all boats up to 20 feet long. This plate states the maximum load capacity. The plate shows persons and gear in pounds the boat will handle safely under normal conditions. The U.S. Coast Guard establishes these load capacity ratings. Overloading and improper distribution of weight are significant causes of accidents. Keep weight below maximum limits for safety in turbulent water.

***Important: The presence of the capacity plate does not relieve the boat operator from the responsibility of using common sense or sound judgment. Turbulent waters and adverse weather conditions reduce the maximum load capacity rating of the boat.***

When loading your gear on board your boat, remember to distribute the load evenly, keep the load low and do not overload. Always step onto the boat, never jump! Have someone on the dock pass your gear aboard. Secure all gear firmly so that it will not move or interfere with operation of the boat.

# 2019 ROBALO WALKAROUNDS

The way your passengers are seated and gear stowed in the boat affects your boat's performance. Passengers should board the boat one at a time and find a seat. Passengers should remain seated during loading of gear to maintain an even trim. Distribute your passengers and gear so that your boat is balanced side to side and front to rear (Figure 5.1)

As the operator, you are responsible for the safety of your passengers.

- **Do not** allow passengers to ride on the bow with feet hanging over the side.
- **Do not** allow passengers to ride sitting on the stern or gunwales. Falling from moving boats is a major cause of fatal recreational boating accidents.
- **Do not** allow passengers to sit in the bow rider area (if so equipped) while underway; doing so will obscure the operator's vision.

A shift in passenger weight changes the planing angle of the hull or the thrust of the propeller. This has the same effect on the boat as if the angle of the drive unit were changed. Minor deficiencies in your boat's ride can be quickly corrected by shifting passengers or gear forward or aft. By taking a little extra time to carefully place such gear as coolers, water jugs, tackle box, anchor, and tools, you create a more desirable trim. On planing-type boats, utilize stern loading in order to slightly raise the bow.



**Correct**

Balanced load: Gives maximum performance



**Incorrect**

Overload forward: Causes boat to plow



**Incorrect**

Overload aft: Causes boat to porpoise

**Figure 5.1 Boat Landing**

# 2019 ROBALO WALKAROUNDS

## Fueling

Improper fueling procedures are the most common cause of boat fires.



**DANGER:** Fuel leaking from any part of the fuel system can lead to fire and explosion that can cause serious bodily injury or death. Inspect systems before fueling.



**WARNING:** Do not smoke; extinguish all open flames, STOP engine and other devices that could cause sparks. Do not use electrical switches or accessories.

Ethanol-infused gasoline is widely available to today's boater. However, it may have harmful effects on marine engines and fuel delivery systems. Please refer to your engine manufacturer's owner's manual to find the recommended type and grade of fuel for your engine as well as a better understanding of the effects of ethanol on your engine.

Before fueling your boat, check the entire fuel system for leaks. Check for weakening, hardening, swelling, or corrosion of fuel system components. These include the fuel tank, fuel lines and fittings, fuel filter, and carburetor. Any sign of leakage or deterioration requires immediate replacement before further engine operation.

### Pre-Fueling Procedures

1. Safely and securely moor your boat to the dock.
2. Turn off engine and all electrical equipment including lights, bilge pump, bilge blower, etc.
3. Extinguish all cigarettes, cigars, pipes, or other items that may produce a spark or flame.

4. Close all hatches, windows, doors, and compartments.
5. Make sure a fire extinguisher is readily available.

### Fueling Procedures

1. Always fuel in an area which has sufficient lighting. Gasoline spills are hard to see when lighting is poor or it is dark.



**DANGER:** Fuel vapors are explosive and can become trapped within the lower portions of the boat. Close all hatches, windows, doors, and compartments while fueling your boat.

**Important:** *When fueling or having someone else fuel your boat, be sure the waste or water fill caps are not mistaken for the fuel fill cap. Also, make sure a fishing rod holder is not mistaken for a fuel fill plate.*

2. Your Robalo boat has fittings for filling the fuel tank on each side of the boat. Remove fuel fill plate. Insert the fuel supply nozzle. Allow nozzle to stay in contact with fitting to prevent possible static-produced sparks.
3. After pumping approximately 5 gallons of fuel into tank, inspect engine and fuel tank area for any signs of fuel leakage. Continue fueling if you do not detect any leaks or other problems.
4. Allow space at the top of the tank for thermal expansion. Do not over- fill tank so that fuel comes out fuel tank vent.

**Note:** Do not over fill tank, causing fuel to spill onto water.

5. If fuel cannot be pumped in at a reasonable rate, check for a plugged fuel vent plug or kink in the line.



# 2019 ROBALO WALKAROUNDS

## Post-Fueling Procedures

1. When you have finished fueling, replace fuel fill cap and wash off any fuel spillage around fuel fill area. Discard, in a safe place, any rags you may have used to wipe off fuel spills.
2. Open engine compartment and all hatches, windows, doors and compartments closed during fueling. Inspect these areas for fuel fumes or fuel line leakage visually and by smelling. Check out any sign of fuel leakage or any indication of fumes and correct problem before starting the engine.
3. Run bilge blower at least four minutes before restarting engine to ventilate engine compartment.

## Operating Your Boat



**DANGER: Carbon Monoxide Hazard!** A cold engine produces more carbon monoxide than a warm engine. Provide adequate ventilation in the cabin and cockpit to prevent exposure and reduce the possibility of carbon monoxide accumulation. Open all hatches, doors, windows, and side vents to increase air movement.

## Starting the Engine

**Important:** Falls from moving boats are a major cause of fatal recreational boating accidents. Do not allow passengers to ride on the bow with feet hanging over the side or ride while sitting on the stern, gunwales, or seat backs. The Coast Guard considers these acts to be negligent or grossly negligent operation and prohibits them by law.

The following information is only a general guide. Chapter 4 has specific starting instructions for boats with battery selector switches. Detailed

instructions are also in the engine owner's manual. Be sure to read and follow all of those instructions.

1. Secure boat to the dock or mooring slip before attempting to start engine. Keep boat secure until engine is running and warmed up.
2. Check lubricating fluid levels. Check fuel supply to make sure you have enough fuel for your planned excursion.
3. To prevent an explosion or fire, look for leaks in fuel, oil, coolant, exhaust, and power steering systems. Be aware of any odors of these fluids.
4. Make sure the throttle is in the neutral position.



**DANGER:** Gasoline vapors are highly explosive. Run bilge blower for at least 4 minutes before starting engine. Check engine and fuel compartments for fumes or accumulation of fuel

5. Start the engine. Refer to your engine owner's manual for recommended procedures for break-in, service, and other related operation.
6. Turn ignition key to START. Release key and allow to return to RUN after engine starts. If engine fails to start, wait one minute. Move throttle only once to maximum position then back to the neutral position. Try to start engine again.

**Note:** Transmission must be in neutral position before engine will turn over.

**Important:** Do not operate starter continuously for more than 15 seconds without pausing. Allow starter to cool at least three minutes between start attempts.



# 2019 ROBALO WALKAROUNDS

7. Warm up a cold engine by running it at fast idle speed (as recommended in engine manual) approximately one to two minutes.

## Leaving the Dock

After the engine has warmed up, you are ready to leave the dock. Before you cast off, check all gauges, particularly the oil pressure gauge, for proper readings. Check the operation of the steering by turning the steering wheel to full port and to full starboard while observing outdrive movement. Check that charging system is working properly. Check again for fuel, oil, and exhaust leaks.

When you are sure your boat is ready, check wind, tide, current or other forces that will affect the way you maneuver your boat away from the dock. Then cast off mooring lines and stow fenders.

Shift your boat's engine into forward or reverse depending on whether you want to move the bow or the stern away from the dock first. Move the throttle lever to neutral position. Then push forward quickly and firmly to shift into forward gear or backward to shift to reverse. Your engine should be running at a slow speed as you move away from the dock. If you move the bow out first, watch that the swim platform does not swing into the

## Getting Up to Cruising Speed

After slowly motoring from the dock area to open water, you can safely accelerate to cruising speed. Advance throttle to setting which provides your desired engine speed (RPMs). As you move the throttle forward, engine RPMs increase, and your boat moves faster through the water.

*Important: Acceleration at full throttle is not recommended during the engine "break-in period." This "break-in period" coincides with the engine "20-hour check-up." Do not attempt full throttle acceleration during the first 20 hours of operation.*

When you throttle up and accelerate, your boat increases the trim angle and causes the boat to ride bow-high. From a maximum angle, the boat levels out to its planing attitude as you continue to accelerate. (Figure 5.2)

The maximum angle is commonly known as the "hump." You should get over the hump as quickly as possible because visibility, handling, and performance are limited until you do. Only a few seconds at full throttle should be needed; however, the way your boat is loaded, the wind, and sea conditions affect the time required. When the boat gets over the hump, it reaches its planing attitude. Then, accelerate until your boat reaches a comfortable plane and then throttle down to cruising speed. This also provides for better fuel efficiency.

When maneuvering at low speeds you can reverse (move throttle forward or aft) the shift mechanism. This will react in a braking action.

Accelerate → Bow Rises → Planing Attitude



**CAUTION:** When shifting between forward and reverse, always pause in neutral for a few seconds before reversing the rotation of the propeller. This will prevent unnecessary damage to the drive system.



**CAUTION:** High speed acceleration in reverse can create a wake that could wash over the transom and flood the boat.

# 2019 ROBALO WALKAROUNDS

## Trimming Your Boat

Trim refers to the way a boat floats on the water. Your boat will work best when it is trimmed to run at an angle between 3 to 5 degrees to the water. You can trim your boat by shifting gear or passengers or, if your boat is so equipped, by adjusting the drive unit angle or the trim tabs.

## Power Trim

The operator can adjust his craft to the ideal boat angle for load and water conditions by trimming the drive unit (Figure 5.3). The power trim system allows the operator to adjust the drive angle while underway by changing the angle of the outdrive in relation to the boat's transom. It also allows the operator to raise and lower the drive for trailering, beaching, launching, or operating in shallow water.

**Note: Refer to your engine owner's manual regarding the operation of the power trim controls installed on your boat.**

## Drive Angle

The drive angle of the boat is the relationship between propeller thrust to the planing surface of the hull's bottom. You can improve the performance of the same boat under varying conditions by adjusting the drive angle.

Moving the drive unit angle towards its innermost adjustment brings the propeller in as close as possible to the transom. The angle of the propeller causes an upward thrust which pushes the boat's bow downward as shown on Figure 5.3.

By gradually shifting the drive unit from its innermost adjustment towards the outermost adjustment, the propeller thrust pushes in a downward motion. This motion, as shown in Figure 5.3, tends to lift the bow.

After reaching plane, under certain load conditions, your boat could have a tendency to bury its forward V-ed section. The boat will begin to plow and lose speed. If the water is choppy the boat will yaw. A boat will spin out if its bow is excessively buried. The only way to correct this situation is to increase the angle and swing the drive unit outward.

If the drive unit is angled out too far, your loaded boat will be sluggish in coming to plane. Once on plane, your boat will tend to porpoise. To correct this motion, move the propeller inward to decrease the angle between the drive shaft and the transom.



Correct  
Gives maximum performance



Incorrect  
Causes boat to "plow"



Incorrect  
Causes boat to "porpoise"

**Figure 5.3 Trimming the Drive Angle**

# 2019 ROBALO WALKAROUNDS

Very often, the optimum drive unit angle setting for the highest speed while carrying a light load will be just short of the porpoise point. However, such a setting is unsuitable when you have a heavy load or are pulling skiers. By reducing the drive angle, you will find it easier to maneuver the boat and to pull skiers to the surface.

## **Trim Tabs**

Trim tabs also help the operator trim the boat. Trim tabs are mounted on the port and starboard transom below the water line. The operator can control the trim tabs at the helm with rocker switches. (Figure 5.4) Pushing the switch activates the system which moves its tab up or down.

If the trim tabs are angled down, they cut into the water as it passes under the hull to force the stern up and the bow down (Figure 5.5).

Trim tabs also compensate for uneven loads in the boat by allowing the operator to trim up one side of the boat or the other.

## **Lenco retractor feature**

Lenco marine's trim tab retractor feature operates from either a 12v-24v signal or from an engine's analog tach signal. The purpose of the accessory signal input is to turn the trim tab control box on and off. When the control box is turned off, the trim tabs will retract.

## **Turn-on condition**

When the Lenco accessory input is connected to either a 12v-24v signal or an analog tach signal, the control box turns on and the trim tab becomes active. At this time the boat operator can run the trim tabs up or down.



**WARNING:** Excessive trim decreases maneuverability, changes steering characteristics, and may cause "porpoising" (bow oscillates up and down) or "chine walking" (rocking side to side). Use power trim with care.

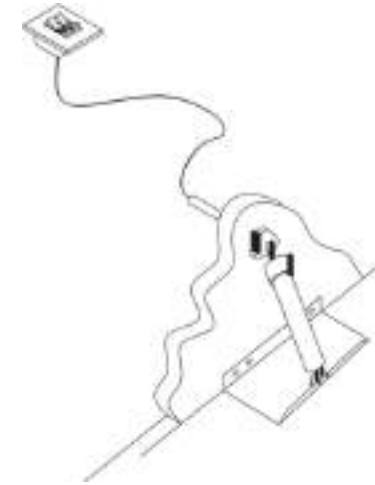

**Figure 5.4 Trim Tab and Switch**

## **Turn-off condition**

If the Lenco accessory input is connected to an analog tach signal, the control box will shut down when the tach signal is lost (i.e. engine stalls, stops). If the Lenco accessory input is connected to a 12v-24v source, the control box will shut down when the voltage source is removed.

## **Test mode**

Lenco marine's trim tab system includes a test mode feature that allows the boat operator to bypass the accessory input signal by holding down all four buttons on the key pad simultaneously for approximately three to four seconds. This will turn on the control box and allow the trim tabs to run up or down.

# 2019 ROBALO WALKAROUNDS

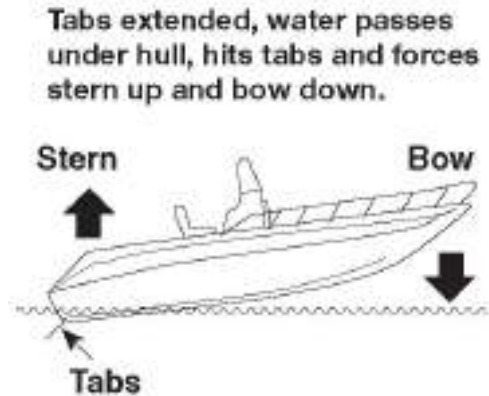

**Figure 5.5 Trim Tab Operation**

Once the control box is turned on in the test mode, the boat operator can turn the control box off by holding down all four buttons on the key pad simultaneously.

**Important:** If the control box is turned on in the test mode and subsequently receives a signal to turn it on via the accessory input, the boat operator cannot turn off the control box by holding down all four buttons on the key pad. The box will only turn off by removing the signal from the accessory input.

**Note:** Refer to your engine manufacturer's owner's manual for information concerning maintenance and operation.

## Stopping Your Boat

A boat has no brakes. Stop the boat by allowing it to slow down to less than 5 miles per hour and then putting the engine in reverse. Slowly increasing reverse power will allow you to stop the boat in a short distance. Remember that a boat does not respond to steering in reverse as well as it does when going forward.

## Additional Underway Information

- Always be aware of local laws on noise limits. Noise means engine noise, radio noise or even yelling by people on your boat. Good seamanship demands that you operate your boat quietly so as not to infringe on the rights of others. Don't use thru-hull exhaust unless you are well offshore



**WARNING:** Check behind you before coming OFF plane. Many accidents occur each year as a result of a driver coming off plane while being followed by a boat that is unable to slow down in time to avoid collision.

- You are responsible for any damage or injury caused by your boat's wake. Observe "No Wake" speed zone warnings. Operate your boat with regard for the safety of other boats and people in your boating area.
- Keep your engine well-tuned to decrease exhaust hydrocarbon emissions that pollute the air and water.

## Anchoring Your Boat



Anchoring is necessary if you stop for recreation or an emergency. Practice anchoring techniques to make sure you know what to do when an emergency occurs. The size and weight of your boat govern the weight of the anchor and the diameter of the anchor line. Your Robalo dealer can help you select the proper anchoring equipment for your boat.

# 2019 ROBALO WALKAROUNDS

---

Use a burying anchor, such as a Danforth or plow anchor, which grips into the bottom and holds your boat secure. Holding power should be more important than weight. For anchoring in relatively quiet waters, you can use a mushroom anchor as an alternative.

The length of the anchor line should be six to eight times the depth of the water to ensure that the anchor bites into the bottom. The bottom end of the anchor line should be galvanized chain which holds up well as the line moves back and forth on the bottom. The rest of the line should be nylon anchor line which stretches to soften the impact of wind and waves on your boat.

Following are general guidelines for anchoring your boat:

- Secure the anchor line to the bow eye or deck cleat. Do not tie line to hardware not designed to support this stress.
- Use two or more anchors if anchoring overnight or extended periods of time. Otherwise, make sure your boat has enough space to swing full circle in case of shifting winds.
- Keep the anchor and line in an area where it will be readily available in an emergency.

## Dropping Anchor

1. Have a crew member carefully lower anchor, keeping a slight tension on the line as the anchor drops. Maintain tension after the anchor reaches the bottom. Simply throwing the anchor overboard usually fouls the line and requires starting over.
2. Maneuver the boat backwards slowly until the proper length of line is run out.
3. Fasten the anchor line around the bow eye or deck cleat. Anchor fluke should dig into bottom and hold boat in position.



**WARNING:** Keep anchor secure while underway to prevent damage or injury if boat's attitude changes suddenly.

4. Check shoreline landmarks at the time anchor is dropped and check again 30 minutes later. If position has changed, anchor is dragging and must be reset.

## Weighing Anchor

Weighing, or pulling in the anchor, requires moving the boat in the direction of the anchor and pulling in the anchor as the boat moves. For this reason, the engines should be running. When the line is vertical, pull up firmly on the anchor line to free the flukes from the bottom. If the anchor remains stuck, feed out a few feet of line and attach it to the bow cleat. Maneuver the boat around the anchor, keeping the line taut, until you find an angle that will pull the anchor free.

## Docking Your Boat

***Important: When operating or docking in close quarters, maneuver your boat at idle speed. Proceed with caution in congested areas.***

As you approach the dock or other mooring area, slow down your boat in time to allow your wake to subside before it reaches other boats or docks. As you get close to the dock, check for wind or currents, and allow them to carry the boat toward the dock if you can. When approaching, check that lines are attached to the cleats on the mooring side and that fenders are lowered on that side. Be sure fenders are at the proper height. If you can, have one person at the stern and one person at the bow, each with a boat hook and a mooring line attached to a cleat. Never approach a dock at a speed at which you would not want to bump the dock.



# 2019 ROBALO WALKAROUNDS

To dock a boat to the starboard side:

1. Approach at an angle approximately 45 degrees to the dock.
2. When the bow is within a few feet of the dock, bring the stern alongside the dock by turning hard to port.
3. Turn to starboard and, at idle speed, put the engine in reverse to bring the stern closer to the dock.

Reverse these steps to dock to the port side

## Mooring Your Boat

When attaching mooring lines to deck cleats on your boat, make a loop in one end of the mooring line. Then, pass it through the hole in the base of the deck cleat. Next, pass the loop back over the deck cleat. The mooring line can now safely be used to secure your boat. Mooring lines may remain attached to the cleats on your boat while underway. The lines must be coiled and placed where they cannot get tangled in deck gear or the propellers.

When you tie up, run the mooring line from your boat around the dock cleat and then back to your boat. This enables you to untie the mooring line without leaving your boat. Just throw off one end of the mooring line and then bring the entire length of mooring line back into the boat (Figure 5.6).

## Shutting Down the Engine

Following are general instructions for engine shutdown. Refer to your engine owner's manual for specific instructions.

1. Allow engine to idle so engine cools gradually.
2. Turn engine off.

**Note:** Manila rope, the standard for many years is not as strong as some ropes made of synthetic materials. For mooring, its ability to stretch is an advantage, but it tends to shrink whenever it gets wet.

Nylon rope is strong and elastic. Because of its elasticity, it works well for mooring lines and anchor lines. Rope made of high tensile strength polyester fibers like Dacron™ is just about as strong as nylon rope, but it does not stretch. Kevlar rope is strong and does not stretch, but it is quite expensive. Polypropylene rope tends to deteriorate rapidly when it is exposed to sun light. Because it floats, it is well-suited for use as a tow rope for water skiing. Use for other nautical purposes is not recommended.

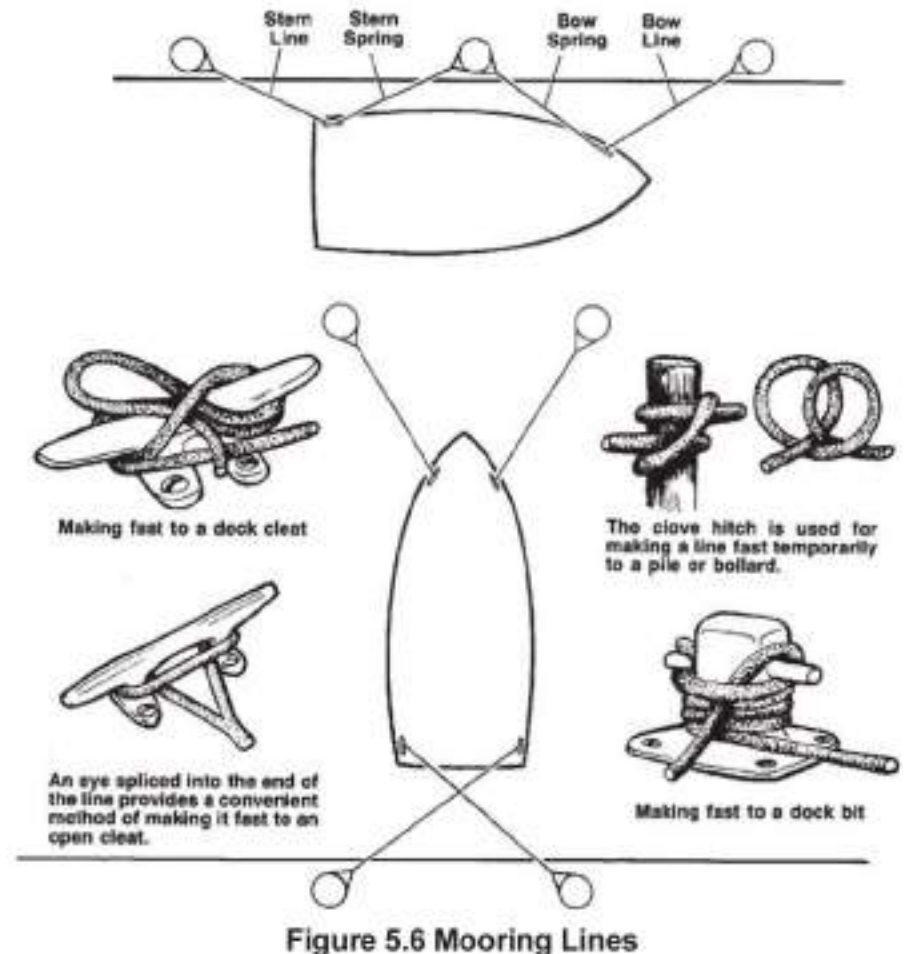

Figure 5.6 Mooring Lines



Do not attempt any repairs on your boat unless qualified to do so. Only use approved marine replacement parts available from your Robalo dealer. Robalo recommends having an authorized Robalo dealer do your maintenance and repair work. Your dealer is qualified to make repairs or modifications to your boat in such a manner as to not compromise safety, design integrity, or warranty coverage. This chapter includes information you can use to do general maintenance and repair. If you choose to do your boat's maintenance and repairs, always refer to the product manuals for detailed information.

### Engine

Refer to the engine owner's manual for detailed information about engine maintenance and repair. That manual has a maintenance and service schedule for the engine on your boat.

### Checking the Oil (On 4-Stroke Models)

**Note: During the engine 10-hour break-in period, or as recommended by the engine manufacturer, Robalo recommends that you check the oil level every two hours.**

To check the oil:

1. Make sure boat is in the water and engine is stopped.
2. Put the outboard motor in an upright position (not tilted).
3. If engine is warm, let it cool for ten minutes to allow oil to drain back into the engine oil pan. This will make the check more accurate.
4. Pull engine oil dipstick out of its sleeve, wipe clean, and push dipstick back into the sleeve. Make certain the dipstick is pushed all the way back in.
5. Pull dipstick out again and check oil level on dipstick. The oil level must be between the ADD and FULL marks on the dipstick.
6. If oil level is at or below the ADD mark you must add oil.
7. Push dipstick back down into the sleeve. Be sure it is all the way in and properly seated.

To add oil:

1. Remove oil fill cap from valve cover.
2. Add oil as required to raise the oil level up between the ADD and FULL marks on the dipstick. Do not overfill. One quart (0.95 liters) of oil will be required if oil level was at the ADD mark on the dipstick. Add more oil if oil level was below ADD mark on dipstick.
3. Check oil level after adding oil.

**Note: Robalo Boats recommends that you use a funnel when you add oil to prevent spillage and to help keep your engine free of surface grime and dirt.**

**Important: *The Federal Water Pollution Control Act prohibits the discharge of oil or oily waste into or upon the navigable waters of the United States or the waters of the contiguous zone if such discharge causes a film or sheen upon or a discoloration of the surface of the water or causes a sludge or emulsion beneath the surface of the water. Violators are subject to a penalty.***

### Fuel Filter



**WARNING:** Gasoline vapor explodes easily. Explosion is likely to cause fire and may burn you and damage your boat. Always STOP engine and do not smoke or allow open flames in area when changing filter.

Refer to your engine owner's manual for detailed information about checking and maintaining the fuel filter.

# 2019 ROBALO WALKAROUNDS

---

The engine exhaust system removes harmful gas created by the engine during combustion. Inspect the system for leaks before each use of the boat. Make sure all hose clamps and connections are tight and there are no cracks in any exhaust system component that would allow carbon monoxide gases to escape.

## **Tune Up**

Tune-ups at recommended intervals keep your engine in top-notch operating condition and help assure the highest possible performance from your engine.

**Note: Refer to your engine owner's manual for detailed information.**

## **Fuel System**

This information describes the fuel system excluding the engine. The fuel system provides a clean, continuous supply of fuel to the engine, in addition to helping prevent possible fire and explosion. All fuel systems installed at the Robalo factory meet federal requirements.

**Note: Refer to your engine owner's manual for detailed information about checking and maintaining the fuel system.**

The fuel system must be inspected frequently and maintained regularly. Check for leaks and/or vapors and repair any problems immediately. Keep fuel tank filled during the boating season to prevent moisture from condensing in the tank.

## **Monthly Inspection**

**Note: A trained marine mechanic should replace parts or repair the fuel system. See your Robalo dealer for parts and repair.**

1. Starting at the fuel tank, check the entire fuel system for leaks or vapors.
2. Check fuel lines and hoses for wear, kinks, cracks, or deterioration.
3. Inspect fuel line fittings, and fuel pump to make sure mounting brackets are tight.
4. Check fuel ventilation ducts and clamps for wear or damage.  
Refer to the engine owner's manual for recommended frequency for checking stern drive unit and its oil.

## **Outboard Drive Unit**

Refer to the engine owner's manual for recommended frequency for checking drive unit and its oil.

## **Propeller**

Note: Refer to the propeller manufacturer's manual for installation, removal, and further detailed information.

The propeller shipped with your boat is the size Robalo recommends for the best overall performance. However, factors such as altitude, temperature, load, bottom growth, and propeller condition can affect your boat's performance. Consult your Robalo dealer regarding your specific performance requirements.

Periodically check propeller for excessive wear and damage. Repair or replace, if required.

# 2019 ROBALO WALKAROUNDS

---

## **Steering System**

1. Check all hydraulic lines and hoses for leaks. Make sure no lines and hoses rub against other parts and or come into contact with any extremely hot parts. Tighten all fittings and clamps as required.
2. Check all bolts for tightness
3. Check the steering fluid level in the helm.
4. Replace any hoses showing signs of wear and remove the cause or re-route hoses.
5. Check fittings and seal locations for leaks, damage, and service as necessary

Consult your Robalo dealer regarding all repairs or replacement parts.

## **Bilge Inspection**

Check the bilge before you use your boat—every time! A small amount of water in the bilge is normal and not a cause for concern. If the amount of water is excessive, check for water leaks. Repair leaks immediately.

If the bilge is ever filled with fuel or oil, check engine, hoses, fuel tank(s), etc. for leaks. Repair immediately.

***Important: Pumping fuel or oil overboard into the water violates the Federal Clean Water Act. Pump into suitable container and dispose of properly.***

## **Cleaning**

Run bilge until pump is dry. Remove all sand, silt, dirt, or foreign material. Make sure all limber holes are open and strainers are clean. Use bilge cleaner to remove any obvious oil stains.

***Important: Never use any flammable solvents for cleaning the bilge. Check with your Robalo dealer for recommended cleaners.***



**WARNING:** Gasoline or vapors in bilge can explode. Remove all sources of ignition. Do not start engine, repair immediately.

## Interior and Exterior Care

The following information will help you keep the interior and exterior of your boat in tip-top shape. If you need more specific information, contact your Robalo dealer.

**Note:** Before you use a particular cleaning solution or method, test the material to be cleaned in a hidden or inconspicuous area for possible adverse reactions. Use cleaning agents sparingly. Never discharge cleaning solutions into the waterways. Do not use products containing phosphates, chlorine, solvents, or non-biodegradable or petroleum based products.

### Fiberglass and Gelcoat

The hull and deck are made of fiberglass. The outer layer of the hull and deck is a color pigmented polyester resin, called gelcoat. Gelcoat is highly resistant to scratches that occur during normal boat use. Nevertheless, during the life of your boat, some damage to the gelcoat is bound to occur.

### **Gelcoat Maintenance**

To remove and prevent the buildup of most salt, soil, and grime, clean the hull and deck regularly with household detergent and water.

**Note:** Make sure household detergent does not contain ammonia or chlorine. Because ammoniate or abrasive cleaners dull and discolor the gelcoat surface, they are not recommended for routine maintenance.

Gelcoat surfaces are very resistant to deep stains. To remove minor stains, wash the affected area with a soft cloth and household detergent. Then rinse thoroughly with clear water. If deep stains do occur, use a special fiberglass cleaner and stain remover.

Waxing the gelcoat surface regularly will help prevent soiling and preserve its luster. Robalo recommends a fiberglass wax that fills the gelcoat pores. Chemicals in fiberglass wax screen out harmful ultraviolet rays that cause fading of the gelcoat color.



**CAUTION:** Waxed gelcoat is slippery. Falls causing bodily injury or falls overboard are possible. Never wax deck surfaces that require sure footing.

### **Repairing Gelcoat Damage**

#### **Minor Scratches**

Repair minor scratches with automotive rubbing compound or polishing wax. Follow the manufacturer's instructions. Although the scratches may not disappear completely, they should not be as noticeable. Apply rubbing compound or polishing wax to a damp, soft cloth. Rub the gelcoat surface with the damp, soft cloth in a circular motion.

#### **Chips, Hairline Cracks, and Small Patches**

Your Robalo dealer has qualified personnel capable of making this type of repair.

Robalo uses the finest gelcoats and resins available to prevent gelcoat crazing and hairline cracks. Over time your boat may develop slight hairline cracks in the outermost gelcoat layer. These usually do not damage the structure of your boat or affect its integrity.

### **Hull Bottom Maintenance**

If your boat will be in water continuously for more than 60 days in any 90-day period, Robalo recommends sealing the hull bottom with a high quality barrier coating. Failure to do so will void your hull blister warranty. Your Robalo dealer can recommend the best barrier coating product for your boat.

# 2019 ROBALO WALKAROUNDS

Never use wire brushes, scouring pads, or other abrasive materials or solutions on the bottom surface of your boat. They cause small scratch marks that will collect dirt, silt, sand, marine growth and other foreign materials.

Keep the hull bottom of your boat clean. Check it regularly for any signs of excessive wear or damage. Make needed repairs to the hull bottom as soon as possible. Accumulation of natural coatings from water and marine growth can create drag and limit the efficiency of your boat.

## **Bottom Paint (Anti-Fouling)**

***Important: Consult your Robalo dealer for recommended bottom paints and local laws that govern your area. Many states regulate the chemical content of bottom paints to meet environmental standards and regulations.***

Anti-fouling bottom paint is designed to prevent marine growth by dissolving slowly. As a result, the bottom of your boat will usually need painting after the boating season. Some variables to consider when selecting a protective bottom paint are the water temperature, water pollution, salinity, current, and organic matter in the water. To protect and repaint the boat bottom, perform the following:

- Remove boat from water once a year. Scrub bottom with a soap and water solution and a bristled brush.

**Note: Repainting the bottom is not necessary each time the bottom is scrubbed, as long as no bare areas are visible in the bottom paint.**

- Sand entire bottom surface of the boat.
- Fair (smooth out) all rough areas as required.
- Clean bottom surface to remove all dust and foreign materials.
- Make sure bottom surface is completely dry.
- Apply new coat of bottom paint.

Allow new bottom paint to dry 24 to 36 hours. Never attempt to haul, paint, and launch on the same day.

## **Hardware and Fittings**

**Note: Always follow the manufacturer's recommendations found in your owner's packet for cleaning and maintaining deck hardware and fittings. These recommendations include the proper cleaning methods and cleaning agents.**

## **Inspection**

Inspect hardware and fittings to make sure they are tight. All screws, bolts, clamps, cleats, etc., should be secure.

## **Cleaning and Care**

- Always clean stainless steel frequently with soap and water. Any cleaner safe for glass is usually safe for stainless steel.
- Always remove rust spots as soon as possible with a brass, silver, or chrome cleaner. Irreversible pitting will develop under rust that remains on stainless steel for any period of time.
- Always use a cleaner, like a good car wax, for added beauty and protection.
- Never use coarse abrasives like sandpaper or steel wool on stainless steel. These may actually cause rusting.
- Never clean with mineral acids or bleaches.
- Never leave stainless steel in contact with iron, steel, or other metals which cause contamination leading to rust or corrosion.

## **Windshield and Portholes**

Clean windshield safety glass with a glass cleaner or ammonia water; then rinse with plenty of clear water.

***Important: Solvents can penetrate glass or porthole surfaces and cause hazing. Hazing obstructs visibility. Never use acetone, benzene, carbon tetrachloride, lacquer thinner or similar solvents to clean glass or portholes.***

The canvas or weather covering windows are made of a synthetic material. Wash any Plexiglass, clear vinyl or other synthetic materials with a mild detergent or dishwashing liquid and water solution, then rinse with plenty of clear water.

# 2019 ROBALO WALKAROUNDS

---

When stowing plastic or vinyl windows, be sure they are dry. Make sure the vinyl is rolled and not folded or creased. Store them in a bag that will breathe.

## **Seats Coverings and Vinyl**

Because seat coverings and trim are made of expandable vinyl, extreme temperatures have little effect on them.

**Note: Follow the manufacturer's recommendations for cleaning and seat covering and removing stains. These recommendations include the proper cleaning methods and cleaning agents.**

## **Care**

Place removable exterior cushions inside the boat when they are not in use.

## **Cleaning**

Remove stains as soon as possible to eliminate any possible reaction between the staining agent and the vinyl. Wipe away dirt and smudges with mild soap and warm water. If additional cleaning is required, scrub with a soft bristle brush to remove dirt from textured patterns. Dry with a soft, lint-free cloth or towel.

Follow manufacturer's instructions closely. NEVER use steel wool, powdered abrasive cleaners, or bleaches. They will mar the surface and leave an unsightly appearance. Never use bleaches or solvents of any kind on monogram parts. Use mild soap and water. Bleaches and solvents will cause monograms to fade.

To store cushions onboard boat for winter or extended periods of time, open zippers and elevate cover away from foam padding. Place a small rounded object (for example, a plastic bowl) inside to allow for air circulation.

## **Canvas (Weathering Coverings)**

The canvas, or weather coverings, is 100% acrylic yarn. Besides its resistance to mildew, rot and weather, canvas also resists industrial pollutants and the effects of ultraviolet light from the sun. Canvas is breathable and, therefore, is not waterproof. Mooring covers are waterproof.

## **Care**

- Keep the top up when boat is not in use or when it's raining.
- Never trailer your boat with the canvas up. None of the canvas or covers supplied with your boat were designed for the stress of highway speed trailering, and to do so may damage the canvas.
- Keep canvas clean. Acrylic fabric will not support mildew growth, but dirt and dust on the canvas will.
- Lubricate zippers with paraffin and snaps with petroleum jelly.
- If canvas or seams leak, apply a light coating of fluorocarbon based water repellent, or "303 High Tech Fabric Guard," available at most marine dealers.
- Allow all canvas to air dry before storing. Never store canvas damp or wet. Provide proper ventilation to limit the possibility of mildew.
- Avoid mooring under trees.
- Do not tow your boat with canvas attached to any hull or windshield mounted fasteners.
- Be careful not to scratch clear vinyl windows. Dry well before stowing. When stowing clear vinyl, make sure the vinyl is rolled and not creased.

## **Cleaning**

- Wet down all canvas material. Scrub with a soft bristle brush and a solution of mild soap and water. Never use a detergent or bleach on your canvas.
- Brush or sweep the underside of the top. Spray with Lysol or other disinfectant to prevent mildew.



This chapter tells you how to winterize and store your Robalo boat in regions where temperatures fall below freezing. If you keep your boat in an area not requiring winter storage, Robalo recommends you perform an annual inspection, similar to the preparation for storage as indicated in this chapter. With proper care, you will have many years of enjoyable boating with your Robalo boat.

### Lifting the Boat



**WARNING:** Lift slings may slip on the hull and result in serious injury or death from dropped load. Exercise extreme caution if in the vicinity of such activity. If possible, slings should be tied together before lifting.

Unless your boat is trailerable, have your dealer or qualified marina personnel lift your boat out of the water for you. Each boat has main frame components designed to support the boat when it is being lifted out of the water. Severe gelcoat crazing or more serious hull damage can occur if the lifting slings exert pressure on the gunwales. Flat, wide belting-type slings should be used. Don't use cable-type slings. The spreader bar at each sling should be as long as the distance across the widest point the sling surrounds.

- Never hoist the boat with more than a minimal amount of water in the bilge.
- Before lifting the boat, empty fuel and water tanks, especially if they have large capacities.
- Be sure to position slings as indicated by the diagrams in Chapter 3.
- Do not use deck cleats or bow or stern eyes for lifting the boat.
- Be sure boat remains level while being lifted to avoid sling movement or boat damage

- If using any boat lifting device other than slings, position lifting device so as not to put pressure on any underwater hull component including trim tabs.

### **Cradle**

A cradle is the ideal support for your boat whenever it is not in the water. Properly designed and located, the cradle will support the boat under the main frames. Support at these points is essential for preventing damage to the hull. Purchase a cradle from your dealer to ensure that your boat has the correct support.

### Dry Storage Preparation

**Note:** Refer to Chapter 7, Interior and Exterior Care, for specific cleaning solutions and procedures.

### **Deck**

- Wash the deck and walkway surfaces.
- Clean all deck hardware, and apply a coat of rust inhibitor.
- Clean the indoor/outdoor carpet.

### **Hull**

- Scrape off any barnacles or crusted marine growth.
- Scrub hull thoroughly to remove marine growth, scum and loose bottom paint.
- Inspect underwater gear and propeller for excessive wear or damage
- Apply fresh coat of bottom paint.
- Remove hull drain plug; store it in a safe place. Allow bilge water to drain, raise bow of boat during period of storage.

# 2019 ROBALO WALKAROUNDS

## **General Housekeeping**

- Clean boat interior including all cabinets.
- Lay all plastic cushions flat.
- Check for adequate air circulation around life jackets and other safety equipment left onboard.
- Clean and dry bilge. Remove any materials such as rags, sponges, or other cleaning material.
- Weather permitting, open all doors, hatches, portals, and windows to air out the interior for a day or two.
- If covering boat while in storage, use a cover constructed of fabric that allows for plenty of ventilation.

## **Systems and Components**

In regions where temperatures fall below freezing, winterization of the systems and components is necessary. Failure to do so will seriously damage them. They include, but are not limited to: generator, air conditioner, strainers, hot water heater, sump pump, Porta-Potti, head, holding tank, water tank, sewer system, and water systems. Refer to the owner's manual for each component or system listed above for detailed information on winterization.

**Note: Robalo strongly recommends having a qualified dealer perform winterization procedures for your boat.**

## **Engine**

**Important: In regions where temperatures fall below freezing, winterizing your engine is necessary. Failure to do so will seriously damage the engine. Refer to your engine owner's manual for detailed winterization information.**

Change engine oil before storing your boat. Refer to the instructions in your engine owner's manual.

## **Fuel System**

Add a gasoline stabilizer solution to the fuel tank. Follow the product manufacturer's recommended procedure.

## **Battery**

Remove battery from boat and store battery in a cool dry place away from freezing temperatures.



**WARNING:** Battery electrolyte can cause severe eye damage and burn your skin. Wear goggles, rubber gloves and a protective apron when working with battery. If electrolyte spills, wash the area with a solution of baking soda and water.

- Cover battery terminals with rubber or plastic caps to prevent accidental contact between battery posts and metal objects.
- Clean outside battery case, terminals, and battery clamps with a baking soda and water solution. Do not allow solution to enter battery cells.
- Clean battery posts and clamps with fine grit emery cloth. Use a light sanding motion when cleaning
- Apply a light coat of petroleum jelly to cover end of battery cables.
- Recharge battery monthly or trickle charge continuously while battery is stored.

# 2019 ROBALO WALKAROUNDS

---

## **Recommissioning**

**NOTE: For detailed information on recommissioning your boat's systems and equipment, refer to the owner's manual for each system or component.**

1. Inspect, visually and by smelling, the fuel system and all associated components for proper connections, wear, leaks, or other damage and needed repair.

***Important: Inspection of the fuel system at recommissioning is very important. We cannot overemphasize our concern for your safety.***

2. Clean battery terminal posts with wire brush or steel wool before reinstallation.
3. Check charge on battery. Recharge or replace if necessary.
4. Inspect all battery wiring. Repair or replace if necessary.
5. Attach battery cables, and tighten cable clamps.
6. Apply petroleum jelly or marine grade grease on battery posts and clamps to eliminate air pockets and possible acid buildups.
7. Reinstall hull drain plug after coating threads with petroleum jelly.
8. Clean bilge area.
9. Reinstall exhaust drain plug.
10. Inspect all exhaust connections to avoid exhaust and carbon monoxide (CO) leaks. Adjust as required.
11. Inspect all wiring for fraying, wear, loose connections, or other damage. Repair or replace, if necessary.
12. Test operation of navigation lights and other lighting onboard. Inspect all switches, controls, and other related equipment for proper operation. Repair or replace as necessary.
13. Inspect all life jackets, anchor lines, and other safety equipment for proper operation and physical condition. Repair or replace, if necessary.

**ROBALO BOATS LLC LIMITED WARRANTY  
2016 and Subsequent Model Years  
P. O. Box 928  
Nashville, GA 31639**

Upon delivery, owner shall complete the Limited Warranty Registration Card and return it to Robalo LLC, P. O. Drawer 928, Nashville, Georgia 31639 (“Robalo”) within fifteen (15) days of delivery of a new Robalo boat from an authorized Robalo dealer.

### DEFINITIONS OF TERMS CONTAINED IN THE LIMITED WARRANTY

Hull: The single molded fiberglass shell that rests in the water below the hull flange and its structural components consisting of the stringers and the transom

Structurally Defective: The presence of a defect in material or workmanship that causes the hull to be unsafe or unfit for use under normal operating conditions.

Original Purchaser: Consumer(s) who purchase a new Robalo boat, retail, from an authorized Robalo dealer.

Subsequent Purchaser: Purchaser(s) who acquire a used Robalo boat from the Original Purchaser, or an authorized Robalo dealer, as evidenced by a Bill of Sale and an Ownership Transfer Record completed by the original retail purchaser/ dealer.

Date of Delivery: The date that the new boat was actually delivered to the first retail purchaser.

Demonstrator Boat: An untitled /unregistered boat with 20 or more hours usage.

Fair Market Value: Defined by [www.nadaguides.com](http://www.nadaguides.com) “Average Retail” as of the date of the Owner’s claim.

### THE WARRANTIES

#### **ORIGINAL OWNER TEN YEAR LIMITED STRUCTURAL HULL WARRANTY**

Subject to the conditions, exclusions and limitations set forth below, Robalo warrants to only the *Original Purchaser* of a new Robalo boat that either Robalo or its authorized dealer will, at Robalo’s option, repair the fiberglass hull manufactured by Robalo if it is found to be Structurally Defective for a period of ten (10) years after the date of delivery. Robalo’s obligation to repair a hull is limited to the fair market value of the owner’s boat as of the date of the owner’s claim.

# 2019 ROBALO WALKAROUNDS

## TRANSFERABLE FIVE-YEAR LIMITED STRUCTURAL HULL WARRANTY

Subject to the conditions, exclusions and limitations set forth below, Robalo warrants to the first subsequent purchaser that Robalo, or its authorized dealer will, at Robalo's option, repair or replace the fiberglass hull manufactured by Robalo if it is found to be Structurally Defective within five (5) years after the date of delivery to the *original* retail purchaser. Robalo's obligation to repair or replace a hull is limited to the fair market value of the owner's boats as of the date of the owner's claim.

To register the above referenced transfers, the Subsequent Purchaser must mail the following to Robalo Warranty Transfer, P. O. Drawer 928, Nashville, GA 31639 no later than thirty (30) days after the purchase from the Original Purchaser:

- (1) An Ownership Transfer Record (included in the Owner's Manual) completed by the Original Purchaser and the Subsequent Purchaser;
- (2) A copy of the bill of sale or other evidence of purchase of the boat from the Original Purchaser, including the model and hull identification number; and,
- (3) The warranty transfer fee of \$500.00 for models less than 26 feet and \$1,000 for models 26 feet or greater.

## TRANSFERABLE ONE-YEAR LIMITED WARRANTY

Subject to the conditions and limitations to coverage and liability discussed below, Robalo warrants to the *original* and first subsequent purchaser who has registered the transfer with Robalo in the manner provided above under "TRANSFERABLE FIVE-YEAR LIMITED STRUCTURAL HULL WARRANTY", for a period of one year from the date of delivery to the *original* purchaser, that each new fiberglass boat manufactured by Robalo is free from defects in material and workmanship.

Please note that engines, outdrives, transom assemblies, controls, batteries, propellers, air conditioners, generators, refrigerators, certain electronics and certain other accessories or components on your boat are not warranted by Robalo under this Limited Warranty, but may be warranted by manufacturers other than Robalo. Please refer to the Robalo Owner's Packet to locate Owner's Manuals for these specific items and instructional information about possible warranties from manufacturers other than Robalo. Except as expressly set out herein, all warranties provided by the manufacturers and distributors of these accessories and components are hereby assigned to the owner, to the extent permitted by the accessory or component manufacturer, as the owner's sole and exclusive remedy with respect to such items. Please note that coverage under any of these other independent warranties is contingent upon your compliance with the warranty registration requirements of the manufacturer of such item.

## CONDITIONS TO COVERAGE

In addition to any other conditions to coverage contained herein, the responsibility of Robalo under each of the foregoing limited warranties is also subject to the following conditions:

- (1) The owner must first notify the dealer from whom the boat was purchased of any claim under this warranty within the applicable warranty period and within thirty (30) days after the defect is or should have been discovered.
- (2) All costs of any nature for delivering any boat to a Robalo dealer, the Robalo factory, or any other point of repair authorized by Robalo and the return thereof shall be paid by the boat owner and are not covered under this warranty. Such cost may include but are not necessarily limited to transportation, freight, haul-outs, blocking and storage.
- (3) All repairs, corrections or replacements shall be performed by Robalo or a dealer or repair facility authorized by Robalo at its sole discretion.

# 2019 ROBALO WALKAROUNDS

## DEALER RESPONSIBILITIES VS. FACTORY WARRANTY COVERAGE

Robalo Dealers are responsible for keeping inventory in new condition at all times prior to sale of the boat. Any damage that occurs to a boat in a dealer's inventory from weathering, theft, vandalism or failure to adequately protect the boat from environmental conditions will not be covered under any Robalo factory warranty.

### STATUTE OF LIMITATIONS

To the extent permitted by applicable State law, any lawsuit with respect to any breach of warranty claim seeking revocation of acceptance or rescission, whether express or implied, must be filed within one (1) year after the cause of action has occurred regardless of the time remaining in the warranty period under the Limited Warranty.

### LIMITATION OF COVERAGE FOR AGED INVENTORY

Robalo reserves the right to modify the warranty on any boat based on the amount of time the boat has remained in dealer inventory. Items that are affected by the passage of time may be voided from the warranty. Such items may include, but are not limited to cosmetic issues such as oxidation of gel, fading of plastics, deterioration of vinyl, deterioration of canvas, deterioration of isinglass, drying of rubber seals / caulking, and corrosion of metal parts. Component warranties may be limited based on availability of replacement parts.

Robalo applies the following policy so that customer's may fully understand the nature of their warranty prior to purchasing the boat:

<b>Invoice Date (to dealer)</b>	<b>Warranty Status</b>
< 2 years	Full Written Warranty Applies
2 to 3 years	Warranty based on inspection of boat condition. Warranty for cockpit upholstery, canvas, and gel coat <u>may</u> be limited. Cosmetic deterioration of powder coated, painted, and anodized surfaces is not warrantable.
3 to 5 year	Cockpit upholstery, canvas, and gel coat have no warranty. Other components normally covered by the One Year Warranty will be honored based on part availability.
> 5 years	Structural Hull Warranty Only

### LIMITATION OF COVERAGE FOR DEMONSTRATION MODELS PURCHASED FROM ROBALO DEALERS

Original retail purchaser(s), who otherwise comply with this Warranty Statement, receive the balance, as they exist at the time of purchase, of the Five-Year Transferable Limited Structural Hull Warranty and the One-Year Transferable Limited Warranty, only. The period of such limited warranties shall commence on the date the boat was first used for in-water demonstration purposes by the Dealer. ALL OTHER WARRANTIES ARE EXCLUDED. Warranty Transfer fees are waived for demonstrator boats.



# 2019 ROBALO WALKAROUNDS

## LIMITATION OF REMEDIES

- (1) Robalo's obligation under this warranty is limited to the cost of repair of the warranted item or replacement thereof, at Robalo's sole option, when returned prepaid to Robalo or other point of repair authorized by Robalo.
- (2) Robalo is not liable for loss of use, loss of time, inconvenience, economic loss, commercial loss or any consequential, incidental, general and/or special damages.
- (3) Robalo reserves the right to use refurbished, repaired, reconditioned, or remanufactured products or parts in the warranty repair or replacement process. Any such products and parts will be comparable in performance and function to the original part and shall only be warranted for the remainder of the original warranty period.
- (4) Decisions made by Robalo may be done so out of an abundance of customer goodwill. Accordingly, the acceptance of any returned product or part by Robalo shall not constitute an admission that the product or part is defective.
- (5) Any products that are replaced by Robalo become the property of Robalo.

## EXCLUSIONS

### THE LIMITED WARRANTIES SET FORTH ABOVE DO NOT COVER:

- 1) Any boat that has been subject to any type of repossession.
- 2) Any boat not purchased by an original retail purchaser, or a subsequent purchaser, as defined herein,
- 3) Any failure or defect resulting from normal wear and tear, climatic conditions, use under other than normal conditions or the lack of proper maintenance;
- 4) Any boat which has been powered or loaded in excess of the manufacturer's maximum horsepower and/or capacity recommendations;
- 5) Any boat used or once used for racing, boat clubs, yacht clubs, law enforcement, military, rental, charter or commercial purposes;
- 6) Any boat that has been subject to misuse, negligence, an accident, or structural modifications;
- 7) Plexiglas windscreen breakage, windshield breakage, windshield leakage,
- 8) Fuel gauges and fuel gauge systems, or fuel tanks;
- 9) Defects in paint or gel coat finishes including blisters below the waterline, cracking, crazing, or minor discoloration;
- 10) Defects in upholstery, canvas, vinyl, and other materials;
- 11) Damage, rot, mildew or other damage to upholstery, canvas, vinyl, carpet and other materials and components within the interior as a result of water damage including, without limitation, condensation or precipitation;
- 12) Installation of engines, or other parts or accessories installed by anyone other than Robalo;
- 13) Any boat that has been used after the discovery of a defect is or should have been discovered and such continued use causes additional or other damage to the boat; and
- 14) Except as described in the Limitations to Coverage above, any boat that has been used by the dealer for demonstration purposes.
- 15) Any defect or repair requiring redesign of the Boat, except pursuant to the recall provision of the United States Federal Boat Safety Act of 1971 or the recall laws of any other foreign jurisdiction.

# 2019 ROBALO WALKAROUNDS

---

- 16) Any Robalo boat acquired by a retail sales outlet from any sources other than the Robalo factory.
- 17) Damage, shrinkage, wear and tear, or deterioration of upholstery, carpet, graphics, and exterior canvas tops, enclosures, and weather covers (including rainwater leakage)
- 18) Rainwater leakage including rainwater leakage through canvas tops and enclosures.
- 19) Engines, controls, gauges, hard-top frames, T-top frames, batteries, propellers, air conditioners, generators, refrigerators, electronics and other accessories, components or other equipment which have been manufactured or purchased from other manufacturers, whether subject to a separate warranty or not, by such other manufacturers;
- 20) Estimates that relate to speed, fuel consumption, weight or statements made by any person other than Robalo Boats.
- 21) Any boat owned by anyone other than the original retail purchaser unless an Ownership Transfer Record has been properly filed with Robalo.
- 22) Electrolysis, galvanic corrosion, crevice corrosion or any other deterioration of underwater components.

## **TRANSFERABILITY OF COMPONENT MANUFACTURE'S WARRANTIES**

Engines, controls, batteries, propellers, air conditioners, generators, refrigerators, certain electronics and certain other accessories or components on your boat may be warranted by manufacturers other than Robalo. Please refer to the Robalo Owner's Packet to locate Owner's Manuals for these specific items and instructional information about possible warranties from manufacturers other than Robalo. Except as expressly set out herein, all warranties provided by the manufacturers and distributors of these accessories and components are hereby assigned to the owner, to the extent permitted by the accessory or component manufacturer, as the owner's sole and exclusive remedy with respect to such items. Please note that coverage under any of these other independent warranties is contingent upon your compliance with the warranty registration requirements of the manufacturer of such item.

**SOME STATES DO NOT ALLOW THE EXCLUSION OR LIMITATION OF INCIDENTAL OR CONSEQUENTIAL DAMAGES, SO THE FOREGOING LIMITATIONS OR EXCLUSIONS MAY NOT APPLY TO YOU.**

**OTHER THAN THOSE LIMITED WARRANTIES CONTAINED HEREIN, ROBALO MAKES NO OTHER WARRANTIES. ANY WARRANTY OF MERCHANTABILITY OR FITNESS FOR A PARTICULAR PURPOSE WITH RESPECT TO ANY COMPONENT OF THE BOAT IS LIMITED TO THE DURATION OF THE LIMITED WARRANTY APPLICABLE TO SUCH COMPONENT, AS SET FORTH ABOVE.**

**SOME STATES DO NOT ALLOW LIMITATIONS ON HOW LONG ANY IMPLIED WARRANTY LASTS, SO THE FOREGOING LIMITATION MAY NOT APPLY TO YOU.**

# 2019 ROBALO WALKAROUNDS

## OWNERSHIP TRANSFER RECORD

Please complete the following information and return to Robalo with the correct transfer fee amount and a copy of the bill of sale or other evidence of purchase within 30 days after purchase from the original retail purchaser. Certified Checks or money orders should be made payable to Robalo Boats.

\_\_\_\_\_  
**Current Owner**

\_\_\_\_\_  
**Transfer To**

\_\_\_\_\_  
**Address**

\_\_\_\_\_  
**Address**

\_\_\_\_\_  
**City, State, Zip**

\_\_\_\_\_  
**City, State, Zip**

\_\_\_\_\_  
**Hull Identification Number**

\_\_\_\_\_  
**Date of Sale**

\_\_\_\_\_  
**Signature**

\_\_\_\_\_  
**Signature**

To register the transfer, the second purchaser must mail the following to Robalo Warranty Transfer, P. O. Drawer 928, Nashville, GA 31639 no later than thirty (30) days after the purchase from the *original* purchaser: (1) An Ownership Transfer Record completed by the *original purchaser* and the subsequent owner; (2) A copy of the bill of sale or other evidence of purchase of the boat from the *original purchaser*, including the model and hull identification number; and, (3) the warranty transfer fee as follows:

- \$500 for any hull length less than 26 feet / \$1,000 for any hull length 26 feet or greater

Note transfer fees are waived for Dealer Demonstrator Boats.

Upon receipt of this transfer record the new owner shall receive the outstanding balance of the ONE-YEAR TRANSFERABLE LIMITED WARRANTY and the FIVE-YEAR TRANSFERABLE LIMITED STRUCTURAL HULL WARRANTY initiated by the original purchaser. Subsequent owner(s) to the original purchaser shall be responsible for a \$100.00 deductible per occurrence for any claim filed in accordance with the Robalo Limited Warranty Policy. Please refer to the Robalo Owner's Manual for detailed provisions concerning the Robalo Limited and Structural Warranty Policies. Robalo Boats LLC reserves the right to deny transfer of warranty to subsequent owners. Questions concerning the Robalo Warranty Policy should be submitted in writing to the Robalo Customer Service Office, P.O. Box 928, Nashville, GA 31639.