

2019 ROBALO CENTER CONSOLE

ROBALO

OWNER'S/OPERATORS MANUAL

P.O. DRAWER 928

300 INDUSTRIAL PARK BLVD.

NASHVILLE, GA 31639

PHONE: (229) 686-7481 FAX (229) 686-3660

This manual has been compiled to help you operate your boat with safety and pleasure. It contains details of the craft; typical equipment supplied or fitted its systems and information on its operation and maintenance. Please read it carefully and familiarize yourself with your boat before using it.

If this is your first boat, or you are changing to a new type, for your own comfort and safety please ensure that you obtain handling and operating experience before "assuming command" of the boat. Your dealer or national sailing federation or yacht club will be pleased to advise you of local sea schools or competent instructors.

Please keep this manual in a secure place and hand it over to the new owner when you sell the craft.

For a complete list of standard and optional features and equipment, consult your local Robalo dealer. Due to a policy of continual product improvement, specifications are subject to change without notice. The weights and volumes shown are estimated and can vary from boat to boat because of equipment, etc.

Robalo boats meet or exceed both NMMA and U.S. Coast Guard standards.

REV: July 2018

2019 ROBALO CENTER CONSOLE

Model Information

This manual contains information on the following models:

- R160
- R180
- R200
- R202EX
- R222
- R222EX
- R242
- R242EX
- R272
- R302



ROBALO

The information refers to standards and options available for the 2019 model year.

Thank you for selecting a Robalo Center Console!

2019 ROBALO CENTER CONSOLE

Table of Contents

Model Information	i	Bilge Pump	44
(1) Introduction	1	Running and Navigation Lights.....	44
Welcome Aboard	1	Docking Lights	45
About This Manual.....	1	Underwater Lights	45
Construction and Standards	2	Stereo Sound System.....	45
Responsibilities.....	4	Transom Shower.....	45
Laws and Regulations.....	5	Fire Extinguishers	45
Owner's Logs and Records	6	(5) Underway	46
Warranty Policy Transfer	6	Transporting Your Boat.....	46
Customer Satisfaction.....	7	Launching and Loading.....	48
Boat Data Record.....	8	Boarding Your Boat	49
Fuel Usage Chart.....	9	Swim Platform and Boarding Ladder.....	50
Travel Plan Log.....	10	Fueling.....	63
(2) Boating Safety	11	Operating Your Boat.....	64
Hazard Communication	15	Trim Tabs.....	67
Safety Recommendations.....	15	Anchoring Your Boat.....	68
Safety Equipment	18	Mooring Your Boat.....	70
Running and Navigation Lights	19	Shutting Down the Engine	70
Safety Afloat.....	19	(6) Preventive Maintenance and Repair	71
Checklist.....	25	Engine.....	71
Water Sports.....	26	Tune Up	72
(3) Systems	29	Fuel System.....	72
Electrical Systems	29	Monthly Inspection	72
Fuel Systems.....	32	Outboard Drive Unit.....	72
Marine Sanitation Devices	33	Propeller.....	72
(4) Components	42	Steering System.....	73
Dashboard and Instrument Panel.....	42	Bilge.....	73
Windlass System.....	43	(7) Interior and Exterior Care	74
Hydraulic Steering System	43	Fiberglass and Gelcoat.....	74
Multifunction Navigation Display System.....	43	Hull Bottom Maintenance	75
Throttle.....	44	Bottom Paint (Anti-Fouling)	75
Controls	44	Hardware and Fittings.....	75
Power Trim	44	Windshield and Portholes.....	76

2019 ROBALO CENTER CONSOLE

Carpet.....	76
Seat Coverings and Vinyl.....	76
Canvas (Weather Coverings).....	77
(8) Winterizing and Storage	78
Lifting the Boat.....	78
Dry Storage Preparation.....	78
Systems and Components.....	79
Engine	79
Fuel System.....	79
Battery	79
Recommissioning.....	80
(9) Warranty.....	81

INTRODUCTION

WELCOME ABOARD

Congratulations!....

on your wise decision to purchase a Robalo boat. We welcome you to the family of thousands of other Robalo boat owners. Since your boat is a substantial investment, we are sure you selected your Robalo because of its value, style, comfort, and performance. This manual contains valuable information concerning your boat's operation, maintenance, and care, plus tips on boating safety and seamanship.

ABOUT THIS MANUAL

More and more people are joining the ranks of boat owners. This manual is written for the first-time boat owner or operator. Even if you are an experienced boater, you will find much valuable information regarding the safe operation and maintenance of your new Robalo boat. Keep this manual on your boat for ready reference.

Due to our policy of continuous product improvement, the illustrations used in this manual may not be identical to the components, controls, gauges, etc. on your boat, as they are intended to be representative reference views. Some controls, indicators, or information may be optional and not included on your boat model.

The precautions in this manual cannot and do not cover every boating situation. If a specific method or procedure is not covered, you must make sure that what you do is safe for you and others. Always use common sense when boating! Remember, too, that every safe boating excursion is a happy experience.

This manual is part of your boat's equipment. Print a copy and keep it on board the boat at all times. If you transfer ownership of this boat to someone else, be sure to give this manual to the new owner.

Your owner's packet contains the manual for the boat selected. Also, in this packet are instruction manuals from the suppliers of standard and optional equipment for your boat. Examples of these manuals include the engine, electrical equipment, pumps, and cabin amenities. The suppliers of these products maintain their own manufacturer's warranty and service facilities. Be sure to fill out each warranty card and mail it to the manufacturer to validate the warrant. Record all information regarding these products on the "Boat Data Record." A copy of this form is near the end of this chapter under Logs and Records.

Important: keep the complete Boat Data Record in a safe place at home. Do not keep it aboard the boat.

Read this manual as well as the manuals for the systems and components on your Robalo boat. They provide the information needed for safe operation and proper maintenance. The information in the manuals provided by the manufacturers takes precedence over any information in this manual if there is a conflict.

Following are summaries of each chapter in this manual:

1. Introduction

Included in this chapter is a summary of the manual plus general information about construction and standards, dealer and owner responsibilities, laws and regulations, logs and records, and the warranty for your boat.

2. Boating Safety

This chapter discusses potential hazards associated with boating, safety recommendations, safety information and practices, and water sports safety. It also discusses safety equipment needed to provide a safe operating system.

2019 ROBALO CENTER CONSOLE

Note: For your safety, this manual has specific safety warnings and comments where appropriate. Be sure to read the entire manual.

3. Systems

Here you will find detailed information about the electrical and fuel systems needed to operate your boat. This chapter discusses the fresh water system and marine sanitation devices which make your boating experience more comfortable.

4. Components

Standard features and optional equipment for your Robalo boat are discussed in this chapter. In general, these pertain to equipment and amenities which make your boat a “home away from home.”

5. Underway

The intent of this chapter is to explain what you need to do before, during, and after your boating excursion to make it an enjoyable and safe experience.

6. Preventive Maintenance and Repairs

Preventive maintenance is the key to trouble-free operation and helps protect your investment. This chapter explains what you should do to maintain your boat and how to make adjustments and repairs.

7. Interior and Exterior Care

This chapter tells you how to inspect, clean, and maintain your boat’s interior and exterior.

8. Winterizing and Storage

What do you do when you need to winterize or store your boat for extended periods of time? This chapter provides the necessary information.

CONSTRUCTION AND STANDARDS

All Robalo boats meet or exceed the construction standards set by the U.S. Coast Guard, the National Marine Manufacturers Association (NMMA), and the American Boat and Yacht Council (ABYC) concerning

- Navigation Lights
- Factory installed fuel systems
- Engine and fuel tank compartment ventilation
- Flotation
- Steering systems
- Backfire flame arresters
- Wiring specifications

NMMA certification means that the boat complies with applicable federal regulations set forth by the U.S. Coast Guard. These regulations are based on American Boat and Yacht Council (ABYC) standards and recommended practices.

Most Robalo models can be certified to carry the CE mark. The CE mark certifies that the boat meets relevant parts of the European Directive for Recreational Craft 94/25/EC of the European Parliament, including the International Organization for Standards (ISO) and Recreational Marine Agreement Group (RMAG) guidelines in effect at the time of manufacture.

We recommend that you see your dealer if you wish to modify factory-installed equipment or add new equipment. Your dealer is qualified to make such modifications or additions without placing the safety or design integrity of your boat at risk and without invalidating the warranty. Robalo builds exceptionally high quality boats. We offer numerous extras you won’t see at a boat show. We’ve created a list for your review.

2019 ROBALO CENTER CONSOLE

Gelcoat

The advanced technology polyester we use offers superior weathering resistance to surface yellowing and chalking. It will also help protect and maintain the original glossy luster of your boat's finish. Robalo uses a premium quality gelcoat which offers improved flexibility over other gelcoats, minimizing the potential for cracking.

Resin

It's an age-old problem. Water penetrates the gelcoat and blisters the bottom. The key is the resin. To cut costs, most use a general purpose resin. Robalo uses a premium quality resin in the hull skin coat of every boat in our line because of its superior bonding characteristics and exceptional flex.

Loom Wrap Wiring

Attention to rigging detail is a Robalo hallmark. Instead of routing the engine wiring harness haphazardly in the bilge in black tape, we rely on automotive style flexguard loom that not only keeps things neat but also protects against abrasion.

Through Bolted Stainless Steel Cleats

It's one of the most often used components on your boat, but most people think a cleat is a cleat, right? Wrong. Robalo's cleats are stainless steel so they won't corrode and so they won't twist. Also, ours are big enough to accept a full-sized looped line.

Heavy Duty Rub Rail

A rub rail is supposed to protect your boat. Robalo uses a heavy-duty PVC rub rail with stainless steel insert that absorbs far more impact without denting.

Acrylic Tops

Ours are acrylic because it's a superior material that won't crack, peel, or mildew. Further, our acrylic tops won't shrink or expand, which means they look and fit better in all weather conditions.

Stain Resistant Fabrics

Accidents happen. Spilled drinks, wet bathing suits and soggy towels are a fact of life on a boat. All our cabin fabrics are stain resistant. Buyers can choose from a wide variety of colors. When it comes to interior fabrics, we have the one that's right for you.

Superior Plastics vs. Wood

Robalo prides itself on building seats that are not only comfortable, but durable. We use plastic seats because they hold their shape and don't retain water, reducing the potential for foam deterioration.

Flotation Requirements

All Robalo boats meet or exceed U.S. Coast Guard requirements for flotation.

Additional Requirements

All Robalo boats also meet or exceed U.S. Coast Guard requirements for the following:

- Engine and Fuel Tank Compartment Ventilation (requirements for flame arresting devices)
- Factory-Installed Fuel Systems
- Navigation Lights
- Steering System
- Wiring Specifications

2019 ROBALO CENTER CONSOLE

RESPONSIBILITIES

Robalo's quality service does not end when you buy one of our boats. Through our dealer network we do everything possible to ensure that you are satisfied with your purchase. Every Robalo dealer has a responsibility to you, the boater.

Dealer

Dealer responsibilities include the following:

1. Discuss with you the terms of all warranties and stress the importance of registering warranties with the appropriate manufacturers.
2. Explain how you can obtain warranty service.
3. Complete new boat and pre-delivery inspection procedures. Sign the form to certify that all items were completed.

Your Robalo dealer can provide you with thorough instruction in the operation of your boat. Please feel free to ask for assistance.

Boat Owner

Your responsibilities include the following:

1. Read this manual as well as all other manuals and information included in your owner's packet.
2. Schedule an appointment with your dealer to go over all warranties. Keep a record of the hull number for future reference.
3. Inspect the boat at the time of delivery to make sure all systems and components are operating properly. Robalo recommends that you refer to your engine warranty for initial inspection and service requirements.

The new boat and pre-delivery inspection form (found towards the back of this chapter) will help you as you inspect your new boat. After completing your inspection, sign the form to certify you have inspected the boat with your dealer.

4. Schedule an appointment with your dealer to go over the pre-delivery engine service record. Sign this record to indicate your dealer has explained this record to you.
5. Operate all equipment in accordance with the manufacturer's instructions.
6. Become familiar with all federal, state, and local laws affecting your boat and its operation.
7. Perform or provide for the appropriate periodic maintenance outlined in the manuals and service guides.

2019 ROBALO CENTER CONSOLE

LAWS AND REGULATIONS

This section of the manual includes general information about government regulations. You, the boater, are responsible for complying with the requirements of federal, state, and local laws. If you have any questions, contact the U.S. Coast Guard or other appropriate authority.

Boat Registration

Federal and state laws require that every boat having propulsion machinery of any type must be registered in the main state of usage. Registration numbers and validation stickers must be displayed on the boat according to regulations. The registration certificate must be carried on board when the boat is in use.

Safety Equipment

The following equipment is required on all boats:

- Display of Registration Numbers
- Fire extinguishers
- Personal flotation devices (PFD's)
- Navigation lights
- Visual distress signal
- Sound signaling device

See Chapter 2 for more information about safety equipment.

Discharge of Oil

The Federal Water Pollution Control Act prohibits the discharge of oil or oily waste into or upon the navigable water of the United States or the waters of the contiguous zone if such discharge cause a film or sheen upon, or a discoloration of, the surface of the water or causes a sludge or emulsion beneath the surface of the water. Violators are subject to a penalty.

Disposal of Plastics and Other Garbage

Plastic refuse dumped in the water can kill fish and marine wildlife and can foul vessel propellers and cooling water intakes. Other forms of waterborne garbage can litter beaches and cause illness. U.S. Coast Guard regulations therefore strictly prohibit dumping plastic refuse or other garbage mixed with plastic into the water anywhere. Further, the regulations restrict the dumping of other forms of garbage within 12 miles from shore on the east coast, and 9 miles from shore on the west coast.

Within 3 miles of shore and in U.S. lakes, rivers, bays, and sounds, it is illegal to dump plastic, dunnage, lining, and packing materials that float; and any garbage except dishwater, gray water, and fresh fish parts.

Between 3 and 12 miles it is illegal to dump plastic, dunnage, lining, and packing materials that float; and any garbage not ground to less than one square inch.

Between 12 and 25 miles it is illegal to dump plastic, dunnage, lining, and packing materials that float.

Beyond 25 miles it is illegal to dump plastic.

The U.S. Coast Guard has issued these regulations to implement Annex of the International Convention for the Prevention of Pollution from Ships, 1973, commonly known as Annex V of the MARPOL (Marine Pollution) Treaty 73/78. They apply to all U.S. vessels wherever they operate (except waters under the exclusive jurisdiction of a state), and foreign vessels operating in U.S. waters out to and including the Exclusive Economic Zone (200 miles).

If your boat is 26 feet or more in length, the regulations require U.S. recreational boaters attach one or more Coast Guard Trash dumping Restrictions placards to your boat. The placard warns against the discharge of plastic and other garbage with U.S. navigable waters and specifies discharge restrictions beyond the territorial sea (generally within 3 or more nautical miles of shore).

2019 ROBALO CENTER CONSOLE

The placard must also contain the warning that a person violating these requirements is liable for civil and criminal penalties. The placard must also state that local regulations may further restrict the discharge of garbage. You may purchase these placards from local marinas, boat dealers, or marine equipment suppliers.

The U.S. Coast Guard has also issued regulations requiring boats to have sanitation system on board to control pollution. Wastes are to be stored in a holding tank or other device, such as Porta-Potti, until the device can be pumped out or otherwise disposed of at a shore facility. Discharging this waste overboard is in most cases prohibited. Check with the Coast Guard regarding regulations in your area.

OWNER'S LOGS AND RECORDS

At the end of this chapter are three (3) forms which you will find very helpful.

Use the **Boat Data Record** to record all important information about your boat and the major components installed. Print a copy and after you have entered all the data, store it in a safe place. **Do not keep this form aboard your boat.**

The **Travel Plan Log** provides a record of your destination, departure and return times, boat description, passenger list, and other information about the trip you have planned. At the bottom of the form is space for listing emergency telephone numbers in case your return is delayed past the expected time. It also has space for indicating information about the person filling this report. Leave the completed form ashore with a responsible person. We recommend you print several copies of this form each boating season to ensure an ample supply.

The **Fuel Usage Chart** is a handy way to record information covering engine hours, fuel consumption, miles traveled, as well as RPM (revolutions per minute), Average MPH (miles per hour), and GPH (gallons per hour).

WARRANTY POLICY TRANSFER

Your Robalo boat is backed by a Limited Express Warranty. It is important that you are aware of its terms. If a problem arises with your Robalo boat as a result of workmanship or materials, contact your dealer as soon as possible to determine whether correcting the problem may be covered by the warranty. Please have your hull identification number and necessary model numbers on hand for the items that may need service or repair. Your hull identification number is below the rub rail on the starboard aft corner of your boat.

The Robalo Limited Warranty Policy may be transferred to subsequent owner(s) providing the Ownership Transfer Record (OTR) is completed and returned to the Robalo Customer Service Office. The OTR is located after the Robalo Limited Warranty Policy in Section 11. Subsequent owner(s) will receive the balance of warranty available subject to a \$100.00 deductible per occurrence for claims filed in accordance with the Robalo Limited Warranty Policy. The Ownership Transfer fee varies depending on the boat model and size. See the Robalo Ownership Transfer Record for details and associated fees. YOU are responsible for your safety and your boat, as well as the safety of passengers and other boaters.

2019 ROBALO CENTER CONSOLE

Boat Data Record

Purchase Dealership		Service Dealership	
Name _____	Sales Manager _____	Name _____	Service Manager _____
Address _____	Phone _____	Address _____	Phone _____
_____	Fax _____	_____	Fax _____

General	Drive Unit	Notes
Model Name _____ State of Registration _____	Serial Number _____	
Hull Identification Number _____	Fuel System	
Boat Name _____	Tank Capacity _____	
Hull Color(s) _____	Fresh Water	
Length _____ Beam _____ Weight _____	Tank Capacity _____	
Draft (Drive Down) _____ Draft (Drive Up) _____	Propeller	
Engine	Manufacturer _____ Pitch _____	
Manufacturer _____ Model Name/Number _____	Model Number _____	
Oil Type/SAE _____ Quarts _____ Filter Type _____	Battery	
Serial Number _____ Transom Plate Serial Number _____	Manufacturer _____	
	Model Number _____	

2019 ROBALO CENTER CONSOLE

TRAVEL PLAN LOG

The boat listed below should return by:
 _____ at the latest.
 Date Time

If it has not, please call the emergency numbers listed at the right.

Police _____
 Coast Guard _____
 Other Authority _____
 Personal _____

Trip Information

Departure Date/Time _____ Departure Location _____
 Return Date/Time _____ Return Location _____

Boat Description

Boat Name _____ Type _____
 Registration Number _____ Manufacturer _____
 Length _____
 Hull Color _____ Deck Color _____
 Cabin Color _____ Trim Color _____

Other Physical Characteristics _____

Engine

Type _____ Horsepower _____
 Fuel Type _____ Fuel Capacity _____

Safety & Emergency Equipment YES/NO & NUMBER

Life Jackets _____ Cushions _____ Distress Light _____
 Flares _____ Smoke Signals _____ Flash Light _____
 Mirror _____ Paddles _____ Anchor _____
 Food _____ Water _____ Life Raft _____

Radio

Onboard (Yes/No) _____ Type _____

Frequencies usually used or monitored. _____

Passenger List (Use another sheet if necessary)

Full Name _____
 Age/Sex _____ Phone Number _____
 Complete Address _____
 Full Name _____
 Age/Sex _____ Phone Number _____
 Complete Address _____
 Full Name _____
 Age/Sex _____ Phone Number _____
 Complete Address _____
 Full Name _____
 Age/Sex _____ Phone Number _____
 Complete Address _____

ALWAYS FILL THIS SHEET OUT COMPLETELY—IN AN EMERGENCY ALL INFORMATION MAY BE HELPFUL

Safety Label Information

The following pages include *general* label information found on the boat.

2019 ROBALO CENTER CONSOLE

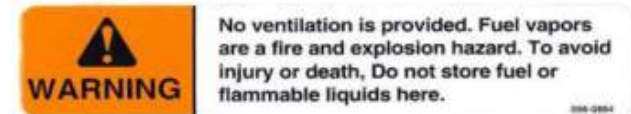
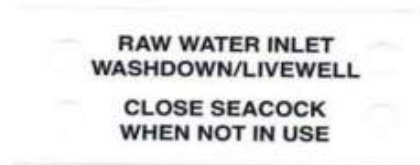
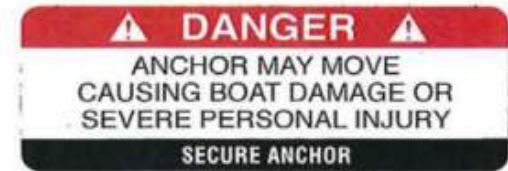
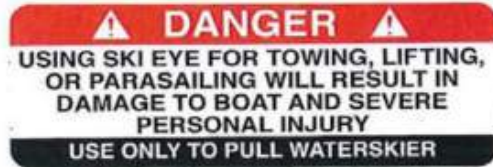

2019 ROBALO CENTER CONSOLE

⚠ DANGER ⚠

CARBON MONOXIDE IS PRODUCED BY ALL GASOLINE ENGINES AND GENERATOR SETS. AVOID BRAIN DAMAGE OR DEATH FROM CARBON MONOXIDE. KEEP COCKPIT AND CABIN AREAS WELL VENTILATED. AVOID BLOCKAGE OF EXHAUST OUTLETS. SIGNS OF EXPOSURE INCLUDE NAUSEA, DIZZINESS, AND DROWSINESS. SEE BOAT OWNER'S MANUAL FOR MORE DETAILS.

USING SWIM PLATFORM WHILE ENGINE IS RUNNING CAN RESULT IN SEVERE PERSONAL INJURY. TURN OFF ENGINE BEFORE USING LADDER OR PLATFORM.

⚠ WARNING ⚠

THE OPERATOR OF THIS VESSEL IS RESPONSIBLE FOR THE ACTIONS OF PERSONS IN AND AROUND THIS VESSEL. SAFETY IS THE OPERATOR'S RESPONSIBILITY.

USING SWIM PLATFORM, FORWARD DECK, OR SUN DECK WHILE BOAT IS UNDERWAY COULD RESULT IN SEVERE PERSONAL INJURY. STOP BOAT AND TURN OFF ENGINES BEFORE USING.

AVOID SERIOUS OR FATAL INJURY DUE TO ROTATION OF SEAT. LOCK SWIVEL WHEN SPEED EXCEEDS 5 M.P.H.

INTERRUPT SWITCH MUST BE ATTACHED TO OPERATOR WHILE ENGINE IS RUNNING. QUALIFIED OPERATOR MUST BE IN CONTROL AT ALL TIMES. READ OWNER'S MANUAL BEFORE USE.

BOATMAN'S CHECK LIST

- For maximum enjoyment and safety, check each of these items BEFORE you start your engine:
- ✓ DRAIN PLUG (Securely in place?)
 - ✓ LIFE-SAVING DEVICES (One for every person on board?)
 - ✓ STEERING SYSTEM (Working smoothly and properly?)
 - ✓ FUEL SYSTEM (Adequate fuel? Leaks? Fumes?)
 - ✓ BATTERY (Fully charged? Cable terminals clean and tight?)
 - ✓ ENGINE (In neutral?)
 - ✓ CAPACITY PLATE (Are you overloaded or overpowered?)
 - ✓ WEATHER CONDITIONS (Safe to go out?)
 - ✓ ELECTRICAL EQUIPMENT (Lights, horn, pump, etc.?)
 - ✓ EMERGENCY GEAR (Fire extinguisher, bailer, paddle, anchor & line, signaling device, tool kit, etc.?)

⚠ DANGER



Carbon monoxide (CO) can cause brain damage or death.

Engine and generator exhaust contains odorless and colorless carbon monoxide gas.

Carbon monoxide will be around the back of the boat when engines or generators are running.

Move to fresh air, if you feel nausea, headache, dizziness, or drowsiness.

REV-206-16

⚠ WARNING

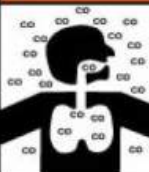

Carbon monoxide (CO) can cause brain damage or death.

Engine and generator exhaust contains odorless and colorless carbon monoxide gas.

Get fresh air if anyone shows signs of carbon monoxide poisoning.

Signs of carbon monoxide poisoning include nausea, headache, dizziness, drowsiness, and lack of consciousness.

See Owner's Manual for information regarding carbon monoxide poisoning.

⚠ WARNING

Wet decks are slippery.

You can be seriously injured if you slip and fall.

Wear slip resistant footwear secured to your feet and hold on to rails or boat structure.

⚠ WARNING

Boat motion can be erratic.

You can fall overboard or be injured by hitting something in or on the boat.

All persons must be in cockpit area or cabin and be prepared for sudden boat movement.

Use front or bow deck area only during anchoring, mooring or emergencies.

2019 ROBALO CENTER CONSOLE

International Symbols

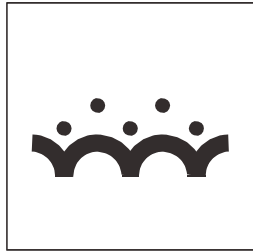

Waste Water Sewage



Fresh Water

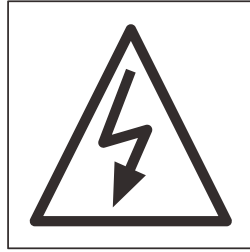

Electrical Hazard

International labels not included on label location page.

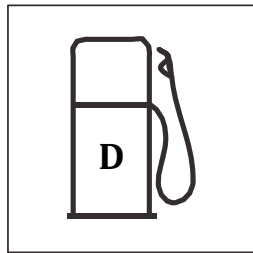

Diesel

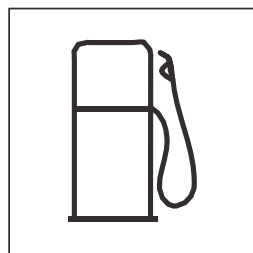

Fuel

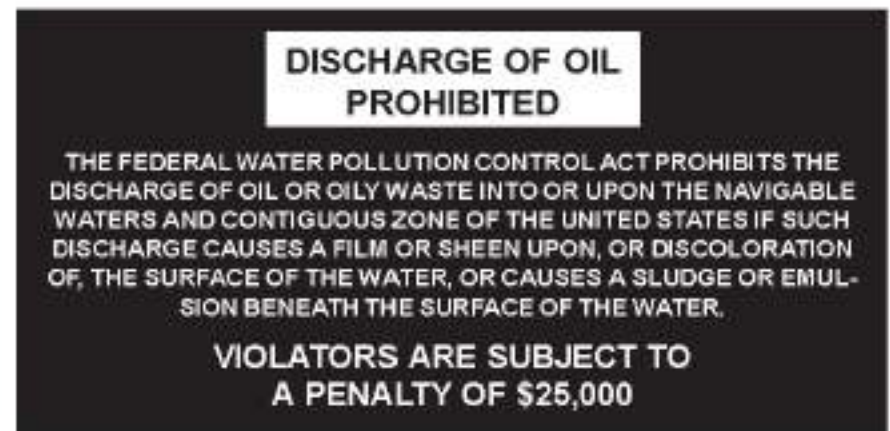
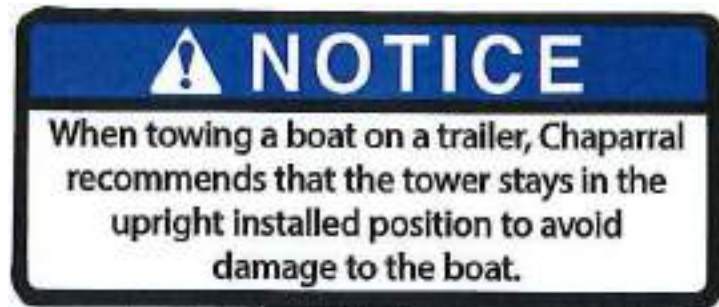

2019 ROBALO CENTER CONSOLE

HAZARD COMMUNICATION

As you read this manual, please note the hazard warnings which alert you to safety precautions related to unsafe conditions or operating procedures. We have included these warnings because we are concerned about your safety and the safety of your passengers. Hazard statements generally have five (5) parts:

1. The Hazard Symbol
2. A signal word which indicates the severity of the hazard
3. A concise description of the hazard
4. The results of ignoring the hazard
5. Steps for avoiding the hazard

The three (3) signal words indicating the severity of the hazard are danger, warning, and caution. The meanings they convey are as follows:



DANGER: calls attention to immediate hazards that WILL result in severe personal injury or death.



WARNING: identifies hazards or unsafe practices that COULD result in severe personal injury or death.



CAUTION: indicates hazards or unsafe practices that COULD result in minor personal injury or product or property damage.

NOTE: This is a general advisory statement relating to equipment operation and maintenance procedures. Its intent is to call attention to information more important than normal text.

SAFETY RECOMMENDATIONS

The popularity of boating and other water sports has grown tremendously in the past few years. Boating safety and the safety of your passengers are your responsibilities. You should fully understand and become familiar with the operating procedures and safety precautions in this manual and the other manuals in the owner's packet before you launch your Robalo boat.

Remember that along with the freedom and exhilaration of boating comes the responsibility that you have for the safety of your passengers and the other boaters who share the water with you. Throughout this manual, specific precautions and symbols identify safety-related information. Be sure to pay close attention to them.

Safe Operation

- Keep your boat and equipment in safe operating condition. Inspect the hull, engine(s), safety equipment, and all boating gear regularly.
- Be very careful when fueling your boat. Be sure you know the capacity of your boat's fuel tank and the amount of fuel you use when operating at frequently used engine speeds (RPMs). Ask your Robalo dealer about the capacity of your boat's fuel tank.
- Make sure you have enough fuel on board for anticipated cruising requirements. In general, use 1/3 of your supply to reach your destination and use 1/3 to return. Keep 1/3 in reserve for changes in your plans due to weather or other circumstances.

2019 ROBALO CENTER CONSOLE

- Be sure lifesaving and fire extinguishing equipment is on board. This equipment must meet regulatory standards and it should be noticeable, accessible, and in safe operating condition. Your passengers should know where this equipment is and how to use it.
- Keep an eye on the weather. Be aware of possible changing conditions by checking local weather reports before your departure. Monitor strong winds and electrical storms closely.
- Always keep accurate, updated charts of the area on board your boat.
- Before you leave the port harbor, file a Travel Plan with a family member, relative, friend, or other responsible person ashore.
- Always operate your boat with care, courtesy, and common sense.
- Instruct at least one other passenger aboard in the basic operating procedures in handling your boat. This person can take over if you unexpectedly become unable to do so.
- Do not allow passengers to ride on parts of your boat other than designated areas.
- Asked all passengers to remain seated while on the boat is in motion.
- Do not use the swim platform or boarding ladder while the engine(s) are running.
- Understand and obey the “Rules of the Road.” Always maintain complete control of your boat.
- Do not overload or improperly load your boat.

The information on your boat’s capacity plate does not override your responsibility for using common sense or sound judgment. Turbulent water and unfavorable weather conditions reduce the capacity of your boat.

Swimming

1. Swim only in areas designated as safe for swimming. These are usually marked with a swim area buoy (see figure left). Do not swim alone or at night.
2. Do not allow anyone near the propeller(s), even when the engine is off. Propeller blades can be sharp and can continue to turn even after the engine is off. Stay well away from areas marked by a diver down float (see figure right).



Safe Boating Courses

Your local U.S. Coast Guard Auxiliary and the U.S. Power Squadrons offer comprehensive safe boating classes several times a year. You may contact the Boat/U.S. Foundation at 1-800-336 BOAT (2628), or in Virginia 1-800-245 BOAT (2628). For a course schedule in your area you may also contact your local U.S. Coast Guard Auxiliary or Power Squadron Flotilla for the time and place for their next scheduled class.

U.S. Coast Guard Website: www.uscg.mil

Power Squadron Website www.usps.org

2019 ROBALO CENTER CONSOLE

Voluntary Inspections

State boating officials in many states or the U.S. Coast Guard Auxiliaries offer courtesy inspections to check out your craft. They will check your boat for compliance with safety standards and required safety equipment. You may voluntarily consent to one of these inspections and you are allowed time to make corrections without prosecution. Check with the appropriate state agency or the Coast Guard Auxiliary for details.

Rules of the Road

All responsible boaters comply with the “Rules of the Road,” the marine traffic laws enforced by the U.S. Coast Guard. There are two sets of rules: The United States Inland Navigational Rules and the International Rules. The United States Inland Rules apply to all vessels inside the demarcation lines separating inland and international waters. The Coast Guard publishes the “Rules of the Road” in its publication “Navigational Rules, International-Inland.” You can get a copy from your local U.S. Coast Guard Unit or the United States Coast Guard Headquarters, 1300 E. Street NW, Washington, D.C. 20226.

Other helpful publications available from the U.S. Coast Guard include “Aids to Navigation” (U.S. Coast Guard pamphlet #123), which explains the significance of various lights and buoys; the Boating Safety Training Manual”, and “Federal Requirements for Recreational Boats.” Check with your local Coast Guard station, your Robalo dealer, or a local marina about navigational aids unique to your area.

U.S. Coast Guard Website: www.uscg.mil

Power Squadron Website www.usps.org

If you have a marine radio telephone, heed storm warnings and answer any distress calls from other boats. The word “MAYDAY” spoken three (3) times is the international signal of distress. Monitor marine radio channel 16 which is reserved for emergency and safety messages.

You can also use this channel to contact the Coast Guard or other boaters if you have trouble.

Important: Never send a “MAYDAY” message unless there is a serious emergency and you are in need of immediate assistance.

Warning Markers

Always check with local authorities concerning regional hazardous areas and how they are marked. Other considerations include:

- Boat operators must be able to recognize marine flag designs and respond accordingly.
- Caution should always be exercised relative to swimmers. Swimming areas may not always be marked.
- Navigation markers identify navigable routes and indicate water hazards. Boat operators should familiarize themselves with these important navigational tools and operate their boats accordingly.
- Be prepared to assist anyone flying a ‘distress’ flag as they are requesting immediate assistance.

Drugs and Alcohol

Drugs and alcohol affect a person’s ability to make sound judgments and react quickly. A responsible boater refrains from using drugs or alcohol while operating their boat. Operation of motorized vessels while under the influence carries a significant penalty. Drugs and alcohol decrease your reaction time, impair your judgment, and inhibit your ability to safely operate your boat.

2019 ROBALO CENTER CONSOLE

SAFETY EQUIPMENT

Important: Federal law requires you to provide and maintain safety equipment on your Robalo boat. As the boat owner, you are responsible for supplying all required safety equipment. Consult your Coast Guard, state, and local regulations to ensure your boat has all required safety equipment on board. Additional equipment may be recommended for your safety and that of your passengers. Make yourself aware of its availability and use.

Personal Flotation Devices (PFDs)

There must be one United States Coast Guard approved wearable personal flotation device of Type I, II, or III for each person on board or being towed on water skis, water sports tubes, kneeboards, etc. and one Type IV throwable device on board. The PFDs must be of a suitable size for each person aboard and must be in serviceable condition and readily accessible.

PFD Type I, Wearable: This off-shore life jacket has the greatest buoyancy. It is most effective for all waters where rescue may be delayed. Its design allows for turning most unconscious persons in the water from a face down position to a vertical or face-up position.

PFD Type II, Wearable: This near-shore buoyant vest provides less buoyancy than a Type I PFD. It is intended for calm inland water or waters where there is a chance of quick rescue. It turns its wearer to a face-up position as does the Type I PFD, but the turning action is not as pronounced as the Type I, and it will not turn as many persons under the same conditions as a Type I.

PFD Type III, Wearable: Classified as a flotation aid, this PFD allows wearers to place themselves in a vertical or face-up position in the water. Type III has the same minimum buoyancy as a Type II PFD. It has little or no turning ability. People participating in water sports often prefer this PFD because it is intended for use in waters where quick rescue is possible and it is generally the most comfortable for continuous wear.

PFD Type IV, Throwable: You must also have aboard at least one throwable PFD Type IV device. The Type IV device can be thrown to a person in the water and grasped and held by the user until rescued. The design does not allow it to be worn. The most common Type IV PFDs are buoyant cushions or ring buoys. This PFD must be immediately available for use and in serviceable condition.

PFD Type V: Must be worn to be effective. When inflated, it provides buoyancy equivalent to Type I, II, or III PFDs.

Fire Extinguishers

As the boat owner, you are responsible for making sure you have the required number of fire extinguishers. Fire extinguishers must be approved by the U.S. Coast Guard.

Boats longer than 26 feet and shorter than 40 feet: Two Type B-1 or at least one Type B-2 portable hand extinguishers. If your boat has a fixed fire extinguishing system approved by the U.S. Coast Guard, one Type B-1 extinguisher is required.

Boats longer than 16 feet and shorter than 26 feet: At least one portable hand Type B-I fire extinguisher.

All fire extinguishers should be mounted in a readily accessible location away from the engine compartment. Everyone on board should know where the fire extinguishers are and how to operate them.

If your fire extinguisher has a charge indicator gauge, cold or hot weather may affect the gauge reading. Consult the instruction manual supplied with the fire extinguisher to determine the accuracy of the gauge.

Visual Distress Signals

The U.S. Coast Guard requires all boats operating on U.S. coastal waters have visual distress signal equipment on board. In general, coastal waters include all waters except rivers, streams, and inland lakes. The Great Lakes are considered coastal waters as is a river mouth more than two miles wide. Boats owned in the United States and operating on the high seas must also carry visual distress signal equipment.

2019 ROBALO CENTER CONSOLE

Visual distress equipment must be in serviceable condition and stowed in a readily accessible location. Equipment having a date showing useful service life must be within the specified usage date shown. Both pyrotechnic and non-pyrotechnic equipment must be U.S. Coast Guard approved.

Pyrotechnic U.S. Coast Guard approved visual distress signals and associated equipment includes:

- Red flares, hand-held, or aerial
- Orange smoke, hand-held or floating
- Launchers for aerial red meteors or parachute flares.

Non-pyrotechnic equipment includes an orange distress flag and an S-O- S electric distress light.

No single signaling device is ideal under all conditions for all purposes. Consider carrying various types of equipment. Careful selection and proper stowage of visual distress equipment are very important. If young children are frequently aboard, you should select devices with packages which children, but not adults, will find difficult to open.

Sound Signaling Device

Your Robalo boat must have a device that can produce a sound signal when conditions require. For boats over 26 feet, the device must be able to produce a two-second blast which can be heard a mile away. For boats less than 26 feet, it must be able to produce a two-second blast which can be heard one-half mile away. It can be a hand, mouth or power operated horn or whistle. Refer to the U.S. Coast Guard's publication "Navigational Rules, International-Inland" for details about the appropriate signals.

RUNNING AND NAVIGATION LIGHTS

Your boat must have running and navigation lights for safe operation after dark. Observe all navigation rules for meeting and passing. Do not run at high speeds during night operation. Always use common sense and good judgment.

SAFETY AFLOAT

Once your boat is launched and your excursion is underway, you need to be aware of your surroundings and how they may affect your safety and that of your passengers. There is no substitute for good judgment and common sense.

Weather

Storms rarely appear without advance notice. Check the weather forecast before you begin a day of boating. Be aware, however, that weather conditions can change rapidly. If you have a marine radio, listen to the weather reports issued by the U.S. Coast Guard and others. If you have a portable radio, keep it tuned to a station broadcasting frequent weather reports. Many boating clubs fly weather signals. Learn to recognize these signals and listen to your local forecasts before leaving port.

Your surroundings can also be a good indicator of changing weather conditions. Watch for changes in wind direction or cloud formations. There is no substitute for a good understanding of weather conditions and what to do when the weather takes a turn for the worse.

Fog

Fog is a result of either warm-surface or cold-surface conditions. You can judge the likelihood of fog formation by periodically measuring the air temperature and dew point temperature. If the difference between these two temperatures is small, fog is likely to develop. Remember the following guidelines:

- Turn on running lights.
- Unless your boat is well equipped with charts, head for shore at the first sign of fog and wait until conditions improve. If you have charts on board, take bearings as fog sets in, mark your position, and continue to log your course and speed.
- Make sure all persons on board have put on their personal floatation devices.
- If your boat has sounding equipment, take soundings regularly and match them with depths shown on your charts.

2019 ROBALO CENTER CONSOLE

- Station a person forward in the boat as a lookout.
- Reduce your speed. From time to time, stop engine(s) and listen for other fog signals.
- Sound the horn or fog bell intermittently to warn others.
- If there is any doubt in continuing your excursion, anchor. Listen for other fog signals while continuing to sound your fog horn or bell.

Storms

The present and forecasted weather conditions are a primary consideration, and the possibility of storms should always be a concern. If storms are a possibility, keep a watch on the horizon, especially to the west, for approaching storms. Monitor the weather forecast on a marine channel or local weather station. The best possible situation is to return to a safe port if time allows.

Other steps to follow to weather the storm include:

- Close and secure port holes. Stow all loose gear below deck and tie down any gear on deck.
- Reduce speed as the seas build. Make sure all persons on board have put on their personal floatation devices.
- Trail a sea anchor from the bow. If you do not have a sea anchor aboard, use a canvas bucket, tackle box, or other object that will work like a sea anchor.
- Radar reflectors (if installed on your boat) should be 18 inches diagonally. They should be placed as far above waterline as possible. Other- wise, a boat with radar may have trouble “seeing” your boat.

Man Overboard

Should someone in the boat fall overboard:

- Act quickly—treat every situation as an emergency.
- Move throttle to idle position and yell “Man Overboard”.
- Immediately throw a Type IV PFD to the person in the water.
- Have someone in the boat assume responsibility for watching the person in the water and keep them in sight while the boat maneuvers back to them.
- Approach the person into the wind and waves. When alongside, put the engine in neutral and throw them a Type IV PFD with a line attached or extend an oar or boat hook.

Fire

Important: A fire aboard your boat is a serious emergency. You must act immediately!

Every boater should develop a fire response plan to determine what kind of fire (fuel, electrical, etc.) might break out, where it might break out, and the best way to react. Having a plan and assigning responsibilities to others results in quicker decisions and quicker reactions.

Important: Everyone on board should know where fire extinguishers are and how to operate them.

Any fire requires stopping the engine(s) immediately. Then:

- If equipped, the fire extinguisher system will discharge in the event of a fire. The heat sensitive automatic head will release the extinguishant as a vapor, totally flooding the compartment in fire-killing concentrations. The system indicator light is wired to the ignition and is turned on when the ignition is turned on. The indicator light, located at the dash panel, indicates to the helmsman when the unit has discharged.

2019 ROBALO CENTER CONSOLE

Under normal operation, the indicator light is lit. If the unit discharges, the charge light will go out.

- Do not open the hatch to the rigging compartment! The fire will flare up if the fresh air supply increases suddenly.
- Keep the fire downwind if possible. If the fire is aft, head into the wind.
- Have all persons on board put on their personal floatation devices.
- If you can get at the fire, aim the fire extinguisher at the base of the flames and use a sweeping action to put out the fire.
- If the fire gets out of control, make a distress signal, and call for help on the radio.

Deciding whether to stay with the boat or abandon ship will be difficult. If the decision is to abandon ship, all persons on board should jump over- board and swim a safe distance away from the burning boat.

Guidelines for Fire Prevention



Warning: Smoking, poor maintenance, or carelessness when refueling can cause hazardous conditions. Always follow proper refueling procedures for your boat.

- Check the bilge for fuel leaks
- Check cleaning products for flammability
- Ventilate when cleaning or painting
- Disconnect electrical system from power source when performing any type of maintenance
- Use extra caution when using exposed flame around urethane foam
- Extinguish smoking materials carefully
- Ensure ventilation systems are not obstructed
- Use only approved marine cooking and heating systems

- Open flames demand constant attention
- Keep flammable materials in approved containers
- Replace circuit breaker fuse with one of the same amperage
- Electrical appliances must be with rated amperage of boat circuits
- A qualified marine electrician should service the electrical system

Flooding, Swamping or Capsized Boat

Flooding or swamping is usually caused by the actions of an inattentive boat operator, or by hazardous weather or water conditions. To prevent boat flooding:

- Install drain plug before launching.
- Ensure proper bilge pump operation.
- Do not overload boat.
- Adjust boat speed and trim to match sea and weather conditions
- Close all cabin hatches, door, etc. while underway to prevent flooding due to heavy seas or rain. Ensure proper ventilation to avoid carbon monoxide poisoning. See carbon monoxide hazard information later in this chapter.
- When only using one anchor, it should be attached to the bow of the boat.
- When slowing down or moving in reverse do not allow wake or following seas to flood cockpit.

If your boat becomes swamped or capsizes, put on a PFD immediately and set off a distress signal. Chances are good that a capsized boat will stay afloat. For this reason, stay with the boat. Do not leave the boat or try to swim to shore except under extreme conditions. A capsized boat is easier to see than a swimmer, and the shore may be farther away than it appears.

2019 ROBALO CENTER CONSOLE

More often than not, boats sink while docked. Any number of factors may contribute to these sinkings. There may have been a mechanical failure such as a failed bilge pump or an electrical problem such as a dead battery or tripped circuit breaker. Check your boat regularly if it is docked for an extended period of time to make sure everything is in order.

Hypothermia

Water Temperature (°F)	Exhaustion Unconsciousness	Expected Time of Survival
32.5	Under 15 min	Under 15-45 min
32.5-40	15-30 min	30-90 min
40-50	30-60 min	1-3 HR
50-60	1-2 HR	1-6 HR
60-70	2-7 HR	2-40 HR
70-80	3-12 HR	3 HR – Indefinite
Over 80	Indefinite	Indefinite

If a person falls overboard, hypothermia may be an immediate concern. Hypothermia means a person's body loses heat to the water faster than the body can replace it. If not rescued, the person will become exhausted or likely drown. In general, the colder the water, the shorter the time for survival. PFDs will increase survival time because they provide insulation.

Collision

If a serious collision occurs, first check the persons on board for injuries. Then inspect the boat to determine the extent of damage.

- Prepare to help the other craft unless it places your passengers or boat in danger.
- If the bow of the other boat penetrated your boat's hull, prepare to plug the fracture once the boats are separated.

- Shore up the hole inside your boat with a spare life jacket or cushion.
- While plugging the hole, shift weight to get the hole above the water level.
- If your boat is in danger of sinking, have all persons put on their personal floatation devices.
- If your boat has a radio, contact the U.S. Coast Guard or other rescue authorities immediately (VHF Channel 16 or 22 CB radio).

Running Around

If you run aground check everyone for injury and inspect damage to the boat and propeller(s). If possible, shift weight of passengers or gear to heel the boat while reversing engine(s). If towing becomes necessary, do not attach tow line to deck cleats. These are not designed to take full load of the boat. Robalo recommends using a commercial towing service.



WARNING: When towing another boat or having your boat towed, make sure the tow line is fastened securely to the bow or transom towing eyes. Never attach tow line to deck cleat or anchor windlass. Cleat or windlass may pull free from deck and cause serious personal injury or property damage.

2019 ROBALO CENTER CONSOLE

Carbon Monoxide Hazard During Operation

Carbon monoxide (CO) in the engine exhaust is a poisonous gas which is odorless, colorless, and heavier than air. Direct prolonged exposure can result in carbon monoxide poisoning which can be harmful and may be fatal.

Indications of excessive exposure to carbon monoxide concentrations may include nausea, dizziness and drowsiness. Carbon monoxide poisoning requires the operator's special and immediate attention! To prevent excess exposure and reduce the possibility of carbon monoxide accumulation in the cabin of the boat, ensure adequate ventilation by opening cabin hatches, cabin doors, cabin windows, and side windshield vents to increase air movement.

Some Robalo models are equipped with a CO detector. Follow the operating instructions supplied with the CO detector and test the unit to verify that it is functioning properly every time you use your boat. Refer to the information provided by the manufacturer in your owner's packet to determine replacement interval for your CO detector.

The following illustrations show how carbon monoxide can possibly accumulate in your boat while at the dock or underway. Become familiar with these examples and their precautions to prevent dangerous accidents from occurring on your boat.

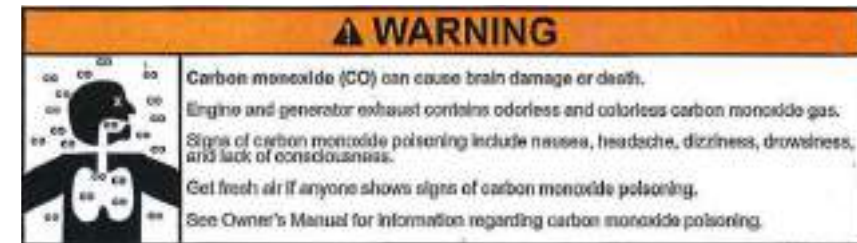
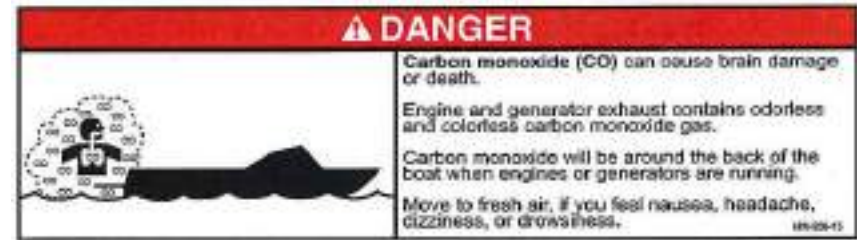

2019 ROBALO CENTER CONSOLE

⚠ DANGER

DANGER: Blocked hull exhaust outlets near a pier, dock, sea wall bulkhead or any other means can cause excessive accumulation of poisonous carbon monoxide gas within the cabin areas. Make sure hull exhaust outlets are not blocked. (Figure 2.1)

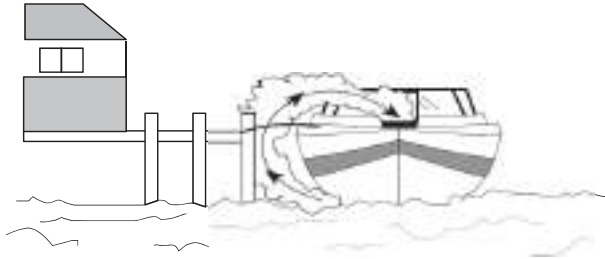

Figure 2.1 - Running engine or generator in confined areas

⚠ DANGER

DANGER: Generator or hull exhaust from other vessels alongside your boat, while docked or anchored, can emit carbon monoxide and cause excessive accumulation within the cabin and cockpit areas. Be alert for generator exhaust from other vessels alongside. (Figure 2.2)



Figure 2.2 - Exhaust fumes from vessel alongside

⚠ DANGER

DANGER: Engine exhaust from your boat while underway can cause excessive accumulation of carbon monoxide within the cabin and cockpit areas when using protective weather coverings. Provide adequate ventilation when the canvas top, side curtains, and/or back curtains are closed. (Figure 2.3)

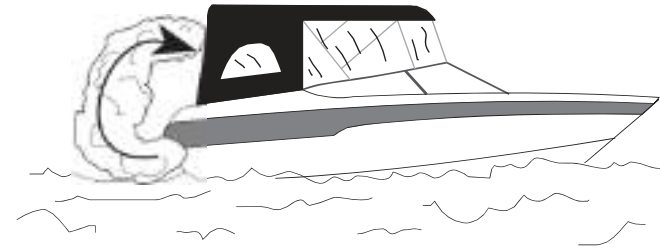

Figure 2.3 - Exhaust accumulations while canvas is in place

Ensure proper ventilation aboard your boat and be aware of the possibility of carbon monoxide poisoning (Figure 2.4). Keep your boat in safe operating condition. Periodically inspect the hull, engine and engine compartment, and all other equipment.

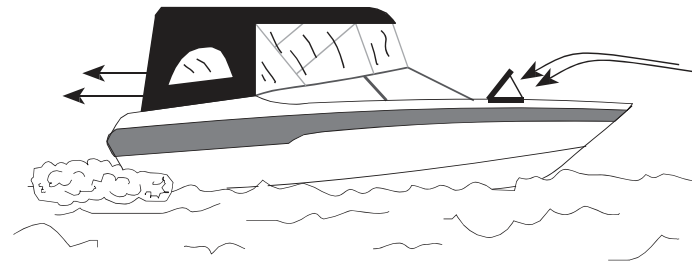

Figure 2.4 - Desired ventilation through the boat

2019 ROBALO CENTER CONSOLE

Checklist

Each Trip

1. Make sure all the exhaust clamps are in place and secure.
2. Look for exhaust leaking from the exhaust system components evidenced by rust and/or black streaking, water leaks, or corrosion or cracked fittings.
3. Inspect rubber exhaust hoses for burned or cracked sections. All rubber hoses should be pliable and free of kinks.
4. Confirm that water flows from the exhaust outlet when the engines and generator are started.
5. Listen for any change in exhaust sound which could indicate a failure of an exhaust component.
6. Test the operator of each carbon monoxide detector by pressing the test button.

NOTE: Do not operate the vessel if any of these problems exist.

At Least Annually (performed by a qualified technician)

1. Replace exhaust hoses if any evidence of cracking, charring or deterioration is found.
2. Replace each water pump impeller and inspect the condition of the water pump housing. Replace if worn. (Refer to the engine manual for further information.)
3. Inspect each of the metallic exhaust components for cracking, rusting, leaking or looseness. Pay particular attention to the cylinder head, exhaust manifold, water injection elbow, and the threaded adapter nipple between the manifold and the elbow.

Fuel System

Everyone who owns or operates a boat must practice fire safety. Each year, boat fires and explosions injure hundreds of individuals and cause millions of dollars in property damage. Many of these accidents can be prevented.

Be alert for damage to your boat's fuel system. Over time, fuel fittings and fuel hoses wear out. Inspect these fittings and hoses regularly,

especially near the engine where engine heat and vibration can accelerate deterioration.

What to do

1. Schedule regular engine and exhaust system maintenance inspections by experienced and trained technicians.
2. Inspect fuel systems annually, particularly hoses, connections and tank surfaces. Use only USCG-approved fuel hoses.
3. Before fueling, shut down engines and auxiliary equipment and all electrical equipment. Also close all hatches and doors on board.
4. Do not allow equipment or gear to contact fuel-system components.
Monitor side storage areas where fill and vent hoses are often located.
5. Do not store portable fuel tanks in enclosed areas, including the engine room compartment (even though it may be "ventilated").
6. Take a boating safety course and learn the correct type and use of a fire extinguisher aboard a boat.

Each Trip

- Before starting the engine "sniff" your bilges. Getting down on your hand and knees and using your nose is the best fuel/vapor detector.
- Make sure all passengers know where to find your fire extinguishers and how to operate them.
- Before refueling, close all hatches, ports and other openings; shut off engines, motors, pumps and blowers; and DO NOT SMOKE. Fill all portable tanks on the dock.
- After refueling, wipe up or wash off any excess or spilled fuel; open all hatches and ports; and let the boat air out. "Sniff" your bilges.

Important: Do not operate your boat until the source of a fuel leak is identified. Have a qualified service technician correct the condition. NEVER USE A MATCH TO INSPECT FOR LEAKS.

2019 ROBALO CENTER CONSOLE

At Least Annually:

(Performed by a qualified marine technician)

- Replace fuel system components if any evidence of cracking, corrosion or deterioration is found.
- Inspect fuel tanks annually. Pay particular attention to bottom surfaces that may have contacted bilge water. Also, check to see if any part of the tank is corroded or damaged from rubbing and abrasion. Permanently installed fuel tanks must be vented to the atmosphere outside the boat. Closed compartments that contain fuel tanks and engines or non-ignition protected electrical components must be ventilated.
- Be sure the fill pipe is securely mounted, grounded and located where spilled fuel is directed overboard. Dry and cracked or soft and mushy fuel fill hoses should be replaced immediately.
- If your boat is equipped with bilge blowers, ensure they are working properly.
- Ensure cooking appliances on board are secured and operate properly. Refer to the appliance owner's manual.
- Ensure flammable items are stowed safely and cannot contact cooking appliances or hot engine parts.
- Ensure fire extinguishers are USCG-approved and in good working order (i.e., gauges register and nozzles are clear)
- Repair all bare wires and loose electrical connections that might cause a short in your boat's electrical system and start a fire.
- Do not store disposable propane cylinders or charcoal lighting fluid on board the boat.
- When replacing starters or other electrical equipment use only ignition-protected parts. Do not use automotive parts.

Navigational Aids Chart

The Navigational Aids Chart (located at the end of this section) contains information about various signals, buoys, and warnings. Robalo recommends you participate in a safe boating course to learn more about navigating your boat safely.

WATER SPORTS

Water skiing and other water sports, such as knee boarding and riding on inflatable towable devices, require increased safety awareness by all the people involved.



WARNING: Death or serious poisoning can result from exposure to carbon monoxide from engine exhaust. Turn off gasoline-powered generators that exhaust at or near the water level when the swim platform on the stern is in use. Swimmers should not enter the cavity beneath the swim platform.

Important: Remember that three people — not two — are required for safe water skiing: the boat operator, the skier, and an observer on the boat facing the skier. The observer relays signals from the skier to the operator. The operator can therefore give full attention to the operation of the boat and the waters ahead.

Figure 2.6 shows a set of hand signals recommended by the American Water Ski Association (AWSA). The skier, the observer, and the boat operator should know and understand these 7 simple signals.

Following these guidelines helps make water skiing a safe and enjoyable experience:

1. Water ski only in safe areas away from other boats and swimmers, out of channels, and in water free of underwater obstructions.
2. Make sure anyone who water skis is a competent swimmer.
3. Be sure the skier is wearing a proper flotation device. A properly designed ski vest will keep a stunned or unconscious person afloat.

2019 ROBALO CENTER CONSOLE

4. Approach a skier in the water from the lee side, and be certain to stop your motor before coming close to the skier.
5. Give immediate attention to a fallen skier. He or she is vulnerable in the water alone and is difficult to see by other boaters.

For more information about water skiing, Please contact the American Water Ski Association, 799 Overlook Drive, Winter Haven, Florida 33884 (1-800-533-2972) or www.usawaterski.org.



WARNING: Serious injury may result from para-sailing, kiting, or similar water sports. Robalo Boats are not designed for towing para-sails, kites, or any other device designed to become airborne when towed behind a boat.

Additional Equipment

You should consider having additional equipment on board to help make your boating experience safer and more enjoyable. Some examples include the following:

- Anchor and line
- Boat hook
- Bucket and sponge
- Commonly used spare parts
- Compass, navigation charts
- Distress signal kit
- Docking and towing lines
- Engine and accessory manuals

- Extra keys
- Fenders
- First aid kit
- Flashlight and extra batteries
- Fuses
- Manually operated bilge pump
- Owner's manual
- Paddle
- Replacement light bulbs
- Ship-to-shore radio
- Spare fuel and oil
- Spare propeller with fastening hardware
- Spare set of spark plugs and ignition parts
- Tool kit

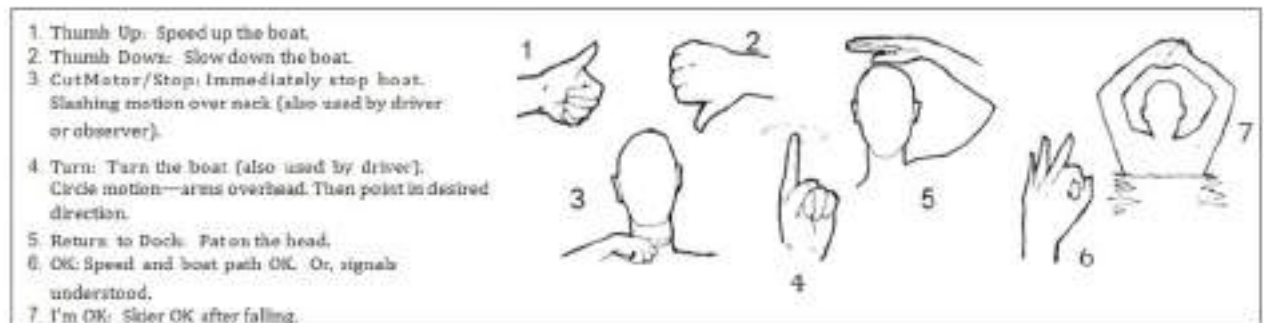

Figure 2.6 AWSA Water Skiing Signals

2019 ROBALO CENTER CONSOLE

NAVIGATIONAL AIDS CHART

REMEMBER THESE RULES

- OVERTAKING- PASSING:** Boat being passed has the right-of-way. **KEEP CLEAR.**
- MEETING HEAD ON:** Keep to the right.
- CROSSING:** Boat on right has the right-of-way. Slow down and permit boat to pass.

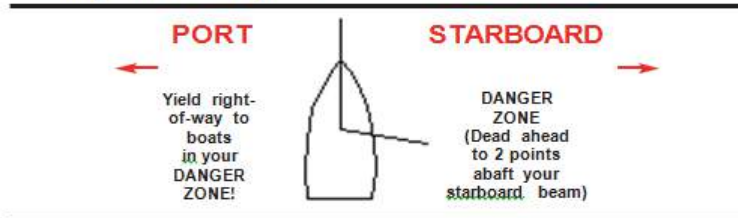

WHISTLE SIGNALS

- ONE LONG BLAST:** Warning signal (Coming out of slip)
- ONE SHORT BLAST:** Pass on my port side
- TWO SHORT BLASTS:** Pass on my starboard side
- THREE SHORT BLASTS:** Engine(s) in reverse
- FOUR OR MORE BLASTS:** Danger signal

BRIDGE SIGNALS

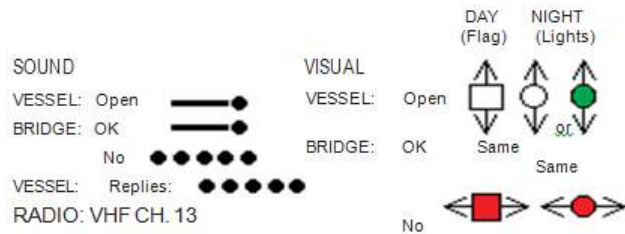

STORM WARNINGS

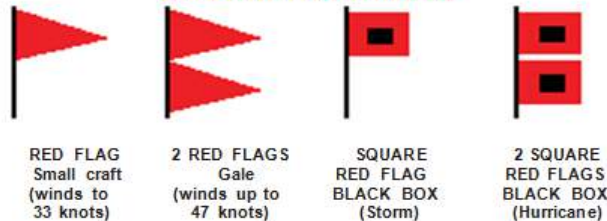

LATERAL AIDS AS SEEN ENTERING FROM SEAWARD

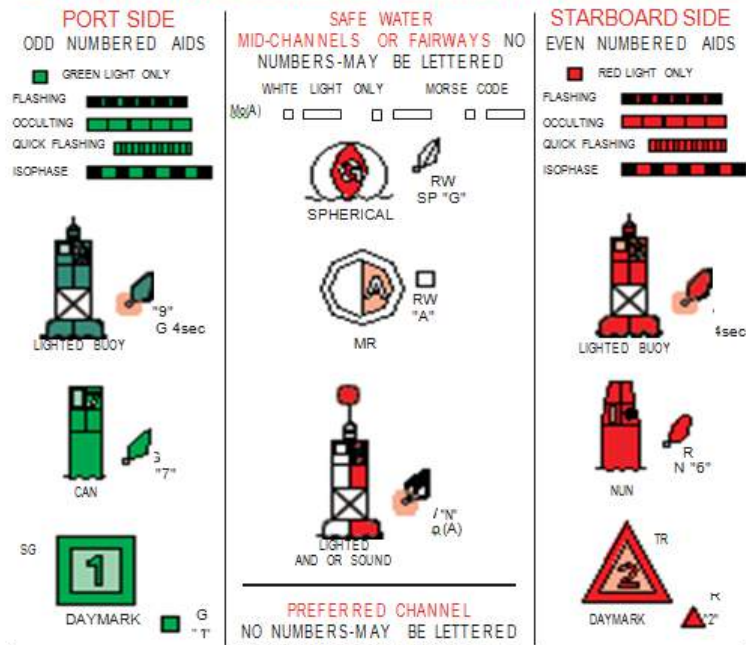

PREFERRED CHANNEL
NO NUMBERS-MAY BE LETTERED
COMPOSITE GROUP FLASHING (2+1)

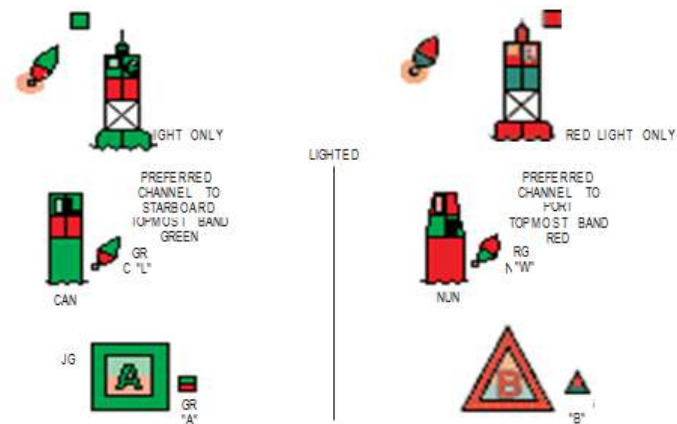

United States Coast Guard Website: www.uscg.mil

The drawings at the end of this chapter show the typical locations of system equipment.

NOTE: For location of items listed in this chapter, refer to the respective drawing. Depending on how your boat is equipped, the location of some items may be different than shown in the illustration.

Electrical Systems

Your Robalo boat has a 12 volt, direct current (DC) battery system.

Safety Precautions

Follow these precautions when working with or on electrical systems or electrically powered equipment:

1. Shut off power supply before starting work.
2. Use insulated mats to prevent accidental grounding.
3. Make sure clothing is dry. Keep skin dry.
4. Remove all metal jewelry.

12 Volt DC Power

Batteries are the source of power for the 12 volt DC (direct current) electrical system. The batteries are charged through the engine-driven alternator. The voltmeter on the instrument panel in the dash shows the battery charging rate when the engine is running.

The negative terminal of each battery is connected to the grounding studs of the main engine(s). This type of negative ground system is the approved system for marine DC electrical systems. If you add additional equipment to your boat it must be adaptable to the negative ground system.

NOTE: A fuse block near the helm has been provided with additional accessory hookups. Consult your Robalo dealer for additional DC power needs on your boat.

Note: The appropriate fuse or circuit breaker must be used. Consult a qualified technician for proper fuse size.



CAUTION: When adding electrical equipment, be careful not to overload the fuse block.



WARNING: Considerable care has been taken to design a safe electrical system to protect you from hazardous shocks. Always have a qualified technician make any modifications to the system.



DANGER: Do Not disconnect or reconnect battery cables if gasoline fumes are present!

2019 ROBALO CENTER CONSOLE

Battery

Note: A dual battery system is standard equipment on some models.

The battery installed in your boat by your Robalo dealer supplies your boat with DC current for lights, engine starting, and accessories. When the engine is running, the alternator supplies the power needed to keep the batteries charged. Lights and accessories draw power from the batteries.

Battery Isolator System

The models with a single engine and two batteries are standard with a battery isolator system to maintain a charge on the house battery while the engine is in operation. Models with twin engines and three batteries are standard with a battery isolator system to maintain a charge on the house battery while the starboard engine is in operations. The isolator for Yamaha powered boats is in the engine and for Honda powered boats; it is in the aft bilge.

Battery Selector Switch

All models have a battery selector switch as standard equipment. If your boat has a battery selector switch, you will find it in the aft rigging area or in the console.

Single Selector Switch with Two Batteries

A selector switch with two batteries is standard on some models. This battery selector switch has four positions:

OFF – Power supplied to automatic bilge pump, CO detector (if equipped), and stereo memory.

1 – Use only number 1 battery.

2 – Use only number 2 battery.

All – Use both 1 and 2 batteries.

Recommended settings are as follows:

1. When boat is not in use or power is not required, turn the switch to OFF. The only power supplied at this setting is the automatic bilge pump, optional corrosion protection system and stereo memory, and the trim pump on some models (**Figure 1**).
2. To start the engine, place switch Number 1 position. With this setting, power will now be supplied to your boat from the Number 1 battery. This will allow the engine alternator to charge both batteries (**Figure 2**).
3. For auxiliary power with the engine off, place the switch in the Number 2 position. Power will now be supplied to your boat from the Number 2 battery (**Figure 3**).

Note: Robalo does not recommend leaving the switch in the ALL position when the engine is off. This will drain both batteries and you will not have a starting battery.

4. If one battery is low, you still have the option of starting the engine from the other battery.

Note: Figure 1-3 below (left to right).

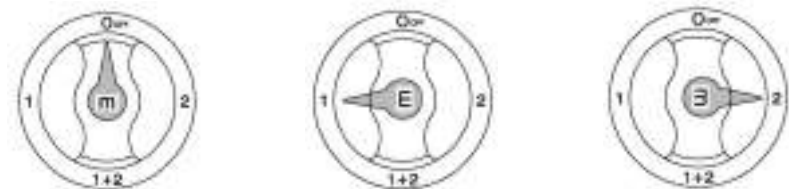

Example 1 (Left): If the Number 1 battery is low, place the switch in the Number 2 position. Then start the engine. Place the switch in Number 1 position. This will allow the engine alternator to recharge both batteries.

2019 ROBALO CENTER CONSOLE

Example 2 (Right): If the Number 2 battery is low, place the switch in the Number 1 position. Then start the engine. This will allow the engine alternator to recharge both batteries.

Note: When recharging a low battery, be sure to run the engine for a sufficient amount of time to fully recharge the battery.

Note: Robalo does not recommend any other settings than mentioned because of possible damage to batteries or engine alternator.

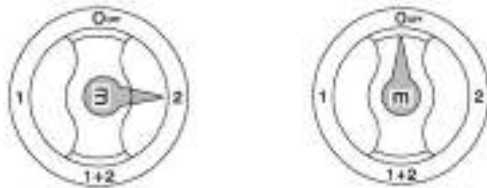

AC/DC Converter and Battery Charger

Your Robalo boat may have an optional battery charging system which operates off 120 or 220 volt AC power from shore power system. Turn the charger on at the main cabin electrical panel whenever your boat is connected to shore power to keep batteries fully charged. The AC-to-DC converting and charging system is fully automatic and permanently wired into the 12 volt DC system. If the monitored battery level drops under the full charge range, the charger automatically turns ON and restores the battery to FULL charge status. If the battery is deeply discharged, the charger will deliver full output. Output automatically decreases as the battery is charged. If the battery is fully charged, the charger provides a trickle charge as needed.

120 or 220 Volt AC Power

The alternating current (AC) electrical system operates of a standard 30 amp 120 or 220 volt, 50 or 60 cycle shower power system. The main distribution panel is in the cabin area.

Lighting

Lighting operates off the 12 volt DC system. Turn lights on or off at the main electrical panel in the cabin or at the light fixture. See your Robalo dealer for information regarding bulb replacement.

Electrolysis and Sacrificial Anodes

Many boaters are unaware of the problems associated with electrolysis and how to properly address corrosion issues. Electrolysis is a reaction between metal and electrical energy. Electrolysis occurs when electrical current is “leaking” into the water, and can come from a variety of things such as ship to shore power, sharing electrical wires, old electrical devices in contact with the water, batteries in boats, etc.

Electrolysis can also be caused by “stray currents” due to a fault in an electrical item, even though correctly grounded.

Electrolysis/corrosion is a very real issue and expense for any boater and boat owners must be aware of the proper protection and maintenance. Corrosion will directly affect the performance of your boat within a very short period of time.

It is the boat owner’s responsibility to check for and replace damaged parts due to galvanic deterioration. Refer to your Robalo dealer to investigate the source of stray corrosive currents.

Sacrificial anodes are installed on the outdrive and trim tabs to protect underwater hardware on your boat. Metals used in sacrificial anodes are less noble than the copper-based alloys and aluminum used in underwater fittings; therefore, the anodes will deteriorate first and protect the more noble parts. Metals commonly used in sacrificial anodes include aluminum, magnesium, and zinc.



CAUTION: Replace sacrificial anodes if they are corroded 50% or more.

The type of metal needed for your boat’s sacrificial anodes will depend on your use of the boat. For instance, the type of water where you commonly go boating is a major factor in determining your need. Robalo recommends you consult your dealer and your engine manufacturer’s owner’s manual to determine the proper metal needed in your sacrificial anodes.

2019 ROBALO CENTER CONSOLE

Zinc anodes generally require replacement about once a year, but may need to be replaced every six months in salt water areas. The need to replace anodes more frequently may indicate a stray current problem within the boat or at the slip or mooring. If zinc anodes are not replaced annually, they may not be providing the necessary protection.

Note: Do not paint between the zinc and any metal it touches. Do not paint over the zinc.

Placing a zinc in the water bonded to the metal outlet box on the dock will reduce zinc loss on the boat. Do not connect this zinc to the boat's ground system.

Important: All electrically operated DC equipment and accessories must be wired so that the ground polarity of each device is the same as that of the battery. Robalo boats have a negative ground system, which is recommended practice throughout the marine industry. All metal items (fuel tanks, underwater hardware) in the boat are connected to the zinc anode by the green bonding wire.

Once a year

(Performed by a qualified marine technician)

Inspect boat receptacles for any signs of deterioration, including cord wear, loose connections, and signs of sparking or overheating and bent or pitted blades. If there are any such signs, examine, correct, and test the equipment or replace it.

Fuel System

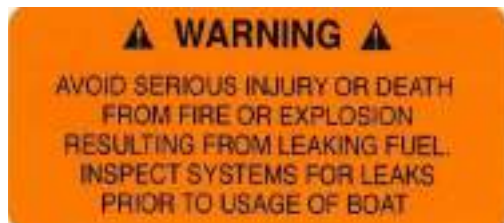

The internal fuel system on your Robalo boat meets all current Federal requirements.

Fuel lines, filters, and all fuel system components should be checked at the start of each season and periodically thereafter, particularly after any work has been done aboard the boat which might have affected any part of the system. Be certain that all are in proper condition and that the entire system is fuel tight.

The fuel tank is located under the cockpit floor. The fuel tank fill pipe is located on the outside deck. Some models have a dual fuel system, providing convenience and flexibility of refilling your tank from either

The fuel tank vent allows air to escape as the tank is being filled and helps equalize tank pressure as temperatures change. The tank has an anti-siphon valve which keeps fuel from leaking into the boat in case of fuel line breaks.

Periodically, check the condition of the fuel tank components. Fuel tank fittings are accessible through the inspection plate of the cockpit floor.

Fuel Recommendations

The quality of the fuel is very important for satisfactory engine performance and long engine life. Fuel should be clean and free of contamination. Your fuel tanks should be kept full of fuel whenever possible. This will reduce the amount of water condensation and reduce the possibility of contamination. Robalo recommends not using fuel containing more than 10% alcohol by volume.

Ethanol-infused gasoline is widely available to today's boater. However, it may have harmful effects on marine engines and fuel delivery systems. Please refer to your engine manufacturer's owner's manual to find the recommended type and grade of fuel for your engine as well as a better understanding of the effects of ethanol on your engine.



2019 ROBALO CENTER CONSOLE

Marine Sanitation Devices

Livewell Pump, Raw Water Pump, and Filter

Once the water pump switch is ON, the water pump supplies water under pressure to the raw water system. The filter keeps particles from entering the pump reservoir. Check the filter periodically and clean if necessary. A clogged filter may result in low water pressure to the system.

Before servicing the filter, turn the water system switch OFF. To clean the filter, remove screen and rinse with clean water. Replace and make sure the O-ring is seated properly when installing the cover.

Note: Refer to the water pump manual for detailed operation and maintenance procedures.

Optional Sanitation equipment with the boat model can include a Porta-Potti (Figure 3.1).

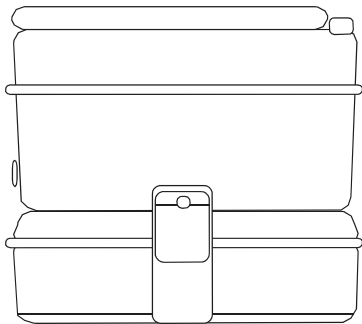
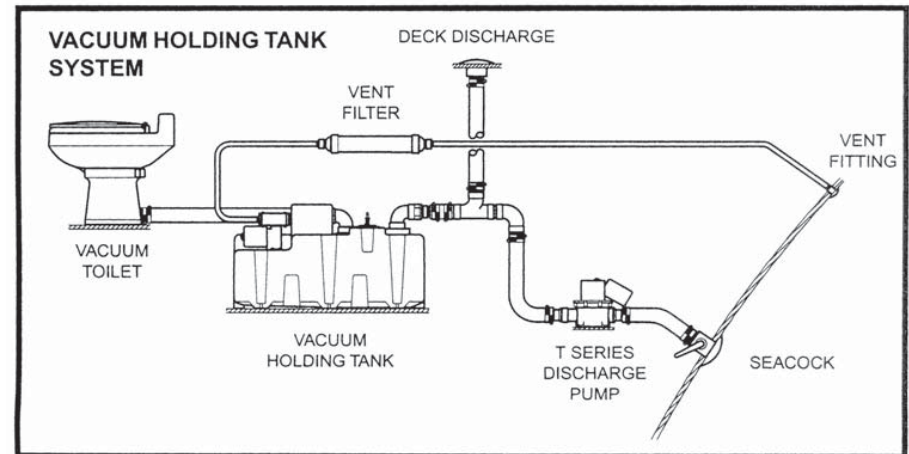

Figure 3.1 Porta-Potti

Note: See the owner's manual supplied by the manufacturer for safety precautions and for detailed operation, maintenance, and winterizing procedures. The manual is in your owner's packet.

The U.S. Coast Guard has also issued regulations requiring boats to have a sanitation system on board to control pollution. Wastes are to be stored in a holding tank or other device, such as a Porta-Potti, until the device can be pumped out and disposed of at a shore facility. Discharging this waste overboard is prohibited in most jurisdictions. Check with the Coast Guard regarding regulations in your area.

If your boat is equipped with the Vacuflush® head, your waste system is actuated by a HEAD or TOILET SYSTEM switch in the head. It uses fresh water to minimize odor problems. To add water to the bowl, raise flush lever until desired water level is reached. Add deodorizer before using the head. The pedal at the base of the head evacuates waste and a vacuum forces the waste to the holding tank.



VacuFlush Head

To flush, press flush lever sharply to floor until contents clear bowl. A sharp popping noise is normal when the vacuum seal is broken. Hold flush lever down for three seconds. If flush lever is accidentally released before waste clears bowl, do not attempt to flush toilet again until vacuum pumps stops running. A small amount of water should remain in the bowl for flushing. Do not dispose of sanitary napkins or other insoluble items in toilet. Do not leave VacuFlush® power on for extended periods when away from the boat as this can cause damaging over-cycling if the bowl is not sealed.

2019 ROBALO CENTER CONSOLE

Make sure all guests understand the operation of the VacuFlush® system and that the instruction label is easy to read and in plain sight.

Refer to your VacuFlush® manual for complete information about the operation of the system.

Overboard Discharge

Important: Overboard discharge of untreated sewage within 12 miles of shore on the east coast and within 9 miles of shore on the west coast is prohibited by law. Check with the local authorities for proper discharge procedures in your area. If your boat is going to be used on inland waters, have your dealer seal the overboard discharge portion of your waste system.

If regulations permit, the macerator can be used to pump waste from the holding tank overboard. The MACERATOR circuit breaker at the battery selector switch panel protects the power supply to the macerator. The macerator pulls the waste from the holding tank, grinds the waste into small particles, and pumps the waste overboard through a hull discharge fitting above the water line.

Follow these procedures to operate the macerator:

1. Switch on the MACERATOR switch in the head compartment.
2. Allow the macerator to run until the holding tank is empty, but not longer. **Running the macerator when the tank is empty will cause damage to the pump.**
3. When you hear the pump speed up (indicates tank is empty), immediately turn the switch off.

Note: If the macerator won't turn on, check the circuit breaker at the battery switch panel. If resetting the breaker doesn't allow the macerator to turn on, see your dealer to determine the cause of the problem.

2019 ROBALO CENTER CONSOLE

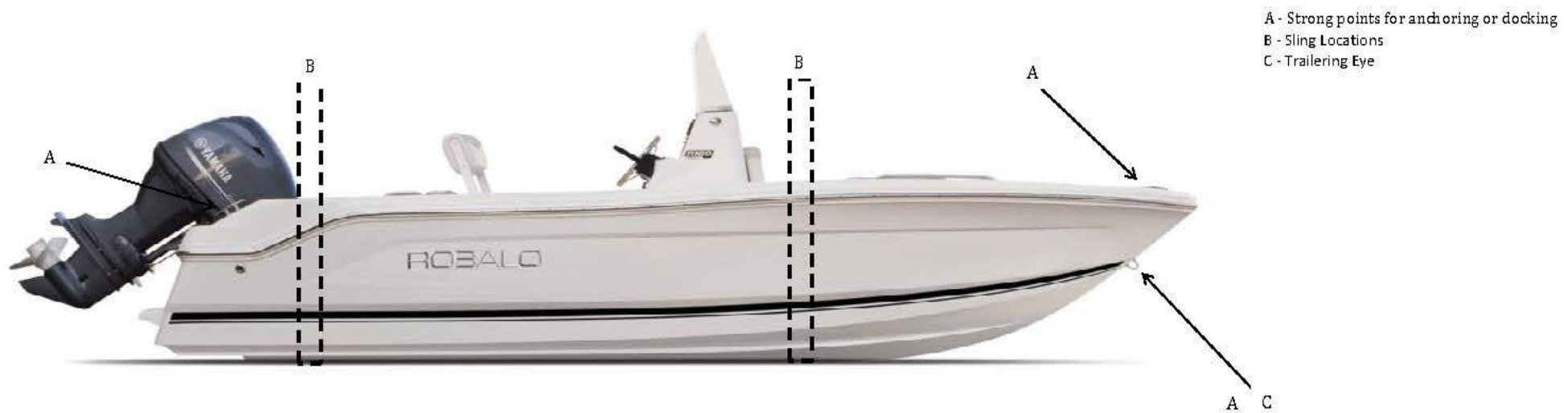

TYPICAL SYSTEMS LAYOUT

1. Bilge Pump and Float
2. Battery Selector Switch
3. Batteries (2 ea)
4. Steering Helm
5. Fuel Tank

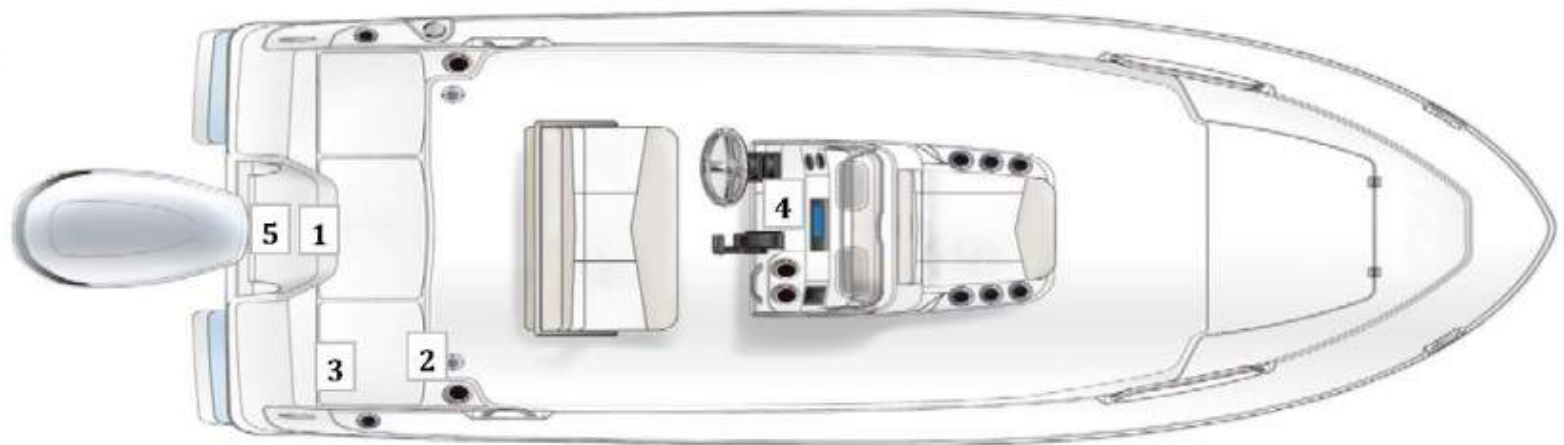

R160

2019 ROBALO CENTER CONSOLE



TYPICAL SYSTEMS LAYOUT

1. Bilge Pump and Float
2. Battery Selector Switch
3. Batteries (2 ea)
4. Livewell/Raw Water Seacock
5. Sea Strainer
6. Livewell Pump
7. Raw Water Washdown Pump
8. Steering Helm
9. Fuel Tank

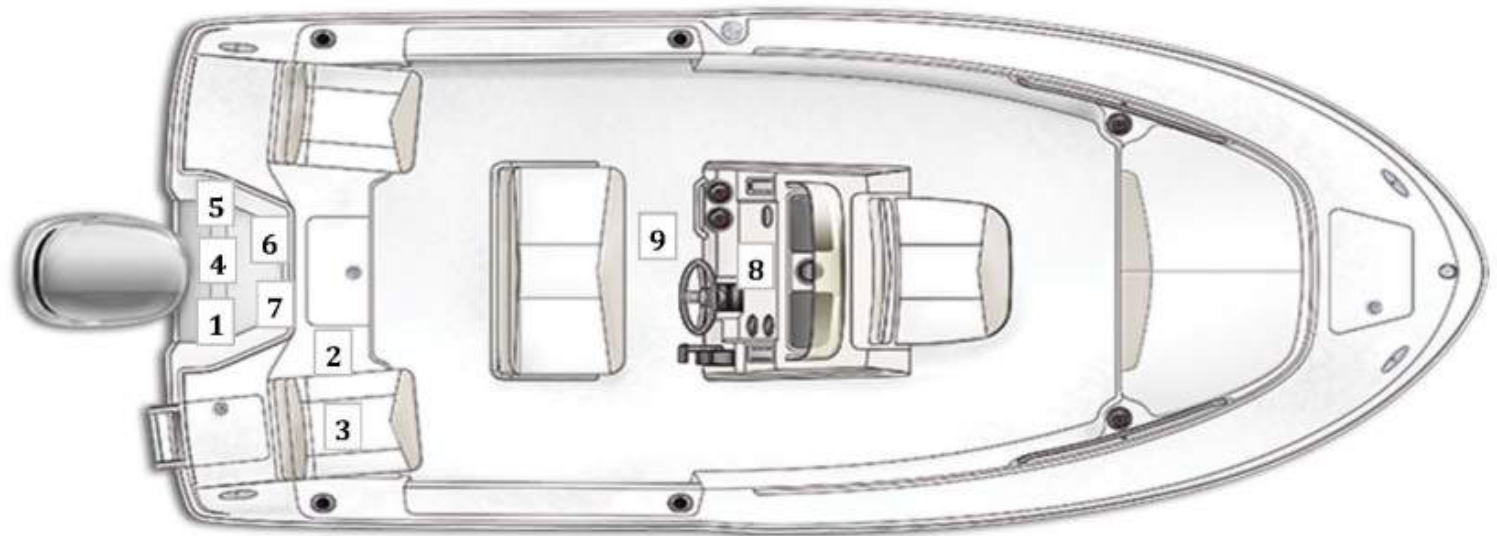

R180

2019 ROBALO CENTER CONSOLE

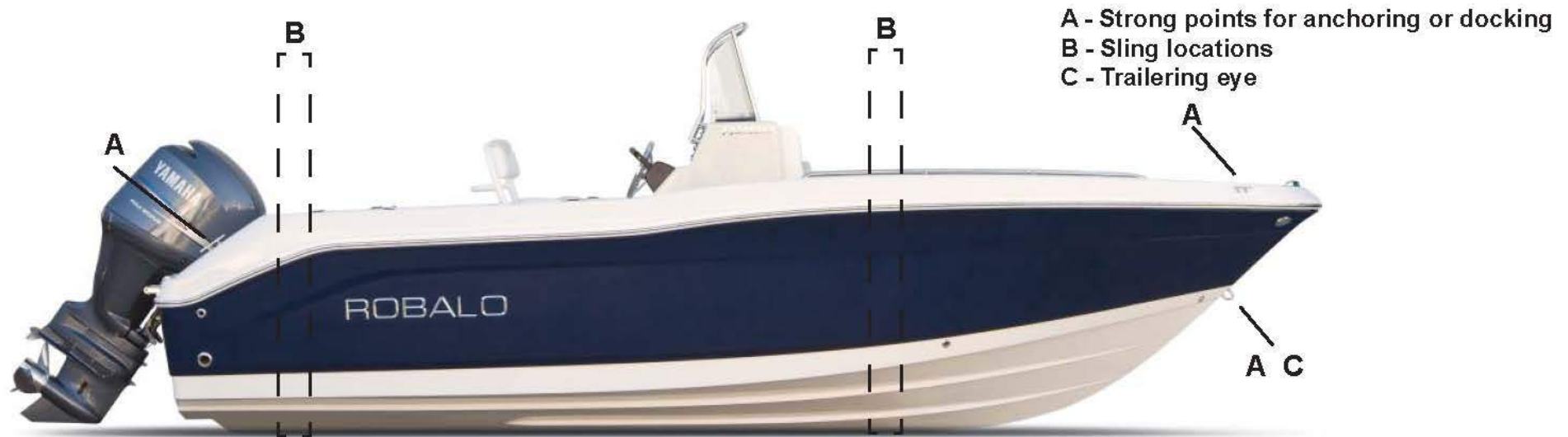

TYPICAL SYSTEMS LAYOUT

1. Bilge Pump and Float
2. Battery Selector Switch
3. Batteries (2 ea)
4. Livewell/Raw Water Seacock
5. Sea Strainer
6. Livewell Pump
7. Raw Water Washdown Pump
8. Steering Helm
9. Fuel Tank

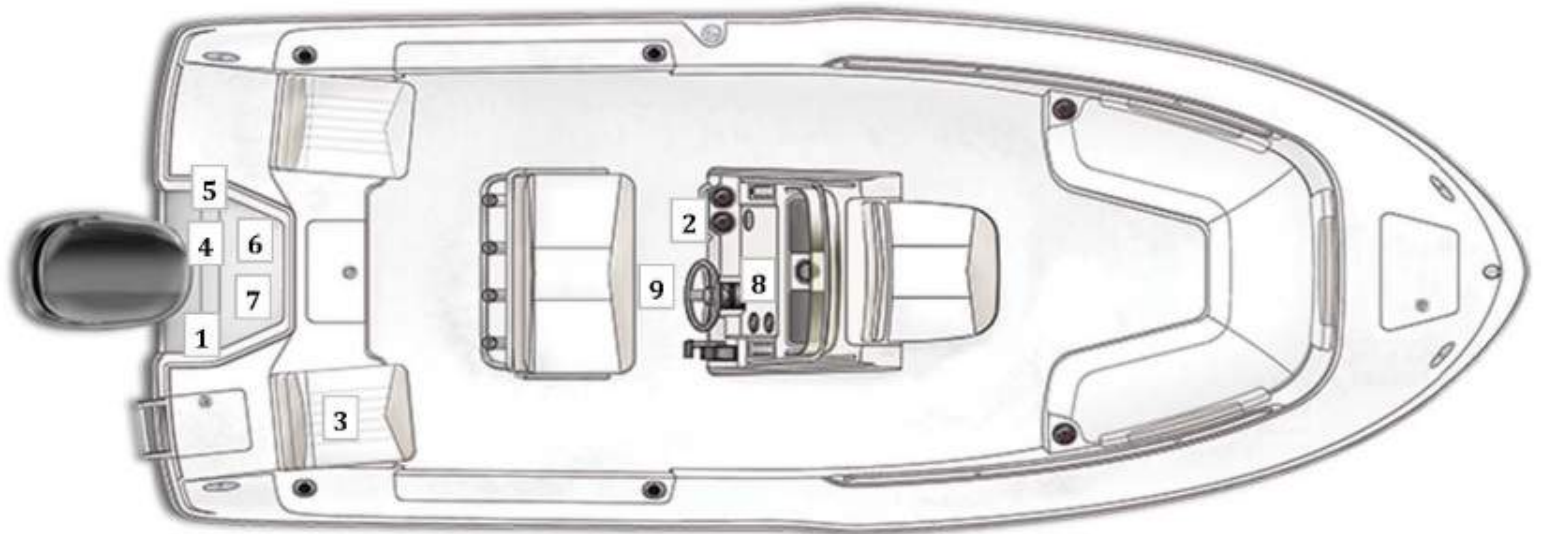

R200

2019 ROBALO CENTER CONSOLE



1. Bilge Pump and Float
2. Battery Selector Switch
3. Batteries (2)
4. Livewell/Raw Water Seacock
5. Sea Strainer
6. Livewell Pump
7. Raw Water Washdown Pump
8. Steering Helm
9. Fuel Tank

R202EX

2019 ROBALO CENTER CONSOLE



- A - Strong Points for Anchoring/Docking
- B - Sling Locations
- C - Trawling Eye

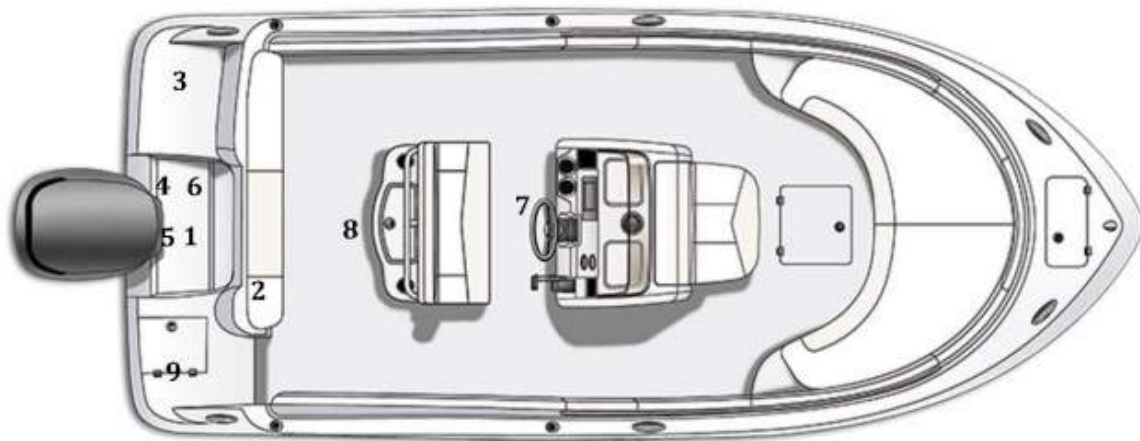

- 1 - Aft Bilge Pump and Float
- 2 - Battery Selector Switch
- 3 - Batteries (2 ea)
- 4 - Livewell/Raw Water Seacock
- 5 - Sea Strainer
- 6 - Livewell/Raw Water Washdown Pump
- 7 - Steering Helm
- 8 - Fuel Tank
- 9 - Water Tank

R222

2019 ROBALO CENTER CONSOLE



1. Aft Bilge Pump and Float
2. Battery Selector Switch
3. Batteries (2)
4. Livewell/Raw Water Seacock
5. Sea Strainer
6. Livewell/Raw Water Washdown Pump
7. Steering Helm
8. Fuel Tank
9. Water Tank

R222EX

2019 ROBALO CENTER CONSOLE



- A - Strong Points for Anchoring/Docking
- B - Sling Locations
- C - Traling Eye



- 1 - Aft Bilge Pump and Float
- 2 - Battery Selector Switch
- 3 - Batteries (2 ea)
- 4 - Livewell/Raw Water Seacock
- 5 - Sea Strainer
- 6 - Livewell Pump
- 7 - Raw Water Washdown Pump
- 8 - Steering Helm
- 9 - Fuel Tank
- 10 - Water Tank

R242

2019 ROBALO CENTER CONSOLE



- A - Strong Points for Anchoring and Docking
- B - Sling Locations
- C - Trawling Eye



- 1. Aft Bilge Pump and Float
- 2. Battery Selector Switch
- 3. Batteries (2ea)
- 4. Livewell/Raw Water Seacock
- 5. Sea Strainer
- 6. Livewell Pump
- 7. Raw Water Washdown Pump
- 8. Steering Helm
- 9. Fuel Tank
- 10. Water Tank

R242EX

2019 ROBALO CENTER CONSOLE



1. Aft Bilge Pump and Float
2. Battery Selector Switch
3. Batteries (4 each)
4. Livewell/Raw Water Seacock
5. Sea Strainer
6. Livewell Pump Aft
7. Livewell Pump Fwd
8. Raw Water Washdown Pump
9. Steering Helm
10. Fuel Tank
11. Sump Pump
12. Water Tank
13. Water Pump and Filter

R302

This chapter describes standard and optional components factory installed on our pleasure boats. Depending on how your boat is equipped, it may or may not have all of the equipment described in this chapter.

Be sure to read all operation, maintenance, and safety information contained in each component's manual before operation. The manuals are in your owner's packet.

Important: Adhere to all safety precautions in the manufacturer's literature when operating the components.



WARNING: When using electrical components, observe safety precautions to reduce the risk of fire, electrical shock, personal injury or damage to your boat and/or component.

Dashboard and Instrument Panel

Instruments on the dashboard are important for monitoring the performance of your boat and alerting you to possible problems or causes of problems.

Most Robalo boats are equipped with a Yamaha Instrument Operation. Please refer to the quick reference information at the end of this section for set up and usage instructions. For boats equipped with the Command Link Plus system, please see the component owner's manual for Command Link Plus provided by Yamaha.

The **fuel gauge** indicates the approximate amount of fuel in your fuel tank. The reading is most accurate when your boat is operating at idle speed. Be aware that you should compare gauge readings with hours of use versus known fuel consumption because the gauge is only an approximate reading of the amount of fuel in your boat's tank.

The **voltmeter** indicates battery voltage. When the engine is running, the meter should read between 12 and 15 volts. A significantly lower reading may indicate a battery or alternator problem or a heavy drain on the battery. If the voltmeter needle moves back and forth in wide swings, the alternator may not be charging properly.

The **tachometer** indicates the operating speed of the engine in revolutions per minute (RPM). It does not indicate the speed of your boat moving through the water. Do not exceed the maximum full throttle RPMs stated in the engine operator's manual.

The **speedometer** indicates the speed your boat is crossing the water in miles per hour. Water pressure from a water pickup at the boat's stern is measured and converted into a reading on the speedometer.

The **compass** indicates the direction or heading in which your boat is traveling. Have the compass calibrated by an experienced technician. See the manufacturer's instructions manual for details about proper operation and maintenance.



CAUTION: Compass reading may be erroneous if compensator is not properly adjusted. Always make a deviation table and use it when navigating with a compass.

2019 ROBALO CENTER CONSOLE

Windlass System

Some models come equipped with a windlass option. Your anchor can be raised and lowered with the windlass by a toggle switch located at the helm or by two separate foot switches located at the bow of the boat. It is important to remember to use the anchor safety lanyard on the anchor chain when anchor is in fully retracted position. By attaching the lanyard clasp to one of the chain links, you are protecting your boat from any incidental damage from a swinging anchor. (Figure 4.1)

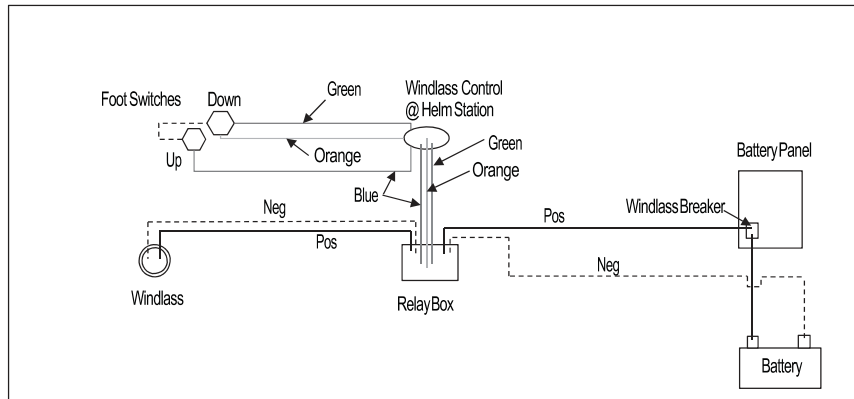

Figure 4.1 Windlass Schematic

Note: When anchor is in the up position and locked in slot, be sure to secure the anchor to the deck before getting underway

Windlass Safety Tips

- Always tie off rode while at anchor
- Always secure rode/anchor when under way
- Always look before deploying your anchor
- Always motor up to anchor while retrieving
- Never use your windlass to pull or tow boat
- Never stick fingers in or around gypsy while operating
- Always shut off breaker when working on windlass
- Always shut off breaker when windlass is not in use

- Keep all loose clothing and hair away from windlass when operating
- Never use windlass to lift a person

Refer to owner's manual packet for instructions and warranty information.

Hydraulic Steering System (N/A on Robalo 160)

Your boat has a hydraulic steering system. This system has two basic elements: helm pump and cylinder. The steering wheel is mounted to the shaft of the helm pump. Turning the steering wheel pumps hydraulic fluid to the steering cylinder. Extra hydraulic fluid prevents air from entering the system. A relief valve protects both the mechanical portion of the rudder (in case the rudder strikes a hard object) and the hydraulic system. This is a manual system, not a power steering system. The effort required to turn the wheel will increase as the system is called on to exert more force on the engines. At no time, should anyone expect this system to turn as easily as a car's power steering.

Check the level of hydraulic fluid in the helm regularly and replenish, if necessary. All other maintenance should be performed by your dealer.

Power Steering Unit

Your boat may have an optional or standard power steering unit for the hydraulic steering system. This unit is powered off of one engine only. If you lose power to the power steering system due to an engine or electrical issue, you will still maintain your normal hydraulic steering system

Multifunction Navigation Display System

An optional high performance multifunction display is available on select models. Robalo provides one of the most powerful multi-function navigational display systems, packed with power and performance features. Boat owners will have access to 3D chart-plotting, HD Digital technology, Sirius Satellite Weather and more.

2019 ROBALO CENTER CONSOLE



Caution: Acceleration at full throttle is not recommended for certain periods of the engine “break-in period.” Refer to the engine owner’s manual for more details.

Throttle

The throttle controls the boat’s speed and the direction the boat travels. If the throttle is in its center neutral position, the boat will not move forward or aft with the engine running. Moving the throttle forward from center moves the boat forward. Moving the throttle aft moves the boat backward. The speed at which the boat moves is directly related to how far the operator pushes the throttle.

Note: The throttle must be in its center neutral position before the engine will start. See your engine manufacturer’s owner’s manual for specific starting instructions.

Controls

Steering

Other than the common sense and good judgment of the operator, the steering system is the most important safety system on your boat. Factors requiring operator attention for safe steering include engine torque, trim tab settings, waves and speed.

Power Trim

The power trim system allows the operator to raise and lower the stern drive to adjust the drive angle while underway. It also allows the operator to raise and lower the drive for trailering, beaching, and operation in shallow water. Control your trim setting with the trim switch on the control handle. Section 5 discusses the importance of proper trim while operating your boat.

Note: Refer to your engine manufacturer’s owner’s manual for information concerning maintenance and operation.

Bilge Pump

Note: All models come equipped with an automatic bilge pump that will activate when water accumulates in the bilge. There is also a switch at the helm for manual activation.

The electric bilge pump removes water from the bilge area. If the pump motor runs but does not remove any water, the pump may be clogged. If there is no visible debris clogging the pump and water is still not being removed, check the discharge hose for kinks or obstruction.

Note: The Federal Water Pollution Act prohibits the discharge of oil or oily waste into or upon the navigable waters and contiguous zones of the United States if such discharge causes a film or sheen upon, or discoloration of, the surface of the water, or causes a sludge or emulsion beneath the surface of the water. Violators are subject to a penalty.

Running and Navigation Lights

If you operate your boat at night, the law requires you to turn your boat’s running lights ON. Your Robalo boat has one white, one red (port), and one green (starboard) light. Check running lights periodically for proper operation. Check them before heading out after dusk.

There are various running light combinations for the types of vessels you may encounter while boating. You should learn to identify what these combinations are and the type of vessel they are associated with. Robalo recommends participation in a “safe boating” course to learn more about the various light combinations.

The running/navigation lights are controlled at the helm station by a three position rocker switch. This allows for selection of the mast

2019 ROBALO CENTER CONSOLE

(white) light ON when anchored or moored, or to have the mast (white), port (red) and starboard (green) lights all ON while underway.

Docking Lights

Docking lights are available on select models. Halogen docking lights are used for safe night time docking, and are glare-free because they mount below the deckline. If your boat is equipped with docking lights, they are powered by a switch at the helm.

Underwater Lights

Underwater lights provide boating enthusiasts with the latest enhancement for their boat, insuring a memorable experience and creating a unique signature visible from shore or other boats. If your boat is equipped with LED underwater lights, they are powered by a toggle switch at the helm.

It is the boat owner's responsibility to manage battery voltage while using this feature, to ensure battery(s) are not drained to a point where engine will not start.

Refer to owner's manual packet for instructions and warranty information.

Stereo Sound System

The stereo in your boat is equipped with an AM/FM radio, MP3 Jack, and premium water resistant speakers. Our sound systems are Sirius Satellite Ready. The stereo will turn off when motor is cranked. This is normal operation. The stereo memory has power at all times.

Note: It is the boat owner's responsibility to manage battery voltage while using this feature to ensure battery/batteries are not drained to a point where engine will not start.

Refer to owner's packet for instructions and warranty information.

Transom Shower

Nothing is more luxurious than being able to rinse yourself off with fresh water after swimming or water skiing in salt water. An optional or standard transom shower, depending on model, is located at the transom and has pressurized water. Most showers have a push button shower head. Pressure water switch is located at helm.

Fire Extinguishers

As the boat owner, you are responsible for making sure you have the required number of fire Extinguishers. Fire Extinguishers must be approved by the U.S. Coast Guard.

Boats longer than 26 feet and shorter than 40 feet: Two Type B-1 or at least one Type B-2 portable hand Extinguishers. If your boat has a fixed fire extinguishing system approved by the U.S. Coast Guard, one Type B-11 extinguisher is required.

Boats longer than 16 feet and shorter than 26 feet: At least one portable hand Type B-1 fire extinguisher.

All fire Extinguishers should be mounted in a readily accessible location away from the engine compartment. Everyone on board should know where the fire Extinguishers are and how to operate them.

If your fire extinguisher has a charge indicator gauge, cold or hot weather may affect the gauge reading. Consult the instruction manual supplied with the fire extinguisher to determine the accuracy of the gauge.

This chapter discusses the operation of your boat from the beginning of a boating excursion to its end. We'd like to remind you to be kind to our environment while you're boating. Don't throw garbage and other refuse overboard. And do your best to keep harmful compounds like gasoline and antifreeze out of the water.



Transporting your Boat

A correctly selected trailer supports your boat properly, makes towing safer, and makes unloading and loading in varying weather conditions easier.

Important: *Improper trailering is one of the major causes for damage to the hull. The warranty does not cover damage of this type.*

NOTE: **Ensure all snap-in carpet has been rolled up and secured prior to moving to prevent carpet damage.**

The type and size of the side supports, or pads, are very important. Side supports run lengthwise to the boat and parallel to the keel. Side supports should only be tight enough to keep the boat from leaning side to side. Any unnecessary pressure will damage the hull. Newer trailers have self-adjusting side supports and a bow pad that can be easily adjusted. These eliminate the need for manually adjusting side supports and keel rollers every time you load your boat. Your Robalo dealer can help you select the best trailer for your boat.

Inspect your trailer regularly to make sure the side supports are in good working condition. Check bolts securing rollers and supports from time to time to make sure they are tight.

The trailer should be designed and built to carry the full weight of your boat, engine, and gear while providing support for the hull. Be sure not to overload your trailer by loading the boat with excess baggage, camping equipment, etc. Check the certification label on the frame of the trailer. It is required to show the gross vehicle weight rating. Be sure the total weight of your boat, engine, fuel, gear, and trailer does not exceed this rating. Make sure your towing vehicle has a hitch appropriate for the rating.

2019 ROBALO CENTER CONSOLE

Distributing the weight on the trailer is important. Place the heaviest items at the bottom of the boat over a roller or chock, and secure them to keep them from shifting.

Balancing the load on the trailer is also important. If too much weight rests on the hitch, the towing vehicle will over steer, a condition that causes the front end of the vehicle to sway. Conversely, too little weight on the hitch causes the trailer to fishtail. In both cases, the vehicle will be difficult to handle and at higher speeds the swaying or fishtailing can become uncontrollable and result in personal injury and damage to the boat, trailer, or towing vehicle.

Weight on the hitch, or tongue weight, should be 5% to 10% of the total weight of the loaded trailer to avoid overloading the tow vehicle and to provide adequate pressure on the hitch ball. If the weight of the loaded trailer is 2000 pounds, the weight on the tongue should be between 100 and 200 pounds. A weight distributing hitch transfers portions of tongue weight to a point between the front and rear wheels of the towing vehicle and to the trailer wheels.

Important: Bumper hitches are not safe and are illegal in many states.

DISCLAIMER:

TOWING REGULATIONS REGARDING GROSS VEHICLE WEIGHT RATINGS VARY BY STATE AS WELL AS REQUIREMENTS FOR BRAKES. CHECK YOUR STATE REGULATIONS TO DETERMINE THE BRAKE REQUIREMENTS FOR YOUR BOAT, MOTOR AND TRAILER PACKAGE.

ROBALO ASSUMES NO LIABILITY FOR THE TRAILER REQUIREMENTS SPECIFIC TO YOUR STATE.

The brake system is usually completely self-contained on the trailer and no hook-up is required to the towing vehicle. Brakes are either drum or disc type. They work the same way as the brakes on a standard

passenger vehicle, but the method of applying the brakes is different. Your Robalo or trailer dealer can explain how the brakes on your trailer work.

Make sure your boat is secure before towing it.



WARNING: Improper towing can result in an accident causing personal injury and equipment damage. Become familiar with towing instructions in owner's manual and with warnings supplied with your trailer and towing vehicle. Ensure all snap-in carpet is stowed during trailering to avoid damage to carpets.

- Close all windows, hatches, and doors.
- Store equipment to keep it from shifting or falling.
- Remove and store convertible top if your boat is so equipped.
- Use a second safety chain to secure your boat's bow to the trailer tongue. Tie down the stern to the trailer.

Towing a boat requires extra caution by the vehicle's driver. Allow extra distance between vehicles. Obey speed limits. Some states have lower speed limits for vehicles with trailers. If you are traveling slower than other traffic, pull over when it is safe to do so and allow traffic to pass. As with all other aspects of owning and operating your boat, use common sense and good judgment.

If you do not have experience backing a trailer, practice before you get into a confined public or private launch site. Take your trailer to an open area and get accustomed to using it. If possible, take someone with you who knows how to back a trailer.

2019 ROBALO CENTER CONSOLE

Steering a trailer while backing it up works the opposite of steering a car. If the trailer needs to go to the right, turn the steering wheel to the left and vice versa. Inexperienced backers tend to turn the wheel too far. Do not over steer. Turn the wheel gradually until you get the feel of safe backing.

Launching and Loading

The handling of your boat and trailer at the ramp requires practice, skill and patience. With care and attention to the following tips, you can launch and relaunch your boat with relative ease.

Important: Typically a beam of 8 feet 6 inches allows you to tow without a special permit in most places. These boats are considered “trailerable” for this reason. Other boats have wider beams and are still “trailerable,” but, in most cases you need a permit to do so. Check with your state on permit requirements before towing.

Roller Trailers – Launching and Loading

Robalo recommends you follow the trailer manufacturer’s guidelines for launching and loading your boat.



WARNING: If the winch handle slips out of your hand, let it spin. DO NOT try to stop it

Bunk or Custom Trailers – Launching

Here are some tips to remember when you are putting your Robalo boat in the water:

Important: Before launching your boat, make sure the transom drain plug is installed. If it is not installed, the bilge could fill with water quickly.

1. Always prepare the boat for launching before you get to the ramp. Stop in a launching prep area near the ramp that doesn’t block traffic and remove your tie-downs, tilt up your engine or drive unit, replace your transom drain plugs, etc.
2. Have someone at the ramp to give you directions. Slowly back the trailer down the ramp to the water. If there isn’t a ramp available, use a solid area of ground to the shore, with a slope if possible. Avoid wet, soft sand. Always remember to launch your boat at a right angle to the shore.
3. Back the trailer down the ramp until there is enough water to make the boat float. Because the bunks generate more friction than rollers, you need to back the trailer further into the water.
4. Tie a mooring line to the boat so you will have control once it is floating.
5. Unfasten the boat bow safety chain. Hold the winch handle securely, reverse the winch lock and begin unwinding the line. Unwind it slowly and carefully.
6. On an average grade, the bunks on your trailer will allow your boat to gently slip back and float into the water. If your boat doesn’t immediately move, try unwinding about six inches of line, lock your winch and give the boat a push. Then unlock the winch and try again. If this doesn’t work, you might try backing the trailer deeper, if possible.
7. Care should be given when launching from trailers with bunks that are equipped with plastic-like materials. These materials make the bunk surfaces very slippery, and the boat may begin to unload as soon as tension is released on the winch cable/strap.

2019 ROBALO CENTER CONSOLE

Bunk or Custom Trailers – Loading

When loading, always prepare for the procedure prior to reaching the ramp. If the ramp is busy, preparation will shorten the time it takes for you to get your boat out of the water.

You probably won't have to back the trailer into the water as far to load the boat as you did to launch it. In fact, the easiest way is to back your trailer up until the rear of the bunks are in the water. By not putting your trailer too deep in the water, your boat will actually center itself on the bunks about 1/3 to 1/2 the distance onto the trailer.

Connect the winch cable/strap to the bow eye of the boat. Lock your winch before attempting to wind the cable/strap in. Once your boat is aligned and is pulled firmly against the winch stand roller or Vee block and

your winch is in the locked position, connect the boat bow safety chain and you are ready to drive to the loading/preparation area near the ramp to connect all other tie-downs, lighting or electric brake connections, etc.

Common Cause of Boat Misalignment

If your boat doesn't sit level in the water or your bunks or rollers are not adjusted properly, you may have misalignment problems with your boat when loading. Basic correction procedures are as follows:

Correction Procedures

Re-measure all roller assemblies that set in a line across from each other. Make sure the distance to each roller from the centerline of the trailer is equal. In other words, the left side of your trailer should be exactly the same as the right side. This is true of bunk or roller trailers.

If your boat keeps going to the port (left) side, remove the boat and loosen the U-bolts and/or the through bolts that clamp the roller assemblies on the stern (back) section of the trailer. Force each

assembly to the right as if you were trying to turn the handlebars of a bicycle. Hold each assembly in this turned position and retighten the U-bolts and/or through bolts.

This repositioning of the roller assemblies should correct the misalignment of the boat on your trailer. If your boat goes toward the starboard (right) side, reverse the procedure.

Another common reason for boats not centering themselves is putting the trailer too deep in the water, which does not allow the trailer adequate time to center the boat. This is especially true on roller style trailers.

Note: Make sure your trailer is not too deep in the water or the boat will float over the rollers and be difficult to load and center.

Boarding Your Boat



Larger pleasure boats remain stable under most operating conditions because of their beam, draft, and weight displacement. However, the U.S. Coast Guard does require that a capacity plate be affixed to all boats up to 20 feet long. This plate states the maximum load capacity. The plate shows persons and gear in pounds the boat will handle safely under normal conditions. The U.S. Coast Guard establishes these load capacity ratings. Overloading and improper distribution of weight are significant causes of accidents. Keep weight below maximum limits for safety in turbulent water.

Important: The presence of the capacity plate does not relieve the boat operator from the responsibility of using common sense or sound judgment. Turbulent waters and adverse weather conditions reduce the maximum load capacity rating of the boat.

2019 ROBALO CENTER CONSOLE

When loading your gear on board your boat, remember to distribute the load evenly, keep the load low and do not overload. Always step onto the boat, never jump! Have someone on the dock pass your gear aboard. Secure all gear firmly so that it will not move or interfere with operation of the boat.

The way your passengers are seated and gear stowed in the boat affects your boat's performance. Passengers should board the boat one at a time and find a seat. Passengers should remain seated during loading of gear to maintain an even trim. Distribute your passengers and gear so that your boat is balanced side to side and front to rear (Figure 5.1)

As the operator, you are responsible for the safety of your passengers.

- **Do not** allow passengers to ride on the bow with feet hanging over the side.
- **Do not** allow passengers to ride sitting on the stern or gunwales. Falling from moving boats is a major cause of fatal recreational boating accidents.
- **Do not** allow passengers to sit in the bow rider area (if so equipped) while underway; doing so will obscure the operator's vision.

A shift in passenger weight changes the planing angle of the hull or the thrust of the propeller. This has the same effect on the boat as if the angle of the drive unit were changed. Minor deficiencies in your boat's ride can be quickly corrected by shifting passengers or gear forward or aft. By taking a little extra time to carefully place such gear as coolers, water jugs, tackle box, anchor, and tools, you create a more desirable trim. On planing-type boats, utilize stern loading in order to slightly raise the bow.



Correct

Balanced load: Gives maximum performance



Incorrect

Overload forward: Causes boat to plow



Incorrect

Overload aft: Causes boat to porpoise

Figure 5.1 Boat Landing

Swim Platform and Boarding Ladder

To board or re-board your boat, ensure to follow the proper steps to avoid injury. For all Center Console boats, with exception of the R242 and R302, the ladder is located under a lid on the swim platform. Lift the latch to free the ladder and unhook the bungee strap holding the telescoping ladder together. Pull on the last rung to extend the ladder out the entire way before placing your weight on it. Using the grab bar at the top of the ladder, carefully climb to enter the boat. Remember to stow the ladder before starting the engine. To stow the ladder, lift it up and push the rungs into each other until the bungee strap can be used to secure the ladder then place it back under the lid and snap the lid closed. The R242 and R302 have periscoping ladders which are stowed inside the boat. You will unhook the metal knob keeping the ladder secured first then extend the ladder all the way. Lastly, push down on the rungs to open them for use. To stow, lift the rungs to fold them inside the ladder bar. Lift the ladder bar until it is parallel to the ground and push the entire ladder up inside the boat and use the metal tab to keep it securely locked away.

2019 ROBALO CENTER CONSOLE

R160 Pending Approval

2019 ROBALO CENTER CONSOLE



R180

SPECIFICATIONS & CAPACITIES

SPEC/CAP.	US	METRIC
LOA:	18' 4"	5.59 m
Beam:	8'	2.44 m
Bridge Clearance:	6' 4"	1.93 m
Bridge Clearance with T-Top:	8'	2.44 m
Deadrise:	18°	18°
Fuel Capacity:	50 gal	189 L
Draft Down:	26.50"	67 cm
Draft Up:	10.50"	27 cm
Max HP:	150 HP	112 kW
Console Headroom:	5'	1.52 m
Dry Weight w/ Engines:	2600 lbs	1179 kg
Passenger Capacity (NMMA):	8/1200 lbs	8/544 kg

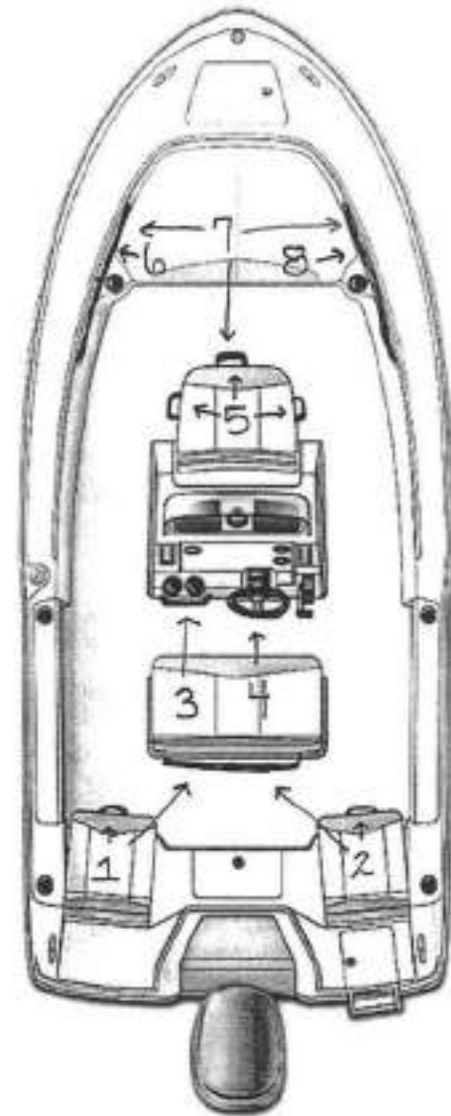

2019 ROBALO CENTER CONSOLE



R 2 0 0

SPECIFICATIONS & CAPACITIES

SPEC/CAP.	US	METRIC
LOA:	20' 7"	6.27 m
Beam:	8' 4"	2.54 m
Bridge Clearance:	6' 4"	1.93 m
Bridge Clearance with T-Top:	8' 6"	2.59 m
Deadrise:	18°	18°
Fuel Capacity:	70 gal	265 L
Draft Down:	30.00"	76 cm
Draft Up:	14.50"	37 cm
Max HP:	200 HP	149 kW
Console Headroom:	5'	1.52 m
Dry Weight w/ Engines:	3000 lbs	1361 kg
Passenger Capacity (NMMA):	8/1200 lbs	8/544 kg

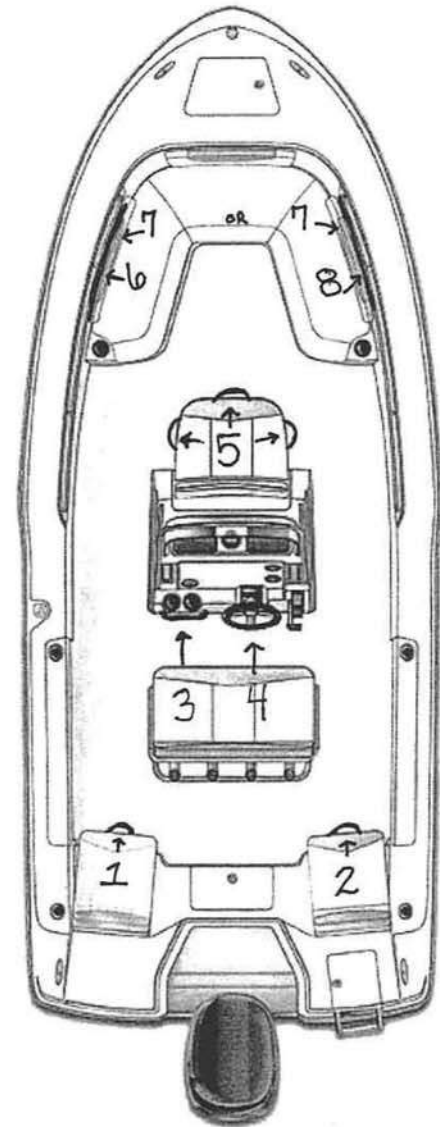

2019 ROBALO CENTER CONSOLE



202 EXPLORER

SPECIFICATIONS & CAPACITIES

SPEC/CAP.	US	METRIC
LDA:	20' 7"	6.27 m
Beam:	8' 4"	2.54 m
Bridge Clearance:	6' 4"	1.93 m
Bridge Clearance with T-Top:	8' 6"	2.59 m
Deadrise:	18°	18°
Fuel Capacity:	70 gal	265 L
Draft Down:	30.00"	76 cm
Draft Up:	14.50"	37 cm
Max HP:	200 HP	149 kW
Console Headroom:	5'	1.52 m
Dry Weight w/ Engines:	3000 lbs	1361 kg
Passenger Capacity (NMMA):	8/1200 lbs	8/544 kg

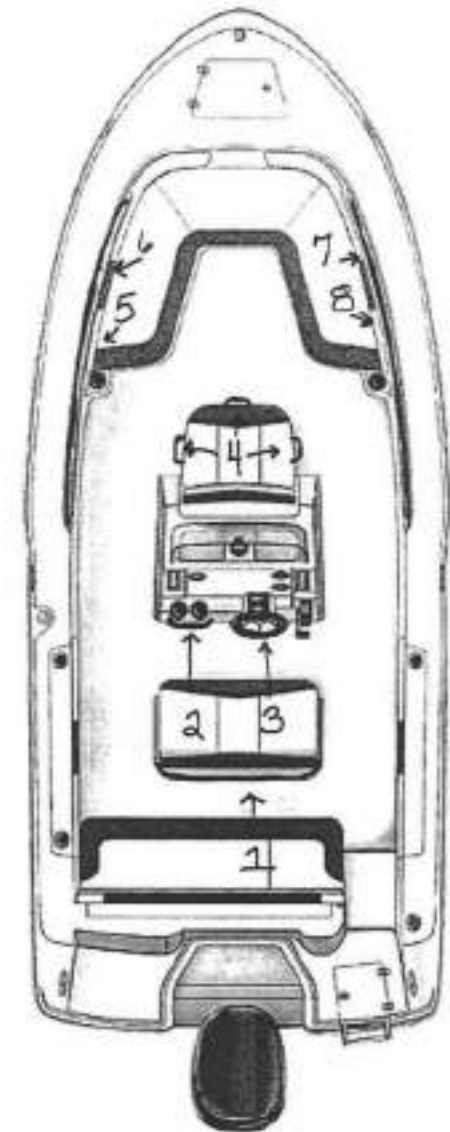

2019 ROBALO CENTER CONSOLE



R 2 2 2

SPECIFICATIONS & CAPACITIES

SPEC/CAP.	US	METRIC
LOA:	21' 6"	6.55 m
Beam:	8' 6"	2.59 m
Bridge Clearance:	6' 11"	2.11 m
Bridge Clearance with T-Top:	8' 2"	2.49 m
Deadrise:	21°	21°
Fuel Capacity:	90 gal	341 L
Optional Vacuflush System:	6.50 gal	25 L
Holding Tank Capacity:	3.80 gal	14 L
Water Capacity:	9.00 gal	34 L
Draft Down:	34.00"	86 cm
Draft Up:	18.00"	46 cm
Max HP:	250 HP	186 kW
Console Headroom:	5' 5"	1.65 m
Dry Weight w/ Engines:	3700 lbs	1678 kg
Passenger Capacity (NMMA):	10/1445 lbs	10/655 kg

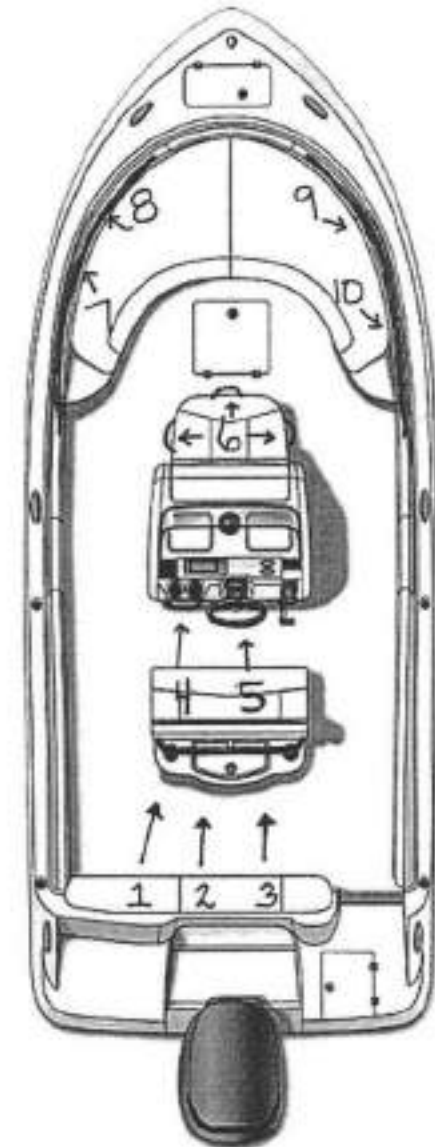

2019 ROBALO CENTER CONSOLE



222 EXPLORER

SPECIFICATIONS & CAPACITIES

SPEC/CAP.	US	METRIC
LOA:	21' 6"	6.55 m
Beam:	8' 6"	2.59 m
Bridge Clearance:	6' 11"	2.11 m
Bridge Clearance with T-Top:	8' 2"	2.49 m
Deadrise:	21°	21°
Fuel Capacity:	90 gal	341 L
Optional Vacuflush System:	8.00 gal	30 L
Holding Tank Capacity:	3.80 gal	14 L
Water Capacity:	9.00 gal	34 L
Draft Down:	34.00"	86 cm
Draft Up:	18.00"	46 cm
Max HP:	250 HP	186 kW
Console Headroom:	5' 5"	1.65 m
Dry Weight w/ Engines:	3700 lbs	1678 kg
Passenger Capacity (NMMA):	10/1445 lbs	10/655 kg

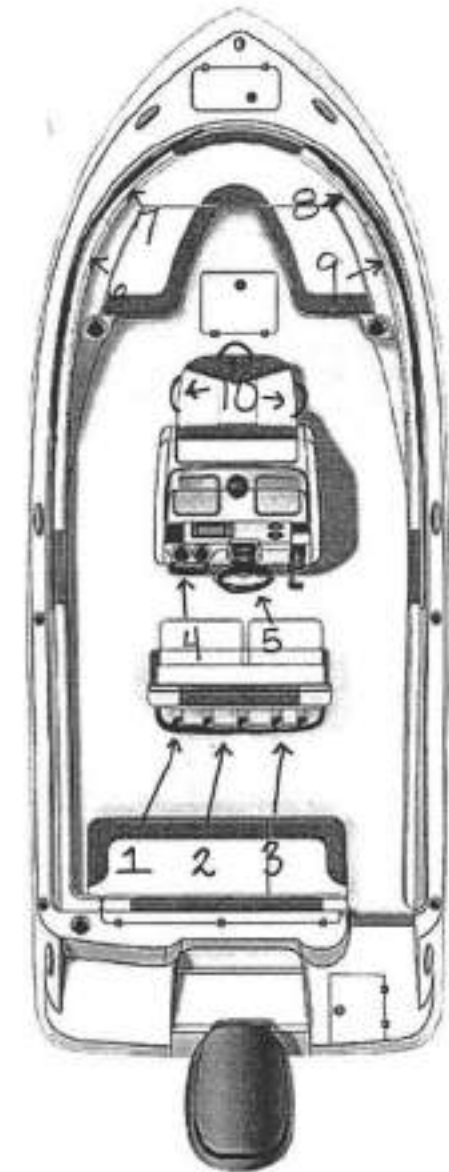

2019 ROBALO CENTER CONSOLE



R 2 4 2

SPECIFICATIONS & CAPACITIES

SPEC/CAP.	US	METRIC
LOA:	24'	7.32 m
Beam:	8' 9"	2.67 m
Bridge Clearance:	6' 3"	1.91 m
Bridge Clearance with Hardtop:	8' 7"	2.62 m
Deadrise:	22°	22°
Fuel Capacity:	150 gal	568 L
Optional Vacuflush System:	6.50 gal	25 L
Water Capacity:	13.50 gal	51 L
Draft Down:	35.00"	89 cm
Draft Up:	20.00"	51 cm
Max HP:	400 HP	298 kW
Console Headroom:	5' 5"	1.65 m
Dry Weight w/ Engines:	4800 lbs	2177 kg
Passenger Capacity (NMMA):	12/1725 lbs	12/782 kg

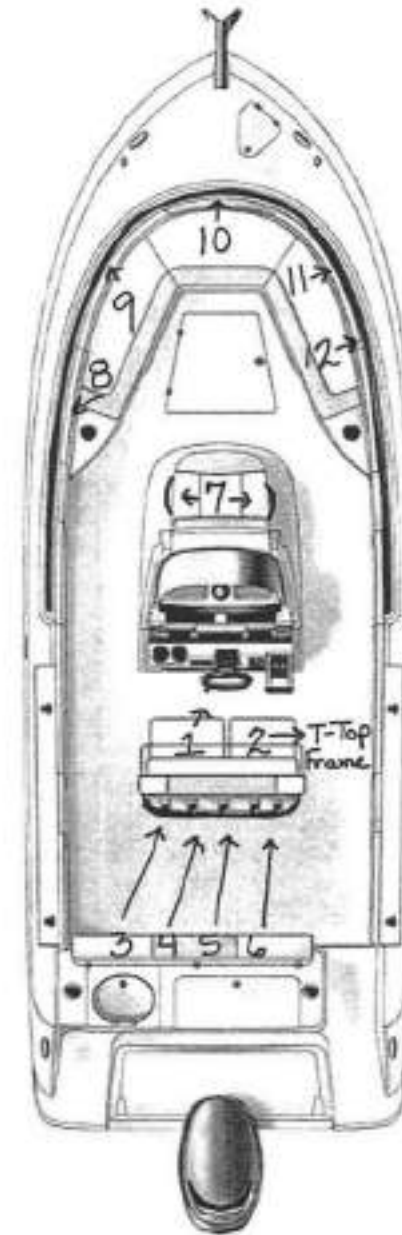

2019 ROBALO CENTER CONSOLE

 242 EXPLORER

SPECIFICATIONS & CAPACITIES

SPEC/CAP.	US	METRIC
LOA:	24'	7.32 m
Beam:	8' 9"	2.67 m
Bridge Clearance:	6' 3"	1.91 m
Bridge Clearance with Hardtop:	8' 7"	2.62 m
Deadrise:	22°	22°
Fuel Capacity:	156 gal	591 L
Optional Vacuflush System:	6.50 gal	25 L
Water Capacity:	13.50 gal	51 L
Draft Down:	35.00"	89 cm
Draft Up:	20.00"	51 cm
Max HP:	350 HP	261 kW
Console Headroom:	5' 5"	1.65 m
Dry Weight w/ Engines:	4800 lbs	2177 kg
Passenger Capacity (NMMA):	12/1725 lbs	12/782 kg

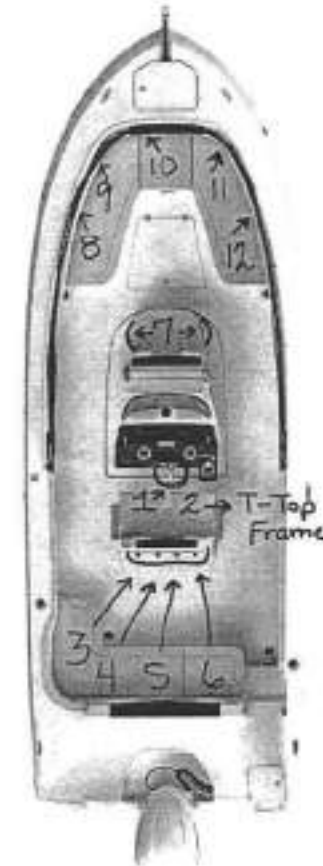

2019 ROBALO CENTER CONSOLE

R302 Pending Approval

2019 ROBALO CENTER CONSOLE

R317 Pending Approval

2019 ROBALO CENTER CONSOLE

Fueling

Improper fueling procedures are the most common cause of boat fires.



DANGER: Fuel leaking from any part of the fuel system can lead to fire and explosion that can cause serious bodily injury or death. Inspect systems before fueling.



WARNING: Do not smoke; extinguish all open flames, STOP engine and other devices that could cause sparks. Do not use electrical switches or accessories.

Ethanol-infused gasoline is widely available to today's boater. However, it may have harmful effects on marine engines and fuel delivery systems. Please refer to your engine manufacturer's owner's manual to find the recommended type and grade of fuel for your engine as well as a better understanding of the effects of ethanol on your engine.

Before fueling your boat, check the entire fuel system for leaks. Check for weakening, hardening, swelling, or corrosion of fuel system components. These include the fuel tank, fuel lines and fittings, fuel filter, and carburetor. Any sign of leakage or deterioration requires immediate replacement before further engine operation.

Pre-Fueling Procedures

1. Safely and securely moor your boat to the dock.
2. Turn off engine and all electrical equipment including lights, bilge pump, bilge blower, etc.
3. Extinguish all cigarettes, cigars, pipes, or other items that may produce a spark or flame.

4. Close all hatches, windows, doors, and compartments.
5. Make sure a fire extinguisher is readily available.

Fueling Procedures

1. Always fuel in an area which has sufficient lighting. Gasoline spills are hard to see when lighting is poor or it is dark.



DANGER: Fuel vapors are explosive and can become trapped within the lower portions of the boat. Close all hatches, windows, doors, and compartments while fueling your boat.

Important: *When fueling or having someone else fuel your boat, be sure the waste or water fill caps are not mistaken for the fuel fill cap. Also, make sure a fishing rod holder is not mistaken for a fuel fill plate.*

2. Your Robalo boat has fittings for filling the fuel tank on each side of the boat. Remove fuel fill plate. Insert the fuel supply nozzle. Allow nozzle to stay in contact with fitting to prevent possible static-produced sparks.
3. After pumping approximately 5 gallons of fuel into tank, inspect engine and fuel tank area for any signs of fuel leakage. Continue fueling if you do not detect any leaks or other problems.
4. Allow space at the top of the tank for thermal expansion. Do not over- fill tank so that fuel comes out fuel tank vent.

Note: Do not over fill tank, causing fuel to spill onto water.

5. If fuel cannot be pumped in at a reasonable rate, check for a plugged fuel vent plug or kink in the line.

2019 ROBALO CENTER CONSOLE

Post-Fueling Procedures

1. When you have finished fueling, replace fuel fill cap and wash off any fuel spillage around fuel fill area. Discard, in a safe place, any rags you may have used to wipe off fuel spills.
2. Open engine compartment and all hatches, windows, doors and compartments closed during fueling. Inspect these areas for fuel fumes or fuel line leakage visually and by smelling. Check out any sign of fuel leakage or any indication of fumes and correct problem before starting the engine.
3. Run bilge blower at least four minutes before restarting engine to ventilate engine compartment.

Operating Your Boat



DANGER: Carbon Monoxide Hazard! A cold engine produces more carbon monoxide than a warm engine. Provide adequate ventilation in the cabin and cockpit to prevent exposure and reduce the possibility of carbon monoxide accumulation. Open all hatches, doors, windows, and side vents to increase air movement.

Starting the Engine

Important: Falls from moving boats are a major cause of fatal recreational boating accidents. Do not allow passengers to ride on the bow with feet hanging over the side or ride while sitting on the stern, gunwales, or seat backs. The Coast Guard considers these acts to be negligent or grossly negligent operation and prohibits them by law.

The following information is only a general guide. Chapter 4 has specific starting instructions for boats with battery selector switches. Detailed instructions are also in the engine owner's manual. Be sure to read and follow all of those instructions.

1. Secure boat to the dock or mooring slip before attempting to start engine. Keep boat secure until engine is running and warmed up.
2. Check lubricating fluid levels. Check fuel supply to make sure you have enough fuel for your planned excursion.
3. To prevent an explosion or fire, look for leaks in fuel, oil, coolant, exhaust, and power steering systems. Be aware of any odors of these fluids.
4. Make sure the throttle is in the neutral position.

DANGER: Gasoline vapors are highly explosive. Run bilge blower for at least 4 minutes before starting engine. Check engine and fuel compartments for fumes or accumulation of fuel

5. Start the engine. Refer to your engine owner's manual for recommended procedures for break-in, service, and other related operation.
6. Turn ignition key to START. Release key and allow to return to RUN after engine starts. If engine fails to start, wait one minute. Move throttle only once to maximum position then back to the neutral position. Try to start engine again.

Note: Transmission must be in neutral position before engine will turn over.

Important: Do not operate starter continuously for more than 15 seconds without pausing. Allow starter to cool at least three minutes between start attempts.

2019 ROBALO CENTER CONSOLE

7. Warm up a cold engine by running it at fast idle speed (as recommended in engine manual) approximately one to two minutes.

Leaving the Dock

After the engine has warmed up, you are ready to leave the dock. Before you cast off, check all gauges, particularly the oil pressure gauge, for proper readings. Check the operation of the steering by turning the steering wheel to full port and to full starboard while observing outdrive movement. Check that charging system is working properly. Check again for fuel, oil, and exhaust leaks.

When you are sure your boat is ready, check wind, tide, current or other forces that will affect the way you maneuver your boat away from the dock. Then cast off mooring lines and stow fenders.

Shift your boat's engine into forward or reverse depending on whether you want to move the bow or the stern away from the dock first. Move the throttle lever to neutral position. Then push forward quickly and firmly to shift into forward gear or backward to shift to reverse. Your engine should be running at a slow speed as you move away from the dock. If you move the bow out first, watch that the swim platform does not swing into the

Getting Up to Cruising Speed

After slowly motoring from the dock area to open water, you can safely accelerate to cruising speed. Advance throttle to setting which provides your desired engine speed (RPMs). As you move the throttle forward, engine RPMs increase, and your boat moves faster through the water.

Important: Acceleration at full throttle is not recommended during the engine "break-in period." This "break-in period" coincides with the engine "20-hour check-up." Do not attempt full throttle acceleration during the first 20 hours of operation.

When you throttle up and accelerate, your boat increases the trim angle and causes the boat to ride bow-high. From a maximum angle, the boat levels out to its planing attitude as you continue to accelerate. (Figure 5.2)

The maximum angle is commonly known as the "hump." You should get over the hump as quickly as possible because visibility, handling, and performance are limited until you do. Only a few seconds at full throttle should be needed; however, the way your boat is loaded, the wind, and sea conditions affect the time required. When the boat gets over the hump, it reaches its planing attitude. Then, accelerate until your boat reaches a comfortable plane and then throttle down to cruising speed. This also provides for better fuel efficiency.

When maneuvering at low speeds you can reverse (move throttle forward or aft) the shift mechanism. This will react in a braking action.

Accelerate → Bow Rises → Planing Attitude



CAUTION: When shifting between forward and reverse, always pause in neutral for a few seconds before reversing the rotation of the propeller. This will prevent unnecessary damage to the drive system.



CAUTION: High speed acceleration in reverse can create a wake that could wash over the transom and flood the boat.

2019 ROBALO CENTER CONSOLE

Trimming Your Boat

Trim refers to the way a boat floats on the water. Your boat will work best when it is trimmed to run at an angle between 3 to 5 degrees to the water. You can trim your boat by shifting gear or passengers or, if your boat is so equipped, by adjusting the drive unit angle or the trim tabs.

Power Trim

The operator can adjust his craft to the ideal boat angle for load and water conditions by trimming the drive unit (Figure 5.3). The power trim system allows the operator to adjust the drive angle while underway by changing the angle of the outdrive in relation to the boat's transom. It also allows the operator to raise and lower the drive for trailering, beaching, launching, or operating in shallow water.

Note: Refer to your engine owner's manual regarding the operation of the power trim controls installed on your boat.

Drive Angle

The drive angle of the boat is the relationship between propeller thrust to the planing surface of the hull's bottom. You can improve the performance of the same boat under varying conditions by adjusting the drive angle.

Moving the drive unit angle towards its innermost adjustment brings the propeller in as close as possible to the transom. The angle of the propeller causes an upward thrust which pushes the boat's bow downward as shown on Figure 5.3.

By gradually shifting the drive unit from its innermost adjustment towards the outermost adjustment, the propeller thrust pushes in a downward motion. This motion, as shown in Figure 5.3, tends to lift the bow.

After reaching plane, under certain load conditions, your boat could have a tendency to bury its forward V-ed section. The boat will begin to plow and lose speed. If the water is choppy the boat will yaw. A boat will spin out if its bow is excessively buried. The only way to correct this situation is to increase the angle and swing the drive unit outward.

If the drive unit is angled out too far, your loaded boat will be sluggish in coming to plane. Once on plane, your boat will tend to porpoise. To correct this motion, move the propeller inward to decrease the angle between the drive shaft and the transom.



Correct
Gives maximum performance



Incorrect
Causes boat to "plow"



Incorrect
Causes boat to "porpoise"

Figure 5.3 Trimming the Drive Angle

2019 ROBALO CENTER CONSOLE

Very often, the optimum drive unit angle setting for the highest speed while carrying a light load will be just short of the porpoise point. However, such a setting is unsuitable when you have a heavy load or are pulling skiers. By reducing the drive angle, you will find it easier to maneuver the boat and to pull skiers to the surface.

Trim Tabs

Trim tabs also help the operator trim the boat. Trim tabs are mounted on the port and starboard transom below the water line. The operator can control the trim tabs at the helm with rocker switches. (Figure 5.4) Pushing the switch activates the system which moves its tab up or down.

If the trim tabs are angled down, they cut into the water as it passes under the hull to force the stern up and the bow down (Figure 5.5).

Trim tabs also compensate for uneven loads in the boat by allowing the operator to trim up one side of the boat or the other.

Lenco retractor feature

Lenco marine's trim tab retractor feature operates from either a 12v-24v signal or from an engine's analog tach signal. The purpose of the accessory signal input is to turn the trim tab control box on and off. When the control box is turned off, the trim tabs will retract.

Turn-on condition

When the Lenco accessory input is connected to either a 12v-24v signal or an analog tach signal, the control box turns on and the trim tab becomes active. At this time the boat operator can run the trim tabs up or down.



WARNING: Excessive trim decreases maneuverability, changes steering characteristics, and may cause "porpoising" (bow oscillates up and down) or "chine walking" (rocking side to side). Use power trim with care.

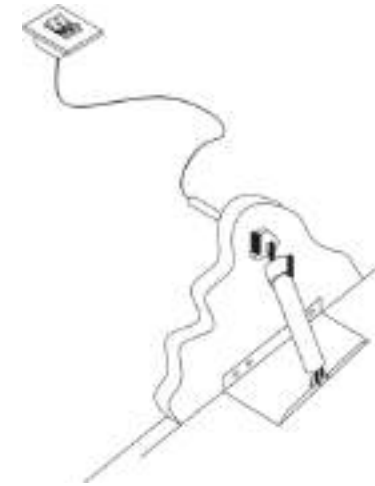

Figure 5.4 Trim Tab and Switch

Turn-off condition

If the Lenco accessory input is connected to an analog tach signal, the control box will shut down when the tach signal is lost (i.e. engine stalls, stops). If the Lenco accessory input is connected to a 12v-24v source, the control box will shut down when the voltage source is removed.

Test mode

Lenco marine's trim tab system includes a test mode feature that allows the boat operator to bypass the accessory input signal by holding down all four buttons on the key pad simultaneously for approximately three to four seconds. This will turn on the control box and allow the trim tabs to run up or down.

2019 ROBALO CENTER CONSOLE

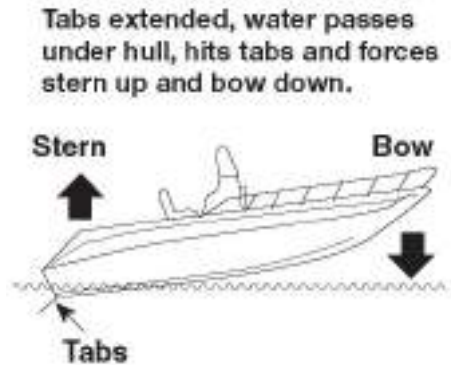

Figure 5.5 Trim Tab Operation

Once the control box is turned on in the test mode, the boat operator can turn the control box off by holding down all four buttons on the key pad simultaneously.

Important: If the control box is turned on in the test mode and subsequently receives a signal to turn it on via the accessory input, the boat operator cannot turn off the control box by holding down all four buttons on the key pad. The box will only turn off by removing the signal from the accessory input.

Note: Refer to your engine manufacturer's owner's manual for information concerning maintenance and operation.

Stopping Your Boat

A boat has no brakes. Stop the boat by allowing it to slow down to less than 5 miles per hour and then putting the engine in reverse. Slowly increasing reverse power will allow you to stop the boat in a short distance. Remember that a boat does not respond to steering in reverse as well as it does when going forward.

Additional Underway Information

- Always be aware of local laws on noise limits. Noise means engine noise, radio noise or even yelling by people on your boat. Good seamanship demands that you operate your boat quietly so as not to infringe on the rights of others. Don't use thru-hull exhaust unless you are well offshore



WARNING: Check behind you before coming OFF plane. Many accidents occur each year as a result of a driver coming off plane while being followed by a boat that is unable to slow down in time to avoid collision.

- You are responsible for any damage or injury caused by your boat's wake. Observe "No Wake" speed zone warnings. Operate your boat with regard for the safety of other boats and people in your boating area.
- Keep your engine well-tuned to decrease exhaust hydrocarbon emissions that pollute the air and water.

Anchoring Your Boat



Anchoring is necessary if you stop for recreation or an emergency. Practice anchoring techniques to make sure you know what to do when an emergency occurs. The size and weight of your boat govern the weight of the anchor and the diameter of the anchor line. Your Robalo dealer can help you select the proper anchoring equipment for your boat.

2019 ROBALO CENTER CONSOLE

Use a burying anchor, such as a Danforth or plow anchor, which grips into the bottom and holds your boat secure. Holding power should be more important than weight. For anchoring in relatively quiet waters, you can use a mushroom anchor as an alternative.

The length of the anchor line should be six to eight times the depth of the water to ensure that the anchor bites into the bottom. The bottom end of the anchor line should be galvanized chain which holds up well as the line moves back and forth on the bottom. The rest of the line should be nylon anchor line which stretches to soften the impact of wind and waves on your boat.

Following are general guidelines for anchoring your boat:

- Secure the anchor line to the bow eye or deck cleat. Do not tie line to hardware not designed to support this stress.
- Use two or more anchors if anchoring overnight or extended periods of time. Otherwise, make sure your boat has enough space to swing full circle in case of shifting winds.
- Keep the anchor and line in an area where it will be readily available in an emergency.

Dropping Anchor

1. Have a crew member carefully lower anchor, keeping a slight tension on the line as the anchor drops. Maintain tension after the anchor reaches the bottom. Simply throwing the anchor overboard usually fouls the line and requires starting over.
2. Maneuver the boat backwards slowly until the proper length of line is run out.
3. Fasten the anchor line around the bow eye or deck cleat. Anchor fluke should dig into bottom and hold boat in position.



WARNING: Keep anchor secure while underway to prevent damage or injury if boat's attitude changes suddenly.

4. Check shoreline landmarks at the time anchor is dropped and check again 30 minutes later. If position has changed, anchor is dragging and must be reset.

Weighing Anchor

Weighing, or pulling in the anchor, requires moving the boat in the direction of the anchor and pulling in the anchor as the boat moves. For this reason, the engines should be running. When the line is vertical, pull up firmly on the anchor line to free the flukes from the bottom. If the anchor remains stuck, feed out a few feet of line and attach it to the bow cleat. Maneuver the boat around the anchor, keeping the line taut, until you find an angle that will pull the anchor free.

Docking Your Boat

Important: When operating or docking in close quarters, maneuver your boat at idle speed. Proceed with caution in congested areas.

As you approach the dock or other mooring area, slow down your boat in time to allow your wake to subside before it reaches other boats or docks. As you get close to the dock, check for wind or currents, and allow them to carry the boat toward the dock if you can. When approaching, check that lines are attached to the cleats on the mooring side and that fenders are lowered on that side. Be sure fenders are at the proper height. If you can, have one person at the stern and one person at the bow, each with a boat hook and a mooring line attached to a cleat. Never approach a dock at a speed at which you would not want to bump the dock.

2019 ROBALO CENTER CONSOLE

To dock a boat to the starboard side:

1. Approach at an angle approximately 45 degrees to the dock.
2. When the bow is within a few feet of the dock, bring the stern alongside the dock by turning hard to port.
3. Turn to starboard and, at idle speed, put the engine in reverse to bring the stern closer to the dock.

Reverse these steps to dock to the port side

Mooring Your Boat

When attaching mooring lines to deck cleats on your boat, make a loop in one end of the mooring line. Then, pass it through the hole in the base of the deck cleat. Next, pass the loop back over the deck cleat. The mooring line can now safely be used to secure your boat. Mooring lines may remain attached to the cleats on your boat while underway. The lines must be coiled and placed where they cannot get tangled in deck gear or the propellers.

When you tie up, run the mooring line from your boat around the dock cleat and then back to your boat. This enables you to untie the mooring line without leaving your boat. Just throw off one end of the mooring line and then bring the entire length of mooring line back into the boat (Figure 5.6).

Shutting Down the Engine

Following are general instructions for engine shutdown. Refer to your engine owner's manual for specific instructions.

1. Allow engine to idle so engine cools gradually.
2. Turn engine off.

Note: Manila rope, the standard for many years is not as strong as some ropes made of synthetic materials. For mooring, its ability to

stretch is an advantage, but it tends to shrink whenever it gets wet. Nylon rope is strong and elastic. Because of its elasticity, it works well for mooring lines and anchor lines. Rope made of high tensile strength polyester fibers like Dacron™ is just about as strong as nylon rope, but it does not stretch. Kevlar rope is strong and does not stretch, but it is quite expensive. Polypropylene rope tends to deteriorate rapidly when it is exposed to sun light. Because it floats, it is well-suited for use as a tow rope for water skiing. Use for other nautical purposes is not recommended.

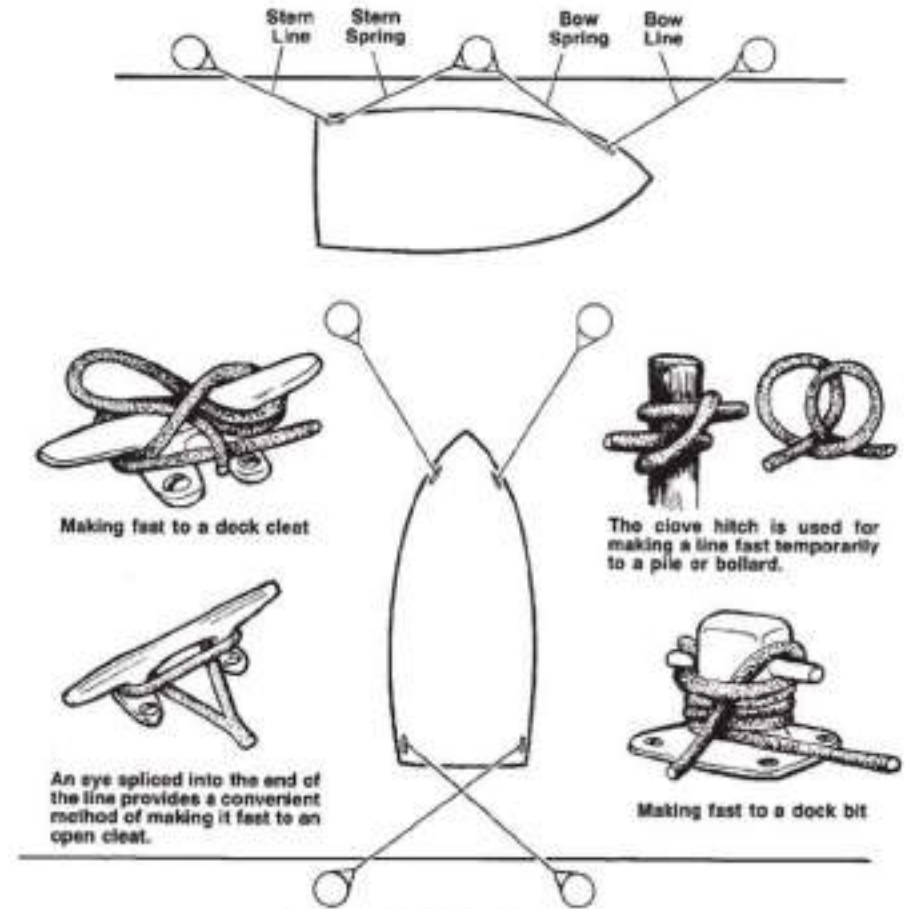

Figure 5.6 Mooring Lines

Do not attempt any repairs on your boat unless qualified to do so. Only use approved marine replacement parts available from your Robalo dealer. Robalo recommends having an authorized Robalo dealer do your maintenance and repair work. Your dealer is qualified to make repairs or modifications to your boat in such a manner as to not compromise safety, design integrity, or warranty coverage. This chapter includes information you can use to do general maintenance and repair. If you choose to do your boat's maintenance and repairs, always refer to the product manuals for detailed information.

Engine

Refer to the engine owner's manual for detailed information about engine maintenance and repair. That manual has a maintenance and service schedule for the engine on your boat.

Checking the Oil (On 4-Stroke Models)

Note: During the engine 10-hour break-in period, or as recommended by the engine manufacturer, Robalo recommends that you check the oil level every two hours.

To check the oil:

1. Make sure boat is in the water and engine is stopped.
2. Put the outboard motor in an upright position (not tilted).
3. If engine is warm, let it cool for ten minutes to allow oil to drain back into the engine oil pan. This will make the check more accurate.
4. Pull engine oil dipstick out of its sleeve, wipe clean, and push dipstick back into the sleeve. Make certain the dipstick is pushed all the way back in.
5. Pull dipstick out again and check oil level on dipstick. The oil level must be between the ADD and FULL marks on the dipstick.
6. If oil level is at or below the ADD mark you must add oil.
7. Push dipstick back down into the sleeve. Be sure it is all the way in and properly seated.

To add oil:

1. Remove oil fill cap from valve cover.
2. Add oil as required to raise the oil level up between the ADD and FULL marks on the dipstick. Do not overfill. One quart (0.95 liters) of oil will be required if oil level was at the ADD mark on the dipstick. Add more oil if oil level was below ADD mark on dipstick.
3. Check oil level after adding oil.

Note: Robalo Boats recommends that you use a funnel when you add oil to prevent spillage and to help keep your engine free of surface grime and dirt.

Important: *The Federal Water Pollution Control Act prohibits the discharge of oil or oily waste into or upon the navigable waters of the United States or the waters of the contiguous zone if such discharge causes a film or sheen upon or a discoloration of the surface of the water or causes a sludge or emulsion beneath the surface of the water. Violators are subject to a penalty.*

Fuel Filter



WARNING: Gasoline vapor explodes easily. Explosion is likely to cause fire and may burn you and damage your boat. Always STOP engine and do not smoke or allow open flames in area when changing filter.

Refer to your engine owner's manual for detailed information about checking and maintaining the fuel filter.

2019 ROBALO CENTER CONSOLE

The engine exhaust system removes harmful gas created by the engine during combustion. Inspect the system for leaks before each use of the boat. Make sure all hose clamps and connections are tight and there are no cracks in any exhaust system component that would allow carbon monoxide gases to escape.

Tune Up

Tune-ups at recommended intervals keep your engine in top-notch operating condition and help assure the highest possible performance from your engine.

Note: Refer to your engine owner's manual for detailed information.

Fuel System

This information describes the fuel system excluding the engine. The fuel system provides a clean, continuous supply of fuel to the engine, in addition to helping prevent possible fire and explosion. All fuel systems installed at the Robalo factory meet federal requirements.

Note: Refer to your engine owner's manual for detailed information about checking and maintaining the fuel system.

The fuel system must be inspected frequently and maintained regularly. Check for leaks and/or vapors and repair any problems immediately. Keep fuel tank filled during the boating season to prevent moisture from condensing in the tank.

Monthly Inspection

Note: A trained marine mechanic should replace parts or repair the fuel system. See your Robalo dealer for parts and repair.

1. Starting at the fuel tank, check the entire fuel system for leaks or vapors.
2. Check fuel lines and hoses for wear, kinks, cracks, or deterioration.
3. Inspect fuel line fittings, and fuel pump to make sure mounting brackets are tight.
4. Check fuel ventilation ducts and clamps for wear or damage.
Refer to the engine owner's manual for recommended frequency for checking stern drive unit and its oil.

Outboard Drive Unit

Refer to the engine owner's manual for recommended frequency for checking drive unit and its oil.

Propeller

Note: Refer to the propeller manufacturer's manual for installation, removal, and further detailed information.

The propeller shipped with your boat is the size Robalo recommends for the best overall performance. However, factors such as altitude, temperature, load, bottom growth, and propeller condition can affect your boat's performance. Consult your Robalo dealer regarding your specific performance requirements.

Periodically check propeller for excessive wear and damage. Repair or replace, if required.

2019 ROBALO CENTER CONSOLE

Steering System

1. Check all hydraulic lines and hoses for leaks. Make sure no lines and hoses rub against other parts and or come into contact with any extremely hot parts. Tighten all fittings and clamps as required.
2. Check all bolts for tightness
3. Check the steering fluid level in the helm.
4. Replace any hoses showing signs of wear and remove the cause or re-route hoses.
5. Check fittings and seal locations for leaks, damage, and service as necessary

Consult your Robalo dealer regarding all repairs or replacement parts.

Bilge Inspection

Check the bilge before you use your boat—every time! A small amount of water in the bilge is normal and not a cause for concern. If the amount of water is excessive, check for water leaks. Repair leaks immediately.

If the bilge is ever filled with fuel or oil, check engine, hoses, fuel tank(s), etc. for leaks. Repair immediately.

Important: Pumping fuel or oil overboard into the water violates the Federal Clean Water Act. Pump into suitable container and dispose of properly.

Cleaning

Run bilge until pump is dry. Remove all sand, silt, dirt, or foreign material. Make sure all limber holes are open and strainers are clean. Use bilge cleaner to remove any obvious oil stains.

Important: Never use any flammable solvents for cleaning the bilge. Check with your Robalo dealer for recommended cleaners.



WARNING: Gasoline or vapors in bilge can explode. Remove all sources of ignition. Do not start engine, repair immediately.

Interior and Exterior Care

The following information will help you keep the interior and exterior of your boat in tip-top shape. If you need more specific information, contact your Robalo dealer.

Note: Before you use a particular cleaning solution or method, test the material to be cleaned in a hidden or inconspicuous area for possible adverse reactions. Use cleaning agents sparingly. Never discharge cleaning solutions into the waterways. Do not use products containing phosphates, chlorine, solvents, or non-biodegradable or petroleum based products.

Fiberglass and Gelcoat

The hull and deck are made of fiberglass. The outer layer of the hull and deck is a color pigmented polyester resin, called gelcoat. Gelcoat is highly resistant to scratches that occur during normal boat use. Nevertheless, during the life of your boat, some damage to the gelcoat is bound to occur.

Gelcoat Maintenance

To remove and prevent the buildup of most salt, soil, and grime, clean the hull and deck regularly with household detergent and water.

Note: Make sure household detergent does not contain ammonia or chlorine. Because ammoniate or abrasive cleaners dull and discolor the gelcoat surface, they are not recommended for routine maintenance.

Gelcoat surfaces are very resistant to deep stains. To remove minor stains, wash the affected area with a soft cloth and household detergent. Then rinse thoroughly with clear water. If deep stains do occur, use a special fiberglass cleaner and stain remover.

Waxing the gelcoat surface regularly will help prevent soiling and preserve its luster. Robalo recommends a fiberglass wax that fills the gelcoat pores. Chemicals in fiberglass wax screen out harmful ultraviolet rays that cause fading of the gelcoat color.



CAUTION: Waxed gelcoat is slippery. Falls causing bodily injury or falls overboard are possible. Never wax deck surfaces that require sure footing.

Repairing Gelcoat Damage

Minor Scratches

Repair minor scratches with automotive rubbing compound or polishing wax. Follow the manufacturer's instructions. Although the scratches may not disappear completely, they should not be as noticeable. Apply rubbing compound or polishing wax to a damp, soft cloth. Rub the gelcoat surface with the damp, soft cloth in a circular motion.

Chips, Hairline Cracks, and Small Patches

Your Robalo dealer has qualified personnel capable of making this type of repair.

Robalo uses the finest gelcoats and resins available to prevent gelcoat crazing and hairline cracks. Over time your boat may develop slight hairline cracks in the outermost gelcoat layer. These usually do not damage the structure of your boat or affect its integrity.

2019 ROBALO CENTER CONSOLE

Hull Bottom Maintenance

If your boat will be in water continuously for more than 60 days in any 90-day period, Robalo recommends sealing the hull bottom with a high quality barrier coating. Failure to do so will void your hull blister warranty. Your Robalo dealer can recommend the best barrier coating product for your boat.

Never use wire brushes, scouring pads, or other abrasive materials or solutions on the bottom surface of your boat. They cause small scratch marks that will collect dirt, silt, sand, marine growth and other foreign materials.

Keep the hull bottom of your boat clean. Check it regularly for any signs of excessive wear or damage. Make needed repairs to the hull bottom as soon as possible. Accumulation of natural coatings from water and marine growth can create drag and limit the efficiency of your boat.

Bottom Paint (Anti-Fouling)

Important: Consult your Robalo dealer for recommended bottom paints and local laws that govern your area. Many states regulate the chemical content of bottom paints to meet environmental standards and regulations.

Anti-fouling bottom paint is designed to prevent marine growth by dissolving slowly. As a result, the bottom of your boat will usually need painting after the boating season. Some variables to consider when selecting a protective bottom paint are the water temperature, water pollution, salinity, current, and organic matter in the water. To protect and repaint the boat bottom, perform the following:

- Remove boat from water once a year. Scrub bottom with a soap and water solution and a bristled brush.

Note: Repainting the bottom is not necessary each time the bottom is scrubbed, as long as no bare areas are visible in the bottom paint.

- Sand entire bottom surface of the boat.
- Fair (smooth out) all rough areas as required.
- Clean bottom surface to remove all dust and foreign materials.
- Make sure bottom surface is completely dry.
- Apply new coat of bottom paint.

Allow new bottom paint to dry 24 to 36 hours. Never attempt to haul, paint, and launch on the same day.

Hardware and Fittings

Note: Always follow the manufacturer's recommendations found in your owner's packet for cleaning and maintaining deck hardware and fittings. These recommendations include the proper cleaning methods and cleaning agents.

Inspection

Inspect hardware and fittings to make sure they are tight. All screws, bolts, clamps, cleats, etc., should be secure.

Cleaning and Care

- Always clean stainless steel frequently with soap and water. Any cleaner safe for glass is usually safe for stainless steel.
- Always remove rust spots as soon as possible with a brass, silver, or chrome cleaner. Irreversible pitting will develop under rust that remains on stainless steel for any period of time.
- Always use a cleaner, like a good car wax, for added beauty and protection.
- Never use coarse abrasives like sandpaper or steel wool on stainless steel. These may actually cause rusting.
- Never clean with mineral acids or bleaches.
- Never leave stainless steel in contact with iron, steel, or other metals which cause contamination leading to rust or corrosion.

2019 ROBALO CENTER CONSOLE

Windshield and Portholes

Clean windshield safety glass with a glass cleaner or ammonia water; then rinse with plenty of clear water.

Important: Solvents can penetrate glass or porthole surfaces and cause hazing. Hazing obstructs visibility. Never use acetone, benzene, carbon tetrachloride, lacquer thinner or similar solvents to clean glass or portholes.

The canvas or weather covering windows are made of a synthetic material. Wash any Plexiglass, clear vinyl or other synthetic materials with a mild detergent or dishwashing liquid and water solution, then rinse with plenty of clear water.

When stowing plastic or vinyl windows, be sure they are dry. Make sure the vinyl is rolled and not folded or creased. Store them in a bag that will breathe.

Carpet

After a boating excursion, allow carpet to dry completely in the sun to prevent mildew.

Vacuum carpet frequently. Clean up spills as quickly as possible. Remove spots before they dry. Clean indoor/outdoor carpet with a mild detergent or dishwashing liquid and warm water solution and a scrub brush. After cleaning, thoroughly rinse carpet with clear water. Your owner's packet has more detailed information provided by the manufacturer. Follow the manufacturer's recommendations for cleaning and stain removal.

Ensure all snap-in carpets are stowed prior to trailering your boat to prevent damaging the carpet.

Seats Coverings and Vinyl

Because seat coverings and trim are made of expandable vinyl, extreme temperatures have little effect on them.

Note: Follow the manufacturer's recommendations for cleaning and seat covering and removing stains. These recommendations include the proper cleaning methods and cleaning agents.

Care

Place removable exterior cushions inside the boat when they are not in use.

Cleaning

Remove stains as soon as possible to eliminate any possible reaction between the staining agent and the vinyl. Wipe away dirt and smudges with mild soap and warm water. If additional cleaning is required, scrub with a soft bristle brush to remove dirt from textured patterns. Dry with a soft, lint-free cloth or towel.

Follow manufacturer's instructions closely. NEVER use steel wool, powdered abrasive cleaners, or bleaches. They will mar the surface and leave an unsightly appearance. Never use bleaches or solvents of any kind on monogram parts. Use mild soap and water. Bleaches and solvents will cause monograms to fade.

To store cushions onboard boat for winter or extended periods of time, open zippers and elevate cover away from foam padding. Place a small rounded object (for example, a plastic bowl) inside to allow for air circulation.

2019 ROBALO CENTER CONSOLE

Canvas (Weathering Coverings)

The canvas, or weather coverings, is 100% acrylic yarn. Besides its resistance to mildew, rot and weather, canvas also resists industrial pollutants and the effects of ultraviolet light from the sun. Canvas is breathable and, therefore, is not waterproof. Mooring covers are waterproof.

Care

- Keep the top up when boat is not in use or when it's raining.
- Never trailer your boat with the canvas up. None of the canvas or covers supplied with your boat were designed for the stress of highway speed trailering, and to do so may damage the canvas.
- Keep canvas clean. Acrylic fabric will not support mildew growth, but dirt and dust on the canvas will.
- Lubricate zippers with paraffin and snaps with petroleum jelly.
- If canvas or seams leak, apply a light coating of fluorocarbon based water repellent, or "303 High Tech Fabric Guard," available at most marine dealers.
- Allow all canvas to air dry before storing. Never store canvas damp or wet. Provide proper ventilation to limit the possibility of mildew.
- Avoid mooring under trees.
- Do not tow your boat with canvas attached to any hull or windshield mounted fasteners.
- Be careful not to scratch clear vinyl windows. Dry well before stowing. When stowing clear vinyl, make sure the vinyl is rolled and not creased.

Cleaning

- Wet down all canvas material. Scrub with a soft bristle brush and a solution of mild soap and water. Never use a detergent or bleach on your canvas.
- Brush or sweep the underside of the top. Spray with Lysol or other disinfectant to prevent mildew.

This chapter tells you how to winterize and store your Robalo boat in regions where temperatures fall below freezing. If you keep your boat in an area not requiring winter storage, Robalo recommends you perform an annual inspection, similar to the preparation for storage as indicated in this chapter. With proper care, you will have many years of enjoyable boating with your Robalo boat.

Lifting the Boat



WARNING: Lift slings may slip on the hull and result in serious injury or death from dropped load. Exercise extreme caution if in the vicinity of such activity. If possible, slings should be tied together before lifting.

Unless your boat is trailerable, have your dealer or qualified marina personnel lift your boat out of the water for you. Each boat has main frame components designed to support the boat when it is being lifted out of the water. Severe gelcoat crazing or more serious hull damage can occur if the lifting slings exert pressure on the gunwales. Flat, wide belting-type slings should be used. Don't use cable-type slings. The spreader bar at each sling should be as long as the distance across the widest point the sling surrounds.

- Never hoist the boat with more than a minimal amount of water in the bilge.
- Before lifting the boat, empty fuel and water tanks, especially if they have large capacities.
- Be sure to position slings as indicated by the diagrams in Chapter 3.
- Do not use deck cleats or bow or stern eyes for lifting the boat.
- Be sure boat remains level while being lifted to avoid sling movement or boat damage

- If using any boat lifting device other than slings, position lifting device so as not to put pressure on any underwater hull component including trim tabs.

Cradle

A cradle is the ideal support for your boat whenever it is not in the water. Properly designed and located, the cradle will support the boat under the main frames. Support at these points is essential for preventing damage to the hull. Purchase a cradle from your dealer to ensure that your boat has the correct support.

Dry Storage Preparation

Note: Refer to Chapter 7, Interior and Exterior Care, for specific cleaning solutions and procedures.

Deck

- Wash the deck and walkway surfaces.
- Clean all deck hardware, and apply a coat of rust inhibitor.
- Clean the indoor/outdoor carpet.

Hull

- Scrape off any barnacles or crusted marine growth.
- Scrub hull thoroughly to remove marine growth, scum and loose bottom paint.
- Inspect underwater gear and propeller for excessive wear or damage
- Apply fresh coat of bottom paint.
- Remove hull drain plug; store it in a safe place. Allow bilge water to drain, raise bow of boat during period of storage.

2019 ROBALO CENTER CONSOLE

General Housekeeping

- Clean boat interior including all cabinets.
- Lay all plastic cushions flat.
- Check for adequate air circulation around life jackets and other safety equipment left onboard.
- Clean and dry bilge. Remove any materials such as rags, sponges, or other cleaning material.
- Weather permitting, open all doors, hatches, portals, and windows to air out the interior for a day or two.
- If covering boat while in storage, use a cover constructed of fabric that allows for plenty of ventilation.

Systems and Components

In regions where temperatures fall below freezing, winterization of the systems and components is necessary. Failure to do so will seriously damage them. They include, but are not limited to: generator, air conditioner, strainers, hot water heater, sump pump, Porta-Potti, head, holding tank, water tank, sewer system, and water systems. Refer to the owner's manual for each component or system listed above for detailed information on winterization.

Note: Robalo strongly recommends having a qualified dealer perform winterization procedures for your boat.

Engine

Important: In regions where temperatures fall below freezing, winterizing your engine is necessary. Failure to do so will seriously damage the engine. Refer to your engine owner's manual for detailed winterization information.

Change engine oil before storing your boat. Refer to the instructions in your engine owner's manual.

Fuel System

Add a gasoline stabilizer solution to the fuel tank. Follow the product manufacturer's recommended procedure.

Battery

Remove battery from boat and store battery in a cool dry place away from freezing temperatures.



WARNING: Battery electrolyte can cause severe eye damage and burn your skin. Wear goggles, rubber gloves and a protective apron when working with battery. If electrolyte spills, wash the area with a solution of baking soda and water.

- Cover battery terminals with rubber or plastic caps to prevent accidental contact between battery posts and metal objects.
- Clean outside battery case, terminals, and battery clamps with a baking soda and water solution. Do not allow solution to enter battery cells.
- Clean battery posts and clamps with fine grit emery cloth. Use a light sanding motion when cleaning.
- Apply a light coat of petroleum jelly to cover end of battery cables.
- Recharge battery monthly or trickle charge continuously while battery is stored.

2019 ROBALO CENTER CONSOLE

Recommissioning

NOTE: For detailed information on recommissioning your boat's systems and equipment, refer to the owner's manual for each system or component.

1. Inspect, visually and by smelling, the fuel system and all associated components for proper connections, wear, leaks, or other damage and needed repair.

Important: Inspection of the fuel system at recommissioning is very important. We cannot overemphasize our concern for your safety.

2. Clean battery terminal posts with wire brush or steel wool before reinstallation.
3. Check charge on battery. Recharge or replace if necessary.
4. Inspect all battery wiring. Repair or replace if necessary.
5. Attach battery cables, and tighten cable clamps.
6. Apply petroleum jelly or marine grade grease on battery posts and clamps to eliminate air pockets and possible acid buildups.
7. Reinstall hull drain plug after coating threads with petroleum jelly.
8. Clean bilge area.
9. Reinstall exhaust drain plug.
10. Inspect all exhaust connections to avoid exhaust and carbon monoxide (CO) leaks. Adjust as required.
11. Inspect all wiring for fraying, wear, loose connections, or other damage. Repair or replace, if necessary.
12. Test operation of navigation lights and other lighting onboard. Inspect all switches, controls, and other related equipment for proper operation. Repair or replace as necessary.
13. Inspect all life jackets, anchor lines, and other safety equipment for proper operation and physical condition. Repair or replace, if necessary.

2019 ROBALO CENTER CONSOLE

Warranty

9

**ROBALO BOATS LLC LIMITED WARRANTY
2016 and Subsequent Model Years
P. O. Box 928
Nashville, GA 31639**

Upon delivery, owner shall complete the Limited Warranty Registration Card and return it to Robalo LLC, P. O. Drawer 928, Nashville, Georgia 31639 ("Robalo") within fifteen (15) days of delivery of a new Robalo boat from an authorized Robalo dealer.

DEFINITIONS OF TERMS CONTAINED IN THE LIMITED WARRANTY

Hull: The single molded fiberglass shell that rests in the water below the hull flange and its structural components consisting of the stringers and the transom

Structurally Defective: The presence of a defect in material or workmanship that causes the hull to be unsafe or unfit for use under normal operating conditions.

Original Purchaser: Consumer(s) who purchase a new Robalo boat, retail, from an authorized Robalo dealer.

Subsequent Purchaser: Purchaser(s) who acquire a used Robalo boat from the Original Purchaser, or an authorized Robalo dealer, as evidenced by a Bill of Sale and an Ownership Transfer Record completed by the original retail purchaser/ dealer.

Date of Delivery: The date that the new boat was actually delivered to the first retail purchaser.

Demonstrator Boat: An untitled /unregistered boat with 20 or more hours usage.

Fair Market Value: Defined by www.nadaguides.com "Average Retail" as of the date of the Owner's claim.

THE WARRANTIES

ORIGINAL OWNER TEN YEAR LIMITED STRUCTURAL HULL WARRANTY

Subject to the conditions, exclusions and limitations set forth below, Robalo warrants to only the *Original Purchaser* of a new Robalo boat that either Robalo or its authorized dealer will, at Robalo's option, repair the fiberglass hull manufactured by Robalo if it is found to be Structurally Defective for a period of ten (10) years after the date of delivery. Robalo's obligation to repair a hull is limited to the fair market value of the owner's boat as of the date of the owner's claim.

2019 ROBALO CENTER CONSOLE

TRANSFERABLE FIVE-YEAR LIMITED STRUCTURAL HULL WARRANTY

Subject to the conditions, exclusions and limitations set forth below, Robalo warrants to the first subsequent purchaser that Robalo, or its authorized dealer will, at Robalo's option, repair or replace the fiberglass hull manufactured by Robalo if it is found to be Structurally Defective within five (5) years after the date of delivery to the *original* retail purchaser. Robalo's obligation to repair or replace a hull is limited to the fair market value of the owner's boats as of the date of the owner's claim.

To register the above referenced transfers, the Subsequent Purchaser must mail the following to Robalo Warranty Transfer, P. O. Drawer 928, Nashville, GA 31639 no later than thirty (30) days after the purchase from the Original Purchaser:

- (1) An Ownership Transfer Record (included in the Owner's Manual) completed by the Original Purchaser and the Subsequent Purchaser;
- (2) A copy of the bill of sale or other evidence of purchase of the boat from the Original Purchaser, including the model and hull identification number; and,
- (3) The warranty transfer fee of \$500.00 for models less than 26 feet and \$1,000 for models 26 feet or greater.

TRANSFERABLE ONE-YEAR LIMITED WARRANTY

Subject to the conditions and limitations to coverage and liability discussed below, Robalo warrants to the *original* and first subsequent purchaser who has registered the transfer with Robalo in the manner provided above under "TRANSFERABLE FIVE-YEAR LIMITED STRUCTURAL HULL WARRANTY", for a period of one year from the date of delivery to the *original* purchaser, that each new fiberglass boat manufactured by Robalo is free from defects in material and workmanship.

Please note that engines, outdrives, transom assemblies, controls, batteries, propellers, air conditioners, generators, refrigerators, certain electronics and certain other accessories or components on your boat are not warranted by Robalo under this Limited Warranty, but may be warranted by manufacturers other than Robalo. Please refer to the Robalo Owner's Packet to locate Owner's Manuals for these specific items and instructional information about possible warranties from manufacturers other than Robalo. Except as expressly set out herein, all warranties provided by the manufacturers and distributors of these accessories and components are hereby assigned to the owner, to the extent permitted by the accessory or component manufacturer, as the owner's sole and exclusive remedy with respect to such items. Please note that coverage under any of these other independent warranties is contingent upon your compliance with the warranty registration requirements of the manufacturer of such item.

CONDITIONS TO COVERAGE

In addition to any other conditions to coverage contained herein, the responsibility of Robalo under each of the foregoing limited warranties is also subject to the following conditions:

- (1) The owner must first notify the dealer from whom the boat was purchased of any claim under this warranty within the applicable warranty period and within thirty (30) days after the defect is or should have been discovered.
- (2) All costs of any nature for delivering any boat to a Robalo dealer, the Robalo factory, or any other point of repair authorized by Robalo and the return thereof shall be paid by the boat owner and are not covered under this warranty. Such cost may include but are not necessarily limited to transportation, freight, haul-outs, blocking and storage.
- (3) All repairs, corrections or replacements shall be performed by Robalo or a dealer or repair facility authorized by Robalo at its sole discretion.

2019 ROBALO CENTER CONSOLE

DEALER RESPONSIBILITIES VS. FACTORY WARRANTY COVERAGE

Robalo Dealers are responsible for keeping inventory in new condition at all times prior to sale of the boat. Any damage that occurs to a boat in a dealer's inventory from weathering, theft, vandalism or failure to adequately protect the boat from environmental conditions will not be covered under any Robalo factory warranty.

STATUTE OF LIMITATIONS

To the extent permitted by applicable State law, any lawsuit with respect to any breach of warranty claim seeking revocation of acceptance or rescission, whether express or implied, must be filed within one (1) year after the cause of action has occurred regardless of the time remaining in the warranty period under the Limited Warranty.

LIMITATION OF COVERAGE FOR AGED INVENTORY

Robalo reserves the right to modify the warranty on any boat based on the amount of time the boat has remained in dealer inventory. Items that are affected by the passage of time may be voided from the warranty. Such items may include, but are not limited to cosmetic issues such as oxidation of gel, fading of plastics, deterioration of vinyl, deterioration of canvas, deterioration of isinglass, drying of rubber seals / caulking, and corrosion of metal parts. Component warranties may be limited based on availability of replacement parts.

Robalo applies the following policy so that customer's may fully understand the nature of their warranty prior to purchasing the boat:

Invoice Date (to dealer)	Warranty Status
< 2 years	Full Written Warranty Applies
2 to 3 years	Warranty based on inspection of boat condition. Warranty for cockpit upholstery, canvas, and gel coat <u>may</u> be limited. Cosmetic deterioration of powder coated, painted, and anodized surfaces is not warrantable.
3 to 5 year	Cockpit upholstery, canvas, and gel coat have no warranty. Other components normally covered by the One Year Warranty will be honored based on part availability.
> 5 years	Structural Hull Warranty Only

LIMITATION OF COVERAGE FOR DEMONSTRATION MODELS PURCHASED FROM ROBALO DEALERS

Original retail purchaser(s), who otherwise comply with this Warranty Statement, receive the balance, as they exist at the time of purchase, of the Five-Year Transferable Limited Structural Hull Warranty and the One-Year Transferable Limited Warranty, only. The period of such limited warranties shall commence on the date the boat was first used for in-water demonstration purposes by the Dealer. ALL OTHER WARRANTIES ARE EXCLUDED. Warranty Transfer fees are waived for demonstrator boats.

2019 ROBALO CENTER CONSOLE

LIMITATION OF REMEDIES

- (1) Robalo's obligation under this warranty is limited to the cost of repair of the warranted item or replacement thereof, at Robalo's sole option, when returned prepaid to Robalo or other point of repair authorized by Robalo.
- (2) Robalo is not liable for loss of use, loss of time, inconvenience, economic loss, commercial loss or any consequential, incidental, general and/or special damages.
- (3) Robalo reserves the right to use refurbished, repaired, reconditioned, or remanufactured products or parts in the warranty repair or replacement process. Any such products and parts will be comparable in performance and function to the original part and shall only be warranted for the remainder of the original warranty period.
- (4) Decisions made by Robalo may be done so out of an abundance of customer goodwill. Accordingly, the acceptance of any returned product or part by Robalo shall not constitute an admission that the product or part is defective.
- (5) Any products that are replaced by Robalo become the property of Robalo.

EXCLUSIONS

THE LIMITED WARRANTIES SET FORTH ABOVE DO NOT COVER:

- 1) Any boat that has been subject to any type of repossession.
- 2) Any boat not purchased by an original retail purchaser, or a subsequent purchaser, as defined herein,
- 3) Any failure or defect resulting from normal wear and tear, climatic conditions, use under other than normal conditions or the lack of proper maintenance;
- 4) Any boat which has been powered or loaded in excess of the manufacturer's maximum horsepower and/or capacity recommendations; R160 - 90HP, R180 - 150HP, R200 - 200HP, R202EX - 200HP, R222 - 250HP, R222EX - 250HP, R242 - 400HP, R242EX - 350HP
- 5) Any boat used or once used for racing, boat clubs, yacht clubs, law enforcement, military, rental, charter or commercial purposes;
- 6) Any boat that has been subject to misuse, negligence, an accident, or structural modifications;
- 7) Plexiglas windscreen breakage, windshield breakage, windshield leakage,
- 8) Fuel gauges and fuel gauge systems, or fuel tanks;
- 9) Defects in paint or gel coat finishes including blisters below the waterline, cracking, crazing, or minor discoloration;
- 10) Defects in upholstery, canvas, vinyl, and other materials;
- 11) Damage, rot, mildew or other damage to upholstery, canvas, vinyl, carpet and other materials and components within the interior as a result of water damage including, without limitation, condensation or precipitation;
- 12) Installation of engines, or other parts or accessories installed by anyone other than Robalo;
- 13) Any boat that has been used after the discovery of a defect is or should have been discovered and such continued use causes additional or other damage to the boat; and
- 14) Except as described in the Limitations to Coverage above, any boat that has been used by the dealer for demonstration purposes.
- 15) Any defect or repair requiring redesign of the Boat, except pursuant to the recall provision of the United States Federal Boat Safety Act of 1971 or the recall laws of any other foreign jurisdiction.

2019 ROBALO CENTER CONSOLE

- 16) Any Robalo boat acquired by a retail sales outlet from any sources other than the Robalo factory.
- 17) Damage, shrinkage, wear and tear, or deterioration of upholstery, carpet, graphics, and exterior canvas tops, enclosures, and weather covers (including rainwater leakage)
- 18) Rainwater leakage including rainwater leakage through canvas tops and enclosures.
- 19) Engines, controls, gauges, hard-top frames, T-top frames, batteries, propellers, air conditioners, generators, refrigerators, electronics and other accessories, components or other equipment which have been manufactured or purchased from other manufacturers, whether subject to a separate warranty or not, by such other manufacturers;
- 20) Estimates that relate to speed, fuel consumption, weight or statements made by any person other than Robalo Boats.
- 21) Any boat owned by anyone other than the original retail purchaser unless an Ownership Transfer Record has been properly filed with Robalo.
- 22) Electrolysis, galvanic corrosion, crevice corrosion or any other deterioration of underwater components.

TRANSFERABILITY OF COMPONENT MANUFACTURE'S WARRANTIES

Engines, controls, batteries, propellers, air conditioners, generators, refrigerators, certain electronics and certain other accessories or components on your boat may be warranted by manufacturers other than Robalo. Please refer to the Robalo Owner's Packet to locate Owner's Manuals for these specific items and instructional information about possible warranties from manufacturers other than Robalo. Except as expressly set out herein, all warranties provided by the manufacturers and distributors of these accessories and components are hereby assigned to the owner, to the extent permitted by the accessory or component manufacturer, as the owner's sole and exclusive remedy with respect to such items. Please note that coverage under any of these other independent warranties is contingent upon your compliance with the warranty registration requirements of the manufacturer of such item.

SOME STATES DO NOT ALLOW THE EXCLUSION OR LIMITATION OF INCIDENTAL OR CONSEQUENTIAL DAMAGES, SO THE FOREGOING LIMITATIONS OR EXCLUSIONS MAY NOT APPLY TO YOU.

OTHER THAN THOSE LIMITED WARRANTIES CONTAINED HEREIN, ROBALO MAKES NO OTHER WARRANTIES. ANY WARRANTY OF MERCHANTABILITY OR FITNESS FOR A PARTICULAR PURPOSE WITH RESPECT TO ANY COMPONENT OF THE BOAT IS LIMITED TO THE DURATION OF THE LIMITED WARRANTY APPLICABLE TO SUCH COMPONENT, AS SET FORTH ABOVE.

SOME STATES DO NOT ALLOW LIMITATIONS ON HOW LONG ANY IMPLIED WARRANTY LASTS, SO THE FOREGOING LIMITATION MAY NOT APPLY TO YOU.

2019 ROBALO CENTER CONSOLE

OWNERSHIP TRANSFER RECORD

Please complete the following information and return to Robalo with the correct transfer fee amount and a copy of the bill of sale or other evidence of purchase within 30 days after purchase from the original retail purchaser. Certified Checks or money orders should be made payable to Robalo Boats.

Current Owner

Transfer To

Address

Address

City, State, Zip

City, State, Zip

Hull Identification Number

Date of Sale

Signature

Signature

To register the transfer, the second purchaser must mail the following to Robalo Warranty Transfer, P. O. Drawer 928, Nashville, GA 31639 no later than thirty (30) days after the purchase from the *original* purchaser: (1) An Ownership Transfer Record completed by the *original purchaser* and the subsequent owner; (2) A copy of the bill of sale or other evidence of purchase of the boat from the *original purchaser*, including the model and hull identification number; and, (3) the warranty transfer fee as follows:

- \$500 for any hull length less than 26 feet / \$1,000 for any hull length 26 feet or greater

Note transfer fees are waived for Dealer Demonstrator Boats.

Upon receipt of this transfer record the new owner shall receive the outstanding balance of the ONE-YEAR TRANSFERABLE LIMITED WARRANTY and the FIVE-YEAR TRANSFERABLE LIMITED STRUCTURAL HULL WARRANTY initiated by the original purchaser. Subsequent owner(s) to the original purchaser shall be responsible for a \$100.00 deductible per occurrence for any claim filed in accordance with the Robalo Limited Warranty Policy. Please refer to the Robalo Owner's Manual for detailed provisions concerning the Robalo Limited and Structural Warranty Policies. Robalo Boats LLC reserves the right to deny transfer of warranty to subsequent owners. Questions concerning the Robalo Warranty Policy should be submitted in writing to the Robalo Customer Service Office, P.O. Box 928, Nashville, GA 31639.