

# RINIKER

## Cruisers Owner's/Operator's Manual

Model/Number: \_\_\_\_\_ Design Category:    A    B    C    D  
(circle one)

Hull Identification Number: \_\_\_\_\_

Date of Purchase: \_\_\_\_\_ Maximum Rated  
Engine Power—  
kilowatts (horsepower) \_\_\_\_\_

Dealer Name: \_\_\_\_\_

Address: \_\_\_\_\_ Unladen Weight—  
kilograms (pounds) \_\_\_\_\_

\_\_\_\_\_ Maximum Load:

Phone Number: \_\_\_\_\_ Weight—kilograms (pounds) \_\_\_\_\_

\_\_\_\_\_ Number of People \_\_\_\_\_

*"This manual has been compiled to help you to operate your craft with safety and pleasure. It contains details of the craft, the equipment supplied or fitted, its systems and information on its operation and maintenance. Please read it carefully, and familiarize yourself with the craft before using it.*

*If this is your first craft, or you are changing to a type of craft you are not familiar with, for your own comforts and safety, please ensure that you obtain handling and operating experience before 'assuming command' of the craft. Your dealer or national sailing federation or yacht club will be pleased to advise you of local sea schools, or competent instructors.*

**PLEASE KEEP THIS MANUAL IN A SECURE PLACE, AND HAND IT OVER TO THE NEW OWNER WHEN YOU SELL THE CRAFT."**

For a complete list of standard and optional features and equipment, consult your local dealer. Due to a policy of continuous product improvement, specifications are subject to change without notice. The weights and volumes shown are estimated and can vary from boat to boat because of equipment, etc. Parker boats meet or exceed both RCMR and U.S. Coast Guard standards.

# CERTIFICATION AND SPECIFICATION

All Rinker boats meet or exceed U.S. Coast Guard requirements.

The CE Mark means your Rinker boat meets or exceeds the European Directives for Recreational Vessels as published by the International Organization for Standardization (ISO).

All Rinker boats are National Marine Manufacturers Association (NMMA) certified. NMMA certified vessels are in compliance with applicable federal regulations.

Rinker boats are International Marine Certification Institute certified (IMCI) for the EU Directive for recreational craft.

International Marine Certificate Institute  
Trevés Centre  
rue de Trevés 45  
1040 Brussels, Belgium  
Tel. Int + (32) 2 238 7892  
Rinker Certificates - RKR001 thru RKR013

National Marine Manufacturers Association  
200 E. Randolph Dr.  
Suite 5100  
Chicago, Illinois U.S.A. 60601  
Tel. (312) 946-6200



# Read This First

The Owner s/Operator's Manual for your new boat has been carefully prepared to include all the necessary information for the safe operation and maintenance of your boat. Before going any further, please help us to assure this by checking your manual to be sure it includes the following pages. After checking, please return this page to us at the address at the bottom of this page. Please indicate any missing items so that we may send them to you. We have also included a copy of this page for your future reference. Thank you for your help.

- Table of Contents Page
- Section 1 - General Information.....pages 1-1 through 1-8
- Section 2 - Safety.....pages 2-1 through 2-9
- Section 3 - Systems.....pages 3-1 through 3-14
- Section 4 - Components.....pages 4-1 through 4-6
- Section 5 - Getting Underway.....pages 5-1 through 5-11
- Section 6 - Maintenance & Repair.....pages 6-1 through 6-5
- Section 7 - Troubleshooting.....pages 7-1 through 7-9
- Section 8 - Interior & Exterior Care.....pages 8-1 through 8-5
- Section 9 - Winterizing & Storage.....pages 9-1 through 9-4
- Section 10 - Nautical Glossary.....pages 10-1 through 10-7

Owner's Name \_\_\_\_\_

Address \_\_\_\_\_

Phone Number (     ) \_\_\_\_\_

Hull I.D. Number \_\_\_\_\_

**Rinker Boat Company, Inc.**  
**300 W. Chicago Street**  
**Syracuse, IN 46567**  
**[www.rinkerboat.com](http://www.rinkerboat.com)**  
**<https://www.boat-manuals.com/>**

# TABLE OF CONTENTS

## GENERAL INFORMATION ..... 1

WELCOME ABOARD.....	1-1
YOUR OWNER'S/OPERATOR'S MANUAL.....	1-1
CONSTRUCTION AND STANDARDS.....	1-2
TRAILERING.....	1-2
RESPONSIBILITIES.....	1-3
OWNER'S/OPERATOR'S LOGS & RECORDS.....	1-4
WARRANTY.....	1-4
BOAT DATA RECORD.....	1-5
TRAVEL PLAN LOG.....	1-6
FUEL USAGE CHART.....	1-7
WARRANTY COPY.....	1-8

## SAFETY ..... 2

HAZARD COMMUNICATION STATEMENTS.....	2-1
RECOMMENDATIONS.....	2-1
SAFETY EQUIPMENT ON BOARD.....	2-3
ILLEGAL TO DUMP.....	2-4
UNDERRWAY.....	2-5
NAVIGATIONAL AIDS CHART.....	2-8
HAZARD COMMUNICATION LABELS.....	2-8

## SYSTEMS ..... 3

ELECTRICAL SYSTEMS • 12 VOLT DC.....	3-2
ELECTRICAL SYSTEMS • BATTERIES.....	3-3
ELECTRICAL SYSTEMS • 110 VOLT AC.....	3-3
DC ELECTRICAL DIAGRAM	
FOR TYPICAL TWIN ENGINE.....	3-5
DC ELECTRICAL DIAGRAM	
FOR TYPICAL SINGLE ENGINE.....	3-6
TYPICAL AC ELECTRICAL DIAGRAM.....	3-7
FUEL SYSTEMS.....	3-8
ENGINE EXHAUST SYSTEM.....	3-10
WATER SYSTEMS.....	3-11

## COMPONENTS..... 4

INSTRUMENTATION AND CONTROLS.....	4-1
GENERATOR.....	4-3
AIR CONDITIONER.....	4-3
REFRIGERATOR/FREEZER.....	4-3
STOVE.....	4-4
MICROWAVE.....	4-4
RACK AND PINION POWER STEERING.....	4-4
BILGE PUMP.....	4-4
BILGE BLOWER.....	4-5
RUNNING UP NAVIGATION LIGHTS.....	4-5
COMPASS.....	4-5
DEPTH FINDER.....	4-6
MARINE STEREO.....	4-6
VHF RADIO WITH ANTENNA.....	4-6

## GETTING UNDERWAY ..... 5

TRAINING COURSES.....	5-1
CARBON MONOXIDE HAZARD.....	5-1
TRANSPORTING.....	5-3
LAUNCHING.....	5-4
FUELING.....	5-4
LOADING PASSENGERS AND GEAR.....	5-6
STARTING THE ENGINE.....	5-6
LEAVING THE DOCK.....	5-7
STEERING.....	5-8
ACCELERATING.....	5-8
TRIMMING.....	5-9
STOPPING (COMING OFF PLANE).....	5-10
ANCHORING.....	5-10
DOCKING.....	5-11
MORING.....	5-11
GOING ASHORE.....	5-12
ADDITIONAL UNDERWAY INFORMATION.....	5-12

## MAINTENANCE & REPAIR..... 6

ENGINE(S).....	6-1
DRIVE BELT TENSION.....	6-2
FUEL SYSTEM.....	6-3
STERN DRIVE UNIT (I/O).....	6-3
PROPELLER(S).....	6-4
POWER STEERING SYSTEM.....	6-4
BILGE.....	6-5

## TROUBLESHOOTING..... 7

ENGINE.....	7-1
POOR PERFORMANCE.....	7-5
VIBRATION.....	7-6
DC ELECTRICAL SYSTEM.....	7-6
AC ELECTRICAL SYSTEM.....	7-7
FUEL SYSTEM.....	7-8
WATER SYSTEM.....	7-9
MARINE SANITATION SYSTEM.....	7-9

## INTERIOR & EXTERIOR CARE..... 8

FIBERGLASS & GELCOAT.....	8-1
DECK HARDWARE & FITTINGS.....	8-3
WINDSHIELD & PORTALS.....	8-3
CARPET.....	8-4
SEAT COVERINGS & VINYL.....	8-4
CANVAS (WEATHER COVERINGS).....	8-4
CABIN CUSHIONS, INTERIOR	
CURTAINS & FABRICS.....	8-5

*Table of Contents is  
continued on next page.*

**WINTERIZING & STORAGE .....9**  
 DRY STORAGE PREPARATION .....9-1  
 ENGINE(S) .....9-1  
 GENERATOR .....9-2  
 AIR CONDITIONER.....9-3  
 FRESH WATER SYSTEM (POTABLE) .....9-3  
 MARINE SANITATION DEVICE (MSD) .....9-3  
 FUEL SYSTEMS.....9-3  
 BATTERIES .....9-3  
 RECOMMISSIONING.....9-3  
 LIFTING T-E BOAT.....9-4  
**NAUTICAL GLOSSARY .....10**

## **WELCOME ABOARD!**

As the owner/operator of a new Rinker boat, you have every right to be proud of your boat's style, comfort and performance.

The Rinker family began building boats in 1945. Because your Rinker boat is backed by over 50 years of boat building experience, you can be confident that your craft has been designed, built and tested to give you the ultimate in boating pleasure. During the manufacturing process, Rinker's skillful craftsmen performed testing and inspection in the tradition of meeting or exceeding existing safety and quality standards established by the U.S. Coast Guard and the National Marine Manufacturers Association (NMFMA).

This manual contains valuable information concerning your boat's operation and care, maintenance, plus tips on boating safety and seamanship. Before putting your boat in the water, read this manual and the engine owner's manual. Then keep both manuals stowed aboard your boat for reference.

If you have not already done so, this would also be a good time to send in your boat's warranty registration card. Your dealer has filled it out. All you have to do is sign it and send it in within 15 days after the purchase. Send the signed card to Rinker Boat Company at the address listed on the card. Prompt registration validates your warranty and protects your interests as the owner of a new Rinker boat.

We at Rinker Boat Company welcome you to our boating family and wish you many happy hours on your Rinker boat in the months and years ahead.

## **YOUR OWNER'S/OPERATOR'S MANUAL**

Your owner's/operator's manual packet contains your boat's owner's/operator's manual in a three ring binder. Suppliers of some of the more complex components such as

engine(s), generator, electronics, pumps, refrigerator, and air conditioner, supply their own instructional manuals which are included. The suppliers of these products maintain their own manufacturer's warranty and service facilities. It is imperative that you fill out each warranty card and mail it to the manufacturer to inform them that you are a registered owner of the product. Record all information regarding the products on the "Boat Data Record" located in this chapter under Logs & Records. Keep the data form in a safe place at home and not aboard the boat.

The owner's/operator's manual has been designed for you, the owner or operator. Use it as a guide to familiarize yourself with your boat's systems and components. The information in this manual will help you operate your boat safely and maintain it properly.

Your Rinker Boat Owner's/Operator's Manual is organized as follows:

## **GENERAL INFORMATION**

Included in the General Information chapter of the manual is the welcome aboard message to our new Rinker boating family members, trailering information, construction and standards, dealer and consumer responsibilities, warranty, logs and records, and this synopsis of your Rinker Boat Owner's/Operator's Manual.

## **SAFETY**

The Safety chapter contains safety recommendations, safety information and practices, and safety equipment (on board and underway) which will provide a reasonably safe operating environment. Additionally, specific safety warnings and comments are located throughout your Rinker Boat Owner's/Operator's Manual where appropriate.

## **SYSTEMS**

The Systems chapter of the manual provides detailed information covering the electrical,

fuel, exhaust, and water systems aboard your new Rinker boat.

## **COMPONENTS**

The Components chapter provides a detailed explanation of the creature comfort components installed on your new Rinker boat.

## **GETTING UNDERWAY**

The Getting Underway chapter provides the owner/operator with the information needed for launching your boat, getting underway, operations underway and returning from your outing.

## **PREVENTIVE MAINTENANCE & REPAIRS**

The Preventive Maintenance & Repairs chapter provides recommendations to keep the boat in sound operational condition, adjustments, and frequency of checks and inspections.

## **TROUBLESHOOTING**

Problems covered in the Troubleshooting chapter are those that can be resolved by the boat owner/operator.

## **INTERIOR & EXTERIOR CARE**

The Interior & Exterior Care chapter provides inspection, cleaning and maintenance for your boat's interior and exterior features.

## **WINTERIZING & STORAGE**

The Winterizing & Storage chapter presents information and procedures to follow when your boat will be winterized or stored for extended periods of time.

## **NAUTICAL GLOSSARY**

The Nautical Glossary defines terms associated with your boat and terms you may encounter during your boating experience.

## **CONSTRUCTION AND STANDARDS**

Your Rinker boat meets or exceeds U.S. Coast Guard and NMMA requirements concerning:

- Backfire Flame Arrestors
- Basic Flotation
- Engine and Fuel Tank Compartment Ventilation
- Factory Installed Fuel Systems
- Navigational Lights
- Steering System

## **TRAILERING**

Improper trailering is one of the major causes for damage to the hull. A correctly selected trailer provides you with proper support, safe and easy towing, and ease of unloading and loading in varying weather conditions.

The type and size of the side supports, or pads, is very important. Side supports run lengthwise to the boat and parallel to the keel. Newer trailers feature side supports that are self-adjusting, and a bow pad that can be easily adjusted. This eliminates the task of manually adjusting side supports and keel rollers every time you load your boat. Your Rinker dealer can help you select the trailer that will best fit your boat.

Periodically inspect your trailer to make sure the side supports are in good working condition. **Remember:** The side supports should only be tight enough to keep the boat from leaning side to side. Any unnecessary pressure will damage the hull.

The trailer for your new Rinker boat should be designed and built to carry the full weight of your boat, engine, and gear while providing support for the hull. Be sure not to overload your trailer by loading the boat with excess baggage, camping equipment, etc. Check the certification label on the frame of the trailer. It is required to show the Gross Vehicle Weight Rating (GVWR). Be sure that the total weight of your boat, engine, fuel, gear and trailer does not exceed the GVWR.

## **▲WARNING**

**WARNING:** The total weight of the trailer, boat and gear must not exceed the GVWR of the trailer. Overloading can cause accidents and personal injury.

Ensure that your towing vehicle is equipped with a hitch capable of handling the GVWR. Your Rinker Cruiser style boat requires a weight distributing hitch.

## **▲WARNING**

**WARNING:** Balancing the load on the trailer is extremely important. If weight at the tongue is excessive the tow vehicle will oversteer, a condition that will cause the front end of the vehicle to sway. Conversely, insufficient tongue weight will cause the trailer to fishtail. In both cases, the vehicle will be difficult to handle and at higher speeds the swaying or fishtailing can become uncontrollable.

Tongue weight is generally determined as a percentage of the total weight of the loaded trailer. This would be not less than five percent (5%) and not more than ten percent (10%). Therefore, if the weight of the loaded trailer is 5000 pounds, the weight on the tongue should be more than 250 pounds but less than 500 pounds.

A weight distributing hitch transfers portions of tongue weight to a point between the front and rear wheels of the towing vehicle and to the trailer wheels.

Hitches are divided into classes that specify the gross trailer weight and the maximum tongue weight for each class. Always use a hitch with the same class number as the trailer. Most boat trailers connect to a ball hitch bolted on or welded to the towing vehicle. Special heavy-duty equalizing hitches are necessary if the tongue weight is more than 350 pounds.

The trailer hitch coupler must match the size of the hitch ball. The correct ball diameter is marked on the trailer coupler.

State regulations usually require that trailers above a specified weight rating be equipped with brakes. Requirements vary; check with your dealer for additional information.

The brake system is usually completely self-contained on the trailer and no hook-up is required to the towing vehicle. The trailer is equipped with either drum or disc type brakes. The brake works like the brake on a standard passenger vehicle. However, the method of actuation requires some explanation. Check with your Rinker dealer for questions regarding the method of actuation.

## **RESPONSIBILITIES**

### **Dealer**

1. The dealer will discuss the terms of all warranties, stress the importance of registering warranties with the appropriate manufacturers and will help you complete the Rinker Limited Warranty Registration Card.
2. The dealer will provide instruction for obtaining warranty service.
3. The dealer will go over the pre-delivery service record with you, and then sign it to certify that all work has been accomplished.
4. The dealer will provide you with a thorough instruction in the operation of your boat and all of its systems and components.

### **Consumer**

1. Schedule an appointment with your dealer to go over all warranties. Complete the Rinker Boat limited warranty registration card and mail it to Rinker Boat. Validating your warranty protects your interests and makes it possible for Rinker to get in touch with you in the event of a recall as required under the Federal Boat Safety Act. Keep a record of the hull number for future reference.



2. Inspect the boat at the time of delivery to ensure that all systems and components are operating properly.
3. Schedule an appointment with your dealer to go over the pre-delivery engine service record. Sign this record to indicate that it has been explained to you by your dealer.
4. Operate all equipment in accordance with the manufacturer's instructions.
5. Rinker Boat recommends that you refer to your engine warranty for initial inspection and service requirements.
6. Perform or provide for the appropriate periodic maintenance outlined in the owner's manuals and service guides.
7. Schedule ahead of time with your dealer for your boat's 20-hour check-up.
8. As a boat owner/operator, it's your responsibility to learn your boat's dimensions, especially its draft and bridge clearance (on and off the trailer), to prevent accidents and damage.

**IMPORTANT:** Make sure your dealer checks the engine alignment during the 20-hour checkup. The engine alignment check should be completed in accordance with the recommended procedures as stated in the engine manual. Failure to do so could result in drive train damage not covered by the warranty. Engine alignment should be checked annually after the 20-hour check.

## **OWNER'S/OPERATOR'S LOGS & RECORDS**

You have been provided with three very useful forms at the end of this section.

The **Boat Data Record** is used to record all of your boat's important information as well as the major components installed on your boat. Once you have entered all the data, remove this form from your owner's/operator's manual and store in a safe place. Do not keep this form aboard your boat.

The **Travel Plan Log** provides a record of your destination, departure and return times, boat description, passenger list, and other information about your trip. At the bottom of the form is an area for listing emergency telephone numbers in case you encounter trouble underway and your return time has elapsed. There is also an entry area for the person filing this report to the proper authorities (in the event of an emergency) to list their name, location, and telephone number. You should make several copies of this form to use during each boating season.

This form is to be left ashore with a responsible person.

The **Fuel Usage Chart** is a handy way to record information covering engine hours, fuel consumption, miles traveled, as well as RPM, Average MPH, and gallons per hour (GPH).

## **WARRANTY**

You are entitled to all the benefits and services as contained in the Rinker Boat Limited Warranty found at the end of this chapter. If a problem arises with your Rinker boat as a result of workmanship or materials, contact your Rinker Boat dealer as soon as possible. Please have your hull identification number, and necessary model numbers on hand for the items that may need service or repair. Your hull identification number is located below the rub rail on the starboard rear corner of your boat.

## Boat Data Record

**Maker Model Name** \_\_\_\_\_ **Hull Identification Number** \_\_\_\_\_

**Boats Name (if any)** \_\_\_\_\_ **State** \_\_\_\_ **Length** \_\_\_\_\_ **Beam** \_\_\_\_\_

### Service Dealership

Name \_\_\_\_\_

Address \_\_\_\_\_

Phone Number \_\_\_\_\_

Fax Number \_\_\_\_\_

Service Manager \_\_\_\_\_

### Purchase Dealership

Name \_\_\_\_\_

Address \_\_\_\_\_

Phone Number \_\_\_\_\_

Fax Number \_\_\_\_\_

Point of Contact \_\_\_\_\_

**Hull Color(s)** \_\_\_\_\_

**Weight** \_\_\_\_\_

**Draft** (drive down) \_\_\_\_\_ (drive up) \_\_\_\_\_

**Freeboard** (forward) \_\_\_\_\_ (aft) \_\_\_\_\_

### Engine(s)

Make \_\_\_\_\_ Model Name \_\_\_\_\_ HP \_\_\_\_\_ Model No. \_\_\_\_\_

Oil SAE \_\_\_\_\_ Cyls/Engine(s) \_\_\_\_\_ Oil Filter Type \_\_\_\_\_

Port Serial No. \_\_\_\_\_ Transom Plate Serial No. \_\_\_\_\_

Starboard Serial No. \_\_\_\_\_ Transom Plate Serial No. \_\_\_\_\_

**Drive Unit(s)** Gear Ratio \_\_\_\_\_

Port Serial No. \_\_\_\_\_ Starboard Serial No. \_\_\_\_\_

**Fuel Tank Capacity** \_\_\_\_\_ **Number of Tanks** \_\_\_\_ **Fuel Filter Type** \_\_\_\_\_

**Freshwater Tank Capacity** \_\_\_\_\_ **Number of Tanks** \_\_\_\_

**Propeller(s)** Manufacturer \_\_\_\_\_ Diameter \_\_\_\_\_ Pitch \_\_\_\_\_

### Generator

Make \_\_\_\_\_ Model Name \_\_\_\_\_ Model No. \_\_\_\_\_

Serial No. \_\_\_\_\_ Kilowatts \_\_\_\_\_

### Air Conditioner

Make \_\_\_\_\_ Model Name \_\_\_\_\_ Model No. \_\_\_\_\_

Serial No. \_\_\_\_\_ BTU \_\_\_\_\_

**Battery** Make \_\_\_\_\_ Type \_\_\_\_\_

### Radio

Make \_\_\_\_\_ Type \_\_\_\_\_ Model No. \_\_\_\_\_ Serial No. \_\_\_\_\_

**Key Numbers** Cabin \_\_\_\_\_ Glove Box \_\_\_\_\_ Ignition(s) \_\_\_\_\_ / \_\_\_\_\_

**Additional Equipment** \_\_\_\_\_

\_\_\_\_\_  
\_\_\_\_\_  
\_\_\_\_\_

## Travel Plan Log

- 1. Trip Expectations** Departure date/time \_\_\_\_\_ From \_\_\_\_\_  
Destination \_\_\_\_\_ or \_\_\_\_\_  
Expected return date/time \_\_\_\_\_ and in no event later than \_\_\_\_\_
- 2. Boat Description** Boat name \_\_\_\_\_ Type \_\_\_\_\_  
Color of: Hull \_\_\_\_\_ Deck \_\_\_\_\_ Cabin \_\_\_\_\_ Trim \_\_\_\_\_  
Registration No. \_\_\_\_\_ Length \_\_\_\_\_ Make \_\_\_\_\_  
Other physical characteristics \_\_\_\_\_
- 3. Engine(s)** Type \_\_\_\_\_ HP \_\_\_\_\_ Fuel Type \_\_\_\_\_ Gallons \_\_\_\_\_
- 4. Survival Equipment On board** (check all that apply) \_\_\_\_\_ Anchor \_\_\_\_\_ Cushions \_\_\_\_\_ Distress Light  
Flares \_\_\_\_\_ Flash Light \_\_\_\_\_ Food \_\_\_\_\_ Life Jackets \_\_\_\_\_ Mirror \_\_\_\_\_ Paddles  
\_\_\_\_\_ Raft/Dingy \_\_\_\_\_ Smoke Signals \_\_\_\_\_ Water \_\_\_\_\_
- 5. Radio On board** (\_\_\_\_ yes \_\_\_\_ no) Frequencies \_\_\_\_\_
- 6. Additional information** \_\_\_\_\_  
\_\_\_\_\_  
\_\_\_\_\_
- 7. Passengers Aboard** Total number \_\_\_\_\_  
Name \_\_\_\_\_ Age \_\_\_\_\_ Sex \_\_\_\_ Phone No. \_\_\_\_\_  
Address \_\_\_\_\_  
Name \_\_\_\_\_ Age \_\_\_\_\_ Sex \_\_\_\_ Phone No. \_\_\_\_\_  
Address \_\_\_\_\_  
Name \_\_\_\_\_ Age \_\_\_\_\_ Sex \_\_\_\_ Phone No. \_\_\_\_\_  
Address \_\_\_\_\_  
Name \_\_\_\_\_ Age \_\_\_\_\_ Sex \_\_\_\_ Phone No. \_\_\_\_\_  
Address \_\_\_\_\_

**Note:** Use additional sheet for more passengers. Additional sheet attached \_\_\_\_ yes \_\_\_\_ no.

**If not returned by \_\_\_\_\_ call one or more of the following emergency telephone numbers:**

Coast Guard \_\_\_\_\_ Local Authority \_\_\_\_\_ Rescue Center \_\_\_\_\_

Name of person filing report \_\_\_\_\_

Location and Telephone Number \_\_\_\_\_

**Rinker Boat recommends filing a copy of this Travel Plan each time you depart in your boat. Leave the form with a responsible person ashore. A relative, friend, marina manager, or dockmaster.**



## LIMITED WARRANTY

### Coverage Under This Limited Warranty

Rinker Boat Company, Inc. ("Rinker") warrants to the original consumer purchaser that each new Rinker boat will be free from substantial defects in materials and workmanship for a period of one (1) year from the date of purchase under normal conditions and recommended use, subject to the exclusions listed below. In addition, Rinker warrants that the boat will be free of structural defects in material and workmanship for a period of five (5) years from date of purchase, subject also to the exclusions listed below.

THIS WARRANTY DOES NOT APPLY TO: (1) equipment or accessories not manufactured by Rinker, whether or not separately warranted, including but not limited to engines, batteries, steering assembly, outdrives, propellers, and controls; (2) any boat which has been repaired or altered in any way so as to affect its use or operation; (3) Gel-Coat cracking or crazing, blistering, or discoloring; (4) windshield breakage; (5) any upholstery damage, including but not limited to tears, punctures, fading or soiling; (6) any boat which was overpowered according to the U.S. Coast Guard recommended engine horsepower on capacity plate; (7) damage caused to fly wheels, ring gears, starters, oil pans, electrical components, and the basic engine by water in the bilge, whether it be fresh or salt; (8) any boat used for racing, commercial, or rental purposes or any boat subject to misuse, negligence, accident or used in any unauthorized manner; (9) accessories, components, machinery or equipment that is not installed by Rinker at its factory; (10) routine maintenance or any condition resulting from failure to perform routine maintenance as required; (11) scratches, dents or other surface blemishes; (12) damage caused by continued use of the boat after a defect is or should have been discovered; (13) water damage of any nature or dry rot to interior surfaces, wood structures, upholstery or polyurethane foam; and (14) any published or announced performance characteristics including, but not limited to, speed, or fuel and oil consumption.

### Registration Required For Limited Warranty Coverage

IN ORDER FOR YOU TO BE ELIGIBLE FOR COVERAGE UNDER THIS LIMITED WARRANTY, THE WARRANTY REGISTRATION CARD MUST BE COMPLETED AND SIGNED BY YOU AND RETURNED TO RINKER WITHIN FIFTEEN (15) DAYS AFTER THE DATE OF PURCHASE.

In addition to validating your warranty coverage, returning the registration card will allow Rinker to provide you with notice of any condition Rinker may need to supply after you have purchased the boat.

### Your Obligations in the Event of a Defect

IF YOU BELIEVE YOU HAVE A CLAIM UNDER THIS LIMITED WARRANTY, YOU MUST GIVE WRITTEN NOTICE OF YOUR CLAIM TO RINKER AT 300 W. CHICAGO STREET, SYRACUSE, INDIANA 46587, AND/OR THE DEALER WITHIN THE APPLICABLE WARRANTY PERIOD AND WITHIN A REASONABLE PERIOD OF TIME (NOT TO EXCEED THIRTY (30) DAYS) AFTER THE DEFECT IS OR SHOULD HAVE BEEN DISCOVERED. Your notice must describe the defect, provide your name and address, the name and address of the dealer from whom you purchased the boat, and the date of purchase. You must pay all incidental expenses incurred in obtaining warranty service, including, without limitation, transportation of the boat and postage or delivery charges to and from the dealership or Rinker's factory.

### Remedies Under This Limited Warranty

Rinker will reply to you within a reasonable period of time after it receives your claim and it reserves the right to require you to furnish additional information or evidence at your expense. Further, Rinker reserves the right to inspect the boat within a reasonable period of time after it receives your claim.

All warranty work is to be performed at a Rinker authorized dealer or service center, or at Rinker's factory, after it is established that Rinker's satisfaction that there is a substantial defect in materials and workmanship covered by this Limited Warranty. Rinker will designate the location where the warranty work will be performed. The defective parts or the entire boat must be delivered, at Rinker's option, to an authorized dealer or service center or to Rinker's factory, at your expense. REPAIR OR REPLACEMENT, AT RINKER'S ELECTON, IS THE SOLE AND EXCLUSIVE REMEDY AND NO OTHER LEGAL OR EQUITABLE REMEDIES SHALL BE AVAILABLE TO THE ORIGINAL CONSUMER PURCHASER.

Warranty performance will commence within a reasonable time after Rinker's receipt of the required notice and confirmation that the defect is covered under this Limited Warranty, and will be completed within a reasonable time, subject to the availability of parts and scheduling. Rinker cannot guarantee any specific completion date due to the different nature of claims that may be made and the services that may be required.

The term of the Limited Warranty for any repaired or replaced defective parts will be the remaining unexpired portion of the original warranty period for the original part.

### Disclaimer of Incidental and Consequential Damages

THE ORIGINAL CONSUMER PURCHASER OF THE NEW RINKER BOAT COVERED UNDER THIS LIMITED WARRANTY SHALL NOT BE ENTITLED TO RECOVER FROM RINKER ANY SPECIAL, INDIRECT, INCIDENTAL OR CONSEQUENTIAL DAMAGES RESULTING FROM ANY DAMAGE OR DEFECTS. RINKER WILL NOT BE LIABLE TO THE ORIGINAL CONSUMER PURCHASER FOR HAUL-OUT, LAUNCH, TOWING OR STORAGE CHARGES, INCONVENIENCE, LOSS OF TIME, LOSS OF INCOME, SHIPPING OR DELIVERY CHARGES, OR ANY OTHER INCIDENTAL OR CONSEQUENTIAL DAMAGES OF ANY NATURE OR KIND.

Some states do not allow the exclusion or limitation of incidental or consequential damages, so the above exclusion or limitation may not apply to you.

### Limitation and Disclaimer of all Implied Warranties

RINKER EXPRESSLY LIMITS THE DURATION OF ANY IMPLIED WARRANTIES OF MERCHANTABILITY AND ALL IMPLIED WARRANTIES OF FITNESS FOR A PARTICULAR PURPOSE TO THE TERM OF THIS LIMITED WARRANTY. RINKER EXPRESSLY DISCLAIMS ANY IMPLIED WARRANTIES OF MERCHANTABILITY AND IMPLIED WARRANTIES OF FITNESS FOR A PARTICULAR PURPOSE AFTER EXPIRATION OF THIS LIMITED WARRANTY. THERE IS NO WARRANTY OF ANY NATURE, EXPRESS OR OTHERWISE, MADE BY RINKER BEYOND THAT CONTAINED IN THIS LIMITED WARRANTY. NO PERSON HAS AUTHORITY TO ENLARGE, AMEND, OR MODIFY THIS LIMITED WARRANTY.

Some states do not allow limitations on how long an implied warranty lasts, so the above limitation may not apply to you.

### General Provisions

This Limited Warranty gives you specific legal rights and you may also have other rights which vary from state to state. No action to enforce this Limited Warranty shall be commenced later than six (6) months after expiration of this Limited Warranty.

Due to continuing improvements and changes in product features and options, Rinker reserves the right to make changes at any time, without notice, in specifications, equipment, materials, pricing, and to discontinue models, without any obligations to maintain spare parts or to make corresponding changes in products previously manufactured.

### Transferable

The unexpired term of this warranty may be transferred to a new owner upon the new owner's written request to Rinker Boat Company, Inc. 300 West Chicago St., Syracuse, IN 46587, and accompanied by a payment to Rinker Boat Company of one hundred twenty five dollars (\$125.00).

RINKER BOAT COMPANY, INC.  
300 West Chicago Street Syracuse, IN 46587  
(219) 457-5731  
www.rinkerboat.com  
Effective 06/01/01

## HAZARD COMMUNICATION STATEMENTS

This manual uses five levels of advisory and cautionary statements to call attention to special information, operating procedures and safety precautions. A signal word identifies the level of significance each statement conveys.

### Advisory Statements

Advisory statements consist of two levels; **NOTE** and **IMPORTANT**. Advisory statements alert you to conditions that effect equipment operation, maintenance and servicing practices.

A **NOTE** statement is a general advisory statement relating to equipment operation and maintenance procedures. A **NOTE** statement draws attention to information that is of more importance than normal text.

An **IMPORTANT** Statement is an advisory statement or procedure intended to prevent damage to the equipment or associated components. Not adhering to the content of an **IMPORTANT** statement could result in damage to the equipment.

### Hazard Seriousness Level

Signal words (**DANGER**, **WARNING** and **CAUTION**) used throughout your Rinker Boat Owner's Manual identify the levels of hazard seriousness. Their selection is based on how the hazard can affect a person in terms of:

1. The degree of severity.  
(Minor injury, severe injury, death)
2. The probability of severity.  
(WILL result in, COULD result in)

Definitions for identifying hazard levels with their respective signal words are:

### **▲ DANGER**

**DANGER:** Immediate hazards that WILL result in severe personal injury or death.

### **▲ WARNING**

**WARNING:** Hazards or unsafe practices that COULD result in severe personal injury or death.

### **▲ CAUTION**

**CAUTION:** Hazards or unsafe practices that COULD result in minor personal injury or product or property damage.

## RECOMMENDATIONS

Your safety, also the safety of your passengers and your new Rinker boat, is your responsibility. You should fully understand and become familiar with the following safety precautions before launching your Rinker boat:

- Your boat and equipment should be kept in safe operating condition. Make a practice of inspecting the hull, engine, safety equipment and all boating gear.
- Maximum **CAUTION** should be exercised when fueling your boat. Be aware of the boat's fuel tank capacity and fuel consumption at various speeds.
- Be sure enough fuel is on board for your cruise as well as for changes in your plans due to adverse weather or other situations. Follow the 1/3 rule: use 1/3 of your fuel to reach your destination, use 1/3 to return, and keep 1/3 in reserve.

- Be sure that required lifesaving and fire extinguishing equipment is on board, noticeable, accessible and in safe operating condition. Your passengers should be familiar with the operation and location of equipment.
- Never operate a boat while under the influence of drugs or alcohol. Doing so is a Federal offense. Make sure only qualified drivers operate your boat.
- Keep an eye on the weather. Be aware of possible changing conditions by checking local weather reports prior to departure. Strong winds and electrical storms should be monitored closely.
- Always keep accurate updated charts of your boating area on board your boat.
- Prior to departure, file a Travel Plan with a responsible person ashore.
- Always operate your boat with care, courtesy and common sense.
- At least one other passenger aboard should know how to handle your boat in case you unexpectedly become unable to do so.
- Do not allow passengers to ride on parts of your boat other than designated seating areas.
- All passengers should remain seated while the boat is in motion.
- Do not use the swim platform or boarding ladder while the engine(s) are running.
- Understand and obey the Rules of the Road. Always maintain complete control of your boat.
- Do not overload or improperly load your boat.

The presence of the boat's capacity plate does not override your responsibility to use common sense or sound judgment. The capacity of your boat will be reduced by turbulent water and unfavorable weather conditions. You should have prior knowledge of weather reports and water conditions.

## Safe Boating Courses

Your local U.S. Coast Guard Auxiliary and the U.S. Power Squadrons offer comprehensive safe boating classes several times a year. You may contact the Boat/U.S. Foundation at 1-800-336-BOAT (2628), or in Virginia 1-800-245-BOAT (2628). For a course schedule in your area you may also contact your local U.S. Coast Guard Auxiliary or Power Squadron Flotilla for the time and place of their next scheduled class.

U.S. Coast Guard Website:  
[www.uscg.mil](http://www.uscg.mil)

California Coast Guard Website:  
[www.ccg-ggc.gc.ca](http://www.ccg-ggc.gc.ca)

## Rules of the Road

Your Rinker boat is subject to U.S. Coast Guard-enforced marine traffic laws known as "**Rules of the Road.**" There are two sets of rules — the United States Inland Navigational Rules and the International Rules. The United States Inland Rules are applicable to all vessels inside the demarcation lines separating inland and international waters. The "**Rules of the Road**" can be obtained from your local U.S. Coast Guard Unit or the United States Coast Guard Headquarters (1300 E. Street NW, Washington, D.C. 20226) in the publication titled, "**Navigational Rules, International-Inland.**"

"**Aids to Navigation**" (U.S. Coast Guard pamphlet #123) explains the significance of various lights and buoys. This and other pamphlets, including the "**Boating Safety Training Manual,**" and "**Federal Requirements For Recreational Boats**" are also available from the U.S. Coast Guard Headquarters.

Because of proposed alterations in buoys and markers, Rinker Boat advises you to contact the U.S. Coast Guard to stay informed of impending changes. If you have a ship-to-shore radio telephone aboard, heed storm warnings and answer any distress calls. The spoken word "**MAYDAY**" is the international signal of distress. "**MAYDAY**" should **NEVER be used unless there is present danger — an emergency — and you are in need of immediate assistance.**

## Drugs and Alcohol

### **▲WARNING**

**WARNING:** Operating a boat while intoxicated or under the influence of drugs is dangerous and illegal. Impaired vision or judgment on the water can quickly lead to disaster. Driving any boat, requires sober, attentive care.

In the interest of safety, you must refrain from the use of drugs or alcohol while operating your boat. Federal law prohibits operating a boat under the influence of drugs or alcohol. These laws, which carry a significant penalty, are vigorously enforced. The use of drugs and/or alcohol will decrease reaction time, impair your judgment and inhibit your ability to operate your boat safely.

## **SAFETY EQUIPMENT ON BOARD**

Federal law requires you to provide and maintain safety equipment on board your Rinker boat. The items listed here are for your boating safety. Please refer to Federal, State, and Local Laws for a complete list of required equipment.

### **Personal Flotation Devices (PFDs)**

United States Coast Guard approved wearable personal flotation devices of Type I, II, or III, along with one Type IV throwable device must be on board your Rinker Boat. The PFDs must be of a suitable size for each person aboard and shall be in serviceable condition and readily accessible.

- **PFD Type I, Wearable** This PFD has the greatest required buoyancy. It's design allows for turning most unconscious persons in the water from face down position to a vertical or slightly backward position. Type I is most effective for all waters, especially offshore when rescue may be delayed.
- **PFD Type II, Wearable** Type II turns its wearer the same as Type I, but the turning action is not as pronounced as the Type I. The Type II will not turn as many persons under the same conditions as a Type I.
- **PFD Type III, Wearable** Type III allows the wearers to place themselves in a vertical or slightly backward position. Type III has the same buoyancy as a Type II PFD. It has little or no turning ability.
- **PFD Type IV, Throwable**, The Type IV device can be thrown to a person in the water and grasped and held by the user until rescued. The design does not allow for it to be worn. The most common type IV PFD's are a buoyant cushion and/or ring buoy. The throwable Type IV PFD shall be immediately available for use and be in serviceable condition.
- **PFD Type V, Wearable**, must be worn to be effective. When inflated, it provides buoyancy equivalent to Type I, II or III PFDs. When it is deflated, however, it may not support some people.

## **Fire Extinguishers**

As the owner of a Rinker boat, it is your responsibility to equip your boat with hand portable fire extinguishers approved by the U.S. Coast Guard. If your Cruiser style boat is 26 feet or longer, one Type B-II or two Type B-I fire extinguishers are required. If your Cruiser/Cuddy style boat is less than 26 feet long, one Type B-I fire extinguisher is required.

All fire extinguishers should be mounted in a readily accessible location away from the engine compartment. All persons on board should know the location and proper operation of the fire extinguishers.

If your fire extinguisher has a charge indicator gauge, cold or hot weather may have an effect on the gauge reading. Consult the instruction manual supplied with the fire extinguisher to determine the accuracy of the gauge.



## Visual Distress Signals

Visual Distress Signal equipment is required and may be of the pyrotechnic or non-pyrotechnic type. The regulation requires all recreational boats when used on coastal waters, which includes the Great Lakes, territorial seas and those waters directly connected to the Great Lakes and the territorial seas, up to a point where the waters are less than two miles wide, and the boats owned in the United States when operating on the high seas, to be equipped with visual distress signal equipment.

Pyrotechnic and non-pyrotechnic equipment must be U.S. Coast Guard approved, in serviceable condition and stowed in a readily accessible location. Equipment providing a date for serviceable life, must be within the specified usage date shown.

### Pyrotechnic equipment:

Pyrotechnic U.S. Coast Guard approved visual distress signals and associated equipment include:

- Red flares, hand held or aerial
- Orange smoke, hand held or floating
- Launchers for aerial red meteors or parachute flares

### Non-pyrotechnic equipment:

- Orange distress flag
- S-O-S Electric distress light

No single signaling device is ideal under all conditions for all purposes. Consideration should be given to carrying various types of equipment. Careful selection and proper stowage of visual distress equipment is very **IMPORTANT** if young children are frequently aboard.

## Horn

All Class 1 (16 to 26 feet) powerboats are required to carry a hand, mouth or power operated horn or whistle. It must produce a blast of two-second duration which can be heard at a distance of at least one-half (1/2) mile.

All Class 2 (26.1 to 39.4 feet) powerboats are required to carry a hand, mouth or power operated horn or whistle. It must produce a

blast of two-second duration which can be heard at a distance of at least one (1) mile.

## Boat Registration

Federal and state laws require that every boat equipped with propulsion machinery of any type must be registered in the main state of usage. Registration numbers and validation stickers must be displayed on the boat according to regulations. The registration certificate must be carried on board when the boat is in use.

## Discharge of Oil

The Federal Water Pollution Control Act prohibits the discharge of oil or oily waste into or upon the navigable waters of the United States or the waters of the contiguous zone if such discharge causes a film or sheen upon or a discoloration of the surface of the water or causes a sludge or emulsion beneath the surface of the water. Violators are subject to a penalty of \$5,000.00.

## Disposal of Plastics & Other Garbage

Plastic refuse dumped in the water can kill fish and marine wildlife, and can foul vessel propellers and cooling water intakes. Other forms of waterborne garbage can litter our beaches and make people sick. Because of this, U.S. Coast Guard regulations completely prohibit the dumping of plastic refuse or other garbage mixed with plastic into the water anywhere, and restrict the dumping of other forms of garbage within specified distances from shore.

## ILLEGAL TO DUMP

**INSIDE 3 MILES (and in U.S. Lakes, Rivers, Bays and Sounds)**

- **PLASTIC**
- **DUNNAGE, LINING AND PACKING MATERIALS THAT FLOAT**
- **ANY GARBAGE EXCEPT DISHWATER/GRAYWATER/FRESH FISH PARTS**

### 3 TO 12 MILES

- PLASTIC
- DUNNAGE, LINING AND PACKING MATERIALS THAT FLOAT
- ANY GARBAGE NOT GROUND TO LESS THAN ONE SQUARE INCH

### 12 TO 25 MILES

- PLASTIC
- DUNNAGE, LINING AND PACKING MATERIALS THAT FLOAT

### OUTSIDE 25 MILES

- PLASTIC

The U.S. Coast Guard has issued these regulations to implement Annex V of the International Convention for the Prevention of Pollution from Ships, 1973, commonly known as Annex V of the MARPOL (Marine Pollution) Treaty 73/78. They apply to all U.S. vessels wherever they operate (except waters under the exclusive jurisdiction of a State), and foreign vessels operating in U.S. waters out to and including the Exclusive Economic Zone (200 miles).

**IMPORTANT:** The regulations require U.S. recreational boaters, if your boat is 26 feet or more in length, to affix one or more USCG Trash Dumping Restrictions placards to your boat. The placard warns against the discharge of plastic and other forms of garbage within the navigable waters of the United States, and specify discharge restrictions beyond the territorial sea ( the territorial sea generally ends 3 nautical miles from the seashore). In addition, the placard must contain the warning that a person who violates these requirements is liable to civil (\$25,000) and criminal (imprisonment) penalties . The placard also must note that State and local regulations may further restrict the disposal of garbage.

Operators shall ensure that one or more placards are displayed in prominent locations and in sufficient numbers, so that they can be observed and read by the crew and passengers. These locations might include embarkation points, food service areas, galleys, garbage handling spaces, and common deck spaces frequented by passengers and crew.

These placards may be purchased from local marinas, boat dealerships and marine equipment suppliers. A special placard is available for boats operating on the Great Lakes.

## UNDERWAY

---

### Warning Makers

Always check with local authorities concerning regional hazardous areas and how they are marked. Other considerations include:

- Boat operators must be able to recognize marine flag designs and respond accordingly.
- Caution should always be exercised relative to swimmers. Swimming areas may not always be marked.
- Navigation markers identify navigable routes and indicate water hazards. Boat operators should familiarize themselves with these important navigational tools and operate their boats accordingly.
- Be prepared to assist anyone flying a 'distress' flag as they are requesting immediate assistance.

### Fog

Fog is a result of either warm-surface or cold-surface conditions. You can judge the likely-hood of fog formation by periodically measuring the air temperature and dew point temperature. If the spread (difference) between these two temperatures is small, fog is likely. Remember the following guidelines:

- Turn on running lights.
- As fog sets in take bearings, mark your position on the chart while continuing to log your course and speed.
- Ensure all persons on board have put on their personal flotation devices.
- If equipped with sounding equipment, you should take soundings and match them with soundings on your charts.
- Station a person forward in the boat as a lookout.

- Reduce your speed. From time to time stop engine(s) and listen for other fog signals.
- Sound the horn or fog bell intermittently to warn others.
- If there is any doubt in continuing your boat's movement, anchor. Listen for other fog signals while continuing to sound your fog horn or bell.

## Weather and Storms

Current and forecasted weather conditions are a primary consideration when planning a cruise. You should listen to local weather forecasts before leaving port. You should also learn to recognize the weather signals flown by many cruiser clubs.

Storms can nevertheless come up without much advance notice. Although accurate weather information is available from meteorological observation and reporting stations, predictions are sometimes incorrect or data gathering equipment may fail. A good skipper will watch the horizon for an approaching storm.

There is no substitute for a keen observation of weather conditions and a good knowledge of what action to take when the weather takes a turn for the worse. If a storm does come up, do the following:

- Turn the radio on. Dial in the local weather station and monitor the forecast.
- The best possible situation is to return to a safe port if time allows.
- Close portals and hatches and secure them. Stow all loose gear below deck and tie-down any gear on deck.
- Reduce speed as the seas build. Ensure all persons on board have put on their personal flotation devices.
- Place a sea anchor out over the bow to keep the bow into seas. If there is no sea anchor aboard use a canvas bucket or any object that will offer resistance.

- Radar reflectors (if installed on your boat) should be 18 inches diagonally and placed 12 feet above waterline.

## Fire

A fire on board your boat is a serious emergency. You must work quickly to implement safety procedures. It is always a good idea to show your passengers how to operate the fire extinguisher. If a fire occurs:

- Stop the engine(s) immediately.
- Have everyone on board put on a PFD (personal flotation device).
- If the fire is small, attempt to put it out with your fire extinguisher.
- If the fire is in the engine compartment, turn off the bilge blower. Do not open the engine compartment. Feeding more oxygen to the fire may cause it to flare up.
- If the fire gets out of control, send up a distress signal. Call for help if your boat has a ship-to-shore radio.

If the fire cannot be controlled and help is not available, everyone on board should jump overboard and swim a safe distance away from the flames. Stay together in a group. Swim to shore only if it is a **short** distance. Be aware that the distance to shore is often much farther than it appears to be. Looking for a person attempting to swim to shore makes rescue efforts more difficult.

**IMPORTANT:** All persons on board should know the location and proper operation of the fire extinguishers.

### Guidelines for Fire Prevention

- Check the bilge for fuel leaks.
- Check cleaning products for flammability.
- Ventilate when cleaning or painting.
- Disconnect electrical system from power source when performing any type of maintenance.

- Use extra caution when using exposed flame around urethane foam.
- Extinguish smoking materials carefully.
- Ensure ventilation systems are not obstructed.
- Use only approved marine cooking and heating systems.
- Open flames demand constant attention.
- Keep flammable materials in approved containers.
- Replace circuit breaker fuse with one of the same amperage.
- The electrical system should be serviced by a qualified marine electrician.

## Collision

If a collision occurs, you should first check the condition of persons aboard and then inspect the boat to figure out the extent of damage.

- Have all persons on board put on their personal flotation devices.
- If your boat is taking on water, turn on the bilge pump immediately.
- Prepare to help the other craft unless your passengers or boat is in danger.
- If the bow of the other boat penetrated your boat's hull, prepare to plug the fracture once the boats are separated.
- Shore up the hole with a spare life jacket or bunk cushion inside your boat.
- While plugging the hole, trim weight to get portion of boat where hole exists out of water during repairs.
- If your boat has a VHF radio, contact the U.S. Coast Guard or other rescue authorities immediately on Channel 16.

## Swamped or Capsized Boat

If your boat becomes swamped or capsizes, put on a PFD immediately and set off a distress signal. Chances are good that a capsized boat will stay afloat. For this reason, stay with the boat. Do not leave the boat or try to swim to shore except under extreme conditions. A capsized boat is easier to see than a swimmer, and the shore may be farther away than it appears.

More often than not, boats sink while docked. Any number of factors may contribute to these sinkings. There may have been a mechanical failure such as a failed bilge pump or an electrical problem such as a dead battery or tripped circuit breaker. Check your boat regularly if it is docked for an extended period of time, to make sure everything is in order.

## Man Overboard

Should someone in the boat fall overboard:

- Act quickly – treat every situation as an emergency.
- Move throttle to idle position and yell "Man Overboard".
- Immediately throw a type IV PFD to the person in the water.
- Have someone in the boat assume responsibility for watching the person in the water and keep them in sight while the boat maneuvers back to them.
- Approach the person into the wind and waves. When alongside, put the engine in neutral and throw them a Type IV PFD with a line attached or extend an oar or boat hook.

## Running Aground

If your boat runs aground, check persons on board for injury and inspect damages to the boat or propeller(s). If possible, shift weight of passengers or gear to heel boat while reversing engine(s).

## **▲WARNING**

**WARNING:** Do not use deck hardware for grounding or towing. Rinker Boat recommends that you use a commercial towing service if your boat becomes grounded.

If you ground your boat on a sand bar, shut down the engine and seek help from another boater or radio for help. See your dealer as soon as possible, as sand sucked into the engine cooling system can cause major engine damage.

## **NAVIGATIONAL AIDS CHART**

The following Navigational Aids Chart on page 2-9 contains information concerning:

- Whistle Signals
- Storm Warnings
- Bridge Signals
- Buoy description and information

## **Additional Equipment**

Rinker Boat recommends additional safety equipment on board to help make your boating experience safer and more enjoyable:

- Anchor and line
- Boat hook
- Bucket & sponge
- Commonly used spare parts
- Compass, navigational charts
- Distress signal kit
- Docking and towing lines
- Engine & Accessories Manuals
- Engine lubricating oil
- Extra keys
- Extra V-belts
- Fenders
- First aid kit
- Flashlight & extra batteries
- Manually operated bilge pump
- Owner's Manual
- Paddle
- Portable plastic fuel can (Recommend seven gallons or less)
- Replacement light bulbs

- Ship-to-shore radio
- Spare fuel & oil filters
- Spare propeller with fastening hardware
- Spare set of spark plugs and ignition parts
- Tool kit





## **HAZARD COMMUNICATION LABELS**

Some or all of the hazard communication labels shown on page 2-10 can be found in various locations on board your Rinker boat. If your boat is missing any of these labels, notify your Rinker dealer for replacement.











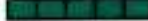









**Note:** Respective labels are determined by the standard and/or optional equipment that is actually installed on board your boat upon delivery.

## REMEMBER THESE RULES

1. **OVERTAKING - PASSING:** Boat being passed has the right-of-way. **KEEP CLEAR.**
2. **MEETING HEAD ON:** Keep to the right.
3. **CROSSING:** Boat on right has the right-of-way. Slow down and permit boat to pass.

<p style="text-align: center;"><b>← PORT</b>                      <b>STARBOARD →</b></p> <div style="display: flex; justify-content: space-around; align-items: center;"> <div style="text-align: center;"> <p>Yield right-of-way to boats in your <b>DANGER ZONE!</b></p>  </div> <div style="text-align: center;"> <p><b>DANGER ZONE</b> (Dead ahead to 2 points abaft your starboard beam)</p> </div> </div>	<p style="text-align: center;"><b>STORM WARNINGS</b></p> <div style="display: flex; justify-content: space-around; align-items: center;"> <div style="text-align: center;">  <p><b>RED FLAG</b> Small craft (winds to 33 knots)</p> </div> <div style="text-align: center;">  <p><b>2 RED FLAGS</b> Gale (winds up to 47 knots)</p> </div> <div style="text-align: center;">  <p><b>SQUARE RED FLAG BLACK BOX</b> (Storm)</p> </div> <div style="text-align: center;">  <p><b>2 SQUARE RED FLAGS BLACK BOX</b> (Hurricane)</p> </div> </div>																					
<p style="text-align: center;"><b>WHISTLE SIGNALS</b></p> <p><b>ONE LONG BLAST:</b> Warning signal (Coming out of slip)</p> <p><b>ONE SHORT BLAST:</b> Pass on my port side</p> <p><b>TWO SHORT BLASTS:</b> Pass on my starboard side</p> <p><b>THREE SHORT BLASTS:</b> Engine(s) in reverse</p> <p><b>FOUR OR MORE BLASTS:</b> Danger signal</p>	<p style="text-align: center;"><b>BRIDGE SIGNALS</b></p> <table style="width: 100%; border-collapse: collapse;"> <thead> <tr> <th style="width: 50%;"></th> <th style="width: 25%;">DAY (Flag)</th> <th style="width: 25%;">NIGHT (Lights)</th> </tr> </thead> <tbody> <tr> <td><b>SOUND</b></td> <td></td> <td></td> </tr> <tr> <td>VESSEL: Open</td> <td style="text-align: center;">— ●</td> <td style="text-align: center;">□ ○ ●</td> </tr> <tr> <td>BRIDGE: OK</td> <td style="text-align: center;">— ●</td> <td style="text-align: center;">□ ○ or ●</td> </tr> <tr> <td>No</td> <td style="text-align: center;">● ● ● ● ● ●</td> <td style="text-align: center;">● ● ● ● ● ●</td> </tr> <tr> <td>VESSEL: Replies:</td> <td style="text-align: center;">● ● ● ● ● ●</td> <td style="text-align: center;">● ● ● ● ● ●</td> </tr> <tr> <td><b>RADIO: VHF CH. 13</b></td> <td style="text-align: center;">No</td> <td style="text-align: center;">No</td> </tr> </tbody> </table>		DAY (Flag)	NIGHT (Lights)	<b>SOUND</b>			VESSEL: Open	— ●	□ ○ ●	BRIDGE: OK	— ●	□ ○ or ●	No	● ● ● ● ● ●	● ● ● ● ● ●	VESSEL: Replies:	● ● ● ● ● ●	● ● ● ● ● ●	<b>RADIO: VHF CH. 13</b>	No	No
	DAY (Flag)	NIGHT (Lights)																				
<b>SOUND</b>																						
VESSEL: Open	— ●	□ ○ ●																				
BRIDGE: OK	— ●	□ ○ or ●																				
No	● ● ● ● ● ●	● ● ● ● ● ●																				
VESSEL: Replies:	● ● ● ● ● ●	● ● ● ● ● ●																				
<b>RADIO: VHF CH. 13</b>	No	No																				

## LATERAL AIDS AS SEEN ENTERING FROM SEAWARD

<p style="text-align: center;"><b>PORT SIDE</b> ODD NUMBERED AIDS</p> <p style="text-align: center;">■ GREEN LIGHT ONLY</p> <p>FLASHING: </p> <p>OCCULTING: </p> <p>QUICK FLASHING: </p> <p>ISOPHASE: </p> <div style="text-align: center; margin-top: 20px;">  <p>LIGHTED BODY G "9" Fl G 4sec</p> </div> <div style="text-align: center; margin-top: 20px;">  <p>CAN G C "1"</p> </div> <div style="text-align: center; margin-top: 20px;">  <p>DAYMARK G "1"</p> </div>	<p style="text-align: center;"><b>SAFE WATER MID-CHANNELS OR FAIRWAYS</b> NO NUMBERS — MAY BE LETTERED</p> <p style="text-align: center;">□ WHITE LIGHT ONLY    MORSE CODE</p> <p style="text-align: center;">Mo (A) □ □ □ □ □ □</p> <div style="display: flex; justify-content: space-around; align-items: center; margin-top: 20px;"> <div style="text-align: center;">  <p>SPHERICAL RW SP "G"</p> </div> <div style="text-align: center;">  <p>MR RW "A"</p> </div> <div style="text-align: center;">  <p>LIGHTED AND/OR SOUND RW "N" Mo (A)</p> </div> </div> <hr/> <p style="text-align: center;"><b>PREFERRED CHANNEL</b> NO NUMBERS — MAY BE LETTERED</p> <p style="text-align: center;">COMPOSITE GROUP FLASHING (2 + 1)</p> <p style="text-align: center;">□ □ □ □ □ □ □ □</p> <div style="display: flex; justify-content: space-around; align-items: center; margin-top: 20px;"> <div style="text-align: center;">  <p>GR "C" Fl (2 + 1)</p> </div> <div style="text-align: center;">  <p>RG "B" Fl (2 + 1)</p> </div> </div> <div style="display: flex; justify-content: space-around; align-items: center; margin-top: 20px;"> <div style="text-align: center;">  <p>CAN GR C "L"</p> <p style="font-size: small;">PREFERRED CHANNEL TO STARBOARD TOPMOST BAND GREEN</p> </div> <div style="text-align: center;">  <p>NUN RG N "W"</p> <p style="font-size: small;">PREFERRED CHANNEL TO PORT TOPMOST BAND RED</p> </div> </div> <div style="text-align: center; margin-top: 20px;">  <p>DAYMARK GR "A"</p> </div>	<p style="text-align: center;"><b>STARBOARD SIDE</b> EVEN NUMBERED AIDS</p> <p style="text-align: center;">■ RED LIGHT ONLY</p> <p>FLASHING: </p> <p>OCCULTING: </p> <p>QUICK FLASHING: </p> <p>ISOPHASE: </p> <div style="text-align: center; margin-top: 20px;">  <p>LIGHTED BODY R "8" Fl R 4sec</p> </div> <div style="text-align: center; margin-top: 20px;">  <p>NUN R N "6"</p> </div> <div style="text-align: center; margin-top: 20px;">  <p>DAYMARK R "2"</p> </div>
---	--	---

## CAUTION

TRIM TABS SHOULD BE USED FOR PORT TO STARBOARD TRIM ADJUSTMENT. EXCESSIVE DOWN TAB MAY RESULT IN POOR HANDLING CHARACTERISTICS. DO NOT RUN TABS DOWN IN FOLLOWING SEA CONDITIONS.

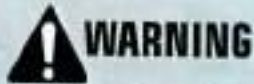

## WARNING



NO JUMPING! NO DIVING!

## SAFETY INSTRUCTIONS

- DO NOT USE WHEN MOTOR IS RUNNING
- FACE LADDER WHEN ENTERING BOAT OR WATER
- ONLY ONE PERSON ON LADDER AT A TIME
- DO NOT GRIP LADDER NEAR HINGE AREAS
- DO NOT GRIP LADDER WHERE IT CONTACTS BOAT

## WARNING

USE ALCOHOL FUEL ONLY IN COOK STOVE  
USE WATER ON ALCOHOL FIRES

H-2221-B

## WARNING

Gasoline vapors can explode:  
Before starting engine:  
• Check engine compartment for gasoline or vapors.  
• Operate blower for 4 minutes.  
Run blower below cruising speed.

## RINKER BOAT COMPANY, INC. SYRACUSE, INDIANA

THIS BOAT COMPLIES WITH U.S. COAST GUARD SAFETY STANDARDS IN EFFECT ON THE DATE OF CERTIFICATION

### APPLY THE PROPER DECAL TO THE DASHBOARD OR OTHER APPROPRIATE LOCATION:

#### AUDIO WARNING HORN WILL SOUND WHEN:

1. ENGINE OIL PRESSURE IS TOO LOW,
2. ENGINE TEMPERATURE IS TOO HOT, OR
3. DRIVE OIL LEVEL IS TOO LOW.

#### TO TEST AUDIO WARNING HORN:

1. TURN KEY TO "ON" POSITION (ENGINE OFF)
2. WAIT 7 TO 14 SECONDS FOR HORN TO SOUND.

FOR MORE INFORMATION, CONSULT YOUR OPERATIONS AND MAINTENANCE MANUAL.

ALL UNITS EQUIPPED WITH DRIVE RESERVOIR HAVING LOW OIL LEVEL SWITCH

## HAZARD COMMUNICATION LABELS

<https://www.boat-manuals.com/>

This chapter includes information about major systems or components on your boat. Please note that this manual does not designate equipment as standard or optional. Your boat may not have some equipment, or it may not be available on some models. If you

have questions, see your dealer for more information.

**NOTE:** The term "engine" in this chapter means one or two engines depending on how your boat is equipped.

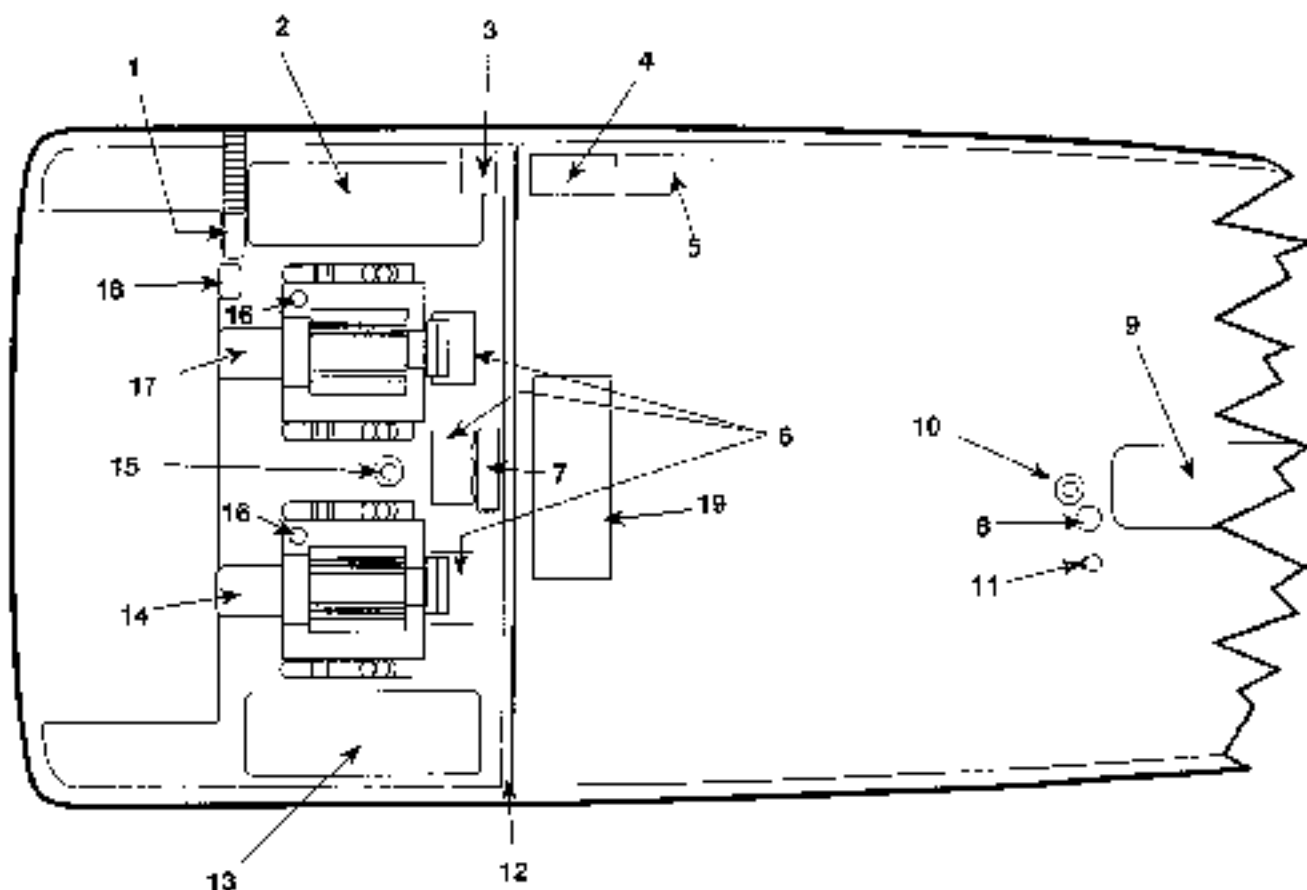
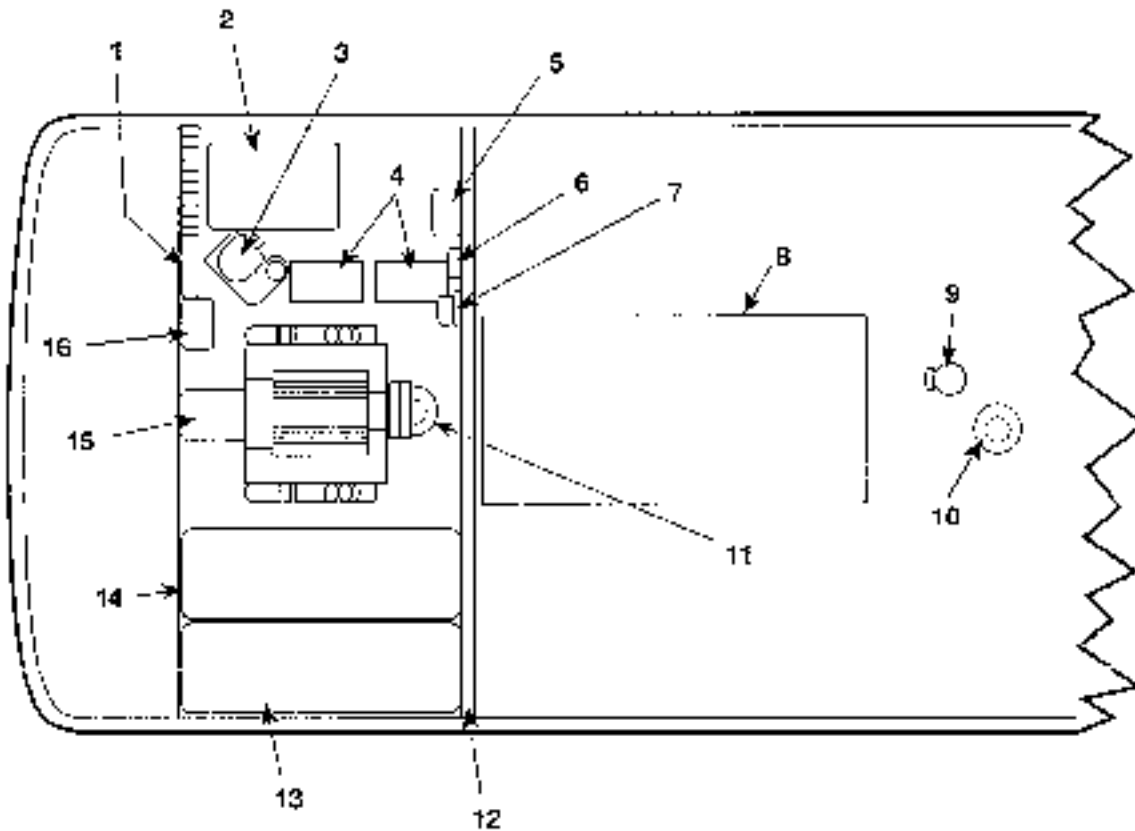

**FIGURE 3.1 TYPICAL TWIN ENGINE COMPARTMENT**

**NOTE:** Location of some items may vary by model.

- |                                     |   |
|-------------------------------------|---|
| 1. Blower                           | 11. Seacock   |
| 2. Port Fuel Tank                   | 12. Fire Resistant Bulkhead                             |
| 3. Battery Charger                  | 13. Starboard Fuel Tank                                 |
| 4. Water Heater                     | 14. Starboard Engine                                    |
| 5. Air Conditioner                  | 15. Aft Bilge Pump                                      |
| 6. (3) Batteries                    | 16. (2) Lower Unit Fluid Bottles<br>(Bravo Drives Only) |
| 7. Battery Switch                   | 17. Port Engine   |
| 8. Sea Strainer and Pump (A/C only) | 18. Trim Tab Pump and Fluid                             |
| 9. Portable Water Tank              | 19. MSD Holding Tank                                    |
| 10. Forward Bilge Pump              | 20. Fuses (not shown)<br>Located Under Helm             |





**FIGURE 3.2 TYPICAL SINGLE ENGINE COMPARTMENT**

**NOTE:** Location of some items may vary by model.

- |                              |   |
|------------------------------|---|
| 1. Blower                    | 10. Forward Bilge Pump                      |
| 2. Water Heater              | 11. Aft Bilge Pump                          |
| 3. Lower Unit Pump and Fluid | 12. Bulkhead                                |
| 4. (2) Batteries             | 13. MSD Holding Tank                        |
| 5. Battery Charger           | 14. Potable Water Tank                      |
| 6. Battery Isolator          | 15. Engine                                  |
| 7. Battery Switch            | 16. Trim Tab Pump and Fluid                 |
| 8. Fuel Tank                 | 17. Fuses (not shown)<br>Located Under Helm |
| 9. Seacock                   |   |

## **ELECTRICAL SYSTEMS**

### **12 Volt DC**

The power supply for the 12 volt DC system is from batteries charged through the engine-driven alternator and an AC converter. The voltmeter on the instrument panel in the dash shows the charge level of the battery. Depending on the boat model, the power from

the battery is supplied through the battery isolator or a dual battery switch on the engine compartment fire wall. From there, power is supplied to the helm dash and the main distribution panel in the galley. The DC circuit breakers on the dash and main distribution panel operate all 12 volt equipment on board. Indicator lights show operating status.

The negative terminal of each battery is connected to the grounding studs of the engine and generator. This negative ground system is the approved system for marine DC electrical systems. If additional equipment is installed on your boat, it must be adaptable to the negative ground system. Be sure to specify that each item's power supply be taken from the main distribution panel. If additional circuit protection is required, it must be added at that panel. Consult your Rinker dealer for additional DC power needs on your boat.

**NOTE:** Power feeds for accessory equipment must NOT be taken from the voltmeter terminals.

**IMPORTANT:** Be sure to protect all electrical components from water, rain, and sea spray.

## Batteries

### **▲ DANGER**

**DANGER: DO NOT** disconnect or reconnect battery cables if gasoline fumes are present!

The batteries installed on your boat by your Rinker dealer are completely sealed using an absorbent electrolyte principle. Depending on the boat model, your boat will have two or three batteries.

### Battery Switches

Depending on the boat model, your boat will have a dual or a single battery switch.

The dual battery switch (if provided) is on the center of the engine compartment fire wall. It is accessible through the engine compartment hatch. The battery switch must be on to start the engine or generator.

There are two battery switches for boats with two engines. Each switch controls its own battery. Contact your Rinker dealer for more specific information.

The single battery switch (if provided) is on the center of the engine compartment fire wall. It is accessible through the engine com-

partment hatch. The battery switch must be on to start the engine. Contact your Rinker dealer for more specific information.

**NOTE:** Battery selection switch location will vary by model.

### Battery Isolator

The battery isolator is beside the single battery switch on the center of the engine compartment fire wall. It is accessible through the engine compartment hatch.

These automatic solid state devices allow for direct connection of the engine's alternator to both batteries or multiples of batteries without fear of overcharging or having one higher charged battery discharging into a lower charged battery. All batteries are electrically isolated from each other. When the engine is running, both batteries are automatically and independently charged. Advantages of the isolators are that they provide complete freedom of battery selection for power use plus alternator protection supplied by the isolator. The isolator is rated for use with alternators having a capacity ranging from 10 to 120 amps for 6, 12, 24 and 32 volt negative ground systems.

### AC/DC Converter and Battery Charger

The AC/DC power converter and battery charging system is fully automatic and permanently wired into the 12 volt DC system. It operates from standard 105 to 125 volt AC power sources. If the monitored battery level drops under the full charge range, the charger automatically turns ON and restores the battery to FULL charge.

**NOTE:** Protect all electrical equipment from rain, water and spray to avoid equipment damage.

### **110 Volt AC**

The AC electrical system operates off the standard dockside 30 amp, 110 volt, 60 cycle shore power or your boat's generator. The main distribution panel in the galley area has a rotary transfer switch to select the preferred AC power source.

## Shore Power

### **CAUTION**

**CAUTION:** Never operate shore power system at less than 105 volts.

Your Rinker boat has one or two male receptacles on the deck for shore power connection. (Boats equipped with air conditioning may have two receptacles.) A water resistant cover protects the receptacle when it is not in use.

## Generator

The generator (optional on some models) provides AC power. The control panel is in the galley area near the main distribution panel.

**NOTE:** See the generator manual for safety precautions and detailed operation, maintenance, and winterizing information.

## Lighting

Lighting is controlled through the main distribution panel. If your boat does not have this panel, you can turn lights on with a switch at the light after you have turned the battery switch on. See your Rinker dealer for information regarding bulb replacement.

## Ground-Fault Circuit Interrupter

The ground-fault circuit interrupter (GFCI) gives added personal protection against electric shock or loss of life. The GFCI outlet on your boat is in the galley. It has a test and reset switch in the middle of the faceplate. If there is a difference of more than 5 milliamperes, a safety switch trips in the GFCI and interrupts the circuit. The tripped switch protects a person from serious electric shock. The GFCI will not eliminate the feeling of an electric shock, but it does open the circuit quickly enough to prevent injury to a person of normal health. Thus, a GFCI provides protection against dangerous currents that do not overload 15- or 20-ampere circuit breakers. All 110 volt outlets and 110 volt lighting are protected by the GFCI.

When the GFCI trips a circuit breaker, you must push the RESET button. Check the GFCI outlet periodically by pushing the TEST button. Pushing the TEST button will cut power to the 110 volt outlets.

## Electrolysis

Electrolysis is the decomposition of compounds, such as metals, exposed to an electric current. This is a common occurrence. A shore power AC electrical system connects your boat to an earth ground circuit. The earth ground circuit "grounds" all metal parts to the earth on shore. This circuit provides protection against hazardous shocks, but it also creates an electrolytic current which causes the decomposition of all submerged metal.

Sacrificial zinc anodes, installed by the dealer or the engine manufacturer, protect metal surfaces exposed to the water. Electrolysis attacks the softest metals first. Because zinc is a softer (less noble) metal, it will decompose before harder (more noble) metals. Check these anodes periodically, and have them replaced as required. See your Rinker dealer for parts and service.

**IMPORTANT:** As the boat owner, you are responsible for periodically inspecting and replacing the sacrificial zinc anodes. Your warranty does not cover damage resulting from electrolytic corrosion.

Another method for preventing electrolysis is using a ground circuit isolator. The isolator prevents the flow of low electrolytic currents, but it does provide a path for catastrophic, short-circuit currents which can trip circuit breakers.

## Schematic Wiring Diagrams

Figures 3-3 through 3-5 are typical AC and DC wiring diagrams for twin engine and single engine boats. Check with your dealer regarding the electrical wiring on your boat.



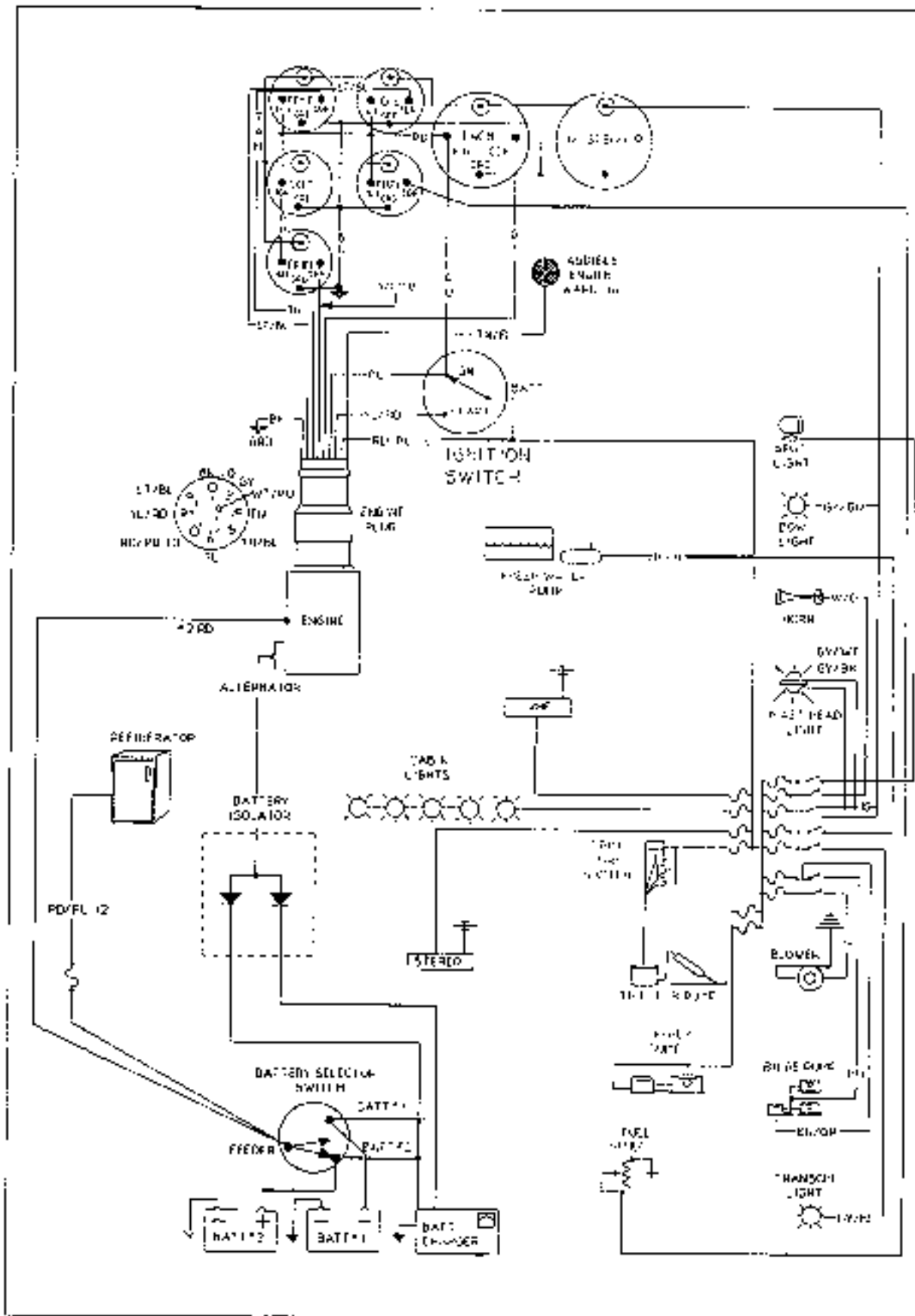

FIGURE 3.4 DC ELECTRICAL DIAGRAM FOR TYPICAL SINGLE ENGINE

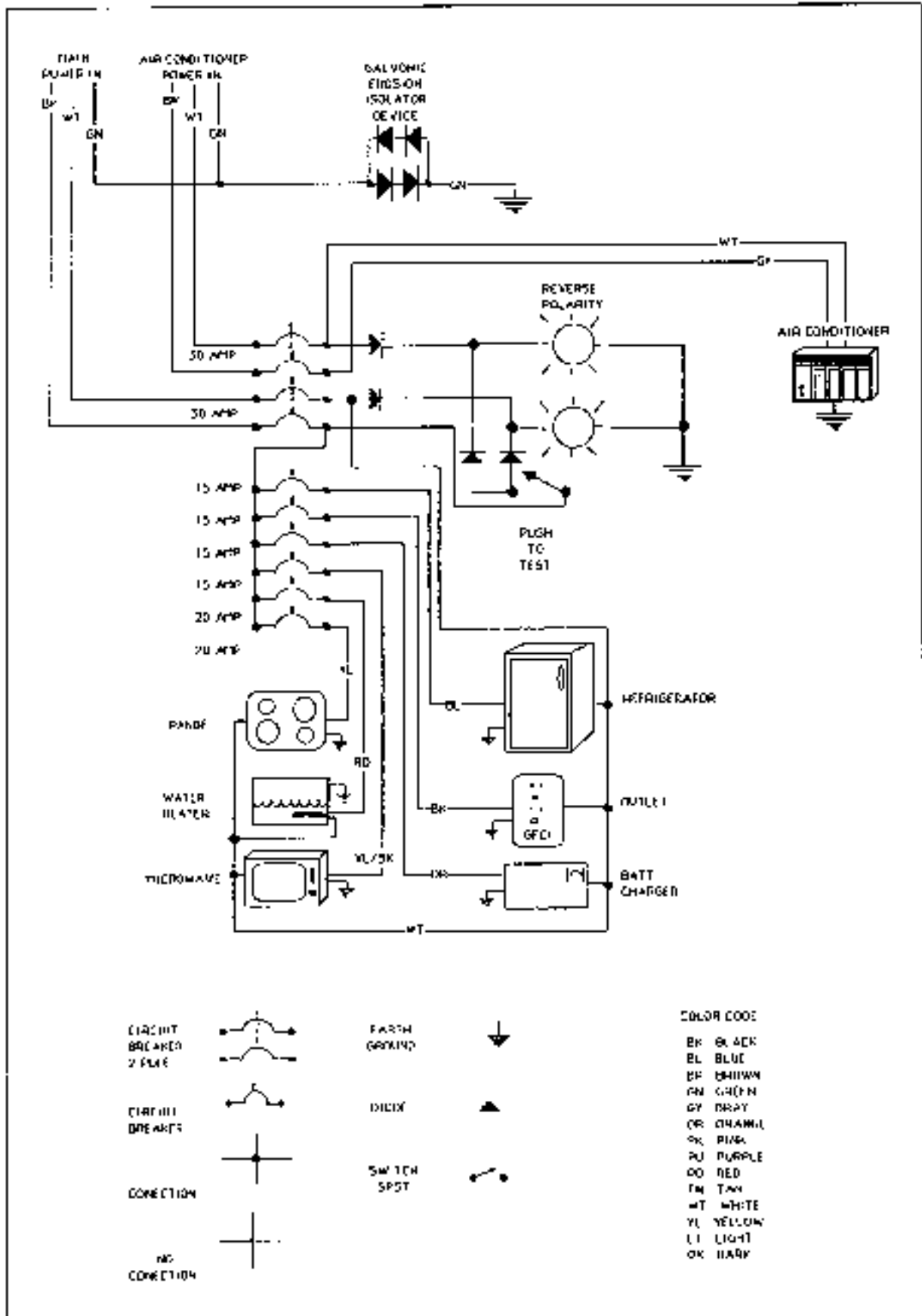

FIGURE 3.5 TYPICAL AC ELECTRICAL DIAGRAM

## FUEL SYSTEMS

**IMPORTANT:** This boat has gas tank(s) under the 'loor—Please check with manufacturer before drilling in the immediate area.

Your boat's fuel system meets all current Federal requirements. The system was assembled with the best materials and components available.

The fuel system consists of the following components:

- Fuel tank or tanks
- Fuel lines and valves
- Fuel filters on engines
- Fuel gauge

Fuel tank capacities vary by model. Check with your Rinker dealer about the fuel tank capacity for your boat. Each tank has an electrical sending unit which provides an electrical signal to the fuel gauge on the command console to indicate the fuel level.

Each engine has a fuel pickup tube in its tank. Each engine also has a separate fuel filter on the forward inboard side of each engine.

**NOTE:** See the engine owner's manual for safety precautions and detailed operation, maintenance, and winterizing instructions.

On boats equipped with twin engines, the fuel tanks are in the engine compartment, one port and one starboard as shown on Figure 3.6. Each fuel tank is accessible through its respective inspection plate in the aft cockpit deck.

The fuel tank fill and vent pipes for each tank are on the transom. The fuel tank vent near the fill plate allows air to escape as the tank is being filled and helps equalize tank pressure as temperatures change. The tank has an anti-siphon valve or manual shutoff valve located at the fuel pickup that keeps fuel from leaking into the boat if a fuel line breaks.

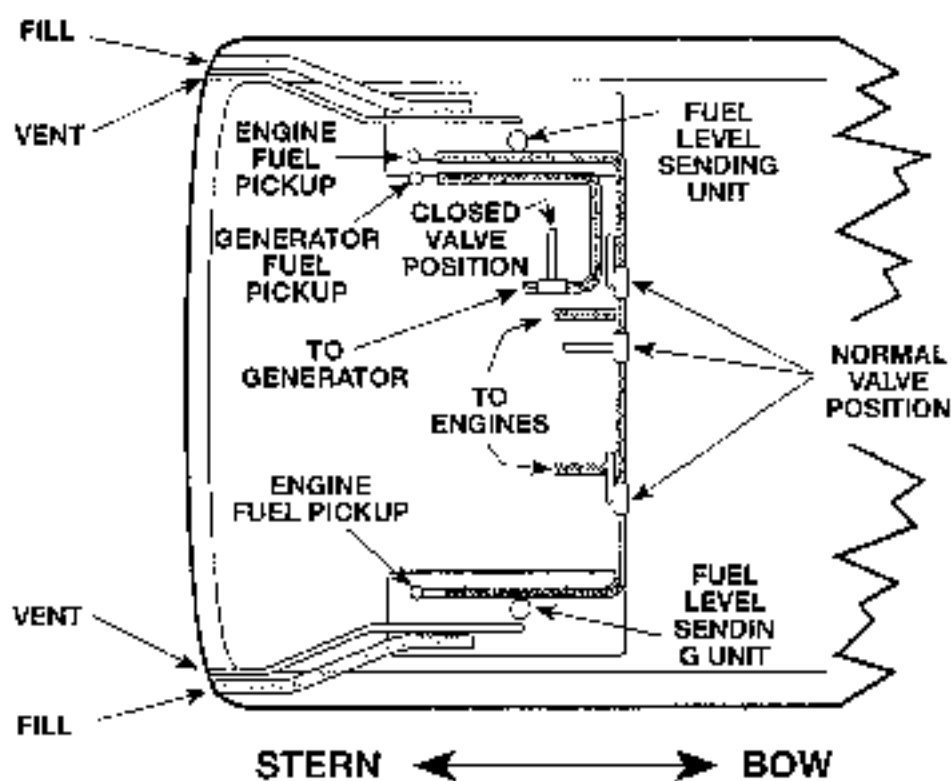
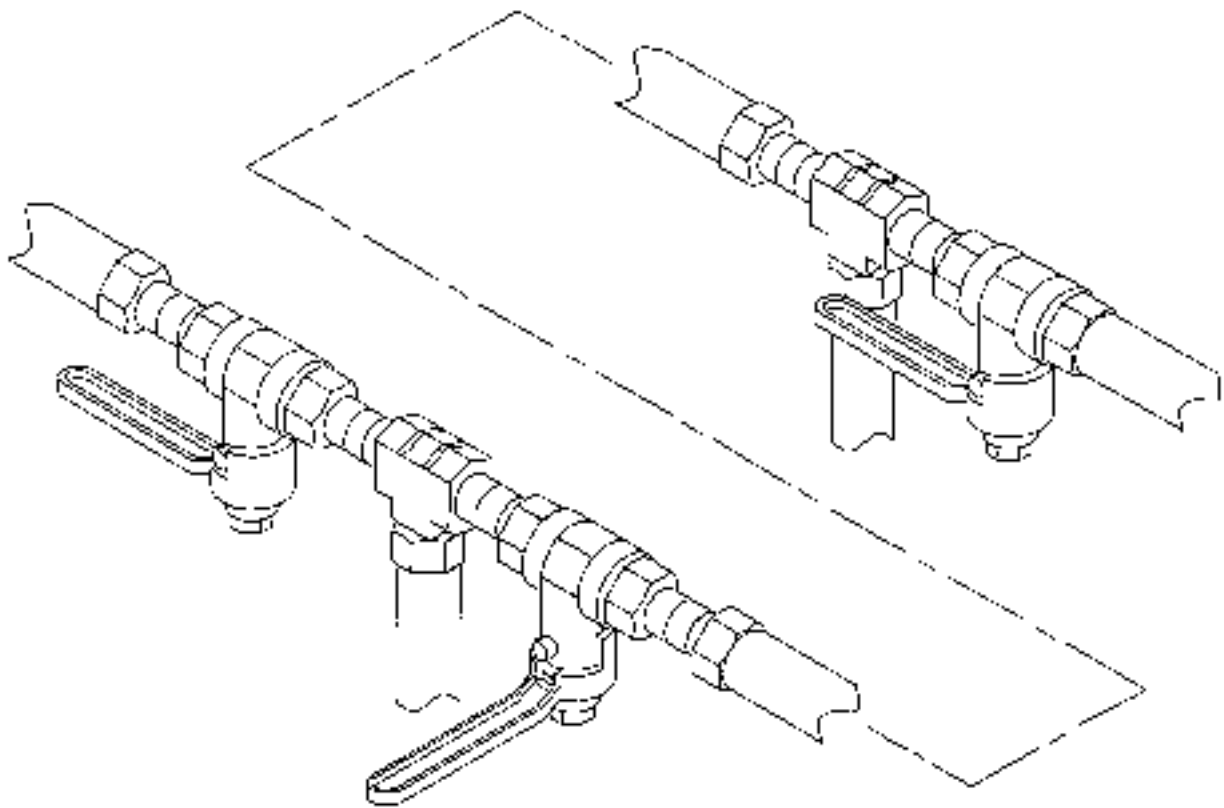

FIGURE 3.6 FUEL SYSTEM FOR TYPICAL TWIN ENGINE



**FIGURE 3.7 FUEL SYSTEM VALVES**

Some models have three manual valves to control flow of fuel to the engine as shown on Figure 3.7. The valves, which are mounted under the cockpit deck, are attached to the fuel tank outlet lines. A valve is closed when its handle is perpendicular to the fuel line and open when its handle is in-line with the fuel line.

These manual valves allow you to control the fuel supply to the engines in three ways:

1. Each engine can receive fuel from its respective tank; port tank to port engine and starboard tank to starboard engine. The crossover valve must be closed and both fuel valves open.
2. Both engines receive fuel from the port tank. Open the crossover valve and the port valve. Close the starboard valve.
3. Both engines receive fuel from the starboard tank. Open the crossover valve and the starboard valve. Close the port valve.



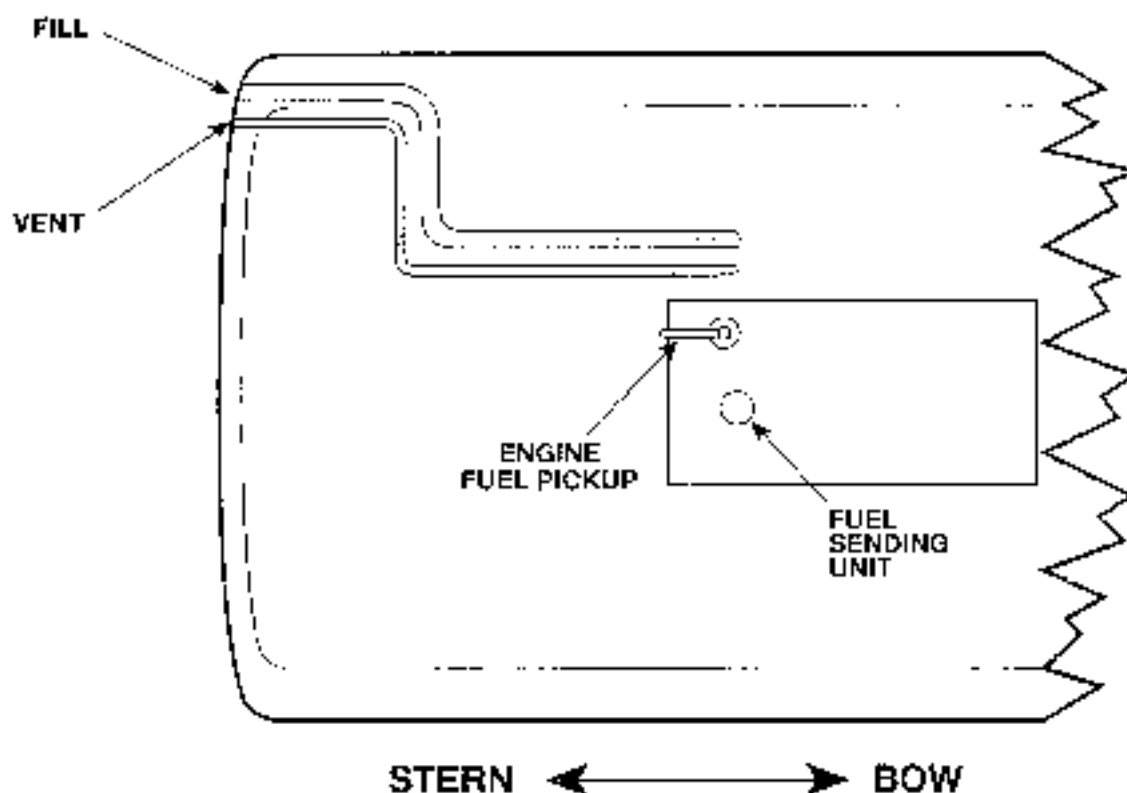

**FIGURE 3.8 FUEL SYSTEM FOR TYPICAL SINGLE ENGINE**

On boats equipped with a single engine, the fuel tank is ahead of the engine compartment fire wall below the cabin deck. See Figure 3.8. Each model's fuel tank is accessible through the engine compartment and has an anti-siphon device located at the fuel pickup.

### **ENGINE EXHAUST SYSTEM**

The engine exhaust system removes harmful gas created by the engine during combustion. Inspect the system for leaks before each use of the boat. Make sure all hose clamps and connections are tight and there are no cracks in any exhaust system component that would allow carbon monoxide gases to escape.

## WATER SYSTEMS

Your boat has a fresh (potable) water system that provides water for drinking and bathing. Figure 3.9 shows a typical system. A supply of water is stored in a fresh water tank. The tank is vented to allow air to enter and escape as water levels change.

**IMPORTANT:** Fill tank only with potable water. Using the water in the tank and refilling it often will help provide a source of fresh and clean drinking water.

### CAUTION

**CAUTION:** Check labels on fill caps carefully. Do not pump gasoline into fresh water tank. Make sure to remove cap labeled FRESH WATER before filling.

### Fresh Water Systems

Your boat has a fresh water system. A water pump provides water under pressure to the system through a pump filter. Water is supplied to the sink and shower in the head compartment, the transom shower in cockpit, the sink in the galley, and the water heater. Hot water is also available at these locations.

The fresh water tank is filled through the fill plate labeled WATER.

Depending on the boat model, the tank vents are next to the fill plate or through the port bow hull. Your dealer can help you find the fill plates and tank vents if you have a question.

### Sanitizing the Fresh Water System

Sanitize the fresh water system before using it the first time, after winter storage, or when system has not been used for extended periods of time.

### CAUTION

**CAUTION:** Bleach solution used to sanitize system is poisonous. Notify all persons on board that fresh water system is being sanitized. Do not allow anyone to drink water from system while sanitizing system.

**NOTE:** Fresh water tank must be empty before beginning sanitizing process. If necessary, empty tank.

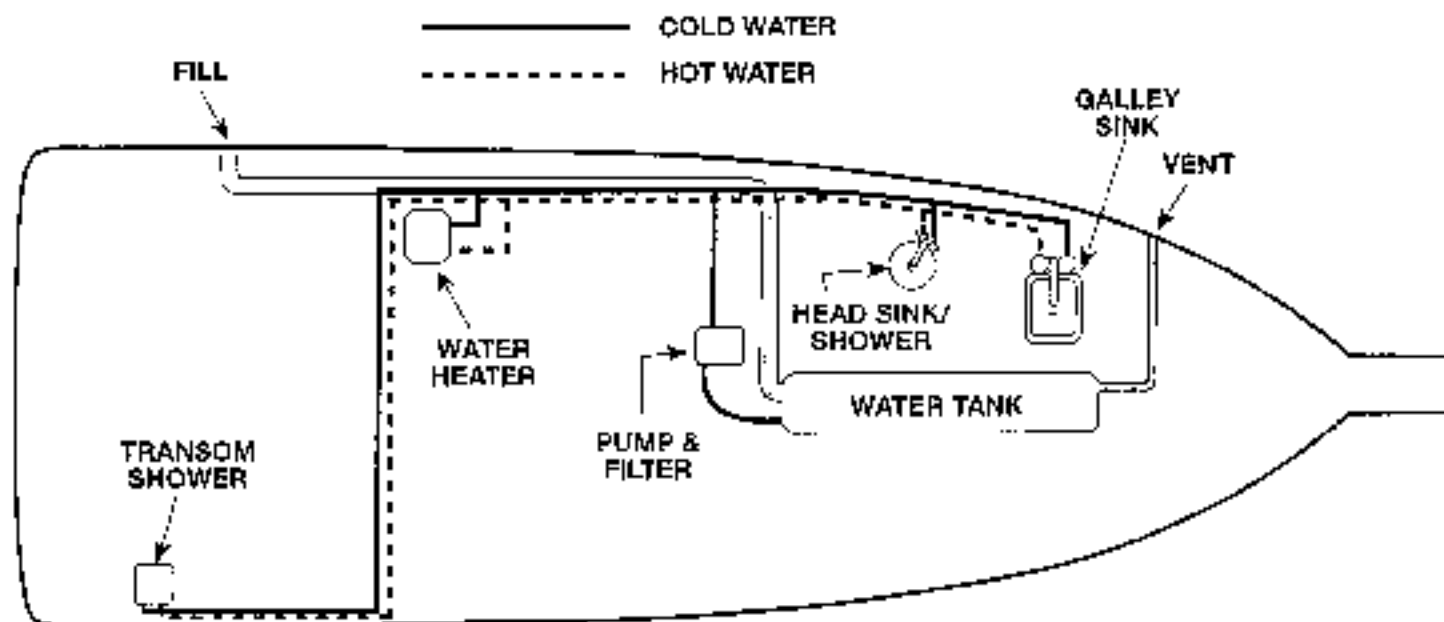

FIGURE 3.9 TYPICAL FRESH WATER SYSTEM

1. In an appropriate size container, make a solution of household bleach and fresh water. Use 2 ounces of bleach per gallon of water. A minimum of ten gallons is recommended.
2. Place solution into empty tank. Fill to capacity with fresh water.
3. Turn fresh water pump ON. Open all faucets, beginning with faucet farthest from pump, to bleed air from entire fresh water system.
4. Allow sanitizing solution to remain in tank for 3 to 4 hours.
5. Drain solution from tank and lines.
6. Flush entire system with fresh water.

**IMPORTANT:** Thoroughly flush entire system with fresh water after each sanitizing process.

If water has a strong chlorine taste after sanitizing, perform the following:

1. Prepare a solution of 1 quart (approximately 1 liter) of vinegar and 5 gallons (19 liters) of water. Pour into fresh water tank.
2. Allow solution to stand in tank for several days.

### **CAUTION**

**CAUTION:** Notify all persons on board that the fresh water system is being treated. Do not allow anyone to drink from the fresh water system during treatment.

3. Drain entire system and flush with fresh water.

**IMPORTANT:** Thoroughly flush entire system with fresh water after treatment.

4. Fill tank with fresh water. Then bleed all lines.

### **Initial Start-Up**

1. Partially fill the fresh water tank with fresh water.
2. Turn Fresh Water Breaker to ON position. Breaker is on main distribution panel in galley area or on the dash.
3. Open cold water faucet in the galley to allow air to escape. Close faucet when steady flow of water is visible.
4. Open hot water faucet in the galley to fill water heater and allow air to escape from line. Close faucet when steady flow of water is visible.
5. Bleed air from remaining faucets as performed in steps 3 and 4.
6. Fill fresh water tank to capacity. Check with your dealer or refer to product literature for tank capacity.

### **Water Pump and Filter**

The water pump supplies water under pressure to the fresh water system. The filter prevents particles from entering the pump reservoir.

Inspect the pump for leakage and clean the filter periodically.

1. Before servicing the system, turn the water system breaker OFF.
2. Check the pump and water lines for leakage.
3. Release pressure on the system by opening all faucets.
4. Remove filter cover.
5. Remove filter screen, rinse with clean water, and reinstall.
5. Make sure the O-ring is seated properly when installing cover.

**NOTE:** Refer to the pump owner's manual for safety precautions and detailed operation, maintenance, and winterizing instructions.

## Water Heater

The water heater runs on 110 volt AC power from the shore power connection or your boat's generator. It has a 15 amp circuit breaker on the main distribution panel in the galley area. A check valve prevents hot water from flowing back into the cold water supply. It also has a pressure relief valve to prevent damage to the heater if water pressure or temperature becomes too high. The water heater's thermostat is preset and is not adjustable.

**IMPORTANT:** Make sure the water heater remains full if power is supplied to heating element inside the heater. Otherwise, the heating element will be damaged.

The water heater can also capture heat from the engine coolant to provide hot water while underway. Hot engine coolant is circulated through the hot side of the heat exchanger, while cooler water from the heater is circulated through the cool side. Heat is transferred from the coolant to the water through the heat exchanger walls. *If the coolant circulates through the heat exchanger for an extended period of time, the water can become very hot.*

**NOTE:** Refer to the water heater instruction manual for safety precautions and detailed operation, maintenance, and winterizing instructions. See your dealer if you have any questions.

## Marine Sanitation Device (MSD)

### ⚠ WARNING

**WARNING:** Explosion Hazard! Waste in holding tank can form methane, an explosive gas. Keep vent open and clear of obstructions. Keep fire and flame away when maintaining sanitary system.

U.S. Coast Guard regulations require that boats have a sanitation system to control pollution. Wastes are to be stored in a holding tank or other device until they can be properly disposed of at a shore facility. **Discharging**

this waste overboard in U.S. lakes, rivers, bays and sounds and within 3 miles of shore in international waters is prohibited. Check with the Coast Guard regarding regulations in your area.

The marine sanitation device (MSD), or head, is similar to a home toilet. The major difference is that the MSD is flushed with sea water supplied by an electric or manual pump, depending on how your boat is equipped. Some models have a flushing system which pumps the water into the head and flushes out the waste water and material into a holding tank.

If your boat has an electric pump, make sure the seacock is open and power to the pump is on before using the head (see Figure 3.10). The seacock, which is in the bilge, is open when the handle is in line with the hose.

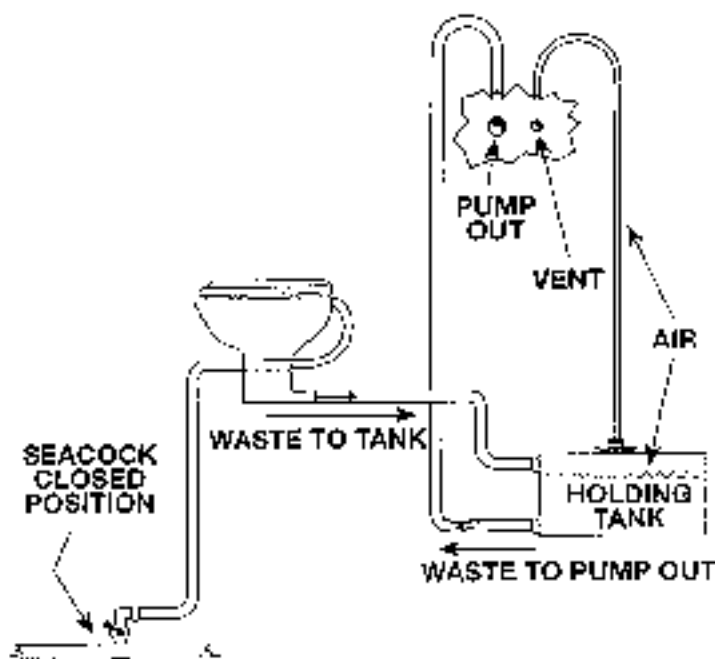

FIGURE 3.10 TYPICAL HEAD DISCHARGE SYSTEM

### ⚠ CAUTION

**CAUTION:** Open seacock only when flushing MSD. Be sure to close seacock while underway or when leaving your boat unattended.

Using marine sanitary system chemicals at the beginning of the boating season and after every pumpout can help control odor in the head and the holding tank. Follow the instructions on the label. Using too much of these chemicals may cause premature deterioration of the hoses.

**IMPORTANT:** Use only biodegradable toilet tissue sold for marine use. Do not deposit any foreign objects into the toilet. A cigarette or paper towel could damage this system.

Pump out the holding tank based on the frequency of usage. The tank must be pumped out at a dockside pumping station.

If the tank is full do not use it. If the tank is over filled, waste can plug the tank vent or, worse yet, the tank can rupture and spill its contents into the bilge.

If you will not be using the head for several days, flushing sea water through the head will clear waste from the lines. Otherwise, waste in the lines tends to dry out. These hardened wastes make the inside diameter of the hose smaller and may affect future operation.

**NOTE:** See the owner's manual provided by manufacturer for safety precautions and detailed operation, maintenance, and winterizing instructions.

This chapter describes standard and optional components that may be installed on your boat at the factory. In a limited number of cases, a component may not be available for a specific model.

Your Owner's Manual packet includes literature supplied by the component manufacturer. Rinker Boat recommends that you read all operation, maintenance, and safety information in the manual for each component before operation.

**NOTE:** The term "engine" in this chapter means one or two engines depending on how your boat is equipped.

## **⚠ WARNING**

**WARNING:** When using electrical components, observe basic safety precautions to reduce the risk of fire, electrical shock, personal injury, or damage to your boat or the component.

## **INSTRUMENTATION AND CONTROLS**

The full set of instruments installed on your Rinker boat show what is taking place within your engine and related systems. When you take delivery of your boat, ask your Rinker dealer about the normal readings of the gauges. This will provide you with a reference point to evaluate how well your boat is operating. Keep in mind that the readings on some gauges tend to fluctuate. You should investigate all gauges that show a continuous variance from normal readings over time or a sudden, substantial variance.

### **Engine Systems Alarm**

Some engine models are equipped with a systems alarm. One of the following problems will activate the alarm:

1. High engine temperature

2. Low oil pressure
3. Low outdrive oil level

Refer to your engine owner's manual or check with your dealer to determine whether your engine is equipped with this alarm.

### **Fuel Gauge**

The fuel gauge shows the amount of fuel in the fuel tank. The most accurate reading of the fuel gauge is at idle speed when your boat maintains an approximately level position. While underway, the fuel gauge will usually indicate that the tank is fuller than it actually is because the bow is higher than when the boat is at rest. Since gauge readings are approximate, they should be compared to the hours of use versus known fuel consumption per hour.

The most common practice for good fuel management is the one-third rule. Use one-third of your fuel supply to travel to your destination and one-third to return. Keep the remaining one-third in reserve for emergencies.

### **Oil Pressure Gauge**

The oil pressure gauge will indicate most, if not all, serious engine problems. A preset valve in the oil pump controls the maximum oil pressure. If the gauge indicates a complete loss of oil pressure, **stop the engine immediately** to prevent serious damage to the engine.

Check the engine oil level, and add oil if it is low. If the oil level is full, contact your Rinker dealer or a qualified mechanic to rectify the problem. **Do not restart the engine until the problem is corrected.**

### **Tachometer**

The tachometer gauge displays the engine operating speed in revolutions per minute (RPM) in increments of 100. The tachometer will show the RPMs necessary under various engine operating conditions. Consult your Rinker dealer if you need more information.

### Temperature Gauge

The temperature gauge shows the temperature of the coolant in the engine's cooling system. Always check this gauge right after starting the engine. Water pumps on marine engines draw in raw water, circulate it through the heat exchanger on the engine, and discharge it overboard through the exhaust system. If the temperature gauge indicates that the coolant is hot, **stop the engine immediately**. Refer to your engine owner's manual for instructions and corrective action.

### Voltmeter

The voltmeter shows battery voltage. If the engine is running at normal speed (1000 RPMs or higher) and the alternator is charging, the reading on the meter will range between 12.0 to 15.5 volts. When the engine is not running and the ignition key or switch is ON, the battery is fully charged if the meter reading is high. Significantly higher or lower readings indicate a battery problem, an alternator malfunction, or heavy drain on the battery. Check the charging system and the battery system for the cause of these readings. An oscillating reading shows a loose voltage regulator connection or loose belts. Low voltage

readings after stopping the engine indicate a bad battery or a heavy load on the battery. **Refer to your engine owner's manual for proper gauge readings.**

### Throttles & Gear Shifts

The throttle acts as the gear shift lever to control the forward and aft movement of the boat and to control engine operating speed. Figure 4.1 shows both a single and dual throttle console. Dual throttle consoles provide independent lever control of both clutch and throttle operation of each engine. This type of design ensures safe control of both engines with one hand.

### **CAUTION**

**CAUTION:** When shifting between forward and reverse, always pause in neutral for a few seconds before reversing propeller rotation to prevent damage to the drive system.

Moving the throttle forward of the neutral position engages the shifting mechanism, causing the boat to move forward. Continuing the forward movement increases engine RPMs and

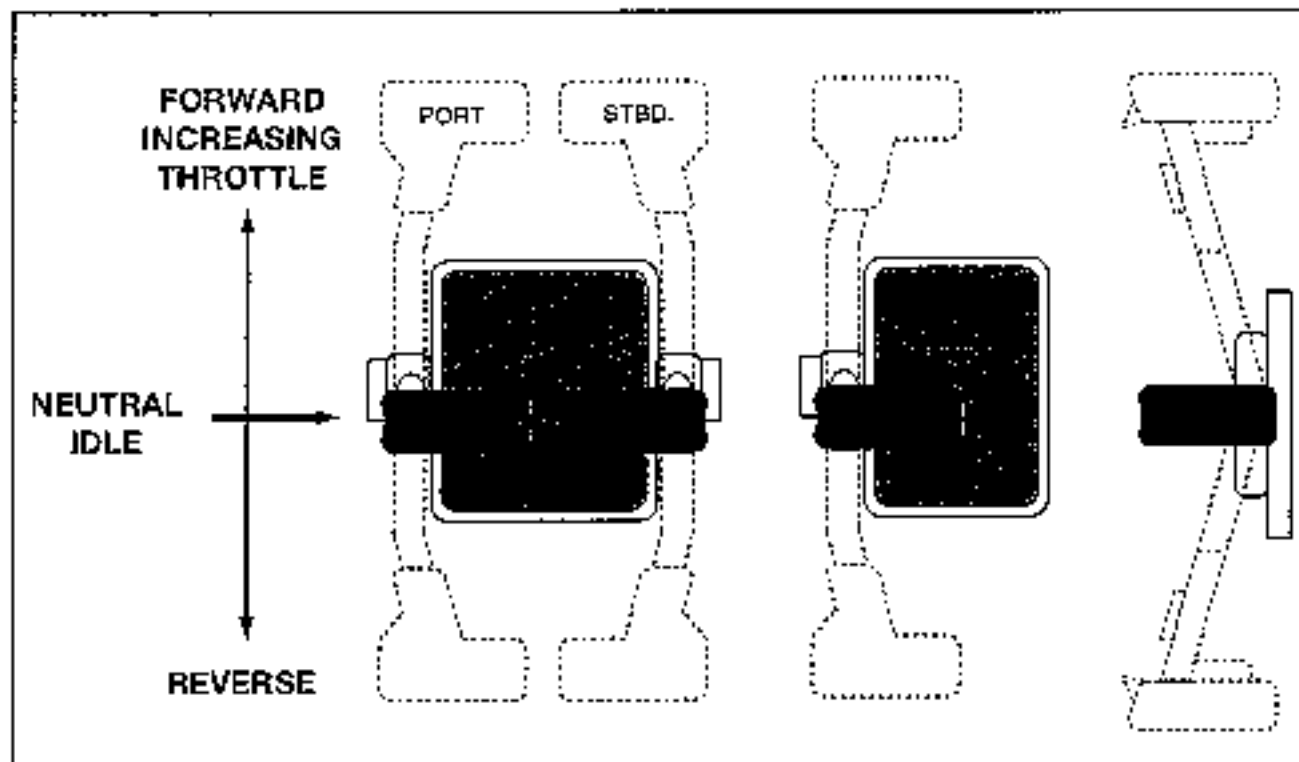

**FIGURE 4.1 DUAL AND SINGLE THROTTLE POSITIONS**

Increases the speed at which the boat moves through the water.

Moving the throttle aft of the neutral position reverses the shift mechanism causing the boat to move backward. Continuing the aft movement of the throttle increases engine RPMs and causes the boat to move faster in a backward direction. When maneuvering at low speeds, you can reverse (move throttle forward or aft) the shift mechanism to brake boat travel.

See your dealer for detailed information about using the throttle and gear shift.

## **GENERATOR**

---

Listed below are basic procedures you should follow when you operate the generator. The owner's manual has detailed information about generator specifications, safe operation, and maintenance and winterizing procedures. It also explains where you can have the generator serviced.

Most electrical components on your boat have separate switches on the main electrical control panel. The panel switch must be turned on to supply power to a component. If a control switch is mounted on the component, it too must be turned on to operate the component. Your dealer can provide more information about the operation of these components.

1. Before starting the generator, run the bilge blower for five minutes to exhaust explosive gas fumes from the engine compartment. Run the blower while the generator is operating.
2. When starting the generator, never operate the starter for more than 30 seconds. Wait at least 30 seconds before each attempted start.
3. Make sure the generator seacock in the engine compartment is open when operating the generator. Inspect the seawater strainer frequently. The seawater strainer must be free of debris to prevent clogging the intake. If the intake is clogged, the generator will overheat.

## **AIR CONDITIONER**

---

The control panel for the Environmental Control Unit (ECU) provides control for both heating and cooling. The control panel displays its programmed factory settings when AC power is supplied to your boat and the air conditioner circuit breaker is ON. These settings are described in the operation section of the ECU manual.

The manufacturer's operation manual includes detailed information about ON/OFF selection, temperature setting, display and calibration; fan speed and calibration; and compressor staging (time delay operation). The manual also has technical data and troubleshooting information to help maintain the unit in safe and proper operating condition.

The air conditioning system uses sea water for operation. The air conditioning pump takes seawater in through a seacock and a strainer located under the steps. It pumps the water through the system from which it is discharged overboard. Make sure the seacock is open when operating the air conditioner. As with the generator, make sure the seacock strainer is clean and free of debris.

## **REFRIGERATOR/FREEZER**

---

The refrigerator/freezer will operate on 12 volt DC power from the batteries.

Keep in mind that using the DC system can drain the battery over several hours. If AC power is not available during an extended outing, run the engine occasionally to keep the battery charged. You can conserve battery power by setting the temperature control at a warmer setting. However, you should check food in the freezer every six to eight hours to make sure it stays frozen.



## STOVE

---

Your boat may have either an alcohol or electric stove. The fuel reservoir holds approximately one quart of ethyl alcohol. **Use marine stove alcohol only.** The alcohol/electric stove operates off the 30 amp shore power system, the boat's generator, or alcohol.

### **⚠ WARNING**

**WARNING:** Alcohol flame is invisible in sunlight. Fueling ignited burner can cause alcohol to flare up. Do not light burner unless flame is extinguished and burner is cool. Carefully follow all instructions in owner's manual.

### **⚠ WARNING**

**WARNING:** Stove flame consumes oxygen. ventilate cabin while stove is in use.

The stove owner's manual has specific and detailed instructions explaining how to use and maintain your stove safely. Rinker Boat emphasizes the importance of using this stove correctly and safely. **CAREFULLY READ and understand the instructions before operating the stove.**

## MICROWAVE

---

An electronic touch control panel controls the microwave. For a detailed description of the microwave oven features refer to the owner's manual supplied by the manufacturer.

### **⚠ WARNING**

**WARNING:** To reduce the risk of burns, electric shock, fire, injury to persons, or exposure to excessive microwave energy read ALL instructions before using the microwave oven.

## RACK AND PINION POWER STEERING

---

Your boat has a rack and pinion power steering system. An enclosed cable system connects the steering wheel to the stern drive. Check the cables regularly and tighten them as needed.

Power steering provides positive steering control while providing you, the operator, with the steering sensitivity and "feel" needed for good steering control.

Getting the "feel" of your boat's steering system is important. Steering does vary from boat to boat depending on the shape of the hull, the type of engine, water and wind conditions, and the load. Turn the wheel from full left to full right. Check that the drive unit is turning correctly, freely, and smoothly.

Check the power steering fluid level and belt tension before you start the engine. The cable output end of the steering system should be clear of fuel lines, control cables, electrical wiring, and outboard gear when an engine is moved through its full operating range.

**NOTE:** Refer to the engine owner's manual for detailed information regarding steering system operation and maintenance.

## BILGE PUMP

---

**NOTE:** The Federal Water Pollution Act prohibits the discharge of oil or oily waste into or upon the navigable waters and contiguous zone of the United States if such discharge causes a film or sheen upon, or discoloration of, the surface of the water, or causes a sludge or emulsion beneath the surface of the water. Violators are subject to a penalty of \$5000.

The electric bilge pump removes water from the bilge area. The pump can be operated automatically and manually. Power is always available to the bilge pump when it is set for operation in the automatic mode. When the water in the bilge rises to a preset level, a float switch at the bilge pump turns the pump on automatically. The pump runs until the water level reaches a preset low level.

The bilge pump can also be operated manually using the pump switch at the helm. When operated in the manual mode, the pump will not shut off automatically.

**IMPORTANT:** Running the pump dry will damage the pump. Be sure pump is pumping water while it is running.

If the pump motor runs but does not remove any water, it may be clogged. If no visible debris is clogging the pump and water is still not being removed, inspect the discharge hose for kinks or obstructions.

## **BILGE BLOWER**

The bilge blower forces fumes out of the engine compartment area while it draws fresh air in through the deck vents. The bilge blower must be running at least four minutes before and while the boat engine is started and while boat is operating below cruising speed.

### **▲WARNING**

**WARNING:** Never assume that by operating the blower all explosive fumes have been removed from the engine compartment. If you smell any fuel fumes, immediately shut down the engine and all electrical components. Determine the source of the fumes, and correct the problem.

## **RUNNING OR NAVIGATION LIGHTS**

If you boat at night, the law requires that you turn on your boat's running lights. Your Rinker boat has one white (mast), one red (port), and one green (starboard) light. Check the running lights periodically for proper operation. If you set out on a boating excursion during daylight hours and will be returning at night, check the lights before you leave port.

You will probably see various running light combinations for the types of vessels you encounter while boating. You should learn to identify what they are and what type of vessel they are associated with. Participation in a

"safe boating" course will help you learn more about boating safety and help develop your navigation skills.

The running/navigation lights are controlled by a three-position rocker switch at the helm station. This switch allows you to turn all lights off, turn on only the mast light when your boat is anchored or moored, or to turn on all three lights while underway.

## **COMPASS**

After all equipment has been installed at the helm, a qualified compass adjuster should compensate for the deviations caused by iron, steel, magnets, and electrical wiring in the helm area. Even after the compass is adjusted, there will be slight deviations. The adjuster will give you a deviation card or chart showing you how the deviations will affect a compass course.

### **▲WARNING**

**WARNING:** Other equipment near compass can cause erroneous readings. Compensator must be adjusted by trained professional to ensure accuracy. Always make a deviation table and use it when navigating with compass. Consult your dealer for more information about using and adjusting the compass.

The compass is a delicate instrument. After the compass has been adjusted, keep all metal or electrical items at least three feet away from the compass. For example, placing a screwdriver or wrench on the helm next to the compass, even for a minute or two, can affect its magnetic field and result in incorrect readings.

**To prevent damage to the compass, use only water and a soft cloth to clean the compass housing.**

See the manufacturer's instruction manual for safety precautions and for operation and maintenance instructions. Check with your dealer if you have questions.

## **DEPTH FINDER**

Refer to the owner's manual for detailed information covering the proper operation of the depth finder.

## **MARINE STEREO**

The unit is a highly sensitive AM/FM stereo receiver with an auto-reverse cassette tape player.

The system employs several electronic circuits especially designed reception on both AM and FM bands. Built into the unit are the SNC (Stereo Noise Cut) for noise reduction on FM broadcasts and the HCC (High Cut Circuit) which automatically cuts hissing noise.

Some boats have four marine stereo speakers, two in the cabin and two in the cockpit area, allowing for total stereo listening pleasure either above or below deck. Other models have speakers located only in the cockpit.

Some other features include AM/FM selector buttons, weather band selector with channel selector, 7 band equalizer, head phone jack, CD (Compact Disc) input jack, automatic seek control, clock, battery backup, memory, and mute control. Some models have a remote control panel at the helm for controlling system functions.

**NOTE:** The above mentioned features may vary on some marine stereo models. See the manufacturer's manual for detailed information and a complete list of features.

## **VHF RADIO WITH ANTENNA**

Although the VHF radio contains protective circuit boards and an extensive gasket system that make it water resistant, you should be careful not to expose the radio to water, rain, or sea spray.

The radio can receive and transmit voice messages and receive weather information. All operations are controlled by a series of touch pads on the reversible front panel. It has fully programmable high speed scanning for entering as few or as many channels you prefer to scan.

**NOTE:** See the manufacturer's manual for safety precautions and detailed operation and maintenance information.

This chapter provides basic information for a typical boating excursion from launching to returning to port. All boaters are responsible for their own safety and the safety of others. Even though you may be an experienced operator, all boaters can nevertheless benefit from reviewing the basic boating principles discussed in this chapter.

**NOTE:** This chapter may refer to equipment and components that are standard on some models and optional or unavailable on other models.

**NOTE:** The term "engine" in this chapter means one or two engines depending on how your boat is equipped.

## TRAINING COURSES

Rinker Boat urges you to attend the instruction classes and boat safety courses sponsored by the U.S. Coast Guard and other organizations. They provide owners and operators the opportunity to gain knowledge and experience in a variety of skills such as those listed below:

- Safety at sea
- Radio communication
- Using distress signals
- Using lifesaving equipment
- "Rules of the Road"
- First aid
- Federal, state, and local regulations
- Predicting the weather
- Survival in bad weather
- Respect for others on the water
- Pollution control
- Understanding your boat and its systems
- Seamanship
- Boat handling and navigation
- Leaving or approaching a dock or mooring
- Anchoring and weighing anchor
- Handling mooring lines and tying up
- Responding to fire, flooding, collision, and other emergencies

## CARBON MONOXIDE HAZARD

Carbon monoxide poisoning can be a hazard whether your boat is moored or underway. You must be aware of your surroundings and how they may affect your safety and that of your passengers. Make sure of proper ventilation at all times.

**IMPORTANT:** Rinker Boat recommends that you have a CO monitor installed. The monitor must be professionally installed and calibrated.

### **▲ DANGER**

**DANGER:** Carbon monoxide can be harmful or fatal if inhaled. Carbon monoxide in high concentrations can be fatal in minutes. To prevent excess exposure and reduce the possibility of carbon monoxide accumulation in the cabin, ensure adequate ventilation by opening cabin hatches, doors, windows, and side windshield vents to increase air movement.

Carbon monoxide (CO) is an odorless and colorless poisonous gas. Burning gasoline or any other fuel containing carbon produces carbon monoxide. Common sources of carbon monoxide include the exhaust from internal combustion engines and open flame devices such as cooking ranges and charcoal grills. Because its weight is about the same as that of air, it can quickly spread throughout a confined space such as a boat's cabin without the occupants being aware of its presence. It does not rise or fall as do some other gases.

When inhaled, carbon monoxide in the lungs combines with the blood to reduce the ability of the blood to carry oxygen. Reducing the oxygen supply to body tissues results in death of the tissue. Carbon monoxide in high concentrations can be fatal in minutes. However, the effects of exposure to lower concentrations are cumulative, and lower concentrations can be as lethal as high concentrations.

The symptoms of excessive exposure to carbon monoxide concentrations may include watering and itchy eyes, throbbing temples, ringing in the ears, inattentiveness, headache, nausea, dizziness and drowsiness. Certain health problems (for example, lung disorders or heart problems) and age will increase the effects of carbon monoxide as does consuming alcohol or high concentrations of cigarette smoke.

Many variables can affect carbon monoxide accumulation. Among these are the following:

- Boat layout and configuration
- Location of hatch, window, door and ventilation openings
- Location of structures and other boats
- Wind direction
- Vessel speed

Because this manual cannot identify or describe every possible variable or combination of variables, boat operators must remain aware of the possibility of carbon monoxide accumulation.

The following illustrations show how carbon monoxide can accumulate while at the dock or while underway. Become familiar with these examples and their precautions to prevent dangerous accidents.

### **▲ DANGER**

**DANGER:** Hull exhaust outlets blocked by a nearby pier, dock, seawall bulkhead, or any other means can cause excessive accumulation of poisonous carbon monoxide gas within the cabin areas. Make sure hull exhaust outlets are clear and open.

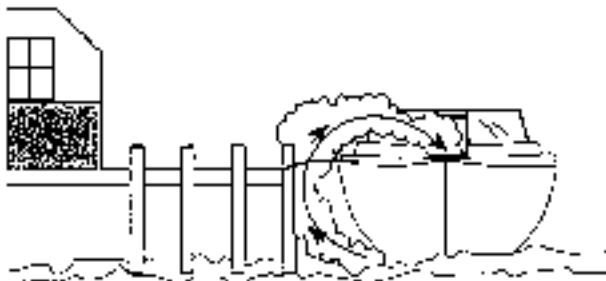

**FIGURE 5.1 BLOCKED HULL EXHAUST OUTLETS**

### **▲ DANGER**

**DANGER:** Engine and generator exhaust from other vessels alongside, while docked or anchored, can emit carbon monoxide and cause excessive accumulation in the cabin and cockpit areas. Be alert for exhaust from other vessels alongside.



**FIGURE 5.2 EXHAUST FROM OTHER VESSELS**

### **▲ DANGER**

**DANGER:** When protective weather coverings are in place, hull exhaust from your boat while underway can cause excessive accumulation of carbon monoxide within the cabin and cockpit areas. Provide adequate ventilation when the canvas top, side curtains, or aft curtains are in place.



**FIGURE 5.3 CO ACCUMULATION WITH PROTECTIVE COVERINGS**

## **▲ DANGER**

**DANGER:** While underway, engine exhaust from your boat can cause excessive accumulation of carbon monoxide within cabin and cockpit areas when operating boat with a high bow angle. Provide adequate ventilation, redistribute the load, or operate at lower bow angle.



**FIGURE 5.4 HIGH BOW ANGLE**

## **▲ DANGER**

**DANGER:** Engine exhaust from your boat, when operating at slow speed or stopped, can cause excessive accumulation of carbon monoxide within the cabin and cockpit areas. Force of tail wind can increase accumulation. Provide adequate ventilation or slightly increase speed if possible.



(Operation at slow speed shown above)



**FIGURE 5.5 OPERATION AT SLOW SPEED & PROPER VENTILATION**

## **TRANSPORTING**

A correctly selected trailer supports your boat properly, makes towing safer, and makes unloading and loading in varying weather conditions easier. Improper trailering is one of the major causes of damage to the hull. The warranty does not cover damage of this type.

Always check local and state laws for legal towing speeds and other requirements such as lighting and turn signals. State laws require that boat trailers above a specific gross vehicle weight rating (GVWR) have brakes. Some states require registration of boat trailers and license plates. Requirements may vary from state to state. Check with the Department of Motor Vehicles or your Rinker dealer for information applicable to your state.

The published weight is the dry weight of your boat. Dry weight does not include the weight of outboard motors, batteries, gasoline, gear and any optional items. The weight of these items must be added to the dry weight to determine the proper trailer GVWR needed. On boats equipped with stern drive engines, the dry weight includes the weight of the standard engine. If your boat is equipped with a larger engine, you must allow for this added weight.

These are some general guidelines for safe trailering of your Rinker Boat.

1. If the weight of the boat and equipment is not properly distributed on the trailer, the trailer may sway or fishtail while being towed. Swaying or fishtailing can result in damage to the boat, trailer, or towing vehicle and can be very dangerous at higher highway speeds.
2. To prevent damage to the hull, make sure the rollers or bunks support a large hull surface area. Distribute the weight of the boat and equipment evenly on the trailer.
3. To prevent wind damage to a boat with a convertible top, do not tow it with the top up. Also, some mooring covers are not intended for use while trailering. Check with your Rinker dealer for more information.

4. Always remove the drain plug while trailering your boat. Be sure to install it before launching.
5. Make sure the overall height of your boat while it is on the trailer does not exceed legal limits.
6. Be sure to balance the load. If too much weight rests on the hitch, the front end of the vehicle will sway or oversteer. Insufficient weight on the trailer will cause the trailer to fishtail. In either case, the vehicle will be hard to handle and could become uncontrollable at high speeds.

## LAUNCHING

Launching your boat will require that you back the trailer down the launch ramp. If you do not have experience in backing a trailer, practice before you get into a confined public or private launch site. Take your trailer to an open area, and have someone guide you. Learn to back the trailer as straight as possible. Remember that if you want the trailer to move right or left, you must turn the steering wheel in the opposite direction. For example, if the trailer needs to go to the right, turn the wheel to the left.

**NOTE:** For more specific information refer to your trailer owner's manual.

Here are some tips to remember when you are putting your Rinker Boat in the water:

1. Prepare for launching **before** backing your boat onto the ramp:
  - Remove stem tiedowns.
  - Store all loose gear properly
  - Inventory your safety equipment.
  - Lock winch and trailer unit.
  - Tilt drive unit up to clear the ramp.
  - Disconnect trailer wiring - car to trailer.
2. Have someone at the ramp give you directions. Back slowly down the ramp. Always remember to launch your boat at a right angle to the shore.

3. When the boat's transom is in several inches of water, stop the towing vehicle. Turn off engine with transmission in first gear (manual transmission) or PARK (automatic transmission). **Set parking brake.**

4. Attach bow line to the boat. Disconnect winch cable and move boat down the trailer and into the water. Tie boat to the pier.

**NOTE:** To keep the boat from drifting away, a person on shore should hold the other end of the bow line until the boat is tied to the pier.

5. Lower drive unit into the water.

6. Pull your vehicle away from the launch ramp. Park your vehicle in a designated area. Be sure you do not block access to the launch ramp.

## FUELING

If possible, fill your boat's fuel tank before loading passengers and gear. If passengers are on board, have them leave the boat until fueling is complete.

### **▲ DANGER**

**DANGER:** Fuel leaking from any part of the fuel system can lead to fire and explosion that can cause serious bodily injury or death.

**IMPORTANT:** Remember that if 1/2 pint of gasoline explodes, it has the same power as 15 sticks of dynamite.

Inspect for leakage, weakening, hardening, swelling or corrosion of fuel components including fuel tanks, fuel lines, fittings, fuel filters, and carburetors. Any sign of leakage or deterioration requires replacement before further engine operation.

## **▲ WARNING**

**WARNING:** Do not use fuels containing any form of alcohol or alcohol derivatives. Alcohol destroys marine fuel system hoses and components. Weakened hoses can lead to hazardous leaks, fire or explosion.

Rinker Boat recommends the use of alcohol-free gasoline when possible because of the adverse effect of alcohol on fuel system components. If only gasoline containing alcohol is available, or the presence of alcohol is unknown, it requires performing more frequent inspections for leaks and abnormalities.

### **Preparing for Fueling**

## **▲ DANGER**

**DANGER:** Fuel vapors are explosive and can become trapped within the lower portions of the boat. All hatches, windows, doors, and compartments must be closed while fueling your boat.

1. Safely and securely moor your boat to the dock. Stop the engine.
2. Turn off all electrical equipment, engines, generator, air conditioner, appliances, lights, bilge pump and blower, etc.
3. Extinguish all cigarettes, cigars, and pipes. Avoid using anything that may produce a spark or flame.
4. Close all hatches, windows, doors, and compartments.
5. Make sure a fire extinguisher is readily available.

### **Filling the Tank**

1. Always fill the tank in an area supplying sufficient lighting conditions. You may not see a gasoline spill under poor lighting or in darkness.

2. Remove fuel fill cap from through-hull fitting on your boat's transom. Insert the fuel supply nozzle. Keep nozzle in contact with metal fill plate (if provided) while fueling.

**IMPORTANT:** When fueling your boat, be sure you do not mistake the waste pumpout or water fill caps for the fuel fill cap. Read the labels!

3. After you have pumped approximately 10 gallons of fuel into the tank, inspect the engine and fuel tank area for any signs of fuel leakage. Continue fueling if you do not detect any leaks or other problems.
4. Stop filling tank before fuel overflows. Allow space at the top of the tank for thermal expansion. Fuel pumped from underground tanks is cooler than the outside air. Gasoline expands as it warms up and can easily overflow the tank.

If fuel cannot be pumped into the tank at a reasonable rate, check for a plugged fuel vent or a kink in the line.

### **After Fueling Procedures**

1. When you have finished fueling, replace the fuel fill cap. If necessary, wash off any fuel spilled around the fuel fill area. Properly dispose of rags used to wipe off fuel spillage.
2. Open the engine compartment and all hatches, windows, doors and compartments closed during fueling. Inspect these areas for fuel fumes or fuel line leakage. Investigate and correct any indication of fumes or fuel leakage before starting the engine.
3. Run the bilge blower for at least five minutes before starting the engine. Continue to run the bilge blower until the boat is underway and has reached its cruising speed.



## LOADING PASSENGERS AND GEAR

### ⚠CAUTION

**CAUTION:** Overloading and improper distribution of weight are significant causes of accidents. Capacity plates, located near the helm, show maximum loads under normal conditions. Give yourself an added margin for safety in turbulent waters. **Overloading is a violation of U.S. Coast Guard regulations.**

The U.S. Coast Guard requires that a plate stating the maximum load capacity be affixed to boats up to 20 feet long. This plate shows the load (persons and gear) in pounds the boat will handle safely under normal conditions. The U.S. Coast Guard establishes these load capacity ratings. Boats over 20 feet long are not subject to U.S. Coast Guard safe loading or labeling requirements.

Whether your boat is shorter or longer than 20 feet, you, the operator, are responsible for using common sense and sound judgment when loading your boat. Pleasure boats tend to remain stable under most operating conditions because of their beam, draft, and weight displacement. Remember that **overloading and improper distribution of weight are significant causes of accidents. Keep weight below maximum limits for safety in turbulent waters.**

When loading your boat, remember to distribute the load evenly, keep the load low and do not overload. When loading your boat, always step onto the boat, never jump. Have someone on the dock pass your gear aboard. Secure all gear firmly so that it will not move or interfere with operation of the boat. **Be sure all required safety gear is aboard your boat in an easily accessible location.**

### ⚠CAUTION

**CAUTION:** Wet surfaces can be slippery. Passengers should wear adequate deck shoes while boarding and underway to avoid accidental slipping and injury.

Passengers should board the boat one at a time and find a seat. Passengers should remain seated during loading of the boat to maintain an even trim. Do not allow passengers to ride on the bow with feet hanging over the side or to ride sitting on the stern or gunwales. Falling from moving boats is a major cause of fatal recreational boating accidents.

## STARTING THE ENGINE

The engine operation and maintenance manual supplied with your boat provides pre-start and starting instructions. The following information is merely a guide and not intended to explain in detail all starting procedures and instructions. **Refer to your engine owner's manual or check with your dealer for more complete information.**

### ⚠WARNING

**WARNING:** Carbon Monoxide Hazard! A cold engine produces more carbon monoxide than a warm engine. Provide adequate ventilation in the cabin and cockpit to prevent excessive exposure and reduce the possibility of carbon monoxide accumulation.

1. Secure the boat to the dock or mooring slip before attempting to start the engine.
2. Check engine oil level.
3. Check fuel supply to ensure you have enough fuel for your expected travel plan.
4. Inspect fuel, oil, coolant, exhaust, and power steering systems for leaks.

## **▲ DANGER**

**DANGER:** Gasoline vapors are highly explosive. To prevent a possible explosion and fire, check engine and fuel compartments for fumes or accumulation of fuel before each engine start. Always operate bilge blower for at least four minutes before starting engine.

5. Always operate the bilge blower for at least four minutes before starting engine. This is also true during the starting process and any time you are operating your boat below cruising speeds.
6. Operate bilge pump until flow of water stops.
7. Make sure throttle is in neutral position.
8. Move battery selector switch to battery 1, 2, or ALL position.
9. If you are starting a cold engine, advance the throttle several times and leave it in the SLOW/START position. This will actuate the carburetor accelerator pump and feed fuel to the engine.
10. If your engine is equipped with electronic fuel injection, the throttle lever should be left in the neutral position during cold or warm starting.
11. Turn ignition key to START position to start engine.

**NOTE:** Engine will not turn over if throttle is not in the neutral position. If engine does not turn over, throttle may not be in neutral. Move throttle lever up and down slightly and try again.

## **▲ CAUTION**

**CAUTION:** Do not operate starter continuously for more than 15 seconds without pausing. Allow starter to cool between start attempts. See engine owner's manual for details.

12. If engine fails to start, wait one minute. Move throttle only once to the maximum position then back to the neutral position, and try to start engine(s) again.
13. When engine is cold, run engine approximately one to two minutes at fast idle speed (1200 to 1500 RPM) to warm up engine. Keep boat secure at dock until the engine is running and warmed up.
14. If your engine is equipped with electronic fuel injection, there is no need to actuate the throttle during engine warm up. Engine idle speed will be controlled automatically by the electronic fuel injection system.

## **LEAVING THE DOCK**

**IMPORTANT:** Falls from moving boats are a major cause of fatal recreational boating accidents. Do not allow passengers to ride on the bow with feet hanging over the side or ride while sitting on the stern, gunwales, or seat backs. The Coast Guard considers these acts to be negligent or grossly negligent operation and prohibits them by law.

After the engine has warmed up, you are ready to leave the dock. Before you cast off, check all gauges for proper readings. If oil pressure reading is abnormally low or temperature reading abnormally high, **stop engine immediately.** Check that the charging system is working properly. Voltmeter should read between 12 to 15 volts. Check again for fuel, oil, and exhaust leaks. Correct the cause for any abnormal condition or gauge reading before getting underway.

Check the operation of the steering by turning the steering wheel to full port and to full starboard while observing outdrive movement. With boat still securely moored to the dock and engine idling at 600 to 800 RPM, move the throttle forward, then aft, then back to neutral to check for proper shifting. Then cast off mooring lines and stow fenders.

**IMPORTANT:** Make sure passengers sitting in the bow area do not obstruct the operator's vision when casting off and while underway.

Before getting underway, close and latch the walk-through windshield to prevent personal injury or damage at higher speeds.

### **CAUTION**

**CAUTION:** Deck areas and swim platform are slippery when wet. Passengers must be careful when passing through companionway to prevent accidental slipping or tripping. Passengers must stay off of swim platform while underway to avoid falling overboard.

When you are sure your boat is ready, check wind, tide, and current or other forces that will affect the way you maneuver your boat away from the dock. Shift your boat's engine into forward or reverse depending on whether you want to move the bow or the stern away from the dock first. Move the throttle lever to neutral position. Then push forward quickly and firmly to shift into forward gear or backward to shift to reverse. Your engine should be running at a slow speed as you move away from the dock. If you move the bow out first, watch that the swim platform does not swing into the dock or a piling.

### **STEERING**

**Watch the stern when you turn!** Steering a boat is like driving a car on slippery or icy pavement. When you turn the steering wheel, the stern responds first by swinging in the opposite direction of the bow. When you are leaving the dock or trying to avoid an object in the water, this swing can be critical.

Always give yourself plenty of room to make a turn. You should also slow the speed of your boat while turning. Never make sharp, fast turns because you can easily lose control of your boat. Remember that your passengers should be seated whenever you are making a turn.

### **ACCELERATING**

#### **CAUTION**

**CAUTION:** Acceleration at full throttle is not recommended until after the engine "break-in period." This break-in period also coincides with the engine 20-hour checkup.

When you throttle up and accelerate, your boat increases the trim angle which causes the boat to ride bow high as shown in Figure 5.6. The maximum angle is commonly known as the "hump." Get over the hump as quickly as possible because visibility, handling, and performance are limited. It should only take a few seconds at full throttle for your boat to level out at its planing attitude. Then, accelerate until you reach a comfortable plane and throttle down to cruising speed. This also will provide for better fuel efficiency.

#### **WARNING**

**WARNING:** High speed acceleration in reverse can create a wake that could wash over the transom and flood the boat.

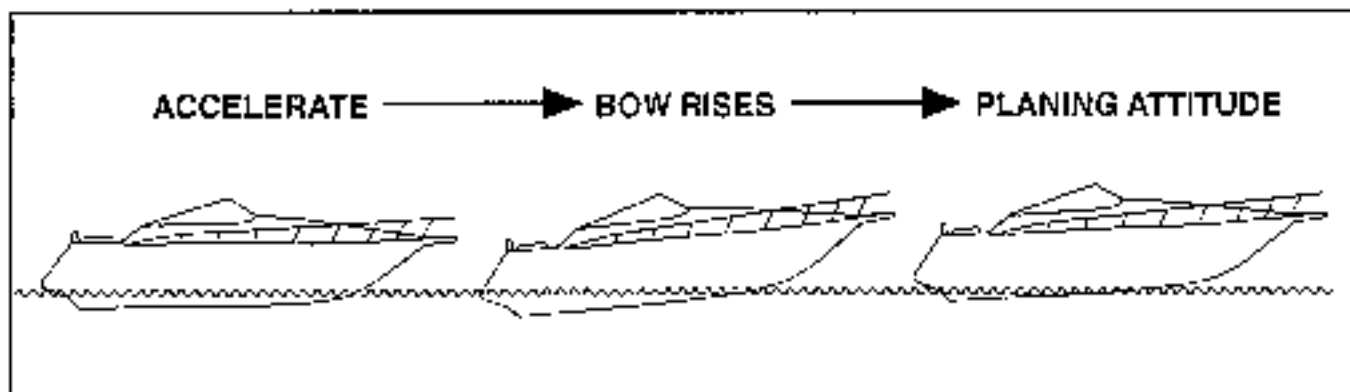

**FIGURE 5.6 ACCELERATION**

## TRIMMING

### Power Trim

Trim is very important in boating. It affects propeller selection and fuel efficiency. You must trim the drive unit to adjust to the ideal boat angle for given load and water conditions. The drive unit has an adjustable trim range. The best all-round performance attainable is when the drive unit is adjusted to allow the boat to run at an angle between 3° and 5° to the water.

If you trim the drive unit out too far, the boat will porpoise and the bow will slam up and down on the water. Your boat is trimmed correctly when it is just short of porpoising.

**NOTE:** Refer to your engine owner's manual regarding the power trim controls installed on your boat.

### Trim Tabs

The operator can adjust the angle of the hydraulically powered trim tabs at the helm station (See Figure 5.7). The function of trim tabs is the same as that of the power trim on the drive unit. Trim tabs cut into the water as it passes under the hull and forces the stern up as shown in Figure 5.8. Trim tabs also compensate for uneven loads in the boat. To compensate for uneven loads, trim up one side or the other of the boat.

Always follow basic safety precautions with respect to the trim tabs:

### CAUTION

**CAUTION:** At high speeds or when underway in following seas, do not extend trim tabs to their lowest position. Boat may become unstable, and controlling direction of boat travel may become difficult.

1. Disconnect power to unit while servicing to prevent electric shock.
2. Do not use trim tabs as a loading platform. Slipping on the edges of the tab can cause injury.

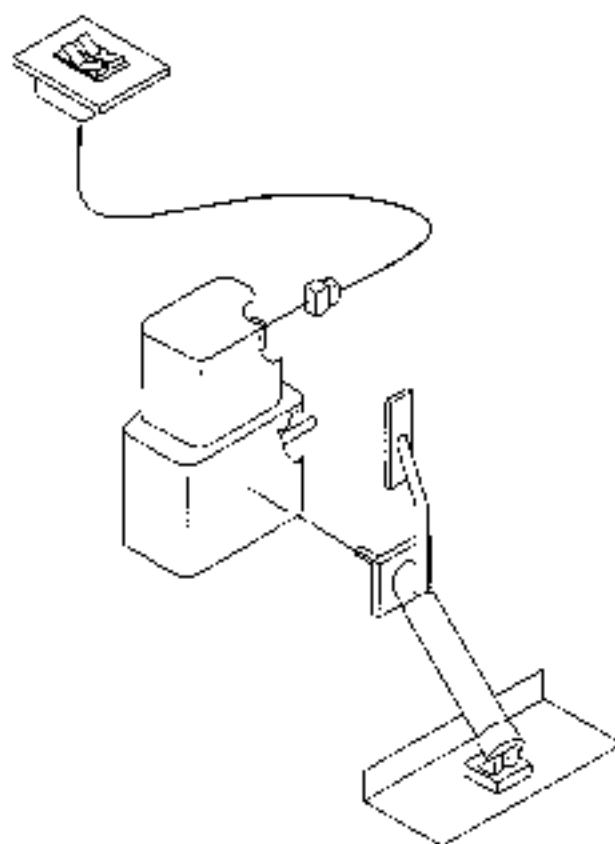

FIGURE 5.7 TRIM TAB, RESERVOIR AND SWITCH

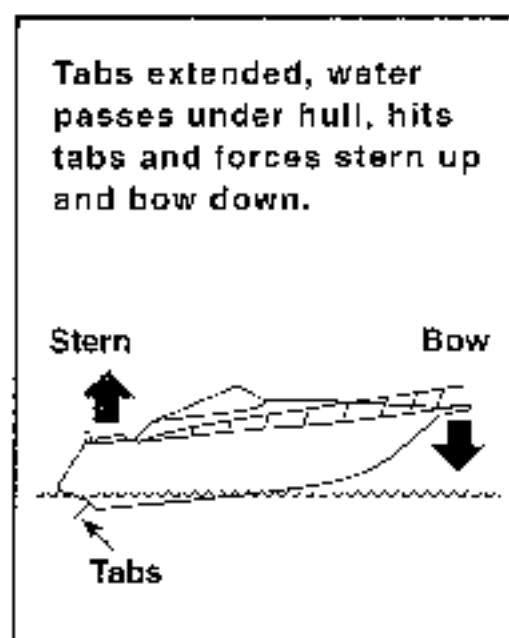

FIGURE 5.8 TRIM TAB OPERATION

3. Keep hydraulic oil away from eyes and mouth.
4. Stay clear of trim tabs and hinges when in operation.

Boats react slowly to trim tabs. Give them enough time to work. Press the trim tabs switches for only two seconds at a time and then allow time for the boat to react. If the boat is still listing after a minute or two, press the trim tab switch again for a two-second interval.

You can extend the life expectancy of the hydraulic cylinders on the trim tabs by keeping the cylinders retracted while at dockside. Press both trim tab controls down until tabs reach their full up position.

As a cautionary measure against damage it is recommended that trim tabs be fully retracted (in the up position) during trailering, launching or beaching your boat.

## **STOPPING (COMING OFF PLANE)**

You cannot stop a boat as quickly as a land vehicle because a boat has no brakes. Stop the boat by allowing it to slow down to less than 5 miles per hour. Then, put the engine in reverse. By slowly increasing reverse power, you can stop the boat in a short distance. Remember that boat does not respond to steering in reverse as well as it does when going forward.

### **▲WARNING**

**WARNING:** Check behind you before coming OFF plane. Accidents may occur as a result of a driver coming off plane while being followed by a boat that is unable to slow down in time to avoid collision.

## **ANCHORING**

If you stop for recreation or an emergency, you must anchor your boat. The size and weight of your boat govern the weight of the anchor and the diameter of the anchor line. A burying anchor, such as a Danforth or plow anchor, grips into the bottom and holds your boat

secure. Holding power should be more important than weight. Your Rinker dealer can help you select the proper anchoring equipment.

The length of the anchor line should be six to eight times the depth of the water to assure that the anchor bites into the bottom. The bottom end of the anchor line should be galvanized chain which holds up well as the line moves back and forth on the bottom. The rest of the line should be nylon anchor line which stretches to soften the impact of wind and waves on your boat.

### **▲WARNING**

**WARNING:** Keep anchor secure while underway to prevent damage or injury if boat's attitude changes suddenly. If your boat has a power winch, do not use it as the primary source for securing anchor or anchor line. See the power winch instruction manual for details about proper operation and maintenance.

Here are some general guidelines for anchoring your boat:

- Secure the anchor line to the deck cleat. Do not tie line to hardware not designed to support this stress.
- Use more than one anchor if you are anchoring overnight or for an extended period of time. If you use only one anchor, make sure your boat has enough space to swing full circle in case of shifting winds.
- Keep the anchor and line in an area where it will be readily available in an emergency.
- Always anchor from the bow; never anchor from the stern. Anchor lines may become fouled in the drive unit. A slight current may make the boat unsteady.

## **Dropping Anchor**

1. Have a crew member carefully lower the anchor, keeping a slight tension on the line as the anchor drops. Maintain tension after the anchor reaches the bottom. Sim-

ply throwing the anchor overboard usually fouls the line and requires starting over.

2. Maneuver the boat slowly aft until the proper length of line is run out. A generally accepted standard is 6-7 times the depth of the water.
3. Fasten the anchor line around the deck cleat. Anchor flukes should dig into the bottom and hold boat in position.
4. Check shoreline landmarks when you drop anchor. Check the position of the landmarks again 30 minutes later. If your boat's position has changed, the anchor is dragging and must be reset.

### **Weighing Anchor**

Weighing, or pulling in the anchor, requires moving the boat towards the anchor and pulling in the anchor line as the boat moves. When the line is vertical, pull up firmly on the anchor line to free the flukes from the bottom. If the anchor remains stuck, feed out a few feet of line and attach it to the bow cleat. Manuever the boat around the anchor, keeping the line taut, until you find an angle that will pull the anchor free.

### **DOCKING**

As you approach the dock or other mooring area, slow down your boat in time for the wake to subside before it reaches other boats or docks. As you get close to the dock, slow down to idle speed. Check for wind or currents, and allow them to carry the boat toward the dock if you can. When approaching, check that fenders are lowered and lines are attached to the cleats on the mooring side. Be sure fenders are at the proper height. If you can, have one person at the stern and one person at the bow, each with a boat hook and a mooring line attached to a cleat.

Approach the dock at idle speed and at approximately 45°. When the bow is within a few feet of the dock, bring the stern alongside the dock. Turn wheel in opposite direction. Then, put the engine in reverse to bring the stern closer to the dock.

If the weather looks bad, use spring-lines from the bow and stern to dock amidships of the boat. Tie up on the down wind side of the dock. Place fenders over the side between the boat and dock.

### **MOORING**

After you have positioned your boat next to the dock, you must secure it with mooring lines to keep it in position. Mooring lines must be long enough to secure your boat in any docking situation. For example, the length of the lines for a 16-foot runabout should be at least 15 feet. An eye splice at the end of each line works well with bow or stern cleats. (See Figure 5.9 on page 5-12.)

The mooring lines you will use most often are the bow line, the stern line, and spring lines. Each line has a specific purpose. The bow line and the stern line secure your boat's bow and stern. The two spring lines keep your boat from moving forward or backward when you are moored alongside a dock.

If you are mooring your boat for a short time, bow and stern lines may be the only lines you will need. If you are mooring your boat for a longer time or the currents are swift, you should use spring lines. The stern spring line leads from the boat's stern cleat forward to the piling or cleat on the dock. The bow spring line leads from the bow cleat aft to the dock.

If you are mooring your boat in a slip, bow and spring lines, port and starboard, will keep your boat in position.

**NOTE:** If tides are a consideration, be sure to leave slack in the lines to make up for the rise and fall of the water while your boat is cocked.

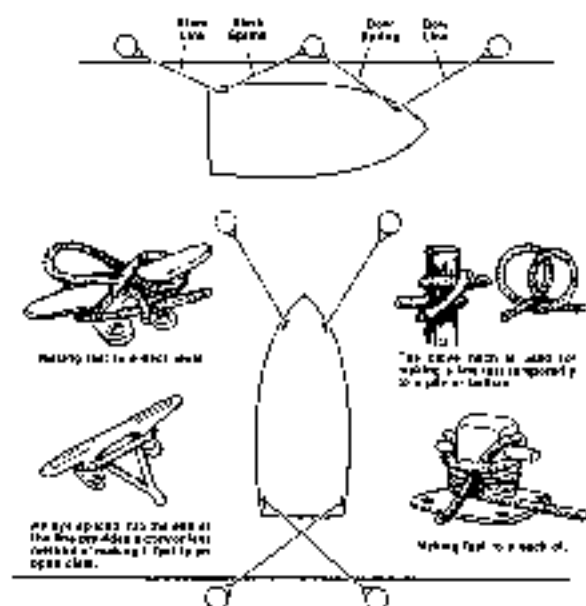

**FIGURE 5.9 MOORING LINES**

**NOTE:** Manila rope, the standard for many years, is not as strong as some ropes made of synthetic materials. For mooring, its ability to stretch is an advantage, but it tends to shrink whenever it gets wet. Nylon rope is strong and elastic. Because of its elasticity, it works well for mooring lines and anchor lines. Rope made of high tensile strength polyester fibers like Dacron™ is just about as strong as nylon rope, but it does not stretch. Kevlar rope is strong and does not stretch, but it is quite expensive. Polypropylene rope tends to deteriorate rapidly when it is exposed to sunlight. Because it floats, it is well-suited for use as a tow rope for water skiing. Use for other nautical purposes is not recommended.

## **GOING ASHORE**

While mooring your boat, allow engine to idle with drive in neutral. After turning off the engine, run bilge blowers for a few minutes to circulate fresh air through the engine compartment. Before going ashore, check that shore power is properly connected and the battery charger is operating. If shore power is not connected, make sure all DC components are turned off to prevent draining the batteries.

## **ADDITIONAL UNDERWAY INFORMATION**

- Be sure to run the bilge blower whenever the boat is operated under cruising speed.
- Keep all bilge blower and engine compartment vents free of obstructions to allow proper ventilation.
- Always be aware of local laws on noise limits. Noise means engine noise, radio noise or even yelling by people on your boat. Good seamanship demands that you operate your boat quietly so as not to infringe on the rights of others. Don't use thru-transom exhaust unless you are well off shore.
- You are responsible for any damage or injury caused by your boat's wake. Observe no wake speed zone warnings. Operate your boat with regard for the safety of other boats and people in your boating area.
- Keep your engine well tuned to decrease exhaust hydrocarbon emissions that pollute the air and water.

Rinker Boat recommends that your maintenance and repairs be performed at an authorized Rinker dealer. Your dealer is qualified to make repairs or modifications to your boat in such a manner as to not compromise safety, design integrity, or warranty coverage. The following information is provided for general maintenance and repair. If you choose to perform your boat's maintenance and repairs, we recommend that you ALWAYS refer to the product manuals for detailed information. Do not attempt any repairs on your boat unless qualified to do so. Only use approved marine replacement parts available from your dealer.

## ENGINE(S)

### Oil Check

**NOTE:** During the engine(s) 20 hour break-in period, Rinker Boat recommends the oil level be checked every two hours.

#### To Check Oil:

1. Ensure boat is in the water and engine(s) is stopped.
2. Allow warm engine(s) to cool for ten (10) minutes. This will enable the oil to drain back into the engine oil pan and provide for a more accurate check.
3. Pull engine(s) oil dipstick out of its sleeve, wipe clean, and push dipstick back into the sleeve. Make certain that the dipstick is pushed all the way back into the sleeve.
4. Pull dipstick out again, check for oil level on dipstick. The oil level must be between the ADD and FULL marks shown on the dipstick.
5. Add oil if oil level is at or below the ADD mark.
6. Push dipstick back down into the sleeve. Ensure it is properly seated all the way down.

#### To Add Oil:

1. Remove oil fill cap from valve cover.
2. Add oil as required to raise the oil level up between the ADD and FULL marks on the dipstick. Do not overfill. One quart (0.95 liter) of oil will be required if oil level was at the ADD mark on the dipstick. Adjust amount of oil being added if oil level was below ADD mark on dipstick.
3. Check oil level after adding oil.

**NOTE:** Rinker Boat recommends that a funnel be used when adding oil. This will prevent spillage and help keep your engine(s) free of surface grime and dirt.

### Oil & Filter Change

#### **⚠ WARNING**

**WARNING:** Discharge of oil. The Federal Water Pollution Control Act prohibits the discharge of oil or oily waste into or upon the navigable waters of the United States or the waters of the contiguous zone if such discharge causes a film or sheen upon or a discoloration of the surface of the water or causes a sludge or emulsion beneath the surface of the water. Violators are subject to a penalty of \$5,000.

#### To Change Oil:

1. Run engine(s) long enough to bring water-temperature gauge up to NORMAL operating temperature. Then, STOP engine(s).
2. Place a container (large enough to avoid spills) under drain plug on crankcase.
3. Slowly remove oil drain plug. Allow all oil to completely drain out of crankcase.
4. Reinstall drain plug by hand. Then tighten 1/2 turn with a wrench.



### To Change Filter:

1. Slowly unscrew filter in a counter-clockwise direction and remove oil filter and filter ring. Properly dispose of old oil filter and filter ring.
2. Apply fresh oil to the filter ring on the new oil filter, lubricate entire surface.
3. Carefully screw the new oil filter and filter ring into the opening by hand.

**IMPORTANT:** Do not cross thread the new filter when installing. This will create possible leaks and damage the threads on the engine(s).

4. Use an oil filter wrench to tighten securely 1/2 turn.
5. Fill crankcase with proper grade and viscosity oil.

### Fuel Filter(s)

#### **▲WARNING**

**WARNING:** Be careful when changing fuel filters. Gasoline is extremely flammable and highly explosive under certain conditions! Always stop engine(s) and do not smoke or allow open flames in area when changing filters.

1. Remove fuel filter canister from engine(s).
2. Remove filter elements and existing sealing gasket, then discard.

**NOTE:** Do not reuse, always replace with new filter.

3. Inspect fuel filter canister for signs of corrosion, replace if any corrosion is evident.
4. Install filter elements. Coat sealing rings with light coating of oil and install filter canisters. Tighten securely.
5. Run engine(s) and check for fuel leaks.

#### **▲CAUTION**

**CAUTION:** Make sure that all fuel line connections are tight and that no fuel leaks exist.

### DRIVE BELT TENSION

#### Alternator

Check alternator drive belt tension by pressing down on the belt midway between the engine circulating pump pulley and the alternator pulley. The belt should depress 1/4 inch (6.4 mm). If depression is more than allowable, adjust tension by loosening alternator mounting screws and pivoting the alternator as required to achieve proper tension. Tighten mounting screws.

#### Sea Water Pump

Check the sea water pump belt tension by pressing down on the belt midway between the crank pulley and the sea water pump pulley. The belt should depress 1/8 inch (3.2 mm). If depression is more than allowable, adjust tension by loosening the sea water pump mounting bolts and slide pump over to achieve proper tension. Tighten mounting bolts.

**NOTE:** Certain models have the sea water pump located inside the drive unit. Rinker Boats recommends replacing the sea water pump impeller every two years to help eliminate pump failures.

**NOTE:** Some models may come equipped with a single serpentine belt which has an auto-tensioning feature and should not require adjustments.

#### Tune-up

**Purpose:** These mechanical adjustments are required to achieve the highest possible performance from your engine(s).

**Intervals:** Every 200 to 300 hours or when engine(s) displays starting or running problems. If your boat is used less the 200 to 300

hours per year. Rinker Boat recommends that a tune-up be performed at least once a year.

### Distributor(s)

1. Periodically check the rotor and distributor caps for wear and deterioration.
2. Inspect the distributor cap and rotor for hairline cracks and excessive deterioration of contacts. Replace distributor cap if either defect is noted.
3. If there is dirt or an oily film on the inside of the distributor cap wash with household dish washing liquid and warm water. Rinse with clean water and dry thoroughly.

**NOTE:** Refer to your engine owner's manual for detailed information.

### Spark Plugs

**NOTE:** When removing spark plugs it is important to remember to mark each plug wire with it's corresponding engine cylinder number.

1. Remove spark plugs and examine each one for carbonization.
2. Replace spark plugs every 150 hours of operation or sooner depending on their condition.

**NOTE:** Refer to your engine owner's manual for detailed information.

### Spark Plug Wires

1. Inspect each spark plug wire for deterioration or cracks in the insulation.
2. If any wires need replacement, replace ALL spark plug wires.
3. Replace spark plug wires every two (2) years, even if they appear to be in good working condition.
4. Remove and replace only one spark plug wire at a time to avoid crisscrossing the firing order.

**NOTE:** Refer to your engine owner's manual for detailed information.

## FUEL SYSTEM

### **General**

This information describes only the fuel system beyond the engine(s). All fuel systems installed at the Rinker Boat factory meet federal requirements.

Frequent inspection and maintenance of the fuel system must be performed. Check for leaks and/or vapors and repair any problems immediately.

Keep fuel tanks filled during the boating season to prevent moisture condensation.

### **Monthly Inspection**

**NOTE:** Any replacement of parts or repairs to the fuel system should be performed by a trained marine mechanic. See your Rinker dealer for parts and repair.

1. Starting at the fuel tank, inspect the complete fuel system for leaks or vapors.
2. Inspect fuel lines and hoses for wear, kinks, cracks, or deterioration.
3. Inspect fuel line fittings, carburetor, and fuel pump for proper tightness of mounting brackets.
4. Inspect for wear or damage to the fuel ventilation ducts and clamps.
5. Inspect fuel tank(s) vent screens (located outside of hull) for any obstruction.

**NOTE:** Refer to your engine owner's manual for detailed information.

## STERN DRIVE UNIT (I/O)

### **Oil Level Check**

**NOTE:** Refer to the stern drive unit(s) owner's manual for recommended oil check intervals.

1. The anti-ventilation plate must be level, this may require repositioning of the stern drive unit(s).

## **▲WARNING**

**WARNING:** Wait until drive unit(s) cool before removing oil vent plug. Heat from the drive unit(s) causes oil to expand. Hot oil will flow rapidly from the vent plug opening if oil vent plug is removed.

2. With drive unit(s) cool, remove oil vent plug and O-ring from drive shaft housing.
3. Check oil level. Oil should be touching the bottom edge of the oil vent plug opening.
4. If oil level is low, add correct grade and viscosity as specified in your stern drive unit(s) owner's manual.
5. Reinstall the O-ring and oil vent plug and tighten.
6. Make sure your dealer checks the engine alignment during the 20-hour checkup. The engine alignment check should be completed in accordance with the recommended procedures as stated in the engine manual. Failure to do so could result in drive train damage not covered by the warranty. Engine alignment should be checked annually after the 20-hour check.

## **▲CAUTION**

**CAUTION:** Low oil levels should NEVER require more than 2 ounces (60 ml) of oil to achieve the proper level. If it requires more than the allowable amount, the drive unit(s) has an oil leak and should be corrected immediately.

**NOTE:** Refer to your drive unit(s) owner's manual for detailed information.

## **PROPELLER(S)**

The propeller(s) shipped with your boat is the size Rinker Boat recommends for the best overall performance. However, factors such as altitude, temperature, load, bottom growth, and propeller(s) condition can have a consid-

erable influence on your boat's performance. Consult your Rinker dealer regarding your specific performance requirements.

Periodically inspect the propeller(s) for excessive wear and/or damage. Repair or replace, if required.

**NOTE:** Refer to the propeller manufacturer's manual for installation, removal, and further detailed information.

## **POWER STEERING SYSTEM**

Your boat is equipped with a rack and pinion power steering system. The steering system requires periodic maintenance to be trouble-free and safe. Regular checks of the complete system is essential.

Lubricate, inspect, and perform maintenance on a regular basis:

- Under normal service every 50 hours of operation or 60 days
- Under excessive use every 25 hours of operation or 30 days

Operating boat in saltwater is classified as excessive use.

1. Lubricate control valve through grease fitting with multi-purpose lubricant until grease is visible around rubber boot.
2. Coat power steering output shaft and exposed steering cable end with multi-purpose lubricant.
3. Lubricate cable end guide pivot point with SAE 30W engine oil.
4. Run engine(s) for 20 to 30 minutes, then check power steering fluid level. If low, add type "A" automatic transmission fluid to bring level up to FULL mark on the dipstick.

**NOTE:** If engine(s) is cold, the correct fluid level should be at the ADD mark. This will allow for oil expansion when engine(s) is hot.

5. Inspect all hydraulic lines and hoses for leaks. Ensure all lines and hoses are free from friction and not exposed to any

extremely hot parts. Tighten all fittings and clamps as required.

6. Check all bolts for tightness.
7. Check pump pulley drive belt for wear and proper tension.

**NOTE:** Over-tightened belts cause bearing failure. Loss of pump pulley drive belt affects steering effort.

Consult your Rinker dealer regarding all repairs or replacement parts, and recommendation of a certified marine mechanic to perform needed service.

**NOTE:** Refer to the steering manufacturer's manual for detailed maintenance and repair or replacement information.

## **CAUTION**

**CAUTION:** Boat steering is not self-centering. Steering is affected by engine and propeller torque, trim tab setting, wave and current action, and the speed of the hull through the water. For safe operation, maintain constant attention and control of the direction of the boat.

## **BILGE**

### **Inspection**

The bilge should be checked each time you use your boat. A small amount of water in the bilge area is usually not a major concern. For excessive amounts of water, investigate for water leaks and repair **immediately**. If the bilge is ever filled with fuel or oil inspect the engine(s) for leaks and repair **immediately**. Never pump fuel or oil overboard. Doing so violates pollution control laws.

## **Cleaning**

Run bilges until pump is dry. Remove all sand, silt, dirt, or foreign material. Ensure all timber holes are open and strainers are clean. Use bilge cleaner to remove any obvious oil stains. Consult your Rinker dealer for recommended types of approved cleaner. **Never** use any flammable type solvents for cleaning the bilge.



The troubleshooting procedures listed in this chapter are designed to correct minor malfunctions for engine, performance, and vibration. Troubleshooting is a process of elimination. The troubleshooting chart displays areas that could be at fault and are presented in the order of probable occurrence.

Use good common sense and always refer to the engine manufacturer's owner/service manual. If the malfunction appears too complicated or unsafe, contact your Rinker dealer. If underway, and contacting your Rinker

dealer is not practical, contact the local marina for information regarding available marine mechanic service.

## **⚠ WARNING**

**WARNING:** To avoid personal injury and damage to equipment, disconnect battery cables before inspecting, checking, or repairing any component. Do not disconnect or reconnect battery cables if you smell gas fumes. Thoroughly ventilate engine compartment before disconnecting or reconnecting battery cables.

## **ENGINE**

<b>Malfunction</b>	<b>Probable Fault</b>	<b>Solution</b>
Engine will not crank (Ignition system) (Throttle/Shift Control Failure)	<ol style="list-style-type: none"> <li>1. Throttle lever in wrong position</li> <li>2. Loose wire in starting circuit</li> <li>3. Ignition switch defective</li> <li>4. Defective solenoid</li> <li>5. Battery switch in OFF position</li> <li>6. Dead battery</li> <li>7. Spark plug(s) fouled or broken</li> <li>8. Distributor broken, wet, cracked, or dirty</li> <li>9. Lanyard stop switch activated (cord pulled from emergency stop button)</li> <li>10. Hydrostatic lock</li> </ol>	<ol style="list-style-type: none"> <li>1. Check position of throttle lever, ensure it is in the "neutral" position.</li> <li>2. Tighten all wiring connections.</li> <li>3. Test switch continuity. Replace switch as required.</li> <li>4. Replace solenoid.</li> <li>5. Turn selector switch to battery position.</li> <li>6. Recharge or replace battery.</li> <li>7. Clean, adjust gap, or replace.</li> <li>8. If wet or dirty, wipe with cloth and cleaning solvent. Inspect cap for cracks, carbonized paths (inside and out) replace cap as required.</li> <li>9. Reinstall cord.</li> <li>10. Remove spark plugs and crank engine. If engine cranks, it indicates that water is getting into the cylinders from the exhaust system or from a possible gasket leak. If water gets into the engine through the exhaust line, it indicates improper draining of exhaust system. Contact your Rinker dealer or a qualified marine mechanic to correct problem.</li> </ol>

**ENGINE**

Continued...

<b>Malfunction</b>	<b>Probable Fault</b>	<b>Solution</b>
Engine cranks but will not start (Fuel system)	<ol style="list-style-type: none"> <li>1. Lack of fuel</li> <li>2. Improper starting procedure</li> <li>3. Clogged fuel filters</li> <li>4. No fuel reaching carburetor (providing all fuel valves are open)</li> <li>5. Engine flooded</li> <li>6. Contaminated fuel</li> <li>7. Water in fuel tank</li> </ol>	<ol style="list-style-type: none"> <li>1. Open shut-off valve, clean filters, check fuel level and anti-siphon valve.</li> <li>2. See Engine Owner's manual to review starting procedure.</li> <li>3. Check and replace filters.</li> <li>4. Check fuel pump, fuel pump filter, anti-siphon valve, carburetor fuel filter, and fuel tank line for cracked flanges or restricted fittings.</li> <li>5. Do not attempt to start engine for at least 5 minutes. For hot engine, fully advance throttle, (make sure throttle lever is in neutral) and crank engine.</li> <li>6. Have your dealer drain and clean the fuel tank.</li> <li>7. Check fuel fill and tighten cap if loose. If water is from condensation forming on walls of partially filled fuel tank, see dealer for fuel drying product. If these remedies fail, have dealer draw and clean tank.</li> </ol>
Low cranking speed	<ol style="list-style-type: none"> <li>1. Loose or dirty electrical connections or damaged wiring</li> <li>2. Bad battery</li> <li>3. Engine oil too heavy for prevailing temperatures</li> </ol>	<ol style="list-style-type: none"> <li>1. Check all related electrical connections and wires.</li> <li>2. Test battery (See Engine Owner's manual).</li> <li>3. Drain oil and refill with correct grade and viscosity oil. (See Engine Owner's manual).</li> </ol>
Starter will not crank engine	<ol style="list-style-type: none"> <li>1. Discharged battery</li> <li>2. Corroded battery cables</li> <li>3. Loose connection in starting circuit</li> <li>4. Defective starter switch</li> <li>5. Starter motor brushes dirty</li> </ol>	<ol style="list-style-type: none"> <li>1. Charge battery, change battery selector switch to "ALL".</li> <li>2. Clean terminals.</li> <li>3. Check and tighten all connections.</li> <li>4. Replace switch.</li> <li>5. Clean or replace brushes.</li> </ol>
Poor acceleration	<ol style="list-style-type: none"> <li>1. Defective fuel pump</li> <li>2. Throttle not fully open</li> <li>3. Flame arrestor dirty or air intake obstructed</li> <li>4. Engine overheating</li> </ol>	<ol style="list-style-type: none"> <li>1. Have dealer replace fuel pump.</li> <li>2. Inspect cable and linkages for binding, obstructions, or loose fasteners.</li> <li>3. Clean flame arrestor and check air intake.</li> <li>4. Determine cause of overheating, consult Engine Owner's manual.</li> </ol>

**ENGINE**

Continued...

<b>Malfunction</b>	<b>Probable Fault</b>	<b>Solution</b>
Engine runs but mistiring	<ol style="list-style-type: none"> <li>1. Improper timing</li> <li>2. Fouled spark plug(s)</li> <li>3. Wet spark plug wires</li> <li>4. Carbon tracked distributor</li> <li>5. Loose ignition wires</li> <li>6. Defective fuel pump</li> <li>7. Partially clogged fuel filter</li> <li>8. Incorrect carburetor mixture</li> <li>9. Contaminated fuel</li> </ol>	<ol style="list-style-type: none"> <li>1. Check timing and adjust as required (See Engine Owner's manual).</li> <li>2. Remove, clean, or replace.</li> <li>3. Wipe dry, inspect and replace damaged wires.</li> <li>4. Clean or replace as required.</li> <li>5. Inspect all wire connections.</li> <li>6. Repair or replace as required.</li> <li>7. Clean or replace fuel filter.</li> <li>8. See Engine Owner's manual for proper carburetor adjustment.</li> <li>9. Drain fuel tank and flush clean and replace fuel filters.</li> </ol>
Excessive fuel consumption	<ol style="list-style-type: none"> <li>1. Restriction in flame arrestor</li> <li>2. Faulty fuel pump</li> <li>3. Dirty flame arrestor screen</li> </ol>	<ol style="list-style-type: none"> <li>1. Remove flame arrestor and clean.</li> <li>2. Have dealer repair or replace as required.</li> <li>3. Clean or replace as required.</li> </ol>
Blue exhaust smoke	<ol style="list-style-type: none"> <li>1. Lube level too high</li> <li>2. Oil too thin</li> </ol>	<ol style="list-style-type: none"> <li>1. Drain off excessive oil</li> <li>2. Drain and replace oil (See Engine Owner's manual).</li> </ol>
Black or gray exhaust smoke	<ol style="list-style-type: none"> <li>1. Fuel mixture too rich</li> <li>2. Choke stuck</li> <li>3. Carburetor fuel level too high</li> <li>4. Clogged flame arrestor</li> </ol>	<ol style="list-style-type: none"> <li>1. Have dealer adjust carburetor.</li> <li>2. Lubricate and adjust.</li> <li>3. Have dealer adjust float in carburetor.</li> <li>4. Clean or replace as required.</li> </ol>
White exhaust smoke	<ol style="list-style-type: none"> <li>1. Engine misfiring</li> <li>2. Spark plugs dirty or not gapped correctly</li> </ol>	<ol style="list-style-type: none"> <li>1. See Engine Owner's manual.</li> <li>2. Clean, adjust gap, or replace.</li> </ol>
Low oil pressure	<ol style="list-style-type: none"> <li>1. Insufficient oil in crankcase</li> <li>2. Excessive oil in crankcase</li> <li>3. Diluted or improper grade and viscosity oil</li> <li>4. Oil leak in pressure line</li> </ol>	<ol style="list-style-type: none"> <li>1. Check and add correct grade and viscosity oil. Visually check engine for leaks.</li> <li>2. Check and remove required amount of oil. Check for cause of excessive oil (improper filling, bad fuel pump, etc.).</li> <li>3. Change oil and oil filter, being sure to use the correct grade and viscosity oil.</li> <li>4. Inspect all oil lines and tighten all connections as necessary.</li> </ol>



**ENGINE**

Continued...

<b>Malfunction</b>	<b>Probable Fault</b>	<b>Solution</b>
No oil pressure	<ol style="list-style-type: none"> <li>1. Defective gauge, gauge tube, or oil line</li> <li>2. No oil in engine</li> </ol>	<ol style="list-style-type: none"> <li>1. Have dealer replace gauge, or tube, and tighten or replace line as necessary.</li> <li>2. Fill with proper grade and viscosity oil (See Engine Owner's manual).</li> </ol>
High oil pressure	<ol style="list-style-type: none"> <li>1. Too heavy grade</li> <li>2. Dirt or obstruction in oil lines</li> </ol>	<ol style="list-style-type: none"> <li>1. Drain oil and replace with proper grade (See Engine Owner's manual).</li> <li>2. Have dealer drain and clear oil system. Check for bent or flattened oil lines and replace as required.</li> </ol>
Knocking or pinging	<ol style="list-style-type: none"> <li>1. Incorrect type fuel</li> <li>2. Incorrect timing</li> <li>3. Pre-ignition</li> <li>4. Overheated engine</li> <li>5. Cooling system trouble</li> </ol>	<ol style="list-style-type: none"> <li>1. Have dealer drain tank and replace with proper fuel.</li> <li>2. Have dealer correct timing.</li> <li>3. Clean or replace spark plugs.</li> <li>4. Check engine cooling system.</li> <li>5. Check water intake and connections for leaks.</li> </ol>
Rough running	<ol style="list-style-type: none"> <li>1. Choke not operating</li> <li>2. Faulty fuel pump</li> <li>3. Idle speed too low</li> <li>4. Faulty ignition system components</li> <li>5. Clogged fuel filters</li> <li>6. Contaminated fuel</li> <li>7. Flame arrestor plugged with foreign material or air intake hose obstructed</li> </ol>	<ol style="list-style-type: none"> <li>1. Check choke linkages for binding or obstruction.</li> <li>2. Refer to Engine Owner's manual for fuel pump testing procedures.</li> <li>3. Have dealer check idle speed and adjust.</li> <li>4. Have dealer service ignition system.</li> <li>5. Replace filters.</li> <li>6. Inspect fuel for water or other contaminants. If contaminated, have dealer drain tank and flush with fresh fuel.</li> <li>7. Clean flame arrestor and check hose.</li> </ol>
Engine overheating	<ol style="list-style-type: none"> <li>1. Bad sending or receiving unit.</li> <li>2. Loose wiring connections at sending or receiving unit</li> <li>3. Worn or broken impeller in sea water pump</li> <li>4. Clogged oil cooler</li> <li>5. Exhaust lines plugged</li> </ol>	<ol style="list-style-type: none"> <li>1. Have dealer replace unit.</li> <li>2. Tighten all connections.</li> <li>3. Replace impeller.</li> <li>4. Remove obstruction.</li> <li>5. Remove obstruction.</li> </ol>

**ENGINE**

Continued...

<b>Malfunction</b>	<b>Probable Fault</b>	<b>Solution</b>
Engine overheating continued... Engine overheating	<ol style="list-style-type: none"> <li>6. Ignition timing late</li> <li>7. Choke valve stuck closed</li> <li>8. Collapsed water pump suction hose</li> <li>9. Loose or worn belts</li> <li>10. Restricted water intake</li> </ol>	<ol style="list-style-type: none"> <li>6. Have dealer time engine.</li> <li>7. Free choke valve movement.</li> <li>8. Install new hose.</li> <li>9. Adjust or replace as required.</li> <li>10. Clean water intake.</li> </ol>
Sludge in oil	<ol style="list-style-type: none"> <li>1. Infrequent oil changes</li> <li>2. Dirty oil filter</li> <li>3. Water in oil</li> </ol>	<ol style="list-style-type: none"> <li>1. Drain and refill with proper grade and viscosity oil.</li> <li>2. Replace filter.</li> <li>3. Drain and refill. If trouble persists, have dealer check engine.</li> </ol>

**POOR PERFORMANCE**

<b>Malfunction</b>	<b>Probable Fault</b>	<b>Solution</b>
Poor performance	<ol style="list-style-type: none"> <li>1. Damaged or improper propeller</li> <li>2. Excessive water in bilge area</li> <li>3. Boat overloaded or improper distribution of load</li> <li>4. Fouled or damaged hull bottom</li> <li>5. Material obstructing propeller</li> <li>6. Bent skeg</li> <li>7. Steering failure</li> </ol>	<ol style="list-style-type: none"> <li>1. Inspect propeller and replace if required. If vibration continues see dealer.</li> <li>2. Pump out bilge area. Inspect for causes related to excess water.</li> <li>3. Reduce load or redistribute load.</li> <li>4. Inspect, clean, or repair as required.</li> <li>5. Remove material from propeller by reversing engine(s). If necessary, stop engine(s) and cut or pull away.</li> <li>6. Replace. See your dealer for service.</li> <li>7. Shut engine off. Put out an anchor to prevent drifting. Determine if you can fix the problem yourself. See engine operator's manual if engine is flooded. Signal for help.</li> <li>8. Clean and adjust cable(s). Adjust propulsion trim. Tighten cable brackets. Tighten steering wheel.</li> </ol>
	<ol style="list-style-type: none"> <li>8. Steers erratically</li> </ol>	

Troubleshooting continued on next page.

## VIBRATION

Malfunction	Probable Fault	Solution
Vibration	<ol style="list-style-type: none"><li>1. Loose engine mounting bolts</li><li>2. Damaged propeller shaft</li><li>3. Propeller bent or pitch out of true</li><li>4. Engine out of alignment</li><li>5. Material wrapped around propeller</li></ol>	<ol style="list-style-type: none"><li>1. Inspect and tighten as required.</li><li>2. Replace shaft.</li><li>3. Inspect propeller and replace as required.</li><li>4. Have dealer correct alignment.</li><li>5. Run engine in reverse. If necessary stop engine(s) and cut or pull material away.</li></ol>

## DC ELECTRICAL SYSTEM

Malfunction	Probable Fault	Solution
12 V equipment not working	<ol style="list-style-type: none"><li>1. Battery selector switch turned to OFF</li><li>2. Main breaker at DC CONTROL panel OFF</li><li>3. Weak or dead battery</li></ol>	<ol style="list-style-type: none"><li>1. Switch selector switch ON for port (1) or starboard (2) battery.</li><li>2. Switch breaker to ON.</li><li>3. Recharge battery. 12 volt charging system not working; check charger and repair if necessary.</li></ol>
Battery not charging (engine running)	<ol style="list-style-type: none"><li>1. Engine alternator belt loose</li></ol>	<ol style="list-style-type: none"><li>1. Tighten belt.</li></ol>
Battery not holding a charge	<ol style="list-style-type: none"><li>1. Bad battery</li></ol>	<ol style="list-style-type: none"><li>1. Replace battery.</li></ol>
12 V device not working	<ol style="list-style-type: none"><li>1. Circuit breaker for device is OFF</li><li>2. Weak or dead battery</li><li>3. Faulty electrical connection</li></ol>	<ol style="list-style-type: none"><li>1. Switch breaker to ON.</li><li>2. Recharge battery. 12 volt charging system not working; check charger and repair if necessary.</li><li>3. Check 12 V connections. Tighten or repair as needed.</li></ol>
Cabin lights not working (off or dim)	<ol style="list-style-type: none"><li>1. CABIN LIGHTS breaker OFF</li><li>2. Weak or dead battery</li><li>3. Light bulb burned out</li></ol>	<ol style="list-style-type: none"><li>1. Switch breaker to ON.</li><li>2. Recharge battery. 12 volt charging system not working; check charger and repair if necessary.</li><li>3. Replace bulb.</li></ol>

## AC ELECTRICAL SYSTEM

Malfunction	Probable Fault	Solution
No AC power	<ol style="list-style-type: none"> <li>1. Breaker(s) at AC CONTROL panel tripped or off</li> <li>2. Shore power cord not connected</li> <li>3. Loose or disconnected wire</li> </ol>	<ol style="list-style-type: none"> <li>1. Turn breakers on or reset.</li> <li>2. Check cord; plug in if necessary.</li> <li>3. Tighten connections. See your dealer.</li> </ol>
No power to AC devices	<ol style="list-style-type: none"> <li>1. Breaker(s) at AC CONTROL panel tripped or off</li> <li>2. Shore power cord not connected</li> <li>3. Loose or disconnected wire</li> </ol>	<ol style="list-style-type: none"> <li>1. Turn breakers on or reset.</li> <li>2. Check cord; plug in if necessary.</li> <li>3. Tighten connections. See your dealer.</li> </ol>
Inadequate power to AC devices (generator running)	<ol style="list-style-type: none"> <li>1. Electrical demand greater than generator output</li> </ol>	<ol style="list-style-type: none"> <li>1. Switch off devices and equipment not needed.</li> </ol>
Continuous tripping of main breaker	<ol style="list-style-type: none"> <li>1. Cause of problem not corrected</li> </ol>	<ol style="list-style-type: none"> <li>1. Determine cause and correct problem before resetting breaker. See your dealer if problem persists.</li> </ol>
No power at AC outlets	<ol style="list-style-type: none"> <li>1. Outlet breakers in AC CONTROL panel OFF</li> <li>2. Ground fault interrupter tripped</li> </ol>	<ol style="list-style-type: none"> <li>1. Switch breakers to ON.</li> <li>2. Reset button on outlet and test.</li> </ol>

Troubleshooting continued on next page.

## FUEL SYSTEM

Malfunction	Probable Fault	Solution
Fuel overflows at fill plate (tank not full)	1. Fill or vent line blocked	1. Check lines. Clear obstruction from line or straighten line if kinked.
Water or moisture in fuel tank	1. Cap on deck fuel fill plate not tight 2. Condensation forming on walls of partially filled tank  3. Poor quality fuel from marina tanks	1. Check cap; tighten  2. Gasoline engines: Add fuel drying product to fuel supply. See your dealer for recommendations. Diesel engines: Check fuel/water separators; drain if necessary. Check with your dealer. 3. Follow remedies for "Condensation" above. If remedies fail to correct problem, fuel tank and lines may need to be drained and flushed. See your dealer for service.
Engine cranks but will not start (fuel system)	1. Lack of fuel  2. Clogged fuel filter 3. No fuel reaching engine with all fuel valves open. 4. Contaminated fuel	1. Clean fuel filter, check fuel level; check whether anti-siphon valve, if so equipped, is stuck shut. Improper starting procedure. Review starting procedures in engine manual. 2. Check and replace fuel filter. 3. Check fuel pump, fuel pump filter, carburetor fuel filter, and fuel tank line for cracked flanges or restricted fittings. 4. Inspect for water or other contaminants in fuel. If contaminated, drain tank and flush with fresh fuel.

## **WATER SYSTEM**

<b>Malfunction</b>	<b>Probable Fault</b>	<b>Solution</b>
Air in system	1. Water tank empty	1. Fill tank.
Fresh water pump cycles on and off	1. Leak in water system	1. Locate leak and repair.
No water at shower or sinks with faucets on	1. FRESH WATER PUMP breaker off 2. Water tank empty 3. Blocked or pinched water lines 4. Loose electrical connections 5. Defective pump	1. Switch breaker to ON. 2. Fill tank. 3. Clear obstruction or straighten line. 4. Check connections; tighten as needed. See your dealer for service. 5. See your dealer for service.
Low water pressure at all sinks and shower	1. Defective pump	1. See your dealer for service.
Low water pressure at one sink	1. Pinched water line 2. Strainer on faucet is plugged	1. Straighten line. 2. Unscrew strainer, clean strainer and replace.
Raw water pump not pumping water	1. Tripped circuit breaker 2. No water supply  3. Loose electrical connections	1. Reset if tripped. 2. Check for clogged pump. Remove material as needed. Check for clogged thru-hull fitting. Clean fitting. 3. Check and tighten connections. Make sure wires are not broken.

## **MARINE SANITATION SYSTEM**

<b>Malfunction</b>	<b>Probable Fault</b>	<b>Solution</b>
Head not flushing	1. Head seacock closed	1. Open seacock.
Head not emptying	1. Blocked line to holding tank	1. Remove material from line.



The following information is for your use in caring for the interior and exterior of your boat. If you need more specific information, contact your Rinker dealer.

**NOTE:** Before attempting to use a particular cleaning solution or method, test the material to be cleaned in a hidden or inconspicuous area for possible adverse reactions. Use cleaning agents sparingly. Never discharge cleaning solutions into the waterways. Do not use products containing phosphates, chlorine, solvents, or nonbiodegradable or petroleum based products.

## **FIBERGLASS & GELCOAT**

The hull and deck are made of fiberglass. The outer layer of the hull and deck is a color pigmented polyester resin, called gelcoat. Gelcoat is highly resistant to scratches that occur during normal boat use. Some damage to the gelcoat during the life of your boat is bound to occur.

### **Gelcoat Maintenance**

To remove and prevent build-up of most salt, soil, and grime, the hull and deck should be routinely cleaned with household detergent and water.

**NOTE:** Ensure household detergent **does not** contain ammonia or chlorine. Ammonite or abrasive type cleaners will dull and discolor the surface of the gelcoat, and are not recommended for use in routine maintenance.

Gelcoat surfaces are very resistant to deep stains. To remove minor stains:

- Wash with a soft cloth and household detergent to remove surface stains. Then rinse thoroughly with clear water.
- If deep stains do occur, use a special fiberglass cleaner and stain remover.

Waxing the gelcoat surface regularly will help prevent soiling and preserve its luster. Rinker

Boat recommends a fiberglass wax that will fill the gelcoat pores. Fiberglass wax contains chemicals that screen out harmful ultraviolet rays that cause fading of the gelcoat color.

### **⚠ WARNING**

**WARNING:** Never wax deck surfaces that require sure footing. Wet or dry waxed gelcoat is very slippery and hazardous to walk on and/or maintain footing.

### **Gelcoat Damage Repair**

#### **Minor Scratches**

Minor scratches can be repaired with automotive rubbing compound or polishing wax. They may not completely disappear, but will not be as noticeable.

- Apply rubbing compound or polishing wax to a damp, soft cloth.
- Rub the gelcoat surface with the damp, soft cloth in a circular motion.

**NOTE:** Refer to the rubbing compound/polishing wax manufacturer's instructions for detailed information.

#### **Discoloration**

The gelcoat surface may discolor if it is not washed and waxed regularly. Discoloration can usually be removed because it is on the gelcoat surface.

- Sand affected areas with 600 grit wet or dry sandpaper. Use plenty of water. **Always sand all areas, including curves, in one direction.**
- After sanding, dry the areas and make sure all discoloration has been removed. If not, repeat the process.
- Buff the sanded surface with a buffing machine having a 1750-2800 rpm capacity to restore the luster.



- Use a soft wool pad and apply a generous amount of a good rubbing compound using a circular motion.
- After buffing, wash off the rubbing compound with clear water. Dry the surface.
- Wax with a high grade fiberglass wax.

### **Chips, Hairline Cracks, and Small Patches**

Purchase gelcoat in the matching color from your Rinker dealer. To match the color properly, specify the boat's model name, color, and year manufactured.

When patching your boat, keep the room temperature at 65° F minimum.

- Area to be repaired must be free of any dirt, water, oil or wax. Wash and dry the damaged area thoroughly before beginning.
- Sand the area with #50 sandpaper or use a power drill with a burr bit. Round out and feather edge the surrounding areas. Remove all flaky edges. If the surface cracks cover a large area, use the power sander to smooth the rough edges.
- Cleanse the area with rubbing alcohol or acetone after you have completed sanding.
- On a piece of wood or cardboard, place one (1) teaspoon of the gelcoat.

### **▲ WARNING**

**WARNING:** Acetone is a hazardous material and should be used only in well-ventilated areas. Follow the manufacturer's instructions. Also, never store rags that are diluted with acetone or any other solvent aboard your boat. Immediately remove them from the boat and discard them to prevent spontaneous combustion and fire.

- Add two (2) to three (3) drops of hardener. Mix for 10 to 15 seconds using a spatula or knife.

- Apply gelcoat to the area. Fill the area a little higher than the surrounding surface.
- Cover with wax paper or clear plastic and smooth to the desired contour.
- Let the area dry. This usually takes between one (1) to two (2) hours.
- Remove the wax paper or plastic. Then water sand with #600 wet or dry sandpaper.
- Buff the area with buffing compound. Follow this with wax and polish.

### **▲ WARNING**

**WARNING:** If using an electric buffer, be very careful not to pause in one area too long. Stalls will cause overheating of the gelcoat and may cut into the boat's surface.

## **Hull Bottom Maintenance**

**NOTE:** If your boat will be in water continuously for periods longer than two (2) weeks, Rinker Boat recommends sealing the hull bottom with a high quality barrier coating. Failure to do so could result in the formation of "water blisters". Repair of water blister damage is not covered under the Rinker Boat Warranty. Several manufacturer's have products on the market. Contact your Rinker dealer for purchase, and/or information concerning barrier coating products.

Wire brushes, scouring pads, or other abrasive type materials/solutions **should never** be used on the bottom surface of your boat. They create small scratch marks that will collect dirt, silt, sand, marine growth and other foreign materials.

Keep the hull bottom of your boat clean and make a practice of inspecting for any signs of excessive wear or damage. Needed repairs to the hull bottom should be performed immediately. Accumulation of natural coatings from water and marine growth can potentially create drag and limit the efficiency of your boat.

## Bottom Paint (Antifouling)

The antifouling bottom paint is designed to dissolve slowly to prevent marine growth. Thus, it is usual for the boat bottom to require painting after your boating season. Some variables to consider when selecting a protective bottom paint are the water temperature, pollution, salinity, current, and organic matter contained within the water. To protect and repair the boat bottom, perform the following:

**IMPORTANT:** Consult with your Finker dealer for recommended bottom paints and local laws that govern your area. Many states regulate the chemical content of bottom paints to meet environmental standards and regulations.

- Annually remove boat from water; then scrub bottom with a bristled brush and solution of soap and water.

**NOTE:** Repainting the bottom is not mandatory each time the bottom is scrubbed, providing there are no bare areas visible in the bottom paint.

- Sand entire bottom surface of the boat.
- Fair (smooth-out) all rough areas as required.
- Clean bottom surface to remove all dust and foreign materials.
- Ensure bottom surface is completely dry.
- Apply new coat of bottom paint.

**NOTE:** Always follow manufacturers' directions and recommendations regarding paint application and drying time. Never attempt to haul, paint and launch on the same day.

## DECK HARDWARE & FITTINGS

### Inspection

Inspect the hardware and fittings to ensure proper tightness. All screws, bolts, clamps, cleats, etc., should be secure.

## Cleaning and Care

- **Always** clean stainless steel frequently with soap and water. Any cleaner safe for glass is usually safe for stainless steel.
- **Always** remove rust spots as soon as possible with a brass, silver, or chrome cleaner. Irreversible pitting will develop under rust that remains on stainless steel for any period of time.
- **Always** use a cleaner, like a good car wax, for added beauty and protection.
- **Never** use coarse abrasives like **sandpaper** or **steel wool** on stainless steel. These may actually cause rusting.
- **Never** clean with mineral acids or bleaches.
- **Never** leave stainless steel in contact with iron, steel, or other metals which cause contamination leading to rust or corrosion.

## WINDSHIELD & PORTALS

1. The helm windshield is made of tempered safety glass. Safety glass will shatter into small pieces upon impact and is affected by temperature changes.

### Cleaning Glass

- Clean glass with glass cleaner or ammonia water, then rinse with plenty of clear water.
- Remove grease and/or oil with kerosene or hexane.

### CAUTION

**CAUTION:** Never use acetone, benzene, carbon tetrachloride, lacquer thinner, or similar type solvents. They penetrate the glass surface and cause crazing that will obstruct visibility.

2. The canvas or weather covering windows are made of a synthetic material.

## Cleaning Plexiglass

Wash all plexiglass, clear vinyl or other synthetic materials with a mild detergent or dish washing liquid and water solution, then rinse with plenty of clear water.

- Remove grease and/or oil with kerosene or hexane.

### **CAUTION**

**CAUTION:** Never use acetone, benzene, carbon tetrachloride, lacquer thinner, or similar type solvents. They penetrate the surface and cause hazing that will obstruct visibility.

## CARPET

### Cleaning

- Clean the indoor/outdoor carpet with a scrub brush, mild detergent or dish washing liquid and warm water solution.
- After cleaning, thoroughly rinse the indoor/outdoor carpet with clear water.

### Care

- After using the boat, allow carpet to dry completely in the sun to prevent mildew.
- Apply a light coating of Scotch Guard® to protect against accidental spills.

## SEAT COVERINGS & VINYL

The seat coverings and trim are made of marine vinyl.

### Cleaning

- Remove stains when possible, to eliminate any possible reaction between staining agent and vinyl fabric.
- Many sunscreens and tanning aids contain chemicals that may stain seat coverings. Vinyls should be cleaned immediately after contact with these products. Stains of this type are not covered under warranty.

- Leaves from trees and plants, and bird droppings may stain seat coverings. Stains of this type are not covered under warranty.
- Wipe most dirt and smudges with mild soap and warm water. If additional cleaning is required, scrub with a soft bristle brush to remove dirt from textured patterns. Dry with a soft, lint-free cloth or towel.
- For more difficult stains, use a stronger detergent following the vinyl manufacturer's instructions closely.
- Never use steel wool or powdered abrasive cleaners. They will mar the surface and leave an unsightly appearance.

### Care

- Apply a vinyl protectorant to keep the seats clean and pliable. Do not use silicone based products.
- Place removable exterior cushions inside the boat when not in use.
- To store cushions on board boat for winter or extended periods of time:
  - A. Open zippers and elevate cover away from foam padding.
  - B. Place a small rounded object (ie., plastic bowl) inside to allow for air circulation.
  - C. Seats that can be folded should be stored in the down position.
  - D. Use plastic seat covers. They will keep out dampness and protect against mildew.

## CANVAS (WEATHER COVERINGS)

Your Rinker boat is fundamentally an open vehicle. Therefore, in spite of well-designed and well-fitting canvas enclosures, your boat is NOT water proof in the same sense that your automobile is waterproof. In spite of the best efforts to design these enclosures to conform with the boat, a certain amount of leakage may transpire. The construction of

the canvas tops and curtains involves sewing as the primary choices of fastening. The needle results in holes at the seam lines which can admit water. Needle holes elongate with time and usage. After cleaning with soap and water, allow seams to thoroughly dry. A vinyl daub sealant can be applied on the seams to somewhat close the needle holes. This sealant must be applied with the canvas up and stretched tight. Your canvas system is not warranted to provide a water-tight enclosure. The canvas top supplied with your boat is not a storage cover. Canvas tops which has been used as a storage cover will not be covered by the manufacturer's warranty.

The canvas, or weather coverings, are manufactured from materials that are resistant to water, mildew, rot and weather.

## Cleaning

- Wet down all canvas material. Then, use a soft bristle brush to scrub with a mild detergent or dish washing liquid and water solution
- If heavy build-up of soil or mildew occurs, apply a mild solution of ammonia and water and scrub. Follow scrubbing with a thorough rinsing.
- Brush or sweep the underside of the top. Spray with Lysol™ or other disinfectant to prevent mildew.

## Care

- Rinker Boat strongly recommends the use of a storage cover when the boat is not in use. The use of a cruising canvas as a storage cover is not recommended.
- Lubricate the zippers with paraffin, and the snaps with petroleum jelly.
- If a leak occurs along a canvas seam, rub with a vinyl daub sealant, or apply Scotch Guard® treatment.
- Air dry all canvas material before storing. Never store canvas damp or wet, and provide proper ventilation to limit the possibility of mildew. If clear plastic canvas

parts are stored wet, permanent clouding of the clear plastic may result.

- Avoid mooring under trees.
- Do not tow your boat with the top in the raised position as this may cause damage not covered under warranty.

Acrylic fabrics should be cleaned regularly before dirt and other particles accumulate and become embedded.

- Brush off dirt and particles and clean with natural soap (not detergent) in lukewarm water. Rinse thoroughly with cold water to remove soap.
- Treat stubborn stains with a solution of 1/2 cup non-chlorine bleach and 1/4 cup natural soap per gallon of lukewarm water. Rinse thoroughly with cold water to remove soap.

**NOTE:** Excessive soaking can deteriorate sewing threads. This treatment may remove part of the fabric's water repellancy.

## CABIN CUSHIONS, INTERIOR CURTAINS & FABRICS

---

### Cleaning

- Clean interior cabin cushions with a foam type cleaner. Follow all instructions as recommended by the product manufacturer.
- All interior curtains & fabrics, other than vinyl, should be dry cleaned.



The information provided here is for winterizing and storage of your Rinker boat after completion of your boating season. In regions where temperatures fall below freezing, **all engine(s) plugs must be removed before storing your boat for the winter.** Failure to do so will seriously damage the engine(s). If your location does not require winter storage, then we recommend an annual inspection, such as listed below. With proper care your Rinker boat will provide you many years of enjoyable boating.

## DRY STORAGE PREPARATION

**NOTE:** Refer to Chapter 8, Interior & Exterior Care for specific cleaning solutions and procedures.

### Deck

- Wash deck, superstructure and cockpit.
- Clean all deck hardware, then apply one coat of rust inhibitor.
- Clean the indoor/outdoor carpet.

### Hull

- Scrape off any barnacles or crusted marine growth.
- Scrub hull thoroughly to remove marine growth, scum and loose paint.
- Inspect underwater gear and propellers for excessive wear or damage.
- Apply fresh coat of bottom paint.
- Remove hull drain plug, then store plug in a safe place.

### General Housekeeping

- Scrub inside boat including all cupboards, cabinets and drawers.
- Remove all cushions, mattresses, curtains, blankets & sheets, pillows, towels

and linen, clothing and any other items that can hold moisture and cause mildew.

**NOTE:** Mattresses and cushions can be left on board only if they can be propped up where air can circulate.

- The cabin should be well ventilated.
- Life jackets and other safety equipment left on board must have adequate air circulation.
- Clean and dry bilge. Remove any materials such as rags, sponges, or other cleaning material.
- Weather permitting, open all doors, hatches, portals, and windows to air out the interior for a day or two.
- If covering boat while in storage, use a cover constructed of fabric that allows for plenty of ventilation.

## ENGINE(S)

### Cooling System

Drain cooling system when storing boat for extended periods of time, or when climate conditions present possible freezing temperatures. This will prevent corrosion damage.

**IMPORTANT:** When placing boat in dry storage, position boat so that engine is level.

- When draining cooling system, ensure that plug openings are free of foreign materials (i.e., sand, silt, marine growth, rust etc.).
- Further protection against rust and freezing can be provided by filling cooling system with anti-freeze and fresh water.
- Mix anti-freeze, as instructed by anti-freeze manufacturer, in recommended proportion for lowest temperature that engine(s) will be exposed.
- Refer to engine(s) owner's manual for detailed winterizing and storage instructions.

## Lubrication

- Drain each crankcase only after engine(s) has reached operating temperature. This will ensure complete drainage of oil.

**NOTE:** If drained engine(s) oil contains sludge, engine(s) should be flushed with flushing oil. Refer to engine owner's manual for detailed winterizing and storage instructions.

- Replace engine(s) oil filter.
- Fill each crankcase with required quantity of recommended engine oil. Refer to engine owner's manual.
- Shut off fuel line and start engine(s).
- Pour or spray fogging oil through carburetor air intake. Continue to pour or spray fogging oil until engine(s) stops.

**NOTE:** Engine(s) will stop due to lack of gasoline supplied from shut off fuel line.

- Clean and lubricate all linkage.
- Spray entire exterior of engine(s) with rust and corrosion inhibitor.
- Remove stern drive unit(s).
- Have engine alignment checked and adjusted as required by a qualified technician.
- Inspect all gaskets and seals, grease the U-joints, and change gear oil.
- Install new gaskets and seals, and reinstall stern drive.
- Remove propeller. Clean and lubricate the prop shaft. Repair if necessary.

## GENERATOR

- Start and run generator with load until it is thoroughly warm. Stop the generator.
- Drain oil from crankcase while engine(s) is still warm. Refill crankcase with new oil. Attach a tag to the generator within clear view showing crankcase oil viscosity.

- Turn off fuel supply valve. Start engine(s) and let generator run until it stops from lack of fuel.
- Remove spark plug and pour about one (1) ounce (30 ml) of rust inhibitor oil (or SAE 50 engine oil) into cylinder plug opening. Crank engine(s) over several revolutions, then install new spark plug.
- Protect cooling system from freezing as follows:
  - A. Shut off seacock.
  - B. Remove inlet hose at seacock (or strainer if used) and insert hose end into a bucket containing about two (2) gallons (7.6 liters) of 50-50 anti-freeze/water mix.
  - C. Crank engine(s) until coolant mixture discharges from outboard exhaust fitting.
  - D. Reinstall inlet hose removed in Step B.
- Plug exhaust outlet to prevent entrance of moisture, insects, dirt, etc.
- Disconnect starting battery and follow standard battery storage procedure. (See Battery Information on page 9-3)

### **CAUTION**

**WARNING:** Battery electrolyte can cause severe eye damage and burns to the skin. Wear goggles, rubber gloves, and a protective apron when working with batteries. If spillage occurs, wash area with a solution of baking soda and water.

- Clean and wipe entire unit. Coat parts susceptible to rust with light coat of rust inhibitor oil or grease.
- Refer to generator owner's manual for detailed winterizing & storage instructions, and recommissioning.

## AIR CONDITIONER

- Disconnect the pump plug and drain the sea water circuit. The system is self-purging to assure that all water will be drained.
- Pump an anti-freeze solution through the condensing coil to displace any water in the system for additional protection.

## FRESH WATER SYSTEM (POTABLE)

- Open all faucets and turn on water pump to empty water tank and intake lines.
- Run pump dry, for one (1) to two (2) minutes, before turning off pump.
- Open ALL drains.
- Disconnect discharge and intake hoses from pump.
- Start pump and allow pump to run to force all water from unit.

**NOTE:** Do not be alarmed that the pump continues to run when dry. This will not damage the pump.

- Reconnect all hoses, close all drains, and leave all faucets open.
- Remove water pump fuse to prevent cycling during storage or lay-up.
- Refer to water heater owner's manual for draining and winterization instructions.

## MARINE SANITATION DEVICE (MSD)

The major cause of marine toilet failures is improper winterizing or storage. For boats used in salt water, the toilet bowl should be filled with fresh water and left for several days to allow the accumulated salt to dissolve.

- Pump system dry and flush with fresh water.
- Fill system with anti-freeze.

## FUEL SYSTEMS

Add a gasoline stabilizer solution to the fuel tank(s). Follow the product manufacturer's recommended procedure.

## BATTERIES

- Remove batteries from boat and store away from freezing temperatures

**NOTE:** Batteries should be stored in a cool dry place on a wooden pallet. Avoid direct placement on concrete, brick, or dirt floors because the charge will be absorbed into the ground.

### **CAUTION**

**WARNING:** Battery electrolyte can cause severe eye damage and burns to the skin. Wear goggles, rubber gloves and a protective apron when working with batteries. If spillage occurs, wash area with a solution of baking soda and water.

- Clean outside battery case, terminals, and battery clamps with a baking soda and water solution.

**NOTE:** Do not allow baking soda and water solution to enter the cells.

- Clean battery posts and clamps with a piece of fine grit emery cloth. Use a light sanding motion when cleaning.
- Apply a light coat of petroleum jelly to cover end of battery cables.
- A monthly recharge or continuous trickle charge should be applied to the batteries during storage.

## RECOMMISSIONING

- Inspect visually and by smelling the fuel system and all associated components for proper connections, wear, leaks, or other damage and needed repair.

**NOTE:** For detailed information on recommissioning your boat's systems and



equipment, refer to the manufacturer's owner/instruction manual.

**IMPORTANT:** Rinker Boat cannot overemphasize our concern for your safety. Inspection of the fuel system is a most important safety precaution.

- Clean battery terminal posts with wire brush or steel wool before reinstallation.
- Check charge on batteries. Recharge or replace if necessary.
- Inspect all battery wiring. Repair or replace if necessary.
- Attach cables, then tighten cable clamps.
- Apply petroleum jelly or marine grade grease on posts and clamps. This will eliminate possible build-ups of air pockets and acid.

**IMPORTANT:** Do not apply petroleum jelly or marine grade grease before connecting and tightening clamps.

- Reinstall the hull drain plug after coating threads with petroleum jelly.
- Clean the bilge area.
- Reinstall the exhaust drain plug.
- Inspect all exhaust connections to avoid exhaust and carbon monoxide (CO) leakage. Make adjustments as required.
- Test operation of navigational lights and other lighting on board. Repair or replace if necessary.
- Inspect all wiring for fraying, wear, loose connections, or other damage. Repair or replace if necessary.
- Inspect all switches, controls, and other related equipment for proper operation. Repair or replace if necessary.
- Inspect anchor lines and other safety related equipment for proper operation and physical condition. Repair or replace if necessary.

- Check personal flotation devices for tears or damage. Do not repair defective PFDs. By law they must be replaced.

## LIFTING THE BOAT

### **▲WARNING**

**WARNING:** Lift slings may slip on the hull and result in serious injury or death from dropped load. Exercise extreme caution if in the vicinity of such activity. If possible, slings should be tied together before lifting.

Unless your boat is trailerable, have your dealer or qualified marina personnel lift your boat out of the water for you. Each boat has main frame components designed to support the boat when it is being lifted out of the water. Severe gelcoat crazing or more serious hull damage can occur if the lifting slings exert pressure on the gunwales. Flat, wide belting-type slings should be used. Don't use cable-type slings. The spreader bar at each sling should be as long as the distance across the widest point the sling surrounds.

- Never hoist the boat with more than a minimal amount of water in the bilge.
- Empty fuel and water tanks, especially if they have large capacities.
- Do not place the slings where they may lift on underwater fittings.
- Do not use deck cleats or bow or stern eyes for lifting unless they are labeled.

**Abaft**

Toward the stern.

**Abeam**

Amidships, at a right angle to the keel.

**Aboard**

On, in, or into a boat.

**ABYC**

American Boat and Yacht Council, Inc., the organization that sets voluntary safety and construction standards for small craft in the USA.

**Adrift**

Without motive power and without anchor or mooring.

**Afloat**

On the water.

**Aft**

Describing the after section of a vessel, or things to the rear of amidships and near the stern.

**Aground**

Touching bottom.

**Amidships**

In the center, the center portion of a vessel.

**Anchor**

A forging or casting shaped to grip the sea bottom and, by means of a cable or rope, hold a boat in a desired position.

**Anchorage**

A customary, suitable and (usually) designated harbor area in which vessels may anchor.

**Astern**

Toward the stern. An object that is aft of a boat is said to be astern of the boat.

**Athwart**

Across.

**Aweigh**

Off the bottom, said of an anchor.

**Aye**

Yes, while aboard a boat or ship. Means "I understand."

**Bail (Bale)**

To remove water from a boat by pump or bailer.

**Ballast**

Heavy material such as iron, lead, or stone placed in the bottom of the vessel.

**Beacon**

A post or buoy placed over a shoal or bank to warn vessels, and so a signal mark on land.

**Beam**

Imaginary line amidships at right angles to keel of vessel. Also vessel's width amidships.

**Bearing**

The direction or point of the compass in which an object is seen.

**Belay**

To make fast to a cleat or belaying pin; to cancel an order.

**Below**

Beneath, or under, the deck. One goes below when going down into the cabin.

**Bend**

To fasten by means of a bend or knot.

**Berth**

A position, as a place to sleep or in which a vessel may be made fast; a margin of safety, as "a wide berth."

**Bilge**

The lower internal part of a boat's hull.

**Bollard**

A strong post for holding lines fast.

**Bow**

The forward part or front of the boat.

**Breakers**

Waves cresting as they reach shallow water, as at or on a beach.

**Breakwater**

A structure, usually stone or concrete, built to create a harbor or improve an existing one.

**Bulkhead**

Vertical partition in a boat.

**Burdened Vessel**

Former term for the vessel which must stay clear of vessels with the right-of-way.

**Calking (Caulking)**

Forcing filler material into the seams of the planks in a boat's deck or sides to make them watertight.

**Camber**

The arch of a deck, sloping downward from the center toward the sides.

**Capsize**

To turn over.

**Carburetor**

**Backfire Flame Arrestor** Required equipment on all motorboats except outboards and diesels. Reduces chance of fire caused by backfires in internal combustion engines.

**Cardinal Points**

The four main points of a compass; north, east, south, and west.

**Ceiling**

The inside lining of the hull.

**Certificate**

Government paper, such as a boat's license.

**Chart**

A map of a body of water that contains piloting information.

**Chine**

The intersection of sides and bottom of a boat.

**Cleat**

A piece of wood or metal with projecting ends to which lines are made fast.

**Clinker**

A method of planking in which the lower edge of each strake overlaps the upper edge of the strake next below. (Also called lapstrake.)

**Coaming**

A raised edge, as around part or all of a cockpit, that prevents seawater from entering the boat.

**Coast Guard**

The federal marine law enforcement and rescue agency in the US.

**Cockpit**

A well or sunken space in the afterdeck of a small boat for the use of the helmsman and crew.

**Companionway**

A hatch or entrance, from deck to cabin.

**Compass**

The instrument which shows the heading of a vessel.

**Cowls**

Hooded openings used for ventilation.

**Cradle**

A frame used to support a vessel on land.

**Current**

The movement of the water in a horizontal direction.

**Deadrise**

The rise of the bottom of a midships frame from the keel to the bilge.

**Deck**

Any permanent covering over a compartment.

**Deep-six**

To discard or throw overboard.

**Depth Sounder**

An electronic depth-finding instrument, measuring the time a sound wave takes to go from the vessel to the bottom and return, then displaying the result in feet, fathoms, or meters.

**Dinghy**

A small, open boat.

**Displacement Hull**

Type of hull that plows through the water even when more power is added.

**Dock**

An enclosed or nearly enclosed water area; all the port installations; a place where vessels can moor, as a pier, wharf, or floating dock.

**Documented Vessel**

Vessel registered with the U.S. Coast Guard.

**Dolphin**

A small group of piles, in the water, generally used for mooring or as a channel marker.

**Draft**

The depth of the vessel below the water line, measured vertically to the lowest part of the hull.

**Dunnage**

Mats, boughs, pieces of wood, or other loose materials placed under or among goods carried as cargo in the hold of a ship to keep them dry and to prevent their motion and chafing; cushioning or padding used in a shipping container to protect fragile articles against shock and breakage; baggage or personal effects.

**Ebb**

An outgoing tide.

**Estuary**

An inlet or arm of the sea.

**Fathom**

Six feet.

**Fenders**

Objects placed along the side of the boat to protect the hull from damage.

**Flare**

The outward spread of the boat's sides from the waterline to the rail at the bow. Also, a pyrotechnic signalling device that can indicate distress.

**Fore**

Used to distinguish the forward part of a boat or things forward of amidships. It is the opposite of aft or after.

**Forward**

Toward the bow.

**Frame**

Ribs of the hull, extending from the keel to the highest continuous deck.

**Freeboard**

The vertical distance measured on a boat's side from the waterline to the gunwale.

**Galley**

The kitchen area of a boat.

**Gimbals**

Swivels used to keep equipment level.

**Give-Way Vessel**

The one which must stay clear of vessels which have the right-of-way.

**Grab Rail**

A convenient grip, on a cabin top or along a companion ladder.

**Gunwale (pronounced gunnel)**

The upper edge of a boat's side.

**Harbor**

A safe anchorage, protected from most storms; may be natural or man-made, with breakwaters and jetties; a place for docking and loading.

**Hatch**

An opening in a boat's deck for persons or cargo to go below.

**Head**

A marine toilet.

**Headway**

Forward motion of a vessel through the water.

**Helm**

The wheel or tiller by which a ship is steered.

**Holding Tank**

Storage tank for sewage, so that it will not be pumped overboard into the water.

**Hull**

The body of a boat.

**Hypothermia**

A physical condition where the body loses heat faster than it can produce it.

**Inboard**

More toward the center of a vessel, inside; a motor fitted inside the boat.

**Inland Rules**

Rules of the road that apply to vessel operation in harbors and certain rivers, lakes, and inland waterways.

**Intracoastal Waterways**

ICW: bays, rivers and canals along the coasts (such as Atlantic and Gulf of Mexico coasts), connected so that vessels may travel without going into the open sea.

**Jetty**

A structure, usually masonry, projecting out from the shore; a jetty may protect a harbor entrance.

**Keel**

The permanently positioned, fore-and-aft backbone member of a boat's hull.

**Knot**

To bend a line. Also, a unit of speed equal to one nautical mile (6,076.10 feet) an hour.

**Launch**

- (1) To put a vessel into the water;
- (2) A small open powerboat, mainly used for transportation between a vessel and shore.

**Lee**

The side opposite to that from which the wind blows.

**Leeward**

Situated on the side turned away from the wind. (Opposite of windward.)

**Leeway**

The amount a boat is carried sideways by the wind's force or current.

**Limber Holes**

Drainage holes in the bilge timbers of a vessel, allowing to run to a low point for pumping out.

**List**

- (1) A continuous leaning to one side, often caused by an imbalance in stowage or a leak into one compartment.
- (2) A light list is a printed listing of aids to navigation, in geographical order or inclining of a vessel toward the side.

**LOA**

Length over all; the maximum length of a vessel's hull, excluding projecting spars or rudder.

**Locker**

A storage place, a closet.

**Log**

A record or diary of a vessel's journey.

**Lubber's Line**

A mark or permanent line on a compass that shows the course of the boat.

**Making Way**

Making progress through the water.

**Marina**

A place, essentially a dock area, where small recreational craft are kept; usually floats or piers, as well as service facilities, are available.

**MAYDAY**

A radio distress call, from the french *m'aidez* (help me); SOS In Morse Code.

**Mooring**

Commonly, the anchor chain, buoy, pennant, etc., by which a boat is permanently anchored in one location.

**Motor**

A source of mechanical power.

**Motorboat**

Any watercraft 65 feet or less in length propelled by machinery, whether or not such machinery is the principal source of propulsion.

**Navigation**

The art of conducting a ship from port to port.

**Nautical Mile**

6076.12 foot, or 1852 meters, an international standard; the geographical mile, the length of one minute of latitude at the equator, is 6087.20 feet.

**Nun Buoy**

A conical, red buoy bearing an even number and marking the starboard side of a channel from seaward.

**Oar**

A long, wooden instrument with a flat blade at one end, used for propelling a boat.

**Outboard**

- (1) A propulsion unit for boats, attached at the transom; includes motor, drive-shaft, and propeller; fuel tank and battery may be integral or installed separately in the boat;
- (2) Outside or away from a vessel's hull; opposite of inboard.

**Outdrive**

A propulsion system for boats, with an inboard motor operating an exterior drive, with driveshaft, gears, and propeller; also called stern-drive and inboard/outboard.

**Overall Length**

The extreme length of a vessel, excluding spars or rigging fittings. See LOA.

**Painter**

A rope attached to the bow of a boat for making it fast.

**PPD**

Personal Flotation Device.

**Pier**

A structure, usually wood or masonry, extending into the water, used as a landing place for boats and ships.

**Pile**

A vertical wooden or concrete pole, driven into the bottom; may be a support for a pier or floats; also used for mooring.

**Piling**

A structure of piles.

**Pitch**

- (1) The up and down movement, as the bow and stern rise and fall due to wave action;
- (2) The theoretical distance advanced by a propeller in one revolution.

**Planing Hull**

Type of hull that is shaped to lift out of the water at high speed and ride on the surface.

**Port**

The left side of a boat when you are facing the bow, also a destination or harbor.

**Privileged Vessel**

Former term for the vessel with the right-of-way.

**Propeller**

Wheel or screw. Mechanism that pushes water aft to propel the boat.

**Rigging**

The general term for all lines(ropes) of a vessel.

**Roll**

The sideward motion of a boat caused by wind or waves.

**Rules of the Road**

The nautical traffic rules for preventing collisions on the water.

**Scope**

The length of the anchor rope or chain. 6 to 1 scope means that the length of the anchor rope from the boat to the anchor is 6 times the depth of the water.

**Scupper**

A hole allowing water to run off the deck.

**Sea Anchor**

A floating canvas cone, held open by wire rings, with an opening in the smaller end, and a rope bridle at the larger end attached to a line leading to the vessel; used in storm conditions to (a) keep the bow of the boat to the wind, and (b) slow downwind drift of the boat.

**Seacock**

A through-hull valve, a shut-off on a plumbing or drain pipe between the vessel's interior and the sea.

**Slip**

- (1) A berth for a boat between two piers or floats;
- (2) The percentage difference between the theoretical and the actual distance that a propeller advances when turning in water under load.

**Sole**

The cabin or cockpit floor.

**Spar Buoy**

A channel marker that looks like a tall, slender pole.

**Stand-On Vessel**

The vessel with the right-of-way

**Starboard**

The right side of a boat when you are facing the bow.

**Stern**

The after end or back of the boat.

**Stow**

To store items neatly and securely.

**Strake**

Planks running fore and aft on the outside of a vessel.

**Taffrail**

The rail around a boat's stern.

**Tide**

The alternate rise and fall of waters caused by the gravitational attraction of moon or sun.

**Topsides**

- (1) The sides of a vessel above the waterline;
- (2) On deck as opposed to helow deck.

**Transom**

The transverse planking which forms the afterend of a small, square-ended boat. (Outboard motors are usually attached to a transom.)

**Trim**

To arrange weights in a vessel in such a manner as to obtain desired draft at bow and stern.

**Trimaran**

Boat with three hulls, the center one is the largest.

**Unbend**

To cast-off or untie.

**Underway**

Vessel in motion, i.e., when not moored, at anchor or aground.

**USPS**

United States Power Squadron, a private membership organization that specializes in boating education and good boating practices

**Vessel**

Every kind of watercraft, other than a sea-plane or the water, capable of being used as a means of transportation on water.

**VHF Radio**

A Very High Frequency electronic communications and direction finding system.

**Wake**

Moving waves, created by vessel motion. Track or path that a boat leaves behind it, when moving across the water.

**Wash**

The loose or broken water left behind a vessel as it moves along; the surging action of waves.

**Waterline**

The intersection of a vessel's hull and the water's surface; the line separating the bottom paint and the topsides.

**Way**

Movement of a vessel through the water. Technically it is underway when not at anchor, aground, or made fast to the shore. The common usage is interpreted as progress through the water. Headway when going forward and Stemway when it is going backwards.

**Well**

Area at the rear of a boat where the motor may be located.

**Wharf**

A structure, parallel to the shore, for docking vessels.

**Wheel**

- (1) The steering wheel;
- (2) The propeller.

**Whistle Signal**

A standard communication signal between boats, to indicate change of course, danger, or other situations.

**Windward**

Situated on the side closest to the wind. (Opposite of leeward.)

**Yaw**

To swing or steer off course, as when running with a quartering sea.



