



REGAL LS4C OWNER'S MANUAL

 REGAL

OCTOBER 2018 EDITION

<https://www.boat-manuals.com/>

Notes

FUEL SYSTEMS

Boats manufactured for use in California for model year 2018 and after meet the California EVAP Emissions regulation for spark-ignition marine watercraft. Boats meeting this requirement will have a label affixed near the helm.



WARNING

Operating, servicing and maintaining a recreational marine vessel can expose you to chemicals including engine exhaust, carbon monoxide, phthalates, and lead, which are known to the State of California to cause cancer and birth defects or other reproductive harm. To minimize exposure, avoid breathing exhaust, service your vessel in a well-ventilated area and wear gloves or wash your hands frequently when servicing this vessel. For more information go to: www.P65warnings.ca.gov/marine.

The fuel system in this boat complies with U.S. EPA mandated evaporative emission standards at time of manufacture using certified components.

MANUFACTURER'S WARRANTY COVERAGE

This evaporative emission control system is warranted for two years. If any evaporative emission-related part on your spark-ignition marine watercraft is defective, the part will be repaired by Regal Marine Industries, Inc.

OWNER'S MANUAL RESPONSIBILITIES

- As the spark-ignition marine watercraft owner, you are responsible for the performance of the required maintenance listed in your owner's manual. Regal Marine Industries, Inc. recommends that you retain all receipts covering maintenance on your spark-ignition marine watercraft, but Regal Marine Industries, Inc. cannot deny warranty solely on the lack of receipts.
- As the owner, you should be aware that Regal Marine Industries, Inc. may deny you warranty coverage of your spark-ignition marine watercraft or a part has failed due to abuse, neglect, or improper maintenance or unapproved modifications.
- You are responsible for presenting your spark-ignition marine watercraft to a Regal Marine Industries, Inc. distribution center or a service center as soon as the problem exists. The warranty repairs should be completed in a reasonable amount of time, not to exceed 30 days. If you have any questions regarding your warranty coverage, you should contact Regal Marine Industries, Inc. at 407-851-4360.

Introduction

Boating is becoming more popular each and every year. There are numerous types of recreational vessels on our waterways today involved in an every growing number of activities. Therefore, as a Regal boat owner it is of the highest priority to learn about general boating practices before operating your vessel.

Your Regal dealer will answer many questions and provide valuable “hands on” information during the completion of the new boat delivery process. In addition, your dealer has received special factory training on the product line and his services should be employed to solve any technical problems and periodic maintenance beyond the scope of this manual. Your Regal dealer carries a line of factory approved parts and accessories.

Your Regal dealer can provide information regarding national training organizations such as the U.S. Power Squadron and United States Coast Guard Auxiliary. Along with other organizations and literature, they can help build your “boating savvy” by developing the necessary skills and awareness to be a safe and confident skipper.

Also, your local library can assist in providing recommended boating literature such as Chapman Piloting Seamanship & Boat Handling by Elbert S. Maloney. Also, boating information is available on the internet.

Remember, waterway conditions can change in a heartbeat. Knowing how to react quickly comes from experience and knowledge which can be gained through boating education.

Welcome aboard!



Welcome to Regal

I know I speak for everyone at Regal when I welcome you to the ever-growing family of Regal boat owners. You've chosen a boat that is recognized worldwide for its standard of excellence. Each step in construction has been carefully scrutinized to assure safety, performance, reliability and comfort for both your passengers and yourself.

Your yacht is certified by the National Marine Manufacturers Association. It also complies with the applicable standards set by the United States Coast Guard , American Boat and Yacht Council and the International Marine Certification Institute. Your Regal boat was built with the same attention to detail and quality of construction that we would expect in a craft we would purchase ourselves.

Whether you're a veteran boater or a newcomer, we strongly urge you to read this manual thoroughly. Familiarize yourself with the various components of your vessel, and heed the safety precautions noted herein.

If you have questions that are not covered in this manual, please consult your authorized Regal dealer for assistance, phone the Regal factory at 407-851-4360 or E-mail us at www.regalboats.com.

Thank you, and welcome to the "World of Regal !"

Duane Kuck
President & CEO

Our Mission

With God's Help and a Steadfast Commitment to Integrity, We will Develop a Team of Exceptional People and Relationships to Provide Exceptional Customer Satisfaction.

Table Of Contents

2	Notes
3	Introduction
4	Welcome to Regal
5	Our Mission
6	Chapter 1 - General Vessel Information
18	Chapter 2 - Safety On Board
41	Chapter 3 - Rules Of The Road
51	Chapter 4 - Systems
82	Chapter 5 - Engine & Controls
95	Chapter 6 - Vessel Operation
109	Chapter 7 - Auxiliary Equipment Operation
152	Chapter 8 - Care & Maintenance
168	Chapter 9 - Troubleshooting
175	Chapter 10 - Storage & Winterization
180	Chapter 11- Towing
185	Chapter 12- Glossary & Index
191	Chapter 13 - Technical

Chapter 1

General Vessel Information

Regal Owner's Manual

Your Regal owner's manual has been compiled with information to assist you in operating your craft with safety and pleasure. This manual targets specific details of Regal related systems and components along with their location, operation and maintenance that normally are not found in the vendor information. In addition, supplier related equipment information is located within the owner's information packet.

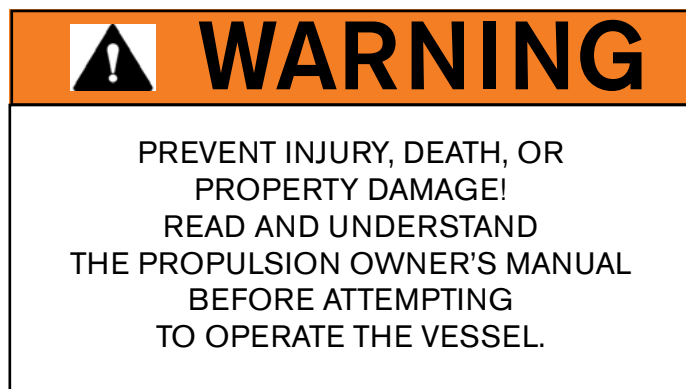

The Regal owner's manual is not to be thought of as a complete shop technical document. Besides the system chapters, there is troubleshooting information devoted to select current standard and optional equipment. In addition, refer to the engine operator's manuals. More detailed information may exist in the owner's packet associated with that component.

Remember that your Regal dealer has received special factory training and his services should be employed to solve more technical problems.

Call 407-851-4360 or go to the internet at regalboats.com to find the closest Regal dealership.

In keeping with its commitment to improvement Regal Marine Industries, Inc. is continually upgrading the product line. Regal notes that all dimensions, specifications, models, standard and optional equipment is subject to change without notice at any time.

QR Label



Currently there is a QR label attached to a visible location such as the helm. This label when scanned by an iPhone will take you via an app to the Regal web-site where you can download your vessel's owner's manual or for that matter any Regal owner's manual.

With the manual downloaded you can duplicate it into a format you are comfortable using. The QR label is used globally for any type product from the food, home and auto business to boats. It affords much more capacity and is much more customer friendly than the traditional bar code used by manufacturer's on their products. *Other Regal owner's manuals can be found by scanning this QR Code or by going to: regalboats.com/owners*

Owner's Information Packet



An owner's information packet (black satchel) is located on the vessel. Read and become familiar with the materials.

This packet contains valuable information on your propulsion package, standard and optional equipment, systems, care and maintenance along with component warranty. Store in a dry location on board the vessel. It is a good practice by the boat operator to show passengers where the owner's information packet is stored along with a summary of its contents.

NMMA Capacity Plate

In proximity to the helm on Regal boats up to 26' in length is a NMMA capacity plate. This plate represents boat manufacturers who participate in the National Marine Manufacturer's Association small boat certification program. The driver of the vessel shall read and understand the plate information before operating the craft. Be sure to read and abide by the capacity limits. Remember the boat operator is responsible for the vessel and passenger safety.

Note the typical capacity plate and information:

1. The maximum number of persons permitted on the vessel also shown as weight in pounds.
 2. The total weight of persons, gear and other items under normal conditions that the boat can carry.
- Overloading, improper loading and weight distribution are all well documented causes of boating accidents. Provide for an extra margin of safety in rough sea conditions.

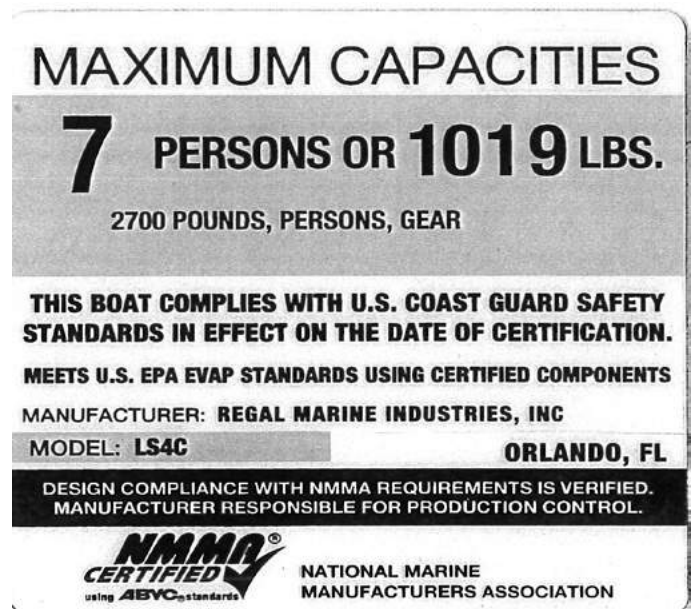

MAXIMUM CAPACITIES

7 PERSONS OR 1019 LBS.

2700 POUNDS, PERSONS, GEAR

THIS BOAT COMPLIES WITH U.S. COAST GUARD SAFETY STANDARDS IN EFFECT ON THE DATE OF CERTIFICATION.

MEETS U.S. EPA EVAP STANDARDS USING CERTIFIED COMPONENTS

MANUFACTURER: **REGAL MARINE INDUSTRIES, INC**

MODEL: **LS4C** **ORLANDO, FL**

DESIGN COMPLIANCE WITH NMMA REQUIREMENTS IS VERIFIED.
MANUFACTURER RESPONSIBLE FOR PRODUCTION CONTROL.

NMMA CERTIFIED
using ABYC standards

NATIONAL MARINE MANUFACTURERS ASSOCIATION

Hull Identification Number

The United States Coast Guard has established a universal system of numerically recognizing vessels by using a hull identification number or "HIN." This number identifies your Regal yachts' model, hull number, month and year of manufacture. The



HIN is normally found on your boat's transom, on the starboard side, just below the rub rail on

the transom vertical surface. The HIN is stamped on a plate and reinforced with a special adhesive. The HIN domestically uses 12 alpha or numeric characters.

It is recommended that you locate and write down the HIN for future reference. It can be especially useful when ordering parts from your Regal dealer. A second HIN number is found in a hidden location. This second HIN is useful to authorities if the vessel is stolen and/or the original transom HIN is modified or eliminated.

Vessel Float Plan

Formulate a float plan before departing. Leave it with a responsible person who will notify the United States Coast Guard or local law enforcement authorities if you do not return as planned. If you change your plans be sure to notify this person. Make copies of the float plan and use one each time you go boating. This will help people know where to find you should you not return on schedule. Do not file the float plan with the United States Coast Guard.

Vessel Float Plan

Fill out this form before departure. Leave it with a responsible person who will notify the Coast Guard or police if you don't return as planned. If you change your plans be sure to notify this person. Make copies of the float plan and use one each time you go on a trip. This will help people know where to find you should you not return on schedule. Do not file this plan with the Coast Guard.

Owner: _____
Address: _____
City & State: _____
Telephone#: _____

Person Filing Report: _____
Name _____
Telephone _____

Food _____ Water _____

Make Of Craft: _____
Length _____ Boat Name _____
Color _____ Trim _____ Hp _____
Inboard _____ Stern Drive _____
Hull I.D.# _____
Documented Vessel # _____

Other Information _____

Safety Equipment Aboard: _____
Life Jackets _____
First Aid Kit _____
Flares _____
Flash Light _____
VHF Radio _____
Cell Phone # _____
Computer ___ Desk Top ___ Lap Top ___
E-mail address _____

State Registration# _____
Destination: _____
Leave From _____
Time Left _____
Going To _____
Fuel Capacity _____
Est. Day Of Arrival _____

Est. Time Of Arrival _____
If Not Back By ___ o'clock Call Authorities

Persons Aboard:

Name	Age	Address	Phone
_____	_____	_____	_____
_____	_____	_____	_____
_____	_____	_____	_____
_____	_____	_____	_____
_____	_____	_____	_____

____ See Other Side For Additional Persons

Vessel Cruise Checklist

- Obtain a current weather update.
- Hoist the boat & periodically inspect the hull bottom and propellers for damage. Marine growth such as barnacles will affect performance and fuel efficiency. Check sacrificial anodes located on the propulsion unit, transom and engine. Replace anode if less than 2/3 remaining.
- Check the electrical system and all safety related equipment. Carry extra fuses. Ensure they are of the proper capacity and type.
- If your boat has been in the water, run the bilge pump until the flow of water stops.
- Check to see that all bilge water has drained and the drain plug is installed before launching If your boat if it has been out of the water.
- Check that all required safety equipment is on board and in good working condition Examples include personal flotation devices (PFD's), horn, bell, hand held fire extinguishers, and visual distress signals.
- Check fuel level. Fuel tanks should be filled to slightly less than capacity. Allow for fuel expansion. Remember the "one third rule".
- Open engine compartment. Inspect for fuel odors and visible leaks in the fuel, oil, coolant, exhaust and power steering systems.
- Check all fuel filters for the presence of water.
- Check fluid levels of engines, drives and generator (if applicable).
- Inspect engine for cracked hoses, worn or loose belts, and loose hardware.

Recommended On Board Equipment

Tools:

Allen Wrenches
Jack Knife
Phillips Screwdriver
Regular & Needle Nose Pliers
Combination Box & End Wrench Set
Screwdriver Set (One With Various Tips)
Side Cutters
Ratchet & Socket Set
Electrical Crimper,Cutter,Stripper Combo
Hammer
VOA Electrical Tester
Water Pump Pliers
Vise Grip Pliers
Floating Flashlight/Lantern
Oil/Fuel Filter Wrench
Tape Rule

Basic Gear & Supplies:

Tow Line
Lubricating Oil, Liquid Wrench
Mooring Lines
Duct & Electricians Tape
Dock Fenders
Coolant (Engine Freshwater Side)
Distress Signals
Engine, Drive, Power Steering Oil
First Aid Kit
Boat Soap (Not Dish Soap)
Boat Hook
Woody Wax
Charts & Plotting Instruments
Back-up
Vinyl Cleaner
Emergency Food & Water
Hydrogen Peroxide (AC Pans)
EPIRB

Spare Parts:

Fuel Filters-Engines & Generator
Poly V- Belt (See Engine Manual)
Coolant For Engine Freshwater System
Extra Light Bulbs
Seawater Filter
Fuses
Propeller Set (See Dealer)
Propeller Hardware
Flashlight Batteries
Engine Spare Parts
Generator Spare Parts
Air Filters-Engine & Generator
Oil Filters-Engine, Generator
Drive Oil Filters

Life Raft
Bailer or Hand Pump
Rust Stain Remover (Star Brite)
Extra Hand Held Fire Extinguishers
Corrosion Block
Personal Floation Devices
Bilge Cleaner
Clean Rags, Diapers
(For Under Engine-Oil Leaks)
Nylon Windbreaker Suit
Sunscreen (SPF 30+)
Shop Vacuum (1 Gal. Cap. Wet-Dry)
Bucket/Pans w/Lids-Draining/Storing
Used Fluids
Squeegee
Mirror (For Inspection & Emergency Signaling)
Binoculars

Owner's Registration & Systems

Please note that your boat requires the proper registration by your authorized Regal dealer. To initiate the vessel warranty your dealer must complete the owner's registration form and systems checklist at the time of delivery. The owner must sign the paperwork to acknowledge that the dealer has reviewed the boat systems and warranty provisions with the owner. The owner should keep the original paperwork that features a temporary warranty registration. A warranty certificate will be sent approximately 6 weeks after receipt of the paperwork at Regal World Headquarters.

Dealer's Responsibility

Your vessel has undergone rigid quality assurance inspections before leaving the factory. In addition, your dealer has been trained to perform final pre-delivery checks and to service your Regal boat.

Your dealer's responsibilities include:

1. An orientation in the operation of your Regal boat including matters relating to the safe operation of the vessel.
2. Completion and mailing of your boat registration warranty form to Regal.
3. Location of vendor warranties, registration materials, owner's manual, operation, installation and maintenance instructions for auxiliary equipment supplied with or installed on your Regal boat.

Owner's Responsibility

You are entitled to all the benefits and services outlined in your Regal warranty. However, you have certain responsibilities to ensure warranty satisfaction. These are:

To read the warranty materials and understand them fully.

To examine the vessel in detail at the time of delivery.

To apply the following: boating rules and regulations, safety equipment, environmental regulations, accident reports and warranty regulations terms and conditions.

To read thoroughly all literature supplied with your boat including this owner's manual and to follow the recommendations in the literature.

To provide proper maintenance and periodic servicing of your boat and equipment as set forth in the various manuals supplied.

Customer Service

Take the time to write down your Regal dealer's phone number and E-mail address for future reference. Along with your Regal dealer information is a listing below of other phone numbers and web addresses which may prove useful.

Regal Marine Customer Service:
1-800-US REGAL (1-800-877-3425)
regal@regalboats.com
customer.service@regalboats.com

Vessel Information Sheet

Owner: _____

Address: _____

City & State: _____

Home Phone: _____ Business Phone: _____

In Case Of Emergency Notify: _____

Address _____

City & State _____

Phone _____

Insurance Agent's Name: _____

Policy#: _____

USCG Phone: _____ Local Po-

lice: _____

Marina Phone: _____ Slip (Dock#): _____

Hull Serial #: RGM _ _ _ _ _

Key #: _____ Engine: _____

Selling Dealer: _____

Address: _____

City & State: _____

Phone: _____ Fax: _____

Servicing Dealer: _____

Address: _____

City & State: _____

Phone: _____ Fax: _____

REGAL MARINE INDUSTRIES, INC. LIMITED WARRANTY

Welcome to the Worldwide Family of Regal Owners! We are very pleased that you have chosen a Regal Powerboat!

This document is your Limited Warranty Registration Certificate and Statement of Limited Warranty. Please check the registration information section for accuracy. If this information is not correct or if you change your address at some future date, please notify us at the following address: Regal Marine Industries, Inc. Attention: Warranty Registrations, 2300 Jetport Drive, Orlando, Florida 32809; or e-mail customerservice@regalboats.com.

Please read the warranty carefully. It contains important information on Regal's claims procedures and your rights and obligations under this warranty.

WHAT IS COVERED: This Limited Warranty applies only to Regal boats beginning with model year 2017.

LIFETIME LIMITED STRUCTURAL DECK & HULL WARRANTY: Regal Marine Industries, Inc. warrants to the original retail purchaser of this boat if purchased from an authorized Regal dealer that the selling dealer or Regal will repair or replace the factory installed fiberglass if it is found to be structurally defective in material or workmanship for as long as the original retail purchaser owns the boat. For purposes of this Limited Warranty, the hull is defined as the single fiberglass casting which rests on the water. This Limited Warranty is subject to all limitations and conditions explained below.

FIVE-YEAR TRANSFERABLE LIMITED STRUCTURAL HULL WARRANTY: In addition to the Lifetime Limited Structural Hull Warranty, Regal offers a Transferable Five-Year Limited Structural Hull Warranty. Under the Five-Year Transferable Limited Structural Hull Warranty, Regal will repair or replace the fiberglass hull or deck if it is found to be structurally defective in material or workmanship within the first (5) years after the date of delivery to the original retail purchaser. Any remaining term of this Five-Year Limited Hull Warranty may be transferred to a second owner if within 60 days of purchase, the new owner registers the transfer with Regal and pays the established Limited Warranty transfer fee. Contact Regal Customer Service at the above address for details.

FIVE-YEAR LIMITED HULL BLISTER WARRANTY: Regal warrants that the Regal selling dealer or Regal will repair any underwater gelcoated surfaces of the hull against laminate blisters which occur as a result of defects in material or workmanship within (5) years of the date of delivery, provided that the original factory gelcoat surface has not been altered. Alternation would include but is not limited to damage repair; excessive sanding, scraping, sandblasting; or from improper surface preparation for application of a marine barrier coating or bottom paint, any of which shall void this Five-Year Limited Hull Blister Warranty. Proper preparation must be applied to the hull bottom if the boat is to be moored for periods in excess of (60) days. Regal Marine shall repair or cause to be repaired any covered laminate blisters based on the following prorated schedule. Less than three (3) years from delivery date - 100%, Three (3) to (4) years from delivery date - 50%, Four (4) to (5) years from delivery date - 25%.

Reimbursement shall be limited to one repair, not to exceed (\$100.00) dollars per foot of boat length prior to prorating. Regal's prior authorization for the method and cost of repair, must be obtained before repairs are commenced. All costs to transport the boat for repairs are the responsibility of the owner.

LIMITED GENERAL WARRANTY: In addition to above hull warranties, Regal warrants to the original purchaser of this boat if purchased from an authorized Regal dealer, that the authorized Regal dealer or Regal will repair or replace any parts found to be defective in materials or workmanship for a period of one (1) year from the date of delivery, subject to all exceptions, limitations and conditions contained herein.

LIMITED EXTERIOR FINISH WARRANTY: Regal warrants that the authorized Regal selling dealer or Regal will repair cosmetic defects in the exterior gelcoated finish including cracks, air voids or crazing for one year from the date of delivery, subject to all limitations and conditions contained herein. All warranty work is to be performed at a Regal dealership or other location authorized by a Regal Customer Service Manager after it is established to Regal's satisfaction that there is a defect in material or workmanship.

CUSTOMER OBLIGATIONS: The following are conditions precedent to the availability of any benefits under these limited warranties:

(a) The purchaser, who is not Regal's sales agent and is otherwise not in any general or sales agency relationship with Regal, must sign and the authorized Regal selling dealer, must submit to Regal the "NEW BOAT DELIVERY and ACCEPTANCE CHECKLIST" within fifteen (15) days of the date of delivery and such information must be on file at Regal.

(b) The purchaser must first notify the authorized Regal selling dealer from whom the boat was purchased of any claim under this Limited Warranty within the applicable Limited Warranty period and within a reasonable period of time (not to exceed thirty (30) days) after the defect is or should have been discovered.

(c) Regal will not be responsible to repair any condition or replace any part, (1) if the use of the boat is continued after the defect is or should have been discovered; and (2) if such continued use causes other or additional damage to the boat or component parts of the boat.

(d) Based on the authorized Regal selling dealer's knowledge of Regal's Limited Warranty policy and/or consultations with Regal, the dealer will accept the claim and arrange for appropriate repairs to be performed, or deny the claim if it is not within the Limited Warranty policy.

(e) The authorized Regal selling dealer will contact the Regal boat owner regarding instructions for delivery of boat or part for covered warranty repair if it is covered by the Limited Warranty.

ALL COSTS TO OR FROM THE BOAT AND/OR TRANSPORT OF THE BOAT FOR REPAIRS ARE THE RESPONSIBILITY OF THE OWNER.

(f) If the Regal boat owner believes a claim has been denied in error or the authorized Regal selling dealer has performed the warranty work in an unsatisfactory manner, the owner must notify Regal's Customer Service Department in writing at the address listed for further consideration. Regal will then review the claim and take appropriate follow-up action.

(g) Before bringing any action, claim, lawsuit, or otherwise seeking relief against Regal based on any alleged breach of any of the Limited Warranties, terms or conditions herein, the Regal Boat owner must contact Regal's Customer Service Department Directly allow Regal, beyond those efforts made by its authorized Regal dealer, notice an opportunity to cure any alleged breach of any of the terms of any of the Limited Warranties.

WARRANTY EXCEPTIONS: THIS LIMITED WARRANTY does not cover, the following are not warranted are excluded from the terms of the Regal Limited Warranty and the following terms apply to any Regal Limited Warranty.

- (a) Engines, drives, controls, propellers, batteries, metal plating or finishes, windshield breakage, leakage, fading and deterioration of paints, canvas, vinyl, upholstery and fabrics;
- (b) Gelcoat surfaces including, but not limited to discoloration or blistering except as noted above;
- (c) Accessories and items which were not part of the boat when shipped from the Regal factory, or which carry their own individual warranty and/or any damage caused by such accessories or items;
- (d) Damage caused by one or more of the following: misuse, accident, corrosion, galvanic corrosion, negligence, lack of proper maintenance, or improper towing;
- (e) Any boat used for racing, or used for rental or commercial purposes;
- (f) Any boat operated contrary to any instructions furnished by Regal, including instructions and guidance provided in the Regal Owner's Manual, or operated in violation of any federal, state, Coast Guard or other governmental agency laws, rules, or regulations;
- (g) The limited warranty is void if alterations have been made to the boat;
- (h) Transportation of boat or parts to and/or from the REGAL factory or service location;
- (i) Travel time or haul outs, loss of time or inconvenience;
- (j) Any published or announced catalog performance characteristics of speed, fuel and oil consumption, and static or dynamic transportation in the water;
- (k) Any boat that has been re-powered beyond Regal's power recommendations;
- (l) Boats damaged by accident and boats damaged while being loaded onto, transported upon or unloaded from trailers, cradles, or other devices used to place boats in water, remove boats from water or store or transport boats on or over land;
- (m) Any item repaired, replaced or modified under the terms of this warranty does not in any way prolong, extend or change any terms set forth in this limited warranty;
- (n) Water damage to, dry rot to, condensation to, or absorption by interior surfaces, wood structures or polyurethane foam; interior wood including, but not limited to mold, bleeding and/or discoloration as a result of condensation or moisture or water continually contacting the plywood causing staining to upholstery, carpet or other interior surfaces;
- (o) Costs or charges derived from inconvenience or loss of use, commercial or monetary loss due to time loss, and any other special, incidental or consequential damage of any kind or nature whatsoever;
- (p) Regal reserves the right to improve the design or manufacture process of Regal boats without obligation to modify previously produced product;

NO WAIVER OF THESE TERMS: The terms, conditions, limitations and disclaimers contained herein cannot be waived except by the Customer Service Manager of Regal. Any such waiver must be in writing. Neither the dealer, nor the customer, nor any service, sales and/or warranty representative of Regal is authorized to waive and/or modify these conditions, limitations and/or disclaimers.

EXCEPT AS SET FORTH HEREIN OR ON ANY OTHER WRITTEN EXPRESS LIMITED WARRANTIES BY REGAL, THERE ARE NO OTHER WARRANTIES EITHER EXPRESSED OR IMPLIED PROVIDED BY REGAL ON THIS BOAT. ALL OTHER WARRANTIES, EXPRESS OR IMPLIED, INCLUDING IMPLIED WARRANTIES OF FITNESS AND MERCHANTABILITY, ARE EXPRESSLY EXCLUDED. REGAL FURTHER DISCLAIMS ANY LIABILITY FOR ECONOMIC LOSS ARISING FROM CLAIMS OF PRODUCT FAILURE, NEGLIGENCE, DEFECTIVE DESIGN, MANUFACTURING DEFECT, FAILURE TO WARN AND/OR INSTRUCT, LACK OF SEAWORTHINESS, AND ANY OTHER THEORY OF LIABILITY NOT EXPRESSLY COVERED UNDER THE TERMS OF THIS LIMITED WARRANTY.

AS SET FORTH ABOVE, REGAL MAKES NO IMPLIED WARRANTY OF MERCHANTABILITY AND EXPRESSLY EXCLUDES ANY SUCH WARRANTY. TO THE EXTENT SUCH EXCLUSION IS NOT ALLOWED BY LAW OR AN IMPLIED WARRANTY OF MERCHANTABILITY IS ALLOWED BY LAW: (1) ANY IMPLIED WARRANTY OF MERCHANTABILITY THAT IS, AS A MATTER OF LAW, NOT PERMITTED TO BE EXCLUDED AS SET FORTH ABOVE, IS LIMITED TO ONE

YEAR FROM THE DATE OF DELIVERY TO THE FIRST RETAIL OWNER; (2) NEITHER REGAL NOR ANY SELLING DEALER SHALL HAVE ANY RESPONSIBILITY FOR LOSS OR USE OF THE BOAT, LOSS OF TIME, INCONVENIENCE, COMMERCIAL LOSS, INCIDENTAL OR CONSEQUENTIAL DAMAGES. SOME STATES MAY NOT ALLOW EXCLUSIONS OF IMPLIED WARRANTIES OR LIMITATIONS ON HOW LONG ANY IMPLIED WARRANTY LASTS, SO THE ABOVE LIMITATION MAY NOT BE APPLICABLE. SOME STATES MAY NOT ALLOW THE EXCLUSION OR LIMITATION OF INCIDENTAL OR CONSEQUENTIAL DAMAGES, SO THE ABOVE LIMITATIONS OR EXCLUSIONS MAY NOT BE APPLICABLE IN THOSE STATES. THIS WARRANTY GIVES THE OWNER SPECIFIC LEGAL RIGHTS, AND THE OWNER MAY ALSO HAVE OTHER RIGHTS WHICH VARY FROM STATE TO STATE.

THE TERMS AND CONDITIONS CONTAINED HEREIN, AS WELL AS THOSE OF ANY DOCUMENTS PREPARED IN CONJUNCTION WITH THE SALE OF THIS VESSEL MAY NOT BE MODIFIED, ALTERED OR WAIVED BY ANY ACTION, INACTION OR REPRESENTATIONS, WHETHER ORAL OR IN WRITING, EXCEPT UPON THE EXPRESSED, WRITTEN AUTHORITY OF A MANAGEMENT LEVEL EMPLOYEE OF REGAL. Some states do not allow limitations on how long an implied warranty lasts, so the above limitation may not apply to you. Regal's obligation with respect to this warranty is limited to making repairs to or replacing the defective parts and no claim for breach of warranty shall be cause for cancellation or rescission of the contract or sale for any boat manufacturer by REGAL MARINE INDUSTRIES, INC.

Regal will discharge its obligations under this warranty as rapidly as possible, but cannot guarantee any specific completion date due to the different nature of claims which may be made and services which may be required. Regal reserves the right to change or improve the design of its boats without obligation to modify any boat previously manufactured. This limited warranty gives you specific legal rights, and you may also have other rights which may vary from state to state. Regal shall in no way be responsible for any repairs not PRE-AUTHORIZED by a Regal Customer Service Manager or repairs performed by a repair shop not PRE-AUTHORIZED by a Regal Customer Service Manager.

ARBITRATION OF DISPUTES AND WAIVER OF JURY TRIAL

EXCEPT AS SPECIFICALLY EXCLUDED IN THIS LIMITED WARRANTY, PURCHASER, REGAL AND AUTHORIZED REGAL DEALER AGREE TO SUBMIT ANY AND ALL CONTROVERSIES, CLAIMS OR DISPUTES ARISING OUT OF OR RELATING TO THE BOAT AND THIS LIMITED WARRANTY AND ALL OTHER AGREEMENTS EXECUTED BY PURCHASER RELATED TO THE BOAT TO BINDING ARBITRATION. IT IS THE EXPRESS INTENT OF PURCHASER, REGAL AND DEALER THAT THIS ARBITRATION PROVISION APPLIES TO ALL DISPUTES, INCLUDING CONTRACT DISPUTES, TORT CLAIMS, FRAUD CLAIMS AND FRAUD-IN-THE INDUCEMENT CLAIMS, STATUTORY CLAIMS AND REGULATORY CLAIMS RELATING IN ANY MANNER TO THE BOAT AND THIS LIMITED WARRANTY.

IF ANY CONTROVERSY OR CLAIM DESCRIBED IN THIS ARBITRATION PROVISION IS DETERMINED FOR ANY REASON TO BE INELIGIBLE FOR ARBITRATION, AND FOR ANY CONTROVERSIES, CLAIMS, OR DISPUTES SPECIFICALLY EXEMPTED FROM ARBITRATION, THEN THOSE CONTROVERSIES, CLAIMS, OR DISPUTES SHALL INSTEAD BE DECIDED BY A JUDGE OF A COURT OF COMPETENT JURISDICTION, IN ORANGE COUNTY, FLORIDA, WITHOUT A JURY. PURCHASER, REGAL AND DEALER KNOWINGLY AND VOLUNTARILY WAIVE THE RIGHT TO A TRIAL BY JURY FOR ALL SUCH CONTROVERSIES, CLAIMS AND DISPUTES. PURCHASER, REGAL, AND DEALER UNDERSTAND THAT THERE SHALL BE NO JURY TRIAL, WHETHER THE CONTROVERSY OR CLAIM IS DECIDED BY ARBITRATION OR BY TRIAL BEFORE A JUDGE. NOTWITHSTANDING THE PROVISIONS OF THIS ARBITRATION AGREEMENT, WITH REGARD TO CONTROVERSIES AND/OR ENTITLEMENT TO POSSESSION OF EITHER THE BOAT OR ANY TRADE-IN, ANY PARTY HERETO MAY RESORT TO A JUDICIAL DETERMINATION (BY A JUDGE AND NOT A JURY). OF SUCH CONTROVERSIES, DISPUTES OR CLAIMS WITHOUT WAIVING ANY RIGHT TO DEMAND ARBITRATION WITH RESPECT TO ALL OTHER CONTROVERSIES, DISPUTES OR CLAIMS BETWEEN THE PARTIES A MORE SPECIFICALLY SET FORTH IN THIS ARBITRATION PROVISION.

ALL ARBITRATIONS SHALL PROCEED THROUGH THE AMERICAN ARBITRATION ASSOCIATION AND BE SUBJECT TO ITS COMMERCIAL ARBITRATION RULES, EXCEPT AS SET FORTH HEREIN. THE ARBITRATORS SHALL HAVE THE AUTHORITY TO AWARD ANY FORM OF RELIEF THAT COULD BE PROPERLY AWARDED IN A CIVIL ACTION IN THE STATE OF FLORIDA FOR THE TYPE OF CLAIMS PRESENTED, SUBJECT HOWEVER, TO ALL LIMITATIONS, PREDICATES, AND CONDITIONS COVERING SUCH REMEDIES OR RELIEF UNDER FLORIDA LAW.

THE PURCHASER, REGAL OR DEALER MAY DEMAND ARBITRATION OF A CLAIM BY FILING A WRITTEN DEMAND FOR ARBITRATION, ALONG WITH A STATEMENT OF THE MATTER IN CONTROVERSY WITH THE AMERICAN ARBITRATION ASSOCIATION, AND SIMULTANEOUSLY SERVING A COPY UPON THE OTHER PARTY. PURCHASER, REGAL AND DEALER AGREE THAT THE ARBITRATION PROCEEDING SHALL BE CONDUCTED IN ORANGE COUNTY, FLORIDA UNLESS OTHERWISE AGREED BY THE PARTIES. EACH PARTY AGREES TO BEAR THEIR OWN ATTORNEY FEES AND COSTS. THE FILING FEES AND ALL OTHER THIRD-PARTY COSTS FOR THE ARBITRATION, INCLUDING THE ARBITRATOR'S FEE SHALL BE PAID BY THE FILING PARTY INITIATING THE ARBITRATION. THE PREVAILING PARTY SHALL BE ENTITLED TO REIMBURSEMENT OF THEIR REASONABLE ATTORNEY FEES AND REASONABLE EXPENSES FROM THE NON-PREVAILING PARTY.

REGISTRATION INFORMATION:

Chapter 2

Safety On Board

Safety awareness can not be over emphasized. Safety on board needs to be the skippers number one priority. In this manual you will find many safety precautions and symbols to identify safety related items. Heed all safety precaution information. Remember, the skipper is responsible for the safety of his passengers and crew.

Safety Labels

Safety Precaution Definition:

Safety precautions are stated as caution, warning and danger signal words. They are highlighted in this manual by font design and symbol usage. Also, a notice heading is included which provides operation and maintenance information but is not hazard-related. An information label provides tips on a variety of topics. Become familiar and understand all safety precaution labels!

NOTICE

General or specific information which is important to correct operation or maintenance, but is not hazard related.

CAUTION

Indicates a potentially hazardous situation or unsafe practice that, if not avoided, may result in injury, property or product damage.



WARNING

Potentially hazardous situation that, if not avoided, could result in death or serious injury.



DANGER

Immediate hazardous situation that if not avoided, will result in death or serious injury.



WARNING

AVOID SERIOUS INJURY OR DEATH
FROM OVERLOADING VESSEL!
MAXIMUM RECOMMENDED LOAD INCLUDES
WEIGHT OF ALL PERSONS, PROVISIONS,
AND PERSONAL EFFECTS, ANY EQUIPMENT
AND CONSUMABLE LIQUIDS.

Precautionary Labels

Read and understand all safety labels affixed to your Regal boat or found in this manual and the vendor literature. Many of the safety labels are posted close to the helm, aft cockpit, cabin and swim platform. The location of the labels may vary. Review the helm safety labels with passengers before disembarking. Use common sense to analyze the result of an action on board your vessel. Always think safety first!

NOTICE

DO NOT REMOVE OR COVER ANY PRECAUTIONARY LABELS. KEEP HARSH CHEMICALS AWAY FROM LABELS. IF A LABEL BECOMES ILLEGIBLE, CONTACT YOUR REGAL DEALER FOR ORDERING REPLACEMENTS.

General Boating Safety

We understand that you are eager to go boating. However, we strongly suggest that you thoroughly familiarize yourself and friends or members of your family with safe boating practices before setting out. Remember, that along with the freedom and exhilaration of boating comes the responsibility that you have for the safety of your passengers and other boaters who share the water with you.

Boating regulations vary from state to state. Check with your local and state authorities for the regulations pertaining to your area.

Check with local FM weather stations, U. S. Coast Guard, or on-line for the latest weather conditions.

Remember getting caught in severe weather is hazardous. Check weather conditions periodically while you are boating. If you are forced to operate your boat in a storm condition, take common sense precautions; wear PFD's, store gear, reduce speed and if possible head for safe refuge.

It is best to avoid operating your boat in foggy weather. When fog sets in, take bearings, log courses and speeds. You are required to emit a five second blast from your horn or whistle once every minute. Also, have your passengers wear PFD's and observe for oncoming vessels.

Operation in shallow water presents a number of hazards including sand bars and water levels influenced by tides. If the vessel strikes an underwater hazard, check for boat and engine damage. If the engine vibrates excessively after striking an underwater obstruction, it may indicate a damaged propeller. If you run aground, seek help by radio or flares.

Make sure your boat and equipment are in top condition. Do this by frequently inspecting the hull, engine and propulsion components.

You must provide a Coast Guard approved personal flotation device (PFD) for every person on board. These PFD's should be in good condition and easily accessible.

Insist that non-swimmers and children on board wear a PFD at all times. If you encounter rough weather conditions, make sure everyone on board is wearing a PFD, including yourself.

Instruct your passengers in how to put on their PFDs and be sure they know their storage location on the boat. Remember, in an emergency, a PFD that cannot be quickly located and worn is useless.

Never allow anyone to sit anywhere on the boat not specifically designed as seating. **While underway, ALWAYS insist passengers occupy a recognized seat position. See technical chapter.**



Never drink and drive! As captain, you are responsible for the safety of your passengers. Alcohol and boating can be a dangerous

combination. **DO NOT** mix them. Alcohol impairs the boat operators ability to make conscious decisions and react to emergency situations quickly.

Never overload your boat! An overloaded boat, or one with uneven weight distribution can be difficult to steer. **Never let people stand in bow area while underway as vision will be obstructed!!!**

 **CAUTION**

READ AND UNDERSTAND THE SEATING ARRANGEMENT DRAWING IN THE TECHNICAL CHAPTER. THIS DRAWING DISPLAYS THE DESIGNATED SEATING ARRANGEMENT FOR A BALANCED LOAD AND VESSEL MAXIMUM PERSONS CAPACITY.

Use maximum caution when fueling. Never allow any smoke or flame nearby while you are fueling. **ALWAYS** check for fuel leaks and fumes when fu-

eling is completed. Be certain there is enough fuel aboard for your cruising needs. Include any reserve that might be needed should you change your plans due to weather or an emergency. Practice the “one-third rule: Use one-third of your fuel going out, one-third to return and retain one-third as a reserve.

Always check the weather before departure. Be particularly cautious of forecasted electrical storms and high winds.

Always have up-to-date charts aboard as a back-up to your plotter and auto pilot option. Charts can be obtained at your closet marina, on-line store or by contacting one of three federal government agencies.

Always file a float plan. Leave details of your trip with someone responsible who will be remaining on shore. Include expected return, plus name and phone number of a contact person in case of emergency.

Use care, courtesy and common sense when launching, docking or operating your boat.

Learn and obey the “Rules of the Road”. A weather resistant placard copy of the “Rules of the Road” is included in the on board Regal information packet. Additional information can be obtained from the U.S. Coast Guard Auxiliary or your local Power Squadron organization.

In case of emergency know the international distress signals for your VHF radio. The spoken word “MAYDAY” is the international signal of distress and is for emergency use only. Under no circumstances should this word be used, unless there is danger at hand.

General Boating Safety - Continued

Operation in shallow water presents a number of hazards including sand bars and water levels influenced by tides. If the vessel strikes an underwater hazard, check for boat and engine damage. If the engine vibrates excessively after striking an underwater obstruction, it may indicate a damaged propeller. If you run aground, seek help by radio or flares.

Make sure your boat and equipment are in top condition. Do this by frequently inspecting the hull, engine and propulsion components.

You must provide a Coast Guard approved personal flotation device (PFD) for every person on board. These PFD's should be in good condition and easily accessible.

Insist that non-swimmers and children on board wear a PFD at all times. If you encounter rough weather conditions, make sure everyone on board is wearing a PFD, including yourself. Instruct your passengers in how to put on their PFDs and be sure they know their storage location on the boat. Remember, in an emergency, a PFD that cannot be quickly located and worn is useless.

Never allow anyone to sit anywhere on the boat not specifically designed as seating. While underway, **ALWAYS** insist passengers sit in a seat and set an example by doing this yourself.

Never drink and drive! As captain, you are responsible for the safety of your passengers. Alcohol and boating can be a dangerous combination. **DO NOT** mix them. Alcohol impairs the boat operators ability to make conscious decisions and react to emergency situations quickly.

Never overload your boat! An overloaded boat, or one with uneven weight distribution can be difficult to steer.

Insist that passengers sit in seats while the vessel is making headway!! No one shall be standing in the bow area while underway as visibility will be obstructed!!!

Posted speed limits, swimming areas, "no wake" zones and other restrictions should be red-flagged. They are so noted for a reason. Sensible boat use, plus courtesy, equals enjoyable and safe boating.

It is your responsibility to stay abreast of all federal, state and local rules, as some laws or regulations may change or be different from state to state. Contact your local boating agencies for updated information.

We can not stress safety enough! Remember, there are no brakes on your boat, and the water current and wind velocity both affect your ability to respond.

Required Safety Equipment

Personal Flotation Devices:

All personal flotation devices (PFD's) must be Coast Guard approved, in good working condition, and must be the correct size for the wearer. All PFD's must be readily accessible. This means being able to wear them in a reasonable amount of time in case of an emergency (fire, boat sinking, etc.). They should not be stored or locked in closed areas. Also, make sure that all coverings are removed such as plastic from any PFD's. Throw-able devices such as a ring buoy need to be available for immediate deployment. A PFD should be worn at all times when your boat is operating on the water. A PFD may save your life, but it must be worn to do so.

As a minimum U. S. Coast Guard requirement all recreational boats must carry one type I, II, III, or V PFD (wearable) for each person aboard. See the explanation following for each type. For type V to be counted they must be used according to the label instructions. In addition, all boats over 16' must carry one Type IV (throw-able) PFD.

Some states require that PFD's be worn by children of specific ages at all times. Check with local and state boating agencies for particular requirements in your state before taking children on the water. Child life jackets are classified by the child's weight and should like all life jackets be sized before being purchased.

Remember PFD's will not necessarily keep you from drowning, even though they are designed to keep a person from sinking. When purchasing PFD's make sure it safely fits the person wearing it. It is a good idea to test PFD's in a life guarded

shallow pool before venturing on the water.

Refer to the USCG minimum equipment requirements at the end of this chapter. It is meant to be a guide only. Contact state and local agencies for additional equipment requirements. Remember as the captain of your vessel you are responsible for its safe operation.



Type I:

Also known as an off-shore jacket, it provides the most buoyancy. It is a PFD for all waters and is especially useful in rough waters where rescue may encompass additional time. It is designed to turn most unconscious users in the water to a true face-up position. Type I PFD is available in adult & child sizes Buoyancy minimum poundages are 15.5 adult, 11 medium child, and 7 for small child and infants.

Type II:

Also known as near-shore buoyant vest, it is recommended for calm, inland water where rescue time will be minimal. It will turn some unconscious people face-up in the water but not as numerous as Type I. They are available in adult, medium child, along with infant and small child sizes.

Type III:

Known as a flotation aid it is good for calm, inland water or where there is a chance for quick rescue. It is designed so wearers can place themselves in a face-up position in the water. The wearer may have to tilt their head back to avoid face-down positions. Type III offer the same buoyancy minimum poundages as the Type II. They are generally the most comfortable for continuous wear. Float coats, fishing vests, and vests featuring designs for various sport activities are examples of Type III.

Type IV:

Intended for calm, inland water with heavy vessel traffic, where help is constantly present. It is designed to be thrown into the water for someone to grab on to and held until rescued. It is not designed to be worn. Type IV includes ring buoys, buoyant cushions, and horseshoe buoys.

Type V:

Also known as a special use device this is the least bulky of all PFD's. It contains a small amount of inherent buoyancy, and an inflatable chamber. It is rated even to a Type I, II, or III PFD (as noted on the jacket label) when inflated. Some Type V devices provide significant hypothermia protection. Varieties include deck suits, work vests, board sailing vests and Hybrid PFD's. Remember that this Type V type PFD may be carried instead of another PFD only if used according to the approval condition on the label.

Note: A water skier or wake boarder is considered on board the vessel and a PFD is required for the purposes of compliance with the PFD carriage requirements. It is advisable and recommended for a skier or wake boarder to wear a PFD designed to withstand the impact of hitting the water at a high speed. "Impact Class" marking on the label refers to PFD strength, not personal protection. Some state laws require a skier or wake boarder to wear a PFD.

PFD's For Pets:

If you are a skipper who needs to have his pet dog or cat on board or dock side then a PFD is recommended. The PFD will aid you in finding the pet if it should fall overboard. The device must fit the pet properly. Also, it may take a bit of training before the pet is comfortable wearing the PFD. Normally, dogs are easier to train wearing a life vest than a cat. Marine type retail stores will fit a pet to a PFD by body weight.

Maintaining Your PFD's

A PFD is only useful if it is well maintained. Always be aware of PFD age since it has a life expectancy like any other piece of equipment.

- ✓ Check periodically for broken zippers, frayed webbing, water soaked kapok bags, missing straps, and sewing that has become undone.
- ✓ Clean each PFD with mild soap and water only. Again, let dry sufficiently before storing.
- ✓ Keep PFD's out of grease and oil since they can deteriorate the jacket inner and outer materials.
- ✓ Check any kapok-bagged jackets by squeezing. If you hear air escaping the bag is defective and the PFD should be thrown away.
- ✓ Grab the cover with the fingers. If the cover material rips, the PFD is rotted and should be thrown away.
- ✓ If the kapok bag is hard the PFD should be discarded.

Fire Extinguishers

General Information:

Fire extinguishers are classified by a letter and numeric symbol. The letter references the type of fire the unit is designed to extinguish.

For example, type B extinguishers commonly used on boats are designed to put out flammable liquids such as grease, oil and gasoline.

The number indicates the general size of the extinguisher (minimum extinguishing agent weight). Coast Guard Approved extinguishers are identified by the following marking on the label:

"Marine Type USCG Approved, Size..., Type..., 162.028/.../", etc.

MINIMUM PORTABLE FIRE EXTINGUISHERS REQUIRED		
VESSEL LENGTH	NO FIXED SYSTEM	WITH FIXED SYSTEM
LESS THAN 26'	1 B-I	0
26' TO LESS THAN 40'	2 B-I or 1 B-II	1 B-I
40' TO 65'	3 B-I or 1 B-I & 1 B-II	2 B-I or 1 B-II

FIRE EXTINGUISHER CONTENTS				
CLASS	FOAM IN GALS.	CO2 IN LBS.	DRY CHEM IN LBS.	HALON IN LBS.
B-I	1.25	4	2	2.5
B-II	2.5	15	10	10

U. S. Coast Guard approved fire extinguishers are required on all Regal boats. Besides the minimum Coast Guard requirements always check state and local agencies for additional requirements and equipment.

Coast Guard approved extinguishers are hand-portable, either B-I or B-II classification. U. S. Coast Guard approved hand-portable and semi-portable extinguishers contain a metal plate that shows the manufacturers name and extinguisher type, capacity and operating instructions. They have a special marine type mounting bracket which keeps the extinguisher secure until needed. The extinguisher needs to be mounted in a readily accessible location but one that will not be bumped by people while underway. All approved extinguishers shall have an indication gauge.

U.S.C.G Approved Fire Extinguisher Types & Features:



The dry chemical agent is widely used because of its convenience and low cost. The extinguisher canister is filled with a white dry chemical powder along with a pressurized gas. It is a good idea to shake this type periodically because they tend to “pack” on the canister bottom.



The foam type uses a chemical foaming agent plus water and is best when used for fires involving flammable liquids- solvents, gasoline, oil, grease and various paints. It will work on fires involving rubber, plastics, cloth, wood, and paper. It leaves a messy residue. Not for electrical fires.



The carbon dioxide unit uses CO₂ gas under high pressure, with a funnel discharge hose usually swivel mounted. This extinguisher leaves no residue

and does not cause interior engine harm. To ensure workability, weigh the unit annually. A 10% maximum weight variance is allowed.

Another type of liquefied gas used today is FE-241. This gas is colorless and odorless, heavier than air and sinks to the lower bilge to extinguish fires. Since the year 2000 ingredients have changed to a more environmental friendly formula (Chlorotetrafluoroethane or FE-241). FE-241 is used in portable-hand units along with making up the majority of boat automatic fire extinguishing systems. The canister needs to be weighed once a year. These clean agent units feature a dash mount indicator. Refer to the information regarding fire prevention in this manual.

Fire Blanket:

A fire blanket is a safety device designed as extinguish incipient (starting) fires. It features a sheet of fire retardant material which is placed over a fire to smother it. It is sometimes made of fiberglass or may be kevlar. Normally it is folded into a quick release device for ease of storage. They are available in various sizes. The non-flammable blankets are useful in fire temperatures up to 900 degrees and smother fires by removing oxygen from the fire. They usually are not used for fat and oil fires. Read the instructions accompanying the fire blanket as many feature two external pull down tails that protect the hands from fire while the blanket is placed over the fire area.

Pyrotechnic Devices:

Pyrotechnic visual distress signals must be Coast Guard approved, be ready for service and must be readily accessible. They all display a marking which is the service life, which must not have expired. A minimum of 3 devices are required for the day and 3 devices for night.

Some devices meet both day and night requirements. Pyrotechnic devices should be stored in a cool, dry location. Most of these devices can be purchased in an highly visible (orange) watertight container. Types of Coast Guard approved pyrotechnic distress signals and associated devices are:

- Pyrotechnic red flares, hand-held or aerial type.
- Pyrotechnic orange smoke, hand-held or floating type.
- Launchers for parachute flares or aerial red meteors.

All in all, each distress signal has certain advantages and disadvantages.

There is no distress signal that is best under all situations. Pyrotechnics are recognized worldwide as superior distress signals. A downfall is they emit a very hot flame that can cause burns and/or ignite flammable materials. Pistol launched and hand-held parachute flares operate consistent with firearms and therefore must be carefully handled. Check with local and state regulations since some of these device are considered firearms and are prohibited.

It is best to carry red aerial flares which are visible from a greater distance. Also, the red parachute flares burn for longer periods and therefore are more likely to be seen by another vessel.

Non-Pyrotechnic Devices:

Non-pyrotechnic devices must all be in serviceable condition, readily accessible, and must be certified by the manufacturer to comply with USCG standards. They include:

- Orange distress flag.
- Electric distress light.

The distress flag is for day use only. It must be 3 x 3 or larger with a black square and ball on an orange background. It can be spotted when attached to a boat hook, long fishing rod, or paddle with the person waving the flag back and forth overhead.

The electric distress light is for night use only flashing the international SOS distress signal (... _ _ _ ...).

Under Inland Navigation Rules, a high intensity white light that flashes at regular intervals from 50-70 times per minute is considered a distress signal.

Remember that regulations prohibit the display of visual distress signals on the water under any circumstances except when assistance is required to prevent immediate or potential danger to passengers on a vessel.

International Distress Signals



BLACK SQUARE
AND BALL ON
ORANGE BACKGROUND

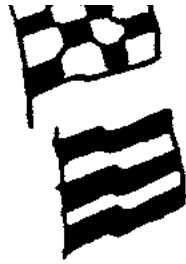

CODE FLAGS
NOVEMBER
& CHARLIE



SQUARE FLAG
& BALL



PERSON
WAVING
HANDS

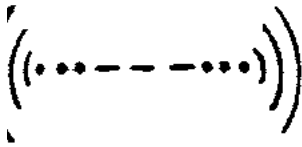

MORSE
CODE S.O.S.



"MAYDAY"
BY
RADIO

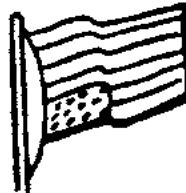

ENSIGN
UPSIDE
DOWN



PARACHUTE
RED FLARE



RED METEOR
FLARES



SMOKE



FOG HORN
SOUNDED
CONTINUOUSLY

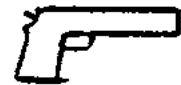

GUN FIRED AT
1- MINUTE
INTERVALS

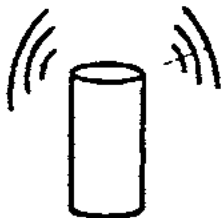

POSITION
INDICATING
RADIO BEACON



DYE MARKER
(ANY COLOR)



HAND-HELD
FLARE

Sound Producing Devices

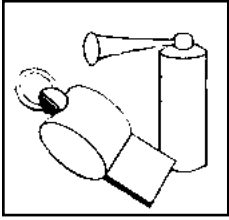

According to both Inland and International Rules, all boats must carry a way of producing an efficient sound signal. If your vessel is 12 meters (39'

4") or longer, a power whistle or power horn and bell must be carried. Bell mouth must be at least 7 7/8" diameter. The sound signal made in all cases must be capable of a four or six second blast audible for one half mile. See the section discussing bridge and whistle signals for more information.

Radio Communications:

VHF radios are used for distress and ship to shore and ship to ship communications today. Learn the specialized messages such as Mayday, Mayday, Mayday. It is only used when life or vessel is in imminent danger.



Many of the more recent VHF's feature DSC capability which offers the ability to

place and receive digital calls directly with vessels and shore stations including USA and Canadian Coast Guards. Channel 70 is reserved exclusively for DSC calls. Refer to the VHF owner's information since you need to establish a Mobile Maritime Safety Identity (MMSI) number before using the DSC feature. A MMSI number identifies each DSC radio, like a telephone number. The FCC requires a ship station license for all vessels equipped with a marine VHF radio.

Navigation Lights:

The U. S. Coast Guard requires recreational boats operating at night to display navigation lights between sunset and sunrise along with other periods of reduced visibility.

Navigation lights help avoid collisions by improving the night visibility of vessels. Red and green directional lights, white stern lights, white masthead lights and white all-around lights must be displayed in specified positions, depending on boat size, and mode of operation.

Marine Sanitation Devices:

Recreational vessels under 65' with installed toilet facilities must have an operable marine sanitation device (MSD) on board. Vessels 65' and under may use Type I, II, or III MSD's. All installed MSD's must be U.S. Coast Guard certified. The MSD's are labeled to show conformity to the regulations.

Navigation Rules:

The navigation rules establish actions to be taken by vessels to avoid collision. They are divided into Inland/International. Operators of vessels 39.4' or more shall have on board and maintain a copy of the Inland navigation rules.

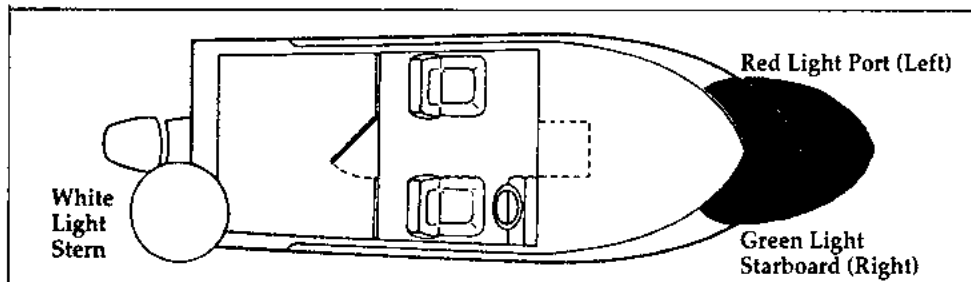

Location of lights on vessel	Visible Range		Degrees of arc lights
	Less than 12 m.	12 m. but less than 20 m.	
Masthead	2	3	225°
All-round	2	2	360°
Side lights	1	2	112.5° each color
Stern light	2	2	135°

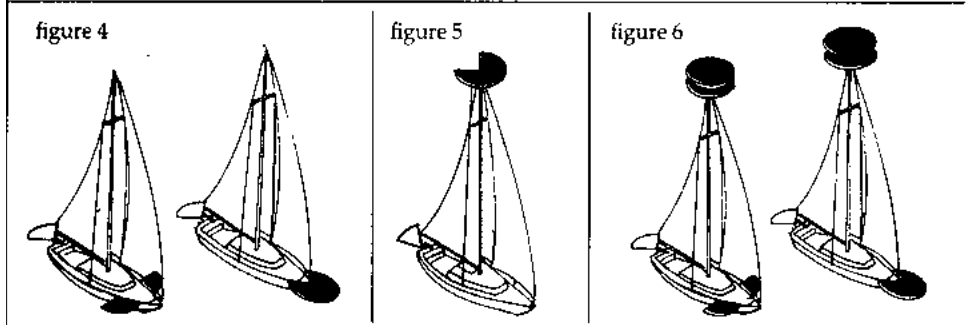
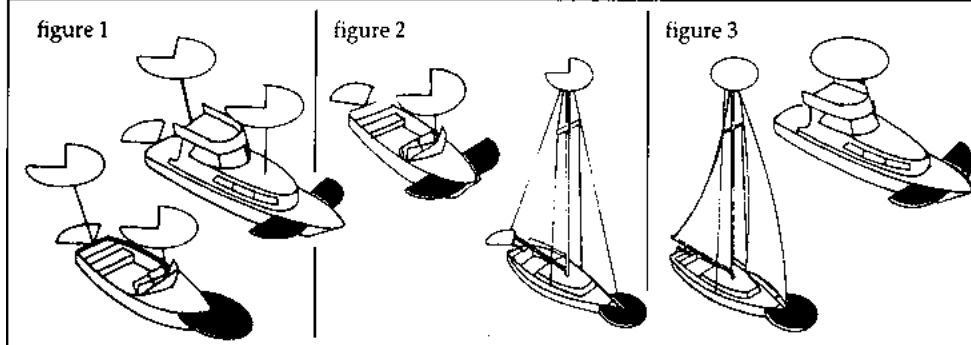

Boats less than 12 meters in length
Motorboats or sailboats using power: The lighting arrangements to figure 1, 2 or 3 may be used.
Sailboat using sails alone: The lighting arrangements in figure 4, 5 or 6 may be used.

Boats 12 meters but less than 20 meters in length
Motorboats or sailboats using power: The lighting arrangements to figure 1 or 2 may be used.
Sailboat using sails alone: The lighting arrangements in figure 4, 5 or 6 may be used.

Location of lights
 Lights should be located as shown in the drawings.
 The masthead light (forward white light in figures 1, 2 and 7d) must be at least one meter higher than the colored lights on a boat less than 12 meters in length and at least 2.5 meters above the gunwale on a boat 12 meters but less than 20 meters in length.

Exceptions
Motorboat or sailboat using power, built before December 24, 1980: The lighting arrangement in figure 1, 2 or 3 may be used. However, the arrangement in figure 3 is not acceptable on a boat that is 12 meters or longer on international waters.

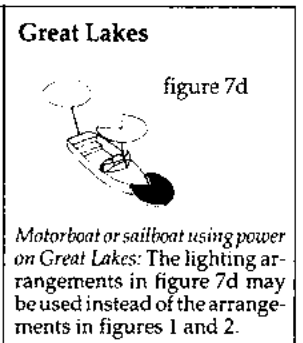
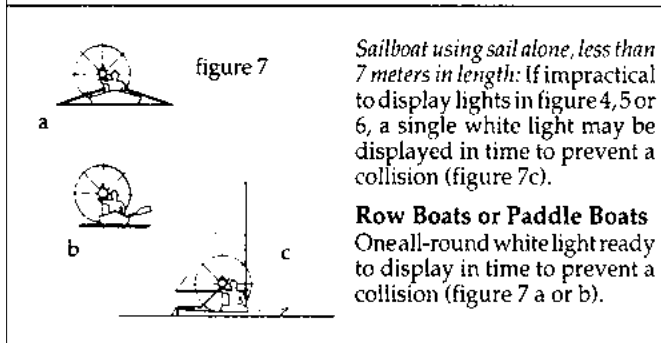

Sailboat using sail alone, less than 7 meters in length: If impractical to display lights in figure 4, 5 or 6, a single white light may be displayed in time to prevent a collision (figure 7c).

Row Boats or Paddle Boats
 One all-round white light ready to display in time to prevent a collision (figure 7 a or b).

Great Lakes

Motorboat or sailboat using power on Great Lakes: The lighting arrangements in figure 7d may be used instead of the arrangements in figures 1 and 2.

DISCHARGE OF OIL PROHIBITED

THE FEDERAL WATER POLLUTION CONTROL ACT PROHIBITS THE DISCHARGE OF OIL OR OILY WASTE INTO OR UPON THE NAVIGABLE WATERS OF THE UNITED STATES, OR THE WATERS OF THE CONTIGUOUS ZONE, OR WHICH MAY AFFECT NATURAL RESOURCES BELONGING TO, APPERTAINING TO, OR UNDER THE EXCLUSIVE MANAGEMENT AUTHORITY OF THE UNITED STATES, IF SUCH DISCHARGE CAUSES A FILM OR DISCOLORATION OF THE SURFACE OF THE WATER OR CAUSES A SLUDGE OR EMULSION BENEATH THE SURFACE OF THE WATER. VIOLATORS ARE SUBJECT TO SUBSTANTIAL CIVIL PENALTIES AND/OR CRIMINAL SANCTIONS INCLUDING FINES AND IMPRISONMENT.

Marpol Treaty:

The USCG now enforces the International Convention for the Prevention of Pollution from ships, referred to commonly as the MARPOL TREATY (marine pollution). This international treaty prohibits the overboard dumping of all oil, garbage, ship-generated plastic and chemicals. There is a placard on board your boat (typical example shown below) that explains the garbage and plastic dumping laws in detail.

Immediately notify the USCG if your vessel discharges oil or hazardous substances in the water. Call toll free 1-800-424-8802. Report the following information: location, source, size, color, substances and time observed.

No vessel may intentionally drain oil or oily waste from any source into the bilge of any vessel. A bucket or bailer is suitable as a portable means of discharging oily waste.

The placard noted above is normally located in the engine compartment or may be attached to the engine hatch.

Garbage Discharge

<p>THE DISCHARGE OF PLASTIC OR GARBAGE WITH PLASTIC INTO ANY WATERS IS PROHIBITED. THE DISCHARGE OF ALL GARBAGE IS PROHIBITED IN THE NAVIGABLE WATERS OF THE UNITED STATES AND IN ALL OTHER WATERS, WITHIN THREE NAUTICAL MILES OF THE NEAREST LAND.</p>		
<p>THE DISCHARGE OF DUNNAGE, LINING, AND PACKING MATERIALS THAT FLOAT IS PROHIBITED WITHIN 25 NAUTICAL MILES FROM THE NEAREST LAND.</p>	<p>OTHER UNGROUND GARBAGE MAY BE DISCHARGED BEYOND 12 NAUTICAL MILES FROM THE NEAREST LAND.</p>	<p>OTHER GARBAGE GREATER THAN ONE INCH MAY BE DISCHARGED BEYOND THREE NAUTICAL MILES FROM THE NEAREST LAND.</p>
<p>A PERSON WHO VIOLATES THE ABOVE REQUIREMENTS IS LIABLE FOR A CIVIL PENALTY OF UP TO \$25,000, A FINE OF UP TO \$50,000, AND IMPRISONMENT FOR UP TO FIVE YEARS FOR EACH VIOLATION, REGIONAL, STATE, AND LOCAL RESTRICTIONS ON GARBAGE DISCHARGES MAY ALSO APPLY.</p>		

The act to prevent pollution from ships places limitations on the discharge of garbage from vessels. It is illegal to dump plastic trash anywhere in the ocean or navigable waters of the United States. Also, it is illegal to discharge garbage in the navigable waters of the United States, including the Great Lakes. The discharge of other types of garbage is allowed outside certain specified distances from shore as determined by the nature of that garbage.

United States vessels of 26 feet or longer must display in a prominent location, a durable placard at least 4" x 9" notifying crew and passengers of discharge restrictions.

USA vessels of 26' or longer equipped with a galley and berthing must have a written Management Plan describing the plan for collecting, processing, storing and discharging garbage, and designate the person charged with carrying out the plan.

The placard noted below is usually found near a galley, inside the engine hatch area or close to a receptacle.

USCG MIN. EQUIPMENT REQUIREMENTS

Use the chart below as a guideline for assuring your vessel is outfitted to meet USCG standards. Remember to check with local and state authorities for additional equipment requirements. Make sure your vessel certificate of numbers are on the boat, updated and displayed properly according to state requirements. Keep the paperwork on board in a watertight and safe environment. On documented vessels keep both the original and current certificate on board stored in a safe, dry, and accessible location. Also, on documented vessels make sure the vessel name/hailing port are marked on the hull exterior with letters not less than 4" in height. In addition, the Official Number must be permanently affixed on a clearly visible interior structure part of the boat-block type Arabic numbers not less than 3" in height.

Life Rafts

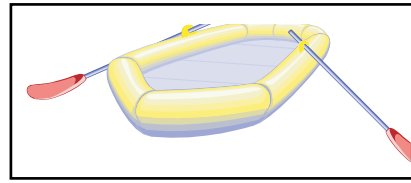

Inflatable life rafts are recommended for ocean going and vessels

operating in a large body of water like the Great Lakes. They provide a shelter for extended periods. If used, make sure it is large enough for all aboard and contains the proper emergency equipment pack. Also, periodically have the unit professionally serviced. Make sure the life raft is Coast Guard approved since it would require meeting a number of stringent material and performance standards.

USCG Minimum Equipment Requirements for Recreational Vessels					
Boat Size in Feet	16'	26'	40'	65'	165'
Personal Flotation Devices¹	One Type I, II, III, or V per person		One Type I, II, III, or V per person plus one Type IV throwable		
Fire Extinguishers²					One or more B-II (vessels 0-50 tons gross) Two or more B-II (vessels 50-100 tons gross)
No Fixed System	One B-I, any type		One B-II or Two B-I	One B-II and one B-I, or three B-I	
With Fixed System	No Portables Required		One B-I	Two B-I or one Class B-II	
Visual Distress Signals	Night signals required when operating at night		Minimum of three day-use and three night-use (or three day/night combination) pyrotechnic devices ⁵		
Sound Producing Devices	Horn or whistle recommended to signal intentions or signal position		One bell, and one whistle or horn required to signal intentions or position		
Backfire Flame Arrestor	One CG-approved device on each carburetor of all gasoline-powered engines built after April 1940, except outboard motors				
Ventilation	CG standard system required on gasoline powered vessels with enclosed engine compartments built after August 1980				
Navigation Lights					
Under Power ^{3,4}	Sidelights, Stern Light and Masthead ^{6,7}				
Under Sail	Sidelights and Stern Light ^{5,8}				
Rowing	Same as "Under Sail"				
At Anchor	All-round light, 2nm (at night) or black anchoring ball (during the day) when outside a designated anchorage				
Visibility Range	1nm Sidelights, 2nm all others		3nm Masthead, 2nm all others		5nm Masthead, 2nm all others
Pollution Regulations	"Honor system" (no plaques required)		5" x 8" Oil Discharge placard and 4" x 9" Waste Discharge placard Vessels over 40' with a galley must have a Waste Management Plan		
Marine Sanitation Devices	Vessels with installed toilet facilities must have an operable, CG-certified Type I, II or III Marine Sanitation Device (MSD). Subject to local laws!				Type II or III MSD only
Navigation Rules	Familiarity with the Inland Navigation Rules required			The Inland Navigation Rules ("Rules of the Road") must be kept on board	

<ol style="list-style-type: none"> 1. PFD's must be CG approved, wearable by the intended user and readily accessible. 2. Fire extinguishers required on boats with enclosed engine compartments (not outboards), enclosed living spaces or permanent fuel tanks. 3. Sailboats operating under engine power are considered power driven and must follow the "Under Power" rules. During the day, motorsailing vessels are required to fly a motoring cone. 4. Power-driven vessels under 25' and under 7 knots can substitute a white lantern or torch in place of the required lights. 	<ol style="list-style-type: none"> 5. Non-pyrotechnic substitutes: 1 orange distress flag (day-use) and 1 electric SOS signal light (night-use). 6. All boats under 65' can substitute a single bi-color light for sidelights. 7. Boats under power under 40' can substitute a single all-round light for separate stern and masthead lights. 8. Boats under sail under 40' can substitute a tri-color light for separate sidelights and stern light.
---	---

Additions to these requirements are prescribed by some individual state laws. Check your state's Boating Safety Handbook for a complete list.

Exhaust & Carbon Monoxide

Carbon monoxide (CO) in exhaust can be hazardous. especially from gasoline engines, gasoline generators, grills, stoves, space heaters and on a much smaller degree diesel engines.

CO is a natural by-product of the gasoline engine using an artificial spark . Diesels on the other hand detonate fuel using pressure and temperature. Looking at the two engines another way, gasoline engines use much more oxygen up in the combustion process which contributes to a much higher CO build-up. Although diesels do produce a small amount of CO the combustion process operates with much greater amounts of oxygen which the end result is a much lower CO level.

Ensure that you read the information and follow all the recommendations regarding CO.

Familiarize your crew, passengers and yourself with the sources, symptoms and possible effects of carbon monoxide poisoning. Remember that boats in the same general vicinity can cause your vessel to accumulate dangerous CO levels in the cabin and or in the cockpit.

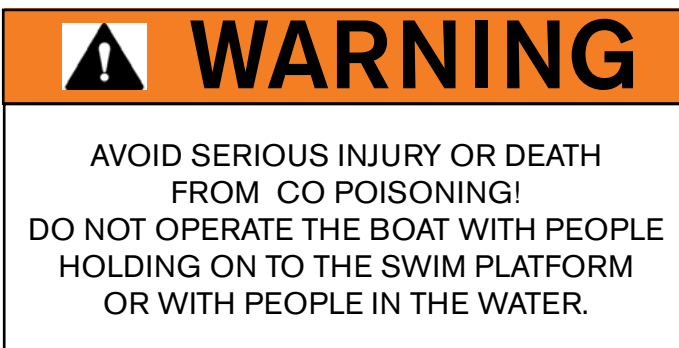

For safety sake avoid the following:

1. Do not park by other boats with their engine idling or generator cycling for an extended period of time.
2. Do not disable the carbon monoxide alarms that come with your Regal boat. Test the units in accordance with the alarm manufacturers instructions.
3. Do not operate an engine for extended periods of time while in a confined area or where exhaust outlets face a sea wall or bulkhead.
4. Do not operate the engine for an extended period of time with the canvas in the upright and installed position.
5. Do have the engine exhaust system inspected when the boat is in for service.
6. Persons sleeping can easily be overcome by carbon monoxide without realizing it. Do not sleep on board while an engine or generator is running close-by.
7. Do not operate your vessel for extended periods with the bow up in slow cruise conditions especially close behind a vessel being towed or one operating at slow speeds.
8. When underway open all hatches, windshield vents, and main cabin entry door to allow proper airflow from bow to stern.

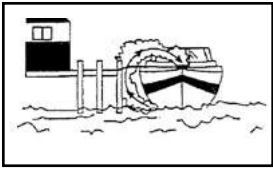

Blockage of exhaust outlets can cause carbon monoxide to accumulate in the cabin and cockpit area even when the hatches, windows, portholes and doors are open. Sea walls and other confined spaces can cause CO levels to be dangerously elevated.

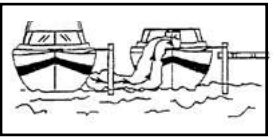

Exhaust from another vessel alongside your boat, while docked or anchored, can emit poisonous CO gas inside the cabin and cockpit areas.

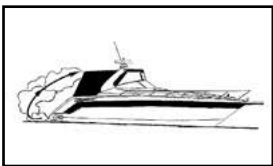

The “station wagon effect” or back drafting can cause CO gas to accumulate inside the cabin, cockpit/hardtop or bridge areas when the boat is underway, using protective weather coverings (canvas), high bow angle, improper or heavy loading, slow speeds, or at rest. This can occur when traveling behind another boat.

How does CO affect us?

In high concentrations, CO can be fatal in minutes. However, the effects of lower concentrations over a extended period of time can be just as lethal.

Our blood uses hemoglobin to carry the oxygen we breathe to different body parts. Unfortunately, hemoglobin carries CO more readily than it does oxygen. The result is when we breathe in CO it replaces oxygen in our blood and we begin to suffocate. Also, when we are removed from the CO source it remains in our blood for hours causing long term effects. People have been known to become sick and even lose consciousness hours after exposure.

Carbon monoxide accumulation requires immediate

attention! Thoroughly ventilate cabin and cockpit areas. Determine the probable source of the carbon monoxide and correct the condition immediately. Anyone with symptoms of CO poisoning should be placed in a fresh air environment and medical attention found immediately. Regal has installed CO detectors on your boat. Have these detectors professionally calibrated at regular intervals according to the equipment manufacturer’s recommendations.

A Few Notes About Diesel/CO Poisoning

The diesel engine under normal combustion produces much smaller amounts of CO. Therefore, it is far less likely to be fatal to a healthy person. Other factors including weather, temperature and engine condition can greatly affect the unsafe build-up of CO.

Be aware that engine and generator diesel exhaust can exist from someone being in a close mooring to your vessel and running the generator all night. Diesel exhaust in the combustion process produces various components and the captain must be aware that the build-up of these select components over a period of time can cause CO or seasickness like symptoms.

These include carbon dioxide, carbon monoxide (CO), nitrogen dioxide, nitric oxide, sulfur dioxide and others.

A healthy person breathing in sulfur dioxide over a period of time through a diesel engine or generator exhaust can develop nausea. This condition is not life threatening but the person may exhibit CO poisoning or seasickness symptoms. Just never rule out that it could be CO poisoning! Immediately find the source of the problem and move the individual to a fresh air environment!

Symptoms of excessive exposure to carbon monoxide (CO) are:

- Dizziness
- Drowsiness
- Nausea
- Headache
- Ringing in the ears
- Throbbing temples
- Watering, itchy eyes
- Flushed appearance
- Inattentiveness
- Incoherence
- Fatigue or vomiting
- Convulsions

DANGER

CARBON MONOXIDE IS A TASTELESS, ODORLESS AND INVISIBLE GAS THAT CAN CAUSE DISCOMFORT, SEVERE ILLNESS, AND EVEN DEATH. EXERCISE CAUTION WHILE OPERATING GENERATOR OR ENGINES IN CONFINED SPACES OR AT DOCK SIDE. DO NOT ALLOW HULL EXHAUST OUTLETS TO BECOME BLOCKED OR EXHAUST FUMES CAN BECOME TRAPPED IN AND AROUND THE CONFINES OF YOUR BOAT. DURING IDLE AND SLOW CRUISE CONDITIONS, BILGE BLOWERS SHOULD BE USED.

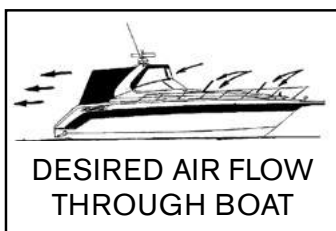

To help prevent carbon monoxide (CO) accumulation, ventilate your cabin and cockpit while

underway. Open a forward hatch, porthole or window to allow air to travel through the boat's interior and cockpit. See the illustration for desired airflow.

NOTE: Never occupy moored boat with engines running and/or canvas completely covering vessel.



WARNING

INSPECT THE EXHAUST SYSTEM. IMMEDIATELY REPAIR OR REPLACE LEAKING, CRACKED AND CORRODED, OR MISSING EXHAUST COMPONENTS.

- Before each trip inspect engine and all systems.
- Make sure all exhaust hose clamps are in place.
- Look for exhaust leaking from the exhaust system components, indicated by rust and or black streaking, water leaks, or corroded or cracked fittings.
- Inspect all rubber exhaust hoses for burned or cracked areas. All rubber hoses should feel soft and and be free of kinks.
- Do not obstruct or modify the ventilation system.
- Keep an ear tuned for changes in exhaust sound that may be an exhaust component malfunction.

Do Not Operate the Vessel If **Any** of the above conditions exist. Contact a marine professional!

NOTICE

CARBON MONOXIDE PRECAUTIONARY LABELS ARE LOCATED AT THE HELM, TRANSOM AND CABIN. ENSURE THAT ALL ABOARD READ AND UNDERSTAND THE SIGNS AND EFFECTS OF CARBON MONOXIDE (CO).

Boating & Alcohol



Operating a vessel while intoxicated became a specific federal offense effective in 1988. The ruling set federal standards for determining when an individual is intoxicated. If the blood alcohol content (BAC) is .10% (.08 in some states) or higher for operators of recreational vessels being used only for pleasure are subject to a civil penalty up to \$1,000 or criminal penalty up to \$5,000, one year imprisonment or both. In some states the fines and imprisonment may increase significantly.

The effects of alcohol and drugs account for the highest single cause of marine accidents and deaths. Most deaths in boating accidents occur when someone falls into the water. Balance is one of the first things you lose when drinking alcohol or under the influence of drugs. The problem arises out of not knowing your balance is restricted.

Overall vision is reduced by alcohol especially at night, along with double or blurred vision. Peripheral vision is lessened which restricts seeing vessels or objects on the side. Also, color awareness decreases especially with red and green which happen to be the colors of boat navigation lights, buoys, and channel markers.

Alcohol will greatly increase your heat loss so it increases the effects of hypothermia. Finally, your ability to make correct judgements in emergency situations is greatly reduced. Alcohol takes away the brains ability to process information quickly and delays a persons reaction time.

Don't drink and drive!

Alcohol Myths & Facts:

Myth: Beer is less intoxicating than other alcoholic beverages.

Fact: One 12 oz. can of beer has about the same amount of alcohol as a 5oz. glass of wine or a shot of liquor.

Myth: Black coffee, fresh air, and a shower will sober the effects of alcohol.

Fact: After consuming alcohol time is the only thing that will sober you up. Our bodies average burning 1 oz. of alcohol every hour. If a person is drunk, it will take a person seven or more hours to sober up.

Myth: Telling if a person is too drunk to operate a vessel is easy.

Fact: Many experienced drinkers have learned to compensate for the visual effects of alcohol and can disguise their drunk condition.

Myth: You can judge if you are fit to operate a boat.
Fact: Judgement is one of the first elements you lose when drinking.

Boating Accidents

The following is a list of common causes of boating accidents. Be aware of them and take the necessary steps to ensure that yourself and crew are educated and prepared to act in an emergency.

1. Mixing boating and alcohol. Remember, the skipper is responsible for his crew, passengers and vessel.
2. Trying to reach the bow by the deck walk-around at unsafe speeds. Use the center walk-through.
3. Someone sitting on the bow, deck, or swim platform while underway.
4. Choosing a boating outing day with inclement weather, especially in high winds and thunderstorms in the forecast or staying out when bad weather is approaching.
5. Disembarking without checking all the fluids or systems, and especially fuel system components.
6. Not monitoring the boating traffic or possible obstructions around you.
7. Emergency communications equipment, signaling devices, and navigation lights not working.
8. Improper boat handling especially high speed turns in rough water. Using trim improperly.
9. Being too far from shore with inadequate fuel supply or navigational aids.

10. Passengers, especially children that are not wearing the proper life saving devices.

11. Skipper or passengers not seated in the boat.

Reporting Boating Accidents:

According to the Federal Boat Safety Act of 1971 involving collision, accident or other casualty, the operator must make a formal report within 48 hours to the nearest state boating authority when the incident involves:

1. Death
2. Injury requiring treatment other than first aid
3. The disappearance of someone from a boat under death or injury circumstances.

A formal report must be made within 10 days for accidents involving more than \$2000 damage or complete loss of vessel.

For information regarding accident reporting, please call the Boating Safety Hot-line at: 800-368-5647.

If there is no state provision for reporting boating accidents a report must be made to the Coast Guard officer in charge, Marine Inspection Unit nearest to the accident site or USCG station.

Federal Regulations Regarding Vessel Security

Federal maritime regulations contain specific information when operating near naval vessels, oil tankers and cruise ships.

1. You may not approach within 100 yards of any U.S. naval vessel, oil tanker, or cruise ship. When this is impossible to avoid, you must contact either the vessel or the Coast Guard escort vessel on channel 16 of the VHF radio.
2. Also, you must operate at minimum speed within 500 yards of these vessels.

Rendering Assistance

The operator of a vessel is obligated by law to provide assistance that can be provided safely to any individuals in a dangerous situation on the waterway. The operator is subject to fine and or imprisonment for failure to do so.



DANGER

AVOID BODILY INJURY OR DEATH FROM FALLING OVERBOARD! ALL OCCUPANTS SHALL STAY SEATED IN THE COCKPIT WHILE THE BOAT IS RUNNING.



WARNING

Do not approach within 100 yards of any U.S. naval vessel. If you need to pass within 100 yards of a U.S. naval vessel in order to ensure a safe passage in accordance with the Navigation Rules, you must contact the U.S. naval vessel or the Coast Guard escort vessel on VHF-FM channel 16.



You must operate at minimum speed within 500 yards of any U.S. naval vessel and proceed as directed by the Commanding Officer or the official patrol.

Violations of the Naval Vessel Protection Zone are a felony offense, punishable by up to 6 years in prison and/or up to \$250,000 in fines

Water Sports

Besides learning the safety precautions for safe boating, as well as understanding and knowing required rules and regulations you are obligated to be particularly careful around other water sportsman, such as scuba divers, water skiers, wake boarders, and fisherman.

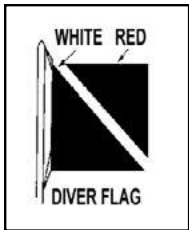

Whenever you see a “Diver Down” flag maintain a distance of at least 100 feet on inland waters. In bays and open waters stay 300 feet away. The flag indicates a diver in

the water. If a diver is operating from your boat, be certain to use this flag and post a lookout on board to observe the diver’s air bubbles.

Swim Platform:

On all types of swim platforms you should make periodic inspections of the swim ladder and hardware that support the platform to ensure that all connections and fittings are tight and in good condition. Always insert ladder and secure in the locked position before making headway!

Use heed when operating the boat in reverse to insure that water does not accumulate excessively on the platform or transom, especially in rough seas or strong currents. If installed, do not exceed the recommended maximum capacity label!

Typical label shown (vary by platform type/model).



WARNING

AVOID SERIOUS INJURY OR DEATH!
DO NOT OPERATE THE BOAT
WITH PEOPLE IN THE WATER
ON TOP OR HOLDING ON TO
THE SWIM PLATFORM STRUCTURE.

Read and understand the warning label above regarding “teak surfing.”

Fishing

Most boaters fish from time to time. With the propulsion systems of today it is possible to fish in out-of-the-way places. When cruising, stay clear of fisherman. They may have lines or nets out which might be cut or get caught in your propeller if you come too close. Slow down when approaching fishing boats. Do not return to cruising speed until the boats have been passed. If a fishing boat should be anchored, a large wake could flip or swamp the boat, upset fishing gear, pull the anchor loose from the bottom or worse yet cause someone to fall overboard.

When fishing from your boat, never anchor in a shipping channel or tie up to any navigational aid. These must be kept clear of at all times. Be sure to carry a local chart of the area to back up your plotter and be on the lookout for shallow water and hidden obstructions. Many times local conditions change and there is a time lag on the plotter chip until the next revision. Pick up a tidal chart if appropriate so you do not end up grounded.

Weather/Water Conditions

Before a boating outing check the weather conditions. As we all know the weather can change rapidly in many parts of the country. It does so sometimes without being predicted. NOAA weather radio reports are continuously available on designated frequencies installed on VHF radios and various hand held devices.

Also, many local radio stations carry weather reports along with on-line information.

Cloud Formations:

Clouds indicate the type of current weather and upcoming changes in the weather. Knowing the type of cloud formation can assist you in understanding current weather. Flat clouds (stratus) normally indicate stable air. Cumulus clouds indicate unstable air.

Many times a “cotton ball” or cumulus cloud builds vertical height in the afternoon and the result is a thunderstorm with increased winds and waves; sometimes these storms are quite violent.

Also, water spouts with high vortex winds can develop over water. You can find additional weather information (meteorology) at your local library or on the internet.

Waves & Fog:

As the wind blows across water waves are created. The stronger the wind and increased distance across the water enlarges the wave action. Other factors that can cause problem situations for vessels are fog, currents, and tidal changes.

Fog can develop inland on clear, calm mornings. Coastal areas see large “blankets” of fog roll in and stay for extended time periods sometimes causing hazardous navigation conditions. If you are caught in the fog, do not panic. Think of the best plan of action and proceed carefully. If you are limited in navigation equipment at the first sign of fog proceed to the nearest shoreline and wait until the fog lifts.

Boats equipped with navigation equipment, local waterway experience and charts should proceed to a safe harbor. Use extreme caution, signal as needed, and reduce to a speed where you can stop within half of your forward vision range.

If foul weather catches you at sea do the following:

1. Slow down. Proceed with caution and put on your life vests.
2. Try to reach the nearest safe shoreline.
3. Navigate your vessel slowly into the waves at a 45 degree angle.
4. Passengers should sit low in the center of the vessel.
5. Monitor your bilge pump. Make sure sump stays free of water.
6. Secure loose gear. Make ready emergency equipment.
7. Anchor over the bow but never over the stern.

Chapter 3

Rules Of The Road

Navigation Rules Defined

The Navigation Rules set forth actions to be followed by boats to avoid collision. They are referred to as the “Rules of the Road”. There are two main parts referred to as the inland and international rules. The inland rules apply to vessels operating inside the boundaries of the United States. The international rules (referred to as 72 COLREGS) apply to vessels operating on the high seas and all connected waters outside the established demarcation boundaries. Most navigational charts show the demarcation lines by red dotted lines and are published in the navigation rules. Remember to consult state and local agencies since areas such as “no wake zones,” swimming beaches, “diver down flag” and inland landlocked lakes fall under their responsibilities. This section is only an introduction to the “rules of the road”. We strongly recommend additional training before getting behind the “wheel”.

Order Inland & International Navigation Rules from:

Superintendent of Documents
U. S. Government Printing Office
Washington, DC 20402
Tel: (202-512-1800) Fax:(202-512-2250)



Navigation Rules

Right Of Way:

1. Cross waves at right angles.
2. When caught in heavy water or squalls, head either directly into the waves or at a slight angle. Reduce speed, but maintain enough power to maneuver your boat safely.
3. Keep your speed under control. Respect the rights of other boaters engaged in all water sports. Give them plenty of operating room.
4. Whenever meeting a boat head on, keep to the right where possible.
5. When two boats cross, the boat to the right (starboard) has the right of way.
6. When overtaking or passing, the boat being passed has the right of way.
7. In general, boats with less maneuverability have right-of-way over more agile craft. The skipper must keep his craft clear of the following vessels:
8. A vessel not under command or aground; due to their circumstances, these vessels have no maneuverability.

9. A vessel restricted in its maneuverability; these vessels usually are performing work which limits their maneuverability. Examples are boats surveying, dredging, laying pipe or cable, or servicing navigational markers.
10. A vessel engaged in fishing; these include boats fishing with lines, trawls or nets, but not trolling lines.
11. Sailboats; they have the right-of-way over powerboats. However, if a sailboat is using a prop to move forward, it is considered a powerboat even if the sails are up.
12. Remember the unwritten "rule of tonnage". Basically a smaller tonnage vessel should take every effort to avoid close quarters with a larger tonnage vessel. One way to accomplish this is to have a designated human lookout to "eyeball" the horizon for any developing collision course.
13. Use defensive driving skills on the waterway just as you do on the roadway. The other vessel may not know the rules of the road. Be alert and ready to take immediate action.
14. If a collision course is unavoidable neither boat has the right of way. Both boats must react to avoid an accident according to the rules of the road.

Lookouts:

International and Inland navigation rules spell out the specifics of establishing a lookout. A lookout is legally defined by the court system as a person who has specifically charged duties on board such as observing sounds, echoes, lights and any inhibitors to navigation with complete thoroughness as permitted by the circumstances.

The term "specifically charged" means that the lookout has no other duties at that time that could prevent him from keeping a proper watch.

Of course the skipper must delegate the lookout duties to a seasoned crew member who can react to events quickly and communicate effectively with the captain with little notice.

As captain of your vessel you are responsible for the vessel and the crew. Choose an experienced individual as lookout and review the navigation rules with this person so he can make the right call quickly as situations develop.

WHISTLE SIGNALS	
ONE LONG BLAST:	Warning signal (Coming out of slip)
ONE SHORT BLAST:	Pass on my port side
TWO SHORT BLASTS:	Pass on my starboard side
THREE SHORT BLASTS:	Engine(s) in reverse
FOUR OR MORE BLASTS:	Danger signal

		BRIDGE SIGNALS	
		DAY (Flag)	NIGHT (Lights)
SOUND	VISUAL	↑	↑
VESSEL: Open	VESSEL: Open	□	○
BRIDGE: OK	BRIDGE: OK	↓	↓ or ↓
No	No	Same	Same
VESSEL: Replies:			
RADIO: VHF CH. 13			
		No	No

Navigation Rules

The Navigation Rules set forth 3 types of crossing situations- crossing, meeting, and overtaking. In each case, both boats are governed by special procedures.

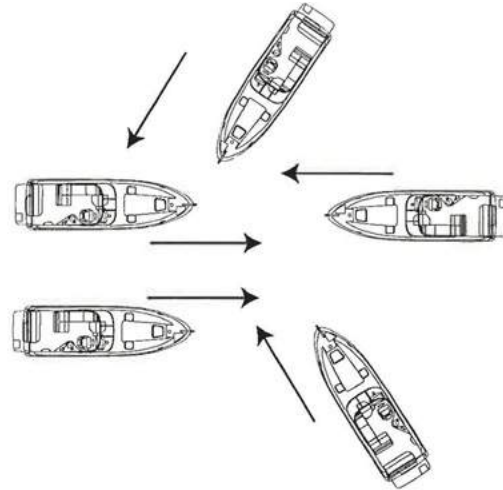

In a head-on meeting, both vessels must sound a single blast to give way toward starboard and pass to port.

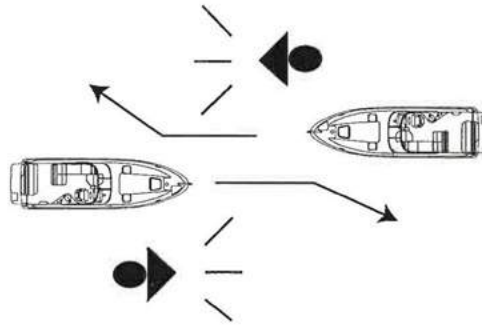

These rules appear when there is a risk of collision. In a crossing situation be aware of the other craft's position. For safety, there should be a noticeable change in the angle, bow or stern; a gradual change in position indicates possible danger.

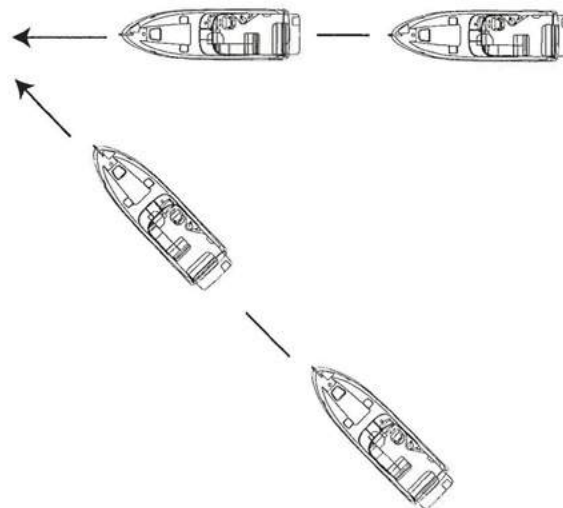

6

Navigation Rules

An overtaking boat is burdened, and is not the privileged craft, even though it approaches the danger zone of the overtaken boat.

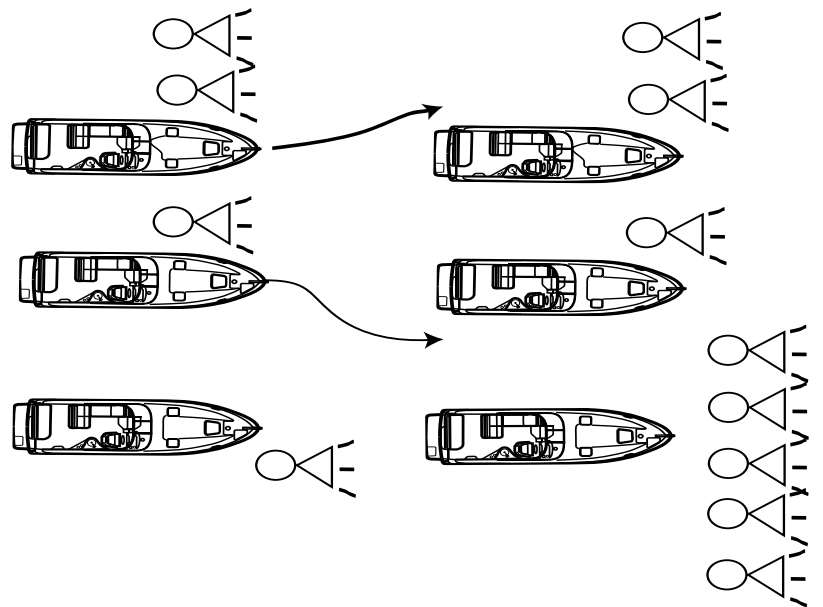
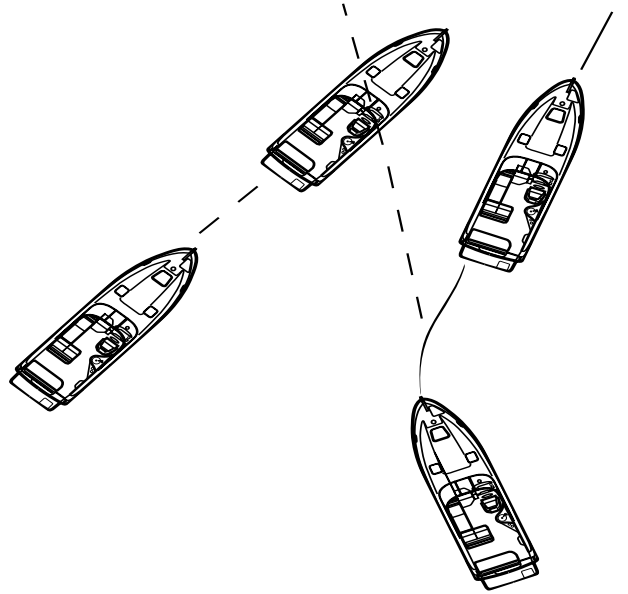

The overtaking boat first signals with a single blast if that boat desires to pass on the starboard side of the boat ahead, or a double blast if passing to port. The overtaken craft responds with the same signal if safe, or with the danger signal (5 short blasts or more) if unsafe. The boat overtaking must not pass unless the appropriate signals are sounded.

Navigation Aids

Navigation aids are placed along coasts and navigable waters as a guide for mariners in determining their position in reference to land and hidden danger. Each aid provides specific information. They form a continuous system of charted markers for monitoring on the plotter or providing accurate piloting on paper as a backup. Your on board plotter provides up to date navigation aids. Besides coastal maps a complete domestic interior waterway grid is featured on the plotter.

If desired, there are hand-held GPS devices that are available as back-up devices. In addition, nautical charts are provided by the National Ocean Service (NOS) and are distributed nationwide through marinas and outlet stores. These charts show the geography of the coast, water depth, landmarks, navigation aids (buoys and markers), marine hazards, and port facilities. Use only up-to-date charts for navigation. We recommend when purchasing a chart to look for the weather resistant ones. Buoys provide a road map to keep the skipper on course and to avoid hazards. Buoys are identified by light, shape, color and in severe weather conditions by sound.

Buoys or beacons called lateral markers indicate the port and starboard sides of the waterway to be followed. U. S markers follow the buoy age system known as Red Right Returning. When returning from sea or traveling upstream, the green markers are to port (on your left) and the red markers are to the starboard side (on your right). When traveling downstream or out to sea the marker color would be reversed.

Before operating your vessel, learn to identify the various navigational aids such as lateral aids, mid-channel markers, information and regulatory markers.

NOTICE



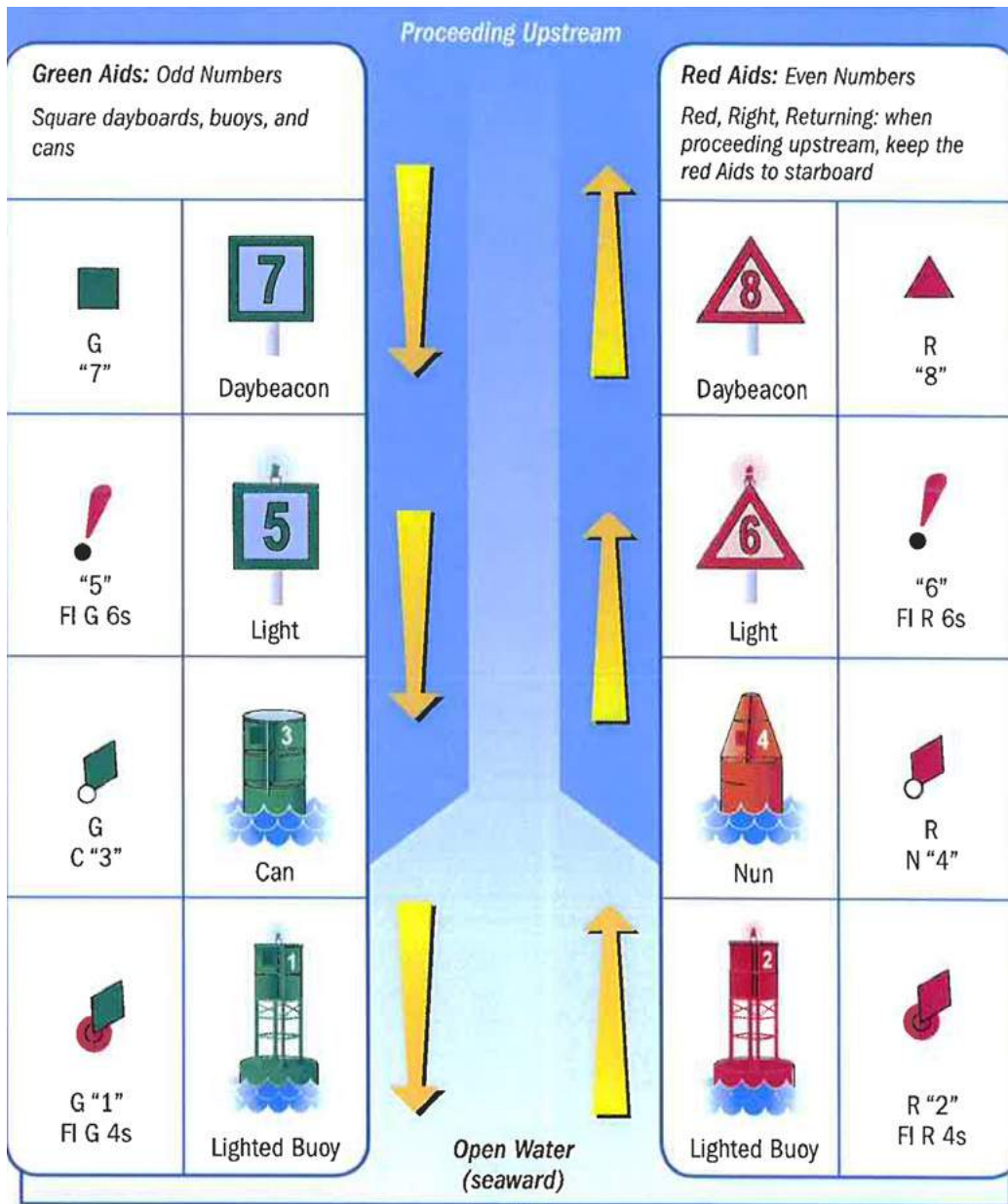

SKIPPERS MUST NOT RELY ON BUOYS ALONE TO MARK THEIR POSITION. SEVERE WEATHER CONDITIONS AND WAVE ACTION CAN ALTER A BUOY'S POSITION. NEVER TIE UP TO A BUOY. IT IS ILLEGAL AND DANGEROUS.

Lateral Aids



Characteristics

- Beacons may have green odd numbers.
- Buoys may have white odd numbers.
- If lit, the light will be green and is likely to flash in one of the following patterns:













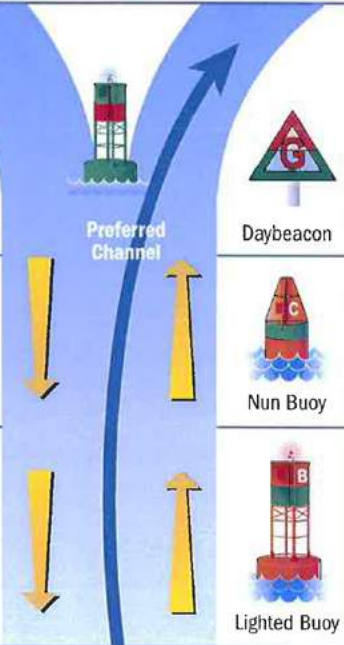

Flashing (2)	
Flashing	
Occulting	
Quick Flashing	
Isophase	

Characteristics

- Beacons may have red even numbers.
- Buoys may have white even numbers.
- If lit, the light will be red and is likely to flash in one of the following patterns:







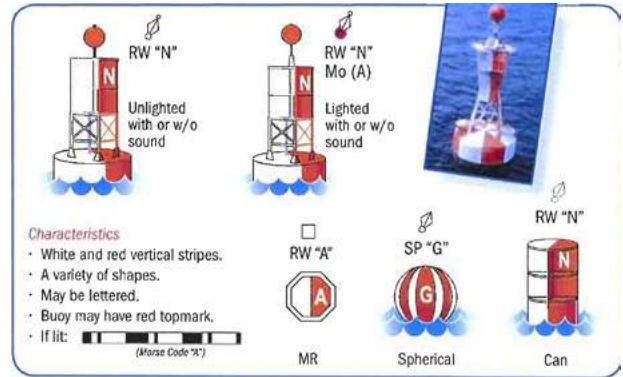





Flashing (2)	
Flashing	
Occulting	
Quick Flashing	
Isophase	

Channel Markers

 GR "U"	 Daybeacon		 Daybeacon	 RG "G"
 GR C "S"	 Can Buoy		 Nun Buoy	 RG N "C"
 GR "A" Fl (2+1) G 6s	 Lighted Buoy		 Lighted Buoy	 RG "B" Fl (2+1) R 6s
<p>Characteristics</p> <ul style="list-style-type: none"> Green on top. Have a letter designation. Buoys will feature a white letter. If lit:  COMPOSITE GROUP FLASHING (2-1) 		<p>Characteristics</p> <ul style="list-style-type: none"> Red on top. Have a letter designation. Buoys will feature a white letter. If lit:  COMPOSITE GROUP FLASHING (2-1) 		



Regulatory Markers

Symbol	Meaning	Examples
	Danger A diamond shape alerts boaters to hazards	 
	Restricted Operations Marks with a circle indicate areas with regulated operations	 
	Exclusion A diamond shape with a cross means boats are prohibited from the area	 
	Information Marks with a square provide helpful information such as directions, distances, and locations	 

Night Running

Boats operating between sunset and sunrise (hours vary by state), or in conditions of reduced visibility, must use navigation lights. Night time operation, especially during bad weather and fog, can be dangerous. All Rules of the Road apply at night, but it is best to slow down and stay clear of all boats regardless of who has the right-of-way.

To see more easily at night, avoid bright lights when possible. Also, it is helpful to have a passenger (appoint as lookout) keep watch for other boats, water hazards and navigational aids.

To determine the size, speed and direction of other vessels at night, you should use the running lights. A green light indicates starboard side, and a red light indicates port side. Generally, if you see a green light, you have the right-of-way. If you see a red light, give way to the other vessel.

Bridge Clearance

Be aware that your vessel requires a specified bridge clearance height. This height is a measured

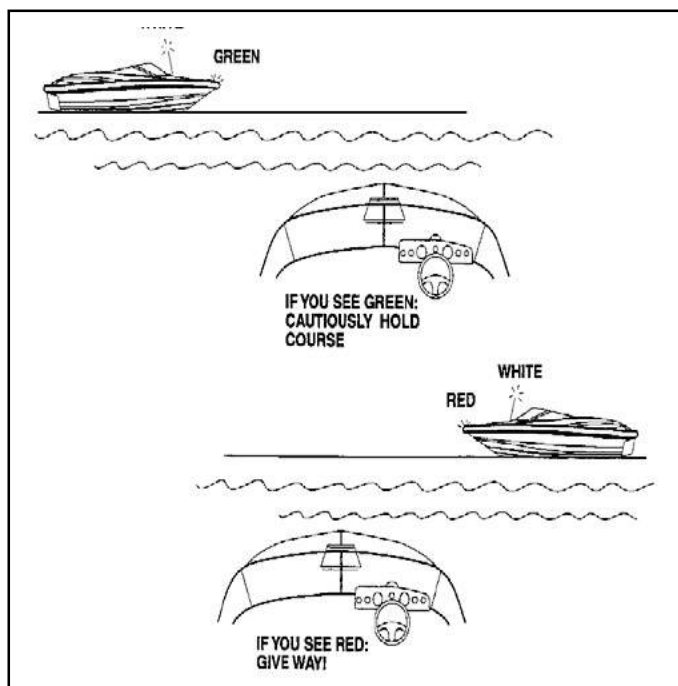

estimate from the waterline to the top of the highest equipment height. The estimated height can change because of variances in the loaded condition of the vessel and equipment variances. Consult the bridge clearance specifications located in Chapter 12 (Technical Information section). Some bridges are tendered. Know and use the proper bridge signals when approaching these bridges (see bridge signals in this chapter). You can also monitor and communicate on channel 13 of a VHF radio for bridge information in most domestic locals. Other bridges are marked with a clearance measurement and you are on your own. It is recommended that you have a look out posted for additional visual assistance when entering a bridge zone.

After determining your vessel will clear the bridge proceed with caution at a safe idle speed. Keep your eye on vessel traffic at all times in order to react quickly. Keep both hands on the helm since you may need to change course because of current and wind conditions. Resume a safe speed once clear of the bridge structure and acknowledgment of clear visibility. Just use common sense around any type of bridge structure!

Bridge Lighting:

Bridge lighting is maintained by the Department of Homeland Security. On the following pages are 2 typical examples of night-time bridge lighting. As the skipper approaches bascule and fixed bridges light position (arc of visibility) and color will indicate the safe channel through the bridge. Notice green denotes the "safe" entry location on single-span bridges and green or white on multiple-span bridges designates the main channel. In addition, green denotes the "up" position for single and double lift bridges.

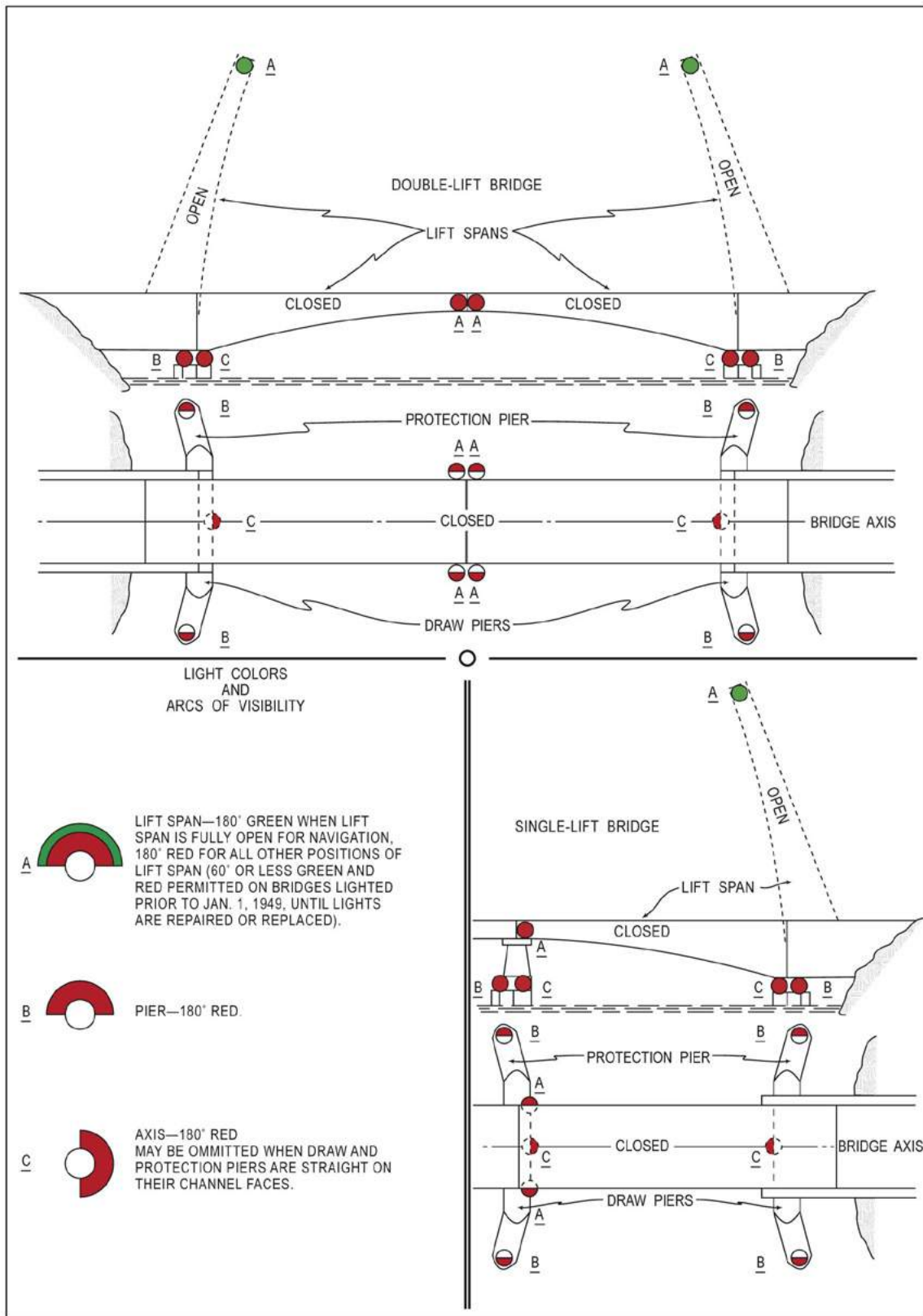

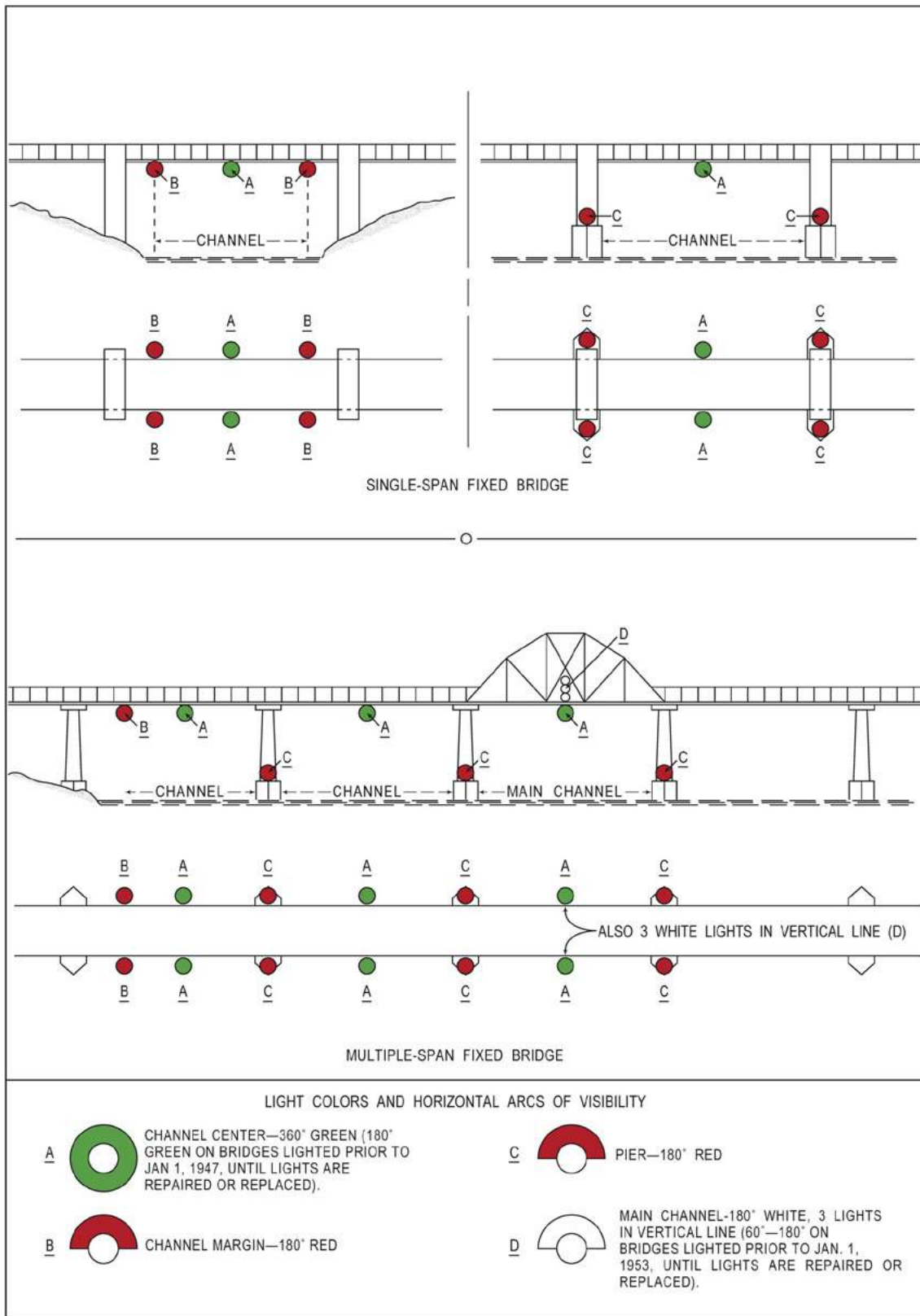

Chapter 4

Systems

Overview

In this chapter Regal on board standard systems are introduced including electrical, fuel, waste, and entertainment. In short, this chapter is the “meat and potato” section for systems. Selected optional equipment and systems are found in Chapter 7.

A system description, location of components, and operational information is found in this section. Enhanced vendor component details and troubleshooting can be found in the owner’s information packet along with the troubleshooting chapter of this manual.



Be sure to read and follow any danger, warning, or caution labels in reference to boat systems or individual equipment components.

Note that your Regal boat may not contain all of the equipment or systems shown. Regal has the right to modify, update or delete equipment and/or systems at anytime. Refer to the vendor documentation located in the owner’s information packet for more details on individual system components. Also, use internet search agents.



WARNING

PREVENT INJURY OR DEATH!
READ AND UNDERSTAND THE
PROPULSION OWNER’S MANUAL
BEFORE ATTEMPTING
TO OPERATE THE VESSEL.

Electrical System

Introduction

In this section, basic DC (direct current) is introduced. Select electrical components are reviewed along with their location and function within the electrical system.

For more complicated issues outside the scope of this manual contact your closet Regal dealer. They have undergone extensive training on the Regal boat systems.

Be sure to read and follow any danger, warning, caution, or notice labels in reference to the vessel's electrical system or individual equipment components. Also, refer to the owner's information packet for further product information or the internet.

 **WARNING**

PREVENT SEVERE INJURY OR DEATH!
DISCONNECT
ALL ELECTRICAL POWER SOURCES
BEFORE ATTEMPTING
TO REPAIR OR REPLACE
ANY ELECTRICAL COMPONENT.

 **CAUTION**

AVOID CHARGING SYSTEM DAMAGE!
DO NOT TURN
BATTERY SWITCH TO THE "OFF"
POSITION WITH THE ENGINE RUNNING.

DC Current

Your Regal boat uses 12 volt DC electricity otherwise known as direct current. It is called DC because it flows only one way in a circuit. Specifically to name a few, helm gauges, batteries, battery cables, engine electrical components, engine wiring harnesses, dash switches, selected lighting, shower sump, bilge pumps, and electric toilets are all components using a 12 volt DC system.

In the domestic DC system the red wire is designated as the "hot" or conductor wire and the black wire is referred to as the ground wire. At times other current carrying wires are color coded such as blue to identify their use as a low voltage conductor. This is especially helpful in troubleshooting and adding additional equipment. Be sure to review the wiring schematics in the drawing section of the technical chapter.

Direct current is stored in the ship's battery(ies) and produced through the engine alternator while the engine is running or by the optional battery charger at shore. Normal DC voltage is between 12 and 15 volts. Lower or higher readings could indicate a charging malfunction or a weak battery.

Note that current specifications for alternator output is around 105 amps depending on engine model. The forward bilge pump and automatic float switch are continuously on with the bilge pump switch in the middle or "off" position. Should a leak develop with the operator away from the vessel the bilge pump will continue to pump bilge water overboard until of course the battery goes dead.

TYPICAL DC (12 VOLT) WIRING COLOR CODE & SIZES		
BLACK	16,14,12,10,8,6,4,2,2/0,40	GROUNDS
BLACK/WHITE	16	HALON INDICATOR
BLACK/YELLOW	10,16	GRD. DIESEL TRANSFER PUMP, MERC DIESEL STOP CIRCUIT
BLACK/WHITE	10	HALON MAIN GRD. FEED
BROWN/BLACK	10	MACERATOR, SUN ROOF
BROWN	10	SUN ROOF
BROWN	14	AFT BILGE PUMP-MANUAL
BROWN/WHITE	14	AFT BILGE PUMP-AUTO
BROWN/RED	14	FWD. BILGE PUMP-AUTO
BROWN/BLUE	14	FWD. BILGE PUMP-MANUAL
BROWN/PINK	16	CO DETECTOR
BROWN/BLACK	16	SHOWER SUMP PUMP
YELLOW	12,10	BLOWER
YELLOW/WHITE	16	HEAD VENT FAN MOTOR
YELLOW/BLACK	16	STEREO MEMORY
YELLOW/RED	14	ENGINE START CIRCUIT

Note: The list above applies to a number of vessels. Vessel components/wiring specifications may vary depending on the model.

TYPICAL DC (12 VOLT) WIRING COLOR CODE & SIZES (CONTINUED)		
ORANGE	10,12	VACUUM TOILET, REFRIGERATOR, HATCH RAM
ORANGE	16	WIPER RUN
ORANGE/WHITE	16	WIPER PARK
ORANGE/BLACK	10,12,16	HORN, HATCH RAM
BLUE	14	INTERIOR LIGHTS, SWITCHED CIRCUIT
BLUE/RED	14	INTERIOR LIGHTS, CONSTANT HOT CIRCUIT
BLUE/BLACK	16	COCKPIT SOFT LIGHTS
BLUE/GREEN	16	INTERIOR SOFT LIGHTS
BLUE	10	CABIN LIGHT MAIN CIRCUIT FEED
GRAY	14	NAVIGATION LIGHTS, RUN- NING, BOW, TRANSOM LIGHTS
GRAY/BLACK	14	NAVIGATION LIGHTS, AFT AN- CHOR, MASTHEAD
GRAY/WHITE	14	NAVIGATION LIGHTS, MAST- HEAD, FWD. RUNNING LIGHTS
RED	16	POSITIVE FEED- ELECTRON- ICS, GAS VAPOR DETECTOR, BREAKER TO DASH SWITCH FEEDS

Note: The list above applies to a number of vessels. Vessel components/wiring may vary depending on the model.

TYPICAL DC (12 VOLT) WIRING COLOR CODE & SIZES (CONTINUED)		
RED/WHITE	16	WINDLASS CONTROL-DOWN
RED/BLACK	16	WINDLASS CONTROL-UP
RED/WHITE	14	BATTERY PARALLEL-LOAD
RED	14	POSITIVE FEED-ELECTRONICS
RED	12	POSITIVE FEED-ELECTRONICS
RED	10	POSITIVE FEED-AUTO PILOT
RED/VIOLET	10	FUEL TANK TRANSFER PUMP AMPLIFIER POWER
RED	8	POSITIVE FEED- MAIN ALTERNATOR CHARGE
RED	6	POSITIVE FEED- MAIN ALTERNATOR CHARGE
RED	4	POSITIVE FEED-MAIN
RED	2	POSITIVE FEED- MAIN STARTER, BATTERY, GENERATOR
RED	2/0	POSITIVE FEED- MAIN, START- ER, BATTERY
PURPLE	16	STBD. IGNITION, HOUR METER- WINDSHIELD VENT
PURPLE/WHITE	16	PORT IGNITION, HOUR METER, WINDSHIELD VENT
PINK	16	STBD. FUEL TANK SENDER
PINK/BLACK	16	PORT FUEL TANK SENDER
TAN/BLUE	16	ENGINE ALARM CIRCUIT
GREEN	16	TANK LEVEL MONITOR, SPOT- LIGHT
GREEN	10	SPOTLIGHT
GREEN	8	BONDING

Note: The list above applies to a number of vessels. Vessel components/wiring may vary depending on the model.

Batteries

All vessel DC equipment and specifications are subject to change at any time, as part of Regal's commitment to product improvement. Equipment information here is up to date per the owner's manual printing date.

BATTERY SPECIFICATIONS			
Battery Type	Group	CCA @32 Degrees F.	Reserve Capacity
Engine Cranking & House	31 A	1260	195 min.

Battery Terminology Descriptions

One battery is standard equipment on your vessel. A second battery is used when the dual battery switch option is chosen. All batteries include a battery box or tray along with fastening hardware. Be sure to periodically check maintenance style batteries for proper electrolyte levels and use only distilled water when filling cells.

Group- Batteries are divided into groups which identify the height, length, and width of the battery. This is useful information should a replacement battery become necessary. Note that the Z/5 & Z/3 currently use 31 A series battery (ies).

Cold Cranking Amps (CCA)- This rating measures the cranking power of a full charged marine battery having the ability to start at 32 degrees F. Basically, the higher the rating the greater starting power of the battery.

Reserve Capacity (RC)- As usage on the boat increases so does the need for more reserve capacity. The reserve capacity represents the length of time in minutes a new fully charged battery can maintain the vessel's electrical needs without the engine running or in the event of alternator failure.

Battery Problems/Solutions



1. Weak battery- This battery problem can be caused by low electrolyte cell levels.

Warm, bilge compartment temperatures will deteriorate a battery's life quicker by evaporating the water from the electrolyte, thus corroding and weakening the positive grids inside the battery.

Low electrolyte levels can be monitored by periodic inspection and filling as needed with distilled water. Boaters in higher climate areas with longer stretches of hot weather will need to check their batteries more often.

"Maintenance free" engine cranking batteries require no water and cells are not accessible. They do feature a different chemistry that does consume less water. Inside the cells as gases are released condensation is formed which aids in maintaining the cell electrolyte level. These batteries incorporate a deeper layer of electrolyte over the plates, but eventually it can run dry. On the 31 series engine cranking batteries keep all terminals clean, connections tight and your electrical system in top shape to extend battery life.

2. Dead Battery- Either the battery will not accept a charge, hold a charge or the charging system is not supplying a charging current through the battery charging system and/or engine alternators.

The battery charger output can be checked by monitoring the lights on the charger front face.

To begin with check the battery post connections for tightness and corrosion.

With the engine running the displayed voltage of the battery should be between 12.5 up to 14.6 volts.

If less than 12 volts check for voltage across the battery terminals.

If less than 12 volts check with a hydrometer to locate faulty cells.

Maintenance free batteries they can be removed from the vessel if necessary and trickle charged. If readings after charging are still low replace the battery.

Battery Switches

The engine cranking battery switch is located in the starboard sump located on the battery management panel. To access the panel lift up the starboard aft seat. Here you will see 1 of 2 different battery switches.

Standard battery switch designates an “off” and “on” position. To start the engine position the battery switch at the “on” detent. Power is now available to the dash and to start the engine.

The engine battery switch is protected by a breaker. Be sure to turn the battery switch to the off position when leaving the vessel. *As a note never turn the battery switch to the “off” position with the engine running.*

Optional dual battery switch designates “off”, “on” and “combine batteries” positions. This particular battery switch is connected to dual batteries and this set-up supplies additional reserve capacity to run extra accessories and to supply cranking amperage to start the engine with the other battery at a low charge condition.

To use this feature position turn the battery switch knob to the “combine batteries” detent (yellow labeled area). At this point you can start the engine. As this particular battery switch features a “make before break” footprint once the engine starts you can reposition the battery switch to the “on” detent to revert back to one battery for engine starting. It is recommended not to leave the dual battery switch in the “combine batteries” position as under the right conditions a severe discharge could result in both batteries becoming discharged.



TYPICAL OFF-ON BATTERY SWITCH



TYPICAL DUAL BATTERY SWITCH

Battery Management Panel

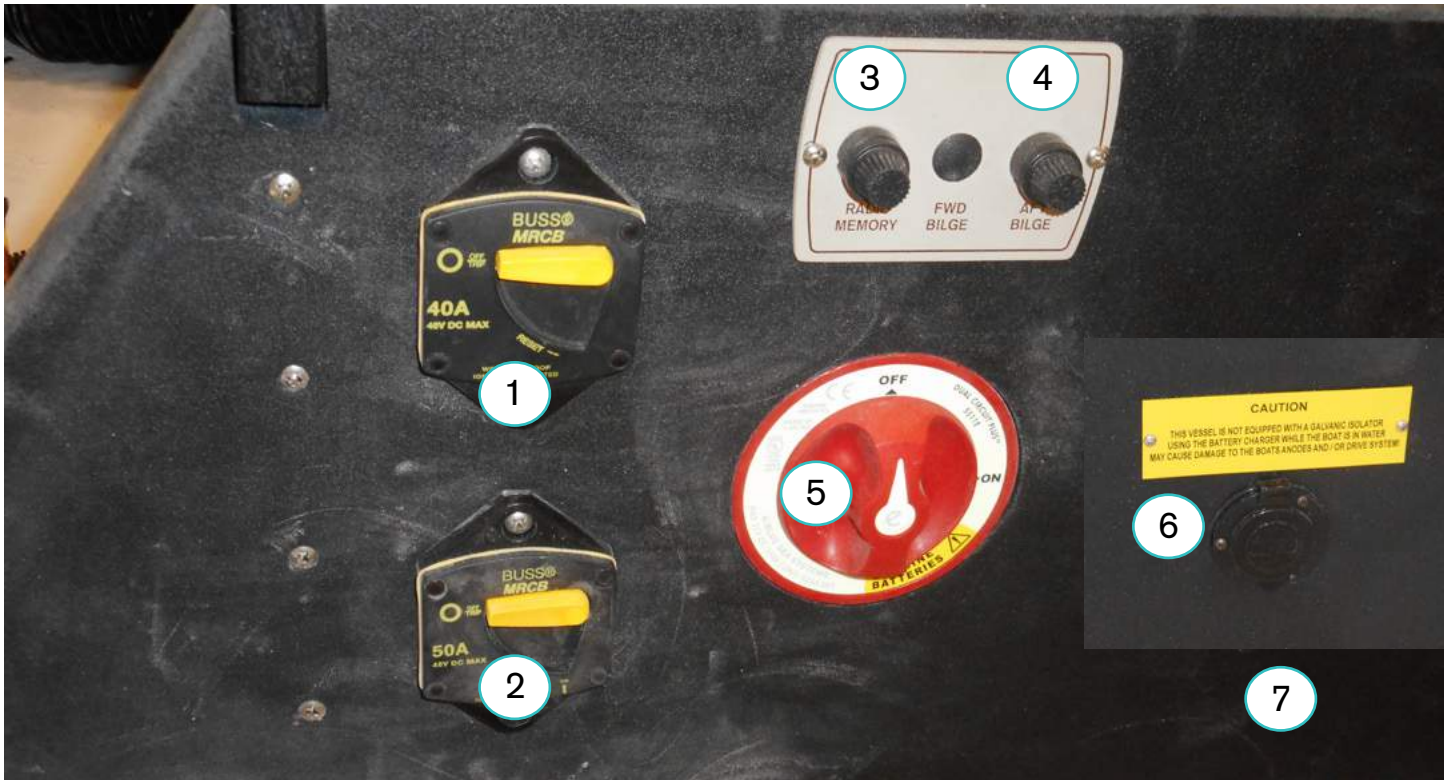

TYPICAL BATTERY MANAGEMENT PANEL (outside view) (DUAL BATTERY SWITCH SHOWN)

The battery management panel features key electrical components including battery switches, breakers, fuse panels and related battery charging components. The panel is accessed by lifting up the aft starboard cushion. Here are selected components you may find on the panel:

1. This 40 amp breaker controls power to the optional anchor windlass. An 80 amp breaker protects an optional PowerTower. Other breakers for options may be found on your vessel.

2. This 50 amp breaker protects the dash or helm circuitry.

Note that the above breakers are shown in the "off" position. Activate the above breakers push the yellow lever down until it ratchets in the "on" position.

3. This fuse protects the stereo memory circuit. This allows you to keep all your stereo program selections when you leave your vessel even with the battery switch turned off.

4. This fuse protects the aft bilge pump which is usually found in the bilge just forward of the engine. When you leave the vessel and turn off the battery switch as recommended the bilge pump circuit is still activated allowing the pump to work should a leak develop.

5. The battery switch when off disconnects any voltage to the dash including the engine key switch. Note that the standard battery switch instead of the optional dual switch shown may be present on your battery management panel.

6. This is the shore plug for the battery charger. It is recommended that you use a 3 prong extension cord rated for the amperage. Read and follow the label instructions below as we do not recommend using the shore cord while vessel is in the water.



CAUTION

THIS VESSEL IS NOT EQUIPPED WITH A GALVANIC ISOLATOR. USING THE BATTERY CHARGER WHILE THE VESSEL IS IN THE WATER MAY CAUSE DAMAGE TO THE BOAT'S ANODES AND/OR DRIVE SYSTEM!

7. There is a warning placed close to the battery charger shore plug. Read and understand the following warning label.



WARNING

PREVENT SEVERE INJURY OR DEATH FROM FIRE, EXPLOSION OR ELECTRICAL SHOCK!

THIS DEVICE MUST BE CONNECTED TO A GROUND FAULT CIRCUIT INTERRUPT (GFCI) PROTECTED AC OUTLET.

WHEN USING AN EXTENSION CORD, CONNECT THE AC CHARGER PLUG BEFORE CONNECTING TO THE GFCI PROTECTED AC OUTLET!

MAKE CONNECTION IN AN OPEN ATMOSPHERE FREE OF EXPLOSIVE FUMES.

MAKE CORD AND CONNECTION IN A SECURE MANNER THAT WILL AVOID CONTACT WITH THE WATER.

Battery Management Panel (Continued)

4. The ground block is a home for a group of negative (black) wires. You may even find an earth ground on the block (green). This may be an additional ground area for added accessories. Periodically check to ensure all wires are fastened securely. When adding accessories never add more than 4 connectors to any stud on a ground block.

5. This bank provides a junction for wiring from the battery charger circuits and from the ACR unit. Periodically check wires for secure fastening.

6. Battery switch (rear view). See earlier information for additional details. Note the red boots on the rear of the battery switch. Periodically check to ensure the boots cover the nuts securely and that the connections and nuts are tight. Disconnect the battery (ies) positive (+) wires before tightening the battery switch nuts.

7. Overboard discharge breaker. Installed as part of optional equipment to protect the overboard discharge motor and wire circuitry. If the breaker pops push button on side of breaker to reset. Always figure out the cause of the overload before resetting the breaker.

8. Electric head breaker. Installed as part of optional equipment to protect the Tecma electric head motor and wire circuitry. If the breaker pops push button on side of breaker to reset. Always figure out the cause of the overload before resetting the breaker.

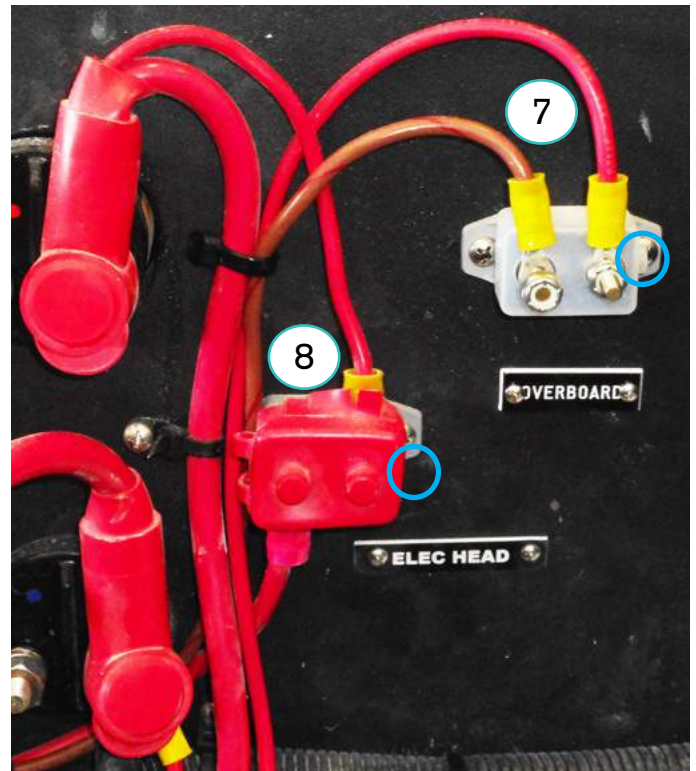

PUSH SIDE BUTTON TO RESET BREAKER

DC (Direct Current) Helm Fuse Panel

Lift up the starboard bow backrest to access the DC fuse panel or take the screws off the blank panel below the main helm panel which may afford easier fuse changing. This fuse panel protects many of the direct current devices along with their circuit wiring on board your vessel.

Below we will acquaint the operator with the function of each fuse and information regarding the related component. These mini fuses can be purchased at most auto and marine supply houses. Never replace a fuse with a higher rated fuse to prevent possible fire or component damage. Always find the reason why the fuse “blew”.

NAV/ANC- This 10 amp fuse protects the bow light located on front deck the deck mounted stern light. With the optional PowerTower an all around light is used verses the stern light.

CPT/CAB LTS- A 10 amp fuse protects the blue LED style blue cockpit lights which allows safer night maneuvering throughout the cockpit.

DOCK LTS- This 15 amp fuse protects the optional hull docking lights which are used for maneuvering in tight quarters at night. It is recommended that the docking lights be off when running above idle speeds at night since they might blind another boater from being able to see the bow light.

GARMIN- This 2.5 amp fuse protects the chartplotter(s) which show engine vitals along with GPS information.

U/WTR LTS The 10 amp fuse protects the stern mounted underwater lights.

DC (Direct Current) Helm Fuse Panel (CONT.)

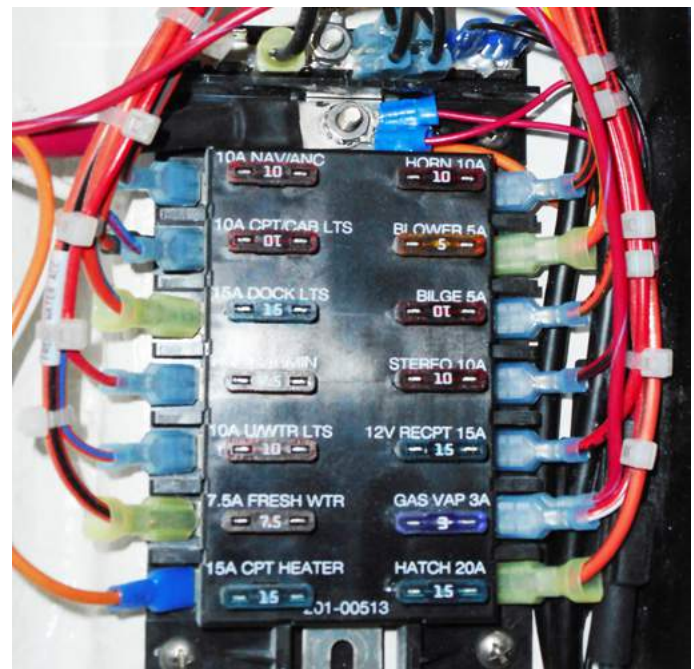

TYPICAL HELM DC FUSE PANEL

FRESH WATER- This 7.5 amp fuse protects the fresh water pressure pump and its wiring circuit. The pump is responsible for supplying potable water to the head faucet and transom shower if installed.

CPT HEATER- This 15 amp fuse protects the cockpit heater which is available on surf models.

BLOWER- This 5 amp fuse protects the ventilation blower. This powered system removes any fumes and bilge air and provides an exit to the atmosphere through ducting located in the lower third of the bilge. Check these 4" black hoses periodically for their condition and fastening of hardware.

BILGE- This fuse protects the bilge pump and its circuit wiring located in the bilge. This pump features a dash switch automatic center position. Remember that your vessels bilge pump system with the automatic position is "on" even with the main battery switch turned off at the battery management panel.

STEREO- This 10 amp fuse protects the Fusion stereo circuit. Note that if stereo performance and lighting package is ordered there are additional fuses located in the system such as at the amplifier unit.

12 VOLT RECPT- This 15 amp fuse protects the 12 volt receptacles on the vessel. These can be used to power accessories such as searchlights or with the correct adapters permit charging phones MP3 devices and tablets.

GAS VAP- This 3 amp fuse protects the optional gas vapor detector system. There is a sensor mounted in the bilge and a head unit close to the helm. If the sensor finds gas fumes in the bilge it sounds an alarm.

Fire Port



Note that as standard equipment with stern drives there is a fire port and plug installed near the aft sun lounge seat area. The plug includes a

decal.

The fire port permits a hand held fire extinguisher to be used safely. If you see evidence of a fire a plastic plate enables you to visually inspect the engine compartment without opening it and adding oxygen to the fire. In a fire emergency break the fire port plastic plate with the fire extinguisher nozzle, place the fire extinguisher in the fire port recess and pull the pin on the extinguisher to discharge the contents. Try to hold the extinguisher in a vertical position for best performance. Do not open the engine hatch until the fire is out and metal parts have an opportunity to cool down.

Typical fire extinguishers have a discharge time of only 10 to 12 seconds, so you need to use them before the fire gets too large.

When using a handheld fire extinguisher in a fire port, use this acronym called PASS:

- Pull the pin
- Aim the fire extinguisher in the fire port
- Squeeze the two handles together
- Move the nozzle in different angles while using so the extinguisher agent sweeps across the flames more effectively.



TYPICAL HALON EXTINGUISHER TYPES & SIZES

It is recommended that a hand held clean agent type fire extinguisher such as the Halotron 1 be used as it removes the oxygen from the area and oxygen is the key element in creating and maintaining most fires. These halon type clean agent extinguishers are EPA approved, safe for most devices coming in contact with them and leave no residue after use. Purchase at boating retail outlets.

Gasoline Fuel System

In this section, a typical EPA approved domestic gasoline fuel system is introduced. The fuel system includes the fuel tank, fuel feed lines, fill and vent fittings along with fuel filters, emission devices, natural and powered ventilation systems.

Gasoline today is processed in a different manner than it was a few years ago. As a result it has become more unstable and the product shelf life has been shortened.

Stern drive engines in this size range normally utilize a metal fuel tank. A special EPA approved low permeability hose system is used as required to supply the engine.

Read and understand the stern drive engine owner's manual fuel section and safety information before attempting to use the vessel.

Note that due to a possible fire or explosion danger never store flammable liquids and/or portable fuel tanks in any storage compartment.

Gasoline Specifications/Octane Ratings:

Gasoline Requirements- Use premium non-leaded gasoline with the following minimum octane rating for stern drive engines:

- **Minimum pump octane number 87 AKI.**

The use of leaded fuels will damage the catalysts and can not be used with catalytic converters.

Gasoline in the United States and other areas is blended with 10% ethanol and is known as E-10 at the pumps. Marine engines used in your Regal boat may be operated with premium unleaded

gasoline blended with no more than 10% ethanol and that meets the minimum octane specification.

Do not use ethanol blends greater than 10% such as a newer blend for select motor vehicles called E-15. Your marine engine may be damaged by more than 10% ethanol. A loss of performance may occur and the engine will not be covered by the engine manufacturer's warranty.

Refer to your stern drive engine manufacturer's operation manual for additional information regarding fuel information for your engine model.

As an option contact your engine manufacturer's hot line or text on web with fuel related questions. Also, additional fuel system information may be as close as your Regal dealer. Your Regal dealer has special training on the propulsion and Regal vessel systems.

Typical EPA Fuel System

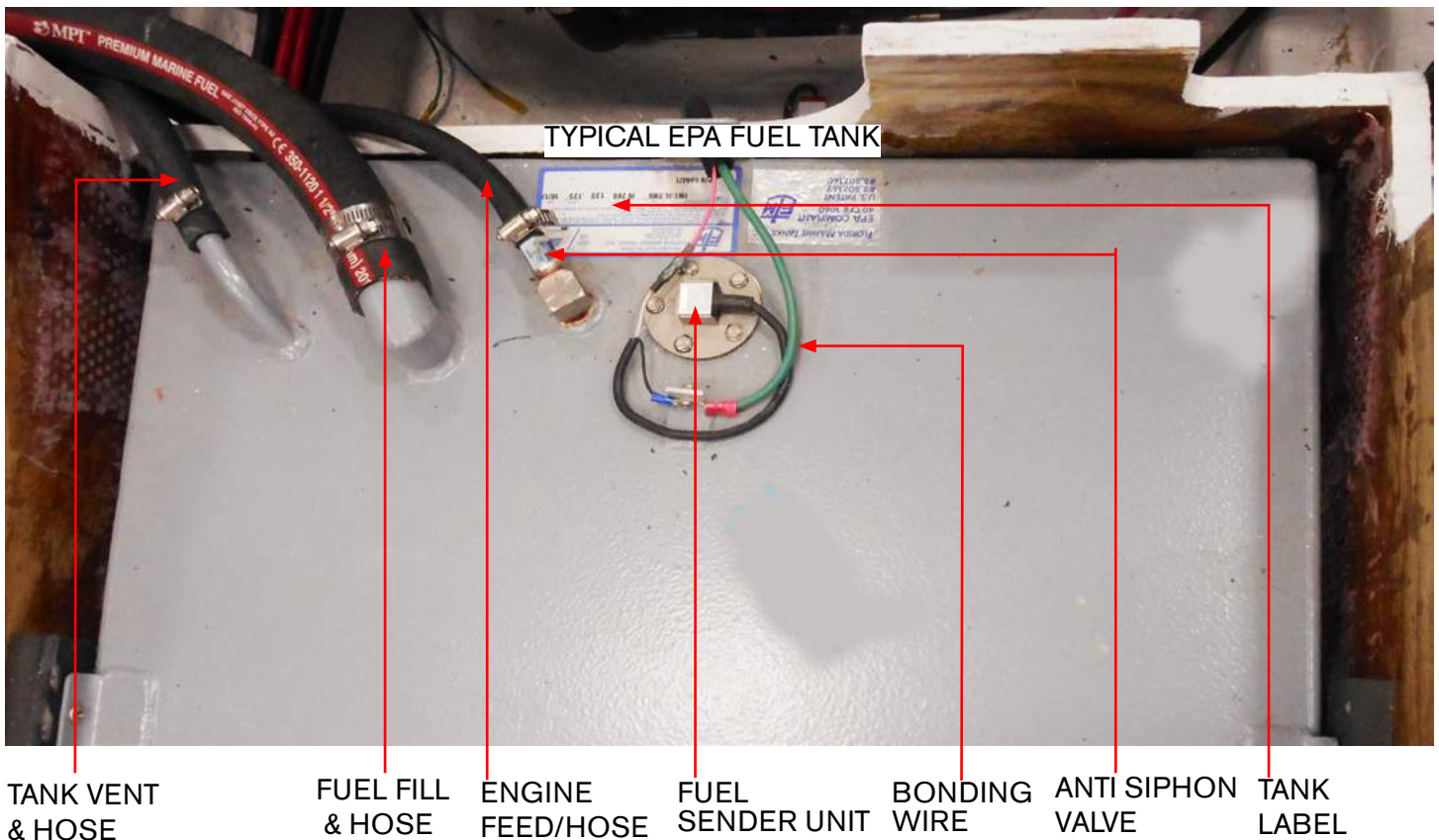

Typical Fuel Tank

Vessels manufactured for *domestic* use are now required to be outfitted with an EPA compliant fuel system typically using an aluminum tank that must pass a battery of tests. This system uses special valves and baffles located inside the fuel tank along with special hoses marked for low permeability. Also, there is a carbon canister in-line with the vent hose which functions much like the one in an automobile by filtering gas fumes. The carbon canister rarely needs to be replaced and is not a serviceable item.

These tanks are tested and inspected along with the complete fuel system several times for safety requirements and quality by the fuel tank supplier, in house personnel and independent inspections by National Marine Manufacturers Association personnel.

Fuel Fill Fitting

The fuel fill fitting is labeled “gas” and in addition displays the international symbol (See the next page). When fueling the boat keep the fill nozzle in contact with the fuel fill pipe since it decreases effects of static electricity. Always use the recommended fuel octane rating as specified in your engine owner’s manual.

Extinguish all flame producing agents before fueling!

 **WARNING**

AVOID SERIOUS INJURY OR DEATH
FROM FIRE OR EXPLOSION, RESULTING
FROM LEAKING FUEL. INSPECT SYSTEM
FOR LEAKS AT LEAST ONCE A YEAR.

Fuel Vent Fitting - Typical



FUEL FILL FITTING

Currently, domestic EPA compliant fuel tanks vent fumes through the fuel tank system. While the tank is being filled fuel vapors displaced by the incoming

fuel are vented through the fuel system charcoal canister and low perm hoses eventually to and through the hull side fuel vent. This purging process occurs on a continuous basis as the fuel in the tank expands due to both internal and external temperature changes. On these systems periodically check the fuel vent screen for debris and obstructions such as insect nests.

Select fuel systems may use a combo type (internal vented) fuel fill. Both the fuel fill and vent occupy the same cavity under a protective cover. If fuel overflows through the vent it is forced back into the fuel fill hose and tank.

On all systems be sure to tighten the fuel fill cap to prevent water and debris from entering the fill system. On select systems you may hear a distinct sound as the tank nears the “top out” or full mode.

NOTICE

DO NOT OVERFILL THE FUEL TANK!
THIS HELPS AVOID ANY OVERBOARD
SPILLS WHICH MAY HARM THE
ENVIRONMENT.

Anti-Siphon Valve

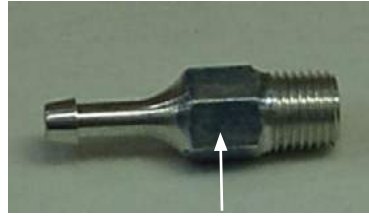

INTERNAL BALL/SPRING

The gasoline fuel tank feed line that runs from the fuel tank to an engine fuel component uses an anti-siphon valve.

The valve is threaded into the fuel tank fitting at the feed line. The valve is pulled off its seat by fuel pump pressure as the engine is cranking or running. There is a ball and spring assembly inside the valve that is activated by fuel pump impulses. It allows a one-way fuel roadway to the engine or generator fuel system. It prevents fuel from siphoning out of the tank in the event of a fuel line rupture or damaged fuel feed hose. When the engine fuel components stop the fuel from cycling the spring forces the ball against the valve opening to prohibit fuel flow.

Never remove an anti-siphon valve as it is a fuel system safety component. Also, never remove the ball and spring from the valve assembly. The anti-siphon valve requires no normal maintenance. Symptoms indicating possible valve problems may be fuel starvation at intermediate or high rpm or in extreme cases an engine that will not start.

Contact your Regal dealer for further information.

Fuel Gauge & Sending Unit

 **WARNING**

PREVENT INJURY OR DEATH!
READ AND UNDERSTAND THE
PROPULSION OWNER'S MANUAL
BEFORE ATTEMPTING
TO OPERATE THE VESSEL.

Fuel Filters



Spin on fuel filters found on stern drive engines and outboard fuel systems function to remove moisture and impurities from the fuel supply before traveling through the engine itself. They should be serviced periodically per the engine

manufacturer's instructions. It is a good idea to keep extra fuel filters on board along with a strap style filter wrench, catch container and clean rags for emergencies. Never use automotive style fuel filters on your vessel. Dispose of all fuel residue materials in an environmentally safe fashion.

These filters are available on-line, through marinas, retail marine outlets, or can be ordered via your closest Regal dealer.

Fuel Storage On Board

 **WARNING**

PREVENT INJURY OR DEATH!
FUEL VAPORS ARE A FIRE
AND EXPLOSION HAZARD.
DO NOT STORE FUELS, FLAMMABLE LIQUIDS
OR PORTABLE FUEL TANKS ON BOARD!

Read and understand the label above regarding the storage of flammables on board the vessel. Also, do not store auxiliary portable fuel tanks on board the vessel since these portable tanks can emit vapors into the atmosphere through their vent.

Hatch-Deck



The deck features a 20" round hatch. This feature is great for cabin ventilation and includes a custom screen for insect protection.

The hatch placement permits a mate to work the deck hardware during inclement weather and water conditions. Cleats and anchor locker are safely accessible from the cabin for docking/anchoring applications.



Close hatch and lock all latches against the frame securely before making headway as the hatch could become a visibility blocker from the helm position. Supervise hatch use when children are present.

Never step on the hatch while on the deck. Close and lock the hatch each time you leave the vessel.

Helm Systems

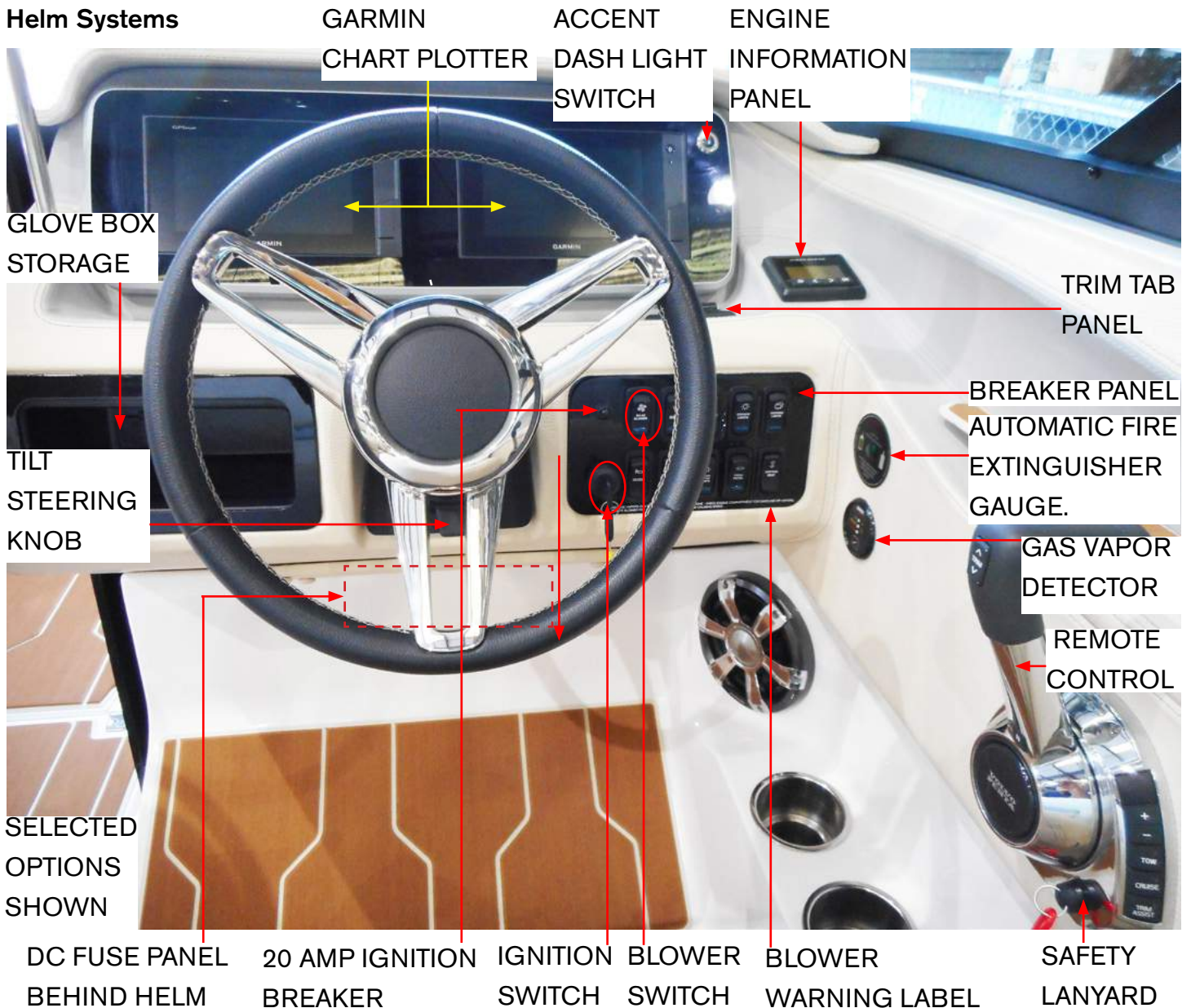

Helm Overview- (Typical)

The helm station may be equipped with the ability to monitor engine functions through a single or dual Garmin chart plotter system. Close observation of the digital display is recommended throughout the trip as you can split the screen to accommodate GPS functions along with monitoring basic engine systems including fuel usage and hours for maintenance cycles. This works in addition to the engine manufacturer's information panel system.

Obviously with the dual chart plotter option another whole dimension of information monitoring is achievable. Note that with the battery switches in the "off" position, there is no power to the helm and the ignition switch will not function.

All electrical features are protected by the main battery management panel located in the sump. Refer to earlier pages in this chapter for additional information. **Note to read and understand the blower warning/operation information on the bottom of the breaker switch panel.**

Helm Switch Panel



Bilge Blower Typical Switch Panel Shown

The helm switch panel controls various vessel electrical components. The main battery switch must be activated for most of the switch functions to work except for the automatic side of the aft bilge pump. When a particular component is activated the blue icon portion of the switch lights up. This feature is great for night cruising, too. Below is a brief description of each switch. *Note that select switches may represent optional equipment that is not installed on your vessel.*

Bilge Blower

One of the most important components on board is the bilge blower. The bilge blower switch (see photo above) controls the powered ventilation system bilge blower sometimes referred to as the blower. **Read & understand the following label!**



WARNING

GASOLINE VAPORS CAN EXPLODE
CAUSING INJURY OR DEATH!
BEFORE STARTING ENGINE, CHECK
ENGINE COMPARTMENT
FOR GASOLINE OR VAPORS.
OPERATE BLOWER 4 MINUTES.
RUN BLOWER BELOW CRUISING SPEEDS.



Typical Ventilation Blower with Hose

The powered ventilation system (blower) aids in removing any gas fumes from the engine compartment and any joined spaces. In addition, the blower removes any polluted air.

Never obstruct or modify the ventilation system!

Periodically check the black “4” hoses connected to the blower for tightness. In addition, ensure there are no holes or tears in the hoses since efficiency may be compromised. Also, make sure the attached hose extends into the lower third of the bilge. This is important since gasoline fumes are heavier than air and tend to gather in the lower bilge.

When the blower is activated any fumes will be drawn up the hose and dispersed overboard through the aft deck mounted exhaust vent.

Note that there are other black hoses attached to the aft vents that may extend a shorter distance from the vent not like the longer extending exhaust hoses. These shorter hoses bring fresh air into the engine compartment and allow the engine to “breathe” so it can run more efficiently. They comprise the “natural” ventilation system.

Bilge

This switch controls the bilge pump which is located below the front of the engine at the bilge floor. This bilge pump removes any accumulated water from the bilge.

Note that with the bilge switch in the center position the pump circuit assumes an "automatic" position and will operate even with the battery switch in the "off" position with the vessel unattended. This is a safety feature.

Periodically check the bilge pump grate for debris that could effect the pumping efficiency. Also, never manually run the pump dry for extended periods as the impeller may develop premature wear.

Nav/Anc

This on/off/on switch energizes the center bow red/green navigation light (may be rail mounted) and all-around light as a standard configuration as the top portion of the switch is pressed. This is the position for nighttime headway navigation. The lower portion of the switch will energize the all-around light on the deck for anchored use only or vessels with PowerTower or hard top will have the all around light on top of the tower or hard top.

Cockpit Lights

This switch controls the blue or white LED lighting which is normally found on vertical surfaces to aid in nighttime cockpit activity. They are especially useful to light stairways, deck walkways, and swim platforms.

Docking Lights

This switch controls the optional hull docking lights. These lights are valuable for maneuvering around docks and tight waterways at night such as you might find at marinas and locks. Do not use these lights for navigation as other vessels may not be able to see your combination bow light especially for head on and crossing situations.

Horn

This momentary switch controls the electric horn located at the starboard bow area. Make sure the horn is tested before each outing as it can be valuable in navigation situations and can be used for bridge communications. Normally there is an adjustment screw on the horn top to alter the tone. Periodically inspect the horn hardware for tightness and polish the horn grill.

Tower

This switch controls the forward or aft tower movement. When the "up" switch position is pressed the PowerTower moves to the forward position which is useful for bridge navigation and storage or towing needs.

When the "down" switch position is pressed the PowerTower moves to a vertical or run position. The vessel operator shall read and understand the following label!

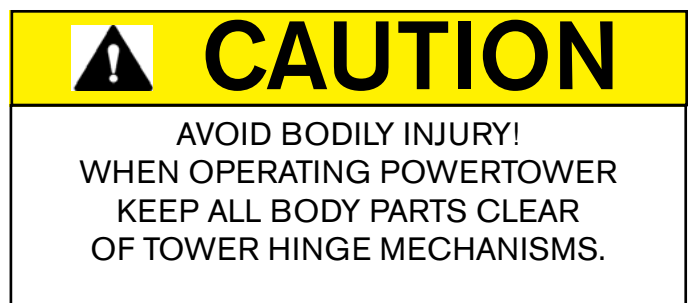

Under Water Lights

This switch controls the hull mounted underwater lights. If installed, these blue or white LED lights illuminate the water around the aft sides and transom areas. It is recommended that these lights not be activated at night with the vessel making headway.

Fresh Water

This switch energizes the on board pressurized water system. It permits the water pump to draw water from the water tank to any faucets or showers/wash downs mounted on board.

Captain Seat

This switch activates the movement of the optional captain seat for more comfortable positioning and visibility enhancement. Press the upper portion of the switch to slide the seat forward. Press the lower portion of the switch to move the seat aft for additional leg room.

Waste System

Chemical Toilet

Selected models use a sanitation toilet with a 2.3 gallon freshwater tank and 2.6 gallon waste tank capacity. There is a prismatic tank level indicator which allows for easy tank level monitoring. The push button flush clears the bowl quickly.

Selected vessels feature pump-out fittings. There is waste deck plate fitted with a hose directly to the holding tank. Most marinas provide pump-out facilities. Their equipment fits onto the waste deck plate and with an adapter hose they pump out the waste into a dedicated container.

Note to read and understand the vendor toilet operating manual before attempting to use the component.



Typical Chemical Toilet Shown

NOTICE

GENERAL INFORMATION SHOWN!
NOTE THAT YOUR TOILET MAY APPEAR AND
OPERATE SOMEWHAT DIFFERENT THAN
THE COMPONENT SHOWN HERE.
READ MANUAL FOR SPECIFIC INFORMATION.

Helpful Hints- Chemical Toilet

- Changes in the ambient temperature or the actual height above sea level while traveling can cause rising or falling holding tank pressure. Before using, equalize the holding tank pressure by opening the flush grip (slide valve) completely by pulling out. Be sure the seat cover is down before opening the slide valve.
- Never fill the portable toilet with chemicals when the slide valve is closed.
- Do not let the flush water tank build up pressure ie; covering up the pressure relief valve.
- Do not pressurize the flush water tank if it is not connected to the holding tank.
- Never empty the holding tank by dumping it into the environment; use an approved disposal station or a real toilet.
- Do not use caustic chemicals to clean the unit or wire brushes. Periodically, clean with a soft wet cloth and mild detergent.
- Use only sanitary chemicals approved by the toilet manufacturer.
- Use supervision with children when using toilet.

1

	Parts Description
1	Pump
2	Cap-Flush Water Tank
3	Flush Water Tank
4	Holding Tank
5	Fill Level Display
6	Flush Grip
7	Locking Grip
8	Flush Button

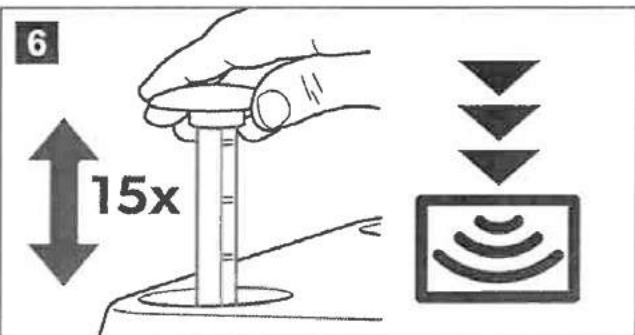
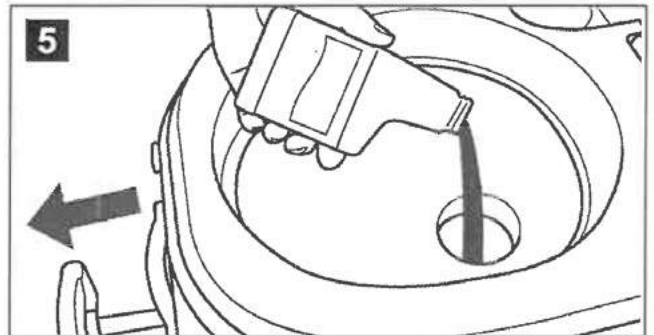
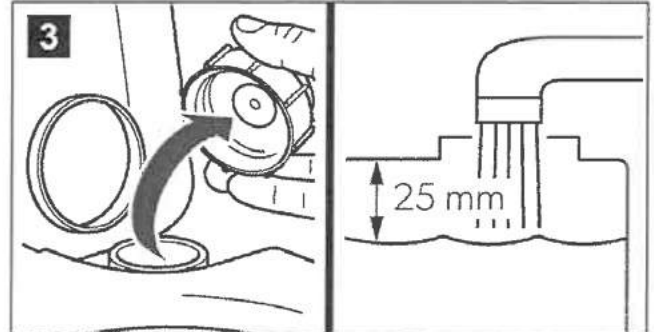
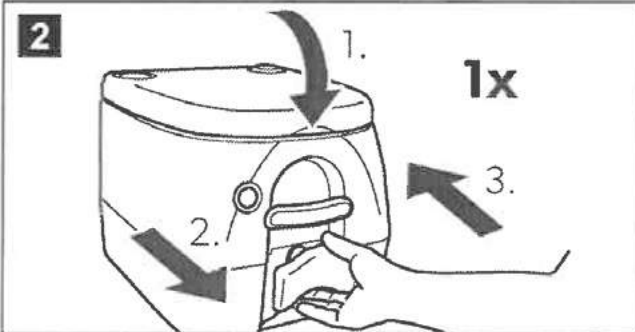
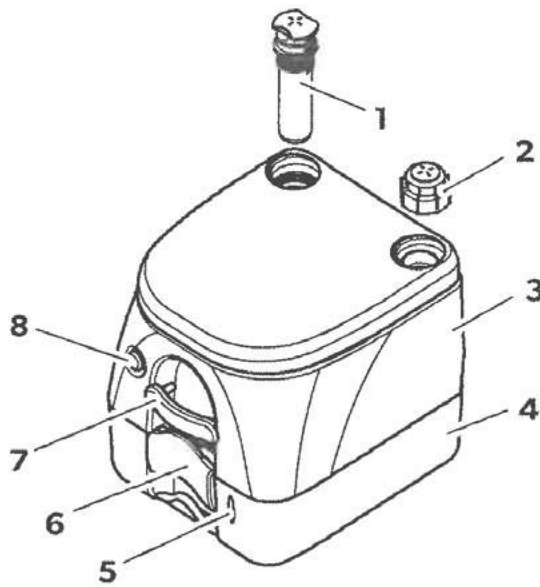

Using Chemical Toilet

Refer to the parts description and action #'s one page back. Note to ensure the pressure in the holding tank is equalized before usage. If needed, review earlier pages and carry out action #2.

1. Remove flush water tank cap and fill the tank with fresh water until level is 1" below the top. Tighten the cap on flush water tank. Refer to action #3.
2. Pull the flush grip to open the slide valve. Refer to action #4.
3. Pour the recommended sanitation chemical directly into the holding tank. Close the slide valve. Refer to action #5.
4. Press the pump approximately 15 times or until air exits the cap of the flush water tank through the pressure relief valve. Refer to action #6.

This completes the initial toilet set-up. Follow the up-coming instructions on flushing the portable toilet and emptying the holding tank.

NOTICE

TO PREVENT HOLDING TANK DAMAGE DUE TO FREEZING IN COLD CLIMATES IT IS RECOMMENDED TO DRAIN HOLDING TANK. READ MANUAL FOR SPECIFIC INFORMATION.

Flushing Toilet

Follow the action #'s on the following page.

1. Pull out the flush grip to permit the waste to pass into the holding tank. Refer to action #8.
2. Press the flush button to flush the toilet. Push the flush grip to close the slide valve. Refer to action #9.

Emptying Toilet (W/O Optional Pump-Out Fittings)

Note that if your toilet includes the pump-out fittings by pass the steps below and have your tank pumped out by an appropriate service company or marina.

1. When the filling display shows full the holding tank needs to be emptied. Pull the locking grip on the holding tank. To reach the aft bracket lift up the toilet and move it. Refer to action #10.
2. Pull up on the aft latch to disconnect the flush water tank from the holding tank. Refer to action #11.
3. Take the holding tank to a reliable disposal station or a normal toilet.
4. Turn the waste pipe away from the tank and open the pressure relief valve on top of the tank. Empty the tank. Refer to action #12.
5. After emptying holding tank rinse unit out with fresh water using a garden hose if available.
6. Reassemble unit and fill with water and chemical.

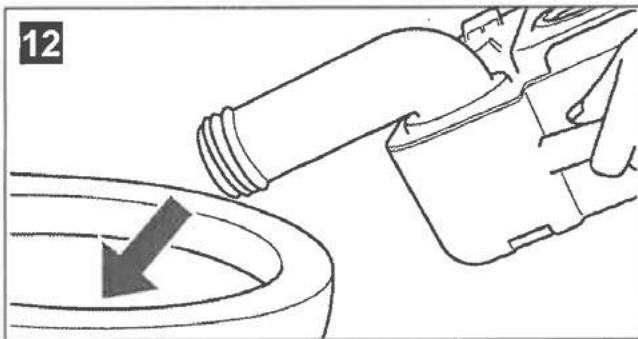
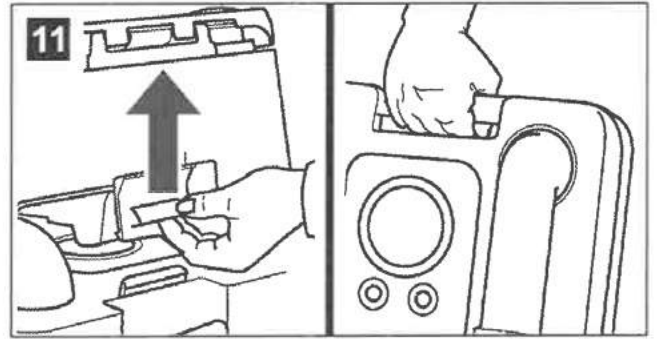
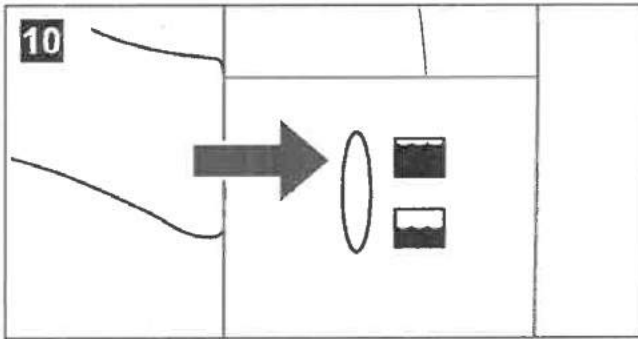
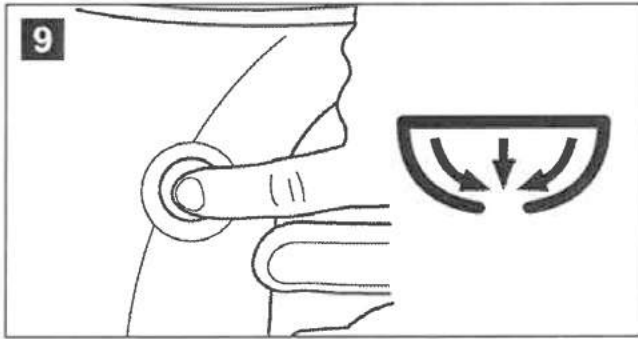
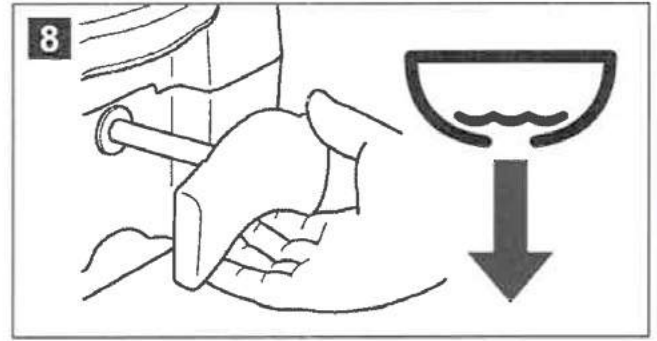
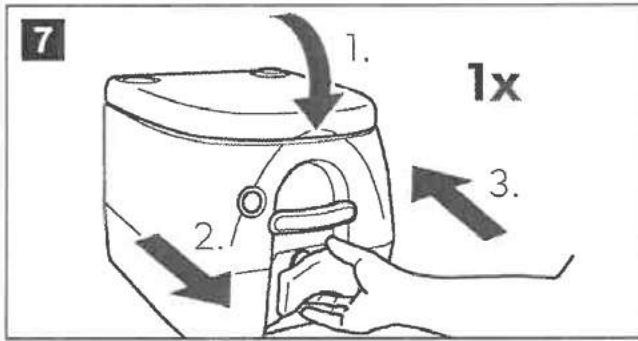

Pump-Out Fittings-Chemical Head

The chemical head features a pump-out fitting option. If installed there is a waste pump-out fitting on the deck designated with the word "waste" and the international symbol for waste.

You need to monitor the waste tank level gauge and when full contact the marina or designated business to have the tank pumped out. They will install an adapter hose into the deck waste fitting and turn on a vacuum pump which will empty the waste.

After this operation it is always recommended that you rinse the waste hose out before screwing in the waste fitting cap. This helps in reducing odor and keeps waste debris from sticking to the inside of the waste hose which in time could build up and affect the pump-out process.



Fusion MSUD650

Introduction

The Fusion stereo unit installed in your vessel is designed and engineered for the harsh marine environment. Head units are globally IPX5 rated against water ingress. When you leave your boat after a cruise weekend you can count on all selections being saved through a stereo memory system featured on your vessel, even with the main battery switch turned off.

Regal offers durable marine speakers and optional speaker LED lighting for ambiance.

The unit offers independent control of your audio entertainment including balance, sub woofer, and volume level from multiple audio zones as part of the optional stereo performance package. The standard head unit features an internal UNI-Dock for the charging, protection, and playback of your favorite media devices. It supports many media devices including Apple® iOS and MTP Android™/Windows®. Also, featured is an internal USB connector for playbacks.

The stereo features Fusion-Link™ an entertainment integration process which permits Fusion to be displayed and controlled on your Garmin chart plotter using NMEA 2000 which communicates with each component.



①		<ul style="list-style-type: none"> • Press to open a menu. • Press to return to the previous screen or menu.
②		Press to move through the available sources.
③		<ul style="list-style-type: none"> • Press to pause or resume. • AM, FM source: <ul style="list-style-type: none"> ◦ Press to move through the tuning modes: auto, manual, and presets (when two or more presets are saved). ◦ Hold to save this station as a preset. • SIRIUSXM source: Press to move through the tuning modes (auto and presets), when you have at least one preset channel. • DAB source: Press to scan for DAB stations.
④		<ul style="list-style-type: none"> • Press to skip to the previous track, when using an applicable source. • Hold to rewind the current track, when using an applicable source. • AM, FM source: <ul style="list-style-type: none"> ◦ Press to tune to the previous station. ◦ Hold for faster tuning (manual mode only). • AUX1, AUX2 source: Press to decrease the gain for the connected source. • ARC source: Press to decrease the gain for the connected source (FUSION™ MS-AV755 only). • SIRIUSXM source: Press to return to the previous channel. • DAB source: Press to return to the previous DAB station in the ensemble. When you reach the beginning of the current ensemble, the stereo automatically changes to the last available station in the previous ensemble.

⑤		<ul style="list-style-type: none"> Press to skip to the next track, when using an applicable source. Hold to fast forward the current track, when using an applicable source. AM, FM source: <ul style="list-style-type: none"> Press to tune to the next station. Hold for faster tuning (manual mode only). AUX1, AUX2 source: Press to increase the gain for the connected source. ARC source: Press to increase the gain for the connected source (FUSION MS-AV755 only). SIRIUSXM source: Press to advance to the next channel. DAB source: Press to advance to the next DAB station in the ensemble. When you reach the end of the current ensemble, the stereo automatically changes to the first available station in the next ensemble.
⑥		<ul style="list-style-type: none"> Press to mute the audio output. Press to unmute the muted audio. The volume continues at the previously set level. Pandora®: Press and hold to tell Pandora not to play this track.
⑦		<ul style="list-style-type: none"> Pandora: Press and hold to tell Pandora you like this track and would like this station to play more tracks similar to it.
⑧	Dial	<ul style="list-style-type: none"> Turn to adjust the volume. Press to switch between zones when adjusting volume. Press and hold for at least one second to adjust the subwoofer levels. Turn to move through the menus or adjust a setting. Press to select the highlighted option.
⑨		<ul style="list-style-type: none"> Press to turn the stereo on and off. Hold for six seconds to reset the stereo.
Not shown		<ul style="list-style-type: none"> Press to eject an inserted CD or DVD (FUSION MS-AV755 only). Located on the back side of the stereo face, and accessible only when the door is open (<i>Inserting a DVD or CD</i>, page 5).

Display Screens

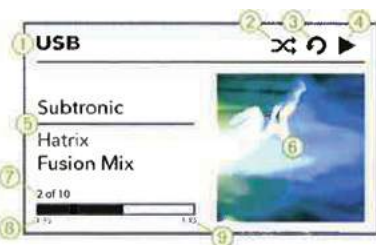

①	Source
②	Shuffle status icon
③	Repeat status icon
④	Play status icon
⑤	Track details (if available)
⑥	Album art (if available from a compatible USB source) NOTE: Album art is not displayed when playing tracks from a device connected using Bluetooth®.
⑦	Current track number out of total number of tracks in the playlist (if available)
⑧	Elapsed time
⑨	Track duration

Connecting Media Player Using Dock

You can connect a compatible media player using the universal dock built into the UD models.

- Slide the button on the top of the stereo, and pull down to open the door.
- Slide out the device tray.
- Insert the adapter cable ① into the USB port ②.
NOTE: You can connect a USB flash drive directly to the USB port.

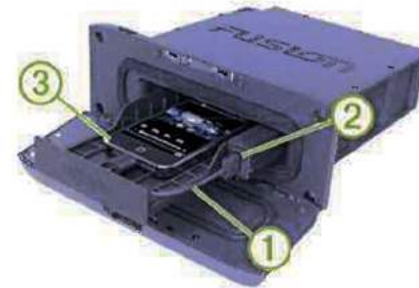

- Connect the adapter cable to the media player ③, and place it in the device tray.
NOTE: If you are connecting an Android™ device to the stereo, you should unlock the device before connecting the adapter cable.
- Slide in the device tray, and close the door.

More product information along with operation manuals can be downloaded at the following web address:

www.fusionentertainment.com/marine

Chapter 5

Engine & Controls

Engine Systems- General

Engine Checklist Before Each Outing

Every engine option may require different checks before each use, but a general engine checklist is included here as a guide.

- Check crankcase engine and stern drive oil levels.
- Check power steering fluid.
- Check power trim fluid/trim tab levels.

At Helm/Deck

- Check power trim for operation.
- Check control lever for operational defects. Check the clip and safety lanyard for functionality.
- Check any gauges for accuracy.
- Check fuel level and ensure the level is sufficient for the trip with a 1/3 reserve.

Engine Cooling System

Your typical engine normally utilizes a raw water system for cooling the engine with intakes at the



Typical Engine Overview Shown

gear case. It is important that this system continues to run unobstructed at all times to avoid hazardous situations and to ensure a safe voyage.

Raw water is drawn up into the vertical drive shaft housing through pick-up feeds above the gear case vicinity into a water pump and impeller and then into the engine itself. Water passes through a thermostat which controls how much water circulates through the engine. The cool water absorbs heat produced by the engine, before being circulated to the coolant exhaust system.

Impeller/ Water Pump

Periodically, the coolant system impeller and water pump should be inspected for debris, damage or excessive wear due to wear, water chemistry such as mineral and/or silt conditions. Damaged parts will affect the system's ability to function, and may cause engine overheating or damage. Contact your closest Regal dealer for more information and maintenance schedules affecting the engine coolant system.

Thermostat

If the temperature gauge starts yielding abnormal readings, it may become necessary to look at or replace the thermostat after determining whether it is functioning properly. The thermostat reads the temperature of coolant and determines whether to open or close a valve to allow warm sea water to pass into the exhaust manifold. The thermostat may recirculate hot coolant for the purposes of reaching standard operating temperatures. If standard operating temperatures have been reached, the thermostat will open a valve and allow hot raw water to exit through the exhaust manifold. For more information read your engine manual or contact the closest Regal dealer. Dealers have the necessary knowledge and tools to troubleshoot any engine related problems.

 WARNING
PREVENT INJURY DUE TO HOT SURFACE! AVOID TOUCHING THE THERMOSTAT OR ITS COMPONENTS WHILE THE ENGINE IS HOT.

 CAUTION
TO PREVENT ENGINE DAMAGE DUE TO OVERHEATING AVOID RUNNING THE ENGINE WITHOUT A FUNCTIONING THERMOSTAT.

 CAUTION
AVOID ENGINE DAMAGE OR FAILURE! DISCONTINUE ENGINE OPERATION AFTER AN ALARM HAS SOUNDED. ADDRESS MALFUNCTION BEFORE RESTARTING ENGINE.

Engine Electrical System

Your engine utilizes a great deal of electronic equipment. Some equipment sends signals between the engine and the Garmin, while other systems set off alarms, and still others are used by the engine to generate a spark and ignite the fuel. The battery switch controls electrical power distribution to the boat systems.

To regularly maintain your DC electrical system, inspect battery condition before each trip. Test all gauges and control equipment prior to departure, and replace as necessary. Spark plugs should be replaced according to your engine owner's manual maintenance schedule.

Gauge Electrical Signals

Your stern drive engine transmits signals through electrical harnesses to different components through the use of NMEA 2000 connections and a "backbone system". A Garmin plotter displays the engine functions. The fuel gauge and depth sounder use stand alone technology to display readings. Also, idiot lights are display tolerances that are classified as being abnormal.

Alarms

If a malfunction with your engine occurs, the Garmin plotter alerts the skipper of a problem. Common engine problems include overheating, low oil pressure, or a miscommunication with equipment. Learn the alarm systems that apply to your engine by consulting your engine owner's manual. Engine manufacturer's feature their own engine display screen which may display rpm, engine hours, coolant temperatures and use alarms.

Garmin Engine Monitoring Display



Typical Display Shown

A Garmin chart plotter may be installed on your vessel. The unit displays many GPS features along with the ability to monitor engine system functions including engine revolutions per minute (rpm's), GPS speed, voltage, fuel flow rate, trim, and temperature along with tracking engine hours. Fusion uses its own display screen on the chartplotter for audio controls on the vessel.

Note that the Garmin and Fusion circuitry use individual DC sources to power up the system. The key switch does not power up these 2 systems.

1. To power up the Garmin GPS press the "on" button located at the upper chart plotter display.
2. The function AV/Gauges,Controls will appear as one of the choice boxes. Press the box. Another screen with engine will appear.
3. Press the engine box and the engine gauge displays will appear (oil pressure is engine code driven only).

For more information refer to the Garmin manual.

Spark Plugs

The spark plugs are components that help make ignition occur. As electrical potential builds on one side of the gap based upon the energy distributed by the ignition system, the potential eventually grows large enough to cause the electric current to jump the gap on the spark plug. This spark is what ignites the compressed fuel generating a controlled explosion that will power the piston down and deliver power to the drive shaft.

Alternator

Under normal circumstances, the starter battery would wear down after being used so often to generate a spark for the engine. This isn't an ideal setup because a strong battery is needed for continual operation. A weak battery does no good out on the water. The alternator recharges the battery(ies) while the engine is running.

However, in an effort to conserve battery life, the battery switch should still be turned off after every trip and turned on at the start of every trip. This limits the drain on the battery during non-use.

As optional equipment a 10 amp battery charging system charges batteries when the shore cord is connected to the vessel 3 prong grounded plug which must be connected to a GFCI outlet. Read and understand the following label!

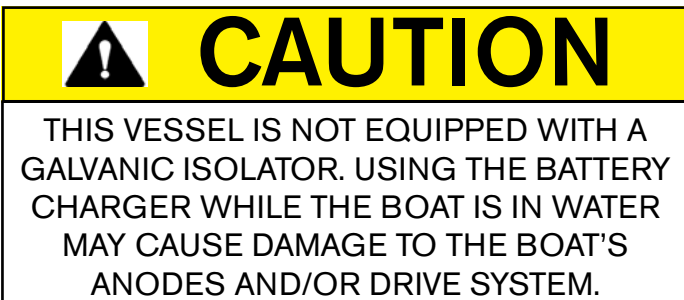

Fuses

Your engine also comes equipped with fuses that will burn out or “blow” when engine components attempt to draw more power than the piece of equipment or wiring can handle. When the fuse blows, it breaks the circuit, and electricity stops flowing. Before replacing the fuse, investigate the cause of the problem, and why the equipment was overworked. Your engine uses a helm mounted fuse box which is accessible by lifting the starboard bow backrest while other engines feature in-line fuses, while still others feature a mixture of both. Refer to your engine owner's manual for complete details on your electrical system and the location of any engine mounted over current protection.

Engine Exhaust System

Your engine expels the by-products of the engine operation through an exhaust system, just like automobiles do. In boats however, this exhaust system mixes the debris left over after the power stroke of the engine with the hot water that is expelled after cooling the engine.

Basically the exhaust flows through the engine before expelling the exhaust through the vertical drive housing either just above the propeller, or through the prop shaft.

Engine Fuel System

Refer to the system chapter of this manual for fuel system specifics. Be sure to read and understand the following warnings.



WARNING

USE OF ALCOHOL ENHANCED FUEL, OR ANY FUEL OTHER THAN GASOLINE CAN LEAD TO DETERIORATION OF THE FUEL SYSTEM COMPONENTS. THIS CAN RESULT IN FIRE AND POSSIBLE EXPLOSION.



WARNING

GASOLINE VAPORS CAN EXPLODE!
BEFORE STARTING ENGINE
CHECK BILGE COMPARTMENTS
FOR GASOLINE LEAKS OR VAPORS.



WARNING

PREVENT INJURY OR DEATH
DUE TO FIRE OR EXPLOSION!
RUN BLOWER AT LEAST 4
MINUTES BEFORE STARTING ENGINE.

Engine Lubrication System

Whenever two components rub together, friction causes wear on both components. To minimize the wear on your engine, a lubrication system has been put in place to help components slide next to each other easier. This is particularly important within the inner workings of an engine. It is important to ensure your lubrication system is working properly at all times.

Your Regal utilizes lubrication and fluids that need regular check ups. Refer to your engine owner's manual for specific details regarding the proper maintenance of the lubrication system.

Note that your engine uses other lubricants in addition to engine oil such as power trim fluid and gear lubricants to reduce wear on moving components. These fluids should be checked according to the recommended maintenance procedures determined by the engine manufacturer.

Engine Oil

The purpose of engine oil is to lubricate the internal components of the engine and ensure parts that regularly move against each other have reduced friction to lessen wear and noise between components. An oil filter traps small particles and keeps harmful debris out of the engine's interior parts.

Stern drive engines performing on regular oil should have the oil drained and replaced after the first 20 hours of operation or 3 months, and every 100 hours or at 1 year intervals thereafter.

Stern Drive Oil

Stern drive oil keeps all the mechanical components of the prop shaft gear assembly functioning optimally. It reduces friction in the gear case as the gears revolve. Sometimes gear case oil is called gear lubricant. Gear case oil should be inspected periodically according to factory maintenance schedules. Use engine manufacturer's recommended oil.

Power Trim Fluid

Power trim fluid permits your out drive to trim up or down. This is particularly useful when trying to reach a planning position.

Power trim fluid is used in hydraulic rams that maneuver the stern drive unit. Power trim fluid should be checked regularly in the reservoir which is located in the bilge.

Propeller System



Regal has carefully tested and chosen the propellers to give your vessel the best possible performance based on the engine and propulsion package you choose. We have allowed for the additional weight in equipment that might be added to the boat. It is a good idea to carry a spare set of propellers and hand tools onboard in order to handle emergency propeller changes.

Marine propellers may display the following information:

1. Propeller pitch shown by inches.
2. Propeller type (L for left or R for right).
3. Propeller diameter in inches

Refer to the engine manual for propeller removal and installation procedures, as the application is unique to the manufacturer. Call a marine professional or your Regal dealer for to order a spare propeller set.

Propeller Checklist

At least twice a year, check the propeller for:

- Loose, missing, or corroded hardware.
- Nicks, dings, or missing propeller material
- Bent propeller blades.
- Objects wrapped around the prop (fish line)
- Decomposing propeller blades (electrolysis symptom).
- If equipped, check the propeller rubber hub for slippage

Contact a propeller shop or your closest Regal dealer if any of the above symptoms exist. They have purchased special equipment to refurbish both stainless steel and aluminum propellers.

Starting Engine

Before Starting Engine

Note that it is important that you read and understand the engine operator's manual carefully and become completely familiar with the operation as well as required maintenance procedures on the engine and related propulsion systems.

Before starting the engine check the guidelines below:

1. Open the engine hatch and sniff for fuel smells and visually check for fuel leaks. If gasoline vapors are sensed or leaks seen be sure to determine the cause and repair the source **before starting the engine**. If you can not locate a fuel leak contact a marine professional immediately or your closest Regal dealer.

1 A. Always run the bilge blower at least 4 minutes before attempting to start the engine. Continue to run the blower after the engine starts below cruising speeds.

2. Remove any loose canvas and store in a dry location.

3. Shut and secure all portholes and doors.

4. Make sure the swim ladder is secured in its folded position and that the cover if installed is in place.

5. Check fuel supply levels. Use the fuel "1/3" rule.

6. Turn battery switch to the "on" position at the battery panel.

7. Activate the VHF if installed and listen for the latest weather conditions along with performing a radio check.

8. Activate the plotter and check its function, set your cruise, and monitor engine read-outs once the engine has started.



Check to ensure that all ventilation duct grills are clear of foreign objects. The

natural and powered ducts provide a continual air supply to the engine compartment and evacuate any fumes along with warm air. Sometimes insects make nests in the vent ducts. Lift the aft cushion on both port and starboard sides to access the ventilation ducts/grilles.

Starting Engine

After the preliminary checks are performed the engine is ready to start. Insert the ignition key into the ignition panel key switch hole. Note that the key switch shows three positions;



A) Straight Up= "Off"

B) 45 Degree Angle to Right= "Ignition" or "On"

C) Spring Loaded Furthest Right= "Start"

When you turn the key switch to the furthest right position you may feel a small resistance which is the spring loaded key switch position. This is normal.

Ensure that your remote control is in the idle neutral position before beginning the starter cranking process!

Crank the starter over until the engine starts. When the engine starts leave go of the key and it will spring back to the ignition or "on" position for normal running.

If the starter continues to crank and the engine does not start turn the key back to the "off" position and let the starter cool down between start attempts.

Note to avoid possible starter damage do not crank the starter over more than 20 seconds on each start cycle.

Note that if a flooding condition should exist put the throttle in full throttle neutral gear position and crank the starter. If it does not start try it again in the same advanced neutral throttle position. When it starts return the throttle to the upright neutral idle position. If it does not start return to the neutral idle position and let it set a few minutes before re-cranking the starter. Never continuously pump the throttle.

After Starting

1. Allow the engines to idle for a short period as they warm up. Never race a cold engine!
2. Check the chart plotter and pay particular attention to volts, oil pressure and temperature display panel functions as they are key indicators of a proper performing engine. Also, check that no alarms are sounding, warning lights are flashing and no fault codes display on screens. See information display.
3. Open the engine compartment and listen to the engine for unusual sounds.
4. Inspect the fuel, exhaust, and engine circulation system for leaks.
5. Visually check the entire sump (bilge) for any unusual conditions ie; oil spillage, high water.
6. Visually check your passengers to ensure they are wearing the proper PFD (personal flotation device), are sitting in a designated seat, boat load is balanced, and the operator has uninterrupted field of vision before shifting the remote control.
7. Make sure that all passengers have been informed on using the various seat hand holds should the sea conditions deteriorate.





8. Selected vessel feature an information display panel as part of the engine related components.

This display located at the helm area shows

engine and operational information, messages and alarms. A portion of the same engine information could be displayed through the chart plotter screen. The basic settings show:

- Engine speed
- Oil Pressure
- Coolant Temperature
- Battery Voltage

One of the features on the information panel is the fault display. If the system finds a fault, the word fault and the number of them are shown on the display. By pressing the OK button the panel will display all detected faults.

Navigating to the Settings menu. Press OK to bring up sub menus. Use the arrows to seek the information. For more detailed information refer to the engine operation manual.

Note that it is recommended to use the display cover on the unit when not in use. The prolonged rays of the sun and high temperatures over time may damage the screen.

Corrosion Protection Systems

Your vessel's engine either Volvo or MerCruiser may be equipped with a corrosion protection system. The Volvo system is called the active corrosion protection system (ACPS) and the MerCruiser system is called a MerCathode system. Refer to your engine manual for more information. We will cover the basic ACPS system here.

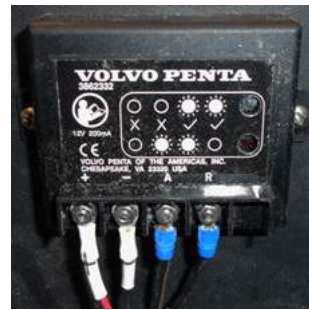

The ACPS works as an active anode and is programmed to reduce the galvanic corrosion in underwater stern drive parts. The system works along with the sacrificial drive

zinc anodes. Longer life for anodes is provided through the ACPS but periodic visual maintenance checks of anodes are still required. This system was designed to work only in salt water.

The system will **not** provide protection from stray currents emitted from a faulty AC power source on the dock, your boat, or other boats close to yours. The module is usually mounted aft of the engine. Note the red and green LED indicator lights. They indicate the system status.

1. Green LED only indicates the system is working.
2. Green and red LED's on, the system is working, but the system is drawing power.
3. Red LED only, the system has power but is not working (no protection).
4. No LED's, the system does not have power, and is not working (no protection).

Remote Control

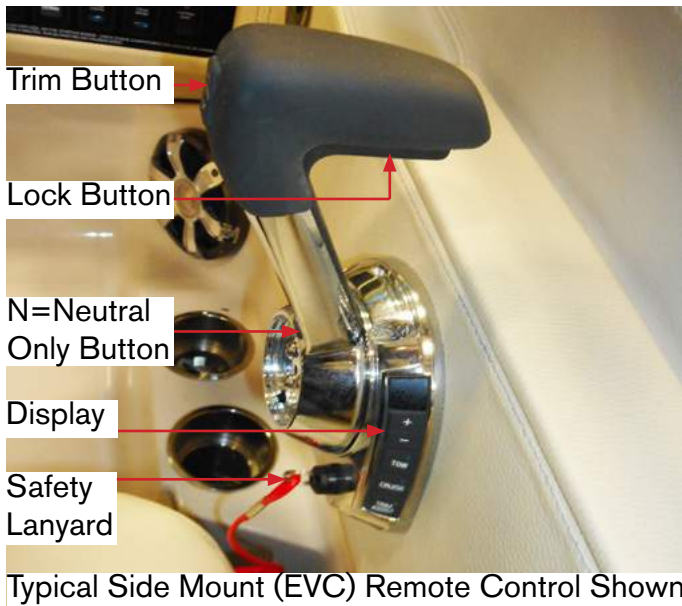

Introduction

A majority of bow rider stern drive vessels use a single lever side mount binnacle control for shifting and throttle operations. The remote control handle controls forward, neutral and reverse shifting as well as throttle operations. A trim button permits raising and lowering the drive to provide an optimum ride and the best vessel position (angle) as it travels through the water. *As there is a neutral safety switch in the system the control must be in the neutral position to crank and start the engine.*

Understand all remote control functions before operating the vessel. The single control handle makes it much easier to maneuver in tight quarters. See the information following for basic component description and operation. *Note to read and understand the engine manufacturer's manual before attempting to operate the vessel remote control.*

Practice docking operations using the remote control in a controlled environment to learn the basic functions and the vessel's response to them.

Safety Lanyard

Locate the remote control handle in the neutral position. Advance the neutral throttle position as instructed in the engine owner's manual. The function of the safety lanyard is to shut down the ignition should the captain become separated from the steering position such as falling down or losing consciousness. Connect the safety lanyard to a belt or secure piece of clothing. Ensure the lanyard is securely fastened to the remote control post. Keep passengers seated and away from helm controls at all times. Never leave the helm unattended when the engines are running.



WARNING

LANYARD MUST BE ATTACHED TO THE OPERATOR WHILE THE ENGINE IS RUNNING. A QUALIFIED OPERATOR MUST BE IN CONTROL AT ALL TIMES. READ AND UNDERSTAND THE OWNER'S MANUAL BEFORE OPERATING VESSEL.



WARNING

AVOID POSSIBLE INJURY OR DEATH! BEFORE MAKING HEADWAY ENSURE THAT ALL PASSENGERS ARE OCCUPYING DESIGNATED SEATS. ENSURE THAT DRIVER HAS UNOBSTRUCTED VISIBILITY IN BOTH FORWARD AND AFT SECTORS.



CAUTION

IF THE LANYARD IS IN THE "OFF" POSITION, THE ENGINE WILL CRANK OVER BUT WILL NOT START. ENSURE SAFETY LANYARD IS ATTACHED SECURELY TO A BELT OR SECURE PIECE OF CLOTHING AND THE REMOTE CONTROL PANEL.

Remote Control Display Bar

There are several features found on the Volvo EVC or MerCruiser DTS remote control display. See the individual buttons on the display strip shown on the previous page. They include trim assist, cruise control and tow mode. A brief description is found below. Note that the MerCruiser DTS remote control uses similar features. For a complete guide refer to the engine operator's manual.

Power Trim Assistant- Activate the PTA by pressing the Trim Assist button on the remote control. When you press the button again you deactivate the PTA. It automatically adjusts the trim angle to the engine speed. This feature permits trim functions to be loaded to control the in and out movement of the drive unit which control the boat angle and ride conditions. It eliminates the need to use the trim button on the side of the remote control handle. When the throttle changes the trim servos automatically "pair" themselves with the control handle position; full speed or anywhere in between they will seek the optimum trim angle for that speed.

Note that the power trim assistant will not move the stern drive if it is manually trimmed above 7 degrees.

Note to ensure the PTA function is "off" if the vessel needs to be removed from the water. This eliminates automatic trimming of the drive if any test runs are performed with the rig land locked.

Cruise Control- Activate the cruise control by pressing the button. This feature controls the vessel speeds in increments of 50 revolutions per minute shown as + or - on the control display. Each time the + button is pressed the engine rpm's increases by 50 rpm's. Each time the - button is pressed the engine rpm's decreases by 50. You can hit the plus or minus 5 times from where you have the throttles set. Beyond that it is time to move the controls and start again.

You might find yourself using this feature in heavy seas where you can make changes as wave height, current and wind conditions change and you do not want to manually use the control handle.

Tow Mode- Activate the tow mode by pressing the button. This feature is especially useful in water sports where you can program the throttle to remain at a specified rpm. Once programmed the tow mode will take the engine to that preset rpm which is best suited for the rider.

Triangle Symbol- The triangle icon lights up if the EVC system has registered a fault; refer to the Fault Code Information in the engine owner's manual.

Mil Light- (indicator light) lights up if the engine's emission system has registered a fault. At engine start, with the ignition on and the engine not running, the MIL will light on the control. This is a system test. The light will disappear when the engine is running unless there are engine faults.

Remote Control Operation

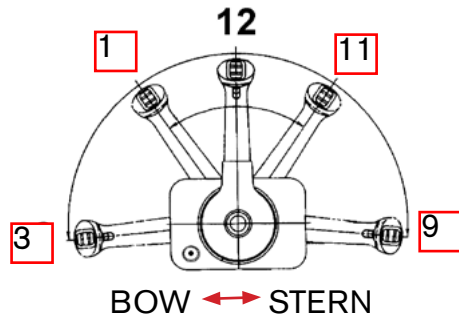

Profile Of Typical Engine Control Lever Displaying Five Positions



Shown here is the Volvo EVC (Electronic Vessel Control) remote control in a 12 o'clock or neutral position above with idle throttle control (left). This is the neutral position for starting and stopping

the engine(s). Press the N button to activate the neutral position and a flashing light appears. Now depress the lock button (provides start in gear protection) upward and this will permit advancing the throttle in a neutral position to warm up a cold engine.



Depress the lock button. Push the throttle control lever forward from the neutral 12 o'clock position to the 1 o'clock position and you will reach forward gear with minimal throttle. From the 1 o'clock position to the 3 o'clock position, the vessel is in forward gear with differing levels of throttle selections.



Shown here is the remote control in a full throttle forward (3 o'clock) gear position.



Pulling the throttle control lever back from the neutral 12 o'clock position to the 11 o'clock position will engage the reverse gear with minimal throttle. From the 11 o'clock position to the 9 o'clock position, the vessel is in reverse gear with differing levels of throttle selections.



Shown here is the remote control in the full reverse position which shows as 9 o'clock.

See the Remote Control Operation diagram. This is a throttle position you would use for an emergency such as to avoid running aground or a collision. *Note that the operator needs to heed the warning that this throttled up reverse position under the right conditions could deposit large amounts of water over the swim platform or transom.*

The control lever features a *neutral safety switch* which ensures the engine and control are in the indented neutral position for starting the engine. You will hear a distinct tone and will feel the remote control's rotation lock in neutral when you shift from reverse or forward into neutral.

Note that if you turn the key and the engine starter doesn't crank the engine, ensure the control lever is in the neutral position.

Note that the Volvo EVC stands for electronic vessel control and MerCruiser DTS stands for (digital throttle and shift). Both are known as "fly by wire" systems. Both systems assume similar control positions as shown above.

Hints For Shifting

- DO NOT shift quickly from forward to reverse gear positions. Drive system damage may occur.
- DO NOT “pump” the throttle in neutral as it is normally not needed since today’s engines use an enrichment valve system that requires very little starting throttle.
- DO NOT try to shift into forward or reverse gear at high rpm’s. Personal injury, drive system, or property damage may result.
- Only use idle throttle positions when docking or maneuvering in tight quarters.
- Wear your safety lanyard at all times.
- Never shift the controls with the engine not running.
- Always ensure you have unobstructed visibility before you shift into forward or reverse gears.
- For more information on remote controls and shifting read engine manufacturer’s operation manual before operating the remote control.

Power Steering Operation

Your vessel features a rack steering system verses a digital based system. The rack includes a mechanical cable that travels from the steering wheel rack to the engine power steering cylinder. It is assisted by a belt driven power steering pump which pushes power steering fluid through the engine mounted power steering cylinder as the steering wheel is rotated to port or starboard.

The system provides smooth, almost effortless tracking to both port and starboard directions.

Note that whenever you check the engine oil it is recommended at that point to check the power steering reservoir fluid level. Fill with correct type of power steering fluid. See the engine owner’s manual for more information regarding power steering specifications.

Chapter 6

Vessel Operation

Getting Underway

Pre-departure Questionnaire

- Have all fluid levels been topped off?
- Is the fuel tank full?
- Is all safety equipment accounted for and easily accessible?
- Are navigation lights and horn operating properly?
- Is the bilge free of water and does the bilge pump operate?
- Is the engine and propeller in good working condition?
- Is the drain plug in place ?
- Have all passengers been briefed on emergency procedures and seated for departure? Is the boat load balanced?
- Is the operator sober, alert and ready to skipper the vessel?
- Have all passengers been fitted for life jackets?
- Has a float plan been filed and left with a component person?

- Has the bilge been sniffed and the fuel system leak checked?
- Are sea cocks open (if applicable)?
- Is all communication equipment in good operating condition?
- Has a second person been briefed on operational procedures should the skipper become disabled?
- Are all gauges and electrical switches functioning properly?
- Has weather information been gathered and analyzed?

Underway Questionnaire

- After casting off have all dock lines and fenders been stowed?
- Are all passengers seated and all doors closed and latched?
- As skipper are you monitoring the dash gauges and/or Garmin plotter for changes?
- As skipper are you on the lookout for changing weather?
- Is the remote control safety lanyard tightly secured to your belt or clothing?

Disembarking Questionnaire

Have you removed the keys from the ignition and secured them?

- Have all systems been checked for leaks?
- Has the battery switch been turned to the “off” position?
- Are all sea cocks closed (if applicable)?
- Has the fuel tank been filled enough to prevent condensation?
- Is the vessel properly tied and covered with equipment stored?

Fueling

 **DANGER**

AVOID SERIOUS INJURY OR DEATH!
GASOLINE IS HIGHLY FLAMMABLE
AND EXPLOSIVE MATERIAL.
PRACTICE “NO SMOKING” AND EXTINGUISH
ALL FLAMMABLE MATERIALS
WITHIN 75 FEET
OF THE FUEL DOCK

 **WARNING**

AVOID INJURY OR DEATH FROM FIRE
OR EXPLOSION
RESULTING FROM LEAKING FUEL!
INSPECT ENTIRE FUEL SYSTEM AT
LEAST ONCE PER YEAR.

 **WARNING**

SINCE GASOLINE IS AVAILABLE
IN SEVERAL GRADES
INCLUDING ETHANOL AND VARIOUS
OCTANE LEVELS, REFER TO THE ENGINE
MANUFACTURER’S OWNER’S MANUAL FOR THE
CORRECT GAS TYPE/GRADE.
USING THE IMPROPER OCTANE LEVEL
OR THE WRONG GASOLINE TYPE CAN CAUSE
ENGINE DAMAGE AND VOID THE WARRANTY!

Before Fueling

- Make sure a working fire extinguisher is available.
- Stop engines and any device that can cause a spark.
- Disembark all passengers and crew not needed for fueling.
- Fuel if possible during the daylight hours.
- Check to ensure nobody is smoking in the boat or near the fueling dock.
- Close all portholes, hatches and doors to keep vapors from blowing aboard and settling in the bilge.
- Tie up your boat securely at the fuel dock.
- Identify the fuel fill. Unfortunately, people have mistakenly filled the water or waste with fuel.
- Visually inspect all fuel system components before each filling.
- Avoid using fuels with E-15 alcohol additives. It can attack fuel system parts along with hoses and cause deterioration.

During Fueling

- Keep the fuel nozzle in contact with the fuel fill to guard against static sparks. The fuel fill pipe is grounded through the fuel system wiring to protect against static electricity.
- Avoid overfilling the fuel tank. Leave room for expansion. Also, if fuel exits the fuel vent indicating the tank is full, this situation is dangerous and unfriendly to the environment.
- Avoid spilling any fuel. Clean up any fuel accidentally spilled with a clean rag and dispose of it on shore.

After Fueling

- Close all fuel fill openings tightly.
- Open all portholes, hatches and doors if applicable.
- Sniff in the bilge and engine area for gas fumes. If fumes are detected continue to let the area ventilate until the odor is gone. Look for any traces of fuel droplets or spillage. Do not start the engine(s), smoke or run any electrical components until the fumes can no longer be detected.

Strong Points- Read Following Warning Label

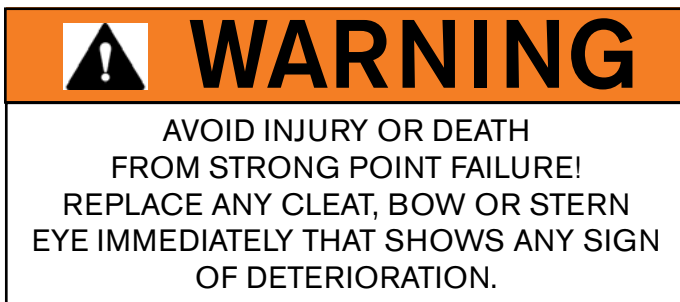

Dock Line Basics

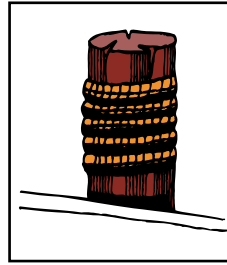

Most skippers use dock line terminology fairly loose but there is more to the basics than just bow or stern lines. There are several lines that can be secured to the bow and stern and depending on their direction and use, can be called other names. Remember that “forward” and “aft” refer to the direction that a spring line runs from the vessel, and not where it is secured on board.

Bow/Stern Lines

There is only one true bow line. It is secured to the forward cleat and run forward along the dock to prevent the vessel from moving to the stern. The stern line leads from a rear cleat to a piling or cleat on the dock astern of the vessel. This line keeps the boat from moving ahead. For small vessels these are the only lines needed for normal wind and current conditions. If located in a tidal environment, keep slack in the lines.

Breast Lines

These lines are attached to the bow and stern that lead to nearly right angles from the center of the vessel to the dock. They help keep larger vessels from moving away from the dock, or are pulled in to help people board the vessel. Larger vessels may use bow or quarter breast lines.

Spring Lines

Most small boats use two spring lines although it is possible to have four. They are called the after bow spring and forward quarter spring.

Bow springs are secured at the vessels bow area. Forward spring lines lead forward from the boat to the dock and control movement toward the stern. After springs stem aft from the vessel, and stop movement ahead. Spring lines are used to prevent movement in a berth, ahead or astern. They are really useful in controlling the effects of a real active tidal surge. Spring lines are useful where fenders need to be kept in place against piles.

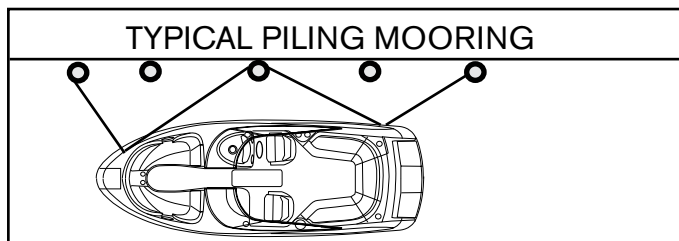
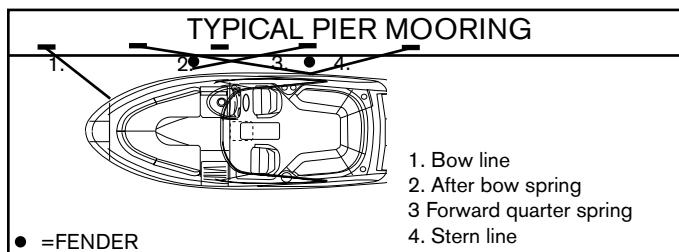

Boat Mooring

Most boats can be secured to a dock using four lines. The after bow spring is crossed with the forward quarter spring and secured to individual dock cleats or pilings. This ensures longer springs and can be snugged up tighter for more efficient tidal control.

Remember, if you only have one piling available, position the vessel so this point is opposite amidships. Run both spring lines to it. These lines will be shorter but still useful. The bow and stern lines should be relatively at a 45 degree angle with the dock. The stern line can be attached to the near-shore quarter cleat, but will work more efficiently to the offshore quarter cleat. The longer line will allow the boat flow with the tide with less time checking the vessel.

Dock Line Sizing

Most dock lines today are made of nylon, either of twisted rope or braided core and cover. The most often used material is nylon because of its stretching abilities absorbing shock loads. It is chafe resistant for extended life and is easier on bare hands.

The line's size varies with the vessel. Normally, a vessel in the 20' to 40' boats will use 1/2" diameter nylon lines. Larger yachts use 5/8" and 3/4" diameter nylon lines. Smaller boats can use 3/8" nylon lines.

Dock lines need to have the strength to hold the vessel and have enough density to resist chafing. They shouldn't be too heavy that they lose their shock-absorbing capabilities. Use the right size line for the vessel since a line too large for the boat will pull hard against the vessel since it won't be forced to stretch. If the line is too small for the vessel, there is no margin for wear and chafe when under strain.

Securing Dock Lines

When mooring your boat, make sure the dock lines are secured at both ends. Depending on your situation you may need to loop the eye splice of the dock line around a piling.

Sometimes the mooring line will lead down sharply from the piling to the deck cleat. Loop the eye splice around the piling twice to keep it from being pulled up off the pile.

Pull the line through the looped eye if the mooring line is too small to go around the piling twice or too small to fit over once.

If you must drop a line over a piling that already holds another boat's line, run the eye of the line up through the first eye from below, then loop it over the pile. This will allow either line to be removed without disturbing the other. If another line is dropped over yours, simply reverse the process. Secure a little slack in the other dock line, then slip your eye up through its loop and over the top of the pile. Your line can be dropped through the other eye.

When debarking from a dock, it is easier to release the line from a cleat or piling, from on board the boat, as soon as you leave the dock. Loop a long line around the cleat or pier and leading both ends on board you can release the line easily. Slip one end around the cleat or pile, then pull it back on board. Release the line without the eye splice, so it will run freely from around the pile without hanging up on the splice.

Fenders

Fenders are normally made of a rubberized plastic and are usually filled with air. Most have a fitting like a basketball so they can be inflated or deflated. Fenders are available in a wide range of sizes and shapes to fit both small and large vessels. Fenders are normally designated in inches. They are used between piers, docks, sea walls and the boat.

They protect the top sides of the boat from rubbing against rough objects. Most fenders have eyes of attachment which allow a line to be inserted vertically or horizontally. This will permit the fender to be tied off to fit a variety of marina, dock and tidal situations. Be sure the fender is correct for the vessel size. It is a good idea to carry extra fenders but half a dozen is normally an acceptable number. Remember to store fenders on board so they can be easily accessed. Some people incorrectly call fenders "bumpers".

Note that optional fender clips are available for your vessel.



There is a variety of fender styles and types, each selected for specified uses. When choosing fenders, contact a marine dealer or supply house. Explain how you moor and use your vessel so they can recommend the best fender type for you. We suggest the type with a fill plug so you can inflate them with a hand pump like the ones used for bicycles.

Stern Drive Maneuvering

Directing propeller energy (thrust) makes slower speed maneuvering easier. The propeller discharge current is turned from one side to the other which results in turning forces. Rudder boats need water to flow by the rudder to be efficient. Stern drive units are designed to have reduced shaft angle, so the propeller does not produce as much unequal blade thrust and resistance. Large horsepower boats do produce more thrust and steering torque but your vessel has the advantage of a "fly by wire" steering.

Below is some basic information on how stern drive boats handle in normal conditions.

Gathering Headway

When a stern drive is not moving forward or reverse in the water and the propeller is not turning, (shift in neutral) the boat will not react to the helm steering wheel.

As soon as the vessel is shifted into forward gear propeller action creates a discharge motion and generates energy in the form of thrust. If the drive is centered, the discharge motion is directed straight back causing the vessel to advance forward.

You may notice that if you advance the throttle quickly in initial take-off (make sure you have a firm grip on the wheel), the boat has a tendency to pull the stern of the vessel to starboard. There is a trim tab (also serves as a sacrificial anode) located on the drive housing. This trim tab helps compensate for the low speed steering torque. Once the boat increases headway and the propeller is operating in a faster water flow this torque effect decreases.

Sometimes the trim tab may need adjustment. Contact your Regal dealer for further information or consult your engine manufacturer's manual.

Turning

Once the boat has gathered headway, with the boat planing at the correct bow angle and the outboard drive unit and helm straight the boat tends to stay on a uniform course heading. To assure the boat trim angle is correct use the chart plotter screen trim gauge as a guide while activating the trim button on the remote control panel.

When the helm wheel is turned to the right or starboard, the drive unit is turned in the same direction. The propeller's discharge force is directed to starboard forcing the boat's stern to port. Water flowing past the hull strikes the stern drive gear housing in its starboard side, creating additional turning torque. The stern starts a move to port, forcing the bow to starboard.

If the helm is turned to the left or port the drive turns to port, the stern of the boat goes starboard as the bow turns to port.

As the vessel operator gains experience, he will better gauge each maneuver and speed situation. In this way he will understand the handling characteristics of his boat. He needs to keep the safety of his passengers in the highest priority.

Backing Down

If your boat has the steering wheel and drive straight with the control in reverse, the stern will be pushed a bit to port by the reversing propeller thrust. This tendency to back to port can be eliminated by turning the drive to starboard.

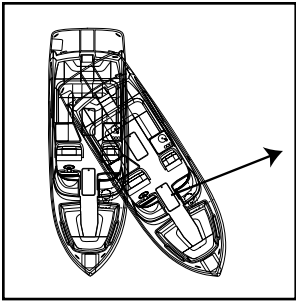

When the vessel begins to gather speed to stern, the water passing by the lower gear case housing will continue to increase steering torque. If the helm wheel is turned to

starboard, and will direct the propeller thrust to port, tracking the stern to starboard.

Wind and current will affect how a vessel backs. Stern drive boats tend to be light displacements and when backing down in a strong crosswind, the bow will tend to fall toward the windward. This may cause steering problems.

Stopping

Remember that your boat does not have any brakes. It uses reverse thrust from the propellers to stop. If the vessel has headway, with the helm and propeller in reverse the propeller thrust is directed backwards, past the lower gear case. Depending on how far the throttle is advanced, the discharged thrust may not be strong enough to reverse the water flowing by the gear case. As the power is increased, the propeller thrust becomes strong enough to stop the flow of water past the lower unit, and, as the throttle is advanced it reverses its flow more completely.

When water is flowing past the gear case, steering torque is increased, but when the thrust stops the water flow, the boat will not respond to the helm. This is a short lived event and is overcome quickly when the water again flows past the gear case. Furthermore, added to the energy of the water hitting the lower gear case, the propeller thrust is directed by turning the stern drive unit which can add to the steering torque.

The prop tends to throw the stern to port. This is why experienced skippers undertake a port side landing when wind and current conditions permit. They allow the prop to move the stern to port toward the dock. With a forward motion when the helm wheel is turned hard to one side, the vessel pivots around a point about 1/3 its length abaft to stern.

Power Trim/Trim Tabs

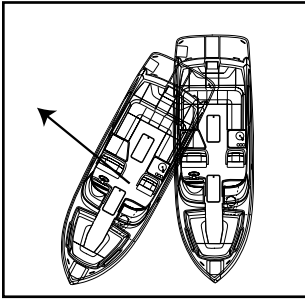

Stern drive boats have the ability to angle in or out their drive unit in relationship to the transom. This is accomplished by hydraulic shocks located on the lower unit housing

along with an electrical sender unit that reads the drive angle and sends information to the chart plotter showing a reading.

Purpose of Power Trim

The purpose of the power trim/tilt is to enable the operator to change the angle of the drive while at the helm. Changing the angle of the drive or “trimming” provides the following benefits:

1. Improves acceleration onto a plane.
2. Maintains boat on plane at reduced throttle settings.
3. Increases fuel economy.
4. Provides smoother ride in choppy water.
5. Increases top speed.

In short, it is a way of fine-tuning the performance of your boat and will enable you to get the most efficient and comfortable ride possible, whatever the conditions.

Using Power Trim

The power trim is normally used prior to accelerating onto a plane, after reaching the desired RPM or boat speed and when there is a change in water or boating conditions.

Position passengers and equipment in the boat so that the weight is balanced correctly fore and aft as well as side to side. Trimming will not compensate for an unbalanced load.

To operate the trim, push the switch until the desired bow position is reached. The trim may be operated at any boat speed or at rest. Avoid operating the trim system when running in reverse. Observe the trim/tilt gauge which indicates the boat's bow position achieved by the trim angle of the vertical drive unit. “Bow-Up” corresponds to the upper portion of the trim range on the gauge while “Bow Down” corresponds to the lower portion of the trim range on the gauge.

To determine the proper trim angle, experiment a little until you are familiar with the changes in your boat. The vessel will be properly trimmed when the trim angle provides the best boat performance for the particular operating conditions. A trim position that provides a balanced steering load is desirable. To familiarize yourself with the power trim, make test runs at slower speeds and at various trim positions to see the effect of trimming. Note the time it takes for the boat to plane. View the chart plotter screen, tachometer and speedometer readings as well as the ride action of the boat.

Operation In “Bow Up”

The “Bow Up” or out position is normally used for cruising, running with a choppy wave condition, or running at full speed. Excessive “bow up” trim will cause propeller ventilation resulting in propeller slippage. Use caution when operating in rough water or crossing another boat's wake.

Excessive “bow up” trim may result in the boat’s bow rising rapidly, creating a hazardous condition.

Operation In “Bow Down” Position

The “Bow Down” or in position is normally used for acceleration onto a plane, operating at slow planning speeds, and running against a choppy wave condition. It is also used when pulling water skiers, tubers, knee boarders, etc. In this position the boats’ bow will want to go deeper into the water. If the boat is operated at high speed and/or against high waves, the bow of the boat will plow into the water.

Operation In ‘Level’ Position”

In normal running conditions, distribute passengers and gear so boat is level. At or below cruising speeds, trim the vessel for optimum performance. The trim gauge will show somewhere in the center of the gauge. This position will also enhance running visibility and overall stability. Again, each outing provides different wave, load and running conditions. Be prepared to make trim changes as needed.

	CAUTION
THE BOAT TRIM SHOULD BE ADJUSTED TO PROVIDE BALANCED STEERING AS SOON AS POSSIBLE EACH TIME YOU GET UNDERWAY. SOME BOAT/ENGINE/ PROPELLER COMBINATIONS MAY CREATE BOAT INSTABILITY AND/OR HIGH STEERING TORQUE WHEN OPERATED AT OR NEAR THE LIMITS OF THE “BOW UP”OR “BOW DOWN” POSITIONS. BOAT STABILITY AND STEERING TORQUE CAN ALSO VARY DUE TO CHANGING WATER CONDITIONS. IF YOU EXPERIENCE BOAT INSTABILITY OR HIGH STEERING TORQUE SEE YOUR AUTHORIZED REGAL DEALER.	

Shallow Water Operation

Operating your vessel in shallow water presents various hazards. You are more apt to hit a submerged object such as a rock, sand bar, stump coral, or other unmarked objects.

Pay close attention to your chart plotter for descriptions of any shallow areas along with marked submerged objects. Always post a lookout when operating in shallow water. Trim your drive up as needed to provide adequate draft. If possible, set the alarm on your depth sounder and travel at a speed that will keep the boat level in these shallow areas.

If your boat strikes a submerged object stop immediately and check for hull, drive, and propeller damage.

TRIMMED "TO FAR IN" POSITION



TRIMMED "TOO FAR OUT" POSITION

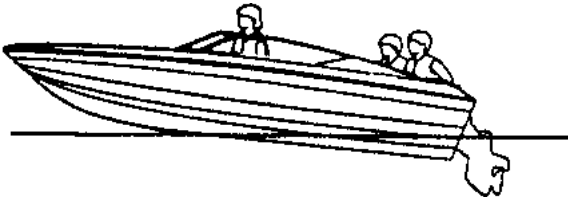

WELL TRIMMED "LEVEL" POSITION

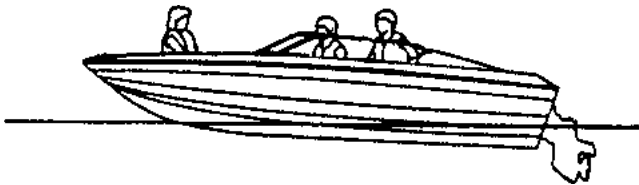

Typical Examples (Stern drive shown)

Anchoring

Selecting the correct anchor is an important decision. The anchor style in part depends on the usage and boat type. Regal may designate an anchor type and or model. Some models incorporate chain, line with an optional windlass. Contact an authorized Regal dealer for more information.

Anchoring is easier with another person on board. First be certain that the line for the anchor is properly attached, to avoid losing the anchor and anchor line overboard.

For most anchors to perform more efficiently, you should attach 3 to 6 feet of chain. The chain will stand up to the abrasion of sand, rock, or mud on the bottom much better than a nylon line. It should be galvanized to reduce corrosion. Next, attach a length of nylon line to the other end of the chain.

The nylon will stretch under a heavy strain cushioning the impact of waves or wind on both the boat and the anchor.

To anchor, select a well protected area, preferably with a flat bottom. Contrary to modern belief, you do not throw the anchor over while the boat is making headway, or moving forward. In fact, the bow of the boat should be brought slowly backward, while easing the anchor slowly over the side of the boat until it hits the bottom. To "snub the line" means to stop its outward "pay" or movement. Usually the length of anchor line used should be 5 to 10 times the depth of the water.

After you have anchored, check your position with landmarks if possible. You need to continue to monitor landmarks to make sure you are not drifting.

Since anchoring can also be an emergency procedure, the anchor and line should be readily accessible.

For increased holding power in windy conditions, two anchors are sometimes set. If your primary anchor drags, you can run out your secondary anchor without picking up the primary one. The important thing is to lay them out at an angle. When setting two anchors, make sure they are fastened to separate rodes or cleats. This is done in case you need to adjust one later so the line is accessible. If two anchors are used ahead of a boat, make sure to set the rodes at an angle than in a straight line to reduce the chances of tangling as the boat moves in wind and current. See the illustration.

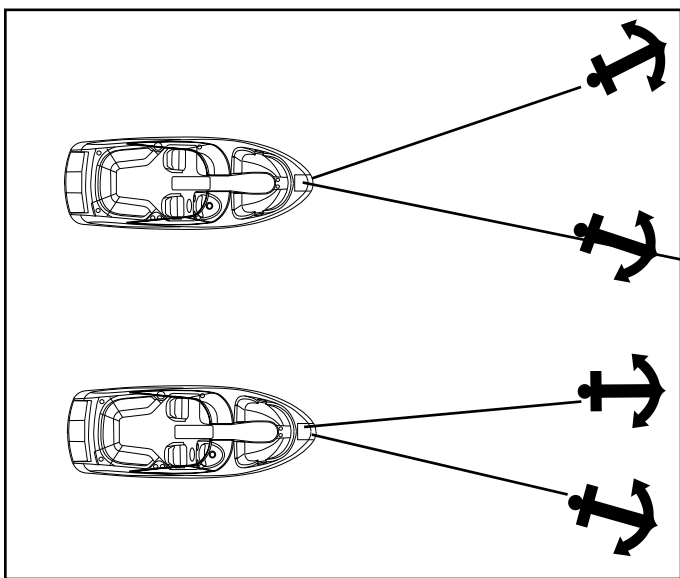

The Law Of Salvage

The Admiralty law sometimes referred to as the salvage law was founded primarily on English law fundamentals and basically says that a vessel distressed, in danger of flounder, if rendered assistance from a towing company or private agency, can be forced to relinquish a portion of the vessels' worth for the assistance received.

NOTICE

IN THE EVENT
YOUR VESSEL IS IN DISTRESS,
PRIOR TO ALLOWING ANY TOWING
COMPANY OR PRIVATE AGENCY THE
RIGHT TO PASS A LINE TO YOUR VESSEL,
BE SURE TO ESTABLISH THAT YOU
DO NOT AGREE TO SALVAGE RIGHTS.
ESTABLISH WITH THE CAPTAIN
OR OPERATOR THAT YOU WISH TO BE
ASSISTED IN A CONTRACT BASIS AND
ESTABLISH A PRICE.
OF COURSE IN CERTAIN SITUATIONS, YOU
MAY NOT HAVE THIS OPTION.

USE YOUR BEST JUDGEMENT!

Towing

Read and understand the above notice! In case you find yourself aground or in need of a tow, or should you want to tow another vessel, keep in mind that you never use deck hardware or cleats to secure lines for towing!

Deck hardware is intended for mooring and anchoring, and is not designed to withstand the strain and pull of towing. Rather than tie the line to your cleats on deck, it is suggested that you tie a bridle by passing a line completely around the hull of your boat to avoid damage.

When towing, always stand clear of a taut line, as any type of line breaking under stress can be extremely dangerous. The preferred line for towing is double-braided nylon, as it has sufficient elasticity to cushion shock loads. Move slowly and cautiously.



WARNING

AVOID INJURY OR DEATH!
DO NOT USE DECK HARDWARE
INCLUDING CLEATS
FOR TOWING.

Knots

Knots are useful in docking, towing and other emergency situations. Learning to tie knots requires practice. As they say “ Practice makes perfect”. Some of the knots used in boating are the square, bowline, anchor bend, clove hitch, figure eight and half hitch. There are several periodicals available that explain various knots and how to tie them effectively. An experienced skipper will know the basic nautical knots and will use them when on the water. Take the time to know the basic knots.

Figure 8 Knot
Tied To Cleat



A useful knot to learn for general docking is the figure eight with one end reversed. By turning the free end of the line back under, the knot can be released without disturbing the boat. After some practice one person can secure a vessel easily to a dock or pier in a variety of weather conditions. This knot normally is used to tie the bow and stern. Then the vessel can further be fastened by tying the spring line in the figure eight knot. Wrap it around the cleat 2 or 3 times.

Emergencies

Always be ready to help others on the water if possible, but do not take any unnecessary risks. Use equipment to save a life, but do not risk a life to save equipment. Consult earlier information in this manual concerning accidents, etc. Also, read other literature concerning on the water emergencies. Be alert and prepared!

Fires

Fire aboard a vessel can spread quickly and can cause tremendous alarm among everyone. Most fires can be prevented by keeping the bilge free from oil and debris. Keep all equipment stowed and maintained in working order. Carry a backup fire extinguisher on board. If something becomes a possible fire hazard, remove that possibility at once. Never use water on gasoline, oil or electrical fires. When you dump water on an electrical fire you can be shocked since water conducts electricity.

Follow these instructions if a fire breaks out:

- A. Fit everyone aboard with a life jacket. Turn off the ignition.
- B. Try to keep the fire downwind. If the fire is to the stern, head the bow toward the wind. If forward, put the stern to the wind.
- C. If the engine should catch fire, shut off the fuel supply. Usually there is a fuel tank access that will enable you can crimp the fuel feed line.

D. Use a hand fire extinguisher. Make sure to point it at the base of the flames. Use short bursts and sweep the extinguisher side to side. Remember : (4 lb. extinguisher discharges in 20 seconds).

These actions help prevent the fire from spreading to other parts of the boat. You can extinguish fires quickly if you act swiftly. Have a plan of action in motion in case a fire breaks out.

First Aid

Knowing first aid can save lives. A first aid kit and the ability to use it are important ingredients for the safety of a skippers' passengers, crew and vessel. Having confidence and competence in handling medical emergencies on board is a must for the skipper. Invest your time in a first aid course available at the American Red Cross.

CPR (Basic Life Support)

If someone is seriously injured have someone call for help while the injured person is being attended.

Check for possible danger signs; loss of breathing, unconsciousness, severe bleeding and heartbeat. If you determine the individual is not breathing or unconscious place the victim on their back on a hard surface and do the following:

1. If unconscious, open the airway. Neck lift, head lift or chin head lift.

2. If not breathing, begin artificial breathing. Pinch the nose. Give 4 quick breaths. If airway is blocked, try back blows, abdominal or chest thrusts and finger probe until airway is open.

3. Check for pulse. Begin artificial circulation. Depress sternum 2".
15 compressions rate 80 per minute. 2 quick breaths. Continue uninterrupted until advanced medical support is available.

Follow up immediately with medical authorities!

Hypothermia

Hypothermia is a condition where the body temperature decreases because the body can't generate enough heat to maintain its normal temperature. It can be serious and usually occurs where victims have been immersed in water (under 68 degrees) for extended periods of time. If you encounter a possible hypothermia victim call for help on the radio and get the person out of the water.

Symptoms are:

1. Shivering that if condition is advanced may stop.
2. Confusion, clumsiness or slurred speech.
3. Rigid muscles.
4. Semiconscious to unconscious.

Treat hypothermia by the following:

- Remove wet clothing.

- Monitor the victim's pulse and breathing.
- Rapidly apply heat to the body core by using blankets, naked bodies or warm water.
- Do not give the person any food or drink.
- Do not warm the arms and legs. Warming of these extremities can be fatal. Follow up immediately with medical authorities!

Electric Shock Drowning (ESD)

ESD occurs when stray AC current enters the water either from marina or private docks and/or open grounding conductors on vessels. People caught in this dangerous electrical field in the water often drown as the body becomes paralyzed. ESD happens much more often in fresh or brackish water as salt water tends to conduct electricity and basically grounds it.

To aid in prevention of ESD do the following:

1. Never swim near a marina, dock, boat yard or near a boat especially if it is running.
2. When in the water stay at least 150 feet away from boats or docks where electricity exists.
3. Always obey "no swimming signs."
4. If your vessel features a battery charger use a 3 prong electrical cord rated for the battery charger receptacle. Plug the male end into a functioning shore system GFCI. Do not let the cord dangle in the water. Allow for cord slack if in tidal zone.
5. Check with marina owner to ensure his electrical system has been recently inspected and up to code.
6. Yearly have a qualified marine electrician inspect your vessels electrical system.

Environmental Awareness

There are numerous vessels operating on our waterways on a daily basis. Each boat has an impact on our environment. Boat operation habits, marine sanitation, and maintenance all play a role in a delicate battle to keep the ecosystem clean. Each of us has a role in doing our part as an environmentally conscious skipper to conserve our waterways.

The National Marine Manufacturer's Association lists their top ten of Eco-Boating Practices as follows:

1. Observe all regulatory agency policies regarding marine toilets.
2. If equipped with a holding tank, use marina pump-out facilities.
3. If used, make sure bottom paints are legal and ecosystem friendly.
4. Use only biodegradable cleaning agents.
5. Dispose of all garbage and litter on shore properly.
6. Don't top off fuel tanks. Leave expansion room. Clean up spills.
7. Watch your wake and propeller wash.
8. Make sure your engine is well maintained.
9. Control your bilge water.
10. When fishing, practice the "catch and release" principle.

Follow these basic practices when on the waterways. Treat the environment in a way that you would like to be treated.

Chapter 7

Auxiliary Equipment Operation

Overview

This chapter will assist the boat operator in understanding selected standard and optional equipment components on the vessel. *Select equipment described may not be installed on your boat or the pictorials and/or instructions may not exactly fit equipment on your craft.* Remember that Regal is constantly improving its product line and therefore may make changes in vendor parts and specifications without notice. For detailed information on equipment, please refer to the owner's information packet.

Anchor Windlass

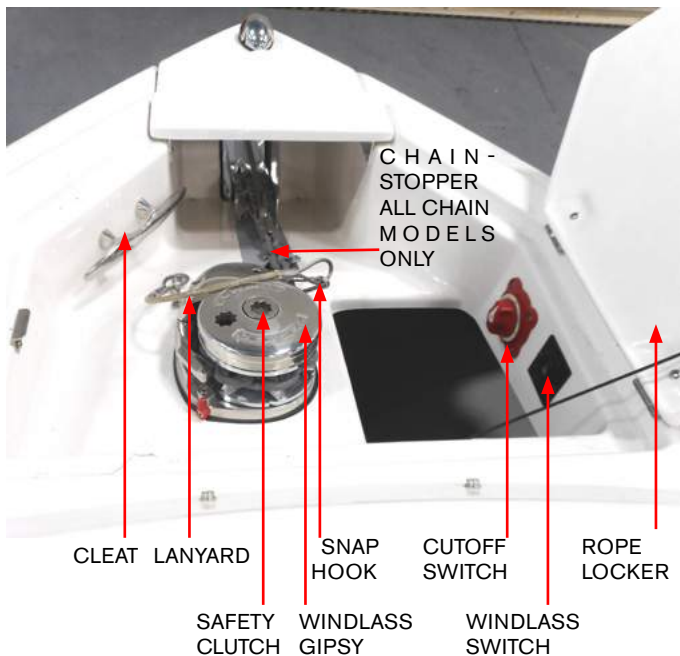

TYPICAL UNIT SHOWN

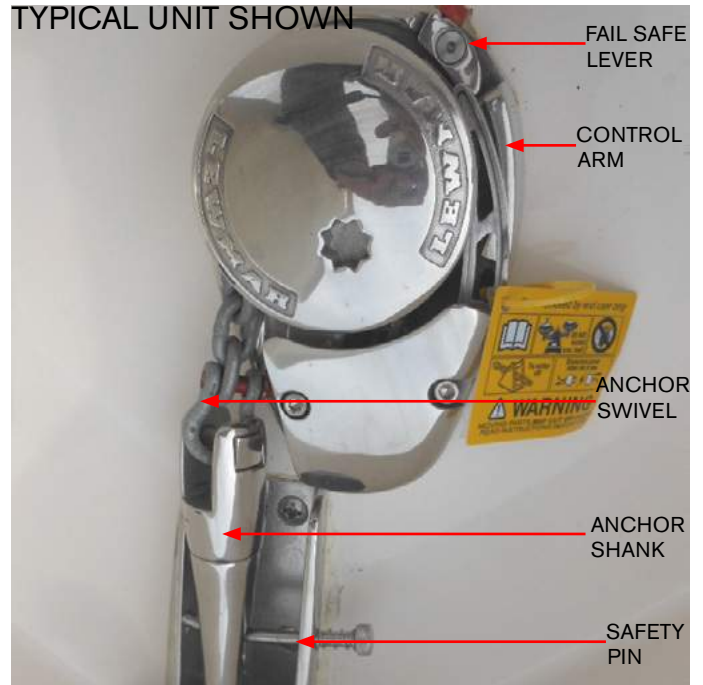

Anchor Windlass Introduction

If installed the windlass *may* feature a stainless steel polished “claw” style anchor complete with swivel. This anchor has high holding power in most seabeds.

Note that select windlass units offer all chain and use a chain stopper as shown. A momentary windlass rocker switch located at the anchor locker controls the lowering and retrieving of the anchor through the windlass. A 40 amp breaker for windlass overcurrent protection is located at the battery management panel. There is a lanyard with a snap hook to add holding power when the anchor is in the stored position. The cleat is for tying off the anchor rode rather than maintaining constant pressure on the windlass itself with a chain-rope unit.

Note: Never use the windlass to break the anchor free from the bottom. This may cause excessive strain on the windlass motor and/or hardware.

Using Anchor Windlass

The domestic windlass may be outfitted with a rode using 100' of 1/2" nylon rope along with 10' of galvanized chain. The chain is connected to the anchor shank which is next to the anchor. The chain acts as a safety margin to protect the rope rode from being damaged by sharp seabed objects such as coral that might sever the rope if it was next to the anchor. If needed for harsh sea bottoms the rode can be converted over to 100' of 6 mm. galvanized chain with a small length of rope at the top for tying off the rode to a cleat.

The safety clutch is used to "pay out the windlass chain or to retrieve the anchor "rode". There is a handle in the anchor locker that inserts into the gypsy drive cap located on top of the windlass framework.

With the handle inserted in the cap, turn the handle *clockwise* which grips the "gypsy", locks it and tightens the clutch. Remove the handle and store it after usage.

To loosen the clutch with the handle inserted in the cap, turn the handle *counterclockwise* which will free up the "gypsy" from the drive train. Remove the handle and store it.

Before attempting to "pay out" the anchor ensure that the fail safe pawl is disengaged from the gypsy and held clear of it by the fail safe lever. See windlass owner's manual for further information.

Be sure to pull the safety pin from the anchor shank before using the system. *The anchor will not pay out with this pin inserted.* This pin should be reinstalled after each anchor retrieval.

A windlass with all chain may use a chain stopper mechanism to transfer the load from the windlass. See your windlass owner's manual for more information regarding the use of the chain stopper.



WARNING

AVOID SERIOUS INJURY!
ENSURE THAT ALL BODY PARTS & CLOTHING
ARE KEPT CLEAR OF THE ANCHOR RODE
AND WINDLASS DURING OPERATION.



WARNING

AVOID SERIOUS INJURY!
DO NOT "PAY OUT" ANCHOR UNTIL IT IS
DETERMINED THAT THERE ARE NO
SWIMMERS OR DIVERS NEAR THE AREA.

Paying Out Anchor Using Gravity

To let out the anchor release any anchor locks, insert the clutch handle into the gypsy drive cap and turn it in a clockwise direction to tighten the clutch. When in a safe mode, pull back on the clutch until the anchor and rode begin to pay out. Control the rate of anchor descent by pushing the clutch lever forward. When the desired rode is paid out, tighten the gypsy drive cap.

Paying Out Anchor Using Power

Make sure any anchor locks are disengaged and the pin through the anchor shank is pulled along with the lanyard hook. Stand clear of all windlass components when paying out. Using the windlass momentary switch, press and hold the lower portion of the switch.

When the proper ratio of anchor rode is paid out disengage the switch and tie off the rode to a cleat since it is not recommended to let the windlass mechanism be the only source holding the rode to the anchor on the sea bottom. Also, do not use the fail safe pawl to hold the anchor load as windlass damage could occur.

Hauling In Anchor-Manual Recovery

Insert clutch handle into the gipsy drive cap and turn clockwise until anchor is fully returned to the bow roller.

Hauling In Anchor-Using Power

When anchor rode is safe to haul in use the windlass momentary switch to haul in the anchor rode. Press and hold the upper portion of the switch until the anchor is returned to the bow roller position.

The fail safe pawl does not need to be disengaged during retrieval as it will act as a ratchet. When the anchor has been retrieved in the bow roller position the fail safe pawl should be left engaged in the gipsy to prevent accidental activation of the windlass while underway. Also, reinstall the pin through the anchor shank and the lanyard hook. Note that the fail safe pawl does not need to be disengaged from the gipsy before the anchor can be paid out again.

It is recommended that during the paying out process the engines be run to stern before full scope is reached. This will help prevent the rode from being tangled in the anchor on the sea bottom. It is recommended that during the retrieval process use the engine to gather headway.

Do not let the vessel sit directly on top or over the area where the anchor lies because the chain rode could damage the hull topside.

As the anchor raises toward the scuff plate area, retrieve the last few feet very carefully to eliminate any hull damage.

Once the anchor is retrieved, check to ensure the fail safe pawl is engaged in the gipsy which will help prevent accidental activation.

Windlass Safety Tips

1. Read the windlass owner's manual.
2. Keep all body parts and clothing away from an activated windlass.
3. Do not exceed the maximum load designated by specifications.
4. Always tie off the anchor rode to the designated cleat.
5. Do not use the windlass to pull or tow another vessel.
6. Always shut off windlass breaker or main battery switch before servicing the component.
7. Always use engine power to gain headway before retrieving anchor.
8. Always look for swimmers or divers before deploying anchor.
9. Always secure rode/anchor while cruising or pulling vessel on highway.

Automatic Fire Extinguishing System



Stern drive engines use a powered ventilation (blower) system and may have installed an optional fire extinguishing system in the sump capable of automatic and manual activation. The dash monitor utilizes an instrument display unit light that provides the operator with a system status of a charged or uncharged condition by an audible alarm and icons. With the ignition switch on and a no light condition indicates that the system has been discharged.



If the fire extinguishing system should discharge the ignition system will be instantaneously interrupted and the engine will shut down. See the automatic fire extinguisher manual in the owner's packet for additional details.



If a fire has started in the engine compartment the system will automatically discharge or the operator can manually discharge the extinguisher. Find the system manual cable assembly located in the cockpit. To use the manual remote remove the safety pin from the

“Fire T Handle” and pull firmly on the “Fire” handle which will activate the fire extinguisher unit in the engine compartment. A loud “rushing air” sound may be heard. Complete discharge will take several seconds. Keep the compartment closed for a period of time sufficient to permit the agent to soak all areas of the protected space. This allows hot metals and fuel time to cool. Refer to the automatic fire extinguisher owner’s manual for additional information.

Note: The boat operator needs to educate the crew on fire protection and more specifically the automatic fire extinguishing system in the event that he becomes incapacitated. It is a good idea to practice by having a mock fire drill.

NOTICE

IF INSTALLED, FIXED FIRE EXTINGUISHER SYSTEM MUST BE SUITABLE FOR A COMPARTMENT VOLUME OF 135 CU. FT.

Portable Fire Extinguishers

Clean agent extinguishers are primarily for Class B and C fires (gasoline is a flammable liquid under the Class B group). The extinguisher should be of the 5 lb. capacity and 2 are recommended based on the maximum capacity of the fuel tank onboard and the boat length. These extinguishers may be available from your dealer, marine speciality stores, or on the internet. It is recommended to have extra portable fire extinguishers to backup the automatic fire extinguisher system since a fire could take place in an area outside of the sump/ machinery space.

As noted above a clean agent type of liquefied gas used today is FE- 241. This gas is colorless and odorless, heavier than air and sinks to the lower parts of the sump to extinguish fires. Since the year 2000 ingredients have changed to a more environmental friendly formula (Chlorotetrafluoroethane or FE- 241). FE- 241 is used in portable-hand units.

The canister needs to be weighed once a year. Also, the canister is engraved with a date which is part of the canister life cycle. Refer to the information regarding fire prevention in this manual and on the internet.

Normally the clean agent fire extinguishers initially cost more than powdered or CO₂ extinguishers but they are more effective with fire ports than powder extinguishers. They work by suffocating the fire via removing oxygen which is the key ingredient in any on board marine fire.

Bilge Pump

Before each outing, check the operation of the bilge pump, automatic switch, and manual switch. The bilge pump should automatically activate when water reaches a pre-determined height in the engine compartment. Test the bilge pump manually at the dashboard with the switch. Periodically check for bilge debris around the grates of both the bilge pump and automatic switch.

The automatic mode for your bilge pump works similarly to the manual method. Both methods control the bilge pump by a switch, but the automatic mode utilizes a float switch. Float switches use a device that sits at water level, and when the float reaches a certain height, it trips the switch and activates the bilge pump.

Periodically you may need to disassemble the bilge pump from the grate in order to clean or access the inner mechanisms. To remove the bilge pump, utilize the quick disconnect tabs on either side of the bilge pump, squeezing them like a backpack clip while pulling up on the pump.

The bilge pump and float switch are normally located close to the center of the hull and at the front of the engine. Once you open the engine hatch it should be easily seen. Refer to the vessel operations chapter for pre-departure use.

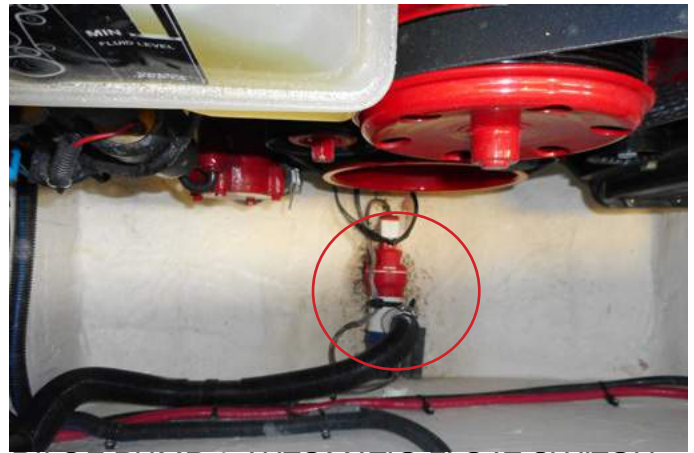

BILGE PUMP & AUTOMATIC FLOAT SWITCH

Cabin-Sleeper Conversion

The cabin features the ability to convert the berth cushions to a sleeper.

Notice there are 3 sets of scalloped cut-out supports on the inside edge of the berth seat bases.



SCALLOPED SUPPORTS

See the photo above showing 2 of the 3 sets of scalloped supports. There are 3 stainless steel bars that fit into these scalloped supports to hold the sleeper cushions. They are located on a rack in the cabin starboard storage compartment under the cushion. Note that the bars are all the same length.

Install each bar into each set of scalloped supports. Remove the port and starboard backrests from the bolster by pulling up. Insert them across the support bars to form the sleeper. The backrest flat side should be forward.

To convert the sleeper back to the standard cabin layout reverse the process.



BARS IN PLACE



SLEEPER WITH BACKRESTS INSTALLED

Canvas

There are canvas options available for your vessel including cockpit covers, PowerTower and travel/storage covers. Let us look at the basic installation on each type. As general information many of our models use Sunbrella a solution dyed fabric well known for its ability to hold up in the harsh marine environment.

Cockpit Cover

If installed, the cockpit cover normally installs over the windshield and snaps to the deck. The cockpit cover is meant to protect the cockpit of the boat from weather elements. *The cockpit cover is not to be used for towing purposes.*

Ensure the center windshield is in the closed position. Start snapping the cover to the deck by use of the eyelet snaps, starting at the bow and working aft. Continue snapping the cockpit cover to the deck snaps. When you reach the rear corner, leave enough room for an exit point. Notice in the middle underside of your cover, you may find an area of reinforced canvas with an eyelet snap. This snap connects to a cockpit cover pole. This pole is adjustable, and by opening the lock, the pole can telescope out to the desired length. This pole should push the canvas up when standing straight up on its rubber enclosed foot. Again, the purpose is to shed water off of the top.

The cockpit cover should be rolled up for storage inside the ski locker when towing or storing your boat. This canvas should not be used while the engines are running.

TYPICAL COCKPIT COVER



Bimini Top (Typical)- No PowerTower

Your Regal boat may feature a bimini top fitted into a boot. This top provides sun protection for the bulk of your cockpit and helm. Stainless steel bimini bows provide support as your bimini top extends forward. *When using your bimini top, read, understand, and follow all warning labels attached to the aft bimini top.*

To install, pull the front bow forward and the bimini top will fold out. At this point pull down on each strap and fasten it to the camel-back hardware as shown in the photo.



CAMEL-BACK

This process may require you to push down on the forward bow on each side to connect the strap to the appropriate camel-back.

At this point you can adjust each strap as needed to tighten the entire top.

At the bimini top rear attach the arms on each side and secure by inserting the pin through the latch. On select bimini tops it may be advantageous to secure the aft bow arms before the forward camel backs are secured.

For further information refer to the canvas care instructions located in the bimini top center pocket.

 CAUTION
AVOID POSSIBLE BODILY INJURY AND PROPERTY DAMAGE! DO NOT TOW VESSEL WITH COCKPIT CARPET OR SEA-GRASS MATING IN PLACE. UNSNAP, ROLL, AND STORE IN LOCKER.

Bimini Top (Typical)- PowerTower



TYPICAL BIMINI TOP WITH POWERTOWER

If your vessel is fitted with the PowerTower it may feature a bimini top which covers the tower for increased resistance to water and leakage.

This top provides sun protection for the center cockpit and helm. Stainless steel bimini bows provide support as your bimini top extends forward. *Note to read, understand, and follow all warning labels attached to the aft bimini top especially those regarding towing.*

 CAUTION
AVOID POSSIBLE BODILY INJURY AND PROPERTY DAMAGE! DO NOT USE THE BIMINI TOP CRUISING AT SPEEDS ABOVE 35 MILES PER HOUR. IF TOWING BOAT MAKE SURE TOP IS SECURELY ATTACHED TO HARDWARE AND INSIDE BOOT.

 CAUTION
AVOID POSSIBLE BODILY INJURY AND PROPERTY DAMAGE! DO NOT TOW VESSEL WITH BIMINI, BOW OR COCKPIT COVER IN PLACE! TOW WITH TRAVEL COVER ONLY!

Bimini Top (Typical)- PowerTower (Continued)

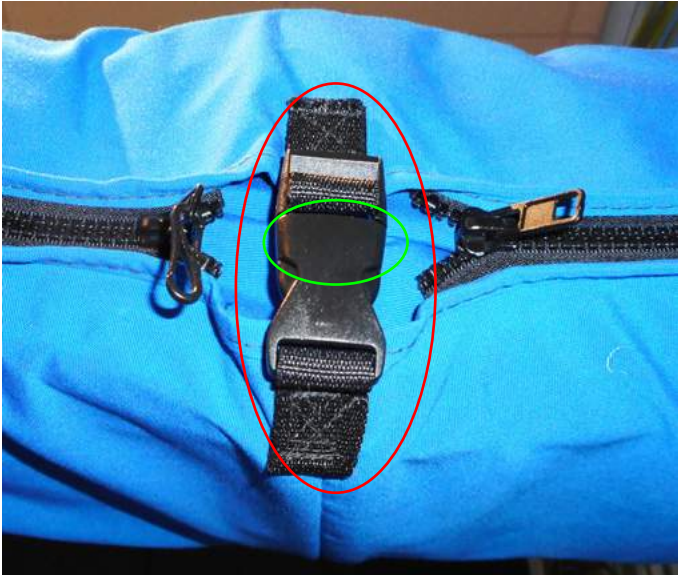

The first step in using the typical bimini top is to remove top from the boot. Push both sides of the latch inward simultaneously (green area) and pull on the ends of the latch to open it. Find the boot zippers in the forward center section of the top. Unzip the boot and remove it from the bimini top. Store it in a dry locker for later reinstallation. See the photo above.

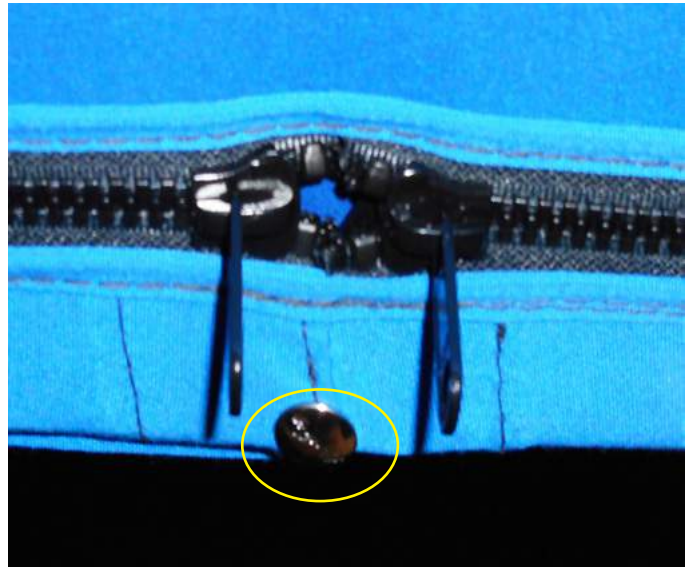

Once the boot is removed note there is an alignment snap in both the forward and aft center top bow. Always make sure these snaps are buttoned down or it may become difficult to install the top arms due to misalignment (bimini top not in the center of the forward and/or aft bow). See the photo above.

TYPICAL BIMINI TOP WITH POWERTOWER PARTS DESCRIPTION

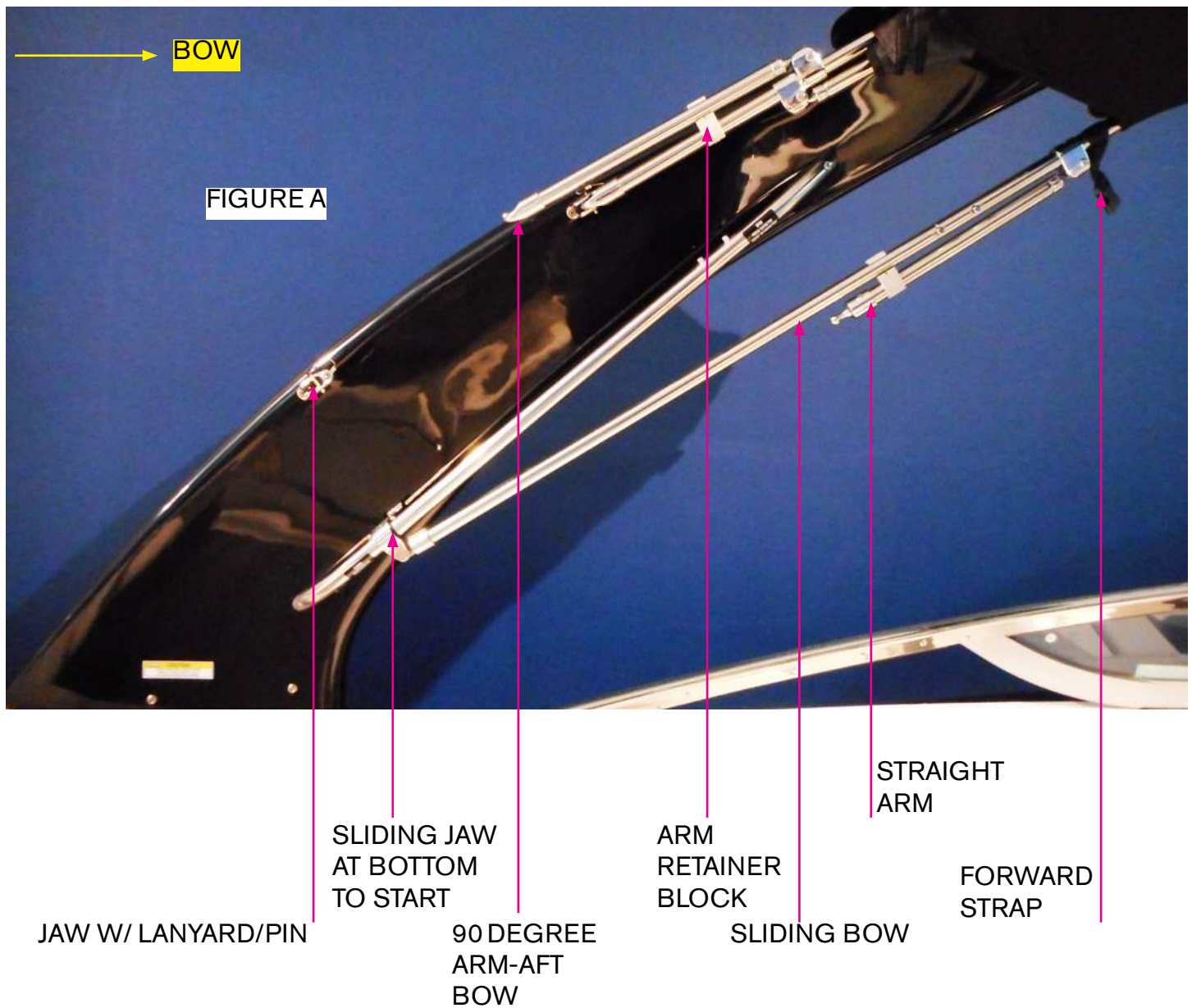

Note that the bimini top hardware shown is in the lay down position (unattached to the hardware).

Note the photo on the next page with the top in place and the hardware connected.

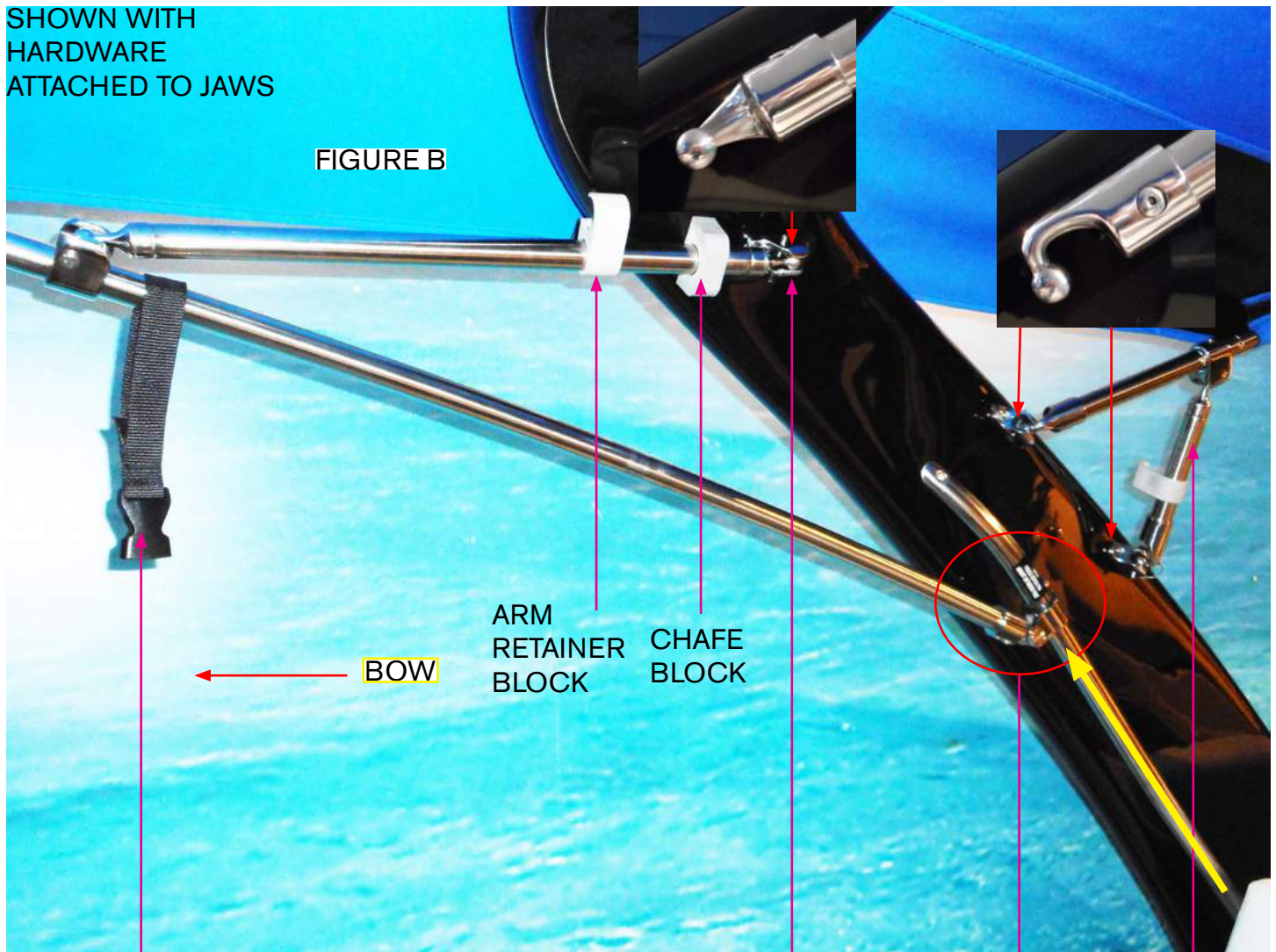

ATTACH STRAP END AND LATCH TO FWD. CAMEL-BACK ON DECK



CAMEL-BACK

STRAIGHT PIN IN JAW-FORWARD BOW

FWD, BOW SLIDING JAW IN BETWEEN PINS



9 0
DEGREE
PIN IN JAW-
AFT BOW

Bimini Top (Typical)- PowerTower (Continued)

USE THE DIAGRAMS AND FOLLOW THESE STEPS TO INSTALL THE BIMINI TOP:

1. Find jaw between pins on bottom of port forward bow. Move sliding jaw over the top pin to release the forward bow and pull up to upper set of pins allowing the jaws to slide over the bottom pin and locking in between the pins (yellow arrow). See figure B. Do the same with the starboard forward bow.

2. Find one of the straight eyed arms as shown in Figure B. Turn the white chafing block in a direction so its flat surface is between the straight arm and the PowerTower to protect it. While pushing down on the starboard forward bow align the straight arm with the forward end of the jaw and install the ball end of the straight arm into the front of the jaw. Install a lanyard pin which will lock it in place. Do the same with the other straight arm.

3. Locate the 90 degree aft arms. There are 2 each for the aft bows. See Figure B. Start with either side. Pull down on the aft top and insert the top arm into the top jaw. Lock the arm in place by inserting a lanyard pin. Repeat the same process with the lower 90 degree arm. Follow the same procedure with the 90 degree arms on the other side.

4. Note that the forward bow utilizes a strap and latch similar to the latch on the boot. This strap assists in holding the bimini top down as the vessel is making forward headway. Attach the upper and lower strap together and attach at the camel-back.

5. Perform the steps in reverse order to disassemble the bimini top. The sliding jaw on the forward bow will need to be pushed down to the lower set of pins on the forward bow on both sides for the top to set in the proper place. Use the arm retainer blocks to latch the arms in place. Reinstall bimini top in boot and zip it up.

6. Be sure to read the canvas manufacturer's information regarding caring for your canvas which can be found in the owner's information bag or visit their web-site.

Remember not to exceed 35 mph with the bimini top up on the waterways.

NOTICE

CHECK YOUR STATE LAWS AND REGULATIONS BEFORE ATTEMPTING TO TOW THIS VESSEL. SPECIAL PERMITS AND EQUIPMENT MAY BE NEEDED. FOR HIGHWAY TOWING THE POWERTOWER SHALL BE IN THE COMPLETE FORWARD POSITION AND ALL CANVAS SHALL BE IN THEIR DEDICATED BOOTS. ALL ATTACHED CANVAS BOW HARDWARE SHALL BE CHECKED FOR TIGHTNESS BEFORE AND AFTER TOWING. CARPET/MATING SHALL BE ROLLED UP AND STORED IN A DEDICATED LOCKER.

Travel/Storage Cover- (Typical)



TYPICAL TRAVEL/STORAGE COVER



RATCHET STRAP

Ensure the ratchet strap is tight and the velcro flap is closed on the travel cover before pulling boat at highway speeds. Tie cover securely to bow and stern eyes. Once on the road periodically pull over and check cover, ratchet strap and pertinent hardware for tightness. Note that select covers use dual aft straps.

Note not exceed manufacturer's miles per hour speed limit. See travel cover information for additional details or visit them on their web-site.

INSTALLING TRAVEL/STORAGE COVER

▲ WARNING: To prevent damage to your boat and/or cover please read and understand instructions before attempting to use cover.

It features:

1. **ON SOME MODELS:** A special anti-pooling system is included to prevent large puddles from ruining your cover.
2. The SurLast® all-weather fabric was chosen to allow stability, water repellency and breathe-ability.
3. The Vacu-Hold™ system allows trailering at highway speeds (65 mph) without billowing or buffeting.
4. The new ratchet and drawstrap type attachment will allow easy, tight and secure installation.

CARE, WARRANTY AND INSTALLATION INSTRUCTIONS

Hint-To properly install ratchet strap system.

1. Pull the webbing through the channeled ratchet cylinder and tension while ratcheting to "start" the webbing.
2. Tension the ratchet with about 5 lbs. of pressure (pinky finger). Pull the sides of the cover to even the webbing throughout. Re-tension about 5 lbs. (the ratchet should be tight on the side of the boat lever, perpendicular to the hull).
3. Crank the ratchet approximately 5 full additional times to add tension (based on an 18' boat).
4. Check boat webbing for tension during stops while trailering. (webbing may stretch during first installation and use CHECK OFTEN).

▲WARNING: Readjust and retighten the cover after trailering and before storage. To prevent pooling do not allow snow and ice to accumulate on the cover. Never trailer at speeds above the speed limit.

CARE INSTRUCTIONS- Wash with warm soapy water (while installed if possible) and allow to air dry. For stubborn stains, mild detergent is recommended.

Storing the boat in constant direct sunlight will shorten the life of the cover and the components used to construct it. We recommend storing the boat in a location that exposes it to some sun and also shades it throughout the day. Preferably morning sun and afternoon shade.

WARRANTY- This cover includes a two-year warranty from date of purchase against any defects in material or workmanship. If you incur any problems or have any comments please contact your dealer or call Commercial Sewing Customer Service directly at (860) 482-5509.

PROPER INSTALLATION-

A. Pooling System Installation:

Note:

Install anti-pooling system as per illustration putting the front webbing to the cleats, standing pole upright. Pull the other two webbing straps to the two rear cleats. Tighten adjustable buckle strap, until the pole stands upright.

B. Proper Cover Installation:

- Place cover on boat starting at front, use cleats as buttons to keep cover in place, work toward back over pooling system until back cleats are "buttoned" in place.
- Maneuver in place until cover fits over gunwale. Check the symmetry. Connect the confidence straps through the openings on the swim platform to the "U" bolts. Disconnect velcro wrap around ratchet. Begin ratcheting by unzipping ratchet pocket(s) and pulling ratchet(s) handle in right-to-left motion until zippered ratchet pocket no longer sags but rests against the hull.
- Pull on webbing to even the tension around the cover and again tighten the ratchet until it does not sag but rests against the boat. Tighten ratchet four to five more times. The ratchet should be very hard to pull with your pinky finger. Zip ratchet pocket closed and connect velcro wrap around ratchet pocket. **On some models:** Connect the rear strap tiedowns in the back of the boat.

Note: Proper installation and operation of this cover requires that it be very tight at the gunwale. Retighten as necessary before, after and during stops while trailering. **BE SURE** cover is installed below gunwale before final ratchet adjustment. ZIP ratchet pocket closed for final installation.

▲ Warning: Zippered ratchet mechanism should be hand tightened only. Do not pry or attempt to operate ratchet mechanism with any type of tool.

REMOVAL-

- Disconnect velcro wrap & zip open ratchet pocket.
- Follow instructions on ratchet label to release pressure.
- Once pressure is released pull out webbing to allow simple future installation, then close handle and ZIP POCKET closed (this is important to prevent damage in future installation).
- Disconnect holddown straps. Remove and fold cover working from rear to front.

ANTI-POOLING POLE STORAGE-

- Disconnect anti-pooling pole from either the front (colored webbing) or back.
- After disconnecting collapse poles by pushing buttons and telescoping them down. Wrap webbing around poles.

ISBLANKMOORING/R0

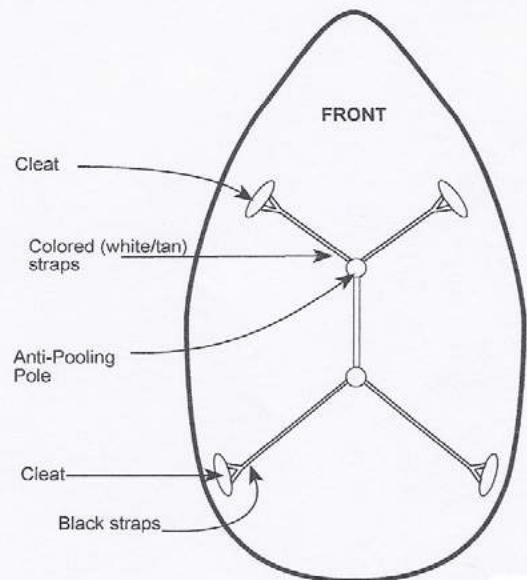

Cockpit Carpet



Cockpit carpet features a forty ounce weight with a heavy duty non-skid marine backing. As required, snaps are installed.

Note that before towing on the highway roll-up the cockpit carpet and store it in a locker to prevent it from blowing out of the vessel. Do not yank on the carpet to remove it as you may pull out a snap. Lift the snap instead to disengage it.

When storing cockpit carpet always roll it verses folding it. Also, before rolling it for periods of extended storage make sure the carpet is dry to help eliminate odors and possible mildew buildup.

Cockpit Sea-Grass Mating



If installed, cockpit sea grass mats feature urethane backing for marine environments. The mats provide style, comfort and durability as well as additional protection in environments where microbes are a concern.

Chilewich® products contain Microban®. This antimicrobial protection inhibits the growth of stain and odor-causing bacteria, mold and mildew for the product's life.

When storing your sea grass mats, always roll with the face of product out with the backing facing in. Do not fold or crease as the backing may split. Vacuum or hose off for regular cleaning. Dry face up or hang. Do not machine wash. Matting may be cleaned with a mild detergent and a sponge. Rinse with fresh water. Do not pull on material when removing from cockpit, but rather lift the snap instead to disengage it.

Docking Lights



If installed docking lights are integrated into the hull near the bow on both port and starboard sides. They are very useful for night mooring approaches and maneuvering. To operate turn on the helm switch marked “docking lights”. It is recommended not to use the docking lights while navigating in open water at night since the illumination could cause a glare on the bow navigation light possibly causing visibility problems for other vessels.

LED type bulbs used in the docking lights are normally used known for long life and low lumen energy usage.

Door-Cabin



The cabin door is designed from reinforced fiberglass for strength and longevity. It features a sliding pocket door type track for easier cabin entry. It is lockable from both sides and includes a soft synthetic seal to keep water and pests out. Also, there is a stainless door latch to keep the door open on the bottom and steps to access the deck through the center windshield.

A few notes concerning the door:

1. Always keep the door shut and closed and locked while making headway.
2. Make sure the bottom door latch is used to keep the door in the open position when entering or exiting the door while vessel is stopped or at dock.
3. Always use windshield support hand holds when entering or exiting the deck using the stairway. Shut door completely before using the stairway.
4. Never wax door treads as they may be fall hazard.

5. Periodically lubricate the door latch lock with powdered graphite.
6. Use silicone on door track wheels as needed.
7. Check for debris in drain.

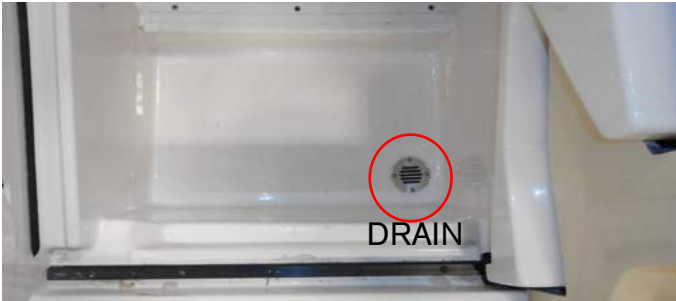

Electronics



Various electronics components may be installed on the vessel including single and optional dual chart plotters.

Each component utilizes individual operator's manuals. Refer to the appropriate electronic component operator's manual for detailed product information since the vast amount of information presented can not be covered here.

These Garmin manuals will cover features, operation, alarm and safety systems along with any cosmetic care and maintenance information.

Fender Clips

The fender clip option features receivers integrated into the vessel hull side and quick release pins. The quick release pins attach to fenders with lines so they are ready to deploy as needed. When the vessel approaches a mooring the quick release pin with fender is attached to the receiver and pushed into place. This will help protect the boat from dock "rash" which could damage the rub rail or gel coat. When leaving the dock the pins feature a quick release mechanism which detach easily.



FENDER CLIP RECEIVER



FENDER CLIP RELEASE PIN

Flexiteek Decking

Flexiteek decking is available on selected models. It features significant advantages over similar wood products. It is made from synthetics. Color is as natural as timber and uniform through the entire thickness adding to its appeal. It sands like wood resulting in a natural wood look and feel. It provides superior grip making it great for boating in general and water sports. It is stain resistant with most stains washing away with soap and water.

The product is UV resistant. Gentle sanding removes most marks on the decking with a minimum of product loss.

Flexiteek may be installed on cockpit sole and/or on the swim platform.



TYPICAL COCKPIT SHOWN

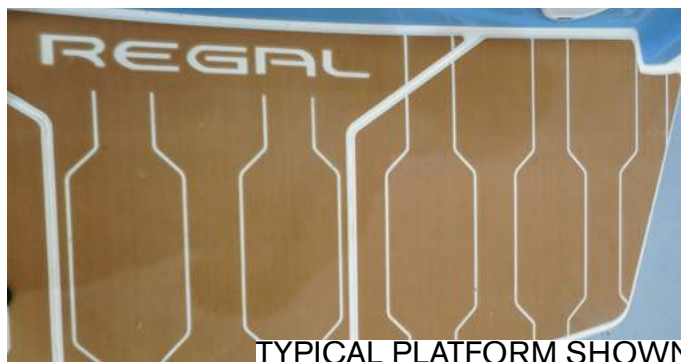

TYPICAL PLATFORM SHOWN

Gas Vapor Detector



If equipped, a gas vapor detector is a state of the art fume monitoring and alarm system. It is a highly effective detector of engine compartment gasoline fumes from unburned hydrocarbons emitted from faulty exhaust systems and hydrogen battery vapors. The unit operates with a head unit at the helm, a sensor located in the bilge installed just above the normal accumulation of oily bilge water. A 3 amp fuse (for over current protection) is located behind the helm which can be accessed by lifting up the starboard bow backrest cushion.

The display panel at the helm features 3 windows. The top green window indicates the system is operational. The center yellow window indicates there is a fault in the system. This notifies the user to check the connections and wire runs of the sensor. There may be a break in the wire or the sensor may be disconnected. The lower window is the red warning indicator indicating a fume buildup of 20% of the LEL (Lower Explosive Limit) which is considered an alarm.

Should this condition last for longer than 10 seconds, the alarm horn will sound.

To check for fumes, turn the ignition key to the "on" position. the green power on LED will show on and the red warning LED may light momentarily to indicate a warm-up period for the sensor. The alarm horn will not sound during this period. The alarm will continue as long as vapors are present. The alarm horn may be silenced by pressing the "mute" switch, the the Red warning light will remain on until the vapor problem has been resolved. Note that the problem should never be considered corrected until red warning light is out.

If the red LED begins to glow softly and or intermittently, it is an indication that the gasoline vapor build-up is beginning to occur and you can anticipate a full alarm momentarily.

Immediately have all passengers and crew exit the passenger compartment. If an explosion or fire should occur, the probability of injury will be greatly reduced if no one is in a confined area of the vessel. In the event of an alarm it is important to understand that an alarm would not occur unless a problem existed. Carefully check all fuel lines, gas lines, and any other potential sources of gas leaks.

The head unit can be tested for electrical continuity by pressing the "Test" switch. The Red LED will come on. The light will glow as long as the switch is held down. If the test switch is held down longer than 10 seconds the horn will sound and the "MUTE" switch must be pushed to silence the horn. Unplug the sensor wire from the helm display head while the unit is powered up. The Red LED will illuminate and within 10-15 seconds the alarm horn will sound.

If warning Red LED fails to come on & horn fails to sound, remove display head & return to factory for repair. *Note that due to the harsh environmental conditions in marine applications, it is recommended to replace the gasoline fume sensors every 3 to 4 years.*

Refer to the equipment manufacturer's manual for additional operating information along with more troubleshooting.

Ladder-Exiting/Re-boarding

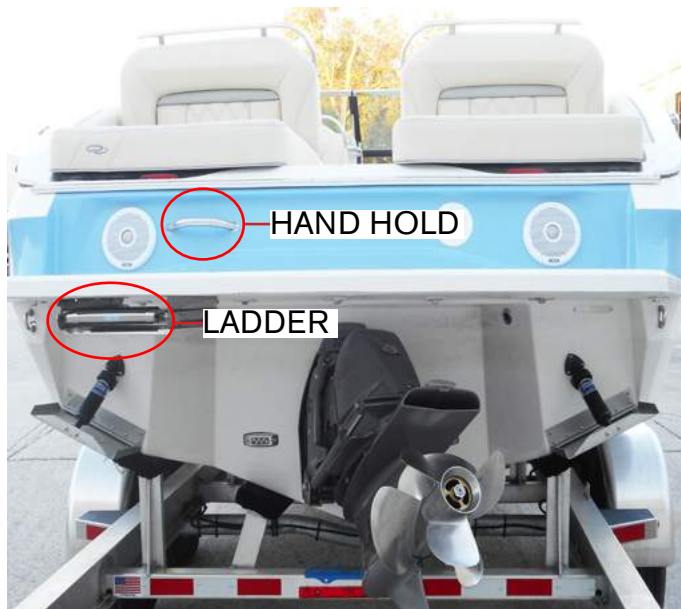

The stern ladder is located under the port side of the swim platform. It is the recommended component for exiting or reboarding the vessel to and from the water. Be sure to use the hand hold for support as needed when using the ladder.

When not using ladder be sure to keep the ladder locked in the framework as shown in top right photo. Insist that only one person use the ladder at a time. Periodically check the ladder hardware for tightness and corrosion. Replace fasteners and lubricate hinges as needed.

See the cosmetic care chapter regarding cleaning and preserving the stainless steel. Read and understand all warning and information labels found in the vicinity of the ladder.



To use the stern ladder grasp the ladder rung and push the ladder up and in until the ladder round pawls clear the spring loaded scalloped lock on the framework. Pull the ladder out to the end of the travel. Then flip the ladder over and let it down gently. Make sure you keep all body parts clear of any moving ladder parts especially the hinged top.

When reattaching pull the ladder up to retract the rungs. Then grasp the rung and push it into the scalloped lock and pull it down until the round pawl is secured. *Note that some resistance may be felt during both the releasing and attaching process as the ladder framework is spring loaded to complete the locking process.*

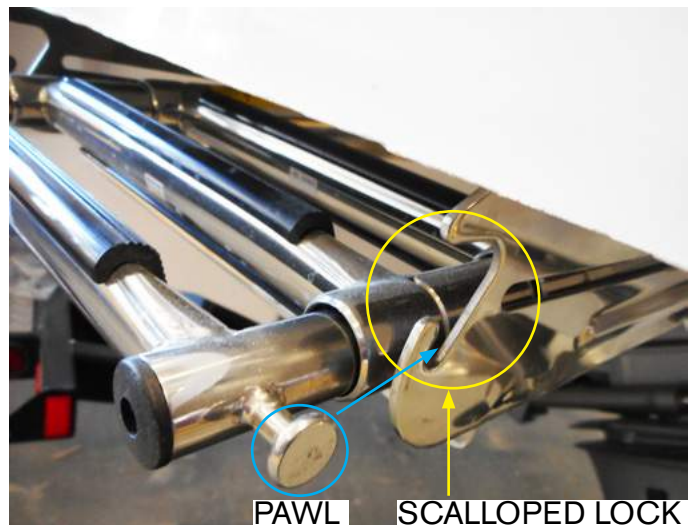

Power Platform



TYPICAL UNIT-UP POSITION



If installed the power platform features the ability to lower a seat structure into the water and also extend it out a bit from the swim platform. It permits a person to sit on the seat of the platform while it is

submerged at varying degrees in the water.

There is a switch on the transom to control the movement of the platform.

Note that the transom boarding ladder is recommended for entering and exiting the water.

Make sure the drive is trimmed in as far as possible and the keys removed from the ignition switch before attempting to use the power platform. Use the platform for sitting only. Do not stand, jump, or dive from the device. There is a 20 amp fuse part of a fuse panel located on the battery management panel board accessible through the engine hatch.

Supervise small children around power platform!



CAUTION

AVOID INJURY OR PROPERTY DAMAGE!
ENSURE THAT POWER PLATFORM IS IN
THE UP POSITION
AND CLEAR OF ALL OBJECTS
BEFORE STARTING THE ENGINE!

PowerTower/Typical

The PowerTower hinges forward for tight overhead clearances such as bridges, restricted storage situations and towing opportunities. The PowerTower features an aluminum framework with a multi-layered powder coated finishing process. Read and understand the warning label on the following pages regarding PowerTower usage.

The PowerTower features an FRP framework, all around light, and the ability to anchor major electronic equipment. Select towers feature a pylon for water sports. Use the switch marked “tower” found on helm panel to energize the PowerTower. It connects to twin actuators that raise or lower the PowerTower.



Located at the aft starboard battery management board (engine compartment) is the PowerTower actuator control box. The purpose of this device is to provide over-

load protection for the port and starboard actuators that energize the rams to move the PowerTower forward and aft.

Facing the box the left reset breaker protects the port power tower lift actuator. The center reset breaker protects the starboard power tower lift actuator.

The far right breaker protects the entire circuit wiring including the helm. If the PowerTower fails to raise check the box for an “open” breaker. Always find the cause of an open breaker situation before resetting the device.



TYPICAL POWERTOWER



CAUTION

WHEN OPERATING POWERTOWER
KEEP ALL BODY PARTS CLEAR
OF TOWER HINGE MECHANISMS.

Make sure the operator and all aboard read and understand the above warning.

As the operator energizes the switch to hinge the tower forward visually monitor the port and starboard aft deck to ensure all passengers are clear of the hinge mechanism. This same procedure applies for raising the mechanism to the cruise position.

For highway towing the PowerTower shall be in the complete forward position and all canvas shall be in their dedicated boots. All attached canvas bow hardware shall be checked for tightness before and after towing. Cockpit carpet shall be rolled up and stored in a dedicated cockpit locker.



AVOID BODILY INJURY OR DEATH DUE TO MISUSE OF THE POWERTOWER!

READ AND UNDERSTAND THE FOLLOWING WARNING!

DO NOT PULL MORE THAN ONE (1) PERSON AT A TIME FROM THE POWERTOWER. USE POWERTOWER ONLY FOR KNEE BOARDING, WATER SKIING, WAKE BOARDING OR WAKE SURFING. THIS POWERTOWER WAS NOT DESIGNED AND SHALL NOT BE USED FOR TUBING, TOWING OF BOATS, PERSONAL WATERCRAFTS, FLOATING DOCKS OR ANY OTHER TYPE OF FLOATING VESSEL OR CRAFT. THIS POWERTOWER SHALL NOT BE USED FOR PULLING PARASAILING OR ANY OTHER EQUIPMENT NOT APPROVED.

THIS POWERTOWER SHALL NOT BE USED TO PULL INFLATABLE WATER SPORTS TOYS OF ANY KIND. NEVER LET PASSENGERS SIT DIRECTLY BEHIND THE POWERTOWER ROPE ATTACHMENT POINT WHILE PULLING APPROVED WATER SPORTS ACTIVITIES. DO NOT LET LOOSE WATER SPORTS ROPE HANG FROM THE POWERTOWER. ALWAYS INSPECT THE POWERTOWER PRIOR TO USE TO ENSURE IT IS NOT DEFORMED, DEFLECTED, AND THAT ALL BOLTS ARE IN PLACE AND TIGHT. WATER LEVELS CAN VARY DAILY AND IN SOME CASES HOURLY.

BE AWARE OF MINIMUM CLEARANCE OF BRIDGES, TREE LIMBS, AND OTHER OBSTACLES, BEFORE ATTEMPTING TO PASS OR GO UNDER ANY OVERHEAD STRUCTURE. WHEN TOWING KEEP POWERTOWER IN THE FURTHEST FORWARD POSITION.

READ AND UNDERSTAND ALL SAFETY LABELS REGARDING THE POWERTOWER IN THIS OWNER'S MANUAL!

Pressurized Water System

Note that the water system is non-potable (not for drinking). If installed the pressurized water system includes a deck fill plate, water tank, hoses, pressure pump and sediment filter, head sink w/faucet and transom shower.

The aluminum water tank is located in the forward center bilge. The pressure pump and sediment filter are normally mounted in the bilge. Periodically clean the filter and screen if installed. Reinstall filter and check for leaks.

TYPICAL WATER TANK

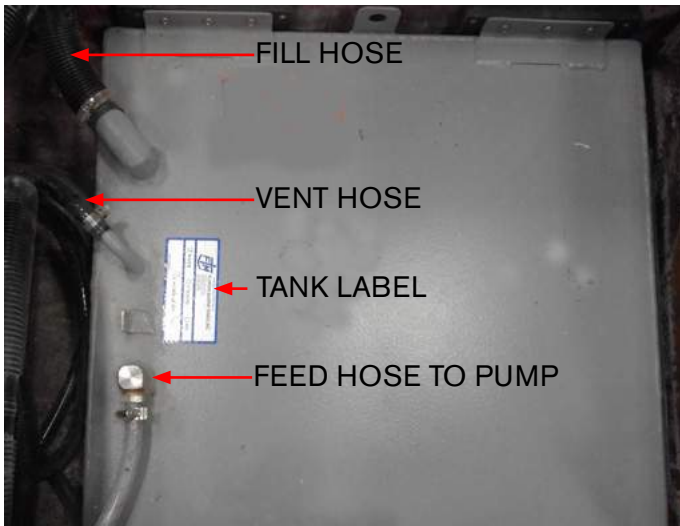

Using Pressurized Water System

1. The tank capacity is around 16 gallons. Fill the water tank at the deck fill plate. You might want to use a white hose manufactured specifically for water tanks. These hoses are available in 25, 50 and 100 foot increments at marinas, marine retailers, RV dealers and big box stores. They do not leave marks on the deck and do not carry a rubber odor. As you look into the deck fill you may see a vent hole. With this style fill plates once the tank is nearly full water will emerge from the vent hole and re-enter the fill.

Shut the fill cap and line up the two dimples on the cap and fill plate to seal the system from foreign debris. You then can lock the cap by pressing on the side of the cap handle.

2. At the helm switch panel activate the water system switch. This will energize the water pressure pump to send water from the water tank through the cold water lines terminating at the head faucet and transom shower.



3. Open the cockpit sink faucet. Water pressure should be present. Opening the faucet for a few seconds will purge any air in the system especially in cases

where the fresh water tank has run out of water. When water is running at a faucet it is not unusual to hear the water pump activate as it is trying to build up the pressure required in the system. Soon after the faucet is turned off the fresh water pump sound will end indicating the water system is now up to specified system pressure.



4. This entire water system is not meant for consumption (non-drinkable) and does not meet the requirements of the U.S. Public Health Drinking Water Standards.

This label found at the optional head and transom shower is a reminder to passengers not to drink the water. It is for cleaning or rinsing purposes only.

Typical Water Pressure Pump



A majority of these pressure pumps use a switch which disengages the water pump after it reaches a predetermined line pressure. If the water pump ever runs continuously it may be a result of the following:

- A faulty internal pressure relief valve
- A faucet on board not turned off
- A broken line or loose line connection

It is recommended that the water pressure pump switch be in the "off" position when leaving your boat to help prevent damage should a leak develop in the cold water system.

NOTICE

AVOID COMPONENT DAMAGE!
NEVER RUN THE WATER PUMP
WITHOUT WATER IN THE WATER
TANK AS PUMP IMPELLER DAMAGE
MAY OCCUR.



CAUTION

PREVENT PROPERTY DAMAGE!
TURN OFF WATER
HELM PANEL SWITCH
BEFORE LEAVING THE VESSEL.

Sanitizing Water System

It is recommended to sanitize your vessel water system at least annually or more often when odors are detected.

1. Flush entire system thoroughly by allowing water to flow through it.
2. Drain system completely.
3. Fill entire system with a chlorine solution having a strength of at least 100 parts per million, and allow to stand for (1) hour. Shorter periods will require greater concentrations of chlorine solutions. See the table.
As a rule of thumb quick reference without the use of the table to reach the recommended proportions use a quarter cup of household bleach for every 15 gallons of water the fresh water tank holds.
4. Drain chlorine solution from entire system.
5. Flush entire system thoroughly with water.
6. Fill system with fresh water.

TABLE I – CHLORINE CONCENTRATIONS

Amount of chlorine compound required for 100 ppm solution

Solution (Gallons)	Chlorinated Lime 25% (ounces)	High Test Calcium Hypochlorite 70% (ounces)	Liquid Sodium Hypochlorite 1% (quarts)
5	0.3	0.1	0.2
10	0.6	0.2	0.4
15	0.9	0.3	0.6
20	1.2	0.4	0.8
30	1.8	0.6	1.2
50	3.0	1.0	2.0
100	6.0	2.0	4.0

Winterizing Water System

Note that In freezing climates make sure the water system is winterized to prevent damage to hoses and components. Contact your Regal dealer since only special alcohol based products like "Winter Ban" are to be used in the system.

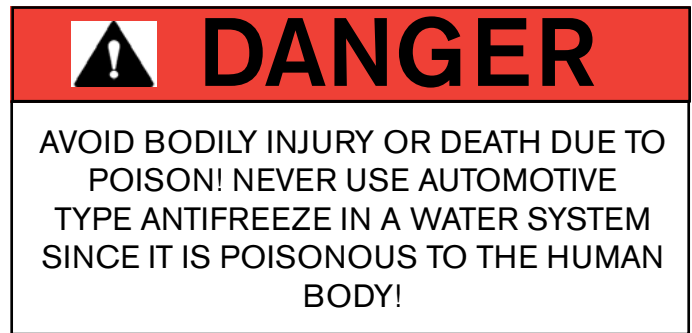

SeaDek Decking

As an option SeaDek® is featured on select vessel swim platform and walk through areas. The non-skid, closed cell material is derived from UV protected non-absorbent foam. You will find the product easy to clean with a high stain resistance.

Other features include noise reduction, great traction even when wet, body comfort when standing, walking or leaning on the swim platform.

To clean small dirt particles first try soap, hot water and a stiff brush.

For surface dirt and footprints use glass cleaner and a clean rag.

If a more thorough cleaning is needed you may use bleach, 409, Simple Green or Soft Scrub. Be sure to rinse thoroughly. Stay away from using any acid base cleaners.



SeaDek-Swim Platform

Transom Wash Down



A transom cold water shower/wash down using the pressurized water system may be installed on your vessel. It consists of the transom mounted sprayer with hose. The wash down is very useful

for rinsing off when exiting from the water and helps keep the swim platform clean. In salt areas it can be used to spray off the aft ladder, hardware and assists in reducing corrosion.

There is a helm switch labeled FRESH WATER PUMP that controls the water pressure to the pump/strainer which in turn delivers the water to the transom shower sprayer.

Remember in freezing climates, drain the system and add Winterban or similar protective additive to the water system.

Turn the sprayer wand to activate/deactivate water flow.

Pressurized Water System-Helpful Hints

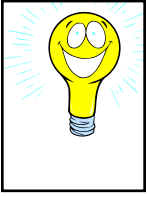

1. Water pressure pump cycles on and off. Normally this type of action indicates a water leak in the system. Check all water system related equipment on the deck and engine compartment for leaks. Look for puddled or dripping water.

2. Using water system the water pressure is weak. Check the fresh water pressure pump filter for debris. Also, make sure the water tank level is sufficient.

3. Water at sink or transom shower is hammering and has air bubbles in it. Check for air leaks in the system along with low water levels in the water tank.

4. There is no water at any of the water related equipment including head faucet or transom shower. Check to make sure the water pressure pump switch is activated. Also, check for a blown fuse.

5. The water system has a bad odor. Use the pressurized water pressure pump to drain the water system. *Do not permit anyone to drink the water as it may be contaminated and it is not a potable water system.* Sanitize the water system.

Remote Stereo Control



As part of the stereo performance package option the remote control may be mounted top side where it makes controlling the main cockpit unit much

easier. It is a plug and play device and uses the same function buttons and rotary encoder as the helm head unit. It features the ability to select various speaker zones on the vessel. Normally the remote is a working partner with signature speakers, amp and subwoofer.

Refer to the Fusion owner's manual for more detailed information.

Seating

Overview Of Cockpit Seating



This photo shows the multi-functionality of the cockpit seating. The captain's seat rotates and travels to stern and bow to accommodate an array of body sizes. The passenger seat converts to a sunlounger (as shown) or the backrest pulls up for cruising. The aft center seat converts to a 2 person sunlounger by depressing the latch assembly.



Pull the latch while pulling back on the seat itself. It will tilt back to a partial lounge position. When latch is activated again the seat will push down into a full tilt aft facing lounge. Reverse the process to convert back to a bench seat/backrest position.

Note that the sun lounge aft facing positions are not to be occupied when the vessel is making headway. The aft port seat features a removable backrest for sunlounger use (See photo). To insert the backrest for cruising seat positioning simply insert the plate attached to the backrest into the seat receptacle. An optional aft starboard seat cushion is shown as snapped in place.

Note that the sun lounge aft facing positions are not to be occupied when the vessel is making headway.

Note that the battery switch and battery are accessible under the starboard aft locker. Periodically check the battery water levels and position the battery switch to the "off" position after each outing.

Captain's Chair-Bucket Seat



The bucket seat features handle devices that operate multiple seat modes. The separate handles when properly locked, prevent the seat from rotating and sliding fore and aft during operation of the vessel. This provides an operator safety margin. Never alter the seat slider mechanism and lubricate per the slider manufacturers recommendations.

To adjust the seat slider follow the instructions and refer to the illustration on this page:

1. To adjust fore and aft movement, pull up on handle "A", slide seat to desired location and release the handle. The slide will lock in the closest detent position.
2. To rotate the seat and adjust the friction control pull handle "B" up to the horizontal position. The seat is now ready to rotate to the desired position.

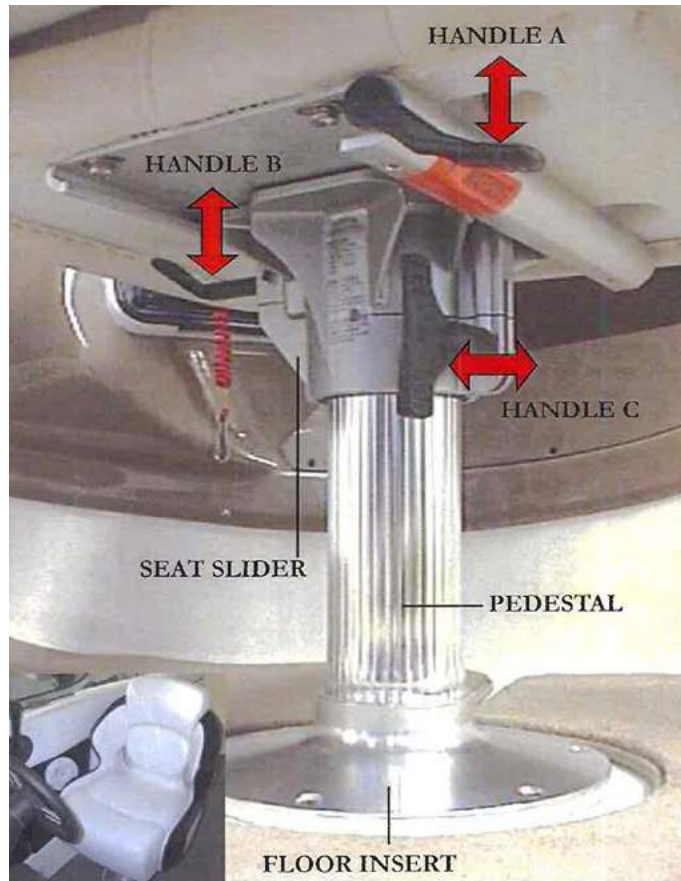

TYPICAL SEAT SLIDER

To increase the rotation friction, turn handle "C" clockwise to desired resistance. To decrease the rotation friction, turn handle "C" counterclockwise.

3. To lock the rotational feature, push handle "B" down and the positive lock feature looks for the next detent position.

Note to always use the positive lock feature when your vessel is underway. For further information contact the closest Regal dealer.

Note that it is the captain's responsibility when making headway to securely attach the safety lanyard and shall make sure all passengers are in designated seats and PFD's are worn by everyone aboard.



CAUTION

TO PREVENT BODILY INJURY!
PERIODICALLY CHECK AND TIGHTEN
THE MOUNTING BOLTS
BETWEEN THE SEAT SLIDER
AND THE BUCKET SEAT BOTTOM.
ALSO, PERIODICALLY CHECK THE
PEDESTAL FASTENERS
FOR TIGHTNESS AND CORROSION.

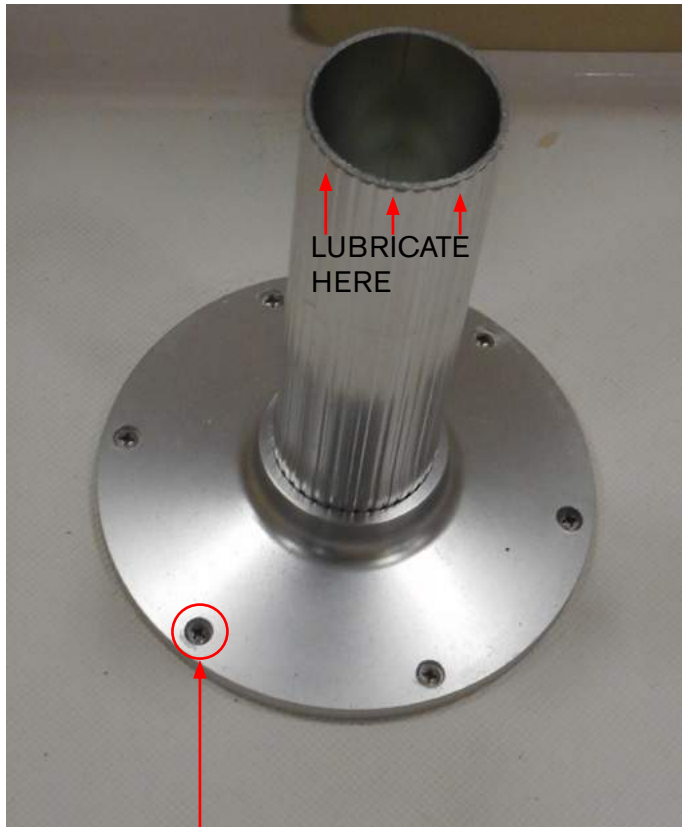

Periodically check floor insert (pedestal) fasteners for tightness and corrosion. Also, lubricate the top of pedestal as shown above along with the mating part (nylon sleeve) on the seat slider with a marine grease such as a wheel bearing type as it will not break down under extreme temperatures and the harsh marine environment.

Seats-Bow Arm Rests

On selected models bow seating includes arm rests. To use pull the arm rest down until completely extended.



Table-Teak (Typical)

If installed the teak bow table is found in a cockpit locker. The table features teak a hardwood known for beauty and durability in the harsh marine environment.

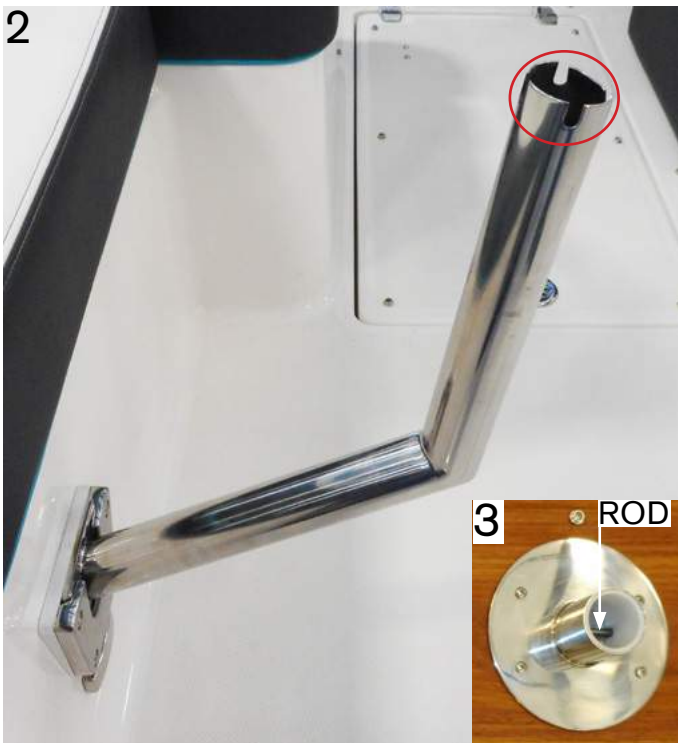

Setting Up Table

1. Remove the table from the cockpit storage area. You will need to move the cooler for table access. Unsnap the holding strap and pull out the table.
2. Locate the table leg under the starboard cockpit seat. Unfasten it from the 2 hold down clamps. Insert the leg into a table holder. Note that the table leg features 4 cut outs at the top.
3. The table base features an alignment rod through the top of the base as shown.
4. The table must be inserted down into one of the two sets of holes depending on how the table fits the seating arrangement. The rod when attached to the table will prevent the table from turning while in use. Ensure that the table is down completely into the rod.
5. To disassemble the table reverse the process.



Note that it is recommended that the table assembly be stored before making a cruise due to possible rough seas or other adverse weather conditions.

Toilet-Electric (12 Volt)

As optional equipment an extra low profile marine toilet provides a comfortable design and reliable macerator toilet high performance. This toilet uses the consolidated ECO smart flush which consumes less power and water.

This unit uses a metal fresh water tank for supplying water for the flushing cycle through a pressurized water pump that is activated by solenoid technology and a rocker switch. Once flushed waste is chopped up by a macerator pump located at the toilet bowl discharge.

Read and understand your toilet owner's manual before operating or servicing this system.

Read, understand, and follow the warnings below ;

 **WARNING**

AVOID SERIOUS INJURY DO TO HIGH SPEED MOVING PARTS!
DISCONNECT POWER TO THE TOILET BEFORE SERVICING! NEVER PLACE HANDS OR FINGERS IN THE BOWL DISCHARGE BECAUSE OF THE HIGH SPEED MACERATOR IMPELLER PLACED DIRECTLY BELOW THE BOWL DISCHARGE. NEVER ATTEMPT TO DISLodge AN OBJECT IN THE PUMP BY PLACING HANDS/FINGERS IN PUMP AREA WHILE IT IS RUNNING!

 **WARNING**

AVOID SERIOUS INJURY!
PROVIDE SUPERVISION FOR CHILDREN WHEN USING THE TOILET.
DO NOT PUT BODY PARTS INSIDE TOILET!

As optional equipment an extra low profile marine toilet provides a comfortable design and reliable macerator toilet high performance. This toilet uses the consolidated ECO smart flush which consumes less power and water.

Operation-

The ECO switch located near the head controls the smart flush cycling. To flush the toilet do the following:

1. Ensure the battery switch is activated on the vessel. This assures 12 volt power to the toilet.
2. Activate the fresh water switch that controls the fresh water pressure pump.

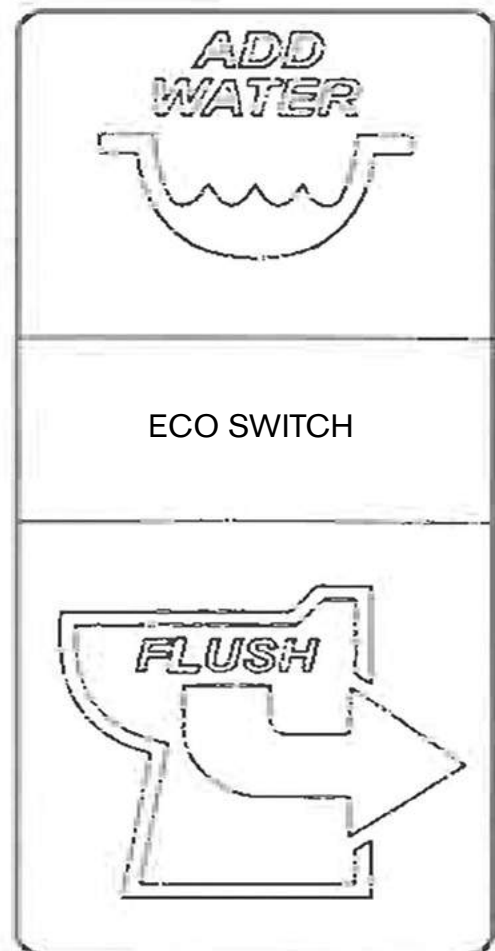

3. Note that the ECO switch consists of 2 parts; ADD WATER (top) and FLUSH modes (bottom).

4. Push the ADD WATER portion of the upper momentary* switch before flushing any solid waste. Note that the system continues to add water as long as the switch is up. (Before use).

Push the FLUSH portion of the switch to remove the solid waste and added water from the bowl.

5. Push the FLUSH portion of the lower momentary* switch for flushing liquid waste. The flush portion in this mode becomes the minimal water usage segment. Note that the flush mode adds water and activates the high-speed macerator as long as the switch is down.

* A momentary switch is only activated as long as you hold pressure on it.

System Recommendations

1. Only human waste and toilet paper should be put in the toilet. Never flush foreign materials such as paper towels, pre-moistened wipes, condoms, feminine hygiene products, dental floss or household garbage.

2. Use only non-abrasive, non-petroleum products to clean the pump. Thetford's Aqua-Clean is a non-abrasive, all purpose cleaner specially formulated to be safe for all components of your toilet system.

3. Never use household cleaners, which can contain bleach, in the toilet system. Household toilet bowl cleaners contain harsh acid. Bleach, petroleum based products, strong acids and abrasives can cause irreversible damage to the toilet system and components.

4. To assist flushing, it is recommended that you use only toilet tissues specifically designed to disintegrate rapidly. Do not use household types. Use types such as Thetford's Aqua-Soft (2 ply) and RV/Marine Toilet Tissue (1 ply).

5. For winterizing, storage, and seasonal start-up refer to the Thetford Operation Manual or contact your closest Regal dealer.

6. For troubleshooting your toilet refer to the information in chapter 9 of this manual.

Holding Tank (Typical)

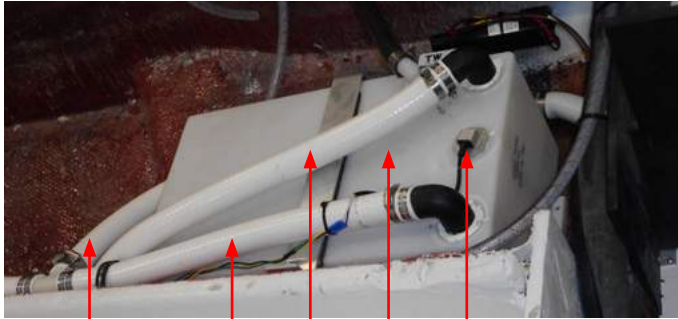

HOSE TO
DISCHARGE
PUMP

HOSE TO DECK
PUMP OUT

HOSE FROM
TOILET

WASTE
SENDER
HOLDING
TANK

If installed the holding tank features a polyurethane construction. A center metal strap wrapped with a space age rubber insulator encapsulates the tank. 90 degree elbows along with low permeability hoses with smooth inside walls to help promote material flow. Periodically check all hardware for wear and tightness especially the hose clamps.

It is recommended that the holding tank be pumped dry at the end of the boating season. Add non-toxic antifreeze to the system. Do not use automotive types as they tend to be corrosive.

Electric Toilet Vent Filter



The electric toilet system uses a vent line filter to control waste system odors. The filter is connected to the holding tank vent line and is mounted on the starboard hull side for easier maintenance.

The filter uses union couplings which when loosened will let the filter be removed and the replacement filter tightened in place without having to remove any hoses and clamps.

It is recommended to replace this cartridge filter once per year as there is no other maintenance required on this component.

Toilet- Pump-Out Fittings-Electric Head



The electric head features a pump-out fitting option. If installed there is a waste pump-out fitting on the deck designated with the word “waste” and the international symbol for

waste. Waste tank deck fittings feature a turning cap. When tightening cap line up the embossment on the inside cap with the embossment on the outside of the pump-out fitting. This alignment assures that the waste fitting is tightened properly. At this point select fittings lock the cap by pushing the center tab to the side.

The pump-out system includes an 11 gallon holding tank. Check the waste tank level monitor (cabin) often and when full contact the marina or designated business to have the tank pumped out.

Do not continue to flush the toilet when full!

Personnel will install an adapter hose into the deck waste fitting and turn on a vacuum pump which will empty the waste from the holding tank.

After this operation it is always recommended that you rinse the waste hose out before screwing in the waste fitting cap. This helps in preventing waste debris from sticking to the inside of the waste hose which in time could build up and affect the pump-out process.

Toilet- Overboard Discharge Pump

If installed as an option to the electric head, an



overboard discharge pump is sometimes called a macerator. It may be used in selected areas such as International waters

for extruding crushed waste from the holding tank through the hull bottom via an opened sea cock.

To use the macerator first remove the tie wrap from the sea cock that ensures a secondary locked closed position.. Next, open the sea cock by aligning the handle so it is parallel with the sea cock. Failure to open the sea cock while the discharge pump is activated may cause high pressure in the waste lines which could burst them.

Once the sea cock is in the “open” position, turn the key switch located on the monitor panel to the far right position which will begin the waste pumping cycle.

While pumping keep a visual check on the waste monitor panel as it will display the holding tank level lessening. Once the tank is near empty turn the key to the “off” position to stop the discharge pump.

Finally, turn the sea cock handle to the closed position (90 degrees to the sea cock) and tie wrap the handle closed to avoid fines related to pumping waste in specified locals.

Trim Switch-Transom



If installed the a trim switch is outfitted on the transom. This location permits the stern drive to be trimmed from the transom which is great for inspecting the drive and more importantly the propeller without needing to remove the vessel from the water.

To operate the switch depress and hold the top portion of the switch until the desired “up” trimming angle is realized. Make sure there are no body parts or any other components near the stern drive before you raise it.

To trim the drive unit down depress and hold the lower portion of the switch until the desired “down” trim angle is reached. Again, make sure there are no body parts or other components near the drive before you lower it.



WARNING

**AVOID SERIOUS INJURY!
KEEP HANDS AND FEET AWAY
FROM DRIVE UNIT & PROPELLER
WHEN USING TRIM SWITCH.**

Trim Tabs



If installed, trim tabs are located on the lower hull of the transom. Water is deflected and redirected as the trim tabs are raised and lowered from the starboard helm located trim tab switch. This change in water flow creates upper pressure under the tabs, and raises the stern. When the stern rises the bow is lowered. Lowering the port tab will cause the port stern to rise, making the starboard bow lower. Lowering the starboard tab will cause the starboard stern to rise, making the port bow lower. The pressure originates from a pump and valve system located in the aft bilge.



TYPICAL TRIM TAB PANEL

When used with the engine power trim a fine tuned ride can be achieved. The trim tabs will compensate for uneven weight distribution, listing, water conditions, and other factors that cause inefficient operation. Remember, that trim tabs are trimming the hull while power trim is trimming the stern drive.

Obtaining A Trimmed Position

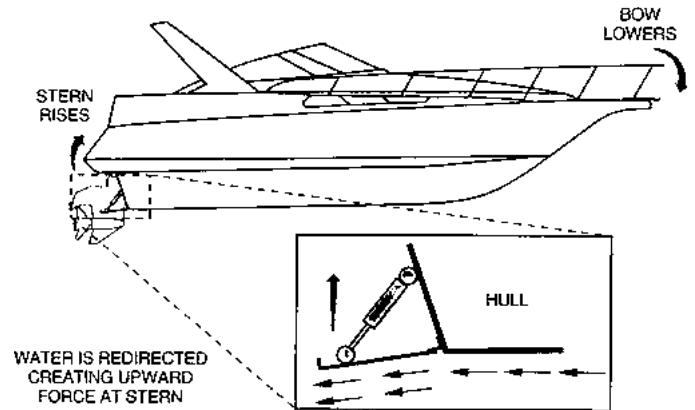

Your vessel will reach a planing position at a specific speed. This speed is determined by bottom design, weight distribution, water conditions, and on board equipment. As the throttle is advanced the stern squats and the bow rises initially. The trim tabs allow your boat to plane at a slower speed than natural conditions allow. *Note a stern drive example above.* In short bursts both trim tab rocker switches are pushed simultaneously in the “bow down” position which causes the trim tabs to move down. As the boat breaks over the bow high attitude the boat speed accelerates and visibility increases.

If the boat is over-trimmed, it will plow the bow and the boat will lose maneuverability. If this occurs, simply short burst the “bow up” trim tab rocker switches simultaneously.

In the “learning curve” process, press the tab switches in half second bursts. You will notice a slight delay from the time the switches are pushed until the boat reacts depending on vessel speed. You will know after awhile the optimum planing angle and speed/rpm for your vessel.

When running in heavy seas press the “bow down” position which will assist the vessel to cut through the waves. This will produce a drier and more comfortable ride. In a following sea run the tabs in a fully retracted angle for maximum drive response. Sometimes you can watch the bow spray or stern wake and the rooster tail (mound of water produced by outboards). In a bow up position the spray is far aft to the hull, the wake is high and the rooster tail is high.

When trimmed or in the bow down position, the bow spray is farther forward, the wake and rooster tail are smaller, and positioned further behind the vessel. Also, when trimmed you will notice that tachometers show an increase in rpm's.

Rectifying A List

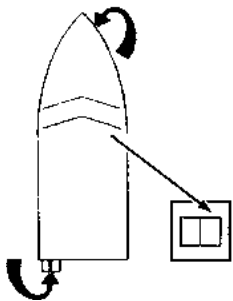

Your vessel can use the trim tabs to rectify a list. The trim tabs adjust the boat's attitude in the direction the helm rocker switch is pushed.

If the port bow is high, push the left-hand “bow down” direction on the dash rocker and the port bow will lower. If the starboard bow is high, push the right-hand “bow down” direction and the starboard bow is lowered.

Using Power Trim With Trim Tabs

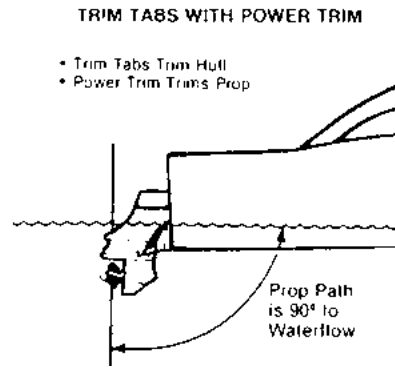

Adjust the trim tabs to achieve a planing altitude. Use the power trim to position the prop path parallel to the water flow. At this point the trim tabs

may need a fine adjustment.

One advantage of the trim tab system is that it allows trimming of the hull while the power trim results in trimming the propeller.

Underwater Lights

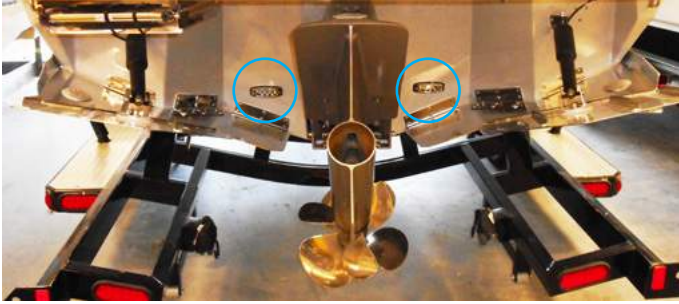

As an option light bars w/ blue or white LED clusters make up the underwater lighting system. The lights are located on the transom along with the port and starboard hull sides. There is a dash switch for energizing the lights and a breaker behind the dash to protect the system.



The underwater light option provides high output, long life and low heat emission.

The lights are made from a high impact resistant polycarbonate housing. The lights are installed under the transom for maximum efficiency. A blue beam increases underwater penetration.

These lights are based on LED technology which stands for light emitting diode which can produce various colors depending on the electron makeup inside the semiconductor body of the device.

Chapter 8

Care & Maintenance

Cosmetic Care

This section covers the care and maintenance of your Regal boat. Many cosmetic care topics including exterior hardware, upholstery, fiberglass and canvas are covered along with major equipment and systems. Refer to the owner's information packet and the appropriate engine manufacturer's manuals for further detailed instructions. Your vessel may include or exclude select components in this chapter.

Upholstery

Cockpit and interior vinyl require periodic cleaning to maintain a neat appearance and to prevent the build up of dirt, mildew and contaminants that may stain and reduce the vinyl life if they are not removed. The frequency of cleaning depends on the amount of use and conditions to which the vinyl is subjected. Most common stains can be cleaned using warm, soapy water and clear rinses. Scrubbing with a soft bristle brush will help loosen soiled material from embossed surfaces and under welting. If the stains are not removed with the above method use a mild cleaner such as Fantastic. This cleaner should be used only as needed and not the normal means.

With more stubborn stains, rubbing alcohol or mineral spirits may be tried cautiously. Widespread solvent use can severely damage or discolor vinyl. Try to remove stains immediately before they have a chance to penetrate the surface of the vinyl.

Powdered abrasives, steel wool, or industrial strength cleaners are not recommended for cleaning our vinyl. Lacquer solvents will cause immediate damage. Dilute chlorine bleach before using. Do not wax the vinyl as it may cause cracking. Always wear protective gloves and make sure there is sufficient ventilation when cleaning vinyl. Wear eye protection.

Remember that suntan oil will damage vinyl. Use suntan lotion instead of suntan oil. Exposure to the sun is a natural enemy of vinyl upholstery. Keep the vessel covered with a cover when not in use.

Cockpit Carpet

Use approved cleaners on carpet. Always try on a test area first. Many spots and spills can be removed using a cleaner combined with a clean, white terry towel. Try not to soak an area excessively and do not use solvents because most interior carpet is rubber backed and glued in place. Solvents and abrasives will break down the backing and fibers. Note: Always roll up cockpit carpet before towing your boat. Store carpet in a locker.

Plastic

Use plastic cleaners and polishes recommended for marine use only. Use proper applicators. Read all instructions carefully. Test the product in a small area first. Use a soft rag and always rinse the surface with water. Ammonia based cleaners and abrasives will damage plastic parts.

Acrylics

The optional walk-through doors are one item made from a heavy acrylic material. Use warm water and a couple drops of mild detergent, The cleaning rag should be lint free and thoroughly rinsed. Do not substitute paper towels, which could lead to fine scratching of the surface. With the right cleaning materials, you can easily remove most dust and grime without creating an additional static discharge.

Do not use an abrasive or scouring pad. Acrylic must not be exposed to organic, oil-based solvents.

This includes:

- Acetone/nail polish remover
- Paint thinner or comparable
- Benzene
- Rubbing, denatured, or other alcohol-based solutions
- Carbon tetrachloride

For scratches and other marks that do not respond to basic cleaning, polishing is the way to renew your acrylic. Again, use a soft, lint-free cloth. You can hand polish or use a polishing machine.

Apply the polish in a snake like S pattern across the surface first horizontally and then vertically. Smaller polish jobs can use an L shape followed by a circular motion. If you are still not able to remove the blemish the scratch is probably too deep. In these situations, the only recourse is an incremental wet sanding, finishing with an #800 grit abrasive, and another coat of polish. After polishing any residual polish should be removed.

NOTICE

AVOID CLEANING PLASTIC SURFACES WITH A DRY CLOTH OR GLASS CLEANING SOLUTIONS CONTAINING AMMONIA. NEVER USE SOLVENTS OR WIPE WITH ABRASIVES.

Spaghetti Mats

Spaghetti mat is used in most of our storage lockers. It is a thick black material that looks like pasta. It provides cushioned support for stored items along with the ability to weep water and condensation through its porous design.

To clean spaghetti mat remove from the storage area and use a hose and nozzle to remove debris. Air dry and reinstall in compartment. Material features ability to dry quickly. For heavier cleaning spray with a mild liquid soap and rinse with fresh water. Air dry.

Interior Fabrics

Clean flat good interior fabrics with dry cleaning fluid style cleaners approved for use with soft fabrics. Allow adequate ventilation and follow the label instructions carefully. Use a soft cleanser with feldspar to clean stubborn marks or stains on wallpaper. Normal interior vinyl such as used on the headliner on cruisers and head clean up with a mild soap and water solution. Rinse immediately with clean water and wipe dry. Always test an area with a cleaner before applying it to a larger area.

Fiberglass & Gel Coat

 **DANGER**

AVOID SERIOUS INJURY!
WAXED GELCOAT SURFACES CAN BE VERY SLIPPERY! DO NOT WAX NORMALLY USED AREAS OF THE DECK, LINER, OR GUNWALES. DO NOT WAX ANY TEXTURED OR NONSKID SURFACES SUCH AS FLOORS, WALKWAYS, STEPS, LADDERS, OR SWIM PLATFORMS. WEAR NON-SLIP FOOTWEAR WHEN WALKING ON VESSEL SURFACES!

NOTICE

WIRE BRUSHES, SCOURING PADS, OR OTHER ABRASIVE TYPE MATERIALS AND SOLUTIONS SHOULD NEVER BE USED ON THE HULL OR DECK. THEY CREATE SMALL SCRATCH THAT COLLECT MARINE GROWTH.

Routine maintenance is the only practical way to keep the surface of your boat looking shiny and new. Most objects left outdoors will gradually deteriorate from exposure to the sun, water, dust and pollution. Such outdoor exposure can cause your boat's gel coated surface to change or fade. Darker colors tend to fade more rapidly than lighter colors because they absorb more of the sun's rays (ultra-violet and infrared).

Basic maintenance includes monthly washing of the boat's surface to remove normal accumulation of soil and stain.

Use a mild detergent such as dishwasher powder or liquid. Do not use automatic dishwasher detergent. Avoid any kind of alkaline cleaners such as trisodium phosphate (TSP), abrasives, bleaches and ammonia. For best results use cleaners that are recommended for fiberglass.

It is recommended that you wax the gel coat surface twice yearly to prevent loss of gloss and to protect the finish. Use only waxes for fiberglass and follow the label instructions. Apply a 3' x 3' section at a time using clean applicator cloths or a buffing bonnet. When a haze develops, use a power buffer at low speeds (1200-2000 rpm) to remove the haze. Keep the buffer moving to avoid heat buildup. The power buffer is very efficient at removing contaminants from gel coat. Never wax gel coat in the direct sun.

When the washing and waxing as recommended does not restore the shine it may be necessary to use a fine rubbing compound. Do not apply rubbing compound in direct sunlight. A power buffer at low speed does an excellent job to remove impurities from the gel coat that cause dulling. Use light pressure and keep the buffer moving. Re-wax after compounding to buff the surface.

“Hairline cracks” or “spider webbing” could develop in the gelcoat surface of a hull or deck. This can be caused by impact or other factors. Small air pockets or gouges may also occur through normal wear.

These do not affect the strength of the hull or deck and can be repaired by yourself, a marine professional or a Regal dealer.

The affected area should be chipped or sanded away and a thin layer of color matched gel coat applied. This layer is then sanded smooth and buffed to its original luster.

Most minor scratches, nicks, and dents can be removed by compounding the surface. Marine type compounds can be found at most auto body supply stores. Specify a number 25 which is a coarser compound up to a number 55 being less coarse. Various glazes and polishes are available as needed. Ask your marine professional or Regal dealer for more information. Fiberglass hulls are strong but they can be damaged. A fiberglass hull has virtually no internal stresses. Thus when a part is broken or punctured, the rest of the hull retains its original shape. A severe blow will either be absorbed or result in a definite localized break. A break of this nature should be checked and repaired by a marine professional or a Regal dealer.

Minor Repairs

You will need the following materials for minor repairs:

- Gel coat
- Clear Liquid Catalyst
- Putty Knife
- Razor Blade
- Fine Sandpaper (400,600,1000)
- Wax Paper (to cover repair area)

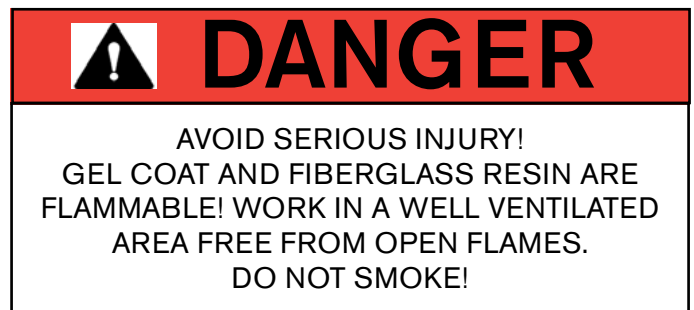

For minor repairs refer to the following procedure:

1. Clean the area to be repaired and get rid of any wax or grease residues.
2. Clean out scratches, chips, and nicks.
3. Sand area to be repaired so gel coat will bond.
4. In a separate container, measure only the amount of gel coat you will need. Mix a ratio of 2% ratio of catalyst to the amount of gel coat being used (a spoonful of gel coat will require only a drop or two of catalyst). Do not pour any unused portions of the gel coat/catalyst mixture back into either original container.

5. Apply gel coat to area leaving a slight lift above the surface.

6. Cover the area with wax paper. It will help the mixture to set up faster.

7. Remove wax paper and shave off any extra gel coat with a razor blade.

8. After the area is shaved smooth, start with the 400, 600, and finally 1000 grit sand papers.

9. Buff the area with compound, polish and a finish wax. You may notice a difference between the repaired area and the original finish due to the natural weathering process.

Canvas

Boat canvas is in most cases subjected to more severe punishment than practically any other type of material. Moisture, dirt and chemicals from industrial fallout, heat, ultraviolet rays and salt water are all factors which accelerate the deterioration of your boat canvas. These elements can cause serious damage if left unchecked.

The boat top and other canvas supplied on your Regal boat are manufactured from top quality materials to provide you with years of trouble free service. The following information on the care, cleaning and proper storage of the fabrics and fasteners that make up your marine canvas is being provided to help you maintain the appearance and ease of operation.

Sunbrella General Information

Sunbrella is used on select bow, cockpit covers and bimini tops. Sunbrella is a woven fabric made from 100% solution dyed acrylic fiber. It is color fast and will withstand long term exposure to the sun (ultraviolet rays) without excessive fading.

Even though it is treated with water repellency some "misting" through the fabric is typical. With new canvas, the greatest potential for leakage is through any sewn seams. Because Sunbrella and the long term thread used is synthetic, the holes created by sewing will not swell up and seal when exposed to water as cotton does. Usually the movement of the fabric in use will move the fibers enough to seal the holes. You may apply Apseal or Uniseal to the seams to speed up this process.

When the canvas is new, the fit will normally be tight. It is designed this way because Sunbrella stretches as it ages. The initial tight fit allows for a suitable fit for the life of the canvas. The Sunbrella fit will vary slightly in the heat, cold, and rain.

Sunbrella canvas should be cleaned regularly before substances such as dirt, roof particles, etc., are allowed to accumulate on and become embedded in the fabric. The fabric can be cleaned without being removed from the boat. Simply brush off any loose dirt, hose down, and clean with a mild solution of natural soap in lukewarm water. Rinse thoroughly to remove soap. **DO NOT USE DETERGENTS!** Allow to air dry.

For heavily soiled fabric, remove the top from the frame.

Soak the fabric in a solution that has been mixed to the following proportions.: 1/2 cup of bleach and 1/4 cup of Ivory or Lux soap (liquid or soap) per each gallon of lukewarm water. Allow the fabric to soak until the bleach has killed the mildew and the stains can be brushed out with a common kitchen scrub brush. Rinse the fabric thoroughly in cold water to remove all the soap. This may require several rinsings. Incomplete rinsing can cause deterioration of sewing threads and prohibit the fabric from being properly retreated. Allow the fabric to dry completely. **DO NOT STEAM PRESS OR DRY IN AN ELECTRIC OR GAS DRYER!** Excessive heat can damage and shrink the fabric since it is heat sensitive.

This method of cleaning may remove part of the water and stain repellent that was applied to the fabric during its manufacture. It is recommended to retreat with such water repellency products as Apseal and Uniseal. We do not recommend any wax based treatments such as Thompson's Water Seal or any of the silicone products such as SC-15 or Aqua-Tite. Wax based products prevent the fabric from breathing, and encourage mildew growth while the silicone products interact with the original fluorocarbon finish and seem to cause a rapid loss of water repellency.

Clear Vinyl, Zipper & Snap Care

Never store canvas wet or in an unventilated, moist area. Always roll the canvas instead of folding. This is of particular importance on side curtains or any other part with the clear vinyl "glass". Roll the top carefully around the bows and cover with the storage boot provided.

The clear vinyl "glass" used in side curtains, aft curtains, visors, and camper enclosures is very susceptible to heat and cold. Keep vinyl curtains from touching metal tubing to minimize burning the vinyl. If the boat is stored with top, side curtains and aft curtain in place, heat build up inside the boat may discolor the vinyl. To clean the clear "vinyl" glass, use a solution of Ivory or Lux soap, liquid or flakes, and lukewarm water. Allow to air dry. Never use any type of abrasive cleaner as it will scratch the "vinyl" glass. There are many cleaners and scratch removers on the market specifically for clear vinyl. Handle the clear curtains carefully. They are soft and prone to scratching.

Canvas parts are designed with zippers. When zippers are new they can be a little difficult to use. Zip carefully without forcing the zipper or the material. They will loosen with use. A zipper lubricant may be used to help new zippers as well as maintaining used ones. The most vulnerable part of the zipper is the starts. Use care when beginning to close the zipper.

Canvas snap fasteners should be unsnapped as close to the button as possible. Never remove canvas by pulling roughly on the edge of the material. This can damage the canvas as well as the fasteners. Use petroleum jelly on snaps to keep them from developing corrosion especially in harsh environments.

Metal

Keep all stainless steel and other metal parts rinsed and wiped dry. To maintain their finish annually polish the stainless steel and other bright works at least annually. Use commercially available metal products and read the labels carefully before use.

Refer to the flyer in the owners information pouch.
 Most marinas and boating retail outlets carry metal care products.

Hull Bottom

Never use wire brushes or highly abrasive scouring pads on your hull bottom. It could damage the gel coat surface or the bottom paint. The bottom of your boat needs to be clean since the build up of natural coatings from water or marine life can potentially create drag and affect your boat's performance.

FREQUENT STAINS/CLEAN-UP STEPS	1	2	3
Coffee, Tea, Chocolate.....	B		
Permanent Marker*	E	B	C
Household Dirt.....	A	B	
Grease.....	D	B	
Ketchup, Tomato Products.....	A	B	
Latex Paint.....	A	B	
Oil Base Paint.....	D	B	
Mustard.....	A	B	C
Suntan Oil.....	A	B	
Asphalt/Road Tar.....	D	B	
Crayon.....	D	B	
Engine Oil.....	B		
Spray Paint.....	B		
Chewing Gum.....	D	A	
Shoe Polish*	D	B	
Ballpoint Pen*	E	B	A
Lipstick.....	A	B	
Eyeshadow.....	E	B	
Mildew*	C	B	A
Wet Leaves *	C	B	A

A= Soft brush; warm soapy water/rinse/ dry

B= Fantastik cleaner

C= One tablespoon ammonia, 1/4 cup of hydrogen peroxide, 3/4 cup of warm water/ rinse/dry

D= Scrape off residue (use ice to lift gum)

E= Denatured alcohol/rinse/dry

* These products contain dyes which leave permanent stains.

Maintenance

Propellers



Out-of-balance and nicked propellers will effect performance or cause vibration. Damaged props should be replaced, but those

that are chipped or bent can usually be reconditioned by a marine dealer or a propeller repair facility. When cruising, consider carrying a spare set of props on board because many marinas do not carry a full inventory of replacement propellers. Also, include an extra set of prop hardware. Refer to the engine manufacturer's manual for appropriate propeller replacement and installation assistance.

Write down the propeller diameter and pitch while the vessel is in dry dock. They are pressed into the prop for easy reading.

Also, note that propellers feature a rubber hub pressed into the center propeller that includes the hole for the prop shaft to slide through. Sometimes as a result of impact the rubber hub becomes damaged and the propeller will not let the boat perform up to the rated revolutions per minute (rpm).

In an emergency a stainless propeller blade may be straightened by laying the propeller blade on a 2 x 4 and hammering the bent portion of the blade until straight. This normally will result in the propeller creating a vibration and if this occurs reduce rpm until back at mooring.

It is advantageous to carry the needed tools to change propellers including pliers to pull cotter key and deep socket and ratchet to remove the propeller shaft nut. See the appropriate outboard manufacturer's owner's manual for further information.

Removing the propeller- Before removing the propeller make sure the remote control is in neutral, battery switch is off, and the ignition keys are removed to prevent the engine starting and possibly causing bodily injury. Always wear gloves when removing or installing propellers since the component blades are very sharp.

Note that special tools are required to remove the DPS style propellers. Contact your nearest Regal dealer for assistance in purchasing and procuring these tools.

Installing propeller- Before installing parts back on to the prop shaft make sure you lubricate the prop shaft with the recommended lube. Again, special tools are required for installation of propellers and hardware. Contact your closest Regal dealer for additional information.

On MerCruiser units, refer to your engine operation manual or contact your closest Regal dealer for propeller removal and installation parts, tools, and periodic maintenance schedules.

Battery



Frequently check your battery terminals for corrosion build-up. If you find a greenish, powdery substance, remove the cable connections and clean

both the both the terminals and the connectors with a wire brush. When the cleaning is finished reconnect the battery cables and coat the terminal with an approved grease or petroleum jelly to help prevent further corrosion.

Check the electrolyte level at least every 30 days, more often in hot weather. The level should be maintained between the top of the battery plates and the bottom of the fill cap opening.

Add distilled water as needed after charging the batteries or periodically as needed. Do not overfill because sulfuric acid could run over and cause burns or an explosion.

Batteries should be charged outside the boat. Do not smoke or bring flames near a battery that is being or has recently been charged. The hydrogen gas generated by battery charging is highly explosive. Set batteries on a block of wood rather than concrete since this procedure will help the batteries from losing their charge.

Do not allow a metal object or loose wires to spark across battery posts while working close to the battery. Contact across terminals will cause a short circuit and personal injury may result.

Tighten all battery connectors securely. Check their tightness by pulling on the connectors. They should not move from their tightened position. Be sure to reinstall the positive boot over the battery terminal after tightening the battery post connection. While using the boat, use the volt meter to monitor the charge level of the battery. Monitor the charge with the engines turned off (static condition).

The engine alternators recharge the batteries. A fully charged battery will indicate between 12.3 and 12.6 volts on the voltmeter. Readings below this could indicate a dead battery cell or a charging system malfunction which should be checked by a marine professional.



WARNING

AVOID SERIOUS INJURY!

BATTERIES CONTAIN SULFURIC ACID (POISON) WHICH ALSO CAN CAUSE BURNS. AVOID CONTACT WITH THE SKIN, EYES, AND CLOTHING. IF CONTACTED, FLUSH WITH WATER FOR AT LEAST 15 MINUTES. IF SWALLOWED, DRINK LARGE AMOUNTS OF WATER, OR MILK. FOLLOW UP WITH MILK OF MAGNESIA, BEATEN EGG, OR VEGETABLE OIL. GET MEDICAL ATTENTION IMMEDIATELY!



WARNING

AVOID SERIOUS INJURY!

WEAR GOGGLES, RUBBER GLOVES, AND A PROTECTIVE APRON WHEN WORKING WITH A BATTERY. BATTERY ELECTROLYTE CAUSES SEVERE EYE DAMAGE AND SKIN BURNS. IN CASE OF SPILLAGE, WASH AREA WITH A SOLUTION OF BAKING SODA AND WATER.

Make sure all terminals are clean. As discussed earlier, a battery cleaner tool along with a toothbrush should be used to clean both the positive and negative terminals. Use a small amount of baking soda and water. Remove any acid residue from the terminal area and battery top with a damp cloth. Be sure to wear plastic gloves and eye protection. See the illustration.

Install an anti-corrosion lubricant to the posts before reinstalling the terminals. This lubricant is available as a paste or spray type and can be found at most marina or auto supply stores.

Be sure to reinstall any red (+) battery (anti-short) boots on the battery terminals.

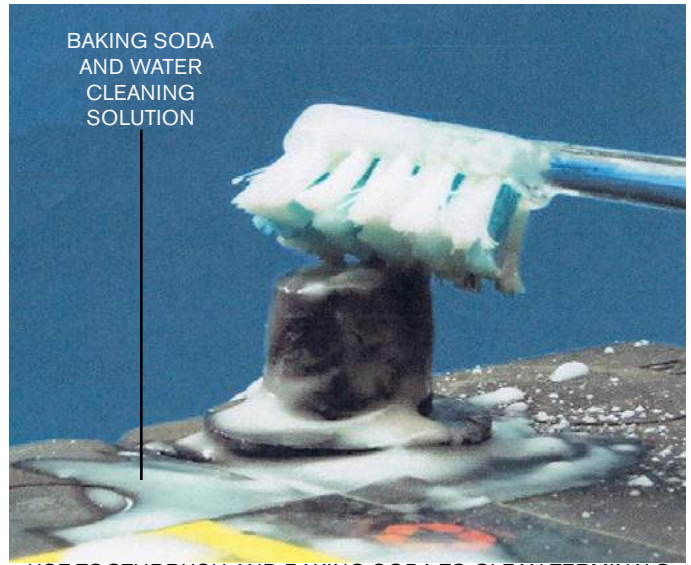

USE TOOTHBRUSH AND BAKING SODA TO CLEAN TERMINALS

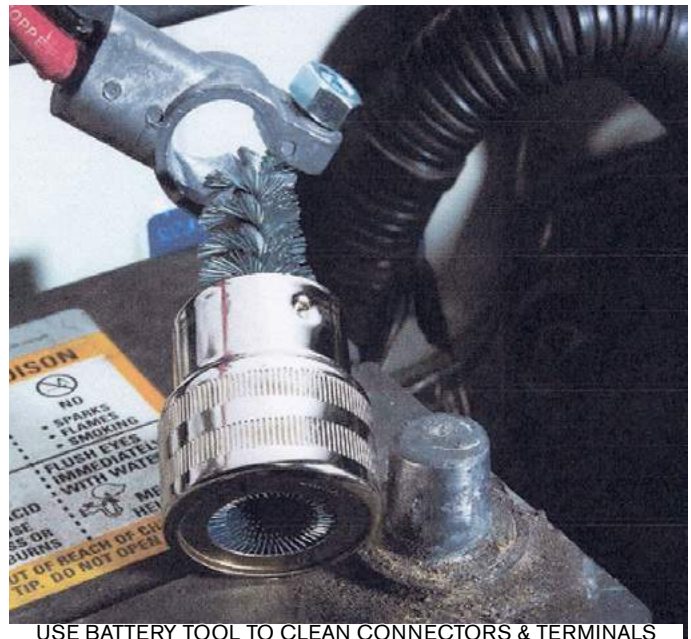

Remote Control-Typical



Check the helm control box and make sure there is no roughness or tightness when shifting. Also, check to make sure the control box hardware is tightly secured. With mechanical controls

check that control cable is secured properly at the helm rack and the engine end. Check throttle control at engine and control box for excessive play.

Select vessels use electronic shifting which is called “fly by wire” Being the engines use electronics to shift it should be effortless. An application of silicone spray on the handles will help fight any corrosion.

There is a friction control which may be altered to personal needs. To adjust the friction control on side mount remote controls it needs to be preformed by an authorized dealer. Contact your closest Regal dealer for further assistance or a marine professional.

Fuel System

At least annually inspect all fuel system components for loose clamps at the vent, fill and feed locations. Examine each hose for signs of deterioration and leakage. Check the fuel sender for loose bolts, nuts, and leaks at all areas of contact. Also, inspect the fuel tank for signs of leakage or abrasion. Tighten all components as needed.

 **WARNING**

AVOID SERIOUS INJURY OR DEATH DUE TO
FIRE OR EXPLOSION RESULTING FROM
LEAKING FUEL!
INSPECT ENTIRE FUEL SYSTEM
AT LEAST ONCE PER YEAR.

Stereo

The Fusion® stereo head unit requires little maintenance. When washing the cockpit, do not discharge water directly at the stereo unit. Possible damage may result. As with any CD unit clean your CD's to keep them from skipping. This process also aids in keeping dust out of the unit. For further information, refer to your stereo owner's manual located in the owner's packet.

TYPICAL EPA FUEL TANK

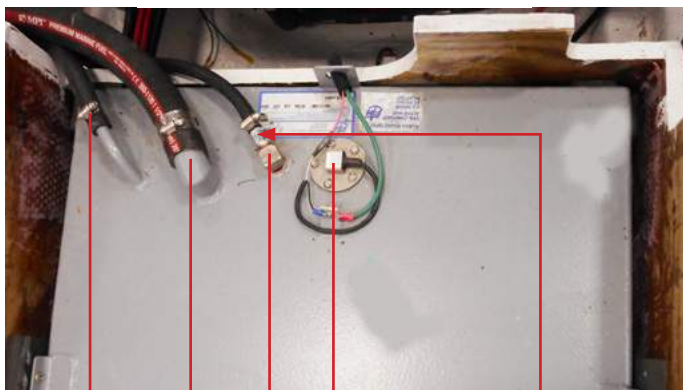

FUEL FILL

FUEL SENDER

FUEL VENT FUEL FEED ANTI-SIPHON VALVE

Galvanic Corrosion/Stray Current

Metal parts underwater can be subjected to two basic styles of electrolysis: galvanic corrosion and stray current corrosion. Both can damage the outboard drive, propeller, underwater parts, boat and motor if not correctly monitored (testing at 2 week intervals) and avoided.

Galvanic corrosion is an electrochemical reaction between two or more metals. Drive systems consist of several different metals. Some are more active than others.

Galvanic corrosion of the more chemically active metals can occur whenever two or more dissimilar metals that are “grounded” (connected by actually touching each other, or through a wire or metal part) are immersed in a conductive solution (any material that can conduct electricity). Anything but pure water is conductive. Saltwater, fresh water with a high mineral content and polluted freshwater are highly conductive. Conductivity increases with temperature. That is why Florida boats experience more corrosion than boats in Maine.

Specifically look at a typical marine drive unit with a stainless steel propeller. The aluminum is the more chemically active metal (called the anode) and the stainless steel propeller is the less chemically active metal (called the cathode).

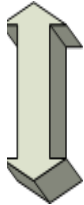
CORROSION TABLE	
Gold	 <p>Least Active</p> <p>Most Active</p>
Stainless Steel	
Bronze	
Copper	
Brass	
Steel	
Aluminum	
Zinc	
Magnesium	

Typically electrons flow from the anode (the aluminum drive unit), via the external conducting path to the cathode (stainless steel propeller). If there is a very large anode connected to a small cathode, the anode will corrode very slowly. If a very large cathode is connected to a small anode, the anode will corrode very quickly. Obviously, if you do not control galvanic corrosion, over time the aluminum will corrode away.

The first sign of galvanic corrosion is paint blistering (starting on sharp edges) below the water line- a white powdery substance forms on the exposed metal areas. As the corrosion advances, the exposed metal will become deeply pitted as the metal is actually eaten away.

Another condition which will increase galvanic corrosion is the removal or reduction in surface area of the sacrificial anodes. Never add aftermarket products that are connected to the engine ground such as stainless steel steering aids and trim planes. Zinc connected to aluminum will form a corrosion cell but the aluminum (drive) becomes the cathode and the zinc (anode) corrodes.

Even though your boat may not have shore power aboard current from nearby vessels with shore power can produce stray current galvanic corrosion. Stray current corrosion occurs when metal with an electrical current flowing into it is immersed in water that is grounded (lake, ocean, pond). The current can leave the metal and flow through the water to ground. This will cause rapid corrosion of the metal at the point where the current leaves.

When a vessel nearby is plugged into shore power, they can potentially tie your drive unit to their boat via the green grounding shore power lead. Your drive unit could be the receiving end of a large galvanic cell (a battery) interconnected with nearby vessels or even through the marina's metal structures via their electrical system.

The vessel should be tested every couple of weeks to determine the integrity of the anode protection system. Another way to test the system is to measure the hull potential. This is accomplished by immersing a reference electrode, usually a silver/silver chloride into the water about six inches behind the drive. With leads attached to a digital multimeter the hull potential is read on the DC scale and compared to recommended specifications for the water body type. See the owner's information vendor packet for more information or contact your nearest authorized Regal dealer.

Tips To Aid In Maintaining Galvanic Integrity

1. Test the galvanic integrity of your vessel every 2 weeks. Raise the drive and inspect anodes/parts for signs of galvanic corrosion, stray current corrosion or loose fasteners. Contact your closest Regal dealer/marine professional where signs of galvanic corrosion exist.
2. Never paint over anodes as they will become inoperative. Always leave at least one inch between bottom paint and any underwater fitting such as sea cocks, swim platform stanchions and all drive and propulsion related underwater parts.

3. Periodically remove vessel from water and clean/pressure wash all drive, anode and hull bottom areas to remove growth.

4. Ensure vessel is using the correct anode metal for the body of water that it is moored. See the engine manufacturer's manual for more information or contact an authorized dealer.

5. Ensure that the drive is completely "in" down to provide more complete anode protection when vessel is moored.

6. Do not attempt to use magnesium anodes in saltwater. They will provide over protection.

7. If marina moored, contact appropriate personnel if signs of galvanic corrosion appear on your drive system. Ask them to check for stray electrical current which may be originating from a nearby vessel's faulty DC wiring or from a marina pier, piling or dock carrying leaking marina ground wiring such as a dock side cord partially submerged.

GALVANIC/STRAY CURRENT CORROSION	
Cause/Observed Condition	Corrective Action
Sacrificial anodes consumed	Replace anodes when 30% consumed
Sacrificial anodes not grounded to drive	Remove anodes, clean contact surface, reinstall, check for continuity
Loss of continuity between underwater parts & ground	Provide good ground connections
Nearby vessel with stray current	Contact appropriate personnel Remove your vessel from water
Paint on drive heavily worn, exposing more metal	Prime and repaint or install additional anodes
Sacrificial anodes painted	Remove paint or replace anodes
Drive tilted/anodes out of water	Leave drive down, install additional anodes below water
Power trim cylinders only corroded	Provide a good ground to drive, all parts must be grounded
Corrosion in area of exhaust outlets	Remove deposits
Corrosion occurring after vessel is removed from saltwater	Wash exterior and flush interior with freshwater
Stainless steel parts corroding	Clean parts, remove foreign material, ensure continuity
Underwater drive parts corroded, sacrificial anodes OK	Oxide film on anode (fresh water only) Replace anode Poor ground. Scrape anode

Zinc Anodes



Sacrificial zinc anodes are located on the drive housing, trim tabs and/or prop shaft to protect softer metals exposed to the water. Electrolysis attacks the least noble metals first. Because

zinc is a less noble metal, it will decompose before other metals. Check these zinc anodes periodically and have them replaced when they are 30% consumed. Notwithstanding, zinc is the most popular metal used to protect parts that are exposed to saltwater, freshwater or brackish water.

See the photos below for anode location on your stern drive.

Zinc anodes in brackish or salt water need to be checked more frequently. If the anodes seem to be requiring frequent replacement there may be a boat leaking DC current into the water taxing the anodes. This is especially possible around a marina environment. Contact a marine professional who can measure the galvanic activity with a special electrode and electric VOA meter. Refer to the engine manufacturer's manual for exact anode location and detailed information.

Inspect the ground leads for tightness if attached.

Note that parts damage due to galvanic or stray current corrosion is not covered under warranty.

Chapter 9

Troubleshooting

The following diagnostic information will assist you in identifying minor electrical, fuel, and mechanical problems. Some of the items listed require technical training and tools. Additional assistance is available in the engine manufacturer's owner's manual.

Also, you can contact your closest Regal dealer or marine professional for more information. Many times a problem can be solved by performing a logical sequence of elimination and/or root cause techniques.



WARNING

AVOID SERIOUS INJURY OR DEATH!
BEFORE PERFORMING ANY MAINTENANCE
WORK, TURN OFF THE BATTERY SWITCH
AND REMOVE THE IGNITION KEY
FROM THE SWITCH.



WARNING

AVOID SERIOUS INJURY OR DEATH!
USE ONLY APPROVED MARINE
REPLACEMENT PARTS THAT
ARE IGNITION PROTECTED.

ENGINE DIAGNOSTIC CHART

Problem	Possible Cause
Engine Overheating	<p>Water pick-up feeds are blocked by debris, especially plastic bag material.</p> <p>Cooling system leak/obstruction</p> <p>Impeller is worn or blocked by debris</p> <p>Propeller is over propped for the circumstances, causing the engine to work extra hard</p> <p>Debris in oil is holding heat more than normal - bad oil filter</p> <p>Defective thermostat.</p>
Starter Will Not Crank	<p>Battery weak, dead or corroded or loose connections.</p> <p>Starter defective</p> <p>Fuse for electric start relay blown</p> <p>Control not in neutral</p> <p>Defective start panel button</p>
Excessive Steering Play	<p>Air in steering lines (Bleed)</p> <p>System low on steering fluid</p> <p>Mechanical parts-loose connection</p> <p>Worn steering cable</p>

ENGINE DIAGNOSTIC CHART

Problem	Possible Cause
No Power To Helm	Battery switch turned off Batteries are weak or dead. Main breaker tripped Loose connection
Engine Cranks But Will Not Start	Fuel flow obstructed/water in fuel Low battery voltage Engine ignition system malfunction Timing belt broken No fuel in tank Lanyard not attached Control not in neutral
Hard Starting	Vacuum In Fuel System Fuel system obstructed Water in fuel system
Engine Idles/ Runs Rough	Old fuel Faulty spark plugs Fuel contaminated/ clogged anti-siphon

ENGINE DIAGNOSTIC CHART

Problem	Possible Cause
Power Loss	<p>Damaged propeller/propeller hub slipping</p> <p>Improper trim angle</p> <p>Spark plugs fouled</p> <p>Fuel system malfunction</p> <p>Hull bottom fouled with debris</p> <p>Excess water in bilge (leak)</p> <p>Engine code system energized due to malfunction (rpm's restricted).</p>
Excessive Vibration	<p>Damaged propeller</p> <p>Damaged propeller shaft</p> <p>Loose/broken motor mount</p> <p>Steering pivot loose or damaged</p> <p>Debris caught on propeller</p> <p>Ignition malfunction</p> <p>Motor mount bolts loose</p> <p>Failed gimbal bearing on drive input shaft</p> <p>U-joint failure (more pronounced in tight turn).</p>

ENGINE DIAGNOSTIC CHART

Problem	Possible Cause
Buzzer Sounds/Icon Lights	Cooling system malfunction Engine oil level low or incorrect type Wrong spark plug heat range Oil pump malfunction

DC ELECTRICAL SYSTEM DIAGNOSTIC CHART

Problem	Possible Cause
No 12 Volt Power At Battery	<p>Battery switch turned off</p> <p>Weak or dead battery</p> <p>Battery cables loose/disconnected</p>
Battery Not Charging While Engine Is Running	<p>Faulty alternator</p> <p>Faulty circuit wiring</p> <p>Faulty battery charger/battery</p>
Battery Will Not Hold Charge	<p>Faulty/ old battery</p> <p>Loose battery cables</p> <p>Corroded battery terminals</p>
12 Volt Equipment Not Working	<p>Fuse blown-Take time to investigate why the equipment was drawing too much current or why it had a short circuit. Check fuses at fuse block and under the engine shroud</p> <p>Weak or dead battery if all 12 volt equipment fails to function.</p> <p>Corroded/loose wire connection</p> <p>Internal equipment short/failure</p>

TECMA ELECTRIC TOILET DIAGNOSTIC CHART

PROBLEM	CAUSE	ACTION
Toilet does not flush or flush performance is poor.	Waste tank is full.	Empty waste tank.
	Clog at pump inlet.	Clear clog. Do not flush foreign objects.
	Solid object in macerator pump.	Turn off power. Attempt to remove object. If unsuccessful, contact Thetford service USA (1-800-543-1219). Do not flush foreign objects.
	Low voltage.	Check that toilet supply voltage is 12 volts DC. Make sure the voltage does not decrease more than 10% with macerator running.
Water does not enter bowl during flush or water add cycle.	Water supply line kinked or not connected.	Check to make sure water supply line is connected to fresh water supply and is not kinked.
	No power to pressure water pump/fresh water switch off.	Check fuse panel to ensure fuse has not "blown". Check all fresh water pump connections.
	Solenoid is unplugged at relay module.	Check wiring harness connections at solenoid.
Bowl drains dry after flush.	Water is siphoning out of bowl due to discharge hose pulled down	Discharge hose from macerator pump is pulled down. Straighten hose so that top of discharge hose is in line with toilet nozzle.
No toilet system voltage.	Battery switch in "off" position. Toilet fuse blown. Ship's battery(ies) dead.	Activate battery switch. Replace fuse Charge batteries out of vessel.

Chapter 10

Storage & Winterization

Overview

Storage procedures are outlined in this chapter. These are general guidelines to follow before longer periods such as over the winter in colder climates. Be sure to familiarize yourself with all relevant information in the owner's sacht.

Special winterization procedures are necessary for the boat equipment and systems. Use the enclosed checklists to help you identify areas of concern and maintenance. Call a Regal dealer or marine professional for further information regarding storage/maintenance procedures. Also, more specific information can be found in the engine manufacturer's owners manual.

NOTICE

AVOID VESSEL AND/OR ENGINE DAMAGE!
CONTACT A MARINE PROFESSIONAL
FOR WINTERIZATION ASSISTANCE.
DAMAGE CAUSED BY
IMPROPER WINTERIZATION IS NOT
COVERED BY VESSEL
OR ENGINE MANUFACTURER.



WARNING

AVOID SERIOUS INJURY OR DEATH
DUE TO FIRE AND EXPLOSION!
DO NOT FILL FUEL TANK TO RATED
CAPACITY. LEAVE ROOM FOR EXPANSION.

NOTICE

REMOVE BATTERIES WHEN VESSEL
IS IN LONG PERIODS OF STORAGE
ESPECIALLY IN COLD CLIMATES.
BATTERIES CAN FREEZE AND POSSIBLY
LOSE ELECTROLYTE.

NOTICE

AVOID SERIOUS ENGINE DAMAGE!
USE ONLY FACTORY APPROVED PRODUCTS
FOR ENGINE AND DRIVE DURING STORAGE
PERIODS.

Decommissioning Checklist

Engine Winterization/Maintenance

- Run engine. Pour approved fuel stabilizer/conditioner in the fuel tank. Allow time for it to circulate through the fuel system.
- Change all engine fluids as referenced in the engine manufacturer's owners manual. Contact a Regal dealer.
- Check engine hoses, clamps, and system wiring for loose connections, abrasion, and corrosion.
- Spray all exterior parts with a rust preventative.
- On surf models drain all water ballast bags, hoses, and pumps of water. Check all related components.
- Perform maintenance as referenced in the manufacturer's owners manual. Contact your Regal dealer.
- Remove propellers. Refurbish as needed.

Engine Care

- After cleaning use touch up paint on unit as needed.
- Apply coat of wax to stern drive exterior parts.

Boat

- Check hull bottom for any fiberglass damage.
- After cleaning apply wax to hull and deck surfaces.

- Pour a pint of 50/50 antifreeze into bilge pump.
- Remove batteries. Use a trickle charger as needed.
- Remove all loose gear and electronics from boat. Inspect all equipment for wear and damage. Store in a clean, dry environment.
- Remove drain plug. Clean drain plug hole of debris as needed. Enclose drain plug in plastic bag and tie to steering wheel.
- Make sure bow is higher than stern to permit proper drainage.
- Clean all upholstery and store so it breathes.
- Conduct a visual inspection to ensure boat is balanced properly on the trailer, cradle or blocks.
- Cover boat with appropriate cover. Tie down for protection from rain, snow and/or wind. Prop up cover to provide proper ventilation. Do not cover up the fuel vents.
- Drain the fresh water system per instructions in this chapter.
- Use sling locations for lifting boat.
- Never block up boat bottom. Doing so may cause structural damage.

Trailer

- Repack all wheel bearings per manufacturer's specifications.
- Check all trailer parts for excessive wear. Replace/ refurbish as needed.
- Use touch up paint on trailer as needed.
- Lubricate all moving parts as needed.
- Check all lighting and brakes (if applicable).

Typical Pressurized Water System

1. Activate the pressure water pump switch.
2. Open all faucets including transom shower (if equipped) and allow tank to empty.
3. Drain the water tank. Shut off water pump switch.
4. Mix nontoxic antifreeze with water in accordance with the manufacturer's recommendations. (Available at marina & RV stores)
5. Pour solution into the water tank.
6. Turn on pressure water pump switch.
7. Open water faucet and purge until a steady stream of nontoxic antifreeze flows from the faucet. If equipped, do the same to the transom shower.
8. Turn the pressure water switch to the "off" position.

Waste System-chemical head

1. With chemical heads, make sure to dump both upper and lower tanks.
2. Chemical heads with pump-out fitting have your closest pump-out facility or marina empty the tank. Rinse fitting hose off to prevent debris clinging to the inside of the waste hose.
2. Rinse well with fresh water.
3. Sanitize system as needed.

Waste System-electric head

1. Use only propylene glycol based non-toxic antifreeze when storing toilet during freezing conditions.
2. Never use automotive antifreeze or windshield washer solvent to winterize.
3. Make sure that both the entire supply and discharge systems are thoroughly winterized to ensure complete protection for your system.
4. Drain fresh water tank.
5. Pump out holding tank.

Recommissioning Checklist

Engine

- Check all components per engine manufacturer's owner's manual especially fluid levels.
- Run engine on "ear muffs" (flushette) before launching. Check for fuel, exhaust, oil, and water leaks.

Boat

- Install drain plug.
- Install battery and tighten all terminals.
- Check all equipment, switches, alarms, gauges and breakers for proper operation.
- Add necessary chemicals and water to chemical head.
- Add necessary chemicals and water to electric head system and run to check operation. Verify there are no system leaks.
- Add water to water tank. Turn on faucet to purge tank. Refill water tank.
- Make sure all safety gear is on board and in excellent working condition.
- After launching, check controls and systems for proper operation through chart plotter screen/information panel.

Trailer

- Make sure all equipment is in excellent working condition including winch, tongue jack, brake actuator, lines and wheel bearings. Check lighting with battery and extra trailer harness plug.

Chapter 11

Towing

Overview

This chapter covers towing basics including equipment, maintenance, and techniques of using a trailer. Check with state and local agencies for detailed information on required equipment, safety issues, and licensing.

Before Towing

Before towing your boat, be sure to check the air pressure of your tires for the recommended inflation rating. Also, be certain that your tow vehicle is in good working order.

Install bimini top in its boot before towing. Also, remove and store cockpit cover. Store cockpit carpet in wake board locker.

This can make it especially difficult to drive safely, as the hitch may be in danger of striking the road. Also, this situation can be caused by worn vehicle rear shock absorbers. One option is to install a set of air shocks which will assist in supporting the load. As a rule of thumb 5 to 7 percent of the total trailer load should be on the trailer tongue.

Check all lights to ensure they all work properly. You may find it helpful to ask someone to check your turn signals, brake lights, and towing lights while you remain in the vehicle. Be certain that the trailer winch cable is securely attached to the boat's bow eye and the cable lock is engaged.

Make sure the bow of the boat is snug against the bow stop at the winch stand.

It is a good idea to tie another line or secure an extra cable to the winch stand and boat bow eye as a backup system.

Be certain that your trailer is of rated capacity for the size and weight of your boat, including the weight for all fuel, water and gear. Your authorized Regal dealer can advise you on the proper trailer capacity and tongue weight (the weight exerted on the rear of your vehicle).

Never use a bumper mounted trailer hitch. Always use a bolted or welded frame-mounted hitch, class 2 or 3. Consult your Regal dealer for more information.

Should your trailer be equipped with surge brakes, that is brakes on the trailer that cut in with a very slight delay when your brakes are applied, be sure to follow recommended service and maintenance instructions. Be sure that the trailer master cylinder is filled with the recommended fluid before towing your boat. Inspect the trailer brake lines for any leakage. Also, if you notice brake fluid on the inside of the tires, you may have a wheel cylinder leaking. Consult a professional.

Never place your hands between the trailer hitch coupling and the hitch ball on your towing vehicle while hooking up. Be sure the tongue jack is in the full up position before departure. Be certain safety chains are crisscrossed and secured; do not allow them to drag on the road.

TRAILER TERMINOLOGY

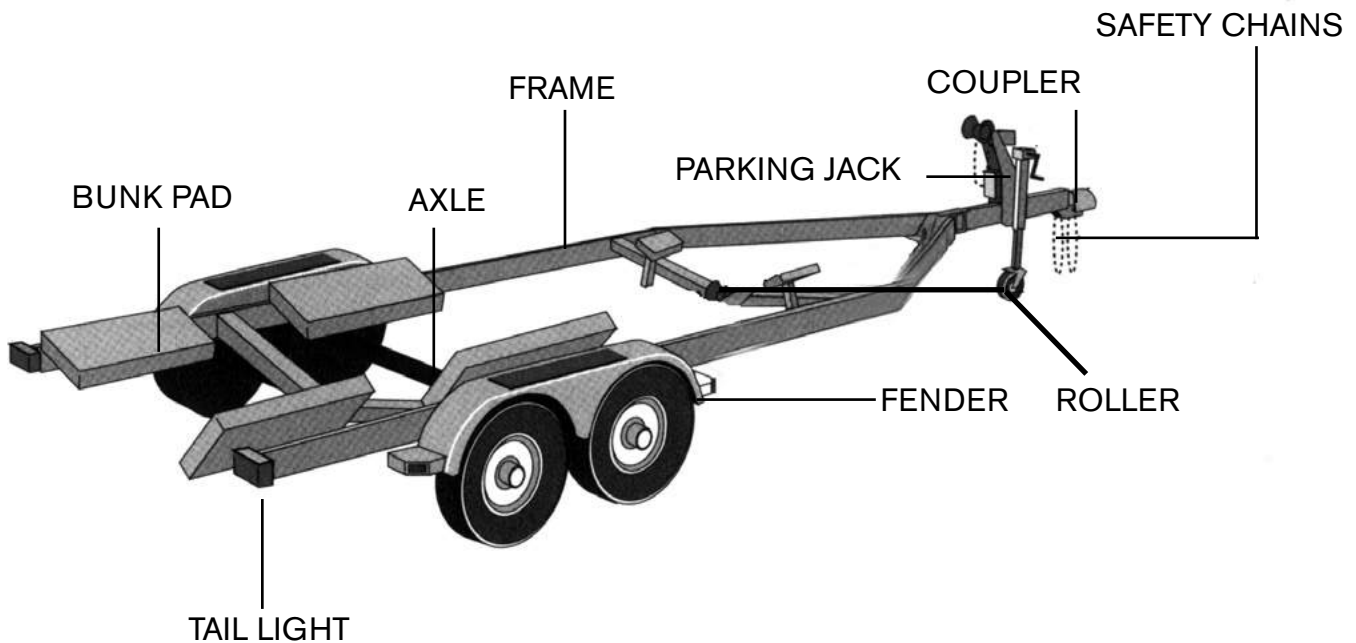

TYPICAL TRAILER SHOWN

Be sure to buy a suitable set of tie downs which can be attached to the boats' stern eyes and the eyelets provided on most trailers. Tighten them securely and neatly fold up the extra strap material and secure it with tape so it doesn't loosen and dangle on the road.

Check the trailer lug nuts for the proper torque. Use a foot pound wrench and torque in a star sequence to the correct poundage as recommended by the trailer manufacturer. Torque the lug nuts at half the poundage on all nuts. Then set the torque wrench to the full poundage and fasten to the last foot poundage figure. Check the trailer tires often for voids, excessive wear or out of round tire conditions.

If the trailer seems to vibrate you may have a bad tire or one that is unbalanced. These wheels can be rebalanced at most automotive or tire shops. Never pull a boat on a patched tire. Buy a spare tire and wheel including a hub and wheel bearing assembly. Mount it on the trailer for speedy installation should a blow out occur.

Check the trailer harness often for signs of fraying. Check the harness connector for corrosion. Make sure the trailer harness when connected to the trailer has enough slack for turning

Check the wheel bearings for wear periodically by a professional.

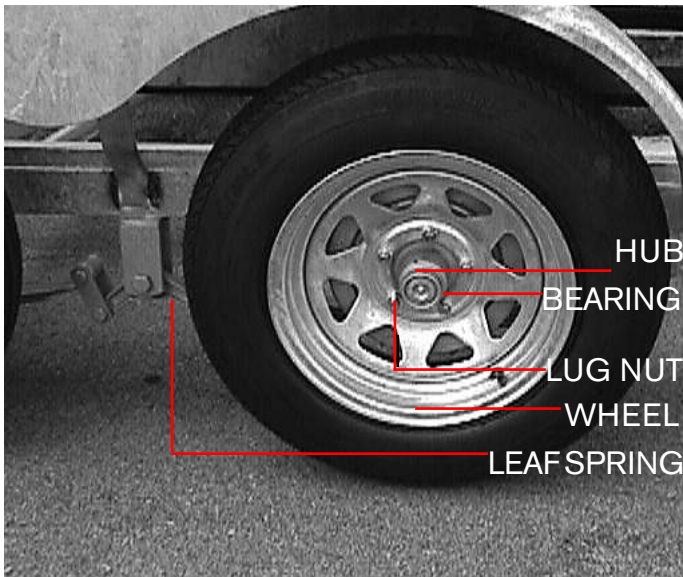

TYPICAL WHEEL PARTS DESCRIPTION

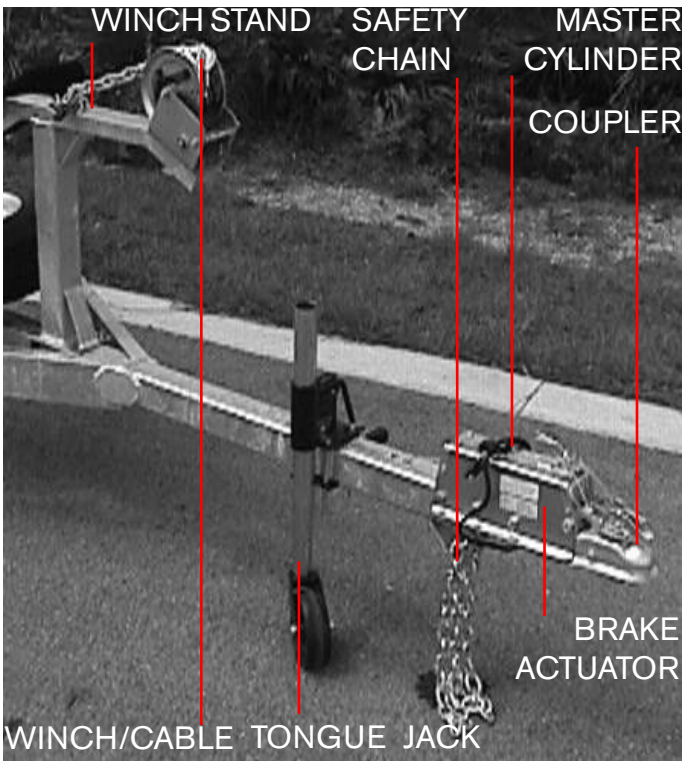

TYPICAL TONGUE SECTION

On most trailers, there is a zerk fitting on the wheel hub to add the proper lubricant to the wheel bearing with a grease gun. These wheel bearing waterproof covers for the bearings can be purchased at retail outlets.

Spare Parts/Tools

Longer towing trips increase the need for special preparations. Sometimes these extended trips cover areas where it is difficult in locating repair parts due to a breakdown. Following is a checklist of recommended items to add a safety net to your trip.

Trailer-

1. Trailer tire jack
2. Spare hub assembly including wheel bearings
3. Spare tire
4. Lug wrench
5. Jack stand
6. 12 volt air compressor-
7. Spare bearing protector
8. Extra tie-down straps
9. Trailer light bulbs
10. Brake pads and brake fluid
11. Grease gun

Tow Vehicle-

1. Tool kit including necessary ratchet and sockets
2. Jumper cables
3. Extra fuses
4. Engine oil & transmission fluid
5. Wheel chocks
6. Highway flares
7. 12 volt spotlight- plugs into 12 volt acc. outlet
8. Flashlight & spare batteries
9. Waterless hand cleaner and rags
10. Electrical connectors and crimpers
11. Low voltage electrical tester

Launching

Serious accidents can occur at the launching ramp. Therefore, it is imperative you be alert and attentive during launching and docking activities. Study the ramp area and surrounding water for any potential hazards, such as a short ramp or one with a drop off at the end. If you are uncertain of the conditions, ask someone else who has just used the ramp if there are any peculiarities to the area.

Install the drain plug. Attach 2 lines, one each at the bow and stern, to control your boat once it is off the trailer. If you need additional fenders to keep the sides of the boat from banging against the ramp walls, use those as well.

Unhook the stern tie-downs and the winch line to the bow. Unplug the trailer harness connector so the hot trailer light bulbs won't blow out when they come in contact with water.

When backing in, have someone assist, giving the palms up stop signal when the boat is in deep enough water to float off, or when the rear wheels of your vehicle approach the water's edge.

After your boat is floating freely, position it clear of the trailer before pulling out of the water. If there is no one to help you, secure one of the lines you've attached from the boat to the dock and use the other line to pull the boat off trailer. The process is easier with 2 people.



WARNING

AVOID SERIOUS INJURY!
BOAT RAMPS ARE VERY SLIPPERY.
DO NOT ATTEMPT TO WALK OR STAND
ON AN ANGLED BOAT RAMP!



CAUTION

AVOID LOSING VEHICLE TRACTION!
DO NOT ALLOW REAR WHEELS TO
ENCOUNTER SAND OR SLIPPERY
CONCRETE CONDITIONS!

Loading



The most important thing to remember when pulling your boat out of the water is that often

the ramp will be crowded. As you approach the ramp, make a visual inspection of the traffic and people, both at the ramp and all around you. This is an important time to use caution, courtesy, and common sense. While you may feel it's your next turn, another boater may not be as courteous. Don't insist on your rightful place in line; it could lead to disastrous consequences in the confines of a crowded boat ramp. If there is any perceived danger, stand off until you can safely approach the ramp. Back your trailer down to the water's edge. At this point it is a good idea to let a sufficient amount of line out of the winch to reach the bow eye. Make sure you disconnect the trailer harness to keep the hot bulbs from blowing out due to being subjected to cold water. When replacing lights if possible shop for LED's which are a sealed unit without any filament and they usually enjoy an extended life.

On roller or bunk style trailers back up until the aft roller is just at the water level. This allows you to hook up the winch cable and to start cranking the boat on to the trailer properly. This method gives you a good starting point and helps keep the boat centered on the trailer as it is reloaded. At times it may be necessary to further back the trailer into the water, permitting easier cranking of the boat on to the trailer.

Once the boat is positioned correctly on the trailer have someone connect the winch cable hook to the bow eye. Also, this will help keep the boat bow against the trailer roller. Shut down the engine and run the stern drive up to the top of the trailer position.

With the bow snug against the roller start to crank the boat up on to the trailer. Make sure the hull bottom or keel stays in the center of each roller as it is being cranked on the trailer. Double check to ensure the hitch is locked tight on the vehicle ball.



RECEPTACLE



Before towing the vehicle connect up the wiring harness to the bow receptacle for the boat transom lights to operate. These lights are high on the boat transom providing additional visibility from the rear while towing in highway traffic, especially at night.

This harness features a raised alignment notch as shown in the male plug. When plugging in the male plug to the female receptacle make sure the 2 notches line up before inserting the plug into the receptacle.

Note that the other end of the harness features wires without ends. Using for the first time requires these wires be spliced into the correct trailer wires (color coded) for the running and brake lights to function. Use connectors that permit removing the harness wires from the trailer wires. Keep the boat female receptacle protected with the cap when not in use.

Chapter 12

Glossary & Index

Overview

Below is a brief list of nautical terminology. For more detailed glossaries we recommend you check your local library, book retailer, marine store or internet.

Glossary

Abeam: at right angles to the fore and aft line and off the boat

Aboard: on or in the boat

Above:the part of the boat on a vessel which is above the interior of the boat

Aft, After:: aft is the boat section toward the stern or back of the boat

Amidships: toward the center of the boat from either side to side or rear to front

Beam: the width of a boat at its widest part

Bilge: the lower interior of the hull of the boat

Bitter end: the end of a line also the end of an anchor line

Bow: the front, or forward part of the boat

Bulkhead: the vertical partition or wall of a boat

Cast off: to let go or release

Chine: the line fore and aft formed by the intersection of the side and bottom of the boat

Chock: deck fitting used to secure or guide anchor or tie lines

Cleat: deck fitting with protruding arms around which lines are secured

Cockpit: the seating space used to accommodate passengers

Cuddy: a small cabin in the fore part of the boat

Deck: the open flooring surface on which crew and passengers walk

Draft: the depth from the waterline of the boat to the lowest part of the boat, which indicates how much water is required to float the boat

FasTrac- a proven hull bottom design which incorporates a full, mid-beam step that reduces drag by forcing air under the hull to decrease drag and friction.

Fathom: a measurement of depth; one fathom equals six feet

Fender: a cushion hung from the side of a boat to prevent it from rubbing against a dock or against other boats.

Fend off: to push off to avoid sharp contact with dock or other vessel

Fore: the part of the boat toward the bow or front

Freeboard: the height of the top side from the waterline to the deck at its shortest point (The distance from sheer or gunwale to the water).

Gunwale: rail or upper edge of the side of the boat

Head: toilet

Hull: the part of the hull from the deck down

Keel: the lowest point of a boat; the backbone of the vessel

Knots: a measurement of speed indicating nautical miles per hour

Lee: the side opposite that from which the wind is blowing; the side sheltered from the wind

Leeward: the direction toward which the wind is blowing

PFD: personal flotation device; required for each person aboard

Port: the left side of the boat when facing forward (an easy way to remember the difference between "port" and "starboard" is that both "port" and "left" have four letters)

Shank: the main body of an anchor

Sheer: the curve of the boat's deck from fore to aft when seen from the side

Starboard: the right side of the boat when facing forward

Stern: the aft end of the boat

Stern drive: an inboard/outboard (I/O) unit

Stringer: strengthening integral unit fastened from fore to aft inside the hull and fiberglass encapsulated for added strength: much like the skeleton system of our body

INDEX

A		C	
Accidents	37	Cabin Conversion To Sleeper	115
Accident Reporting	37	California EVAP Regulation	2
Acrylics	153	California Spark Ignition Information	2
Anchor Light	29	Canvas	116
Anchor Windlass	109		156
Anchoring	105	Carbon Monoxide	33
Audible Alarms	83	Cardiopulmonary Resuscitation (CPR)	107
Automatic Fire Extinguisher	112	Cockpit Carpet	126
		Cockpit Sea-Grass Mat	126
B		Controls	91
Battery	56		
	160	D	
Battery Charger	61	Dealer Responsibilities	12
Battery Switch	58	Decommissioning	176
Bilge Pump	114	Direct Current Protection	59
Boating Under The Influence	36	Distress Signals	27
Bottom Blocking	176	Diver's Flag	39
Bridge Clearance	48	Docking Lights	125
Buoys	45	Dock Line Basics	97
		Drain Plug	95
		Drowning-Electric Shock (ESD)	108
		E	
		EPIRB	11
		Electrical	52
		Electronics	126
		Emergencies	106
		Engine	82
		Engine-Starting	88
		Environmental Awareness	108
		Exhaust	85

F		I	
Fender Clips	127	Ignition Panel/Switch	88
Fenders	99	Index	187
Fiberglass	154	Instruments	84
Filters	68	Interior Fabrics	154
Fire Extinguishers	24		
	112	K	
First Aid	107	Knots	106
Fishing	39		
Flexiteek Decking	127	L	
Float Plan	9	Labels	18
Fueling	96	Ladder	130
Fuel System	66	Lighting	63
Fuse Panel (DC)	63	Life Raft	32
		Loading	20
G			21
Galvanic Corrosion Protection	87	Law Of Salvage	105
Garmin	84	Lubrication-Engine	86
Garbage Placard	31	Lubrication- Stern Drive	86
Gas Vapor Detector	128		
Gel Coat Maintenance	154	M	
General Boating Safety	19	Maneuvering	99
Getting Underway	95	Maintaining PFD'S	24
Glossary	185	Masthead Light	29
		Metal Cleaning	157
H		Minimum Required Equipment	32
HIN	8		
Horn	28		
Hull Bottom	158		
Hypothermia	107		

N		S	
NMMA Capacity Plate	7	Safety Labels	18
Navigational Aids	45	SeaDek	137
Navigation Lights	28	Seating	20
Navigation Rules	41		140
Neutral Safety Switch	91	Shallow Water Operation	103
Night Running	48	Shifting-Remote Control	91
		Signals-Navigation	42
O		Sound Producing Devices	28
Oil Spills	30	Spaghetti Matts	153
Overloading	7	Spring Line	98
	20	Stopping	101
Owner's Information Packet	7	Stern Line	97
Owner's Registration	12	Stereo	80
Owner's Responsibilities	12		
		T	
P		Table	143
Personal Flotation Devices	22	Table Of Contents	5
Plastics	152	Tachometer	84
Pollution Regulations	30	Technical	191
Portable Fire Extinguishers	113	Toilet	75
Power Platform	131	Towing	105
PowerTower	132	Trim Angle	102
Power Trim	102	Trim Switch	148
Pre-departure questionnaire	95	Trim Tabs	149
Propellers	87	Troubleshooting	168
	159		
Q		U	
QR Label (Owners Manual)	6	Underwater Lighting	151
		Upholstery	152
R			
Radio Communications	28		
Recommended Onboard Equipment	11		
Recommissioning	178		
Remote Stereo Control	139		
Required Safety Equipment	32		
Right Of Way	41		
Rules Of The Road	43		
	44		

V	
Ventilation	70
Vessel Information Sheet	13
Visual Distress Signals	26
W	
Water System-Pressurized	134
Water Sports	39
Warning Labels	18
Warranty	14
Weather	40
Winterizing	175
Wiring Color Codes	53
Z	
Zinc Anodes	167

Chapter 13

Technical

NOTICE

The following technical information and drawings can be an aid in troubleshooting various problems along with the charts located in the troubleshooting chapter.

Note that all product specifications, models, standard and optional equipment, systems, wiring, along with technical information and drawings is subject to change without notice.

For more information contact your nearest authorized Regal dealer. For the location of your nearest authorized dealer call 407-851-4360 or visit the web-site at www.regalboats.com.

Your Regal dealer has received special factory training on the entire product line and his services should be employed to solve technical problems.

TYPICAL DOMESTIC COMPLIANT FUEL SYSTEM LS SERIES

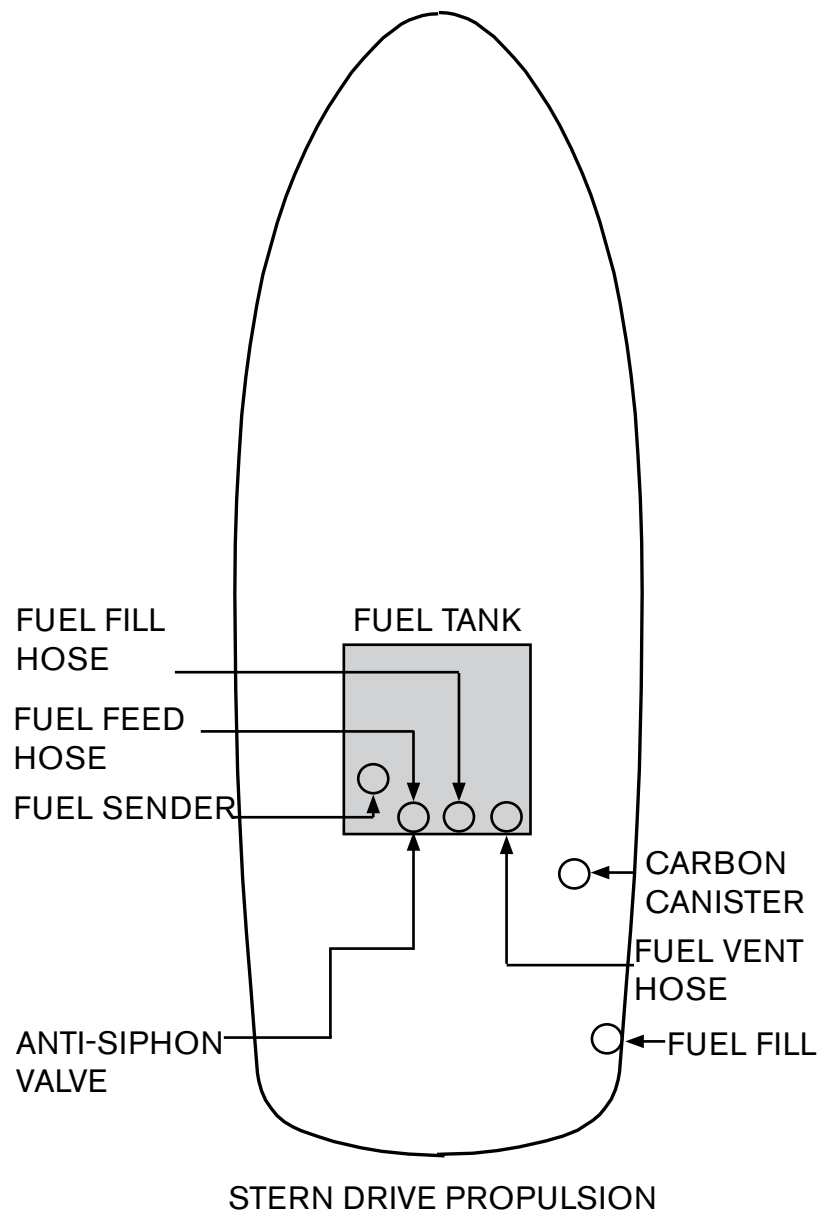

TYPICAL LABELS & LOCATIONS

WARNING
USE PROPER BLOCKING TECHNIQUES
WHEN LIFTING BOAT

NOTICE
Retrieval of Windlass Chain
Winch operator may be required
to periodically spread chain out
within anchor locker



CAUTION
WHEN OPERATING POWERTOWER
KEEP ALL BODY PARTS CLEAR
OF TOWER HINGE MECHANISMS.

WARNING
AVOID SERIOUS INJURY OR DEATH
FROM FIRE OR EXPLOSION
RESULTING FROM LEAKING FUEL.
INSPECT SYSTEM FOR LEAKS AT
LEAST ONCE A YEAR.

WARNING
ROTATING PROPELLER(S) MAY CAUSE
SERIOUS INJURY OR DEATH!
DO NOT APPROACH OR USE LADDER
WHEN ENGINE IS RUNNING.

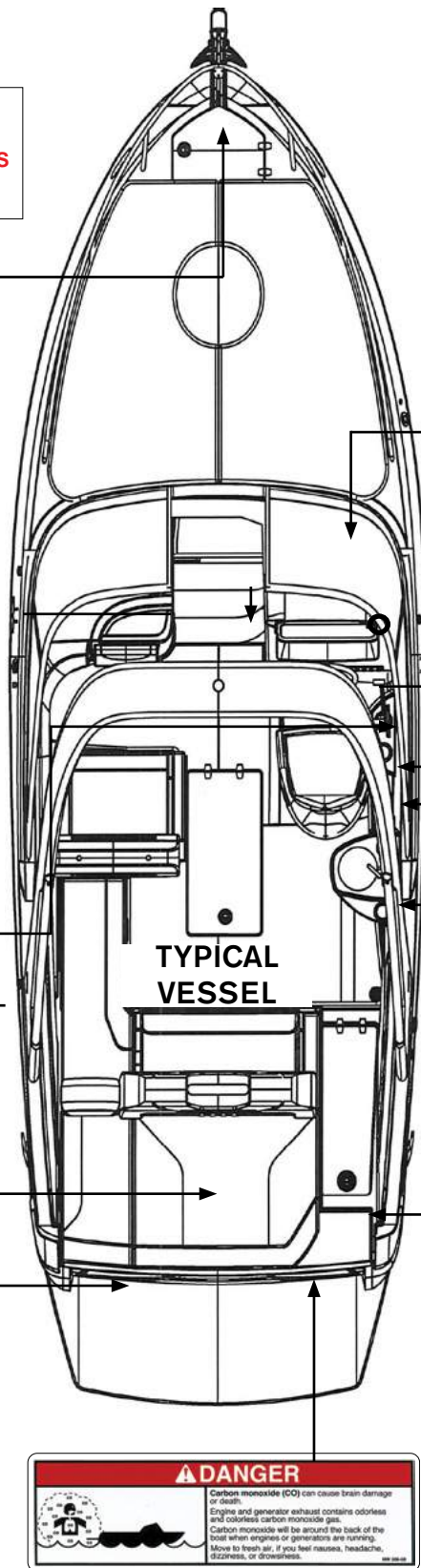

WARNING
ROTATING PROPELLER MAY CAUSE
SERIOUS INJURY OR DEATH.
SHUT OFF ENGINE WHEN
NEAR PERSONS IN THE WATER.
NW-207-08

WARNING
Carbon monoxide (CO) can cause brain damage or death.
Engine and generator exhaust contains odorless and colorless carbon monoxide gas.
Signs of carbon monoxide poisoning include nausea, headache, dizziness, drowsiness
and lack of consciousness.
Get fresh air if anyone shows signs of carbon monoxide poisoning.
See Owner's Manual for information regarding carbon monoxide poisoning.

WARNING
GASOLINE VAPORS CAN EXPLODE BEFORE STARTING
ENGINE. OPERATE BLOWER 4 MIN. AND CHECK ENGINE
COMPARTMENT FOR GASOLINE LEAKS OR VAPORS. RUN
BLOWER BELOW CRUISING SPEED.

MEETS U.S. EPA EVAP
STANDARDS USING
CERTIFIED COMPONENTS
REGAL MARINE INC., ORLANDO, FL



WARNING
AVOID PERSONAL INJURY!
INTERRUPT SWITCH MUST BE ATTACHED TO OPERATOR
WHILE ENGINE IS RUNNING. QUALIFIED OPERATOR MUST
BE IN CONTROL AT ALL TIMES.
READ OWNER'S MANUAL BEFORE USE.

WARNING
CARBON MONOXIDE IS A TASTELESS, ODORLESS, AND
INVISIBLE GAS THAT CAN CAUSE DISCOMFORT, SEVERE
AND EVEN DEATH. EXERCISE CAUTION WHILE OPERATING
A GENERATOR OR ENGINE IN CONFINED SPACES OR AT
DOCK SIDE. DO NOT ALLOW HULL EXHAUST OUTLETS TO
BECOME BLOCKED OR EXHAUST FUMES CAN BECOME
TRAPPED IN OR AROUND THE CONFINES OF YOUR VESSEL.

CAUTION
THIS VESSEL IS NOT EQUIPPED WITH A
GALVANIC ISOLATOR. USING THE BATTERY
CHARGER WHILE THE VESSEL IS IN THE
WATER MAY CAUSE DAMAGE TO THE
BOAT'S ANODES AND/OR DRIVE SYSTEM!

WARNING
PREVENT SEVERE INJURY OR DEATH
FROM FIRE, EXPLOSION
OR ELECTRICAL SHOCK!
THIS DEVICE MUST BE CONNECTED TO A
GROUND FAULT CIRCUIT INTERRUPT
(GFCI) PROTECTED AC OUTLET.
WHEN USING AN EXTENSION CORD,
CONNECT THE AC CHARGER PLUG
BEFORE CONNECTING TO THE GFCI
PROTECTED AC OUTLET!
MAKE CONNECTION IN AN OPEN
ATMOSPHERE FREE OF EXPLOSIVE FUMES.
MAKE CORD AND CONNECTION IN A
SECURE MANNER THAT WILL AVOID
CONTACT WITH THE WATER.

DANGER
Carbon monoxide (CO) can cause brain damage
or death.
Engine and generator exhaust contains odorless
and colorless carbon monoxide gas.
Carbon monoxide will be around the back of the
boat when engines or generators are running.
Move to fresh air, if you feel nausea, headache,
dizziness, or drowsiness.

NOTE: SELECT LABELS MAY BE LOCATED
IN AREAS OTHER THAN SHOWN HERE

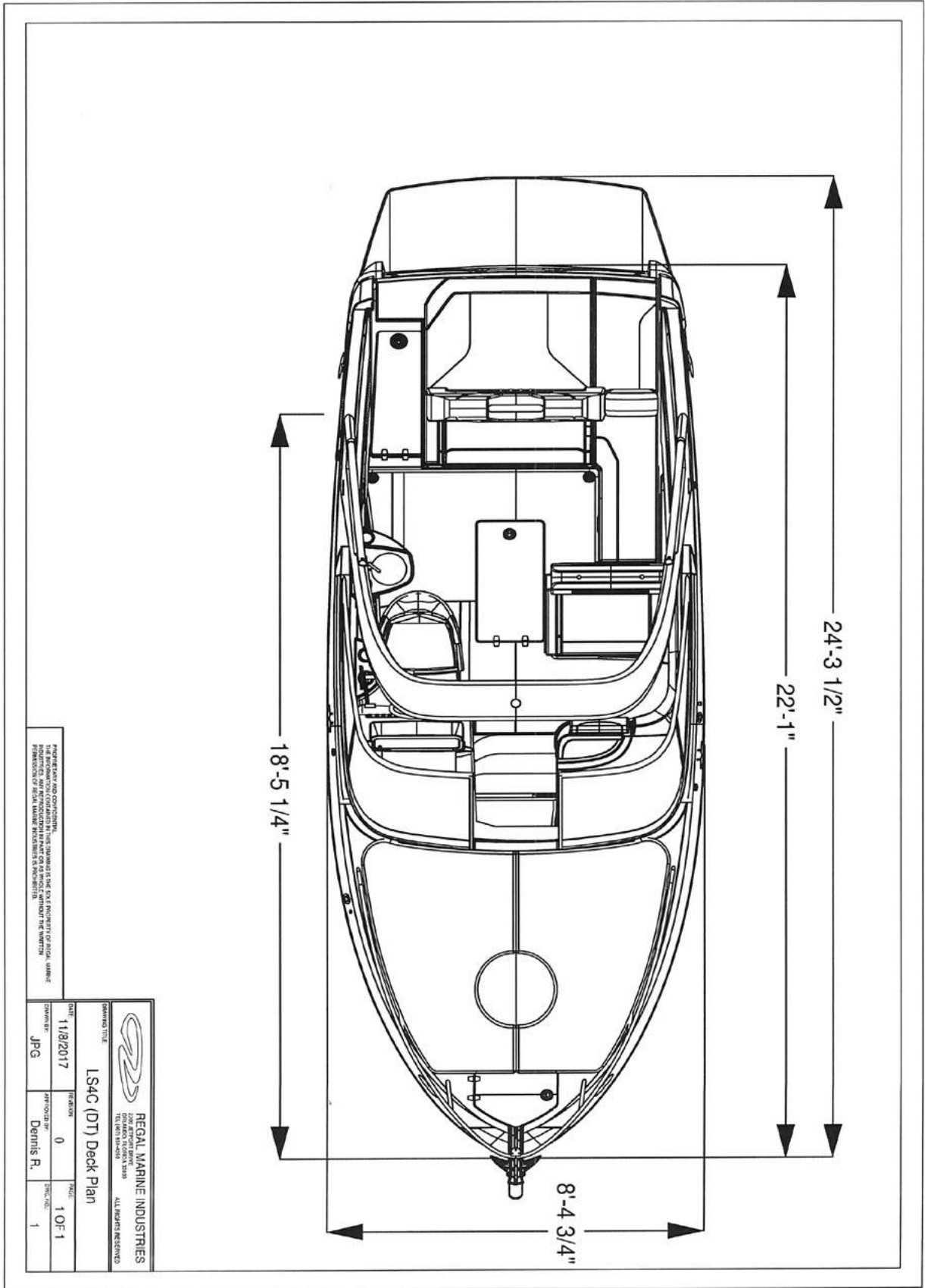

PROPRIETARY AND CONFIDENTIAL. THIS DRAWING IS THE PROPERTY OF REGAL MARINE INDUSTRIES. ANY REPRODUCTION IN PART OR IN WHOLE WITHOUT THE WRITTEN PERMISSION OF REGAL MARINE INDUSTRIES IS PROHIBITED.

 REGAL MARINE INDUSTRIES 2000 W. STATE ST. #100 FORT MYERS, FL 33901 TEL: (888) 414-5454 FAX: (239) 938-8888 ALL RIGHTS RESERVED			
DRAWING TITLE			
LS4C (DT) Deck Plan			
DATE	REVISION	SCALE	
11/8/2017	0	1 OF 1	
DRAWN BY	APPROVED BY	DATE	
JPG	Dennis R.		

15.5" W X 29.5" L
Allowance Per Person

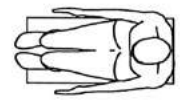

CE Persons Occupancy: 7 Persons

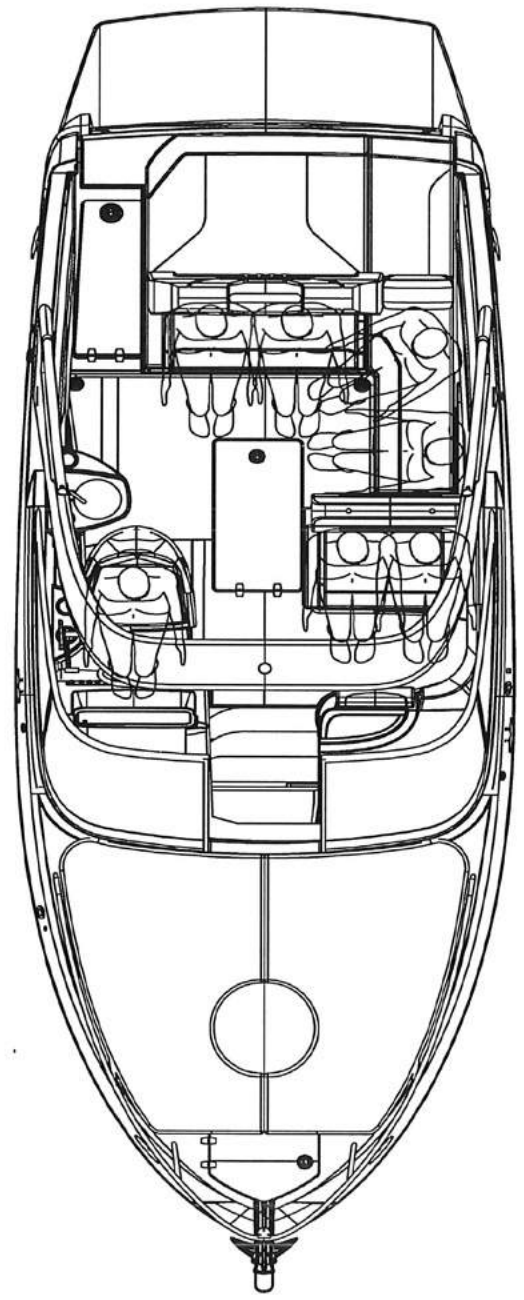

REGAL MARINE INDUSTRIES
1118/2017
JPG

	
REGAL MARINE INDUSTRIES 2225 S. BOAT TRAIL DADE CITY, FLORIDA 34608 ALL RIGHTS RESERVED	
DATE:	11/8/2017
VERSION:	0
SIZE:	1 OF 1
FILE NAME:	LS4C (DT) Deck Plan
CREATED BY:	Dennis R.
NO. OF SHEETS:	2



REGAL MARINE INDUSTRIES
 1118/2017
 0
 DENNIS R.

 REGAL MARINE INDUSTRIES <small>1118/2017 0 DENNIS R.</small>	
LS4C (DT) Deck Plan	
DATE	11/8/2017
DESIGNED BY	JPG
REVISIONS	0
APPROVED BY	Dennis R.
SIZE	1 OF 1
TOTAL SHEETS	3

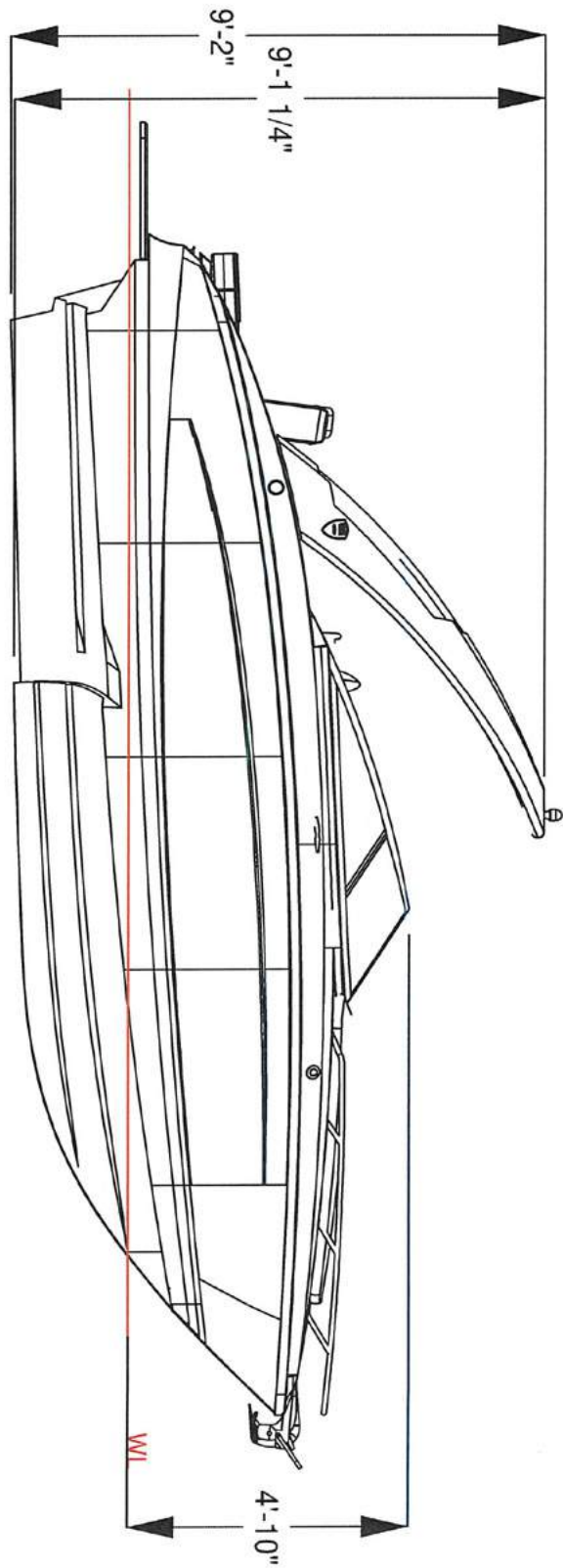

FIGURES AND DIMENSIONS ARE APPROXIMATE. THE DRAWING IS THE PROPERTY OF REGAL MARINE INDUSTRIES. ANY REPRODUCTION IN PART OR AS WHOLE WITHOUT THE WRITTEN PERMISSION OF REGAL MARINE INDUSTRIES IS PROHIBITED.

 REGAL MARINE INDUSTRIES <small>ONE ANDY FLOREN YARD</small> <small>1735 W. BAYVIEW AVE.</small>		<small>ALL DIMENSIONS IN INCHES</small>	
LS4C (DT) Profile			
DATE: 7/8/2016	BY: DENNIS R.	TITLE: 1 OF 1	
DRAWN BY: CVL	APPROVED BY: DENNIS R.	SCALE: 1:1	6



REGAL MARINE INDUSTRIES
 2000 E. 10TH AVE.
 DENVER, CO 80202
 (303) 751-8800
 WWW.REGALMARINE.COM

 REGAL MARINE INDUSTRIES <small>2000 E. 10TH AVE. DENVER, CO 80202 (303) 751-8800 WWW.REGALMARINE.COM</small>	
ITEM NO. 154C (DT) Profile	DATE 11/10/17
REVISED BY Dennis R.	FILE 1 OF 1
DATE 11/10/17	SCALE 5

PROPRIETARY RIGHTS
 THIS DOCUMENT IS THE PROPERTY OF BHI ELECTRONICS, INC. THE INFORMATION AND DESIGN DISCLOSED HEREIN WERE NOT OBTAINED FROM ANY OTHER SOURCE AND ARE NOT TO BE REPRODUCED, COPIED, OR TRANSMITTED IN ANY FORM OR BY ANY MEANS, ELECTRONIC OR MECHANICAL, INCLUDING PHOTOCOPYING, RECORDING, OR BY ANY INFORMATION STORAGE AND RETRIEVAL SYSTEM, WITHOUT THE WRITTEN PERMISSION FROM BHI ELECTRONICS, INC. THIS DOCUMENT IS TO BE RETURNED TO BHI ELECTRONICS, INC. UPON REQUEST.

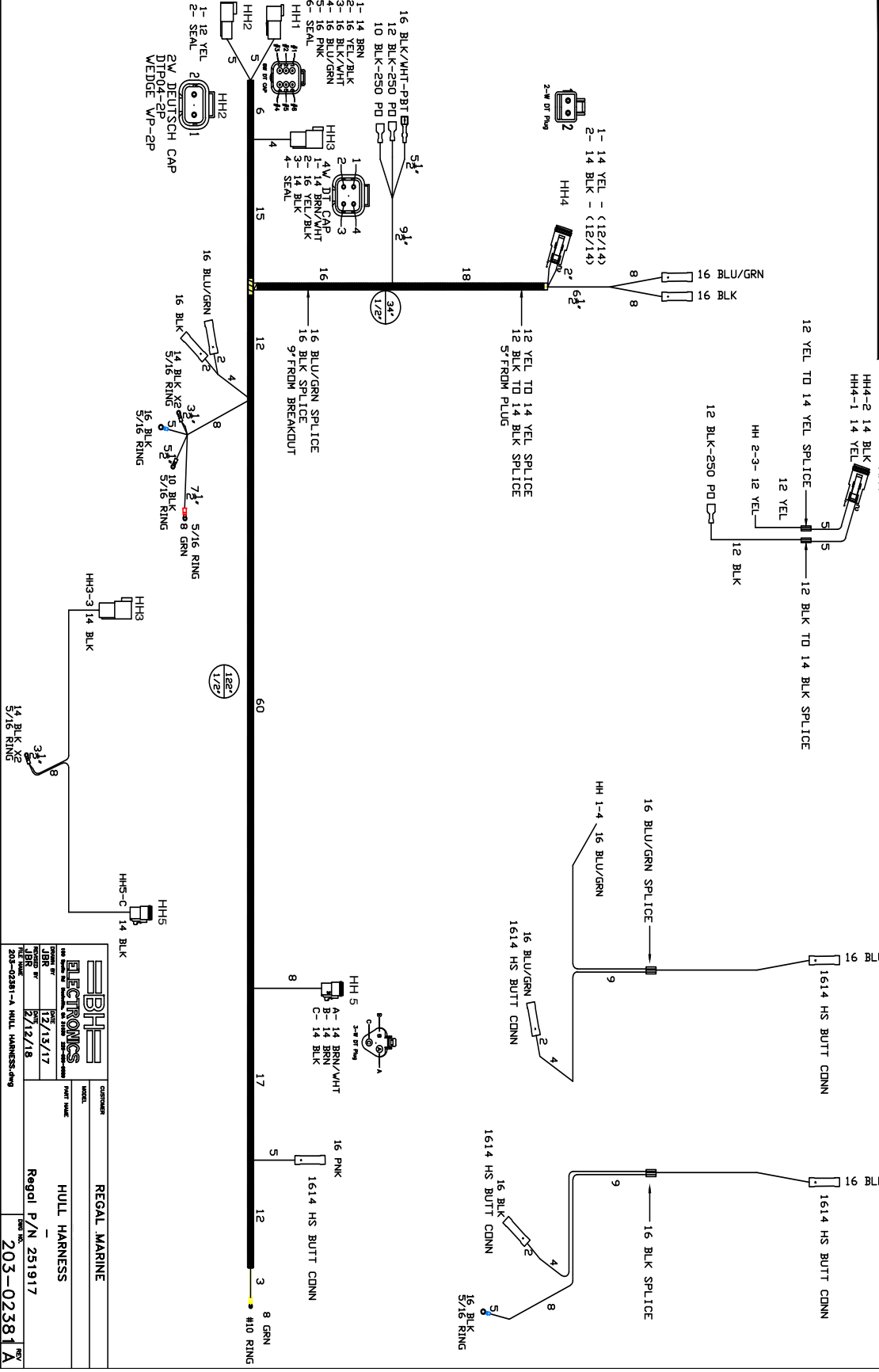

BHI ELECTRONICS
 1000 W. 10th St., Suite 100
 Duluth, GA 30091
 Phone: 404-251-1111
 Fax: 404-251-1112
 Email: sales@bhi-electronics.com

REGAL MARINE
 MODEL: HULL HARNESS
 PART NAME: Regal P/N 231917
 DATE: 203-02381-A

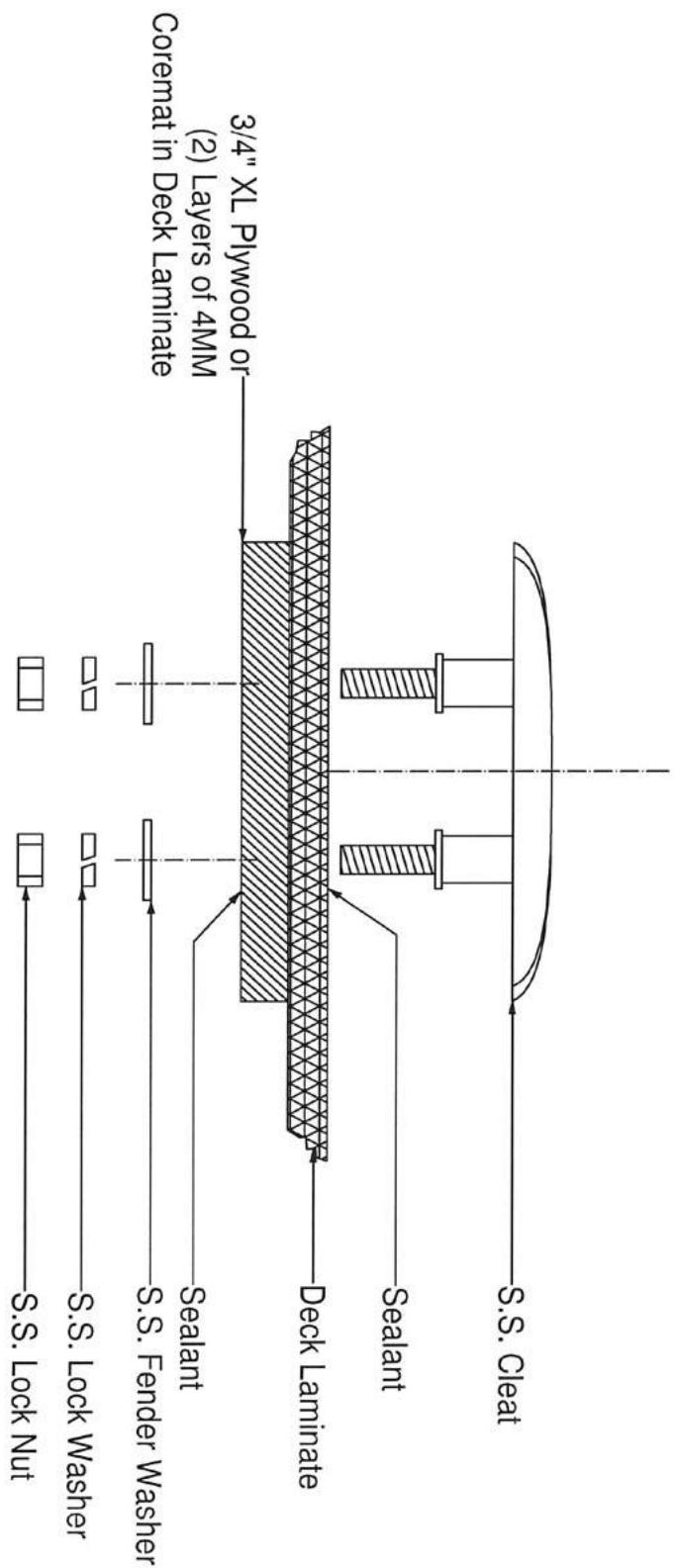

PROPRIETARY AND CONFIDENTIAL
 THE INFORMATION CONTAINED IN THIS DRAWING IS THE SOLE PROPERTY OF REGAL MARINE
 INDUSTRIES. ANY REPRODUCTION OR TRANSMISSION OF THIS INFORMATION WITHOUT THE
 PERMISSION OF REGAL MARINE INDUSTRIES IS PROHIBITED.

 REGAL MARINE INDUSTRIES 2000 W. BAYVIEW BLVD. FORT MYERS, FL 33907 ALL RIGHTS RESERVED	
DRAWING TITLE LS4C (DT) Strong Point Cleat Installation	
DATE 7/8/2016	REVISION -
DRAWN BY CVL	APPROVED BY Spentor M
PAGE 1 OF 1	
TOTAL NO. 23	

STBD Side

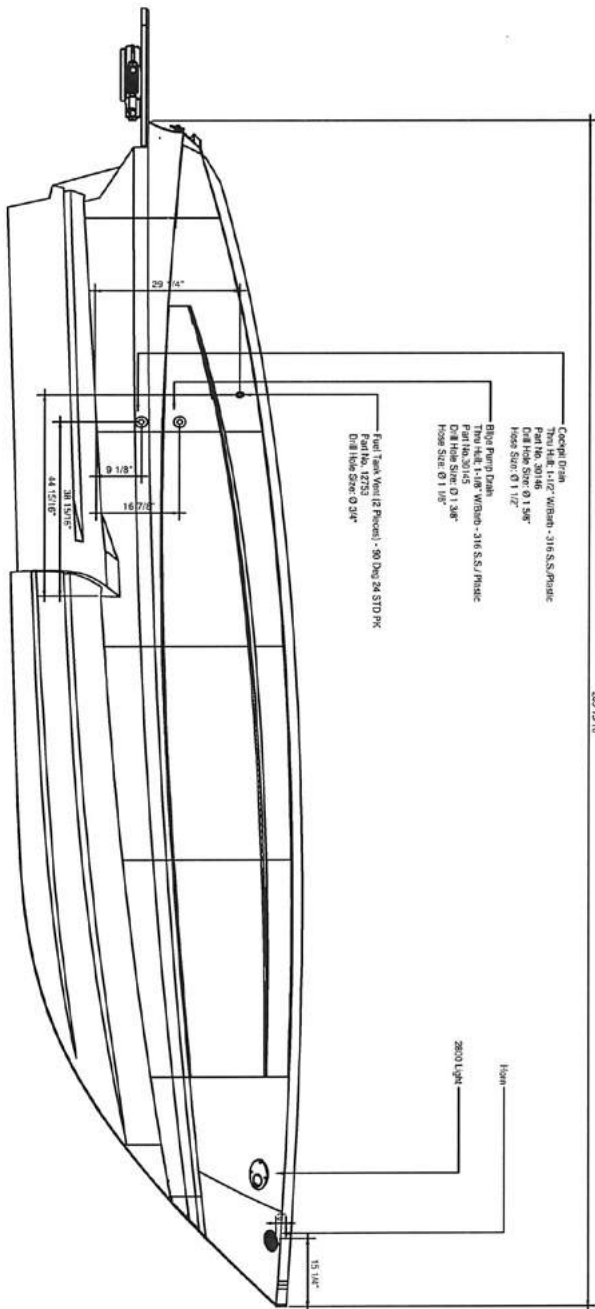

PROPRIETARY AND CONFIDENTIAL. THIS INFORMATION IS THE PROPERTY OF REGAL MARINE INDUSTRIES. ANY UNAUTHORIZED REPRODUCTION OR DISTRIBUTION OF THIS INFORMATION WITHOUT THE WRITTEN PERMISSION OF REGAL MARINE INDUSTRIES IS PROHIBITED.

 REGAL MARINE INDUSTRIES 2000 AIRPORT ROAD FORT WORTH, TEXAS 76116 TEL: 817/341-4000 FAX: 817/341-4001			
DRAWING TITLE: LS4C (DT) Hull Hardware			
DATE:	DESIGNER:	TRACER:	
3/28/2018	JPG	1 OF 3	
APPROVED BY:	DATE:		
Spencer M			
			33

Port Side

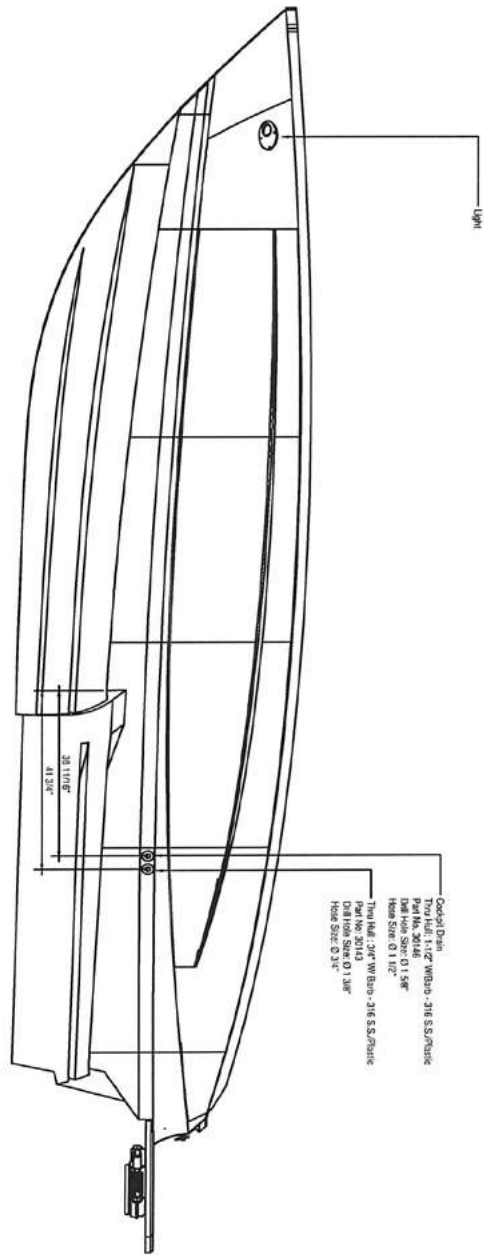

REGAL MARINE INDUSTRIES
 THE INFORMATION CONTAINED IN THIS DRAWING IS THE SOLE PROPERTY OF REGAL MARINE INDUSTRIES.
 REPRODUCTION OR TRANSMISSION OF THIS DRAWING WITHOUT THE WRITTEN PERMISSION OF REGAL MARINE INDUSTRIES IS PROHIBITED.

 REGAL MARINE INDUSTRIES 2008 WILSON BLVD WILSON, NC 27157-1400 ALL RIGHTS RESERVED	
DRAWING TITLE	
LS4C (DT) Hull Hardware	
DATE	REVISION
3/28/2018	-
DRAWN BY	APPROVED BY
JPG	Spencer M
PAGE NO.	
2 OF 3	
SHEET NO.	
34	

Transom Views

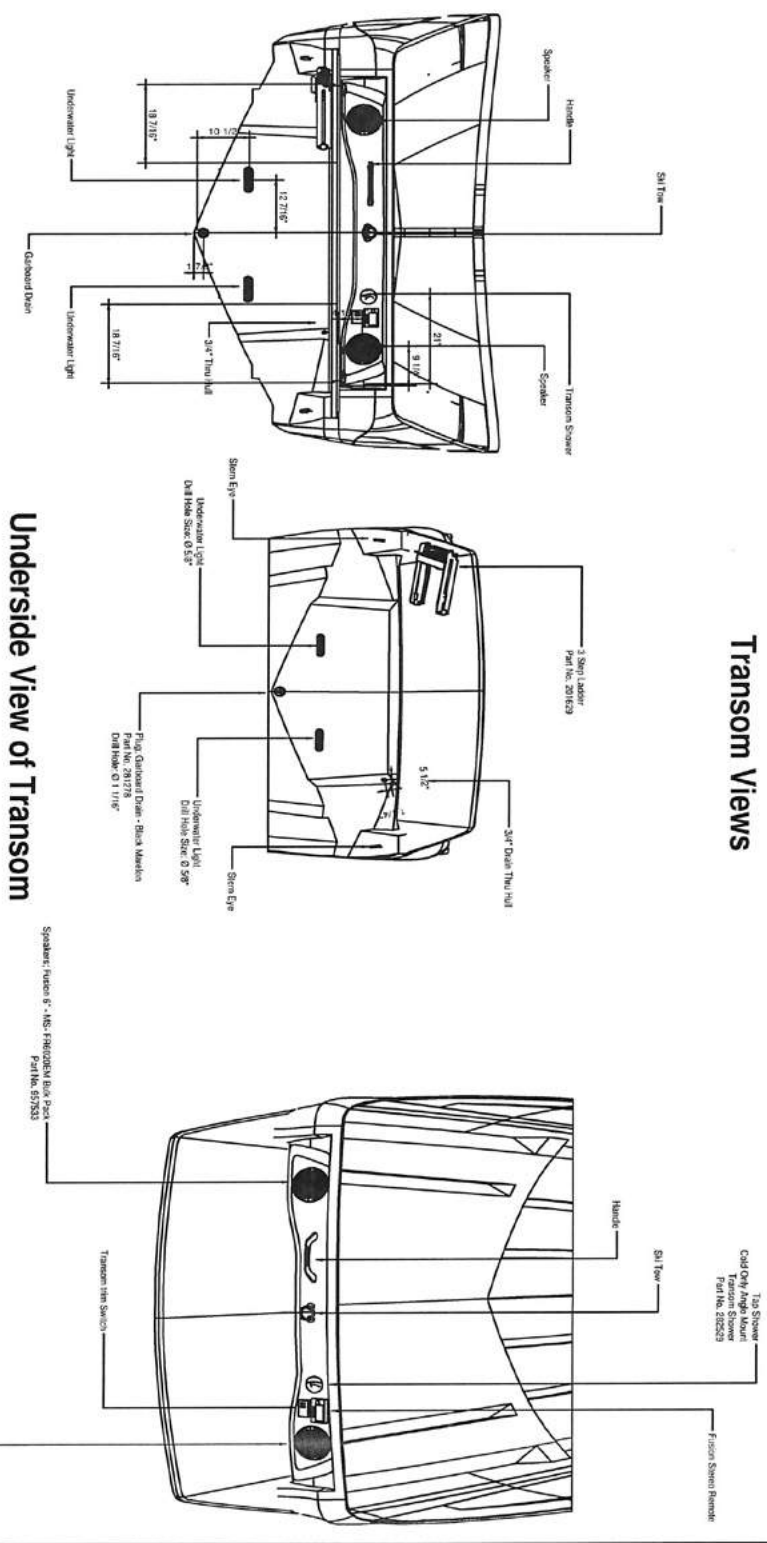

Underside View of Transom

REGAL MARINE INDUSTRIES
 2000 N. HIGHWAY 101, SUITE 100
 TAMPA, FL 33610
 TEL: 813-972-2200
 FAX: 813-972-2201
 WWW.REGALMARINE.COM

REGAL MARINE INDUSTRIES
 ALL RIGHTS RESERVED

DATE: 3/29/2018
 DRAWN BY: JPG
 CHECKED BY: Spencer M.
 TITLE: 3 OF 3
 SHEET NO.: 35

REGAL MARINE INDUSTRIES
 LS4C (DT) Hull Hardware

PROPERTY AND CONFIDENTIALITY NOTICE: THIS INFORMATION CONTAINED HEREIN IS SOLE PROPERTY OF REGAL MARINE INDUSTRIES. IT IS TO BE KEPT CONFIDENTIAL AND NOT TO BE REPRODUCED OR TRANSMITTED IN ANY FORM OR BY ANY MEANS, ELECTRONIC OR MECHANICAL, INCLUDING PHOTOCOPYING, RECORDING, OR BY ANY INFORMATION STORAGE AND RETRIEVAL SYSTEM.

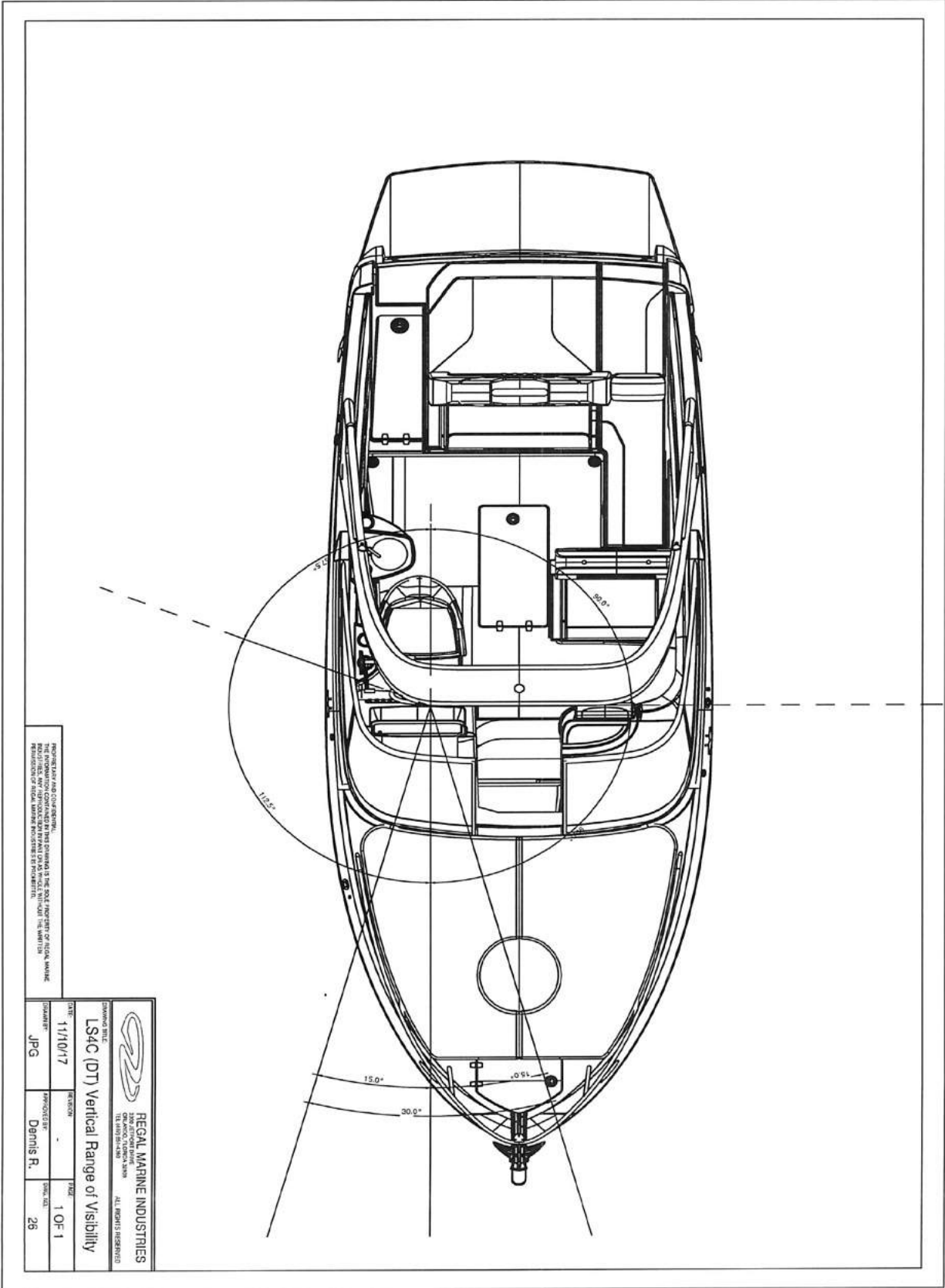

REGAL MARINE INDUSTRIES
 2800 FORT WORTH
 11600 WILSON
 DENVER, CO 80231
 TEL: 303.440.1000
 WWW.REGALMARINE.COM

 REGAL MARINE INDUSTRIES <small>2800 FORT WORTH 11600 WILSON DENVER, CO 80231 TEL: 303.440.1000 WWW.REGALMARINE.COM</small>	
DRAWING TITLE	LS4C (DT) Vertical Range of Visibility
DATE	11/10/17
BY	DP
CHECKED BY	Dennis R.
SCALE	1 OF 1
SHEET NO.	28

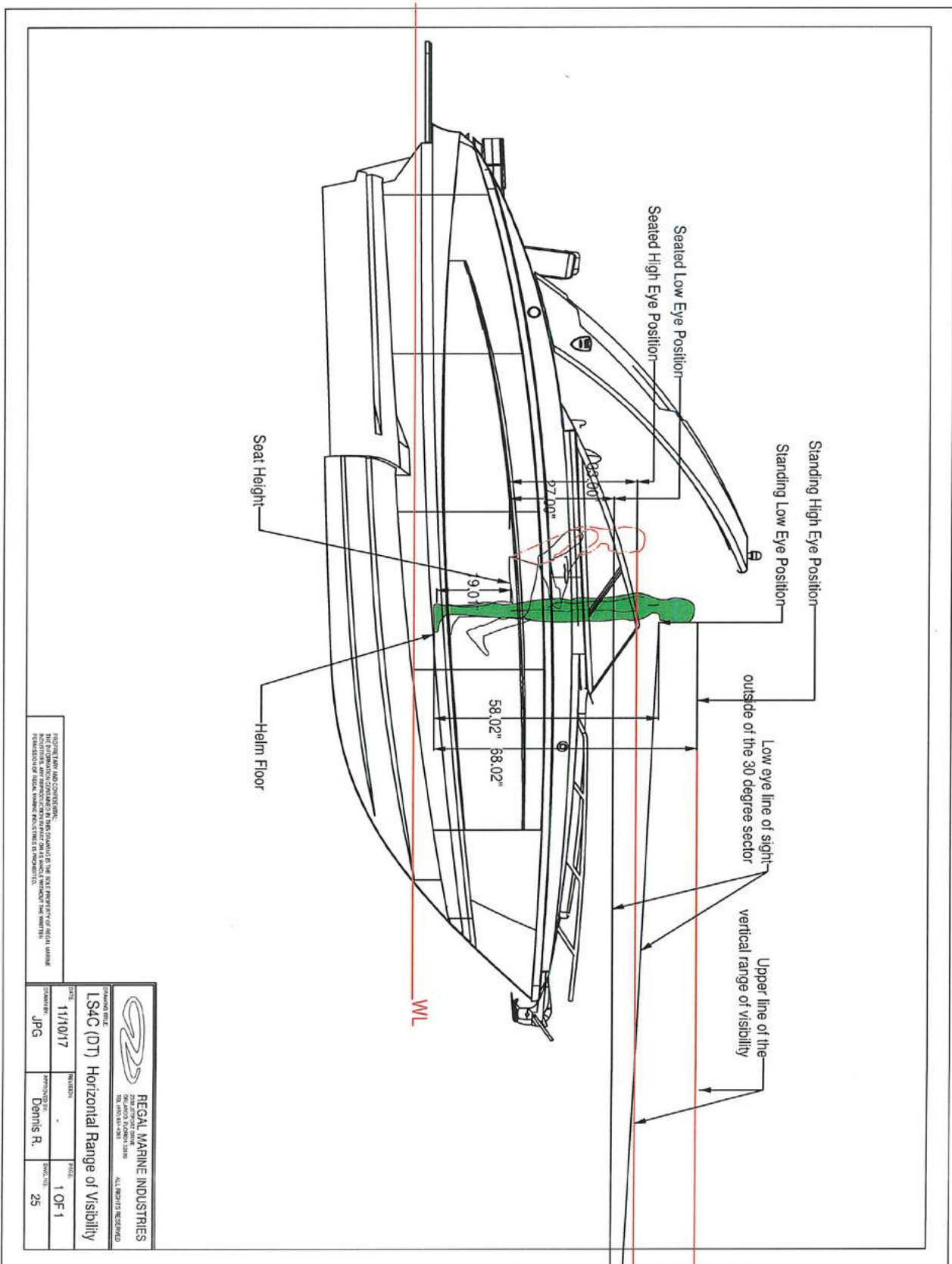

REGAL MARINE INDUSTRIES
 2000 WEST BAY BLVD
 FORT MYERS, FL 33909
 TEL: 888-468-7828

 REGAL MARINE INDUSTRIES <small>2000 WEST BAY BLVD FORT MYERS, FL 33909 TEL: 888-468-7828</small>			
LS4C (DT) Horizontal Range of Visibility			
DATE	REVISED	PRICE	
11/10/17		1 OF 1	
EXTENSION	APPROVED BY	SHEET NO.	
JPG	Dennis R.	25	

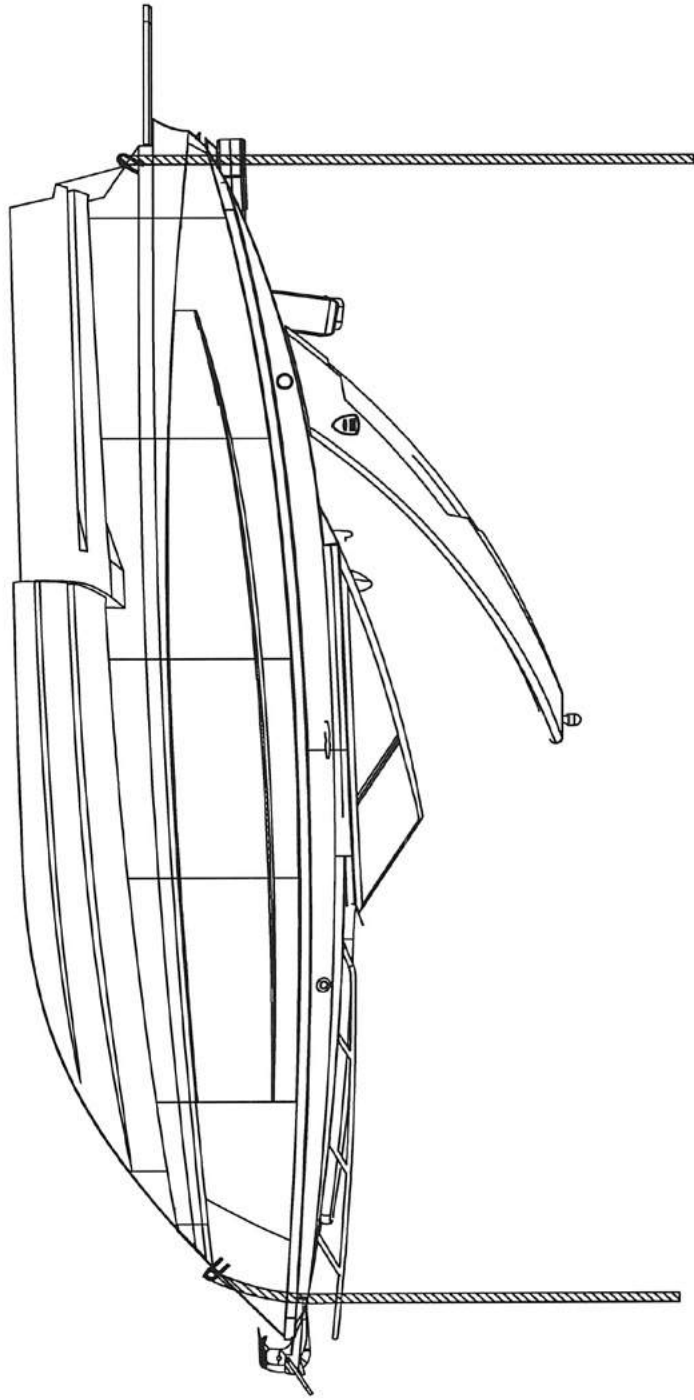

REGAL MARINE INDUSTRIES, INC.
 REGAL MARINE INDUSTRIES, INC. IS NOT RESPONSIBLE FOR THE USE OF THIS DRAWING IN THE CONSTRUCTION OF A VESSEL OR THE OPERATION OF A VESSEL.
 REGAL MARINE INDUSTRIES, INC. IS NOT RESPONSIBLE FOR THE USE OF THIS DRAWING IN THE CONSTRUCTION OF A VESSEL OR THE OPERATION OF A VESSEL.

 REGAL MARINE INDUSTRIES <small>2200 JEFFERSON DRIVE DEERFIELD BEACH, FLORIDA 33442-3000 TEL: 561-993-3333 FAX: 561-993-3334</small>		
DATE	REVISED	PAGE
11/10/17	0	1 OF 1
DRAWN BY	DESIGNED BY	DATE
JPG	Dennis R.	27

LS4C (DT) Slings Locations