

# REGAL



## OWNER'S MANUAL

**2000 ES/ESX**

**21 OBX**

REGAL# 783072

12-2017

<https://www.boat-manuals.com/>

## FUEL SYSTEMS

Boats manufactured for use in California for model year 2018 and after meet the California EVAP Emissions regulation for spark-ignition marine watercraft. Boats meeting this requirement will have a label affixed near the helm.

 <b>WARNING</b>
<p><b>Operating, servicing and maintaining a recreational marine vessel can expose you to chemicals including engine exhaust, carbon monoxide, phthalates, and lead, which are known to the State of California to cause cancer and birth defects or other reproductive harm. To minimize exposure, avoid breathing exhaust, service your vessel in a well-ventilated area and wear gloves or wash your hands frequently when servicing this vessel. For more information go to: <a href="http://www.P65warnings.ca.gov/marine">www.P65warnings.ca.gov/marine</a>.</b></p>

The fuel system in this boat complies with U.S. EPA mandated evaporative emission standards at time of manufacture using certified components.

## CALIFORNIA EVAPORATIVE EMISSION CONTROL WARRANTY STATEMENT

### YOUR WARRANTY RIGHTS AND OBLIGATIONS

The California Air Resources Board and Regal Marine Industries Inc. are pleased to explain the evaporative emission control system warranty on your Model Year 2018 spark-ignition marine watercraft. In California, new spark ignition marine watercraft must be designed, built, and equipped to meet the states stringent anti-smog standards. Regal Marine Industries must warrant the evaporative emission control system on your spark-ignition marine watercraft for the person listed below provided there has been no abuse, neglect or improper maintenance of your spark-ignition marine watercraft. Your evaporative emission control system may include parts such as carburetors, fuel tanks, fuel lines, fuel caps, valves, canisters, filters, vapor hoses, clamps, connectors and other associated components.

### MANUFACTURER'S WARRANTY COVERAGE

This evaporative emission control system is warranted for two years. If any evaporative emission-related part on your spark-ignition marine watercraft is defective, the part will be repaired by Regal Marine Industries, Inc.

### OWNER'S MANUAL RESPONSIBILITIES

- As the spark ignition marine watercraft owner, you are responsible for the performance of the required maintenance listed in your owner's manual. Regal Marine Industries, Inc. recommends that you retain all receipts covering maintenance on your spark-ignition marine watercraft, but Regal Marine Industries, Inc. cannot deny warranty solely on the lack of receipts.
- As the owner, you should be aware that Regal Marine Industries, Inc. may deny you warranty coverage of your spark-ignition marine watercraft or a part has failed due to abuse, neglect, or improper maintenance or unapproved modifications.
- You are responsible for presenting your spark-ignition marine watercraft to a Regal Marine Industries, Inc. distribution center or a service center as soon as the problem exists. The warranty repairs should be completed in a reasonable amount of time, not to exceed 30 days. If you have any questions regarding your warranty coverage, you should contact Regal Marine Industries, Inc. at 407-851-4360.

## CALIFORNIA EVAPORATIVE EMISSION CONTROL WARRANTY STATEMENT (CONTINUED)

13 CCR 2861 PARTS LIST:

Evaporative System Parts List includes:

Canisters-US EPA Evaporative family names HDPHMDRNT10 &  
HDPHMDRNN10

Fuel Hose- CARB Component Executive Order #'s RM-17-003 & RM  
17-008

Fuel Tanks- (Aluminum)

Deck Fills- EPA Compliant

Fuel Vent- P-TRAP ISO 10088 Compliant

Primer Bulb- Low Perm EPA & CARB Certified- EPA # GAT-  
WPLINE121-008

## CALIFORNIA AIR RESOURCE BOARD (CARB) LABEL

Your Regal boat if shipped to California normally will display an oval shaped label with stars. This label is part of the California Air Resource Board (Carb) SD/I rule. If your boat is operated in the state of California and/or bordering waters, this label **MUST** remain intact. The label shows that the engine installed as original equipment meets a currently approved California state regulatory emission level. On outboard vessels the carb label may be affixed to the shroud (cover). On stern drive vessels the label may be affixed to the engine cowling.



Engine Type Carb Label (4 star) Sample



# Table Of Contents

---

INTRODUCTION	4 SYSTEMS	
Your Regal Owner's Manual	11	Fire Port/Auto Fire Ext. 157
General Information	12	Bilge/Drainage 158
Regal Warranty	22	Electrical 160
		Canvas 168
		Entertainment 175
1 SAFETY ON BOARD		
Safety Labels	27	5 VESSEL OPERATION
General Boating Safety	29	
Required Safety Equipment	33	Getting Underway 176
Fire Extinguishers	36	Fueling 178
Visual Distress Signals	38	Starting & Stopping 181
Sound Protecting Devices	41	Steering 184
Navigation Lights	41	Fenders 186
Pollution Regulations	43	Dock Line Basics 187
Exhaust & Carbon Monoxide	47	Steps To Stern Drive Docking 190
Boating Under The Influence	51	Stern Drive Maneuvering 192
Boating Accidents	53	Trim Angle 195
Water Sports	55	Anchoring 200
Weather & Water Conditions	62	Emergencies 204
Federal Regulations-Security	65	First Aid 205
		Hypothermia 206
		Environmental Awareness 207
2 RULES OF THE ROAD		
Navigation Rules Defined	67	
Navigation Rules	68	
Night Running	75	
Bridge Clearance	76	
3 ENGINES & CONTROLS		
Engine Basics	79	
Stern Drive Basics	96	
Propellers	100	
Instrumentation	101	
Helm Controls	108	
21 OBX Outboard Engine/Controls	117	

# Table Of Contents

---

## 6 EQUIPMENT OPERATION

Automatic Fire Extinguisher	209
Battery Switch	210
Bilge Pump	211
Blower	212
Canvas	213
Bow Filler Cushion	218
Bow Walk Through Doors	219
Cockpit Carpet	220
Cockpit Seagrass Mat	221
Cockpit Table	222
Docking Lights	224
Dual Battery Switch	225
Drain Plug	227
Power Tower	228
Pressure Water System	231
SeaDek-Swim Platform	234
Seat Operation-Helm	235
Seat Operation-Sundeck	237
Ski Tow	238
Storage-Seat	239
Sport Tower	240
Stereo Performance Package	242
Transom Door	244
Transom Trim Switch	245

## 7 CARE & MAINTENANCE

Cosmetic Care	246
Maintenance	256

## 8 TROUBLESHOOTING

Diagnostic Charts	293
-------------------	-----

## 9 STORAGE/WINTERIZATION

Decommissioning Checklist	304
Recommissioning Checklist	307

## 10 TRAILERING

Before Towing	309
Driving	314
Launching	315
Loading Boat	317

## 11 GLOSSARY & INDEX

Glossary	319
Index	323

## 12 TECHNICAL

Information	327
Drawings	345



# Welcome To Regal

---

Dear Regal Owner,

I know I speak for everyone at Regal when I welcome you to the ever-growing family of Regal boat owners. You've chosen a craft that is recognized worldwide for its standard of excellence. Each step in construction has been carefully scrutinized to assure comfort, performance, reliability and safety for both your passengers and yourself.

Your boat is certified by the National Marine Manufacturers Association. It also complies with the applicable standards set by the United States Coast Guard and the American Boat and Yacht Council. Your Regal boat was built with the same attention to detail and quality of construction that we would expect in a boat we would purchase ourselves.

Whether you're a veteran boater or a newcomer, we strongly urge you to read this boat owner's manual thoroughly. Familiarize yourself with the various components of your boat, and heed the safety precautions noted herein.

If you have questions that are not covered in this manual, please consult your authorized Regal dealer for assistance or phone the Regal factory at 407-851-4360.

Thank you, and welcome to the "World of Regal !"

Duane Kuck  
President & CEO

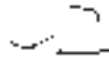

---

With God's help  
and a steadfast commitment to integrity,  
we will develop a team  
of exceptional people and relationships  
to provide  
exceptional customer satisfaction.





# Introduction

---

THIS PAGE IS LEFT INTENTIONALLY BLANK

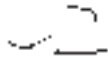

---

# Introduction

Boating is becoming more popular every year. There are numerous types of recreational vessels on our waterways today involved in an every growing number of activities. Therefore, as a new boat owner it is of the highest priority to learn about general boating practices before operating your craft.

Your Regal dealer will answer many questions and provide valuable “hands on” information during the completion of the new boat delivery process. In addition, your dealer has received special factory training on the product line and his services should be employed to solve technical problems and periodic maintenance beyond the scope of this manual. Also, your Regal dealer carries a line of factory approved parts and accessories.

Your Regal dealer can provide information regarding national training organizations such as the U.S. Power Squadron and United States Coast Guard Auxiliary. Along with other organizations and literature, they can help build your “boating savvy” by developing the necessary skills and awareness to be a safe and competent skipper. Your local library can also help in providing recommended boating literature such as Chapman Piloting (Seamanship & Boat Handling by Elbert S. Maloney).

Remember, the waterways can change from normal to abnormal conditions in a heartbeat. Knowing how to react quickly comes from experience and knowledge which can be gained through boating education.

Welcome aboard!



# Introduction

## YOUR REGAL OWNER'S MANUAL



You may find a QR label in the proximity of the dash (helm area). Use your smart phone and scan the label as it takes you to a secure Regal owner's web-site where you can select your owner's manual (PDF format) and download it to your desired device. If your vessel utilizes Regal installed Garmin the manual can be downloaded on a mini SD card and then inserted into the Garmin card slot, select info tab, go to the next page, find owner's manual and click open. At this point you can search chapters through bookmarks and find items by using the index, a key word search, or touch control functions.

Your Regal owner's manual has been developed to assist you in operating your vessel with safety and pleasure. Be sure to read and become familiar with the contents before operating your craft. Your owner's manual has been divided into general chapters to assist you in becoming more knowledgeable with your Regal boat. Also, we have added a special technical drawing chapter which can be valuable in maintenance and troubleshooting. This owners manual is not intended to be a complete source of boating maintenance, boat handling techniques, boating safety or seamanship. These skills require education and experience levels beyond this manual.

*Note that select information in this manual is shared by both stern drive and outboard vessels. There is a special section in chapter 3 that addresses the 21 OBX outboard exclusively.*

More detailed outboard information can be found in the outboard vendors engine manual and this document must be read and understood before attempting to operate the OBX outboard version. In keeping with its commitment to continued improvement, Regal notes that all drawings, specifications, models, standard and optional equipment referred to in this manual can change without notice.

INT-11

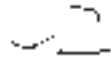

## OWNER'S INFORMATION PACKET



Regal has provided an information pouch for on board reference. Read and become familiar with the materials. This packet contains valuable literature on your propulsion package, standard and optional equipment, systems, along with various care and cleaning instructions. Be sure to store the information pouch in a clean dry location.

## GENERAL INFORMATION

### Hull Identification Number (HIN)

The United States Coast Guard has established a universal system of numerically identifying vessels by using a hull identification number or "HIN." This number identifies your Regal boats model, hull number, month and year of manufacture. The HIN is found on your boat's starboard side, just below the rub rail in the transom area. The HIN consists of 12 alpha or numeric characters. It is recommended that you locate and write down the HIN for future reference. It can be especially useful when ordering parts from your Regal dealer. A second HIN number is found in a hidden location. This second HIN is useful to authorities if for example the boat is stolen and the original transom HIN is modified or eliminated. Example seen below.



RGMFQ000J718

INT-12



# Introduction

---

## Vessel Information Sheet

It is recommended that you fill out the information on the following page. It will supply vital statistics on your vessel. Make a copy of the data for safe keeping at home.

## Vessel Float Plan

Fill out the float plan on the following page before departing. Leave it with a responsible person who will notify the United States Coast Guard or local law enforcement authorities if you do not return as planned. If you change your plans be sure to notify this person. Make copies of the float plan and use one each time you go boating. This will help people know where to find you should you not return on schedule. Do not file the float plan with the United States Coast Guard.

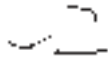

---

## VESSEL INFORMATION SHEET

Owner: \_\_\_\_\_

Address: \_\_\_\_\_

City & State: \_\_\_\_\_

Home Phone: \_\_\_\_\_ Business Phone: \_\_\_\_\_

In Case Of Emergency Notify: \_\_\_\_\_

Address: \_\_\_\_\_

City: \_\_\_\_\_ State: \_\_\_\_\_

Phone: \_\_\_\_\_

Insurance Agent's Name: \_\_\_\_\_

Policy#: \_\_\_\_\_

USCG Phone: \_\_\_\_\_ Local Police: \_\_\_\_\_

Marina Phone: \_\_\_\_\_ Slip (Dock#): \_\_\_\_\_

Hull Serial #: RGM \_\_\_\_\_

Key #: \_\_\_\_\_ Engine Serial #: \_\_\_\_\_

Stern Drive Serial #: \_\_\_\_\_

Key #: \_\_\_\_\_ Cabin Door: (If Applicable) \_\_\_\_\_

Selling Dealer: \_\_\_\_\_

Address: \_\_\_\_\_

City & State: \_\_\_\_\_

Phone: \_\_\_\_\_

Servicing Dealer: \_\_\_\_\_

Address: \_\_\_\_\_

City & State: \_\_\_\_\_

Phone: \_\_\_\_\_

INT-14



# Introduction

## FLOAT PLAN

Owner: \_\_\_\_\_ Safety Equipment Aboard:  
 Address: \_\_\_\_\_ Life Jackets  
 City & State: \_\_\_\_\_ First Aid Kit  
 Telephone#: \_\_\_\_\_ Flares  
 Cell Phone#: \_\_\_\_\_ Flashlight  
 \_\_\_\_\_ VHF Radio  
 Person Filing Report: \_\_\_\_\_ Anchor  
 Name: \_\_\_\_\_ Compass  
 Home Telephone#: \_\_\_\_\_ Food  
 Cell Phone #: \_\_\_\_\_ Water

Make Of Boat: \_\_\_\_\_ Destination: \_\_\_\_\_  
 Registration#: \_\_\_\_\_ Leave From: \_\_\_\_\_  
 Length: \_\_\_\_\_ Time Left: \_\_\_\_\_  
 Boat Name: \_\_\_\_\_ Going To: \_\_\_\_\_  
 Gel Color: \_\_\_\_\_ Fuel Level: 1/4, 1/2, 3/4, F  
 Trim Color: \_\_\_\_\_ Est. Time Of Arrival: \_\_\_\_\_  
 I/O-Outboard: \_\_\_\_\_  
 Hull I.D.#: \_\_\_\_\_ Return: \_\_\_\_\_  
 Fuel Capacity: \_\_\_\_\_ Est. Time of Arrival: \_\_\_\_\_  
 If not back by \_\_\_\_\_ o'clock  
 call Coast Guard

Other Information: \_\_\_\_\_  
 \_\_\_\_\_

Name Of Person Aboard	Age	Address	Phone#
_____	_____	_____	_____
_____	_____	_____	_____

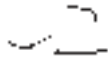

---

## LAUNCH & CRUISE CHECKLIST

Obtain a current weather report.

Inspect the hull and propeller for damage.

Check all electrical system switches for proper operation.

If your boat has been in the water, run the bilge pump until the flow of water stops.

If your boat has been out of the water, check to see that all bilge water has drained out. Install the drain plug.

Check that all required safety equipment is on board and in good working condition.

Check that all other equipment is on board such as mooring lines, first aid kit, tool kit and extra parts.

Open engine compartment. Inspect for fuel odors and visible leaks in the fuel, oil, exhaust & power steering systems.

Visually inspect engine for cracked hoses, defective belts, loose fasteners such as bolts, nuts and hose clamps.

Check fuel level. Fuel tanks should be filled to near full capacity.

Make sure all navigation charts, equipment and vessel registration paperwork are onboard.

Check operation of bilge blower, steering system, navigation lights and horn.

Make sure passengers and crew know how to operate safety equipment and react to an emergency.

File a float plan with a responsible party ashore.

INT-16





# Introduction

---

## SUGGESTED TOOLS, PARTS & GEAR

### SUGGESTED TOOLS

Allen Wrenches  
Jack Knife  
Phillips Screwdriver Set  
Slotted Screwdriver Set  
Regular Pliers  
Combination Wrench Set  
Ratchet & Socket Set  
Hammer  
Wire Crimpers  
Vise Grip Pliers  
Floating Flashlight  
Nut Driver Set  
Oil Filter Wrench  
Fuel Filter Wrench

### SPARE PARTS

Fuel Filter  
Spark Plugs  
Water Pump Belt  
Propellers  
Alternator Belt  
Anti-Siphon Set  
Propeller Nut & Hardware  
Engine Oil  
Extra Light Bulbs  
Extra Batteries  
Duct Tape  
Electrical Tape  
Power Steering, Trim Fluids  
Water Pump Impeller  
Spare Keys On Floater

### BASIC GEAR

Tie Lines  
Mooring Lines  
Dock Fenders  
First Aid Kit  
Boat Hook  
Foul Weather Gear  
VHF Radio, EPIRB, GPS, Cell Phone  
Charts & Plotting Instruments  
Emergency Water & Food  
Bailer Or Hand Pump  
Fire Extinguisher  
Personal Flotation Devices  
Anchor & Line  
Life Raft

INT-17

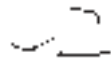

## Capacity Plate

Close to the helm on Regal boats up to 26' in length is a capacity plate. A typical capacity plate for domestic vessels is shown below. This plate represents manufacturers who participate in the National Marine Manufacturer's Association small boat certification program. The driver of the craft must read and understand the plate information before operating the vessel.

The capacity plate data applies under normal conditions. Be sure to read and abide by the capacity limits. Remember, the boat operator is responsible for the vessel and the safety of its passengers.

Note the 2018 model year capacity plate information below regarding the models in this owner's manual:

- The plate states the maximum number of persons allowed on the boat.
- The total weight of persons, gear and other items under normal conditions that the boat is capable of carrying.
- Overloading, improper loading and weight distribution are well documented causes of accidents. Provide for an extra margin of safety in rough sea conditions.

### TYPICAL EXAMPLES SHOWN

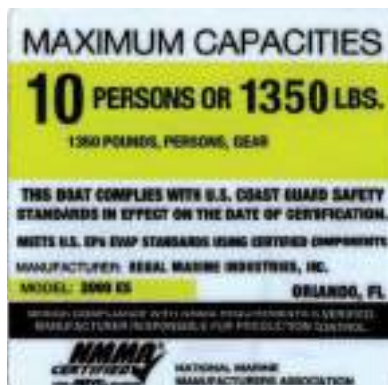

INT-18



# Introduction

---

## Owner Registration & Systems Checklist

Please note that your Regal boat requires the proper registration by your authorized Regal dealer. To initiate your warranty the dealer must complete the owner's registration form and systems checklist at the time of delivery. The owner must sign the paperwork to acknowledge that the dealer has reviewed the boat systems and warranty provisions with the owner. The owner should keep the original paperwork that features a temporary warranty registration. A Regal express limited warranty certificate containing all relevant boat and engine serial numbers will be sent after the factory receives the paperwork.

## Dealer Responsibility

Your boat has undergone rigid quality assurance inspections before leaving the factory. However, your dealer has been trained to perform final pre-delivery checks and to service your Regal boat prior to your pick-up. Your dealer's responsibilities include:

A complete orientation in the operation of your Regal boat, including matters relating to the safe operation of your craft.

Completion and mailing of your boat registration warranty form to Regal.

Warranties, registration materials, owner's manual, operation, installation and maintenance instructions for all auxiliary equipment supplied with or installed on your Regal boat.

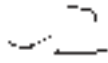

---

## Owner Responsibility

You are entitled to all the benefits and services outlined in your Regal boat warranty. However, you have certain responsibilities to ensure warranty satisfaction.

These are:

To read the warranty materials and understand them fully.

To examine the boat in detail at the time of delivery.

To apply the following; boating rules and regulations, safety equipment, environmental regulations, accident reports and warranty regulation terms and conditions.

To read thoroughly all literature supplied with your boat, including this owner's manual and to follow the recommendations in the literature.

To return the boat after the recommended hours of engine operation for the proper dealer service inspections.

To provide proper maintenance and periodic servicing of your boat and equipment as set forth in the various manuals supplied.



# Introduction



## DELIVERY INSPECTION AND ACCEPTANCE SHEET

REGAL MARINE INDUSTRIES  
2300 JETPORT DRIVE  
ORLANDO, FLORIDA 32809  
(407) 851-4360

### Owner Registration Information

Name*			Dealer*		
Address			Hull / RGM*		
City	State		E-Mail		
Country			Phone		

\*mandatory

**INSTRUCTIONS:** This checklist is designed to assist dealers in the delivery of a Regal Boat to a new owner. Review the location, operation and maintenance of each item noted below with the owner and acknowledge this by checking the appropriate boxes. Indicate if item is not applicable with "NA". This form must be completed and signed by the dealer's representative and the customer to acknowledge proper receipt of the boat. **The warranty will not be activated until a fully completed and signed copy has been scanned and attached to the registration in RegalDealer.com.**

New Boat Information			Dealer	Owner	N/A	Head and Waste			Dealer	Owner	N/A
1	Review Regal Warranty					1	Toilet operation				
2	Review Extended Warranty					2	Shower sump				
3	Review Engine Warranty					3	Holding tank				
4	Owners Package					4	Overboard System				
5	Dealer service procedures										
6	Owners responsibilities										
7	Complete ALL warranty Cards										
Cabin			Dealer	Owner	N/A	ELECTRIAL			Dealer	Owner	N/A
1	Audio system					1	Main Distribution Panel Operation				
2	Video/Entertainment System					2	Battery switch(s)				
3	Galley Systems					3	VSR operation				
4	AC					4	Breaker Location				
	a Controller operation					5	Battery Charging				
	b Condensation system					6	Shore Power				
	c Proper maintenance										
Deck & cockpit			Dealer	Owner	N/A	SUMP			Dealer	Owner	N/A
1	Canvas set-up and storage					1	Bilge pump				
2	Windlass operation and breaker location					2	High water alarm				
3	Sunroof operation & proper maintenance					3	Fire suppression system				
4	Electronics operation					4	Battery fuse/breaker				
5	Entertainment system					5	Engine PDI Complete				

**CAUTION:** This checklist is only intended to provide a general overview and does not represent all information necessary for proper operation of the boat. It is very important that persons operating this boat study the various manuals and materials provided with the boat and follow the recommendations contained in these materials and local laws. They contain important information including cautions and warnings that are vital to safe and enjoyable operation of the vessel. It is the owner's responsibility to insure that anyone operating the boat has been properly trained.

We have completed a review and orientation of the boat and its systems. The boat is in order and functioning properly with the exception of any items **specifically noted below**. This confirms that owner has received a copy of the Regal Limited Lifetime Warranty and engine manufacturer's warranty and agrees to these warranty terms and conditions.

---



---



---



---



---

Dealer Rep, Signed: \_\_\_\_\_ Delivery Date \_\_\_\_\_

Owner, Signed: \_\_\_\_\_ Today's Date \_\_\_\_\_

FRM: CS-DIA / Rev. (5-12-16)

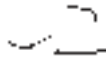

---

## REGAL MARINE INDUSTRIES, INC. LIMITED WARRANTY

Welcome to the Worldwide Family of Regal Owners! We are very pleased that you have chosen a Regal Powerboat!

This document is your Limited Warranty Registration Certificate and Statement of Limited Warranty. Please check the registration information section for accuracy. If this information is not correct or if you change your address at some future date, please notify us at the following address: Regal Marine Industries, Inc. Attention: Warranty Registrations, 2300 Jetport Drive, Orlando, Florida 32809; or e-mail [customerservice@regalboats.com](mailto:customerservice@regalboats.com).

Please read the warranty carefully. It contains important information on Regal's claims procedures and your rights and obligations under this warranty.

**WHAT IS COVERED:** This Limited Warranty applies only to Regal boats beginning with model year 2017.

**LIFETIME LIMITED STRUCTURAL DECK & HULL WARRANTY:** Regal Marine Industries, Inc. warrants to the original retail purchaser of this boat if purchased from an authorized Regal dealer that the selling dealer or Regal will repair or replace the factory installed fiberglass if it is found to be structurally defective in material or workmanship for as long as the original retail purchaser owns the boat. For purposes of this Limited Warranty, the hull is defined as the single fiberglass casting which rests on the water. This Limited Warranty is subject to all limitations and conditions explained below.

**FIVE-YEAR TRANSFERABLE LIMITED STRUCTURAL HULL WARRANTY:** In addition to the Lifetime Limited Structural Hull Warranty, Regal offers a Transferable Five-Year Limited Structural Hull Warranty. Under the Five-Year Transferable Limited Structural Hull Warranty, Regal will repair or replace the fiberglass hull or deck if it is found to be structurally defective in material or workmanship within the first (5) years after the date of delivery to the original retail purchaser. Any remaining term of this Five-Year Limited Hull Warranty may be transferred to a second owner if within 60 days of purchase, the new owner registers the transfer with Regal and pays the established Limited Warranty transfer fee. Contact Regal Customer Service at the above address for details.

**FIVE-YEAR LIMITED HULL BLISTER WARRANTY:** Regal warrants that the Regal selling dealer or Regal will repair any underwater gelcoated surfaces of the hull against laminate blisters which occur as a result of defects in material or workmanship within (5) years of the date of delivery, provided that the original factory gelcoat surface has not been altered. Alternation would include but is not limited to damage repair; excessive sanding, scraping, sandblasting; or from improper surface preparation for application of a marine barrier coating or bottom paint, any of which shall void this Five-Year Limited Hull Blister Warranty. Proper preparation must be applied to the hull bottom if the boat is to be moored for periods in excess of (60) days. Regal Marine shall repair or cause to be repaired any covered laminate blisters based on the following prorated schedule. Less than three (3) years from delivery date - 100%, Three (3) to (4) years from delivery date - 50%, Four (4) to (5) years from delivery date - 25%.

INT-22



# Introduction

---

Reimbursement shall be limited to one repair, not to exceed (\$100.00) dollars per foot of boat length prior to prorating. Regal's prior authorization for the method and cost of repair, must be obtained before repairs are commenced. All costs to transport the boat for repairs are the responsibility of the owner.

**LIMITED GENERAL WARRANTY:** In addition to above hull warranties, Regal warrants to the original purchaser of this boat if purchased from an authorized Regal dealer, that the authorized Regal dealer or Regal will repair or replace any parts found to be defective in materials or workmanship for a period of one (1) year from the date of delivery, subject to all exceptions, limitations and conditions contained herein.

**LIMITED EXTERIOR FINISH WARRANTY:** Regal warrants that the authorized Regal selling dealer or Regal will repair cosmetic defects in the exterior gelcoated finish including cracks, air voids or crazing for one year from the date of delivery, subject to all limitations and conditions contained herein. All warranty work is to be performed at a Regal dealership or other location authorized by a Regal Customer Service Manager after it is established to Regal's satisfaction that there is a defect in material or workmanship.

**CUSTOMER OBLIGATIONS:** The following are conditions precedent to the availability of any benefits under these limited warranties:

(a) The purchaser, who is not Regal's sales agent and is otherwise not in any general or sales agency relationship with Regal, must sign and the authorized Regal selling dealer, must submit to Regal the "NEW BOAT DELIVERY and ACCEPTANCE CHECKLIST" within fifteen (15) days of the date of delivery and such information must be on file at Regal.

(b) The purchaser must first notify the authorized Regal selling dealer from whom the boat was purchased of any claim under this Limited Warranty within the applicable Limited Warranty period and within a reasonable period of time (not to exceed thirty (30) days) after the defect is or should have been discovered.

(c) Regal will not be responsible to repair any condition or replace any part, (1) if the use of the boat is continued after the defect is or should have been discovered; and (2) if such continued use causes other or additional damage to the boat or component parts of the boat.

(d) Based on the authorized Regal selling dealer's knowledge of Regal's Limited Warranty policy and/or consultations with Regal, the dealer will accept the claim and arrange for appropriate repairs to be performed, or deny the claim if it is not within the Limited Warranty policy.

(e) The authorized Regal selling dealer will contact the Regal boat owner regarding instructions for delivery of boat or part for covered warranty repair if it is covered by the Limited Warranty.

**ALL COSTS TO OR FROM THE BOAT AND/OR TRANSPORT OF THE BOAT FOR REPAIRS ARE THE RESPONSIBILITY OF THE OWNER.**

(f) If the Regal boat owner believes a claim has been denied in error or the authorized Regal selling dealer has performed the warranty work in an unsatisfactory manner, the owner must notify Regal's Customer Service Department in writing at the address listed for further consideration. Regal will then review the claim and take appropriate follow-up action.

(g) Before bringing any action, claim, lawsuit, or otherwise seeking relief against Regal based on any alleged breach of any of the Limited Warranties, terms or conditions herein, the Regal Boat owner must contact Regal's Customer Service Department Directly allow Regal, beyond those efforts made by its authorized Regal dealer, notice an opportunity to cure any alleged breach of any of the terms of any of the Limited Warranties.

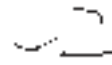

**WARRANTY EXCEPTIONS:** THIS LIMITED WARRANTY does not cover, the following are not warranted are excluded from the terms of the Regal Limited Warranty and the following terms apply to any Regal Limited Warranty.

- (a) Engines, drives, controls, propellers, batteries, metal plating or finishes, windshield breakage, leakage, fading and deterioration of paints, canvas, vinyl, upholstery and fabrics;
- (b) Gelcoat surfaces including, but not limited to discoloration or blistering except as noted above;
- (c) Accessories and items which were not part of the boat when shipped from the Regal factory, or which carry their own individual warranty and/or any damage caused by such accessories or items;
- (d) Damage caused by one or more of the following: misuse, accident, corrosion, galvanic corrosion, negligence, lack of proper maintenance, or improper trailering;
- (e) Any boat used for racing, or used for rental or commercial purposes;
- (f) Any boat operated contrary to any instructions furnished by Regal, including instructions and guidance provided in the Regal Owner's Manual, or operated in violation of any federal, state, Coast Guard or other governmental agency laws, rules, or regulations;
- (g) The limited warranty is void if alterations have been made to the boat;
- (h) Transportation of boat or parts to and/or from the REGAL factory or service location;
- (i) Travel time or haul outs, loss of time or inconvenience;
- (j) Any published or announced catalog performance characteristics of speed, fuel and oil consumption, and static or dynamic transportation in the water;
- (k) Any boat that has been re-powered beyond Regal's power recommendations;
- (l) Boats damaged by accident and boats damaged while being loaded onto, transported upon or unloaded from trailers, cradles, or other devices used to place boats in water, remove boats from water or store or transport boats on or over land;
- (m) Any item repaired, replaced or modified under the terms of this warranty does not in any way prolong, extend or change any terms set forth in this limited warranty;
- (n) Water damage to, dry rot to, condensation to, or absorption by interior surfaces, wood structures or polyurethane foam; interior wood including, but not limited to mold, bleeding and/or discoloration as a result of condensation or moisture or water continually contacting the plywood causing staining to upholstery, carpet or other interior surfaces;
- (o) Costs or charges derived from inconvenience or loss of use, commercial or monetary loss due to time loss, and any other special, incidental or consequential damage of any kind or nature whatsoever;
- (p) Regal reserves the right to improve the design or manufacture process of Regal boats without obligation to modify previously produced product;

**NO WAIVER OF THESE TERMS:** The terms, conditions, limitations and disclaimers contained herein cannot be waived except by the Customer Service Manager of Regal. Any such waiver must be in writing. Neither the dealer, nor the customer, nor any service, sales and/or warranty representative of Regal is authorized to waive and/or modify these conditions, limitations and/or disclaimers.

EXCEPT AS SET FORTH HEREIN OR ON ANY OTHER WRITTEN EXPRESS LIMITED WARRANTIES BY REGAL, THERE ARE NO OTHER WARRANTIES EITHER EXPRESSED OR IMPLIED PROVIDED BY REGAL ON THIS BOAT. ALL OTHER WARRANTIES, EXPRESS OR IMPLIED, INCLUDING IMPLIED WARRANTIES OF FITNESS AND MERCHANTABILITY, ARE EXPRESSLY EXCLUDED. REGAL FURTHER DISCLAIMS ANY LIABILITY FOR ECONOMIC LOSS ARISING FROM CLAIMS OF PRODUCT FAILURE, NEGLIGENCE, DEFECTIVE DESIGN, MANUFACTURING DEFECT, FAILURE TO WARN AND/OR INSTRUCT, LACK OF SEAWORTHINESS, AND ANY OTHER THEORY OF LIABILITY NOT EXPRESSLY COVERED UNDER THE TERMS OF THIS LIMITED WARRANTY.

AS SET FORTH ABOVE, REGAL MAKES NO IMPLIED WARRANTY OF MERCHANTABILITY AND EXPRESSLY EXCLUDES ANY SUCH WARRANTY. TO THE EXTENT SUCH EXCLUSION IS NOT ALLOWED BY LAW OR AN IMPLIED WARRANTY OF MERCHANTABILITY IS ALLOWED BY LAW: (1) ANY IMPLIED WARRANTY OF MERCHANTABILITY THAT IS, AS A MATTER OF LAW, NOT PERMITTED TO BE EXCLUDED AS SET FORTH ABOVE, IS LIMITED TO ONE





# Introduction

YEAR FROM THE DATE OF DELIVERY TO THE FIRST RETAIL OWNER; (2) NEITHER REGAL NOR ANY SELLING DEALER SHALL HAVE ANY RESPONSIBILITY FOR LOSS OR USE OF THE BOAT, LOSS OF TIME, INCONVENIENCE, COMMERCIAL LOSS, INCIDENTAL OR CONSEQUENTIAL DAMAGES. SOME STATES MAY NOT ALLOW EXCLUSIONS OF IMPLIED WARRANTIES OR LIMITATIONS ON HOW LONG ANY IMPLIED WARRANTY LASTS, SO THE ABOVE LIMITATION MAY NOT BE APPLICABLE. SOME STATES MAY NOT ALLOW THE EXCLUSION OR LIMITATION OF INCIDENTAL OR CONSEQUENTIAL DAMAGES, SO THE ABOVE LIMITATIONS OR EXCLUSIONS MAY NOT BE APPLICABLE IN THOSE STATES. THIS WARRANTY GIVES THE OWNER SPECIFIC LEGAL RIGHTS, AND THE OWNER MAY ALSO HAVE OTHER RIGHTS WHICH VARY FROM STATE TO STATE.

THE TERMS AND CONDITIONS CONTAINED HEREIN, AS WELL AS THOSE OF ANY DOCUMENTS PREPARED IN CONJUNCTION WITH THE SALE OF THIS VESSEL MAY NOT BE MODIFIED, ALTERED OR WAIVED BY ANY ACTION, INACTION OR REPRESENTATIONS, WHETHER ORAL OR IN WRITING, EXCEPT UPON THE EXPRESSED, WRITTEN AUTHORITY OF A MANAGEMENT LEVEL EMPLOYEE OF REGAL. Some states do not allow limitations on how long an implied warranty lasts, so the above limitation may not apply to you. Regal's obligation with respect to this warranty is limited to making repairs to or replacing the defective parts and no claim for breach of warranty shall be cause for cancellation or rescission of the contract or sale for any boat manufacturer by REGAL MARINE INDUSTRIES, INC.

Regal will discharge its obligations under this warranty as rapidly as possible, but cannot guarantee any specific completion date due to the different nature of claims which may be made and services which may be required. Regal reserves the right to change or improve the design of its boats without obligation to modify any boat previously manufactured. This limited warranty gives you specific legal rights, and you may also have other rights which may vary from state to state. Regal shall in no way be responsible for any repairs not PRE-AUTHORIZED by a Regal Customer Service Manager or repairs performed by a repair shop not PRE-AUTHORIZED by a Regal Customer Service Manager.

## ARBITRATION OF DISPUTES AND WAIVER OF JURY TRIAL

EXCEPT AS SPECIFICALLY EXCLUDED IN THIS LIMITED WARRANTY, PURCHASER, REGAL AND AUTHORIZED REGAL DEALER AGREE TO SUBMIT ANY AND ALL CONTROVERSIES, CLAIMS OR DISPUTED ARISING OUT OF OR RELATING TO THE BOAT AND THIS LIMITED WARRANTY AND ALL OTHER AGREEMENTS EXECUTED BY PURCHASER RELATED TO THE BOAT TO BINDING ARBITRATION. IT IS THE EXPRESS INTENT OF PURCHASER, REGAL AND DEALER THAT THIS ARBITRATION PROVISION APPLIES TO ALL DISPUTES, INCLUDING CONTRACT DISPUTES, TORT CLAIMS, FRAUD CLAIMS AND FRAUD-IN-THE INDUCEMENT CLAIMS, STATUTORY CLAIMS AND REGULATORY CLAIMS RELATING IN ANY MANNER TO THE BOAT AND THIS LIMITED WARRANTY.

IF ANY CONTROVERSY OR CLAIM DESCRIBED IN THIS ARBITRATION PROVISION IS DETERMINED FOR ANY REASON TO BE INELIGIBLE FOR ARBITRATION, AND FOR ANY CONTROVERSIES, CLAIMS, OR DISPUTES SPECIFICALLY EXEMPTED FROM ARBITRATION, THEN THOSE CONTROVERSIES, CLAIMS, OR DISPUTES SHALL INSTEAD BE DECIDED BY A JUDGE OF A COURT OF COMPETENT JURISDICTION, IN ORANGE COUNTY, FLORIDA, WITHOUT A JURY. PURCHASER, REGAL AND DEALER KNOWINGLY AND VOLUNTARILY WAIVE THE RIGHT TO A TRIAL BY JURY FOR ALL SUCH CONTROVERSIES, CLAIMS AND DISPUTES. PURCHASER, REGAL, AND DEALER UNDERSTAND THAT THERE SHALL BE NO JURY TRIAL, WHETHER THE CONTROVERSY OR CLAIM IS DECIDED BY ARBITRATION OR BY TRIAL BEFORE A JUDGE. NOTWITHSTANDING THE PROVISIONS OF THIS ARBITRATION AGREEMENT, WITH REGARD TO CONTROVERSIES AND/OR ENTITLEMENT TO POSSESSION OF EITHER THE BOAT OR ANY TRADE-IN, ANY PARTY HERETO MAY RESORT TO A JUDICIAL DETERMINATION (BY A JUDGE AND NOT A JURY). OF SUCH CONTROVERSIES, DISPUTES OR CLAIMS WITHOUT WAIVING ANY RIGHT TO DEMAND ARBITRATION WITH RESPECT TO ALL OTHER CONTROVERSIES, DISPUTES OR CLAIMS BETWEEN THE PARTIES A MORE SPECIFICALLY SET FORTH IN THIS ARBITRATION PROVISION.

ALL ARBITRATIONS SHALL PROCEED THROUGH THE AMERICAN ARBITRATION ASSOCIATION AND BE SUBJECT TO ITS COMMERCIAL ARBITRATION RULES, EXCEPT AS SET FORTH HEREIN. THE ARBITRATORS SHALL HAVE THE AUTHORITY TO AWARD ANY FORM OF RELIEF THAT COULD BE PROPERLY AWARDED IN A CIVIL ACTION IN THE STATE OF FLORIDA FOR THE TYPE OF CLAIMS PRESENTED, SUBJECT HOWEVER, TO ALL LIMITATIONS, PREDICATES, AND CONDITIONS COVERING SUCH REMEDIES OR RELIEF UNDER FLORIDA LAW.

THE PURCHASER, REGAL OR DEALER MAY DEMAND ARBITRATION OF A CLAIM BY FILING A WRITTEN DEMAND FOR ARBITRATION, ALONG WITH A STATEMENT OF THE MATTER IN CONTROVERSY WITH THE AMERICAN ARBITRATION ASSOCIATION, AND SIMULTANEOUSLY SERVING A COPY UPON THE OTHER PARTY. PURCHASER, REGAL AND DEALER AGREE THAT THE ARBITRATION PROCEEDING SHALL BE CONDUCTED IN ORANGE COUNTY, FLORIDA UNLESS OTHERWISE AGREED BY THE PARTIES. EACH PARTY AGREES TO BEAR THEIR OWN ATTORNEY FEES AND COSTS. THE FILING FEES AND ALL OTHER THIRD-PARTY COSTS FOR THE ARBITRATION, INCLUDING THE ARBITRATOR'S FEE SHALL BE PAID BY THE FILING PARTY INITIATING THE ARBITRATION. THE PREVAILING PARTY SHALL BE ENTITLED TO REIMBURSEMENT OF THEIR REASONABLE ATTORNEY FEES AND REASONABLE EXPENSES FROM THE NON-PREVAILING PARTY.

## REGISTRATION INFORMATION:



---

# Notes



# Safety On Board

Safety awareness can't be over emphasized. Safety on board needs to be the skipper's number one priority. In this manual you will find many safety precautions labels in various locations. See technical information chapter for typical examples and locations. Heed all safety precaution information. *Remember, the skipper is responsible for the safety of his passengers, crew and wake of the vessel.*

## SAFETY LABELS

### Safety Precaution Definition

Safety precautions are stated as caution, warning and danger signal words. They are highlighted in this manual by font design and symbol usage. Also, a notice heading is included which provides operation and maintenance information but is not hazard-related. Become familiar and understand all safety precaution labels!

 <b>DANGER</b>
IMMEDIATE HAZARDOUS SITUATION THAT, IF NOT AVOIDED, WILL RESULT IN DEATH OR SERIOUS INJURY.
 <b>WARNING</b>
POTENTIALLY HAZARDOUS SITUATION THAT, IF NOT AVOIDED, COULD RESULT IN DEATH OR SERIOUS INJURY.

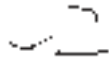

# Chapter 1

---



## CAUTION

INDICATES A POTENTIALLY HAZARDOUS SITUATION OR UNSAFE PRACTICE THAT, IF NOT AVOIDED, MAY RESULT IN INJURY OR PROPERTY OR PRODUCT DAMAGE.



## NOTICE

GENERAL OR SPECIFICATION WHICH IS IMPORTANT TO CORRECT OPERATION OR MAINTENANCE, BUT IS NOT HAZARD RELATED.

### Precautionary Labels

Read and understand all safety labels affixed to your Regal boat. Most of the safety labels are found close to the helm, aft cockpit and or swim platform. The location of the labels may vary by model and the label list does not cover everything! Use common sense to analyze the result of an action on board your vessel. Always think safety first!



## NOTICE

DO NOT REMOVE OR COVER ANY PRECAUTIONARY LABELS.  
KEEP HARSH CHEMICALS AWAY FROM LABELS.  
IF A LABEL BECOMES ILLEGIBLE, CONTACT THE CLOSEST  
REGAL DEALER FOR ORDERING REPLACEMENTS.



# Safety On Board

---

## GENERAL BOATING SAFETY

We understand that you are eager to get your Regal boat on the water. However, we strongly suggest that you thoroughly familiarize yourself and friends or members of your family with safe boating practices before setting out.

Remember, that along with the freedom and exhilaration of boating comes the responsibility that you have for the safety of your passengers and other boaters who share the water with you.

Boating regulations vary from state to state. Check with your local state and local authorities for the regulations pertaining to your area.

Check with local weather stations, the U. S. Coast Guard, or weather station broadcasts for the latest conditions. Remember getting caught in severe weather is hazardous, Check weather conditions periodically while you are boating and before your outing. If you are forced to operate your boat in a storm condition, take common sense precautions; wear PFD's, store gear, reduce speed and head for safe refuge.

It is best to avoid operating your boat in foggy weather. When fog sets in, take bearings, log courses and speeds. You are required to emit a five second blast from your horn or whistle once a minute. Also, have your passengers wear PFD's and observe for oncoming vessels.

Operating in shallow water presents a number of hazards including sand bars and water levels influenced by tides. If the vessel ever strikes an underwater hazard, check for boat and engine damage. If the engine vibrates excessively after striking an underwater obstruction, it may indicate a damaged propeller. If you run aground, seek help by radio or flares.

Make sure your boat and equipment are in top condition. Do this by frequently inspecting the hull, engine and gear.

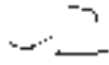

# Chapter 1

---

You must provide a Coast Guard approved personal flotation device (PFD) for every person on board. These PFD's should be in good condition and easily accessible.

Insist that non-swimmers and children on board wear a PFD at all times. Any time you encounter rough weather conditions, make sure everyone on board is wearing a PFD, including yourself. Instruct your passengers in how to put on their PFDs and be sure they know their storage location on the boat. Remember, in an emergency, a PFD that cannot be quickly located and worn is useless.

Never allow anyone to sit anywhere on the boat not specifically designed as a seat. While underway, ALWAYS insist passengers remain seated.

Use maximum caution when fueling. Never allow any smoke or flame nearby while you are fueling. ALWAYS check for fuel leaks and fumes when fueling is completed.



## WARNING

GASOLINE VAPORS CAN EXPLODE!  
BEFORE STARTING ENGINES, OPERATE BLOWER  
4 MINUTES. VISUALLY CHECK AND SNIFF ENGINE  
COMPARTMENT FOR GASOLINE FUMES OR LEAKS.  
RUN BLOWER MOTOR BELOW CRUISING SPEEDS.



## WARNING

USE OF ALCOHOL ENHANCED FUEL, OR A FUEL  
OTHER THAN GASOLINE CAN LEAD TO DETERIORATION  
OF THE FUEL SYSTEM COMPONENTS,  
CAN RESULT IN FIRE AND POSSIBLE EXPLOSION!



## Safety On Board

---



Never drink and drive! As captain, you are responsible for the safety of your passengers and yourself. Alcohol and boating can be a dangerous combination. DO NOT mix them. Alcohol impairs the boat operators ability to make conscious decisions and react to emergency situations quickly.

Never overload your boat! An overloaded boat, or one with uneven weight distribution, can be difficult to steer.

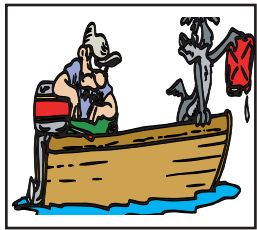

Be certain there is enough fuel aboard for your cruising needs. Include any reserve that might be needed should you change your plans due to weather or emergency. Practice the “one-third rule: (Use one-third of your fuel going out, one-third to return and keep one-third as a reserve).

Check the weather before departure. Be particularly cautious of electrical storms and high winds.

Have up-to-date charts aboard. You will need current charts of the area you’ll be cruising to stay on proper course. Local Charts can be found at your closest marine outlet or store or by contacting one of three federal government agencies.

File a float plan. Leave details of your trip with someone who will be remaining on shore. Include expected return, plus name and phone number of a contact person in case of emergency.

Use care, courtesy and common sense when launching, docking or operating your boat.

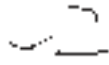

# Chapter 1

---

Learn and obey the “Rules of the Road”. A copy of the “Rules of the Road” can be obtained from the U. S. Coast Guard Auxiliary or local Power Squadron.

In case of emergency: Know the international distress signals if you have a VHF radio aboard. The spoken word “MAYDAY” is the international signal of distress and is for emergency use only. Under no circumstances should this word be used, unless there is danger at hand.

Posted speed limits, swimming areas, “no wake” zones and other restrictions should be red-flagged. They are so noted for a reason. Sensible boat use plus courtesy fosters enjoyable and safe boating.

It is your responsibility to stay abreast of all federal, state and local rules, as some laws or regulations may change or be different from state to state. Contact your local boating agencies for updated information.

We can not stress safety enough! Remember, there are no brakes on your boat, and the water current and wind velocity all affect your ability to respond. The driver must use caution at all times to maintain control of his vessel and especially to maintain a safe distance from other boats and obstacles.

Always keep all safety gear in optimum condition. Pay special attention to attached tags and plates indicating expiration dates on equipment such as fire extinguishers, and personal flotation devices. Encourage a periodic maintenance check on all safety equipment. Contact your Regal dealer or marine professional for more information. Again, remember that the captain is responsible for his passengers and vessel.





# Safety On Board

---

## REQUIRED SAFETY EQUIPMENT

### Personal Flotation Devices



All personal flotation devices (PFD's) must be Coast Guard approved, in good working condition, and must be the correct size for the wearer. All PFD's must be readily accessible. This means being able to wear them in a reasonable amount of time

in case of an emergency (fire, boat sinking, etc.). They should not be stored or locked in closed areas. Also, make sure that all coverings are removed, such as plastic from any PFD's. Throwable devices such as a ring buoys need to be available for immediate deployment. A PFD should be worn at all times when your boat is operating on the water. A PFD may save your life, but it must be worn to do so.

As minimum U. S. Coast Guard requirements all recreational boats must carry one type I, II, III, or V PFD (wearable) for each person aboard. See the explanation following for each type. For type V to be counted they must be used according to the label instructions. In addition, all boats over 16' must carry one Type IV (throwable) PFD. Some states require that PFD's be worn by children of specific ages at all times. Check with state boating agencies for particular requirements in your state before taking children on the water.

Remember PFD's will not necessarily keep you from drowning, even though they are designed to keep a person from sinking. When purchasing PFD's make sure it safely fits the person wearing it. It is a good idea to test PFD's in a shallow pool before trying on the water. Refer to the USCG minimum equipment requirements at the end of this chapter. It is meant to be a guide only. Contact state and local agencies for additional equipment requirements. Remember as the captain of your vessel you are responsible for its safe operation.

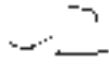

# Chapter 1

---



- TYPE I- Also known as an offshore jacket, it provides the most buoyancy. It is a PFD for all waters and is especially useful in rough waters where rescue may encompass additional time. It is designed to turn most unconscious users in the water to a face-up position. Type I PFD is available in adult & child sizes.

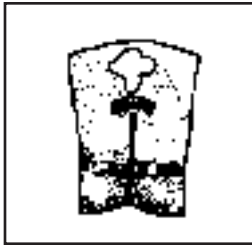

- TYPE II- Also known as near-shore buoyant vest, it is recommended for calm, inland water where rescue time will be minimal. It will turn some unconscious people face-up in the water but not as numerous as Type I. They are available in adult, medium child, along with infant and small child sizes.



- TYPE III- Known as a flotation aid it is good for calm, inland water or where there is a chance for quick rescue. It is designed so wearers can place themselves in a face-up position in the water. The wearer may have to tilt their head back to avoid turning facedown in the water.

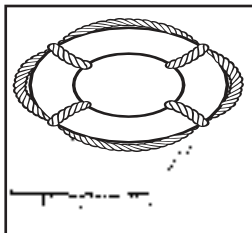

- TYPE IV- Intended for calm, inland water with heavy vessel traffic, where help is constantly present. It is designed to be thrown into the water for someone to grab on to and held until rescued. It should not be worn. Type IV includes ring buoys, buoyant cushions, and horseshoe buoys.



## Safety On Board

---

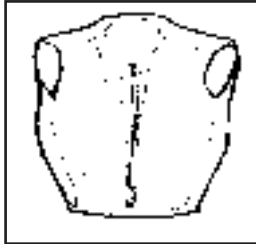

- TYPE V- This is the least bulky of all PFD's. It contains a small amount of inherent buoyancy, and an inflatable chamber. It is rated even to a Type I, II, or III PFD (as noted on the jacket label) when inflated. Hybrid PFD's must be worn to be acceptable equipment.

### Maintaining your PFD's

A PFD is only useful if it's well maintained. Always be aware of PFD age since it has a life expectancy like any other piece of equipment.

- √ Do a periodic operation check of all PFD's in shallow water.
- √ Be sure to air dry all PFD's after each use. Store in a dry, easily accessible location.
- √ Check periodically for broken zippers, frayed webbing, water soaked kapok bags, missing straps, and sewing that is undone.
- √ Clean each PFD with mild soap and water only. Again, let dry sufficiently before storing.
- √ Keep PFD's out of grease and oil since they can deteriorate the jacket inner and outer materials.
- √ Check any kapok-bagged jackets by squeezing. If jacket loses air the bag is defective and the PFD should be thrown away.
- √ Grab the cover with the fingers. If the cover material rips, the PFD is rotted and should be thrown away.
- √ If the kapok bag is hard the PFD should be discarded.

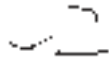

# Chapter 1

## FIRE EXTINGUISHERS

### General Information

Fire extinguishers are classified by a letter and numeric symbol. The letter references the type of fire the unit is designed to extinguish. For example, type B extinguishers commonly used on boats are designed to put out flammable liquids such as grease, oil and gasoline. The number indicates the general size of the extinguisher and minimum extinguishing agent weight.

FIRE EXTINGUISHER CONTENTS				
CLASS	FOAM IN GALS.	CO2 IN LBS.	DRY CHEM. IN LBS.	HALON IN LBS.
B-I	1.25	4	2	2.5
B-II 2.5	15	10	10	

MINIMUM PORTABLE FIRE EXTINGUISHERS REQUIRED		
VESSEL LENGTH	NO FIXED SYSTEM	WITH FIXED SYSTEM
LESS THAN 26' 26' TO LESS THAN 40' 40' TO 65'	1 B-1 2 B-1 OR 1 B-II 3 B-1 OR 1 B-II	0 1 B-1 2 B-1 AND 1 B-1 OR 1 B-II



## Safety On Board

---

U. S. Coast Guard approved fire extinguishers are required on all Regal boats. Besides the minimum Coast Guard requirements always check state and local agencies for additional requirements.

Coast Guard approved extinguishers are hand-portable, either B-I or B-II classification.

U. S. Coast Guard approved hand-portable and semi-portable extinguishers contain a metal plate that shows the manufacturer's name and extinguisher type, capacity and operating instructions. They have a special marine type mounting bracket which keeps the extinguisher solidly mounted until needed. The extinguisher needs to be mounted in a readily accessible location. All approved extinguishers need to have an indication gauge.

### USCG- Approved Fire Extinguisher Types & Features



The dry chemical agent is widely used because of its convenience and low cost. The extinguisher canister is filled with a white dry chemical powder along with a pressurized gas. Shake this type periodically because they tend to "pack" on the canister bottom.



The foam type uses a chemical foaming agent plus water and is best when used for fires involving flammable liquids- solvents, gasoline, oil, grease and various paints. It will work on fires involving rubber, plastics, cloth, wood, and paper. It leaves a messy residue. Not for electric fires.



The carbon dioxide unit uses CO<sub>2</sub> gas under high pressure, with a funnel discharge hose usually swivel mounted. This extinguisher leaves no residue and no interior engine harm. To ensure workability, weigh the unit annually. A 10% max. weight variance is allowed.

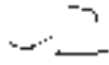

# Chapter 1

---

Another type of liquefied gas used today is Halon. This gas is colorless and odorless, heavier than air and sinks to the lower bilge to extinguish fires. Since the year 2000 ingredients for Halon have changed to a more environmental friendly formula. Halon is used in portable-hand units along with making up the majority of boat automatic fire extinguishing systems. The canister needs to be weighed once a year. Halon units must feature a dash mount indicator. Refer to the information regarding fire prevention in this manual.

## VISUAL DISTRESS SIGNALS

All vessels used on coastal waters, any of the Great Lakes, territorial seas, and those waters connected directly to them, up to point where a body of water is less than two miles wide, must have Coast Guard approved visual distress signals.

### Pyrotechnic Devices

Pyrotechnic visual distress signals must be Coast Guard approved, be ready for service and must be readily accessible. They all display a marking which is the service life, which must not have expired. A minimum of 3 devices are required for day and 3 devices for night. Some devices meet both day and night requirements. Pyrotechnic devices should be stored in a cool, dry location. Most of these devices can be purchased in an highly visible (orange) watertight container. Types of Coast Guard approved pyrotechnic distress signals and associated devices are:

Pyrotechnic red flares, hand- held or aerial type.

Pyrotechnic orange smoke, hand-held or floating type.

Launchers for parachute flares or aerial red meteors.



# Safety On Board

---

All in all, each distress signal has certain pros and cons. There is no distress signal that is best under all situations. Pyrotechnics are recognized worldwide as superior distress signals. A downfall is they emit a very hot flame that can cause burns and or ignite flammable materials. Pistol launched and hand-held parachute flares operate consistent with firearms and therefore must be carefully handled. Check with local and state regulations since some of these device are considered firearms and are prohibited.

## Non-Pyrotechnic Devices

Non-pyrotechnic devices must all be in serviceable condition, readily accessible, and must be certified by the manufacturer to comply with Coast Guard standards. They include:

Orange distress flag.

Electric distress flag.

The distress flag is for day use only. It must be 3 x 3 or larger with a black square and ball on an orange background. It can be spotted when attached to a boat hook, long fishing rod, or paddle with the person waving the flag back and forth overhead.

The electric distress flag is for night use only flashing the international SOS distress signal (... \_ \_ ...).

Under Inland Navigation Rules, a high intensity white light that flashes at regular intervals from 50-70 times per minute is considered a distress signal.

Remember that regulations prohibit the display of visual distress signals on the water under any circumstances except when assistance is required to prevent immediate or potential danger to passengers on a vessel.

# Chapter 1

## INTERNATIONAL DISTRESS SIGNALS



BLACK SQUARE  
AND BALL ON  
ORANGE  
BACKGROUND



CODE FLAGS  
NOVEMBER AND  
CHARLIE



SQUARE  
FLAG AND  
BALL



PERSON  
RAISING  
ARMS

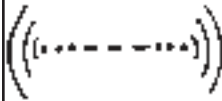

MORSE  
CODE  
S.O.S.



"MAYDAY"  
BY  
RADIO



DESIGN  
UPSIDE  
DOWN



PARACHUTE  
RED  
FLAG



RED METEOR  
FLARES



SMOKE



FOG HORN  
SOUNDED  
CONTINUOUSLY



GUN FIRED  
AT 1-MINUTE  
INTERVALS



POSITION  
INDICATING  
RADIO BEACON



DYE MARKER  
(ANY COLOR)



HAND-HELD  
FLARE





# Safety On Board

---

## SOUND PRODUCING DEVICES



According to both Inland and International Rules, all boats must carry some way of producing an efficient sound signal. If your vessel is 12 meters (39' 4") or longer, a power whistle, power horn or bell must be carried. The bell must be 7 7/8" in diameter.

Boats less than 12 meters a horn or whistle is recommended to signal intentions or signal position. The sound signal made in all cases must be capable of a four or six second blast audible for one half mile. See the section discussing bridge and whistle signals for more information.

## RADIO COMMUNICATIONS

VHF radios are used for distress and ship to shore and ship to ship communications today. Learn the specialized messages such as Mayday, Mayday, Mayday is only used when life or vessel is in imminent danger.

## NAVIGATION LIGHTS

The U. S. Coast Guard requires recreational boats operating at night to display navigation lights between sunset and sunrise. Navigation lights help avoid collisions by improving the night visibility of vessels. Red and green directional lights, white stern lights, white masthead lights and white all-around lights must be displayed in specified positions, depending on boat size, and mode of operation. The configuration of visible lights tells and operator the size, direction of travel and means of propulsion (sail, power, rowing or at anchor) of another vessel. Larger boats are required to carry larger, brighter lights that are visible over longer distances.

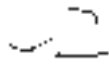

# Chapter 1

## NAVIGATION LIGHT RULES

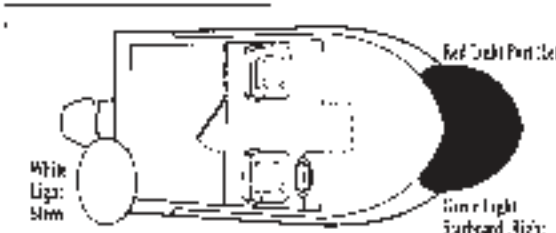

White Light: Stem

Red Light: Port Stern

Green Light: Starboard Stern

Location of Light on vessel	VESSEL LENGTH	
	Less Than 12 Meters (39 Feet)	12 Meters (39 Feet) and Over
Stem Light	1	2
Port Stern Light	1	2
Starboard Stern Light	1	2
Navigation Light	1	2



Boats less than 12 meters in length  
At least one stem light is required. The lighting arrangement is longer if the vessel has a mast.

Section 100-10-1010 The centerline navigation lights of a vessel less than 12 m

Boats less than 12 meters in length  
At least one stem light is required. The lighting arrangement is longer if the vessel has a mast.

Section 100-10-1010 The centerline navigation lights of a vessel less than 12 m



Boats 12 meters or more in length  
At least one stem light is required. The lighting arrangement is longer if the vessel has a mast.

Section 100-10-1010 The centerline navigation lights of a vessel 12 m or more in length

Boats 12 meters or more in length  
At least one stem light is required. The lighting arrangement is longer if the vessel has a mast.

Section 100-10-1010 The centerline navigation lights of a vessel 12 m or more in length

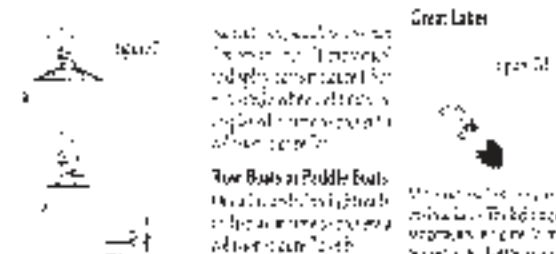

Rowing or Plying Boats  
The lights shall be lighted in the same manner as for a vessel of the same length.

Rowing or Plying Boats  
The lights shall be lighted in the same manner as for a vessel of the same length.

Rowing or Plying Boats  
The lights shall be lighted in the same manner as for a vessel of the same length.

Rowing or Plying Boats  
The lights shall be lighted in the same manner as for a vessel of the same length.



# Safety On Board

---

## POLLUTION REGULATIONS

The Federal Water Pollution Control Act prohibits the discharge of oil or hazardous substances which may be harmful into U. S. navigable waters. Vessels 26' and larger must display a placard at least 5" x 8", made of durable material, fixed in a conspicuous machinery space location, stating the following:

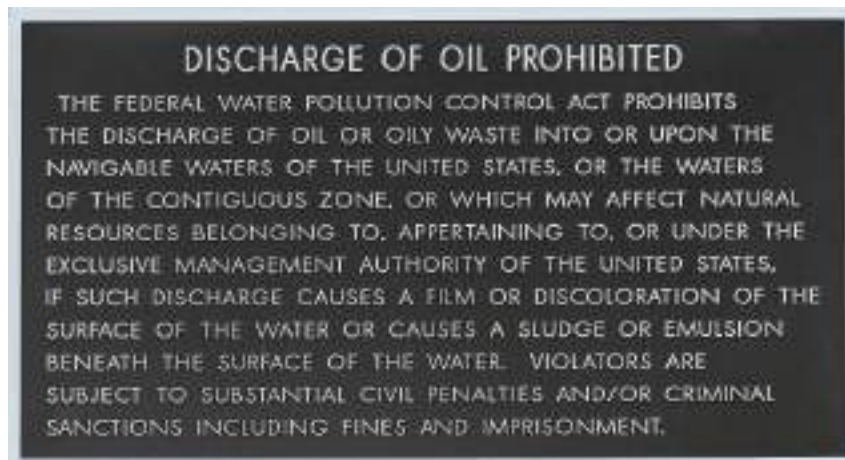

All vessels regardless of size must immediately notify the U. S. Coast Guard if your vessel discharges oil or hazardous substances in the water. Call toll free 800-424-8802. Report the following information: location, source, size, color, substances and time observed. If installed, this placard may be located in the engine compartment.

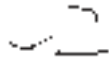

# Chapter 1

---

## Garbage

The Act to Prevent Pollution from Ships places limitations on the discharge of garbage from vessels. It is illegal to dump plastic trash anywhere in the ocean or navigable waters of the United States.

Also, it is illegal to discharge garbage in the navigable waters of the United States, including the Great Lakes. The discharge of other types of garbage is allowed outside certain specified distances from shore as determined by the nature of that garbage. Below is a typical label that may be found on your vessel.

THE DISCHARGE OF PLASTIC OR GARBAGE WITH PLASTIC INTO ANY WATERS IS <b>PROHIBITED</b> . THE DISCHARGE OF ALL GARBAGE IS <b>PROHIBITED</b> IN THE NAVIGABLE WATERS OF THE UNITED STATES AND IN ALL OTHER WATERS, WITHIN THREE NAUTICAL MILES OF THE NEAREST LAND.		
THE DISCHARGE OF DUNNAGE, LINING, AND PACKING MATERIALS THAT FLOAT IS <b>PROHIBITED</b> WITHIN 25 NAUTICAL MILES FROM THE NEAREST LAND.	OTHER UNGROUND GARBAGE MAY BE DISCHARGED BEYOND 12 NAUTICAL MILES FROM THE NEAREST LAND.	OTHER GARBAGE GRUND TO LESS THAN ONE INCH MAY BE DISCHARGED BEYOND THREE NAUTICAL MILES FROM THE NEAREST LAND.
A PERSON WHO VIOLATES THE ABOVE REQUIREMENTS IS LIABLE FOR A CIVIL PENALTY OF UP TO \$25,000, A FINE OF UP TO \$50,000, AND IMPRISONMENT FOR UP TO FIVE YEARS FOR EACH VIOLATION. REGIONAL, STATE, AND LOCAL RESTRICTIONS ON GARBAGE DISCHARGES MAY ALSO APPLY.		



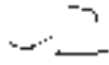

# Chapter 1

---

## COMMUNICATIONS

EPIRB

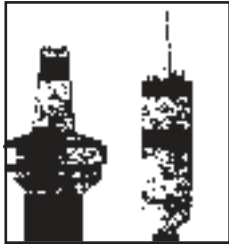

It is a good idea to carry communication gear such as a VHF-FM and/or HF transceivers set up for your operating area. Also, cell phones are useful in many coastal areas. Be sure to carry extra batteries. Also, mainly for offshore vessels, EPIRB's are designed to quickly and accurately alert rescue forces, indicate an accurate distress position, and guide units to the distress scene. These devices operate from satellite signals sent to a ground station where the signal is downloaded. The downside is that they are relatively expensive and are used less today by the recreational boater but they are reliable even when other communications have been exhausted.

## LIFE RAFTS

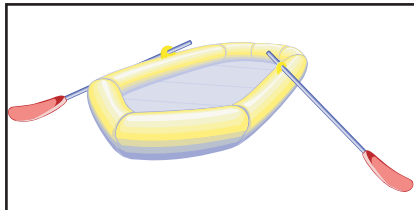

Inflatable life rafts are recommended for oceangoing and operating a vessel in a large body of water like the Great Lakes. They provide a shelter for extended periods. If used, make sure it is large enough for all aboard and contains the proper emergency equipment pack. Periodically find a professional to service the life raft. Store it on board in an area safe from sharp objects. Make sure the life raft is Coast Guard approved.

Remember the U. S. Coast Guard requirements are minimal standards. They are an excellent starting point. Check with local and state boating agencies for further required safety equipment. You are best prepared for emergencies by a well equipped vessel. Don't skimp when purchasing equipment for your boat!



# Safety On Board

---

## EXHAUST & CARBON MONOXIDE

Carbon monoxide (CO) in exhaust can be hazardous. It is important for you and your passengers to be aware of the potential safety hazard created by exhaust gases. Familiarize yourself with the symptoms of carbon monoxide poisoning.

For safety sake avoid the following:

1. Do not allow the boat to remain stationary with the engine idling for an extended period of time.
2. Do not disable the carbon monoxide alarms that come with your Regal boat. Test the unit in accordance with the alarm manufacturers instructions.
3. Do not operate the engine for extended periods of time while in a confined area or where exhaust outlets face a wall or bulkhead.
4. Do not operate the engine for an extended period of time with the canvas in the upright and installed position.
5. Have the engine exhaust system inspected when the boat is in for service.
6. Persons sleeping can easily be overcome by carbon monoxide without realizing it. Do not sleep on board while the engine is running or a neighboring boats engine is running.

 <b>WARNING</b>
AVOID SERIOUS INJURY OR DEATH FROM CO POISONING! DO NOT OPERATE THE VESSEL WITH PEOPLE HOLDING ON TO THE SWIM PLATFORM WHILE IN THE WATER.

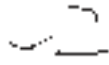

# Chapter 1

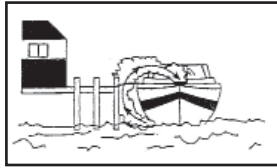

Blockage of exhaust outlets can cause carbon monoxide to accumulate in the cabin and cockpit area even when the hatches, windows, portholes and doors are open.

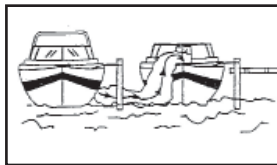

Exhaust from another vessel alongside your boat, while docked or anchored, can emit poisonous CO gas inside the cabin and cockpit areas of your boat.

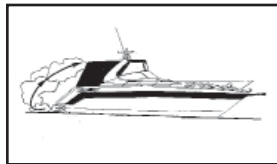

The “station wagon effect” or back drafting can cause CO gas to accumulate inside the cabin, cockpit or bridge areas when the boat is under-way, using protective weather coverings, high bow angle, improper or heavy loading, slow speeds, or when boat is at rest.

## Typical Carbon Monoxide Label At Helm

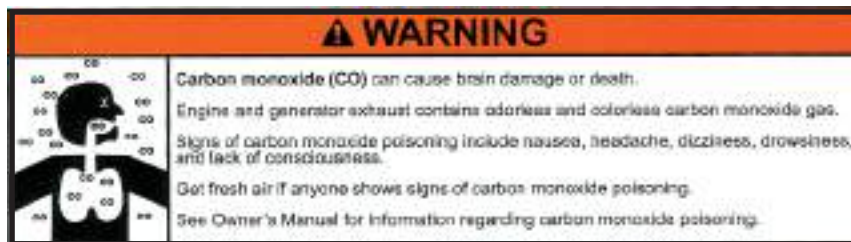

## Typical Carbon Monoxide Label At Transom

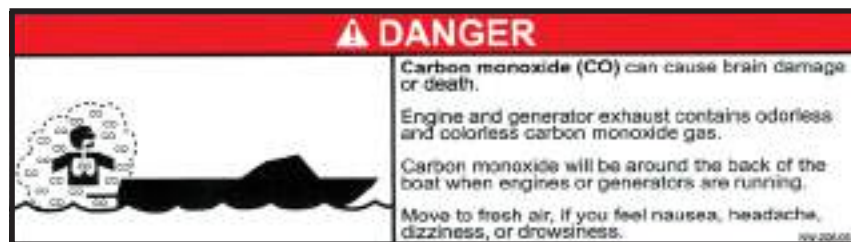





# Safety On Board

## Typical Carbon Monoxide Label In Cabin/Head

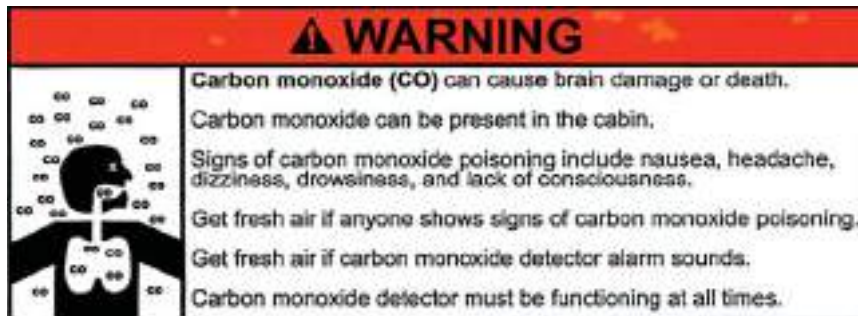

In high concentrations, CO can be fatal in minutes. However, lower concentrations over an extended period of time can be just as lethal.

Symptoms of excessive exposure to carbon monoxide are:

- Dizziness
- Drowsiness
- Nausea
- Headache
- Ringing in the ears
- Throbbing temples
- Watery, itchy eyes
- Flushed appearance
- Inattentiveness
- Incoherence
- Fatigue or vomiting
- Convulsions

Carbon monoxide accumulation requires immediate attention! Thoroughly ventilate cabin and cockpit areas. Determine the probable source of the carbon monoxide and correct the condition immediately. Regal has installed CO detectors on your boat. Have these detectors professionally calibrated at regular intervals.



DESIRED AIR FLOW  
THROUGH BOAT

To help prevent carbon monoxide accumulation, ventilate your cabin and cockpit while underway. Open a forward hatch, porthole or window to allow air to travel through the boat's interior. See the illustration below for desired air flow.

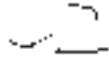

# Chapter 1

---

## Each Trip

Make sure all exhaust clamps are in place and secure.

Look for exhaust leaking from the exhaust system components, indicated by rust and or black streaking, water leaks, or corroded or cracked fittings.

Inspect all rubber exhaust hoses for burned or cracked areas. All rubber hoses should feel soft and be free of kinks.

Visually verify that water exits at the engine exhaust outlet.

Keep an ear tuned for any change in exhaust sound that could indicate an exhaust component malfunction.

**DO NOT OPERATE THE VESSEL IF ANY OF THE ABOVE ITEMS EXIST! CONTACT A MARINE PROFESSIONAL!**

At Least Annually (To be performed by a marine professional)

Replace exhaust hoses or mufflers if any evidence of cracking, charring or deterioration is found.

Replace the engine water pump impeller along with the plate and housing if necessary. This will help prevent cooling system and in turn exhaust system overheating.

Inspect each of the metallic exhaust components for cracking, rusting, leaking or looseness. Pay detailed attention to the exhaust manifold, cylinder head and water injection elbows. Make sure all exhaust clamps are in place and secure.



# Safety On Board

## BOATING UNDER THE INFLUENCE



### WARNING

FEDERAL LAWS PROHIBIT OPERATING A VESSEL UNDER THE INFLUENCE OF ALCOHOL OR DRUGS. THESE LAWS ARE VIGOROUSLY ENFORCED BY ALL LAW ENFORCEMENT AGENCIES.

Operating a vessel while intoxicated became a specific federal offense effective in 1988. The ruling set federal standards for determining when an individual is intoxicated. If the blood alcohol content (BAC) is .10% (.08 in some states) or higher for operators of recreational vessels being used only for pleasure are subject to a civil penalty up to \$1,000 or criminal penalty up to \$5,000, one year imprisonment or both. In some states the fines and imprisonment may increase significantly.

The effects of alcohol and drugs account for the highest single cause of marine accidents and deaths. Most deaths in boating accidents occur when someone falls into the water. Balance is one of the first things you lose when drinking alcohol or under the influence of drugs. The problem arises out of not knowing your balance is restricted.

Overall vision is reduced by alcohol especially at night, along with double or blurred vision. Peripheral vision is lessened which restricts seeing vessels or objects on the side. Also, color awareness decreases especially with red and green which happen to be the colors of boat navigation lights, buoys, and channel markers.

Alcohol will greatly increase your heat loss so it increases the effects of hypothermia. Finally, your ability to make correct judgements in emergency situations is greatly reduced. Alcohol takes away the brains ability to process information quickly and delays a persons reaction time. Don't drink and drive!

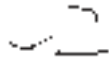

# Chapter 1

## Alcohol Myths And Facts

Myth: Beer is less intoxicating than other alcoholic beverages.

Fact: One 12 oz. can of beer has about the same amount of alcohol as a 5oz. glass of wine or a shot of liquor.

Myth: Black coffee, fresh air, and a shower will sober the effects of alcohol.

Fact: After consuming alcohol time is the only thing that will sober you up. Our bodies average burning 1 oz. of alcohol every hour. If a person is drunk, it will take about seven or more hours to sober up.

Myth: Telling if a person is too drunk to operate a vessel is easy.

Fact: Many experienced drinkers have learned to compensate for the visual effects of alcohol and can disguise their drunk condition.

Myth: You're the best person to judge if you are fit to operate a boat.

Fact: Judgement is one of the first elements you lose when drinking.

BLOOD ALCOHOL CONTENT CHART									
Body Weight In Pounds	Number of Drinks In A 2 Hour Period (12 oz. beer=5 oz. wine=1 oz. 80 proof liquor)								
100	1	2	3	4	5	6	7	8	9
120	1	2	3	4	5	6	7	8	9
140	1	2	3	4	5	6	7	8	9
160	1	2	3	4	5	6	7	8	9
180	1	2	3	4	5	6	7	8	9
200	1	2	3	4	5	6	7	8	9
220	1	2	3	4	5	6	7	8	9
240	1	2	3	4	5	6	7	8	9
BAC to .05%	--- Be Careful- Loss of Judgement & Coordination								
BAC .05% to .10%	==== Abilities Impaired- Accident Chance Increased								
BAX. Over 10%	===== Do Not Operate A Boat- High Accident Risk								



# Safety On Board

---

## BOATING ACCIDENTS

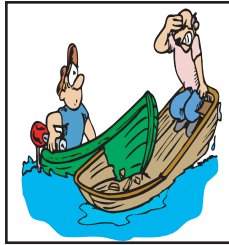

The following is a list of common causes of boating accidents. Be aware of them and take the necessary steps to ensure that your crew and yourself are educated and prepared to act in an emergency.

Mixing boating and alcohol. Remember the skipper is responsible for his boat and crew.

Trying to reach the bow by the deck walk-around while the boat is moving too fast.

Someone sitting on the bow, deck, or swim platform while underway.

Choosing a boating outing day with inclement weather, especially with high winds and thunderstorms in the forecast or staying out when bad weather is approaching..

Disembarking without checking all fluids or systems and especially fuel system components.

Not monitoring the boating traffic or possible obstructions around you.

Emergency communications equipment, signaling devices, and navigation lights not working.

Improper boat handling especially high speed turns in rough water. Improper trim.

Being too far from shore with inadequate fuel supply or navigational aids.

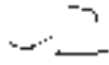

# Chapter 1

---

Passengers, especially children that are not wearing the proper life saving devices.

Skipper or passengers not seated in the boat.

Running a craft that is mechanically marginal.

## Reporting Boating Accidents

According to the Federal Boat Safety Act of 1971 involving collision, accident or other casualty, the operator must make a formal report within 48 hours to the nearest state boating authority when the incident involves:

1. Death
2. Injury requiring treatment other than first aid
3. The disappearance of someone from a boat under death or injury circumstances.

A formal report must be made within 10 days for accidents involving more than \$500 damage or complete loss of vessel.

For information regarding accident reporting, please call:

Boating Safety Hotline at 800-368-5647.

## Rendering Assistance

The operator of a vessel is obligated by law to provide assistance that can be provided safely to any individuals in dangerous situation on the waterways. The operator is subject to fine and or imprisonment for failure to do so. Move cautiously and think before acting.



# Safety On Board

---

## WATER SPORTS

Besides learning the safety precautions for safe boating, as well as understanding and knowing required rules and regulations, you are obligated to be particularly careful around other water sportsman, such as scuba divers, water skiers, wakeboarders, and fisherman.

### Skin & Scuba Divers

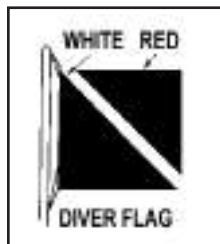

Whenever you see a “Diver Down” flag, maintain a distance of at least 100 feet on inland waters. In bays and open waters stay 300 feet away. The flag indicates a diver in the water. If a diver is operating from your boat, be certain to use this flag and post a lookout on board for a divers air bubbles. Sometimes divers stray from the flag area.

### Water Skiers & Wakeboarders

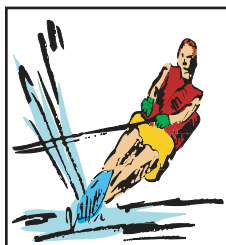

For information on water skiing and how to get started, we recommend you contact the American Water Ski Association, P. O. Box 191, Winter Haven, Florida 33880. They offer pamphlets and instructional materials. For wakeboarding information there are numerous training schools throughout the country along with instructional videos and

the internet.

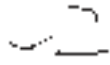

# Chapter 1

---

General safety procedures for towing skiers and wakeboarders include the following:

Know your hand signals and make sure all your passengers know them. See the illustration.

Do not allow non-swimmers to ski or wakeboard. You're asking for trouble!

Always have an observer on board whose sole job is to watch the skier/wakeboarder and communicate with the driver.

If you plan to do a lot of skiing/wakeboarding, it is advisable to have a ski pylon and driver's rear view mirror installed.

Acquaint yourself with the ski site before skiing/wakeboarding.

Follow the speed limits and all posted signs- i.e. no wake, etc.

Keep the boat away from swimmers or other people in the water.

Avoid running near the shoreline or in heavily congested areas with skier/wakeboarder in tow.

Do not allow skier/wakeboarder to spray fisherman or other parties.

Keep the engine speed steady while towing a skier/wakeboarder.

Make wide turns with skier/wakeboarder in tow.

Instruct skier/wakeboarder in case of a fall to raise his ski in the air to ensure his visibility.

Always turn your engine off when the skier/wakeboarder is near the platform or transom.





## Safety On Board

---

If the skier falls, return promptly to retrieve him, circling wide from the starboard side, to bring his rope within easy grasp. See illustration.

### Ski Tow



Insert the ski tow line as shown for safe operation. It provides a tight fastening for skiing while allowing the line to be readily removed if needed. Check your tow line for abrasion and tow ring for tightness periodically. The illustration shows a typical hookup.



## WARNING

AVOID SERIOUS INJURY OR DEATH!  
DO NOT USE SKI TOW FITTING  
FOR LIFTING OR PARASAILING.  
THE FITTING COULD PULL OUT OF THE DECK.

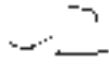

# Chapter 1

---

## Swim Platform



The boat operator shall perform periodic inspections of the swim platform hardware to ensure that all connectors and fittings are tight and free from corrosion. Also, check the laminated fiberglass under platform for fatigue and cracks.

Never run the boat with someone holding on to or standing/sitting on the platform. Use heed when operating the boat in reverse to insure that water does not accumulate excessively on the platform especially in rough seas or strong currents. Do not exceed the platform recommended maximum capacity weight as shown on your vessel's label! See photo on next page for typical label location.



# Safety On Board

---

## Swim Platform Boarding Ladder



Regarding swim/boarding ladders you need to make periodic inspections of the ladder hardware to ensure that all connectors and fittings are tight and free from corrosion.

*Ensure that the ladder is secured in place after use and the ladder cover is latched before starting engines and making headway.* Periodically check the rungs for wear. Never use silicon based sprays on the rungs as they become a fall hazard. Read and understand all labels around the ladder area. Never start the engine with people still in the water.

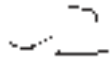

# Chapter 1

## WATER SKI & WAKE BOARD SIGNALS



FASTER



SLOWER



SKIER OK  
AFTER FALL



CAUTION OR FALLEN  
SKIER; PICK ME UP

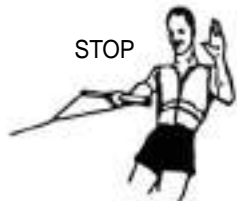

STOP

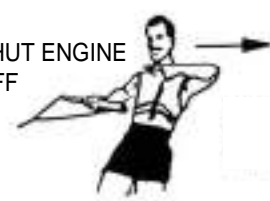

SHUT ENGINE  
OFF



RETURN TO DROP  
OFF AREA



SPEED OK

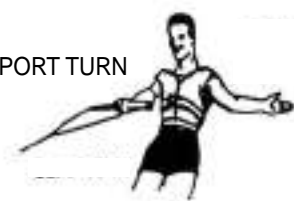

PORT TURN



STARBOARD  
TURN



## Safety On Board



### WARNING

AVOID SERIOUS INJURY OR DEATH!  
DO NOT OPERATE THE VESSEL  
WITH PEOPLE IN THE WATER OR  
HOLDING ON TO THE SWIM PLATFORM STRUCTURE  
OR HARDWARE.

### Fishing

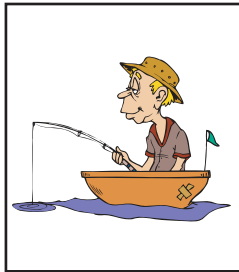

Most boaters fish from time to time. With the propulsion systems of today it is possible to fish in out-of-the-way places. When cruising, stay clear of fisherman. They may have lines or nets out which might be cut or get caught in your propeller if you come too close. Slow down when approaching fishing boats.

Do not return to cruising speed until the boats have been passed. If a fishing boat should be anchored, a large wake could flip or swamp the boat, upset fishing gear, pull the anchor loose from the bottom or worse yet cause someone to fall overboard.

When fishing from your boat, never anchor in shipping channel or tie up to any navigational aids. These must be kept clear of at all times. Be sure to carry a chart of the area and be on the lookout for shallow water and hidden obstructions. Pick up a local tidal chart if appropriate so you do not end up grounded.

Remember, the skipper is responsible for any damage caused by his wake. Use common sense and be a responsible captain!

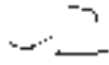

# Chapter 1

## WEATHER & WATER CONDITIONS

Before a boating outing check the weather conditions. As we all know the weather can change rapidly in many parts of the country. It does so sometimes without being predicted. NOAA weather radio reports are continuously available on designated frequencies installed on VHF radios and various handheld devices. Also, many local radio stations carry weather reports.

### Cloud Formations

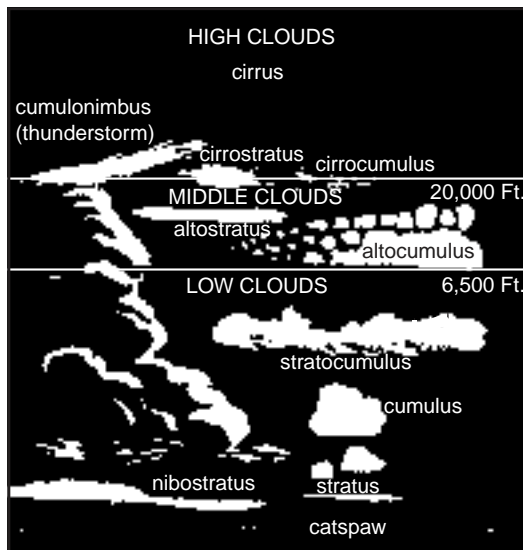

Clouds indicate the type of current weather and upcoming changes in the weather. Knowing the type of cloud formations can assist you in choosing the appropriate boating day or if already on the water will help you understand any upcoming weather changes.

Flat clouds (stratus) normally indicate stable air. Cumulus clouds indicate unstable air.

Many times a “cotton ball” or cumulus cloud builds vertical height in the afternoon and the result is a thunderstorm with increased winds and waves; sometimes these storms are quite violent. You can find additional information on weather (meteorology) at your local library.



# Safety On Board

---

## Waves & Fog



As the wind blows across water waves are created. The stronger the wind and increased distance across the water enlarges the wave action.

Other factors that can cause problem situations for vessels are fog, currents, and tidal changes.

Fog can develop inland on clear, calm mornings. Coastal areas see large “blankets” of fog roll in and stay for extended time periods causing sometimes hazardous navigation conditions. If you are

caught in the fog, do not panic. Think of the best plan of action and proceed carefully. If you are limited in navigation equipment at the first sign of fog proceed to the nearest shoreline and wait until the fog lifts.

Boats equipped with navigation equipment, local waterway experience and charts should proceed to a safe harbor. Use extreme caution, signal as needed, and reduce to a speed where you can stop within half of your forward vision range.



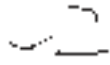

If foul weather catches you at sea do the following:

1. Slow down. Proceed with caution and put on your life vests.
2. Try to reach the nearest safe shoreline.
3. Navigate your vessel slowly into the waves at a 45 degree angle.
4. Passengers should sit low in the center of the vessel.
5. Monitor your bilge pump. Make sure sump stays free of water.
6. Secure loose gear. Make ready emergency equipment.
7. If the engine stops, throw the anchor over the bow.

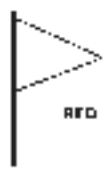
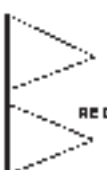

# Chapter 1

## Marine Weather Symbols

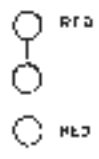
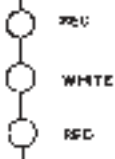
	SMALL CRAFT	GALE	STORM	HURRICANE
DAY FLAGS	 RED	 RED	 RED & BLACK	 RED & BLACK
NIGHT LIGHTS	 RED WHITE RED	 WHITE WHITE RED	 RED RED RED	 RED WHITE RED

Although the National Weather Service has discontinued the use of the day flags and night lights, many marinas and ports of call still display them.





# Safety On Board

## Federal Regulations Regarding Vessel Security

Federal maritime regulations contain specific information when operating near naval vessels, oil tankers and cruise ships.

1. You may not approach within 100 yards of any U.S. naval vessel, oil tanker, or cruise ship. When this is impossible to avoid, you must contact either the vessel or the Coast Guard escort vessel on channel 16 of the VHF radio.
2. Also, you must operate at minimum speed within 500 yards of these vessels.

**Do not approach within 100 yards of any U.S. naval vessel.** If you need to pass within 100 yards of a U.S. naval vessel in order to ensure a safe passage in accordance with the Navigation Rules, you must contact the U.S. naval vessel or the Coast Guard escort vessel on VHF-FM channel 16.

**500 Yards**

**KEEP OUT**

**OPERATE AT MINIMUM SPEED**

**You must operate at minimum speed within 500 yards of any U.S. naval vessel** and proceed as directed by the Commanding Officer or the official patrol.

**Violations of the Naval Vessel Protection Zone are a felony offense, punishable by up to 6 years in prison and/or up to \$250,000 in fines**

1-39

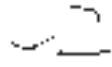

# Chapter 1

---

## Notes



# Rules Of The Road

## NAVIGATION RULES DEFINED



The Navigation Rules set forth actions to be followed by boats to avoid collision. They are referred to as the “Rules of the Road”. There are two main parts referred to as the inland and international rules. The inland rules apply to vessels operating inside the boundaries of the United States.

The international rules referred to as 72 COLREGS apply to vessels operating on the high seas and all connected waters outside the established demarcation boundaries. Most navigational charts show the demarcation lines by red dotted lines and are published in the navigation rules. Remember to consult state and local agencies since areas such as “no wake zones” , swimming beaches, “diver down flag” and inland landlocked lakes fall under their jurisdiction. This section is only an introduction to the “rules of the road”. We strongly recommend additional training before getting behind the “wheel” of your vessel.



### **WARNING**

TO AVOID INJURY AND DEATH  
FOLLOW THE NAVIGATION “RULES OF THE ROAD”  
TO PREVENT COLLISIONS..

You can order the Inland & International Navigation Rules from:  
Superintendent of Documents  
U. S. Government Printing Office  
Washington, DC 20402  
Telephone: (202-512-1800), Fax:(202-512-2250, web-site.

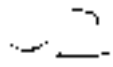

## Chapter 2

---

### NAVIGATION RULES

#### Right Of Way

1. Cross waves at right angles.
2. When caught in heavy water or squalls, head either directly into the waves or at a slight angle. Reduce speed, but maintain enough power to maneuver your boat safely.
3. Keep your speed under control. Respect the rights of other boaters engaged in all water sports. Give them a “wide berth”.
4. Whenever meeting a boat head on, keep to the right where possible.
5. When two boats cross, the boat to the right (starboard) has the right of way.
6. When overtaking or passing, the boat being passed has the right of way.

In general, boats with less maneuverability have right-of-way over more agile craft. The skipper must keep his craft clear of the following vessels:

- A vessel not under command or aground; due to their circumstances, these vessels have no maneuverability.
- A vessel restricted in its maneuverability; these vessels usually are performing work which limits their maneuverability such as surveying, dredging, laying pipe or cable, or servicing navigational markers among others.
- A vessel engaged in fishing; these include boats fishing with lines, trawls or nets, but not trolling lines.



# Rules Of The Road

- Sailboats; they have the right-of-way over power boats. However, if a sailboat is using a prop to move forward, it is considered a powerboat even if the sails are up.
- Remember the unwritten “rule of tonnage”. Basically a smaller tonnage vessel should take every effort to avoid close quarters with a larger tonnage vessel. One way to accomplish this is to have a designated human lookout to “eyeball” the horizon for any developing collision course.
- Use defensive driving skills on the waterway just as you do on the roadway. The other vessel may not know the “rules of the road” Be alert and ready to take immediate action.
- If a collision course is unavoidable neither boat has the right of way. Both boats must react to avoid an accident according to the rules of the road.

## Signals

### WHISTLE SIGNALS

ONE LONG BLAST: Warning signal  
(Coming out of slip)  
ONE SHORT BLAST: Pass on my port side  
TWO SHORT BLASTS: Pass on my starboard side  
THREE SHORT BLASTS: Engine(s) in reverse  
FOUR OR MORE BLASTS: Danger signal

### BRIDGE SIGNALS

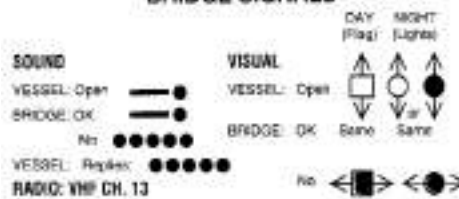

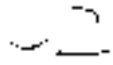

## Chapter 2

### NAVIGATION RULES

The Navigation Rules set forth 3 types of crossing situations- crossing, meeting, and overtaking. In each case, both boats are governed by special procedures.

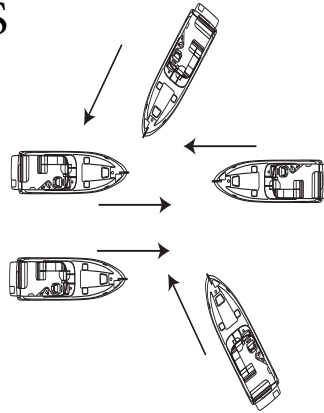

In a head-on meeting, both vessels must sound a single blast to give way toward starboard and pass to port.

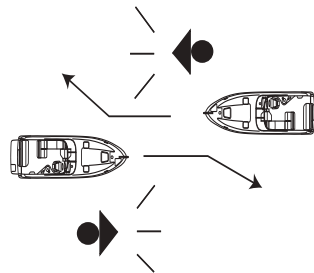

These rules appear when there is a risk of collision. In a crossing situation be aware of the other craft's position. For safety, there should be a noticeable change in the angle, bow or stern; a gradual change in position indicates possible danger.

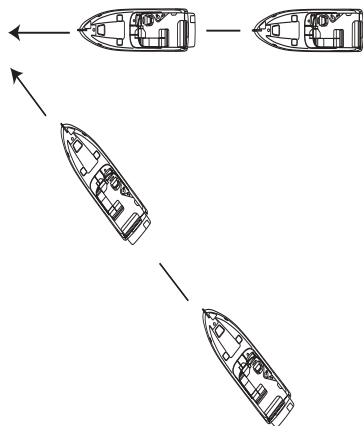



# Rules Of The Road

## NAVIGATION RULES

An overtaking boat is burdened, and is not the privileged craft, even though it approaches the danger zone of the overtaken boat.

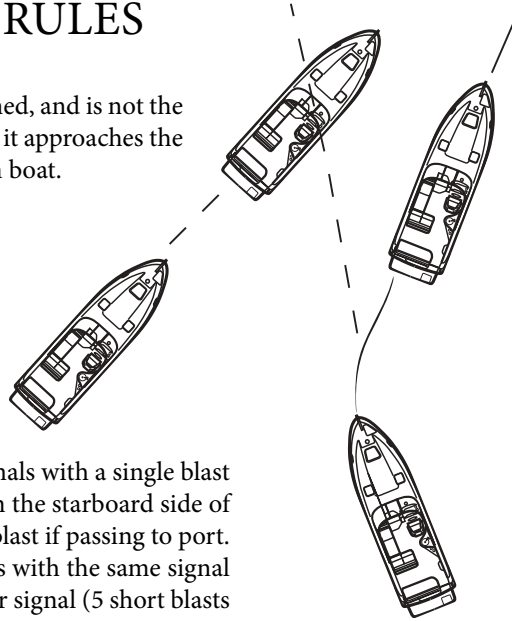

The overtaking boat first signals with a single blast if that boat desires to pass on the starboard side of the boat ahead, or a double blast if passing to port. The overtaken craft responds with the same signal if it is safe, or with the danger signal (5 short blasts or more) if unsafe. The boat overtaking must not pass unless the appropriate signals are sounded.

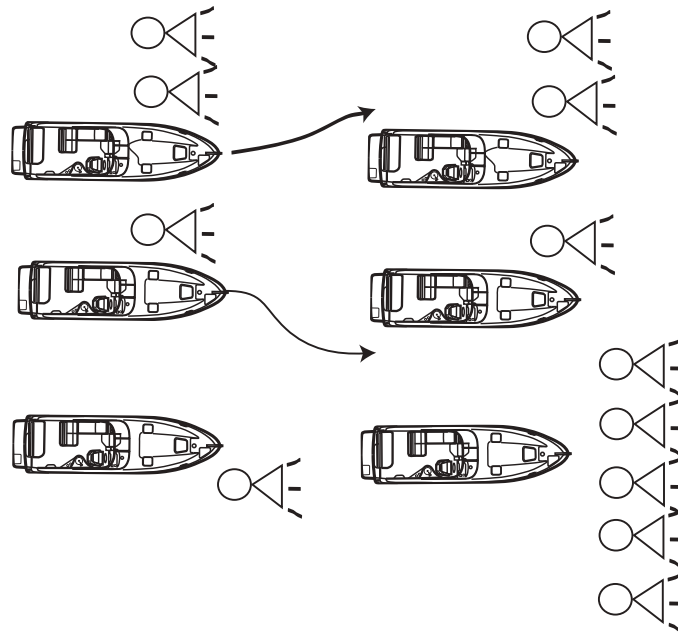

## Chapter 2

---

### NAVIGATION AIDS

Navigation aids are placed along coasts and navigable waters as a guide for mariners in determining their position in reference to land and hidden danger. Each aid provides specific information. They form a continuous system of charted markers for accurate piloting on paper and on the water.

Nautical charts are provided by the National Ocean Service (NOS) and are distributed nationwide through marinas and outlet stores. These charts show the geography of the coast, water depth, landmarks, navigation aids (buoys and markers), marine hazards, and port facilities. Use only up-to-date charts for navigation. We recommend when purchasing a chart to look for the weather resistant ones.

Buoys provide a road map to keep the skipper on course and to avoid hazards. Buoys are identified by light, shape, color and in severe weather conditions by sound.

Buoys or beacons called lateral markers indicate the port and starboard sides of the waterway to be followed. U. S markers follow the buoy system known as Red Right Returning. When returning from sea or traveling upstream, the green markers are to port (on your left) and the red markers are to the starboard side (on your right). When traveling downstream or out to sea the marker color would be reversed. The Intercoastal waterway uses a different system of lateral markers for port and starboard. Before operating your vessel, learn to identify the various navigational aids such as lateral aids, mid-channel markers, information and regulatory markers.



### **NOTICE**

SKIPPERS MUST NOT RELY ON BUOYS ALONE TO MARK  
THEIR POSITION. SEVERE WEATHER CONDITIONS  
AND WAVE ACTION CAN ALTER A BUOY'S POSITION.  
NEVER TIE UP TO A BUOY.  
IT IS ILLEGAL AND EXTREMELY DANGEROUS.





# Rules Of The Road

## LATERAL AIDS

Port Side  
Odd Numbers

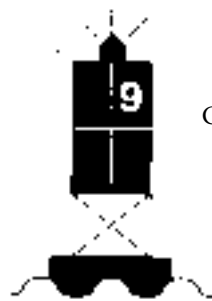
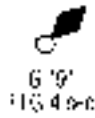

Chart Symbol



Lighted Buoy  
(Green Light Only)

Starboard Side  
Even Numbers

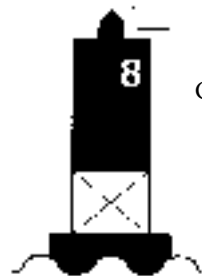
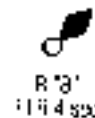

Chart Symbol



Lighted Buoy  
(Red Light Only)

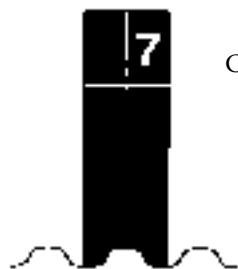

Chart Symbol



Can Buoy  
(Unlighted)



Chart Symbol



Nun Buoy  
(Unlighted)



Chart Symbol



Daymark



Chart Symbol



Daymark

# Chapter 2

## MID-CHANNEL MARKERS

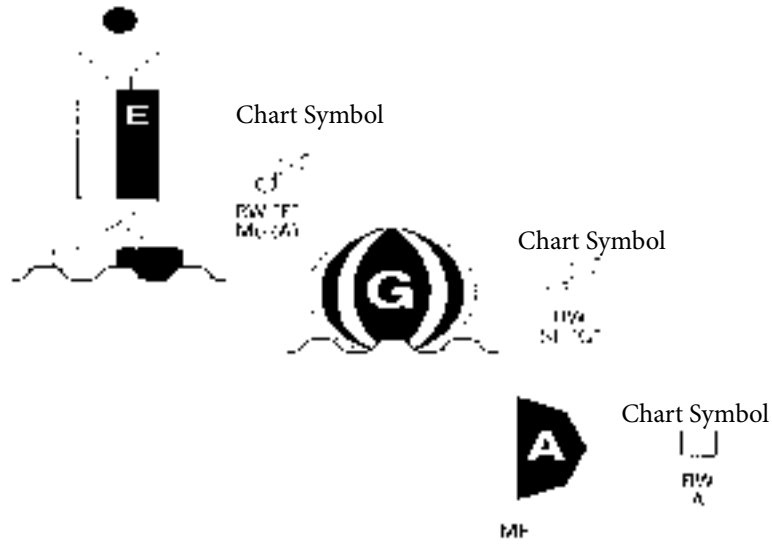

## REGULATORY MARKERS

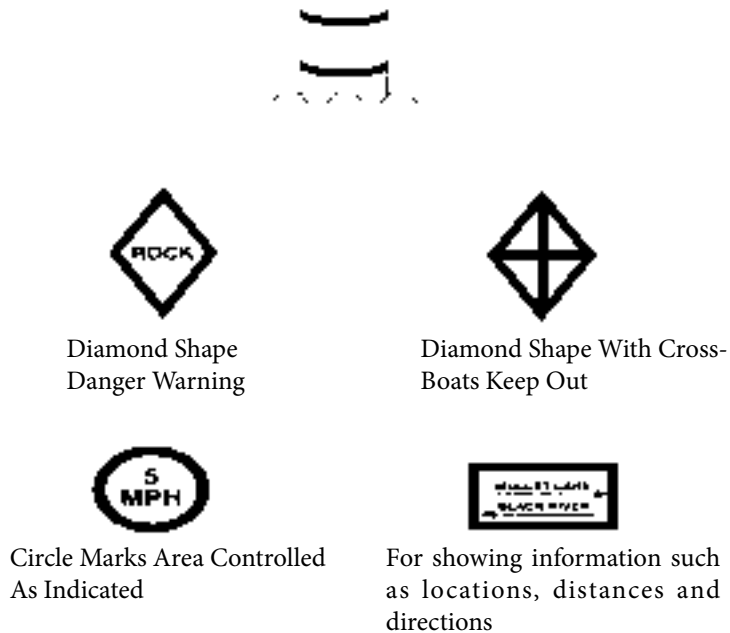



# Rules Of The Road

---

## NIGHT RUNNING

Boats operating between sunset and sunrise ( hours vary by state), or in conditions of reduced visibility, must use navigation lights. Nighttime operation, especially during bad weather and fog, can be dangerous. All Rules of the Road apply at night, but it is best to slow down and stay clear of all boats regardless of who has the right-of-way. To see more easily at night, avoid bright lights when possible. Also, it is helpful to have a passenger keep watch for other boats, water hazards and navigational aids.

To determine the size, speed and direction of other vessels at night, you should use the running lights. A green light indicates starboard side, and a red light indicates port side. Generally, if you see a green light, you have the right-of-way. If you see a red light, give way to the other vessel.

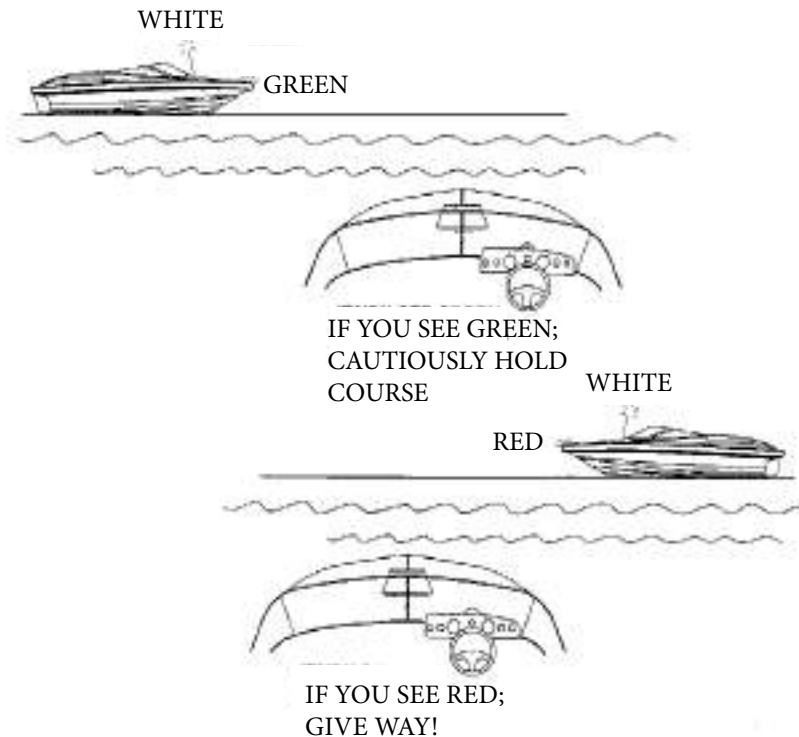

## Chapter 2

---

### BRIDGE CLEARANCE

Be aware that your vessel requires a specified bridge clearance height. This height is a measured estimate from the waterline to the top of the highest object usually the sport arch, radar or the masthead light depending on what arch equipment is installed. All canvas should be in the stored position. The estimated height can change because of variances in the loaded condition of the vessel. Consult the bridge clearance specifications located in Chapter 12 (technical information section). An easy way to measure bridge clearance is to have someone place a long straightedge such as a piece of wood at a 90 degree angle across the highest point of the boat with the boat in the water. Then with a tape rule measure the distance straight down (90 degrees) to the waterline. Take this measurement with the fuel and water tanks 1/2 full and only 1 person besides yourself on board. This will give you a safe measurement. As your boat is loaded down with people the bridge clearance will be slightly lower.

Some bridges are tendered. Know and use the proper bridge signals when approaching these bridges (see bridge signals on page 2-3). You can also monitor and communicate on channel 13 of a VHF radio for bridge information in most domestic locals. Other bridges are marked with a clearance measurement and you are on your own. After determining your vessel will clear the bridge proceed with caution at a safe idle speed. Keep your eye on vessel traffic at all times in order to react quickly. Resume a safe speed once clear of the bridge structure and acknowledgment of clear visibility.

Use common sense regarding bridge clearance because bodily injury and property damage could result if a mishap occurs with a bridge.

### BRIDGE LIGHTING

Bridge lighting is maintained by the Department of Homeland Security. On the following pages are 2 typical examples of night-time bridge lighting. As the skipper approaches bascule and fixed bridges light position (arc of visibility) and color will indicate the safe channel

2-10



# Rules Of The Road

Notice green denotes the “safe” entry location on single-span bridges and green or white on multiple-span bridges designates the main channel. In addition, green denotes the “up” position for single and double lift bridges.

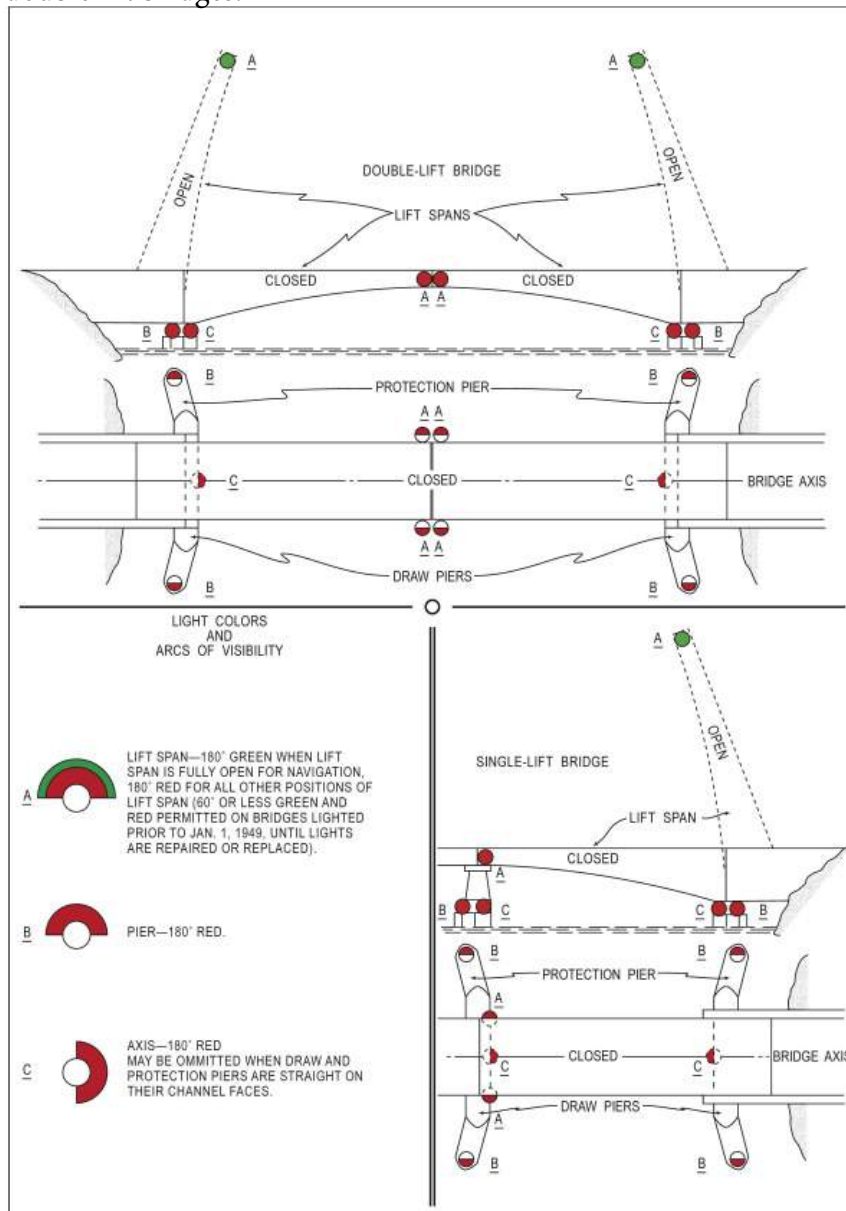

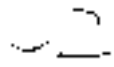

# Chapter 2

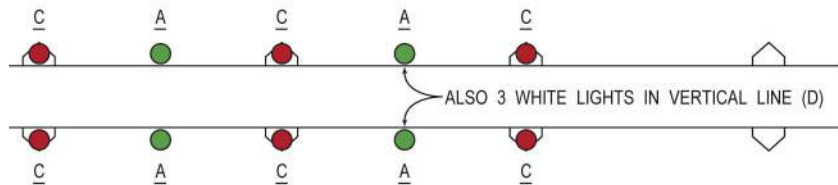
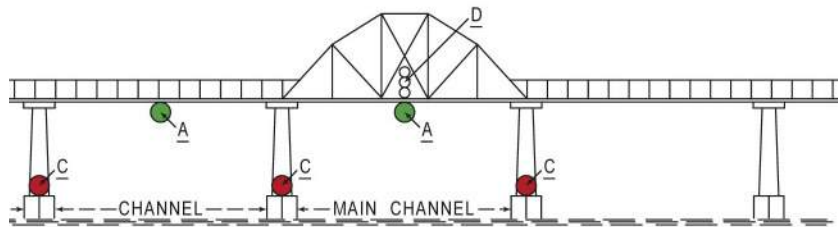
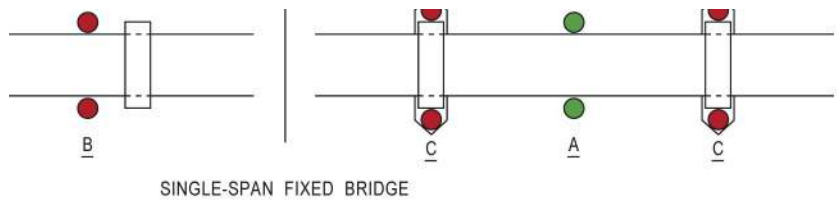

MULTIPLE-SPAN FIXED BRIDGE

### LIGHT COLORS AND HORIZONTAL ARCS OF VISIBILITY

PIER—360° GREEN (180°  
 LIGHTS LIGHTED PRIOR TO  
 1953, UNTIL LIGHTS ARE  
 REPLACED).



MAIN CHANNEL—180° RED

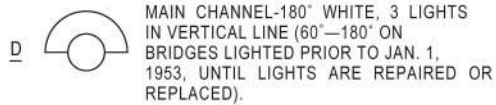



# Engine & Controls

## ENGINE BASICS

It is important that you read the engine manual carefully and become completely familiar with the operation as well as necessary maintenance on the engine and propulsion systems. Pay careful attention to the sections on winterization if you live in freezing climates. Extensive damage can result if proper winter storage is not followed. Contact your closest authorized Regal dealer for further information regarding technical issues and parts. Refer to the maintenance section of this manual for further information or contact your nearest Regal dealer.



### **WARNING**

AVOID SERIOUS INJURY OR DEATH! READ ALL MANUFACTURER'S ENGINE AND PROPULSION OWNER'S MANUALS BEFORE OPERATING YOUR CRAFT.

This chapter is intended to give general information about the location and function of a typical stern drive engine and controls. Note that select outboard (OBX) information is located at the end of this chapter. More detailed outboard information can be found in the outboard vendors engine owner's manual.

3-1

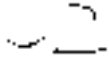

## Chapter 3

---



### **WARNING**

AVOID SERIOUS INJURY OR DEATH! USE ONLY APPROVED MARINE REPLACEMENT PARTS THAT ARE IGNITION PROTECTED IN AND AROUND THE ENGINE COMPARTMENT

Engine function is based off four principles; fuel, compression, ignition, and exhaust. The proper ratio of fuel and air must be drawn into the engine's cylinders in order to be compressed by the pistons and ignited by a spark. The force of which pushes the piston back down, providing the energy used to turn your propeller, before the engine kicks into the exhaust stage where it expels the by-products. If any of these four functions fail, so does the engine itself.

Beyond these basic concepts of engine functionality include engine cooling, lubrication, electrical, and ventilation systems. The specific details of these systems can be found in your owner's manual for the specific engine option you chose on your Regal boat. These options are limited to specific single drive Mercury and Volvo engines.

### Engine Mounts

The engine is placed in the boat on a set of metal or wooden platforms called mounts. In addition, engines use rubber insulated mounts to keep the engine from moving laterally and athwart ship (right angles to the center line), as well as reduce vibration from the engine and drive. Periodically, the mount hardware should be checked for tightness.





# Engine & Controls

---

## Engine Alignment

The engine uses a rubber spline hub to which the out drive shaft is attached. This alignment specification between the engine and out drive needs to be checked periodically. It should be checked after every 50 hours of operation, or if the vessel has run aground or hit a submerged object. Alignment should be checked by a Regal dealer or marine professional, since special tools and procedures are required.

## Engine Removal

In the event the engine or out drive (sometimes referred to as stern drive) require major service where it needs to be removed, consult your Regal dealer as they have special training on these procedures.

## Engine Checklist Before Each Outing

Every engine option may require different checks before each use, but a general engine checklist is included here as a guide.

### Engine/ Stern Drive:

Check the cooling system. Ensure there are no leaks, and that coolant level is sufficient.

Check the fuel pump for operation, and check fuel lines for leaks.

Check engine oil level.

Check power steering fluid level.

Check power trim fluid.

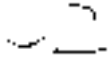

## Chapter 3

---

At Helm/ Deck

Check power trim for operation.

Check control lever for operational defects. Check the clip and safety lanyard for functionality.

Check gauges for accuracy.

Check fuel level and ensure it is sufficient for the outboard and inbound trip with a reserve.

### ENGINE COOLING SYSTEM

Your typical engine normally utilizes a raw water cooling system for cooling the engine. It is important that this system continues to run properly at all times to avoid hazardous situations and ensure a safe voyage.

Raw water is drawn up through the stern drive through pick-up feeds by the water pump. Water passes through a thermostat which controls how much cool water circulates through the engine before passing through a circulatory pump and impeller that distributes the coolant throughout the engine block. The cool water absorbs heat produced by the engine, before being emitted via a coolant exhaust system.

#### Impeller/ Water Pump

Periodically, the coolant system's impeller and pump should be inspected for debris or damage. Damaged parts will affect the system's ability to function, and may cause engine damage.



# Engine & Controls

---

## Coolant Hoses

Before each trip, the coolant system should be checked for leaks. After locating the pump housing, check the hose feeds for leaks, particularly around the hose clamps. Inspect the hoses for signs of melting or cracks, and replace as necessary.



### **WARNING**

AVOID OPENING THE FILLER CAP FOR THE COOLANT SYSTEM OR DISCONNECTING THE COOLANT SYSTEM HOSES WHILE THE ENGINE IS STILL ON / HOT. UPON LOSS OF SYSTEM PRESSURE, STEAM OR HOT COOLANT CAN SPRAY OUT OF THE SYSTEM CAUSING BURNS.

## Thermostat

If the temperature gauge starts yielding abnormal readings, it may become necessary to look at or replace the engine thermostat after determining whether it is functioning properly. The thermostat reads the temperature of coolant and determines whether to open or close a valve to allow warm sea water to pass into the exhaust manifold. The thermostat may recirculate hot coolant for the purposes of reaching standard operating temperatures. If standard operating temperatures have been reached, the thermostat will open a valve and allow hot raw water to exit through the exhaust manifold. To inspect the thermostat, locate the thermostat housing, remove the housing, thermostat, o-ring, and gasket. Inspect these components for damage, and replace as necessary. Clean the intake manifold and thermostat housing at the location of the gasket to ensure a tight fit before replacing components.

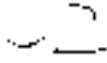

## Chapter 3

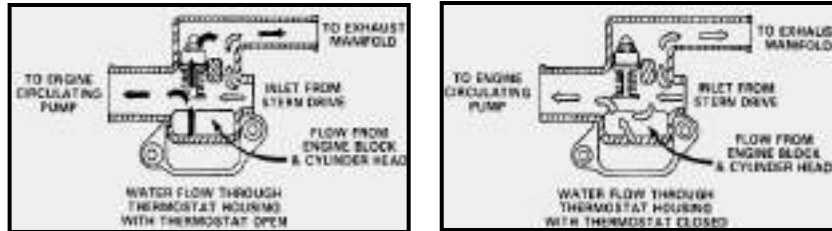

Typical Open Thermostat Diagram  
Typical Closed Thermostat Diagram

### Freshwater Flushing Port

Some engines offer a fresh water flushing system. After linking up to a fresh water hose at the flush port, water can be pumped through the engine's raw water cooling system to flush out all salt and debris that may be left behind. It is supposed to be utilized after each trip to ensure a maximum lifespan of your cooling system components. Check your engine owner's manual regarding this system's availability and use. Some manufacturers incorporate a flushing port directly into the engine's coolant hose system while others require an adapter to be inserted onto the pick up feeds on the stern drive.

## ENGINE ELECTRICAL SYSTEM

Your engine utilizes a great deal of electronic equipment. Some equipment sends signals between the engine and dash mounted instruments, while other systems set off alarms, and still others are used by the engine to generate a spark and ignite the fuel. The battery switch controls electrical power distribution to the boat systems.

To regularly maintain your DC electrical system, inspect the battery charge before each trip. Test all gauges and control equipment prior to departure, and replace as necessary. Spark plugs should



## Engine & Controls

---

be replaced according to your engine owner's manual maintenance schedule. When a fuse blows, investigate the problem, fix it, and then replace the fuse.

### Gauge Electrical Signals

Most engines transmit signals through electrical harnesses to different components. The thermostat for instance transmits an electrical signal to the dash temperature gauge which mechanically rotates the needle in the display to represent the approximate engine temperature. Faults in these electrical components should be fully inspected by your Regal dealer.

### Alarms

When a malfunction with your engine or drive occurs, select engines will sound an alarm to alert the skipper of a problem. Common engine and stern drive problems include overheating, low oil pressure, or a miscommunication with equipment. Learn the alarm systems that apply to your engine by consulting your engine owner's manual.



## **WARNING**

AVOID OPERATION OF THE ENGINE AFTER AN ALARM HAS SOUNDED. USE OF THE ENGINE WITHOUT ADDRESSING THE PROBLEM MAY RESULT IN ENGINE DAMAGE OR FAILURE.

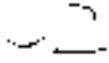

## Chapter 3

---

### Distributor

Your gasoline engine ignites the fuel by use of a spark generated at the precise moment when the fuel mixture has been fully compressed. However, your engine doesn't spark each cylinder at the same time; each cylinder requires a spark according to which stage of the engine cycle the cylinder is located. A distributor takes the electrical current generated by the starter battery and distributes the electrical potential to each cylinder in turn as needed to generate the spark.

### Spark Plugs

The spark plugs are the parts that make the spark occur. As electrical potential builds on one side of the gap based upon the energy distributed by the distributor, the potential eventually grows large enough to cause the electric current to jump the gap on the spark plug. This spark is what ignites the compressed fuel generating a controlled explosion that will power the piston down and deliver power to the drive shaft.

### Alternator

Under normal circumstances, the starter battery would wear down after being used so often to generate a spark for the engine. This isn't an ideal setup because a strong battery is needed for continual operation. A weak battery does no good out on the water. The alternator connected to a serpentine belt takes care of recharging the battery(ies). As the serpentine belt rotates the pulley, a magnet inside a coil of electric wire rotates with the pulley. The rotation of this magnet inside the coil of wire (alternator) generates a current which is the used to recharge the battery.



## Engine & Controls

---

However, in an effort to conserve battery life, the starter battery should still be turned off after every trip. This limits the drain on the battery while the boat is not in use. The alternator will only recharge the battery while the engine is running. So if the battery is drained before it can provide the initial spark to the engine to start the serpentine belt turning, the alternator cannot charge the battery system.

### Fuses

In addition, the engine comes equipped with fuses that could “blow” when engine components attempt to draw more power than the piece of equipment or wiring can handle. When the fuse blows, it breaks the circuit, and electricity stops flowing. Before replacing the fuse, investigate the cause of the problem, and why the equipment was overworked. Some engines feature a fuse box, while others feature in-line fuses, while still others feature a mixture of both. Refer to your engine owner’s manual for complete details on your electrical system.

## ENGINE EXHAUST SYSTEM

Your engine expels the by-products of the engine operation through an exhaust system, just like cars do. In boats however, this exhaust system mixes the debris left over after the power stroke of the engine with the hot water that is expelled after cooling the engine. Basically the exhaust system contains the exhaust manifolds, exhaust vent and most likely a catalytic converter. Basically the exhaust flows through the catalytic converter to purify the exhaust before expelling the exhaust through the stern drive either just above the propeller, or through the prop shaft.

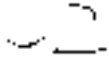

## Chapter 3

---

### Catalytic Converter

The catalytic converter is now required on modern engines. These catalytic converters sit at the top of the exhaust manifolds on either side of the engine. These boxes grow very warm and burn excess hydrocarbons emitted by the engine, resulting in cleaner emissions. These converters require oxygen to fuel the burning process of these hydrocarbons, and will often times have an upstream oxygen sensor that will adjust the fuel injection process to add more oxygen in the fuel ratio. Bottom line these converters have been implemented to provide cleaner emissions.



Typical Catalytic Converter Diagram

## ENGINE FUEL SYSTEM

All engines require a source of fuel in order to run. The fuel that an engine uses, is not only comprised of gasoline (in some cases diesel), but also air. This mixture of gas and air are combined into a ratio, best suited for your engine and boat. If this system fails, the engine will have no fuel to compress and ignite. It is important to make sure your fuel system is functioning properly.





## Engine & Controls

---



### **WARNING**

GASOLINE VAPORS CAN EXPLODE. BEFORE STARTING THE ENGINE, OPERATE BLOWER FOR 4 MINUTES AND CHECK ENGINE COMPARTMENT FOR GASOLINE LEAKS OR VAPORS. RUN BLOWER BELOW CRUISING SPEED.



### **WARNING**

USE OF ALCOHOL ENHANCED FUEL, OR ANY FUEL OTHER THAN GASOLINE, CAN LEAD TO DETERIORATION OF THE FUEL SYSTEM COMPONENTS. THIS CAN RESULT IN FIRE AND POSSIBLE EXPLOSION.

Your typical factory installed fuel system is comprised of a fuel fill fitting marked “gas”, fuel tank, fuel hoses, fuel vents, anti-siphon valve, fuel filter, fuel pumps, fuel injectors, fuel gauge, sender and canisters among other items.

You should understand the purposes of each of these components and discover their location by reading the owner’s manual.

### Fuel Fill Cap

The fuel fill is labeled with either “gas” or “diesel” and is normally located along the starboard side of the boat on the aft portion of the deck. When fueling, it is important to keep the fill nozzle in contact with the fuel fill line since it decreases static electricity, which may spark and ignite gasoline vapors. Always use the recommended fuel octane rating as specified in your engine owner’s manual. Extinguish all flame producing agents before fueling.

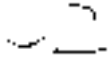

## Chapter 3

---

### Anti Siphon Valve

The anti-siphon valve at the base of the fuel feed line is pulled off its seat by fuel pump pressure as the engine is cranking or running. It forms a one-way fuel roadway by sealing off the fuel feed line from the fuel fitting. It prevents fuel from siphoning out of the tank in the event of a fuel line rupture, or disconnected fuel feed hose. It is an important safety item, so DO NOT remove the anti-siphon valve.

### Fuel Vent

Fuel vents are often combined into the fuel fitting on the deck. Fuel tanks are vented overboard for the fumes to escape. While the tank is filled with fuel, air is displaced by the incoming fuel, and relieved through the fuel vent hose. When the fuel tank is near full, slow down or stop the nozzle flow to keep the fuel from splashing out the vent.

### Fuel Hoses

Fuel hoses transport gasoline from one component to another. These hoses are required to be of certain diameters in order to comply with engineering and environmental standards. Hose clamps are often used to seal the hose to a fitting, and these connections should be checked regularly along with the entire system at least yearly.

### Fuel Pumps/ Filter

From the fuel tank, gasoline is moved from the tank to the engine by the pressure produced by fuel pumps. One fuel pump is used to move fuel from the fuel tank to the fuel filter, while a second pump will pump filtered fuel to each cylinder in the engine block. The filter normally located right next to the fuel pumps is meant to



## Engine & Controls

---

take out some small debris as well as small amounts of water. Fuel filters are not able to remove large amounts of water. If the fuel becomes contaminated with water, the fuel must be run through a fuel polisher available at select marinas to remove large amounts of water.

### Fuel Injectors

After the fuel has passed through the fuel pumps and filter, it is ready to be injected into the engine. Because boat engines run off four strokes (intake, compression, spark, exhaust), fuel must be delivered to the appropriate cylinders at the appropriate time for optimal engine performance. This action is performed by fuel injectors that inject an air and fuel mixture into the engine cylinders.

### Fuel Sender & Gauge

A fuel sender on the fuel gauge uses a dipstick/float system to measure the amount of fuel left in the tank. This measurement generates a specific resistance value in an electronic circuit connected to the fuel gauge at the helm. As different fuel levels are reached, the resistance value in the circuit with the fuel gauge changes which is read by the fuel gauge and is converted to an approximate fuel level.

### Fuel Tank

The fuel tank should be inspected before each cruise. This should be done when you check the fuel lines for tightness and leaks. Your Regal boat uses an aluminum or polyester fuel tank that has been tested several times along with other fuel system components for safety requirements and dependability in house, and they are inspected independently by National Marine Manufacturers Association personnel.

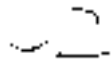

## Chapter 3

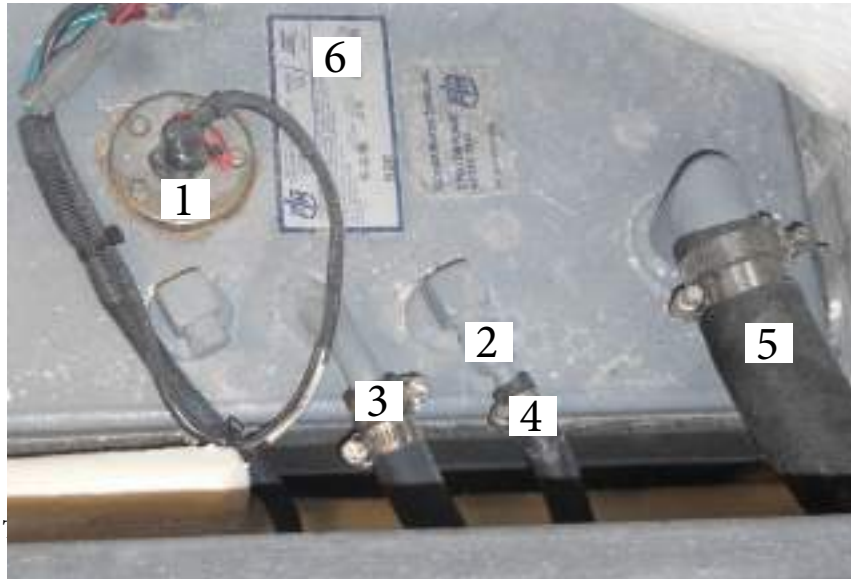

- |                      |                    |
|----------------------|--------------------|
| 1) Fuel Sender       | 4) Fuel Feed Line  |
| 2) Anti Siphon Valve | 5) Fuel Fill Line  |
| 3) Fuel Vent Line    | 6) Fuel Tank Label |

Typical Domestic Fuel Tank



### **WARNING**

GASOLINE VAPORS CAN EXPLODE CAUSING BODILY INJURY OR DEATH! INSPECT SYSTEM FOR LEAKS BEFORE EACH OUTING. BEFORE STARTING ENGINE OPEN ENGINE HATCH. PERFORM A VISUAL AND SNIFF TEST FOR LEAKS. EXAMINE ENTIRE FUEL SYSTEM FOR LEAKS AND CORROSION AT LEAST ANNUALLY.



# Engine & Controls

---

## ENGINE LUBRICATION SYSTEM

Whenever two components rub together, friction causes wear on both components. To minimize the wear on your engine, a lubrication system has been put in place to help components slide next to each other easier. This is particularly important within the inner workings of an engine. It is important to ensure your lubrication system is working properly at all times.

Your Regal utilizes lubrication and fluids that need regular check ups. These engine fluids are engine oil and power steering fluid. Refer to your engine owner's manual for specific details regarding the proper maintenance procedure of your lubrication system. The pictures displayed in this section may represent a different engine model than the one equipped on your Regal boat. All pictures and procedures in this section are meant to be used as a guide, and should not take priority over the proper engine owner's manual.

### Engine Oil

The purpose of engine oil is to lubricate the cylinders of the engine and ensure that parts that regularly move against each other have reduced friction to reduce wear and noise between components. An oil filter keeps metal particles and water out of the engine's interior.

Engines performing on regular oil should have the oil drained and replaced every 100 hours while synthetic oil typically should be drained and replaced every 200 hours. In either case, if your Regal boat has endured one year since its last oil change, the oil should be changed again. The oil filter should be replaced every time the oil is changed, or upon damage. It is normal for the first 50 hours of operation to require frequent changes until the engine is seasoned.

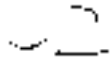

## Chapter 3

---



Typical Volvo Engine Oil Dipstick And Fill  
Typical Mercury Engine Oil Dipstick

### Power Steering Fluid

Power steering fluid should be checked before every trip. It shouldn't require changing unless contaminated with debris or water, in which case a root cause must be investigated. Contact your Regal dealer.



Typical Volvo Power Steering Fluid Fill  
Typical Mercury Power Steering Fluid Fill



# Engine & Controls

---

## Other Component Lubrication

System components may also require their own lubrication schedule. Steering systems, throttle cable, shift cable, stern drive u-joint splines and o-rings, and the engine coupler may require grease, oil, or other lubrication. Refer to your engine owner's manual for specific details.

## ENGINE VENTILATION

Ventilation systems are required for all engine compartments. Your vessel features a set of deck vents located in proximity to the sun pad seat which constantly supply fresh air to the engine compartment. A powered blower motor attached to duct work in the lower one third of the bilge (4" black hoses) evacuates air to the atmosphere. The other vents are used to take air into the engine/engine compartment. Read and understand the following warning!

	<b>WARNING</b>
<p>GASOLINE VAPORS CAN EXPLODE. BEFORE STARTING THE ENGINE, OPERATE THE BLOWER FOR 4 MINUTES AND CHECK THE ENGINE COMPARTMENT FOR GASOLINE LEAKS OR VAPORS. ALWAYS RUN BLOWER BELOW CRUISING SPEEDS.</p>	

All owners are responsible for keeping their boat's ventilation system operating properly. This means making sure the vent openings are obstruction free, ducts are not blocked, blower operates properly, and all worn parts are replaced with approved marine ignition protected components.

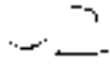

## Chapter 3

---

### STERN DRIVE BASICS

Inboard/outboard drives, or stern drives, make it easier to control your boat. Your Regal comes standard with either a Mercury or Volvo stern drive. This drive is what converts the power produced by the engine into the force required to spin a propeller. It is important that you read the stern drive manual carefully and become familiar with the operation as well as necessary maintenance on the drive unit components. Pay careful attention to the section on winterization if you live in freezing climates. Extensive damage can result if proper winter storage is not followed.

#### Stern Drive Mounts

The stern drive attaches to your vessel via the transom assembly. It is through this assembly that the engine passes its energy to the stern drive to spin the propeller. These mounts should be inspected by a marine professional periodically.

#### Stern Drive Alignment

Your stern drive unit connects to the engine coupler by use of the drive shaft. The splines on the drive shaft are inserted into the engine coupler, allowing energy to be transferred to the drive. This alignment should be inspected periodically or after running aground.

#### Stern Drive Removal

The stern drive should only be removed by a professional. The stern drive should be removed or inspected after failure, in particular, after water enters the power trim fluid or bellows. It is best to leave stern drive removal to a marine professional or your Regal dealer.





# Engine & Controls

---

## STERN DRIVE MECHANICS

The engine transmits rotational energy to the drive shaft at the engine coupler. Once engine output energy is transferred to the drive shaft, it undergoes a ratio change determined by the gear case. This converts the revolutions of your engine to applicable rotations of the propeller. From here, the propeller shaft turns in accordance with the energy ratio determined by the gear case, and rotates the propeller shaft. Your drive hub and other prop hardware keeps the propeller in contact with the prop shaft allowing the propeller to spin without coming off the shaft.

The stern drive uses water pickup feeds normally found on the port and starboard face of the stern drive. These holes allow raw water to be drawn up into the stern drive and pass through the transom to the engine where it can be used as coolant. Used water as regulated by the thermostat is transferred back to the stern drive and emitted at a vent above the propeller, or through the prop shaft, depending on the engine and drive manufacturer. Refer to your stern drive owner's manual for details on the location and operation of the components.

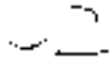

## Chapter 3

---

### STERN DRIVE LUBRICATION

The stern drive uses power trim fluid, drive oil, and propshaft lubricants to reduce wear on moving components. These fluids should be checked according to the recommended maintenance procedures determined by the stern drive manufacturer.

#### Drive Oil

Drive oil keeps all the mechanical components in the stern drive functioning optimally. It reduces friction in the stern drive. Sometimes drive oil is called gear lubricant, as the oil essentially lubricates the gears inside the gear box. Drive oil should be inspected with each trip. The location of the drive oil may change based on your manufacturer, as some chose to mount the fill on the stern drive, while others chose to mount it separately in the engine compartment or on the engine.



Typical Volvo Drive Oil Dipstick



Typical Mercury Gear Lube Fill



## Engine & Controls

---

### Power Trim Fluid

Power trim fluid allows your stern drive to angle up or down. This is particularly useful when trying to get your boat to plane where the hull is as much out of the water as physically possible, reducing friction, and improving ride performance. This power trim fluid is used in hydraulic rams that maneuver the stern drive unit, and shouldn't need to be replaced very often, if at all.

Power trim fluid should be checked regularly, despite not requiring replacement unless something serious happens. Discoloration or water presence indicates a water leak in the stern drive. In that case, contact your Regal dealer.



Typical Volvo Power Trim Housing (Power Trim Fill Underneath)

Typical Mercury Power Trim Fill

### Shaft Lubricant

Drive and prop shaft lubricant keeps the turning parts on the prop shaft from wearing out too quickly. It also assists in the removal of the props by preventing the metal parts from binding. Lubricant should be placed on the u-joint and spline shaft, along with an anti-corrosive grease to ensure continued functionality. Consider having the shafts serviced periodically to ensure proper lubrication at the engine coupler and propeller.

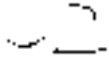

## Chapter 3

---

### PROPELLERS

Regal has carefully tested and chosen the propellers to give your stern drive boat the best possible performance based on the engine and propulsion package you choose. We have allowed for the additional weight in equipment that might be added to the boat. It is a good idea to carry a spare set of propellers and hand tools onboard, in order to handle emergency propeller changes. Refer to the sterndrive manual for procedures, as the application is unique to the manufacturer. Call a marine professional or your Regal dealer for further information.

#### Propulsion Checklist

At least twice a year, check the propeller for:

- Loose, missing, or corroded hardware.
- Nicks, dings, or missing propeller material
- Bent propeller blades.
- Objects wrapped around the prop such as fish line.
- Decomposing propeller blades (electrolysis symptom).
- Aluminum prop with paint coming off near blade tip (ventilation symptom).
- Check the propeller rubber hub for slippage

Contact a propeller shop or your closest Regal dealer if any of the above symptoms exist. They have purchased special equipment to refurbish both stainless steel and aluminum propellers.



# Engine & Controls

---

## INSTRUMENTATION

The helm station is equipped with a complete set of instruments that allows you to monitor the condition of the engine. Close observation of the gauges may save the engine from damage. Gauges do however have some inaccuracy, so do not rely upon them fully.

The dash ignition panel is protected by a main 20 amp ignition breaker located next to the key switch on the panel. It is connected through the ignition switch. Your dash instrumentation (gauges, displays, etc.) are protected by a 10 amp fuse underneath the dash. Should this fuse “blow”, investigate the cause before replacing it. Also located on your ignition panel is a 12 volt accessory plug that fits many portable electronic chargers meant for a cigarette plug.

Note that with the battery switch in the “off” position, there is no power to the dashboard, and the ignition switch will not function properly.

All electrical features are protected by a 50 amp main breaker mounted close to the battery switch. A fuse for the stereo memory and the automatic bilge pump system are also located next to the battery switch in the engine compartment. Fuses for the engine may be located either in-line, between components, or in a fuse box. A separate 40 amp breaker protects the optional stereo performance package and is located next to the battery switch. All the switches on the dashboard also have a fuse, located in the forward starboard storage area directly in front of the helm. Should a fuse “blow” it is first necessary to figure out the reason and address the cause.

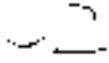

## Chapter 3

---

### Depth Gauge

The depth gauge indicates the water depth under the keel of the boat. It features a shallow water alarm to warn the skipper of hazardous situations. By monitoring the water depth, damage to props, and underwater hardware can be avoided. This gauge is connected to a transducer on the bottom of the hull, accessible through a removable plate in the ski locker. Refer to the equipment operation chapter for details on gauge settings/operation.



Typical Depth Gauge

### Multi Gauge (Fuel, Volt, Oil, Temp)

There may be a multi gauge on the dash which consists of four engine system measurement gauges.

The fuel gauge indicates the level of fuel inside the fuel tank sent by the fuel sender. It is a good idea to keep the fuel tanks “topped off” when possible to reduce fuel vapors inside the tank. Do not run your fuel gauge to low and allow for a “safety” factor.

The gauge in the upper right location is the volt meter. It monitors the battery condition as well as the alternator performance. Normal voltage is between 12.0 and 15.0 volts. Readings outside this range may indicate a charging system problem. Operation of a boat with low battery may lead to a hazardous situation.



## Engine & Controls

---

The gauge in the lower left location is the oil pressure gauge. It indicates the pressure of the oil inside the engine lubrication system. A drop in oil pressure may indicate a low oil situation or leak. Operation of the engines with low oil pressure could lead to engine damage.

The gauge in the lower right location is the temperature gauge. It monitors the cooling system's effect on the engine as registered by the thermostat. A sudden increase in the temperature could be a sign of a malfunctioning cooling system. Continued operation of the engines without a proper cooling system could lead to engine damage.



Typical Multi Gauge

### Speedometer

The speedometer indicates the approximate speed of travel of your boat in miles per hour and kilometers per hour by measuring water pressure against a small hole in a device mounted on the transom or stern drive. Obey all posted speed limit signs and slow down near other boaters and swimmers to a safe speed. Remember, you are responsible for the wake produced by your boat.

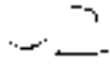

## Chapter 3

---



Typical Speedometer

### Tachometer

The tachometer indicates the approximate speed of the engine in revolutions per minute. The tachometer allows you to monitor the engine speed so you can be sure not to exceed the recommended limits described in your engine owner's manual. Some tachometers feature an hour meter, which is useful to time your maintenance needs. Remember that anytime the ignition switch is in the on position the tachometer is adding hours or parts of hours to the hour meter. Bottom line is you should only have the ignition key in the on position when the engine is running.



Typical Tachometer





## Engine & Controls

---

### Trim Gauge

This gauge measures the stern drive tilt and indicates the relative position of the bow, up or down when the boat is on plane. The power trim normally begins in the down position when used to accelerate the boat onto a plane position. The gauge can be helpful in achieving the most economical running plane. A sensor in the stern drive communicates with the gauge on the dash.



Typical Trim Gauge

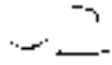

## Chapter 3

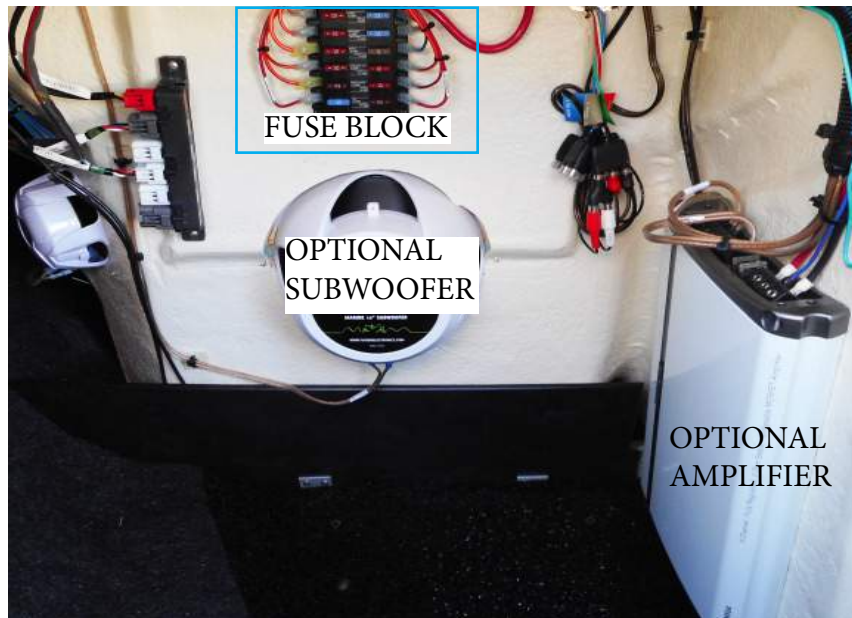

VIEW FROM STBD. BACKREST (DASH ELECTRIC /ELECTRONICS)

When you lift the starboard backrest up you will see the fuse block which controls many of the 12 volt standard and optional equipment components. These 12 volt fuses are available at most marine stores, big box stores and automobile parts outlets. We encourage you to carry extra fuses on board. If a fuse “blows” figure out what caused the malfunction. At this point you should replace the blown fuse with the same type and amperage. Using the improper type or amperage fuse could cause a fire! Also, note that there is a variety of other electronics in this area so use common sense when storing items in this compartment.



## Engine & Controls



Instrumentation

Feature Switch Panel

Accessory Switch Panel

Ignition Switch Panel

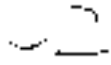

## Chapter 3

---

### HELM CONTROLS

It is important that the skipper fully understands all control equipment located at the helm before operating the boat.

Each gauge is designed with a light source so it can be seen at night. On most models, this is normally activated by the navigation lights. Dash relay circuits are protected by a fuses located on the dash fuse panel located in the fuse panel behind the starboard backrest panel.

#### Feature Switch Panel

This switch panel controls the featured systems on your Regal boat. It may feature a horn switch, bilge blower switch, navigation light/anchor light switch, and a manual bilge pump switch depending on options. A red light shows activation on individual switches.



#### Accessory Switch Panel

The accessory switch panel activates optional docking and cockpit lights along with aftermarket accessories. Cockpit lights are placed at the bow and transom walk-thru. When activated a red icon shows activation on individual switches.



## Engine & Controls

---



### Steering Wheel

Your Regal utilizes a power steering system controlled by a steering wheel. While in forward gear, to turn your bow to starboard, rotate the steering wheel clockwise to starboard from the straight position. To turn to port while moving forward, simply rotate the steering wheel counter-clockwise. In reverse, rotation of the wheel achieves the same effect, only it controls the stern of the boat. A lever on the bottom locks/unlocks the steering wheel tilt which can be manipulated for maximum comfort while boating.

### Ignition Panel

The ignition switch may feature four positions; off, run, start, and auxiliary (Aux.). Typical is three positions. The start position is spring loaded and the key should be held in this position to engage the starter. Once the engine has started, release the key from the start position. It will then be energized in the run position. Be a smart skipper and remove the ignition key from the ignition switch, especially with children aboard and when there are persons in the water.

The ignition switch auxiliary position is used when the engine is "off". With the key in the far left auxiliary position, the stereo can be activated without sending current through the engine wiring circuit. It supplies power only to the stereo unit.

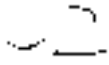

## Chapter 3



Typical Ignition Switch (Note that only select key switches feature the auxiliary position).

Typical Ignition Panel

- |                     |                           |
|---------------------|---------------------------|
| 1) Ignition Switch  | 3) 12 Volt Accessory Plug |
| 2) Ignition Breaker | 4) Blower Warning Label   |

Your ignition panel may feature a 20 amp ignition breaker that protects the dash instrumentation. Should this breaker pop, investigate the cause before resetting it.

## NOTICE

TO AVOID DRAINING THE BATTERY, DO NOT LEAVE IGNITION KEY  
IN THE “RUN” POSITION WITH THE ENGINE NOT RUNNING  
FOR EXTENDED PERIODS.  
REMOVE THE KEYS FROM THE IGNITION SWITCH!



# Engine & Controls

## Control

Your vessel uses a single side-mount control to operate the stern drive on your Regal. The three positions the remote control lever can shift into are forward, reverse, and neutral (straight up).

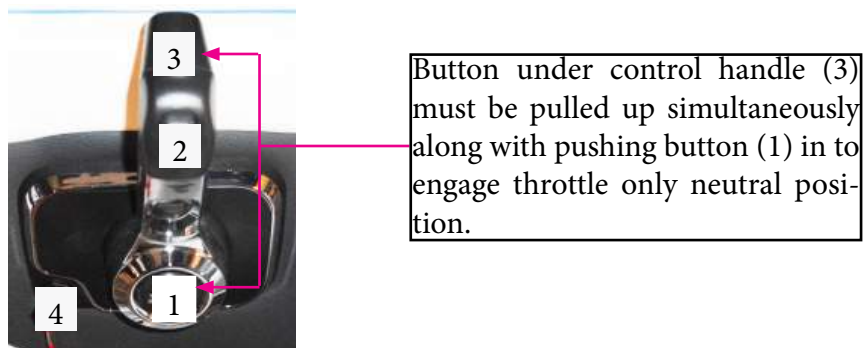

Typical Control Lever In Neutral Position

- 1) Neutral Release Buttons
- 2) Trim Control Switch
- 3) Control Lever
- 4) Safety Lanyard

To help visualize the operating principles, we have used a clock mode on the next page. The lever in the straight up position is indented in the neutral position. In order to start the engine, your control lever must be in the 12 o'clock neutral position.

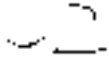

## Chapter 3

---

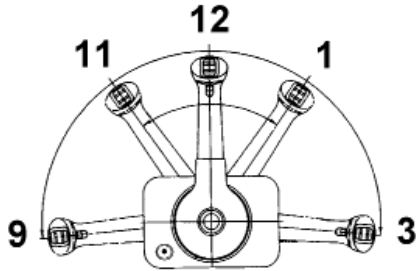

Typical Control Lever Showing Five Positions

Pushing the throttle control lever forward from the neutral 12 o'clock position to the 11 o'clock position will engage forward gear with minimal throttle. From the 11 o'clock position to the 9 o'clock position, the vessel is in forward gear with differing levels of throttle selections.

Pulling the throttle control lever back from the neutral 12 o'clock position to the 1 o'clock position will engage the reverse gear with minimal throttle. From the 1 o'clock position to the 3 o'clock position, the vessel is in reverse gear with differing levels of throttle selections.

As you shift from neutral to forward or reverse, push the neutral release button, this allows the control lever to come out of the indented position.

The control lever features a neutral safety switch which ensures the stern drive and control are in the indented neutral position for starting the engine. You will hear a distinct sound and will feel the remote control's rotation lock, once in the proper position. If you turn the key to the start position and the engine starter doesn't crank the engine, ensure the control lever is in the neutral position. Your control lever also features a trim control switch. This switch allows the captain to set the trim for the drive from the helm either up or down to achieve a plane position. Refer to the vessel operations chapter for further information on trim angle.





## Engine & Controls

---

Follow these points when shifting:

DO NOT shift quickly from forward to reverse gear positions as drive system damage may occur.

DO NOT “pump” the throttle in neutral or flooding will result just as will happen if you pump the automobile accelerator pedal. Today’s engines use an enrichment valve system that requires very little starting throttle.

DO NOT try to shift into forward or reverse gear at high rpm’s. Personal injury, drive system, or property damage may result.

Only use idle throttle positions when docking or maneuvering in tight quarters.

Wear your safety lanyard at all times.

Never shift the controls with the engine not running. Control, linkage, and/or stern drive damage may occur.

For more information, read and understand your engine manufacturer’s manual before operating remote control.

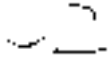

## Chapter 3

### Safety Lanyard (Interrupter Switch)

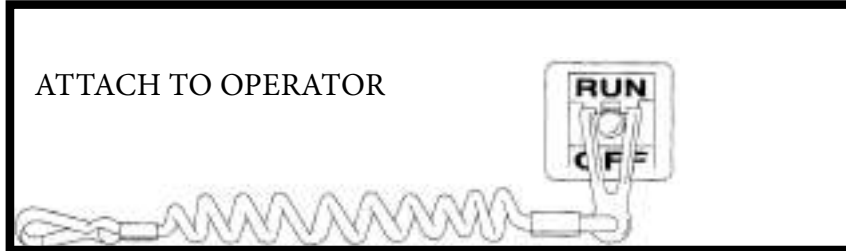

The safety lanyard (used on selected control levers) sometimes called an interrupter switch is attached to the operator and the remote control panel. Should the operator lose control of the vessel and become dislodged from his/her seat or fall overboard, the lanyard will shut the engine off.

Make sure the lanyard is fastened to a clothing part such as a belt before operating the vessel. Flip the switch to the run position before starting the engine.



### WARNING

IF THE INTERRUPTER SWITCH IS IN THE “OFF” POSITION, THE ENGINE WILL CRANK OVER BUT WILL NOT START. ENSURE THE SAFETY LANYARD IS ATTACHED CORRECTLY AND SWITCHED TO THE “RUN” POSITION.



### NOTICE

INTERRUPTER SWITCH MUST BE ATTACHED TO THE OPERATOR WHILE THE ENGINE IS RUNNING. A QUALIFIED OPERATOR MUST BE IN CONTROL AT ALL TIMES. READ THE OWNER’S MANUAL BEFORE USE.



# Engine & Controls

---

## STEERING

Your Regal stern drive uses a rack style steering system. These systems transfer helm mechanical motion to the engine. There is a hydraulic steering cylinder which with the assistance of a steering pump sends fluid force to the stern drive steering arm, changing the course of the boat, depending on the direction the steering wheel is turned. Since the steering system is the primary link for engine control, it must be periodically inspected and maintained. The hardware at both the helm and engine must be checked regularly for tightness and lubrication. Check the steering system for full steering to port and starboard before disembarking. Refer to the steering manufacturer's owner's manual for more information.



### **WARNING**

AVOID PERSONAL INJURY AND PROPERTY DAMAGE! LOOSENING OR LOSS OF ONE OR MORE FASTENERS MAY CAUSE FAILURE OF THE STEERING SYSTEM, OR DAMAGE TO THE STEERING CABLE, RESULTING IN LOSS OF STEERING CONTROL. PERIODICALLY INSPECT THE STEERING SYSTEM.



### **WARNING**

AVOID PERSONAL INJURY AND PROPERTY DAMAGE! ABRUPT TURNS ABOVE 30 MPH MAY RESULT IN LOSS OF CONTROL. STEERING RESPONSE AT HIGH SPEEDS CAN BE VERY SUDDEN. ABRUPT TURNS MAY CAUSE YOU TO CROSS OVER YOUR OWN WAKE. JUMPING A WAKE, SUDDEN TURNS, AND INCREASES OR DECREASES IN SPEED MAY PROVE DANGEROUS. THE OPERATOR MUST MAKE SURE THAT ALL PASSENGERS ARE SEATED SECURELY BEFORE MAKING SPEED OR DIRECTIONAL CHANGES.

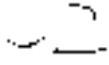

## Chapter 3

---

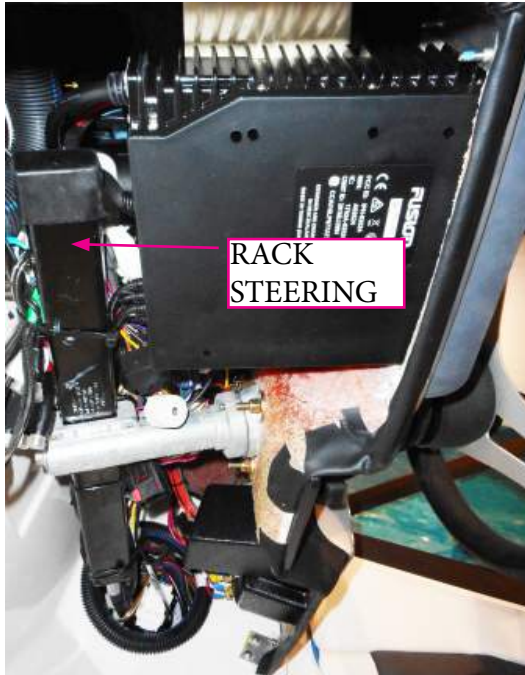

Typical Rack Steering-Under Dash View



# 21 OBX Engine & Controls

## OUTBOARD ENGINE BASICS

*Besides this manual it is important that you read the manufacturer's outboard engine manual carefully and become completely familiar with the operation as well as necessary maintenance on the engine and propulsion systems.*



Pay careful attention to the sections on winterization if you live in freezing climates. Extensive damage can result if proper winter storage is not followed. Contact your Regal dealer for information regarding technical issues and parts. Refer to the maintenance section of your outboard owner's manual for detailed information.



### **WARNING**

AVOID SERIOUS INJURY OR DEATH! READ ALL  
MANUFACTURER'S ENGINE AND PROPULSION  
OWNER'S MANUALS BEFORE OPERATING YOUR VESSELS.

This chapter is intended to provide *general information* about the location and function of a typical engine and controls. Control systems and engines may vary from model to model. Refer to the specific outboard engine owner's manual for your vessel that would include the following information in greater detail along with technical specifications and engine maintenance schedules.

1-39

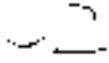

## Chapter 3

---

Engines function is based from four principles; fuel, compression, ignition, and exhaust. The proper ratio of fuel and air must be drawn into the engine's cylinders in order to be compressed by the pistons and ignited by a spark the force of which pushes the piston back down, providing the energy used to turn your propeller, before the engine kicks into the exhaust stage where it expels the by-products. If any of these four functions fail, so does the engine itself.

Beyond these basic concepts of engine functionality include engine cooling, lubrication, and electrical systems. The specific details of these systems can be found in your owner's manual for the specific engine option you chose on your Regal boat.

### Engine Removal

In the event the outboard engine needs to be removed from the vessel consult your Regal dealer. He has the factory trained knowledge and equipment to remove the engine safely and efficiently.

### Engine Checklist Before Each Outing

Every engine option may require different checks before each use, but a general engine checklist is included here as a guide.

- Check crankcase engine and gear case oil levels.
- If installed, check power steering fluid level at the pump.
- Check power trim fluid.

#### At Helm/ Deck

- Check power trim for operation.
- Check control lever for operational defects.

1-40



# Engine & Controls

---

- Check the clip and safety lanyard for functionality.
- Check gauges for accuracy.
- Check fuel level and ensure it is sufficient for the outboard and inbound trip with a reserve.

## ENGINE COOLING SYSTEM

Your typical engine normally utilizes a raw water system for cooling the engine with intakes at the gear case. It is important that this system continues to run unobstructed at all times to avoid hazardous situations and to ensure a safe voyage.

Raw water is drawn up through the outboard vertical driveshaft housing through pick-up feeds in the gear case vicinity. Water passes through a power head thermostat which controls how much water circulates through the engine. The cool water absorbs heat produced by the engine, before being emitted via the coolant exhaust system. There is a access hole on the port side of the power head which shows a visual stream of water at all times. If no water is visible with the engine running shut down the engine and investigate the problem. At times this relief hole can be plugged by debris.

### Impeller/ Water Pump

Periodically, the water pump and impeller should be inspected for debris, damage or excessive wear due to water chemistry such as mineral or silt conditions. Damaged parts will affect the system's ability to function, and may cause engine overheating or damage. Contact your closest Regal dealer for more information and maintenance schedules of key outboard engine cooling systems.

1-41

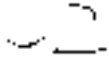

## Chapter 3

---

### Thermostat

If the temperature gauge starts yielding abnormal readings, it may become necessary to look at or replace the powerhead thermostat after determining whether it is functioning properly. The thermostat reads the temperature of coolant and determines whether to open or close a valve to allow warm sea water to pass into the exhaust manifold. The thermostat may recirculate hot coolant for the purposes of reaching standard operating temperatures. If standard operating temperatures have been reached, the thermostat will open a valve and allow hot raw water to exit through the exhaust manifold. For more information read your outboard engine manual or contact the closest Regal dealer. Dealers have the necessary knowledge and tools to troubleshoot any engine related problems.



### **WARNING**

AVOID TOUCHING THE THERMOSTAT OR ITS COMPONENTS WHILE THE ENGINE IS ON / HOT. AVOID RUNNING THE ENGINE WITHOUT A FUNCTIONING THERMOSTAT, AS IT MAY OVERHEAT.

### Freshwater Flushing Attachment

Your outboard features a fresh water flushing system. After linking up to a fresh water hose at the flush port, water can be pumped through the engine's raw water cooling system to flush out all salt and debris that may be left behind. Normally there is a hose thread fitting on the side of the engine. After the connection is opened a garden hose is connected to the fitting and the engine can be flushed. It is best to connect the flushing system up when the engine is warm since the thermostat is open at this time to allow water to circulate through the entire head rather than bypassing the cylinder head areas.





# Engine & Controls

---

## ENGINE ELECTRICAL SYSTEM

Your engine utilizes a great deal of electronic equipment. Select equipment sends signals between the engine and the Garmin, while other systems set off alarms, and still others are used by the engine to generate a spark and ignite the fuel. The battery switch controls electrical power distribution to the boat systems.

To regularly maintain your DC electrical system, inspect the battery charge before each trip. Test all gauges and control equipment prior to departure, and replace as necessary. Spark plugs should be replaced according to your engine owner's manual maintenance schedule. When a fuse blows, investigate the problem before replacing fuse.

### Gauge Electrical Signals

Your outboard transmits signals through electrical harnesses to different components through the use of NMEA 2000 connections and a "backbone system". A standard Garmin plotter displays the engine functions. The fuel gauge and power trim gauges use stand alone technology to display readings. Also, idiot lights are display tolerances that are classified as being abnormal. Faults in these electrical components should be fully inspected by your Regal dealer.

### Alarms

When a malfunction with your outboard engine occurs, the Garmin plotter alerts the skipper of a problem. Common engine problems include overheating, low oil pressure, or a miscommunication with equipment. Learn the alarm systems that apply to your engine by consulting your engine owner's manual.

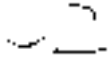

## Chapter 3

---



### **WARNING**

AVOID OPERATION OF THE ENGINE AFTER AN ALARM HAS SOUNDED. USE OF THE ENGINE WITHOUT ADDRESSING THE PROBLEM MAY RESULT IN ENGINE DAMAGE OR FAILURE. REFER TO YOUR OUTBOARD ENGINE MANUAL FOR MORE INFORMATION.

### Spark Plugs

The spark plugs are the piece of equipment that make the spark occur. As electrical potential builds on one side of the gap based upon the energy distributed by the distributor, the potential eventually grows large enough to cause the electric current to jump the gap on the spark plug. This spark is what ignites the compressed fuel generating a controlled explosion that will power the piston down and deliver power to the drive shaft.

### Stator

Under normal circumstances, the starter battery would wear down after being used so often to generate a spark for the engine. This isn't an ideal setup because a strong battery is needed for continual operation. A weak battery does no good out on the water. The stator takes care of recharging the battery(ies).

However, in an effort to conserve battery life, the starter battery switch should still be turned off after every trip and turned on at the start of every trip. This limits the drain on the battery while the boat is not in use. The stator will only recharge the battery while the engine is running.



# Engine & Controls

---

## Fuses

Your engine also comes equipped with fuses that will “blow” when engine components attempt to draw more power than the piece of equipment or wiring can handle. When the fuse blows, it breaks the circuit, and electricity stops flowing. Before replacing the fuse, investigate the cause of the problem, and why the equipment was overworked. Your outboard engine uses a helm mounted fuse box which is accessible by lifting the starboard bow backrest while others feature in-line fuses, while still others feature a mixture of both. Refer to your outboard engine owner’s manual for complete details on your electrical system and the location of any engine mounted over current protection.

## ENGINE EXHAUST SYSTEM

Your engine expels the by-products of the engine operation through an exhaust system, just like cars do. In boats however, this exhaust system mixes the debris left over after the power stroke of the engine with the hot water that is expelled after cooling the engine.

Basically the exhaust flows through the powerhead before expelling the exhaust through the vertical drive housing either just above the propeller, or through the prop shaft.

## ENGINE FUEL SYSTEM

All engines require a source of fuel in order to run. The fuel that an engine uses, is not only comprised of gasoline but also air. This mixture of gas and air are combined into a ratio, best suited for your engine and boat. If this system fails, the engine will have no fuel to compress and ignite. It is important to make sure your fuel system is functioning properly.

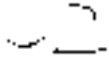

## Chapter 3

---



### **WARNING**

USE OF ALCOHOL ENHANCED FUEL, OR ANY FUEL OTHER THAN GASOLINE, CAN LEAD TO DETERIORATION OF THE FUEL SYSTEM COMPONENTS. THIS CAN RESULT IN FIRE AND POSSIBLE EXPLOSION.



### **WARNING**

GASOLINE VAPORS CAN EXPLODE. BEFORE STARTING THE ENGINE, CHECK ENGINE COMPARTMENT FOR GASOLINE LEAKS OR VAPORS. INSPECT ENTIRE FUEL SYSTEM AT LEAST ON AN ANNUAL BASIS.



### **WARNING**

AVOID BODILY INJURY OR DEATH DUE TO FIRE OR EXPLOSION FROM GASOLINE VAPORS!  
NEVER STORE PORTABLE FUEL TANKS OR OTHER FLAMMABLE LIQUIDS ON BOARD THE VESSEL

Your typical factory installed fuel system is comprised of a fuel fill fitting marked “gas”, fuel tank, fuel hoses, fuel vents, anti-siphon valve, water separator filter, fuel gauge, and sender among other items.

You should understand the purposes of each of these components and discover their location by reading this manual along with the outboard owner’s manual so that you can fix a fuel system problem when the need arises out on the water. The pictures displayed in this section may not reflect your specific engine model.

1-46



# Engine & Controls

---

## Fuel Fill Cap



The fuel fill is labeled “gas” and is located along the starboard aft deck. When fueling it is important to keep the fill nozzle in contact with the fuel fill line since it decreases static electricity, which may spark and ignite gasoline vapors. Always use the recommended fuel octane rating as specified in your outboard engine owner’s manual. Extinguish all flame producing agents before fueling. The fill cap leads to the anti-siphon valve and fuel tank. Ensure that the gas cap ratchets shut which ensures that vapors are contained within the system.

## Anti Siphon Valve

The anti-siphon valve at the base of the fuel feed line is pulled off its seat by fuel pump pressure as the engine is cranking or running. It forms a one-way fuel roadway by sealing off the fuel feed line from the fuel fitting. It prevents fuel from siphoning out of the tank in the event of a fuel line rupture, or disconnected fuel feed hose. It is an important safety item, so DO NOT remove the anti-siphon valve.

## Fuel Vent

Fuel vents are often combined into the fuel fitting on the deck. Fuel tanks are vented overboard for the fumes to escape. While the tank is filled with fuel, air is displaced by the incoming fuel, and relieved through the fuel vent hose. When the fuel tank is near full, slow or stop the nozzle flow to keep the fuel from splashing out the vent.

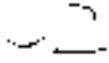

## Chapter 3

---

### Fuel Hoses

Fuel hoses transport gasoline from one component to another. These hoses are required to be of certain diameters in order to comply with engineering standards. Hose clamps are often used to seal the hose to a fitting, and should be checked regularly.

### Fuel Pumps/Filter

From the fuel tank, gasoline is moved from the tank to the engine by the pressure produced in fuel pumps. Fuel filters are used to catch debris and water. Typically, a fuel filter is located before the engine fuel pump and a water separator filter is found between the fuel tank and the outboard engine.

### Fuel Sender & Gauge

A fuel sender on the fuel gauge uses a dipstick/float system to measure the amount of fuel left in the tank. This measurement generates a specific resistance value in an electronic circuit connected to the fuel gauge at the helm. As different fuel levels are reached, the resistance value in the circuit with the fuel gauge changes which is read by the fuel gauge and is converted to an approximate fuel level.

### Fuel Tank

The fuel tank should be inspected for damage before each voyage. This should be done when you check the fuel lines for tightness and leaks. Your Regal boat uses an aluminum or polyester fuel tank that has been tested several times along with other fuel system components for safety requirements and dependability in house, and they are inspected independently by National Marine Manufactures Association personnel. Typical fuel tank and hoses shown below.

1-48

# Engine & Controls

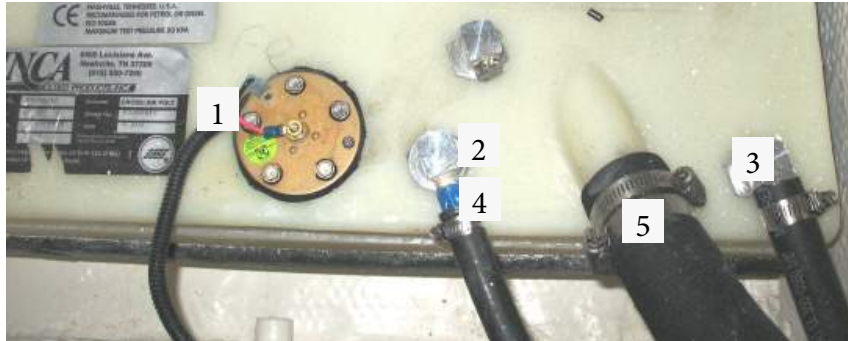

Typical Fuel Tank- Note that fuel tanks feature aluminum or polyester material

- |                      |                   |
|----------------------|-------------------|
| 1) Fuel Sender       | 4) Fuel Feed Line |
| 2) Anti Siphon Valve | 5) Fuel Fill Line |
| 3) Fuel Vent Line    |                   |

## ENGINE LUBRICATION SYSTEM

Whenever two components rub together, friction causes wear on both components. To minimize the wear on your engine, a lubrication system has been put in place to help components slide next to each other easier. This is particularly important within the inner workings of an engine. It is important to ensure your lubrication system is working properly at all times.

Your Regal utilizes lubrication and fluids that need regular check ups. These engine fluids include engine and gearcase oil along with steering fluids. Refer to your outboard engine owner's manual for specific details regarding the proper maintenance procedure of your lubrication system. The pictures displayed in this section may represent a different engine model than your vessel.

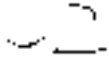

## Chapter 3

---

### Engine Oil

The purpose of engine oil is to lubricate the cylinders of the engine and ensure that parts that regularly move against each other have reduced friction to reduce wear and noise between components. An oil filter keeps metal particles and water out of the engine's interior.

Engines performing on regular oil should have the oil drained and replaced every 100 hours while synthetic oil typically should be drained and replaced every 200 hours. In either case, if your Regal boat has endured one year since its last oil change, the oil should be changed again. The oil filter should be replaced every time the oil is changed, or upon damage. It is normal for the first 50 hours of operation to require frequent changes until the engine is seasoned.

### Other Component Lubrication

System components may also require their own lubrication schedule. Steering systems, throttle cable, shift cable, stern drive u-joint splines and o-rings, and the engine coupler may require grease, oil, or other lubrication. Refer to your engine owner's manual for specific details.

## LOWER UNIT LUBRICATION

Your outboard uses power trim fluid, drive oil, and propshaft lubricants to reduce wear on moving components. These fluids should be checked according to the recommended maintenance procedures determined by the outboard manufacturer.





# Engine & Controls

---

## Gearcase Oil

Gearcase oil keeps all the mechanical components of the propshaft gear assembly functioning optimally. It reduces friction in the gearcase as the gears revolve. Sometimes gearcase oil is called gear lubricant, as the oil essentially lubricates the gears inside the gear box. Gearcase oil should be inspected periodically according to factory maintenance schedules.

## Power Trim Fluid

Power trim fluid allows your outboard to angle up or down. This is particularly useful when trying to get your boat to plane where the hull is as much out of the water as physically possible, reducing friction, and improving ride performance. This power trim fluid is used in hydraulic rams that maneuver the outboard unit, and shouldn't need to be replaced very often, if at all.

Power trim fluid should be checked regularly, despite not requiring replacement unless something serious happens. Discoloration or water presence indicates a water leak in the stern drive. In that case, contact your Regal dealer.

## PROPELLERS

Regal has carefully tested and chosen the propellers to give your outboard boat the best possible performance based on the engine and propulsion package you choose. We have allowed for the additional weight in equipment that might be added to the boat. It is a good idea to carry a spare set of propellers and hand tools onboard, in order to handle emergency propeller changes. Refer to the outboard manual for procedures, as the application is unique to the manufacturer. Call a marine professional or your Regal dealer for further information.

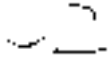

## Chapter 3

---

### Propeller Checklist

At least twice a year, check the propeller for:

- Loose, missing, or corroded hardware.
- Nicks, dings, or missing propeller material
- Bent propeller blades.
- Objects wrapped around the prop such as fish line.
- Decomposing propeller blades (electrolysis symptom).
- Check the propeller rubber hub for slippage

Contact a propeller shop or your closest Regal dealer if any of the above symptoms exist. They have purchased special equipment to refurbish both stainless steel and aluminum propellers.



1-52



# Engine & Controls

---

## INSTRUMENTATION

The helm station is equipped with a fuel gauge and depth gauge along with the ability to monitor engine functions through the Garmin unit. Close observation of the gauges may save the engine from damage. Gauges do however have some inaccuracy, so do not rely upon them fully.

Note that with the battery switch in the “off” position, there is no power to the dashboard, and the ignition switch will not function properly.

All electrical features are protected by a main fuse mounted close to the battery switch. A fuse for the stereo memory and the automatic bilge pump system are also located next to the battery switch in the engine compartment. Fuses for the engine are located either in-line, between components, or in a fuse box. All the switches on the dashboard also have a fuse, located in the forward starboard storage area directly in front of the helm. Should a fuse “blow” it is first necessary to figure out the reason and address the cause before resetting it.

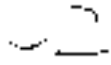

## Chapter 3

---

### Depth Gauge



The depth gauge indicates the water depth under the keel of the boat. It features a shallow water alarm to warn the skipper of hazardous situations. By monitoring the water depth, damage to props, and underwater hardware can be avoided.

This gauge is connected to a transducer on the bottom of the hull, accessible through a removable plate in the ski locker. Refer to the equipment operation chapter for details on gauge settings/operation.

### Fuel Gauge



The fuel gauge indicates the level of fuel inside the fuel tank sent by the fuel sender. It is a good idea to keep the fuel tank “topped off” when possible to reduce fuel vapors inside the tank. Do not run your fuel too low as this style gauge is not always accurate. Always allow for a “safety” factor.

Remember that the Garmin is not set up to monitor fuel tank levels. The dash gauge works independently of the Garmin engine functions in this case.



# Engine & Controls

## Typical Outboard Helm

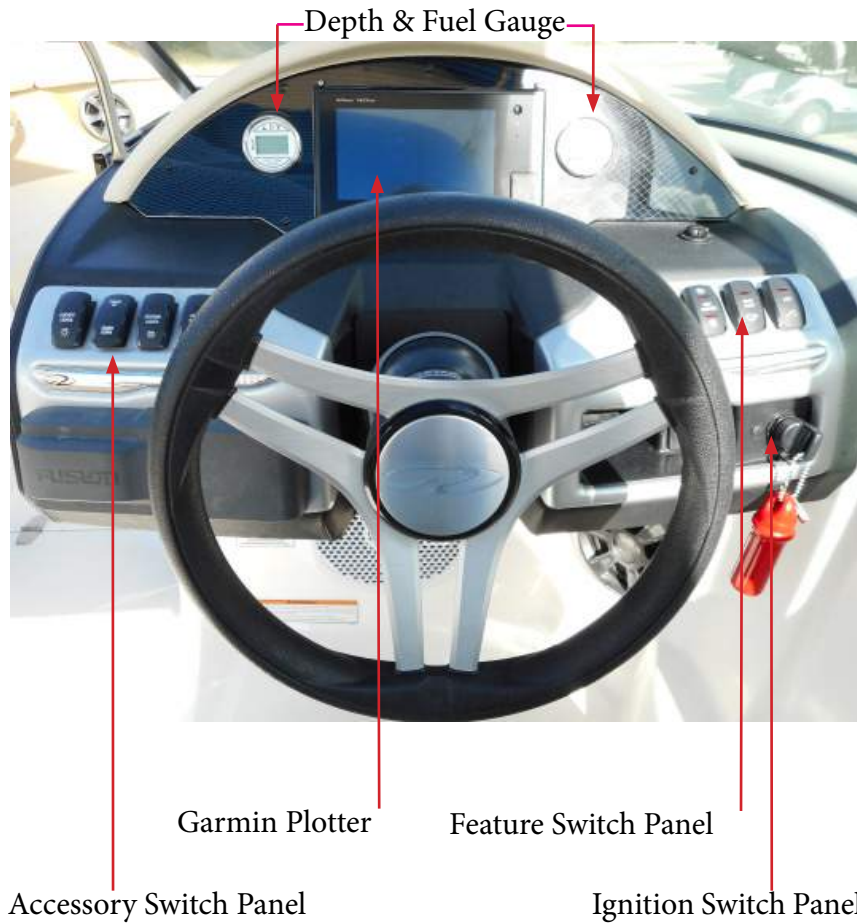

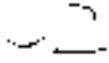

## Chapter 3

---

### Garmin Engine Monitoring Display

A Garmin chartplotter is currently standard equipment on your outboard. It features many GPS features along with the ability to monitor engine system functions including revolutions per minute (rpm's), GPS speed, voltage, fuel flow rate, trim, and temperature along with tracking engine hours.

Note that the Garmin and Fusion circuitry use individual sources to power up the system. The key switch does not power up these 2 systems. Also, the depth and fuel gauge displays are independent of the Garmin engine displays.

1. To power up the Garmin GPS press the on button located on the upper display.
2. The function AV/Gauges,Controls will appear as one of the choice boxes. Press the box. Another screen with engine will appear.
3. Press the engine box and the engine gauge displays will appear (oil pressure is engine code driven only); fuel level uses dash gauge to display fuel levels).



1-56



## Engine & Controls



Garmin screen showing sample GPS functions. For detailed plotter instructions refer to the Garmin operator's manual in the owner's information packet as it guides you through the simple to the more complex operations. Also, more technical information can be found on the Garmin web-site under the key word MARINE.

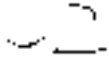

## Chapter 3

---

### REMOTE CONTROL



Your vessel uses a single side-mount control for shifting and throttle operations. The remote control handle controls forward, neutral, and reverse outboard shifting operations. Also, the control features power trim up and down functions. See the following page for component description and features. Practice docking operations using the remote control in a controlled environment to learn the basic control functions.





# Engine & Controls



Typical Control Lever In Neutral Position

- 1) Neutral Release Button    3) Control Lever
- 2) Trim Control Switch    4) Interrupter Switch

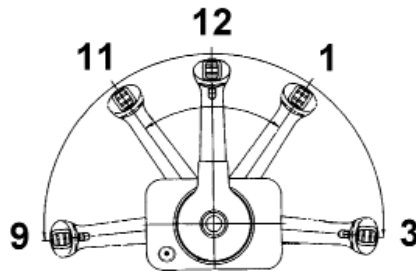

Typical Control Lever Showing Five Positions

Pushing the throttle control lever forward from the neutral 12 o'clock position to the 11 o'clock position will engage forward gear with minimal throttle. From the 11 o'clock position to the 9 o'clock position, the vessel is in forward gear with differing levels of throttle selections.

Pulling the throttle control lever back from the neutral 12 o'clock position to the 1 o'clock position will engage the reverse gear with minimal throttle. From the 1 o'clock position to the 3 o'clock position, the vessel is in reverse gear with differing levels of throttle selections.

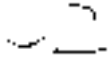

## Chapter 3

---

As you shift from neutral to forward or reverse, push the neutral release button, this allows the control lever to come out of the indented position.

The control lever features a neutral safety switch which ensures the stern drive and control are in the indented neutral position for starting the engine. You will hear a distinct sound and will feel the remote control's rotation lock, once in the proper position. If you turn the key to the start position and the engine starter doesn't crank the engine, ensure the control lever is in the neutral position.

Your control lever also features a trim control switch. This switch allows the captain to set the trim for the drive from the helm either up or down to achieve a plane position. Refer to the vessel operations chapter for further information on trim angle.

Follow these points when shifting:

- DO NOT shift quickly from forward to reverse gear positions. Drive system damage may occur.
- DO NOT “pump” the throttle in neutral or flooding will result. The same thing will happen if you keep pumping the automobile accelerator pedal. Today's engines use an enrichment valve system that requires very little starting throttle.
- DO NOT try to shift into forward or reverse gear at high rpm's. Personal injury, drive system, or property damage may result.
- Only use idle throttle positions when docking or maneuvering in tight quarters.



## Engine & Controls

---

- Wear your safety lanyard at all times.
- Never shift the controls with the engine not running. Control, linkage, and/or stern drive damage may occur.
- For more information, read your engine manufacturer's manual before operating the remote control.

### Safety Lanyard (Interrupter Switch)

The safety lanyard (used on selected control levers), sometimes called an interrupter switch is attached to the operator and the remote control panel. Should the operator lose control of the vessel and become dislodged from his/her seat or fall overboard, the lanyard will shut the engine off.

Make sure the lanyard is installed to the driver's belt before operating the vessel. Flip the switch to the run position before starting the engine.

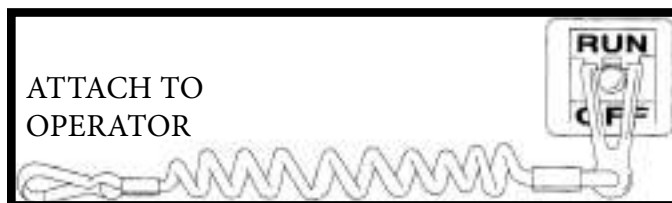

 **WARNING**

INTERRUPTER SWITCH MUST BE ATTACHED TO THE OPERATOR WHILE THE ENGINE IS RUNNING. A QUALIFIED OPERATOR MUST BE IN CONTROL AT ALL TIMES. READ THE OWNER'S MANUAL BEFORE USE.

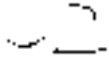

## Chapter 3

---



### **NOTICE**

IF THE INTERRUPTER AT THE REMOTE CONTROL SWITCH IS IN THE “OFF” POSITION, THE ENGINE WILL CRANK OVER BUT WILL NOT START. ENSURE THE SAFETY LANYARD IS ATTACHED CORRECTLY AND SWITCHED TO THE “RUN” POSITION.



# Engine & Controls

---

## STEERING-HYDRAULIC



### **WARNING**

AVOID BODILY INJURY, DEATH AND/OR PROPERTY DAMAGE  
DUE TO LOSS OF STEERING CONTROL!  
THE FLUID LEVEL MUST BE CHECKED AND MAINTAINED BEFORE  
EACH USE TO ENSURE SAFE STEERING OPERATION.  
INSPECT ENTIRE STEERING SYSTEM AT LEAST TWO (2)  
TIMES PER YEAR.

Typical outboards feature a hydraulic style steering system. The unit utilizes check valves which permit hydraulic fluid to pass through the system allowing the steering arm at the outboard to turn the vessel to port or starboard as the steering wheel is rotated in either direction. This check valve cluster is located in a pump assembly behind the steering wheel. The hardware at both the helm and engine must be checked regularly for tightness, lubrication, and leaks. See the steering system overview on the following page.

Check the steering system before each outing by turning steering wheel fully to port and starboard. Check for fluid leaks at the helm and outboard ends and air in the system.

There is a hydraulic steering plug integrated into the dash that must be removed before filling the system with fluid. Refer to the steering manufacturer's information in the owner's information packet for filling instructions or contact a Regal dealer to schedule maintenance. Filling hardware (plastic bottle, hose and hardware) is needed for filling and bleeding the system. *Note that only SeaStar Steering Fluid is to be used.*

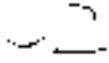

## Chapter 3

---

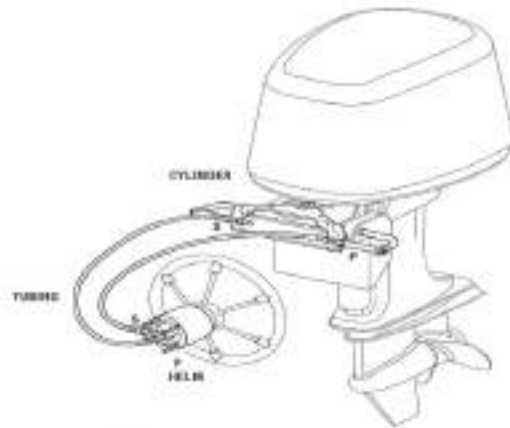

Typical Basic Hydraulic Steering System

Note the basic hydraulic steering system above uses designated hose marked port and starboard. These hoses can not be reversed or the system will not operate properly. Use the above illustration to understand the basic fluid flow and parts involved in the system.

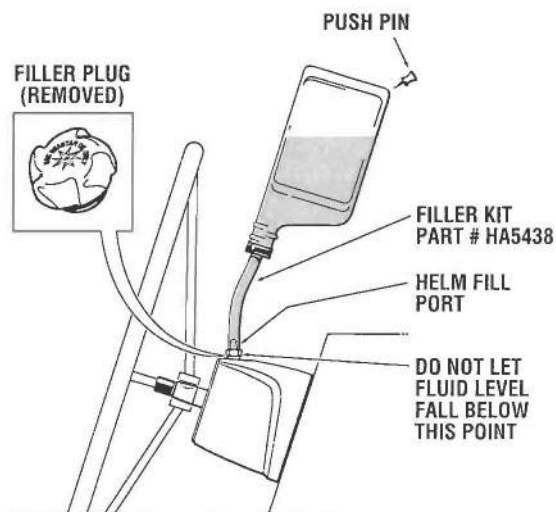

Typical Helm Fill Kit Shown



## Engine & Controls

### STEERING-HYDRAULIC POWER ASSIST

A hydraulic power assist steering system is optional equipment. The hydraulic pump used in the system is shown below and provides “power” for the system. The system consists of two circuits; a hand operated manual system being the control element, and the hydraulic pump which is the working element.

The manual system consists of a helm pump with internal check valve design with integrated relief, and a built-in reservoir. Two separate steering lines along with a compensating which provide a complete route for the fluid, and a steering cylinder to move the steering device on the boat from port to starboard.

The power system, is a hydraulic type pump with electronic controls



1-65

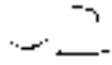

## Chapter 3

---

### STEERING-HYDRAULIC POWER ASSIST

that increases the fluid being sent from the helm pump to the steering cylinder which results in much easier steering at the wheel for the operator even with larger loads. A compensating line connects the power assist unit to the helm pump, allowing the power assist unit to share fluid with the helm reservoir.

Should the power assist unit fail or lose power, the hydraulic system will automatically revert to a manual hydraulic system.

There is a hydraulic steering plug integrated into the dash that must be removed before filling the system with fluid. Refer to the steering manufacturer's information in the owner's information packet for filling instructions or contact a Regal dealer to schedule maintenance. Filling hardware (plastic bottle, hose and hardware) is needed for filling and bleeding the system. Use only hydraulic fluid type as recommended by SeaStar.



### **WARNING**

AVOID BODILY INJURY, DEATH AND/OR PROPERTY DAMAGE  
DUE TO LOSS OF STEERING CONTROL!  
THE FLUID LEVEL MUST BE CHECKED AND MAINTAINED BEFORE  
EACH USE TO ENSURE SAFE STEERING OPERATION.  
INSPECT ENTIRE STEERING SYSTEM AT LEAST TWO (2) TIMES  
PER YEAR.





# Engine & Controls

## STEERING-HYDRAULIC POWER ASSIST

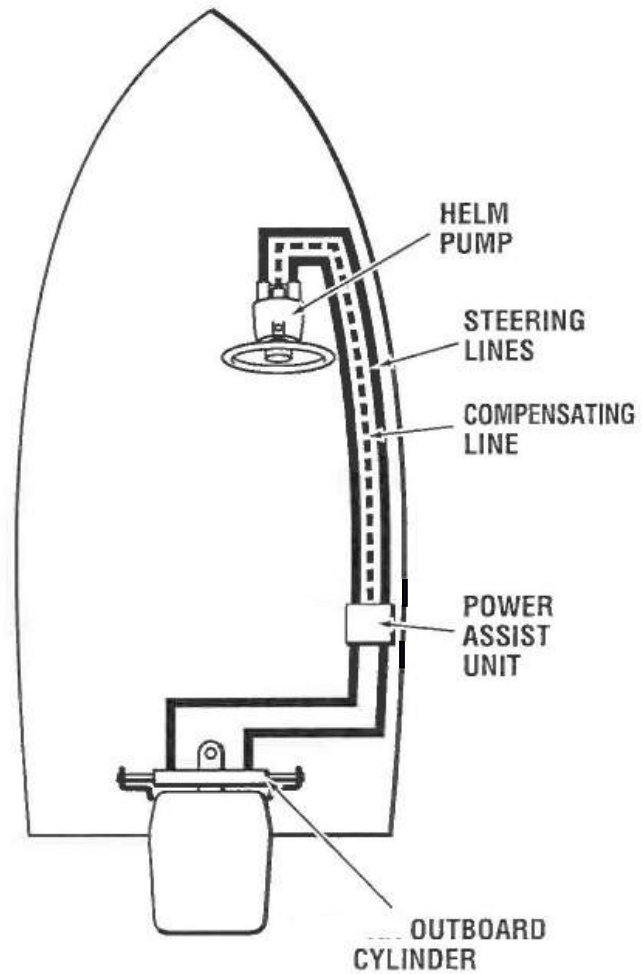

Hydraulic Power Assist Steering System Overview

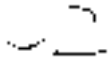

## Chapter 3

### POWER ASSIST STEERING

The following diagram identifies a typical outboard power assisted steering system circuitry.

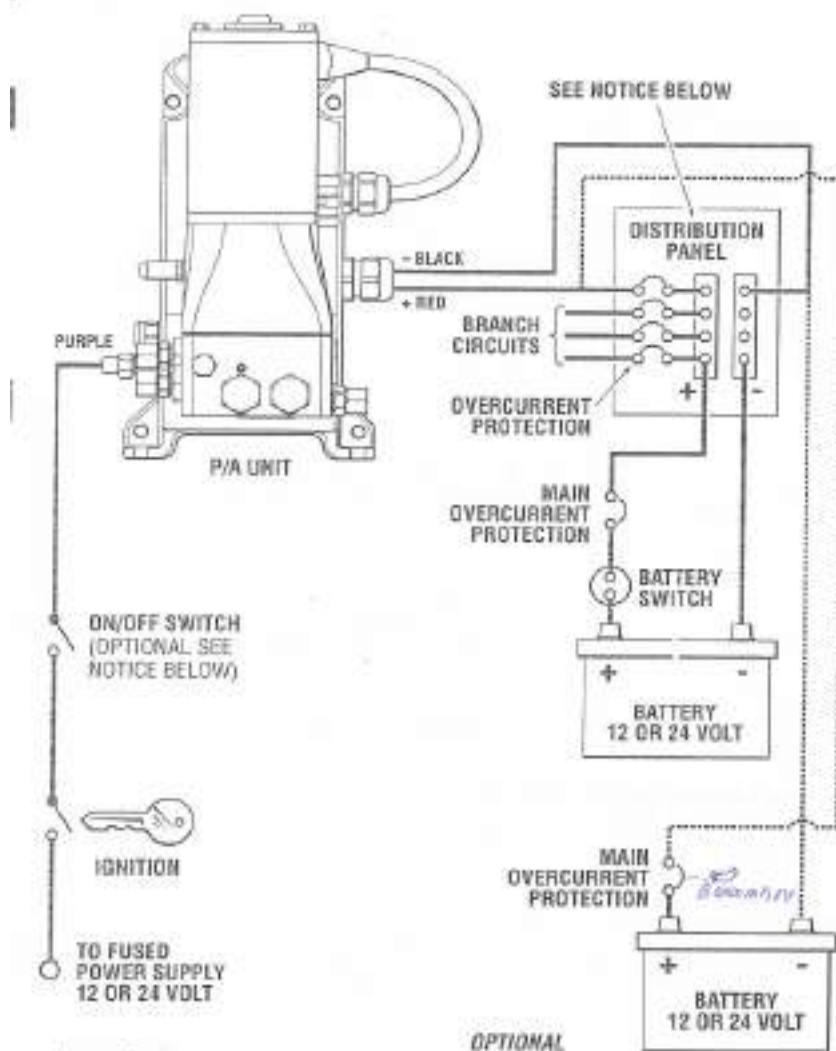



# Engine & Controls

---

## Port Switch Panel

The port switch panel activates optional docking lights, cockpit lights, Power Tower along with accessories installed aftermarket. Cockpit lights are placed at the bow/transom walk through areas. A red icon shows activation on individual switches. Switch names may vary.



Typical Panel

## Starboard Switch Panel

The starboard switch panel controls key systems on your outboard vessel. It normally features a horn switch, navigation light & anchor light switch, plus a manual bilge pump switch. A red icon shows activation on individual switches. Switch names may vary.



Typical Panel

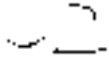

## Chapter 3

---

### Outboard Engine Checks

A select portion of checks from engine break-in to periodic maintenance are covered in the following pages. Since advanced ignition and fuel injection systems are used on outboard engines along with special factory training and tools it is best to contact your Regal dealer for more of the detailed procedures. Always refer to your engine manual for detailed information and technical specifications.



### **CAUTION**

AVOID ENGINE DAMAGE!  
FOLLOW ALL ENGINE BREAK-IN PROCEDURES AS  
RECOMMENDED BY THE ENGINE MANUFACTURER.  
FAILURE TO FOLLOW THE BREAK-IN-PROCEDURE MAY  
VOID THE OUTBOARD ENGINE WARRANTY!



### **CAUTION**

AVOID ENGINE DAMAGE!  
DO NOT RUN ENGINE AT A CONSTANT RPM  
FOR PROLONGED PERIODS OF TIME  
DURING BREAK-IN PERIOD.  
CHECK ENGINE OIL OFTEN.



### **CAUTION**

AVOID ENGINE DAMAGE!  
DO NOT RUN ENGINE OUT OF WATER UNLESS YOU  
USE A FLUSHETTE APPROVED BY THE OUTBOARD ENGINE  
MANUFACTURER.  
FOLLOW MANUFACTURER'S ATTACHING AND  
RUNNING INSTRUCTIONS.



## Engine & Controls

---

### Fuses- Electric Cover



As part of Yamaha outboards under the motor shroud (engine cover) on the port side of the outboard engine is an electrical cover. Inside this cover is a variety of fuses protecting various engine components. There are also extra fuses stored along with a fuse puller. For further information, refer to the manufacturer's outboard engine manual.

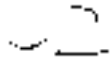

## Chapter 3

---

### Checking Fuel System Water Separator Filter



Inside the lazarette center cockpit storage area a 10 micron in-line water separator filter is installed. Use an oil spanner type wrench and turn the filter counterclockwise to remove the element. Using a clean pan empty the filter contents. Water in fuel tends to hug the bottom and will show a different color than the fuel. At least yearly or on an as needed basis replace the filter element. Fill the element up with fresh unleaded fuel of the correct octane rating and turn it clockwise until tight. Finish

tightening with the spanner wrench. As always check for leaks before starting the engine.

It is a great idea to keep extra filter elements on board in protective wrap for emergency use.



## Engine & Controls

---

### Checking Engine Mounted Fuel Filter



As part of Yamaha outboards under the motor shroud (engine cover) on the lower port side of the outboard engine is a fuel filter. Periodically check to ensure the fuel filter is clean and free of water. When reinstalling the filter tighten to manufacturer's specifications. Check for leaks after starting the engine. For more information refer to the

outboard manufacturer's owners manual or contact a Regal dealer or marine professional. Always carry extra filter elements and proper tools to change out this component.

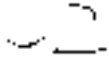

## Chapter 3

---

### Engine Crankcase Oil

Note that Yamaha outboard engines are shipped from the factory without engine oil. Before starting the engine for the first time the correct type and amount of oil must be added (See your outboard owner's manual for details before attempting to start the engine). There is a tag shipped with the engine saying that the engine oil is to be filled. This tag should be removed after the engine oil has been filled for the first time. Also, refer to the following pages and the outboard engine owner's manual for the correct procedures for checking and/or adding engine oil to the crankcase.



### NOTICE

CHECK THAT THE ENGINE IS FILLED WITH TYPE AND VISCOSITY  
OF OIL BEFORE  
FIRST TIME OPERATION TO AVOID ENGINE DAMAGE.

### Engine Break-In Procedure

Note that your 4 cycle outboard engine requires a period of break-in for the internal engine parts to wear in properly. Following the break-in procedure will assist in producing longer engine life and increased performance. See your outboard owner's manual for specific break-in procedures for your specific model.



### NOTICE

FAILURE TO FOLLOW THE ENGINE MANUFACTURER'S  
PROPER BREAK-IN PROCEDURE COULD RESULT  
IN SEVERE ENGINE DAMAGE, REDUCED ENGINE LIFE CYCLE  
AND MAY VOID THE ENGINE MANUFACTURER'S WARRANTY.





# Engine & Controls

## Checking Engine Crankcase Oil

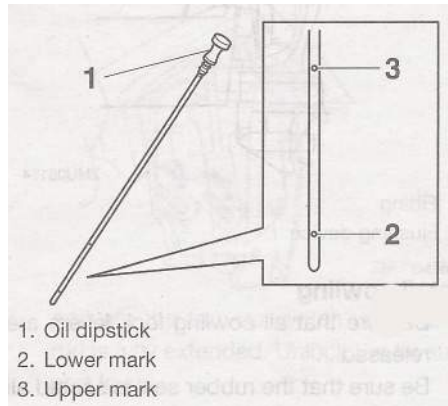

Your Yamaha outboard features 4 cycle engine operation. Unlike 2 cycle outboards which mix gas with oil technology, the 4 cycle engine uses crankcase 4 cycle oil to lubricate internal moving parts. This operation is similar to automobile engine technology.

As part of this process, there is a dipstick placed in the crankcase to offer periodic checking of engine crankcase oil.

To check the crankcase oil do the following:

1. Ensure the outboard is setting in a flat vertical position or the dipstick may not display an accurate oil level.
2. Remove the crankcase oil dipstick and wipe it clean.
3. Reinstall the crankcase oil dipstick completely into the hole. Remove it again.
4. The oil level should be between the upper and lower dipstick holes as needed add the manufacturer's recommended oil or contact your closest dealer especially if the oil is contaminated with water which will show a milky color verses a clear look. Refer to the outboard manufacturer's owner's manual for oil changing maintenance schedules.

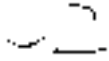

## Chapter 3

---

### Checking/Filling Crankcase Oil- (Continued)



When adding crankcase oil be sure to utilize the manufacturer's recommended type and viscosity. For changing crankcase oil contact your closest Regal dealer for additional information since they have the special

tools and knowledge for these maintenance procedures.



## Engine & Controls

---

### Flushing Device



Your Yamaha outboard features a flushing device which when connected to a garden hose circulates fresh water through the engine to purge unwanted debris such as found in salty, brackish, and silty water.

To use open the flushing device by turning it counterclockwise.

Notice there is a

garden hose bib thread. Attach the male end of a garden hose to the fitting and tighten it. Make sure the fitting does not leak as the power head could overheat and cause internal damage. Next, turn on the fresh water supply. Start the engine and run in neutral idle speed only. Let the engine warm up enough so that the thermostat opens and permits purging of the power head cylinder water jackets. If the thermostat is not open the cylinder head areas normally are bypassed. When flushing completed remove the garden hose from the fitting and reattach the hose connections and of course check for tightness.

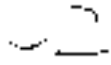

## Chapter 3

---

### Zinc Anodes

Sacrificial zinc anodes are located on the outboard drive housing, trim cylinders and/or prop shaft to protect softer metals exposed to the water. Electrolysis attacks the least noble metals first. Because zinc is a less noble metal, it will decompose before other metals. Check these zinc anodes periodically and have them replaced when they are 30% consumed. Notwithstanding, zinc is the most popular metal used to protect parts that are exposed to saltwater, freshwater or brackish water.

See the photos below for anode location on your outboard.



Zinc anodes in brackish or salt water need to be checked more frequently. If the anodes seem to be requiring frequent replacement there may be a boat leaking DC current into the water taxing the anodes. This is especially possible around a marina environment. Contact

a marine professional who can measure the galvanic activity with a special electrode and VOA meter. Refer to the engine manufacturer's manual for exact anode location and detailed information.



Inspect the ground leads for tightness if attached.

Parts damage due to galvanic or stray current corrosion is not covered under warranty.



---

# Systems

## Standard Fire Port



Note that as standard equipment (stern drive) there is a fire port and plug installed in the rear bench seat area. The plug includes a decal. In a fire emergency place a hand held fire extinguisher in the port and pull the pin to evacuate the agent.

## Automatic Fire Extinguisher

This optional system features a fixed fire extinguisher mounted along the engine compartment wall. The extinguishing system uses an environmentally friendly agent HFC227 ea. This colorless, odorless gas is liquefied in the canister until deployment. The agent has acceptable toxicity ratings in enclosed spaces of your engine compartment's size and is approved by the EPA. The fire extinguisher should be checked according to manufacturer specifications by a marine professional. DO NOT attempt to disassemble the fire extinguishing contraption. This fixed system is not intended to be explosion suppressive. Boat owner's need to take normal precautions for checking gasoline fumes and using blowers.

Your automatic fire extinguisher uses an actuator to discharge. This is usually enclosed by a metal cage. DO NOT handle the fire extinguisher at this location. Sensors are mounted to the extinguisher to detect a fire. A pressure gauge is also mounted for easier checkups.

A manual discharge cable runs from the fire extinguisher to the helm or aft cockpit where a "T" handle and pin can manually discharge the extinguisher. If a fire starts, DO NOT wait for the automatic system to take effect - manually discharge the system by removing the pin and pulling the "T" handle.

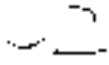

## Chapter 4

---

### BILGE/DRAINAGE

Regal boats are designed with a drainage system so water can be moved to the bilge from the deck where the bilge pump can pump it out to the through hull drain normally on the aft starboard side. It is important to keep all drains clear of debris so when a wave floods the deck of the boat, all water will leave in an effective manner.

Your boat is equipped with main drains installed near the transom walk-thru on the aft starboard side of your boat, underneath the aft cockpit seats where the cooler normally is set, and a third drain installed in the ski locker. All three of these drains then route back to the bilge pump in the engine compartment. All cup holders and the bow storage compartment drain to the ski locker whereupon it is transferred to the engine compartment bilge pump.

Once the water has been drained to the bilge pump in the engine compartment, the bilge pump can pump it out through a hole located along the aft starboard side of your boat. The bilge pump is connected to a fuse located near the battery switch in the engine compartment and also to an automatic float switch placed directly forward of the bilge pump. The bilge pump receives power from your battery, and the automatic float switch is installed so that the bilge pump will automatically turn on as required. The circuit to the bilge pump receives battery power regardless of the state of your battery switch, so turning off the battery switch at the end of each voyage will not affect your boat's ability to pump water out of the bilge. A manual switch, operated from the dashboard however, requires the battery switch to be turned on.

Monitor your bilge pump's condition to keep your vessel from sinking due to taking on large amounts of water. Debris should be cleared from the impeller regularly. Inspect the condition of the impeller and replace the impeller as necessary.

4-2

## Systems

To gain access to the impeller, the pump must be disassembled from the bilge pump grate. Simply push the tabs of the grate inward towards the bilge pump, while simultaneously pulling up on the bilge pump. This locking mechanism functions much like a quick disconnect clip. If the fuse for your bilge pump “blows”, be sure to investigate why the bilge pump was drawing too much power. Likely causes of bilge pump malfunction are debris in the impeller, bad impeller, debris in the float switch, bad motor, or short circuit.



Typical Bilge Pump And Automatic Float Switch

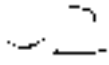

## Chapter 4

---

### ELECTRICAL

Your boat runs off direct current (DC), supplied by your battery. Regal boats primarily use 12 volt DC batteries located in your engine compartment. It is called direct current because the current flows one way in the circuit. Your automobile is a typical example of 12 volt DC current

#### Direct Current (12 Volt DC)

Storage batteries (sometimes called wet-lead cell batteries) furnish 12 volt electricity to boat components. Storage batteries use two dissimilar metals immersed in a liquid (acid) to carry current. The engines require large amounts of battery power for starting purposes. Check the maintenance chapter for battery information.

An automobile battery is charged up by the engine alternator. The same holds true for the marine battery. The dash volt meter displays the battery voltage. If the volt meter shows below 12 volts, there could be a charging system malfunction. This condition needs to be addressed before the voyage and before the batteries become completely drained.

Your battery should be removed for proper winter storage. A battery not properly stored for winter or extended periods of latency may exhibit charging problems. See the storage and winterization chapter for battery storage information.

#### Wire Color Codes

Utilize the following table when looking at your electrical harnesses. Your boat may not feature all of these functions, as some are optional features, while others are not available on your model.





# Systems

---

COLOR	GAUGE	FUNCTION
Black	16 to 4	All Grounds
Black / White	16	Halon Automatic Fire Extinguishing System
Blue	14	Interior Lights
Blue	10	Cabin Light Main Feed
Blue / White	16	Transom Courtesy Lights
Blue / White	14	Cockpit Lights
Brown	12	Water Pressure Pump
Brown	16	Aft Bilge Pump / Manual
Brown	16	Fwd. Bilge Pump / Manual
Brown / Black	10	Overboard Discharge
Brown / Pink	16	Carbon Monoxide Detector
Brown / Red	16	Fwd. Auto Bilge Pump
Brown / White	16	Aft Auto Bilge Pump
Grey	16	Bow Navigation Lights
Grey / Black	16	Mast Light (Anchor Light)
Grey / White	16	Mast Light (Fwd. Running)
Green	16	Tank Level Monitor
Green	8	Bonding
Orange	16	Windshield Wiper / Run
Orange	12	Refrigerator, Hatch Run
Orange	10	Spotlight
Orange / Black	16	Horn
Orange / White	16	Windshield Wiper Park
Purple	16	Hour Meter
Red	16	Gas Vapor Detector, Stereo Remote, Breaker To Dash Feed Lines
Red	14	Positive Feed, Electronics
Red	8	Positive Feed, Alternator Charge
Red	8	Positive Feed, Alternator Charge

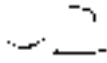

## Chapter 4

---

COLOR	GAUGE	FUNCTION
Red	4	Positive Feed
Red	2	Positive Feed, Starter Battery
Red	2 / 0	Main DC Panel Feed
Red	00	Battery Cable To Engine
Red / Black	16	Windlass Up
Red / White	16	Windlass Down
Yellow	12	Blower
Yellow / Black	16	Stereo Memory
Yellow / Black	16	Track Monitor
Yellow / Red	14	Engine Cranking Circuit

The standard wire color, gauge size, and function shown is used throughout the marine industry. The chart is helpful in identifying wire circuitry during troubleshooting or the adding or marine accessories. NEVER replace a wire with a size other than shown in the chart. This practice could result in fire or component failure. Contact your Regal dealer for replacement wires and harnesses.

### DC Switches

Switches located at the helm are part of your DC circuitry. Switches are in essence a break in the circuit from the battery to your electrical components. When the switch is turned on, a red light shows activation. See chapter 3.



## DC CIRCUIT PROTECTION

As part of the direct current circuitry, depending on the make and model engine you chose, will have either in line fuses or a fuse box for its electrical components. These fuses protect the engine wiring from overloads. Refer to the engine manufacturer's manual for the fuse locations, sizes, and operations.

A dash fuse box protects the individual switch controlled components and is located in the starboard bow storage locker. The ignition panel is protected by a 20 amp breaker usually mounted to the panel itself. All gauges and helm electrical systems like the head radio unit are protected by a dashboard protection fuse located underneath the dash connected to the ignition switch. Your fusion stereo is also protected by a fusion installed stereo memory fuse normally located underneath the dash along the radio wiring, in addition to the Regal provided stereo memory fuse in the engine compartment near the battery switch. Additionally, there is an automatic bilge pump fuse located next to the battery switch in the engine compartment. See chapter 3.

If the fuses "blow" or breakers "pop" due to an overload, the cause should be investigated before replacing the fuse or resetting the breaker. Only replace fuses with the same amperage and type. In emergency situations, fuses installed in the fuse block for features that are not used on your model can be used as replacements when appropriately sized for the fuse your are replacing.

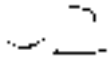

## Chapter 4

FUSE FUNCTION	AMPS	TYPE	PLACE
Accessory 1 (If Included)	15	Fuse	Dash Fuse Box
Accessory 2 (Not Available)	15	Fuse	Dash Fuse Box
Bilge Pump Manual	7.5	Fuse	Dash Fuse Box
Bilge Pump Automatic	10	Fuse	Engine
Blower	10	Fuse	Dash Fuse Box
Cockpit Lights	10	Fuse	Dash Fuse Box
Actuator- Protects Dash Switching	10	Breaker	Actuator Box
Actuator- Port or Starboard Gear	25	Fuse	Actuator Box
Main Breaker- Battery Switch to Helm	50	Breaker	Battery Switch Area
Docking Lights (Not Available)	15	Fuse	Dash Fuse Box
Fresh Water	7.5	Fuse	Dash Fuse Box
Garmin (Not Available)	10	Fuse	Dash Fuse Box
Horn	10	Fuse	Dash Fuse Box
Ignition Breaker	20	Breaker	Ignition Panel
Navigation / Anchor Lights	10	Fuse	Dash Fuse Box
Stereo Memory Fusion Feed	15	Fuse	Underneath Dash
Stereo Memory Main Feed	15	Fuse	Engine
Stereo Performance (Optional)	40	Breaker	Battery Switch Area
12 Volt Accessory	15	Fuse	Dash Fuse Box

\*\*Typical Fuses

4-8

## MAIN BREAKER-BATTERY PANEL



As part of the battery circuit protection from the battery to the helm or dash panel a breaker is installed within 40" of the battery. If the breaker would draw excessive amperage it is possible it could "blow". At this point it would need to be reset.

Always determine the reason why the breaker blew before resetting it.

To reset the breaker move the lever from the "off" position to the "on" position.

These Buss brand breakers are ignition protected which means they are sealed providing protection from spark sources. When replacing breakers ensure they are marketed as being ignition protected

### POSSIBLE BREAKER PROBLEMS/SOLUTIONS

1. It is possible that the main circuit breaker may trip from long-term arcing and heat. The breaker may need to be reset.
2. Breaker will not reset- Replace the breaker. Contact the nearest Regal dealer for replacement parts.
3. Breaker continues to "trip". Check the affected equipment to determine if it is responsible for the excessive draw to trip the breaker. If the equipment is determined to be within specifications check for a "short" in the wiring circuit. Contact the nearest Regal dealer.

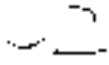

## Chapter 4

---

### Transducer

Your transducer is the device mounted on the hull bottom that sends out sonar signals that rebound upon hitting the bottom of a lake or ocean. These signals are measured, and converted into a usable depth measurement displayed by the depth gauge at the helm. This system does not register signal deflections due to fish. Access the transducer for removal via an access plate in the ski locker. Note that the transducer is a sealed, non-serviceable unit.

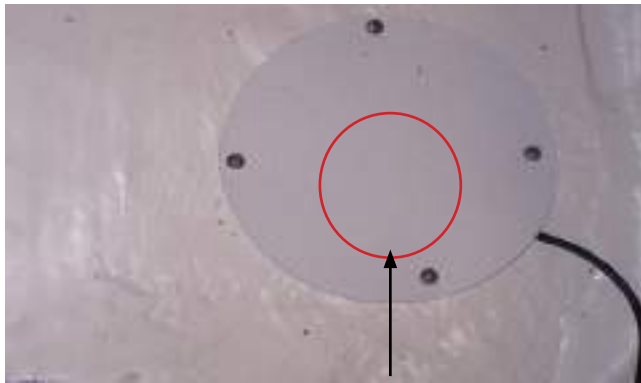

Typical Transducer Cover/Transducer Underneath

### Battery Switch

All of your electrical systems onboard your Regal eventually connect with your battery. This is where electrical power originates. In order for any electrical systems to receive power, with the exception of your automatic bilge pump function and stereo memory require the battery switch to be turned “ON”. The two excluded systems have a direct battery feed a tall times without the use of the battery switch. The battery switch connects the battery to all deck and engine circuitry. It is important to turn your battery “ON” before each trip, and “OFF” at the end of each trip to avoid battery drain.

Never turn the battery switch to the “OFF” position when the engine is running as alternator or other electrical system damage will occur. For non-use times, turn battery switch to “off” position.

4-10



## Systems

The battery switch is located in the starboard aft sump. With the stereo performance package option normally a 40 amp breaker protects the circuit and a 50 amp breaker protects the wiring up to the helm.

The stereo memory and the bilge pump fuses are located near the battery switch box as reference below. The stereo memory fuse is 15 amps and the bilge pump fuse is 5 amps. These circuits will continue to function even with the battery switch in the “OFF” position. It is recommended to turn the red battery switch to the “OFF” position when leaving the vessel for extended periods

Stereo Memory &  
Bilge Pump Fuse

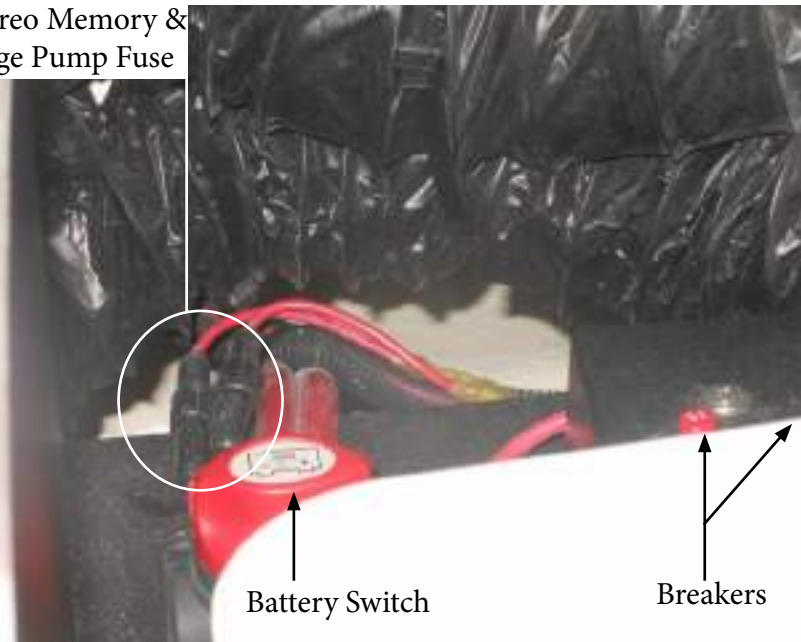

Typical Single Battery Switch

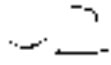

## Chapter 4

---

### CANVAS PREPARATIONS TO INSTALL BIMINI TOP



Before the top can be installed it must be removed from the boot. Push both sides of the latch inward simultaneously (green area) and pull on the ends of the latch to open it. Find the boot zippers in the forward center section of the top. Unzip the boot and remove it from the bimini top. Store it in a dry locker for later reinstallation. See the photo above.





## Systems

---

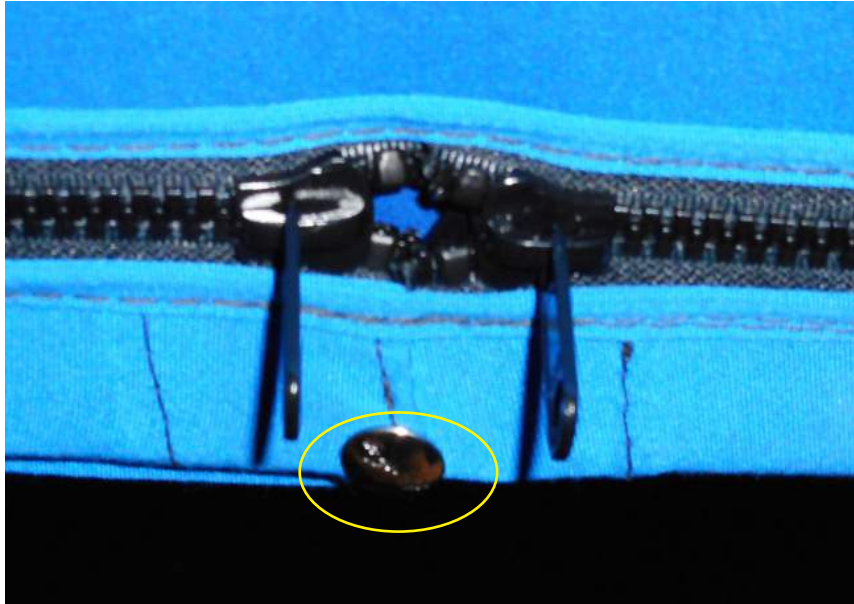

Once the boot is removed note there is an alignment snap in both the forward and aft center top bow. Always make sure these snaps are buttoned down or it may become difficult to install the top arms due to misalignment (bimini top not in the center of the forward and/or aft bow).

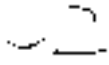

## Chapter 4

---

### INSTALLING BIMINI TOP/SUNSHADE W/O POWERTOWER

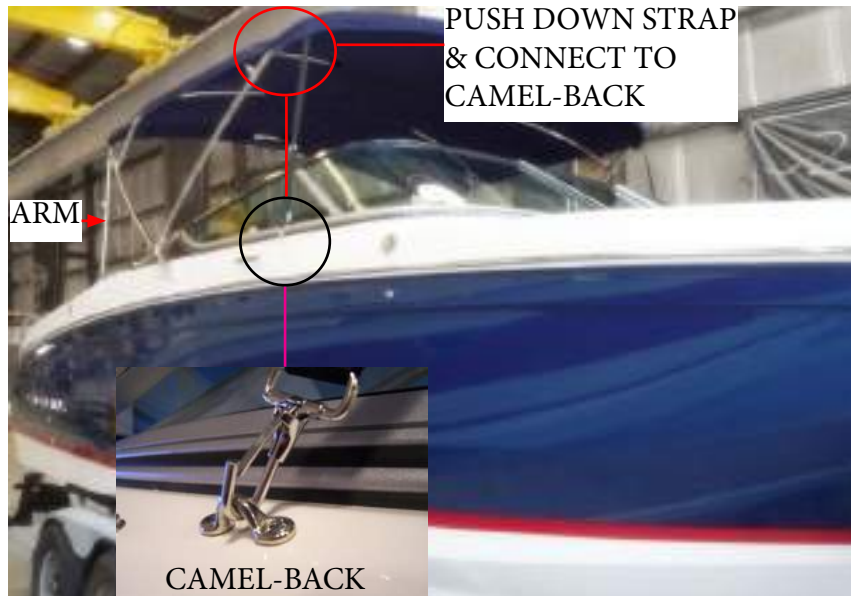

Your Regal boat features a bimini top fitted into a boot. This top provides sun protection for the bulk of your cockpit and helm. Stainless steel bimini bows provide support as your bimini top extends forward. *When using your bimini top, read, understand, and follow all warning labels attached to the aft bimini top.*

Pull the front bow forward and the bimini top will fold out. At this point pull down on each strap and fasten it to the camel-back hardware as shown in the photo. This process may require you to push down on the forward bow on each side to connect the strap to the appropriate camel-back. At this point you can adjust each strap as needed to tighten the entire top.

At the bimini top rear attach the arms on each side and secure by inserting the pin through the latch. On select bimini tops it may be advantageous to secure the aft bow arms before the forward camel backs are secured.

4-14



## Systems

---

### DIAGRAM AND INSTALLATION INSTRUCTIONS FOR BIMINI TOP/SUNSHADE-VESSELS WITH OPTIONAL POWERTOWER.

1. Find jaw between pins on bottom of port forward bow. Move sliding jaw over the top pin to release the forward bow and pull up to upper set of pins allowing the jaws to slide over the bottom pin and locking in between the pins (yellow arrow). See figure B. Do the same with the starboard forward bow.
2. Find one of the straight eyed arms as shown in **Figure B** on the following pages. Turn the white chafing block in a direction so its flat surface is between the straight arm and the PowerTower to protect it. While pushing down on the starboard forward bow align the straight arm with the forward end of the jaw and install the ball end of the straight arm into the front of the jaw. Install a lanyard pin which will lock it in place. Do the same with the other straight arm.
3. Locate the 90 degree aft arms. There are 2 each for the aft bows. See Figure B. Start with either side. Pull down on the aft top and insert the top arm into the top jaw. Lock the arm in place by inserting a lanyard pin. Repeat the same process with the lower 90 degree arm. Follow the same procedure with the 90 degree arms on the other side.
4. Note that the forward bow utilizes a strap and latch similar to the latch on the boot. This strap assists in holding the bimini top down as the vessel is making forward headway. Attach the upper and lower strap together and attach at the camel-back.  
***Remember not to exceed 35 mph with the bimini top up on the waterways Also, the bimini top must be disassembled and zipped into the boot before towing on the highway.***

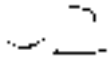

## Chapter 4

---

5. Perform the steps in reverse order to disassemble the bimini top. The sliding jaw on the forward bow will need to be pushed down to the lower set of pins on the forward bow on both sides for the top to set in the proper place. Use the arm retainer blocks to latch the arms in place.

Reinstall bimini top in boot and zip up the boot.

6. Be sure to read the canvas manufacturer's information regarding caring for your canvas and more detailed installation information which can be found in the owner's information packet.



### **WARNING**

PREVENT POSSIBLE BODILY INJURY AND PROPERTY DAMAGE  
DUE TO THE CANVAS/CANVAS HARDWARE DISLODGING!  
DO NOT USE BIMINI CANVAS CRUISING ABOVE A SPEED OF  
30 MILES PER HOUR. IF TOWING BOAT BEFORE TRAILERING  
MAKE SURE BIMINI TOP/SUNSCREEN IS ATTACHED TO  
HARDWARE SECURELY, ZIPPERED AND LATCHED  
INSIDE CANVAS BOOT!

# Systems

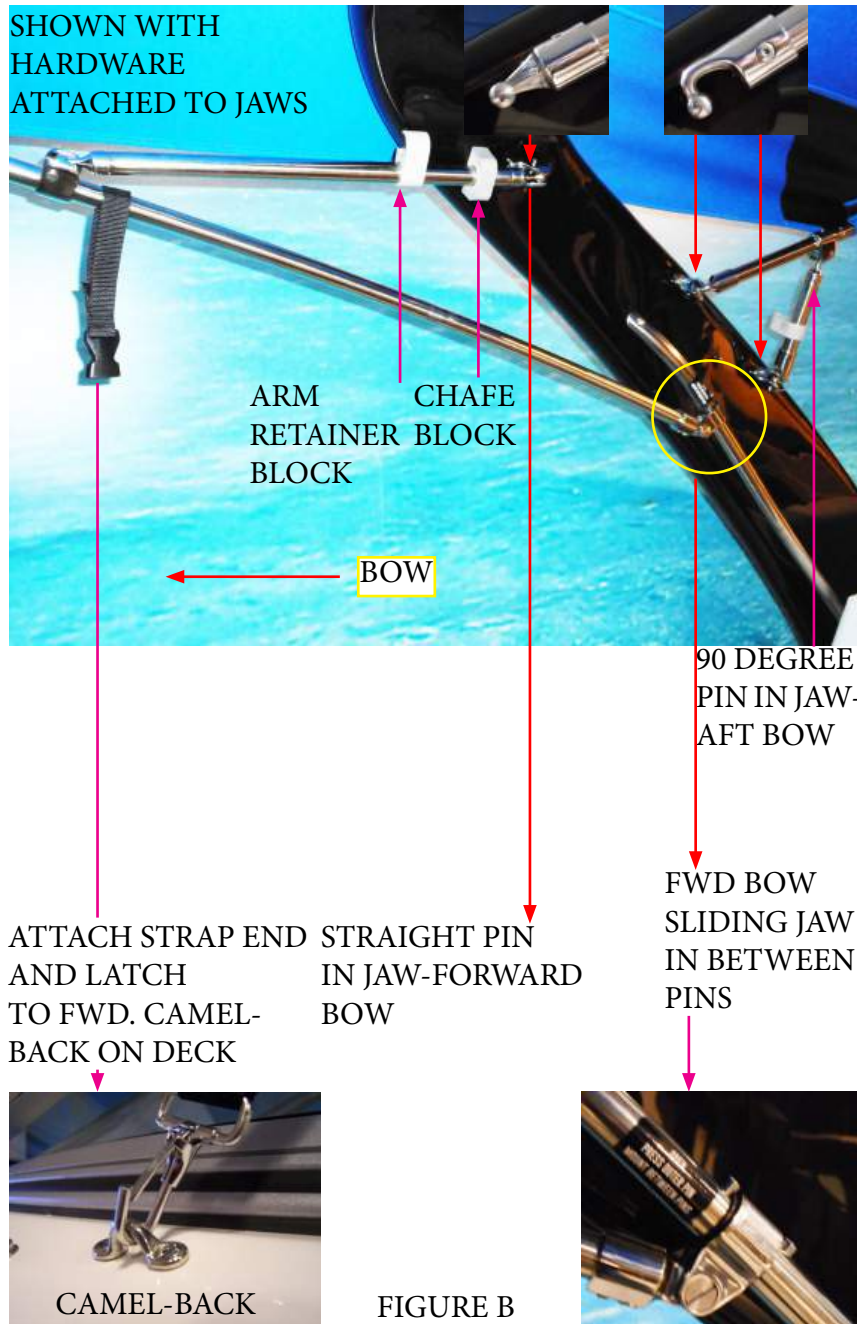

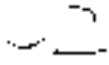

## Chapter 4

---

### BIMINI TOP/SUNSHADE PROFILES

Bimini Top/Sunshade





## ENTERTAINMENT

### STEREO-TYPICAL



The stereo is located at the helm. The unit features an Unidock and Bluetooth technology compatible for different brands of cell phones. See photo above.

An iPod features several adapters to cover an array of earlier and later vintage iPods currently in the marketplace.

Stereo over current protection is located on the fuse block behind the helm. For further information refer to the vendor manual located in the owner's information packet or search the Goggle under FUSION as a key word.

Note: Most modern electronic devices such as smart phones and tablets have a limited operating temperature range and smart phones are optimized to operate in a narrower temperature range than MP3 devices. All electronic devices generate heat during normal day-to-day use and to reduce temperature while they are being used may stop charging, the device may display a temperature warning, and eventually may shut down if the operating temperature exceeds its specified limits.

If you are in an environment where there is a high ambient temperature and the device shuts down while inside the unit, remove it and let it cool down.



# Vessel Operation



This chapter explores the many facets of running your vessel from casting off to docking and handling emergencies. We cover the basics but suggest you read other information on the chapter topics. Also, become familiar with your engine owner's manual since many of the items discussed here are found there in more detail.

## GETTING UNDERWAY

### Pre-Departure Questionnaire (Typical)

- Have all fluid levels been topped off?
- Is the fuel tank full?
- Is all safety equipment accounted for and easily accessible?
- Are navigation lights and horn operating properly?
- Is the bilge free of water and does the bilge pump operate?
- Is the engine, stern drive, and propeller in good working condition?
- Is the drain plug in place (dry stored boats put in water)?
- Have all passengers been briefed on emergency procedures and seated for departure? Is the boat load balanced?



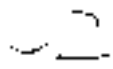

## Chapter 5

---

- Is the operator sober, alert and ready to skipper the vessel?
- Have all passengers been fitted for life jackets?
- Has a float plan been filed and left with a competent person?
- Has the bilge been sniffed and the fuel system leak checked?
- Are all seacocks open (if applicable)?
- Is all communication equipment in good operating condition?
- Has a second person been briefed on operational procedures should the skipper become disabled?
- Are all gauges and electrical switches functioning properly?
- Has weather information been gathered and analyzed?

### Underway Questionnaire

- After casting off have all dock lines and fenders been stowed?
- Are all passengers seated and all transom doors closed?
- As skipper are you monitoring the dash gauges for changes?
- As skipper are you on the lookout for changing weather?
- As skipper are you checking for abnormal vibration?
- Is the remote control safety lanyard (if equipped) tightly secured to your belt or clothing?



# Vessel Operation

---

## Disembarking Questionnaire

- Have you removed the keys from the ignition and secured them?
- Have all systems been checked for leaks?
- Has the battery switch been turned to the “off” position?
- Are all seacocks closed?
- Has the fuel tank been filled enough to prevent condensation?
- Is the vessel properly tied and covered with equipment stored?

## FUELING

 <b>DANGER</b>
AVOID PERSONAL INJURY OR DEATH! GASOLINE IS A HIGHLY FLAMMABLE AND EXPLOSIVE MATERIAL. PRACTICE “NO SMOKING” AND EXTINGUISH ALL FLAMMABLE MATERIALS WITHIN 75 FEET OF THE FUEL DOCK.

 <b>WARNING</b>
AVOID SERIOUS INJURY OR DEATH FROM LEAKING FUEL! INSPECT ENTIRE FUEL SYSTEM AT LEAST ONCE A YEAR.

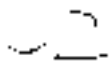

## Chapter 5

---



### **NOTICE**

SINCE GASOLINE IS AVAILABLE IN SEVERAL GRADES INCLUDING ETHANOL & VARIOUS OCTANE LEVELS, REFER TO THE ENGINE MANUFACTURER'S OWNER'S MANUAL FOR THE CORRECT ONE FOR YOUR ENGINE USING IMPROPER OCTANE FUEL CAN CAUSE ENGINE DAMAGE AND VOID THE WARRANTY.

#### Before Fueling

- Make sure a working fire extinguisher is available.
- Stop engines and any device that can cause a spark.
- Disembark all passengers and crew not needed for fueling.
- Fuel if possible during the daylight hours.
- Check to ensure nobody is smoking in the boat or near the fueling dock.
- Close all portholes, hatches and doors to keep vapors from blowing aboard and settling in the bilge.
- Tie up your boat securely at the fuel dock.
- Identify the fuel fill. Unfortunately, people have mistakenly filled the water or waste with fuel.
- Visually inspect all fuel system components before each filling.
- Avoid using fuels with alcohol additives. They can attack fuel system hoses and cause deterioration.

5-4



# Vessel Operation

---

## During Fueling

- Keep the fuel nozzle in contact with the fuel fill to guard against static sparks. The fuel fill pipe is grounded through the fuel system wiring to protect against static electricity.
- Avoid overfilling the fuel tank. Leave room for expansion. Also, if fuel exits the fuel vent indicating the tank is full, this situation is dangerous and unfriendly to the environment.
- Avoid spilling any fuel. Clean up any fuel accidentally spilled with a clean rag and dispose of it on shore.

## After Fueling

- Close all fuel fill openings tightly. Use a fuel key if needed.
- Open all portholes, hatches and doors.
- Energize the blower for a minimum of 4 minutes.
- Sniff in the lower bilge and engine compartment for gas fumes. If fumes are detected continue to ventilate until the odor is gone. Look for any traces of fuel droplets or spillage. Do not start the engines, smoke or run any electrical components except the blower until the fumes can no longer be detected.

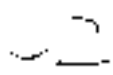

## Chapter 5

### STARTING & STOPPING

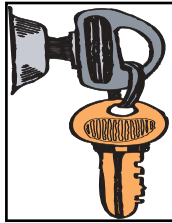

The following general information covers starting and stopping your engine. Read and understand all previous information on remote controls, fueling and operational procedures. Pay particular attention to all labels. Refer to the engine owner's manual for in- -depth propulsion system information.

#### Starting Guidelines

 <b>WARNING</b>
AVOID SERIOUS INJURY OR DEATH FROM GASOLINE VAPORS! BEFORE STARTING ENGINE, OPERATE BLOWER 4 MINUTES AND VISUALLY CHECK ENGINE COMPARTMENT AND PERFORM SNIFF TEST FOR GASOLINE LEAKS OR VAPORS. RUN BLOWER BELOW CRUISING SPEEDS.

Review all pre-departure information. Before starting your engine make sure all canvas is removed and stored. Start engine only in a well ventilated location to avoid CO buildup. Turn the battery switch to the number 1 or 2 position.

Set the remote control handle in the neutral position. Advance the neutral throttle position as instructed in the engine owner's manual. Connect the safety lanyard to a belt or secure to clothing such as a pants belt loop. Keep passengers seated and away from controls.

Turn the ignition key to the momentarily start position. You will hear the starter cranking over the engine. When the engine starts release the key switch. It will automatically align itself in the run position.

If the engine does not start, refrain from cranking the engine over 10-12 seconds. Allow the starter and battery a chance to recover. Advance the remote control in the neutral throttle position as recommended in engine manual. Do not race the remote control in neutral position.



# Vessel Operation

---



## CAUTION

TO AVOID ENGINE DAMAGE!  
CHECK THE OIL GAUGE IMMEDIATELY AFTER  
STARTING ENGINE. IF LOW OR NO READING SHUT DOWN  
ENGINE IMMEDIATELY AND INVESTIGATE THE PROBLEM.

### Shifting Guidelines



Before shifting into reverse or forward gear positions make sure the coast is clear. When shifting to either gear from neutral make sure the throttle is in the idle position. Always allow your vessel to lose all headway before shifting into reverse or forward gear. Practice shifting! You will become more familiar with the procedure and self-confidence will build especially in tight docking situations. Stay alert at all times!

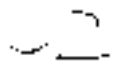

## Chapter 5

---

### Stopping

Before stopping the engine make sure the remote control is in neutral low idle speed. After an outing let the engine cool down at idle speeds for a few minutes before turning the ignition off. Glance at the gauges one last time to monitor their readings. *Do not pull on the safety lanyard versus the ignition switch to stop the engine.* Never turn off the engine off while in gear since water could enter the engine through the exhaust system and cause extensive damage. Above all, use common sense!



# Vessel Operation

---

## STEERING

Most vessels use a rotary or rack style steering system. These systems transfer helm mechanical motion to the engine. There is a hydraulic steering cylinder which with the assistance of a steering pump sends fluid force to the stern drive steering arm changing the course of the boat, depending on the direction the steering wheel is turned.

Since the steering system is the primary link for engine control, it must be periodically inspected and maintained. The hardware at both the helm and engine must be checked regularly for tightness. Check the steering system for full steering port and starboard before disembarking. Refer to the steering manufacturer's literature in the owner's packet and the maintenance chapter for more information.



### **WARNING**

AVOID SERIOUS INJURY OR DEATH!  
THE OPERATOR OF THE VESSEL MUST HAVE COMPLETE CONTROL OF THE HELM STEERING STATION WHILE THE VESSEL IS MOVING. NEVER LEAVE THE HELM STATION UNATTENDED WHILE THE VESSEL IS MAKING HEADWAY.



### **WARNING**

AVOID SERIOUS INJURY OR DEATH!  
LOOSENING OR LOSS OF ONE OR MORE FASTENERS MAY CAUSE FAILURE OF THE STEERING SYSTEM OR DAMAGE TO THE STEERING CABLE, RESULTING IN LOSS OF STEERING CONTROL INSPECT THE SYSTEM AT LEAST ANNUALLY.



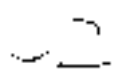

## Chapter 5

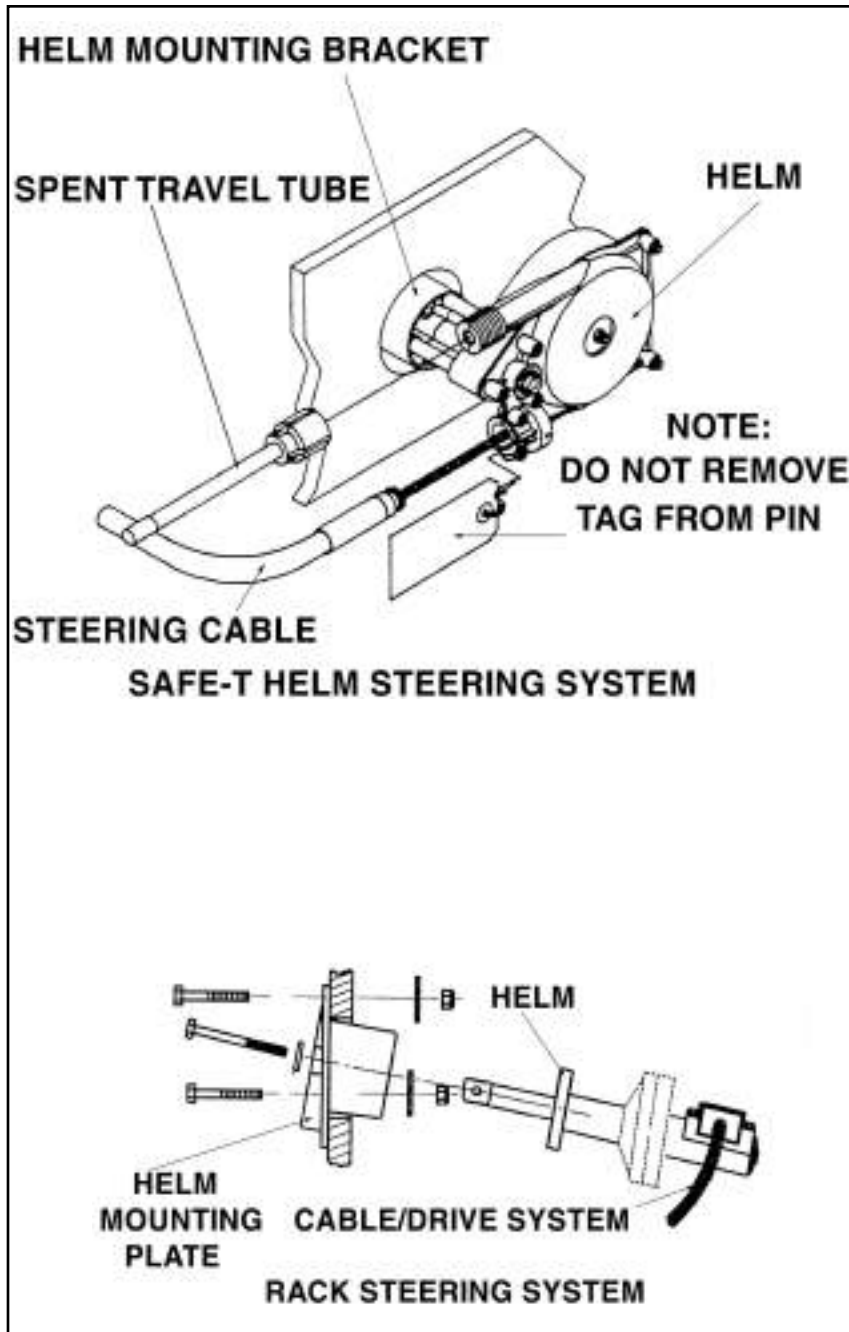



# Vessel Operation

---

## FENDERS

### Fender Usage

Fenders are normally made of a rubberized plastic and usually filled with air. Most have a fitting like a basketball so they can be inflated or deflated with a hand pump or air compressor. Fenders are available in a wide range of sizes and shapes to fit both small and large vessels. Fenders are normally designated in inches. They are used between piers, docks, sea walls and the boat. They protect the top sides of the boat from rubbing against rough objects. Most fenders have eyes of attachment which allow a line to be inserted vertically or horizontally. This will permit the fender to be tied off to fit a variety of marina, dock and tidal situations. Be sure the fender is correct for the vessel size. It is a good idea to carry extra fenders but half a dozen is normally an acceptable number. Remember to store fenders on board so they can be easily accessed. Some people incorrectly call fenders “bumpers”.

### Fender Types



There is a variety of fender styles and types, each selected for specified uses. When choosing fenders, contact a marine dealer or supply house. Explain how you moor and use your vessel so they can recommend the best fender type for you. We suggest the type with a fill plug so you can inflate them with a hand pump like the ones used for bicycles.

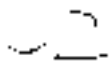

## Chapter 5

---

### DOCK LINE BASICS

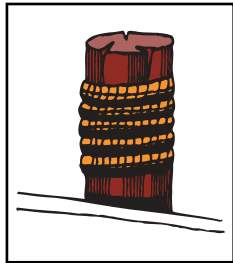

Most skippers use dock line terminology fairly loose but there is more to the basics than just bow or stern lines. There are several lines that can be secured to the bow and stern and depending on their direction and use, can be called other names. Remember that “forward” and “aft” refer to the direction that a spring line runs from the vessel, and not where it is secured on board.

#### Bow & Stern Lines

There is only one true bow line. It is secured to the forward cleat and run forward along the dock to prevent the vessel from moving to the stern. The stern line leads from a rear cleat to a piling or cleat on the dock astern of the vessel. This line keeps the boat from moving ahead. For small vessels these are the only lines needed for normal wind and current conditions. If located in a tidal environment, keep slack in the lines.

#### Breast Lines

These lines are attached to the bow and stern that lead to nearly right angles from the center of the vessel to the dock. They help keep larger vessels from moving away from the dock, or are pulled in to help people board the vessel. Larger vessels may use bow or quarter breast lines.

#### Spring Lines

Most small boats use two spring lines although it is possible to have four. They are called the after bow spring and forward quarter spring.



# Vessel Operation

Bow springs are secured at the vessels bow area. Forward spring lines lead forward from the boat to the dock and control movement toward the stern. After springs stem aft from the vessel, and stop movement ahead. Spring lines are used to prevent movement in a berth, ahead or astern. They are really useful in controlling the effects of a real active tidal surge. Spring lines are useful where fenders need to be kept in place against piles.

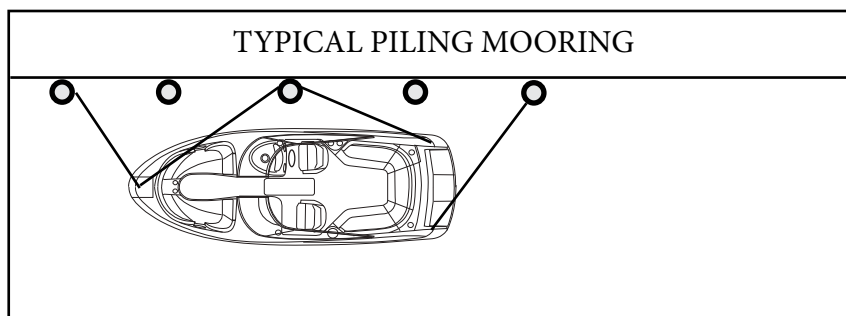
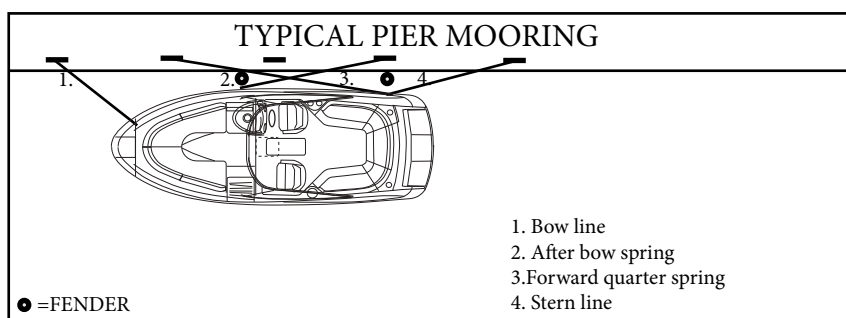

## Boat Mooring

Most boats can be secured to a dock using four lines. The after bow spring is crossed with the forward quarter spring and secured to individual dock cleats or pilings. This ensures longer springs and can be snugged up tighter for more efficient tidal control. Remember, if you only have one piling available, position the vessel so this point is opposite amidships. Run both spring lines to it. These lines will be shorter but still useful.

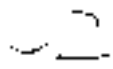

## Chapter 5

---

The bow and stern lines should be relatively at a 45 degree angle with the dock. The stern line can be attached to the near-shore quarter cleat, but will work more efficiently to the offshore quarter cleat. The longer line will allow the boat flow with the tide with less time checking the vessel.

### Dock Line Sizing

Most dock lines today are made of nylon, either of twisted rope or braided core and cover. The most often used material is nylon because of its stretching abilities absorbing shock loads. It is chafe resistant for extended life and is easier on bare hands.

The line's size varies with the vessel. Normally, a vessel in the 20' to 40' boats will use 1/2" diameter nylon lines. Larger yachts use 5/8" and 3/4" diameter nylon lines. Smaller boats can use 3/8" nylon lines. Dock lines need to have the strength to hold the vessel and have enough density to resist chafing. They shouldn't be too heavy that they lose their shock-absorbing capabilities. Use the right size line for the vessel since a line too large for the boat will pull hard against the vessel since it won't be forced to stretch. If the line is too small for the vessel, there is no margin for wear and chafe when under strain.

### Securing Lines

When mooring your boat, make sure the dock lines are secured at both ends. Depending on your situation you may need to loop the eye splice of the dock line around a piling. Sometimes the mooring line will lead down sharply from the piling to the deck cleat. Loop the eye splice around the piling twice to keep it from being pulled up off the pile. Pull the line through the looped eye if the mooring line is too small to go around the piling twice or too small to fit over once. If you must drop a line over a piling that already holds another boat's line, run the eye of the line up through the first eye from below, then loop it over the pile. This will allow either line to be removed without



# Vessel Operation

disturbing the other. If another line is dropped over yours, simply reverse the process. Secure a little slack in the other dock line, then slip your eye up through its loop and over the top of the pile. Your line can be dropped through the other eye.

When debarking from a dock, it is easier to release the line from a cleat or piling, from on board the boat, as soon as you leave the dock. Loop a long line around the cleat or pier and leading both ends on board you can release the line easily. Slip one end around the cleat or pile, then pull it back on board. Release the line without the eye splice, so it will run freely from around the pile without hanging up on the splice.

## STEPS TO STERN DRIVE DOCKING

Inboard/Outboard powered boats are fairly easy to back up and maneuver with a little knowledge and docking practice. One of the most important aspects of the process is to keep your calm in the wake of a busy marina. Basically, the reversing propeller is turned in the direction you want to go by using the wheel.

Some boats tend to be influenced by the wind. When backing down in a crosswind, allow room to maneuver and watch the bow. Try not to overreact or get excited, but use your knowledge and experience. If the wind begins to swing the bow, you need to stop backing, turn the wheel to port and go forward to straighten the boat. Use a quick burst of power but not too much to knock your crew off balance.

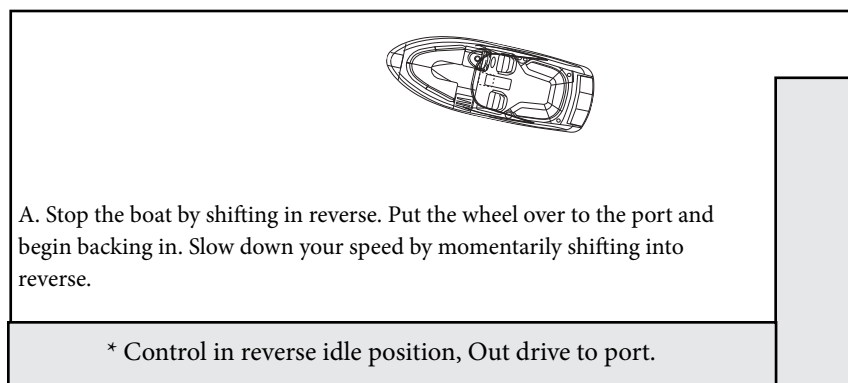

5-15

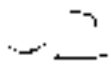

## Chapter 5

B. Continue backing up the boat with the wheel hard to port. Keep an eye on the bow, and begin to straighten the wheel as the boat enters the slip.

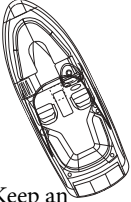

\* Control in reverse idle position, Out drive to port.

C. Center the wheel to align the boat parallel with the dock. If the stern is too far from the dock, shift to neutral, then put the wheel hard over to port and then go forward a second or two.

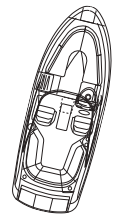

\* Control in neutral idle position. Out drive centered.

D. When the boat is completely into the dock, stop stern movement by shifting into forward. Put the wheel to port to kick the stern over close to the dock if necessary. Shift into neutral and tie up the boat.

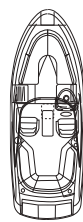

\* Control in forward idle position. Out drive to port.



# Vessel Operation

---

## STERN DRIVE MANEUVERING

Inboard/outboard, I/O or sometimes called stern drive boats do not have rudders. The boat uses a steering system that directs the propeller thrust, by turning the stern drive unit where the propeller is mounted. Normally maneuvering the I/O boat is easier than a similar single screw vessel.

Directing propeller energy (thrust) makes slower speed maneuvering easier. The propeller discharge current is turned from one side to the other which results in turning forces. Rudder boats need water to flow by the rudder to be efficient. Stern drive units are designed to have reduced shaft angle, so the propeller does not produce as much unequal blade thrust and resistance as does a propeller on a single screw boat. Large horsepower stern drive boats do produce more thrust and steering torque but your vessel has the advantage of power steering. Below is some basic information on how single stern drive boats handle in normal conditions.

### Gathering Headway

When a stern drive is not moving forward or reverse in the water and the propeller is not turning, (shift in neutral) the boat will not react to the helm steering wheel.

As soon as the vessel is shifted into forward gear the propellers action creates a discharge motion and generates energy in the form of thrust. If the stern drive is centered, the discharge motion is directed straight back causing the vessel to advance forward.

You may notice that if you advance the throttle quickly in initial take-off (make sure you have a firm grip on the wheel), the boat has a tendency to pull the stern of the vessel to starboard. There is a trim tab (also serves as a sacrificial anode) located on the vertical drive housing just to the top of the propeller blade. This trim tab helps compensate for the low speed steering torque. Once the boat increases headway and the propeller is operating in a faster water flow this torque effect decreases.



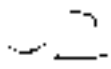

## Chapter 5

---

Sometimes the trim tab may need adjustment on stern drive models. Contact your Regal dealer for further information or consult your engine manufacturer's manual.

### Turning

Once the boat has gathered headway, with the boat planing at the correct bow angle and the stern drive unit and helm straight the boat tends to stay on a uniform course heading. To assure the boat trim angle is correct use the trim gauge as a guide while activating the trim button on the remote control panel.

When the helm wheel is turned to the right or starboard, the stern drive unit is turned in the same direction. The propeller's discharge force is directed to starboard forcing the boat's stern to port. Water flowing past the hull strikes the stern drive gear housing in its starboard side, creating additional turning torque. The stern starts a move to port, forcing the bow to starboard.

If the helm is turned to the left or port the stern drive turns to port, the stern of the boat goes starboard as the bow turns to port.

As the vessel operator gains experience, he will better gauge each maneuver and speed situation. In this way he will understand the handling characteristics of his boat. He needs to keep the safety of his passengers in the highest priority.

### Backing Down

Inboard/Outboard (I/O) boats do not have rudders. The boat uses a steering system that directs the propeller thrust, by turning the stern drive unit where the propeller is mounted. Normally maneuvering the I/O boat is easier than a similar single screw vessel.

If your boat has the steering wheel and stern drive straight with the control in reverse, the stern will be pushed a bit to port by the reversing propeller thrust. This tendency to back to port can be eliminated by turning the stern drive to starboard.



# Vessel Operation

---

When the vessel begins to gather speed to stern, the water passing by the lower gearcase housing will continue to increase steering torque. If the helm wheel is turned to starboard, and will direct the propeller thrust to port, tracking the stern to starboard.

Wind and current will affect how a vessel backs. Stern drive boats tend to be light displacements and when backing down in a strong crosswind, the bow will tend to fall toward the windward. This may cause steering problems.

Once increased headway is gathered in reverse gear, the force of the lower hull moving through the water is enough to track straight. When backing, the stern will lead as it heads to port or starboard, before the vessel actually starts to turn.

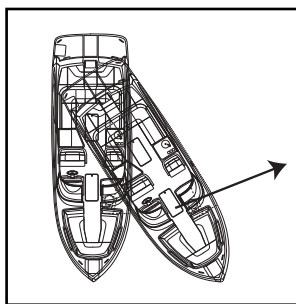

When the control is put in forward gear position, the stern is pushed to starboard; the amount of push depends on the hull design and the amount of throttle advance. See illustration.

## Stopping

Remember that your boat does not have any brakes. It uses reverse thrust from the propeller to stop. If the vessel has headway, with the helm and propeller in reverse the propeller thrust is directed backwards, past the lower gearcase of the stern drive.

Depending on how far the throttle is advanced, the discharged thrust may not be strong enough to reverse the water flowing by the gearcase. As the power is increased, the propeller thrust becomes strong enough to stop the flow of water past the lower unit, and, as the throttle is advanced it reverses its flow more completely.

When water is flowing past the gearcase, steering torque is increased, but when the thrust stops the water flow, the boat will not respond to the helm. This is a short lived event and is overcome quickly when the water again flows past the gearcase. Furthermore, added to the

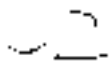

## Chapter 5

---

energy of the water hitting the lower gear case, the propeller thrust is directed by turning the stern drive, which can add to the steering torque.

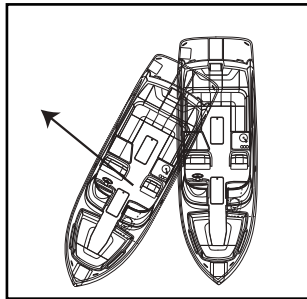

The prop tends to throw the stern to port. This is why experienced skippers undertake a portside landing when wind and current conditions permit. They allow the prop to move the stern to port toward the dock.

With a forward motion when the helm wheel is turned hard to one side, the vessel pivots around a point about 1/3 its length abaft to stern. See illustration.

### TRIM ANGLE

Stern drive boats have the ability to angle in or out their drive unit in relationship to the transom. This is accomplished by hydraulic shocks located on the stern drive along with an electrical sender unit that reads the drive angle and sends information to the dash trim gauge showing a reading.

#### Purpose Of Power Trim

The purpose of the power trim/tilt is to enable the operator to change the angle of the drive while at the helm. Changing the angle of the drive or “trimming” provides the following benefits:

1. Improves acceleration onto a plane.
2. Maintains boat on plane at reduced throttle settings.
3. Increases fuel economy.
4. Provides smoother ride in choppy water.
5. Increases top speed.



# Vessel Operation

---

In short, it is a way of fine-tuning the ride of your boat and will enable you to get the most efficient and comfortable ride possible, whatever the conditions.

## Use Of Power Trim

The power trim is normally used prior to accelerating onto a plane, after reaching the desired RPM or boat speed and when there is a change in water or boating conditions. Position passengers and equipment in the boat so that the weight is balanced correctly fore and aft as well as side to side. Trimming will not compensate for an unbalanced load.

To operate the trim, push the switch until the desired bow position is reached. The trim may be operated at any boat speed or at rest. Avoid operating the trim system when running in reverse. Observe the trim/tilt gauge which indicates the boat's bow position achieved by the trim angle of the vertical drive unit. "Bow-Up" corresponds to the upper portion of the trim range on the gauge while "Bow Down" corresponds to the lower portion of the trim range on the gauge.

To determine the proper trim angle, experiment a little until you are familiar with the changes in your boat. The vessel will be properly trimmed when the trim angle provides the best boat performance for the particular operating conditions. A trim position that provides a balanced steering load is desirable.

To familiarize yourself with the power trim, make test runs at slower speeds and at various trim positions to see the effect of trimming. Note the time it takes for the boat to plane. Watch the tachometer and speedometer readings as well as the ride action of the boat.

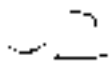

## Chapter 5

---

### Operation In “Bow Up” Position

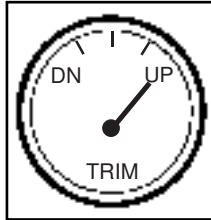

The “Bow Up” or out position is normally used for cruising, running with a choppy wave condition, or running at full speed. Excessive “bow up” trim will cause propeller ventilation resulting in propeller slippage. Use caution when operating in rough water or crossing another boat’s wake. Excessive “bow up” trim may result in the boat’s

bow rising rapidly, creating a hazardous condition.

### Operation In “Bow Down” Position

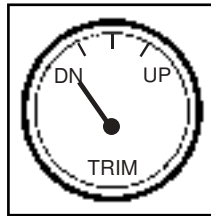

The “Bow Down” or in position is normally used for acceleration onto a plane, operating at slow planning speeds, and running against a choppy wave condition. It is also used when pulling water skiers, tubers, knee boarders, etc. In this position the boats’ bow will want to go deeper into the water. If the boat is operated at high speed and/or against high waves, the bow of the boat will

plow into the water.

### Operation In “Level” Position

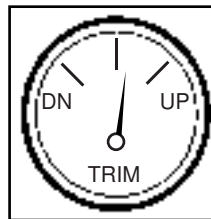

In normal running conditions, distribute passengers and gear so boat is level. At or below cruising speeds, trim the vessel for optimum performance. The trim gauge will show somewhere in the center of the gauge. This position will also enhance running visibility and overall stability. Again, each outing provides

different wave, load and running conditions. Make trim changes as needed.

# Vessel Operation



## NOTICE

THE BOAT TRIM SHOULD BE ADJUSTED TO PROVIDE BALANCED STEERING AS SOON AS POSSIBLE EACH TIME YOU GET UNDERWAY. SOME BOAT/ENGINE/PROPELLER COMBINATIONS MAY CREATE BOAT INSTABILITY AND/ OR HIGH STEERING TORQUE WHEN OPERATED AT OR NEAR THE LIMITS OF THE “BOW UP” OR “BOW DOWN” POSITIONS. BOAT STABILITY AND STEERING TORQUE CAN ALSO VARY DUE TO CHANGING WATER CONDITIONS. IF YOU EXPERIENCE BOAT INSTABILITY AND/OR HIGH STEERING TORQUE, SEE YOUR AUTHORIZED REGAL DEALER.

## Shallow Water Operation

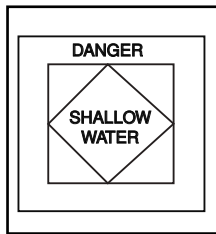

Operating your vessel in shallow water presents various hazards. You are more apt to hit a submerged object such as a rock, sand bar, stump coral, or other unmarked objects.

Pay close attention to your charts for descriptions of any shallow areas along with marked submerged objects. Always post a lookout when operating in shallow water. Trim your out drive up as needed to provide adequate draft. Set the alarm on your depth sounder and travel at a speed that will keep the boat level in these shallow areas. If your boat strikes a submerged object stop immediately and check for hull, out drive and propeller damage.

## Chapter 5

TRIMMED "TO FAR IN" POSITION

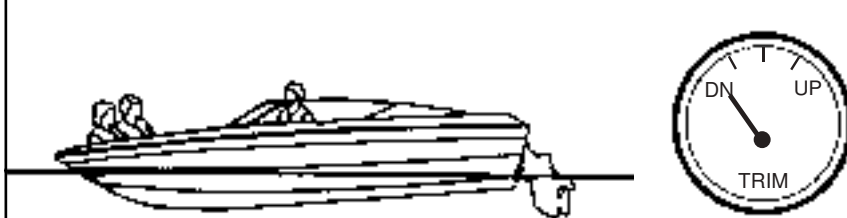

TRIMMED "TOO FAR OUT" POSITION

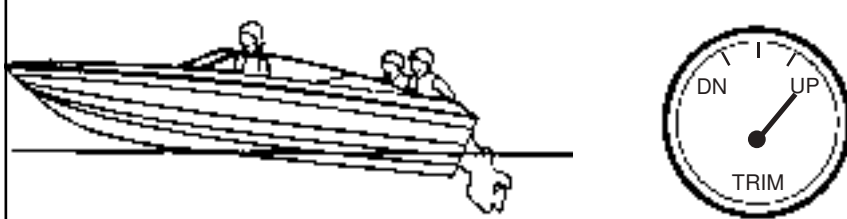

WELL TRIMMED "LEVEL" POSITION

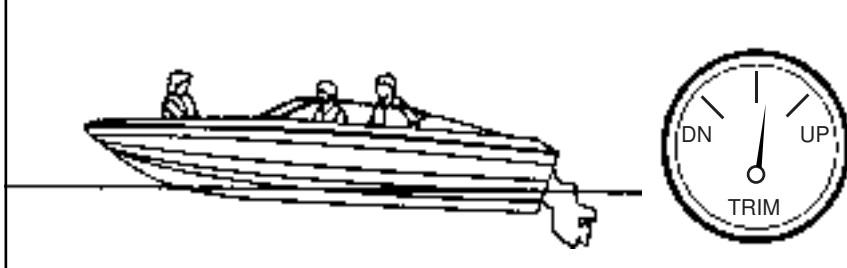

### CAUTION

DO NOT RUN ENGINE ABOVE 1000 RPM'S WITH THE STERN DRIVE TRIMMED FOR SHALLOW WATER MANEUVERING SINCE THE STERN DRIVE COULD BE OUT BEYOND THE GIMBAL RING SIDE SUPPORT BRACKETS. OPERATING IN ABOVE MANNER COULD PRODUCE A DANGEROUS STEERING CONDITION OR COULD DAMAGE THE STERN DRIVE COMPONENTS.



# Vessel Operation

---

## ANCHORING



Selecting the correct anchor is an important decision. The anchor style in part depends on the usage and boat type. Regal boats designate an anchor type and or model. Some models incorporate chain, line with an optional windlass. Contact an authorized Regal dealer for more information.

Anchoring is easier with another person on board. First be certain that the line for the anchor is properly attached, to avoid losing the anchor and anchor line overboard.

For most anchors to perform more efficiently, you should attach 3 to 6 feet of chain. The chain will stand up to the abrasion of sand, rock, or mud on the bottom much better than a nylon line. It should be galvanized to reduce corrosion. Next, attach a length of nylon line to the other end of the chain.

The nylon will stretch under a heavy strain cushioning the impact of waves or wind on both the boat and the anchor.

To anchor, select a well protected area, preferably with a flat bottom. Contrary to modern belief, you do not throw the anchor over while the boat is making headway, or moving forward. In fact, the bow of the boat should be brought slowly backward, while easing the anchor slowly over the side of the boat until it hits the bottom. To “snub the line” means to stop its outward “pay” or movement. Usually the length of anchor line used should be 5 to 10 times the depth of the water.

After you have anchored, check your position with landmarks if possible. You need to continue to monitor these landmarks to make sure you are not drifting. Since anchoring can also be an emergency procedure, the anchor and line should be readily accessible.

For increased holding power in windy conditions, two anchors are sometimes set. If your primary anchor drags, you can run out your secondary anchor without picking up the primary one. The important thing is to lay them out at an angle. When setting two anchors, make sure they are fastened to separate rodes or cleats. This is done in case you need to adjust one later so the line is accessible.

5-25



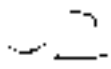

## Chapter 5

---

If two anchors are used ahead of a boat, make sure to set the rodes at an angle to reduce the chances of tangling as the boat moves in wind and current. See the above illustration.

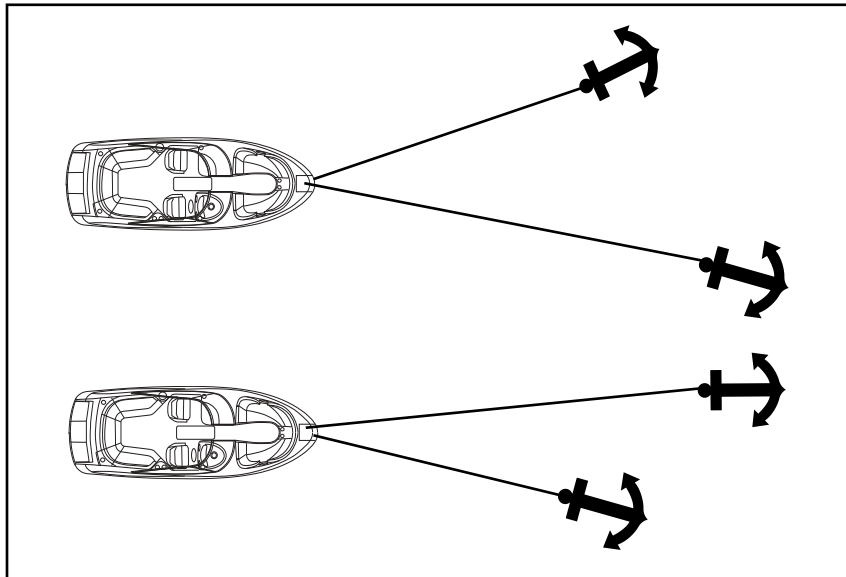

### TOWING

In case you find yourself aground or in need of a tow, or should you want to tow another vessel, keep in mind that you never use deck hardware or cleats to secure lines for towing!

Deck hardware is intended for mooring and anchoring, and is not designed to withstand the strain and pull of towing. Rather than tie the line to your cleats on deck, it is suggested that you tie a bridle by passing a line completely around the hull of your boat to avoid damage.

When towing, always stand clear of a taut line, as any type of line breaking under stress can be extremely dangerous. The preferred line for towing is double-braided nylon; as it has sufficient elasticity to cushion shock loads. Move slowly and cautiously.

5-26



# Vessel Operation

---



## **DANGER**

AVOID BODILY INJURY OR DEATH!  
DO NOT USE DECK HARDWARE INCLUDING CLEATS  
FOR TOWING PURPOSES.

### Law Of Salvage

The Admiralty law sometimes referred to as the salvage law was founded primarily on English law fundamentals and basically says that a vessel distressed, in danger of flounder, if rendered assistance from a towing company or private agency, can be forced to relinquish a portion of the vessels' worth for the assistance received.



## **NOTICE**

IN THE EVENT YOUR VESSEL IS IN DISTRESS,  
PRIOR TO ALLOWING ANY TOWING COMPANY OR  
PRIVATE AGENCY THE RIGHT TO PASS A LINE TO  
YOUR VESSEL, BE SURE TO ESTABLISH THAT YOU  
DO NOT AGREE TO ANY SALVAGE RIGHTS.  
ESTABLISH WITH THE CAPTAIN OR OPERATOR  
THAT YOU WISH TO BE ASSISTED IN A CONTRACT  
BASIS AND ESTABLISH A PRICE.  
OF COURSE IN CERTAIN SITUATIONS, YOU MAY  
NOT HAVE THIS OPTION.

**USE YOUR BEST JUDGEMENT!**

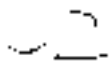

## Chapter 5

---

### Knots

Knots are useful in docking, towing and other emergency situations. Learning to tie knots requires practice. As they say “ Practice makes perfect”. Some of the knots used in boating are the square, bowline, anchor bend, clove hitch, figure eight and half hitch. There are several periodicals available that explain various knots and how to tie them effectively. An experienced skipper will know the basic nautical knots and will use them when on the water. Take the time to know the basic knots.

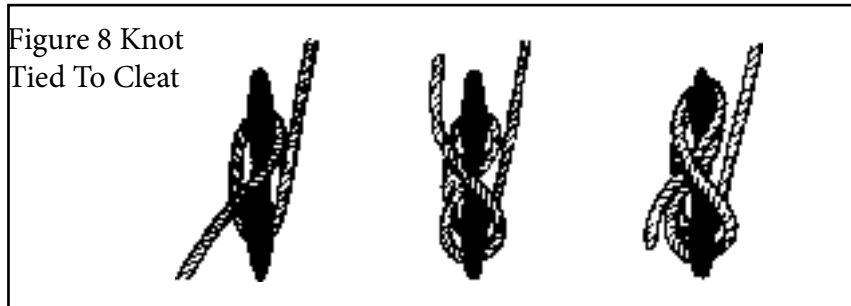

A useful knot to learn for general docking is the figure eight with one end reversed. By turning the free end of the line back under, the knot can be released without disturbing the boat. After some practice one person can secure a vessel easily to a dock or pier in a variety of weather conditions. This knot normally is used to tie the bow and stern. Then the vessel can further be fastened by tying the spring line in the figure eight knot. Wrap it around the cleat 2 or 3 times.



# Vessel Operation

---

## EMERGENCIES

Always be ready to help others on the water if possible, but do not take any unnecessary risks. Use equipment to save a life, but do not risk a life to save equipment. Consult earlier information in this manual concerning accidents, etc. Also, read other literature concerning on the water emergencies. Be alert and prepared!

### Fire

Fire aboard a vessel can spread quickly and can cause tremendous alarm among everyone. Most fires can be prevented by keeping the bilge free from oil and debris. Keep all equipment stowed and maintained in working order. Carry a backup fire extinguisher on board. If something becomes a possible fire hazard, remove that possibility at once.

Never use water on gasoline, oil or electrical fires. When you dump water on an electrical fire a you can be shocked since water conducts electricity.

Follow these instructions if a fire breaks out:

- A. Fit everyone aboard with a life jacket. Turn off the ignition.
- B. Try to keep the fire downwind. If the fire is to the stern, head the bow toward the wind. If forward, put the stern to the wind.
- C. If the engine should catch fire, shut off the fuel supply Usually there is a fuel tank access that you can crimp the fuel feed line.
- D. Use a hand fire extinguisher. Make sure to point it at the base of the flames. Use short bursts and sweep the extinguisher side to side. Remember : (4 lb. extinguisher discharges in 20 seconds)  
These actions help prevent the fire from spreading to other parts of the boat. You can extinguish fires quickly if you act swiftly. Have a plan of action in motion in case a fire breaks out.

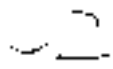

## Chapter 5

---

### FIRST AID

Knowing first aid can save lives. A first aid kit and the ability to use it are important ingredients for the safety of a skipper's passengers, crew and vessel. Having confidence and competence in handling medical emergencies on board is a must for the skipper. Invest your time in a first aid course available at the American Red Cross.

#### CPR (Basic Life Support)

If someone is seriously injured have another person call for help while the injured individual is being attended.

Check for possible danger signs; loss of breathing, unconsciousness, severe bleeding and heartbeat. If you determine the individual is not breathing or unconscious place the victim on their back on a hard surface and do the following:

1. If unconscious, open the airway. Neck lift, head lift or chin head lift.
2. If not breathing, begin artificial breathing. Pinch the nose. Give 4 quick breaths. If airway is blocked, try back blows, abdominal or chest thrusts and finger probe until airway is open.
3. Check for pulse. Begin artificial circulation. Depress sternum 2". 15 compressions rate 80 per minute. 2 quick breaths. Continue uninterrupted until advanced medical support is available.

Follow up immediately with medical authorities!



# Vessel Operation

---

## HYPOTHERMIA

Hypothermia is a condition where the body temperature decreases because the body can't generate enough heat to maintain its normal temperature. It can be serious and usually occurs where victims have been immersed in water (under 68 degrees) for extended periods of time. If you encounter a possible hypothermia victim call for help on the radio and get the person out of the water.

Symptoms are:

1. Shivering that if condition is advanced may stop.
2. Confusion, clumsiness or slurred speech.
3. Rigid muscles.
4. Semiconscious to unconscious.

Treat hypothermia by the following:

- ☒ Remove wet clothing.
- ☒ Monitor the victim's pulse and breathing.
- ☒ Rapidly apply heat to the body core by using blankets, naked bodies or warm water.
- ☒ Do not give the person any food or drink.
- ☒ Do not warm the arms and legs. Warming of these extremities can be fatal.

Follow up immediately with medical authorities!

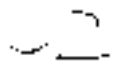

## Chapter 5

---

### ENVIRONMENTAL AWARENESS

There are numerous vessels operating on our waterways on a daily basis. Each boat has an impact on our environment. Boat operation habits, marine sanitation, and maintenance all play a role in a delicate battle to keep the ecosystem clean. Each of us has a role in doing our part as an environmentally conscious skipper to conserve our waterways.

The National Marine Manufacturer's Association lists their top ten of Eco-Boating Practices as follows:

1. Observe all regulatory agency policies regarding marine toilets.
2. If equipped with a holding tank, use marina pump-out facilities.
3. If used, make sure bottom paints are legal and ecosystem friendly.
4. Use only biodegradable cleaning agents.
5. Dispose of all garbage and litter on shore properly, not on the water.
6. Don't top off fuel tanks. Leave expansion room. Clean up spills.
7. Watch your wake and propeller wash.
8. Make sure your engines are well tuned and maintained.
9. Control your bilge water.
10. When fishing, practice the "catch and release" principle.

Follow these basic practices when on the waterways. Treat the environment in a way that you would like to be treated.



---

# Equipment Operation

This chapter will supply basic information to the boat operator to assist in understanding selected standard and optional equipment components on the vessel. Select equipment described here may not be installed on your boat or the pictorials may not exactly resemble components on your craft. Remember that equipment changes somewhat by boat model. Regal is constantly improving its product line and therefore may make changes in vendor parts and specifications without notice. *For detailed information on equipment, please refer to the owner's information packet.*

## AFTERMARKET ACCESSORIES

Aftermarket equipment can be controlled via accessory switches at the dash. Due to the selection of options like a PowerTower, docking lights, and pressure water your accessory switches may control a variety of systems. You may elect to have non-factory based accessories installed on your vessel. Ensure that your equipment is installed by a licensed marine professional and that it will not jeopardize the safety of your vessel. Don't forget to install the appropriate gauge wire and fuse for your aftermarket products. REGAL IS NOT RESPONSIBLE FOR PROBLEMS CAUSED BY AFTERMARKET INSTALLATIONS.



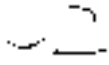

## Chapter 6

---

### AUTOMATIC FIRE EXTINGUISHER

#### Optional Automatic Fire Extinguisher

If installed the automatic fire extinguisher is mounted in the engine compartment. It uses sensors to automatically discharge when a fire occurs, although it can be manually discharged. Upon actuation, you may hear a sound similar to that of a small firearm, followed by a rushing air sound. A charged system shows a light at the dash indicator, while a discharged system shows no light at the indicator - refill accordingly.

Automatic activation will occur at different times depending on the severity of the fire picked up by sensors. WHEN THE FIRE EXTINGUISHER IS ACTIVATED, IMMEDIATELY SHUT DOWN ALL ENGINES, POWERED VENTILATION (BLOWER), ELECTRICAL SYSTEMS, AND EXTINGUISH ALL SMOKING MATERIALS. DO NOT OPEN THE ENGINE COMPARTMENT UNTIL A SUITABLE AMOUNT OF TIME HAS PASSED SINCE THE EXTINGUISHER STOPPED DISCHARGING. Opening the engine compartment prematurely may cause a reflash as air is allowed to fill the engine compartment. When opening the engine compartment door, have a hand-held extinguisher ready in case of reflash. Be cautious of hot metal when investigating the cause of the fire.

If a fire has started in the engine compartment, DO NOT wait for the automatic fire extinguisher system to kick in. Locate the fire extinguisher manual discharge lever after closing the engine compartment, and turning off the blower and electronic equipment. Remove the safety pin from the "T" handle, and pull firmly to release.



# Equipment Operation

For safety information, refer to your fire extinguisher label. General safety requirements are described in the safety on board chapter of this manual. For system information, refer to the systems chapter of this manual. Maintenance requirements are described in the maintenance chapter of this manual.

 **WARNING**

AVOID SERIOUS INJURY OR DEATH!  
DO NOT BREATHE FUMES OR VAPORS  
CAUSED BY AN EXTINGUISHING AGENT.  
VAPORS ARE HAZARDOUS AND TOXIC.



Typical Dashboard Automatic Extinguishing System Light

Typical Mounted Automatic Fire Extinguisher

Typical Manual Discharge Pin For Automatic Fire Extinguisher

## BATTERY SWITCH

### Standard Battery Switch

Your Regal uses an “ON” and “OFF” position battery switch located in the cockpit that not only provides power for the engine, but runs all the features on your boat. With this style switch, the operator simply turns the knob to the “on” position before starting the engine and to the “off” position when exiting the boat. Make sure the knob is fully detented when selecting the “on” or “off” functions. *Again, remember to deactivate the battery switch upon leaving the vessel.*

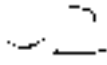

## Chapter 6

---



### **CAUTION**

AVOID DAMAGE TO THE ALTERNATOR  
AND/OR CHARGING SYSTEM COMPONENTS.  
NEVER TURN THE BATTERY SWITCH TO THE "OFF" POSITION  
WHILE THE ENGINE IS RUNNING.

## BILGE PUMP

Before each outing, check the operation of the bilge pump, automatic switch, and manual switch. The bilge pump should automatically activate when water reaches a pre-determined height in the engine compartment. Test the bilge pump manually at the dashboard with the switch. Periodically check for bilge debris around the grates of both the bilge pump and automatic switch, and also bilge pump impeller.

The automatic mode for your bilge pump works similarly to the manual method. Both methods control the bilge pump by a switch, but the automatic mode utilizes a float switch. Float switches have a float that sits at water level, and when the float reaches a certain height, it trips the switch and activates the bilge pump.

You may need to disassemble the bilge pump from the grate in order to clean or access the inner mechanisms. To remove the bilge pump, utilize the quick disconnect tabs on either side of the bilge pump, squeezing them like a backpack clip while pulling up on the pump.

For switch control location, refer to the engine and controls chapter. For bilge and drainage system information and electrical system information, refer to the systems chapter. Refer to the vessel operations chapter for pre departure use. Maintenance requirements are described in the maintenance chapter.



# Equipment Operation

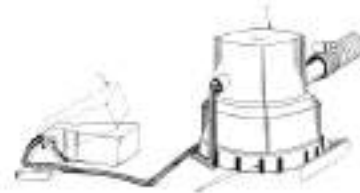

Typical Bilge Pump And Automatic Switch Diagram

## BLOWER



Typical Blower

On stern drive models a switch at the helm controls the bilge blower. The blower must be activated and run at least 4 minutes prior to starting the engine. The fan cycle removes air from the engine compartment. It is connected to the ventilation hoses reaching the lower 1/3 of your bilge. The blower must be

operated below cruising speeds.

For safety requirements on blower use, refer to the safety on board chapter. For switch control location, refer to the engine and controls chapter. Refer to the systems chapter for electrical system explanations. Refer to the vessel operation chapter for pre-departure use. Refer to the technical chapter for sump schematics.



## WARNING

GASOLINE VAPORS CAN EXPLODE. BEFORE STARTING THE ENGINE, OPERATE BLOWER FOR 4 MINUTES. VISUALLY CHECK AND SNIFF THE ENGINE COMPARTMENT FOR GASOLINE LEAKS OR VAPORS. ALWAYS RUN BLOWER BELOW CRUISING SPEEDS.

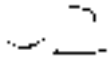

## Chapter 6

---

### CANVAS & COVERS

#### Bimini Top

Your Regal boat is equipped with a bimini top. Refer to the systems chapter where the installation process is explained in detail. Pay special attention to the diagrams for parts identification used in the application.

#### Bow & Cockpit Cover

The optional cockpit cover installs over the windshield and snaps to the deck. The cockpit cover is meant to protect the cockpit of the boat from weather elements, and is not used for towing purposes. The same is true for the bow cover. The bow cover, sometimes called a tonneau cover, protects the front of the boat from weather and snaps to the deck. Likewise, the bow cover should not be used for towing. The bow and cockpit cover usually snap and velcro together at the center windshield location.

To install the bow/cockpit cover:

First note that on the bow end of the cockpit cover, there is a velcro strip used to attach to an optional bow cover. This strip can be used to align the covers with your boat. Simply align the velcroed edge with the windshield.

Ensure the center windshield is in the closed position. Start snapping the cover to the deck by use of the eyelet snaps, starting at the bow and working aft.

Notice in the middle underside of your cover, you may find an area of reinforced canvas with an eyelet snap. This snap connects to a



## Equipment Operation

cockpit cover pole. This pole is adjustable, and by opening the lock, the pole can telescope out to the desired length. This pole should push the canvas up when standing straight up on its rubber enclosed foot. The purpose here is to prevent the pooling of water. The same is true for your bow cover.

Continue snapping the cockpit cover to the deck snaps. When you reach the rear corner, leave enough room to allow a safe exit.

The cockpit cover and bow cover should be rolled up for storage inside the ski locker when trailering or storing your boat. This canvas should not be used while the engines are running, or when towing.



### NOTICE

TO AVOID DAMAGE TO THE CLEAR PLASTIC CANVAS WINDOWS (IF INSTALLED) ALWAYS ROLL CANVAS PARTS VERSES FOLDING THE COMPONENTS.



Typical Cockpit Cover

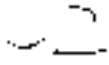

## Chapter 6

---



Typical Bow Cover



### **WARNING**

AVOID PROPERTY DAMAGE AND PHYSICAL INJURY.  
DO NOT USE THE COCKPIT OR BOW CANVAS WHEN TOWING  
BOAT. USE TRAVEL COVER. FOLLOW MANUFACTURER'S  
INSTRUCTIONS FOR INSTALLATION AND TOWING WITH  
TRAVEL COVER.



# Equipment Operation



Typical Travel /Storage Cover

## Storage/Travel Cover

The optional travel/storage cover is the only cover approved for towing purposes. The storage cover is meant to keep debris out of your boat while trailering or when in storage.

To install the storage/travel cover:

Place the cover over your boat from bow to stern with a closed windshield. Use the aft ratchet system to strap the cover in place and prevent damage caused by loose canvas. Cleats should protrude from the travel cover as well as a closed bimini top if installed. Latch all strap connectors before towing. See detailed info on next page.



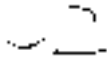

# Chapter 6

## Storage/Travel Cover Installation Information

**▲ WARNING:** To prevent damage to your boat and/or cover please read and understand instructions before attempting to use cover.

It features:

1. **ON SOME MODELS:** A special anti-pooling system is included to prevent large puddles from ruining your cover.
2. The SunLace® all-weather fabric was chosen to allow stability, water repellency and breathe-ability.
3. The Vacu-Hold™ system allows trailering at highway speeds (65 mph) without billowing or buffeting.
4. The new ratchet and drawstrip type attachment will allow easy, tight and secure installation.

### CARE, WARRANTY AND INSTALLATION INSTRUCTIONS

**Hint-** To properly install ratchet strap system:

1. Pull the webbing through the channelled ratchet cylinder and tension while ratcheting to "start" the webbing.
2. Tension the ratchet with about 5 lbs. of pressure (pinkie finger). Pull the sides of the cover to even the webbing throughout. Retension about 5 lbs. (the ratchet should be tight on the side of the boat level, perpendicular to the hull).
3. Check the ratchet approximately 3 full additional times to add tension (based on an 18' boat).
4. Check boat webbing for tension during slope while trailering. (webbing may stretch during first installation and use. CHECK OFTEN).

**▲ WARNING:** Readjust and re-tighten the cover after trailering and before storage. To prevent pooling do not allow snow and ice to accumulate on the cover. Never trailer at speeds above the speed limit.

**CARE INSTRUCTIONS-** Wash with warm soapy water (while installed if possible) and allow to air dry. For stubborn stains, mild detergent is recommended.

Storing the boat in constant direct sunlight will shorten the life of the cover and the components used to construct it. We recommend storing the boat in a location that exposes it to some sun and also shades it throughout the day. Preferably morning sun and afternoon shade.

**WARRANTY-** This cover includes a two-year warranty from date of purchase against any defects in material or workmanship. If you incur any problems or have any comments please contact your dealer or call Commercial Sewing Customer Service directly at (855) 482-5503.

### PROPER INSTALLATION-

#### A. Pooling System Installation:

**Note:**

Install anti-pooling system as per illustration putting the front webbing to the cleats, standing pole upright. Pull the other two webbing straps to the two rear cleats. Tighten adjustable buckle strap, until the pole stands upright.

#### B. Proper Cover Installation:

- Place cover on boat starting at front, use cleats as buttons to keep cover in place, work toward back over pooling system.
- until back cleats are "buttoned" in place.
- Maneuver in place until cover fits over gunwale. Check the symmetry. Connect the confidence straps through the openings on the swim platform to the "U" bolts. Disconnect velcro wrap around ratchet. Begin ratcheting by unzipping ratchet pocket(s) and pulling ratchet(s) handle in right-to-left motion until zippered ratchet pocket no longer sag but rests against the hull.
- Pull on webbing to even the tension around the cover and again tighten the ratchet until it does not sag but rests against the boat. Tighten ratchet four to five more times. The ratchet should be very hard to pull with your pinkie finger. Zip ratchet pocket closed and connect velcro wrap around ratchet pocket. **On some models:** Connect the rear strap holdowns in the back of the boat.

**Note:** Proper installation and operation of this cover requires that it be very tight at the gunwale. Retighten as necessary before, after and during stops while trailering. **BE SURE** cover is installed below gunwale before final ratchet adjustment. ZIP ratchet pocket closed for final installation.

**▲ Warning:** Zippered ratchet mechanism should be hand tightened only. Do not pry or attempt to operate ratchet mechanism with any type of tool.

### REMOVAL-

- Disconnect velcro wrap & zip open ratchet pocket.
- Follow instructions on ratchet label to release pressure.
- Once pressure is released pull out webbing to allow simple future installation, then close handle and ZIP POCKET closed (this is important to prevent damage in future installation).
- Disconnect holddown straps. Remove and fold cover working from rear to front.

### ANTI-POOLING POLE STORAGE-

- Disconnect anti-pooling pole from either the front (colored webbing) or back.
- After disconnecting collapse poles by pushing buttons and telescoping them down.
- Wrap webbing around poles.

ISSUE#CC010304

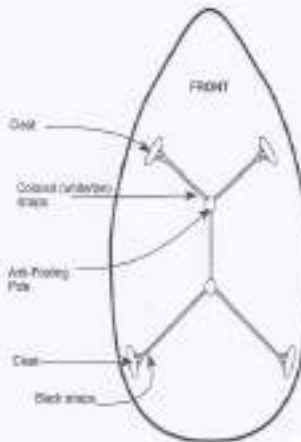



# Equipment Operation

## BOW FILLER CUSHION



To set up the bow filler cushion find the two stainless steel bars (usually stored in the center floor storage area next to the helm) and the cushion.

Install the shorter bar in the front cut-out. Install the longer bar at the aft cut-out. See photo. Install the filler cushion. Always store the bars in the holder after each use and the cushion in a storage locker.

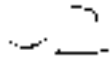

## Chapter 6

---

### BOW WALK THROUGH DOORS



To set up the bow walk through doors simply pull each door to the center of the walkway and lift the stainless steel latch enough to clear the top of the doors and lower the latch to hold the door set in place. The doors provide a barrier to the elements such as wind, rain or wave action at the bow.

Ensure that the center windshield latch set is locked after setting up the doors.



## Equipment Operation

---

### COCKPIT CARPET



Cockpit carpet features a forty ounce weight with a heavy duty non-skid marine backing. As required, snaps are installed. When removing carpet use care when pulling on the snaps. Use silicone spray on snaps. Note: Before towing on the highway roll-up the cockpit carpet and store it in a locker to prevent it from blowing out of the vessel. Do not yank on the carpet to remove it as you may pull out a snap. When storing cockpit carpet always roll it verses folding it. Also, before rolling it for periods of extended storage make sure the carpet is dry to help eliminate odors and possible mildew.

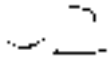

## Chapter 6

---

### COCKPIT SEAGRASS MAT



If installed, cockpit seagrass mats feature urethane backing for marine environments. The mats provide style, comfort and durability as well as additional protection in environments where microbes are a concern.

Chilewich® products contain Microban®. This antimicrobial protection inhibits the growth of stain and odor-causing bacteria, mold and mildew for the product's life.

When storing your Seagrass mats, always roll with the face of product out and the backing facing in. Do not fold or crease as the backing may split. Vacuum or hose off for regular cleaning. Dry face up or hang. Do not machine wash. Matting may be cleaned with a mild detergent and a sponge. Rinse with fresh water.

6-14



# Equipment Operation

---

## COCKPIT TABLE



As an option, a composite cockpit table can be used at the bow and aft cockpit.

To use the table find the table pedestal leg normally found in a cockpit storage locker. Next, install the table pedestal leg in the table receiver underneath the table. Next, install the table with leg in one of the receivers securely. Pull the latch pin and hold until the table pedestal leg slides in the receiver sleeve. Then release the latch pin to lock the pedestal leg in the receiver. Periodically lubricate the latch pins with a silicone lube spray.

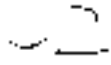

## Chapter 6

---



Showing Table In Bow Receiver



Showing Table In Cockpit Receiver



Showing Table Receiver



Showing Pedestal Leg In Table Receiver



# Equipment Operation

---

## DOCKING LIGHTS



If installed docking lights are integrated into the hull near the bow on both port and starboard sides. They are very useful for night mooring and maneuvering.

To operate turn on the helm switch marked “docking lights”. It is recommended not to use the docking lights while navigating in open water at night since the illumination could cause a glare on the bow navigation light possibly causing visibility problems for other vessels.



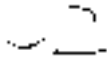

## Chapter 6

### DUAL BATTERY SWITCH



If installed the dual battery system features an additional Group 31 A battery for additional emergency engine cranking power. Also, included in this system is a dual battery switch. This permits the operator to select an additional position on this battery switch named “combine

batteries”. Let’s say the engine cranks very slow in the battery switch “on” position. When “combine batteries” position is chosen both batteries operate together for increased engine starting power.



### NOTICE

Note that if one battery is weak choose the “combine batteries” position on the battery switch in order for both batteries to initiate the charging process. If the dual battery switch is left in the “on” position both batteries will not charge up since the engine alternator /stator can not recognize the other battery in the “on” position.

**Once the reason for a weak battery is found and repaired and both batteries are recharged then the battery switch should be turned to the “on” or single battery position.**

# Equipment Operation

## DUAL BATTERY SWITCH (continued)

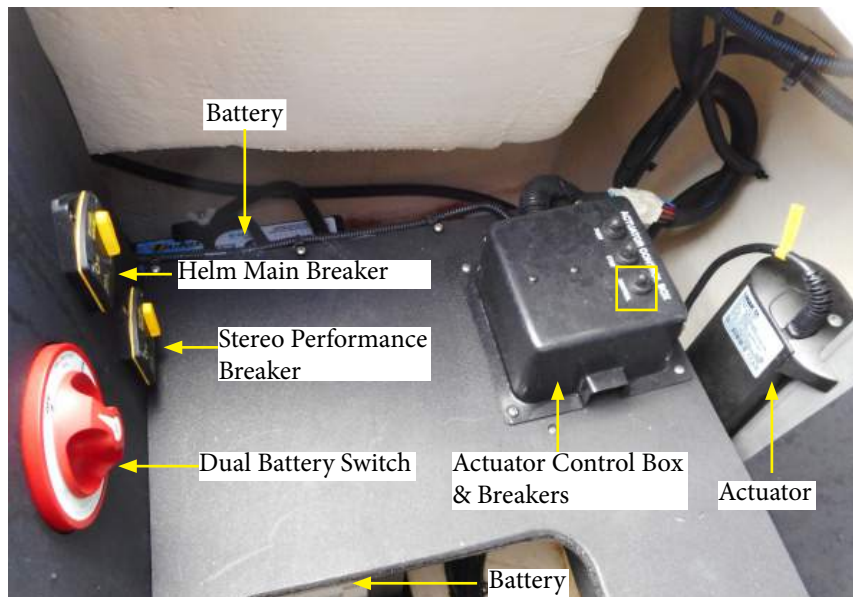

Typical Dual Battery System Description With Power Tower

Here is a typical layout for vessels using the dual battery system. The main breaker that protects the battery circuit and the helm wiring is rated at 50 amps. If the stereo performance package is installed a 40 amp breaker protects the system especially the amplifier which is located under the helm. It can be accessed by lifting up the starboard bow seat back. A separate fuse may protect select amplifier systems. Note that the 2 Group 31 batteries shown in the above photo for location purposes may require periodic maintenance such as post cleaning, adding distilled water, and tightening battery post and hold down hardware. See the battery maintenance chapter of this manual for battery post cleaning information. The actuator control box incorporates 2 breakers that protect the port and starboard actuators which control the optional PowerTower forward and backward motion (down and up). Also, as part of the actuator box a separate

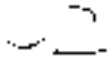

## Chapter 6

---

### DRAIN PLUG



If your boat is towed to the launching ramp ensure that the drain plug is installed with a wrench not just finger tight. Do not overtighten it. The drain plug is made of a polymer material that is very hard and resistant to the water environment. When relaunching on trailer pull the drain plug and let any accumulated bilge water drain out at the ramp. Run your

finger through the opening to clear any debris.

If using “dry” storage racks at marinas make sure the drain plug is removed anytime the vessel is in dry dock.



# Equipment Operation

## POWERTOWER-TYPICAL

As part of the innovative design the PowerTower hinges forward for tight overhead clearances such as bridges, restricted storage situations and towing opportunities. Read and understand the warning label on the following pages regarding PowerTower usage.

The PowerTower features an FRP framework, all around light, and the ability to anchor major electronic equipment. Select towers feature a pylon for water sports. Use the switch marked “tower” found on helm panel to energize the power tower. It connects to twin actuators that raise or lower the PowerTower.



### NOTICE

For highway towing over 35 mph the PowerTower shall be upright with all canvas zippered and stowed in their dedicated boots. All attached canvas bow hardware shall be checked for tightness before and after towing.

Cockpit carpet shall be rolled up and stored in a dedicated locker.

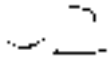

## Chapter 6

---

### POWERTOWER (Continued)

 <b>WARNING</b>
AVOID BODILY INJURY! WHEN OPERATING POWERTOWER KEEP ALL BODY PARTS CLEAR OF TOWER HINGE MECHANISMS.

Make sure the operator and all aboard read and understand the above warning.

Before energizing the PowerTower switch explain to all passengers that they shall maintain a safe distance from the tower hinge mechanisms located at the base of the power tower on the deck.

As the operator energizes the switch to hinge the tower forward visually monitor the port and starboard deck to ensure all passengers are clear of the hinge mechanism. This same procedure applies for lowering the mechanism to the cruise position.



The Power Tower features an actuator control box. This component is located in the sump (bilge). The unit provides over current protection through a set of breakers on the face of the actuator box. Facing the box the left reset breaker protects the port power tower lift actuator. The center reset breaker protects the starboard power tower lift

actuator.

The far right breaker protects the entire circuit wiring. If the Power Tower fails to raise check the box for an “open” breaker. Always find the cause of an open breaker situation before resetting the device. For further information, refer to earlier pages in this chapter.



## Equipment Operation

---



### **WARNING**

AVOID BODILY INJURY OR DEATH DUE TO MISUSE OF THE SPORTS TOWER! DO NOT PULL MORE THAN TWO (2) PEOPLE AT A TIME FROM THE SPORTS TOWER. USE SPORTS TOWER ONLY FOR KNEEBOARDS, WATER SKIS, WAKEBOARDS, OR SINGLE PERSON WATERSPORTS PRODUCTS. THIS SPORTS TOWER WAS NOT DESIGNED AND SHALL NOT BE USED FOR TOWING OF BOATS, PERSONAL WATERCRAFTS, FLOATING DOCKS OR ANY OTHER TYPE OF FLOATING VESSEL OR CRAFT. THIS SPORTS TOWER SHALL NOT BE USED FOR PULLING PARASAILING OR ANY OTHER EQUIPMENT NOT APPROVED. THIS SPORTS TOWER SHALL NOT BE USED TO PULL INFLATABLE WATERSPORTS TOYS OF ANY KIND. NEVER LET PASSENGERS SIT DIRECTLY BEHIND THE SPORTS TOWER ROPE ATTACHMENT POINT WHILE PULLING APPROVED WATERSPORTS ACTIVITIES, DO NOT LET LOOSE WATERSPORTS ROPE HANG FROM THE SPORTS TOWER. ALWAYS INSPECT THE SPORTS TOWER PRIOR TO USE TO ENSURE IT IS NOT DEFORMED, DEFLECTED, AND THAT ALL BOLTS ARE IN PLACE AND TIGHT. WATER LEVELS CAN VARY DAILY AND IN SOME CASES HOURLY. BE AWARE OF MINIMUM CLEARANCE OF BRIDGES, TREE LIMBS, AND OTHER OBSTACLES, BEFORE ATTEMPTING TO PASS OR GO UNDER ANY OVERHEAD STRUCTURE.

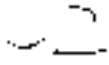

## Chapter 6

---

### PRESSURE WATER SYSTEM



A transom cold water shower/wash down using a pressurized water system is available on select models. It consists of a 11 gallon water tank, deck fill/vent, water pump/strainer, piping and of course the transom mounted sprayer with hose. The option is very useful for rinsing off when exiting from the water and helps keep the swim platform clean. In salt areas it can be used to spray off the aft ladder, hardware and assists in reducing corrosion.

There is a helm switch labeled FRESH WATER PUMP that controls the water pressure to the pump/strainer which in turn delivers the water to the transom shower sprayer.

Remember in freezing climates, drain the system and add Winterban or similar protective additive to the water system.

Turn the sprayer wand to activate/deactivate water flow.

6-24



# Equipment Operation

## PRESSURE WATER SYSTEM (Continued)

It is important not to operate the pump unless there is water in the fresh water tank since damage to the pump may occur. Energizing the switch allows the pump to increase the water pressure in the distribution lines to a level to provide the best flow at the shower/wash down head. When the pump reaches its highest level the pump should automatically shut off. If the system drops below a certain pressure then the pump will restart. If the pump cycles on and off with no water being used, a leak in the water system is likely. Periodically remove the water inlet strainer/filter combo and clean it. Additional filters can be ordered through your Regal yacht dealer or marine outlets. Be sure to turn the water pump helm switch to the “off” position upon exiting the vessel.

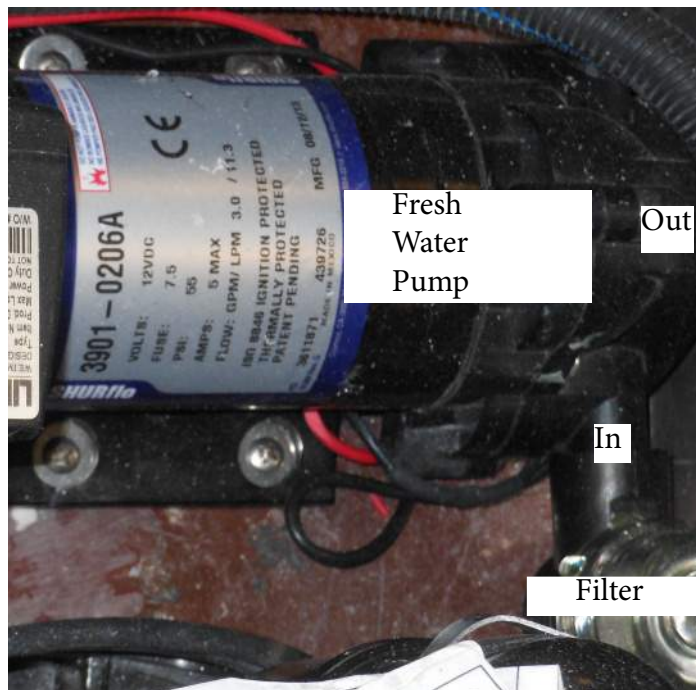

TYPICAL FRESH WATER PUMP



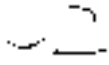

## Chapter 6

---



This label identifies the fresh water system used on this vessel as non-potable (not drinkable) and is found on the fiberglass near the component or directly attached to the transom spray wand.



### **NOTICE**

THE FRESH WATER SYSTEM IS NOT POTABLE (DRINKABLE).  
USE IT FOR RINSING AND WASH DOWN PURPOSES ONLY.



# Equipment Operation

---

## SEADEK SWIM PLATFORM



If installed, SeaDek® is located on swim platform and walk through areas. The non-skid, closed cell material is derived from UV protected non-absorbent foam. You will find the product easy to clean with a high stain resistance.

Other features include noise reduction, great traction even when wet, body comfort when standing, walking or leaning on the swim platform.

To clean small dirt particles first try soap, hot water and a stiff brush.

For surface dirt and footprints use glass cleaner and a clean rag.

If a more thorough cleaning is needed you may use bleach, 409, Simple Green or Soft Scrub.

Stay away from using any acid base cleaners.

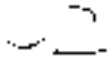

## Chapter 6

---

### SEAT OPERATION- HELM W/ BOLSTER



The bucket helm seat features forward and aft movement, as well as a swivel motion that allows the seat to pivot, and a flip up bolster cushion that allows any user to control his/her comfort and position.

To adjust the fore and aft helm seat position:

Loosen black fore & aft adjustment handle A located amidships by turning counter clockwise. Then slide the seat to the desired location and retighten the handle.

To swivel the seat:

Loosen handle C. Pull up on swivel handle B to unlock the detention system. While the detention system is unlocked, pivot the seat to the desired position. Be sure to lock the swivel handle B in the de-tented position by pushing down on the handle and finding a locked position. Tighten handle C. DO NOT run the vessel unless the swivel is in the locked position.



### CAUTION

TO PREVENT BODILY INJURY PERIODICALLY CHECK AND TIGHTEN THE MOUNTING BOLTS BETWEEN THE SEAT SLIDER AND THE BUCKET SEAT BOTTOM. ALSO, CHECK THE FLOOR INSERT BOLTS.

# Equipment Operation

## SEAT OPERATION- HELM W/ BOLSTER

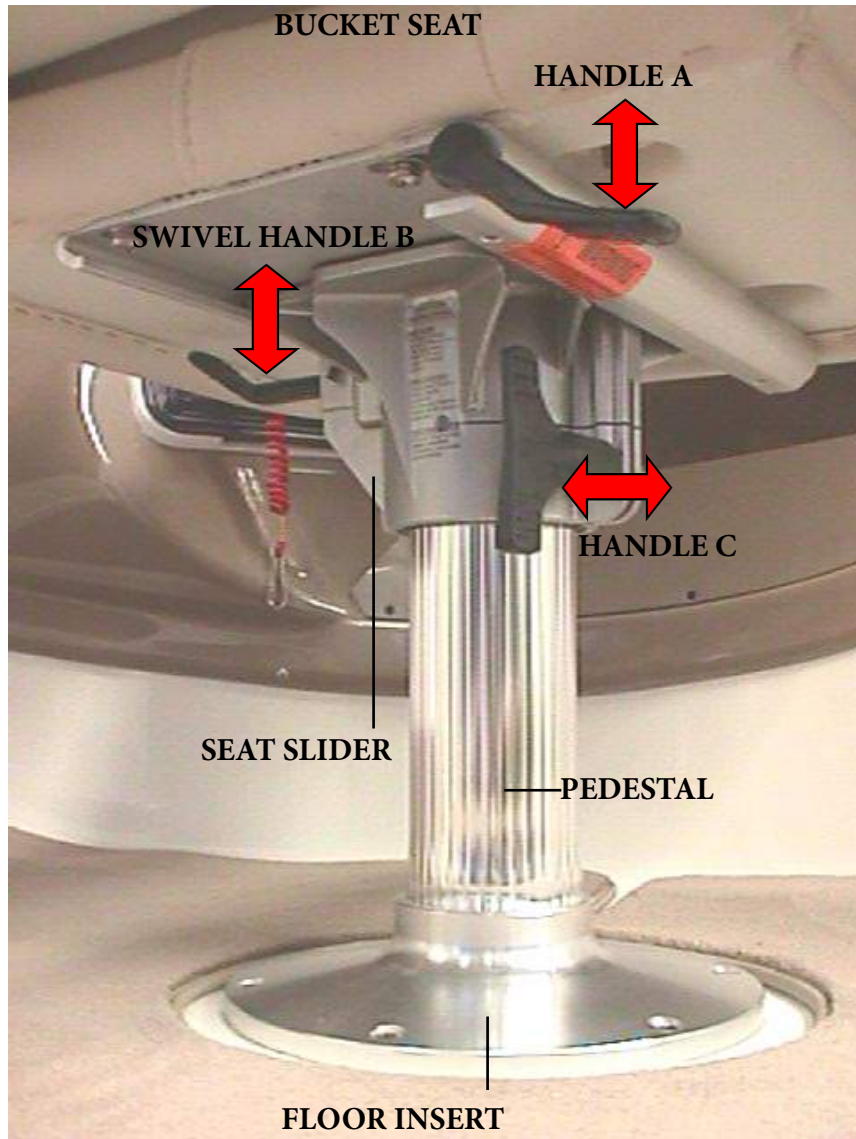

TYPICAL BUCKET SEAT LOCK MECHANISM

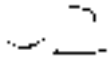

## Chapter 6

### SEAT OPERATION- SUNDECK

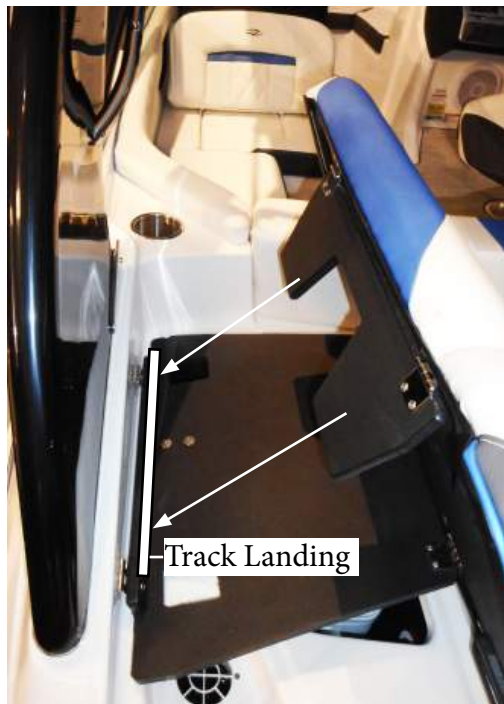

The extra large transom sunpad features a flip-up headrest and has plenty of room to layout. The sunpad headrest is part of the port aft cushion.

To raise and position the headrest, lift the cushion and note the upper hinged arm attached to the cushion. While holding the arm push the cushion down to fit in the landing track at the seat bottom.

Reposition to original flat sundeck by lifting the arm and push arm against cushion while

lowering assembly.

6-30



## Equipment Operation

---

### SKI TOW



A ski tow is located center line at the stern deck. Double loop the line first through the hole and then around the ski pylon and cinch it tightly. This procedure helps to keep the line intact when there is no strain on it.

Always appoint a person to keep their “eye out” for the tow line when the vessel is running to prevent the line from being caught in the propeller. Be aware of the line location when maneuvering.

Do not use for tubing, parasailing, or towing objects such as boats, floating docks or other craft. Always appoint a third person as an observer when skiing, etc. The operator may find a rear view mirror will provide enhanced aft visibility.

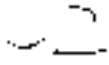

## Chapter 6

---

### SEAT STORAGE



Typical Lazarette Outboard Storage Above

Use the large amount of storage on your vessel to organize your gear. Store fenders, throwables, and extra life jackets in an easy to get to locker such as this lazarette shown above. Of course, all passengers should be wearing life jackets when making headway. There is plenty of other storage areas such as under the starboard backrest, bow cushions, cockpit cushions and ski locker.

Always alert crew members regarding emergency procedures and equipment locations.



# Equipment Operation

## SPORT TOWER

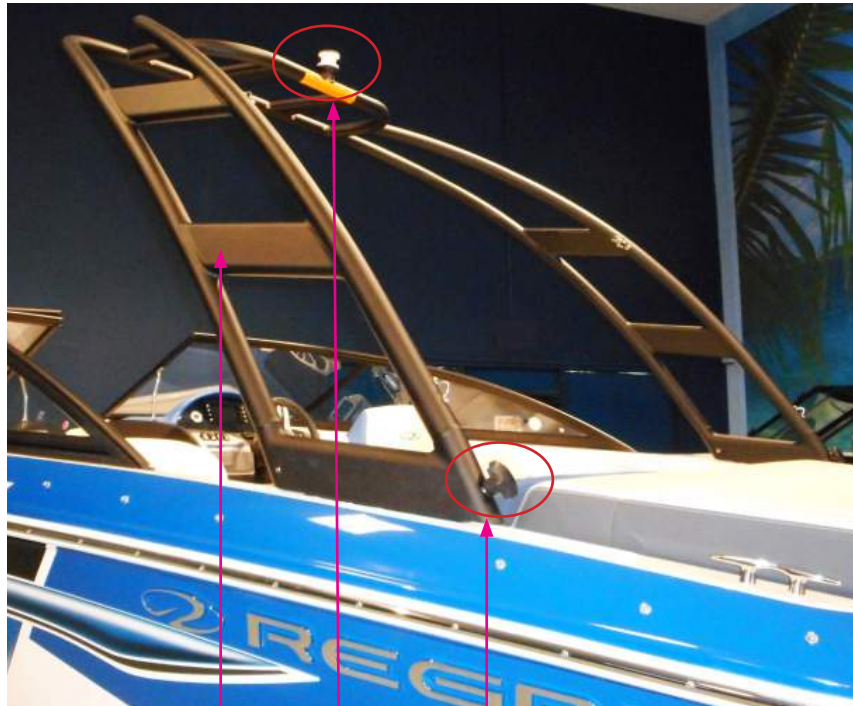

Sport Tower

Sports Tow  
& Warning  
Label

Tower Knob Mechanism

As installed the sport tower option features the ability to be lowered in a forward position allowing for low bridges, towing, and storage circumstances. Also, it features a sports tow on top of the tower. The sport tower is designed of high strength aluminum tubing along with a powder coated surface for appearance and longevity. To convert the standing tower to a forward position unscrew both adjustment nuts and the tower will pivot as you push it to the forward position. Bungee the railing down for towing.

*Read and understand sports tower warning label on the next page.*



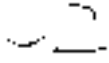

## Chapter 6

---



### **WARNING**

AVOID BODILY INJURY OR DEATH DUE TO MISUSE OF THE SPORTS TOWER! DO NOT PULL MORE THAN TWO (2) PEOPLE AT A TIME FROM THE SPORTS TOWER. USE SPORTS TOWER ONLY FOR KNEEBOARDS, WATER SKIS, WAKEBOARDS, OR SINGLE PERSON WATERSPORTS PRODUCTS. THIS SPORTS TOWER WAS NOT DESIGNED AND SHALL NOT BE USED FOR TOWING OF BOATS, PERSONAL WATERCRAFTS, FLOATING DOCKS OR ANY OTHER TYPE OF FLOATING VESSEL OR CRAFT. THIS SPORTS TOWER SHALL NOT BE USED FOR PULLING PARASAILING OR ANY OTHER EQUIPMENT NOT APPROVED. THIS SPORTS TOWER SHALL NOT BE USED TO PULL INFLATABLE WATERSPORTS TOYS OF ANY KIND. NEVER LET PASSENGERS SIT DIRECTLY BEHIND THE SPORTS TOWER ROPE ATTACHMENT POINT WHILE PULLING APPROVED WATERSPORTS ACTIVITIES, DO NOT LET LOOSE WATERSPORTS ROPE HANG FROM THE SPORTS TOWER. ALWAYS INSPECT THE SPORTS TOWER PRIOR TO USE TO ENSURE IT IS NOT DEFORMED, DEFLECTED, AND THAT ALL BOLTS ARE IN PLACE AND TIGHT. WATER LEVELS CAN VARY DAILY AND IN SOME CASES HOURLY. BE AWARE OF MINIMUM CLEARANCE OF BRIDGES, TREE LIMBS, AND OTHER OBSTACLES, BEFORE ATTEMPTING TO PASS OR GO UNDER ANY OVERHEAD STRUCTURE.



# Equipment Operation

---

## STEREO PERFORMANCE PACKAGE

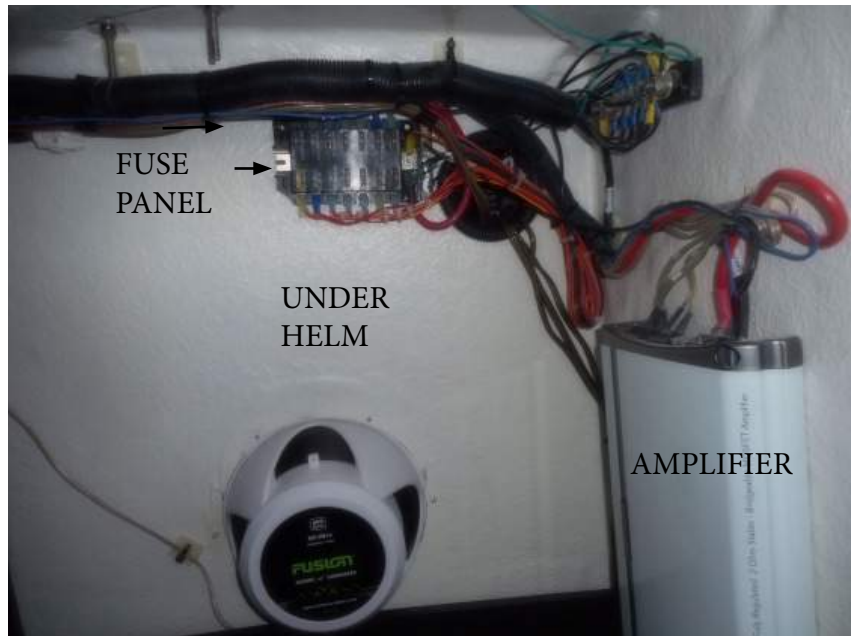

The optional stereo performance package features Fusion signature speakers including a sub-woofer, 4 channel amplifier and transom remote to provide leading edge performance in sound, power and usability. The simplicity of design contributes to low distortion and high efficiency. Normally the amp is located under the starboard helm. The circuit is protected by a 40 amp breaker located in the aft port sump. The amplifier does not require any type of maintenance other than periodic checking of the wiring connectors for tightness. Since the amplifier can generate heat when used keep objects away from it under the helm area. Contact your Fusion owner's manual or closest Regal dealer for additional information.

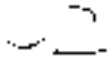

## Chapter 6

---

### STEREO PERFORMANCE PACKAGE



TYPICAL REMOTE CONTROL.

As part of the stereo performance package the Fusion remote control is normally mounted at the transom area which makes it easier to use during water activities.

It is a plug and play device and uses the same function buttons and rotary encoder as the helm head unit. It features the ability to select various speaker zones

on the vessel. Refer to the Fusion owner's manual for more detailed information.



# Equipment Operation

---

## TRANSOM DOOR (GATE)



Typical Transom Door (Gate) Showing Latch

The transom door features a latch to secure it. With the starboard aft cushion positioned it provides down flooding relief from rough seas especially when traveling in reverse or catching the trough of a wave.

Boat operator to ensure the transom door is closed and latched when making headway!

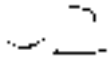

## Chapter 6

---

### TRANSOM TRIM SWITCH



A stern drive trim switch may be located on the transom. It permits tilting the stern drive in the “up” or “down” positions from the stern of the boat. Note that this switch travels a complete up and down cycle from the lowest down trim position to an up trailer position. Always

remove the keys from the ignition switch when engine is not running. Make sure nobody is near the stern drive when using the tilt switch. Make sure the stern drive unit is in a complete down position before starting the engine. Failure to do so may result in stern drive component damage.

# Cosmetic Care & Maintenance

## COSMETIC CARE



This section covers the care and maintenance of your Regal boat. Many cosmetic care topics including exterior hardware, upholstery, fiberglass and canvas are covered along with major equipment and systems. Refer to the owner's information packet and the appropriate engine manufacturer's manuals for further detailed instructions.

### Upholstery

Cockpit and vinyl require periodic cleaning to maintain a neat appearance and to prevent the build up of dirt, mildew and contaminants that may stain and reduce the vinyl life if they are not removed. The frequency of cleaning depends on the amount of use and conditions to which the vinyl is subjected.

Most common stains can be cleaned using warm, soapy water and clear rinses. Scrubbing with a soft bristle brush will help loosen soiled material from embossed surfaces and under welting. If the stains are not removed with the above method use a mild cleaner such as Fantastic. This cleaner should be used only as needed and not the normal means.

With more stubborn stains, rubbing alcohol or mineral spirits may be tried cautiously. Widespread solvent use can severely damage or discolor vinyl. Try to remove stains immediately before they have a chance to penetrate the surface of the vinyl.

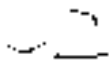

## Chapter 7

---

Powdered abrasives, steel wool, or industrial strength cleaners are not recommended for cleaning our vinyl. Lacquer solvents will cause immediate damage. Dilute chlorine bleach before using. Do not wax the vinyl as it may cause cracking. Always wear protective gloves and make sure there is sufficient ventilation when cleaning vinyl. Wear eye protection.

Remember that suntan oil will damage vinyl. Use suntan lotion instead of suntan oil. Exposure to the sun is a natural enemy of vinyl upholstery. Keep the vessel covered with a cockpit cover when not in use.

### Cockpit Carpet

Use approved cleaners on carpet. Always try on a test area first. Many spots and spills can be removed using a cleaner combined with a clean, white terry towel. Try not to soak an area excessively and do not use solvents because most interior carpet is rubber backed and glued in place. Solvents and abrasives will break down the backing and fibers. Note: Always roll up cockpit carpet before towing your boat. Store carpet in a locker.

### Plastics

Use plastic cleaners and polishes recommended for marine use only. Use proper applicators. Read all instructions carefully. Test the product in a small area first. Use a soft rag and always rinse the surface with water. Ammonia based cleaners and abrasives will damage plastic parts.



## NOTICE

TO AVOID PROPERTY DAMAGE NEVER CLEAN PLASTIC SURFACES WITH A DRY CLOTH OR GLASS CLEANING SOLUTIONS CONTAINING AMMONIA. NEVER USE SOLVENTS OR WIPE WITH ABRASIVES.



## Cosmetic Care & Maintenance

---

### Spaghetti Mat

Spaghetti mat is used in most of our storage lockers. It is a thick black material that looks like pasta. It provides cushioned support for stored items along with the ability to weep water and condensation through its porous design.

To clean spaghetti mat remove from the storage area and use a hose and nozzle to remove debris. Air dry and reinstall in compartment. Material features ability to dry quickly. For heavier cleaning spray with a mild liquid soap and rinse with fresh water. Air dry.

### Fiberglass & Gelcoat

 <b>CAUTION</b>
AVOID BODILY INJURY FROM FALLING! WAXED SURFACES CAN BE VERY SLIPPERY. DO NOT WAX NORMALLY USED AREAS OF THE DECK, LINER, OR GUNWALES. DO NOT WAX ANY TEXTURED OR NONSKID SURFACES SUCH AS FLOORS, WALKWAYS, STEPS, LADDERS OR SWIM PLATFORMS. WEAR NON-SLIP FOOTWEAR WHEN WALKING ON VESSEL SURFACES.

Routine maintenance is the only practical way to keep the surface of your boat looking shiny and new. Most objects left outdoors will gradually deteriorate from exposure to the sun, water, dust and pollution. Such outdoor exposure can cause your boat's gelcoated surface to change or fade. Darker colors tend to fade more rapidly than lighter colors because they absorb more of the sun's rays (ultraviolet and infrared). Basic maintenance includes monthly washing of the boat's surface to remove normal accumulation of soil and stain.



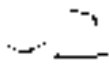

## Chapter 7

---

Use a mild detergent such as dishwasher powder or liquid. Do not use automatic dishwasher detergent. Avoid any kind of alkaline cleaners such as trisodium phosphate (TSP), abrasives, bleaches and ammonia. For best results use cleaners that are recommended for fiberglass.



### NOTICE

TO AVOID DAMAGE TO THE DECK OR HULL BOTTOM DUE TO SCRATCH MARKS. NEVER USE WIRE BRUSHES, SCOURING PADS, OR OTHER ABRASIVE TYPE MATERIALS AND SOLUTIONS. THEY WILL COLLECT MARINE GROWTH ALONG WITH OTHER FOREIGN MATERIALS.

It is recommended that you wax the gelcoat surface twice yearly to prevent loss of gloss and to protect the finish. Use only waxes for fiberglass and follow the label instructions. Apply a 3' x 3' section at a time using clean applicator cloths or a buffing bonnet. When a haze develops, use a power buffer at low speeds (1200-2000 rpm) to remove the haze. Keep the buffer moving to avoid heat buildup. The power buffer is very efficient at removing contaminants from gelcoat. Never wax gelcoat in the direct sun.

When the washing and waxing as recommended does not restore the shine it may be necessary to use a fine rubbing compound. Do not apply rubbing compound in direct sunlight. A power buffer at low speed does an excellent job to remove impurities from the gel coat that cause dulling. Use light pressure and keep the buffer moving. Re-wax after compounding to buff the surface.

“Hairline cracks” or “spider webbing” could develop in the gelcoat surface of a hull or deck. This can be caused by impact or other factors. Small air pockets or gouges may also occur through normal wear. These do not affect the strength of the hull or deck and can be repaired by yourself, a marine professional or a Regal dealer.

The affected area should be chipped or sanded away and a thin layer of color matched gelcoat applied. This layer is then sanded smooth and buffed to its original luster.

7-4



## Cosmetic Care & Maintenance

---

Most minor scratches, nicks, and dents can be removed by compounding the surface. Marine type compounds can be found at most auto body supply stores. Specify a number 25 which is a coarser compound up to a number 55 being less coarse. Various glazes and polishes are available as needed. Ask your marine professional or Regal dealer for more information. Fiberglass hulls are strong but they can be damaged. A fiberglass hull has virtually no internal stresses. Thus when a part is broken or punctured, the rest of the hull retains its original shape. A severe blow will either be absorbed or result in a definite localized break. A break of this nature should be checked and repaired by a marine professional or a Regal dealer.

### Minor Repairs

You will need the following materials for minor repairs:

- Gelcoat
- Clear Liquid Catalyst
- Putty Knife
- Razor Blade
- Fine Sandpaper (400,600,1000)
- Wax Paper (to cover repair area)



## WARNING

AVOID BODILY INJURY DUE TO FLAMMABLES!  
GELCOAT & FIBERGLASS RESIN ARE FLAMMABLE.  
WORK IN A WELL VENTILATED AREA FREE FROM OPEN FLAMES.  
DO NOT SMOKE.

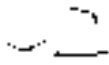

## Chapter 7

---

For minor repairs refer to the following procedure:

1. Clean the area to be repaired and get rid of any wax or grease residues.
2. Clean out scratches, chips, and nicks.
3. Sand area to be repaired so gelcoat will bond.
4. In a separate container, measure only the amount of gelcoat you will need. Mix a ratio of 2% ratio of catalyst to the amount of gelcoat being used (a spoonful of gelcoat will require only a drop or two of catalyst). Do not pour any unused portions of the gelcoat/catalyst mixture back into either original container.
5. Apply gelcoat to area leaving a slight lift above the surface.
6. Cover the area with wax paper. It will help the mixture to set up faster.
7. Remove wax paper and shave off any extra gel coat with a razor blade.
8. After the area is shaved smooth, start with the 400, 600, and finally 1000 grit sand papers.
9. Buff the area with compound, polish and a finish wax. You may notice a difference between the repaired area and the original finish due to the natural weathering process.

### Canvas

Boat canvas is in most cases subjected to more severe punishment than practically any other type of material. Moisture, dirt and chemicals from industrial fallout, heat, ultraviolet rays and salt water are all factors which accelerate the deterioration of your boat canvas.

7-6



## Cosmetic Care & Maintenance

---

These elements can cause serious damage if left unchecked.

The boat top and other canvas supplied on your Regal boat are manufactured from top quality materials to provide you with years of trouble free service. The following information on the care, cleaning and proper storage of the fabrics and fasteners that make up your marine canvas is being provided to help you maintain the appearance and ease of operation.

Sunbrella is used on most Regal tops, aft curtains, camper enclosures, bow tonneaus and cockpit covers. Sunbrella is a woven fabric made from 100% solution dyed acrylic fiber. It is color fast and will withstand long term exposure to the sun (ultraviolet rays) without excessive fading.

Sunbrella is a woven fabric. Even though it is treated with water repellency some “misting” through the fabric is typical. With new canvas, the greatest potential for leakage is through the sewn seams. Because Sunbrella and the long term thread used is synthetic, the holes created by sewing will not swell up and seal when exposed to water as cotton does. Usually the movement of the fabric in use will move the fibers enough to seal the holes. You may apply Apeal or Uniseal to the seams to speed up this process.

When the canvas is new, the fit will normally be tight. It is designed this way because Sunbrella stretches as it ages. The initial tight fit allows for a suitable fit for the life of the canvas. The Sunbrella fit will vary slightly in the heat, cold, and rain.

### Sunbrella Cleaning Instructions

Sunbrella should be cleaned regularly before substances such as dirt, roof particles, etc., are allowed to accumulate on and become embedded in the fabric. The fabric can be cleaned without being removed from the boat. Simply brush off any loose dirt, hose down, and clean with a mild solution of natural soap in lukewarm water. Rinse thoroughly to remove soap. **DO NOT USE DETERGENTS!** Allow to air dry.

For heavily soiled fabric, remove the top from the frame.

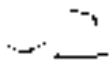

## Chapter 7

---

Soak the fabric in a solution that has been mixed to the following proportions.: 1/2 cup of bleach and 1/4 cup of Ivory or Lux soap (liquid or soap) per each gallon of lukewarm water. Allow the fabric to soak until the bleach has killed the mildew and the stains can be brushed out with a common kitchen scrub brush. Rinse the fabric thoroughly in cold water to remove all the soap. This may require several rinsings. Incomplete rinsing can cause deterioration of sewing threads and prohibit the fabric from being properly retreated. Allow the fabric to dry completely. **DO NOT STEAM PRESS OR DRY IN AN ELECTRIC OR GAS DRYER!** Excessive heat can damage and shrink the fabric since it is heat sensitive.

This method of cleaning may remove part of the water and stain repellent that was applied to the fabric during its manufacture. It is recommended to retreat with such water repellency products as Apsel and Uniseal. We do not recommend any wax based treatments such as Thompson's Water Seal or any of the silicone products such as SC-15 or Aqua-Tite. Wax based products prevent the fabric from breathing, and encourage mildew growth while the silicone products interact with the original fluorocarbon finish and seem to cause a rapid loss of water repellency.

### Clear Vinyl, Zipper & Snap Care

Never store canvas wet or in an unventilated, moist area. Always roll the canvas instead of folding. This is of particular importance on side curtains or any other part with the clear vinyl "glass". Roll the top carefully around the bows and cover with the storage boot provided. The clear vinyl "glass" used in side curtains, aft curtains, visors, and camper enclosures is very susceptible to heat and cold. Keep vinyl curtains from touching metal tubing to minimize burning the vinyl. If the boat is stored with top, side curtains and aft curtain in place, heat build up inside the boat may discolor the vinyl.

To clean the clear "vinyl" glass, use a solution of Ivory or Lux soap, liquid or flakes, and lukewarm water. Allow to air dry. Never use any type of abrasive cleaner as it will scratch the "vinyl" glass. There



## Cosmetic Care & Maintenance

---

are many cleaners and scratch removers on the market specifically for clear vinyl. Handle the clear curtains carefully. They are soft and prone to scratching.

Canvas parts are designed with zippers. When zippers are new they can be a little difficult to use. Zip carefully without forcing the zipper or the material. They will loosen with use. A zipper lubricant may be used to help new zippers as well as maintaining used ones. The most vulnerable part of the zipper is the starts. Use care when beginning to close the zipper.

Canvas snap fasteners should be unsnapped as close to the button as possible. Never remove canvas by pulling roughly on the edge of the material. This can damage the canvas as well as the fasteners. Use petroleum jelly on snaps to keep them from developing corrosion especially in harsh environments.

### Metal

Keep all stainless steel and other metal parts rinsed and wiped dry. To maintain their finish annually polish the stainless steel and other bright works at least annually. Use commercially available metal products and read the labels carefully before use. Refer to the flyer in the owners information pouch. Most marinas and boating retail outlets carry metal care products.

### Hull Bottom

Never use wire brushes or highly abrasive scouring pads on your hull bottom. It could damage the gel coat surface or the bottom paint. The bottom of your boat needs to be clean since the build up of natural coatings from water or marine life can potentially create drag and affect your boat's performance. Contact a marine professional or Regal dealer for more information.

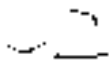

# Chapter 7

FREQUENT STAINS/CLEAN-UP STEPS	1	2	3
Coffee, Tea, Chocolate.....	B		
Permanent Marker* .....	E	B	C
Household Dirt.....	A	B	
Grease.....	D	B	
Ketchup, Tomato Products.....	A	B	
Latex Paint.....	A	B	
Oil Base Paint.....	D	B	
Mustard.....	A	B	C
Suntan Oil.....	A	B	
Asphalt/Road Tar.....	D	B	
Crayon.....	D	B	
Engine Oil.....	B		
Spray Paint.....	B		
Chewing Gum.....	D	A	
Shoe Polish* .....	D	B	
Ballpoint Pen*.....	E	B	A
Lipstick.....	A	B	
Eyeshadow.....	E	B	
Mildew* .....	C	B	A
Wet Leaves * .....	C	B	A

A= Soft brush; warm soapy water/rinse/ dry

B= Fantastik cleaner

C= One tablespoon ammonia, 1/4 cup of hydrogen peroxide, 3/4 cup of warm water/rinse/dry

D= Scrape off residue ( use ice to lift gum)

E= Denatured alcohol/rinse/dry

\* These products contain dyes which leave permanent stains.



## Cosmetic Care & Maintenance

---

### MAINTENANCE

#### Engine

Each stern drive engine package is unique and quite complex. A select portion of the maintenance items are covered in this chapter. Many times because of the advanced ignition and fuel injection systems used on marine engines it is best to use trained marine professionals. For more detailed information, refer to the manufacturer's engine owner's manual or call your closest authorized Regal dealer.

#### Stern Drive

The stern drive unit should be checked before each outing. Tilt up the drive and check for any debris around the intake and any fish line tangled in the propeller. Check your engine manual for stern drive maintenance schedules or call your nearest authorized Regal dealer.

#### Propellers

Out-of-balance or nicked props may effect performance or cause vibration. Damaged props should be replaced, but those that are chipped or bent can usually be reconditioned by a marine dealer or a propeller repair facility. When cruising, carry an spare set of props on board because many marinas do not carry a full inventory of replacement propellers. Also, carry an extra set of prop hardware. Refer to the manufacturer's engine manual for appropriate stern drive and inboard propeller replacement.

Be sure to make a note of the propeller diameter and pitch while the vessel is in dry dock. They are pressed into the prop for easy reading. In an emergency select propeller blades can be straightened by laying the propeller blade on a 2 x 4 and hammering the bent portion of the blade until straight. This procedure will assist the operator in reaching port so he can have the propeller re-pitched in a jig.



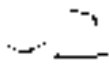

## Chapter 7

---

### VOLVO SX PROPELLER INSTALLATION

It is advantageous to carry the needed tools to change propellers and approved lubricants to be used on the propshaft. This method provides a safety margin from sharp blades especially those with stainless steel propellers. Wear gloves when changing the propeller. A 2" x 4" piece of wood placed across the ventilation plate allows safer removal of the propeller as the wood holds the blades from moving while removing and installing hardware.

With propeller units you may need to add a shim to the 2" x 4" piece of wood to remove the propeller safely. Always consult the engine manufacturer's owner's manual for further detailed information.

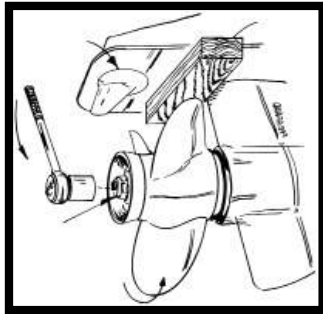

Typical Propeller Change

### TYPICAL VOLVO PROPELLER INSTALLATION

1. To install a propeller on a Volvo equipped propulsion package:
2. Coat the propeller shaft with the recommended marine lubricant.
3. Place the thrust bushing on the prop shaft with inner taper toward the gear case to match the taper on the propeller shaft.



## Cosmetic Care & Maintenance

---

### VOLVO SX PROPELLER INSTALLATION CON'T

4. Slide propeller on shaft completely.
5. Place thrust washer on propeller shaft splines.
6. With the key switch in the off position remove the keys from the ignition. Now shift the remote control into reverse
7. Install and tighten the propeller nut to the engine manufacturer's specifications using a torque wrench.
8. If used place keeper on prop nut until aligned with cotter key hole. Install cotter key and bend tabs over.

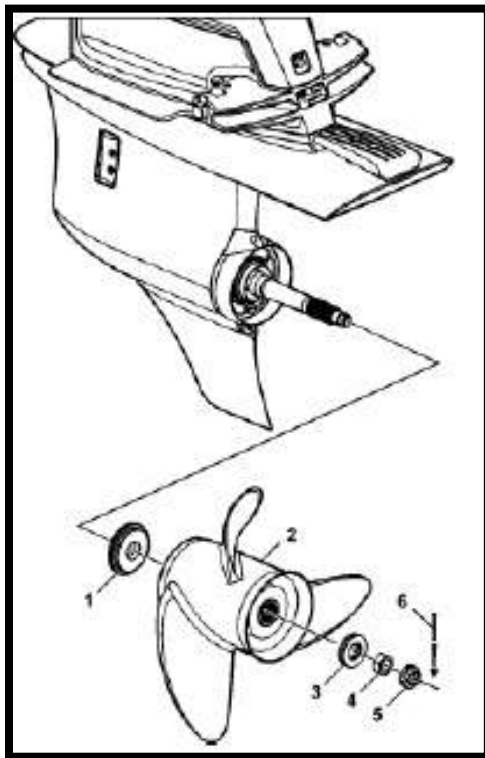

- 1) Thrust Bushing
- 2) Propeller
- 3) Thrust Washer
- 4) Propeller Nut
- 5) Keeper (If used)
- 6) Cotter Key

Typical Volvo SX Installation

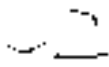

## Chapter 7

---

### TYPICAL MERCUISER ALPHA PROPELLER INSTALLATION

Follow the steps below to install a propeller on a MerCruiser equipped propulsion package:

1. Coat the propeller shaft with the recommended marine lubricant.
2. Place the forward thrust hub on the prop shaft with the taper matching the taper on the propeller shaft.
3. Slide drive hub on next install the propeller.
4. Place the drive sleeve adapter in place.
5. Place the tab washer on the shaft.
6. Install locknut to manufacturer specifications with a torque wrench.

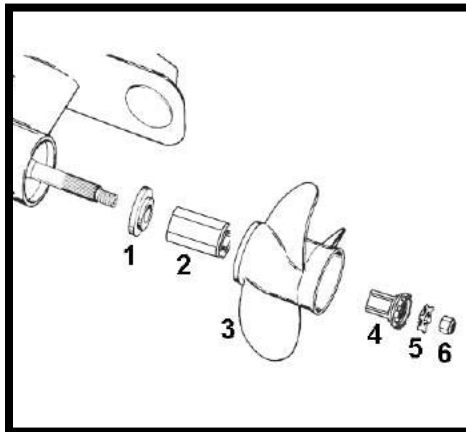

- 1) Forward Thrust Hub
- 2) Flo-Torque Drive Hub
- 3) Propeller
- 4) Drive Sleeve Adapter
- 5) Tab Washer
- 6) Locknut

Typical MerCruiser Alpha Drive Installation



## Cosmetic Care & Maintenance

---

### STEERING

Your stern drive boat may use a rack or rotary style steering system featuring a cable that functions with assistance through the engine power steering pump. As you turn the wheel force is applied through the system to a hydraulic cylinder found at the aft end of the engine and attached through the engine power steering pump hoses.

With the engine running, check the engine power steering pump level before each outing. Add the appropriate power steering fluid. Periodically inspect the entire steering system for tightness and signs of wear and leaks including the steering wheel. Lubricate the steering shaft at the engine. Refer to the manufacturer's engine manual in the owner's information packet for additional information or contact your closest Regal dealer.

CHECK HOSE CONNECTIONS  
FOR LEAKS & TIGHTNESS

CHECK NUT FOR  
TIGHTNESS.



7-15

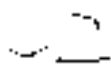

## Chapter 7

---

### BATTERY

Frequently check your battery terminals for corrosion build-up. If you find a greenish, powdery substance, remove the cable connections and clean both the terminals and the connectors with a wire brush. When the cleaning is finished reconnect the battery cables and coat the terminal with an approved grease or petroleum jelly to help prevent further corrosion. Check the electrolyte level at least every 30 days, more often in hot weather. The level should be maintained between the top of the battery plates and the bottom of the fill cap opening. Add distilled water as needed after charging the batteries or periodically as needed. Do not overfill because sulfuric acid could run over and cause burns or an explosion.

Batteries should be charged outside the boat. Do not smoke or bring flames near a battery that is being or has recently been charged. The hydrogen gas generated by battery charging is highly explosive.

Set batteries on a block of wood rather than concrete since this procedure will help the batteries from losing their charge.

Do not allow a metal object or loose wires to spark across battery posts while working close to the battery. Contact across terminals will cause a short circuit and personal injury may result.

Tighten all battery connectors securely. Check their tightness by pulling on the connectors. They should not move from their tightened position. Be sure to reinstall the positive boot over the battery terminal after tightening the battery post connection. While using the boat, use the volt meter to monitor the charge level of the battery. Monitor the charge with the engines turned off (static condition).

The engine alternators recharge the batteries. A fully charged battery will indicate between 12.3 and 12.6 volts on the voltmeter. Readings below this could indicate a dead battery cell or a charging system malfunction which should be checked by a marine professional.



## Cosmetic Care & Maintenance

---



### **WARNING**

TO PREVENT BODILY INJURY!  
BATTERIES CONTAIN SULFURIC ACID (POISON)  
WHICH ALSO CAN CAUSE BURNS.  
AVOID CONTACT WITH THE SKIN, EYES & CLOTHING.  
IF CONTACTED, FLUSH WITH WATER AT LEAST 15 MINUTES. IF  
SWALLOWED, DRINK LARGE AMOUNTS OF WATER OR MILK. FOLLOW  
UP WITH MILK OF MAGNESIA, BEATEN EGG OR VEGETABLE OIL. GET  
MEDICAL ATTENTION IMMEDIATELY!



### **WARNING**

TO PREVENT BODILY INJURY!  
WEAR GOGGLES, RUBBER GLOVES  
AND A PROTECTIVE APRON  
WHEN WORKING WITH A BATTERY.  
BATTERY ELECTROLYTE CAUSES SEVERE EYE DAMAGE AND SKIN  
BURNS.  
IN CASE OF SPILLAGE, WASH AREA WITH  
A SOLUTION OF BAKING SODA AND WATER.

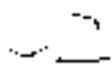

## Chapter 7

---

### REMOTE CONTROL



Check the helm control box and the cable attachment at the engine for tightness and shifting without binding. Shift and throttle controls at both the engine and helm areas must be checked on a periodic basis. At the engine end, make sure all control cable hardware is tight and control cable brackets are secure. An application of silicone spray on the cable ends periodically will keep control cables working freely and fights corrosion. At the helm end check to

make sure the control box hardware is tightly secured. Contact a marine professional or Regal dealer for further assistance.



## Cosmetic Care & Maintenance

---

### SEATING-BUCKET SEAT SLIDER ASSY.



The typical bucket seat slider assembly needs periodic inspection and maintenance. Loosen the tension knob located on the slider and pull up to separate the slider from the pedestal. In some cases, you may need to pull up on the swivel handle to release spring tension while pulling up on the slider assembly. Inspect all fasteners and metal for fatigue. Lubricate the top/outside of the pedestal as needed with a marine type grease that will not run off under warm temperatures. A narrow paint brush is a way to apply the grease. Also, use silicone spray for areas that can not be accessed with the grease. Check for loose fasteners and tighten as necessary. Reassemble slider to pedestal and tighten tension knob.

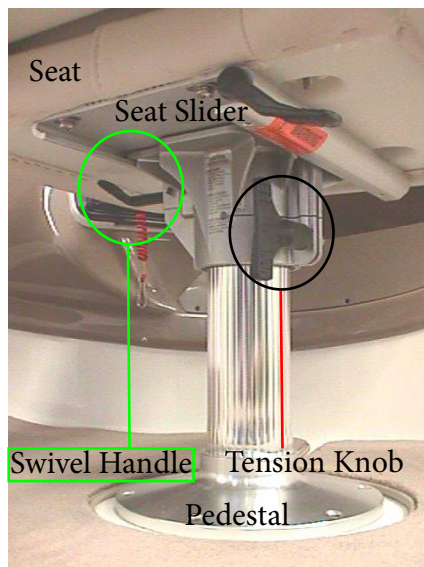



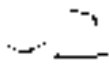

## Chapter 7

---

### BILGE PUMP W/AUTOMATIC FLOAT



The bilge pump is usually installed in the engine compartment just in front of the engine center line. Check for foreign materials stuck in the strainer area or discharge hose.

Check all clamps and electrical connections for tightness. A quick check of the bilge pump

automatic float switch is afforded by lifting up on the float and listening for the pump operating. Look around the float area for foreign debris and remove as necessary.



## Cosmetic Care & Maintenance

### FUEL SYSTEM

At least twice annually inspect all fuel system components for loose clamps at the vent, fill and feed locations. Examine each hose for signs of deterioration and leakage. Check the fuel sender for loose bolts, nuts, and leaks at all areas of contact. Also, inspect the fuel tank for signs of leakage or abrasion. Tighten all components as needed.



### WARNING

AVOID SERIOUS INJURY OR DEATH FROM EXPLOSION  
OR FIRE RESULTING FROM LEAKING FUEL!  
INSPECT ENTIRE FUEL SYSTEM  
AT LEAST TWICE ANNUALLY.

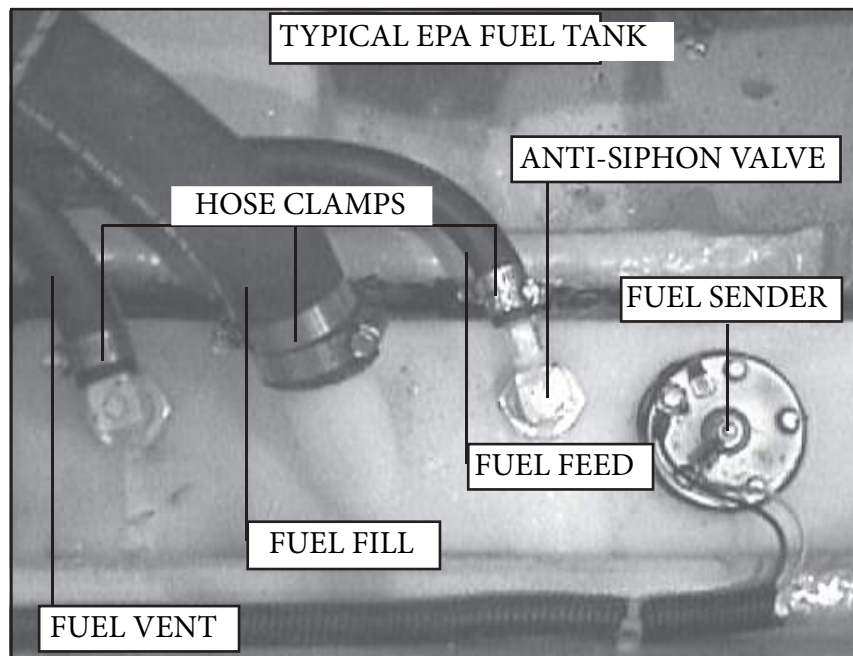

7-21

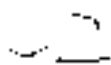

## Chapter 7

---

### PANEL-FUSES



Typical Fuse Panel

The fuse panel is located near the helm area. On select models the panel can be accessed by lifting the starboard bow seat backrest. Fuses are of the automotive type and can be obtained at most auto aftermarket stores or your closest authorized Regal dealer who can order it as a designated fuse pack. It is recommended that you carry all the different amperages. When a fuse “blows” determine the cause before replacing the fuse. Never replace with a higher amperage fuse since the equipment or wiring could overheat and may cause a fire.



## Cosmetic Care & Maintenance

---

### STEREO



The Fusion® stereo head unit requires little maintenance. When washing the cockpit, do not discharge water directly at the stereo unit. Possible damage may result. As with any CD unit clean your CD's to keep them from skipping. This process also aids in keeping dust out of the unit. Never allow water to enter the iPod mechanism behind the head cover. For further information, refer to your stereo owner's manual located in the owner's information packet.

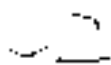

## Chapter 7

---

### AUTOMATIC FIRE EXT. SYSTEM



Vessels with the automatic fire extinguisher system should check the halon unit for tightness at the engine compartment monthly. At that time the unit itself should be weighed to ensure it is full. If the green dash indicator light is not on when the key is in the ignition position there is a system

malfunction that must be investigated immediately. Refer to the manual in the owner's information packet.

### BLOWER

Note with stern drive vessels to periodically check the blower hoses to ensure they are fastened in the bilge properly and they are free of holes. The hose connected to the blower needs to be positioned about 3/4 of the way down in the bilge to evacuate fumes properly. All vents need to be checked for debris.

Make sure the blower motor is securely fastened and all hose clamps and or tie wraps are tight. Also, check all electrical eyelet connectors for tightness.

*Always activate blower for at least 4 minutes before starting engine. Run blower below cruising speed. Besides running the blower, always sniff the bilge for gas fumes. Do not attempt to start engines if fumes are detected. Call for professional assistance to find root cause of fumes and repair components as needed.*



## Cosmetic Care & Maintenance

---

### GALVANIC CORROSION

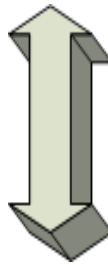
CORROSION TABLE	
Gold	<p>Least Active</p>  <p>Most Active</p>
Stainless Steel	
Bronze	
Copper	
Brass	
Steel	
Aluminum	
Zinc	
Magnesium	

Metal parts underwater can be subjected to two basic styles of electrolysis: galvanic corrosion and stray current corrosion. Both can damage the drive, propeller, underwater parts, boat and motor if not correctly monitored (testing at 2 week intervals) and avoided. Galvanic corrosion is an electrochemical reaction between two or more metals. Drive systems consist of several different metals. Some are more active than others.

Galvanic corrosion of the more chemically active metals can occur whenever two or more dissimilar metals that are “grounded” (connected by actually touching each other, or through a wire or metal part) are immersed in a conductive solution (any material that can conduct electricity). Anything but pure water is conductive. Saltwater, fresh water with a high mineral content and polluted freshwater are highly conductive. Conductivity increases with temperature. That is why Florida boats experience more corrosion than boats in Maine.

Specifically look at a typical marine drive unit with a stainless steel propeller. The aluminum is the more chemically active metal (called the anode) and the stainless steel propeller is the less chemically active metal (called the cathode).

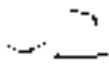

## Chapter 7

---

Typically electrons flow from the anode (the aluminum drive unit), via the external conducting path to the cathode (stainless steel propeller). If there is a very large anode connected to a small cathode, the anode will corrode very slowly. If a very large cathode is connected to a small anode, the anode will corrode very quickly. Obviously, if you do not control galvanic corrosion, over time the aluminum will corrode away.

The first sign of galvanic corrosion is paint blistering (starting on sharp edges) below the water line- a white powdery substance forms on the exposed metal areas. As the corrosion advances, the exposed metal will become deeply pitted as the metal is actually eaten away. Another condition which will increase galvanic corrosion is the removal or reduction in surface area of the sacrificial anodes. Never add aftermarket products that are connected to the engine ground such as stainless steel steering aids and trim planes.

Zinc connected to aluminum will form a corrosion cell but the aluminum (drive) becomes the cathode and the zinc (anode) corrodes.

Even though your boat may not have shore power aboard current from nearby vessels with shore power can produce stray current galvanic corrosion. Stray current corrosion occurs when metal with an electrical current flowing into it is immersed in water that is grounded (lake, ocean, pond). The current can leave the metal and flow through the water to ground. This will cause rapid corrosion of the metal at the point where the current leaves.

When a vessel nearby is plugged into shore power, they can potentially tie your aluminum drive unit to their boat via the green grounding shore power lead. Your aluminum drive unit could be the receiving end of a large galvanic cell (a battery) interconnected with nearby vessels or even through the marina's metal structures via their electrical system.



## Cosmetic Care & Maintenance

---

The vessel should be tested every couple of weeks to determine the integrity of the anode protection system. If not installed, Volvo and Mercury offer an optional corrosion protection system that utilizes the anode/cathode theory to assist in offsetting galvanic corrosion. Another way to test the system is to measure the hull potential. This is accomplished by immersing a reference electrode, usually a silver/silver chloride into the water about six inches behind the drive. With leads attached to a digital multi-meter the hull potential is read on the DC scale and compared to recommended specifications for the water body type. See the owner's information vendor packet for more information or contact your nearest authorized Regal dealer.

### Tips To Aid In Maintaining Galvanic Integrity

1. Test the galvanic integrity of your vessel every 2 weeks. Trim the stern drive/outboard and inspect anodes/parts for signs of galvanic corrosion, stray current corrosion or loose fasteners. Contact your closest Regal dealer/marine professional for further information.
2. Never paint over anodes as they will become inoperative. Always leave at least one inch between bottom paint and any underwater fitting such as seacocks, swim platform stanchions and all drive and propulsion related underwater parts.
3. Periodically remove vessel from water and clean/pressure wash all outdrive, anode and hull bottom areas to remove growth.
4. Ensure vessel is using the correct anode metal for the body of water that it is moored. See the engine/drive manufacturer information packets for more information or contact an authorized dealer.
5. Ensure that the drive is completely "in" down to provide more complete anode protection when vessel is moored.
6. Do not attempt to use magnesium anodes in saltwater. They will provide overprotection.



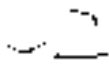

## Chapter 7

---

7. If marina moored, contact appropriate personnel if signs of galvanic corrosion appear on your drive system. Ask them to check for stray electrical current which may be originating from a nearby vessel's faulty DC wiring or from a marina dock carrying leaking marina ground wiring.

GALVANIC/STRAY CURRENT CORROSION	
Cause/Observed Condition	Corrective Action
Sacrificial anodes consumed	Replace anodes when 30% consumed
Sacrificial anodes not grounded to drive	Remove anodes, clean contact surface, reinstall, check for continuity
Loss of continuity between underwater parts & ground	Provide good ground connections
Nearby vessel with stray current	Contact appropriate personnel Remove your vessel from water
Paint on drive heavily worn, exposing more metal	Prime and repaint or install additional anodes
Sacrificial anodes painted	Remove paint or replace anodes
Drive tilted/anodes out of water	Leave drive down, install additional anodes below water
Power trim cylinders only corroded	Provide a good ground to drive, all parts must be grounded
Corrosion in exhaust outlets	Remove deposits
Corrosion occurring after vessel is removed from saltwater	Wash exterior and flush interior with freshwater
Stainless steel parts corroding	Clean parts, remove foreign material, ensure continuity
Underwater drive parts corroded, sacrificial anodes OK	Oxide film on anode (fresh water only) Replace anode Poor Grd. Replace anode



## Cosmetic Care & Maintenance

---

### Zinc Anodes

Sacrificial zinc anodes are located on the stern drive/outboard housing, trim cylinders and/or propshaft to protect softer metals exposed to the water. Electrolysis attacks the least noble metals first. Because zinc is a less noble metal, it will decompose before other metals. Check these zinc anodes periodically and have them replaced when they are 30% consumed. Notwithstanding, zinc is the most popular metal used to protect parts that are exposed to saltwater, freshwater or brackish water.



Zinc anodes in brackish or salt water need to be checked more frequently. If the anodes seem to be requiring frequent replacement there may be a boat leaking DC current into the water taxing the anodes. This is especially possible around a marina environment. Contact a marine professional who can measure the galvanic activity with a special electrode and electric VOA meter. Refer to the engine manufacturer's manual for anode location and detailed information. Stern drive or related parts damage due to galvanic or stray current corrosion is not covered under the Regal limited warranty.

7-29

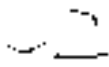

# Chapter 7

## MAINTENANCE CHECKLISTS

The information presented here is merely a guide to be used on typical engines, and may not directly apply to your engine package. Refer to your engine owner's manual for complete details and latest information on your engine specifications & maintenance schedules.

### Volvo Maintenance Guide

Volvo recommends strictly following their maintenance schedule to ensure proper functionality and longevity of your engine.

VOLVO MAINTENANCE GUIDE					
CHECK	EVERY TRIP	EVERY MONTH	EVERY YEAR / 100 HRS	EVERY 2 YEARS	EVERY 3 YEARS
Cooling System - Leaks	•				
Cooling System - Flush System	•				
Cooling System Water Pick-Up Feed Unblocked	•				
Fuel System - Leaks, Pump Functionality	•				
Lubrication System - Check Engine Oil	•				
Lubrication System - Power Steering Fluid Leaks, Discoloring, Level	•				
Anodes Check & Replace if 30% Eroded	•				
Power Trim - Functions At Helm	•				
Emergency Stop Switch & Lanyard - Functions At Helm	•				



## Cosmetic Care & Maintenance

VOLVO MAINTENANCE GUIDE					
CHECK	EVERY TRIP	EVERY MONTH	EVERY YEAR / 100 HRS	EVERY 2 YEARS	EVERY 3 YEARS
Binnacle Control Lever - Functions At Helm	.				
Batteries - Hold Charge, No Corrosion		.			
Lubrication System - Stern Drive Oil		.			
Stern Drive Bellows - Wear or Leaks		.			
Exhaust Hoses - Loose Clamps or Wear		.			
Propshaft, Props & Hub - Damage, Corrosion, Lubricate Propshaft		.			
Cooling System - Wear or Leaks			.		
Cooling System - Replace Impeller in Raw Water Pump			.		
Fuel System - Fuel Filter Change			.		
Fuel System - Fuel Pump Function, Leaks			.		
Lubrication System - U-Joint & Spline Wear, Corrosion, Lubrication			.		
Lubrication System - Engine Oil Change and Oil Filter Change			.		
Lubrication System - Power Steering Fluid Level			.		
Lubrication System - Steering System Operational and Lubricated			.		
Serpentine Belt Wear and Tension			.		
* PCV Valve - Check for Operation			.		

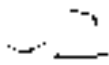

# Chapter 7

VOLVO MAINTENANCE GUIDE					
CHECK	EVERY TRIP	EVERY MONTH	EVERY YEAR / 100 HRS	EVERY 2 YEARS	EVERY 3 YEARS
Flame Arrestor - Clean & Secure			•		
Anodes - Check & Replace if 30 % Eroded			•		
Stern Drive Bellows - Wear or Leaks			•		
Exhaust Hoses - Loose Clamps or Wear			•		
Exhaust Manifold, Risers, Pipes - Corrosion, Damage, Leaks			•		
Distributor Cap - Corrosion			•		
Binnacle Control Lever - Functions At Helm			•		
Power Trim - Functions At Helm			•		
Engine Computer - Clear Codes			•		
Check for Recalls - Call Dealer for Updates			•		
Stern Drive Bellows & U-Joint - Replace				•	
Exhaust Hoses - Replace				•	
Spark Plugs - Replace					•

Typical Volvo Maintenance Guide

\*Not Used On All Volvo Engine Models



## Cosmetic Care & Maintenance

### MerCruiser Maintenance Guide

MerCruiser recommends strictly following their maintenance schedule to ensure proper functionality and longevity of your engine.

MERCURY MAINTENANCE GUIDE					
CHECK	EVERY TRIP	EVERY WEEK	EVERY 2 MTHS.	EVERY YEAR / 100 HRS	EVERY 3 YEARS
Cooling System - Flush System	•				
Lubrication System - Check Engine Oil	•				
Lubrication System - Stern Drive Oil	•				
Lubrication System - Power Steering Fluid Leaks, Discoloring, Level	•				
Power Trim - Functions At Helm	•				
Binnacle Control Lever - Functions At Helm	•				
Cooling System Water Pick-Up Feed Unblocked		•			
Fuel System - Leaks, Pump Functionality		•			
Anodes Check & Replace If 30% Eroded		•			
Batteries - Hold Charge, No Corrosion		•			
Propshaft, Props, & Hub - Damage, Tightness, Lubricate Propshaft			•		
Engine Corrosion Guard			•		
Cooling System - Wear or Leaks				•	
Cooling System - Replace Impeller, Clean				•	

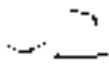

# Chapter 7

MERCURY MAINTENANCE GUIDE					
CHECK	EVERY TRIP	EVERY WEEK	EVERY 2 MTHS.	EVERY YEAR / 100 HRS	EVERY 3 YEARS
Fuel System - Fuel Filter Change				•	
Fuel System - Fuel Pump Function, Leaks				•	
Lubrication System - U-Joint & Spline Wear, Corrosion, Lubrication				•	
Lubrication System - Lubricate Gimbal Bearing & Engine Coupler				•	
Lubrication System - Drive Oil / Gear Lube Change				•	
Lubrication System - Engine Oil Change & Oil Filter Change				•	
Exhaust Hoses - Loose Clamps or Wear				•	
Lubrication System - Power Steering Fluid Level				•	
Lubrication System - Steering System Operational & Lubricated				•	
Check Ignition Parts, Timing				•	
PCV Valve Replace				•	
Flame Arrestor - Clean & Secure				•	
Serpentine Belt - Wear & Tension				•	

Typical Mercury Maintenance Guide



## Cosmetic Care & Maintenance

---

### Engine

Each engine and stern drive package is unique and quite complex. A select portion of the maintenance items are covered in this chapter including general lubrication specifications and periodic maintenance. Because of the advanced ignition and fuel injection systems used on marine engines it is best to contact your Regal dealer for more of the detailed service procedures.



### NOTICE

AVOID ENGINE DAMAGE!  
FOLLOW ALL ENGINE BREAK-IN PROCEDURES AS  
RECOMMENDED BY THE ENGINE MANUFACTURER.  
FAILURE TO FOLLOW THE BREAK-IN PROCEDURE MAY VOID  
THE ENGINE AND STERN DRIVE WARRANTY.



### CAUTION

AVOID ENGINE DAMAGE!  
DO NOT RUN ENGINE AT A CONSTANT RPM  
FOR PROLONGED PERIODS OF TIME DURING BREAK-IN  
PERIOD. CHECK ENGINE OIL OFTEN.



### CAUTION

AVOID ENGINE DAMAGE!  
DO NOT RUN ENGINE OUT OF WATER  
UNLESS YOU HAVE AN OPTIONAL FLUSHETTE.  
FOLLOW MANUFACTURER'S ATTACHING &  
RUNNING INSTRUCTIONS.



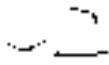

## Chapter 7

---

### Recommended Lubricant Specifications

#### Volvo Engine Oil Requirements

Due to recent EPA mandates on internal combustion engines new units are built with catalytic convertors installed in the exhaust manifolds, along with a system of sensors and computer controls. These newer engines require special oil requirements to extend the life of the catalysts.

Refer to the Volvo engine operator's manual for the correct oil requirements for catalyst type engines, or contact your nearest Regal or Volvo dealer for further information.

For other engines not manufactured as catalyst engines refer to your engine operator's manual for correct oil recommendations.



## Cosmetic Care & Maintenance

---

### Volvo Engine

#### Checking the Engine Oil

Before adding oil refer to the Volvo engine operator's manual for oil viscosity and type or contact your closest Regal or Volvo marine authorized dealer.

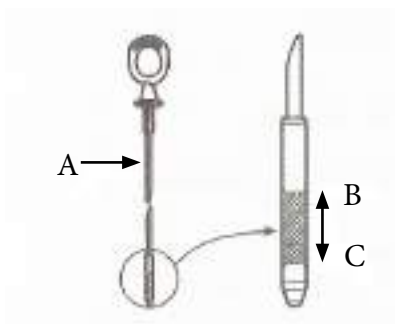

1. To properly check the dipstick (A) oil level run the engine to normal operating temperature and wait about 5 minutes.

2. The oil must be between the B & C marks on the dipstick. Add the recommended oil to maintain the proper level. Make sure you use the correct oil for non catalyzed

or catalyzed engines depending on the age of the vessel.

3. Recheck the engine oil dipstick level.

Note: Refer to your Volvo engine owner's manual for adding any oil during the break-in period since special blends are required.

Note: All fluid recommendations are based on this manual's printing date. Regal is not responsible for the accuracy of the information since it can change at any time. For more detailed information and procedures check your engine operator's manual or contact your closest authorized Regal dealer.

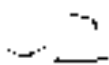

## Chapter 7



### NOTICE

PREVENT ENGINE DAMAGE!  
DO NOT ALLOW THE CRANKCASE OIL LEVEL TO RECEDE BELOW  
THE ADD MARK, AND DO NOT FILL  
ABOVE THE FULL MARK. OVERFILLING RESULTS IN REDUCED  
ENGINE LIFE, HIGH OPERATING TEMPERATURES, FOAMING  
& LOSS OF POWER.

#### Checking the Power Trim/Tilt Fluid Level

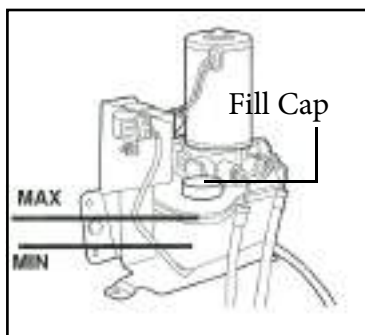

1. At least once annually preferably at the start of the boating season check the system fluid level. Begin with the stern drive trimmed in (down) as far as possible.
2. Remove the fill cap on the power trim pump reservoir.
3. Check the fluid level. It should be between the minimum and maximum marks on the reservoir.
4. Add Volvo Penta DuraPlus Power Trim/Tilt and Steering Fluid as required.
5. Replace the fill cap and tighten cap securely.



## Cosmetic Care & Maintenance

---

### Checking Power Steering Fluid

1. Check the power steering fluid before each boating outing. Remove the steering reservoir and check the fluid level. If the engine has not been running use the “COLD” mark. Use the “HOT” mark for engines that have been running at normal operating temperature as indicated by the temperature gauge.
2. The fluid should be between the minimum and maximum marks on the dipstick. If needed, fill to the proper level with Volvo Penta Dura Plus Power Trim/Tilt & Steering Fluid. **DO NOT OVERFILL THE STEERING PUMP RESERVOIR.**



### **CAUTION**

PREVENT STEERING OPERATION IMPAIRMENT  
OR COMPONENT DAMAGE!  
NEVER FILL THE POWER STEERING SYSTEM  
WITH AN UNKNOWN OIL.

3. Replace the fill cap and tighten securely.



### **NOTICE**

TO FILL TRIM, CRANKCASE & POWER STEERING LEVELS  
WITHOUT SPILLING FLUID  
PURCHASE A FUNNEL AT AN AUTOMOTIVE STORE  
WITH A LONGER NECK  
THAT WILL FIT THE RESERVOIR OPENINGS.

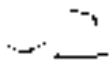

## Chapter 7

### Volvo Stern Drive

#### Checking Volvo Stern Drive Oil

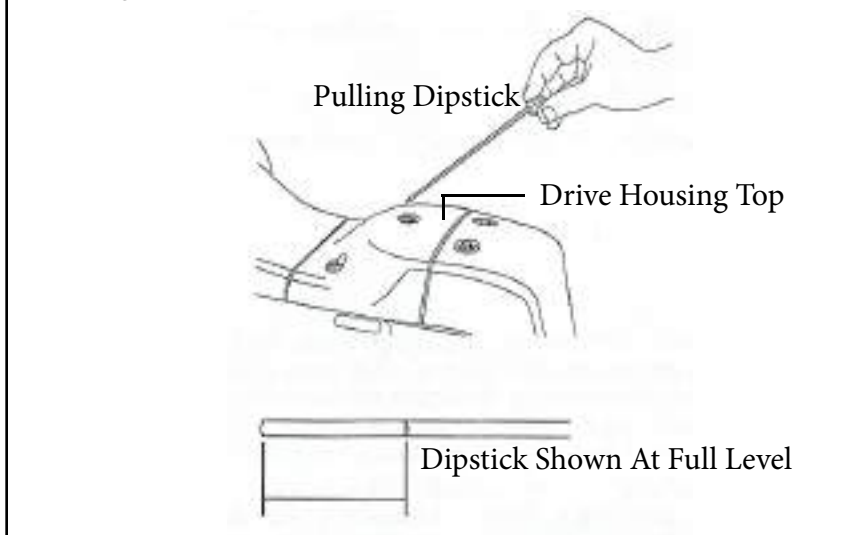

## CAUTION

FULLY THREAD OIL DIPSTICK INTO THE OIL LEVEL HOLE  
IN THE DRIVE UNIT TO PROPERLY CHECK THE OIL LEVEL.  
IMPROPER OIL LEVELS MAY RESULT  
IN SERIOUS STERN DRIVE COMPONENT DAMAGE.

It is recommended to check the drive oil level on a weekly schedule. Fully thread the dipstick into the hole. Remove the dipstick and make sure the oil level is at the top of the mark as shown above.

If the oil level is low, add enough oil to bring the level to the top of the mark on the dipstick. **DO NOT OVERFILL.** Tighten up the dipstick with a slotted screwdriver.

If the oil color is milky in appearance there probably is water in the unit normally caused by a leaking seal.

No metal flakes should be present in the oil. If the above conditions exist contact a Regal dealer.

7-40



## Cosmetic Care & Maintenance

---

### MerCruiser Engine

#### Checking Engine Crankcase Oil

1. Before adding oil make sure it is the type recommended for the type of engine installed. Consult your MerCruiser engine operator's manual. Check the engine oil by first allowing the engine to warm up. Stop the engine and allow about 5 minutes for the oil to drain to the oil pan to obtain an accurate reading.
2. Remove the dipstick. Wipe it clean and reinstall it into the dipstick tube. Wait 1 minute to allow any trapped air to vent. ( Install dipstick with oil indication marks facing the flywheel end of the engine. Add engine oil type and viscosity as recommended in the engine operator's manual. to the full or OK points on the oil dipstick.  
**DO NOT OVERFILL!**
3. Remove the dipstick and look at the oil level. Level must be between full or OK range and add. Reinstall dipstick into the tube.
4. When checking or filling the engine crankcase oil ensure that the vessel is level in the water or on a trailer.

For changing the engine oil & filter see the MerCruiser maintenance schedule and operation manual or contact your Regal dealer.

Note: Above are basic recommendations. Regal is not responsible for the accuracy of the information since it can change at any time. For more detailed information and procedures check your engine operators manual or call your closest Regal dealer.

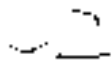

## Chapter 7

---

### Changing Engine Crankcase Oil

Due to recent EPA mandates on internal combustion engines new units are built with catalytic convertors installed in the exhaust manifolds, along with a system of sensors and computer controls. These newer engines require special oil requirements to extend the life of the catalysts.

Refer to the MerCruiser engine operator's manual for the correct oil requirements for catalyst type engines, or contact your nearest Regal or MerCruiser dealer for further information.

For other engines not manufactured as catalyst engines refer to your engine operator's manual for correct oil recommendations.



## Cosmetic Care & Maintenance

### Checking MerCruiser Stern Drive Oil

 **CAUTION**

ENVIRONMENTAL HAZARD!  
DISCHARGE OF OIL OR OIL WASTE  
INTO THE ENVIRONMENT IS RESTRICTED BY LAW.  
DO NOT SPILL OIL OR OIL WASTE INTO THE ENVIRONMENT  
WHEN USING OR SERVICING YOUR VESSEL.  
DISPOSE OF OIL OR OIL WASTE AS DEFINED  
BY LOCAL & STATE AUTHORITIES.

1. Drive oil level must be checked with the engine cold before starting.
2. Check the gear oil level in the reservoir located on the engine. Keep the gear oil level at the recommended ranges as marked on the reservoir. If any water is visible at the bottom of the reservoir or there are any metal chips in the drive oil do not run the engine since component damage can result. Contact your Regal dealer for more information.

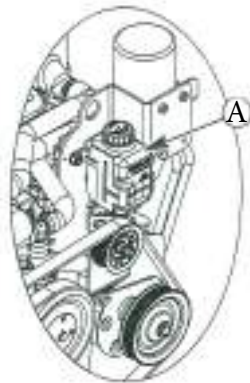

A=Drive Reservoir

#### Filling the Stern Drive

1. If more than 2 ounces of High Performance Gear Lubricant is required to fill the monitor reservoir a seal may be leaking. Contact your Regal dealer.
2. If drive lubricant is free from water and metal chips proceed to fill the reservoir. Remove the gear lube monitor cap. Fill the reservoir with High Performance Gear Lubricant (Merc part # 92-802854A1).



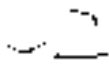

## Chapter 7

---

3. Fill the reservoir so that drive oil level is in the operating range. Do not overfill reservoir. For changing the drive oil refer to the MerCruiser operation manual or contact a Regal dealer for more information.

### Checking Power Steering Fluid

1. Stop the engine and center the out drive unit.
2. Remove the combo fill cap/dipstick and observe the level.
  - a. Proper fluid level with engine at normal operating temperature should be within the warm range.
  - b. Proper fluid level with engine cold should be within cold range.
3. Fill to line with Quicksilver Power Trim & Steering Fluid (Merc # 92-802880A1) or Dextron III automatic transmission fluid. If you can not see any fluid in the power steering reservoir contact your Regal dealer since a leak must of developed in the system.

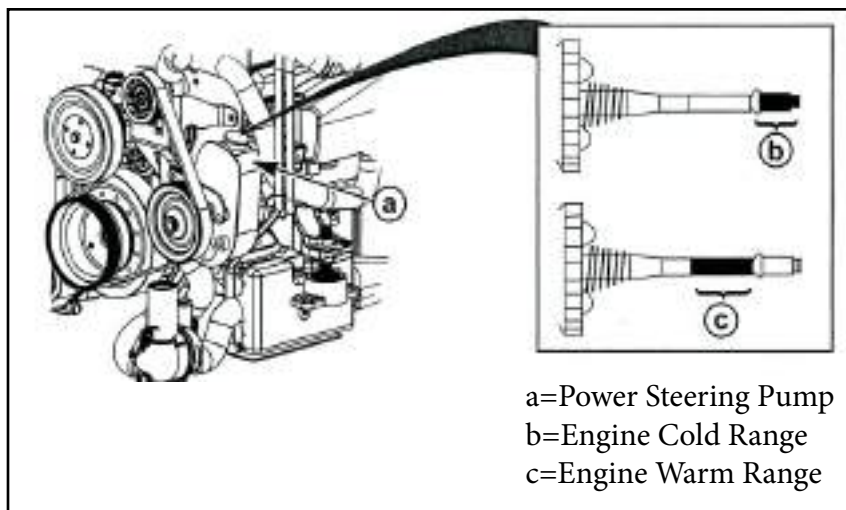



## Cosmetic Care & Maintenance

---

### Checking Power Trim Fluid

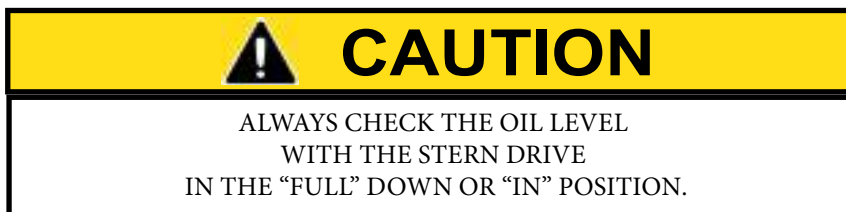

1. Place the stern drive unit in the full down position.
2. Observe the oil level. Level must be between the “MIN” or “MAX” lines on the reservoir.
3. Fill as necessary with Power Trim & Steering Fluid (Merc part # 92-802880A1).

### Refilling The Reservoir

1. Remove the fill cap from the reservoir. Fill cap is vented.
2. Add lubricant to bring level to the within the “MIN” and “MAX” lines on the reservoir. Use Power Trim & Steering Fluid (92-802880A1).
3. Install the cap.

### Changing Power Trim Fluid

1. Power steering fluid does not require changing unless it becomes contaminated with water or debris. Contact a Regal dealer to change the fluid.

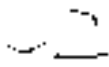

## Chapter 7

---

### Checking Engine Coolant



## WARNING

AVOID BODILY INJURY!  
ALLOW ENGINE TO COOL DOWN  
BEFORE REMOVING THE COOLANT PRESSURE CAP.  
A SUDDEN LOSS OF PRESSURE COULD CAUSE HOT COOLANT  
TO BOIL AND DISCHARGE VIOLENTLY.  
AFTER THE ENGINE HAS COOLED,  
TURN THE CAP 1/4 TURN  
TO ALLOW PRESSURE TO ESCAPE SLOWLY,  
THEN PUSH DOWN AND TURN THE CAP COMPLETELY OFF.

1. Remove the cap from the heat exchanger and observe the level of the fluid.
2. The coolant level in the heat exchanger should be at the bottom of the filler neck. If coolant is lower you should contact your Regal dealer.
3. Install the cap onto the heat exchanger.
4. When reinstalling the pressure cap, be sure to tighten it until it seats on the filler neck.
5. With the engine at normal operating temperature, check the coolant level in the coolant recovery canister.

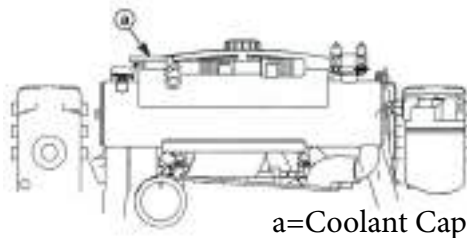

a=Coolant Cap



## Cosmetic Care & Maintenance

6. The coolant level should be between the “ADD” and “FULL” marks.
7. Add Extended Life Antifreeze/Coolant (Mercury part # 92-877770K1).



### CAUTION

AVOID ENGINE DAMAGE!  
DO NOT USE ALCOHOL OR METHANOL BASED ANTI-FREEZE OR PLAIN WATER IN THE COOLANT SECTION OF THE CLOSED COOLING SYSTEM AT ANY TIME.



### NOTICE

ADD COOLANT ONLY WHEN THE ENGINE IS AT A NORMAL OPERATING TEMPERATURE.

#### Filling Engine Coolant



1. Remove the fill cap from the coolant recovery canister.
2. Fill to the “FULL” line with Extended Life Antifreeze/Coolant Mercury part # 92-877770K1.
3. Reinstall the cap onto the coolant recovery canister.

#### Changing Engine Coolant

Call your Regal dealer to change coolant in the entire system.

# Troubleshooting

The following diagnostic information will assist you in identifying minor electrical, fuel, and mechanical problems. Some of the items listed require technical training and tools. *Additional assistance is available in your engine manufacturer's owner's manual. This is especially true for outboard diagnostics as there is a major section for troubleshooting outboard systems.*

Also, you can contact your closest Regal dealer or marine professional for more information. Most defects can be found by doing a logical sequence of elimination.



## WARNING

PREVENT INJURY OR DEATH!  
USE ONLY APPROVED MARINE REPLACEMENT PARTS  
THAT ARE IGNITION PROTECTED.



## WARNING

PREVENT INJURY OR DEATH!  
BEFORE PERFORMING ANY MAINTENANCE WORK,  
TURN OFF THE BATTERY SWITCH AND  
REMOVE THE IGNITION KEY FROM THE SWITCH.

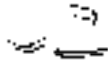

## Chapter 8

ENGINE & STERN DRIVE DIAGNOSTIC CHART	
Problem	Possible Cause
Engine Overheating	Water pick-up feeds are blocked by debris  Cooling system drain plugs not installed  Cooling system leak  Impeller is damaged or blocked by debris  Propeller is over propped for the circumstances, causing the engine to work extra hard  Debris in oil is holding heat more than normal - bad oil filter  Bad thermostat or gauge  Raw water cooling system has corroded from raw water left in the system
Low Oil Pressure	High oil level  Low oil level  Oil system leak  Drive oil sensor not reset at last oil change  Increased engine temperature (see engine overheating)
Engine Will Not Crank	Binnacle control lever not in neutral  Emergency stop switch activated



# Troubleshooting

ENGINE & STERN DRIVE DIAGNOSTIC CHART	
Problem	Possible Cause
	Battery switch turned off Battery is weak Fuses are blown on the engine Bad ignition relay / ignition switch
Engine Cranks But Will Not Start	Fuel tank vent obstructed Low battery level Inadequate fuel level Inadequate fuel pump pressure Fuel tank vent blocked Water in fuel Spark plugs have a bad gap Distributor malfunction
Hard Starting	Flooded Engine Fuel lines obstructed Water in fuel Debris in fuel - bad fuel filter
Engine Runs Rough	Bad fuel quality Inadequate fuel pump pressure Water or debris in fuel
	Manifold vacuum leak

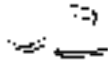

## Chapter 8

---

ENGINE & STERN DRIVE DIAGNOSTIC CHART	
Problem	Possible Cause
Stern Drive Groans	Not enough lubricant on drive shaft or in drive  Bad gimbal bearing due to water in bellows  Poor engine alignment
Excessive Vibration	Drive prop was grounded, bent, or destroyed  Engine mounts loose / broken  Bad oil quality / type  Distributor cap / rotor corroded  Loose serpentine belt  Bad alignment
Water In Oil / Power Trim / Power Steering Fluid	Could be any number of problems - Contact your Regal dealer





# Troubleshooting

CONTROL SYSTEM DIAGNOSTIC CHART	
Problem	Possible Cause
No Reading On Gauge or Gauge Is Inaccurate	Faulty gauge Faulty wiring to gauge Faulty sender
Gauge Reads Erratic	Loose ground or hot wire connection
Binnacle Control Lever Stiff / Inoperative / Stalls When Shifting	Shift system bushings and seals broken Kinked, broken, damaged cable Friction brake is too tight and must be loosened Control box jammed
Depth Gauge Inaccurate	Blocked transducer sight hole Bad gauge Bad transducer
Stern Drive Trim Not Functioning	Bad motor in trim control unit Faulty wiring Water in bellows / power trim fluid
Steering System Not Functioning	Uneven load Poorly lubricated steering system Lack of power steering fluid Kinked, broken, damaged cable

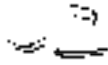

## Chapter 8

ELECTRICAL SYSTEM DIAGNOSTIC CHART	
Problem	Possible Cause
No 12 Volt Power At Battery	Battery switch turned off  Weak or dead battery  Battery cables disconnected from storage  Bad voltmeter or voltmeter connection
Battery Not Charging While Engine Is Running	Loose / damaged serpentine belt  Faulty alternator - check with volt meter  Faulty volt meter
Battery Will Not Hold Charge	Faulty / old battery
12 Volt Equipment Not Working	Fuse blown - investigate why the equipment was drawing too much current or why it had a circuit short. Check fuses in dash fuse box, underneath the dash, and in the engine compartment  Weak or dead battery if all 12v equipment fails to function  Corroded / loose wire connection  Internal equipment short / failure



# Troubleshooting

BILGE & DRAINAGE SYSTEM DIAGNOSTIC CHART	
Problem	Possible Cause
Bilge Pump Not Functioning Automatically	Float switch jammed - check for debris  Automatic bilge pump fuse blown - investigate why the equipment was drawing too much current or why it had a circuit short  Battery connection corroded  Impeller is damaged or blocked by debris  Bad bilge pump motor  Bilge pump discharge hose blocked
Bilge Pump Not Functioning Manually	Battery switch turned off  Bilge pump dashboard fuse blown - investigate why the equipment was drawing too much current or why it had a circuit short  Battery connection corroded  Bad bilge pump switch  Impeller is damaged or blocked by debris  Bad bilge pump motor  Bilge pump discharge hose blocked

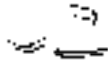

## Chapter 8

STEREO DIAGNOSTIC CHART	
Problem	Possible Cause
No Power At Stereo	Battery switch turned off  Fuse is blown - investigate why the equipment was drawing too much current or why it had a circuit short. Check ignition panel breaker, memory fuse in engine compartment, memory fuse underneath dash, and ignition protection fuse underneath dash  Water in unit
Stereo Will Not Play	Water in unit  Radio Signal Unavailable  Bad antenna  Mode selection isn't correct
Stereo Memory Lost	Stereo memory fuse in engine compartment or underneath dash is blown - investigate why the equipment was drawing too much current or why it had a circuit short
No Output Sound / Volume Is Low / Sound Is Distorted	Balance and max volume settings are limiting the speaker volume - adjust zone settings and setup settings  Rotary encoder malfunction  Loose speaker wire  Water in speakers



# Troubleshooting

STEREO DIAGNOSTIC CHART	
Problem	Possible Cause
Added Performance Package Speakers Working Only	Amplifier fuse blown - investigate why the equipment was drawing too much current or why it had a circuit short
	Standard zone max volume settings are low
	Loose speaker wire connections
	Water in cockpit speakers
Standard Speakers Working Only	Added speaker zone max volume settings are low
	Loose speaker wire connection
	Water in bow speakers
iPod Not Working	iPod not plugged in properly using appropriate sleeves
	iPod mode not selected
	Internal iPod problem
LCD Screen Not Displaying	Water in unit

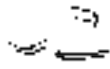

## Chapter 8

---

### AUDIBLE ALARMS

It is important to read the engine owner's manual to diagnose engine alarms and faults. Depending on the propulsion package installed, alarm sounds can vary.

On your Regal boat, your engine sounds an alarm in the case of one of the following causes:

- Low Oil Pressure
- Engine Overheating

To quickly diagnose these problems, look at the multi-gauge equipped on your vessel. Monitor the oil pressure gauge and temperature gauge, and troubleshoot accordingly. Be weary of faulty gauges however, and investigate the problem at the engine as necessary.



# Storage & Winterization

Storage procedures are outlined in this chapter. These are general guidelines to follow before longer periods of storage such as over the winter in colder climates. Be sure to familiarize yourself with all relevant information in the owner's information packet. Special winterization procedures are necessary for the boat equipment and systems. Use the enclosed checklists to help you identify areas of concern and maintenance. These lists cover land stored boats either inside or outside. Call a Regal dealer or marine professional for further information.



## WARNING

EXPLOSION, FIRE AND POLLUTION HAZARD!  
DO NOT FILL FUEL TANK TO RATED CAPACITY.  
LEAVE ROOM FOR EXPANSION.  
USE A FUEL STABILIZER IN THE FUEL TANK.



## CAUTION

REMOVE BATTERY(IES) WHEN VESSEL  
IS IN LONG PERIODS OF STORAGE.



## CAUTION

TO PREVENT ENGINE DAMAGE!  
USE ONLY ETHYLENE GLYCOL BASE ANTIFREEZE.  
DO NOT USE ALCOHOL BASE PRODUCTS.

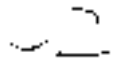

## Chapter 9

---

### DECOMISSIONING CHECKLIST

#### ENGINE

1. Run engine. Pour a fuel stabilizer/conditioner in the fuel tank. Allow time for it to circulate through the fuel system.
2. Change all engine fluids as referenced in the engine manufacturer's owners manual. Contact a Regal dealer.
3. Drain cooling and exhaust system by a marine professional Pickle the engine. Contact a Regal dealer for more information.
4. Spray all exterior parts with Remove propeller. Refurbish as needed.
5. After cleaning touch up paint on stern drive/outboard as needed.
6. Apply coat of wax to stern drive/outboard drive hsg and shroud.

#### BOAT

1. Check hull bottom for any fiberglass damage.
2. After cleaning apply a coat of wax to hull and deck surfaces.
3. Pour a pint of 50/50 antifreeze into bilge pump.
4. Never block up boat bottom. May cause structural damage.
5. Remove battery. Use a trickle charger as needed.
6. Remove all loose gear and electronics from boat. Inspect all equipment for wear and damage. Store in a clean, dry environment.





## Storage & Winterization

---

7. Remove drain plug. Clean drain plug hole of debris as needed. Enclose drain plug in plastic bag and tie to steering wheel.
8. Regarding outside storage, make sure bow is higher than stern to permit proper drainage.
9. Clean all upholstery and store so it breathes.
10. Conduct a visual inspection to ensure boat is balanced properly on the trailer, cradle or blocks.
11. Wrap boat with appropriate cover. Tie down for protection from rain, snow and/or wind. Prop up cover to provide proper ventilation. Do not cover up the fuel vents.  
Drain the fresh water system per instructions in this chapter.

### TRAILER

1. Repack all wheel bearings per manufacturer's specifications.
2. Check all trailer parts for excessive wear. Replace/refurbish as needed.
3. Use touch up paint on trailer as needed.
4. Lubricate all moving parts as needed.
5. Check all lighting and brakes (if applicable).

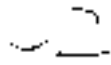

## Chapter 9

---

### FRESH WATER SYSTEM (Models w/Transom Shower Wand)

1. Activate the fresh water pump switch.
2. Activate transom shower wand and allow tank to empty.
3. When tank is empty shut off fresh water pump switch.
4. Mix nontoxic antifreeze with water in accordance with the manufacturer's recommendations. (Available at marina & RV stores)
5. Pour solution into the fresh water tank.
6. Turn on fresh water pump switch.
7. Open transom shower wand (if equipped) and purge until a steady stream of nontoxic antifreeze flows from the faucet. Turn the fresh water switch to the "off" position.

### WASTE SYSTEM (If Equipped)

1. With chemical heads, make sure to dump both upper and lower tanks.
2. Rinse well with fresh water.



## NOTICE

AVOID VESSEL AND ENGINE DAMAGE!  
CONTACT MARINE PROFESSIONAL FOR WINTERIZATION  
INSTRUCTIONS AS DAMAGE IS  
NOT COVERED BY REGAL WARRANTY.



# Storage & Winterization

---

## RECOMMISSIONING CHECKLIST

### ENGINE/STERN DRIVE

Check all components per engine manufacturer's owners manual especially fluid levels. Check for fuel, exhaust, oil, and water leaks. Run engine at idle on "ear muffs" (flushette) before launching. Note that select outboards use a garden hose adapter system.

### BOAT

Install drain plug.

Install battery and tighten all terminals.

Check all equipment, switches, alarms, gauges and breakers for proper operation.

Add necessary chemicals and water to chemical head (If Equipped).

Add water to fresh water tank. Turn on faucet to purge tank.

Refill water tank.

Make sure all safety gear is on board and in excellent working condition.

After launching, check controls and gauges for proper operation.

### TRAILER

Make sure all equipment is in excellent working condition.

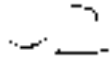

## CHAPTER 9

---

### Notes



---

# Trailer

This chapter covers trailering/towing basics including equipment, maintenance, and techniques of using a trailer. *Check with state and local agencies for detailed information on required equipment, safety issues, and licensing before attempting to tow your vessel.*

## BEFORE TOWING

Before towing your boat, be sure to check the air pressure of your tires for the recommended inflation specification. Also, be certain that your tow vehicle is in good working order.

Install any bimini top and sunshade in their respective boots before towing. Store cockpit carpet along with cockpit/bow covers. This can make it especially difficult to drive safely, as the hitch may be in danger of striking the road. Also, this situation can be caused by worn vehicle rear shock absorbers. One option is to install a set of air shocks which will assist in supporting the load. As a rule of thumb 5 to 7 percent of the total trailer load should be on the trailer tongue. Check all lights to ensure they all work properly. You may find it helpful to ask someone to check your turn signals, brake lights, and towing lights while you remain in the vehicle. Be certain that the trailer winch cable is securely attached to the boat's bow eye and the cable lock is engaged. Make sure the bow of the boat is snug against the bow stop at the winch stand.

It is a good idea to tie another line or secure an extra cable to the winch stand and boat bow eye as a backup system.

Be certain that your trailer is of rated capacity for the size and weight of your boat, including the weight for all fuel, water and gear. Your authorized Regal dealer can advise you on the proper trailer capacity and tongue weight (weight exerted on the rear of your vehicle).

Never use a bumper mounted trailer hitch. Always use a bolted or welded frame-mounted hitch, class 2 or 3.

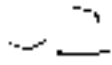

# Chapter 10

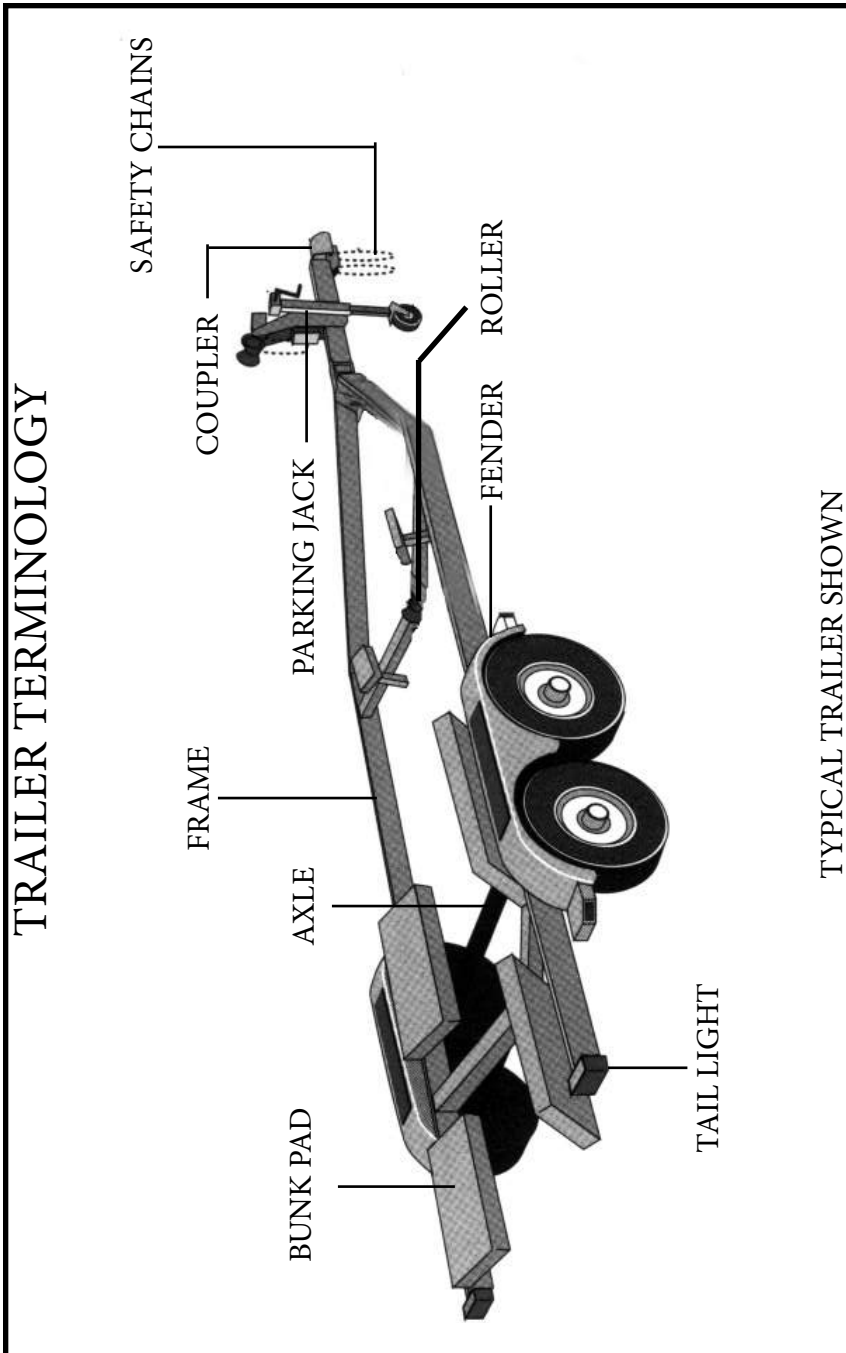

10-2



# Trailer

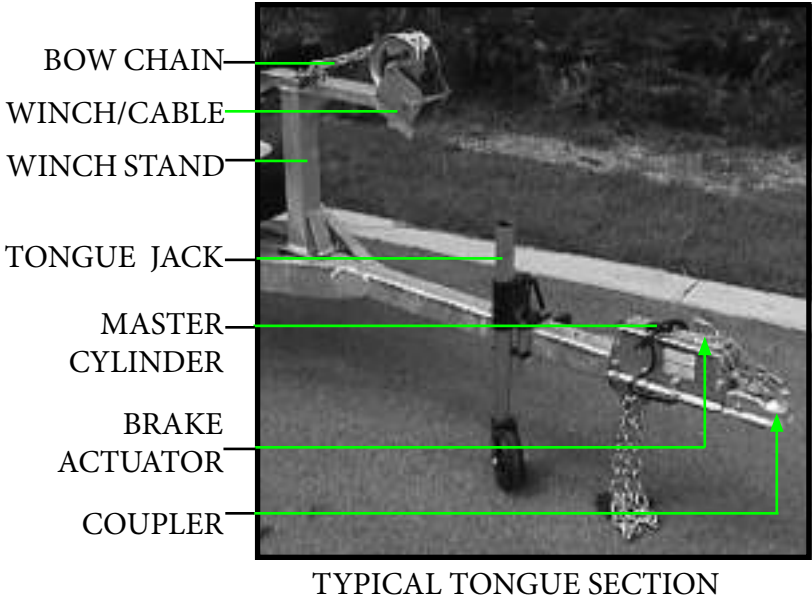
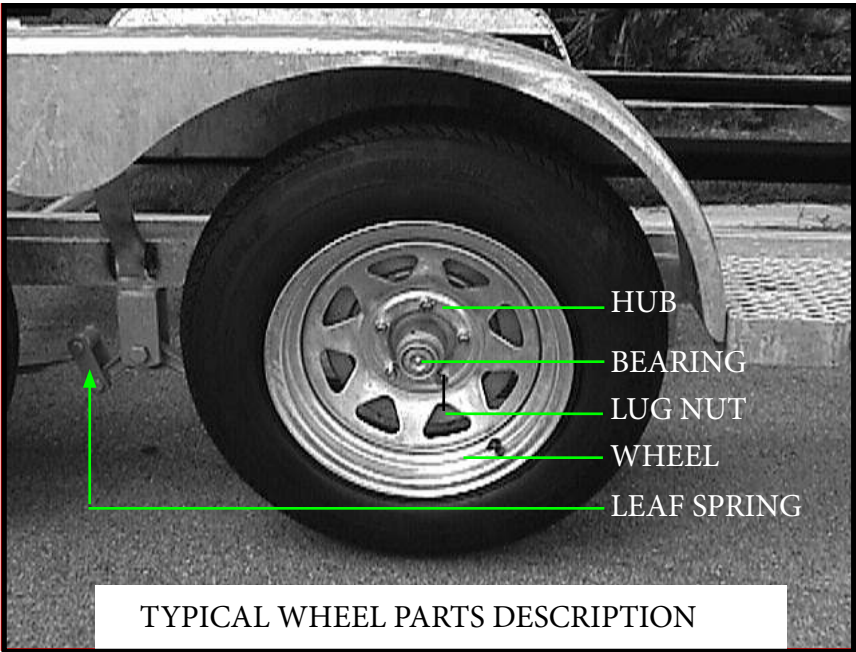

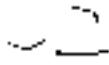

## Chapter 10

---

Consult your Regal dealer for more information.

Should your trailer be equipped with surge brakes, that is brakes on the trailer that cut in with a very slight delay when your brakes are applied, be sure to follow recommended service and maintenance instructions. Be sure that the trailer master cylinder is filled with the recommended fluid before towing your boat. Inspect the trailer brake lines for any leakage. Also, if you notice brake fluid on the inside of the tires, you may have a wheel cylinder leaking. Consult a professional. Never place your hands between the trailer hitch coupling and the hitch ball on your towing vehicle while hooking up. Be sure the tongue jack is in the full up position before departure. Be certain safety chains are crisscrossed and secured; do not allow them to drag on the road. Be sure to buy a suitable set of tie downs which can be attached to the boats' stern eyes and the eyelets provided on most trailers. Tighten them securely and neatly fold up the extra strap material and secure it with tape so it doesn't loosen and dangle on the road.

Check the trailer lug nuts for the proper torque. Use a foot pound wrench and torque in a star sequence to the correct poundage as recommended by the trailer manufacturer. Torque the lug nuts at half the poundage on all nuts. Then set the torque wrench to the full poundage and fasten to the last foot poundage figure.

Check the trailer tires often for voids, excessive wear or out of round tire conditions. If the trailer seems to vibrate you may have a bad tire or one that is unbalanced. These wheels can be rebalanced at most automotive or tire shops. Never pull a boat on a patched tire. Buy a spare tire and wheel including a hub and wheel bearing assembly. Mount it on the trailer for speedy installation should a blow out occur. Check the trailer harness often for signs of fraying. Check the harness connector for corrosion. Make sure the trailer harness when connected to the trailer has enough slack for turning

Check the wheel bearings for wear periodically by a professional. On most trailers, there is a zerk fitting on the wheel hub to add the proper lubricant to the wheel bearing with a grease gun. These wheel bearing waterproof covers for the bearings can be purchased at retail outlets.





## SPARE PARTS CHECKLIST

Longer towing trips increase the need for special preparations. Sometimes these extended trips cover areas where it is difficult in locating repair parts due to a breakdown. *Following is a checklist of recommended items to add a safety net to your trip.*

### Trailer-

1. Trailer tire jack
2. Spare hub assembly including wheel bearings
3. Spare tire
4. Lug wrench
5. Jack stand
6. 12 volt air compressor- found at automotive box stores
7. Spare bearing protector
8. Extra tie-down straps
9. Trailer light bulbs
10. Brake pads and brake fluid
11. Grease gun

### Tow Vehicle-

1. Tool kit including necessary ratchet and sockets
2. Jumper cables
3. Extra fuses
4. Engine oil
5. Transmission fluid
6. Wheel chocks
7. Highway flares
8. 12 volt spotlight- type that plugs into 12 volt accessory outlet
9. Flashlight & spare batteries
10. Waterless hand cleaner and rags
11. Electrical connectors and crimpers
12. Low voltage electrical tester

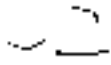

## Chapter 10

---

Be sure everything is secured in the boat and canvas is down in the towing position with the bimini stored in the boot. Tilt the stern drive up to clear the road and any bumps that might occur while in transit.

### DRIVING

Practice maneuvering the vehicle and trailer in a large, empty parking lot or open space. If you practice slowly and cautiously, you will soon develop a feel for maneuvering the trailer .

Test your vehicle and trailer brakes before departure along with the lights. Pack a tool kit with extra bulbs, fuses and fluids.

Drive as smoothly as possible, anticipating your stops and giving yourself plenty of room for turning and stopping. Avoid any quick turns or sudden jerks of the steering wheel.

Remember to maintain safe speed limits. It takes longer to stop your loaded boat. Allow enough room to the front in bad weather.

Keep an eye on your rig through the rear view and side mirrors. If your rear view mirror is obstructed, purchase a set of side mirrors that extend out over the side of the vehicle for increased visibility. In addition, it is a good idea to install a set of round mirrors to the side mirrors as they help identify blind spots.

Plan to stop periodically on your way to check the trailer hitch for tightness, harness connector, tires and wheel bearings. Also, check to make sure the load is balanced.



# Trailer

## LAUNCHING

Serious accidents can occur at the launching ramp. Therefore, it is imperative you be alert and attentive during launching and docking activities. Study the ramp area and surrounding water for any potential hazards, such as a short ramp or one with a drop off at the end. If you are uncertain of the conditions, ask someone else who has just used the ramp if there are any peculiarities to the area.

Install the drain plug. Attach 2 lines, one each at the bow and stern, to control your boat once it is off the trailer. If you need additional fenders to keep the sides of the boat from banging against the ramp walls, use those as well.

Unhook the stern tie-downs and the winch line to the bow. Unplug the trailer harness connector so the hot trailer light bulbs won't blow out when they come in contact with water.

When backing in, have someone assist, giving the palms up stop signal when the boat is in deep enough water to float off, or when the rear wheels of your vehicle approach the water's edge.

After your boat is floating freely, position it clear of the trailer before pulling out of the water. If there is no one to help you, secure one of the lines you've attached from the boat to the dock and use the other line to pull the boat off trailer. The process is easier with 2 people.



### CAUTION

AVOID LOSING VEHICLE TRACTION!  
DO NOT ALLOW REAR WHEELS TO ENCOUNTER  
SAND OR SLIPPERY CONCRETE CONDITIONS.



### WARNING

AVOID BODILY INJURY!  
RAMPS ARE VERY SLIPPERY.  
DO NOT ATTEMPT TO WALK OR STAND  
ON AN ANGLED BOAT RAMP.

10-7

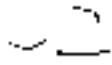

# Chapter 10

## BACKING A TRAILER

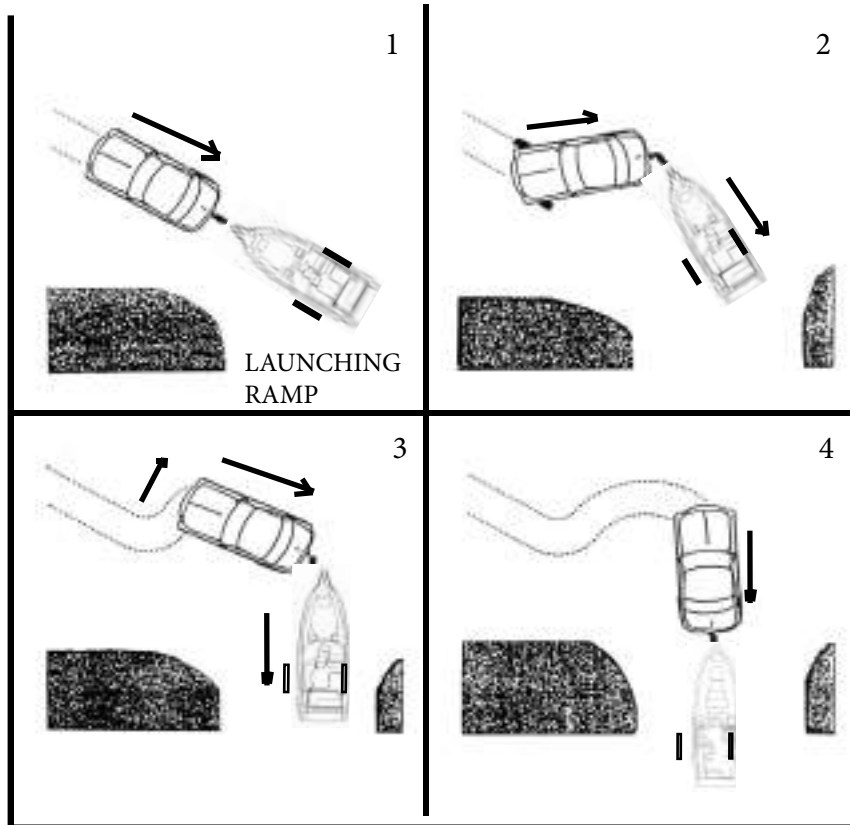

A trailer backs in a direction opposite to an automobile. In 1, driver swings the rig near the launching ramp. In 2, the driver cuts the vehicle toward the driveway. In 3, the driver cuts the vehicle wheels to the left and then backs into the ramp as the trailer moves to the right. In 4, the driver straightens the vehicle wheels to follow the trailer as it backs down the ramp.



### NOTICE

ALLOW TRAILER WHEEL BEARINGS AND LIGHTS  
TO COOL BEFORE SUBMERGING



# Trailer

## LOADING



The most important thing to remember when pulling your boat out of the water is that often the ramp will be crowded. As you approach the ramp, make a visual inspection of the traffic and people, both at the ramp and all around you. *This is an important time to use*

*caution, courtesy, and common sense!* While you may feel it's your next turn, another boater may not be as courteous. Don't insist on your rightful place in line; it could lead to disastrous consequences in the confines of a crowded boat ramp. If there is any perceived danger, stand off until you can safely approach the ramp.

Back your trailer down to the water's edge. At this point it is a good idea to let a sufficient amount of line out of the winch to reach the bow eye. Make sure you disconnect the trailer harness to keep the bulbs from blowing out due them being subjected to the cold water. On roller or bunk style trailers back up until the aft roller is just at the water level. This allows you to hook up the winch cable and to start cranking the boat on to the trailer properly. This method gives you a good starting point and helps keep the boat centered on the trailer as it is reloaded. It may be necessary to further back the trailer into the water. This permits cranking the boat easier on to the trailer. Once the boat is positioned correctly on the trailer have someone hook up the winch cable hook to the bow eye. Also, this will help keep the boat bow against the trailer roller. Shut down the engine and run the stern drive up to the top of the trailer position.

With the bow snug against the roller, start to crank the boat up on to the trailer. Make sure the hull bottom or keel stays in the center of each roller as it is being cranked on the trailer. Double check to ensure the hitch is locked tight on the vehicle ball.

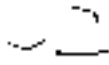

## Chapter 10

---

Make sure the boat is covered properly and all loose gear is stowed. On bunk style trailers, watch the bunks to make sure the boat is centered as they usually do not touch any rollers other than the aft one because the boat weight is being supported more by the bunks as it is cranked onto the trailer. Stop cranking the winch when the boat bow contacts the bow roller. Be sure the winch is in the locked position. Stand back and visually check to see that the boat is centered on the trailer.

After pulling your boat away from the ramp, be sure to go through all the checks involved before departure. Reinstall the harness connector and check the lights, brakes, safety chain, winch, hitch, and tie downs. Remove the drain plug to exit any excess water in the bilge. Reinstall the hull drain plug and tighten it. For longer storage periods remove the drain plug and keep in a plastic bag tied to the steering wheel.



### **WARNING**

AVOID PERSONAL INJURY!  
DO NOT LET ANYONE STAND NEAR THE WINCH OR CABLE AS THE  
CABLE UNDER LOAD COULD BREAK.



### **CAUTION**

HULL BOTTOM DAMAGE COULD RESULT  
FROM THE BOAT NOT BEING POSITIONED  
ON THE ROLLERS BUT RESTING  
ON THE TRAILER FRAME.  
AVOID BACKING TRAILER  
TOO FAR INTO THE WATER!



# Glossary & Index

Below is a brief list of nautical terminology. For more detailed glossaries we recommend you check your local library, book retailer, marine store or internet.

## GLOSSARY

Abeam: at right angles to the fore and aft line and off the boat

Aboard: on or in the boat

Above: the part of the boat on a vessel which is above the interior of the boat

Aft, After:: aft is the boat section toward the stern or back of the boat

Amidships: toward the center of the boat from either side to side or rear to front

Beam: the width of a boat at its widest part

Bilge: the lower interior of the hull of the boat

Bitter end: the end of a line also the end of an anchor line

Bow: the front, or forward part of the boat

Bulkhead: the vertical partition or wall of a boat

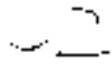

## Chapter 11

---

Cast off: to let go or release

Chine: the line fore and aft formed by the intersection of the side and bottom of the boat

Chock: deck fitting used to secure or guide anchor or tie lines

Cleat: deck fitting with protruding arms around which lines are secured

Cockpit: the seating space used to accommodate passengers

Cuddy: a small cabin in the fore part of the boat

Deck: the open flooring surface on which crew and passengers walk

Draft: the depth from the waterline of the boat to the lowest part of the boat, which indicates how much water is required to float the boat

FasTrac- a proven hull bottom design which incorporates a full, mid-beam step that reduces drag by forcing air under the hull to decrease drag and friction.

Fathom: a measurement of depth; one fathom equals six feet

Fender: a cushion hung from the side of a boat to prevent it from rubbing against a dock or against other boats

Fend off: to push off to avoid sharp contact with dock or other vessel

Fore: the part of the boat toward the bow or front

Freeboard: the height of the top side from the waterline to the deck at its shortest point (The distance from sheer or gunwale to the water).





## Glossary & Index

---

Gunwale: rail or upper edge of the side of the boat

Head: toilet

Hull: the part of the hull from the deck down

Keel: the lowest point of a boat; the backbone of the vessel

Knots: a measurement of speed indicating nautical miles per hour

Lee: the side opposite that from which the wind is blowing; the side sheltered from the wind

Leeward: the direction toward which the wind is blowing

PFID: personal flotation device; required for each person aboard

Port: the left side of the boat when facing forward (an easy way to remember the difference between “port” and “starboard” is that both “port” and “left” have four letters)

Shank: the main body of an anchor

Sheer: the curve of the boat’s deck from fore to aft when seen from the side

Starboard: the right side of the boat when facing forward

Stern: the aft end of the boat

Stern drive: an inboard/outboard (I/O) unit

Stringer: strengthening integral unit fastened from fore to aft inside the hull and fiberglass encapsulated for added strength: much like the skeleton system of our body

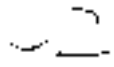

## Chapter 11

---

Top off: to fill up a tank

Transom: the vertical part of the stern

Trim: the boat's balance when properly loaded

Wake: the path of a boat left astern in the water

Windward: the direction from which the wind blows; opposite of leeward



# Glossary & Index

---

## INDEX

### A

Accessories	208
Accidents	53
Accident Reporting	54
Aids To Navigation	72
Anchor Light	42
Anchoring	200
Audible Alarms	302
Automatic Fire Extinguisher	38

### B

Battery	261
	294
Battery Switch	166
	210
	225
	295
Bilge/Drainage	158
	299
Bilge Pump	159
	211
	265
	299
Bimini Top	168
	213
	309
Blower	30
	95
	212
Boating Under The Influence	51
Bottom Blocking	304
Bow Cover	213
Bow Filler Cushion	218
Bow Walk Through Doors	219
Bridge Clearance	76
Bucket Seat	235
Buoys & Markers	74

### C

Canvas	213
	257
Capacity Plate	18
Carbon Monoxide	47
Cardiopulmonary Resuscitation	205
Cockpit Carpet	220
Cockpit Cover	213
Circuit Breakers	267
Controls	111
	136

### D

Dealer Responsibilities	19
Decommissioning	304
Depth Sounder	102
	225
	295
Diagnostic Charts	293
Direct Current (DC)	160
Distress Signals	41
Diver's Flag	55
Docking	190
Dock Lines	187
Drain Plug	227

### E

EPIRB	146
Electrical	160
Emergencies	204
Engine-Basics	117
	179
Environmental Awareness	207
Exhaust	47

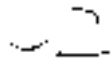

# Chapter 11

---

<b>F</b>		<b>I</b>	
Fenders	186	Ignition Panel	109
Fiberglass	248	Ignition Switch	110
Filters	232	Index	323
Fire Extinguishers	36	Interrupt Switch	112
Fire Port	157		
First Aid	207	<b>K</b>	
Fishing	61	Knots	203
Float Plan	15		
Fueling	178	<b>L</b>	
Fuel System- Engine	88	Ladder	33
	123	Lighting	164
Fuel System Warning	2		224
	266	Life Raft	46
Fuses	164	Load Capacity	18
		Law of Salvage	202
<b>G</b>		Launch & Cruise Checklist	16
Galvanic Corrosion	270	Lubrication-Engine	93
Garbage Placard	44		127
Gauges (Instrumentation)	101		281
	131		286
Gelcoat Maintenance	248	Lubrication-Drive	98
General Boating Safety	29		128
Getting Underway	176		285
Glossary	320		
		<b>M</b>	
<b>H</b>		Maneuvering	192
Helm Controls	108	Maintenance Guides	275
	147	Maintaining PFD'S	35
HIN	12	Masthead Light	42
Horn	108		45
	164	Matts	221
Hour Meter	104	Metal (Cleaning)	254
Hull Bottom	254	Minimum Required Equipment	45
Hypothermia	206		



# Glossary & Index

---

## N

Navigational Aids	72
Navigation Lights	41
	161
Navigation Rules	60
Neutral Safety Switch	111
New Boat Delivery Sheet	21
Night Running	75

## O

Oil Spills	43
Overloading	18
Owner's Information Packet	12
Owner's Registration	19
Owner Responsibilities	20

## P

Personal Flotation Devices	33
Plastics	247
Pollution Regulations	43
PowerTower	228
Power Trim	195
Precautionary Safety Labels	27
Pre-departure Questionnaire	176
Pressure Water System	231
Propellers	100
	130
Pyrotechnic Devices	28

## R

Radio Communication	41
Recommissioning	307
Registration Information	19
Right-Of-Way	68
Rules Of The Road	67

## S

Safety Labels	27
Safety Inspection	29
Seating	235
	264
Shallow Water Operation	198
Shifting-Remote Control	112
	137
	182
Signals-Navigation	69
Signals-Skiing	60
Skiing Precautions	56
Ski Tow	57
	238
Specifications	Tech
Sound Producing Devices	41
Speedometer	103
Sport Tower	240
Spring Line	187
Starting & Stopping	181
Stern Line	187
Steering	115
	184
	284
Stereo	175
	242
	268
	301
Stereo Performance Package	242
Stereo Remote	243
Stern Drive Basics	96
Storage/Travel Cover	216
Swim Platform	58
	234

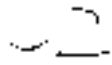

## Chapter 11

---

<b>T</b>		<b>V</b>	
Tachometer	104	Ventilation	49
Table	222	Visual Distress Signals	38
Technical	327	Volvo Engine Alarm	85
Temperature Gauge	103		
Towing	201		
Trailer	309		
Trailer Switch	245	<b>W</b>	
Transducer	166	Wake	61
Transom Door	244	Wake Sports	55
Transom Remote	245	Warning Labels	27
Travel Cover	216	Warranty	22
Trim Angle	195	Weather	12
Trim Gauge	105	Windshield-Center Latch	219
Troubleshooting	293	Winterizing	303
		Wiring Color Codes	161
<b>U</b>			
Upholstery	246		
		<b>Z</b>	
		Zinc Anodes	274



# Technical Information

## NOTICE

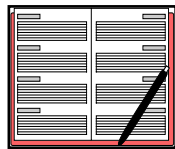

The following technical information and drawings can be an aid in troubleshooting electrical and mechanical problems along with the charts located in the troubleshooting chapter.

Note that all product specifications, models, standard and optional equipment, systems, along with the technical information is subject to change without notice.

For more information contact your nearest authorized Regal dealer. For the location of your nearest authorized dealer call 407-851-4360. or visit the web-site at [www.RegalBoats.com](http://www.RegalBoats.com).

Your Regal dealer has received special factory training on the entire product line and his services should be employed to solve technical problems.







## Technical Information

2000 ES/ESX SPECIFICATIONS		
LENGTH OVERALL	USA 20'2"	CE 6.15 M
CENTERLINE LENGTH	20'2"	6.15 M
BEAM	8' 6"	2.5 M
DEADRISE	20 DEGREES	
APPROXIMATE DRY WEIGHT W/ BASE ENGINE	3400 LBS.	1542.0 KG
APPROXIMATE OVER-ALL HEIGHT TO TOP OF WINDSHIELD ON TRAILER	6' 5"	1.96 M
APPROXIMATE BRIDGE CLEARANCE-TOWER UP	6' 3"	1.9 M
APPROXIMATE BRIDGE CLEARANCE-TOWER DOWN	4' 4"	1.3 M
COCKPIT DEPTH-HELM	30"	0.79 M
APPROXIMATE DRAFT-TRIM DRIVE UP/DOWN	20"-31"	.50-.79 M
FUEL CAPACITY	40 GALS EST.	151 L
PERSONS CAPACITY	10	8
MAXIMUM CAPACITY; PERSONS & GEAR	1350 LBS.	N/A
MAXIMUM LOAD RECOMMENDED; PERSONS & GEAR	N/A	762.0 KG * RCD II

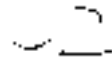

21 OBX SPECIFICATIONS		
LENGTH OVERALL	USA 20'2"	CE 6.15 M
CENTERLINE LENGTH	20'2"	6.15 M
BEAM	8' 6"	2.5 M
DEADRISE	20 DEGREES	
APPROXIMATE DRY WEIGHT W/ BASE ENGINE	3470 LBS.	1574.0 KG
APPROXIMATE OVER-ALL HEIGHT TO TOP OF WINDSHIELD ON TRAILER	6' 5"	1.96 M
APPROXIMATE BRIDGE CLEARANCE-TOWER UP	6' 3"	1.9 M
APPROXIMATE BRIDGE CLEARANCE-TOWER DOWN	4' 4"	1.3 M
COCKPIT DEPTH-HELM	30"	0.79 M
APPROXIMATE DRAFT-TRIM DRIVE UP/DOWN	20"-36"	.50-.91 M
FUEL CAPACITY	40 GALS	151 L
PERSONS CAPACITY	10	8
MAXIMUM CAPACITY; PERSONS & GEAR	1800 LBS.	N/A
MAXIMUM LOAD RECOMMENDED; PERSONS & GEAR	N/A	916.0 KG * RCDII

## TYPICAL LABELS & LOCATIONS

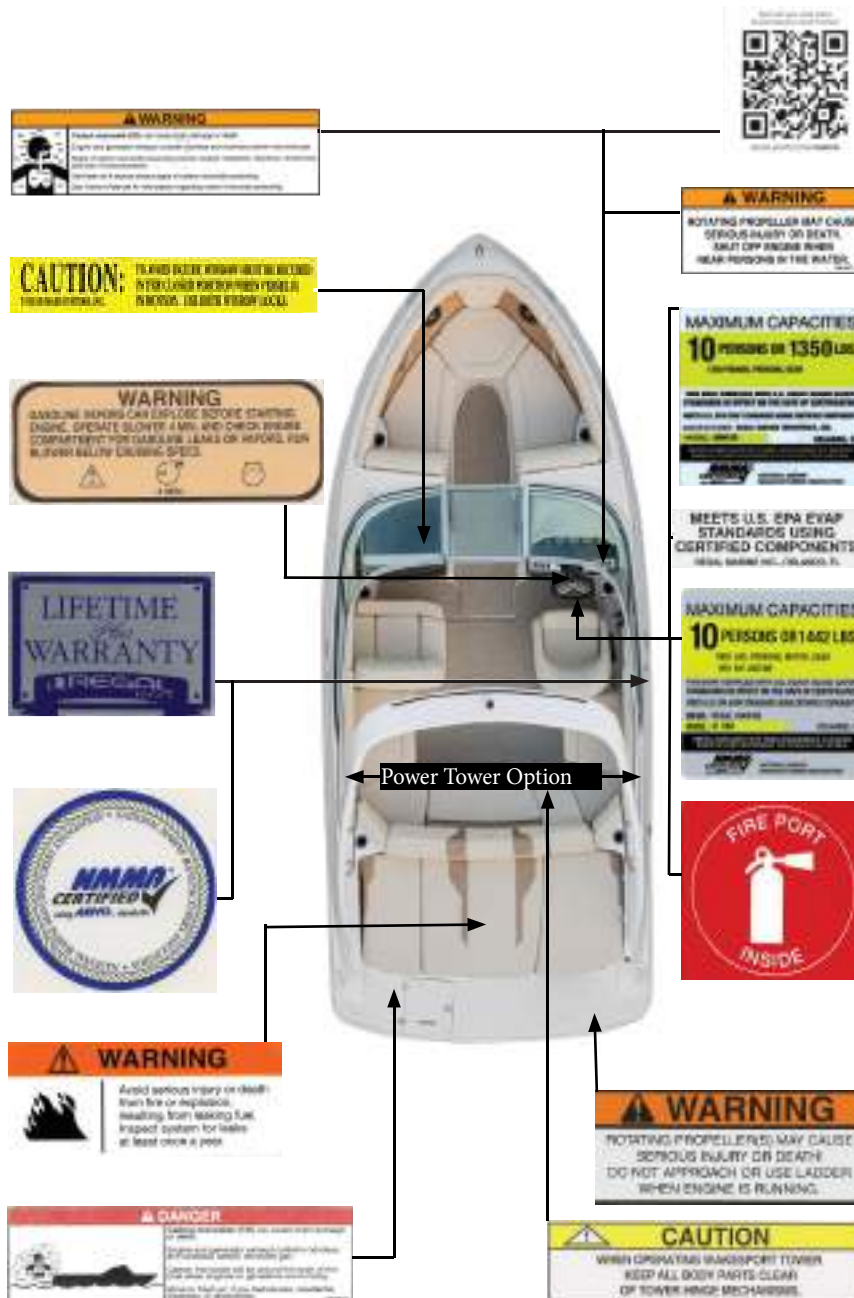

12-6





# Technical Information

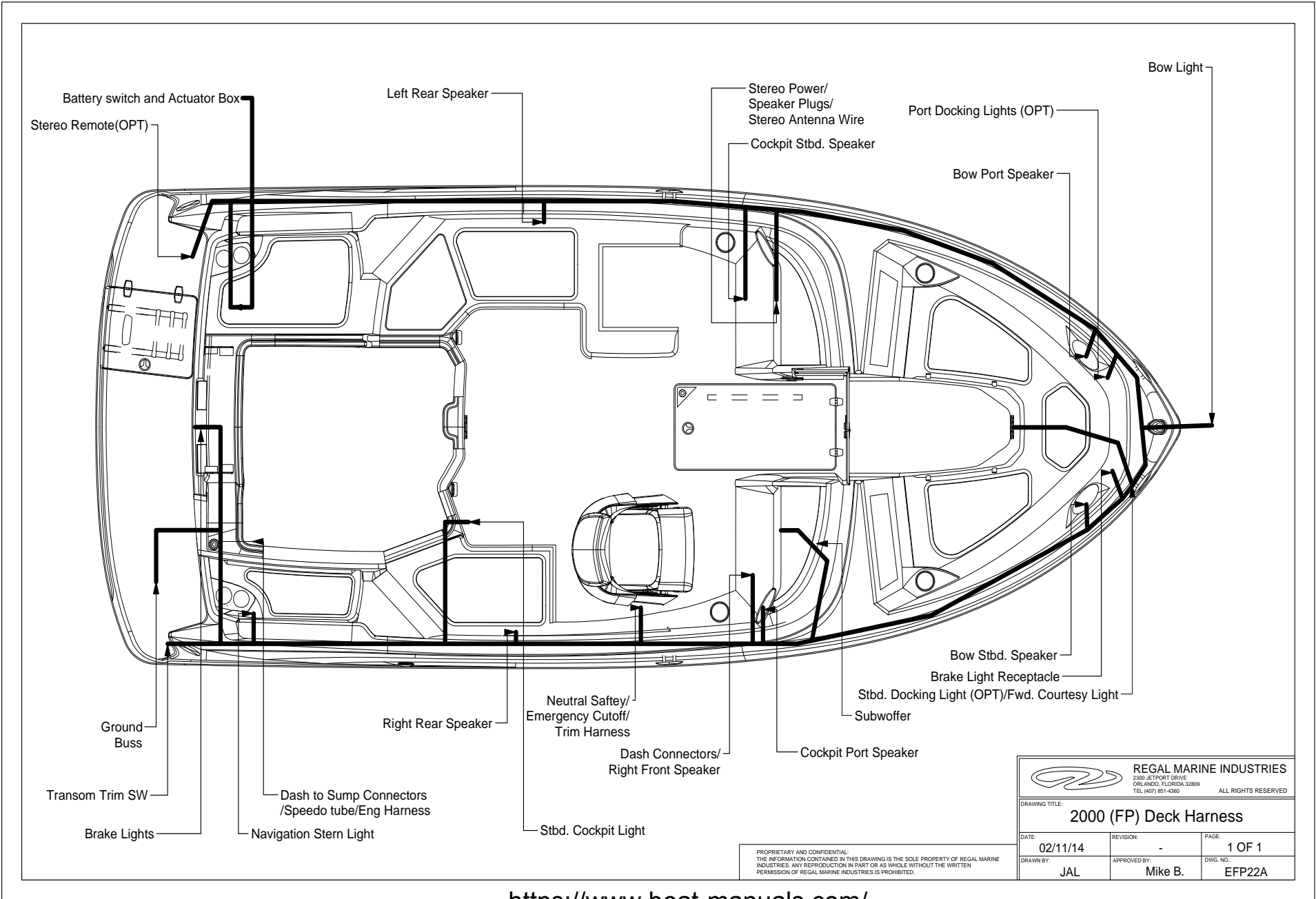

PROPRIETARY AND CONFIDENTIAL:  
THE INFORMATION CONTAINED IN THIS DRAWING IS THE SOLE PROPERTY OF REGAL MARINE  
INDUSTRIES. ANY REPRODUCTION IN PART OR AS WHOLE WITHOUT THE WRITTEN  
PERMISSION OF REGAL MARINE INDUSTRIES IS PROHIBITED.

		
REGAL MARINE INDUSTRIES 2300 LETTPORT DRIVE ORLANDO, FLORIDA 32809 TEL (407) 851-4380		
ALL RIGHTS RESERVED		
DRAWING TITLE: <b>2000 ES Starboard Profile</b>		
DATE: 8/25/14	REVISION: -	PAGE: 1 OF 1
DRAWN BY: JAL	APPROVED BY: -	DWG. NO.: 4



		
REGAL MARINE INDUSTRIES 2300 ZEPHYR DRIVE ORLANDO, FLORIDA 32809 TEL (407) 851-4360		
ALL RIGHTS RESERVED		
DRAWING TITLE: <b>2000 (FP) Deck Harness</b>		
DATE: 02/11/14	REVISION: -	PAGE: 1 OF 1
DRAWN BY: JAL	APPROVED BY: Mike B.	DWG. NO.: EFP22A

PROPRIETARY AND CONFIDENTIAL:  
THE INFORMATION CONTAINED IN THIS DRAWING IS THE SOLE PROPERTY OF REGAL MARINE INDUSTRIES. ANY REPRODUCTION IN PART OR AS WHOLE WITHOUT THE WRITTEN PERMISSION OF REGAL MARINE INDUSTRIES IS PROHIBITED.

TRAILER CONNECTOR PLUG INSERTS INTO BOAT BOW RECEPTACLE

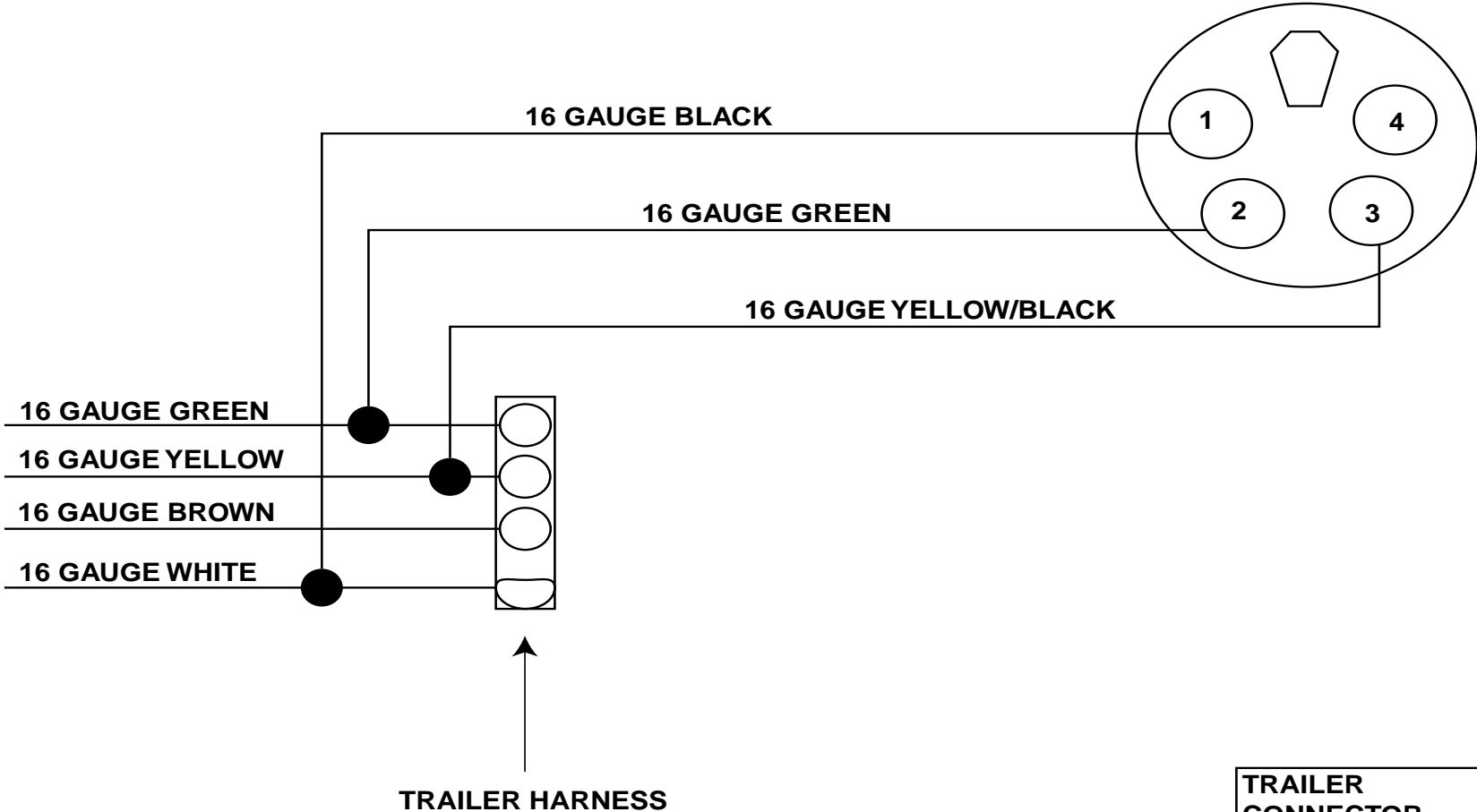

TYPICAL TRAILER PLUG

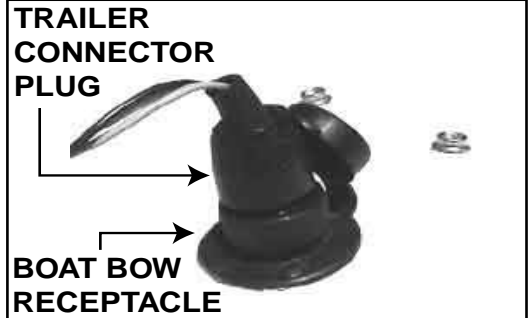

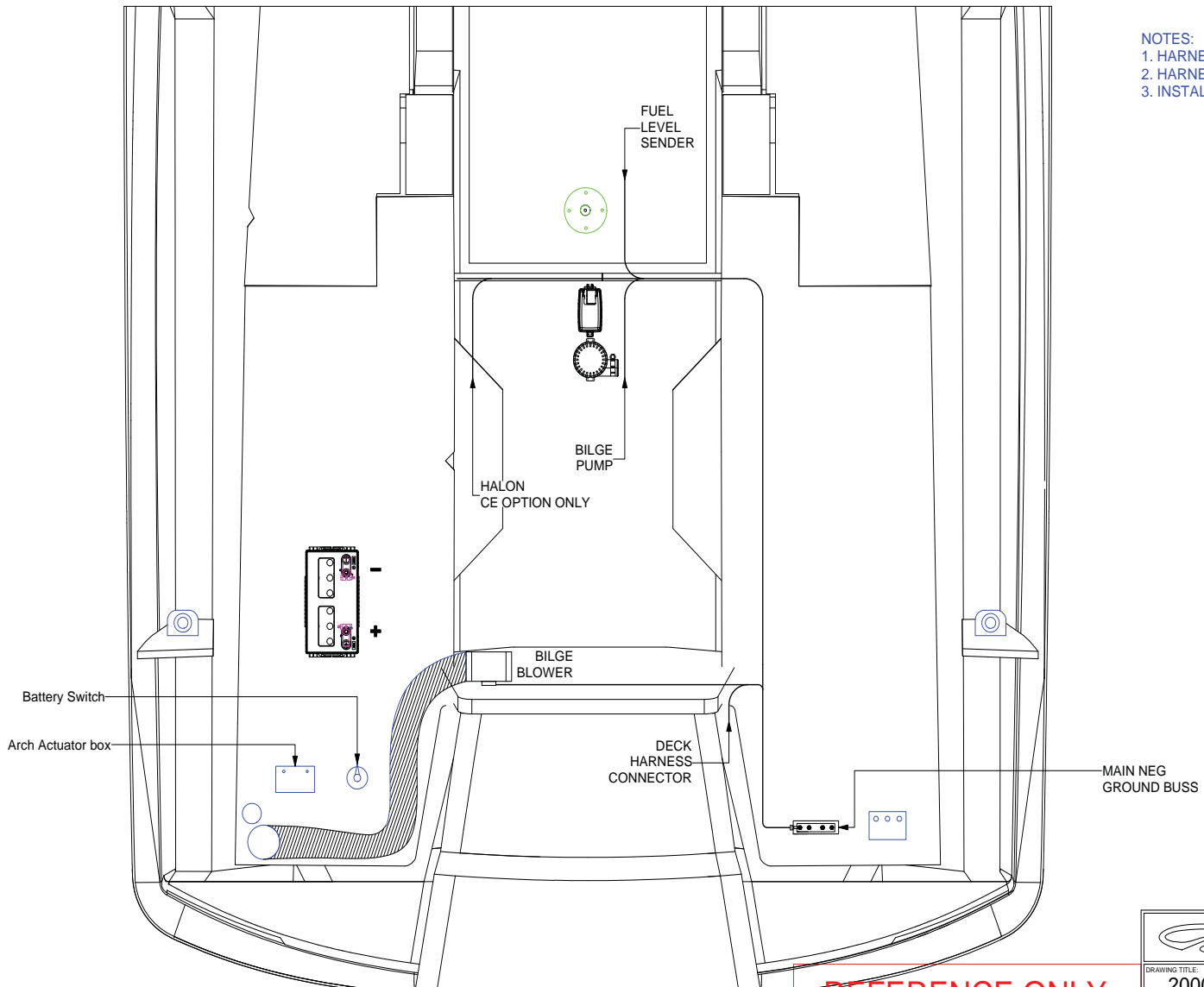

- NOTES:
1. HARNESS TO BE INSTALLED AS SHOWN.
  2. HARNESS TO BE SECURED EVERY 18" MIN.
  3. INSTALL CHAFE PROTECTION AS NEEDED.

**REFERENCE ONLY**

PROPRIETARY AND CONFIDENTIAL:  
THE INFORMATION CONTAINED IN THIS DRAWING IS THE SOLE PROPERTY OF REGAL MARINE INDUSTRIES. ANY REPRODUCTION IN PART OR AS WHOLE WITHOUT THE WRITTEN PERMISSION OF REGAL MARINE INDUSTRIES IS PROHIBITED.

		
REGAL MARINE INDUSTRIES 2300 JETPORT DRIVE ORLANDO, FLORIDA 32809 TEL (407) 851-4360 ALL RIGHTS RESERVED		
DRAWING TITLE: <b>2000 (FP) Deck to Sump Harness</b>		
DATE: 02/21/14	REVISION: -	PAGE: 1 OF 1
DRAWN BY: JAH	APPROVED BY: Mike B	DWG. NO.: EFP22B

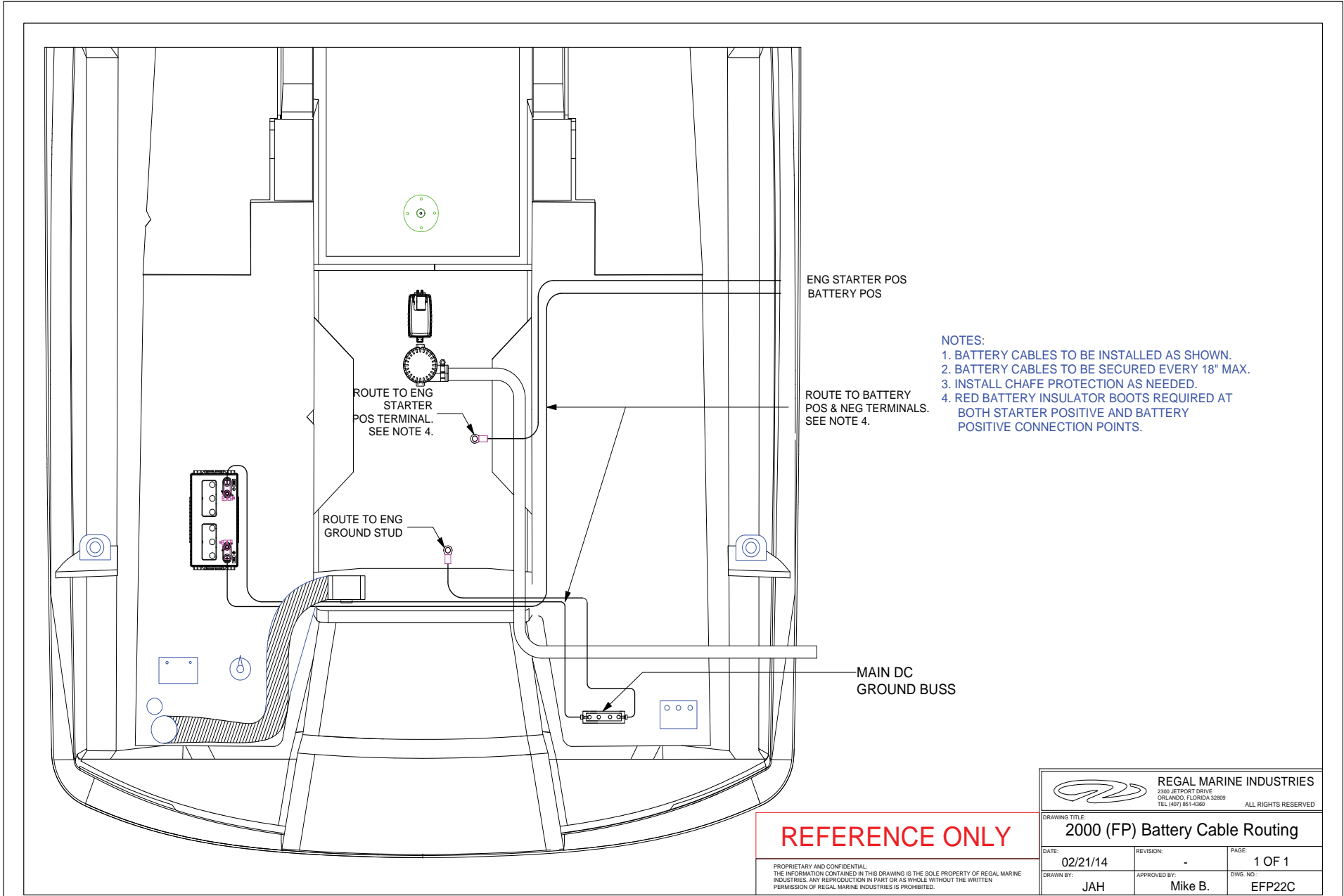

**REFERENCE ONLY**

PROPRIETARY AND CONFIDENTIAL:  
 THE INFORMATION CONTAINED IN THIS DRAWING IS THE SOLE PROPERTY OF REGAL MARINE INDUSTRIES. ANY REPRODUCTION IN PART OR AS WHOLE WITHOUT THE WRITTEN PERMISSION OF REGAL MARINE INDUSTRIES IS PROHIBITED.

 REGAL MARINE INDUSTRIES 2300 JETPORT DRIVE ORLANDO, FLORIDA 32809 TEL: (407) 851-4380			ALL RIGHTS RESERVED
DRAWING TITLE: 2000 (FP) Battery Cable Routing			
DATE: 02/21/14	REVISION: -	PAGE: 1 OF 1	
DRAWN BY: JAH	APPROVED BY: Mike B.	DWG. NO.: EFP22C	



- NOTES:**
1. PLACE TAPE OVER ALL DT PLUGS TO PREVENT LOSS OF SEAL.
  2. ALL WIRES 16 AWG UNLESS OTHERWISE NOTED.
  3. ALL FLEX TO BE FIRE RETARDANT (BLUE STRIPE).

9-23-07	F: RECH#22192 BLWR TERM CHG TO DEUTSCH PLUG	MD
9-23-08	G: RECH#23100 SEE ECH FOR CHANGES	MD
33-04-13	H: RECH#24181 SEE ECH FOR CHANGES	MD
7-7-04	C: ECH#20281 HALON/BLWR S&D CHGD TO PROPER CONT.	MS
11-05-04	D: ECH#20084 CHGD FLOAT PLUG TO RECEPT	MS
10-05-05	E: RECH#1972 CHG BLWR DEUTSCH CONN TO PERMASEAL	MD

**GROUNDS/BONDS**

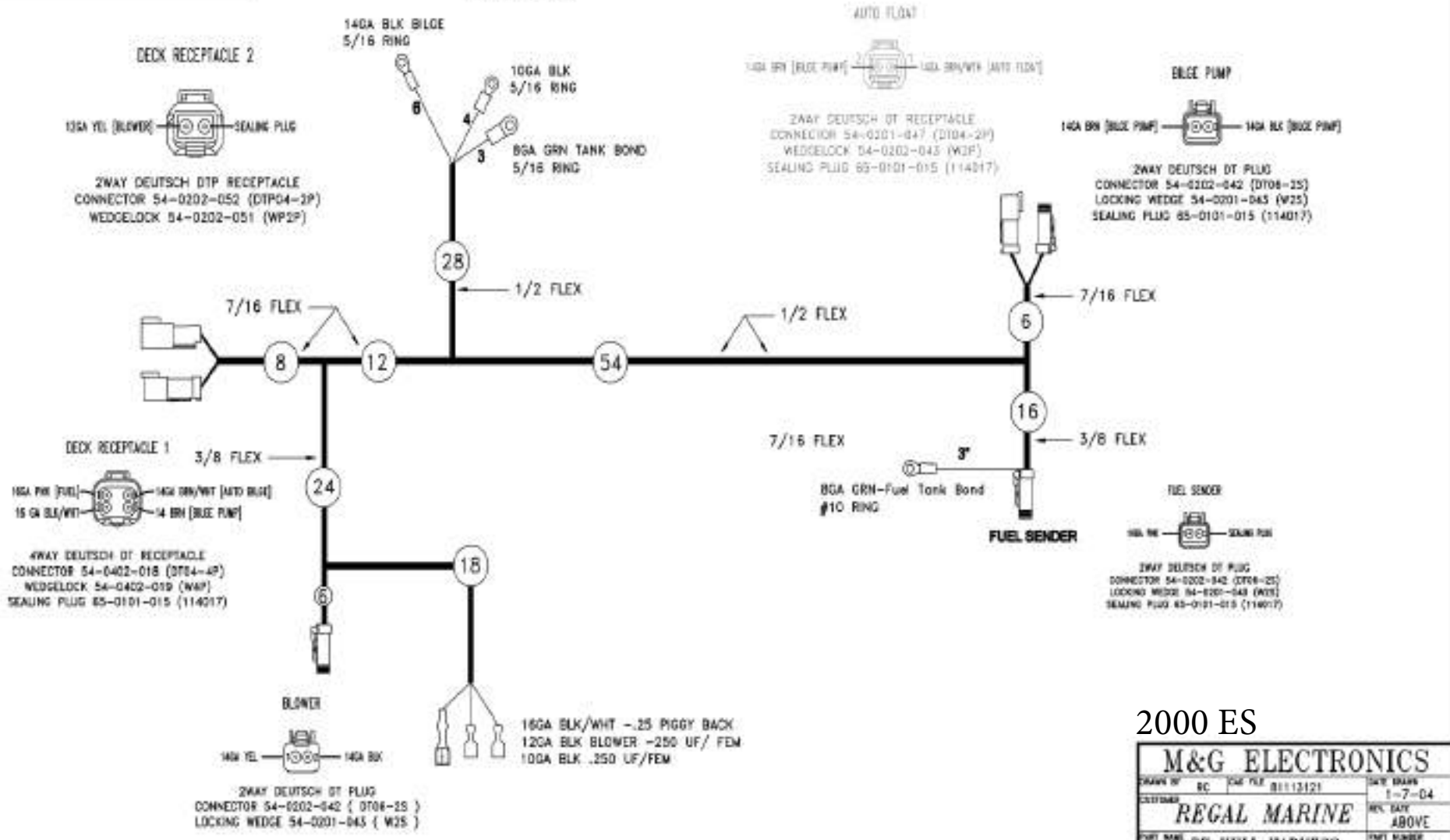

2000 ES

<b>M&amp;G ELECTRONICS</b>			
DRAWN BY: BC	DATE FILED: 01113121	CHECKED BY: 1-7-04	
CUSTOMER: <b>REGAL MARINE</b>		MFG. DATE: ABOVE	
PART NAME: <b>FK HULL HARNESS 9676</b>		PART NUMBER: 81113121	

15.5"W X 29.5"L Allowance Per Person

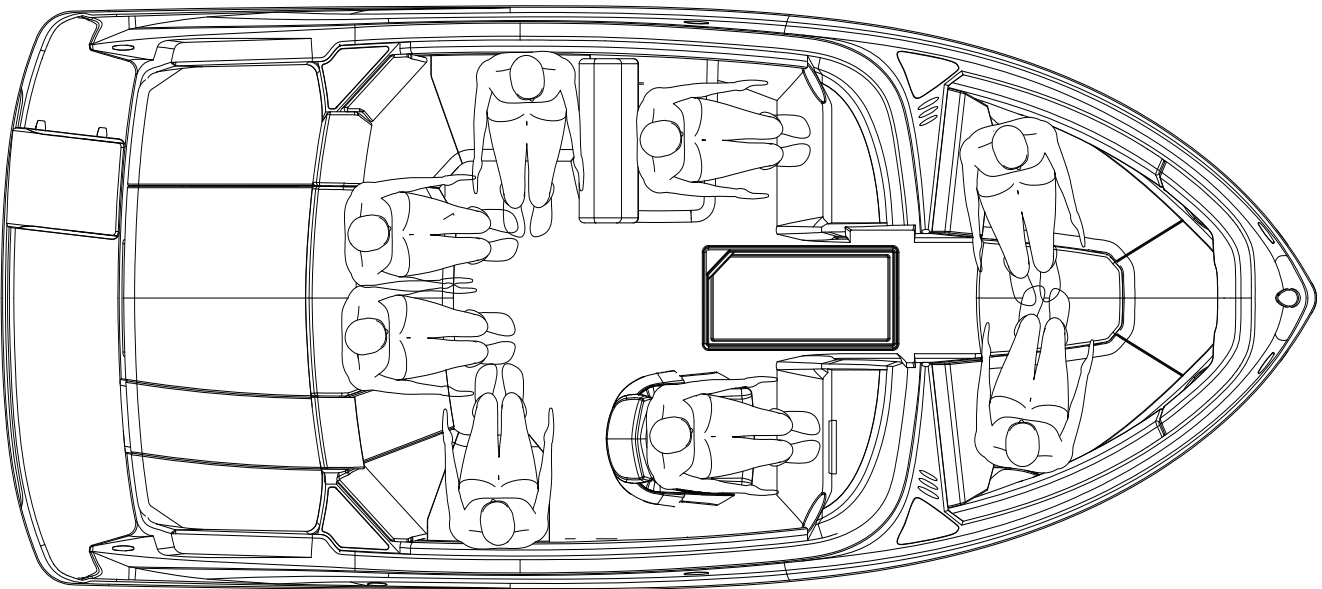
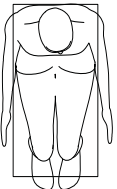

**CE Persons Capacity: 8 Persons**

 <b>REGAL MARINE INDUSTRIES</b> <small>2300 JETPORT DRIVE          ORLANDO, FLORIDA 32809          TEL (407) 851-4300</small>			ALL RIGHTS RESERVED
DRAWING TITLE:			
<b>2000 ES Persons Capacity</b>			
DATE:	8/25/14	REVISION:	-
		PAGE:	1 OF 1
DRAWN BY:	JAH	APPROVED BY:	-
		DWG. NO.:	2

PROPRIETARY AND CONFIDENTIAL:  
 THE INFORMATION CONTAINED IN THIS DRAWING IS THE SOLE PROPERTY OF REGAL MARINE INDUSTRIES. ANY REPRODUCTION IN PART OR AS WHOLE WITHOUT THE WRITTEN PERMISSION OF REGAL MARINE INDUSTRIES IS PROHIBITED.

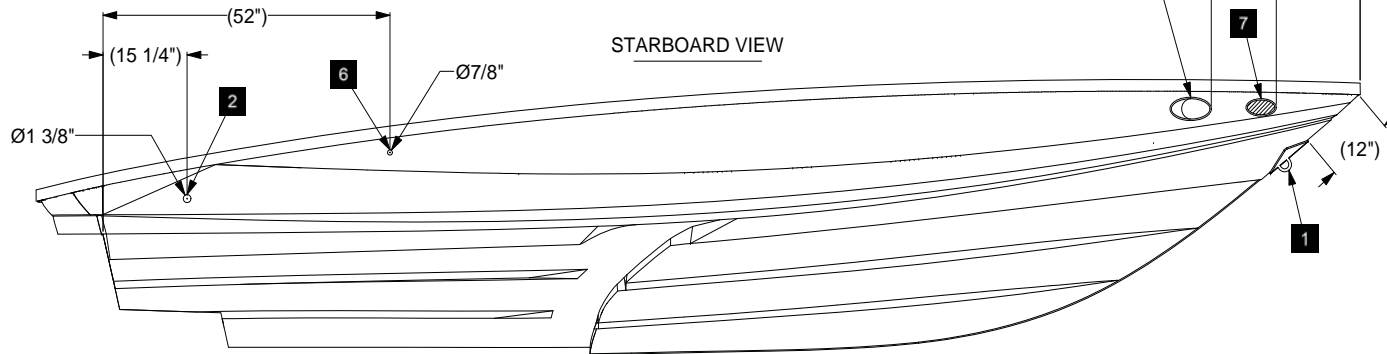
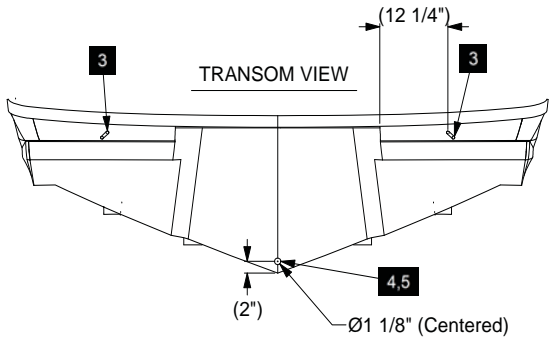

NOTES:  
 1) Dimensions given are for reference,  
 use splashes/fixtures to locate hardware.

BILL OF MATERIALS		
ITEM	QTY.	DESCRIPTION
1	1	BOW SCUFF PLATE SS
2	1	CHROME PLATE NYLON THRU HULL
3	2	STERN EYE
4	1	BRONZE DRAIN PLUG
5	1	DRAIN
6	1	FUEL VENT
7	1	ELECTRIC HORN
8	1	DOCKING LIGHTS (Optional)

**REFERENCE ONLY**

PROPRIETARY AND CONFIDENTIAL:  
 THE INFORMATION CONTAINED IN THIS DRAWING IS THE SOLE PROPERTY OF REGAL MARINE INDUSTRIES. ANY REPRODUCTION IN PART OR AS WHOLE WITHOUT THE WRITTEN PERMISSION OF REGAL MARINE INDUSTRIES IS PROHIBITED.

 <b>REGAL MARINE INDUSTRIES</b> 2380 JETPORT DRIVE ORLANDO, FLORIDA 32809 TEL (407) 851-4360 ALL RIGHTS RESERVED		
DRAWING TITLE: <b>2000 (FP) Hull Hardware</b>		
DATE: <b>02/25/14</b>	REVISION: -	PAGE: <b>1 OF 1</b>
DRAWN BY: <b>JAH</b>	APPROVED BY: <b>Mike B.</b>	DWG. NO.: <b>MFP24B</b>

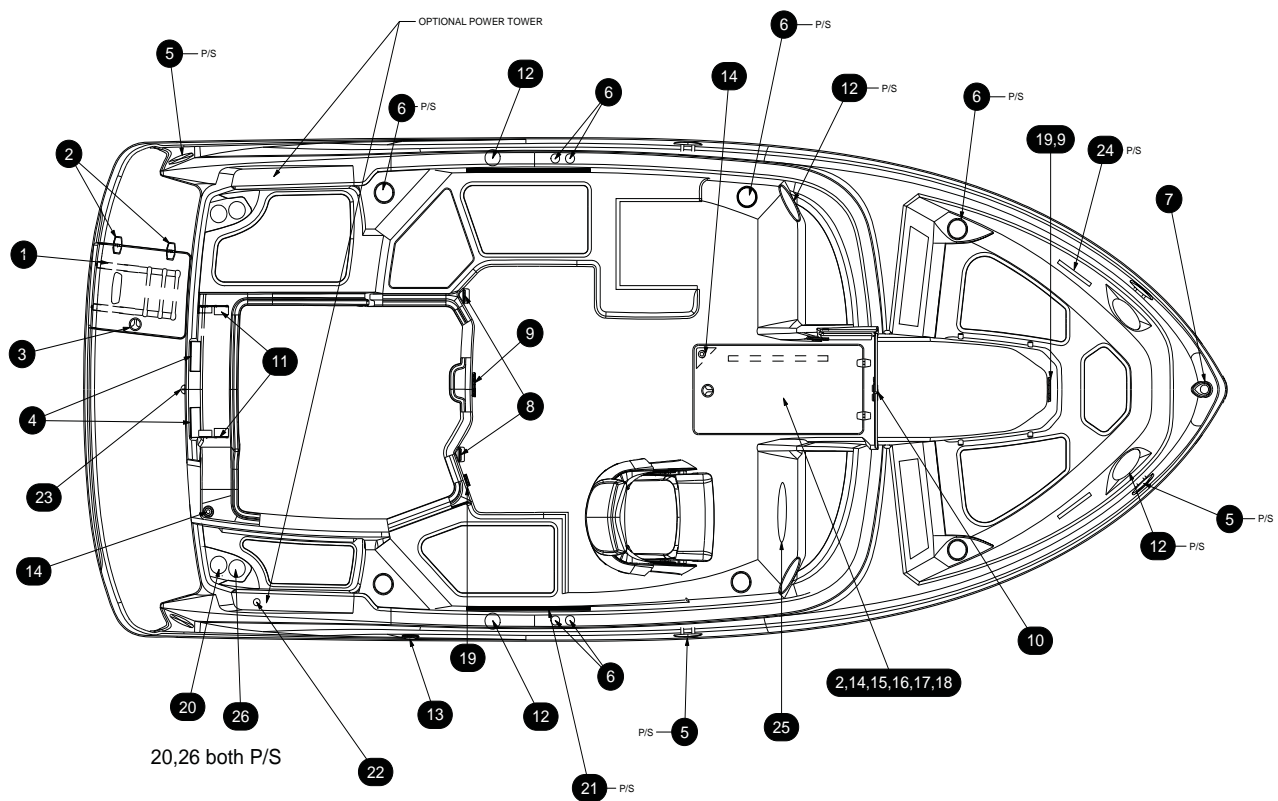

BILL OF MATERIALS		
ITEM	QTY.	DESCRIPTION
1	1	3 STEP LADDER SS
2	4	REVERSE HINGE W/ COVER
3	1	SLAM LATCH SS
4	2	BRAKE LIGHTS
5	6	CLEAT
6	4	CUPHOLDERS
7	1	NAVIGATION LIGHT
8	2	DRAIN ASSY. STRAIGHT
9	2	TABLE PEDESTAL MOUNT
10	1	WALK THRU DOOR
11	2	ENGINE HATCH HINGE
12	6	SPEAKER
13	1	GAS/FILL VENT
14	2	GUTTER DRAIN
15	2	90 DEGREE BALL GAS RAM MOUNT
16	2	FLAT W/STUD GAS RAM MOUNT
17	1	GAS RAM
18	1	ROUND "D" HANDLE LATCH
19	3	COURTESY LIGHT
20	2	ENGINE COMPARTMENT VENT 4"
21	2	COMING TUB
22	1	ANCHOR LIGHT
23	1	TOW HOOK
24	1	GRAB RAIL
25	1	SUBWOFFER
26	2	ENGINE COMPARTMENT VENT 3"

**REGAL MARINE INDUSTRIES**  
 2300 JETPORT DRIVE  
 ORLANDO, FLORIDA 32809  
 TEL: (407) 851-4360

ALL RIGHTS RESERVED

---

DRAWING TITLE:  
**2000 ES Deck Hardware**

DATE: 8/24/14	REVISION: -	PAGE: 1 OF 1
DRAWN BY: JAH	APPROVED BY: -	DWG. NO.: 14

PROPRIETARY AND CONFIDENTIAL:  
 THE INFORMATION CONTAINED IN THIS DRAWING IS THE SOLE PROPERTY OF REGAL MARINE INDUSTRIES. ANY REPRODUCTION IN PART OR AS WHOLE WITHOUT THE WRITTEN PERMISSION OF REGAL MARINE INDUSTRIES IS PROHIBITED.

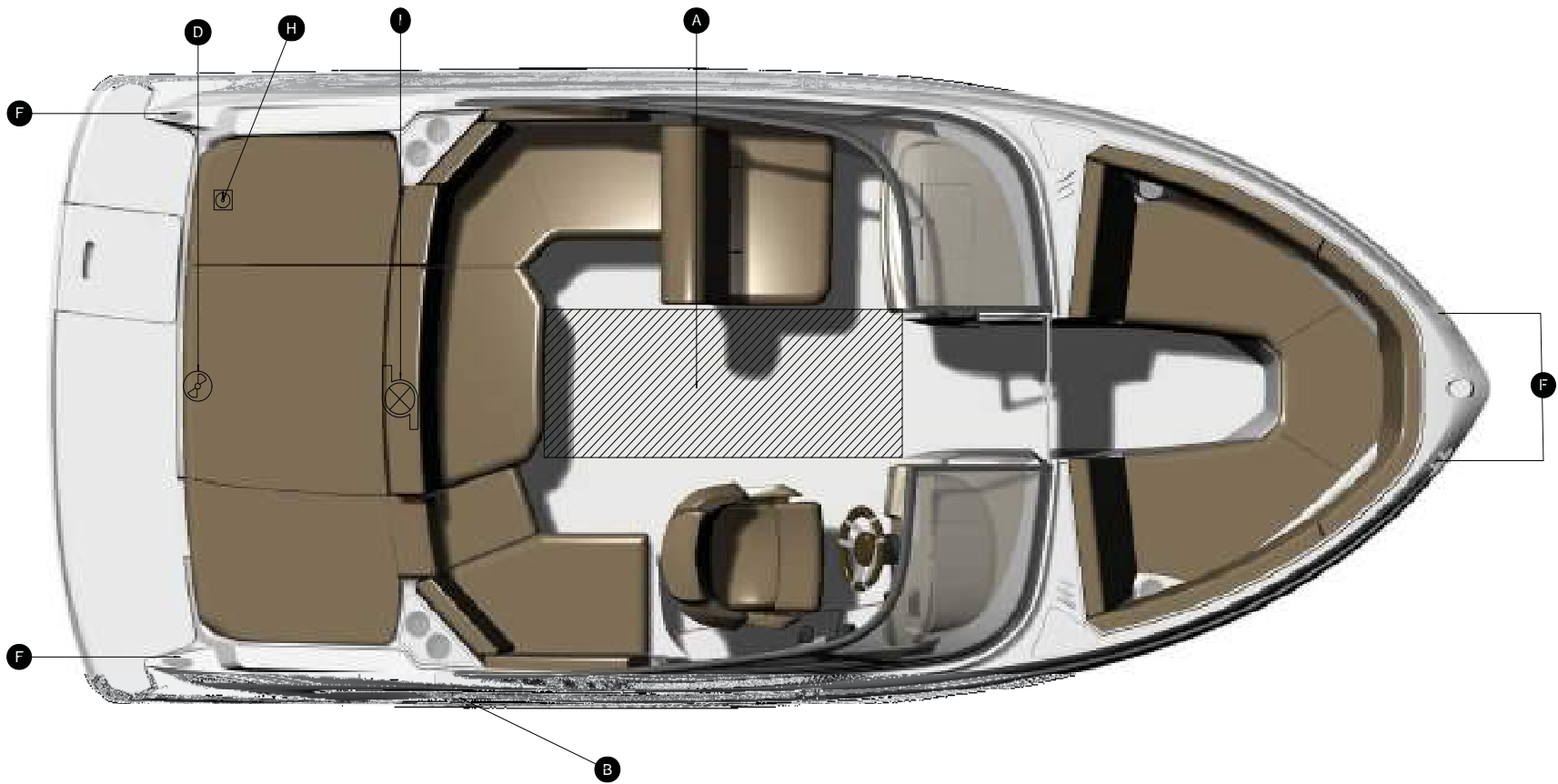

- KEY
- A. FUEL TANK
  - B. FUEL TANK FILLING POINT
  - C. THRU-HULL FITTINGS
  - D. AUTOMATIC FIRE EXTINGUISHER
  - E. CARBON MONOXIDE DETECTOR
  - F. ANCHOR STRONG POINT
  - G. TOWING STRONG POINT
  - H. BATTERY SWITCH
  - I. BILGE PUMP

		
<b>REGAL MARINE INDUSTRIES</b> 2300 JETPORT DRIVE ORLANDO, FLORIDA 32809 TEL (407) 851-4360		
<small>ALL RIGHTS RESERVED</small>		
DRAWING TITLE:		
<b>2000 ES Component Location</b>		
DATE:	REVISION:	PAGE:
8/25/14	-	1 OF 1
DRAWN BY:	APPROVED BY:	DWG. NO.:
JAL	-	7

PROPRIETARY AND CONFIDENTIAL:  
 THE INFORMATION CONTAINED IN THIS DRAWING IS THE SOLE PROPERTY OF REGAL MARINE INDUSTRIES. ANY REPRODUCTION IN PART OR AS WHOLE WITHOUT THE WRITTEN PERMISSION OF REGAL MARINE INDUSTRIES IS PROHIBITED.

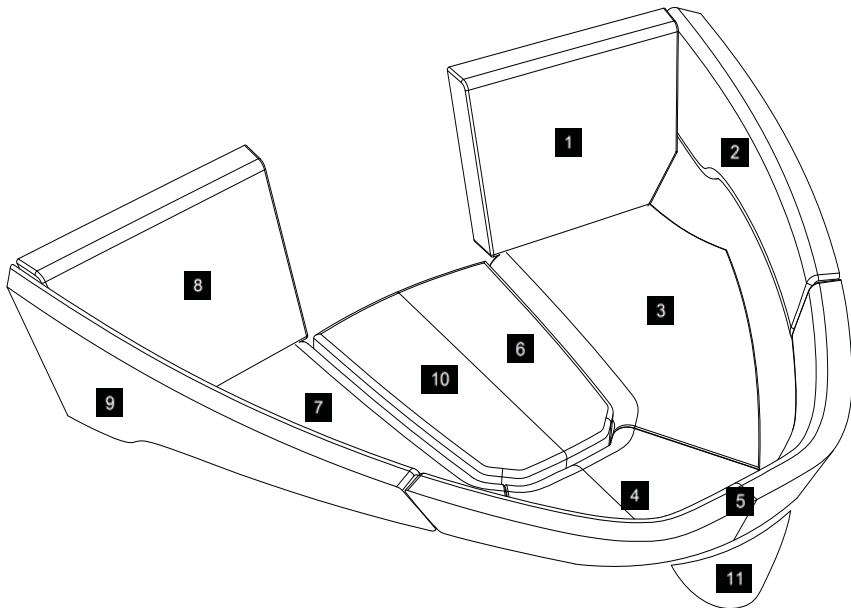

BOW UPHOLSTERY PART IDENTIFIER			
PATTERN	ITEM	DESCRIPTION	NOTES
UFP06A	1	Bow Port Backrest	-
UFP06B	2	Bow Port Aft Coaming	-
UFP06C	3	Bow Port Cushion	-
UFP06D	4	Bow Center Cushion	-
UFP06E	5	Bow FWD Coaming	-
UFP06F	6	Bow port filler cushion option	-
UFP06G	7	Bow STBD Cushion	-
UFP06H	8	Bow STBD Backrest	-
UFP06J	9	Bow STBD Aft Coaming	-
UFP06K	10	Bow STBD filler cushion option	-
UFP06L	11	Bow Lower Forward Coaming	-

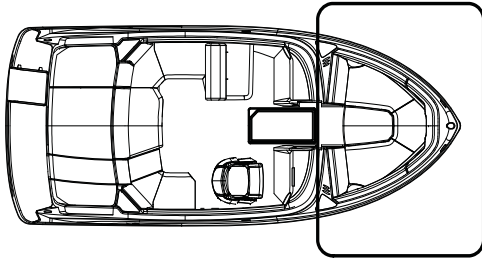



**REGAL MARINE INDUSTRIES**  
 2300 JETPORT DRIVE  
 ORLANDO, FLORIDA 32809  
 TEL: (407) 851-4360 ALL RIGHTS RESERVED

DRAWING TITLE: <b>2000 FP UPHOLSTERY IDENTIFIER</b>		
DATE: 01/30/14	REVISION: -	PAGE: 1 OF 2
DRAWN BY: JAH	APPROVED BY: Rick N.	DWG. NO.: UFP25X

NOTE: THIS DRAWING ALSO APPLIES TO 21 OBX

**REFERENCE ONLY**

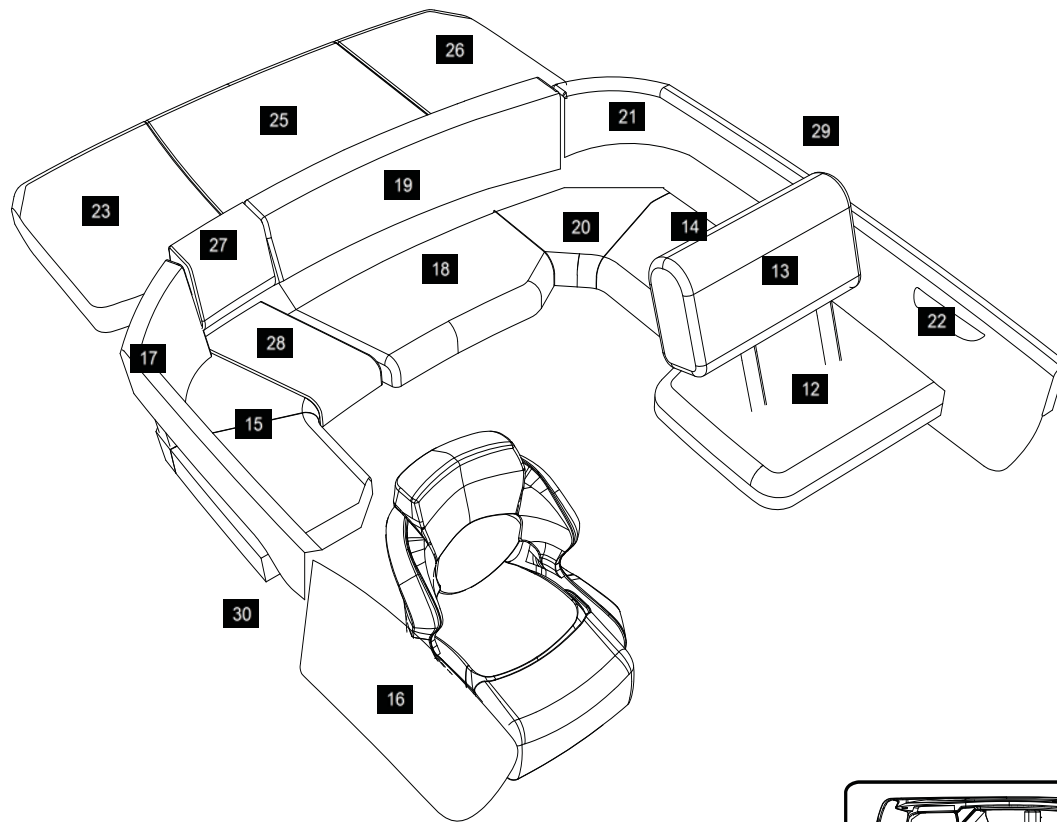
PROPRIETARY AND CONFIDENTIAL:  
THE INFORMATION CONTAINED IN THIS DRAWING IS THE SOLE PROPERTY OF REGAL MARINE INDUSTRIES. ANY REPRODUCTION IN PART OR AS A WHOLE WITHOUT THE WRITTEN PERMISSION OF REGAL MARINE INDUSTRIES IS PROHIBITED.



COCKPIT UPHOLSTERY PART IDENTIFIER			
PATTERN	ITEM	DESCRIPTION	NOTES
UFP13A	10	-	-
UFP13B	11	-	-
UFP14A	12	CKPT Port Companion Cushion	-
UFP14B	13	CKPT Port Companion Backrest	-
UFP15A	14	CKPT Port Center Cushion	-
UFP15B	15	CKPT STBD Center Cushion	-
UFP15C	16	CKPT Helm FWD Coaming	-
UFP15D	17	CKPT STBD Aft Backrest	-
UFP15E	18	CKPT Center Aft Cushion	-
UFP15F	19	CKPT Center Aft Backrest	-
UFP15G	20	CKPT Port Corner Cushion	-
UFP15H	21	CKPT Port Aft Backrest	-
UFP15J	22	CKPT Companion FWD coaming	-
UFP15K	23	Sundeck STBD Cushion	-
-	24	-	-
UFP15M	25	Sundeck Center Cushion	-
UFP15N	26	Sundeck Port Cushion	-
UFP15P	27	CKPT Filler Backrest	-
UFP15Q	28	CKPT Filler Cushion	-
UFP15U	29	CKPT Port Drink Holder Panel	-
UFP15R	30	CKPT STBD Drink Holder Panel	-

NOTE: THIS DRAWING ALSO APPLIES TO 21 OBX

REFERENCE ONLY

PROPRIETARY AND CONFIDENTIAL:  
THE INFORMATION CONTAINED IN THIS DRAWING IS THE SOLE PROPERTY OF REGAL MARINE INDUSTRIES. ANY REPRODUCTION IN PART OR AS WHOLE WITHOUT THE WRITTEN PERMISSION OF REGAL MARINE INDUSTRIES IS PROHIBITED.

 <b>REGAL MARINE INDUSTRIES</b> 2350 SETPOINT DRIVE ORLANDO, FLORIDA 32809 TEL (407) 851-4360 ALL RIGHTS RESERVED		
DRAWING TITLE:		
<b>2000 FP UPHOLSTERY IDENTIFIER</b>		
DATE:	REVISION:	PAGE:
01/30/14	-	2 OF 2
DRAWN BY:	APPROVED BY:	DWG. NO.:
JAH	Rick N.	UFP25X

NOTES:  
1) LIFTING LOCATIONS WILL BE LOCATED AT  
PORT AND STARBOARD AFT STERN EYES  
AND THROUGH BOW EYE

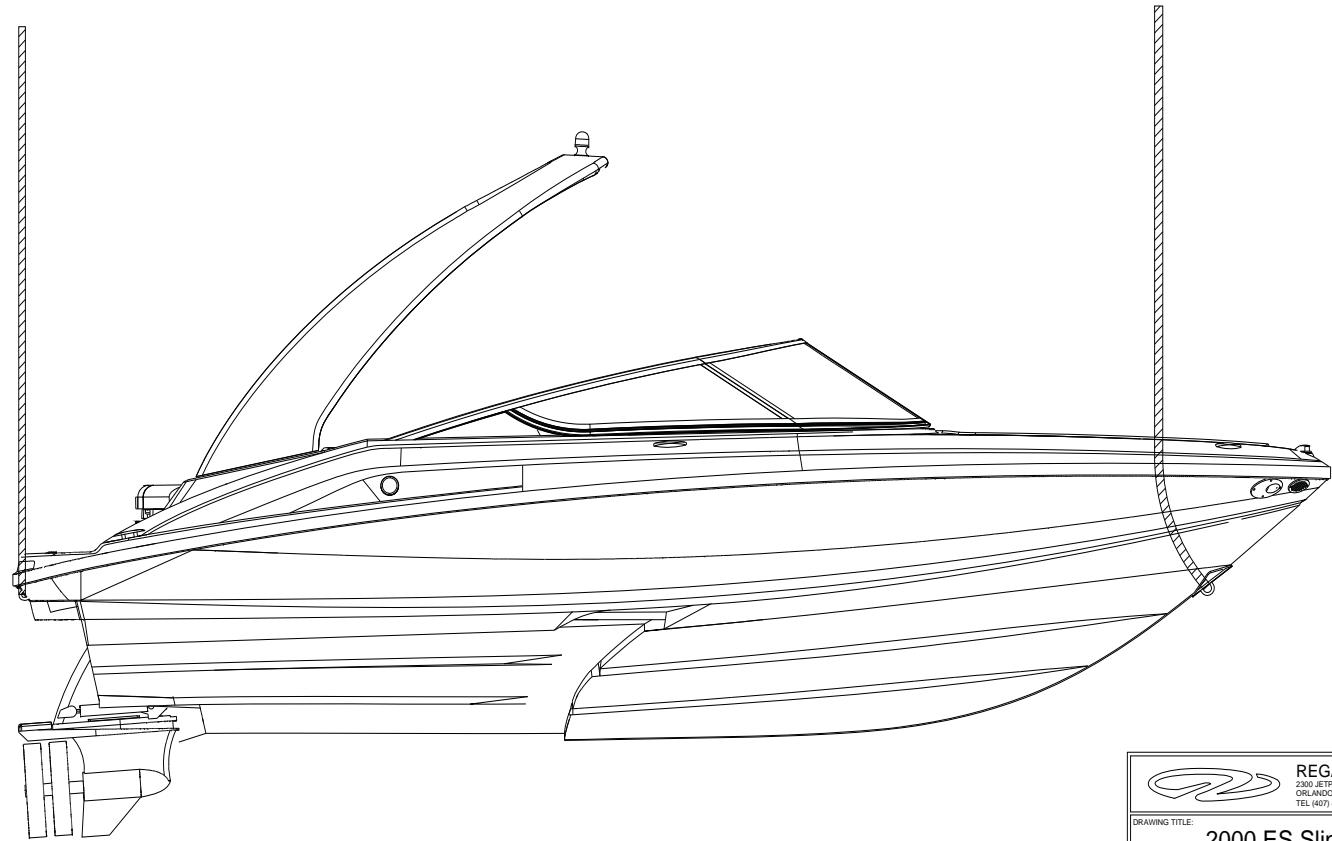

PROPRIETARY AND CONFIDENTIAL:  
THE INFORMATION CONTAINED IN THIS DRAWING IS THE SOLE PROPERTY OF REGAL MARINE INDUSTRIES. ANY REPRODUCTION IN PART OR AS WHOLE WITHOUT THE WRITTEN PERMISSION OF REGAL MARINE INDUSTRIES IS PROHIBITED.

 <b>REGAL MARINE INDUSTRIES</b> 2300 JETPORT DRIVE ORLANDO, FLORIDA 32809 TEL (407) 851-4360 ALL RIGHTS RESERVED		
DRAWING TITLE: <b>2000 ES Sling Locations</b>		
DATE: <b>8/25/14</b>	REVISION: -	PAGE: <b>1 OF 1</b>
DRAWN BY: <b>JAL</b>	APPROVED BY: -	DWG. NO.: <b>17</b>





21 OBX





05 12 17 - 210BX DECK  
REGAL #201823

FWD BRAKE LT CONNECTOR

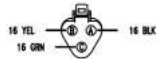

2WAY DEUTSCH DT PLUG  
CONNECTOR 54-0302-017 (DT06-3S)  
LOCKING WEDGE 54-0301-018 (W3S)  
SEALING PLUG 65-0101-015 (114017)

STBD BRAKE LT



2WAY DEUTSCH DTM PLUG  
CONNECTOR 54-0202-056 (DTM08-2S)  
WEDGE LOCK 54-0202-057 (WM-2S)  
SEALING PLUG 65-0101-022 (0413-204-2005)

PORT BRAKE LT



2WAY DEUTSCH DTM PLUG  
CONNECTOR 54-0202-056 (DTM08-2S)  
WEDGE LOCK 54-0202-057 (WM-2S)  
SEALING PLUG 65-0101-022 (0413-204-2005)

PORT DOCKING LT



2WAY DEUTSCH DT PLUG  
CONNECTOR 54-0202-042 (DT06-2S)  
LOCKING WEDGE 54-0201-043 (W2S)

STBD DOCKING LT



2WAY DEUTSCH DT PLUG  
CONNECTOR 54-0202-042 (DT06-2S)  
LOCKING WEDGE 54-0201-043 (W2S)

ANCHOR LT

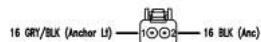

2WAY DEUTSCH DT PLUG  
CONNECTOR 54-0202-042 (DT06-2S)  
LOCKING WEDGE 54-0201-043 (W2S)

HULL PLUG 1

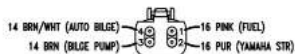

4WAY DEUTSCH DT PLUG  
CONNECTOR 54-0401-018 (DT06-4S)  
LOCKING WEDGE 54-0401-019 (W4S)

HULL PLUG 2



2WAY DEUTSCH DTP PLUG  
CONNECTOR 54-0201-061 (DTP06-2S)  
LOCKING WEDGE 54-0201-062 (WP2S)

STEREO PLUG (SOCKETS)

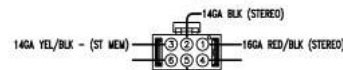

6 WAY PLUG MNL II  
54-0602-007 (770020-1)

SPEAKERS (SOCKETS)

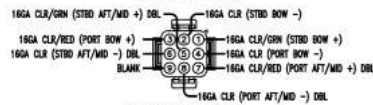

9 WAY PLUG MNL II  
54-0902-005 (770021-1)

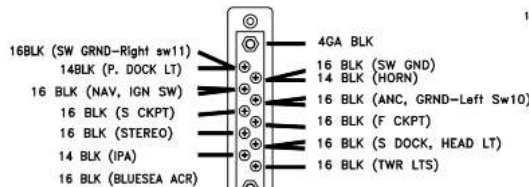

10 WAY #8 TERMINAL BUSS BLOCK  
07-0105-016 (BLUE SEAS #2301)

TO LEFT (PORT) SWP (W/ SOC)

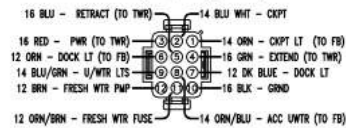

12 WAY PLUG MNL II  
54-1202-002 (770022-1)

TO FUSEBLOCK (PINS)

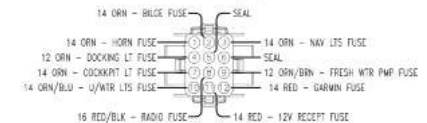

TO IPA (W/ SOC)

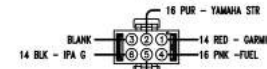

6 WAY PLUG MNL II  
54-0602-007 (770020-1)

TO IGN RIGHT (STBD) SW (SOC)

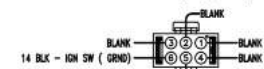

6 WAY PLUG MNL II  
54-0602-007 (770020-1)

TO TWR HRNS

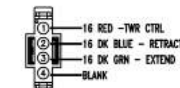

4 WAY PLUG MNL II  
CONNECTOR 54-0402-017  
(770019-1)

TO RIGHT (STBD) SWP (W/ SOC)

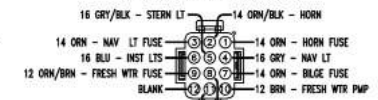

12 WAY PLUG MNL II  
54-1202-002 (770022-1)



**NOTES:**  
1) Dimensions given are for reference, use splashes/figures to locate hardware.

BILL OF MATERIALS		
ITEM	QTY.	DESCRIPTION
1	1	BOW SCUFF PLATE SS
2	1	CHROME PLATE NYLON THRU HULL
3	2	STERN EYE
4	1	BRONZE DRAIN PLUG
5	1	DRAIN
6	1	FUEL VENT
7	1	ELECTRIC HORN
8	1	DOCKING LIGHTS (Optional)

**TRANSOM VIEW**

**STARBOARD VIEW**

**REGAL MARINE INDUSTRIES**  
1000 W. 10th Ave. Ft. Lauderdale, FL 33304  
 TEL: 954-333-3333 FAX: 954-333-3334

**21 OBX (FO) Hull Hardware**

DATE: 8/14/17	REVISED: 0	PAGE: 1 OF 1
DESIGNER: CVL	APPROVED: Mkw W.	DWG. NO.: MFG24B

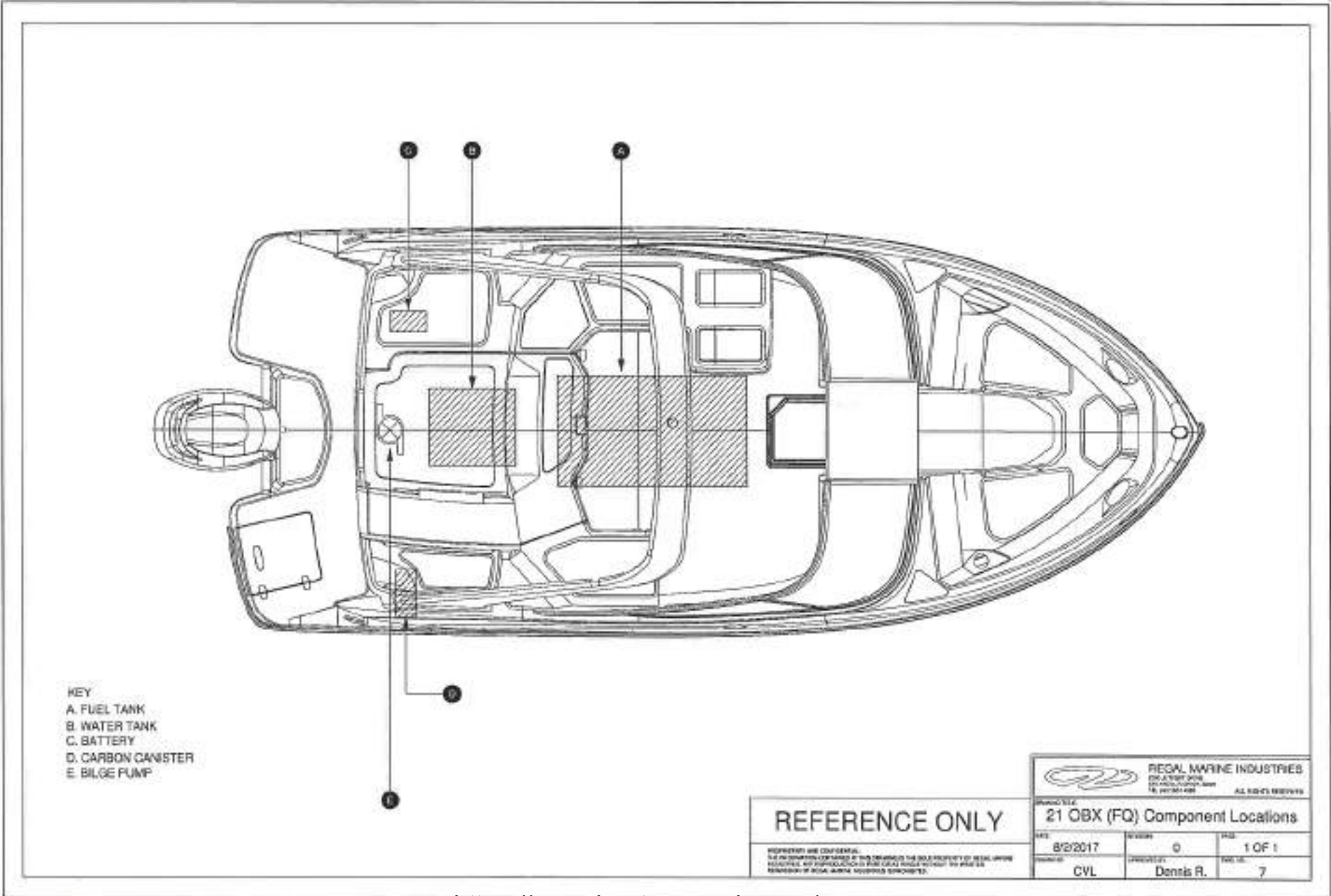

- KEY  
A. FUEL TANK  
B. WATER TANK  
C. BATTERY  
D. CARBON CANISTER  
E. BILGE PUMP

**REFERENCE ONLY**  
REGAL MARINE INDUSTRIES  
18, 2015A 408

 REGAL MARINE INDUSTRIES 18, 2015A 408		
REGAL MARINE INDUSTRIES 18, 2015A 408		
ALL RIGHTS RESERVED		
Drawing Title <b>21 OBX (FQ) Component Locations</b>		
DATE 8/2/2017	ISSUE 0	PAGE 1 OF 1
DRAWN BY CVL	APPROVED BY Dennis R.	SCALE 7

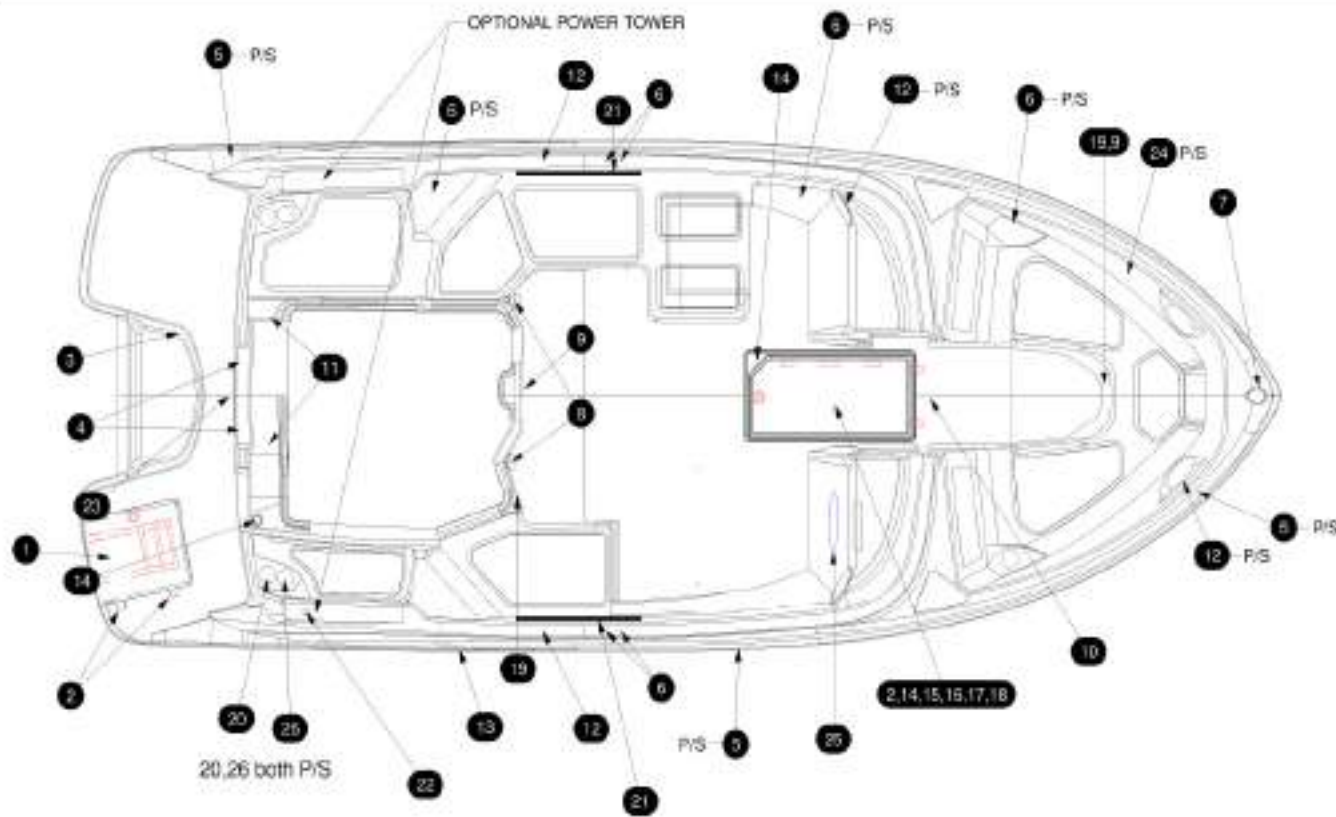

BILL OF MATERIALS		
ITEM	QTY.	DESCRIPTION
1	1	3 STEP LADDER SS
2	4	REVERSE HINGE W/ COVER
3	1	SLAM LATCH SS
4	2	BRAKE LIGHTS
5	6	CLEAT
6	4	CUPHOLDERS
7	1	NAVIGATION LIGHT
8	2	DRAIN ASSY. STRAIGHT
9	2	TABLE PEDESTAL MOUNT
10	1	WALK THRU DOOR
11	2	ENGINE HATCH HINGE
12	4	SPEAKER
13	1	GAS/FILL VENT
14	2	GUTTER DRAIN
15	2	90 DEGREE BALL GAS RAM MOUNT
16	2	FLAT W/STUD GAS RAM MOUNT
17	1	GAS RAM
18	1	ROUND 1/2" HANDLE LATCH
19	3	COURTESY LIGHT
20	2	ENGINE COMPARTMENT VENT 4"
21	2	COMING TUB
22	1	ANCHOR LIGHT
23	1	TOW HOOK
24	1	GRAB RAIL
25	1	SUBWOFFER
26	2	ENGINE COMPARTMENT VENT 3"

### Aft STBD Gas Ram Dimension Detail



Measured from Gelcoat Side of Hole

Measured to Ball Joint of Gas Ram

REGAL MARINE INDUSTRIES CONFIDENTIAL  
 THIS AND ALL OTHER INFORMATION IS UNCLASSIFIED AND THE PROPERTY OF REGAL MARINE INDUSTRIES. ANY REPRODUCTION OR DISSEMINATION OF THIS INFORMATION WITHOUT THE EXPRESS WRITTEN PERMISSION OF REGAL MARINE INDUSTRIES IS PROHIBITED.

 <b>REGAL MARINE INDUSTRIES</b> 200 ATLANTIC DRIVE ORLANDO, FLORIDA 32817 TEL: 407-621-0300 ALL RIGHTS RESERVED		
<b>21 OBX (FQ) Deck Hardware</b>		
DATE	ISSUES	PAGE
8/14/17	0	1 OF 1
DESIGNED BY	APPROVED BY	TESTED BY
CVL	Mik W.	MFC24A

NOTES:  
1) Lifting locations will be located at port and stbd. aft stern eyes and through bow eye

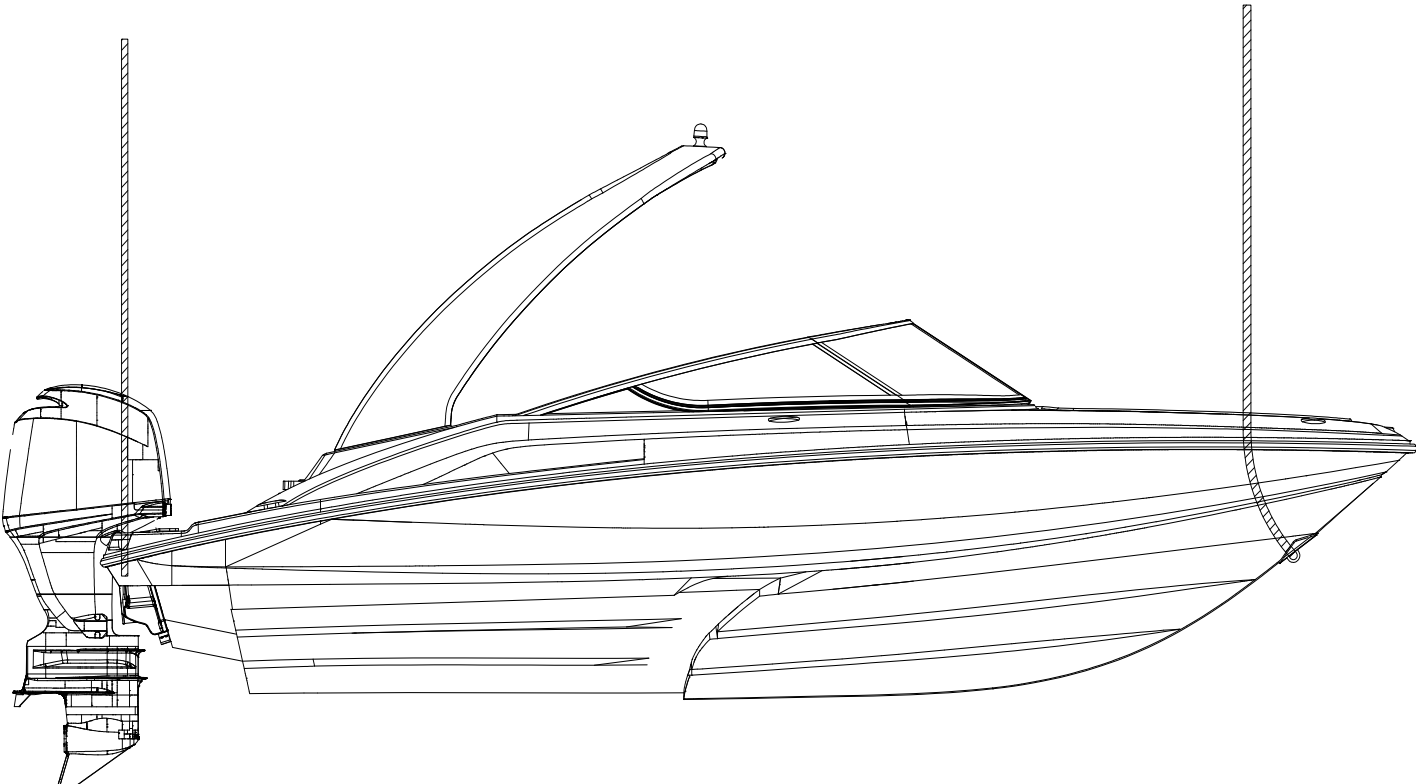

PROPRIETARY AND CONFIDENTIAL.  
THE INFORMATION CONTAINED IN THIS DRAWING IS THE SOLE PROPERTY OF REGAL MARINE INDUSTRIES. ANY REPRODUCTION IN PART OR AS WHOLE WITHOUT THE WRITTEN PERMISSION OF REGAL MARINE INDUSTRIES IS PROHIBITED.

 <b>REGAL MARINE INDUSTRIES</b> 2300 JETPORT DRIVE ORLANDO, FLORIDA 32809 TEL (407) 851-4360 ALL RIGHTS RESERVED		
DRAWING TITLE: <b>21 OBX (FQ) Sling Locations</b>		
DATE: <b>8/14/2017</b>	REVISION: <b>0</b>	PAGE: <b>1 OF 1</b>
DRAWN BY: <b>CVL</b>	APPROVED BY: <b>Mike W.</b>	DWG. NO.: <b>MFQ25E</b>