



REGAL®

————— Follow no one.



OWNER'S MANUAL

1900

REGAL 784015

10/2012 REVISION

<https://www.boat-manuals.com/>

Table Of Contents

INTRODUCTION

Your Regal Owner's Manual	INT-8
General Information	INT-9
Regal Warranty	INT-18

1 SAFETY ON BOARD

Safety Labels	1-1
Load Capacity	104
Safety Equipment	1-6
Pollution Regulations	1-18
General Boating Precautions	1-19
Water Sport Precautions	1-24
Ski Tow	1-27
Swim Platform	1-28
Boating Accidents	1-29
Operation By Minors	1-31
Hazardous Conditions	1-36
First Aid	1-43
Safety Inspection	1-45

2 RULES OF THE ROAD

Right Of Way	2-2
Signals	2-3
Vessel Interaction	2-5
Night Running	2-7
Navigational Aids & Markers	2-9

3 ENGINES & CONTROLS

Engine Basics	3-1
Engine Cooling System	3-4
Engine Electrical System	3-7
Engine Exhausting System	3-10
Engine Fueling System	3-11
Engine Lubrication System	3-15
Engine Ventilation System	3-17

Stern Drive Basics	3-18
Stern Drive Mechanics	3-19
Stern Drive Lubrication	3-20
Propellers	3-22
Instrumentation	3-23
Helm Control Overview	3-28
Steering System	3-36

4 SYSTEMS

Automatic Fire Extinguisher	4-1
Bilge & Drainage	4-2
Electrical	4-4

5 VESSEL OPERATION

Getting Underway	5-1
Fueling	5-4
Starting, Shifting, Stopping	5-7
Stern Drive Maneuvering	5-10
Trim Angle	5-15
Fenders	5-20
Dock Line Basics	5-21
Stern Drive Docking	5-24
Anchoring	5-26
Towing	5-27
Knots	5-28
Environmental Awareness	5-29
CARB	5-30
California Proposition 65	5-31
Fuel Spillage	5-32

6 EQUIPMENT OPERATION

Aftermarket Accessories	6-1
Automatic Fire Extinguisher	6-2
Battery Switch	6-4
Bilge Pump	6-5
Blower	6-6

Table Of Contents

Canvas & Covers	6-7
Cockpit Lights	6-15
Depth Sounder	6-16
Horn	6-20
Marine Stereo	6-21
Navigation Lights	6-21
Seat, Hatch, & Storage	6-29
Sport Tower	6-35
Swim Ladder	6-36
Swim Platform	6-36
Windshield	6-38

7 COSMETIC CARE & MAINTENANCE

Cosmetic Care	7-1
Engine Maintenance	7-12
Stern Drive Maintenance	7-18
Equipment Maintenance	7-25
Maintenance Checklists	7-29

8 TROUBLESHOOTING

Engine & Stern Drive	8-2
Control System	8-5
Electrical System	8-6
Bilge & Drainage	8-7
Stereo	8-8
Audible Alarms	8-10

9 STORAGE & WINTERIZATION

Decommissioning Checklist	9-2
Recommissioning Checklist	9-6

10 TRAILERING

Before Trailering	10-1
Driving	10-8
Backing A Trailer	10-9
Launching Your Boat	10-10
Loading Your Boat	10-12

11 GLOSSARY & INDEX

Glossary	11-1
Index	11-6

12 TECHNICAL INFORMATION

Specifications	12-2
Plan View	12-3
Technical Drawings	12-5

Welcome To Regal

WELCOME TO REGAL

I know I speak for everyone at Regal when I welcome you to the ever-growing family of Regal boat owners. You've chosen a vessel that is recognized worldwide for its standard of excellence. Each step in construction has been carefully scrutinized to assure comfort, performance, reliability and safety for both your passengers and yourself.

Your boat is certified by the National Marine Manufacturers Association. It also complies with the applicable standards set by the United States Coast Guard, American Boat and Yacht Council plus the International Marine Certification Institute. Your Regal boat was built with the same attention to detail and quality of construction that we would expect in a boat we would purchase ourselves.

Whether you're a veteran boater or a newcomer, we strongly urge you to read this boat owner's manual thoroughly. Familiarize yourself with the various components of your boat, and heed the safety precautions noted herein.

If you have questions that are not covered in this manual, please consult your authorized Regal dealer for assistance or phone the Regal factory at 407-851-4360.

Thank you and welcome to the "World of Regal!"

*Duane Kuck
President/CEO*

Mission Statement

*With God's help
and a steadfast commitment to integrity,
we will develop a team
of exceptional people and relationships
to provide exceptional customer
satisfaction*



THIS PAGE IS LEFT INTENTIONALLY BLANK

Introduction

Boating is becoming more popular every year. There are numerous types of recreational vessels on our waterways today involved in an ever growing number of activities. Therefore, as a new boat owner it is of the highest priority to learn about general boating practices before operating your craft.

Your Regal dealer will answer many questions and provide valuable “hands on” information during the completion of the new boat delivery process. In addition, your dealer has received special factory training on the product line and his services should be employed to solve technical problems and periodic maintenance beyond the scope of this manual. Also, your Regal dealer carries a line of factory approved parts and accessories.

Your Regal dealer can provide information regarding national training organizations such as the U.S. Power Squadron and United States Coast Guard Auxiliary. Along with other organizations and literature, they can help build your “boating savvy” by developing the necessary skills and awareness to be a safe and competent skipper. Your local library can also help in providing recommended boating literature such as Chapman Piloting (Seamanship & Boat Handling by Elbert S. Maloney). Remember, the waterways can change from normal to abnormal conditions in a heartbeat. Knowing how to react quickly comes from experience and knowledge which can be gained through boating education.

Welcome aboard!



YOUR REGAL OWNER'S MANUAL

Your Regal owner's manual has been developed to assist you in operating your vessel with safety and pleasure. **BE SURE TO READ AND BECOME FAMILIAR WITH THE CONTENTS BEFORE OPERATING YOUR CRAFT.** Your owner's manual has been divided into general chapters to assist you in becoming more knowledgeable with your Regal boat. Also, we have added a special technical drawing chapter for maintenance and troubleshooting.

THIS MANUAL IS NOT INTENDED TO BE A COMPLETE SOURCE OF TECHNICAL MAINTENANCE, BOAT HANDLING TECHNIQUES, BOATING SAFETY, OR SEAMANSHIP. THESE SKILLS REQUIRE EDUCATION AND EXPERIENCE LEVELS BEYOND THIS MANUAL. ALSO, REMEMBER YOUR REGAL DEALER HAS BEEN TRAINED ON THE VARIOUS BOAT SYSTEMS ALONG WITH THE PROPER TOOLS TO MAKE REPAIRS.

In keeping with its commitment to continued improvement, Regal notes that all drawings, specifications, models, standard, and optional equipment referred to in this manual are subject to change without notice. Information is only accurate to the revision date.

OWNER'S INFORMATION PACKET

Regal has provided an information pouch aboard the vessel. Read and become familiar with the materials. This packet contains valuable literature on your propulsion package, standard, and optional equipment systems and various care and cleaning instructions. Be sure to store the information pouch in a clean dry area for quick reference.

Introduction

GENERAL INFORMATION

Hull Identification Number (HIN)_____

The United States Coast Guard has established a universal system of numerically identifying vessels by using a hull identification number or “HIN.” This number identifies your boat’s manufacturer, boat model, hull number, month, and year of manufacture. The HIN is found on a metal plate affixed to your boat’s starboard side just below the rub rail on the transom near the vertical edge of the chine. The HIN consists of 12 alpha and numeric characters. It is recommended that you locate and write down the HIN for future reference. It can be especially useful when buying boat insurance and ordering parts. A second HIN number is found in a hidden location. This second HIN is useful to authorities if for example the boat is stolen and the original transom HIN is modified or eliminated.

Vessel Information Sheet_____

It is recommended that you fill out the information on the following page. It will supply vital statistics on your vessel. Make a copy of the data for safe keeping at home.

Vessel Float Plan_____

Fill out a float plan similar to the one on the following pages and leave it with a responsible person who will notify the United States Coast Guard or local law enforcement authorities upon your extended absence. If you change your plans, be sure to notify this person. Make copies of the float plan included in this owner’s manual for each time you go boating. This will help people know where to find you should you not return on schedule. Do not file the float plan with the United States Coast Guard.

Vessel Information Sheet _____

Owner: _____

Address: _____

City & State: _____

Home Phone: _____ Business: _____

In Case Of Emergency Notify: _____

Address: _____

City & State: _____

Phone: _____

Insurance Agent's Name: _____

Policy #: _____

USCG Phone: _____ Local Police: _____

Marina Phone: _____ Slip/Dock #: _____

Hull Identification #: R G M _____

Key #: _____ Engine Serial #: _____

Key #: _____ Sterndrive Serial #: _____

Selling Dealer: _____

Address: _____

City & State: _____

Phone: _____ Fax: _____

Servicing Dealer: _____

Address: _____

City & State: _____

Phone: _____ Fax: _____

Introduction

Float Plan _____

Owner: _____

Address: _____

City & State: _____

Phone #: _____ Alt. Phone #: _____

Person Filing Report Relationship: _____

Name: _____

Phone #: _____ Alt. Phone #: _____

Make Of Boat: _____ Destination: _____

Registration #: _____ Departure Dock: _____

Length: _____ Departure Time: _____

Boat Name: _____ Arrival Dock: _____

Gel Color: _____ Arrival Time: _____

Trim Color: _____ Fuel Level: _____

Inboard/Outboard: _____ Return Dock: _____

Hull ID #: _____ Return Time: _____

Number Of Passengers: _____ Fuel In Reserve: _____

If Not Back By _____ o'clock on date _____, call Coast Guard

Safety Equipment Aboard (Check All That Apply):

Life Jacket

VHF Radio

First Aid Kit

Anchor

Flares

Compass

Flashlight

Food

EPIRB #: _____

Water

Other Information: _____

Name Of Person Aboard

Age

Address

Phone#



Launch & Cruise Checklist

- Obtain a current weather report.
- Inspect the hull and propeller for damage.
- Check all electrical system switches for proper operation.
- Run the bilge pump until the flow of water stops.
- If your boat has been out of the water, check to see that the drain plug is installed.
- Check that all required safety equipment is on board and in good working condition.
- Check that all other equipment is on board such as mooring lines, tool kit, and extra parts.
- Open the engine compartment. Inspect for fuel odors and visible signs of leaks in the fuel, oil, exhaust, and power steering systems.
- Visually inspect the engine for cracked hoses, defective belts, loose fasteners, etc. and repair or replace
- Check fuel level. Fuel tanks should be filled to full capacity.
- Make sure all navigational charts, equipment, and vessel registration paperwork are onboard.
- Check operation of bilge blower, steering system, navigation lights, and horn.
- Ensure passengers know how to use safety equipment.
- File a float plan with a responsible party ashore.

Introduction

Suggested Tools, Parts, & Gear

SUGGESTED TOOLS

Allen Wrenches
Jack Knife
Phillips Screwdriver Set
Slotted Screwdriver Set
Regular Pliers
Combination Wrench Set
Ratchet & Socket Set
Hammer
Wire Crimpers
Vise Grip Pliers
Multi Meter
Nut Driver Set
Oil Filter Wrench
Fuel Filter Wrench

SPARE PARTS

Fuel Filter
Spark Plugs
Serpentine Belt
Propellers
Propeller Nut & Hardware
Anti- Siphon Set
Penetrating Oil
Extra Light Bulbs
Extra Batteries
Duct Tape
Electrical Tape
Power Steering Fluid
Water Pump Impeller Kit
Spare Keys on Floater

BASIC GEAR

Tie Lines
Mooring Lines
Dock Fenders
First Aid Kit
Boat Hook
Foul Weather Gear
VHF Radio
Charts & Plotting Instruments
Emergency Food & Water
Bailer or Hand Pump
Fire Extinguisher
Personal Flotation Device
Anchor & Line
Life Raft
EPIRB

Capacity Plate

Close to the helm on Regal boats up to 26' in length is a capacity plate. This plate represents manufacturers who participate in the National Marine Manufacturer's Association small boat certification program. A similar yacht certification plate for boats over 26' covers many of the same guidelines and others from ABYC into the yacht program. Your boat has been certified by NMMA approved inspectors to be in compliance with their system guidelines along with federal safety regulations. The driver of the craft must read the plate information before operating the vessel. The plate is located at the helm, and an image can also be found on the safety aboard chapter.

The capacity plate data applies under normal conditions. **BE SURE TO READ AND ABIDE BY THE CAPACITY LIMITS. REMEMBER, THE BOAT OPERATOR IS RESPONSIBLE FOR THE VESSEL AND PASSENGERS.**

Note the following typical capacity plate information below:

- The plate states the maximum number of persons allowed on the boat, or an equivalent weight regardless of the number of passengers
- The total weight of persons, gear, and other items under normal conditions that the boat is capable of carrying.
- Overloading, improper loading, and weight distribution are well documented causes of accidents. Provide for an extra margin of safety in rough sea conditions.

Introduction

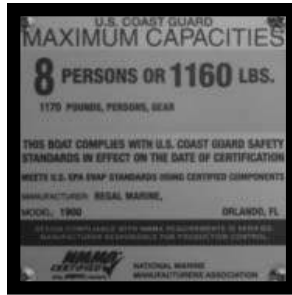

FIGURE 1 Typical Maximum Capacity Plate

Owner's Registration & Systems Checklist _____

Please note that your Regal boat requires the proper registration by your authorized Regal dealer. To initiate your warranty the dealer must complete the owner's registration form and systems checklist at the time of delivery. The owner must sign the paperwork to acknowledge that the dealer has reviewed the boat systems and warranty provisions with the owner. The owner should keep the original paperwork that features a temporary warranty registration. A Regal express limited warranty certificate containing all relevant boat and engine serial numbers will be sent after the factory receives the paperwork.

Dealer's Responsibility _____

Your boat has undergone rigid quality assurance inspections before leaving the factory. However, your dealer has been trained to perform final pre-delivery checks and to service your Regal boat prior to your pick-up. Your dealer's responsibilities include:

- A complete orientation in the operation of your Regal boat, including matters relating to the safe operation of your craft.

- 
-
- Completion and mailing of your boat registration warranty form to Regal.
 - Warranties, registration materials, owner's manual, operation, installation, and maintenance instructions for all auxiliary equipment supplied with or installed on your Regal boat.

Owner's Responsibility_____

You are entitled to all the benefits and services outlined in your Regal boat warranty. However, you have certain responsibilities to ensure warranty satisfaction. These are:

- To read the warranty materials and understand them fully.
- To examine the boat in detail at the time of delivery.
- Apply the following: boating rules and regulations, safety equipment, environmental regulations, accident reports, and warranty regulations terms and conditions.
- To read through all literature supplied with your boat, including this owner's manual and to follow the recommendations in the literature.
- To return the boat after the recommended hours of engine operation for the proper dealer service inspections.
- To provide proper maintenance and periodic servicing of your boat and equipment as set forth in the various manuals supplied.

Introduction



RUNABOUTS and CUDDY NEW BOAT DELIVERY CHECKLIST

REGAL MARINE INDUSTRIES
3000 JETCRAFT DRIVE
ORLANDO, FL 32834-5068
(407) 821-4200

OWNER REGISTRATION INFORMATION

NAME _____ BUAEI _____
 ADDRESS _____ HALL # _____
 CITY _____ STATE _____ ZIP _____ MOBILE _____
 COUNTRY _____ PHONE # _____ BIRTH _____

INSTRUCTIONS: This checklist is designed to assist delivery in the delivery of a Regal Boat to a new owner. Review the location, operation and maintenance of each item noted below with the owner and acknowledge this by checking the appropriate boxes. This checklist is not applicable with "NU". This form must be completed and signed by the dealer's representative and the customer to acknowledge proper receipt of the boat. The warranty will not be activated until a fully completed and signed copy has been received by Regal Marine.

A. NEW BOAT INFORMATION	OWNER	DEALER	D. INSTRUMENTATION	OWNER	DEALER
1. Review Regal's warranty	_____	_____	1. Function of all gauges	_____	_____
2. Review engine warranty	_____	_____	2. Function of all switches	_____	_____
3. Review Regal's owner manual	_____	_____	3. Throttle & shifts	_____	_____
4. Review owner's package	_____	_____	4. Steering	_____	_____
5. Review dealer's service procedures	_____	_____	5. Ignition	_____	_____
6. Review owner's service responsibilities	_____	_____	6. Operation of all optional electronics	_____	_____
B. CABIN (IF APP)	OWNER	DEALER	E. ENGINE ROOM	OWNER	DEALER
1. Location of all storage bins	_____	_____	1. Engine fuel tank	_____	_____
2. Cabin lighting	_____	_____	2. Trim pump location & fuse sheet	_____	_____
3. Deck hatch	_____	_____	3. Battery 1	_____	_____
4. Port table	_____	_____	4. Battery switch (only for in cockpit)	_____	_____
5. Carbon monoxide detector	_____	_____	5. Bilge pump	_____	_____
6. Onable table set up	_____	_____	6. Fire bilge pump	_____	_____
7. Cabin cushions set up	_____	_____	7. Fire extinguisher	_____	_____
8. Technical panel	_____	_____	8. Bower	_____	_____
9. Tidal / Vent	_____	_____	F. COWLING	OWNER	DEALER
10. POWER SYSTEM	_____	_____	1. Cowling set up	_____	_____
C. COCKPIT	OWNER	DEALER	2. Cowling storage	_____	_____
1. Swim ladder	_____	_____	3. Cowling deck lid cleaning	_____	_____
2. Tripod / stool	_____	_____	G. CARE & CLEANING	OWNER	DEALER
3. Cockpit padding set up	_____	_____	1. Wry with care & cleaning	_____	_____
4. Engine helm operation	_____	_____	2. Windshield care & cleaning	_____	_____
5. Cockpit storage system	_____	_____	3. Gel coat care & cleaning	_____	_____
6. Reinforcement cover	_____	_____	4. Canvas care (including care & cleaning)	_____	_____
7. Fishing package	_____	_____	5. Tidal system care & cleaning	_____	_____

CAUTION: This checklist is only intended to provide a general overview and does not represent information necessary for proper operation of the boat. It is very important that anyone operating this boat study the related manuals and instructions provided with the boat and review the recommendations contained in these materials. They contain important information including cautions and warnings that are vital to safe and enjoyable operation of the vessel. It is the owner's responsibility to ensure that anyone operating the boat has been properly trained.

We have completed a review and installation of the boat and its systems. The boat is in order and functioning properly with the exception of any items specifically noted above. This contractual owner has received a copy of the Regal Limited Lifetime Warranty and engine manufacturer's warranty and agrees to these warranty terms and conditions.

DATE OF INSPECTION

OWNER SIGN

OWNER

DATE



REGAL MARINE INDUSTRIES, INC. LIFETIME PLUS LIMITED HULL WARRANTY

Welcome to the worldwide family of Regal owners! We are very pleased that you have chosen a Regal powerboat!

This document is your Warranty Registration Certificate and Statement of Warranty. Please check the registration information section for accuracy. If this information is not correct or if you change your address at some future date, please notify us at the following address: Regal Marine Industries, Inc. Attention: Warranty Registrations, 2300 Jetport Drive, Orlando, Florida 32809

Please read the warranty carefully. It contains important information on Regal's claims procedures and your rights and obligations under this warranty.

WHAT IS COVERED: This Limited Warranty applies only to Regal beginning with model year 2005.

LIFETIME LIMITED STRUCTURAL HULL WARRANTY: Regal Marine Industries, Inc. warrants to the original retail purchaser of this boat if purchased from an authorized Regal dealer that the selling dealer or Regal will repair or replace the fiberglass hull if it is found to be structurally defective in material or workmanship for as long as the original retail purchaser owns the boat. For purposes of this warranty, the hull is defined as the single fiberglass casting which rests on the water. This limited warranty is subject to all limitations and conditions explained below.

FIVE-YEAR TRANSFERABLE LIMITED STRUCTURAL HULL WARRANTY: In addition to the Lifetime Limited Structural Hull Warranty, Regal offers a Transferable Five-Year Limited Structural

Introduction

Hull Warranty. Under the Five-Year Transferable Limited Structural Hull Warranty, Regal will repair or replace the fiberglass hull if it is found to be structurally defective in material or workmanship within the first (5) years after the date of delivery to the original retail purchaser. Any remaining term of this Five-Year Limited Hull Warranty may be transferred to a second owner if within 60 days of purchase, the new owner registers the transfer with Regal and pays the established warranty transfer fee. Contact Regal Customer Service at the above address for details.

FIVE-YEAR LIMITED HULL BLISTER WARRANTY: Regal warrants that the selling dealer or Regal will repair any underwater gelcoated surfaces of the hull against laminate blisters which occur as a result of defects in material or workmanship within (5) years of the date of delivery, provided that the original factory gelcoat surface has not been altered. Alternation would include but is not limited to damage repair; excessive sanding, scraping, sandblasting; or from improper surface preparation for application of a marine barrier coating or bottom paint, any of which shall void this Five-Year Limited Hull Blister Warranty. Proper preparation must be applied to the hull bottom if the boat is to be moored in the water for periods in excess of 60 days. Regal Marine shall repair or cause to be repaired any covered laminate blisters based on the following prorated schedule. Less than two (2) years from delivery date - 100%, Two (2) to three (3) years from delivery date - 75%, Three (3) to four (4) years from delivery date - 50%, Four (4) to five (5) years from delivery date - 25%.

Reimbursement shall be limited to one repair, not to exceed (\$80.00) dollars per foot of boat length prior to prorating. Regal's prior authorization for the method and cost of repair, must be obtained before repairs are commenced. All costs to transport the boat for repairs are the responsibility of the owner.

LIMITED GENERAL WARRANTY: In addition to above hull warranties, Regal warrants to the original purchaser of this boat if purchased from an authorized dealer that the dealer or Regal will repair or replace any parts found to be defective in materials or workmanship for a period of one (1) year from the date of delivery, subject to all limitations and conditions contained herein.

LIMITED EXTERIOR FINISH WARRANTY: Regal warrants that the selling dealer or Regal will repair cosmetic defects in the exterior gelcoated finish including cracks or crazing reported to Regal within 90 days from the date of delivery to the original purchaser, subject to all limitations and conditions contained herein. All warranty work is to be performed at a Regal dealership or other location authorized by a Regal Customer Service Manager after it is established to Regal's satisfaction that there is a defect in material or workmanship.

REGISTRATION INFORMATION:

CUSTOMER OBLIGATIONS: The following are conditions precedent to the availability of any benefits under these limited warranties:

(a) The purchaser must sign and the dealer must submit to Regal the "OWNER REGISTRATION AND SYSTEMS CHECKLIST FORM" within ten (10) days of the date of delivery and such information must be on file at Regal;

(b) The purchaser must first notify the dealer from whom the boat was purchased of any claim under this warranty within the applicable warranty period and within a reasonable period of time (not to exceed thirty (30) days) after the defect is or should have been discovered;

Introduction

(c) Regal will not be responsible to repair or replace any part, (1) if the use of the boat is continued after the defect is or should have been discovered; and (2) if such continued use causes other or additional damage to the boat or component parts of the boat;

(d) Based on the dealer's knowledge of Regal's warranty policy and/or consultations with Regal, the dealer will accept the claim and arrange for appropriate repairs to be performed, or deny the claim if it is not within the warranty;

(e) The dealer will contact the Regal boat owner regarding instructions for delivery of boat or part for warranty repair if it is covered by the limited warranty. **ALL COSTS TO TRANSPORT THE BOAT FOR REPAIRS ARE THE RESPONSIBILITY OF THE OWNER;**

(f) If the Regal boat owner believes a claim has been denied in error or the dealer has performed the warranty work in an unsatisfactory manner, the owner must notify Regal's Customer Service Department in writing at the address listed for further consideration. Regal will then review the claim and take appropriate follow-up action.

WARRANTY EXCEPTIONS: THIS LIMITED WARRANTY does not cover and the following are not warranted:

(a) Engines, metal plating or finishes, windshield breakage, leakage, fading and deterioration of paints, canvas, upholstery and fabrics;

(b) Gelcoat surfaces including, but not limited to, cracking, crazing, discoloration or blistering except as noted above;

(c) Accessories and items which were not part of the boat when shipped from the Regal factory, and/or any damage caused thereby;



(d) Damage caused by misuse, accident, galvanic corrosion, negligence, lack of proper maintenance, or improper trailering;

(e) Any boat used for racing, or used for rental or commercial purposes;

(f) Any boat operated contrary to any instructions furnished by Regal, or operated in violation of any federal, state, Coast Guard or other governmental agency laws, rules, or regulations;

(g) The limited warranty is void if alterations have been made to the boat;

(h) Transportation of boat or parts to and/or from the REGAL factory or service location;

(i) Travel time or haul outs, loss of time or inconvenience;

(j) Any published or announced catalog performance characteristics of speed, fuel and oil consumption, and static or dynamic transportation in the water;

(k) Any boat that has been repowered beyond Regal's power recommendations;

(l) Boats damaged by accident and boats damaged while being loaded onto, transported upon or unloaded from trailers, cradles, or other devices used to place boats in water, remove boats from water or store or transport boats on or over land;

(m) Water damage to, dry rot to, condensation to, or absorption by interior surfaces, wood structures or polyurethane foam; interior wood including, but not limited to, bleeding and/or discoloration as a result of condensation or moisture or water

Safety On Board

Safety awareness can't be over emphasized. The safety of passengers and crew members should be the skipper's number one priority. This chapter provides details for safe boating actions, as well as how to react to hazardous situations, and what equipment is necessary to have a safe and enjoyable voyage. Heed all safety precautions and be prepared to react to any hazardous situation.

SAFETY LABELS

Precautionary Label Definitions_____

Safety precautions are stated using danger, warning, and caution signal words. They are highlighted in this manual by font design and symbol usage. A notice heading is also included, which will provide operation and maintenance information, but is not directly hazard related. Become familiar and understand the situations described on all safety precaution labels!

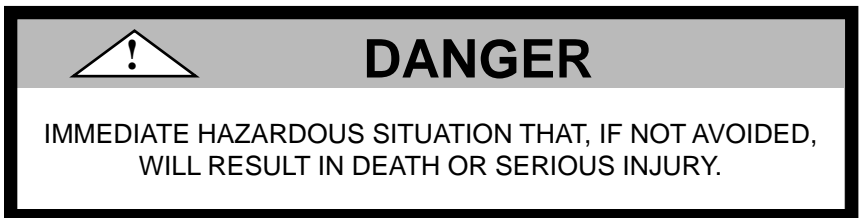

Danger Precautionary Label

Chapter 1



WARNING

POTENTIALLY HAZARDOUS SITUATION THAT, IF NOT AVOIDED, COULD RESULT IN DEATH OR SERIOUS INJURY.

Warning Precautionary Label



CAUTION

POTENTIALLY HAZARDOUS SITUATION OR UNSAFE PRACTICE THAT, IF NOT AVOIDED, MAY RESULT IN INJURY, PROPERTY OR PRODUCT DAMAGE.

Caution Precautionary Label



NOTICE

GENERAL OR SPECIFIC INFORMATION WHICH IS IMPORTANT TO CORRECT OPERATION OR MAINTENANCE, BUT IS NOT HAZARD RELATED.

Notive Label

Precautionary Labels

Read and understand all safety labels affixed to your Regal boat. Most of the safety labels are found close to the helm, swim platform, or engine compartment. A skipper should always analyze the result of their actions in the presence or absence of precautionary labels. **DO NOT** remove or cover labels. Keep harsh chemicals away from labels.

Safety On Board

If any of the labels in the following figure are missing, contact your Regal dealer for replacements. Depending on your optional features, you may have more precautionary labels than those listed here. Obey all precautionary labels at all times.

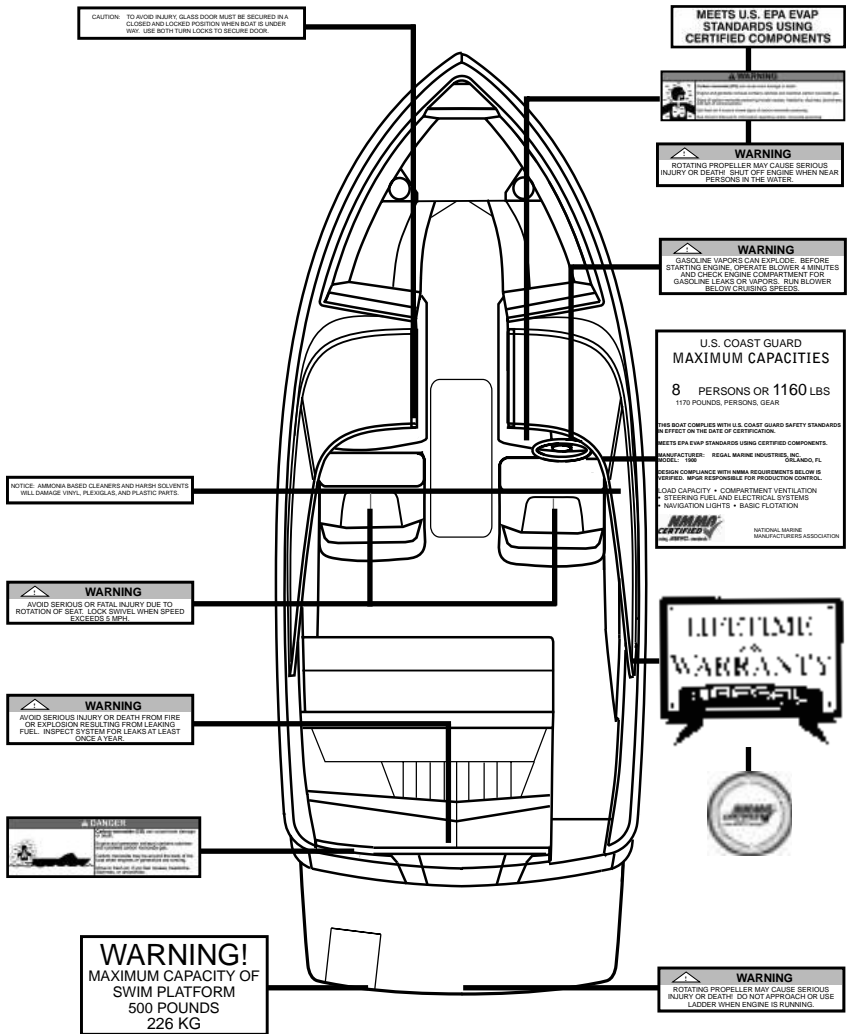

Label Locations

Chapter 1

LOAD CAPACITY

Capacity Plate _____

Your Regal is designed to hold a maximum load that will ensure stability and structural integrity. This load is described on your load capacity plate, located on the starboard side of the helm, below the shifting lever. Your Regal can hold a maximum of eight people, or up to 1170 lbs in people and gear. Follow both of these limiting factors when transporting people or equipment.

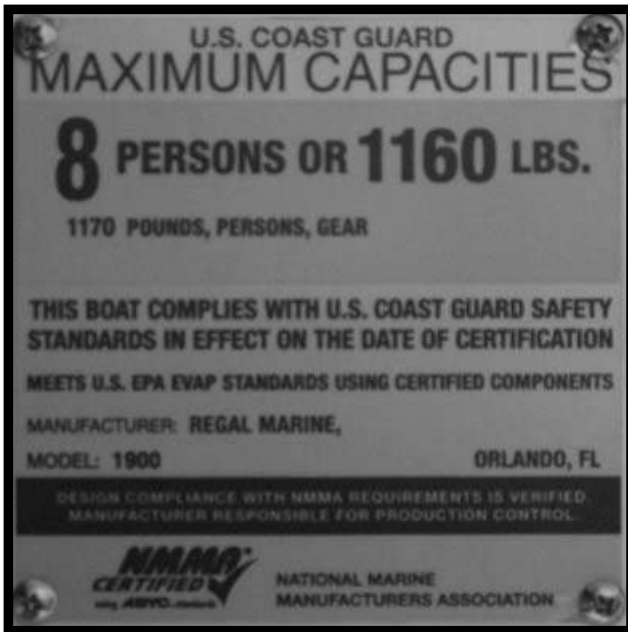

Maximum Capacities Plate

Safety On Board

Passenger Location_____

For maximum stability, performance, structural integrity, and safety, all passengers should be seated according to designated seating arrangements. Furthermore, any load your boat carries should be distributed as evenly as possible from aft to bow and port to starboard. As your capacity plate says, only eight people can ride your boat at once; one person at the helm, one person in the companion seat, three people along the aft cockpit seats, and a total of three people in the bow seating area. Each person should brace themselves with hand rails while the boat is in motion. **ALWAYS** remain seated while the boat is in motion. While underway, **DO NOT** use the swim platform or transom sunpad. **NEVER** operate the boat under unsafe conditions for passengers.

Chapter 1

Safety Equipment

Fire Extinguishers

All Regal boats are built to accommodate ABYC and U.S. Coast Guard standards. Besides these minimum requirements, always check state and local agencies for additional requirements. Fire extinguishers are classified by a letter and numeric symbol. Class B extinguishers are commonly used on boats, as they are designed to put out flammable liquids such as grease, oil, and gasoline. The numeric symbol refers to the minimum extinguishing agent weight. Coast Guard approved hand-portable extinguishers are either a B-I or B-II classification.

FIRE EXTINGUISHER CONTENTS				
CLASS	FOAM IN GALS.	CO ₂ IN LBS.	DRY CHEM IN LBS.	HALON IN LBS.
B-I	1.25	4	2	2.5
B-II	2.5	15	10	10

Fire Extinguisher Contents

Both hand-portable and fixed system fire extinguishers approved by the U.S. Coast Guard contain a metal plate detailing the extinguisher type, capacity, and operating instructions. They have a special marine type mounting bracket which keeps the extinguisher solidly mounted until needed. Extinguishers should be mounted and must be readily accessible, yet out of the way to avoid a hazard, with at least one charged unit mounted at the helm.

Safety On Board

MINIMUM PORTABLE FIRE EXTINGUISHERS REQUIRED		
Vessel Length	No Fixed System	With Fixed System
Less Than 26'	2 B-I	1 B-I
26' To Less Than 40'	3 B-I	2 B-I
40' To Less To 65'	4 B-I	3 B-I

Number of Extinguishers Required

Your Regal should always be equipped with at least one hand-portable B-I fire extinguisher, along with your automatic fire extinguishing system if the option is installed. Otherwise, two B-I fire extinguishers are required. It is important to understand how to use the fire extinguisher you equip. General fire extinguishing strategy involves pulling the pin, aiming the discharge end at the fire, and squeezing the handle to release the extinguishing agent.

If there is a fire in the engine compartment, utilize the fire port along the transom walk-thru if using a hand portable extinguisher, or the manual discharge lever for the optional automatic fire extinguishing system. The fire extinguisher(s) you equip can be one of four class B designs approved by the U.S. Coast Guard, dry chemical, foam, carbon dioxide, and Halon gas.

The dry chemical extinguisher is filled with a white dry chemical powder along with a pressurized gas. It is a good idea to shake this type periodically to ensure proper function at any time, because powder along with a pressurized gas. It is a good idea to shake this type periodically to ensure proper function at any time, because the contents will tend to become packed on the canister's bottom. Cleanup should be vacuumed out or swept up. It is suitable for ordinary combustibles, flammable liquids, flammable gases, and electrical fires.

Chapter 1

The foam extinguisher is filled with a chemical foaming agent with water. It floats on top of flammable liquids to extinguish the fire, but will leave behind a messy residue that must be washed away. It is suitable for ordinary combustibles, flammable liquids, and flammable gases.

The carbon dioxide unit uses CO₂ gas under high pressure, with a funnel to direct the discharge. This extinguisher leaves no residue and does not cause interior engine harm. To ensure functionality, weight the unit annually. A 10% maximum weight variance is allowed for properly equipped units. It is suitable for flammable liquids, and electrical fires.

A Halon extinguisher is becoming more common and environmentally friendly. This colorless and odorless, heavier than air gas sinks to the lower bilge to extinguish fires. Halon is featured in both hand-portable and automatic fire extinguishing systems. This canister needs to be weighed once a year to ensure proper functionality. Halon units must feature a dash mounted indicator. It is suitable for ordinary combustibles, flammable liquids, and electrical fires.

Your automatic fire extinguishing system if equipped on your Regal is a heptafluoropropane fire extinguisher - an acceptable replacement for Halon. Yearly maintenance is required. A light mounted at the dash senses that the extinguisher is charged. When the light goes off the system is discharged and must be replaced.

Pyrotechnic Visual Devices_____

Pyrotechnic visual distress signals must be U.S. Coast Guard approved, be ready for service and be readily accessible. They all display a marking which is the service life. It is important to ensure that all pyrotechnic devices have not expired before beginning your voyage. A minimum of three devices for daytime use and three devices for night time use are required to be ready to use on your boat.

Safety On Board

Pyrotechnic devices should be stored in a cool, dry location. Most of these devices can be purchased in a bright, watertight container.

Daytime devices include:

- Pyrotechnic red hand-held or aerial flares
- Pyrotechnic orange smoke emitting devices

Evening devices include:

- Hand-held or aerial flares
- Red parachute flares or meteor flares

Each distress signal has certain advantages and disadvantages, and there is no distress signal that is best under all situations. Meteor and parachute flares operate consistent with firearms and therefore must be carefully handled. Check with local and state regulations since some of these devices are considered firearms and are prohibited.

Pyrotechnics are generally recognized world-wide as superior distress signals. A downfall is they emit a very hot flame that can cause burns and/or ignite flammable materials. Your Regal **DOES NOT** come equipped with pyrotechnic devices, and owners should purchase the devices that will best serve their boating needs.

Non-Pyrotechnic Visual Devices_____

Non-pyrotechnic devices must be in serviceable condition, readily accessible, and must be certified by the manufacturer to comply with U.S. Coast Guard standards.

Chapter 1

Daytime visual non pyrotechnic devices include:

- Orange distress flag
- Dye markers

The distress flag is for day use only. It must be three feet by three feet or larger with a black square and a ball on top of an orange background. This can be spotted when attached to a boat hook, long fishing rod, or a paddle with a person waving the flag overhead.

Evening non-pyrotechnic devices include:

- Electric distress flag

The electric distress flag is used for night use only, flashing the international SOS distress signal (...---...). Under Inland Navigation Rules, a high intensity white light that flashes regularly 50-70 times per minute is also considered a distress signal.

Remember that regulations prohibit the display of visual distress signals on the water under any circumstances except when assistance is required to prevent immediate or potential danger to passengers on a vessel. Your Regal **DOES NOT** come equipped with non-pyrotechnic devices, and owners should purchase the devices that will best serve their boating needs.

Safety On Board

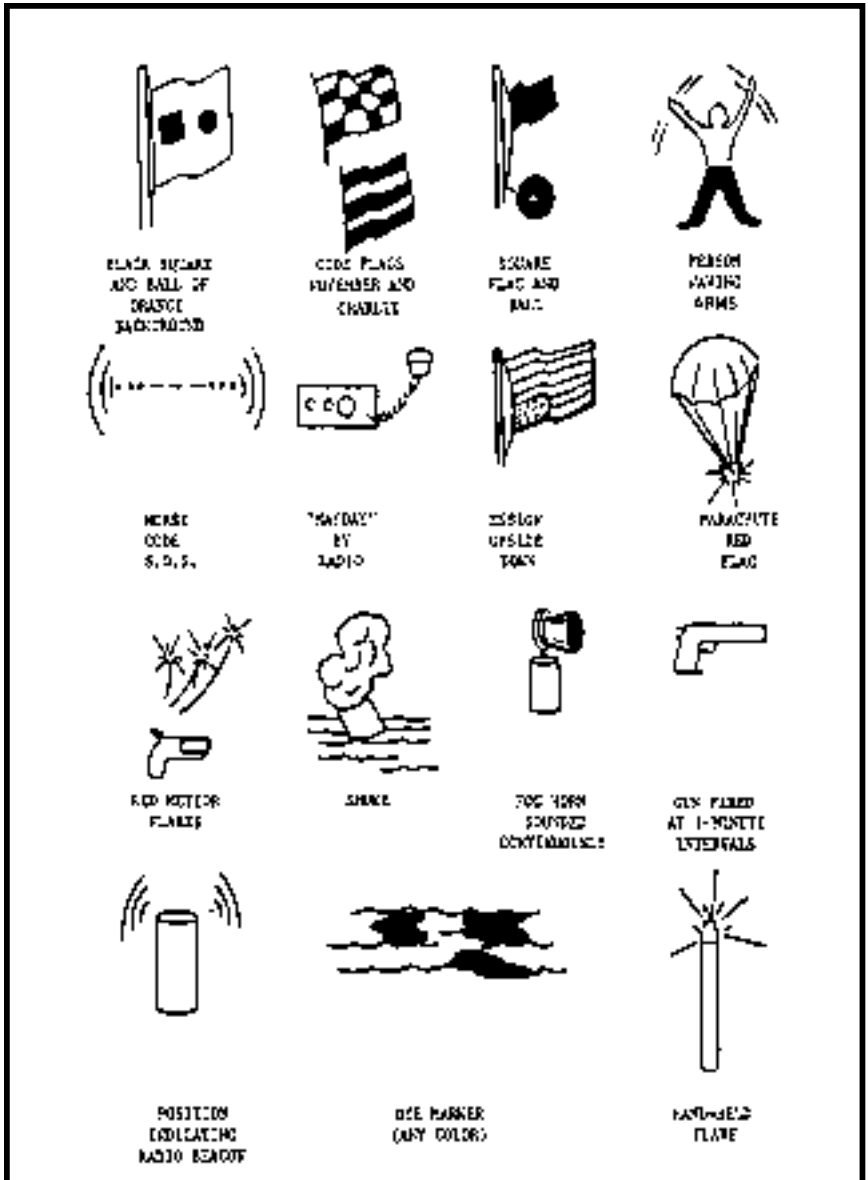

International Distress Signals

Chapter 1

Sound Producing Devices

According to both Inland and International Rules, all boats must carry some way of producing an efficient sound signal. If your vessel is 12 meters (39' 4") or longer, a power whistle, power horn or bell must be carried. The bell must be 7 7/8" in diameter. Boats less than 12 meters a horn or whistle is required to signal intentions or signal position. The sound signal made in all cases must be capable of a four or six second blast audible for one half mile. A switch located on the dashboard will activate your horn, meeting these requirements while functional.

Radio Communications





VHF radios are used for distress, ship to shore communications, and ship to ship communications. Learn the specialized messages such as Mayday, Mayday, Mayday, which is used when life or vessel is in imminent danger. Your Regal boat **DOES NOT** come equipped with a VHF radio, but it would be wise to purchase one.

Navigation Lights

The U.S. Coast Guard requires boats operating at night (from sunset to sunrise), or in fog to display navigation lights. Navigation lights help avoid collisions by improving the night visibility of vessels. Red and green directional lights, white stern lights, white masthead lights, and the white all-around light must be displayed in specified positions, depending on boat size and mode of operation. A switch located on the dashboard will activate your navigation lights. The configuration of lights help others determine the size of your boat, direction of travel, means of propulsion (sail, power, rowing, or at anchor), and a relative speed at which you are traveling. Larger boats are required to carry larger and brighter lights, visible over longer distances. Your

Safety On Board

Regal boat, being under 12 meters, requires red and green side lights, a white mast light, and a white stern light. A single 360 degree all-around light can be used in lieu of the mast and stern light combination.

Location of lights on vessel	Visible Range		Degrees of arc lights
	Less than 12 m	12 m. but less than 20 m.	
 Masthead	2	3	325°
 All-round	2	2	360°
 Side lights	1	2	112.5° each color
 Stern light	2	2	135°

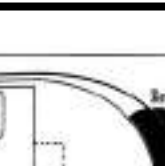

Figure 1

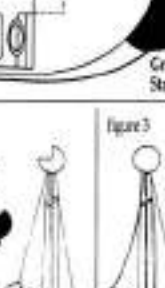

Figure 2

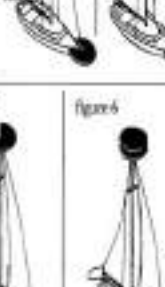

Figure 3



Figure 4



Figure 5



Figure 6



Figure 7a



Figure 7b

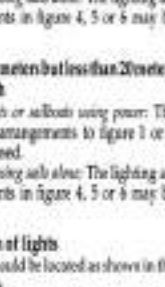

Figure 7c

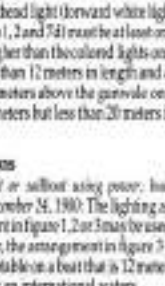

Figure 7d

Boats less than 12 meters in length
Motorboats or sailboats using power: The lighting arrangements to figure 1, 2 or 3 may be used.
Sailboat using sails alone: The lighting arrangements in figure 4, 5 or 6 may be used.

Boats 12 meters but less than 20 meters in length
Motorboats or sailboats using power: The lighting arrangements to figure 1 or 2 may be used.
Sailboat using sails alone: The lighting arrangements in figure 4, 5 or 6 may be used.

Location of lights
Lights should be located as shown in the drawings.
The masthead light (forward white light in figures 1, 2 and 7d) must be at least one meter higher than the colored lights on a boat less than 12 meters in length and at least 2.5 meters above the gunwale on a boat 12 meters but less than 20 meters in length.

Exceptions
Motorboat or sailboat using power: Inal before December 31, 1980. The lighting arrangement in figure 1, 2 or 3 may be used. However, the arrangement in figure 3 is not acceptable on a boat that is 12 meters or longer in international waters.

Row Boats or Paddle Boats
One all-round white light ready to display in time to prevent a collision (figure 7a or b).

Great Lakes
Motorboat or sailboat using power on Great Lakes: The lighting arrangements in figure 7d may be used instead of the arrangements in figures 1 and 2.

Chapter 1

Personal Flotation Devices

All personal flotation devices (PFDs) must be Coast Guard approved, in good working condition, the correct size for the wearer, and readily accessible. This means being able to wear them in a reasonable amount of time in case of an emergency. They should not be locked away or in close proximity to potential fire hazards. Also, ensure that all coverings are removed such as plastic from any PFDs. Each passenger must have a properly fitted PFD for themselves only, while onboard the vessel. A PFD should be worn at all times while your boat is operating on the water. A PFD may save your life, but it must be worn to do so.

As minimum U.S. Coast Guard requirements state, all recreational boats must carry one type I, II, III or V PFD (wearable) for each person aboard. Any type IV PFD (ring buoy) needs to be available for immediate deployment. A type V PFD must be rated equivalent to a type I, II, or III PFD to meet U.S. Coast Guard requirements. To meet U.S. Coast Guard regulations, in addition to one wearable PFD per person aboard your vessel, your Regal must also be equipped with a type IV (throwable) PFD. Note that your Regal **DOES NOT** come equipped with personal flotation devices.



Type I PFDs are also known as an off-shore jacket. It provides the most buoyancy. It is a PFD for all waters, and especially useful in rough waters where rescue may encompass additional time. It is designed to turn most unconscious users in the water to a face-up position. Type I PFDs are available in adult and children's sizes.

Type I Personal Flotation Device

Safety On Board



Type II Personal Flotation Device

Type II PFDs are also known as near-shore buoyant vests. It is recommended for calm, inland water where rescue time will be minimal. It will turn some unconscious people face-up in the water, but not as numerous as Type I PFDs. They are available in adult, medium child, small child and infant sizes.

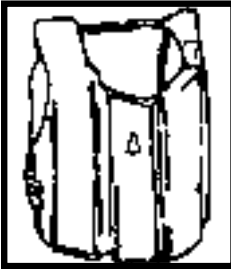

Type III Personal Flotation Device

Type III PFDs are also known as flotation aids. It is recommended for calm inland water or where there is a chance for quick rescue. It is designed so wearers can place themselves in a face up position in the water. The wearer may have to tilt their head back to avoid turning face-down in the water.

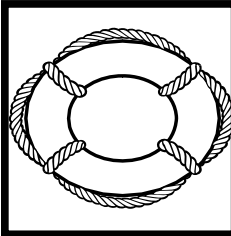

Type IV Personal Flotation Device

TYPE IV PFDs are Intended for calm, inland water with heavy vessel traffic, where help is constantly present. It is designed to be thrown into the water for someone to grab on to and held until rescued. Type IV PFDs include ring buoys, buoyant cushions, and horseshoe buoys.

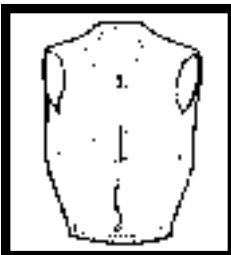

Type V Personal Flotation Device

TYPE V PFDs are the least bulky of all PFDs. It contains a small amount of inherent buoyancy, and an inflatable chamber. It must be rated equivalent to a type I, II, or III PFD in order to be Coast Guard approved. These hybrid PFDs must be worn at all times to be acceptable.

Chapter 1

Be sure to check with state and local regulations about PFD use by children of specific ages before taking them out on the water. Remember that PFDs will not necessarily keep you from drowning, even though they are designed to keep a person from sinking. When purchasing PFD's make sure it safely fits the person wearing it. It is a good idea to test PFDs in a life guarded shallow pool before venturing on the water.

To size your PFD:

- 1) Put it on given manufacturer's directions.
- 2) Tighten all straps until snug.
- 3) Try to pull the shoulder straps above your ears. If the straps reach your ear height, get a smaller size.

To maintain your PFD:

- Do a periodic operation check of all PFDs in shallow water.
- Be sure to air dry all PFDs after each use. Store in a dry, easily accessible location.
- Check periodically for broken zippers, frayed webbing, water loaded kapok bags, missing straps, and sewing that has become undone.
- Clean each PFD with mild soap and water only. Again, let it dry sufficiently before storing.
- Keep PFD's out of grease and oil since they can deteriorate the jacket's inner and outer materials.

Safety On Board

- Check any kapok-bagged jackets by squeezing. If you hear air escaping, the bag is defective and the PFD should be thrown away.
- Grab the cover with the fingers. If the cover material rips, the PFD is rotted and should be thrown away.
- If the kapok bag is hard, the PFD should be discarded.

Life Rafts

Inflatable life rafts are recommended for oceangoing and operating a vessel in a large body of water like the Great Lakes. They can provide shelter for extended periods. If used, make sure it is large enough for all aboard and contains the proper emergency equipment pack. Also, get the unit professionally serviced. Your Regal boat **DOES NOT** come with a life raft, although they are recommended. If purchased separately, make sure the life raft is U.S. Coast Guard approved.

Distress Radio Beacons

Emergency beacons, EPIRBs, and ELTs aid in tracking the location of boats and passengers. They are tracking transmitters used by search and rescue squads, and are normally activated upon immersion, while some are manually activated. Your Regal boat **DOES NOT** come with a distress radio beacon. It is highly recommended that an EPIRB or similar device is stored on board for emergency use.

Chapter 1

POLLUTION REGULATIONS

Garbage & Waste Disposal

The Act to Prevent Pollution from Ships places limitations on the discharge of garbage from vessels. The discharge of certain types of garbage is allowed outside certain specified distances from shore as determined by the nature of that garbage. It is illegal however to dump plastic trash anywhere in the ocean or navigable waters of the United States. Discharge of certain garbage types can only legally occur in oceans. Vessels 26' and over must display a placard at least 5" x 8" made of a durable material stating waste disposal regulations and penalties.

GARBAGE TYPE	DISCHARGE
Plastics- includes synthetic ropes, fishing nets, and plastic bags	Prohibited in all areas
Floating dunnage, lining and packing materials	Prohibited less than 25 miles from nearest land
Food, waste, paper bags, rags, glass, metal, bottles, crockery	Prohibited less than 12 miles from nearest land
Comminuted or ground food waste, paper, rags, glass, etc.	Prohibited less than 3 miles from the nearest land

Garbage Disposal Information

The Federal Water Pollution Control Act prohibits the discharge of oil or hazardous substances into the navigable waters of the United States. Violators are subject to a penalty of a \$5,000 fine, with possible further ramifications.

Safety On Board

GENERAL BOATING PRECAUTIONS

We understand that you are eager to get your Regal boat on the water. However, we strongly suggest that you thoroughly familiarize yourself and friends or members of your family with safe boating practices before setting out.

Remember that along with the freedom and exhilaration of boating comes the responsibility that you have for the safety of your passengers and other boaters who share the water with you. Boating regulations vary from state to state. Check with your local state and local authorities for the regulations pertaining to your area.

- Check with local weather stations, the U. S. Coast Guard, or weather station broadcasts for the latest conditions. Remember getting caught in sever weather is hazardous. Check weather conditions periodically while you are boating and before your outing. If you are forced to operate your boat in a storm condition, take common sense precautions; wear PFDs, store gear, reduce speed and head for safe refuge
- It is best to avoid operating your boat in foggy weather. When fog sets in, take bearings, log courses, and speeds. You are required to emit a five second blast from your horn or whistle once every minute. Also, have your passengers wear PFDs and observe for oncoming vessels.
- Operating in shallow water presents a number of hazards including sand bars and water levels influenced by tides. If the vessel strikes an underwater hazard, check for boat and engine damage. Excessive vibration after striking an underwater obstruction may indicate a damaged propeller. If you run aground, seek help by radio or flares and flags.

Chapter 1

- Always close and lock the windshield while in motion. Use both turn locks to secure the windshield in place. Secure the walk-thru door if equipped.
- You must provide a Coast Guard approved personal flotation device (PFD) for every person on board. These PFD's should be in good condition and easily accessible.
- Insist that non-swimmers and children on board wear a PFD at all times. Any time you encounter rough weather conditions, make sure everyone on board is wearing a PFD, including yourself. Instruct your passengers on how to put on their PFDs and be sure they know their storage location on the boat. Remember, in an emergency, a PFD that cannot be quickly located and worn is useless.
- Never allow anyone to sit anywhere on the boat not specifically designed seating. While underway, **ALWAYS** insist passengers sit in the provided seating and set an example by doing this yourself.
- **USE MAXIMUM CAUTION WHEN FUELING.** **NEVER** allow any smoke or flame nearby while fueling. Check for fuel leaks and fumes once fueling is completed.



WARNING

GASOLINE VAPORS CAN EXPLODE. BEFORE STARTING ENGINE, OPERATE BLOWER 4 MINUTES AND CHECK ENGINE COMPARTMENT FOR GASOLINE LEAKS OR VAPORS. RUN BLOWER BELOW CRUISING SPEED.

Gasoline Vapor Warning

Safety On Board



WARNING

USE OF ALCOHOL ENHANCED FUEL, OR ANY FUEL OTHER THAN GASOLINE, CAN LEAD TO DETERIORATION OF THE FUEL SYSTEM COMPONENTS OR RESULT IN ENGINE DAMAGE, FIRE, AND POSSIBLE EXPLOSION.

Alcohol Enhanced Fuel Warning

- **NEVER** drink and drive! As captain, you are responsible for the safety of your passengers and yourself. Alcohol and boating is a dangerous combination. Alcohol impairs the boat operators ability to make conscious decisions and react to emergency situations quickly.
- **NEVER** overload your boat! An overloaded boat, or one with uneven weight distribution, can be difficult to steer, and can affect structural integrity.
- **BE CERTAIN THERE IS ENOUGH FUEL ABOARD FOR YOUR CRUISING NEEDS.** Include any reserve that might be needed should you change your plans due to weather or emergency. Use one-third of your fuel going out, one-third to return, and the rest as reserve.
- Use care, courtesy and common sense when launching, docking, or operating your boat.
- In case of emergency, know the international distress signals. If you have a VHF radio aboard. The spoken word “MAYDAY” is the international signal of distress and is for emergency use only. Recognize flares and flags, as well as light and sound distress signals in case of emergency.

Chapter 1

- Posted speed limits, swimming areas, “no wake” zones and other restrictions should be red-flagged. They are so noted for a reason. Sensible boat use, plus courtesy, equals enjoyable and safe boating.
- It is your responsibility to stay abreast of all federal, state, and local rules, as some laws or regulations may change or be different from state to state. Contact your local boating agencies for updated information.
- We cannot stress safety enough! Remember, there are no brakes on your boat, and the water current and wind velocity all affect your ability to respond. The driver must use caution at all times to maintain control of his/her vessel and especially to maintain a safe distance from other boats and obstacles.
- **ALWAYS** keep all safety gear in optimum condition. Pay special attention to attached tags and plates indicating expiration dates on equipment such as fire extinguishers and PFDs. Regal encourages periodic maintenance checks on all safety equipment. But remember, the captain is responsible for his passenger safety, his vessel, and his actions.
- **ALWAYS** check the weather before departure. Be particularly cautious of electrical storms and high winds.
- **ALWAYS** have up-to-date charts aboard. You will need current charts of the area you’ll be cruising to stay on proper course. Charts can be obtained at your closest marine outlet store, or federal government agencies.

Safety On Board

- **ALWAYS** file a float plan. Leave details of your trip with someone responsible who will be remaining on shore. Include expected return times, plus a name and phone number of a contact person in case of emergency.
- **DO NOT** replace parts in the engine compartment or bilge with non marine rated parts. All parts must be ignition protected and must be installed so they comply with applicable standards for the region in which the boat operates, including but not limited to ABYC, NMMA, and CE standards.
- **LEARN AND OBEY THE “RULES OF THE ROAD”**. A copy of the “Rules of the Road” can be obtained from the U.S. Coast Guard Auxiliary or local Power Squadron.

Chapter 1

WATER SPORT PRECAUTIONS

Besides learning the safety precautions for safe boating, as well as understanding and knowing required rules and regulations, you are obligated to be particularly careful around other water sportsmen, such as scuba divers, fishermen, water skiers and wake boarders.

Skin & Scuba Divers

Whenever you see a “Diver Down” flag, maintain a distance of at least 100 feet on inland waters. In bays and open waters, stay 300 feet away. The flag indicates a diver in the water. If a diver is operating from your boat, be certain to use this flag and post a lookout on board for a divers air bubbles. Sometimes divers stray from the flag area, so be cautious and slow down.

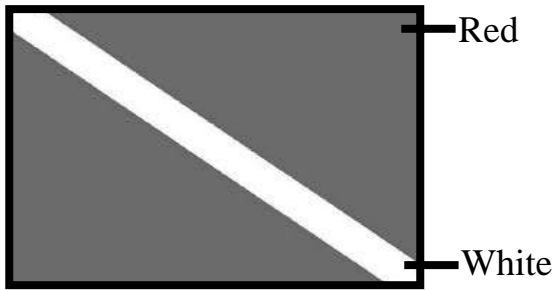

Diver Down Flag

Fishermen

As far as general conduct towards other fishermen, leave them plenty of space to fish their area. Stay clear of fishermen who may have lines or nets out which might get caught in your propeller if you come too close. Slow down when approaching fishing boats. **DO NOT** return to cruising speed until the fishing boats have been passed. If a fishing boat is anchored, a large wake could flip or swamp the boat.

Safety On Board

If fishing from your boat, never anchor in shipping channels, or tie up to any navigational aids. These must be kept clear of at all times. Be sure to carry a chart of the area and be on the lookout for shallow water and hidden obstructions. Tidal charts can help you avoid grounding. **Remember, the skipper is responsible for any damage caused by his wake. Use common sense and be a responsible captain!**

Water Skiers & Wake boarders _____

Give all skiers and wake boarders room to maneuver. **DO NOT** trail either of these sportsmen in case they fall; leave plenty of room to maneuver safely out of the way. General safety procedures for towing skiers and wake boarders include the following:

- Know your hand signals and make sure all our passengers know them. Refer to the figure illustrating signaling.
- **DO NOT** allow non-swimmers to ski or wake board.
- **ALWAYS** have an observer on board whose sole job is to watch the skier/wake boarder and communicate with the driver.
- If planning to tow skiers or wake boarders, ensure your ski tow is in proper condition before use.
- Acquaint yourself with the ski site before skiing / wake boarding.
- Follow the speed limits and all posted signs
- Keep the boat away from swimmers or other people in the water.

Chapter 1

- Avoid running near the shoreline or in heavily congested areas.
- **DO NOT** allow skier / wake boarder to spray fishermen or other parties.
- Keep the engine speed steady while towing a skier/ wake boarder.
- Make wide turns with skier / wake boarder in tow.
- Instruct skier / wake boarder in case of a fall to raise his ski in the air to ensure his visibility.
- If the skier falls, return promptly to retrieve them, circling wide from the starboard side to bring the rope within easy grasp.

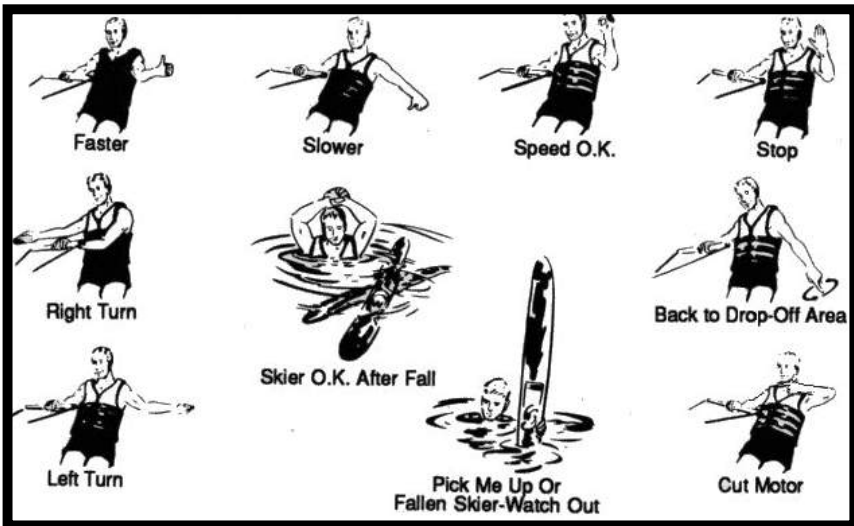

Ski Signals

Safety On Board

SKI TOW

Standard Ski Tow _____

Your Regal boat comes standard with a ski tow fastened at the transom. Check the tow line for abrasions before each use and check the ski tow connection to the hull for tightness periodically. Press down on top of the ski tow and release for the mechanism to pop up for access. Push the ski tow back down after use to avoid a hazard.



Ski Tow



WARNING

AVOID SERIOUS INJURY OR DEATH! DO NOT USE SKI TOW FITTING FOR LIFTING OR PARASAILING. FITTING COULD PULL OUT OF DECK.

Ski Tow Safety Warning

Optional Tow Mirror _____

Your Regal may be equipped with a wide angle tow mirror mounted to the windshield to help the driver keep an eye on the skier. Be cautious of mirror distortion.

Chapter 1

SWIM PLATFORM

Regal prides itself by equipping a swim platform standard on your boat. Inspections of the swim ladder and hardware should be done periodically to ensure that all connections are tight. Use heed when operating the boat in reverse to insure that water does not accumulate excessively on the platform or transom. Follow all labels around the swim platform and transom. **DO NOT** approach the swim ladder while the engine is on. **ALWAYS** store away the swim ladder while in motion. **DO NOT** use the swim platform while the boat is underway. Be aware of any weight limitations of your swim platform. Be aware that the swim platform in particular may be slippery when wet. Exercise caution when using the swim platform.



Swim Platform

Safety On Board

BOATING ACCIDENTS

Common Accident Causes_____

The following is a list of common causes of boating accidents. Be aware of them and take the necessary steps to ensure that yourself and crew are educated and prepared to act.

- Mixing boating and alcohol. Remember the skipper is responsible for his boat and crew.
- Trying to reach the bow by the deck walk-around while the boat is moving too fast.
- Someone sitting on the bow, deck, or swim platform while underway.
- Choosing a boating outing day with inclement weather, especially with high winds and thunderstorms in the forecast, or staying out when bad weather is approaching.
- Disembarking without checking all fluids or systems, and especially fuel system components.
- Not monitoring the boating traffic or possible obstructions around you.
- Emergency communications equipment, signaling devices, and navigation lights not working.
- Improper boat handling especially high speed turns in rough water. Improper trim can also cause problems steering.

Chapter 1

- Being too far from shore with inadequate fuel supply or navigational aids.
- Passengers not wearing the proper life saving devices.
- Skipper or passengers not seated in the boat.
- Running a craft that is mechanically marginal.

Reporting Boating Accidents _____

According to the Federal Boat Safety Act of 1971 involving a collision, accident, or other casualty, the operator must make a formal report within 48 hours to the nearest state boating authority when the incident involves:

- Death or disappearance of someone
- Injury requiring treatment other than first aid

A formal report must be made within 10 days for accidents involving more than \$500 damage or complete loss of the vessel. For information regarding accident reporting, please call the **BOATING SAFETY HOTLINE** at 800-368-5647.

Rendering Assistance _____

The operator of a vessel is obligated by law to provide assistance that can be provided safely to any individuals in dangerous situations on the waterways. The operator is subject to fine and or imprisonment for failure to do so. Move cautiously and think before acting.

Safety On Board

OPERATION BY MINORS

There are rules and regulations in place set by states and local authorities regarding the operation of boats by minors. Some states require minors age 16 and under to complete boating safety courses before operating a boat. Other states may require operators under the age of 18 to be licensed in boat operation. Be sure to check federal, state, and local regulations for operating limitations.

In any case, minors must be supervised by an adult when operating a boat. All minors are equally obliged as adults to read and understand all boating rules and regulations, and are responsible for reading and understanding fully how to operate a vessel.

There are opportunities to learn about boat operation. Boating schools are available and offer courses to teach boat operation. While this manual may go into details about how to operate a vessel, nothing can replace hands-on experience.

Chapter 1

HAZARDOUS CONDITIONS

It is important to constantly be looking out for hazardous conditions, and know how to respond to them, should they occur. It is the captain's responsibility to act responsibly under hazardous conditions.

Shallow Water

Your digital depth sounder, located as the port-most gauge on the dash, will be most useful when navigating shallow waters, but don't rely on it fully. Look around for sand bars and debris, and stay in the deepest area possible. If it looks like you will bottom out, stop and go in reverse. Utilize sea floor topographical maps when possible. Take it slow the first few times until you get used to the terrain and the tidal level. Take your speed up a notch when you feel comfortable and believe it is safe to do so, because a boat's draft will shrink when on a plane.

If you do run aground, check the boat and engine for damage. If the engine is vibrating, it may signal a damaged propeller. Signal for help by radio, flares, flags, and horns. Get your boat checked out by your Regal dealer after grounding out in shallow water.

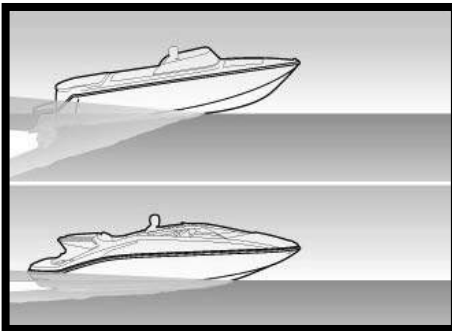

Boat While Planing

Safety On Board

Weeds

Be cautious about navigating through weeds. Debris will not only catch on the impeller, but floating debris may work its way into the bilge area, causing bilge pumps to clog. Weeds, sand, and debris can get into an engine's cooling system and cause problems.

If your boat gives you problems after going through a weeds and debris, be sure to get it checked out by your Regal dealer to ensure the functionality of the engine and propellers.

Weather

Before a boating outing, check the weather conditions. As we all know the weather can change rapidly in many parts of the country. It does so sometimes without being predicted. NOAA weather radio reports are continuously available on designated frequencies installed on VHF radios and various hand held devices.

Thunderstorms can be dangerous for boating. Lightning may target boats on the water, and is capable of frying electronic circuits and stern drive equipment leading to a hazardous situation. Remember, the captain is responsible for the safety of himself and his passengers. If operating in the rain, be sure to monitor the bilge for accumulated water, and the bilge pump for functionality.

As wind blows across water, waves are created. The stronger the wind and the longer the distance across the water, wave actions enlarge. It is important to learn how to navigate in a variety of wave conditions to ensure proper control of your vessel at all times.

Chapter 1

Fog can sometimes lead to hazardous navigation conditions. The best way to act in fog is to immediately head for the coastline, keeping a safe distance away from swimmers, divers, and other people; and following the coastline to your destination. Navigation lights, activated by pressing the appropriate switch on the dashboard, are required to be shown in fog conditions. Also during fog conditions, Navigation Rules state that one prolonged blast every two minutes should be cast by the horn activated by a switch on the dashboard.

Buoys and Markers

Buoys and markers can alert boaters to different situations, so it is important to be able to understand what markings and buoys mean.

Regulatory Markers are white with black lettering. They typically have orange warning borders in different shapes. Square borders are informative buoys, circle borders signal boating restrictions, diamond borders signal a danger area, while a crossed diamond signals a prohibited area that boats should **ALWAYS** stay out of.



Prohibited Area Buoy





Safety On Board

Mooring buoys are white with blue bands. These are the only buoys and markers it is legal to anchor to in public waters. It is illegal to attach your boat to any other buoy, beacon, or marker.

Lateral markers indicate the sides of channels. Safe passage can be found between pairs of green and red buoys. On your way to open waters, a green buoy should be on your starboard side, while the red is to your port. Returning from open waters, lateral markers follow the “red-right-return” rule, with the red buoy to your right (starboard) upon return.

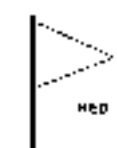
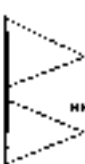
On inland waters, obstruction markers are typically white with black stripes. Never pass between these buoys and the shore. Inland waters may however have locally placed buoys that refer to outdated or incorrect navigational systems.

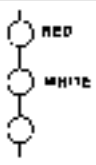
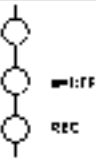
It is also important to follow all signs posted in and around the water. It is the responsibility of the skipper to follow buoy and marker navigation principles and to follow any posted signs.

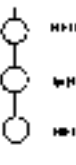
	SMALL CRAFT	GALE	STORM	HURRICANE
DAY FLAQS	 RED	 GREEN	 RED & BLACK	 RED & BLACK
NIGHT LIGHTS	 RED WHITE	 GREEN WHITE RED	 RED RED	 GREEN WHITE GREEN

Weather Markers

Chapter 1

Boating Under The Influence _____



WARNING

FEDERAL LAWS PROHIBIT OPERATING A VESSEL UNDER THE INFLUENCE OF ALCOHOL OR DRUGS. THESE LAWS ARE VIGOROUSLY ENFORCED BY LOCAL, STATE, AND FEDERAL AGENCIES.

Under The Influence Warning

Operating a vessel while intoxicated became a specific federal offence effective in 1988. The ruling set federal standards for determining when an individual is intoxicated. If the blood alcohol content (BAC) is .10 (.08 in some states) or higher for operators of recreational vessels being used for pleasure are subject to a civil penalty up to \$1,000 or criminal penalty up to \$5,000, one year imprisonment, or some combinations thereof. In some states the fines and imprisonment may increase significantly. Understand the rules regarding driving under the influence in the state your boat will operate in.

The effects of alcohol and drugs account for the highest single cause of marine accidents and deaths. Most deaths in boating accidents occur when someone falls into the water. Balance is one of the first skills lost when drinking alcohol, or under the influence of drugs. The problem arises out of not knowing your balance is restricted.

Overall, vision is reduced by alcohol, especially at night, along with double or blurred vision. Peripheral vision is lessened which restricts seeing vessels or objects. Also, color awareness decreases especially with red and green, which happens to be the colors of boat navigation lights, buoys, and channel markers.

Safety On Board

Alcohol will greatly increase your heat loss, so it increases the effects of hyperthermia.

Finally, your ability to make correct judgements in emergency situations is greatly reduced. Alcohol takes away the brains ability to process information quickly and delays a persons reaction time.

DON'T DRINK AND DRIVE!

Some alcohol facts to remember are:

- One 12 oz. can of beer has about the same amount of alcohol as a 5 oz. glass of wine or a shot of liquor.
- After consuming alcohol, time is the only thing that will sober you up. Our bodies average burning approximately 1 oz. of alcohol every hour.
- Recognizing that someone is too drunk to drive is difficult. Experienced drinkers have learned to compensate for the visual effects of alcohol and can disguise their drunk condition.
- A person who has been drinking cannot properly judge if they are fit to operate a boat. Judgement is one of the first elements you lose when drinking. Sober people should drive, and make decisions about boat operation.

Chapter 1

BLOOD ALCOHOL CONTENT CHART									
Body Weight in Pounds	Number of Drinks in a 2 Hour Period (12 oz. beer = 5 oz. wine = 1 oz. 80 proof liquor)								
	1	2	3	4	5	6	7	8	9
100	1	2	3	4	5	6	7	8	9
120	1	2	3	4	5	6	7	8	9
140	1	2	3	4	5	6	7	8	9
160	1	2	3	4	5	6	7	8	9
180	1	2	3	4	5	6	7	8	9
200	1	2	3	4	5	6	7	8	9
220	1	2	3	4	5	6	7	8	9
240	1	2	3	4	5	6	7	8	9
BAC to .05	————— Be Careful - Loss of Judgement & Coordination								
BAC .05 to .10	————— Abilities Impaired - Accident Chance Increased								
BAC over .10	- - - - - Do Not Operate A Boat - High Accident Risk								

Blood Alcohol Content Chart

Exhaust & Carbon Monoxide

Carbon Monoxide (CO) in exhaust can be hazardous. It is important for you and your passengers to be aware of the potential safety hazard created by exhaust gases. For safety's sake do the following:

- **DO NOT** allow the boat to remain stationary with the engine idling for an extended period of time.
- **DO NOT** disable the carbon monoxide alarms that come with your Regal boat. Test the unit in accordance with the alarm manufacturer's instructions
- **DO NOT** operate the engine for extended periods of time while in a confined area or where exhaust outlets face a wall or bulkhead.

Safety On Board

- Have the engine exhaust system inspected when the boat is in for service.
- Persons sleeping can easily be overcome by carbon monoxide without realizing it. **DO NOT** sleep on board while the engine is running.



WARNING

AVOID SERIOUS INJURY OR DEATH FROM CO POISONING! DO NOT OPERATE THE BOAT WITH PEOPLE ON OR NEAR THE SWIM PLATFORM.

Carbon Monoxide Poisoning Warning

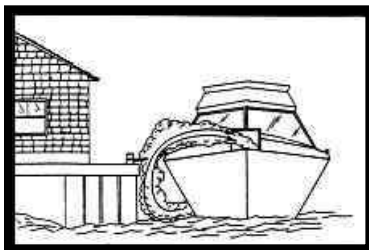

Blockage of exhaust outlets located along the transom can cause carbon monoxide to accumulate in the cabin and cockpit area, even when the hatches, windows, portholes, and doors are open.

Carbon Monoxide Poisoning From Blocked Outlets

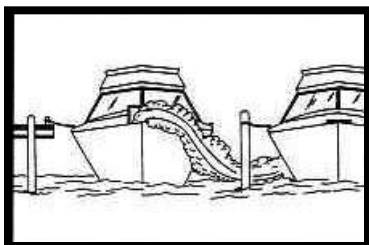

Exhaust from another vessel alongside your boat, while docked or anchored, can emit poisonous CO gas inside the cabin and cockpit areas of your boat.

Carbon Monoxide Poisoning From Other Vessel

Chapter 1

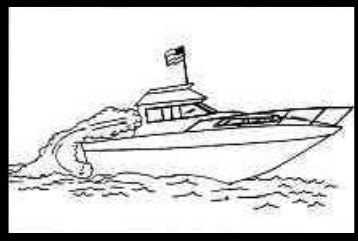

The “station wagon effect” or back drafting can cause CO gas to accumulate inside the cabin and cockpit areas. Slow speeds, high bow angles, and use of protective weather coverings can cause accumulation.

Carbon Monoxide Poisoning Station Wagon Effect

High concentrations of carbon monoxide can be fatal in minutes. However, lower concentrations over an extended period of time can be just as lethal. Symptoms of excessive exposure to carbon monoxide are:

- Dizziness
- Drowsiness
- Nausea
- Headache
- Ringing in the ears
- Throbbing temples
- Water, itchy eyes
- Flushed appearance
- Inattentiveness
- Incoherence
- Fatigue or vomiting
- Convulsions

Carbon monoxide accumulation requires immediate attention! Thoroughly ventilate cabin and cockpit areas. Determine the source of the carbon monoxide and correct the condition immediately. Have any carbon monoxide detectors on your boat checked regularly.

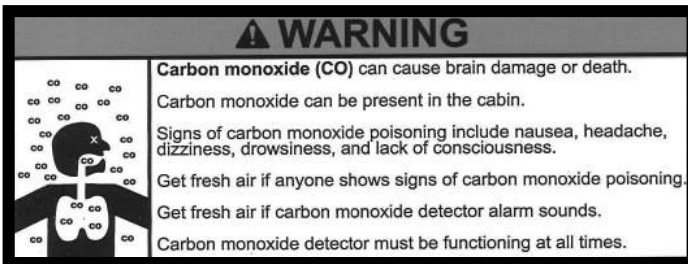

Carbon Monoxide Poisoning Helm Warning

Safety On Board

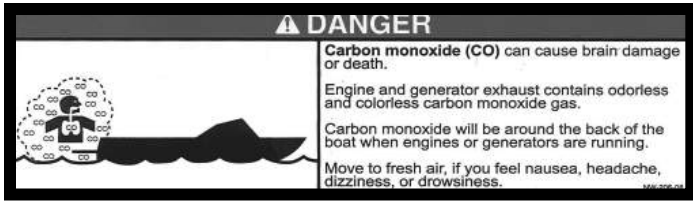

Carbon Monoxide Poisoning Transom Warning

Fire

Fire within a vessel can spread quickly and can cause tremendous alarm. Most fires can be prevented by keeping the bilge free from oil and debris. Keep all safety equipment stowed and maintained in working order. Carry a backup fire extinguisher on board. If anything becomes a possible fire hazard, fix the problem at once. Exercise caution when extinguishing fires. Know when to abandon your boat, and proper fire extinguishing technique.

Never use water on gasoline, oil or electrical fires. When you dump water on an electrical fire a you can be shocked since water conducts electricity. Follow these instructions if a fire breaks out:

- Fit everyone aboard with a life jacket. Turn off the ignition.
- Try to keep the fire downwind. If the fire is to the stern, head the bow toward the wind. If forward, put the stern to the wind.
- If the engine should catch fire, shut off the fuel supply. Usually there is a fuel tank access that you can crimp the fuel feed line.

Chapter 1

- Use a hand fire extinguisher. Make sure to point it at the base of the flames. Use short bursts and sweep the extinguisher side to side. Remember: A 4 lb. extinguisher discharges in 20 seconds, so be efficient.

These actions help prevent the fire from spreading to other parts of the boat. You can extinguish fires quickly if you act swiftly. Have a plan of action in case a fire breaks out. At least one hand portable fire extinguisher must always be equipped at the helm, ready for the captain to use at any time.

In order to comply with Coast Guard regulations, all engines should come equipped with a flame arrestor. As your engine operates, sometimes fuel vapors can linger in certain areas of the engine and catch fire. The flame arrestor prevents flames from backfiring out of your engine and exposing the flame to the entire engine compartment. The removal of this device while the engine is on, is not only hazardous, but breaks Coast Guard regulations. Check your flame arrestor according to the engine manufacturer specifications to ensure your engine compartment is properly protected.

Safety On Board

First Aid

A first aid kit and the ability to use it are important ingredients for the safety of a captain and his passengers. Having confidence and competence in handling medical emergencies is a necessity. Invest your time in a first aid course available at the American Red Cross.

In addition to knowing first aid for boating accidents, learn first aid associated with hazards of any water sports you may perform.

CPR (Basic Life Support)_____

If someone is seriously injured, have someone call for help while the injured person is being attended. Check for responsiveness and breathing. Place your head near the victim's mouth. Look for the chest to rise and fall, and feel for breathing on your cheek. Check for a pulse and call 911. If a pulse exists, perform rescue breaths at the rate of 1 breath every 5 seconds. If no pulse exists, perform CPR.

Chest compressions are the most crucial element of CPR. Studies have shown it takes an average of 15 timely compressions for blood to start circulating. If compressions stops for rescue breaths, circulation stops and takes another 15 compressions to restart. CPR requires:

- 1) Chest compressions of 2" at the sternum at the rate of 100 compressions per minute. Continue to perform until medical help arrives or upon complete exhaustion.
- 2) Two rescue breaths may be given after four minutes, but are not required. Continue chest compressions as stated.

FOLLOW UP WITH MEDICAL AUTHORITIES AFTER TREATING CPR.

Chapter 1

Hypothermia

Hypothermia is a condition where the body temperature drops below the threshold to maintain a normal metabolism. It can be serious and usually occurs where victims have been immersed in cold water for an extended time. If you encounter a possible victim of hypothermia call for help on the radio and get the person out of the water.

Look for the following symptoms of hypothermia:

- Shivering that may stop in advanced stages of hypothermia.
- Confusion, clumsiness or slurred speech.
- Rigid muscles.
- Semiconscious to unconscious.

Treatment of hypothermia is best done when it is caught early. Perform the following for treatment:

- 1) Remove wet clothing.
- 2) Monitor the victim's pulse and breathing.
- 3) Rapidly apply heat to the body core by using blankets, naked bodies, or warm water. **DO NOT** warm the arms and legs. Warming extremities may prove fatal.

FOLLOW UP WITH MEDICAL AUTHORITIES AFTER TREATING HYPOTHERMIA.

Safety On Board

SAFETY INSPECTION

It is important to ensure a safe voyage before setting out on the water. Perform the following safety inspections to ensure your vessel is properly equipped for each voyage to minimize problems and safety hazards. Get into a habit about checking these items in the same order until it becomes routine.

Before Each Voyage_____

Perform the following safety check:

- 1) Check the weather report, including both wind and water conditions
- 2) Ensure that all required safety equipment is onboard. Check local regulations that may apply.
- 3) Check that fire extinguishers) are fully charged. If you have an automatic fire extinguishing system, ensure it is functional by using the gauges on the dashboard and by referring to the system's manual.
- 4) Confirm that the drain plug is installed
- 5) Make sure all exhaust clamps are in place and secure.
- 6) Look for exhaust leaking from the exhaust system components, indicated by rust or black streaking, water leaks, or corroded and cracked fittings. Check the vents and ensure they are not blocked.

Chapter 1

- 7) Ensure batteries are charged to the proper operating level
- 8) Check electrical circuits (navigation lights, bilge pumps, horn, etc.) for functionality.
- 9) Check that all regular maintenance has been performed.
- 10) Operate blowers for 4 minutes before starting the engine.

ANNUALLY

- 1) Replace exhaust hoses or mufflers if any evidence of cracking, charring, or deterioration is found.
- 2) Replace the engine water pump impeller along with the plate and housing if necessary to ensure the cooling system and exhaust system doesn't overheat
- 3) Inspect each of the metallic exhaust components for cracking, rusting, leaking, or looseness.
- 4) Check safety equipment, and weigh fire extinguishers as required

Safety On Board

Boat Size in Feet	16'	26'	40'	65'	105'
Personal Flotation Devices ¹	One Type I, II, or V per person	One Type I, II, or V per person plus one Type IV throwable	One Type I, II, or V per person plus one Type IV throwable	One Type I, II, or V per person plus one Type IV throwable	One Type I, II, or V per person plus one Type IV throwable
Fire Extinguishers ²	None	One B-I, any type	One B-II or B-I	One B-II or B-I	One or more B-I (unless 6-8 ft. long) two or more B-I (unless 26-40 ft. long) or more B-I (unless 41-100 ft. long)
No-Fixed System	None	None	None	None	None
With Fixed System	No Extinguishers Required	No Extinguishers Required	One B-I	Two B-I or one Class B-II	One or more B-I (unless 6-8 ft. long) two or more B-I (unless 26-40 ft. long) or more B-I (unless 41-100 ft. long)
Visual Distress	None	None	None	None	None
Signals	None	None	None	None	None
Sound Producing Devices	None	None	None	None	None
Backfire Flame Arrestor	None	None	None	None	None
Ventilators	None	None	None	None	None
Navigation Lights Under Power ^{3,4}	None	None	None	None	None
Under Sail	None	None	None	None	None
Bowing	None	None	None	None	None
RJ Anchor	None	None	None	None	None
Washdown	None	None	None	None	None
Relatives	None	None	None	None	None
Regulators	None	None	None	None	None
Marine Sanitation	None	None	None	None	None
Devices	None	None	None	None	None
Navigation Buoy	None	None	None	None	None

1. PFD's must be USCG approved, wearable by the intended user and readily accessible.
2. The extinguisher required on boats with enclosed engine compartments (not outboards), increased living space or permanent live tanks.
3. Sailboats (except under power) are considered power-driven and must follow the "Under Power" rules. During the day, non-sailing vessels are required to fly a non-sailing cone.
4. Power-driven vessels under 25' and under 7 knots can substitute a white lantern or torch in place of the required light.

Additional to these requirements are prescribed by some individual state laws. Check your state's Boating Safety Handbook for a complete list.

U.S. Coast Guard Minimum Safety Requirements



Notes

Rules Of The Road

The Navigation Rules set forth actions to be followed by boats to avoid collision. They are referred to as the “rules of the Road”. There are two main parts referred to as the inland rules and international rules. The inland rules apply to vessels operating inside the boundaries of the United States. The international rules (referred to as 72 COLREGS) apply to vessels operating on the high seas and all connected waters outside the established demarcation boundaries. Most navigational charts show the demarcation lines by a red dotted line and are published in the navigation rules. Remember to consult state and local agencies since areas such as “no wake zones”, swimming beaches, “diver down flag”, and inland landlocked lakes fall under their jurisdiction. This section is only an introduction to the “rules of the road”. It is strongly recommended that additional training be sought out before getting behind the “wheel” of your boat.



Navigation Rules Warning

You can order the inland and international navigation rules from:

Superintendent of Documents
U. S. Government Printing Office
Washington, DC 20402
Tel: (202-512-1800) Fax: (202-512-2250)

Chapter 2

RIGHT OF WAY

- 1) Cross waves at right angles.
- 2) When caught in heavy water or squalls, head either directly into the waves or at a slight angle. Reduce speed, but maintain enough power to maneuver your boat safely.
- 3) Keep your speed under control. Respect the rights of other boaters engaged in all water sports. Give them a “wide berth”.
- 4) Whenever meeting a boat head-on, keep to the right where possible. Cross port side to port side.
- 5) When two boats cross paths, the boat to the right (starboard) has the right of way.
- 6) When overtaking or passing, the boat being passed has the right of way.

In general, boats with less maneuverability have right-of-way over more agile craft. The skipper must keep his craft clear of the following vessels:

- A vessel not under command or aground; due to their circumstances, these vessels have no maneuverability.
- A vessel restricted in its maneuverability; these vessels are usually performing work which limits their maneuverability such as surveying, dredging, laying pipe or cable, or servicing navigational markers among other such boats.

Rules Of The Road

- A vessel engaged in fishing; these include boats fishing with lines, trawls or nets, but not trolling lines. Sailboats have the right-of-way over power boats. However, if a sailboat is using a prop to move forward, it is considered a power boat, even if sails are up.
- Remember the unwritten “rule of tonnage”. Basically, a smaller tonnage vessel should take every effort to avoid close quarters with a larger tonnage vessel. One way to accomplish this is to have a designated human lookout to “eyeball” the horizon for any developing collision course.
- Use defensive driving skills on the waterway just as you do on the roadway. The other vessel may not know the rules of the road”. Be alert and ready to take immediate action.
- If a collision course is unavoidable, neither boat has the right of way. Both boats must react to avoid an accident according to the rules of the road.

SIGNALS

When it comes to naval navigation, a mixture of “traffic” signals are used. Whistles or bells, along with lights and flags are used to communicate information to all skippers, so you must readily be able to identify them.

Horn and whistle signals, although antiquated with the invention of VHF radio are still commonly used for quick communication. It is important to recognize these signals quickly, as they are normally used under circumstances that quickly alter your surroundings.

Chapter 2

Whistle Signals	
One Short Blast	- Cross Port to Port (Red to Red) - Overtaking to starboard
Two Short Blasts	- Cross Starboard to Starboard (Green to Green) - Overtaking to port
Three Short Blasts	Engines In Reverse
Five or More Short Blasts	Danger Signal
One Long Blast	Warning Signal

Whistle Signals

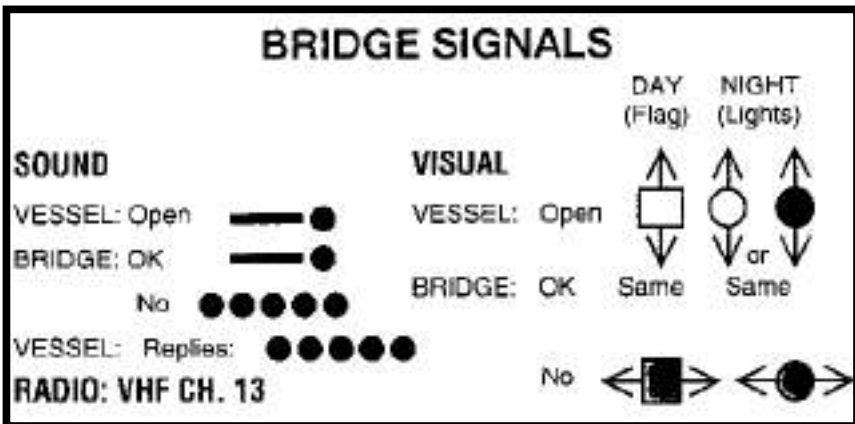

Bridge Signals

Some people may find remembering the whistle signals difficult, as crossing port to port is also the signal used to overtake on the starboard side, while two whistle signals mean the opposite. It becomes easier to remember whistle signals when considering your course of travel. After sounding a whistle once, you intend to alter your course to starboard, either to avoid a head on collision, or to overtake another vessel. Sounding two whistle signals suggests an alteration of your course to port. In response to any whistle signal offered, a response mimicking the request is required before proceeding.

Rules Of The Road

VESSEL INTERACTION

Navigation Rules recognize three types of crossing situations - meeting head-on, overtaking, and crossing. In each case, both boats are governed by special procedures.

In a head on meeting, both vessels must sound a single blast and give way toward starboard, passing port to port. These rules appear when there is risk of collision.

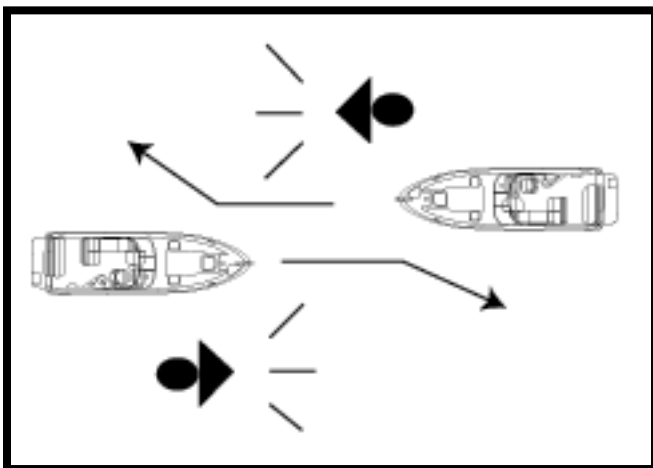

Head On Meeting Signals

In an overtaking situation, the overtaking boat is burdened, and is not the privileged craft, even though it approaches the danger zone of the overtaken boat. The overtaking boat first signals with a single blast if the boat desires to pass on the starboard side of the boat ahead, or a double blast if passing to port. The overtaken craft responds with the same signal if it is safe, or with the danger signal (5 short blasts or more) if unsafe. The boat overtaking must not pass unless the appropriate signals are sounded.

Chapter 2

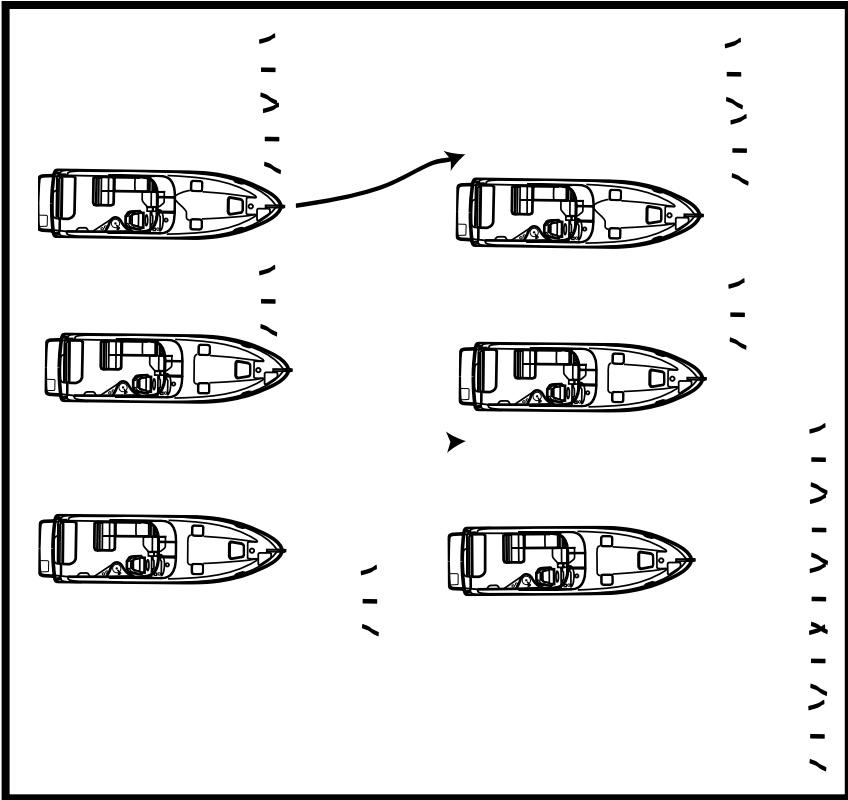

Overtaking Signals

When involved in a situation where crossing paths with a risk of collision, beware of the other craft's position as well as your own. For safety, there should be a noticeable change in the angle, bow or stern; a gradual change in position indicates possible danger.

Rules Of The Road

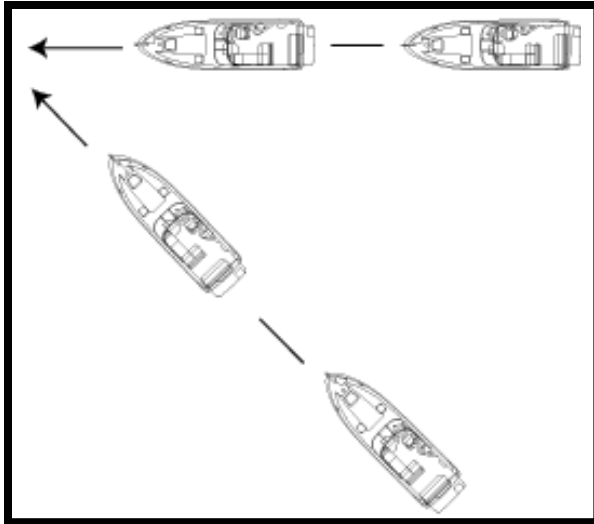

Crossing Signals

NIGHT RUNNING

Boats operating between sunset and sunrise (hours vary by state), or in conditions of reduced visibility, must use navigation lights. Nighttime operations, especially during bad weather and fog, can be dangerous. All rules of the road apply at night, but it is best to slow down and stay clear of all boats regardless of who has the right-of-way.

Your navigation lights should always be functional. These lights include the red/green light at the bow of your boat, and the 360 degree anchor pole light. The pole light is not permanently affixed to your vessel. It must be assembled and plugged in each time your vessel operates at night. Your pole light is normally stored in the ski locker. Extend the pole and lock the pieces together and then insert the light into the socket normally located on the aft starboard side of your vessel near the transom walk-thru. Then test the lights by activating the navigation lights and anchor lights at the dash.

Chapter 2

To see more easily at night, avoid bright lights when possible. Also, it is helpful to have a passenger keep watch for other boats, water hazards, and navigational aids.

To determine the size, speed, and direction of other vessels at night, you should use the running lights. A green light indicates starboard side, and a red light indicates port side. Generally, if you see a green light, you have the right-of-way. If you see a red light, give way to the other vessel. A combination of red and green lights would therefore represent a boat coming at you, and you should then react with head-on meeting signaling and maneuvering.

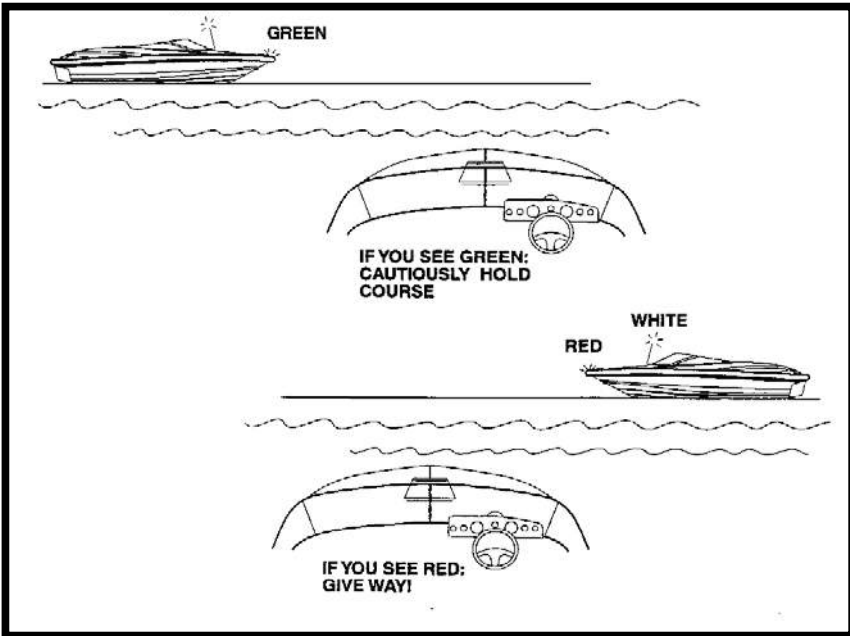

Night Running

Rules Of The Road

NAVIGATION AIDS & MARKERS

Navigation aids are placed along coasts and navigable waters as a guide for mariners in determining their position in reference to land and hidden danger. Each aid provides specific information.

Buoys provide a road map to keep the skipper on course and to avoid hazards. Buoys are identified by light, shape, color, and in severe weather conditions by sound. Buoys or beacons called lateral markers indicate the port and starboard sides of the waterway to be followed. U.S. markers follow the buoy system known as Red Right Returning. When returning from sea or traveling upstream, the green markers are to your port (on your left), and the red markers are to the starboard side (on your right). When traveling downstream or out to sea, the marker color would be reversed.

Before operating your vessel, learn to identify the various navigational aids such as lateral aids, mid-channel markers, and regulatory markers. Nautical charts are provided by the National Ocean Service (NOS) and are distributed nationwide through marinas and outlet stores. These charts show the geography of the coast, water depth, landmarks, navigation aids (buoys and markers), marine hazards, and port facilities. Use only up-to-date charts for navigation. We recommend when purchasing a chart to look for the weather resistant ones.



CAUTION

SKIPPERS MUST NOT RELY ON BUOYS ALONE TO MARK THEIR POSITION. SEVERE WEATHER CONDITIONS AND WAVE ACTION CAN ALTER BUOY POSITIONS.

Buoy And Marker Caution

Chapter 2



WARNING

NEVER TIE UP TO A BUOY. IT IS ILLEGAL AND EXTREMELY DANGEROUS

Buoy Warning

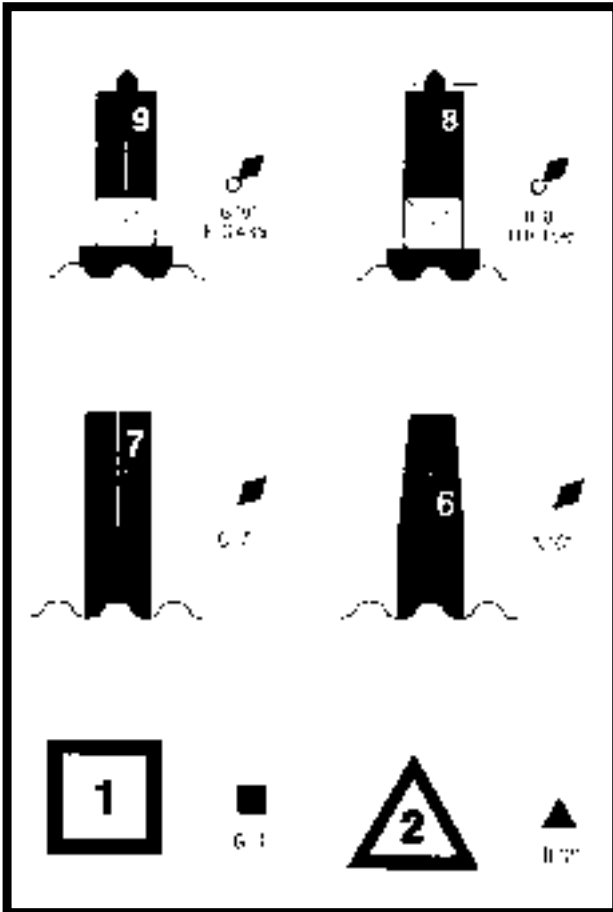

Lateral Aids

Rules Of The Road

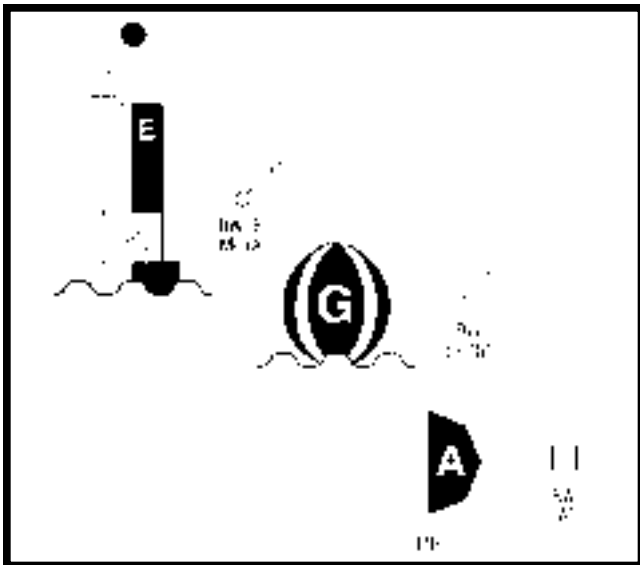

Mid Channel Markers

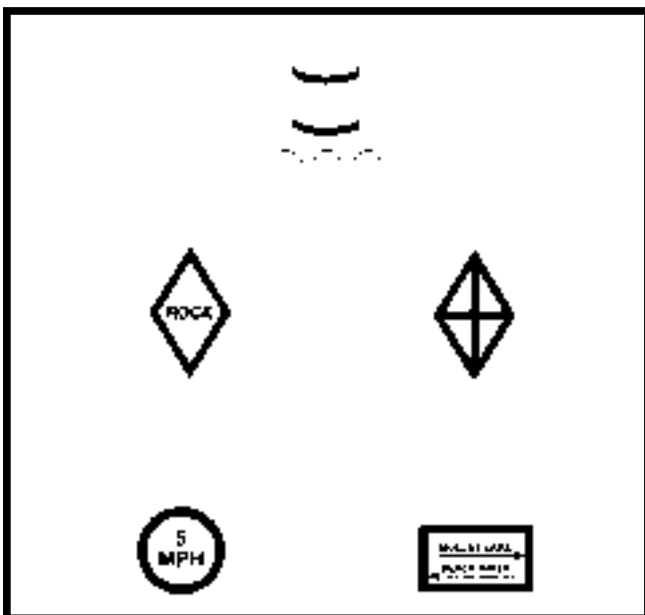

Regulatory Markers



Notes

Engine & Controls

ENGINE BASICS

It is important that you read the engine manual carefully and become completely familiar with the operation as well as necessary maintenance on the engine and propulsion systems. Pay careful attention to the sections on winterization if you live in freezing climates. Extensive damage can result if proper winter storage is not followed. Your Regal dealer for further information regarding technical issues and parts. Refer to the maintenance section of this manual for further information or call your nearest Regal dealer.



WARNING

AVOID SERIOUS INJURY OR DEATH! READ ALL MANUFACTURER'S ENGINE AND PROPULSION OWNER'S MANUALS BEFORE OPERATING YOUR VESSELS.

Engine Owner's Manual Warning

This chapter is intended to give general information about the location and function of a typical engine and control setup. Control systems and engines may vary from model to model. Refer to the specific owner's manual for your equipment that would include the following information and much more in greater detail and accuracy.

Chapter 3



WARNING

AVOID SERIOUS INJURY OR DEATH! USE ONLY APPROVED MARINE REPLACEMENT PARTS THAT ARE IGNITION PROTECTED IN AND AROUND THE ENGINE COMPARTMENT.

Marine Approved Replacement Parts Warning

Engines function based off four principles, fuel, compression, ignition, and exhaust. The proper ratio of fuel and air must be drawn into the engine's cylinders in order to be compressed by the pistons and ignited by a spark. The force of which pushes the piston back down, providing the energy used to turn your propeller, before the engine kicks into the exhaust stage where it expels the by-products. If any of these four functions fail, so does the engine itself.

Beyond these basic concepts of engine functionality include engine cooling, lubrication, electrical, and ventilation systems. The specific details of these systems can be found in your owner's manual for the specific engine option you chose on your Regal boat. These options are limited to specific single drive Mercury and Volvo engines.

Engine Mounts

The engine is placed in the boat on a set of metal or wooden platforms called mounts. These rubber insulated mounts keep the engine from moving laterally and athwart ship (right angles to the center line), as well as reduce vibration from the engine and drive. Periodically, the mount hardware should be checked for tightness.

Engine & Controls

Engine Alignment_____

The engine uses a rubber spline hub to which the out drive shaft is attached. This alignment specification between the engine and out drive needs to be checked periodically. It should be checked after every 50 hours of operation, or if the vessel has run aground or hit a submerged object. Alignment should be checked by a Regal dealer or marine professional, since special tools and procedures are required.

Engine Removal_____

In the event the engine or out drive (sometimes referred to as stern drive) requires major service where it needs to be removed, consult your Regal dealer.

Engine Checklist Before Each Voyage_____

Every engine option may require different checks before each use, but a general engine checklist is included here as a guide.

At Engine / Stern Drive:

- Check the cooling system. Ensure no leaks, and that coolant level is sufficient.
- Check the fuel pump for operation, and check fuel lines for any leaks.
- Check engine oil.
- Check power steering fluid level.
- Check power trim fluid.

Chapter 3

At Helm / Deck

- Check power trim for operation.
- Check control lever for operational defects. Check the clip and safety lanyard for functionality.
- Check gauges for accuracy.
- Check fuel level and ensure it is sufficient for the outboard and inbound trip with a reserve.

ENGINE COOLING SYSTEM

Your typical engine normally utilizes a raw water cooling system for cooling the engine. It is important that this system continues to run properly at all times to avoid hazardous situations and ensure a safe voyage.

Raw water is drawn up through the stern drive through pick-up feeds by the water pump. Water passes through a thermostat which controls how much cool water circulates through the engine before passing through a circulatory pump and impeller that distributes the coolant throughout the engine block. The cool water absorbs heat produced by the engine, before being emitted via a coolant exhaust system.

Impeller / Water Pump

Periodically, the coolant system's impeller and pump should be inspected for debris or damage. Damaged parts will affect the system's ability to function, and may cause engine damage. The water pump is can normally be traced back from the thermostat.

Engine & Controls

Coolant Hoses

Before each trip, the coolant system should be checked for leaks. After locating the pump housing, check the hose feeds for leaks, particularly around the hose clamps. Inspect the hoses for signs of melting or cracks, and replace as necessary.

WARNING

AVOID OPENING THE FILLER CAP FOR THE COOLANT SYSTEM OR DISCONNECTING THE COOLANT SYSTEM HOSES WHILE THE ENGINE IS STILL ON / HOT. UPON LOSS OF SYSTEM PRESSURE, STEAM OR HOT COOLANT CAN SPRAY OUT OF THE SYSTEM CAUSING BURNS.

Engine Coolant Warning

Thermostat

If the temperature gauge starts yielding abnormal readings, it may become necessary to look at or replace the engine thermostat after determining whether it is functioning properly. The thermostat reads the temperature of coolant and determines whether to open or close a valve to allow warm sea water to pass into the exhaust manifold. The thermostat may recirculate hot coolant for the purposes of reaching standard operating temperatures. If standard operating temperatures have been reached, the thermostat will open a valve and allow hot raw water to exit through the exhaust manifold. To inspect the thermostat, locate the thermostat housing, remove the housing, thermostat, o-ring, and gasket. Inspect these components for damage, and replace as necessary. Clean the intake manifold and thermostat housing at the location of the gasket to ensure a tight fit before replacing components.

Chapter 3



WARNING

AVOID TOUCHING THE THERMOSTAT OR ITS COMPONENTS WHILE THE ENGINE IS ON / HOT. AVOID RUNNING THE ENGINE WITHOUT A FUNCTIONING THERMOSTAT, AS IT MAY OVERHEAT.

Engine Thermostat Warning

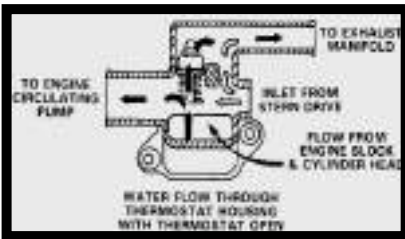

Typical Open Thermostat Diagram

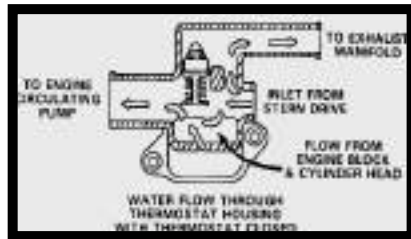

Typical Closed Thermostat Diagram

Freshwater Flushing Port

Some engines offer a fresh water flushing system. After linking up to a fresh water hose at the flush port, water can be pumped through the engine's raw water cooling system to flush out all salt and debris that may be left behind. It is supposed to be utilized after each trip to ensure a maximum lifespan of your cooling system components. Check your engine owner's manual regarding this system's availability and use. Some manufacturers incorporate a flushing port directly into the engine's coolant hose system while others require an adapter to be inserted onto the pick up feeds on the stern drive.

Engine & Controls

ENGINE ELECTRICAL SYSTEM

Your engine utilizes a great deal of electronic equipment. Some equipment sends signals between the engine and dash mounted instruments, while other systems set off alarms, and still others are used by the engine to generate a spark and ignite the fuel. The battery switch controls electrical power distribution to the boat systems.

To regularly maintain your DC electrical system, inspect the battery charge before each trip. Test all gauges and control equipment prior to departure, and replace as necessary. Spark plugs should be replaced according to your engine owner's manual maintenance schedule. When a fuse blows, investigate the problem, fix it, and then replace the fuse.

Gauge Electrical Signals _____

Most engines transmit signals through electrical harnesses to different components. The thermostat for instance transmits an electrical signal to the dash temperature gauge which mechanically rotates the needle in the display to represent the approximate engine temperature. Faults in these electrical components should be fully inspected by your Regal dealer.

Alarms _____

When a malfunction with your engine or drive occurs, select engines will sound an alarm to alert the skipper of a problem. Common engine and stern drive problems include overheating, low oil pressure, or a miscommunication with equipment. Learn the alarm systems that apply to your engine by consulting your engine owner's manual.

Chapter 3



WARNING

AVOID OPERATION OF THE ENGINE AFTER AN ALARM HAS SOUNDED. USE OF THE ENGINE WITHOUT ADDRESSING THE PROBLEM MAY RESULT IN ENGINE DAMAGE OR FAILURE.

Engine Thermostat Warning

Distributor

Your gasoline engine ignites the fuel by use of a spark generated at the precise moment when the fuel mixture has been fully compressed. However, your engine doesn't spark each cylinder at the same time, each cylinder requires a spark according to which stage of the engine cycle the cylinder is in. A distributor takes the electrical current generated by the starter battery and distributes the electrical potential to each cylinder in turn as needed to generate the spark as needed.

Spark Plugs

The spark plugs are the piece of equipment that make the spark occur. As electrical potential builds on one side of the gap based upon the energy distributed by the distributor, the potential eventually grows large enough to cause the electric current to jump the gap on the spark plug. This spark is what ignites the compressed fuel generating a controlled explosion that will power the piston down and deliver power to the drive shaft.

Engine & Controls

Alternator

Under normal circumstances, the starter battery would wear down after being used so often to generate a spark for the engine. This isn't an ideal setup because a strong battery is needed for continual operation. A weak battery does no good out on the water. The alternator connected to the serpentine belt takes care of recharging the battery(ies). As the serpentine belt rotates the pulley, a magnet inside a coil of electric wire rotates with the pulley. The rotation of this magnet inside the coil of wire generates a current which is the used to recharge the battery.

However, in an effort to conserve battery life, the starter battery should still be turned off after every trip and turned on at the start of every trip. This limits the drain on the battery while the boat is not in use. The alternator will only recharge the battery while the engine is running. So if the battery is drained before it can provide the initial spark to the engine to start the serpentine belt turning, the alternator does no good.

Fuses

Your engine also comes equipped with fuses that will burn out when engine components attempt to draw more power than the piece of equipment or wiring can handle. When the fuse blows, it breaks the circuit, and electricity stops flowing. Before replacing the fuse, investigate the cause of the problem, and why the equipment was overworked. Some engines feature a fuse box, while others feature in-line fuses, while still others feature a mixture of both. Refer to your engine owner's manual for complete details on your electrical system.

Chapter 3

ENGINE EXHAUSTING SYSTEM

Your engine expels the by-products of the engine operation through an exhaust system, just like cars do. In boats however, this exhaust system mixes the debris left over after the power stroke of the engine with the hot water that is expelled after cooling the engine. Basically the exhaust system contains the exhaust manifolds, exhaust vent and most likely a catalytic converter. Basically the exhaust flows through the catalytic converter to purify the exhaust before expelling the exhaust through the stern drive either just above the propeller, or through the prop shaft.

Catalytic Converter

The catalytic converter is now required on modern engines. These catalytic converters sit at the top of the exhaust manifolds on either side of the engine. These boxes grow very warm and burn excess hydrocarbons emitted by the engine, resulting in cleaner emissions. These converters require oxygen to fuel the burning process of these hydrocarbons, and will often times have an upstream oxygen sensor that will adjust the fuel injection process to add more oxygen in the fuel ratio. These converters have been implemented to provide cleaner emissions.

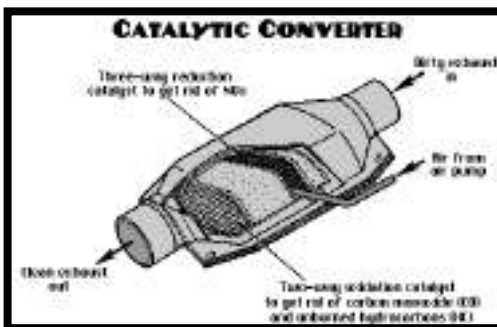

Typical Catalytic Converter Diagram

Engine & Controls

ENGINE FUELING SYSTEM

All engines require a source of fuel in order to run. The fuel that an engine uses, is not only comprised of gasoline (in some cases diesel), but also air. This mixture of gas and air are combined into a ratio, best suited for your engine, and therefore best suited for your boat. If this system fails, the engine will have no fuel to compress and ignite. It is important to make sure your fuel system is functioning properly.



WARNING

GASOLINE VAPORS CAN EXPLODE. BEFORE STARTING THE ENGINE, OPERATE BLOWER FOR 4 MINUTES AND CHECK ENGINE COMPARTMENT FOR GASOLINE LEAKS OR VAPORS. RUN BLOWER BELOW CRUISING SPEED.

Gasoline Vapor Warning



WARNING

USE OF ALCOHOL ENHANCED FUEL, OR ANY FUEL OTHER THAN GASOLINE, CAN LEAD TO DETERIORATION OF THE FUEL SYSTEM COMPONENTS. THIS CAN RESULT IN FIRE AND POSSIBLE EXPLOSION.

Alcohol Enhanced Fuel Warning

Your typical factory installed fuel system is comprised of a fuel fill fitting marked “gas”, fuel tank, fuel hoses, fuel vents, anti-siphon valve, fuel filter, fuel pumps, fuel injectors, fuel gauge, and sender among other items.

Chapter 3

You should understand the purposes of each of these components and discover their location by reading the associated owner's manual so that you can fix a fuel system problem when the need arises out on the water. The pictures displayed in this section may not reflect your specific engine. Always review your engine owner's manual first.

Fuel Fill Cap

The fuel fill is labeled with either "gas" or "diesel" and are normally located along the starboard side of the boat on the aft portion of the deck. When fueling, it is important to keep the fill nozzle in contact with the fuel fill line since it decreases static electricity, which may spark and ignite gasoline vapors. Always use the recommended fuel octane rating as specified in your engine owner's manual. Extinguish all flame producing agents before fueling. The fill cap leads to the anti-siphon valve and fuel tank.

Anti Siphon Valve

The anti-siphon valve at the base of the fuel feed line is pulled off its seat by fuel pump pressure as the engine is cranking or running. It forms a one-way fuel roadway by sealing off the fuel feed line from the fuel fitting. It prevents fuel from siphoning out of the tank in the event of a fuel line rupture, or disconnected fuel feed hose. It is an important safety item, so **DO NOT** remove the anti-siphon valve.

Fuel Vent

Fuel vents are often combined into the fuel fitting on the deck. Fuel tanks are vented overboard for the fumes to escape. While the tank is filled with fuel, air is displaced by the incoming fuel, and relieved through the fuel vent hose. When the fuel tank is near full, slow down or stop the nozzle flow to keep the fuel from splashing out the vent.

Engine & Controls

Fuel Hoses

Fuel hoses transport gasoline from one component to another. These hoses are required to be of certain diameters in order to comply with engineering and environmental standards. Hose clamps are often used to seal the hose to a fitting, and these connections should be checked regularly.

Fuel Pumps / Filter

From the fuel tank, gasoline is moved from the tank to the engine by the pressure produced by fuel pumps. One fuel pump is used to move fuel from the fuel tank to the fuel filter, while a second pump will pump filtered fuel to each cylinder in the engine block. The filter normally located right next to the fuel pumps is meant to take out some small debris as well as small amounts of water. Fuel filters are not able to remove large amounts of water. If the fuel becomes contaminated with water, the fuel must be run through a fuel polisher available at select marinas to remove large amounts of water.

Fuel Injectors

After the fuel has passed through the fuel pumps and filter, it is ready to be injected into the engine. Because boat engines run off four strokes (intake, compression, spark, exhaust), fuel must be delivered to the appropriate cylinders at the appropriate time for optimal engine performance. This action is performed by fuel injectors that inject an air and fuel mixture into the engine cylinders.

Chapter 3

Fuel Sender & Gauge

A fuel sender on the fuel gauge uses a dipstick/float system to measure the amount of fuel left in the tank. This measurement generates a specific resistance value in an electronic circuit connected to the fuel gauge at the helm. As different fuel levels are reached, the resistance value in the circuit with the fuel gauge changes which is read by the fuel gauge and is converted to an approximate fuel level.

Fuel Tank

The fuel tank should be inspected for damage before each voyage. This should be done when you check the fuel lines for tightness and leaks. Your Regal boat uses an aluminum or polyester fuel tank that has been tested several times along with other fuel system components for safety requirements and dependability in house, and they are inspected independently by National Marine Manufacturers Association personnel.

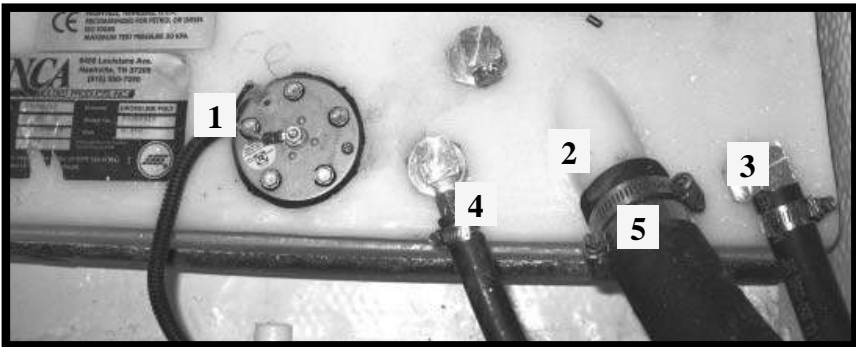

Fuel Tank

- | | |
|----------------------|-------------------|
| 1) Fuel Sender | 4) Fuel Feed Line |
| 2) Anti Siphon Valve | 5) Fuel Fill Line |
| 3) Fuel Vent Line | |

Engine & Controls

ENGINE LUBRICATION SYSTEM

Whenever two components rub together, friction causes wear on both components. To minimize the wear on your engine, a lubrication system has been put in place to help components slide next to each other easier. This is particularly important within the inner workings of an engine. It is important to ensure your lubrication system is working properly at all times.

Your Regal utilizes lubrication and fluids that need regular check ups. These engine fluids are engine oil and power steering fluid. Refer to your engine owner's manual for specific details regarding the proper maintenance procedure of your lubrication system. The pictures displayed in this section may represent a different engine model than the one equipped on your Regal boat. All pictures and procedures in this section are meant to be used as a guide, and should not take priority over the proper engine owner's manual.

Engine Oil

The purpose of engine oil is to lubricate the cylinders of the engine and ensure that parts that regularly move against each other have reduced friction to reduce wear and noise between components. An oil filter keeps metal particles and water out of the engine's interior.

Engines performing on regular oil should have the oil drained and replaced every 100 hours while synthetic oil typically should be drained and replaced every 200 hours. In either case, if your Regal boat has endured one year since its last oil change, the oil should be changed again. The oil filter should be replaced every time the oil is changed, or upon damage. It is normal for the first 50 hours of operation to require frequent changes until the engine is seasoned.

Chapter 3



*Typical Volvo Engine Oil Dipstick And Fill
Typical Mercury Engine Oil Dipstick*



Power Steering Fluid

Power steering fluid should be checked before every trip. It shouldn't require changing unless contaminated with debris or water, in which case a root cause must be investigated. Contact your Regal dealer.



*Typical Volvo Power Steering Fluid Fill
Typical Mercury Power Steering Fluid Fill*



Other Component Lubrication

System components may also require their own lubrication schedule. Steering systems, throttle cable, shift cable, stern drive u-joint splines and o-rings, and the engine coupler may require grease, oil, or other lubrication. Refer to your engine owner's manual for specific details.

Engine & Controls

ENGINE VENTILATION

Ventilation systems are required for all engine compartments. Your vessel features a set of four deck vents located underneath the sun pad seat, which constantly supplies fresh air to the engine compartment. A powered blower motor attached to duct work in the lower one third of the bilge evacuates air to the atmosphere. The other vents are used to take air into the engine compartment. Understand the following warning!

	WARNING
<p>GASOLINE VAPORS CAN EXPLODE. BEFORE STARTING THE ENGINE, OPERATE THE BLOWER FOR 4 MINUTES AND CHECK THE ENGINE COMPARTMENT FOR GASOLINE LEAKS OR VAPORS. RUN BLOWER BELOW CRUISING SPEEDS.</p>	

Gasoline Vapor Warning



Engine Compartment Deck Vents

All owners are responsible for keeping their boat's ventilation system operating properly. This means making sure the vent openings are obstruction free, ducts are not blocked, blower operates properly, and all worn parts are replaced with approved marine ignition protected parts.

Chapter 3

STERN DRIVE BASICS

Inboard/outboard drives, or stern drives, make it easier to control your boat. Your Regal comes standard with either a Mercury or Volvo stern drive. This drive is what converts the power produced by the engine into the force required to spin a propeller. It is important that you read the stern drive manual carefully and become familiar with the operation as well as necessary maintenance on the drive unit components. Pay careful attention to the section on winterization if you live in freezing climates. Extensive damage can result if proper winter storage is not followed.

Stern Drive Mounts

The stern drive attaches to your vessel via the transom assembly. It is through this assembly that the engine passes its energy to the stern drive to spin the propeller. These mounts should be inspected by a marine professional periodically.

Stern Drive Alignment

Your stern drive unit connects to the engine coupler by use of the drive shaft. The splines on the drive shaft are inserted into the engine coupler, allowing energy to be transferred to the drive. This alignment should be inspected periodically or after running aground.

Stern Drive Removal

The stern drive should only be removed by a professional. The stern drive should be removed or inspected after failure, in particular, after water enters the power trim fluid or bellows. It is best to leave stern drive removal to a marine professional or your Regal dealer.

Engine & Controls

STERN DRIVE MECHANICS

The engine transmits rotational energy to the drive shaft at the engine coupler. Once engine output energy is transferred to the drive shaft, it undergoes a ratio change determined by the gear case. This converts the revolutions of your engine to applicable rotations of the propeller. From here, the propeller shaft turns in accordance with the energy ratio determined by the gear case, and rotates the propeller shaft. Your drive hub and other prop hardware keeps the propeller in contact with the prop shaft allowing the propeller to spin without coming off the shaft.

The stern drive uses water pickup feeds normally found on the port and starboard face of the stern drive. These holes allow raw water to be drawn up into the stern drive and pass through the transom to the engine where it can be used as coolant. Used water as regulated by the thermostat is transferred back to the stern drive and emitted at a vent above the propeller, or through the prop shaft, depending on the engine and drive manufacturer. Refer to your stern drive owner's manual for details on the location and operation of the components.

Chapter 3

STERN DRIVE LUBRICATION

The stern drive uses power trim fluid, drive oil, and propshaft lubricants to reduce wear on moving components. These fluids should be checked according to the recommended maintenance procedures determined by the stern drive manufacturer.

Drive Oil

Drive oil keeps all the mechanical components in the stern drive functioning optimally. It reduces friction in the stern drive. Sometimes drive oil is called gear lubricant, as the oil essentially lubricates the gears inside the gear box. Drive oil should be inspected with each trip. The location of the drive oil may change based on your manufacturer, as some chose to mount the fill on the stern drive, while others chose to mount it separately in the engine compartment or on the engine.



Typical Volvo Drive Oil Dipstick



Typical Mercury Gear Lube Fill

Engine & Controls

Power Trim Fluid

Power trim fluid allows your stern drive to angle up or down. This is particularly useful when trying to get your boat to plane where the hull is as much out of the water as physically possible, reducing friction, and improving ride performance. This power trim fluid is used in hydraulic rams that maneuver the stern drive unit, and shouldn't need to be replaced very often, if at all.

Power trim fluid should be checked regularly, despite not requiring replacement unless something serious happens. Discoloration or water presence indicates a water leak in the stern drive. In that case, contact your Regal dealer.



Typical Volvo Power Trim Housing (Power Trim Fill Underneath)



Typical Mercury Power Trim Fill

Shaft Lubricant

Drive and prop shaft lubricant keeps the turning parts on the propshaft from wearing out too quickly. It also assists in the removal of the props by preventing the metal parts from binding. Lubricant should be placed on the u-joint and spline shaft, along with an anti-corrosive grease to ensure continued functionality. Consider having the shafts serviced periodically to ensure proper lubrication at the engine coupler and propeller.

Chapter 3

PROPELLERS

Regal has carefully tested and chosen the propellers to give your stern drive boat the best possible performance based on the engine and propulsion package you choose. We have allowed for the additional weight in equipment that might be added to the boat. It is a good idea to carry a spare set of propellers and hand tools onboard, in order to handle emergency propeller changes. Refer to the sterndrive manual for procedures, as the application is unique to the manufacturer. Call a marine professional or your Regal dealer for further information.

Propulsion Checklist

At least twice a year, check the propeller for:

- Loose, missing, or corroded hardware.
- Nicks, dings, or missing propeller material
- Bent propeller blades.
- Objects wrapped around the prop such as fish line.
- Decomposing propeller blades (electrolysis symptom).
- Aluminum prop with paint coming off near blade tip (ventilation symptom).
- Check the propeller rubber hub for slippage

Contact a propeller shop or your closest Regal dealer if any of the above symptoms exist. They have purchased special equipment to refurbish both stainless steel and aluminum propellers.

Engine & Controls

INSTRUMENTATION

The helm station is equipped with a complete set of instruments that allows you to monitor the condition of the engine. Close observation of the gauges may save the engine from damage. Gauges do however have some inaccuracy, so do not rely upon them fully.

The dash ignition panel is protected by a main 20 amp ignition breaker located next to the key switch on the panel. It is connected through the ignition switch. Your dash instrumentation (gauges, displays, etc.) are protected by a 10 amp fuse underneath the dash. Should this fuse “blow”, investigate the cause before replacing it. Also located on your ignition panel is a 12 volt accessory plug that fits many portable electronic chargers meant for a cigarette plug.

Note that with the battery switch in the “off” position, there is no power to the dashboard, and the ignition switch will not function properly.

All electrical features are protected by a main fuse mounted close to the battery switch. A fuse for the stereo memory and the automatic bilge pump system are also located next to the battery switch in the engine compartment. Fuses for the engine are located either in-line, between components, or in a fuse box. All the switches on the dashboard also have a fuse, located in the forward starboard storage area directly in front of the helm. Should a fuse “blow” it is first necessary to figure out the reason and address the cause before replacing it.

Chapter 3

Depth Gauge_____

The depth gauge indicates the water depth under the keel of the boat. It features a shallow water alarm to warn the skipper of hazardous situations. By monitoring the water depth, damage to props, and underwater hardware can be avoided. This gauge is connected to a transducer on the bottom of the hull, accessible through a removable plate in the ski locker. Refer to the equipment operation chapter for details on gauge settings/operation.



Typical Depth Gauge

Multi Gauge (Fuel, Volt, Oil, Temp)_____

The multi gauge consists of four engine system measurement gauges.

The gauge in the upper left location is the fuel gauge. It indicates the level of fuel inside the fuel tank sent by the fuel sender. It is a good idea to keep the fuel tanks “topped off” when possible to reduce fuel vapors inside the tank. Do not run your fuel gauge to low and allow for a “safety” factor.

Engine & Controls

The gauge in the upper right location is the volt meter. It monitors the battery condition as well as the alternator performance. Normal voltage is between 12.0 and 15.0 volts. Readings outside this range may indicate a charging system problem. Operation of a boat with low battery may lead to a hazardous situation.

The gauge in the lower left location is the oil pressure gauge. It indicates the pressure of the oil inside the engine lubrication system. A drop in oil pressure may indicate a low oil situation or leak. Operation of the engines with low oil pressure could lead to engine damage.

The gauge in the lower right location is the temperature gauge. It monitors the cooling system's effect on the engine as registered by the thermostat. A sudden increase in the temperature could be a sign of a malfunctioning cooling system. Continued operation of the engines without a proper cooling system could lead to engine damage.



Typical Multi Gauge

Chapter 3

Speedometer

The speedometer indicates the approximate speed of travel of your boat in miles per hour and kilometers per hour by measuring water pressure against a small hole in a device mounted on the transom or stern drive. Obey all posted speed limit signs and slow down near other boaters and swimmers to a safe speed. Remember, you are responsible for the wake produced by your boat.



Typical Speedometer

Tachometer

The tachometer indicates the speed of the engine in revolutions per minute. The tachometer allows you to monitor the engine speed so you can be sure not to exceed the recommended limits described in your engine owner's manual. Some tachometers equip an hour meter, which is useful to time your maintenance needs.



Typical Tachometer

Engine & Controls

Trim Gauge

The gauge measures the stern drive tilt and indicates the relative position of the bow, up or down when the boat is on plane. The power trim normally begins in the down position when used to accelerate the boat onto a plane position. The gauge can be helpful in achieving the most economical running plane. A sensor in the stern drive communicates with the gauge on the dash.



Typical Trim Gauge

Chapter 3

HELM CONTROL OVERVIEW

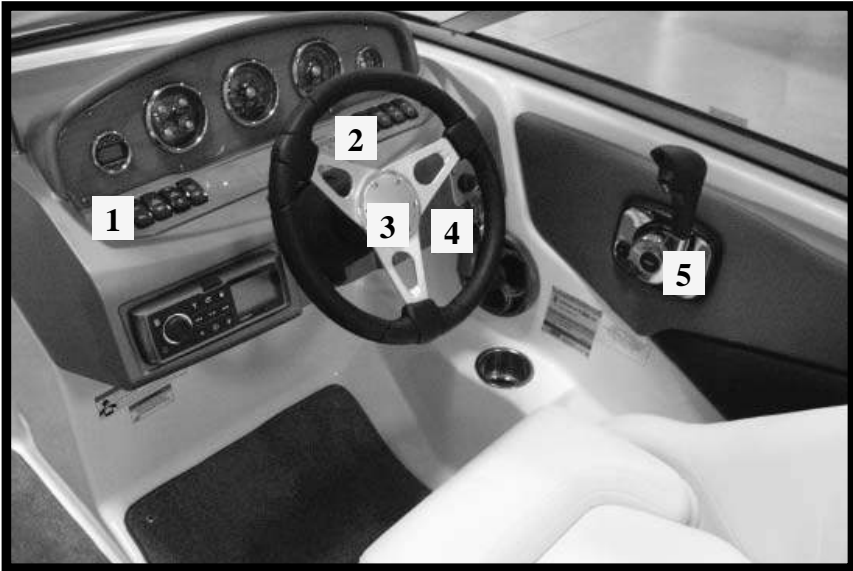

Typical Helm Overview

- | | |
|---------------------------|---------------------------|
| 1) Feature Switch Panel | 4) Ignition Panel |
| 2) Accessory Switch Panel | 5) Binnacle Control Lever |
| 3) Steering Wheel | |

It is important that the skipper fully understands all control equipment located at the helm before operating the boat.

Each gauge is designed with a light bulb so it can be seen at night. On most models, this is normally activated by the navigation lights. Dash relay circuits are protected by fuses on the dash fuse panel located in the starboard storage locker directly in front of the helm.

Engine & Controls

Feature Switch Panel

This switch panel controls the featured systems on your Regal boat. It features a horn switch, bilge blow switch, navigation light & anchor light switch, and a manual bilge pump switch. A red light shows activation.



Feature Switch Panel

Accessory Switch Panel

The accessory switch panel activates cockpit lights and optional accessories installed aftermarket. The two cockpit lights are placed at the bow and transom walk-thru. A red light shows activation.



Accessory Switch Panel

Chapter 3

Steering Wheel

Your Regal utilizes a power steering system controlled by a steering wheel. While in forward gear, to turn your bow to starboard, rotate the steering wheel clockwise to starboard from the straight position. To turn to port while moving forward, simply rotate the steering wheel counter-clockwise. In reverse, rotation of the wheel achieves the same effect, only it controls the stern of the boat. A button on the bottom locks/unlocks the steering wheel tilt which can be manipulated for maximum comfort while boating.



Typical Steering Wheel

Ignition Panel

The ignition switch features four positions; off, run, start, and auxiliary (aux.) The start position is spring loaded and the key should be held in this position to engage the starter. Once the engine has started, release the key from the start position. It will then be energized in the run position. Be a smart skipper and remove the ignition key from the ignition switch, especially with children aboard and when there are persons in the water. The ignition switch auxiliary position is used when the engine is “off”. With the key in the far left auxiliary position, the stereo can be activated without sending current through the engine wiring circuit. It supplies power only to the stereo unit.

Engine & Controls



NOTICE

TO AVOID DRAINING THE BATTERY, DO NOT LEAVE IGNITION KEY IN THE "RUN" POSITION WITH THE ENGINE NOT RUNNING. REMOVE THE KEYS FROM THE IGNITION SWITCH.

Avoid Draining Battery Notice

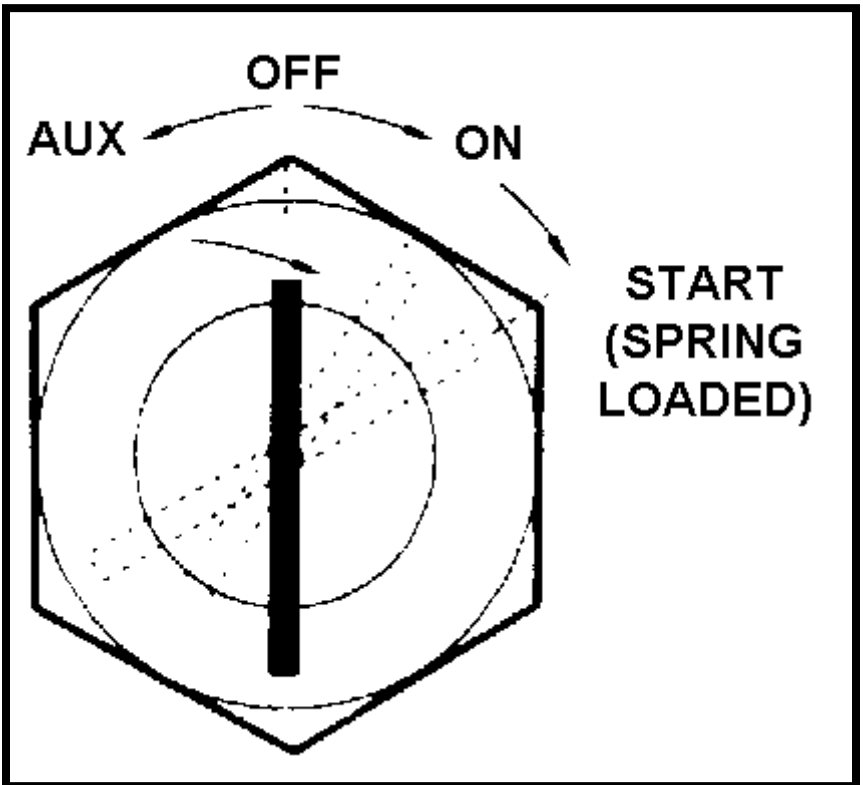

Typical Ignition Switch

Chapter 3

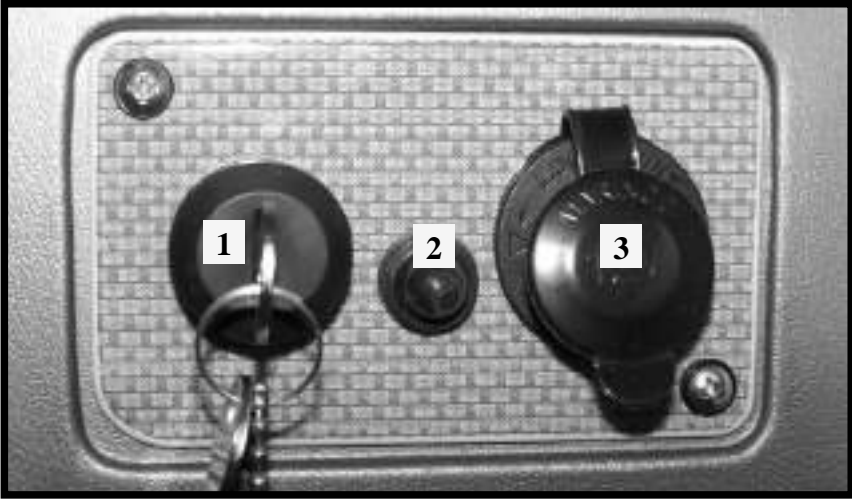

Typical Ignition Panel

- 1) Ignition Switch
- 2) Ignition Breaker
- 3) 12 Volt Accessory Plug

Your ignition panel features a 20 amp ignition breaker that protects the dash instrumentation. Should this breaker pop, investigate the cause before resetting it.

Binnacle Control Lever

Your vessel uses a single side-mount control lever (binnacle lever) to control the stern drive on your Regal. The three gears the binnacle can shift into are forward, reverse, and neutral.

To help visualize the operating principles, we have used a clock mode. The lever in the straight up position is indented in the neutral position. In order to start the engine, your control lever must be in the 12 o'clock neutral position. Your neutral release button may be useful in helping to find the locked neutral position.

Engine & Controls



Typical Control Lever In Neutral Position

- 1) Neutral Release Button
- 2) Trim Control Switch
- 3) Control Lever

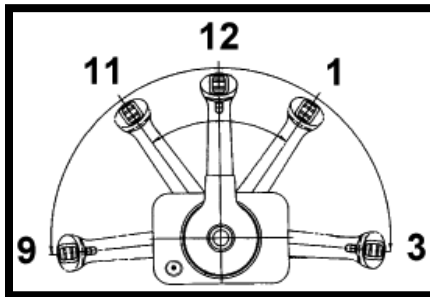

Typical Control Lever Showing Five Positions

Pushing the throttle control lever forward from the neutral 12 o'clock position to the 11 o'clock position will engage forward gear with minimal throttle. From the 11 o'clock position to the 9 o'clock position, the vessel is in forward gear with differing levels of throttle selections.

Pulling the throttle control lever back from the neutral 12 o'clock position to the 1 o'clock position will engage the reverse gear with minimal throttle. From the 1 o'clock position to the 3 o'clock position, the vessel is in reverse gear with differing levels of throttle selections.

Chapter 3

As you shift from neutral to forward or reverse, push the neutral release button, this allows the control lever to come out of the indented position.

The control lever features a neutral safety switch which ensures the stern drive and control are in the indented neutral position for starting the engine. You will hear a distinct sound and will feel the remote control's rotation lock, once in the proper position. If you turn the key to the start position and the engine starter doesn't crank the engine, ensure the control lever is in the neutral position.

Your control lever also features a trim control switch. This switch allows the captain to set the trim for the drive from the helm either up or down to achieve a plane position. Refer to the vessel operations chapter for further information on trim angle.

Follow these points when shifting:

- 1) **DO NOT** shift quickly from forward to reverse gear positions. Drive system damage may occur.
- 2) **DO NOT** "pump" the throttle in neutral or flooding will result. The same thing will happen if you keep pumping the automobile accelerator pedal. Today's engines use an enrichment valve system that requires very little starting throttle.
- 3) **DO NOT** try to shift into forward or reverse gear at high rpm's. Personal injury, drive system, or property damage may result.
- 4) Only use idle throttle positions when docking or maneuvering in tight quarters.

Engine & Controls

- 5) Wear your safety lanyard at all times.
- 6) Never shift the controls with the engine not running. Control, linkage, and/or sterndrive damage may occur.
- 7) For more information, read your engine manufacturer's manual before operating the remote control.

Safety Lanyard (Interrupter Switch)_____

The safety lanyard (used on selected control levers) sometimes called an interrupter switch is attached to the operator and the remote control panel. Should the operator lose control of the vessel and become dislodged from his/her seat or fall overboard, the lanyard will shut the engine off.

Make sure the lanyard is installed to a part of clothing such as a belt or belt loop before operating the vessel. Flip the switch to the run position before starting the engine.



WARNING

INTERRUPTER SWITCH MUST BE ATTACHED TO THE OPERATOR WHILE THE ENGINE IS RUNNING. A QUALIFIED OPERATOR MUST BE IN CONTROL AT ALL TIMES. READ THE OWNER'S MANUAL BEFORE USE.

Interrupter Switch Warning

Chapter 3



NOTICE

IF THE INTERRUPTER SWITCH IS IN THE “OFF” POSITION, THE ENGINE WILL CRANK OVER BUT WILL NOT START. ENSURE THE SAFETY LANYARD IS ATTACHED CORRECTLY AND SWITCHED TO THE “RUN” POSITION.

Interrupter Switch Notice

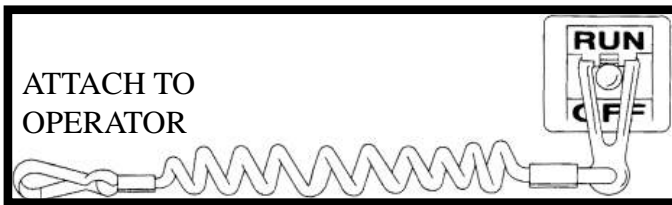

Safety Lanyard

STEERING SYSTEM

Your Regal uses a rotary or rack style steering system. These systems transfer helm mechanical motion to the engine. There is a hydraulic steering cylinder which with the assistance of a steering pump sends fluid force to the stern drive steering arm, changing the course of the boat, depending on the direction the steering wheel is turned. Since the steering system is the primary link for engine control, it must be periodically inspected and maintained. The hardware at both the helm and engine must be checked regularly for tightness and lubrication. Check the steering system for full steering to port and starboard before disembarking. Refer to the steering manufacturer's owner's manual and the maintenance chapter of this manual for more information.

Engine & Controls



WARNING

AVOID PERSONAL INJURY AND PROPERTY DAMAGE! LOOSENING OR LOSS OF ONE OR MORE FASTENERS MAY CAUSE FAILURE OF THE STEERING SYSTEM, OR DAMAGE TO THE STEERING CABLE, RESULTING IN LOSS OF STEERING CONTROL. PERIODICALLY INSPECT THE STEERING SYSTEM.

Steering System Warning



WARNING

AVOID PERSONAL INJURY AND PROPERTY DAMAGE! ABRUPT TURNS ABOVE 30 MPH MAY RESULT IN LOSS OF CONTROL. STEERING RESPONSE AT HIGH SPEEDS CAN BE VERY SUDDEN. ABRUPT TURNS MAY CAUSE YOU TO CROSS OVER YOUR OWN WAKE. JUMPING A WAKE, SUDDEN TURNS, AND INCREASES OR DECREASES IN SPEED MAY PROVE DANGEROUS. THE OPERATOR MUST MAKE SURE THAT ALL PASSENGERS ARE SEATED SECURELY BEFORE MAKING SPEED OR DIRECTIONAL CHANGES.

Steering Warning

Chapter 3

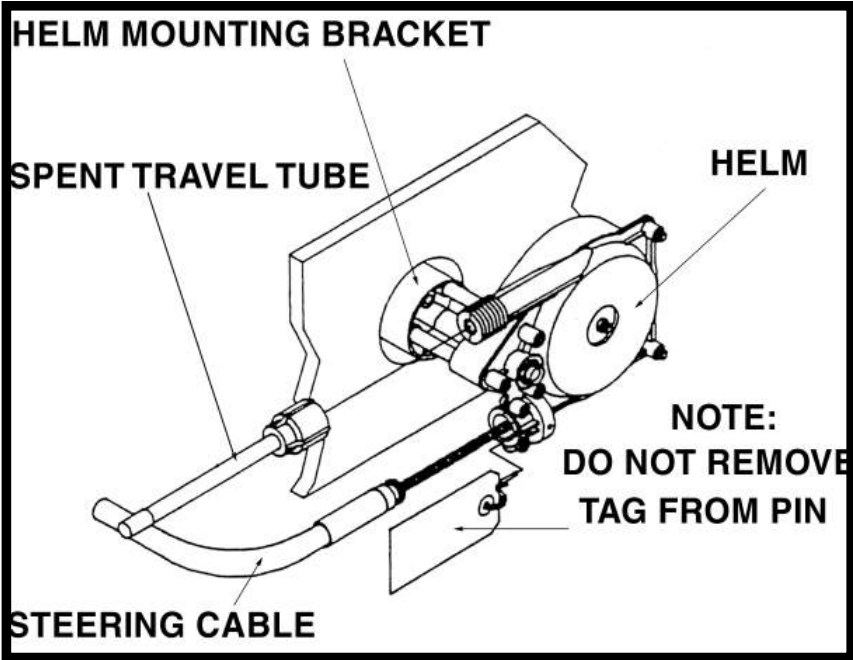

Rotary Style Steering System

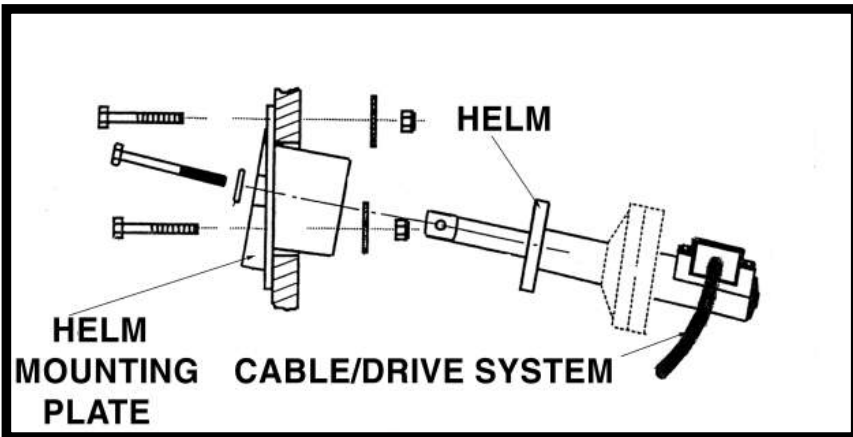

Rack Style Steering System

Systems

AUTOMATIC FIRE EXTINGUISHER

Optional Automatic Fire Extinguisher_____

This system installs a fixed fire extinguisher mounted along the engine compartment wall. The extinguishing system uses an environmentally friendly agent HFC227 ea. This colorless, odorless gas is liquefied in the canister until deployment. The agent has acceptable toxicity ratings in enclosed spaces of your engine compartment's size and is approved by the EPA. It leaves no residue upon discharge in your engine compartment. The fire extinguisher should be checked according to manufacturer specifications by a marine professional. **DO NOT** attempt to disassemble the fire extinguishing contraption. This fixed system is not intended to be explosion suppressive. Boat owner's need to take normal precautions for checking gasoline fumes and using blowers.

Your automatic fire extinguisher uses an actuator to discharge. This is usually enclosed by a metal cage. **DO NOT** handle the fire extinguisher at this location. Sensors are mounted to the extinguisher to detect a fire. A pressure gauge is also mounted to make checkups a lot easier. A manual discharge cable runs from the fire extinguisher to the helm or aft cockpit where a "T" handle and pin can manually discharge the extinguisher. If a fire starts, **DO NOT** wait for the automatic system to take effect - manually discharge the system by removing the pin and pulling the "T" handle.

Chapter 4

BILGE AND DRAINAGE

Regal boats are designed with a drainage system so water can be moved to the bilge from the deck where the bilge pump can pump it out to the through hull drain normally on the aft starboard side. It is important to keep all drains clear of debris so when a wave floods the deck of the boat, all water will leave in an effective manner.

Your boat is equipped with main drains installed near the transom walk-thru on the aft starboard side of your boat, underneath the aft cockpit seats where the cooler normally is set, and a third drain installed in the ski locker. All three of these drains then route back to the bilge pump in the engine compartment. All cup holders and the bow storage compartment drain to the ski locker whereupon it is transferred to the engine compartment bilge pump.

Once the water has been drained to the bilge pump in the engine compartment, the bilge pump can pump it out through a hole located along the aft starboard side of your boat. The bilge pump is connected to a fuse located near the battery switch in the engine compartment and also to an automatic float switch placed directly forward of the bilge pump. The bilge pump receives power from your battery, and the automatic float switch is installed so that the bilge pump will automatically turn on as required. The circuit to the bilge pump receives battery power regardless of the state of your battery switch, so turning off the battery switch at the end of each voyage will not affect your boat's ability to pump water out of the bilge. A manual switch, operated from the dashboard however, requires the battery switch to be turned on.

Monitor your bilge pump's condition to keep your vessel from sinking due to taking on large amounts of water. Debris should be cleared from the impeller regularly. Inspect the condition of the impeller

Systems

and replace the impeller as necessary. To gain access to the impeller, the pump must be disassembled from the bilge pump grate. Simply push the tabs of the grate inward towards the bilge pump, while simultaneously pulling up on the bilge pump. This locking mechanism functions much like a quick disconnect clip. If the fuse for your bilge pump “blows”, be sure to investigate why the bilge pump was drawing too much power. Likely causes of bilge pump malfunction are debris in the impeller, bad impeller, debris in the float switch, bad motor, or short circuit.



Typical Bilge Pump And Automatic Float Switch

Chapter 4

ELECTRICAL

Your boat runs off direct current (DC), supplied by your battery. Regal boats primarily use 12 volt DC batteries located in your engine compartment. It is called direct current because the current flows one way in the circuit. Your automobile is a typical example of 12 volt DC current.

Direct Current (12 Volt DC)_____

Storage batteries (sometimes called wet-lead cell batteries) furnish 12 volt electricity to boat components. Storage batteries use two dissimilar metals immersed in a liquid (acid) to carry current. The engines require large amounts of battery power for starting purposes. Check the maintenacne chapter for battery information.

An automobile battery is charged up by the engine alternator. The same holds true for the marine battery. The dash volt meter displays the battery voltage. If the volt meter shows below 12 volts, there could be a charging system malfunction. This condition needs to be addressed before the voyage and before the batteries become completely drained.

Your battery should be removed for proper winter storage. A battery not properly stored for winter or extended periods of latency may exhibit charging problems. See the storage and winterization chapter for battery storage information.

Wire Color Codes_____

Utilize the following table when looking at your electrical harnesses. Your boat may not feature all of these functions, as some are optional features, while others are not available on your model.

Systems

COLOR	GAUGE	FUNCTION
Black	16 to 4	All Grounds
Black / White	16	Halon Automatic Fire Extinguishing System
Blue	14	Interior Lights
Blue	10	Cabin Light Main Feed
Blue / White	16	Transom Courtesy Lights
Blue / White	14	Cockpit Lights
Brown	12	Water Pressure Pump
Brown	16	Aft Bilge Pump / Manual
Brown	16	Fwd. Bilge Pump / Manual
Brown / Black	10	Overboard Discharge
Brown / Pink	16	Carbon Monoxide Detector
Brown / Red	16	Fwd. Auto Bilge Pump
Brown / White	16	Aft Auto Bilge Pump
Grey	16	Bow Navigation Lights
Grey / Black	16	Mast Light (Anchor Light)
Grey / White	16	Mast Light (Fwd. Running)
Green	16	Tank Level Monitor
Green	8	Bonding
Orange	16	Windshield Wiper / Run
Orange	12	Refrigerator, Hatch Run
Orange	10	Spotlight
Orange / Black	16	Horn
Orange / White	16	Windshield Wiper Park
Purple	16	Hour Meter
Red	16	Gas Vapor Detector, Stereo Remote, Breaker To Dash Feed Lines
Red	14	Positive Feed, Electronics
Red	8	Positive Feed, Alternator Charge
Red	8	Positive Feed, Alternator Charge
Red	4	Positive Feed
Red	2	Positive Feed, Starter Battery

Chapter 4

COLOR	GAUGE	FUNCTION
Red	2 / 0	Main DC Panel Feed
Red	00	Battery Cable To Engine
Red / Black	16	Windlass Up
Red / White	16	Windlass Down
Yellow	12	Blower
Yellow / Black	16	Stereo Memory
Yellow / Black	16	Track Monitor
Yellow / Red	14	Engine Cranking Circuit

Wire Color Code Table

The standard wire color, gauge size, and function shown is used throughout the marine industry. The chart is helpful in identifying wire circuitry during troubleshooting or the adding of marine accessories. **NEVER** replace a wire with a size other than shown in the chart. This practice could result in fire or component failure. Contact your Regal dealer for replacement wires and harnesses.

DC Switches

Switches located at the helm are part of your DC circuitry. Switches are in essence a break in the circuit from the battery to your electrical components. When the switch is turned on, a red light shows activation.

DC Circuit Protection

As part of the direct current circuitry, depending on the make and model engine you chose, will have either in line fuses or a fuse box for its electrical components. These fuses protect the engine wiring from overloads. Refer to the engine manufacturer's manual for the fuse locations, sizes, and operations.

Systems

A dash fuse box protects the individual switch controlled components and is located in the starboard bow storage locker.

The ignition panel is protected by a 20 amp breaker mounted to the panel itself. All gauges and helm electrical systems like the head radio unit are protected by a dashboard protection fuse located underneath the dash connected to the ignition switch. Your fusion stereo is also protected by a fusion installed stereo memory fuse located underneath the dash along the radio wiring, in addition to the Regal provided stereo memory fuse in the engine compartment near the battery switch. Additionally, there is an automatic bilge pump fuse located next to the battery switch in the engine compartment.

If the fuses “blow” or breakers “pop” due to an overload, the cause should be investigated before replacing the fuse or resetting the breaker. Only replace fuses with the same amperage and type. In emergency situations, fuses installed in the fuse block for features that are not used on your model can be used as replacements when appropriately sized for the fuse your are replacing, but be careful of electrical shock when removing or replacing a fuse.

FUNCTION	AMPS	TYPE	PLACE
Accessory 1 (If Included)	15	Fuse	Dash Fuse Box
Accessory 2 (Not Available)	15	Fuse	Dash Fuse Box
Bilge Pump Manual	7.5	Fuse	Dash Fuse Box
Bilge Pump Automatic	10	Fuse	Engine Compartment
Blower	10	Fuse	Dash Fuse Box
Cabin Lights (Not Available)	5	Fuse	Dash Fuse Box

Chapter 4

FUNCTION	AMPS	TYPE	PLACE
Cockpit Lights	10	Fuse	Dash Fuse Box
CO Monitor (Not Available)	2	Fuse	Dash Fuse Box
Dashboard Protection Fuse	10	Fuse	Underneath Dash
Docking Lights (Not Available)	15	Fuse	Dash Fuse Box
Fresh Water (Not Available)	7.5	Fuse	Dash Fuse Box
Garmin (Not Available)	10	Fuse	Dash Fuse Box
Horn	10	Fuse	Dash Fuse Box
Ignition Breaker	20	Breaker	Ignition Panel
Navigation / Anchor Lights	10	Fuse	Dash Fuse Box
Stereo Memory Fusion Feed	15	Fuse	Underneath Dash
Stereo Memory Main Feed	15	Fuse	Engine Compartment
Stereo Performance (Optional)	30	Breaker / Fuse	Engine Compartment
Wiper (Not Available)	10	Fuse	Dash Fuse Box
12 Volt Accessory	15	Fuse	Dash Fuse Box

Typical Fuse Listings

Transducer

Your transducer is the device mounted on the hull bottom that sends out sonar signals that rebound upon hitting the bottom of a lake or ocean. These signals are measured, and converted into a usable depth measurement displayed by the depth gauge at the helm. This system does not register signal deflections due to fish. Access the transducer for removal via an access plate in the ski locker. Note that the transducer is a sealed, non-serviceable unit.

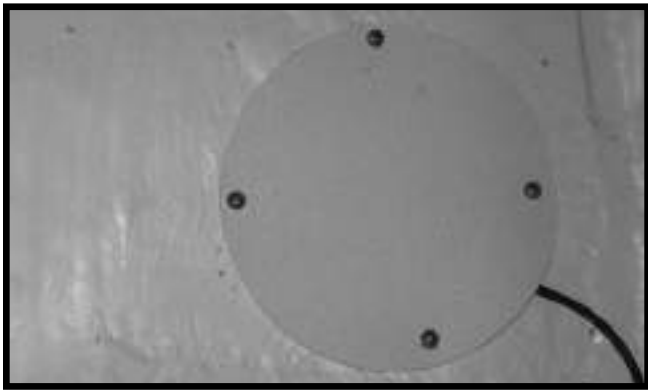

Transducer Access Plate

Battery Switch

All of your electrical systems onboard your Regal eventually connect with your battery. This is where electrical power originates. In order for any electrical systems to receive power, with the exception of your automatic bilge pump function and stereo memory require the battery switch to be turned “ON”. The two excluded systems have a direct battery feed a tall times without the use of the battery switch. The battery switch connects the battery to all deck and engine circuitry. It is important to turn your battery “ON” before each trip, and “OFF” at the end of each trip to avoid battery drain. Your battery switch is normally located in the engine compartment.



Notes

Vessel Operation

This chapter explores the many facets of running your vessel from casting off to docking. We cover the basics, but suggest you read other information on the chapter topics. Also, become familiar with your engine owner's manual, since many of the items discussed are found there in more detail.

GETTING UNDERWAY

Pre-Departure Questionnaire_____

- Have all engine / stern drive fluid levels been topped off?
- Is the fuel tank full?
- Is all safety equipment accounted for and easily accessible?
- Are navigation lights and horn in good working condition?
- Is the bilge free of water and does the bilge pump operate?
- Is the engine, out drive, and propeller in good working condition?
- Is the drain plug in place (dry stored vessels)?

Chapter 5

- Have all passengers been briefed on emergency procedures and seated for departure? Is the boat load balanced?
- Is the operator sober, alert, and ready to skipper the vessel?
- Have all passengers been fitted for life jackets?
- Has a float plan been filed and left with a competent person?
- Has the bilge been sniffed and the fuel system leak checked?
- Are the sea cocks open (if applicable)?
- Are all communication tools in good operating condition?
- Has a second person been briefed on operational procedures should the skipper become disabled?
- Are all gauges and electrical switches functional?
- Has weather information been gathered and analyzed?

Underway Questionnaire _____

- After casting off have all dock lines and fenders been stowed?
- Are all passengers seated and all transom doors closed?
- As skipper are you monitoring the dash gauges for changes?

Vessel Operation

- As skipper, are you on the lookout for changing weather?
- As skipper, are you checking for abnormal vibration or steering?
- Is the remote control safety lanyard (if equipped) tightly secured to your belt or clothing?

Disembarking Questionnaire_____

- Have you removed the keys from the ignition and secured them?
- Have all systems been checked for leaks?
- Has the battery switch been turned to the “off” position?
- Are all hatches and portholes secured and sea cocks closed?
- Has the fuel tank been filled enough to prevent condensation?
- Is the vessel properly tied and covered with equipment stored?

Chapter 5

FUELING



WARNING

AVOID PERSONAL INJURY OR DEATH! GASOLINE IS A HIGHLY FLAMMABLE AND EXPLOSIVE MATERIAL. PRACTICE “NO SMOKING” AND EXTINGUISH ALL FLAMMABLE MATERIALS WITHIN 75 FEET OF THE FUEL DOCK.

No Flames Near Fuel Warning



WARNING

AVOID SERIOUS INJURY OR DEATH FROM LEAKING FUEL RESULTING IN AN EXPLOSION OR FIRE. INSPECT THE ENTIRE FUEL SYSTEM AT LEAST ONCE A YEAR.

Check Fuel System Warning



CAUTION

SINCE GASOLINE IS AVAILABLE IN VARIOUS OCTANE LEVELS, REFER TO THE ENGINE OWNER’S MANUAL FOR THE CORRECT RATING FOR YOUR ENGINE. USING IMPROPER FUEL CAN CAUSE ENGINE DAMAGE AND VOID THE WARRANTY.

Improper Fuel Caution

Vessel Operation



Fuel Fill Fitting

Before Fueling

- Make sure a working fire extinguisher is close at hand
- Stop engines and any device that can cause a spark.
- Disembark all passengers and crew not needed for fueling.
- Fuel if possible during the daylight hours.
- Check to ensure nobody is smoking in the boat or near the fueling dock.
- Close all portholes, hatches, and doors to keep vapors from blowing aboard and settling in the bilge.

Chapter 5

- Tie up your boat securely at the fuel dock.
- Identify the fuel fill. Unfortunately, people have mistakenly filled the water or waste with fuel.
- Visually inspect all fuel system components before each filling
- Avoid using fuels with alcohol additives. They can attack fuel system hoses and cause deterioration.

During Fueling

- Keep the fuel nozzle in contact with the fuel fill to guard against static sparks. The fuel fill pipe is grounded through the fuel system wiring to protect against static electricity..
- Avoid overfilling the fuel tank. Leave room for expansion. Also, if fuel exits the fuel vent, this indicates a full tank. Fuel spilling out onto the water is dangerous and unfriendly to the environment.
- Avoid spilling any fuel. Clean up any fuel accidentally spilled with a clean rag and dispose of it onshore.

After Fueling

- Close all fuel fill openings tightly. use a fuel key if needed.
- Open all portholes, hatches, and doors.
- Energize the blower for a minimum of 4 minutes before getting underway.

Vessel Operation

- Sniff in the lower bilge and engine compartment for gas fumes. If fumes are detected, continue to ventilate until the odor is gone. Look for any traces of fuel droplets or spillage. **Do not start the engines, smoke, or run any electrical components until the fumes can no longer be detected.**



WARNING

AVOID SERIOUS INJURY OR DEATH! THE OPERATOR OF THE CRAFT MUST HAVE COMPLETE CONTROL OF THE HELM STEERING STATION WHILE THE VESSEL IS MOVING. NEVER LEAVE THE HELM STATION UNATTENDED WHILE THE VESSEL IS MOVING.

Captain Must Keep Control Of The Helm Warning

STARTING, SHIFTING, STOPPING

The following general information covers starting & stopping your engine. Read and understand all information on your engine, control systems, and other systems including fueling and operational procedures. Pay particular attention to all labels. Refer to the engine owner's manual for in depth propulsion and system information.

Starting Guidelines

Review all pre-departure information. Before starting your engine, make sure all canvas is removed and stored. Be sure your vessel is in a well ventilated location to avoid carbon monoxide build-up.

- 1) Turn the battery switch to the "on" position.

Chapter 5

- 2) Position the binnacle control lever in the neutral position.
- 3) Connect the safety lanyard to the cut off switch, and fasten it to a belt or article of clothing such as a belt loop, and turn the switch to the run position.
- 4) Turn the ignition key to the momentary start position. You will hear the starter cranking over the engine. When the engine starts, release the key switch. It will automatically align itself in the run position.
- 5) If the engine does not start, refrain from cranking the engine over 10-12 seconds. Allow the starter and battery a chance to recover, and try again. If it continues not to start, investigate the problem as described in the troubleshooting section of your engine owner's manual.



CAUTION

TO AVOID ENGINE DAMAGE, CHECK OIL GAUGE IMMEDIATELY AFTER STARTING. IF LOW OR NO READING APPEARS, SHUT DOWN ENGINE IMMEDIATELY AND INVESTIGATE THE PROBLEM.

Check Engine Oil Caution

Shifting Guidelines

Before shifting into reverse or forward, make sure the coast is clear. When shifting to either gear from neutral, make sure the throttle is in the idle position. Do not pause, but engage the shifter quickly into the desired gear. Utilize the neutral release button to release the detention system on the binnacle as you shift gears from neutral.

Vessel Operation

Shifting the control lever forward to the 11 o'clock position engages forward gear, in which throttle can be adjusted until the 9 o'clock position. Shifting the control lever backward to the 1 o'clock position engages reverse, in which the throttle can be controlled through the 3 o'clock position.

Practice shifting! You will become more familiar with the procedure and self-confidence will build especially in tight docking situations. Most importantly, stay alert!

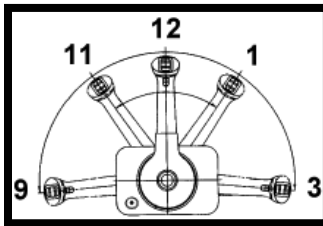

Typical Control Lever Showing Five Positions

Stopping

Remember to never turn off the engine while in forward or reverse gear, since water could enter the engine through the exhaust system and cause extensive damage.

- 1) After an outing, let the engine cool down at idle speeds for a few minutes before turning the ignition off.
- 2) Before turning the ignition off, glance at the gauges one last time to monitor their readings. **DO NOT** pull on the safety lanyard verses using the ignition switch to stop the engine.
- 3) Rotate the ignition key to the off position and remove the key.

Chapter 5

STERN DRIVE MANEUVERING

Inboard/outboard, I/O, or sometimes called stern drive boats do not feature conventional rudders. The boat uses a steering system that directs the propeller thrust by turning the stern drive unit where the propeller is mounted.

Directing propeller energy (thrust) makes slower speed maneuvering easier. The propeller discharge current is turned from one side to the other which results in turning forces. Rudder boats need water to flow by the rudder to be efficient. Stern drive units are designed to have reduced shaft angle, so the propeller does not produce as much unequal blade thrust and resistance as does a propeller on a rudder equipped boat. Large horsepower stern drive boats do produce more thrust and steering torque but Regal boats have the advantage of power steering.

Boats do not handle like automobiles do. Where a car would turn about its front wheels, a boat turns about its center of gravity. This effect is most pronounced when on plane where friction is particularly reduced. There is no substitute for hands on experience practicing steering both at low and high speeds in a variety of current, wind, and weather conditions. But below is some basic information on how single stern drive boats handle in normal conditions.

Prop Walk

The factory equipped propeller on your Regal is right handed and rotates clockwise as viewed from the stern when in forward gear. So as it turns, because of its screw like shape, not only is it pushing water backward, but also to the port side. Blades in shallower water provide less propulsion force than blades in deeper water. This uneven propulsion is known as prop walk, as it tends to push your stern in an

Vessel Operation

unwanted direction. It is a normal occurrence, but the effect can be managed with trim tabs on the stern drive.

On your stern drive, there is a trim tab (also serves as a sacrificial anode). This trim tab in essence puts a little more drag to the starboard side of your boat. As water pushes past this trim tab, pressure is applied to it, and it will counteract prop walk by torquing the stern back into place. This trim tab can be adjusted, and should be checked annually and adjusted as necessary, unless an underwater obstacle has been hit. This trim tab best counteracts prop walk at higher speeds because the force of the water hitting the tab would increase, providing a greater force to counteract prop walk.

Because your trim tab on the stern drive is meant to counteract prop walk when moving forward at high speeds, moving at slow speeds, or in reverse at any speed will present noticeable prop walk. This is best handled by slightly turning the steering wheel to starboard. Learning to adjust steering for prop walk is an acquired skill that is affected by both wind and current conditions.

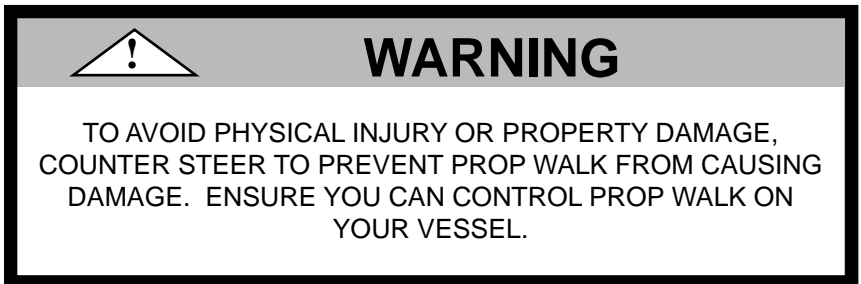

Prop Walk Warning

Chapter 5

Gathering Headway

When a stern drive is not moving forward or reverse in the water and the propeller is not turning (shift in neutral), the boat will not react to the helm steering wheel. As soon as the vessel is shifted into forward gear, the propellers action creates a discharge motion and generates energy in the form of thrust. If the stern drive is centered, the discharge motion is directed straight back causing the vessel to advance forward. You may notice prop walk to starboard during initial take off or when quickly opening the throttle. This is because the trim tab on the stern drive isn't receiving the fast water flow it needs to counteract this effect. Simply turn your steering wheel to counter the prop walk.

When gathering headway, the bow will lead any movement of the boat before the vessel actually starts turning. Remember, there is no replacement for hands on experience.

Turning

Once the helm wheel is turned to the right or starboard, the stern drive unit is turned in the same direction. This redirects the thrust to starboard, forcing the stern to port. Water pushing past the hull now strikes the drive's broadside, and acting like a rudder, also aids in turning the boat to starboard. As the stern is directed to port, the bow is forced to starboard. Similarly, if the helm is turned to the left or port, the stern drive turns to port, and the stern of the boat goes to starboard. This therefore directs the bow to port.

Remember boats turn about their center of gravity. To completely make a turn, a wide berth is needed, and the radius of the turn will depend on a variety of factors such as hull shape and speed. At slow speeds there appears to be a delay between turning the helm wheel,

Vessel Operation

and the act of pushing the bow to the appropriate direction. At greater speeds, even the slightest movement at the helm will result in quick reaction by the boat. As the vessel operator gains experience, he/she will better gauge each maneuver and speed situation. There is no substitute for actual experience driving a vessel, and the skipper should always keep that in mind while keeping the safety of himself and his passengers in the highest priority.

Backing Down

Inboard-outboard (I/O) boats do not feature conventional rudders. The boat uses a steering system that directs the propeller thrust by turning the stern drive unit where the propeller is mounted. If your boat has the steering wheel and stern drive straight while in reverse, not only will you put your thrust forward, thus directing the boat backwards, but due to prop walk, you may feel the stern being pushed to port by the reversing propeller thrust. This tendency to back to port can be eliminated by turning the stern drive to starboard.

Usually once a vessel begins to gather speed to stern, water passing by the drive will continue to increase steering torque, and movements will begin to seem more dramatic. When in reverse, turning the helm wheel to starboard will direct propeller thrust to port, tracking the stern to starboard. When backing to port, the helm wheel must be turned to port. Also, prop walk is normally more pronounced in reverse, and steering should be adjusted accordingly.

Remember a boat turns about its center of gravity. The stern of your boat when going in reverse will lead before the vessel actually starts to turn. Nothing can replace hands on experience.

Chapter 5

Stopping

Remember that your boat does not have any brakes. It uses reverse thrust from the propeller to stop. Remember that once headway is gathered, water is flowing past the drive in a set direction. Reversing this flow to slow down will take some time. As power to the propeller is increased, the propeller thrust becomes stronger and will reverse the flow of water past the drive more completely.

At the instant between slowing down and reversing, there is a time when there is no thrust delivered by the propeller. At this short lived instant, the boat will not respond to the helm's steering maneuvers, as the boat is essentially in neutral with no thrust being provided. Steering will begin to work again once water flows past the drive. Don't forget that once the boat starts moving in reverse, prop walk will become more apparent. This is why experienced skippers undertake a port side landing when wind and current conditions permit.

Experience is crucial to determining stopping distances and direction under different current and wind conditions. Practice stopping so that you can safely operate your boat under all boating conditions.

Vessel Operation

TRIM ANGLE

Stern drive boats have the ability to angle in or out their stern drive unit in relationship to the transom. This is accomplished by hydraulic cylinders located on the out drive along with an electrical sender unit that reads the drive angle and relays the information to the dash trim gauge.

Purpose Of Power Trim_____

The purpose of the power trim/tilt is to enable the operator to change the angle of the drive while at the helm. Changing the angle of the drive, or “trimming”, provides the following benefits:

- Improves acceleration onto a plane.
- Maintains boat on plane at reduced throttle settings.
- Increased fuel economy.
- Provides smoother ride in choppy water.
- Increases top speed.

In short, your trim angle is a way of fine-tuning the ride of your boat and will enable you to get the most efficient and comfortable ride possible, whatever the conditions.

Chapter 5



CAUTION

THE BOAT TRIM SHOULD BE ADJUSTED TO PROVIDE BALANCED STEERING AS SOON AS POSSIBLE EACH TIME YOU GET UNDERWAY. SOME BOAT / ENGINE / PROPELLER COMBINATIONS MAY CREATE BOAT INSTABILITY AND / OR HIGH STEERING TORQUE WHEN OPERATED AT OR NEAR THE LIMITS OF THE “BOW UP” OR “BOW DOWN” POSITIONS. BOAT STABILITY AND STEERING TORQUE CAN ALSO VARY DUE TO CHANGING WATER CONDITIONS. IF YOU EXPERIENCE ABNORMAL BOAT INSTABILITY AND / OR HIGH STEERING TORQUE, SEE YOUR AUTHORIZED REGAL DEALER.

Trim Adjustment Caution

Use Of Power Trim

The power trim is normally used prior to accelerating onto a plane, after reaching the desired RPM or boat speed and when there is a change in water or boating conditions. Position passengers and equipment in the boat so that the weight is balanced correctly fore and aft as well as side to side. Trimming will not compensate for an unbalanced load.

Your power trim is operated by a switch on the binnacle control lever. Set the power trim to the full down position before accelerating onto a plane. To operate the trim, push the trim switch up until the desired bow position is reached. The trim may be operated at any boat speed or at rest. Avoid operating the trim system when running in reverse. Observe the trim/tilt gauge on the dash, which indicates the boats bow position achieved by the trim angle of the drive unit. “Bow Up”, corresponds to the upper portion of the trim range on the gauge while “Bow Down” corresponds to the lower portion of the trim range on the gauge.

Vessel Operation

To determine the proper trim angle, experiment a little until you are familiar with the changes in your boat. The vessel will be properly trimmed when the trim angle provides the best boat performance for the particular operating conditions. A trim position that provides a balanced steering load is desirable.

To familiarize yourself with the power trim, make test runs at slower speeds and at various trim positions to see the effect of trimming. Note the time it takes for the boat to plane. Watch the tachometer and speedometer readings as well as the ride action of the boat.

Operation In “Bow Up” Position_____

The “bow up” or “out” position is normally used for cruising, running with a choppy wave condition, or running at full speed. Excessive “bow up” trim will cause propeller ventilation resulting in propeller slippage. Use caution when operating in rough water or crossing another boat’s wake. Excessive “bow up” trim may result in the boat’s bow rising rapidly, creating a hazardous condition.

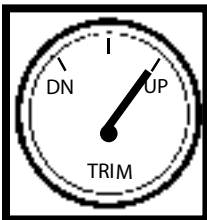

Trim Up Gauge

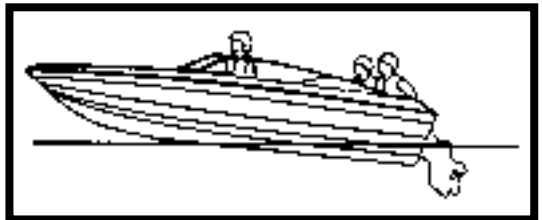

Boat In “Bow Up” Position

Chapter 5

Operation In “Bow Down” Position _____

The “bow down” or “in” position is normally used for acceleration onto a plane, operating at slow planning speeds, and running against a choppy wave condition. It is also used when pulling water skiers, tubers, knee boarders, etc. The boat’s bow will want to go deeper into the water in this position. If the boat is operated at high speed and/or against high waves, the bow of the boat will plow into the water.

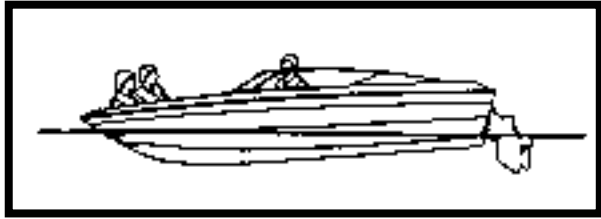
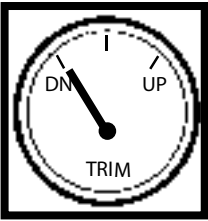

Trim Down Gauge

Boat In “Bow Down” Position

Operation In “Level” Position _____

In normal running conditions, distribute passengers and gear so the boat is level. At or below cruising speeds, trim the vessel for optimum performance. The trim gauge will normally indicate a near center mark. This position will also enhance running visibility and overall stability. Again, each outing provides different wave, load, and running conditions. Be prepared to make trim adjustments as needed.

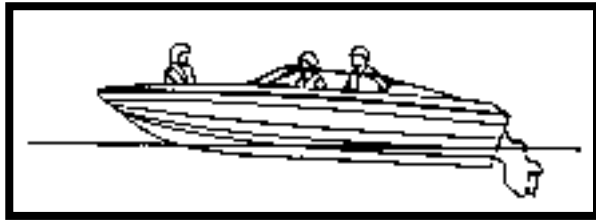
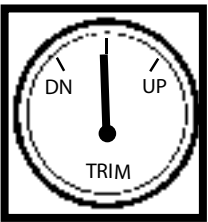

Trim Level Gauge

Boat In “Level” Position

Vessel Operation

Shallow Water Operation _____

Operating your vessel in shallow water presents various hazards. You are more apt to hit a submerged object such as a rock, sand bar, stump, coral, or other unmarked objects. Pay close attention to your charts for descriptions of any shallow areas, along with navigational markers on the water. Always post a lookout when operating in shallow water. Trim your stern drive up as needed to provide adequate draft, and get to a level plane position in accordance with your speed. Set the alarm on your depth sounder and travel at a speed that keeps the boat on plane as much as possible in these shallow areas.

If your boat strikes a submerged object, stop immediately, and check for hull, sterndrive, and propeller for damage.

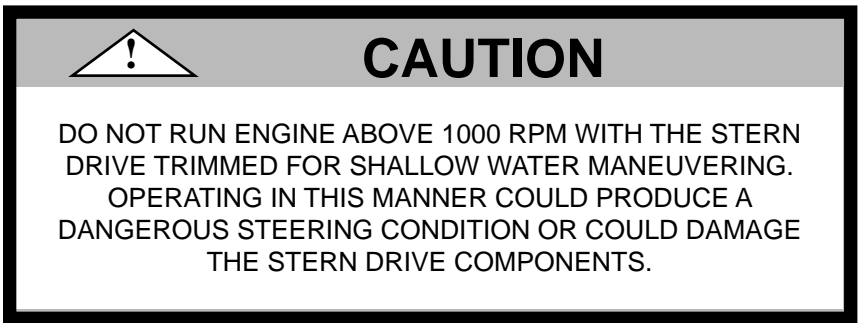

Trim And Engine Speed Caution

Chapter 5

FENDERS

Fender Usage

Fenders are normally made of a rubberized plastic and are usually filled with air. Most have a fitting like a basketball, so they can be inflated or deflated. Fenders are available in a wide range of sizes and shapes to fit both small and large vessels. Fenders are normally designated in inches. They are used between piers, docks, sea walls, tugboats, and your vessel. They protect the topsides of the boat from rubbing against rough objects. Most fenders have eyes of attachment which allow a line to be tied off to fit a variety of marina, dock, and tidal situations. Be sure the fender is correct for the vessel size. It is a good idea to carry extra fenders, but half a dozen is normally an acceptable number. Remember to store fenders on board so they can be easily accessed.

Fender Types

There is a variety of fender styles and types, each selected for specified uses. When choosing fenders, contact a marine dealer or supply house. Explain how you moor and use your vessel so they can recommend the best fender type for you. We suggest the type with a fill plug so you can inflate them with a hand pump like the ones used for bicycles.



Typical Boat Fenders

Vessel Operation

DOCK LINE BASICS

Most skippers use dock line terminology fairly loose, but there is more to the basics than just bow or stern lines. There are several lines that can be secured to the bow and stern and depending on their direction and use can be called other names. Remember that “forward” and “aft” refer to the direction that a spring line runs from the vessel, and not where it is secured on board.

Bow & Stern Lines

There is only one true bow line. It is secured to the forward cleat and runs forward along the dock to prevent the vessel from moving to the stern. The stern line leads from a rear cleat to a piling or cleat on the dock astern of the vessel. This line keeps the boat from moving forward.

For small vessels, these are typically the only lines needed for normal wind and current conditions. If located in a tidal environment, keep slack in the lines.

Spring Lines

Most small boats use the two spring lines, although it is possible to have four.

They are called the forward spring and aft spring lines. Forward spring lines are typically tied to the stern cleats and attach to a forward piling or cleat along the dock. These lines prevent movement aft. Aft spring lines are typically tied to bow cleats and run to an aft cleat on the dock to prevent movement astern.

Chapter 5

Boat Mooring

Most boats can be secured to a dock using four lines. The bow and aft spring lines cross over each other and are secured to individual dock cleats or pilings. This ensures longer springs.

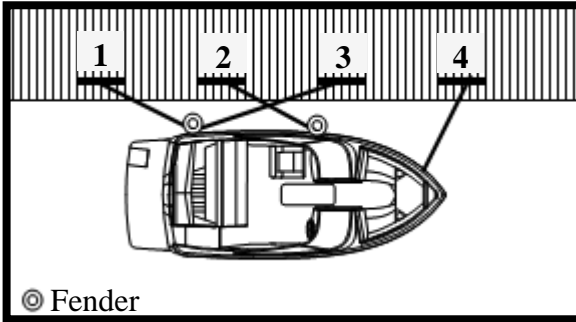

Typical Mooring Diagram

- | | |
|--------------------|------------------------|
| 1) Stern Line | 3) Forward Spring Line |
| 2) Aft Spring Line | 4) Bow Line |

Dock Line Sizing

Most dock lines today are made of nylon, either of twisted rope or braided core and cover. The most often used material is nylon because of its stretching abilities, absorbing shock loads. It is chafe resistant for extended life periods, and is easier on bare hands.

The line's size varies with the vessel. Normally a vessel in the 20' to 40' range will use 1/2" diameter nylon lines, while larger yachts would use 5/8" to 3/4" diameter nylon lines. Boats smaller than 20' can often get away with 3/8" nylon lines. Dock lines need to have the strength to hold the vessel and have enough density to resist chafing. They shouldn't be so heavy as to lose their shock absorbing capabilities.

Vessel Operation

Use the right line for your vessel, since a line too large will pull hard against the vessel rather than stretch and ease the vessel into place, and lines too small will wear and chafe under strain.

Securing Lines

When mooring your boat, make sure the dock lines are secured at both ends. Depending on your situation, you may need to loop the eye splice of the dock line around a piling to ensure it doesn't come off with weather or tide conditions. Loop the eye splice around piling twice to keep it from being pulled up off the pile. If your line is too small to loop around twice, consider wrapping the line around the piling and inserting the tail end of the line through the eye splice, and pulling tight before attaching the tail end to your boat.

If you must drop a line over a piling that already holds another boat's line, run the eye of the line up through the first eye of the other boat's line, before dropping your eye splice over the piling. This will allow either line to be removed without disturbing the other.

Chapter 5

STERN DRIVE DOCKING

Inboard/outboard powered boats are fairly easy to back up and maneuver with a little knowledge and docking practice. One of the most important aspects of the process is to keep your calm in the wake of a busy marina. Basically the reversing propeller is turned in the direction you want to go by using the helm wheel.

Some boats tend to be influenced by the wind. When backing down in a cross wind, allow room to maneuver and watch the bow. If the wind begins to swing the bow, you need to stop backing, turn the wheel to straighten out the boat, while using a quick burst of throttle.

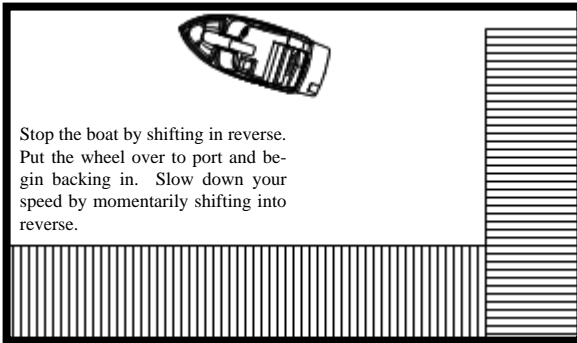

Docking Step One

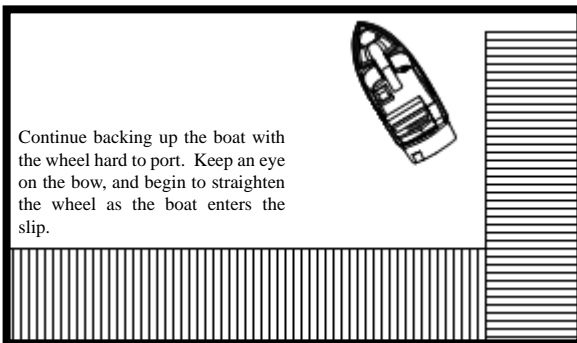

Docking Step Two

Vessel Operation

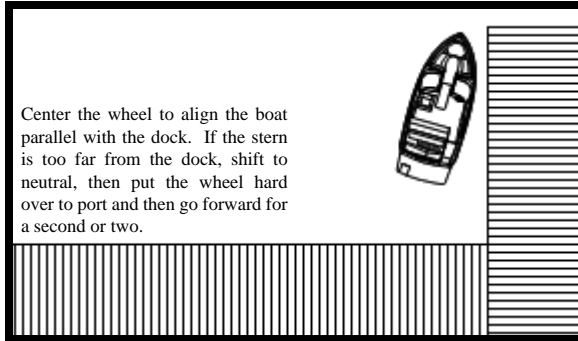

Docking Step Three

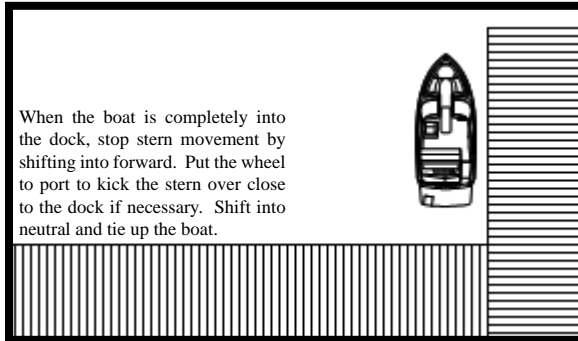

Docking Step Four

Chapter 5

ANCHORING

Selecting the correct anchor is an important decision. For most anchors to perform more efficiently, you should attach 3 to 6 feet of chain to the anchor. The chain will stand up to the abrasion of sand, rock, or mud on the bottom much better than a nylon line. It should be galvanized to reduce corrosion. Attach a length of nylon line to the other end of the chain. The nylon will stretch under a heavy strain, cushioning the impact of waves or wind on both the boat and the anchor. The anchor style in part depends on boat usage and type.

To anchor, select a well protected area, preferably with a flat bottom. Contrary to modern belief, you do not throw the anchor over while the boat is making headway, or moving forward. In fact, the bow of the boat should be brought slowly backward, while easing the anchor slowly over the side of the boat until it hits the bottom. To “snub the line” means to stop its outward “pay” or movement. Usually the length of anchor line used should be 5 to 10 times the depth of the water. To attach an anchor to your boat, the rode must be attached to one of the deck cleats.

After you have anchored, check your position with landmarks if possible. Continue to monitor these landmarks to make sure you are not drifting. Since anchoring can also be an emergency procedure, the anchor and line should be readily accessible.

For increased holding power in windy conditions, two anchors are sometimes set. If your primary anchor drags, you can run out your secondary anchor without picking up the primary one. The important thing is to lay them out at an angle. When setting two anchors, make sure they are fastened to separate cleats. Setting up two anchors using an in-line pattern (one at bow and one at stern) is best for tight anchoring situations, while a v-shaped pattern (two anchors at an angle at the bow) is best used in a changing wind or current condition.

Vessel Operation

TOWING

In case you find yourself aground or in need of a tow, or should you want to tow another vessel, keep in mind that you **NEVER** use deck hardware or cleats to secure lines for towing!

Deck hardware is intended for mooring and anchoring, and is not designed to withstand the strain and pull of towing. Rather than tie the line to your cleats on deck, it is suggested that you tie a bridle by passing a line completely around the hull of your boat to avoid structural damage.

When towing, always stand clear of a taut line, as any type of line breaking under stress can be extremely dangerous. The preferred line for towing is double-braided nylon, as it has sufficient elasticity to cushion shock loads. Move slowly and cautiously.

	DANGER
AVOID DEATH OR SERIOUS BODILY INJURY! DO NOT USE DECK HARDWARE INCLUDING CLEATS FOR TOWING. THESE MAY BREAK OFF DUE TO ABNORMAL LOADS.	

Towing Danger

Chapter 5

KNOTS

Knots are useful in docking, towing, and other emergency situations. Learning to tie knots requires practice. As they say, “Practice makes perfect”. Some of the knots used in boating are the square, bowline, anchor bend, clove hitch, figure eight, and half hitch. There are several periodicals available that explain various knots and how to tie them effectively, often available at marinas and boat shops. An experienced skipper will know the basic nautical knots and will use them when on the water. Take time to know the basic knots.



Figure Eight Knot Tie To Cleat

A useful knot to learn for general docking is the figure eight with one end reversed. By turning the free end of the line back under the knot, the knot can be released without disturbing the boat. After a bit of practice, a person can secure a vessel easily to a dock or pier in a variety of weather conditions. This knot normally is used to tie the bow and stern. Then the vessel can further be fastened by tying the spring lines in the figure eight knot. Wrap it around the cleat two or three times.

Vessel Operation

ENVIRONMENTAL AWARENESS

There are numerous vessels operating on our waterways on a daily basis. Every boat has an impact on our environment. Boat operation habits, marine sanitation, and maintenance all play a role in a delicate battle to keep the ecosystem clean. Each of us has a role in doing our part as an environmentally conscious skipper to conserve our waterways.

- Observe all regulatory agency policies regarding marine toilets.
- If equipped with a holding tank, use marina pump-out facilities.
- If used, make sure bottom paints are legal and ecosystem friendly.
- Use only biodegradable cleaning agents.
- Dispose of all garbage and litter on shore properly.
- Don't top off fuel tanks. Leave expansion room. Clean up spills.
- Watch your wake and propeller wash.
- Make sure your engines are well tuned and maintained.
- Control your bilge water.
- When fishing, practice the "catch and release" principle.

Chapter 5

CALIFORNIA AIR RESOURCE BOARD (CARB LABEL

Your Regal boat may have a star shaped label affixed to the bow, port hull side. It is located in the area in front, where normally the state registration numbers are positioned. This label is part of the California Air Resource Board (CARB) SD/I rule. If your boat is operated in the state of California and / or bordering waters, this label **MUST** remain intact. The label shows that the engine installed as original equipment meets a currently approved California state regulatory emission level. See the example below which shows the current California ultra low three star label.



California CARB Label

Vessel Operation

CALIFORNIA PROPOSITION 65

Proposition 65 relates to the state of California and is an additional requirement added to their Safe Drinking & Toxic Enforcement Act of 1986. Prop 65 basically summarized states that:

“No person in the course of doing business shall knowingly discharge or release a chemical known to the state to cause cancer or reproductive toxicity into water or onto land where such chemical passes or probably will pass into any source of drinking water...” and it goes on to say “no person in the course of doing business shall knowingly and intentionally expose any individual to a chemical known to the state to cause cancer or reproductive toxicity without first giving clear and reasonable warning to such individual...”

For more information contact the California Office of Environmental Health Hazard Assessment at 916-445-6900.

DANGER

A WIDE VARIETY OF COMPONENTS USED ON THIS VESSEL CONTAIN OR EMIT CHEMICALS KNOWN TO THE STATE OF CALIFORNIA TO CAUSE BIRTH DEFECTS AND OTHER REPRODUCTIVE HARM.

EXAMPLES INCLUDE:

- ENGINE AND GENERATOR FUEL, EXHAUST, COOLANTS, AND OIL.
- CLEANERS, PAINTS, SUBSTANCES USED FOR VESSEL REPAIR.
- WASTE MATERIALS THAT RESULT FROM WEAR OF VESSEL COMPONENTS.
- LEAD FROM BATTERY TERMINALS

TO AVOID HARM:

- KEEP AWAY FROM ENGINE, GENERATOR, AND EXHAUST FUMES.
 - WASH AREAS THOROUGHLY WITH SOAP AND WATER AFTER HANDLING THE SUBSTANCES ABOVE.

Harmful Substances Warning

Chapter 5

FUEL SPILLAGE

The Federal Water Pollution Control Act prohibits the discharge of oil or oil waste (such as from the sump bilge pump) into or upon the navigable waters of the United States or the waters of the contiguous zone. Violators are subject to substantial civil fines and criminal sanctions. A placard is normally found inside the engine hatch area or in the sump (bilge) warning of overboard discharge of oil or oily waste.

Your Regal comes equipped with a bulkhead to hold back fuel in case of a fuel tank leak or in the event of fuel tank drainage. **DO NOT** remove the drain plug along the fuel tank bulkhead between the fuel tank and the engine compartment to allow fuel to flow to the bilge pump if the fuel will discharge out the starboard through hull into the navigable waters of the United States.

Equipment Operation

This chapter assists the operator in understanding many of the standard equipment items on the vessel. Some of the equipment described may not be installed on your boat or the pictorials may not exactly resemble equipment on your boat. Remember, Regal is constantly improving its product line and therefore may make changes in parts and specifications without notice. For detailed information on equipment, please refer to the owner's pouch.

AFTERMARKET ACCESSORIES

Aftermarket equipment can be controlled via accessory switches at the dash. Due to the selection of electronic options like a PowerTower, docking lights, and underwater lights, your accessory switches may control a variety of optional systems. You may elect to have non-factory based accessories installed on your vessel. Ensure that your equipment is installed by a licensed marine professional and that it will not jeopardize the safety of your vessel. Don't forget to install the appropriate gauge wire and fuse for your aftermarket products. **REGAL IS NOT RESPONSIBLE FOR PROBLEMS CAUSED BY AFTERMARKET INSTALLATIONS.**

Chapter 6

AUTOMATIC FIRE EXTINGUISHER

Optional Automatic Fire Extinguisher_____

The automatic fire extinguisher is mounted in the engine compartment. It uses sensors to automatically discharge when a fire occurs, although it can be manually discharged. Upon actuation, you may hear a sound similar to that of a small firearm, followed by a rushing air sound. A charged system shows a light at the dash indicator, while a discharged system shows no light at the indicator - refill accordingly.

Automatic activation will occur at different times depending on the severity of the fire picked up by sensors. **WHEN THE FIRE EXTINGUISHER IS ACTIVATED, IMMEDIATELY SHUT DOWN ALL ENGINES, POWERED VENTILATION (BLOWER), ELECTRICAL SYSTEMS, AND EXTINGUISH ALL SMOKING MATERIALS. DO NOT OPEN THE ENGINE COMPARTMENT UNTIL A SUITABLE AMOUNT OF TIME HAS PASSED SINCE THE EXTINGUISHER STOPPED DISCHARGING.** Opening the engine compartment prematurely may cause a reflash as air is allowed to fill the engine compartment. When opening the engine compartment door, have a hand-held extinguisher ready in case of reflash. Be cautious of hot metal when investigating the cause of the fire.

If a fire has started in the engine compartment, **DO NOT** wait for the automatic fire extinguisher system to kick in. Locate the fire extinguisher manual discharge lever after closing the engine compartment, and turning off the blower and electronic equipment. Remove the safety pin from the "T" handle, and pull firmly to release.

Equipment Operations

For safety information, refer to your fire extinguisher label. General safety requirements are described in the safety on board chapter of this manual. For system information, refer to the systems chapter of this manual. Maintenance requirements are described in the maintenance chapter of this manual.



WARNING

AVOID SERIOUS INJURY OR DEATH! DO NOT BREATHE FUMES OR VAPORS CAUSED BY AN EXTINGUISHING AGENT. VAPORS ARE HAZARDOUS AND TOXIC.

Fire Extinguisher Warning



Typical Dashboard Automatic Extinguishing System Light



Typical Mounted Automatic Fire Extinguisher



Typical Manual Discharge Pin For Automatic Fire Extinguisher

Chapter 6

BATTERY SWITCH

Standard Battery Switch

Your Regal uses an “ON” and “OFF” position battery switch located in the engine compartment that not only provides power for the engine, but runs all the features on your boat. With this style switch, the operator simply turns the knob to the “on” position before starting the engine and to the “off” position when exiting the boat. Make sure the knob is fully detented when selecting the “on” or “off” functions. The location of the battery switch is on the starboard side of the engine compartment. Remember to deactivate the battery switch upon leaving the vessel.

Refer to the systems chapter for information on what systems this switch controls. Refer to the vessel operation chapter for pre-departure use.



WARNING

AVOID DAMAGE TO THE ALTERNATOR AND/OR CHARGING SYSTEM COMPONENTS. NEVER TURN THE BATTERY SWITCH TO THE “OFF” POSITION WHILE THE ENGINE IS RUNNING.

Battery Switch Warning



Typical Two Position Battery Switch

Equipment Operations

BILGE PUMP

Before each outing, check the operation of the bilge pump, automatic switch, and manual switch. The bilge pump should automatically activate when water reaches a pre-determined height in the engine compartment. Test the bilge pump manually at the dashboard with the switch. Periodically check for bilge debris around the grates of both the bilge pump and automatic switch, and also bilge pump impeller.

The automatic mode for your bilge pump works similarly to the manual method. Both methods control the bilge pump by a switch, but the automatic mode utilizes a float switch. Float switches have a float that sits at water level, and when the float reaches a certain height, it trips the switch and activates the bilge pump.

You may need to disassemble the bilge pump from the grate in order to clean or access the inner mechanisms. To remove the bilge pump, utilize the quick disconnect tabs on either side of the bilge pump, squeezing them like a backpack clip while pulling up on the pump.

For switch control location, refer to the engine and controls chapter. For bilge and drainage system information and electrical system information, refer to the systems chapter. Refer to the vessel operations chapter for pre0departure use. Maintenance requirements are described in the maintenance chapter of this manual.

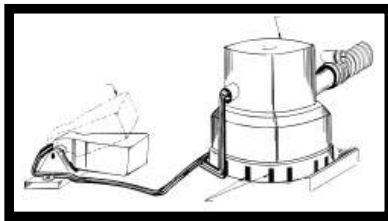

Typical Bilge Pump And Automatic Switch Diagram

Chapter 6

BLOWER

A switch at the helm controls the blower in the bilge. The blower must be activated and run at least 4 minutes prior to starting the engine. The fan cycles fresh air into the engine compartment. It is connected to the ventilation hoses reaching the lower 1/3 of your bilge. The blower should be operated below cruising speeds.

For safety requirements on blower use, refer to the safety on board chapter. For switch control location, refer to the engine and controls chapter. Refer to the systems chapter for electrical system explanations. Refer to the vessel operation chapter for pre-departure use. Refer to the technical chapter for sump schematics.



WARNING

GASOLINE VAPORS CAN EXPLODE. BEFORE STARTING THE ENGINE, OPERATE BLOWER FOR 4 MINUTES AND CHECK THE ENGINE COMPARTMENT FOR GASOLINE LEAKS OR VAPORS. RUN BLOWER BELOW CRUISING SPEED.

Gasoline Vapor Warning



Typical Blower

Equipment Operations

CANVAS & COVERS

Optional Bimini Top_____

Your Regal boat has the option of being equipped with a bimini top. This option provides some sun protection for the bulk of your cockpit and helm. Your bimini top comes fitted inside a zippered boot. Bimini bows provide support as your bimini top extends forward. When using your Bimini, follow all warning labels attached to the Bimini top. Not that the bimini top option is not available with the purchase of the sport tower option.



Typical Bimini Top

To install your bimini:

Chapter 6

- 1) First assemble your bimini. Slide all bows through the appropriate sleeves on your canvas. Then attach all bows to the appropriate support arm on the bimini. These bows attach by use of a ball and saddle joint. Slide the ball through the saddle until it stops, then secure the joint from behind by sliding the tethered pin through the saddle.
- 2) Next attach your bimini contraption to your boat. Use the ball and saddle joints located on your windshield to mount you bimini to your boat. Slide the ball through the saddle until it stops, then secure the joint from behind by sliding the tethered pin through the saddle. Ensure your bimini can expand forward over the helm before continuing.



Typical Saddle Joint

- 3) From the storage position, the next step is to unzip your bimini from the boot that encloses the canvas. The boot will need to be stored for future storage purposes. Now unroll the canvas and extend your bimini out over the cockpit.
- 4) The front of your bimini requires tension to prevent it from collapsing under the designed conditions. The two straps positioned on the forward side of the bimini should be adjusted to the appropriate length and fastened to the camel back eye strap hardware affixed to your windshield. Ensure these straps tightly hold the bimini in place. Your bimini top can now be used for recreation.

Equipment Operations



Typical "Camel Back" Eye Strap Connection

For towing and trailering purposes, the bimini top can be left on the boat, but the boot sleeve must be installed with the bimini rolled up and fully collapsed. This storage procedure should be followed when boat speeds exceed 35 miles per hour. Be aware of potential carbon monoxide buildup while the bimini is used.

**WARNING**

AVOID PROPERTY DAMAGE AND PHYSICAL INJURY. DO NOT USE THE BIMINI TOP ABOVE A SPEED OF 35 MILES PER HOUR.

Bimini Top Warning

Optional Bow & Cockpit Cover _____

The optional cockpit cover installs over the windshield and snaps to the deck. The cockpit cover is meant to protect the cockpit of the boat from weather elements, and is not used for towing purposes. The same is true for the bow cover. The bow cover is a separate option from the cockpit cover available for purchase. The bow cover protects the bow of the boat from weather and snaps to the deck. Likewise, the bow cover should not be used for towing. If both the bow and cockpit cover options are purchased, the two halves snap and velcro together at the center windshield location.

Chapter 6

To install the bow/cockpit cover:

- 1) First note that on the bow end of the cockpit cover, there is a velcro strip used to attach to an optional bow cover. This strip can be used to align the covers with your boat. Simply align the velcroed edge with the windshield.
- 2) Ensure the center windshield is in the closed position. Start snapping the cover to the deck by use of the eyelet snaps, starting at the bow and working aft.
- 3) Notice in the middle underside of your cover, you may find an area of reinforced canvas with an eyelet snap. This snap connects to a cockpit cover pole. This pole is adjustable, and by opening the lock, the pole can telescope out to the desired length. This pole should push the canvas up when standing straight up on its rubber enclosed foot. The purpose here is to prevent the pooling of water. The same is true for your bow cover.
- 4) Continue snapping the cockpit cover to the deck snaps. When you reach the rear corner, leave enough room to allow a safe exit.

The cockpit cover and bow cover should be rolled up for storage inside the ski locker when trailering or storing your boat. This canvas should not be used while the engines are running, or when towing.

Equipment Operations



WARNING

AVOID PROPERTY DAMAGE AND PHYSICAL INJURY! DO NOT TOW BOAT WITH CANVAS COCKPIT OR BOW COVERS IN PLACE. ONLY TOW YOUR BOAT USING THE TRAVEL COVER.

Bow and Cockpit Cover Warning



Typical Bow And Cockpit Cover

Optional Storage / Travel Cover _____

The optional travel cover is the only cover approved for towing purposes. The storage cover is meant to keep debris out of your boat while trailering or when in storage.

To install the storage/travel cover:

Chapter 6

- 1) Place the cover over your boat from bow to stern over a closed windshield. Use the ratchet system to hold the cover in place and prevent damage caused by loose canvas. Cleats should protrude from the travel cover as well as a closed bimini top if that option was purchased separately.



Typical Travel Cover

Optional Sunshade For Sport Tower_____

With the purchase of the sport tower comes a separate option available for purchase - the tower sunshade. The sunshade attaches to the sport tower to provide some sun protection for the helm and companion cockpit area.

After ensuring your sport tower is installed correctly, install the sunshade on the sport tower:

- 1) First ensure your sunshade is properly attached to your sport tower. Slide the bow through the appropriate sleeve on your canvas. Then attach the bow to the appropriate support arm on the sport tower. The bow will attach by

Equipment Operations

use of a ball and saddle joint. Slide the ball through the saddle until it stops, then secure the joint from behind by sliding the tethered pin through the saddle.

- 2) From the storage position, un-clip and fully unroll the sunshade. Extend the sunshade over the sport tower top and attach the sunshade to the sport tower by use of the eyelet snaps.
- 3) Finally, apply tension to the front end of the sunshade to secure it in place while in motion. Attach the straps on the forward side of the sunshade to the camel back eye straps located on the sport tower's frame. After connecting the carabiner clips on the port and starboard side, your sunshade is ready for recreation.

For trailering and storage purposes, the sport tower can be left on the boat, but the sunshade must be rolled up and stored in the boot. The sunshade assembly must be collapsed back against the sport tower and clipped around the sport tower with the quick release clips. This is also how the sunshade should be stored with speeds exceeding 35 miles per hour. Be aware of potential carbon monoxide buildup while the sunshade is in use.



WARNING

AVOID PROPERTY DAMAGE AND PHYSICAL INJURY. DO NOT USE THE SUNSHADE ABOVE A SPEED OF 35 MILES PER HOUR.

Sunshade Warning

Chapter 6



Typical Sunshade For Sport Tower

Equipment Operations

COCKPIT LIGHTS

A switch at the helm controls the courtesy lights in the cockpit area. Using these lights is especially useful when boarding or exiting the vessel at night. A light is normally located at the bow and transom walk-thru areas.

Refer to the engine and controls chapter for switch location and function. Refer to the systems chapter for electrical system wiring. Refer to the technical chapter for component locations and hookup.

Chapter 6

DEPTH GAUGE / SOUNDER

In theory the depth gauge picks up a bottom signal sent through a transducer to the helm gauge unit which is converted to readings in feet, meters, or fathoms, and displayed on the gauge. The unit features shallow or deep water alarms, both of the audio and visual type, and keel offset.

Refer to the engine and controls chapter for gauge use. Electrical systems are described in the systems chapter. Technical drawings are in the technical chapter.

Operation

The depth finder will display depths of 2-199 feet, 1-92 meters, or 1-54 fathoms. To accommodate greater depths to be displayed in the feet mode (ft), the depth sounder will automatically change to the fathoms (f) mode and continue to display depths to around 54 fathoms. When the depth becomes larger than 200 feet, the display will return to the feet mode. Limits on depth will vary depending on transducers and bottom conditions.

If the reading is less than 19.9 feet, meters, or fathoms, 1/10th increments will be displayed. If the reading is more than 19.9 feet, all readings will be in whole numbers.

The depth finder features an audible and LCD displayed depth alarm with adjustable shallow and deep limits and a depth below keel offset feature. These settings once made are stored in memory and will remain, even if the battery is not connected.

Equipment Operations

POWER ON

When the helm is powered up by the key switch, 12 volt DC energy is available at the depth gauge along with the remainder of the instrument cluster. You do not need to press the “ON/OFF MODE” keypad.

The LCD will illuminate showing the depth and the type of units selected; feet (FT), meters (M), or fathoms (F). To deactivate the depth sounder, hold the “ON/OFF MODE” keypad for 4 seconds. Pressing the “ON/OFF MODE” keypad again, reactivates the unit.

DEPTH ALARM SHALLOW MODE

If you press the “ON/OFF MODE” keypad again, the shallow depth alarm setting is displayed. This is the shallowest water that will energize the alarm. Press and hold the up or down arrow keypads to adjust the reading to the desired depth.

DEPTH ALARM DEEP MODE

By pressing the “ON/OFF MODE” keypad again, the deep depth alarm setting is displayed. This is the deepest water that will energize the alarm. Press and hold the up or down arrow keypads to adjust the reading to the desired depth.

When the shallow depth setting is read by the depth finder, the “SH” will flash on the LCD and the audible alarm will sound in a rapid sequence. When the deep depth setting is read by the transducer, the “DP” will flash on the LCD and the audible alarm will sound at two beeps per second.

To fully deactivate the alarm, reset it to zero. Pressing the “ON/OFF MODE” keypad temporarily deactivates the alarm. To reactivate, press the “ON/OFF MODE” keypad until the depth reading appears.

Chapter 6

KEEL OFFSET

By pressing the “ON/OFF MODE” keypad again, the alarm will display the keel offset setting “KL”. It can be set so the depth finder shows the depth below the transducer, or the depth under the keel. Press the up or down arrow keypads to adjust the reading to the desired depth no further than 19.9 feet.

An example would be if the keel bottom is 3 feet below the transducer, and you desire the depth sounder to read the depth below the keel, the keel offset display should be adjusted to 3.0 FT.

Once the keel offset is programmed, the shallow and deep water alarms will be energized by the depth under the keel.

UNITS

Pressing the “ON/OFF MODE” keypad again displays the units mode “UN”. Press either the up or down arrow keypads to set the units to feet (FT), meters (M), or fathoms (F). Once these units are set, they will remain the same for all modes. By pressing the “ON/OFF MODE” keypad again, the depth finder will return to the normal operations screen.



NOTICE

AVOID EQUIPMENT DAMAGE! THE TRANSDUCER IS A SEALED UNIT. DO NOT ATTEMPT TO OPEN IT, SINCE IT IS NOT SERVICEABLE.

Transducer Notice

Equipment Operations



WARNING

AVOID INJURY OR DEATH! THE DEPTH SOUNDER IS NOT TO BE USED FOR NAVIGATION OR AS A DEVICE TO AVOID GROUNDING. USE CAUTION WHEN OPERATING IN SHALLOW AREAS AND MAINTAIN A VERY SLOW SPEED. BE AWARE THAT WATER DEPTHS MAY CHANGE TOO QUICKLY FOR YOU TO REACT AND AVOID GROUNDING!

Depth Sounder Warning

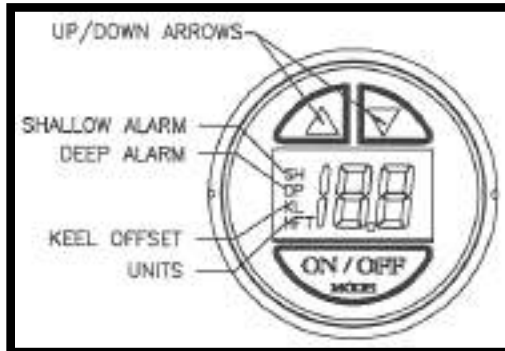

Depth Gauge With Functions

Chapter 6

DRAIN PLUG

Your boat is equipped with a drain plug centrally located on the transom below deck level. Make sure it is installed tightly before launching. Tighten with a wrench. Do not use your fingers alone to tighten it. After your outing, while the boat is angled on the ramp, remove the drain plug to eliminate any bilge water accumulation. If the water stream is diminished, check for foreign objects stuck in the drain hole. Pull the drain plug if dry storing the boat for extended periods, especially in colder climates.

Refer to the vessel operation chapter for pre-departure use. Refer to the storage and winterization chapter for storage directions. Refer to the trailering section for pre-launch and post-trip use.



WARNING

TO PREVENT THE VESSEL FROM SINKING, INSTALL THE DRAIN PLUG.

Drain Plug Warning

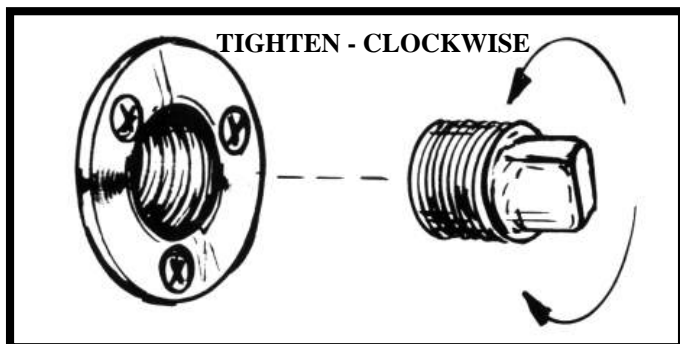

Drain Plug Diagram

Equipment Operations

HORN

A switch at the helm controls the audible horn signal installed on your vessel. Be sure to test the horn before each outing and learn the horn and bridge signals by reviewing the rules of the road chapter. The horn is activated as long as the switch is activated.

MARINE STEREO

Standard Stereo System ---

The stereo system installed on your Regal boat features an AM/FM radio with an internal iPod docking station, auxiliary device, and clock. Your Fusion MS-IP600 radio is Sirius Satellite Radio compatible, but your radio does not come with the Sirius Satellite Tuner required to function. This can be installed as an after market installation to the factory equipped stereo unit on your Regal.

A total of four speakers are installed on your Regal, which can be upgraded to a total of six speakers with an amplifier with the purchase of the stereo performance package option. Reference optional stereo system later in this section for further details.

A 10 amp stereo memory fuse is located in the engine compartment near the battery switch. Should this fuse blow investigate the source of the problem before replacing it.

Basic stereo features are covered in this manual. For more detailed information, refer to the stereo manufacturer's owner's manual.

Chapter 6



- | | |
|---------------------------|--------------------------|
| 1) Catch / Release Button | 8) Play / Pause Button |
| 2) Menu Button | 9) Forward / Next Button |
| 3) Radio Button | 10) Power Button |
| 4) Auxiliary Button | 11) Mute Button |
| 5) iPod Button | 12) Clock Button |
| 6) Rotary Encoder | 13) Brightness Button |
| 7) Back / Previous Button | |

POWER

To energize the stereo, first ensure the unit is receiving power from the ignition switch being turned on/run. Be sure not to drain the battery from stereo use if the engines have not been started. Then press the power button located in the lower left hand corner of the display. To deactivate the unit, press the power button once more.

SELECTING THE SOURCE

Press on of the function buttons on the top row.

The radio button selects the radio source. Toggle this button to switch between AM, FM, and Sirius Radio (sirius tuner not included)

Equipment Operations

The auxiliary button selects an auxiliary device hooked up to the stereo unit.

The iPod button selects the iPod source from the internal hook-up.

SEARCH STATIONS (FM ONLY)

Your antenna may pick up different radio stations as you change your location. To search for available radio stations that register via your antenna, press the menu button in the upper left hand corner and turn the rotary encoder to scroll through the menu options and select “Search Stations” by pressing the encoder in. Your Fusion radio will now search for frequencies it can receive based on your current location. Frequencies found will be saved as presets.

Press the menu button to level up and out of the main menu to the regular display.

TUNING / SELECTING A STATION OR SONG

Utilize the back / previous button (|<<) and the forward / next button (>>|) to scroll through available radio channels when using the radio source, or to scroll through songs on your iPod when using the iPod source.

SAVE A CURRENT RADIO STATION AS PRESET

To save a current radio station, have your Fusion radio set to that station. Select the menu button and use the rotary encoder to select the “Preset” option by pressing the encoder in. Now use the rotary encoder to select the “Save Current” option.

Press the menu button once to return to the presets menu, again for the main menu, and a third time to return to the original display.

Chapter 6

This can alternatively be accomplished by pressing and holding the play button while listening to the radio station.

REMOVE PRESETS

To remove a radio station from your preset list, press the menu button and use the rotary encoder to select the “Presets” option. Now use the rotary encoder to select the “Remove Presets” option, and select the stations to remove again using the encoder.

Press the menu button once to return to the presets menu, again for the main menu, and a third time to return to the original display.

VOLUME

Utilize the rotary encoder to increase or decrease the volume coming out of the speakers. Volume is displayed on a scale from 0-24 for all active zones.

STONE

Select the menu button in the upper left hand corner and turn the rotary encoder to scroll through the menu options and select “Setup” by pressing the encoder in. In this sub menu, use the rotary encoder to select “Tone”.

Now use the rotary encoder to modify the bass setting from -7 to +7. Press the rotary encoder to select the setting. Now the treble scale is selected. Again use the rotary encoder to modify the treble setting from -7 to +7. Press the rotary encoder to select the treble setting.

Press the menu button to level up one menu to the tone menu. Press the menu button again to reach the setup menu, again to return to the base menu, and once more to return to the regular display.

Equipment Operations

BALANCE

Select the menu button in the upper left hand corner and turn the rotary encoder to scroll through the menu options and select “Setup” by pressing the encoder in. In this sub-menu, use the rotary encoder to select “Balance”.

Now use the rotary encoder to modify the sound coming out of the left and right speakers on a scale from -7 (left) to +7 (right). Press the rotary encoder to select the setting.

Press the menu button to level up one menu to the balance menu. Press the menu button again to return to the setup menu, again from the main menu, and once more to return to the regular display.

MUTE

To mute the sound coming out of the speakers with the press of a button, select the mute button located as the lower left function button on the stereo face. Press this button once more to un-mute.

PLAY / PAUSE

The button directly in the middle of all function buttons controls the ability to play or pause a song on an iPod or auxiliary capable device. This button toggles between the play function and pause function.

SELECT VOLUME LIMIT ON ZONES

Select the menu button in the upper left hand corner and turn the rotary encoder to scroll through the menu options and select “Zones” by pressing the encoder in. In this sub-menu, select which zones you wish to modify the volume limit by using the rotary encoder.

Chapter 6

Now use the rotary encoder to modify the volume limit on the selected zone from 0 to 24.

Press the menu button to level up one menu to the selected zone menu. Press the menu button again to return to the zones menu, again for the main menu, and once more to return to the regular display.

ZONES

Your Regal comes standard with two equipped zones. Zone one refers to the two speakers in the forward position nearest the helm and companion seats. Zone two refers to the two speakers in the aft position nearest the aft cockpit. Zone three is reserved for additional speakers installed as an optional feature (see later in this section).

CLOCK ADJUSTMENT

To adjust the clock, press the menu button in the upper left hand corner, and turn the rotary encoder to scroll through the menu option and select “Setup” by pressing the encoder in. In this sub menu, use the rotary encoder to select the “Clock Adjust” option.

Use the rotary encoder to toggle the 24 hour clock mode, or to select the “Set Time” function. Once “Set Time” has been selected, use the rotary encoder to change the hour on the clock, pressing it in when finalized. This allows the rotary encoder to change the minutes on the clock in a similar manner.

Once the time is finalized, hit the menu button to return to the clock adjustment menu, again to return to the setup menu, again for the main menu, and a fourth time to return to the regular display.

Equipment Operations

CLOCK DISPLAY

To display the clock, simply press the clock button on the face of the stereo. It is the middle button on the bottom row of function buttons on the stereo face. This toggles the clock display on the LCD screen.

BRIGHTNESS

Use the brightness button to bring up the brightness menu. From here, the rotary encoder can change the brightness of the LCD screen - selecting a brightness by pressing the rotary encoder. Toggle the brightness button to return to the regular display.

IPOD CONNECTION & PLAYBACK

Your Fusion radio comes with an internal iPod dock. Use the catch / release button to unlock the stern face and rotate it downward. Here, the iPod dock is accessible. It features stackable inserts for different iPod sizes and models to connect to the port in the back of the docking station. Simply find the correct sleeve for your model iPod (refer to the Fusion Radio documentation) and insert the sleeves back into the docking station as directed by the Fusion Stereo documentation. Be sure not to insert your iPod without the appropriate sleeve, or in the docking station with debris inside. Playback of the iPod should start automatically after selecting the iPod source on the face of the Fusion radio. Be sure to close the radio face and enclose your iPod in the dock to prevent it from falling out or damaging the docking connection.

Chapter 6



Typical Internal iPod Docking Station

The play/pause, back/previous, and next/forward buttons should function as previously described. To repeat or shuffle, press the menu button and select the “Repeat/shuffle” option. Select “Repeat Track” to repeat the current track, or “Shuffle Tracks” to shuffle individual tracks or “Shuffle Album” to shuffle the playback of songs within an album.

AUXILIARY CONNECTION & PLAYBACK

Auxiliary listening devices are connected using RCA cables at the back of the stereo device. Some auxiliary devices may require an adapter cable to connect to your stereo system. Simply plug in the left (white) and right (red) inputs to their mating plug on the stereo. Turn on your device and then select the auxiliary device using the auxiliary button located in the middle of the top row of function buttons on the stereo face.

Volume depending on the auxiliary device may be controlled on the device itself, through the Fusion radio, or some combination thereof.

Equipment Operations

Optional Performance Package_____

The optional upgrade includes 2 extra speakers and an amplifier to drive the system. The amplifier is normally located in the port bow storage area. The 30 amp fuse for the amplifier is normally located in the engine compartment near the battery switch. Should the fuse “blow”, investigate the problem before replacing the fuses with the same type and capacity fuse. These features are normally connected to zone three of the Fusion stereo system.

NAVIGATION / ANCHOR LIGHTS

This switch controls the running and stern lights. It is a two position switch. Activate the top section and the running lights (navigation and stern lights) are activated. Activate the bottom portion and the anchor light (360 degree light) only is activated. Remember the navigation lights, sometimes called running lights must be used between sunset and sunrise. Should you anchor or stop the vessel at night, the 360 degree light is required to be plugged into the terminal located along the aft starboard deck and lit.

Chapter 6

SEAT, HATCH, & STORAGE

Bucket Helm Seat

The bucket helm seat and optional companion bucket seat (see later in this section) features forward and aft movement, as well as a swivel motion that allows the seat to pivot, and a flip up bolster cushion that allows any user to control his/her comfort and position.

To adjust the fore and aft helm seat position, loosen the black fore & aft adjustment knob located amidship by turning counter clockwise. Then slide the seat to the desired location and retighten the knob.

To swivel the seat, pull up on the swivel handle to unlock the detention system. While the detention system is unlocked, pivot the seat to the desired position. Be sure to lock the swivel in the detented position by pushing down on the handle and finding a locked position. **DO NOT** run the vessel unless the swivel is in the locked position.

To flip the bolster cushion up, simply grab the front cushion and pull up.

Seat slider fasteners should periodically be checked for tightness. **DO NOT** alter the seat slide system in any way.



CAUTION

TO PREVENT BODILY INJURY! PERIODICALLY CHECK AND TIGHTEN THE MOUNTING BOLTS BETWEEN THE SEAT SLIDER AND THE BUCKET SEAT BOTTOM. ALSO, CHECK THE FLOOR INSERT BOLTS.

Bucket Seat Maintenance Caution

Equipment Operations

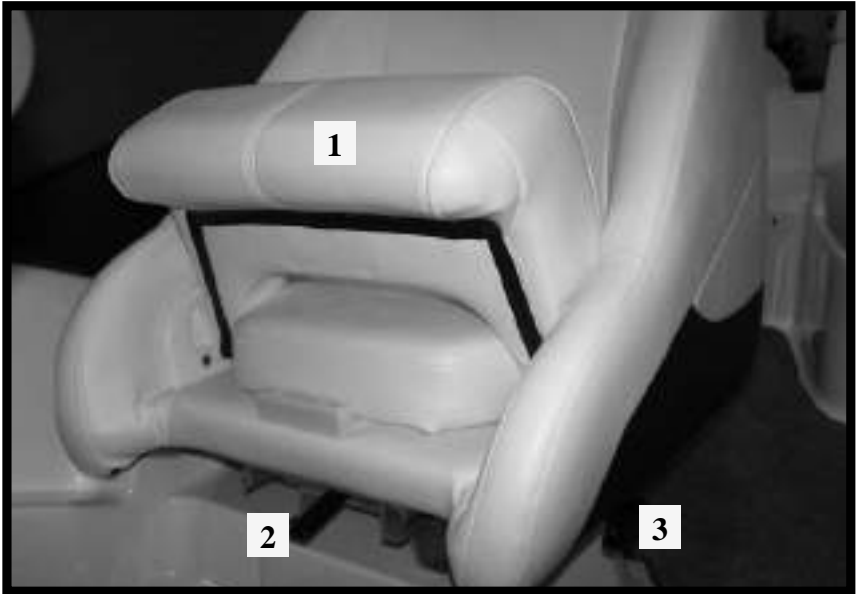

Typical Bucket Seat Layout

- 1) Flip up Bolster
- 2) Swivel Handle
- 3) Fore & Aft Adjustment Knob

Optional Companion Bucket Seat _____

The companion bucket seat option replaces the standard companion seat with a bucket seat just like the helm. Controls and maintenance procedures are the same.

Aft Cockpit Seat _____

The aft cockpit seat has the ability to flip up for access to the cooler compartment. It features a hydraulic ram to support the cushion while open. To open the aft cockpit seat, unsnap the seat from the deck, grab the cushion by the metal bar, and pull up. **ALWAYS** make sure the aft cockpit seat is down when underway.

Chapter 6

Engine Hatch / Sun Pad _____

Your engine is accessible through the engine hatch which doubles as a sun pad. This hatch must **ALWAYS** be closed and locked while underway. The sun pad should **NEVER** be used while the engines are on. This is also how you access the transom storage compartment.

To open the engine hatch, pull up on the engine hatch release lever located along the backrest of the aft cockpit seat, and lift the engine hatch open. Your engine hatch uses hydraulic rams to keep it open. To close the engine hatch, push the engine hatch down completely until the release lever locks the engine hatch back down.

Transom Filler Cushion _____

The transom walk-thru can double as a seat when needed. A filler cushion and backrest can be snapped into place on the walk-thru to provide support.

The seat cushion is placed on the walk-thru first. Two snaps attach to the step tread, while an additional two straps snap to the riser near the cockpit light. The backrest is put in place next. It is secured by attaching two straps to the walk-thru walls, one on either side of the walk-thru.

This is only a filler cushion for use while drifting or when anchored. **DO NOT** use the filler cushion while the boat is underway or while the walk-thru is in use.

Equipment Operations



Typical Transom Filler Cushion

Ski Locker

Your Regal is equipped with a ski locker amidship, which is used to store equipment. Its long and narrow profile make it perfect for storing ski equipment. To open your ski locker, pop the handle up, rotate the handle 180 degrees, and pull up on it. Your ski locker opens with the assist of a hydraulic ram. Your ski locker contains its own drain and allows access to the transducer for removal. **DO NOT** open the ski locker while underway. Ensure the ski locker is in the locked position after use.

Chapter 6

Glove Box

The glove box on the port dash panel can be closed and locked with a key to keep valuables safe while onboard. To open the glove box, unlock it using the key, and press the lock mechanism down while lifting the lid open. Don't forget to lock this compartment once closed to keep items secure.

Bow Storage Compartment

The very front seat of your boat features a storage compartment underneath the seat. To access this storage compartment, lift the seat cushion upward. This storage area naturally drains to the ski locker and down to the bilge.

Bow Storage Locker

For further storage locations, your boat is equipped with bow storage lockers. To access these lockers, firmly grasp the backrest of the forward facing bow seats and open them in an outboard direction. The storage locker in front of the helm also features the dashboard fuse box. Close these lockers firmly to secure the backrest.



Typical Bow Storage Locker

Equipment Operations

SPORT TOWER

Optional Sport Tower_____

An optional sport tower feature is available for your boat. This tower option is a collapsible design for trailering and storage purposes. To collapse and expand the sport tower, simply unscrew the black knobs at the attachment joints, and remove or reassemble the aluminum poles. The expanded sport tower should not be used in speeds in excess of 35 miles per hour. If collapsed, store the sport tower poles in the ski locker. Your sport tower also features a pylon on the top of the structure. This is used as an alternative ski or tubing anchor. The sport tower features additional attachments when the optional sunshade canvas is equipped. Note that the sport tower option is not available with the purchase of the bimini top option.



Typical Sport Tower Assembly

Chapter 6

SWIM LADDER



Typical Swim Ladder

Utilize the swim ladder for entering and exiting the water. Use the appropriate hand rails and ladder rungs. Be sure all body parts are clear of the ladder when folding the ladder up or down. Keep body parts away from the hinged and sliding parts. Read and adhere to any written warnings posted on the dash or swim platform regarding ladder load limits.

TURN THE ENGINE OFF AND REMOVE THE IGNITION KEYS WHILE PEOPLE ARE SWIMMING NEAR THE BOAT, USING THE SWIM PLATFORM, OR BOARDING THE LADDER.

Also, insist people use the ladder and not the stern drive for entering and exiting the vessel.

SWIM PLATFORM

Your Regal features the largest-in-class swim platform available. It is important to note that the swim platform is connected to the transom of your boat by hardware that should be periodically inspected for tightness. The hardware should be kept in good condition to avoid safety hazards. **NEVER** exceed the maximum weight for your swim platform as described on a label near the swim ladder.

Equipment Operations

WARNING!

MAXIMUM CAPACITY OF SWIM PLATFORM
500 POUNDS
226 KG

Swim Platform Warning



WARNING

AVOID SERIOUS INJURY OR DEATH! DO NOT OPERATE THE ENGINES WITH PEOPLE ON TOP OR HOLDING ONTO THE SWIM PLATFORM OR HARDWARE.

Do Not Start Engine With Swim Platform In Use Warning



WARNING

AVOID SERIOUS INJURY OR DEATH! DO NOT ALLOW ANYONE TO TEAK SURF BY USING THE SWIM PLATFORM AND/OR HARDWARE.

Do Not Teak Surf Warning



CAUTION

AVOID SERIOUS INJURY OR PROPERTY DAMAGE! DO NOT USE THE SWIM PLATFORM CLEATS FOR TOWING OR ANY TYPE OF PERMANENT MOORING OR DOCKING. USE BOW, STERN, AND SPRING LINE CLEATS FOR MOORING.

Do Not Use Swim Platform Cleats Caution

Chapter 6



Typical Swim Platform

WINDSHIELD



Typical Windshield Locks

The center windshield must be closed and locked at all times during which the boat engine is running. Make sure both locking latches are firmly seated in a horizontal position against the windshield framework. Magnets will secure the center windshield when open.

Care & Maintenance

This section covers the care and maintenance of your Regal boat. Many cosmetic care topics including exterior hardware, upholstery, fiberglass, and canvas are discussed. Also, major equipment and system maintenance is covered. As always, refer to the owner's information pouch and the manufacturer's owner's manuals for detailed instructions.

COSMETIC CARE

Upholstery

Cockpit and interior vinyl require periodic cleaning to maintain a neat appearance and to prevent the build up of dirt and contaminants that may stain and reduce the vinyl life if they are not removed. The frequency of cleaning depends on the amount of use and conditions to which the vinyl is subjected.

Most common stains can be cleaned using warm, soapy water, and clear rinses. Scrubbing with a soft bristle brush will help loosen soiled material from embossed surfaces and under welting. If the stains are not removed with the above method use a mild cleaner such as Fantastic. This cleaner should be used only as needed and not the normal means.

Chapter 7

With more stubborn stains, rubbing alcohol or mineral spirits may be tried cautiously. Widespread solvent use can severely damage or discolor vinyl. Try to remove stains immediately before they have a chance to penetrate the surface of the vinyl. Try a test area first.

Powdered abrasives, steel wool, or industrial strength cleaners are not recommended for cleaning our vinyl. Lacquer solvents will cause immediate damage. Dilute chlorine bleach before using. **DO NOT** wax the vinyl as it may cause cracking. Always wear protective gloves and make sure there is sufficient ventilation when cleaning vinyl. Wear eye protection.

Remember that suntan oil will damage vinyl. Use suntan lotion instead of suntan oil. Exposure to the sun is a natural enemy of vinyl upholstery. For maximum life, keep the vessel covered with a cockpit and bow cover when not in use.

Optional Cockpit Carpet _____

Your Regal has an optional carpet feature that covers select portions of your hull in carpet. The three carpet pieces attach via eyelet snaps on the deck of your boat.

Use approved household cleaners on carpet. Perform on a test area first. Many spots and spills can be removed using a cleaner combined with a clean, white terry towel. Try not to soak an area excessively and **DO NOT** use solvents. Solvents will break down the backing and fibers.

Care & Maintenance

Plastics

Use plastic cleaners and polishes recommended for marine use only. Use proper applicators. Read all instructions carefully. Test the product in a small area first. Use a soft rag and always rinse the surface with water. Ammonia based cleaners and abrasives will damage plastic parts.



NOTICE

NEVER CLEAN PLASTIC SURFACES WITH A DRY CLOTH OR GLASS CLEANING SOLUTIONS CONTAINING AMMONIA. NEVER USE SOLVENTS OR WIPE PLASTICS WITH ABRASIVES.

Plastic Care Notice

Fiberglass & Gelcoat



CAUTION

NEVER CLEAN PLASTIC SURFACES WITH A DRY CLOTH OR GLASS CLEANING SOLUTIONS CONTAINING AMMONIA. NEVER USE SOLVENTS OR WIPE PLASTICS WITH ABRASIVES.

Fiberglass And Gelcoat Care Caution

Routine maintenance is the only practical way to keep the surface of your boat looking shiny and new. Most objects left outdoors will gradually deteriorate from exposure to the sun, water, dust, and pollution. Such outdoor exposure can cause your boat's gelcoated surface to change or fade. Darker colors tend to fade more rapidly than lighter colors because they absorb more of the sun's rays (ultraviolet and infrared).

Chapter 7

Basic maintenance includes monthly washing of the boat's surface to remove normal accumulation of soil and stain.

Mild detergents such as dishwasher powder or liquid. **DO NOT** use automatic dishwasher detergent. Avoid any kind of alkaline cleaners such as tri-sodium phosphate (TSP), abrasives, bleaches, and ammonia. For best results, use cleaners recommended for fiberglass.



NOTICE

WIRE BRUSHES, SCOURING PADS, OR OTHER ABRASIVE TYPE MATERIALS AND SOLUTIONS SHOULD NEVER BE USED ON THE HULL OR DECK OF YOUR VESSEL. THEY CREATE SMALL SCRATCH MARKS THAT WILL COLLECT MARINE GROWTH AND OTHER FOREIGN MATERIALS.

Fiberglass And Gelcoat Care Notice

It is recommended that you wax the gelcoat surface twice yearly to prevent loss of gloss and to protect the finish. Use only waxes for fiberglass and follow the label instructions. Apply a 3' x 3' section at a time using clean applicator cloths or a buffing bonnet. When a haze develops, use a power buffer at low speeds (1200-2000rpm) to remove the haze. Keep the buffer moving to avoid heat build-up. The power buffer is very efficient at removing contaminants from gelcoat. **NEVER** wax gelcoat in the direct sun.

When washing and waxing as recommended does not restore the shine, it may be necessary to use a fine rubbing compound. **DO NOT** apply rubbing compound in direct sunlight. A power buffer at low speed does an excellent job to remove impurities from the gelcoat that cause dulling. Use light pressure and keep the buffer moving. Re-wax after compounding to buff the surface.

Care & Maintenance

“Hairline cracks” or “spider webbing” could develop in the gelcoat surface of a hull or deck. This can be caused by impact or other factors.

Small air pockets or hairline cracks may also occur through normal wear. These do not affect the strength of the hull or deck, and can be repaired by a marine professional, Regal dealer, or owner.

The affected area should be chipped or sanded away and a thin lay of color matched gelcoat applied. This layer is then sanded smooth and buffed to its original luster.

Most minor scratches, nicks, and dents can be removed by compounding the surface. Marine type compounds can be found at most auto body supply stores. Specify a number 25 compound to a number 55 compound. Compounds are graded like sandpaper, the higher the compound, the finer it is. Various glazes and polishes are available as needed. Ask your marine professional or Regal dealer for more information. Fiberglass hulls are strong, but they can be damaged. A fiberglass hull has virtually no internal stresses. Thus when a part is broken or punctured, the rest of the hull retains its original shape. A severe blow will either be absorbed or result in a definite localized break. A break of this nature should be checked/ repaired by a marine professional or Regal dealer.

Minor Repairs_____

You will need the following materials for minor repairs:

- Gelcoat
- Clear Liquid Catalyst
- Putty Knife

Chapter 7

- Razor Blade
- Fine Sandpaper (400, 600, 1000)
- Wax Paper (to cover repair area)



WARNING

AVOID BODILY INJURY! GELCOAT & FIBERGLASS RESIN ARE FLAMMABLE. WORK IN A WELL VENTILATED AREA FREE FROM OPEN FLAMES. DO NOT SMOKE!

Resin Warning

For most minor repairs, refer to the following procedure:

- 1) Clean the area to be repaired and get rid of any wax or grease residues.
- 2) Clean out scratches, chips, and nicks.
- 3) Sand area to be repaired so gelcoat will bond.
- 4) In a separate container, measure only the amount of gelcoat you will need. Mix a ratio of 2% catalyst to the amount of gelcoat being used (a spoonful of gelcoat will require only a drop or two of catalyst). **DO NOT** pour any unused portions of the gelcoat or catalyst mixture back into either original container.
- 5) Apply gelcoat to the area, leaving a slight lift above the surface.

Care & Maintenance

- 6) Cover the area with wax paper. It will help the mixture to set up faster.
- 7) Remove wax paper and shave off any extra gelcoat with a razor blade.
- 8) After the area is shave smooth, start with the 400 grit sand paper, working up through the 600 and 1000 grit papers.
- 9) Buff the area with compound, polish, and a finish wax. You may notice a difference between the repaired area and the original finish due to the natural weathering process.

Canvas

In most cases, boat canvas is subjected to more severe punishment than practically any other type of material. Moisture, dirt, chemicals from industrial fallout, heat, ultraviolet rays, and salt water are all factors which accelerate the deterioration of your boat canvas. These elements can cause serious damage if left unchecked.

The optional bimini top and other optional canvas that may be supplied on your Regal boat are manufactured from top quality materials to provide you with years of trouble free service. The following information on the care, cleaning, and proper storage of the fabrics and fasteners that make up your marine canvas is being provided to help you maintain the appearance and ease of operation.

Sunbrealla is used on bimini tops sunshades, cockpit covers, and bow covers. Sunbrella is a woven fabric made from dyed acrylic fibers that are capable of withstanding longer sun exposure without excessive fading.

Chapter 7

Sunbrella is a woven fabric. Even though it is treated with water repellency, some “misting” through the fabric is typical. With new canvas, the greatest potential for leakage is through the sewn seams. Because Sunbrella and the long term thread used is synthetic, the holes created by sewing will not swell up and seal when exposed to water as cotton does. Usually the movement of the fabric in use will move the fibers enough to seal the holes. You may apply Apeal or Uniseal to the seams to speed up this process.

When the canvas is new the fit will normally be tight. It is designed this way because Sunbrella stretches as it ages. The initial tight fit allows for a suitable fit for the life of the canvas. The Sunbrella fit will vary slightly in the heat, cold, and/or rain.

Sunbrella Cleaning Instructions

Sunbrella should be cleaned regularly before substances such as dirt, roof particles, etc., are allowed to accumulate on and become embedded in the fabric. The fabric can be cleaned without being removed from the boat. Simply brush off any loose dirt, hose down the canvas, and clean with a mild solution of natural soap in lukewarm water. Rinse thoroughly to remove the soap. **DO NOT** use detergents! Allow the canvas to air dry.

For heavily soiled fabric, remove the sunbrella from the frame. Soak the fabric in a solution that has been mixed to the following proportions: 1/2 cup of Clorox bleach and 1/4 cup of Ivory or Lux soap (liquid or soap) per each gallon of lukewarm water. Allow the fabric to soak until the bleach has killed the mildew and the stains can be brushed out with a common kitchen scrub brush. Rinse the fabric thoroughly in cold water to remove all the soap. This may require several rinsings. Incomplete rinsing can cause deterioration of sewing threads and prohibit the fabric from being properly retreated. Allow the fabric to dry completely. **DO NOT** steam press or dry in an

Care & Maintenance

electric or gas dryer! Excessive heat can damage and shrink the fabric since it is heat sensitive.

This method of cleaning may remove part of the water and stain repellent that was applied to the fabric during its manufacture. It is recommended to retreat with such water repellency products as Apsel and Uniseal. We do not recommend any wax based treatments such as Thompson's Water Seal or any of the silicone products such as SC-15 or Aqua-Tite. Wax based products prevent the fabric from breathing, and encourage mildew growth while silicone products interact with the original fluorocarbon finish and seem to cause a rapid loss of water repellency. In addition, water repellent additives have not been found to be very effective long term for Sunbrella canvas.

Zipper & Snap Care

Canvas parts may be designed with zippers. When zippers are new they can be somewhat difficult to sue. Zip carefully without forcing the zipper or the material. They will loosen with use. A zipper lubricant may be used to help new zippers as well as maintaining used ones. The most vulnerable part of the zipper is the start. Use care when starting the zipper.

Canvas fasteners should be unsnapped as close to the button as possible. **NEVER** remove canvas by pulling roughly on the edge of the material. This can damage the canvas as well as the fasteners. use petroleum jelly on snaps to keep them from developing corrosion, especially in salty environments.

Chapter 7

Metal

Keep all stainless steel and other metal parts rinsed and wiped dry. To maintain their finish, annually polish the stainless steel and other bright works. Use commercially available metal products and read the labels carefully before use. Refer to the flyer in the owner's information pouch. Most marinas and boating retail outlets carry metal care products.

Optional Flexiteek / Soft Step Mat Inlay

An optional inlay of flexiteek or soft step material is available for your swim platform and transom walk-thru.

To care for these materials, wash with dishwater solvent and water immediately after a mark appears.

Hull Bottom

NEVER use wire brushes or highly abrasive scouring pads on your hull bottom. It could damage the gel coat surface or the bottom paint. The bottom of your boat needs to be clean since the build up of natural coatings from water or marine life can potentially create drag and affect your boat's performance. Contact a marine professional or Regal dealer for more information.

Frequent Stains

There are many items that can cause stains to your boat. Some items can even leave permanent stains. The following table indicates general steps that should be taken to remove frequent stains.

Care & Maintenance

FREQUENT STAINS	STEP 1	STEP 2	STEP 3
Coffee, Tea, Chocolate	B		
Permanent Marker *	E	B	C
Household Dirt	A	B	
Grease	D	B	
Ketchup, Tomato Products	A	B	
Latex Paint	A	B	
Oil Based Paint	D	B	
Mustard	A	B	C
Suntan Oil	A	B	
Asphalt / Road Tar	D	B	
Crayon	D	B	
Engine Oil	B		
Spray Paint	B		
Chewing Gum	D	A	
Shoe Polish *	D	B	
Ball Point Pen *	E	B	A
Lipstick	A	B	
Eye Shadow	E	B	
Mildew *	C	B	A
Wet Leaves	C	B	A

Frequent Stain Removal Chart

A = Soft brush; warm soapy water / rinse / dry

B = Fantastik or 409 cleaner

C = One tablespoon ammonia, 1/4 cup of hydrogen peroxide, 3/4 cup of warm water / rinse / dry

D = Scrape off residue (use ice to lift gum)

E = Rubbing alcohol / rinse / dry

* These products contain dyes which leave permanent stains

Chapter 7

ENGINE MAINTENANCE

Each engine and stern drive package is unique and quite complex. A select portion of the maintenance items are covered in this chapter including basic periodic maintenance and lubrication specifications. Because of the advanced ignition and fuel injection systems used on marine engines, it is best to contact your Regal dealer or engine manufacturer for more detailed service procedures for your specific engine. Refer to your engine owner's manual for complete details and specific information about your engine's maintenance schedule and break-in instructions. The information presented here is merely a guide to be used on typical engines, and may not directly apply to your engine package. Also, **DO NOT** apply lubricant or fluids not approved by your engine manufacturer.



WARNING

PREVENT INJURY OR DEATH! USE ONLY APPROVED MARINE REPLACEMENT PARTS THAT ARE IGNITION PROTECTED IN AND AROUND THE ENGINE COMPARTMENT.

Marine Approved Replacement Parts Warning

Engine Cooling System

Your cooling system requires inspection and maintenance with each trip, with extended maintenance every 50 hours. In addition, the water pump impeller needs replacement every two years.

To inspect your cooling system, all lines need to be visually inspected for cracks, melting, crimped spots, and leaks. These lines lead from your raw water intake system to your water pump, which circulates water internally through the engine.

Care & Maintenance

Check the intake and exhausting lines before each voyage. These lines enter your water pump which is normally located on the forward side of your engine near the bottom.

To flush your engine, ensure that the engine is turned off. Then connect a freshwater source to the fresh water port either as part of the engine, or available as an attachment on the stern drive depending on the engine manufacturer. Turn on the freshwater source and turn on your engine. Let the engine run at idle until it reaches normal operating temperature, then shut down the engine, disconnect the hose, and reinstall the cap. Your engine should be flushed after each trip.

To inspect your water pick-up feed, locate the screens on your stern drive unit and remove the debris lodged in the screen. Smaller debris can make its way all the way up to the water pump impeller and build up there, causing malfunction.

To inspect your water pump impeller, ensure the engine is turned off before locating the water pump housing. Remove the housing to get access to the impeller. Inspect the impeller for nicks, dings, and ease of turning.

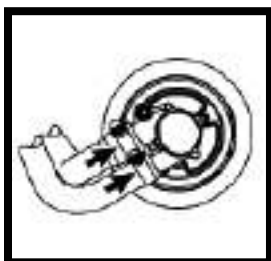

Typical Volvo Water Pump

Typical Mercury Water Pump

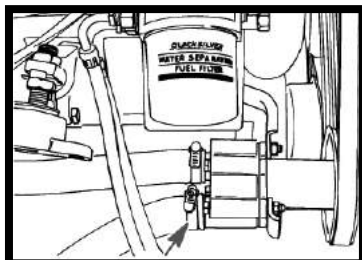

Chapter 7

Engine Fueling System

Your fuel system requires inspection with each trip, along with yearly inspection and maintenance.

To inspect your fuel lines, all lines need to be visually inspected for cracks, melting, crimped spots, and leaks. These lines can be traced back from the fuel tank. Check clamps for tightness and replace as necessary. Smell and look for signs of fuel in the engine compartment.

To replace a fuel filter, ensure that the engine is turned off. Also ensure the battery switch is turned off. Eliminate all potential sources of spark or flame from the boat before replacing the fuel filter. Locate the fuel filter, typically near the fuel pumps. Using a filter wrench, loosen and remove the fuel filter. Be prepared to catch excess fuel that may spill. Dispose of the used fuel filter according to environmental standards. Lubricate the new fuel filter gasket with clean engine oil. Screw in the fuel filter and tighten according to the engine manufacturer's specifications.

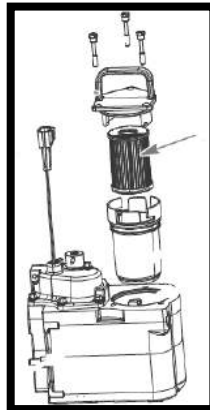
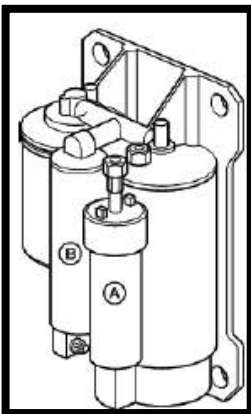

*Typical Volvo Fuel Pumps And Fuel Filter
Typical Mercury Fuel Filter*

Care & Maintenance

Engine Lubrication System

Your engine, propulsion, and control systems require lubricant inspection before each trip, every couple of months (or seasonally as directed), and annually. Engine oil, drive oil, and power steering fluid should be inspected before each trip. Lubrication on the propulsion system should be checked every month, or when replacing a propeller. Power trim fluid should be inspected every boating season, along with steering system lubrication, oil change, and filter changes.

CHECKING ENGINE OIL & DRIVE OIL / GEAR LUBE

To check the engine oil on your engine, locate the dipstick normally near the oil fill and normally colored yellow. Remove the dipstick and check that the oil level is between the two marks on the dipstick. Wipe clean with a rag before rechecking the oil level. Add the recommended oil to the reservoir located by the yellow color coded cap. Check the level again with the dipstick to confirm the proper engine oil level. Be sure all rags used are disposed of according to environmental laws.

DO NOT overfill your engine or stern drive with oil. Ensure that when checking drive oil your stern drive is entirely in the down position; and when checking the engine oil, ensure the your boat is level in the water. If the color is milky in appearance, there probably is water in the unit caused by a leaking seal. No metal flakes should be present in the oil. If these conditions exist, contact a Regal dealer and avoid operation until the problem is fixed to ensure minimal property damage. Be sure only to add approved oil by your engine manufacturer as described in your engine owner's manual.

Volvo based systems normally have a dipstick located near the top of the engine, while Mercury systems often have a dipstick mounted on the bottom of the engine. Both manufacturers normally identify oil dipsticks or fill caps with a yellow color.

Chapter 7

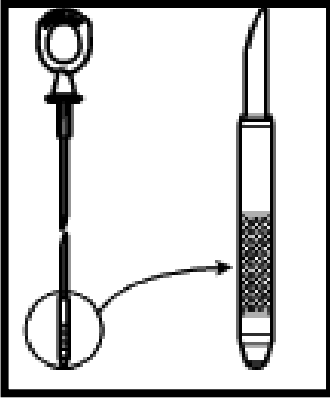

Typical Volvo Engine Oil Dipstick

Typical Mercury Engine Oil Dipstick

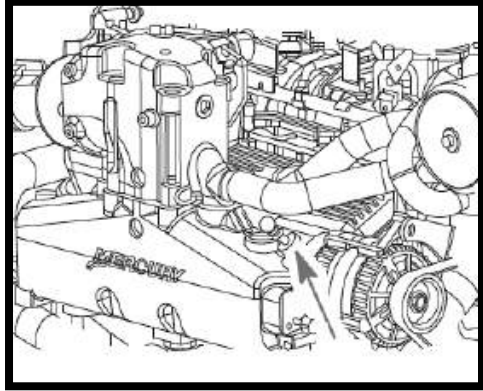

CHANGING ENGINE OIL, DRIVE OIL, & FILTERS

Changing engine oil and drive oil requires special tools carried by your Regal dealer. It is best to contact your Regal dealer for oil changes as required. When they change the oil, the oil filter should be changed as well. When the oil is changed, the oil sensor on the stern drive must also be reset.

CHECKING POWER STEERING FLUID

Ensure the engine is off and cold before checking power steering fluid. Locate the power steering fluid reservoir and check that the fluid within is its normal color and level. Discolored fluid may suggest water infiltrating the power trim system. This fluid normally does not need to be replaced or topped off. Fluid increases may also be a sign of water in the power trim fluid, while fluid loss may be a sign of a leak. If water presence is discovered, contact your Regal dealer.

Care & Maintenance

Volvo based systems normally keep the power steering reservoir mounted on the engine near the serpentine belt. Volvo systems place two marks on the exterior of the translucent reservoir to make checking the fluid easy. Mercury systems normally keep their reservoir in a similar location. Mercury systems allow the user to check power steering fluid with the engine warm or cold, using specified markings on the dipstick located inside the filling cap. The level when cold should be at the bottom tip of the dipstick, while at the middle of the dipstick when warm. See the figures below for details regarding the proper level for the Volvo or Mercury based system. Both manufacturers normally identify power steering fluid with an orange-brown color.

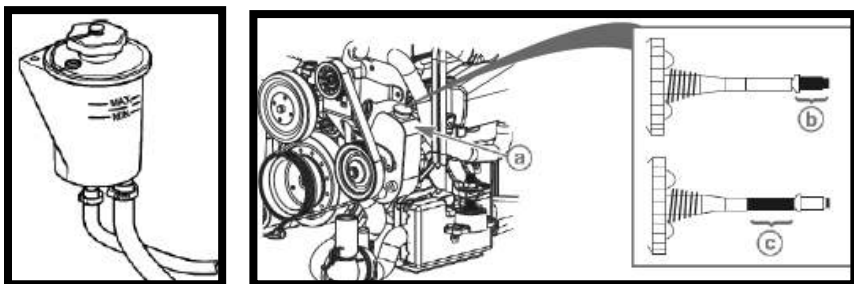

Typical Volvo Power Steering Fluid Fill

Typical Mercury Power Steering Fluid Fill

Engine Electrical System

The maintenance on engine electrical systems is designed to be minimal. Electrical problems should be handled by your Regal dealer or marine professional as they crop up. Routine maintenance for engine electrical systems is limited to keeping a good battery hooked up at all times. Beyond the possible replacement of a bad battery, when fuses “blow”, the engine should be inspected by your Regal dealer before replacing the fuse. Beyond this, your engine computer should be cleared of codes annually by your Regal dealer.

Chapter 7

STERN DRIVE MAINTENANCE

Each engine and stern drive package is unique and quite complex. A select portion of the maintenance items are covered in this chapter including basic periodic maintenance and lubrication specifications. Refer to your propulsion manufacturer's owner's manual for complete details and specific information about your propulsion system maintenance schedule and break-in. The information presented here is merely a guide to be used on typical packages, and may not directly apply to your stern drive unit. When performing your own maintenance, only use marine approved parts on your stern drive. Also **DO NOT** use lubricant or fluids not approved by the manufacturer.



WARNING

PREVENT INJURY OR DEATH! USE ONLY MANUFACTURER APPROVED MARINE REPLACEMENT PARTS THAT ARE IGNITION PROTECTED.

Marine Approved Replacement Parts Warning

Stern Drives

Your stern drive requires maintenance just like your engine. Stern drives require daily, weekly, monthly, and yearly inspections to keep your equipment in optimal form.

CHECKING THE WATER PICK-UP FEEDS

Your water pick-up feeds are normally located on your sterndrive. They consist of a series of holes that raw water can flow through, where it will be picked up by your cooling system. Ensure that these are not blocked before each trip, or you will risk engine failure.

Care & Maintenance

CHECKING THE BELLOWS

The rubber insulating part of your stern drive (bellow) that harbors equipment should be kept clear of debris and replaced if ripped. If water enters the stern drive here, have the drive inspected by a marine professional or your Regal dealer.

CHECKING DRIVE OIL / GEAR LUBE

Furthermore, your gear box requires lubricant to function. Drive oil, sometimes called gear lube, needs to be inspected at each trip. The drive oil is inspected much like engine oil. Either with a dipstick, or by reading straight from the container, lubricant must be kept between the minimum and maximum limits at all times. The level of your drive oil may vary through the course of stern drive operation, so check your drive oil with the drive trimmed fully down and with the system cold. Discolored fluid suggests a water leakage problems. If discolored drive oil presents itself, contact your Regal dealer.

Volvo normally places the drive oil dipstick on top of the stern drive, while Mercury makes the reservoir accessible on the engine.

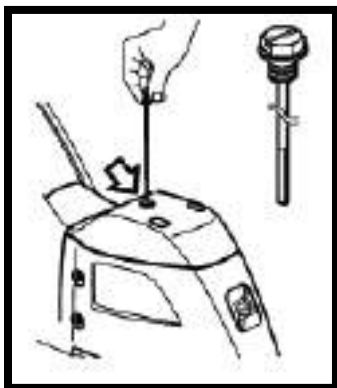

Typical Volvo Drive Oil Dipstick

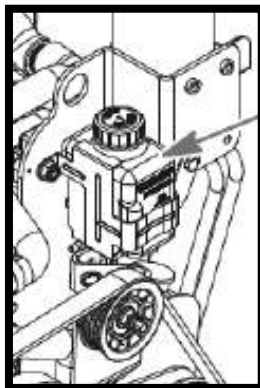

Typical Mercury Drive Gear Lube Fill

Chapter 7

CHECKING POWER TRIM FLUID

Ensure the engine is off and cold before checking power trim fluid. Locate the power trim fluid reservoir and check that the fluid within is its normal color and level. Discolored fluid may suggest water infiltrating the power trim system. This fluid normally does not need to be replaced or topped off. Fluid increases may also be a sign of water in the power trim fluid while fluid loss may be a sign of a leak. If water presence is discovered, contact your Regal dealer.

Volvo based systems normally have power trim fluid located on the stern drive mounted to the transom, while Mercury systems normally have a reservoir mounted in the engine compartment.

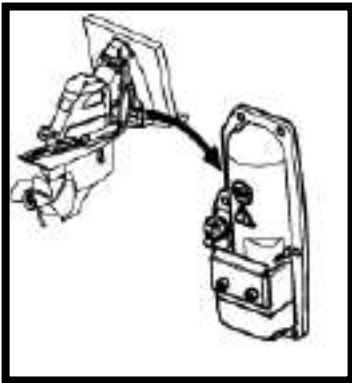

Typical Volvo Power Trim Fluid Reservoir

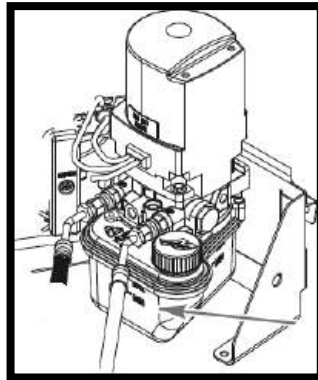

Typical Mercury Power Trim Fluid Reservoir

CHECKING YOUR ANODES

Water acts as an excellent conductor. In certain situations, it is possible to have electric current leak out into the water. This risk particularly presents itself around marinas with shore power. The added electricity to the water speeds up chemical reactions that take place between your boat and the water. This process is known by

Care & Maintenance

boaters as electrolysis. Zinc is a relatively cheap conductor compared to other metal used on your propeller and stern drive. Due to zinc's higher electric potential, electric current in the water will commonly flow to your sacrificial zinc anodes as opposed to your propeller. With the electric current concentrated around your zinc anodes, electrolysis attacks these anodes before attacking other more noble metals. Zinc anodes in saltwater need to be checked more frequently due to the higher potential of electrolysis accelerating corrosion.

With electrolysis targeting these anodes, they must be inspected and replaced often so that an electric current leak continues to target these anodes as opposed to your stern drive. Zinc anodes should be replaced when 30% deteriorated. For the exact location of these anodes, check your stern drive owner's manual. If electrolysis continually targets your anodes while docked at a marina, contact the marina personnel to resolve the issue.

Damage due to neglecting anode inspection service is not covered under Regal or engine manufacturer warranty.

Propellers

Out of balance or nicked props will effect performance or cause vibration. Damaged props should be replaced, but those that are chipped or bent can usually be reconditioned by a marine dealer or a propeller repair facility. When cruising, consider carrying a spare prop on board because many marinas do not offer a full inventory of replacement propellers. Refer to the manufacturer's engine owner's manual for appropriate stern drive propeller replacement.

Be sure to make a note of the propeller diameter and pitch while the vessel is in dry dock. They are pressed into the prop for easy reading. In an emergency, an aluminum propeller blade can be straightened by laying the propeller on a 2 x 4 piece of wood and hammering the

Chapter 7

bent portion of the blade until straight. This procedure will assist the operator in reaching port in order to fully repair / re-pitch the propeller.

Use the following procedure to remove single stern drive propellers. This method provides a safety margin from sharp propeller blades - especially those with stainless steel propellers. The 2 x 4 when laid across the ventilation plate allows safe removal of propellers. With Volvo SX drives, remove the propshaft cotter key and splined washer first to access the nut. With MerCruiser Alpha Drives, make sure the washer tabs are bent up before trying to remove the prop nut. Turn your prop wrench counter-clockwise to loosen and clockwise to tighten.

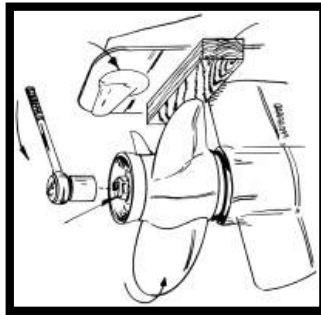

Typical Propeller Change

TYPICAL VOLVO PROPELLER INSTALLATION

To install a propeller on a volvo equipped propulsion package:

- 1) Coat the propeller shaft with the recommended marine lubricant.
- 2) Place the thrust bushing on the prop shaft with inner taper toward the gear case to match the taper on the propeller shaft.

Care & Maintenance

- 3) Slide propeller on shaft completely.
- 4) Place thrust washer on propeller shaft splines.
- 5) Shift the remote control into reverse with the key switch in the off position.
- 6) Install and tighten the propeller nut to manufacturer specifications.
- 7) Install keeper on prop nut until aligned with cotter key hole. Install cotter key and bend tabs over.

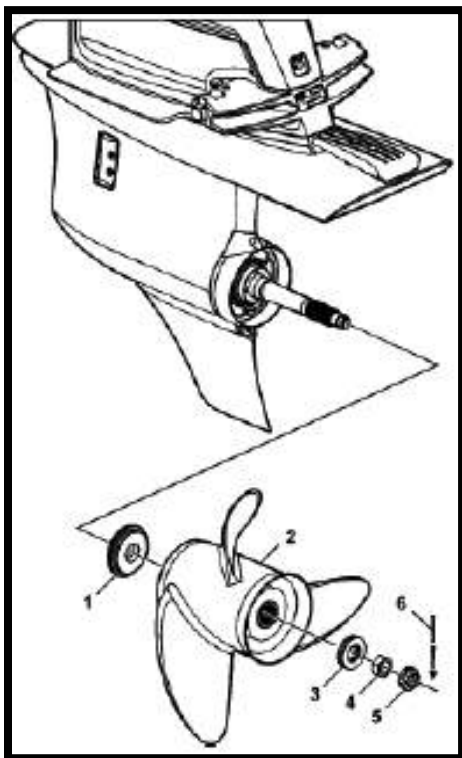

- 1) Thrust Bushing
- 2) Propeller
- 3) Thrust Washer
- 4) Propeller Nut
- 5) Keeper
- 6) Cotter Key

Typical Volvo SX Installation

Chapter 7

TYPICAL MERCURY PROPELLER INSTALLATION

To install a propeller on a mercury equipped propulsion package:

- 1) Coat the propeller shaft with the recommended marine lubricant.
- 2) Place the forward thrust hub on the prop shaft with the taper matching the taper on the propeller shaft.
- 3) Slide drive hub on, with the propeller installed over that.
- 4) Place the drive sleeve adapter in place
- 5) Place the tab washer on
- 6) Install locknut to manufacturer specifications.

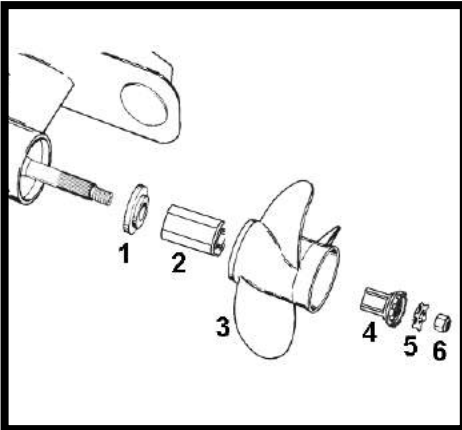

- 1) Forward Thrust Hub
- 2) Flo-Torque Drive Hub
- 3) Propeller
- 4) Drive Sleeve Adapter
- 5) Tab Washer
- 6) Locknut

Typical MerCruiser Alpha Drive Installation

Care & Maintenance

EQUIPMENT MAINTENANCE

Your Regal comes with important equipment that may also require periodic maintenance to ensure it functions when needed. Be sure to check your owner's manuals for the installed equipment to make sure you follow the manufacturer's directions.

Steering

Regal boats use rack or rotary style systems that feature a cable with assistance through the engine power steering pump. As you turn the wheel, the force is applied through the system to a hydraulic cylinder attached to the engine rear and attached through the engine power steering pump hoses.

When the engine is running, check the engine power steering pump level before each outing. Add the appropriate power steering fluid. Periodically inspect the entire steering system for tightness and signs of wear and leaks including the steering wheel. Lubricate the steering shaft at the engine. Refer to the engine owner's manual for additional information about maintenance schedules and procedures.

Battery

Frequently check your battery terminals for corrosion build-up. If you find a greenish powdery substance, remove the cable connections and clean both terminals and the connectors with a wire brush. When the cleaning is finished, reconnect the battery cables and coat the terminals with an approved grease or petroleum jelly to help prevent further corrosion. Check the electrolyte level at least every 30 days, but more often in hot weather. The level should be maintained between the top of the battery plates and the bottom of the fill cap opening.

Chapter 7

Add only distilled water after charging the batteries or periodically as needed. Distilled water contains no mineral residues and therefore is noncorrosive. **DO NOT** overfill because sulfuric acid could run over and cause burns or an explosion.



WARNING

PREVENT BODILY INJURY! WEAR GOGGLES, RUBBER GLOVES, AND A PROTECTIVE APRON WHEN WORKING WITH A BATTERY. BATTERY ELECTROLYTES CAUSE SEVERE EYE DAMAGE AND SKIN BURNS. IN CASE OF CONTACT, WASH AREA WITH A SOLUTION OF BAKING SODA AND WATER.

Battery Warning



WARNING

PREVENT BODILY INJURY! BATTERIES CONTAIN SULFURIC ACID (POISON) WHICH CAN ALSO CAUSE BURNS. AVOID CONTACT WITH SKIN, EYES, AND CLOTHING. IF CONTACTED, FLUSH WITH WATER AT LEAST 15 MINUTES. IF SWALLOWED, DRINK LARGE AMOUNTS OF WATER OR MILK. FOLLOW UP WITH MILK OF MAGNESIA, BEATEN EGG, OR VEGETABLE OIL. GET MEDICAL ATTENTION IMMEDIATELY.

Sulfuric Acid Warning

Binnacle Control Lever _____

The control cables at the helm control box and the cable attachments at the engine should be tight and shift without binding. Shift and throttle cables at both the helm and engine areas must be checked on a periodic basis. At the helm area, check to make sure the control box

Care & Maintenance

hardware is tightly secured. At the engine end, make sure all control cable hardware is tight and control cable engine brackets are secure. An application of silicone spray on the cable ends periodically will keep control cables working freely and fights corrosion. Contact a marine professional or Regal dealer for further assistance.

Seating

Inspect all fasteners and metal for fatigue. Lubricate the slider track with a marine type lubricant only. Use silicone spray for areas that cannot be accessed with the lubricant. Check all fasteners periodically for tightness and the effects of corrosion especially in moist environments.

Bilge Pump

The bilge pump is installed in the engine compartment just below the engine. Check for foreign materials stuck in the strainer area or discharge hose. Check all clamps and electrical connections for tightness. A quick check of the bilge pump automatic float switch is afforded by lifting up on the float and listening for the pump operating. Look around the float area for foreign debris and remove as necessary.

It may sometimes become necessary to replace the bilge pump impeller. Unfasten the bilge pump housing from the unit by pressing on the quick release tabs on the grate and pulling up, similar to a quick disconnect clip on a backpack. Remove the o-ring and access the impeller. Remove any debris lodged in the impeller and replace if fractured in any form. Then reinstall the unit as before. The bilge pump impeller should be changed as often as every couple years.

Chapter 7

Circuit Breakers / Fuses

The fuse panel is found in the starboard bow storage locker in front of the helm. Open the bow backrest to access the panel. The helm or sometimes called the dash, features fuses for each system it controls. A fuse is recognized as a color coded piece inserted into the fuse block. Should a piece of equipment linked to the fuse start to draw more power than normal, the thin piece of wire in the fuse will melt and “blow” the fuse. After determining and fixing the system fault, replace the fuse with one of the same size to complete the circuit and protect the equipment once more. Fuses are located on the dash fuse box, underneath the dash, on the engine, and in the engine compartment, while some circuit breakers are located on the ignition panel and/or the engine itself depending on the manufacturer.

Stereo

The stereo requires little maintenance. Keep the cover closed as it protects the unit from water, dirt, and ultra-violet damage. When washing the interior, **DO NOT** discharge water directly at the cover or stereo unit. **DO NOT** discharge water into the speakers either. For further information, refer to your stereo owner’s manual.

Blower

Check the blower hoses to ensure they are fastened in the bilge properly and that there are no holes in them. The exhaust hose connected to the blower needs to be at least 3/4 of the way into the bilge to evacuate fumes properly. Check to ensure the blower hoses are free from any traps. All vents need to be checked for debris as well.

Make sure the blower motor is securely fastened and all hose clamps and tie wraps are tight. Periodically, tighten electrical connectors.

Care & Maintenance

MAINTENANCE CHECKLISTS

The information presented here is merely a guide to be used on typical engines, and may not directly apply to your engine package. Refer to your engine owner's manual for complete details and specific information about your engine's maintenance schedule.

Volvo Maintenance Guide _____

Volvo recommends strictly following their maintenance schedule to ensure proper functionality and longevity of your engine.

VOLVO MAINTENANCE GUIDE					
CHECK	EVERY TRIP	EVERY MONTH	EVERY YEAR / 100 HRS	EVERY 2 YEARS	EVERY 3 YEARS
Cooling System - Leaks	•				
Cooling System - Flush System	•				
Cooling System - Water Pick-Up Feed Unblocked	•				
Fuel System - Leaks, Pump Functionality	•				
Lubrication System - Check Engine Oil	•				
Lubrication System - Power Steering Fluid Leaks, Discoloring, Level	•				
Anodes - Check & Replace if 30% Eroded	•				
Power Trim - Functions At Helm	•				
Emergency Stop Switch & Lanyard - Functions At Helm	•				

Chapter 7

VOLVO MAINTENANCE GUIDE

CHECK	EVERY TRIP	EVERY MONTH	EVERY YEAR / 100 HRS	EVERY 2 YEARS	EVERY 3 YEARS
Binnacle Control Lever - Functions At Helm	.				
Batteries - Hold Charge, No Corrosion		.			
Lubrication System - Stern Drive Oil		.			
Stern Drive Bellows - Wear or Leaks		.			
Exhaust Hoses - Loose Clamps or Wear		.			
Propshaft, Props & Hub - Damage, Corrosion, Lubricate Propshaft		.			
Cooling System - Wear or Leaks			.		
Cooling System - Replace Impeller in Raw Water Pump			.		
Fuel System - Fuel Filter Change			.		
Fuel System - Fuel Pump Function, Leaks			.		
Lubrication System - U-Joint & Spline Wear, Corrosion, Lubrication			.		
Lubrication System - Engine Oil Change and Oil Filter Change			.		
Lubrication System - Power Steering Fluid Level			.		
Lubrication System - Steering System Operational and Lubricated			.		
Serpentine Belt Wear and Tension			.		
* PCV Valve - Check for Operation			.		

Care & Maintenance

VOLVO MAINTENANCE GUIDE					
CHECK	EVERY TRIP	EVERY MONTH	EVERY YEAR / 100 HRS	EVERY 2 YEARS	EVERY 3 YEARS
Flame Arrestor - Clean & Secure			.		
Anodes - Check & Replace if 30 % Eroded			.		
Stern Drive Bellows - Wear or Leaks			.		
Exhaust Hoses - Loose Clamps or Wear			.		
Exhaust Manifold, Risers, Pipes - Corrosion, Damage, Leaks			.		
Distributor Cap - Corrosion			.		
Binnacle Control Lever - Functions At Helm			.		
Power Trim - Functions At Helm			.		
Engine Computer - Clear Codes			.		
Check for Recalls - Call Dealer for Updates			.		
Stern Drive Bellows & U-Joint - Replace				.	
Exhaust Hoses - Replace				.	
Spark Plugs - Replace					.

Typical Volvo Maintenance Guide

* Not Used On All Volvo Engine Models

Chapter 7

Mercury Maintenance Guide _____

Mercury recommends strictly following their maintenance schedule to ensure proper functionality and longevity of your engine.

MERCURY MAINTENANCE GUIDE					
CHECK	EVERY TRIP	EVERY WEEK	EVERY 2 MTHS.	EVERY YEAR / 100 HRS	EVERY 3 YEARS
Cooling System - Flush System	•				
Lubrication System - Check Engine Oil	•				
Lubrication System - Stern Drive Oil	•				
Lubrication System - Power Steering Fluid Leaks, Discoloring, Level	•				
Power Trim - Functions At Helm	•				
Binnacle Control Lever - Functions At Helm	•				
Cooling System - Water Pick-Up Feed Unblocked		•			
Fuel System - Leaks, Pump Functionality		•			
Anodes - Check & Replace If 30% Eroded		•			
Batteries - Hold Charge, No Corrosion		•			
Propshaft, Props, & Hub - Damage, Tightness, Lubricate Propshaft			•		
Engine Corrosion Guard			•		
Cooling System - Wear or Leaks				•	
Cooling System - Replace Impeller, Clean				•	

Care & Maintenance

MERCURY MAINTENANCE GUIDE					
CHECK	EVERY TRIP	EVERY WEEK	EVERY 2 MTHS.	EVERY YEAR / 100 HRS	EVERY 3 YEARS
Fuel System - Fuel Filter Change				•	
Fuel System - Fuel Pump Function, Leaks				•	
Lubrication System - U-Joint & Spline Wear, Corrosion, Lubrication				•	
Lubrication System - Lubricate Gimbal Bearing & Engine Coupler				•	
Lubrication System - Drive Oil / Gear Lube Change				•	
Lubrication System - Engine Oil Change & Oil Filter Change				•	
Exhaust Hoses - Loose Clamps or Wear				•	
Lubrication System - Power Steering Fluid Level				•	
Lubrication System - Steering System Operational & Lubricated				•	
Check Ignition Parts, Timing				•	
PCV Valve - Replace				•	
Flame Arrestor - Clean & Secure				•	
Serpentine Belt - Wear & Tension				•	

Typical Mercury Maintenance Guide



Notes

Troubleshooting

The following diagnostic information will assist you in identifying minor electrical, fuel, and mechanical problems. Some of the items listed require technical training and tools. Additional assistance is available in the engine manufacturer's owner's manual. Also, you can contact your closest Regal dealer or marine professional for more information. Most defects can be found by doing a logical sequence of elimination



WARNING

PREVENT INJURY OR DEATH! USE ONLY APPROVED MARINE REPLACEMENT PARTS THAT ARE IGNITION PROTECTED.

Marine Approved Replacement Parts Warning



WARNING

PREVENT INJURY OR DEATH! BEFORE PERFORMING ANY MAINTENANCE WORK, TURN OFF THE BATTERY SWITCH AND REMOVE THE IGNITION KEY FROM THE SWITCH.

Ignition Warning

Chapter 8

ENGINE & STERN DRIVE DIAGNOSTIC CHART

Problem	Possible Cause
Engine Overheating	Water pick-up feeds are blocked by debris Cooling system drain plugs not installed Cooling system leak Impeller is damaged or blocked by debris Propeller is over propped for the circumstances, causing the engine to work extra hard Debris in oil is holding heat more than normal - bad oil filter Bad thermostat or gauge Raw water cooling system has corroded from raw water left in the system
Low Oil Pressure	High oil level Low oil level Oil system leak Drive oil sensor not reset at last oil change Increased engine temperature (see engine overheating)
Engine Will Not Crank	Binnacle control lever not in neutral Emergency stop switch activated

Troubleshooting

ENGINE & STERN DRIVE DIAGNOSTIC CHART	
Problem	Possible Cause
	Battery switch turned off Battery is weak Fuses are blown on the engine Bad ignition relay / ignition switch
Engine Cranks But Will Not Start	Fuel tank vent obstructed Low battery level Inadequate fuel level Inadequate fuel pump pressure Fuel tank vent blocked Water in fuel Spark plugs have a bad gap Distributor malfunction
Hard Starting	Flooded Engine Fuel lines obstructed Water in fuel Debris in fuel - bad fuel filter
Engine Runs Rough	Bad fuel quality Inadequate fuel pump pressure Water or debris in fuel

Chapter 8

ENGINE & STERN DRIVE DIAGNOSTIC CHART

Problem	Possible Cause
	Manifold vacuum leak
Stern Drive Groans	Not enough lubricant on drive shaft or in drive Bad gimbal bearing due to water in bellows Poor engine alignment
Excessive Vibration	Drive prop was grounded, bent, or destroyed Engine mounts loose / broken Bad oil quality / type Distributor cap / rotor corroded Loose serpentine belt Bad alignment
Water In Oil / Power Trim / Power Steering Fluid	Could be any number of problems - Contact your Regal dealer

Engine And Stern Drive Diagnostic Chart

Troubleshooting

CONTROL SYSTEM DIAGNOSTIC CHART	
Problem	Possible Cause
No Reading On Gauge or Gauge Is Inaccurate	Faulty gauge Faulty wiring to gauge Faulty sender
Gauge Reads Erratic	Loose ground or hot wire connection
Binnacle Control Lever Stiff / Inoperative / Stalls When Shifting	Shift system bushings and seals broken Kinked, broken, damaged cable Friction brake is too tight and must be loosened Control box jammed
Depth Gauge Inaccurate	Blocked transducer sight hole Bad gauge Bad transducer
Stern Drive Trim Not Functioning	Bad motor in trim control unit Faulty wiring Water in bellows / power trim fluid
Steering System Not Functioning	Uneven load Poorly lubricated steering system Lack of power steering fluid Kinked, broken, damaged cable

Control System Diagnostic Chart

Chapter 8

ELECTRICAL SYSTEM DIAGNOSTIC CHART

Problem	Possible Cause
No 12 Volt Power At Battery	Battery switch turned off Weak or dead battery Battery cables disconnected from storage Bad voltmeter or voltmeter connection
Battery Not Charging While Engine Is Running	Loose / damaged serpentine belt Faulty alternator - check with volt meter Faulty volt meter
Battery Will Not Hold Charge	Faulty / old battery
12 Volt Equipment Not Working	Fuse blown - investigate why the equipment was drawing too much current or why it had a circuit short. Check fuses in dash fuse box, underneath the dash, and in the engine compartment Weak or dead battery if all 12v equipment fails to function Corroded / loose wire connection Internal equipment short / failure

Electrical System Diagnostic Chart

Troubleshooting

BILGE & DRAINAGE SYSTEM DIAGNOSTIC CHART

Problem	Possible Cause
Bilge Pump Not Functioning Automatically	Float switch jammed - check for debris Automatic bilge pump fuse blown - investigate why the equipment was drawing too much current or why it had a circuit short Battery connection corroded Impeller is damaged or blocked by debris Bad bilge pump motor Bilge pump discharge hose blocked
Bilge Pump Not Functioning Manually	Battery switch turned off Bilge pump dashboard fuse blown - investigate why the equipment was drawing too much current or why it had a circuit short Battery connection corroded Bad bilge pump switch Impeller is damaged or blocked by debris Bad bilge pump motor Bilge pump discharge hose blocked

Bilge And Drainage System Diagnostic Chart

Chapter 8

STEREO DIAGNOSTIC CHART

Problem	Possible Cause
No Power At Stereo	Battery switch turned off Fuse is blown - investigate why the equipment was drawing too much current or why it had a circuit short. Check ignition panel breaker, memory fuse in engine compartment, memory fuse underneath dash, and ignition protection fuse underneath dash Water in unit
Stereo Will Not Play	Water in unit Radio Signal Unavailable Bad antenna Mode selection isn't correct
Stereo Memory Lost	Stereo memory fuse in engine compartment or underneath dash is blown - investigate why the equipment was drawing too much current or why it had a circuit short
No Output Sound / Volume Is Low / Sound Is Distorted	Balance and max volume settings are limiting the speaker volume - adjust zone settings and setup settings Rotary encoder malfunction Loose speaker wire Water in speakers
Added Performance Package Speakers Working Only	Amplifier fuse blown - investigate why the equipment was drawing too much current or why it had a circuit short

Troubleshooting

STEREO DIAGNOSTIC CHART	
Problem	Possible Cause
	Standard zone max volume settings are low Loose speaker wire connections Water in cockpit speakers
Standard Speakers Working Only	Added speaker zone max volume settings are low Loose speaker wire connection Water in bow speakers
iPod Not Working	iPod not plugged in properly using appropriate sleeves iPod mode not selected Internal iPod problem
LCD Screen Not Displaying	Water in unit

Stereo Diagnostic Chart

Chapter 8

AUDIBLE ALARMS

It is important to read the engine owner's manual to diagnose engine alarms and faults. Depending on the propulsion package you chose to equip on your Regal, alarm sounds can vary.

On your Regal boat, your engine sounds an alarm in the case of one of the following causes:

- Low Oil Pressure
- Engine Overheating

To quickly diagnose these problems, look at the multi-gauge equipped on your vessel. Monitor the oil pressure gauge and temperature gauge, and troubleshoot accordingly. Be wary of faulty gauges however, and investigate the problem at the engine.

Storage & Winterization

Storage procedures are outlined in this chapter. These are general guidelines to follow before longer periods of storage such as over the winter in colder climates. Be sure to familiarize yourself with all relevant information in the owner's pouch. Special winterization procedures are necessary for the boat equipment and systems. Use the enclosed checklists to help you identify areas of concern and maintenance. These lists cover land stored boats either inside or outside. Call a Regal dealer or marine professional for further information.



WARNING

EXPLOSION, FIRE, AND POLLUTION HAZARD! DO NOT FILL FUEL TANK TO RATED CAPACITY. LEAVE ROOM FOR EXPANSION TO AVOID RUPTURE.

Fueling Warning



WARNING

PREVENT ENGINE DAMAGE! USE ONLY ETHYLENE GLYCOL BASED ANTIFREEZE. DO NOT USE ALCOHOL BASED PRODUCTS. IT IS HIGHLY FLAMMABLE UPON START UP.

Avoid Alcohol Based Antifreeze Warning



CAUTION

REMOVE BATTERY(IES) WHEN VESSEL IS IN LONG PERIODS OF STORAGE. BEFORE YOU REMOVE THE BATTERY, TURN OFF THE IGNITION SWITCH ALL ELECTRICAL SWITCHES, AND BATTERY SWITCH.

Battery Caution

DECOMMISSIONING CHECKLIST

Engine

- Run engine. Pour a fuel stabilizer / conditioner in the fuel tank. Allow time for it to circulate through the fuel system to stabilize the fuel for storage. Then turn off the engine and remove the key for further decommissioning.
- Check engine alignment.
- Lubricate shift cables as directed by engine owner's manual.
- Flush cooling system with freshwater (see care and maintenance section). Then fully drain the cooling system. Locate and remove all cooling system drains, normally mounted on the bottom of your engine and colored blue. Allow all water to completely drain before reinstalling the drain plugs. Loosen the hose clamps on the hoses connected to the water pump and disconnect the hoses. Disconnect the hose from any circulation pump, and remove the cooling hose at the thermostat housing.

Storage & Winterization

- Change engine oil, drive oil, oil filter, and fuel filter, along with any other fluids recommended by your engine manufacturer's owner's manual.
- Perform additional engine seasonal/yearly maintenance as required.
- Spray all exterior parts with a rust preventative.

Sterndrive

- Remove propellers as directed in the care and maintenance chapter and store in a dry location. Refurbish as needed.
- Remove drive to inspect bellows for water. Inspect engine coupler and gimbal bearing for signs of wear. Replace components as required, then reinstall the stern drive.
- Touch up paint on stern drive upper and lower gear housings as required.
- Apply a coat of wax to stern drive.
- Perform additional stern drive seasonal/yearly maintenance as required.

Boat

- Check hull bottom for any fiberglass damage. Repair as needed.
- Pour a pint of 50/50 antifreeze into bilge pump and circulate.

Chapter 9

- Remove battery(ies). Charge and refill batteries with distilled water as required to maintain an appropriate charge. Consider a trickle charge for winter storage, or check the battery monthly to maintain charge levels. Seek directions from the battery manufacturer.
- Remove all loose gear from the boat such as life jackets etc. Inspect all safety equipment and store in a cool, dry environment.
- Remove all water from bilge by use of the drain plug. Clean drain plug hole of debris as needed. Store the drain plug in a plastic bag tied to the steering wheel so as not to forget it upon recommission. Make sure the bow is higher than the stern to permit proper drainage throughout storage.
- Clean all upholstery and store so it breaths. All canvas should be stored in a cool dry location as well.
- Conduct a visual inspection to ensure the boat is balanced properly on the trailer, cradle or blocks.
- Apply a coat of wax to hull and deck surfaces.
- Perform additional boat seasonal/yearly maintenance as required.
- Cover boat with a tarp/storage cover. Tie down for wind protection if outside. Prop tarp up as needed to provide proper ventilation. Be sure not to let the cover sag and collect water. Be sure not to cover up fuel vents.

Storage & Winterization

Trailer

- Repack all wheel bearing per manufacturer's specifications.
- Check all trailer parts for excessive wear. Replace/refurbish as needed.
- Use touch up paint on trailer as needed.
- Lubricate all moving parts as needed.
- Block the trailer up to remove some of the strain on the wheels.
- Install a coupler lock to prevent theft.

RECOMMISSIONING CHECKLIST

Engine _____

- Replace all cooling system components in their original operating position
- Finish performing all engine seasonal/yearly maintenance as required. Replace damaged parts as required.
- Ensure water hasn't entered the oil, fuel, power steering, or power trim reservoirs. Contact your Regal dealer if water is present.
- Run the engine before launching. Check for leaks in cooling, fuel, and lubrication systems. Also ensure the engine is clear of codes.

Sterndrive _____

- Finish performing all stern drive seasonal/yearly maintenance as required.
- Install the propellers as described in the engine owner's manual.
- Ensure anodes are replaced when 30% deteriorated.
- Run the sterndrive before launching. Check for leaks in its systems.

Storage & Winterization

Boat

- Finish performing all boat seasonal/yearly maintenance as required.
- Install drain plug after ensuring water has been drained.
- Install battery(ies) and tighten all terminals.
- Check all control systems, equipment, switches, alarms, gauges, and fuses for proper operation.
- Make sure all safety gear is onboard and in good working condition.

Trailer

- Make sure all equipment is in excellent working condition.



Notes

Trailer

This chapter covers trailer basics including equipment, maintenance, and maneuvering techniques. **Check with state and local agencies for detailed information on required equipment, safety issues, and trailer licensing.**

BEFORE TRAILERING

Trailer Condition

Before trailering your boat, be sure to check the air pressure of your tires for the recommended inflation rating. Also, be certain that your tow vehicle is in good working order.

Check all lights to ensure they are in good working order. Trailers come with an electrical harness that plugs into your vehicle. Some vehicles may require a towing adapter for special electrical harnesses. You may find it helpful to ask someone to check your turn signals, brake lights, and towing lights while you remain in the vehicle applying them. Your Regal also features a towing electrical connection at the bow next to the navigation light.

Check the trailer harness often for signs of fraying. Check the harness connector for corrosion. Make sure the trailer harness when connected to the trailer has enough slack for turning.

Chapter 10

Check the trailer tires often for voids, excessive wear, or out of round tire conditions. If the trailer seems to vibrate, you may have a bad tire or one that is unbalanced. These wheels can be rebalanced at most automotive or tire shops. **NEVER** pull a boat on a patched tire. Buy a spare tire and wheel. Mount it on the trailer for speedy installation should a blow out occur.

Check the trailer lug nuts for the proper torque. Use a foot pound wrench and torque the lug nuts at opposite ends of the wheel in a star sequence to the correct poundage as recommended by the trailer manufacturer. This ensures the wheel is evenly tightened into place on the axle and the wheel will stand straight up. Torque the lug nuts at half the poundage on all nuts first, then set the torque wrench to the full poundage and torque to the last foot poundage figure as specified by the manufacturer. This also helps ensure your wheel is straight.

Check the wheel bearings for wear periodically by a professional. On most trailers, there is a fitting on the wheel hub to add the proper lubricant to the wheel bearing with a grease gun that can be purchased at a supply house or marine store.

Should your trailer be equipped with surge brakes on the trailer that cut in with a very slight delay when your brakes are applied, be sure to follow recommended service and maintenance instructions. Be sure that the trailer master cylinder is filled with the recommended fluid before trailering your boat. Inspect the trailer brake lines for any leakage. Also, if you notice brake fluid on the inside of the tires, you may have a wheel cylinder leaking. Consult a professional.

Securing Your Boat

Be certain that your trailer is of rated capacity for the size and weight of your boat, including the weight of all fuel, water, and gear. Your authorized Regal dealer can advise you on the proper trailer capacity

Trailer

and tongue weight (the weight exerted on the rear of your vehicle).

Give consideration to the weight distribution of your trailer. If the rear end of your vehicle sags, chances are the load is positioned too far forward on your trailer. This can make it especially difficult to drive safely as the hitch may be in danger of striking the road. This situation can also be caused by worn rear shock absorbers. One option is to install a set of air shocks which will assist in supporting the load. As a rule of thumb, 5 to 7 percent of the total trailer load should be on the trailer tongue.

Be certain that the trailer winch cable is securely attached to the boat's bow eye and the cable lock is engaged. Make sure the bow of the boat is snug against the bow stop at the winch stand. It is a good idea to tie another line or secure an extra cable to the winch stand and boat bow eye as a backup system. Be sure to buy a suitable set of tie downs that can be attached to both the boat's stern eyes, located on the transom and the eyelets provided on most boating trailers. Tighten them securely and neatly fold up the extra strap material and secure it with tape so it doesn't loosen and dangle on the road.

Stow all gear to be carried properly, especially heavy items such as batteries or anchors. Be sure these items are secured. Don't overload and try to carry too much on your trailer. All loose gear should be stored in the storage areas. Any optional equipment such as the bimini top or sport tower should be stored in the boot and in the collapsed position and properly secured on your boat to avoid property damage or injury. The bimini top or sunshade if equipped should be rolled up, in their boot, and clipped to their support structures. Optional canvas like the bow or cockpit covers, and the cockpit carpet, should be removed from the boat and stored securely while traveling. The only cover available for use while towing is the storage / tow cover made specifically for your boat. The ratchet system when tightened correctly will hold the cover in place while towing.

Chapter 10

Tilt the sterndrive up to clear the road and any bumps that might occur while in transit. Standard boats operate the trim from the helm.

Optional Transom Trim / Tilt Switch

You Regal has the option to be equipped with a transom trailer switch. If equipped, this switch is located on the transom of your boat, above the swim platform, normally on the port side. This switch maneuvers the drive up by pressing the upper portion of this switch, and down while pushing the lower portion of the switch. The close access to the ground makes this switch most useful when trimming the stern drive up for trailering without having to climb up to the helm of the boat.



Transom Trim Switch

Securing Your Trailer

Start with the parking jack up high enough that the tongue of the trailer extends over the trailer hitch securely mounted to your vehicle. Most trailer hitches use a pin and keeper system to connect to a vehicle. Your hitch should also have a location for each of the safety chains to be mounted. If these locations are not available on your hitch, most towing packages include a location for safety chains on your vehicle if your vehicle's towing package is equipped. Always use a bolted or welded frame-mounted hitch, class 2 or 3.

With the hitch now directly beneath the coupler, unlock the coupler and use the parking jack to lower the trailer until the ball of the trailer fully enters the socket of the coupler. Continue turning the parking jack until it is in the full up position before departure. Close and lock the coupler in place to prevent the trailer from coming detached from your hitch. Use a padlock of appropriate size to lock the lever of the coupler mechanism down to the trailer and prevent it from coming loose. A tethered bolt of the appropriate size to fit through the hole on the coupler lock with a keeper pin or nut is also a secure method of latching the coupler closed.

Criss-cross the safety chains and engage them to the vehicle using locking hooks versus "S" hooks. Then connect your electrical harnesses and ensure all lights are functional.

Chapter 10

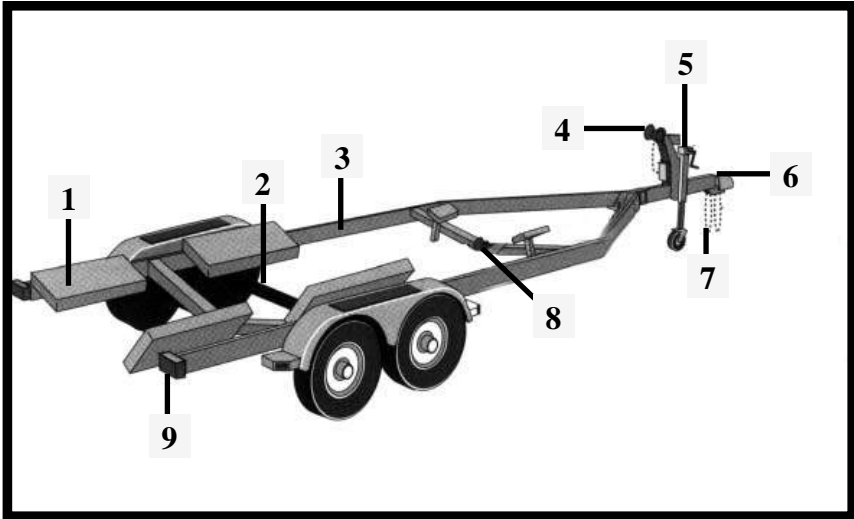

Typical Boating Trailer

- | | |
|-----------------|------------------|
| 1) Bunk Pad | 6) Coupler |
| 2) Axle | 7) Safety Chains |
| 3) Frame | 8) Roller |
| 4) Bow Stop | 9) Trail Light |
| 5) Parking Jack | |

Trailering

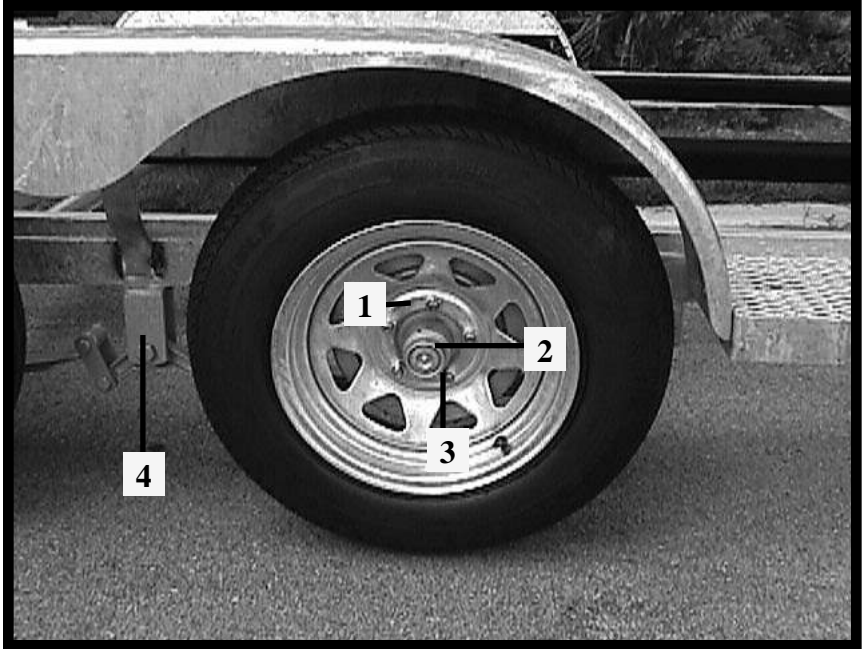

Typical Wheel Parts

- | | |
|------------|----------------|
| 1) Hub | 2) Bearing |
| 3) Lug Nut | 4) Leaf Spring |

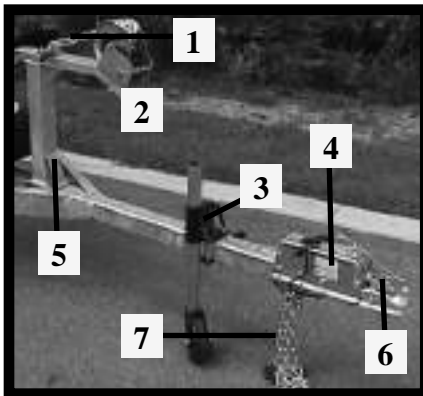

Typical Trailer Tongue Parts

- | |
|--------------------|
| 1) Bow Chain |
| 2) Winch / Cable |
| 3) Parking Jack |
| 4) Master Cylinder |
| 5) Winch Stand |
| 6) Coupler |
| 7) Safety Chains |

Chapter 10

DRIVING

Practice maneuvering the vehicle and trailer in a large, empty parking lot or open space. If you practice slowly and cautiously, you will soon develop a feel for maneuvering the trailer properly.

Test your vehicle and trailer brakes before departure along with the lights. Also, be sure you pack a tool kit with extra bulbs, fuses, and fluids.

Drive as smoothly as possible, anticipating your stops and giving yourself plenty of room for turning and stopping. Avoid any quick turns or sudden jerks of the steering wheel.

Remember to maintain safe speed limits. It takes longer to stop your vehicle when towing any load, particularly a boat. Allow more than enough room to the front in bad weather. Keep an eye on your rig through the rear view and side mirrors. If your rear view mirror is obstructed, purchase a set of side mirrors that extend out over the side of your vehicle for increased visibility. It is a good idea to install a set of round mirrors to the side mirrors, as they help identify blind spots.

Plan to stop periodically on your way to check the trailer hitch for tightness, harness connection, tires, wheel bearings, etc. Also check to make sure the cockpit covers, carpet, bimini top, and sunshade are secure and the load is balanced.

Trailer

BACKING A TRAILER

A trailer backs in a direction opposite to an automobile. To turn a trailer, turn your steering wheel in the opposite direction you intend the back end of the trailer to go. To back a trailer to the left, the steering wheel must be turned to the right; oppositely so for turning the trailer to the right. It may become necessary to pull forward and back up again until you have reached the proper angle of attack.

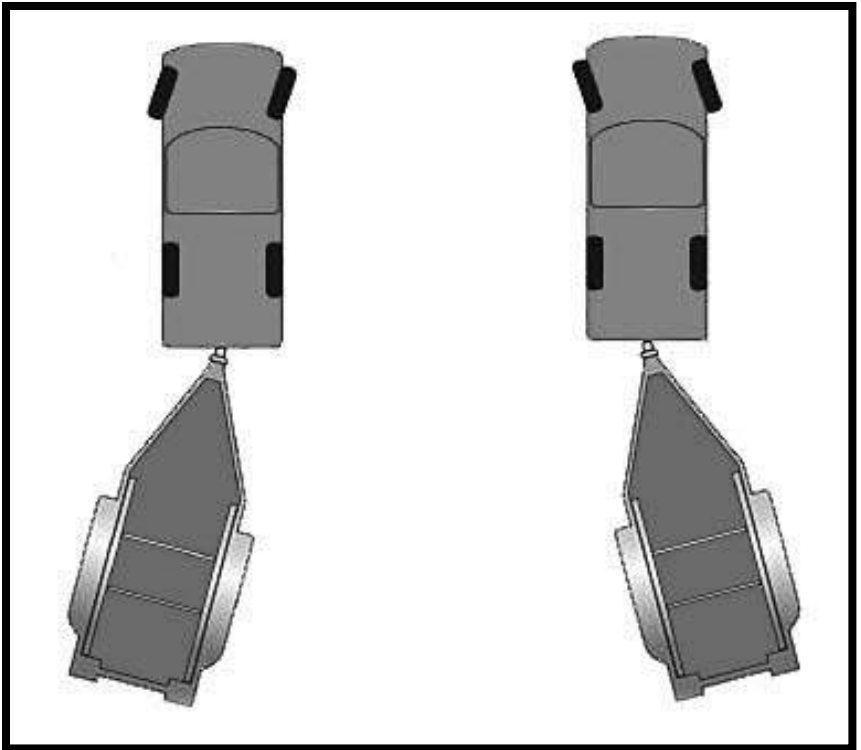

Backing Up A Trailer Diagram

Chapter 10

LAUNCHING

Serious accidents can occur at the launching ramp. Therefore, it is imperative you be alert and attentive during launching and docking activities. Study the ramp area and surrounding water for any potential hazards, such as a short ramp, or one with a drop off at the end. If you are uncertain of the conditions, ask someone else who has just used the ramp if there are any peculiarities to the area.

Attach two lines, one each at the bow and stern to control your boat once it is off the trailer. If you need additional fenders to keep the sides of the boat from banging against walls, put those on as well. Unhook the stern tie-downs and the winch line to the bow. unplug the trailer harness connector so the trailer lights won't blow out when they come in contact with the water.

When backing in, have someone assist, giving signals to stop or turn when required. Stop the trailer when the boat is in deep enough water to float off, or when the rear of your vehicle approaches the water's edge.

After the boat is floating freely, position it clear of the trailer before pulling the trailer away. If there is no one to help you, secure one of the lines you've attached from the boat to the dock, and use the other line to pull the boat off the trailer.



CAUTION

AVOID LOSING VEHICLE TRACTION! DO NOT ALLOW REAR WHEELS TO ENCOUNTER SAND OR SLIPPERY CONCRETE CONDITIONS.

Vehicle Traction Caution

Trailer



CAUTION

AVOID BODILY INJURY! RAMPS ARE VERY SLIPPERY. DO NOT ATTEMPT TO WALK OR STAND ON AN ANGLED BOAT RAMP.

Ramp Conditions



WARNING

ALLOW THE TRAILER WHEEL BEARINGS AND LIGHTS TO COOL OFF BEFORE SUBMERGING. UNPLUG THE ELECTRICAL HARNESS FOR THE TRAILER BEFORE BACKING INTO WATER.

Trailer Light And Wheel Bearings Warning

Chapter 10

LOADING YOUR BOAT

The most important thing to remember when getting your boat out of the water is that often the ramp will be crowded. As you approach the ramp, make a visual inspection of the traffic, both at the ramp, and all around you. This is an important time to use caution, courtesy, and common sense. While you may feel it's your next turn, another boater may not be as courteous. Don't insist on your rightful place in line; it could lead to disastrous consequences in the confines of a crowded boat ramp. If there is any perceived danger, stand off until you can safely approach the ramp.

Back your trailer down to the water's edge. At this point, it is a good idea to let a sufficient amount of line out of the winch to reach the bow eye. Make sure your trailer harness is disconnected to keep the bulbs from blowing out due to being submerged. On roller or bunk style trailers, back up until the roller is at the water's edge. This method gives you a good starting point and helps keep the boat centered on the trailer as it is reloaded. It may be necessary to further back the trailer into the water to allow cranking up the boat.

Once the boat is positioned correctly on the trailer, have someone hook up the winch cable hook to the bow eye. Also, this will help keep the boat bow against the trailer roller. Shut down the engine and run the stern drive up to the top of the trailer position.

With the bow snug against the roller, start to crank the boat up onto the trailer. Make sure the hull bottom or keel stays in the center of the trailer. Stop cranking the winch when the boat bow contacts the bow roller. Be sure the winch is in the locked position. Stand back, and make sure the boat is centered on the trailer.

Trailer

After pulling you boat away from the ramp, be sure to go through all the checks involved before departure. Reinstall the harness connector and check the lights, brakes, safety chain, winch, hitch, wheel bearings, and tie downs. Remove the drain plug to drain excess water in the bilge. Make sure to reinstall the hull drain plug and securely tighten it. Make sure the boat is prepared properly for trailering before disembarking.



WARNING

AVOID PERSONAL INJURY! DO NOT LET ANYONE STAND NEAR THE WINCH OR CABLE AS IT COULD BREAK.

Winch Warning



CAUTION

HULL BOTTOM DAMAGE COULD RESULT FROM THE BOAT NOT BEING POSITIONED ON THE ROLLERS, BUT RESTING ON THE TRAILER FRAME.

Loading Your Boat Caution



Notes

Glossary & Index

Below is a brief list of nautical terms useful in everyday boating communications. For a more detailed glossary of nautical terminology, we recommend you check your local library or search the internet for boating books.

GLOSSARY

Abeam: At right angles to the keel or center line and off the boat; parallel to the boat's beam.

Aboard: On or in the boat.

Aft: In the direction of the boat's stern, or back of the boat.

Amidship: In the direction of the center of the boat.

Beam: The width of a boat at its widest part.

Bilge: The lower interior of the hull of the boat.

Bitter End: The end of a line, in particular, the anchor line.

Bow: The front, or forward part of the boat.

Bulkhead: A vertical partition or wall in the hull of a vessel to compartmentalize the vessel.

Cast Off: To let go or release.

Chapter 11

Channel: The navigable portion of a waterway of sufficient depth for most boat drafts.

Chine: The junctions of the vessel's die and bottom. When the two sides of the boat join at a shallow angle, a soft chine is produced. At steeper junction angles, a hard chine is produced.

Chock: A fitting through which the anchor or mooring lines are led. It is usually "U" shaped to reduce chafe.

Cleat: Deck fitting with protruding arms and which lines are secured.

Cuddy: A small cabin in the forward part of the boat equipped on some cruiser models.

Deck: The open flooring surface on which the crew and passengers walk.

Draft: The depth from the waterline of the boat to the lowest part of the boat, indicating the depth of water required to float the boat.

Fathom: A measurement of depth; one fathom equals six feet.

Fender: A cushion hung from the side of a boat to prevent it from rubbing against a dock or against other boats.

Fore / Forward: In the direction of the boat's bow, or front of the boat.

Freeboard: The vertical distance between the waterline and the top of the hull side (gunwale)

Galley: Cooking area

Glossary & Index

Gunwale: The upper edge of the side of the boat where the hull folds over into the deck.

Hatch: An opening in the deck to provide access below.

Head: Toilet.

Hull: The part of the ship from the deck down. The hull forms the shape of a boat's bottom exterior.

Inboard: In the direction of the boat's middle or interior.

Keel: The lowest point of a boat and backbone of a vessel. The keel line runs bow to stern, centered along the boat's hull.

Knots: A measurement of speed indicating nautical miles per hour.

Lee: The side opposite that from which the wind is blowing - the side sheltered from the wind.

Leeward: Towards the lee side of your vessel.

Make Fast: To secure a line.

Mayday: A radio distress call.

Nautical Mile: A distance of 6,076 feet or 1852 meters, which is 15% longer than a statute mile and is equivalent to one minute of latitude on a navigational chart.

Outboard: In the direction of the water, over the side of a boat; can also refer to a propulsion system that hangs over the gunwale.

Chapter 11

Personal Flotation Device (PFD): A safety vest or jacket capable of keeping an individual afloat when worn properly.

Piling: A post driven into the ground below the waterline to support a pier, dock, etc.

Pitch: Theoretical distance a propeller would travel in one minute. Also, the rise and fall of a vessel's bow and stern.

Port: The left side of the boat when facing forward (an easy way to remember the difference between "port" and "starboard" is that both "port" and "left" have four letters).

Propeller: A rotating multi-blade device that propels a boat through the water.

Quartering: The practice of aiming the boat's bow at a 45 degree angle to oncoming waves.

Rode: Line, chain, cable, or any combination thereof used to connect the anchor to the boat.

Rubrail: Protective outer bumper that runs around the boat at the point where the top deck meets the hull.

Shank: The main body of an anchor.

Sheer: The curve of the boat's deck from fore to aft when seen in profile. Reflective of the chine's pitch from bow to stern.

Starboard: The right side of the boat when facing forward.

Stern: The aft end of the boat.

Glossary & Index

Stern drive: An inboard/outboard (I/O) unit that utilizes a drive shaft inserted through a boat's transom.

Stringer: Strengthening integral unit fastened from fore to aft inside the hull. Skeletal support structure encapsulated in fiberglass for added strength.

Top Off: To fill up a tank.

Transom: The vertical part of the stern.

Trim: The boat's balance when properly loaded. "Bow Up", "Bow Down", and "Level" positions are reflective of the boat's trim.

Wake: The path of a boat left astern in the water.

Windward: The direction from which the wind blows. In the direction of the side of the boat taking the brunt of a wind force.

Chapter 11

INDEX

A			
Accidents	1-29		7-32
Accident Reporting	1-30		8-5
Aft Cockpit Seat	6-31		1-20
Aftermarket Accessories	4-7		1-46
	6-1		3-29
Aids - Navigation	2-9		4-7
Anchor Light	1-12		6-6
	4-10		7-28
	6-29	Boating Under The Influence	1-36
Anchoring	5-26	Bow Cover	6-9
Audible Alarms	8-10		7-7
Automatic Fire Extinguisher	1-8	Bow Storage Compartment	10-3
	6-2	Bow Storage Locker	6-34
		Bridge Signals	2-3
		Bucket Seat	6-30
			7-27
		Buoys and Markers	1-34
			2-9
B			
Battery	3-15		
	4-4	C	
	7-25	Canvas	6-7
	8-6		7-7
Battery Switch	3-15	Capacity Plate	INT-14
	4-9		1-4
	6-4		12-4
	8-6	Carbon Monoxide	1-43
Bilge And Drainage	4-2	CPR	7-2
	8-7	Carpet	10-3
Bilge Pump	4-2	Circuit Breakers	4-6
	4-7	Cockpit Cover	6-9
	7-27	Cockpit Lights	7-7
	8-7	Controls	10-3
Bimini Top	6-7	Cooling System - Engine	4-8
	7-7		6-15
	10-3		3-23
Binnacle Control Lever	3-32		3-25
	5-7		3-4
	7-26		7-12
	7-30		7-29

Chapter 11

H		M	
Hazardous Conditions	1-32	Metal	7-10
Hazardous Substances	1-18	Multi Gauge	3-24
Helm Controls Overview	3-25	N	
HIN	INT-9	Navigation Aids	2-9
	INT-10	Navigation Lights	1-12
	INT-11		4-10
Horn	3-29		6-29
	4-8	Night Running	2-7
	6-21	Non-Pyrotechnic Devices	1-9
Hour Meter	3-26	O	
Hull Bottom	7-10	Operation By Minors	1-31
Hypothermia	1-44	P	
I		Personal Flotation Devices	1-14
Ignition Panel	3-30	Plastics	7-2
	4-8	Pollution Regulation	1-18
Ignition Switch	3-30	Propellers	3-22
Interrupter Switch	3-35		5-1
K			7-21
Knots	5-28		7-29
			7-32
L		Prop Walk	5-10
Lights	4-8	Pyrotechnic Devices	1-8
	6-15	R	
Life Rafts	1-17	Radio Communications	1-12
Load Capacity	1-4	Recommissioning	9-6
Lubrication System - Engine	3-15	Registration Information	INT-20
	7-15	Right Of Way	2-2
	7-29		
	7-32		
Lubrication System - Drive	3-20		
	7-19		
	7-20		
	7-29		
	7-32		

Glossary & Index

S

Safety Lanyard	3-35
Safety Inspection	1-45
Shallow Water	1-32
Shifting	3-32
	5-8
Signals - Navigation	2-3
Skiing Precautions	1-25
Ski Locker	6-33
Ski Signals	1-26
Ski Tow	1-27
Sound Producing Devices	1-12
Speedometer	3-26
Sport Tower	6-35
Starting	5-7
Steering System	3-36
	7-25
Stereo	4-8
	6-21
	7-28
Stern Drive Basics	3-18
Stern Drive Mechanics	3-19
Stern Drive Maneuvering	5-10
Stern Drive Maintenance	7-18
Storage / Travel Cover	6-11
	10-3
Stopping	5-9
Sunshade	6-12
	7-7
	10-3
Swim Ladder	6-36
Swim Platform	1-28
	6-36
Switches	3-28
	3-29
	4-6

T

Tachometer	3-26
Towing	5-27
Tow Mirror Option	1-27
Transducer	4-9
Transom Filler Cushion	6-33
Transom Storage	6-32
Transom Trim Switch	10-4
Trim Angle	5-15
Trim Gauge	3-27

U

Upholstery	7-1
------------	-----

V

Ventilation System - Engine	3-17
-----------------------------	------

W

Water Sport Precautions	1-24
Weather	1-33
Weeds	1-33
Windshield	6-38
Wiring	4-4

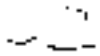

Notes

Technical Information

The following technical information and drawings are accurate up to the printing date listed at the beginning of this manual. Note that all product specifications, models, standard, and optional equipment, systems, along with the technical information is subject to change without notice. For more information, contact your nearest authorized Regal dealer. For the location of your nearest authorized dealer, call 407-851-4360. You may also contact Regal through the internet at www.RegalBoats.com. Your Regal dealer has received special factory training on the entire product line and his services should be employed to solve more technical problems.

Chapter 12

SPECIFICATIONS

The following specifications describe the dimensions relative to your boat model. Note that all specifications are approximate measurements.

1900 SPECIFICATIONS	U.S.A.	METRIC
Length Overall	19' 10"	6.0 M
Beam	8' 3"	2.5 M
Draft - Drive Down	31"	0.8 M
Draft - Drive Up - High Trim	20"	0.5 M
Deadrise	22 ^o	22 ^o
Approximate Dry Weight w/ 4.3 L	3100 Lbs.	1406 Kg
Est. Height On Trailer - Top of W/S	6' 5"	1.9 M
Boat Height - W/S to Keel	4' 11"	1.4 M
Bridge Clearance - Top Up	6' 3"	1.9 M
Bridge Clearance - Top Down	4' 4"	1.3 M
Cockpit Depth - Helm	30"	0.8 M
Cockpit Storage	46 Cu. Ft.	1.3 Cu. M.
Fuel Capacity	30 Gals	114 L
Maximum Capacity Persons	8 People	CE - 6 People
Maximum Capacity Persons & Gear	1170 Lbs.	530 Kg

Boat Specifications

Technical Information

PLAN VIEW

The following figure shows where key features are located on your vessel.

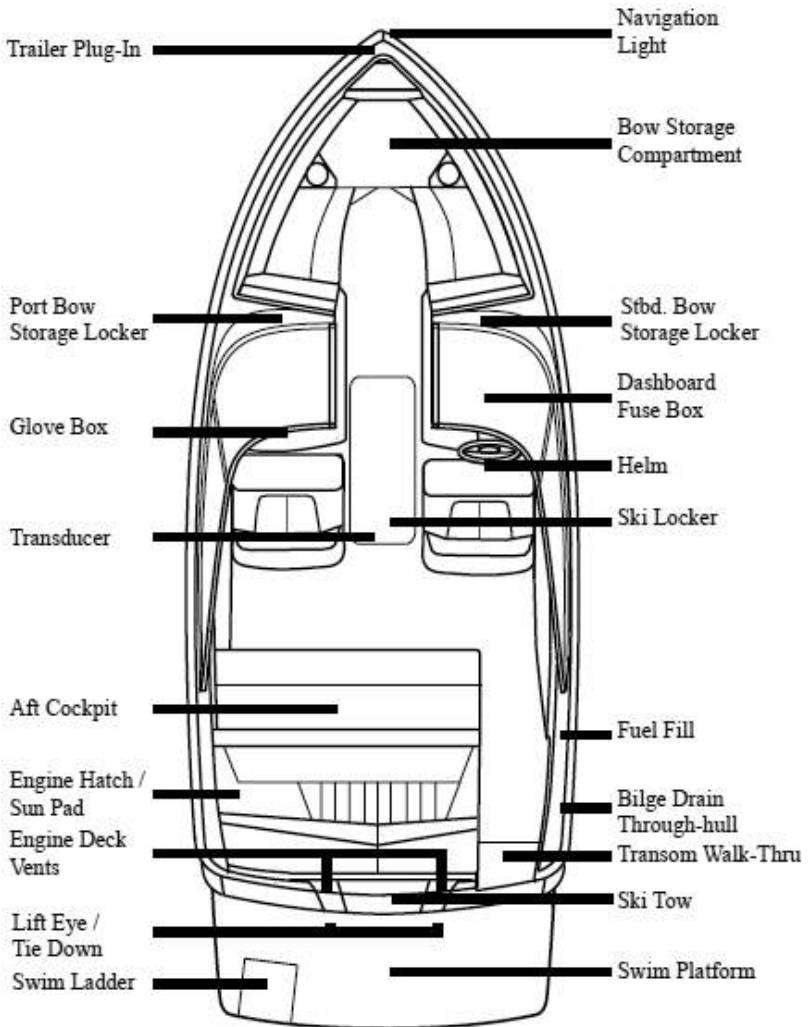

Plan View

Chapter 12

If any of the labels in the following figure are missing, contact your Regal dealer for replacements. Depending on your optional features, you may have more precautionary labels.

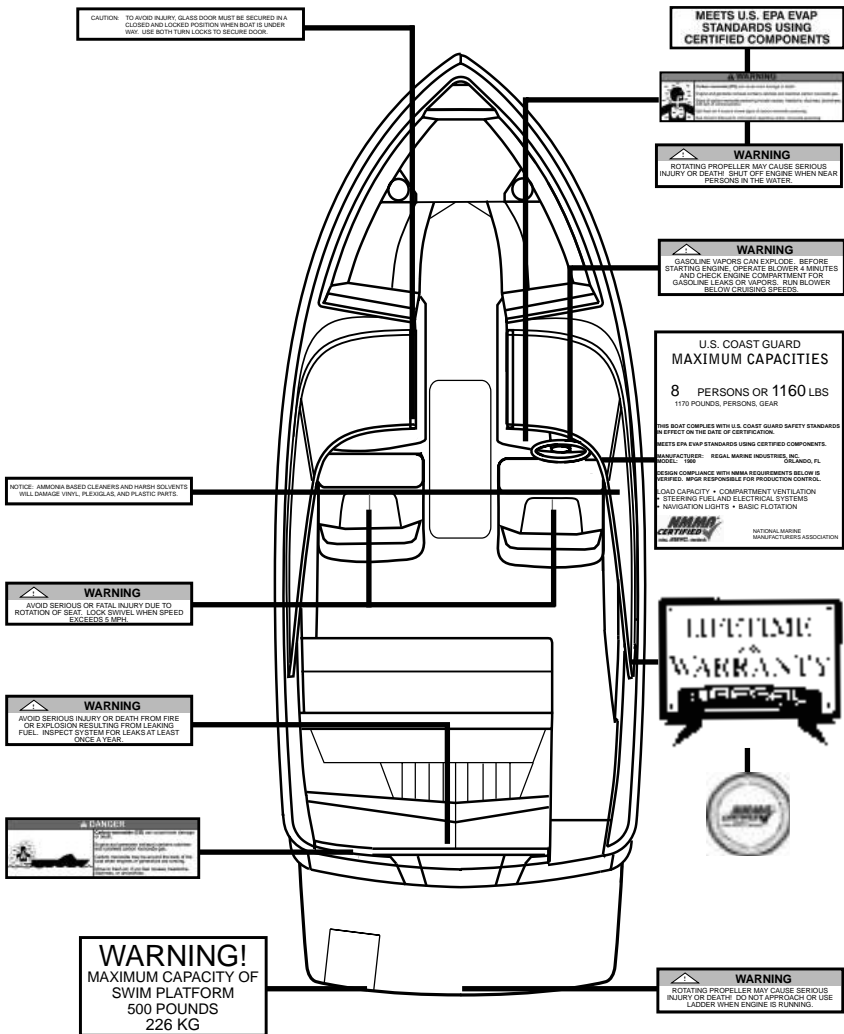

Label Locations

Chapter 12

Fuel System Layout

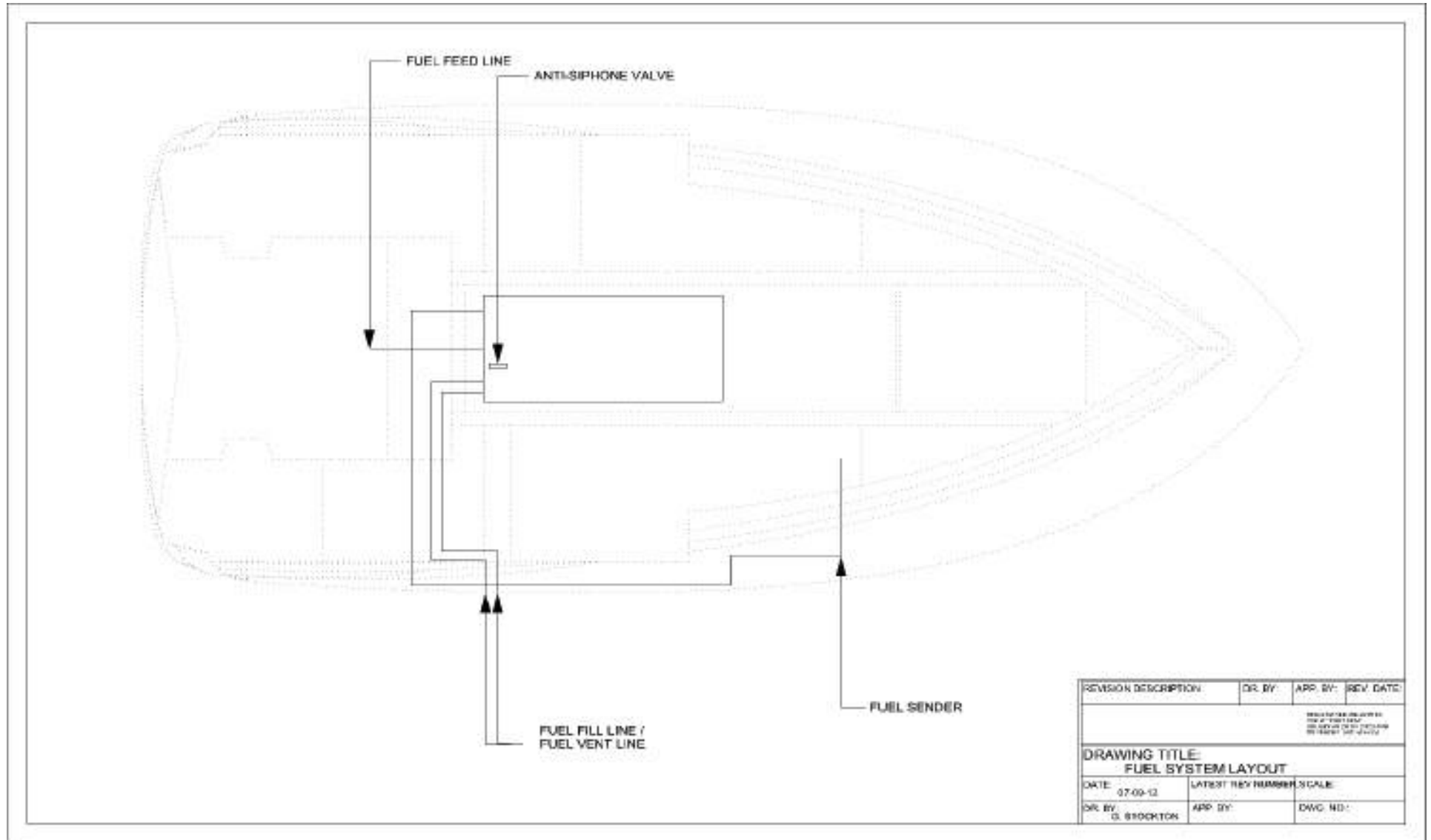

Fuel System Layout

Chapter 12

Bilge System Layout

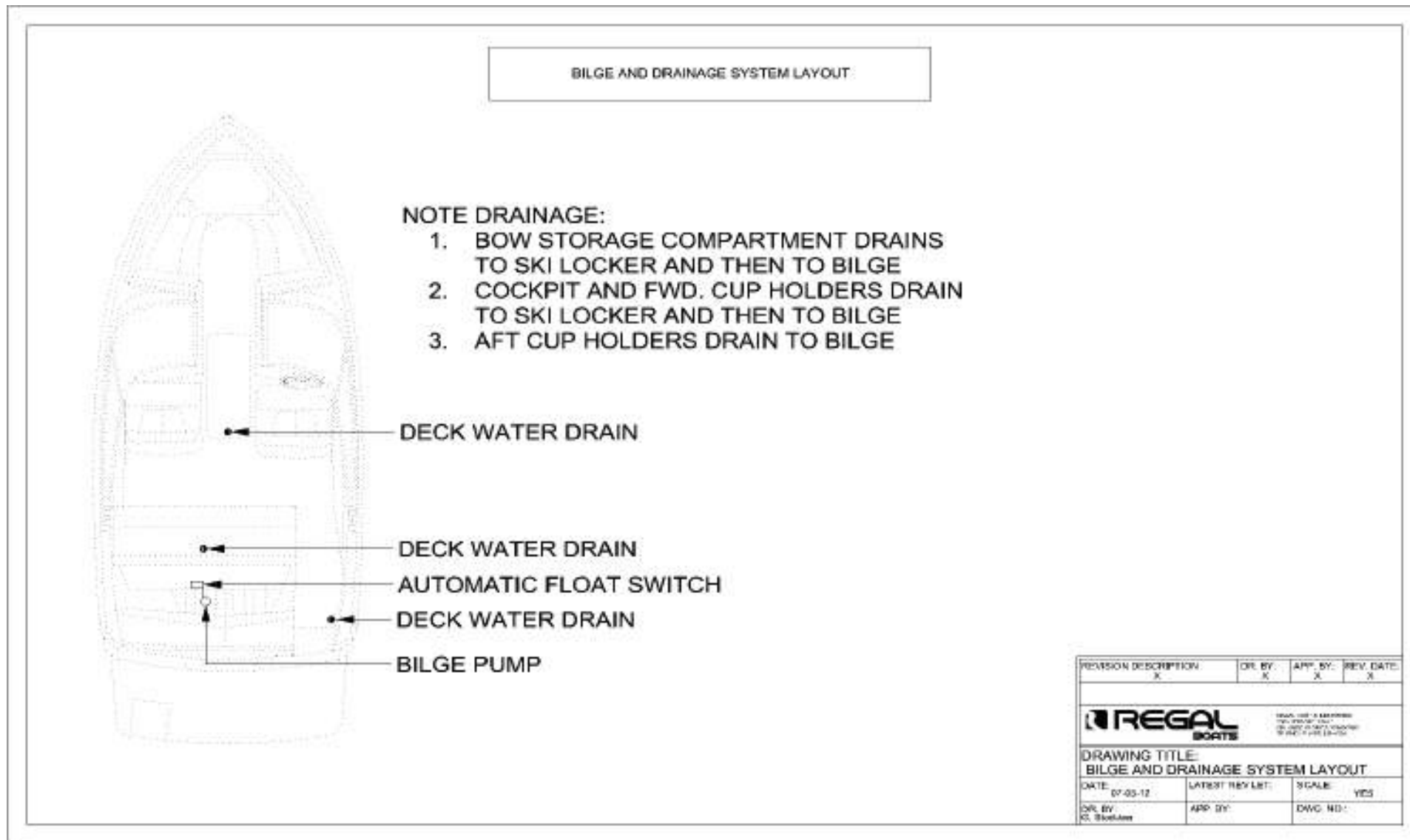

Bilge And Drainage Diagram

Chapter 12

Electrical System Layout

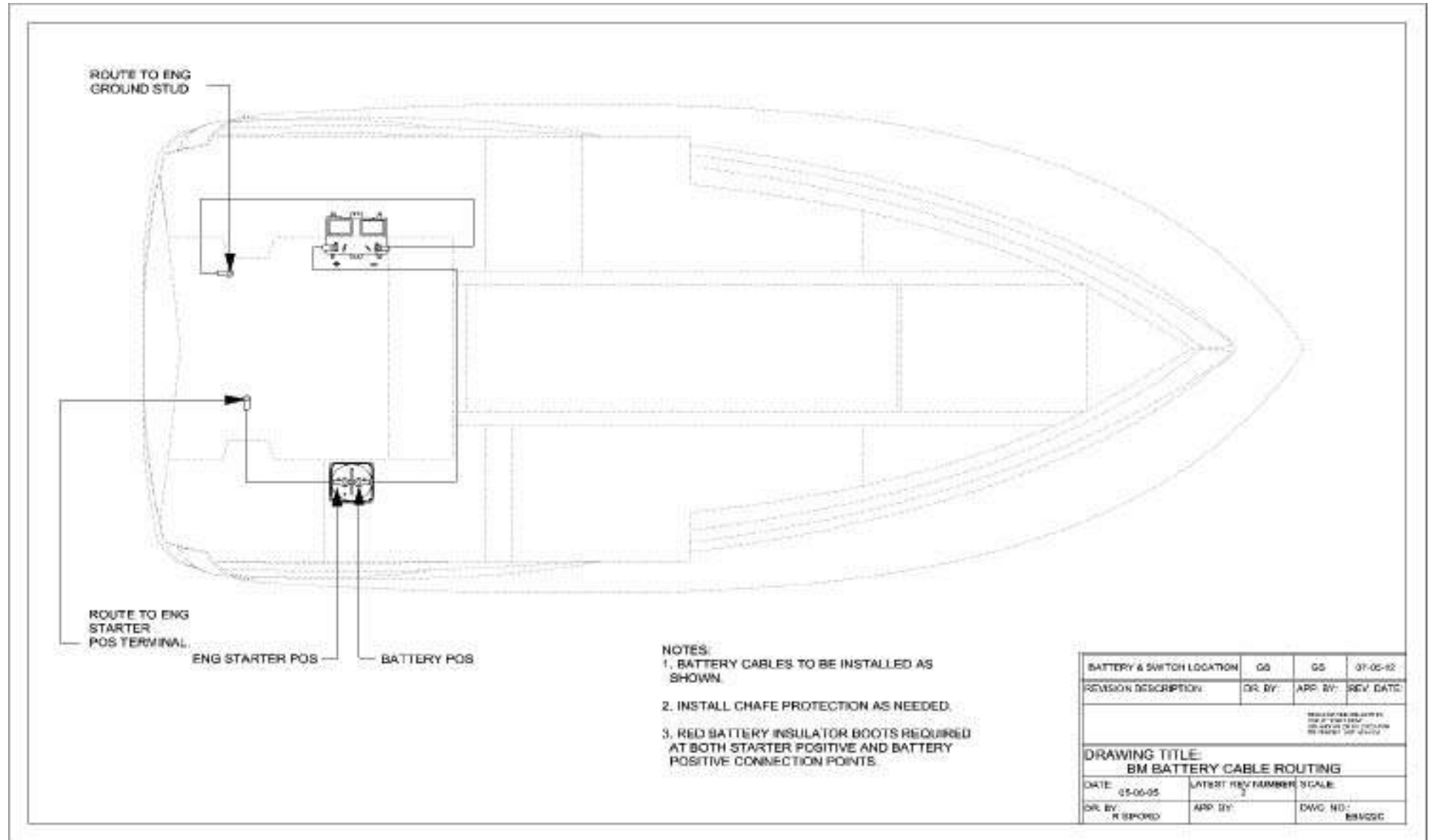

Battery Cable Routing

Chapter 12

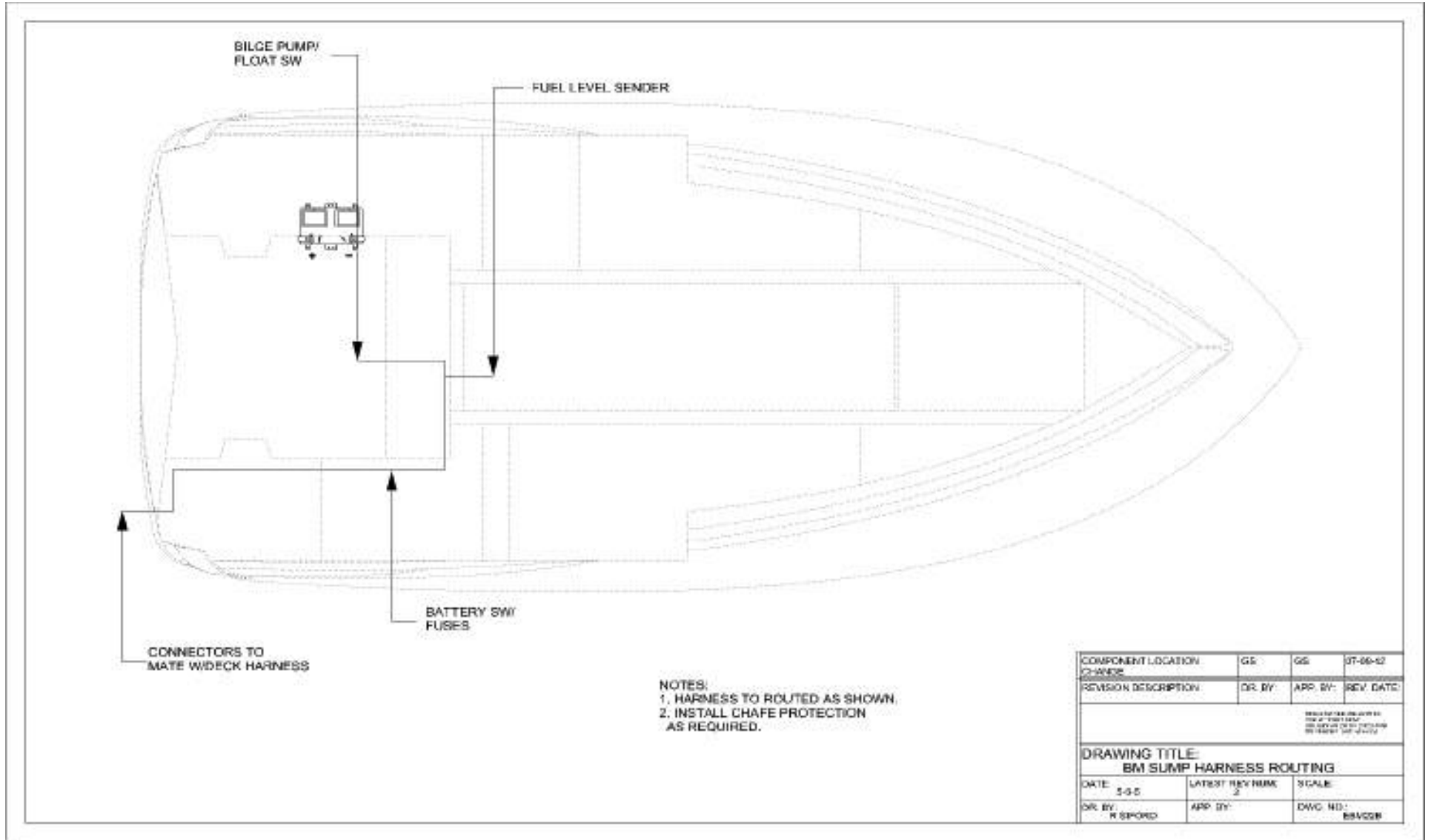

Sump Harness Routing

Chapter 12

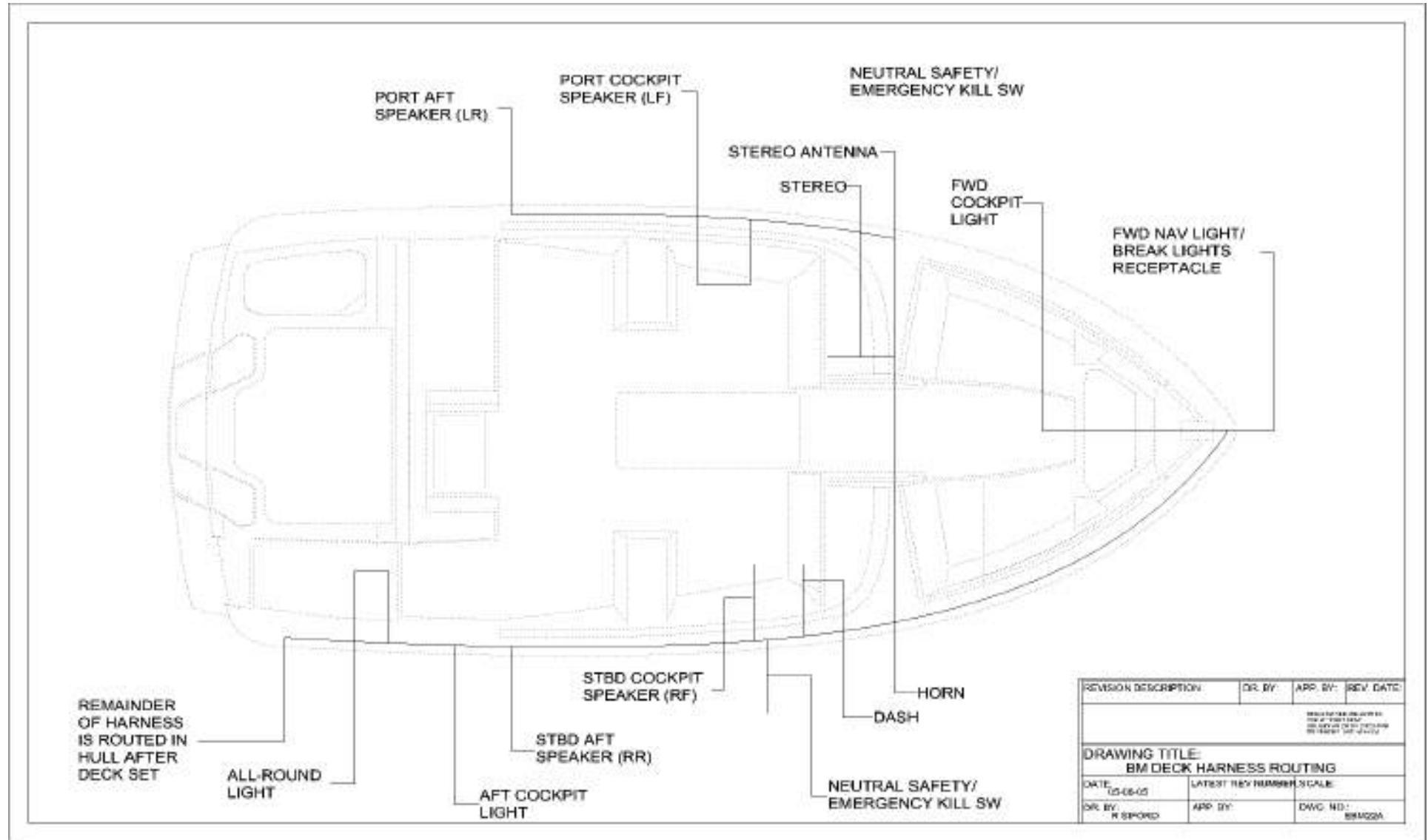

Deck Harness Routing

Chapter 12

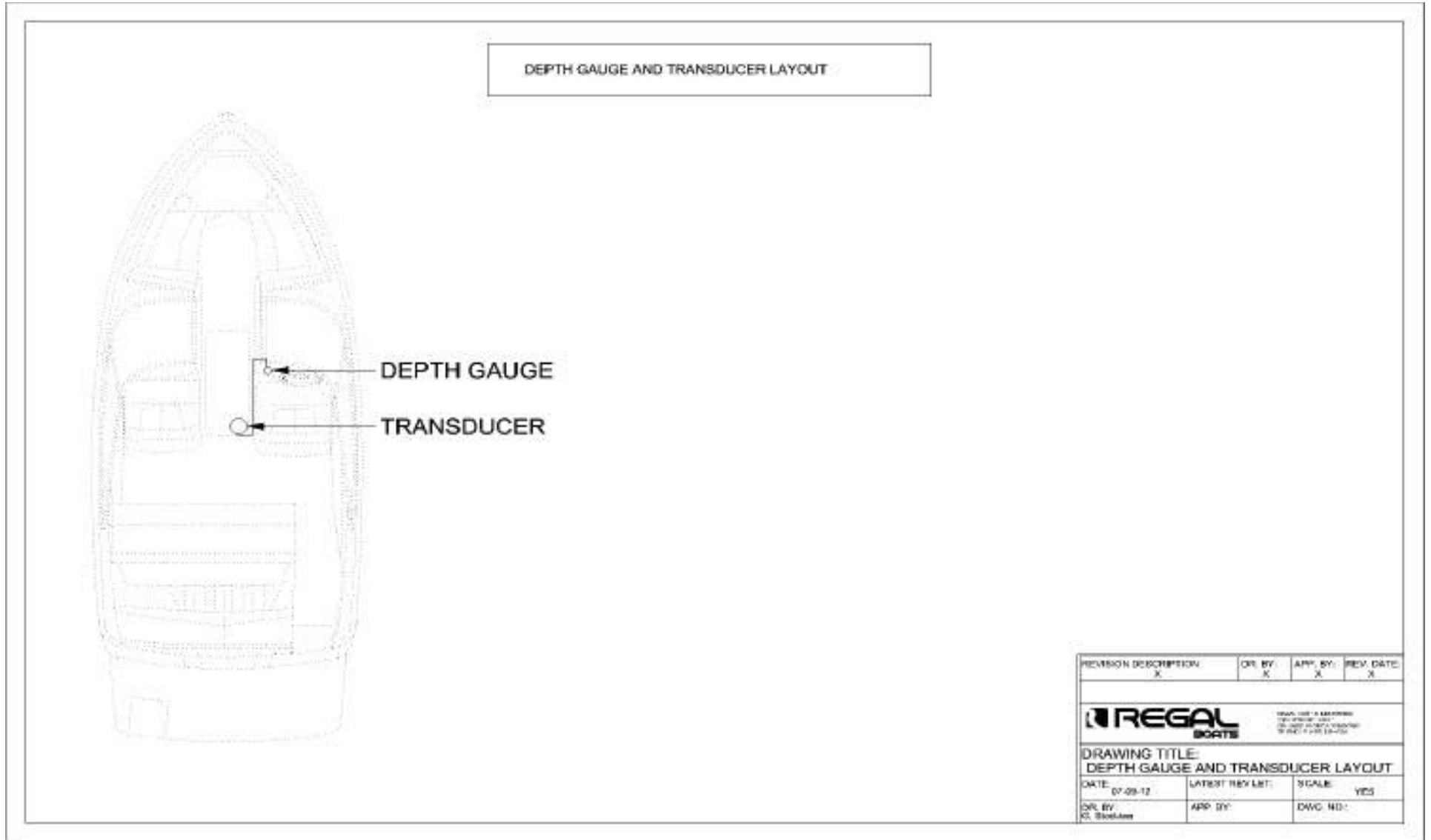

Depth Gauge And Transducer

Chapter 12

AFT DECK DETAIL

PORT DECK DETAIL

BILL OF MATERIALS			
ITEM QUANTITY	SIZE	MATERIAL	PART #
26	2	BRASS BILD SUPPORT	782000
27	1	BRASS BILD HARDWARE KIT	782207
28	1	COASTER BILD BILD	782208
29	1	PORT BILD BILD	782209
30	1	STBD WINDSHIELD	152312
31	2	1/2" TYP	8222
32	1	LED WORK LIGHT	8222
33	1	BRASS	8222
34	1	TR. MOUNTING SUPPORT	152313
35	1	TR. MOUNTING SUPPORT	152314
36	1	TR. MOUNTING SUPPORT	152315
37	1	COASTING TUSH	8222
38	1	STERNAL TUSH	8222
39	1	STERNAL TUSH	8222
40	1	STERNAL TUSH	8222
41	1	STERNAL TUSH	8222
42	1	STERNAL TUSH	8222
43	1	STERNAL TUSH	8222
44	1	STERNAL TUSH	8222
45	1	STERNAL TUSH	8222
46	1	STERNAL TUSH	8222
47	1	STERNAL TUSH	8222
48	1	STERNAL TUSH	8222
49	1	STERNAL TUSH	8222
50	1	STERNAL TUSH	8222
51	1	STERNAL TUSH	8222
52	1	STERNAL TUSH	8222
53	1	STERNAL TUSH	8222
54	1	STERNAL TUSH	8222
55	1	STERNAL TUSH	8222
56	1	STERNAL TUSH	8222
57	1	STERNAL TUSH	8222
58	1	STERNAL TUSH	8222
59	1	STERNAL TUSH	8222
60	1	STERNAL TUSH	8222
61	1	STERNAL TUSH	8222
62	1	STERNAL TUSH	8222
63	1	STERNAL TUSH	8222
64	1	STERNAL TUSH	8222
65	1	STERNAL TUSH	8222
66	1	STERNAL TUSH	8222
67	1	STERNAL TUSH	8222
68	1	STERNAL TUSH	8222
69	1	STERNAL TUSH	8222
70	1	STERNAL TUSH	8222
71	1	STERNAL TUSH	8222
72	1	STERNAL TUSH	8222
73	1	STERNAL TUSH	8222
74	1	STERNAL TUSH	8222
75	1	STERNAL TUSH	8222
76	1	STERNAL TUSH	8222
77	1	STERNAL TUSH	8222
78	1	STERNAL TUSH	8222
79	1	STERNAL TUSH	8222
80	1	STERNAL TUSH	8222
81	1	STERNAL TUSH	8222
82	1	STERNAL TUSH	8222
83	1	STERNAL TUSH	8222
84	1	STERNAL TUSH	8222
85	1	STERNAL TUSH	8222
86	1	STERNAL TUSH	8222
87	1	STERNAL TUSH	8222
88	1	STERNAL TUSH	8222
89	1	STERNAL TUSH	8222
90	1	STERNAL TUSH	8222
91	1	STERNAL TUSH	8222
92	1	STERNAL TUSH	8222
93	1	STERNAL TUSH	8222
94	1	STERNAL TUSH	8222
95	1	STERNAL TUSH	8222
96	1	STERNAL TUSH	8222
97	1	STERNAL TUSH	8222
98	1	STERNAL TUSH	8222
99	1	STERNAL TUSH	8222
100	1	STERNAL TUSH	8222

STBD DECK DETAIL

Drawn Assembly	CS	CS	07-23-12
REVISION DESCRIPTION	DR BY:	APP BY:	REV DATE
<small>REVISIONS: 001 002 003 004 005 006 007 008 009 010 011 012 013 014 015 016 017 018 019 020 021 022 023 024 025 026 027 028 029 030 031 032 033 034 035 036 037 038 039 040 041 042 043 044 045 046 047 048 049 050 051 052 053 054 055 056 057 058 059 060 061 062 063 064 065 066 067 068 069 070 071 072 073 074 075 076 077 078 079 080 081 082 083 084 085 086 087 088 089 090 091 092 093 094 095 096 097 098 099 100 101 102 103 104 105 106 107 108 109 110</small>			
DRAWING TITLE: 2 OF 2 RM DECK HARDWARE			
DATE: 05-05-05	LATEST REV NUMBER/SCALE:		
DR BY: R SIFORD	APP BY:	DWD. NO.: MBB24A	

Chapter 12

Hull Hardware

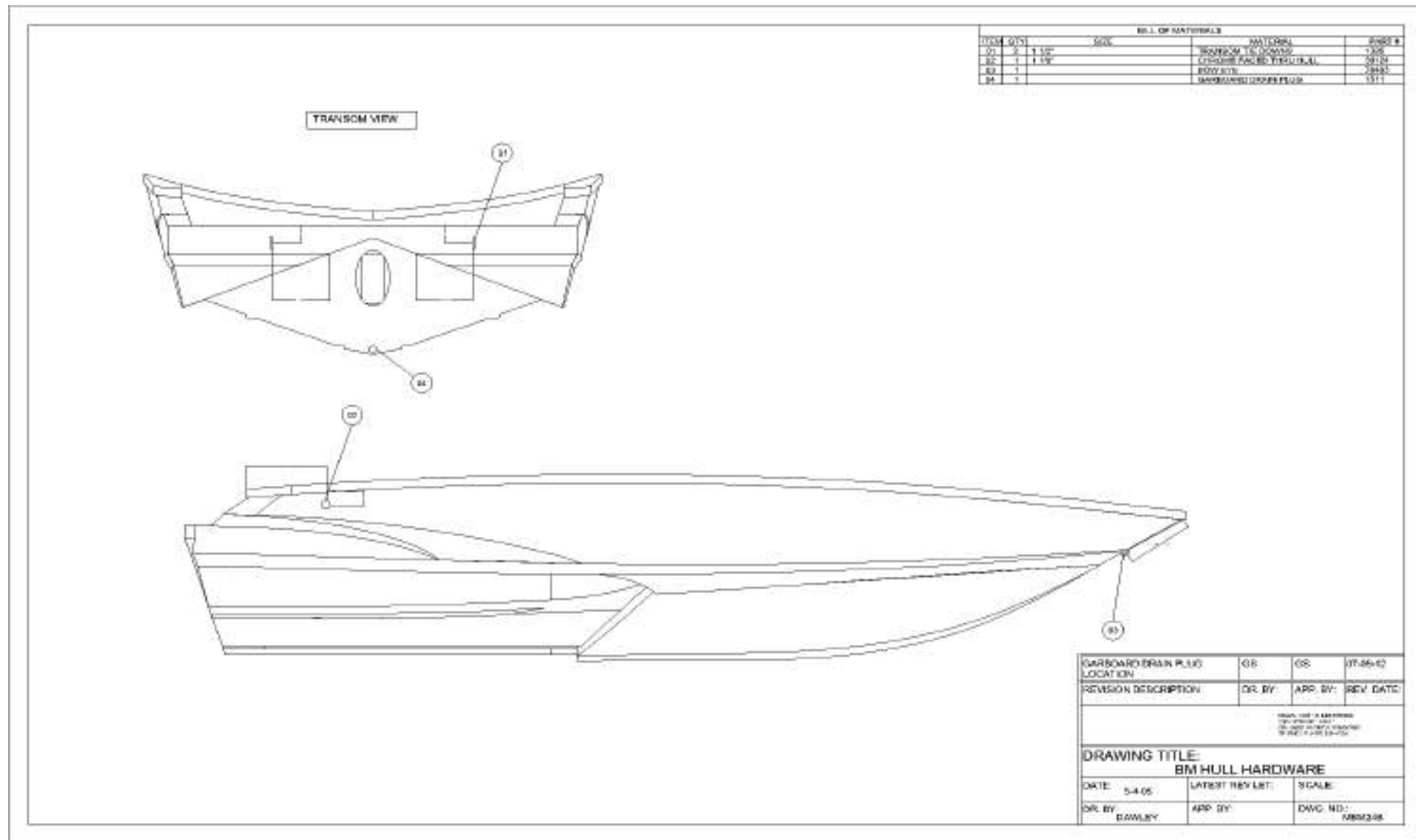

Hull Hardware

Chapter 12

Fusion Stereo Connection

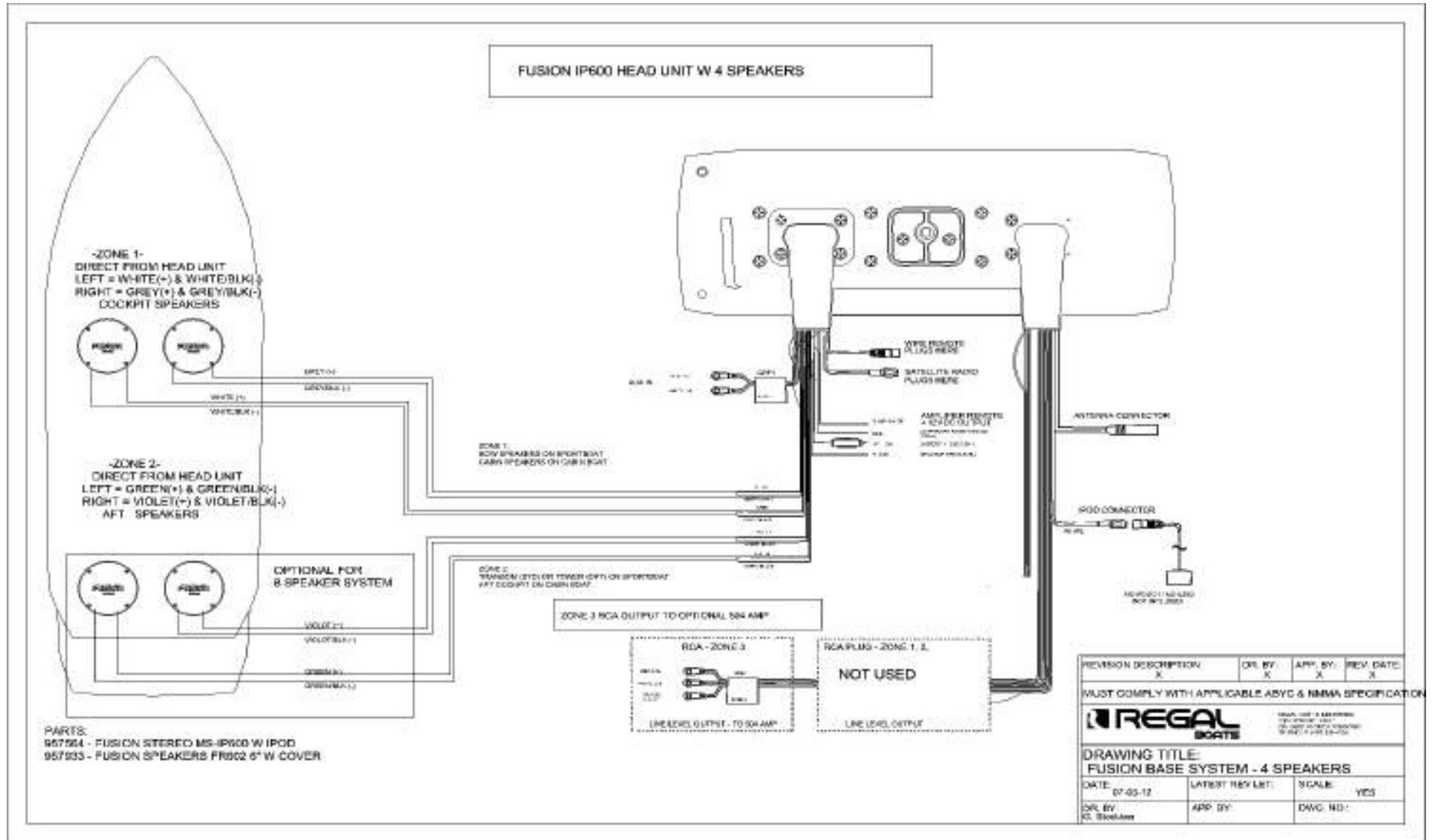

Fusion Stereo Connection

Chapter 12

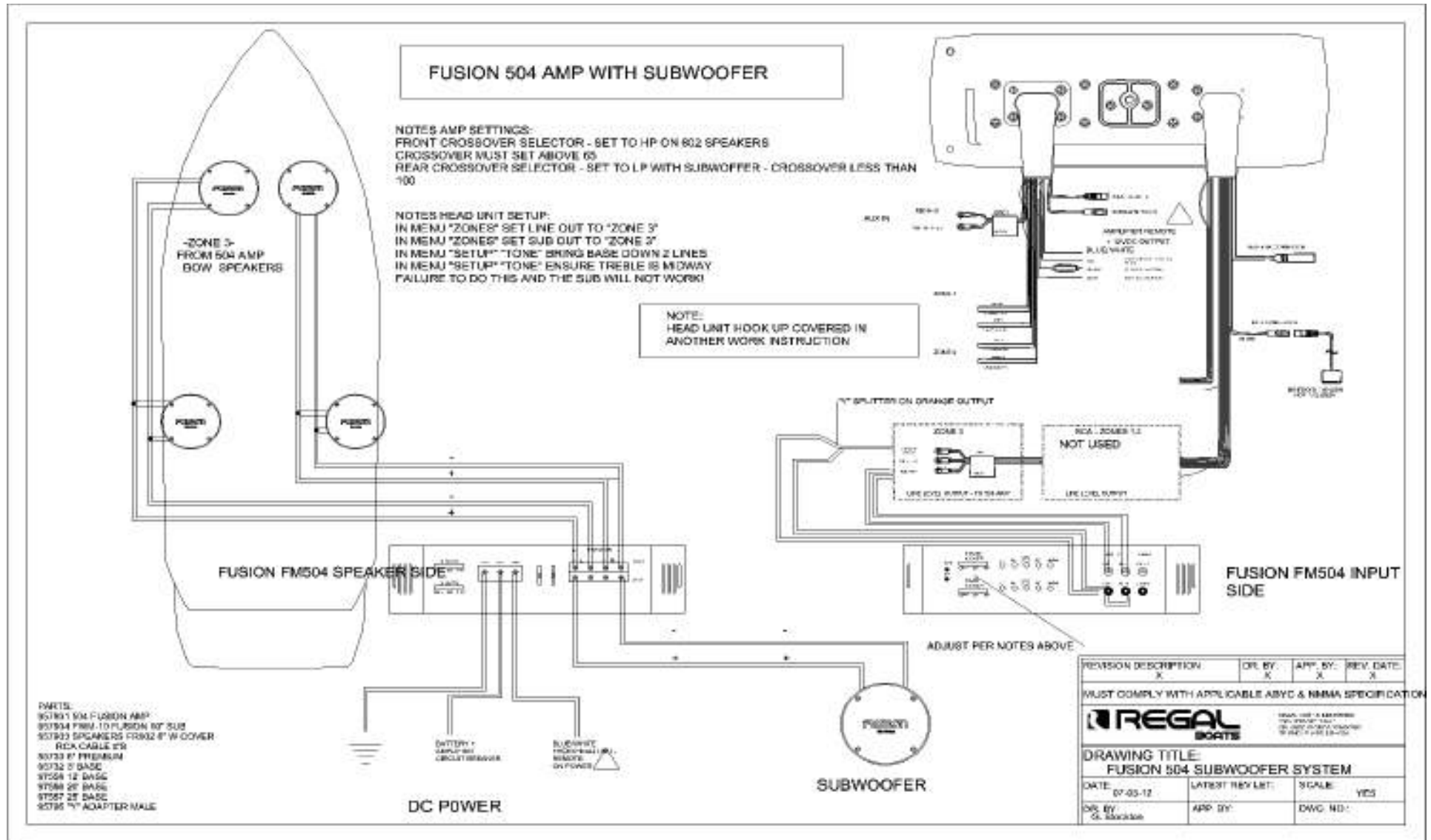

Fusion Stereo Optional Performance Package Connection

Chapter 12

Trailer Harness Connection

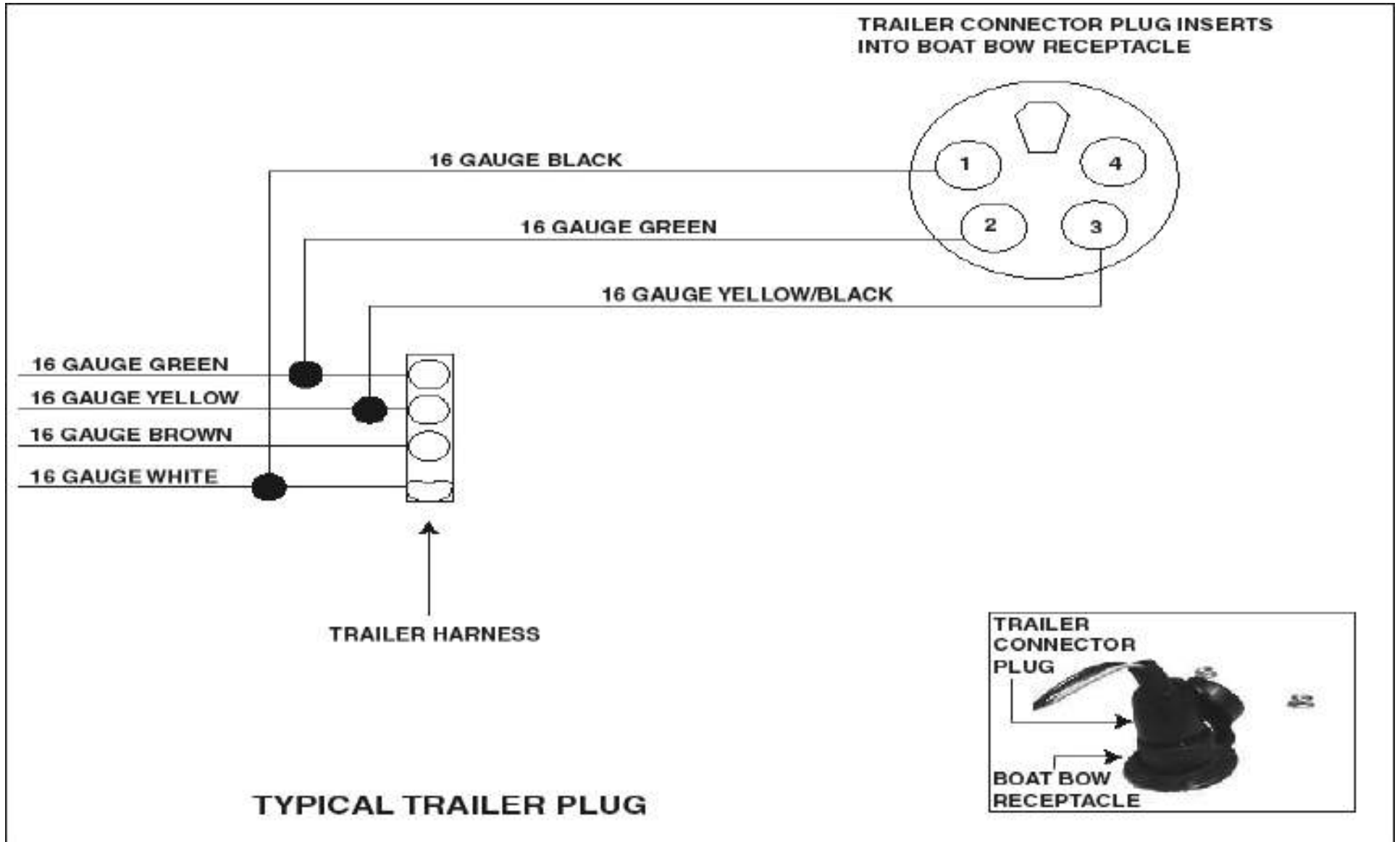

Trailer Harness Plug