

OWNERS MANUAL

3 5 S P O R T C O U P E



REGAL

<https://www.boat-manuals.com/>



Follow no one.

OWNER'S MANUAL

35 Sport Coupe



Table Of Contents

1 INTRODUCTION

| | |
|---------------------------|------|
| Your Regal Owner's Manual | 1-4 |
| General Information | 1-4 |
| Regal Marine Warranty | 1-12 |

2 SAFETY ON BOARD

| | |
|-------------------------------------|------|
| Safety Labels | 2-1 |
| General Boating Safety | 2-2 |
| Required Safety Equipment | 2-4 |
| Fire Extinguishers | 2-6 |
| Visual Distress Signals | 2-7 |
| Sound Protecting Devices | 2-10 |
| Radio Communications | 2-10 |
| Marine Sanitation Devices | 2-10 |
| Navigation Lights | 2-11 |
| Garbage | 2-12 |
| EBIRB | 2-12 |
| Life Rafts | 2-13 |
| USCG Minimum Equipment Requirements | 2-13 |
| Exhaust & Carbon Dioxide | 2-14 |
| Boating & Alcohol | 2-16 |
| Boating Accidents | 2-17 |
| Water Sports | 2-19 |
| Weather & Water Conditions | 2-20 |

3 RULES OF THE ROAD

| | |
|--------------------------|-----|
| Navigation Rules Defined | 3-1 |
| Navigation Rules | 3-1 |
| Bridge Clearance | 3-8 |

Table Of Contents

4 ENGINES & CONTROLS

| | |
|------------|-----|
| Engines | 4-1 |
| Propulsion | 4-2 |
| Propellers | 4-3 |
| Controls | 4-3 |

5 SYSTEMS

| | |
|---------------|------|
| Electrical | 5-1 |
| Fuel | 5-16 |
| Steering | 5-18 |
| Trim | 5-19 |
| Water & Waste | 5-23 |

6 VESSEL OPERATION

| | |
|------------------------------|------|
| Getting Underway | 6-1 |
| Starting & Stopping | 6-4 |
| Fenders | 6-5 |
| Dock Line Basics | 6-6 |
| Steps To Stern Drive Docking | 6-8 |
| Stern Drive Maneuvering | 6-9 |
| Anchoring | 6-11 |
| Towing | 6-12 |
| Admiralty Law | 6-12 |
| Knots | 6-13 |
| Emergencies | 6-14 |
| Environmental Awareness | 6-15 |



Table Of Contents

7 EQUIPMENT OPERATION

| | |
|--------------------|------|
| Interior Equipment | 7-1 |
| Exterior Equipment | 7-27 |

8 COSMETIC CARE & MAINTENANCE

| | |
|-------------------------|------|
| Cosmetic Care | 8-1 |
| Maintenance (Interior) | 8-7 |
| Maintenance (Exterior) | 8-17 |
| Propulsion Maintenance | 8-22 |
| Maintenance Schedule | 8-27 |
| Maintenance Service Log | 8-30 |

9 TROUBLESHOOTING

| | |
|-------------------|-----|
| Diagnostic Charts | 9-1 |
|-------------------|-----|

10 STORAGE & WINTERIZATION

| | |
|---------------------------|------|
| Decommissioning Checklist | 10-1 |
|---------------------------|------|

| | |
|--------------------------------|------|
| 11 GLOSSARY & INDEX | 11-1 |
|--------------------------------|------|

12 TECHNICAL

| | |
|-----------------------|------|
| Technical Information | 12-1 |
| Drawings | 12-6 |



Chapter 1

Introduction

Boating is becoming more popular every year. There are numerous types of recreational vessels on our waterways today involved in an every growing number of activities. Therefore, as a new boat owner it is of the highest priority to learn about general boating practices before operating your craft.

Your Regal dealer will answer many questions and provide valuable “hands on” information during the completion of the new boat delivery process. In addition, your dealer has received special factory training on the product line and his services should be employed to solve technical problems and periodic maintenance beyond the scope of this manual. Also, your Regal dealer carries a line of factory approved parts and accessories.

Your Regal dealer can provide information regarding national training organizations such as the U.S. Power Squadron and United States Coast Guard Auxiliary. Along with other organizations and literature, they can help build your “boating savvy” by developing the necessary skills and awareness to be a safe and competent skipper.

Your local library can also help in providing recommended boating literature such as *Chapman Piloting (Seamanship & Boat Handling* by Elbert S. Maloney).

Remember, the waterways can change from normal to abnormal conditions in a heartbeat. Knowing how to react quickly comes from experience and knowledge which can be gained through boating education.

Welcome aboard!



Chapter 1

WELCOME TO REGAL

I know I speak for everyone at Regal when I welcome you to the ever-growing fraternity of Regal boat owners. You've chosen a craft that is recognized worldwide for its standard of excellence. Each step in construction has been carefully scrutinized to assure comfort, performance, reliability and safety for both your passengers and yourself.

Your boat is certified by the National Marine Manufacturers Association. It also complies with the applicable standards set by the United States Coast Guard , American Boat and Yacht Council and the International Marine Certification Institute. Your Regal boat was built with the same attention to detail and quality of construction that we would expect in a boat we would purchase ourselves.

Whether you're a veteran boater or a newcomer, we strongly urge you to read this boat owner's manual thoroughly. Familiarize yourself with the various components of your boat, and heed the safety precautions noted herein.

If you have questions that are not covered in this manual, please consult your authorized Regal dealer for assistance or phone the Regal factory at *407-851-4360*.

Thank you, and welcome to the "World of Regal !"

Paul Kuck
Founder

**REGAL MARINE INDUSTRIES, INC.
MISSION STATEMENT**

With God's help
and a steadfast commitment to integrity
we will develop a team
of exceptional people and relationships
to provide exceptional customer satisfaction.



Chapter 1

YOUR REGAL OWNER'S MANUAL

Your Regal owner's manual has been compiled to help you operate your craft with safety and pleasure. It contains specific details of the craft, the equipment, its systems, and information on its operation and maintenance. Please read it carefully and familiarize yourself with the craft before using it.

This manual is not to be thought of as a complete shop technical manual. Your Regal dealer has received special factory training on our complete product line and his services should be employed to solve technical problems. In addition to your Regal owner's manual, we have provided a folder called the **Owner's Information Pouch** on the vessel. This folder contains important equipment literature along with vendor and warranty information.

Please ensure that you obtain handling and operating experience before assuming control of your boat. Your dealer will be pleased to advise you of local training organizations such as the Power Squadron and United States Coast Guard Auxiliary.

Contact your local dealer if any of the above material is missing. In keeping with its commitment to continued improvement, **Regal notes that all specifications, models, standard and optional equipment are subject to change without notice.**

OWNER'S INFORMATION POUCH

Regal has provided an information pouch aboard the vessel. Read and become familiar with the materials. This packet contains valuable literature on your propulsion package, standard and optional equipment, systems and various care and cleaning instructions. Be sure to store the information pouch in a clean dry area for quick reference.

GENERAL INFORMATION

HULL IDENTIFICATION NUMBER (HIN)

The United States Coast Guard has established a universal system of numerically identifying vessels by using a hull identification number or "HIN." This number identifies your Regal boats' model, hull number, month and year of manufacture. The HIN is found on the starboard side of the transom just below the rub rail or swim platform on the vertical gelcoat surface. The HIN consists of 12 alpha or numeric characters.

It is recommended that you locate and write down the HIN for future reference. Make a listing in the owner's manual. It can be especially useful when ordering parts from your Regal dealer. A second HIN number is found in a hidden location. This second HIN is useful to authorities if the boat is stolen and the original transom HIN is modified or eliminated.

HULL IDENTIFICATION NUMBER

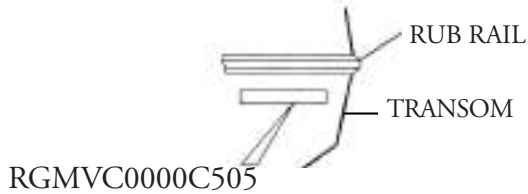

NMMA YACHT CERTIFICATION PLATE

In the dash area you will notice a metal plate which recognizes that your boat was built to design compliance in effect on the date the certification was verified. The plate also states that your vessel complies with U. S. Coast Guard safety standards in effect on the date of certification.

VESSEL INFORMATION SHEET

It is recommended that you fill out the information on the following page. It will supply vital statistics on your vessel. Make a copy of the data for safe keeping at home.

VESSEL FLOAT PLAN

Fill out the float plan on the following page before departing. Leave it with a responsible person who will notify the United States Coast Guard or local law enforcement authorities if you do not return as planned. If you change your plans be sure to notify this person. Make copies of the float plan and use one each time you go boating. This will help people know where to find you should you not return on schedule. Do not file the float plan with the United States Coast Guard.





Chapter 1

VESSEL INFORMATION

Owner: _____

Address: _____

City & State: _____

Home Phone: _____ Business Phone: _____

In Case Of Emergency Notify: _____

Address _____

City__

_____ State _____

Phone _____

Insurance Agent's Name: _____

Policy#: _____

USCG Phone: _____ Local Police: _____

Marina Phone: _____ Slip (Dock#): _____

Hull Serial #: RGM _____

Key #: _____ Port Engine: _____ Stbd Engine: _____

Key #: _____ Cabin Door: _____

Selling Dealer: _____

Address: _____

City & State: _____

Phone: _____ Fax: _____

Servicing Dealer: _____

Address: _____

City & State: _____

Phone: _____ Fax: _____

FLOAT PLAN

Fill out this form before departure. Leave it with a responsible person who will notify the Coast Guard or police if you don't return as planned. If you change your plans be sure to notify this person. Make copies of the float plan and use one each time you go on a trip. This will help people know where to find you should you not return on schedule. **Do not** file this plan with the Coast Guard.

Owner: _____

Address: _____

City & State: _____

Telephone#: _____

Person Filing Report: _____

Name _____

Telephone _____

Make Of Boat: _____

Length _____ Boat Name _____

Color _____ Trim _____ Hp _____

Inboard _____ Outboard _____

Hull I.D.# _____

Other Information: _____

Persons Aboard:

| Name | Age | Address | Phone |
|------|-----|---------|-------|
|------|-----|---------|-------|

Safety Equipment Aboard: _____

Life Jackets

First Aid Kit

Flares

Flash Light

VHF Radio

Anchor

Compass

Food

Water

Registration# _____

Destination:

Leave From _____

Time Left _____

Going To _____

Fuel Capacity _____

Est. Time Of Arrival _____

Return: _____

Est. Time Of Arrival _____

If Not Back By _____ o'clock Call Coast Guard



Chapter 1

LAUNCH & CRUISE CHECKLIST

- Obtain a current weather report.
- Inspect the hull and propeller for damage. Excessive dirt or marine growth will affect your boat's performance and fuel efficiency.
- Check the electrical system and navigation lights.
- If your boat has been in the water, run the bilge pump until the flow of water stops.
- If your boat has been out of the water, check to see that all bilge water has drained out. Then install the drain plug.
- Check that all required safety equipment is on board and in good working condition. Examples include personal flotation devices (PFD's), horn, fire extinguishers, visual distress signals, etc. Take along a gallon of drinking water.
- Check that all other equipment is on board such as mooring lines, first aid kit, tool kit and extra parts.
- Open engine compartment. Inspect for fuel odors and visible leaks in the fuel, oil, coolant, exhaust and power steering systems.
- Visually inspect engine for cracked hoses, defective belts, and loose fasteners such as bolts, nuts or hose clamps.
- Check fuel level. Fuel tanks should be filled to slightly less than capacity. Allow for fuel expansion.
- Make sure all navigation charts, equipment and vessel registration paperwork are on board.
- Check operation of bilge blower, steering system, navigation lights and horn.

RECOMMENDED ON BOARD EQUIPMENT

TOOLS

Allen Wrenches
Jack Knife
Phillips Screwdriver Set
Slotted Screwdriver Set
Combination Box & End Wrench Set
Pliers
Ratchet & Socket Set
Electrical Crimper & Cutter
Hammer
Jumper Cables
Battery Terminal Remover
Vise Grip
Floating Flashlight/Lantern
GFIC Tester
Electrical Strippers
Oil & Fuel Filter Wrench

SPARE PARTS

Fuel Filter
Spark Plugs
Water Pump Belt
Alternator Belts
Anti-siphon Valve
Extra Propellers
Propeller Nuts & Hardware
Extra Light Bulbs/Batteries
Fuses
Liquid Wrench & Oil
Gear Lubricant
Water Pump Impeller
Funnel
Duct & Electricians Tape
Serpentine/V Belt
Engine & Transmission Oil

BASIC GEAR

Tow Line
Mooring Lines
Dock Fenders
Distress Signals
First Aid Kit
Boat Hook
Foul Weather Gear
VHF Radio
Charts & Plotting Instruments
Emergency Water & Food
Bailer or Hand Bilge Pump
EPIRB & Fire Extinguisher
Personal Floatation Devices
Life Raft
Clean Rags & Bucket



Chapter 1

Owner's Registration & Systems Checklist

Please note that your Regal boat requires the proper registration by your authorized Regal dealer. To initiate your warranty your dealer must complete the owner's registration form and systems checklist at the time of delivery. The owner must sign the paperwork to acknowledge that the dealer has reviewed the boat systems and warranty provisions with the owner. The owner should keep the original paperwork that features temporary warranty registration. A warranty certificate will be sent approximately 3-4 weeks after receipt of the paperwork at Regal headquarters.

Your boat has undergone rigid quality assurance inspections before leaving the factory. However, your dealer has been trained to perform final pre-delivery checks and to service your Regal boat prior to your pickup.

Dealer's Responsibility

Your boat has undergone rigid quality assurance inspections before leaving the factory. However, your dealer has been trained to perform final pre-delivery checks and to service your Regal boat prior to your pickup. Your dealer's responsibilities include:

A complete orientation in the operation of your Regal boat, including matters relating to the safe operation of your craft.

Completion and mailing of your boat registration warranty form to Regal.

Warranties, registration materials, owner's manual, operation, installation and maintenance instructions for all auxiliary equipment supplied with or installed on your Regal boat.

Owner's Responsibility

You are entitled to all the benefits and services outlined in your Regal boat warranty. However, you have certain responsibilities to ensure warranty satisfaction. These are:

To read the warranty materials and understand them fully.

To examine the boat in detail at the time of delivery.

Apply the following: boating rules and regulations, safety equipment, environmental regulations, accident reports and warranty regulations terms and conditions.

To read thoroughly all literature supplied with your boat, including this owner's manual and to follow the recommendations in the literature.

To return the boat after the recommended hours of engine operation for the proper dealer service inspections.

To provide proper maintenance and periodic servicing of your boat and equipment as set forth in the various manuals supplied.

Chapter 1

REGAL MARINE INDUSTRIES, INC. LIFETIME PLUS LIMITED HULL WARRANTY

Welcome to the Worldwide Family of Regal Owners! We are very pleased that you have chosen a Regal Powerboat!

This document is your Warranty Registration Certificate and Statement of Warranty. Please check the registration information section for accuracy. If this information is not correct or if you change your address at some future date, please notify us at the following address: Regal Marine Industries, Inc. Attention: Warranty Registrations, 2300 Jetport Drive, Orlando, Florida 32809

Please read the warranty carefully. It contains important information on Regal's claims procedures and your rights and obligations under this warranty.

WHAT IS COVERED: This Limited Warranty applies only to Regal beginning with model year 2005.

LIFETIME LIMITED STRUCTURAL HULL WARRANTY: Regal Marine Industries, Inc. warrants to the original retail purchaser of this boat if purchased from an authorized Regal dealer that the selling dealer or Regal will repair or replace the fiberglass hull if it is found to be structurally defective in material or workmanship for as long as the original retail purchaser owns the boat. For purposes of this warranty, the hull is defined as the single fiberglass casting which rests on the water. This limited warranty is subject to all limitations and conditions explained below.

FIVE-YEAR TRANSFERABLE LIMITED STRUCTURAL HULL WARRANTY: In addition to the Lifetime Limited Structural Hull Warranty, Regal offers a Transferable Five-Year Limited Structural Hull Warranty. Under the Five-Year Transferable Limited Structural Hull Warranty, Regal will repair or replace the fiberglass hull if it is found to be structurally defective in material or workmanship within the first (5) years after the date of delivery to the original retail purchaser. Any remaining term of this Five-Year Limited Hull Warranty may be transferred to a second owner if within 60 days of purchase, the new owner registers the transfer with Regal and pays the established warranty transfer fee. Contact Regal Customer Service at the above address for details.

FIVE-YEAR LIMITED HULL BLISTER WARRANTY: Regal will warrant to the original retail purchaser, any underwater gelcoated surfaces of the hull against laminate blisters which occur as a result of defects in material or workmanship within (5) years of the date of delivery, provided that the original factory gelcoat surface has not been altered. Alternation would include but is not limited to damage repair; excessive sanding, scraping, sandblasting; or from improper surface preparation for application of a marine barrier coating or bottom paint, any of which shall void this Five-Year Limited Hull Blister Warranty. Regal Marine shall repair or cause to be repaired any covered laminate blisters based on the following prorated schedule. Less than two (2) years from delivery date - 100%, Two (2) to three (3) years from delivery date - 75%, Three (3) to four (4) years from delivery date - 50%, Four (4) to five (5) years from delivery date - 25%. Reimbursement shall be limited to one repair, not to exceed (\$80.00) dollars per foot of boat length prior to prorating. Regals prior authorization for the method and cost of repair, must be obtained before repairs are commenced. All costs to transport the boat for repairs are the responsibility of the owner.

LIMITED GENERAL WARRANTY: In addition to above hull warranties, Regal warrants to the original purchaser of this boat if purchased from an authorized dealer that the dealer or Regal will repair or replace any parts found to be defective in materials or workmanship for a period of one (1) year from the date of delivery, subject to all limitations and conditions contained herein.

LIMITED EXTERIOR FINISH WARRANTY: Regal warrants that the selling dealer or Regal will repair cosmetic defects in the exterior gelcoated finish including cracks or crazing reported to Regal within 90 days from the date of delivery to the original purchaser, subject to all limitations and conditions contained herein. All warranty work is to be performed at a Regal dealership or other location authorized by a Regal Customer Service Manager after it is established to Regal's satisfaction that there is a defect in material or workmanship.

REGISTRATION INFORMATION:

CUSTOMER OBLIGATIONS: The following are conditions precedent to the availability of any benefits under these limited warranties:

- (a) The purchaser must sign and the dealer must submit to Regal the "OWNER REGISTRATION AND SYSTEMS CHECKLIST FORM" within ten (10) days of the date of delivery and such information must be on file at Regal.
- (b) The purchaser must first notify the dealer from whom the boat was purchased of any claim under this warranty within the applicable warranty period and within a reasonable period of time (not to exceed thirty (30) days) after the defect is or should have been discovered.
- (c) Regal will not be responsible to repair or replace any part, (1) if the use of the boat is continued after the defect is or should have been discovered; and (2) if such continued use causes other or additional damage to the boat or component parts of the boat.
- (d) Based on the dealer's knowledge of Regal's warranty policy and/or consultations with Regal, the dealer will accept the claim and arrange for appropriate repairs to be performed, or deny the claim if it is not within the warranty.
- (e) The dealer will contact the Regal boat owner regarding instructions for delivery of boat or part for warranty repair if it is covered by the limited warranty.

ALL COSTS TO TRANSPORT THE BOAT FOR REPAIRS ARE THE RESPONSIBILITY OF THE OWNER;

- (f) If the Regal boat owner believes a claim has been denied in error or the dealer has performed the warranty work in an unsatisfactory manner, the owner must notify Regal's Customer Service Department in writing at the address listed for further consideration. Regal will then review the claim and take appropriate follow-up action.

WARRANTY EXCEPTIONS: THIS LIMITED WARRANTY does not cover and the following are not warranted:

- (a) Engines, metal plating or finishes, windshield breakage, leakage, fading and deterioration of paints, canvas, upholstery and fabrics;
- (b) Gelcoat surfaces including, but not limited to, cracking, crazing, discoloration or blistering except as noted above;
- (c) Accessories and items which were not part of the boat when shipped from the Regal factory, and/or any damage caused thereby;
- (d) Damage caused by misuse, accident, galvanic corrosion, negligence, lack of proper maintenance, or improper trailering;
- (e) Any boat used for racing, or used for rental or commercial purposes;
- (f) Any boat operated contrary to any instructions furnished by Regal, or operated in violation of any federal, state, Coast Guard or other governmental agency laws, rules, or regulations;
- (g) The limited warranty is void if alterations have been made to the boat;
- (h) Transportation of boat or parts to and/or from the REGAL factory or service location;
- (i) Travel time or haul outs, loss of time or inconvenience;
- (j) Any published or announced catalog performance characteristics of speed, fuel and oil consumption, and static or dynamic transportation in the water;
- (k) Any boat that has been re-powered beyond Regal's power recommendations;
- (l) Boats damaged by accident and boats damaged while being loaded onto, transported upon or unloaded from trailers, cradles, or other devices used to place boats in water, remove boats from water or store or transport boats on or over land;
- (m) Water damage to, dry rot to, condensation to, or absorption by interior surfaces, wood structures or polyurethane foam; interior wood including, but not limited to, bleeding and/or discoloration as a result of condensation or moisture or water continually contacting the plywood causing staining to upholstery, carpet or other interior surfaces;
- (n) Costs or charges derived from inconveniences or loss of use, commercial or monetary loss due to time loss, and any other special, incidental or consequential damage of any kind or nature whatsoever.

WARRANTY EXCEPTIONS: The terms, conditions, limitations and disclaimers contained herein cannot be waived except by the Customer Service Manager of Regal. Any such waiver must be in writing. Neither the dealer, nor the customer, nor any service, sales and/or warranty representative of Regal is authorized to waive and/or modify these conditions, limitations and/or disclaimers.

GENERAL PROVISIONS:

ALL GENERAL, SPECIAL, INDIRECT, INCIDENTAL AND/OR CONSEQUENTIAL DAMAGES ARE EXCLUDED FROM THIS WARRANTY AND ARE TOTALLY DISCLAIMED BY REGAL. IT IS THE INTEREST OF THE PARTIES THAT THE OWNER'S SOLE REMEDY IS THE REPAIR OR REPLACEMENT OF THE VESSEL OR ITS ALLEGEDLY DEFECTIVE COMPONENT PARTS AND THAT NO OTHER LEGAL OR EQUITABLE REMEDIES SHALL BE AVAILABLE TO SAID OWNER. SOME STATES DO NOT ALLOW THE EXCLUSION OF INCIDENTAL OR CONSEQUENTIAL DAMAGES SO THE FOREGOING MAY NOT APPLY TO YOU.



Chapter 1

THIS IS A LIMITED WARRANTY; REGAL MAKES NO WARRANTY, OTHER THAN CONTAINED HEREIN; TO THE EXTENT ALLOWED BY LAW ANY WARRANTIES OF MERCHANTABILITY OR FITNESS FOR A PARTICULAR PURPOSE ARISING IN STATE LAW ARE EXPRESSLY EXCLUDED TO THE EXTENT ALLOWED BY LAW. ANY IMPLIED WARRANTY OF MERCHANTABILITY IS LIMITED TO THE PERIOD OF THIS LIMITED WARRANTY. ALL OBLIGATIONS OF REGAL ARE SPECIFICALLY SET FORTH HEREIN. REGAL DOES NOT AUTHORIZE ANY PERSON OR DEALER TO ASSUME ANY LIABILITY IN CONNECTION WITH REGAL BOATS. **Some states do not allow limitations on how long an implied warranty lasts, so the above limitation may not apply to you. Regal's obligation with respect to this warranty is limited to making repairs to or replacing the defective parts and no claim for breach of warranty shall be cause for cancellation or rescission of the contract or sale for any boat manufactured by REGAL MARINE INDUSTRIES, INC.**

Regal will discharge its obligations under this warranty as rapidly as possible, but cannot guarantee any specific completion date due to the different nature of claims which may be made and services which may be required. Regal reserves the right to change or improve the design of its boats without obligation to modify any boat previously manufactured. This limited warranty gives you specific legal rights, and you may also have other rights which may vary from state to state. Regal shall in no way be responsible for any repairs not PRE-AUTHORIZED by a Regal Customer Service Manager or repairs performed by a repair shop not PRE- AUTHORIZED by a Regal Customer Service Manager.

✓ 2

Chapter 2

On Board Safety

Safety awareness can't be over emphasized. Safety on board needs to be the skippers number one priority. In this manual you will find many safety precautions and symbols to identify safety related items. Heed all safety precaution information. Remember, the skipper is responsible for the safety of his passengers and crew.

| |
|---|
|  WARNING |
| Potentially hazardous situation that, if not avoided, could result in death or serious injury. |

SAFETY LABELS

Safety Precaution Definition

Safety precautions are stated as caution, warning and danger signal words. They are highlighted in this manual by font design and symbol usage. Also, a notice heading is included which provides operation and maintenance information **but is not hazard-related**. **Become familiar and understand all safety precaution labels!**

| |
|--|
|  CAUTION |
| Indicates a potentially hazardous situation or unsafe practice that, if not avoided, may result in injury or property or product damage.. |

| |
|---|
|  DANGER |
| Immediate hazardous situation that, if not avoided, will result in death or serious injury.. |

| |
|--|
| NOTICE |
| General or specific information which is important to correct operation or maintenance, but is not hazard related . |



Chapter 2

PRECAUTIONARY LABELS

Read and understand all safety labels affixed to your Regal boat. Most of the safety labels are found close to the helm, aft cockpit and or swim platform. The location of the labels may vary by model. The label list does not cover everything! Use common sense to analyze the result of an action on board your vessel. **Always think safety first!**

NOTICE

DO NOT REMOVE OR COVER ANY
PRECAUTIONARY LABELS.
KEEP HARSH CHEMICALS
AWAY FROM LABELS.
IF A LABEL BECOMES ILLEGIBLE,
CONTACT YOUR REGAL DEALER
FOR ORDERING REPLACEMENTS.

GENERAL BOATING SAFETY

We understand that you are eager to get your Regal boat on the water. However, we strongly suggest that you thoroughly familiarize yourself and friends or members of your family with safe boating practices before setting out. Remember, that along with the freedom and exhilaration of boating comes the responsibility that you have for the safety of your passengers and other boaters who share the water with you.

Boating regulations vary from state to state. Check with your local state and local authorities for the regulations pertaining to your area.

☐ Check with local weather stations, the U. S. Coast Guard, or weather station broadcasts for the latest conditions. Remember getting caught in severe weather is hazardous, Check weather conditions periodically while you are boating and before your outing. If you are forced to operate your boat in a storm condition, take common sense precautions; wear PFD's, store gear, reduce speed and head for safe refuge.

☐ It is best to avoid operating your boat in foggy weather. When fog sets in, take bearings, log courses and speeds. You are required to emit a five second blast from your horn or whistle once every minute. Also, have your passengers wear PFD's and observe for oncoming vessels.

☐ Operate in shallow water presents a number of hazards including sand bars and water levels influenced by tides. If the vessel strikes an underwater hazard, check for boat and engine damage. If the engine vibrates excessively after striking an underwater obstruction, it may indicate a damaged propeller. If you run aground, seek help by radio or flares.

☐ Make sure your boat and equipment are in top condition. Do this by frequently inspecting the hull, engine and all the gear.

Safety On Board

☐ You must provide a Coast Guard approved personal flotation device (PFD) for every person on board. These PFD's should be in good condition and easily accessible.

☐ Insist that non-swimmers and children on board wear a PFD at all times. Any time you encounter rough weather conditions, make sure everyone on board is wearing a PFD, including yourself. Instruct your passengers in how to put on their PFD's and be sure they know their storage location on the boat. Remember, in an emergency, a PFD that cannot be quickly located and worn is useless.

☐ Never allow anyone to sit anywhere on the boat not specifically designed seating. While underway, **ALWAYS** insist passengers sit in the provided seating and set an example by doing this yourself.

☐ **Use maximum caution when fueling.** **Never** allow any smoke or flame nearby while you are fueling. **ALWAYS** check for fuel leaks and fumes when fueling is completed.



☐ **Never drink and drive!** As captain, you are responsible for the safety of your passengers and yourself. Alcohol and boating can be a dangerous combination. **DO NOT** mix them. Alcohol impairs the boat operators ability to make conscious decisions and react

to emergency situations quickly..

☐ **Never overload your boat!** An overloaded boat, or one with uneven weight distribution can be difficult to steer.



☐ **Be certain there is enough fuel aboard for your cruising needs.** Include any reserve that might be needed should you change your plans due to weather or emergency. **Practice the “one-third rule:** Use one-third of your fuel going out, one-third to return and keep one-third as a reserve.

☐ Always check the weather before departure. Be particularly cautious of electrical storms and high winds.

☐ Always have up-to-date charts aboard. You will need current charts of the area you'll be cruising to stay on proper course. Charts can be obtained at your closet marine outlet or store or by contacting one of three federal government agencies.

☐ **Always file a float plan.** Leave details of your trip with someone responsible who will be remaining on shore. Include expected return, plus name and phone number of a contact person in case of emergency.

☐ Use care, courtesy and common sense when launching, docking or operating your boat.

☐ **Learn and obey the “Rules of the Road”.** A copy of the “Rules of the Road” can be obtained from the U. S. Coast Guard Auxillary or local Power Squadron.



Chapter 2

□ In case of emergency: Know the international distress signals if you have a VHF radio aboard. The spoken word “MAYDAY” is the international signal of distress and is for emergency use only. Under no circumstances should this word be used, unless there is danger at hand.

□ Posted speed limits, swimming areas, “no wake” zones and other restrictions should be red-flagged. They are so noted for a reason. Sensible boat use, plus courtesy, equals enjoyable and safe boating.

□ It is your responsibility to stay abreast of all federal, state and local rules, as some laws or regulations may change or be different from state to state. Contact your local boating agencies for updated information.

□ We can not stress safety enough! Remember, there are no brakes on your boat, and the water current and wind velocity all affect your ability to respond. The driver must use caution at all times to maintain control of his vessel and especially to maintain a safe distance from other boats and obstacles.

□ **Always keep all safety gear in optimum condition.** Pay special attention to attached tags and plates indicating expiration dates on equipment such as fire extinguishers, and personal flotation devices. Encourage a periodic maintenance check on all safety equipment. Contact your Regal dealer or marine professional for more information. Again, remember that the captain is responsible for his passengers and vessel.

REQUIRED SAFETY EQUIPMENT

PERSONAL FLOTATION DEVICES

All personal flotation devices (PFD's) must be Coast Guard approved, in good working condition, and must be the correct size for the wearer. All PFD's must be readily accessible. This means being able to wear them in a reasonable amount of time in case of an emergency (fire, boat sinking, etc.). They should not be stored or locked in closed areas. Also, make sure that all coverings are removed such as plastic from any PFD's. Throw able devices such as a ring buoys need to be available for **immediate** deployment. A PFD should be worn at all times when your boat is operating on the water. A PFD may save your life, but it must be worn to do so.

As minimum U. S. Coast Guard requirements all recreational boats must carry one type I, II, III, or V PFD (wearable) for each person aboard. See the explanation following for each type. For type V to be counted they must be used according to the label instructions. In addition, all boats over 16' must carry one Type IV (throw able) PFD.

Some states require that PFD's be worn by children of specific ages at all times. Check with state boating agencies for particular requirements in your state before taking children on the water.

Remember PFD's will not necessarily keep you from drowning, even though they are designed to keep a person from sinking. When purchasing PFD's make sure it safely fits the person wearing it. It is a good idea to test PFD's in a lifeguard-ed shallow pool before venturing on the water.

Safety On Board

Refer to the USCG minimum equipment requirements at the end of this chapter. It is meant to be a guide only. Contact state and local agencies for additional equipment requirements. Remember as the captain of your vessel you are responsible for its safe operation.

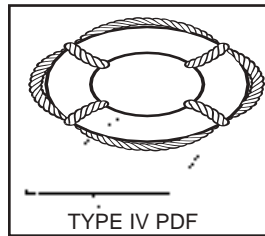

TYPE IV- Intended for calm, inland water with heavy vessel traffic, where help is constantly present. It is designed to be thrown into the water for someone to grab on to and held until rescued. It should not be worn. Type IV includes ring buoys, buoyant cushions, and horseshoe buoys.

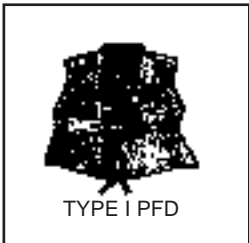

TYPE I- Also known as an offshore jacket, it provides the most buoyancy. It is a PFD for all waters and is especially useful in rough waters where rescue may encompass additional time. It is designed to turn most unconscious users in the water to a face-up position. Type I

PFD is available in adult & child sizes.

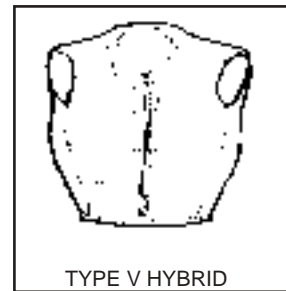

TYPE V- This is the least bulky of all PFD's. It contains a small amount of inherent buoyancy, and an inflatable chamber. It is rated even to a Type I, II, or III PFD (as noted on the jacket label) when inflated. Hybrid PFD's must be worn to be acceptable.



TYPE II- Also known as near-shore buoyant vest, it is recommended for calm, inland water where rescue time will be minimal. It will turn some unconscious people face-up in the water but not as numerous as Type I. They are available in adult, medium child, along with infant

and small child sizes.



TYPE III- Known as a flotation aid it is good for calm, inland water or where there is a chance for quick rescue. It is designed so wearers can place themselves in a face-up position in the water. The wearer may have to tilt their head back to avoid turning face-down in the

water.



Chapter 2

MAINTAINING YOUR PFD'S

A PFD is only useful if it is well maintained. Always be aware of PFD age since it has a life expectancy like any other piece of equipment.

- Check periodically for broken zippers, frayed webbing, water soaked kapok bags, missing straps, and sewing that has become undone.
- Clean each PFD with mild soap and water only. Again, let dry sufficiently before storing.
- Keep PFD's out of grease and oil since they can deteriorate the jacket inner and outer materials.
- Check any kapok-bagged jackets by squeezing. If you hear air escaping the bag is defective and the PFD should be thrown away.
- Grab the cover with the fingers. If the cover material rips, the PFD is rotted and should be thrown away.
- If the kapok bag is hard the PFD should be discarded.

FIRE EXTINGUISHERS

GENERAL INFORMATION

Fire extinguishers are classified by a letter and numeric symbol. The letter references the type of fire the unit is designed to extinguish.

(For example, type B extinguishers commonly used on boats are designed to put out flammable liquids such as grease, oil and gasoline.

The number indicates the general size of the extinguisher (minimum extinguishing agent weight).

| FIRE EXTINGUISHER CONTENTS | | | | |
|----------------------------|------------------|----------------|---------------------|------------------|
| CLASS | FOAM IN GALS. | CO2 IN LBS. | DRY CHEM IN LBS. | HALON IN LBS. |
| B-I | 1.25 | 4 | 2 | 2.5 |
| B-II | 2.5 | 15 | 10 | 10 |

| MINIMUM PORTABLE FIRE EXTINGUISH REQUIRED | | |
|--|------------------------------|----------------------|
| VESSEL LENGTH | NO FIXED SYSTEM | WITH FIXED SYSTEM |
| LESS THAN 26' | 1 B-1 | 0 |
| 26' TO LESS THAN 40' | 2 B-1 OR 1 B-II | 1 B-1 |
| 40'-65' | 3 B-1 OR 1 B-II AND 1 B-1 | 2 B-1 OR 1 B-II |

U. S. Coast Guard approved fire extinguishers are required on all Regal boats. Besides the **minimum** Coast Guard requirements always check state and local agencies for additional requirements and equipment.

Coast Guard approved extinguishers are hand-portable, either B-I or B-II classification. U. S. Coast Guard approved hand-portable and semi-portable extinguishers contain a metal plate that shows the manufacturers name and extinguisher type, capacity and operating instructions. They have a special marine type mounting bracket which keeps the extinguisher solidly mounted until needed. The extinguisher needs to be mounted in a readily accessible location but one out of being bumped by people while underway. All approved extinguishers need to have an indication gauge.

USCG APPROVED FIRE EXTINGUISHER TYPES & FEATURES



■ The dry chemical agent is widely used because of its convenience and low cost. The extinguisher canister is filled with a white dry chemical power along with a pressurized gas. It is a good idea to shake this type periodically because they tend to

“pack” on the canister bottom.

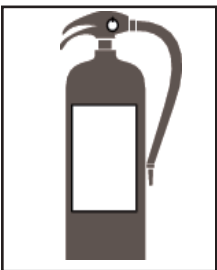

■ The foam type uses a chemical foaming agent plus water and is best when used for fires involving flammable liquids- solvents, gasoline, oil, grease and various paints. It will work on fires involving rubber, plastics, cloth, wood, and paper. It leaves a messy residue. Do not use this

extinguisher for electric fires.

rubber, plastics, cloth wood, and paper. It leaves a messy residue. Not for electric fires.



■ The carbon dioxide unit uses CO₂ gas under high pressure, with a funnel discharge hose usually swivel mounted. This extinguisher leaves no residue and does not cause interior engine harm. To ensure workability, weigh the unit annually. A 10% maximum weight variance is

allowed.

Another type of liquefied gas used today is Halon. This gas is colorless and odorless, heavier than air and sinks to the lower bilge to extinguish fires. Since the year 2000 ingredients for Halon has changed to a more environmental friendly formula. Halon is used in portable-hand units along with making up the majority of boat automatic fire extinguishing systems. The canister needs to be weighed once a year. Halon units must feature a dash mount indicator.

Refer to the information regarding fire prevention in this manual.

VISUAL DISTRESS SIGNALS

All vessels used on coastal waters, any of the Great Lakes, territorial seas, and those waters connected directly to them up to point where a body of water is less than two miles wide, must have Coast Guard approved visual distress signals.



Chapter 2

PYROTECHNIC DEVICES

Pyrotechnic visual distress signals must be Coast Guard approved, be ready for service and must be readily accessible. They all display a marking which is the service life, which must not have expired. A minimum of 3 devices are required for the day and 3 devices for night.

Some devices meet both day and night requirements. Pyrotechnic devices should be stored in a cool, dry location. Most of these devices can be purchased in an highly visible (orange) watertight container. Types of Coast Guard approved pyrotechnic distress signals and associated devices are:

- Pyrotechnic red flares, hand-held or aerial type.
- Pyrotechnic orange smoke, hand-held or floating type.
- Launchers for parachute flares or aerial red meteors.

All in all, each distress signal has certain advantages and disadvantages.

There is no distress signal that is best under all situations.

Pyrotechnics are recognized world-wide as superior distress signals. A downfall is they emit a very hot flame that can cause burns and or ignite flammable materials. Pistol launched and hand-held parachute flares operate consistent with firearms and therefore must be carefully handled. Check with local and state regulations since some of these devices are considered firearms and are prohibited.

NON-PYROTECHNIC DEVICES

Non-pyrotechnic devices must all be in serviceable condition, readily accessible, and must be certified by the manufacturer to comply with Coast Guard standards. They include:

- Orange distress flag.
- Electric distress flag.

The distress flag is for day use only. It must be 3 x 3 or larger with a black square and ball on an orange background. It can be spotted when attached to a boat hook, long fishing rod, or paddle with the person waving the flag back and forth overhead.

The electric distress flag is for night use only flashing the international SOS distress signal (... _ _ _ ...).

Under Inland Navigation Rules, a high intensity white light that flashes at regular intervals from 50-70 times per minute is considered a distress signal.

Remember that regulations prohibit the display of visual distress signals on the water under any circumstances except when assistance is required to prevent immediate or potential danger to passengers on a vessel.

Safety On Board

INTERNATIONAL DISTRESS SIGNALS



BLACK SQUARE
AND BALL ON
ORANGE BACKGROUND



CODE FLAGS
NOVEMBER
& CHARLIE



SQUARE FLAG
& BALL



PERSON
WAVING
HANDS



MORSE
CODE S.O.S.



"MAYDAY"
BY
RADIO



ENSIGN
UPSIDE
DOWN



PARACHUTE
RED FLARE



RED METEOR
FLARES



SMOKE



FOG HORN
SOUNDED
CONTINUOUSLY



GUN FIRED AT
1- MINUTE
INTERVALS



POSITION
INDICATING
RADIO BEACON



DYE MARKER
(ANY COLOR)



HAND-HELD
FLARE



Chapter 2

SOUND PRODUCING DEVICES

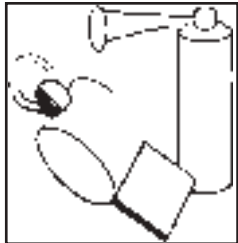

According to both Inland and International Rules, all boats **must** carry some way of producing an efficient sound signal. If your vessel is 12 meters (39' 4") or longer, a power whistle, power horn or bell must be carried. The bell must be a minimum of 7 7/8" in diameter.

Boats less than 12 meters a horn or whistle is **recommended** to signal intentions or signal position. The sound signal made in all cases must be capable of a four or six second blast audible for one half mile. See the section discussing bridge and whistle signals for more information.

RADIO COMMUNICATIONS

VHF radios are used for distress and ship to shore and ship to ship communications today. Learn the specialized messages such as

Mayday, Mayday, Mayday is only used when life or vessel is in imminent danger.

NAVIGATION LIGHTS

The U. S. Coast Guard requires recreational boats operating at night to display navigation lights between sunset and sunrise. Navigation lights help avoid collisions by improving the night visibility of vessels. Red and green directional lights, white stern lights, white masthead lights and white all-around lights must be displayed in specified positions, depending on boat size, and mode of operation.

The configuration of visible lights tells and operator the size, direction of travel and means of propulsion (sail, power, rowing or at anchor) of another vessel.

This helps both operators determine who has the right of way. Larger boats are required to carry larger, brighter lights that are visible over longer distances. See the light requirement chart for pleasure craft.

MARINE SANITATION DEVICES

Recreational vessels under 65' with installed toilet facilities must have an operable marine sanitation device (MSD) on board. Vessels 65' and under may use Type I, II, or III MSD. All installed MSD's must be U.S. Coast Guard certified. Most of the devices are labeled to show conformity to the regulations.

NOTICE

DISCHARGE OF OIL PROHIBITED
THE FEDERAL WATER POLLUTION CONTROL
ACT PROHIBITS THE DISCHARGE
OF OIL OR OILY WASTE
INTO OR UPON THE NAVIGABLE WATERS
AND CONTIGUOUS ZONE
OF THE UNITED STATES. IF SUCH DISCHARGE
CAUSES A FILM OR SHEEN
UPON, OR DISCOLORATION OF THE SURFACE
OF THE WATER, OR CAUSES A SLUDGE OR
EMULSION BENEATH THE SURFACE
OF THE WATER
**VIOLATORS ARE SUBJECT TO
A PENALTY OF \$5,000.**

Safety On Board

NAVIGATION LIGHT RULES

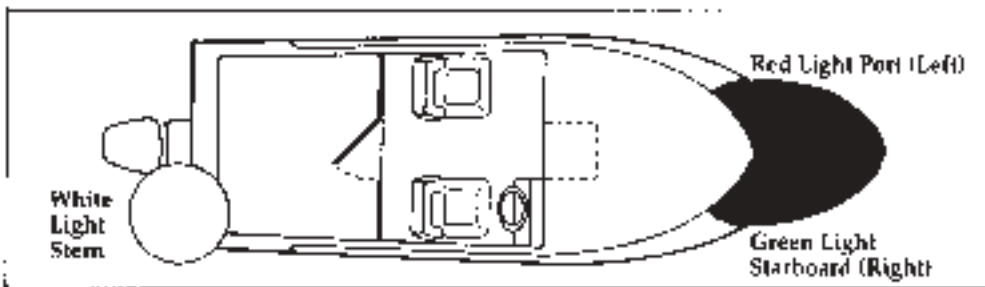

| Location of lights on vessel | Visible Range | | Degrees of arc light's |
|------------------------------|----------------|---------------------------|------------------------|
| | Less than 12 m | 12 m, but less than 20 m. | |
| Masthead | 2 | 3 | 225 |
| All-round | 2 | 2 | 360 |
| Side lights | 1 | 2 | 112.5° each color |
| Stern light | 2 | 2 | 135° |

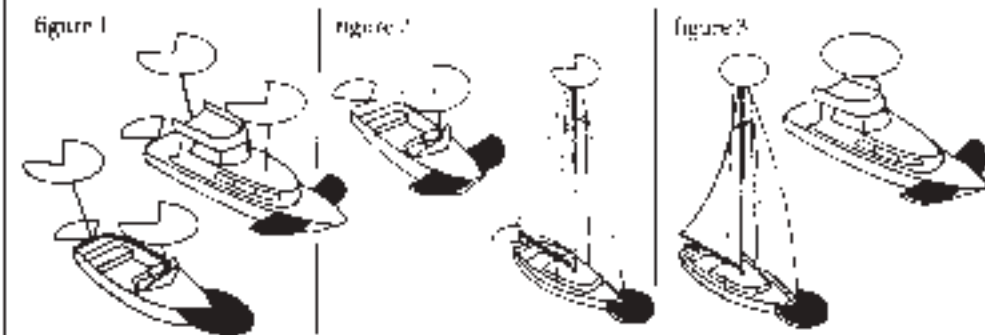

Boats less than 12 meters in length
Motorboats or sailboats using power. The lighting arrangements in figure 1, 2 or 3 may be used.
Sailboat using sails alone. The lighting arrangements in figure 4, 5 or 6 may be used.

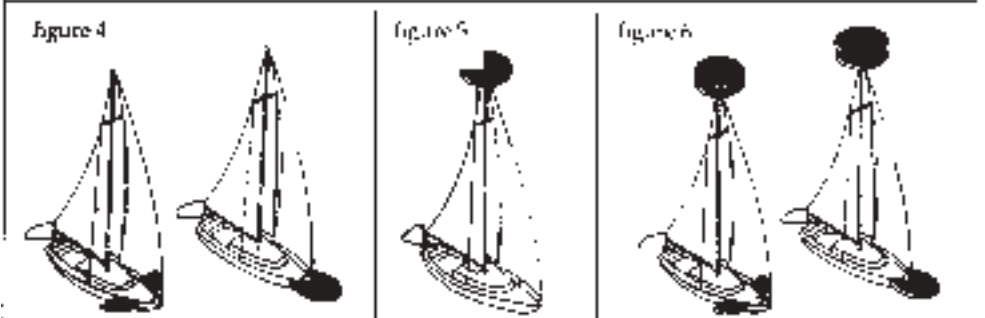

Boats 12 meters but less than 20 meters in length
Motorboats or sailboats using power. The lighting arrangements in figure 1 or 2 may be used.
Sailboat using sails alone. The lighting arrangements in figure 4, 5 or 6 may be used.

Location of lights
 Lights should be located as shown in the drawings.

The masthead light (forward white light in figures 1, 2 and 7d) must be at least one meter higher than the colored lights on a boat less than 12 meters in length and at least 2.5 meters above the gunwale on a boat 12 meters but less than 20 meters in length.

Exceptions
Motorboat or sailboat using power, both before December 21, 1998. The lighting arrangement in figure 1, 2 or 3 may be used. However, the arrangement in figure 3 is not acceptable on a boat that is 12 meters or longer on international waters.

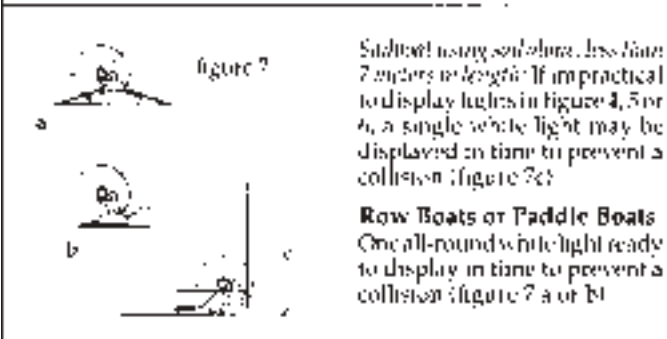

Sailboat using sails alone, less than 7 meters in length. If impractical to display lights in figure 4, 5 or 6, a single white light may be displayed in time to prevent a collision (figure 7a).

Row Boats or Paddle Boats
 One all-round white light ready to display in time to prevent a collision (figure 7a or b).



Great Lakes
 figure 7d

Motorboat or sailboat using power on Great Lakes. The lighting arrangements in figure 7d may be used instead of the arrangements in figures 1 and 2.



Chapter 2

You must immediately notify the U. S. Coast Guard if your vessel discharges oil or hazardous substances in the water. Call toll free 800-424-8802. Report the following information: location, source, size, color, substances and time observed.

GARBAGE

The Act to Prevent Pollution from Ships places limitations on the discharge of garbage from vessels. It is illegal to dump plastic trash anywhere in the ocean or navigable waters of the United States. Also, it is illegal to discharge garbage in the navigable waters of the United States, including the Great Lakes. The discharge of other types of garbage is allowed outside certain specified distances from shore as determined by the nature of that garbage.

United States vessels of 26 feet or longer must display in a prominent location, a durable placard at least 4" x 9" notifying crew and passengers of discharge restrictions.

EBIRB

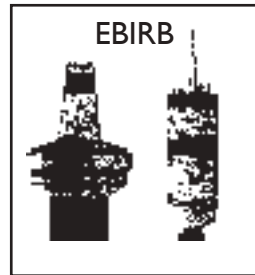

It is a good idea to carry communication gear such as a VHF-FM and/or HF transceivers set up for your operating area. Also, cell phones are useful in many coastal areas. Be sure to carry extra batteries. Also, mainly for offshore vessels, EPIRBs are

designed to quickly and accurately alert rescue forces, indicate an accurate distress position, and guide units to the distress scene. These devices operate from satellite signals sent to a ground station where the signal is downloaded. The downside is that they are relatively expensive but they are reliable even when other types of communications have been exhausted.

| GARBAGE TYPE | DISCHARGE |
|--|--|
| Plastics including synthetic ropes, fishing nets, and plastic bags | Prohibited in all areas |
| Floating dunnage, lining and packing materials | Prohibited less than 25 miles from nearest land |
| Food, waste, paper bags, rags, glass, metal, bottles and crockery | Prohibited less than 12 miles from nearest land |
| Comminuted or ground food waste, paper, rags, glass, etc. | Prohibited less than 3 miles from the nearest land |



Chapter 2

EXHAUST & CARBON MONOXIDE

Carbon monoxide(CO) in exhaust can be hazardous. It is important for you and your passengers to be aware of the potential safety hazard created by exhaust gases. Familiarize yourself with the symptoms of carbon monoxide poisoning. For safety sake avoid the following:

1. Do not allow the boat to remain stationary with the engine idling for an extended period of time.
2. Do not disable the carbon monoxide alarms that come with your Regal boat. Test the unit in accordance with the alarm manufacturers instructions.
3. Do not operate the engine for extended periods of time while in a confined area or where exhaust outlets face a wall or bulkhead.
4. Do not operate the engine for an extended period of time with the canvas in the upright and installed position.
5. Have the engine exhaust system inspected when the boat is in for service.
6. Persons sleeping can easily be overcome by carbon monoxide without realizing it. Do not sleep on board while the engine is running.



Blockage of exhaust outlets can cause carbon monoxide to accumulate in the cabin and cockpit area even when the hatches, windows, portholes and doors are open.

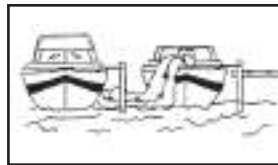

Exhaust from another vessel alongside your boat, while docked or anchored, can emit poisonous CO gas inside the cabin and cockpit areas of your boat.



The “station wagon effect” or back drafting can cause CO gas to accumulate inside the cabin, cockpit or bridge areas when the boat is under-way, using protective weather coverings,

high bow angle, improper or heavy loading, slow speeds, or when boat is at rest.

In high concentrations, CO can be fatal in minutes. However, the effects of lower concentrations over a extended period of time can be just as lethal.

Carbon Monoxide accumulation requires immediate attention! Thoroughly ventilate cabin and cockpit areas. Determine the probable source of the carbon monoxide and correct the condition immediately. Regal has installed CO detectors on your boat. Have these detectors professionally calibrated at regular intervals.

 **WARNING**

AVOID SERIOUS INJURY OR DEATH
FROM CO POISONING!
DO NOT OPERATE THE BOAT WITH PEOPLE
HOLDING ON TO THE SWIM PLATFORM
WHILE IN THE WATER

Safety On Board

Symptoms of excessive exposure to carbon monoxide are:

- Dizziness
- Drowsiness
- Nausea
- Headache
- Ringing in the ears
- Throbbing temples
- Watering, itchy eyes
- Flushed appearance
- Inattentiveness
- Incoherence
- Fatigue or vomiting
- Convulsions

WARNING

AVOID INJURY OR DEATH!
EXHAUST FUMES CAN KILL!
INSPECT THE EXHAUST SYSTEM BEFORE
EACH OUTING.
REPAIR OR REPLACE LEAKING, CRACKED,
CORRODED, AND/OR MISSING EXHAUST
COMPONENTS.

DANGER

CARBON MONOXIDE IS A TASTELESS,
ODORLESS AND INVISIBLE GAS THAT CAN
CAUSE DISCOMFORT, SEVERE ILLNESS,
AND EVEN DEATH. EXERCISE CAUTION
WHILE OPERATING GENERATOR OR
ENGINES IN CONFINED SPACES OR AT
DOCKSIDE. DO NOT ALLOW HULL EXHAUST
OUTLETS TO BECOME BLOCKED.
EXHAUST FUMES CAN BECOME TRAPPED
IN AND AROUND THE CONFINES
OF YOUR BOAT. DURING IDLE AND SLOW
CRUISE CONDITIONS, BILGE BLOWERS
SHOULD BE USED.

EACH TRIP

- Make sure all exhaust clamps are in place and secure.
- Look for exhaust leaking from the exhaust system components, indicated by rust and or black streaking, water leaks, or corroded or cracked fittings.
- Inspect all rubber exhaust hoses for burned or cracked areas. All rubber hoses should feel soft and be free of kinks.
- Visually verify that water exits at the engine exhaust outlet.
- Keep an ear tuned for any change in exhaust sound that could indicate an exhaust component malfunction.
- Do not operate the vessel if any of the above items exist. Consult a marine professional.



To help prevent carbon monoxide accumulation, ventilate your cabin and cockpit while underway. Open a forward hatch, porthole or window to allow air to travel through the boat's interior. See the

illustration below for desired airflow.

At Least Annually (To be performed by a marine professional);



Chapter 2

BOATING & ALCOHOL

- ☑ Replace exhaust hoses or mufflers if any evidence of cracking, charring or deterioration is found.
- ☑ Replace the engine water pump impeller along with the plate and housing if necessary. This will help prevent cooling system and in turn exhaust system overheating.
- ☑ Inspect each of the metallic exhaust components for cracking, rusting, leaking or looseness. Pay detailed attention to the exhaust manifold, cylinder head, water injection elbows.

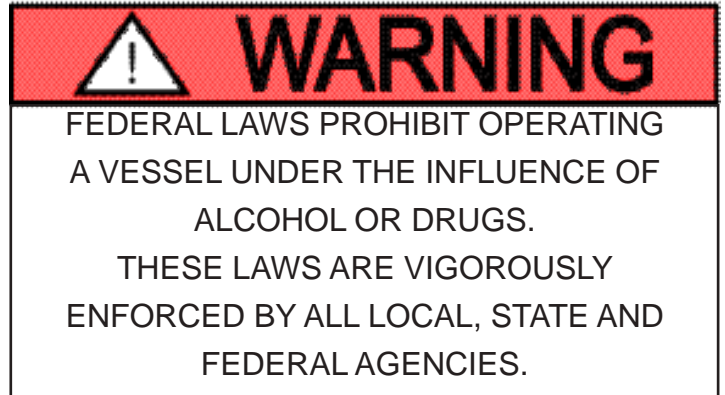

Operating a vessel while intoxicated became a specific federal offense effective in 1988. The ruling set federal standards for determining when an individual is intoxicated. If the blood alcohol content (BAC) is .10% (.08 in some states) or higher for operators of recreational vessels being used only for pleasure are subject to a civil penalty up to \$1,000 or criminal penalty up to \$5,000, one year imprisonment or both. In some states the fines and imprisonment may increase significantly.

The effects of alcohol and drugs account for the highest single cause of marine accidents and deaths. Most deaths in boating accidents occur when someone falls into the water. Balance is one of the first things you lose when drinking alcohol or under the influence of drugs. The problem arises out of not knowing your balance is restricted.

Overall vision is reduced by alcohol especially at night, along with double or blurred vision. Peripheral vision is lessened which restricts seeing vessels or objects on the side. Also, color awareness decreases especially with red and green which happen to be the colors of boat navigation lights, buoys, and channel markers.

Alcohol will greatly increase your heat loss so it increases the effects of hypothermia. Finally, your ability to make correct judgements in emergency situations is greatly reduced. Alcohol takes away the brains ability to process information quickly and delays a persons reaction time.

Don't drink and drive!

Safety On Board

ALCOHOL MYTHS AND FACTS

Myth: Beer is less intoxicating than other alcoholic beverages.

Fact: One 12 oz. can of beer has about the same amount of alcohol as a 5oz. glass of wine or a shot of liquor.

Myth: Black coffee, fresh air, and a shower will sober the effects of alcohol.

Fact: After consuming alcohol time is the only thing that will sober you up. Our bodies average burning 1 oz. of alcohol every hour. If a person is drunk, it will take a person seven or more hours to sober up.

Myth: Telling if a person is too drunk to operate a vessel is easy.

Fact: Many experienced drinkers have learned to compensate for the visual effects of alcohol and can disguise their drunk condition.

Myth: You can judge if you are fit to operate a boat.

Fact: Judgement is one of the first elements you lose when drinking.

BOATING ACCIDENTS



The following is a list of common causes of boating accidents. Be aware of them and take the necessary steps to ensure that yourself and crew are educated and prepared to act in an emergency.

- Mixing boating and alcohol. Remember the skipper is responsible for his boat and crew.
- Trying to reach the bow by the deck walk-around while the boat is moving too fast.
- Someone sitting on the bow, deck, or swim platform while underway.
- Choosing a boating outing day with inclement weather, especially with high winds and thunderstorms in the forecast or staying out when bad weather is approaching..
- Disembarking without checking all fluids or systems, and especially fuel system components.
- Not monitoring the boating traffic or possible obstructions around you.
- Emergency communications equipment, signaling devices, and navigation lights not working.



Chapter 2

- Improper boat handling especially high speed turns in rough water. Improper trim.
- Being too far from shore with inadequate fuel supply or navigational aids..
- Passengers, especially children that are not wearing the proper life saving devices.
- Skipper or passengers not seated in the boat.
- Running a craft that is mechanically marginal.

REPORTING BOATING ACCIDENTS

According to the Federal Boat Safety Act of 1971 involving collision, accident or other casualty, the operator must make a formal report within 48 hours to the nearest state boating authority when the incident involves:

1. Death
2. Injury requiring treatment other than first aid
3. The disappearance of someone from a boat under death or injury circumstances.

A formal report must be made within 10 days for accidents involving more than \$500 damage or complete loss of vessel.

For information regarding accident reporting, please call the **Boating Safety Hot line** at 800-368-5647.

The operator of a vessel is obligated by law to provide assistance that can be provided safely to any individuals in dangerous situation on the waterways. The operator is subject to fine and or imprisonment for failure to do so. Move cautiously and think before acting.

RENDERING ASSISTANCE

The operator of a vessel is obligated by law to provide assistance that can be provided safely to any individuals in dangerous situation on the waterways. The operator is subject to fine and or imprisonment for failure to do so. Move cautiously and think before acting.

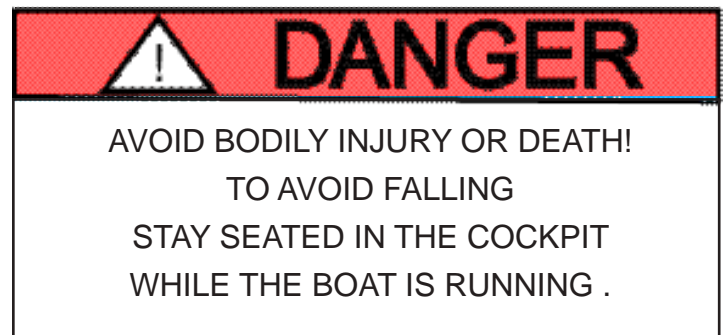

Safety On Board

WATER SPORTS

Besides learning the safety precautions for safe boating, as well as understanding and knowing required rules and regulations, you are obligated to be particularly careful around other water sportsman, such as scuba divers, water skiers, wake boarders, and fisherman.

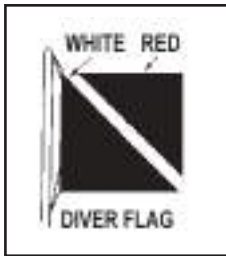
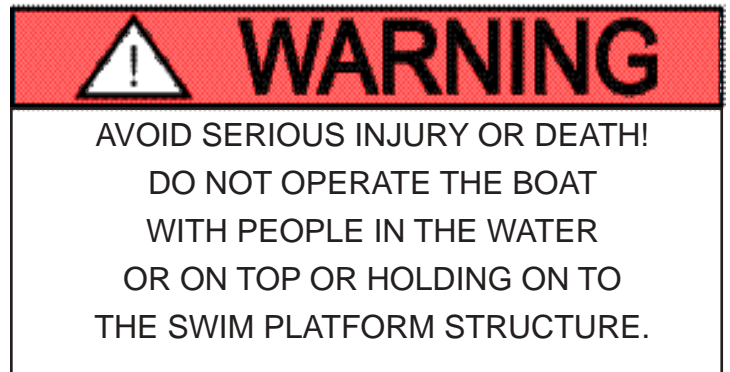

Whenever you see a “Diver Down” flag, maintain a distance of at least 100 feet on inland waters. In bays and open waters stay 300 feet away. The flag indicates a diver in the water. If a diver is operating from your boat, be certain to use this flag and post a lookout on board to observe the

divers air bubbles.



Most boaters fish from time to time. With the propulsion systems of today it is possible to fish in out-of-the-way places. When cruising, stay clear of fisherman. They may have lines or nets out which might be cut or get caught in your propeller if you come too close. Slow down

when approaching fishing boats.

Do not return to cruising speed until the boats have been passed. If a fishing boat should be anchored, a large wake could flip or swamp the boat, upset fishing gear, pull the anchor loose from the bottom or worse yet cause someone to fall overboard.

Do not return to cruising speed until the boats have been passed. If a fishing boat should be anchored, a large wake could flip or swamp the boat, upset fishing gear, pull the anchor loose from the bottom or worse yet cause someone to fall overboard.

When fishing from your boat, never anchor in shipping channel or tie up to any navigational aids. These must be kept clear of at all times.

Be sure to carry a chart of the area and be on the lookout for shallow water and hidden obstructions. Pick up a local tidal chart if appropriate so you do not end up grounded.

WARNING!
MAXIMUM CAPACITY
OF SWIM PLATFORM
750 POUNDS
226 KG

the platform or transom, especially in rough seas or strong currents. **Do not exceed the platform recommended maximum capacity label!** Typical label shown above.



Chapter 2

WEATHER & WATER CONDITIONS

WAVES & FOG

Before a boating outing check the weather conditions. As we all know the weather can change rapidly in many parts of the country. It does so sometimes without being predicted. NOAA weather radio reports are continuously available on designated frequencies installed on VHF radios and various handhelds. Also, many local radio stations carry weather reports .



As the wind blows across water waves are created. The stronger the wind and increased distance across the water enlarges the wave action.

Other factors that can cause problem situations for vessels are fog, currents, and tidal changes.

CLOUD FORMATIONS

Clouds indicate the type of current weather and upcoming changes in the weather. Knowing the type of cloud formations

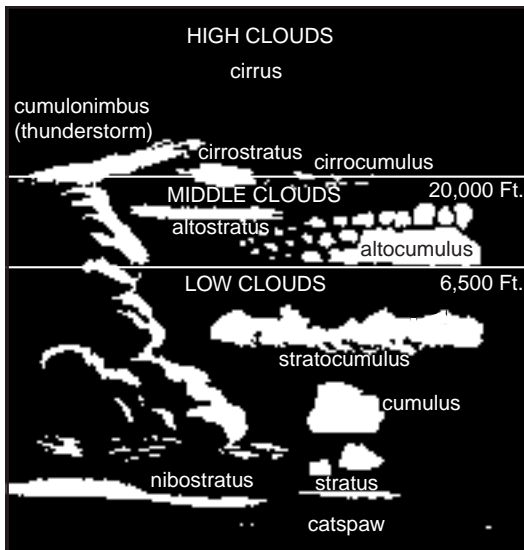

can assist you choosing the appropriate boating day or if already on the water will help you understand upcoming weather changes. Flat clouds (stratus) normally indicate

stable air. Cumulus clouds indicate unstable air. Often a “cottonball” or cumulus cloud builds vertical height in the afternoon and the result is a thunderstorm with increased winds and waves; sometimes these storms are quite violent. You can find additional information on weather (meteorology) at your local library.

Fog can develop inland on clear, calm mornings. Coastal areas see large “blankets” of fog roll in and stay for extended time periods causing sometimes hazardous navigation conditions. If you are caught in the fog, do not panic. Think of the best plan of action and proceed carefully. If you are limited in navigation equipment **at the first sign of fog** proceed to the nearest shoreline and wait until the fog lifts.

Boats equipped with navigation equipment, local waterway experience and charts should proceed to a safe harbor. Use extreme caution, signal as needed, and reduce to a speed where you can stop within half of your forward vision range.



If foul weather catches you at sea do the following:

1. Slow down. Proceed with caution and put on your life vests.
2. Try to reach the nearest safe shoreline.
3. Navigate your vessel slowly into the waves at a 45 degree angle.
4. Passengers should sit low in the center of the vessel.

Safety On Board

5. Monitor your bilge pump. Make sure sump stays free of water.
6. Secure loose gear. Make ready emergency equipment.
7. If the engine stops, throw the anchor over the bow. If needed use a sea anchor. Never anchor off the stern.

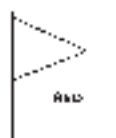
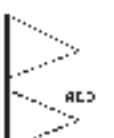
MARINE WEATHER SYMBOLS

| | SMALL CRAFT | GALE | STORM | HURRICANE |
|--------------|---|---|---|---|
| DAY FLAGS |  |  |  |  |
| NIGHT LIGHTS | <ul style="list-style-type: none">○ RED○ WHITE○ | <ul style="list-style-type: none">○○ WHITE○ RED | <ul style="list-style-type: none">○ RED○○ RED | <ul style="list-style-type: none">○ RED○ WHITE○ RED |

Although the National Weather Service has discontinued the use of the day flags and night lights, many marinas and ports of call still use them.

Notes

Chapter 3

Rules Of The Road

NAVIGATION RULES DEFINED

The Navigation Rules set forth actions to be followed by boats to avoid collision. They are referred to as the “Rules of the Road”. There are two main parts referred to as the inland and international rules. The inland rules apply to vessels operating inside the boundaries of the United States. The international rules (referred to as COLREGS) apply to vessels operating on the high seas and all connected waters outside the established demarcation boundaries. Most navigational charts show the demarcation lines by red dotted lines and are published in the navigation rules. Remember to consult state and local agencies since areas such as “no wake zones”, swimming beaches, “diver down flag” and inland landlocked lakes fall under their jurisdiction. This section is only an introduction to the “rules of the road”. We strongly recommend additional training before getting behind the “wheel” of your boat.

You can order the Inland & International Navigation Rules from:

Superintendent of Documents
U. S. Government Printing Office
Washington, DC 20402
Tel: (202-512-1800) Fax:(202-512-2250)

NAVIGATION RULES

RIGHT OF WAY

1. Cross waves at right angles.
2. When caught in heavy water or squalls, head either directly into the waves or at a slight angle. Reduce speed, but maintain enough power to maneuver your boat safely.
3. Keep your speed under control. Respect the rights of other boaters engaged in all water sports. Give them a “wide berth”.
4. Whenever meeting a boat head on, keep to the right where possible.
5. When two boats cross, the boat to the right (starboard) has the right of way.

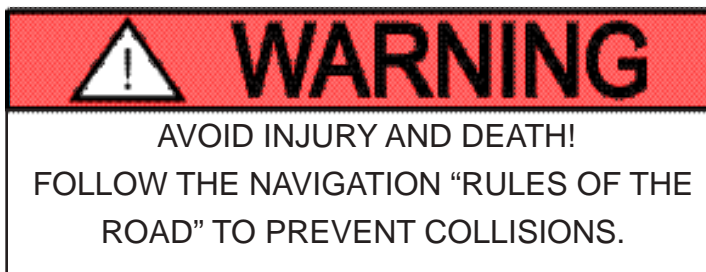



Chapter 3

6. When overtaking or passing, the boat being passed has the right of way.

In general, boats with less maneuverability have right-of-way over more agile craft. The skipper must keep his craft clear of the following vessels:

- A vessel not under command or aground; due to their circumstances, these vessels have no maneuverability.
- A vessel restricted in its maneuverability; these vessels usually are performing work which limits their maneuverability such as surveying, dredging, laying pipe or cable, or servicing navigational markers among others.
- A vessel engaged in fishing; these include boats fishing with lines, trawls or nets, but not trolling lines.
- Sailboats; they have the right-of-way over powerboats. However, if a sailboat is using a prop to move forward, it is considered a powerboat even if the sails are up.
- Remember the unwritten “rule of tonnage”. Basically a smaller tonnage vessel should take every effort to avoid close quarters with a larger tonnage vessel. One way to accomplish this is to have a designated human lookout to “eyeball” the horizon for any developing collision course.
- Use defensive driving skills on the waterway just as you do on the roadway. The other vessel may not know the “rules of the road” Be alert and ready to take immediate action.
- If a collision course is unavoidable neither boat has the right of way. Both boats must react to avoid an accident according to the rules of the road.

WHISTLE SIGNALS

ONE LONG BLAST: Warning signal

(Coming out of slip)

ONE SHORT BLAST: Pass on my port side

TWO SHORT BLASTS: Pass on my starboard side

THREE SHORT BLASTS: Engine(s) in reverse

FOUR OR MORE BLASTS: Danger signal



Rules Of The Road

NAVIGATION RULES

The Navigation Rules set forth 3 types of crossing situations- crossing, meeting, and overtaking. In each case, both boats are governed by special procedures.

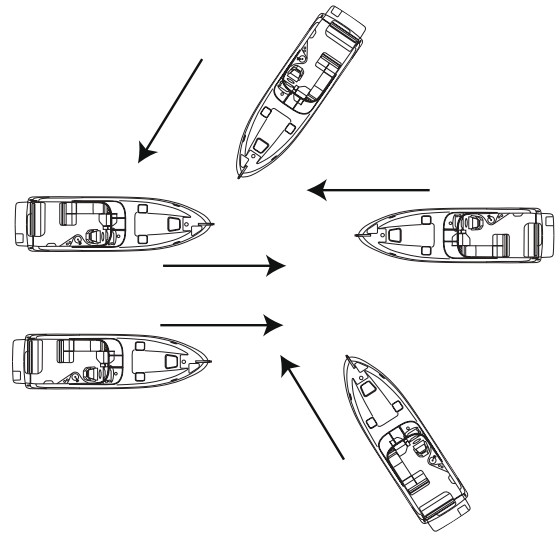

In a head-on meeting, both vessels must sound a single blast to give way toward starboard and pass to port.

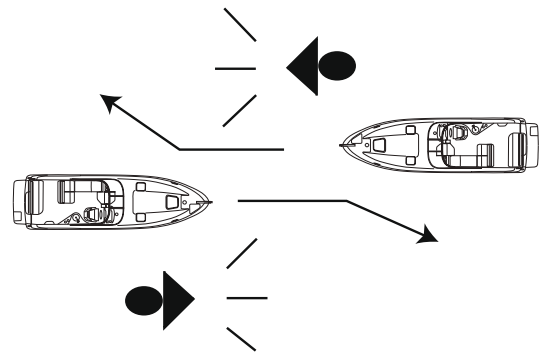

These rules appear when there is a risk of collision. In a crossing situation be aware of the other craft's position. For safety, there should be a noticeable change in the angle, bow or stern; a gradual change in position indicates possible danger.

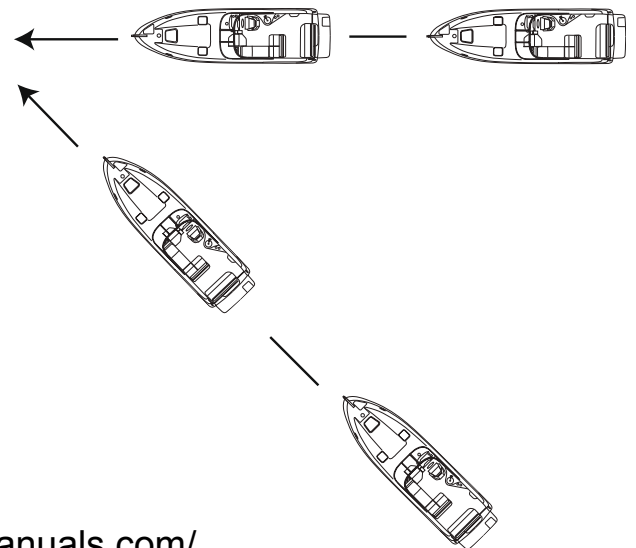

Chapter 3

NAVIGATION RULES

An overtaking boat is burdened, and is not the privileged craft, even though it approaches the danger zone of the overtaken boat.

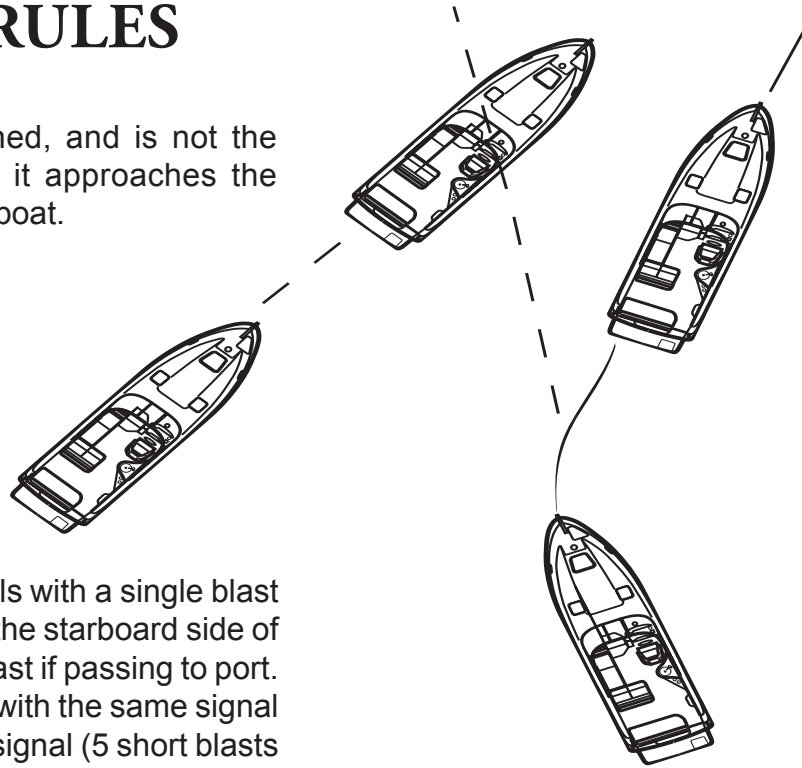

The overtaking boat first signals with a single blast if that boat desires to pass on the starboard side of the boat ahead, or a double blast if passing to port. The overtaken craft responds with the same signal if it is safe, or with the danger signal (5 short blasts or more) if unsafe. The boat overtaking must not pass unless the appropriate signals are sounded.

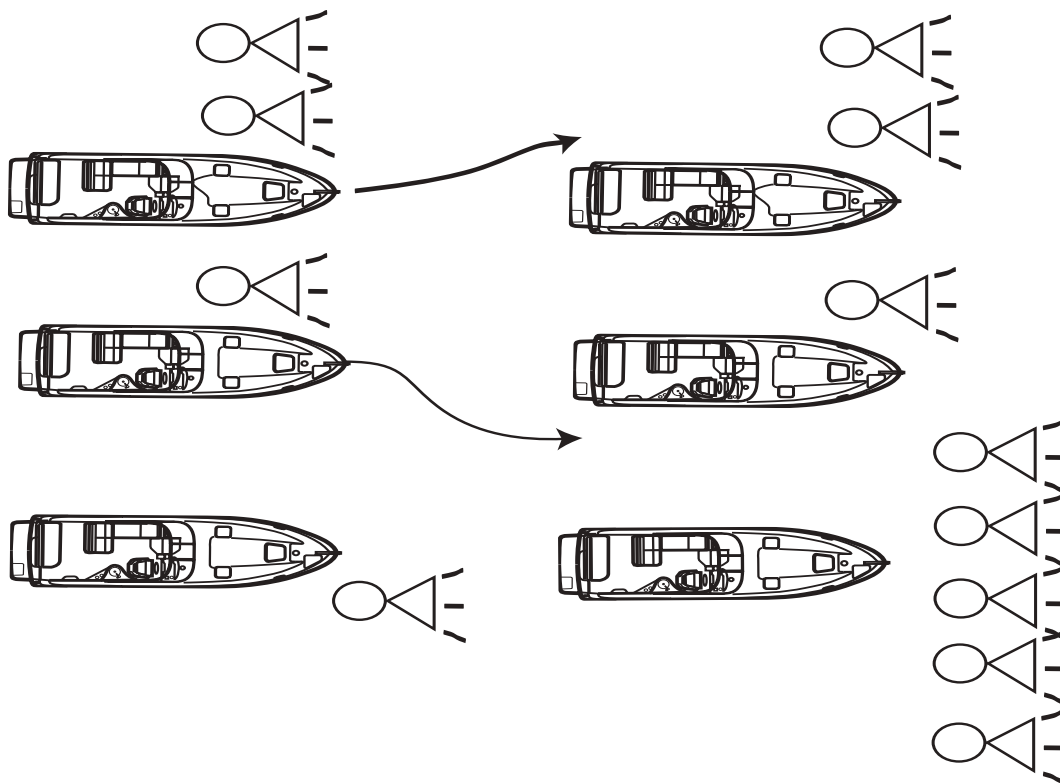

Rules Of The Road

NAVIGATION AIDS

Navigation aids are placed along coasts and navigable waters as a guide for mariners in determining their position in reference to land and hidden danger. Each aid provides specific information. They form a continuous system of charted markers for accurate piloting on paper and on the water.

Nautical charts are provided by the National Ocean Service (NOS) and are distributed nationwide through marinas and outlet stores. These charts show the geography of the coast, water depth, landmarks, navigation aids (buoys and markers), marine hazards, and port facilities. Use only up-to-date charts for navigation. We recommend when purchasing a chart to look for the weather resistant ones. Buoys provide a road map to keep the skipper on course and to avoid hazards. Buoys are identified by light, shape, color and in severe weather conditions by sound.

Buoys or beacons called lateral markers indicate the port and starboard sides of the waterway to be followed. U. S markers follow the buoyage system known as Red Right Returning. When returning from sea or traveling upstream, the green markers are to port (on your left) and the red markers are to the starboard side (on your right). When traveling downstream or out to sea the marker color would be reversed.

Before operating your vessel, learn to identify the various navigational aids such as lateral aids, mid-channel markers, information and regulatory markers.

NOTICE

SKIPPERS MUST NOT RELY ON BUOYS
ALONE TO MARK THEIR POSITION.
SEVERE WEATHER CONDITIONS
AND WAVE ACTION CAN ALTER
A BUOYS POSITION.
NEVER TIE UP TO A BUOY.
IT IS ILLEGAL AND DANGEROUS.



Chapter 3

WAIDS

Port Side
Odd Numbers

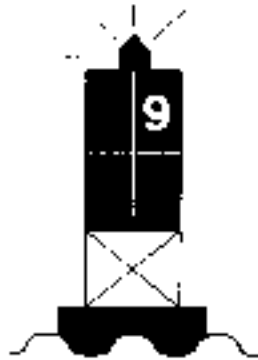

Lighted Buoy
(Green Light Only)

Chart Symbol

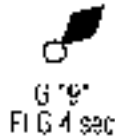

G '9'
Fl G 4 sec

Starboard Side
Even Numbers

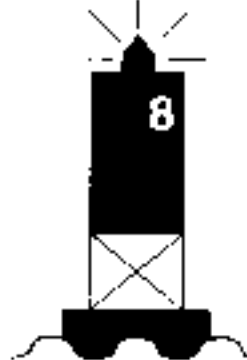

Lighted Buoy
(Red Light Only)

Chart Symbol



R '8'
Fl R 4 sec

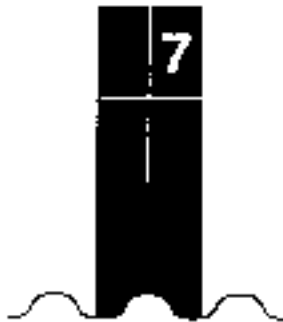

Can Buoy
(Unlighted)

Chart Symbol



C '7'

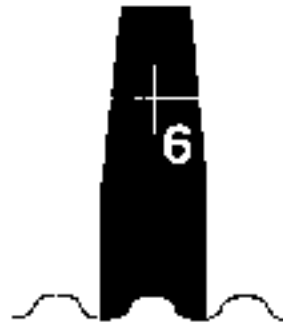

Nun Buoy
(Unlighted)

Chart Symbol



N '6'



Daymark

Chart Symbol



G '1'



Daymark

Chart Symbol



R '2'

Rules Of The Road

MID-CHANNEL MARKERS

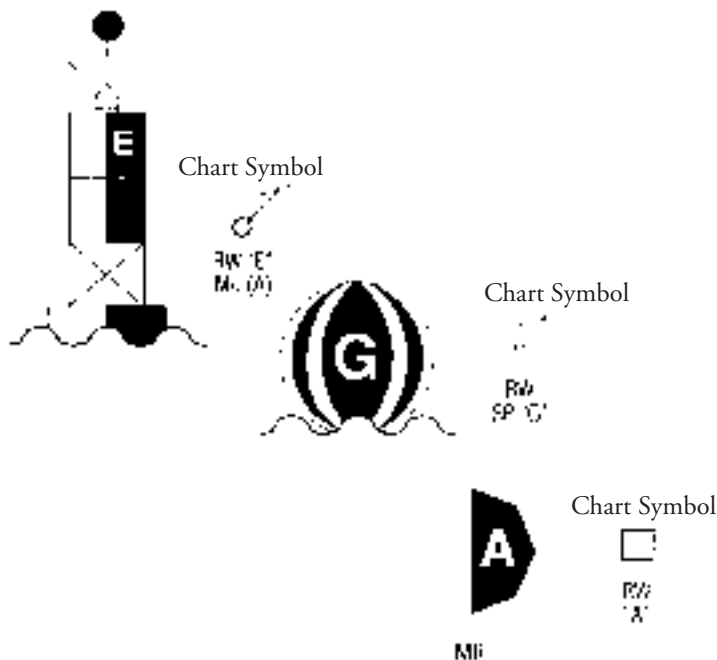

REGULATORY MARKERS



Diamond Shape Warns Of Danger



Diamond Shape With Cross-Boats Keep Out



Circle Marks Area Controlled As Indicated



For showing information such as locations, distances and directions

Chapter 3

NIGHT RUNNING

Boats operating between sunset and sunrise (hours vary by state), or in conditions of reduced visibility, must use navigation lights. Nighttime operation, especially during bad weather and fog, can be dangerous. All Rules of the Road apply at night, but it is best to slow down and stay clear of all boats regardless of who has the right-of-way.

To see more easily at night, avoid bright lights when possible. Also, it is helpful to have a passenger keep watch for other boats, water hazards and navigational aids.

To determine the size, speed and direction of other vessels at night, you should use the running lights. A green light indicates starboard side, and a red light indicates port side. Generally, if you see a green light, you have the right-of-way. If you see a red light, give way to the other vessel.

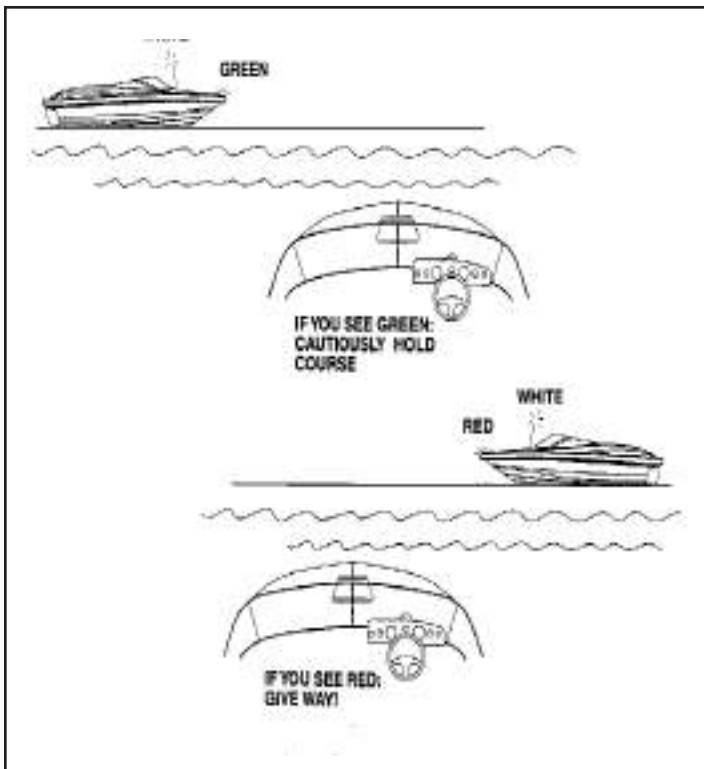

BRIDGE CLEARANCE

Be aware that your vessel requires a specified bridge clearance height. This height is a measured estimate from the waterline to the top of the highest object usually the radar arch, radar or the masthead light depending on what arch equipment is installed. The estimated height can change because of variances in the loaded condition of the vessel. Consult the bridge clearance specifications located in Chapter 12 (technical information section). An easy way to measure bridge clearance is to have someone place a long straightedge such as a piece of wood at a 90 degree angle across the highest point of the boat. Then with a tape rule measure the distance straight down to the waterline. Take this measurement with the fuel and water tanks 1/2 full and only 1 person besides yourself on board. This will give you a safe measurement. As your boat is loaded down with people the bridge clearance will become somewhat lower.

Some bridges are tendered. Know and use the proper bridge signals when approaching these bridges (see bridge signals in this chapter). You can also monitor and communicate on channel 13 of a VHF radio for bridge information in most domestic locals. Other bridges are marked with a clearance measurement and you are on your own. After determining your vessel will clear the bridge proceed with caution at a safe idle speed. Keep your eye on vessel traffic at all times in order to react quickly. Resume a safe speed once clear of the bridge structure and acknowledgment of clear visibility.

Use common sense regarding bridge clearance because bodily injury and property damage could result if a mishap occurs with a bridge structure.



Chapter 4

Engines & Controls

ENGINES

MANUFACTURER'S MANUALS

It is important that you read the manufacturer's engine manual carefully and become completely familiar with the operation as well as necessary maintenance on the engine and propulsion systems. Your Regal dealer has been factory trained on all Regal boat systems. Consult your Regal dealer for further information regarding technical issues and parts. Use only approved marine replacement parts.

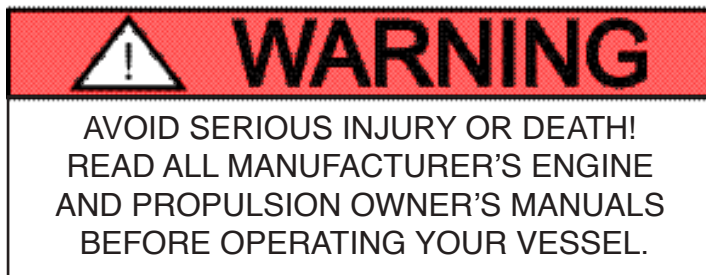

ENGINE MOUNTS

The engines are placed in the boat on a set of metal or wooden platforms called mounts. These rubber isolation mounts keep the engine from moving laterally and athwart ships (right angles to the center line). The mounts help reduce the vibration caused by the engine and drive. Periodically, the mount hardware should be checked for tightness.

ENGINE ALIGNMENT

MerCruiser stern drives use a rubber splined hub to which the stern drive shaft is attached. There is an alignment specification between the engine and outdrive that needs to be checked periodically. A special alignment shaft is greased at the tip and inserted through the gimbal housing. The alignment angle can be determined by the spline image left on the tool. The engine mounts are then adjusted to permit a similar spline image 360 degrees around the greased alignment tool. This specification should be checked after each 50 hours of operation or if the vessel has run aground or hit a submerged object. Alignment should be checked by a Regal dealer or marine professional since a special tool and procedure is required.

ENGINE REMOVAL

In the event the engine requires major service and needs to be removed, consult your Regal dealer. The dealer possesses the knowledge and factory training necessary to accomplish such a job. Do not undertake this type of repair yourself.



Chapter 4

PROPULSION

STERN DRIVES

Ventilation systems are required for engine compartments. Your boat features a set of deck vent shrouds which supply a constant amount of air to the engine compartment. A powered blower motor (s) connected to ducts in the lower one third of the bilge evacuates contaminated air to the atmosphere. Understand the following warning.

It is important that you read the propulsion manufacturer's manual carefully and become familiar with the operation as well as necessary maintenance on the drive train components. Pay careful attention to the sections on winterization if you live in freezing climates. Extensive damage can result if proper winterization is not followed. Refer to the maintenance section of this manual for more information or call your nearest Regal dealer.

 **WARNING**

GASOLINE VAPORS CAN EXPLODE!
BEFORE STARTING ENGINE(S)
OPERATE BLOWER(S) 4 MINUTES
AND CHECK ENGINE COMPARTMENT FOR
GASOLINE LEAKS AND VAPORS.
RUN BLOWER(S) BELOW CRUISING SPEED.

AUDIBLE ALARMS

All owners are responsible for keeping their boat's ventilation systems in operating condition. This means making sure the ventilation openings are obstruction free, ducts are not blocked or tore, blower operates properly and any worn parts are replaced with approved marine parts.

MerCruiser engines use audible alarms. They are designed to use sensors which pick up deviations from the normal operating parameters. Oil pressure and temperature sensors send a signal to a buzzer under the dash which sounds a high pitched alarm indicating a possible problem. In addition to the dash, some engines use buzzers at the engine itself. On start up it is not unusual to hear an audible alarm sound when cranking the engine over. This occurs normally because it takes a second or two to build up the engine oil pressure. Then the alarm will stop. A seasoned skipper monitors his instrument panel often while cruising.

 **WARNING**

TO PREVENT INJURY OR DEATH
USE ONLY APPROVED MARINE
REPLACEMENT PARTS
THAT ARE IGNITION PROTECTED

Engine & Controls

PROPELLERS

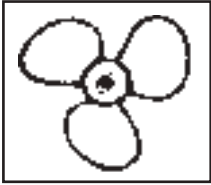

We have carefully tested and chosen the propellers to give your boat the best possible performance and have allowed for the additional weight in equipment that might be added to the boat.

With stern drives it is a good idea to carry a spare set of propellers and hand tools in order to handle an emergency propeller change. Refer to the engine manual for proper procedures since each stern drive application is unique. Call a marine professional or your Regal dealer for further information.

PROPELLER CHECKLIST

At least twice a year check the propeller for:

- Loose, missing or corroded hardware.
- Nicks, dings or missing propeller material
- Bent propeller blades.
- Objects wrapped around the prop such as fish line.
- Decomposing propeller blades (Electrolysis symptom).
- Aluminum prop with paint coming off near blade tip (ventilation symptom).
- Check the propeller pressed in rubber hub for slippage.

Contact a propeller shop or your closest Regal dealer if any of the propeller checklist symptoms exist. Propeller shops have special equipment to refurbish both stainless steel and aluminum propellers. After making any blade alternations the propellers are “re-pitched” in special jigs.



DANGER

PREVENT SEVERE INJURY OR DEATH!
SHUT OFF ENGINE NEAR SWIMMERS
TO AVOID ROTATING PROPELLER BLADES.

CONTROLS

INSTRUMENTATION

The helm station is equipped with a complete set of instruments that allows you to monitor the condition of the engines. Close observation of the gauges may save the engines from damage.

The dash instrument panel is powered and protected by twin 20 amp ignition breakers located above each key switch. The breakers protect each individual engines instrumentation wiring. The engine wiring itself is protected by a main breaker with a push button reset mounted on the engine. Refer to your engine manual for information on type and location. If a breaker “pops” figure out the reason why before resetting it. Each dash switch is also protected by a breaker. For an overview of the dash refer to the pictorial in this chapter.

NOTICE

WITH THE BATTERY SWITCH
IN THE “OFF” POSITION
THERE IS NO POWER TO THE DASH.
KEY SWITCHES.

Chapter 4

GAUGE OPERATION



Tachometer

The tachometer (tach) indicates the speed of the engine in revolutions per minute (rpm). The tachometer allows you to monitor the engine speed so you do not exceed the recommended limits of the engine manufacturer. Selected tachometers

have built in hour meters.



Oil Pressure

The oil pressure gauge indicates the pressure of the oil inside the engine lubrication system. A drop in oil pressure may be an indication of a low oil situation or a leak. Continued operation of the engines with low oil pressure could lead to

engine damage. Refer to appropriate manufacturer's engine manual for more information..



Temperature Gauge

The temperature gauge monitors the cooling system of the engine. A sudden increase in the temperature could be a sign that the engine cooling system is malfunctioning. Shut down the engine immediately and

investigate the problem. Consult your engine manual for allowable limits.



Fuel Gauge

The fuel gauge indicates the level of fuel inside the fuel tanks. It is a good idea to keep the fuel tanks "topped off" when possible to reduce fuel vapors inside the tank. Do not run the fuel level close to empty.

Figure in an adequate "safety" factor when monitoring fuel gauges since they are not entirely accurate.



Depth Gauge

The depth gauge indicates the water depth under the keel of the boat. It features a shallow water alarm. By monitoring the water depth closely, damage related to props and underwater hardware can be avoided.



Speedometer

The speedometer is used on selected models indicates kilometers per hour and miles per hour by measuring water pressure against a small hole in a device mounted under the boat. Consult the owner's information

packet on speedometer maintenance.

Engine & Controls



Volt Meter

The volt meter monitors the battery condition as well as the alternator performance. Normal voltage is between 12.0 and 15.0 volts. Readings outside of this range may indicate a charging system or

battery problem.



Automatic Fire Extinguisher

The automatic fire extinguishing system utilizes an instrument display unit (gauge) that provides the operator with a system status of charged or uncharged condition by an audible

alarm. With the ignition on and no light indicates the system has discharged. If the system should discharge the ignition system will be instantaneously interrupted. Should this occur shut down the engine, ventilation blower and any electrical system components. Investigate the source of the shutdown immediately and take appropriate action. For more information, refer to the owner's information.



Trim Gauge

This **stern drive** only gauge measures the stern drive tilt and indicates the relative position of the bow, up or down when the boat is on plane. The power trim normally begins in the down position when

used to accelerate the boat onto a plane position.

When the boat reaches the desired trim the operator disengages the trim button which through the trim gauge indicates the relative altitude of the vessel. The gauge can be helpful in achieving the most economical running condition.



High Water Alarm

This gauge through a bilge sensor determines a high water situation and sends an audible signal. This may indicate that a large amount of water has entered the hull and/or the bilge pump cannot evacuate water overboard fast enough.



Gas Vapor Detector

The **optional** gas vapor detector determines if there is a level of gasoline vapors that is unsafe in the engine room of the boat. If installed, turn on the unit and wait about one minute for it to do its safety test. If all is well it will give you a green light.

You must run the test before you start the engines. In the event you don't get a green light, you must investigate the bilge of the boat for gas fumes or signs of a fuel leak before starting the engines. If uncertain, consult a marine service professional.

INSTRUMENT LIGHTING

Each gauge is designed with a light so it can be seen at night. You can activate the instrument lighting by energizing the navigation light switch. If condensation inside the gauges develops in high humidity areas or from a vessel being covered for extended periods energize the gauge light switch until the condensation subsides.



Chapter 4

TYPICAL DASH OVERVIEW

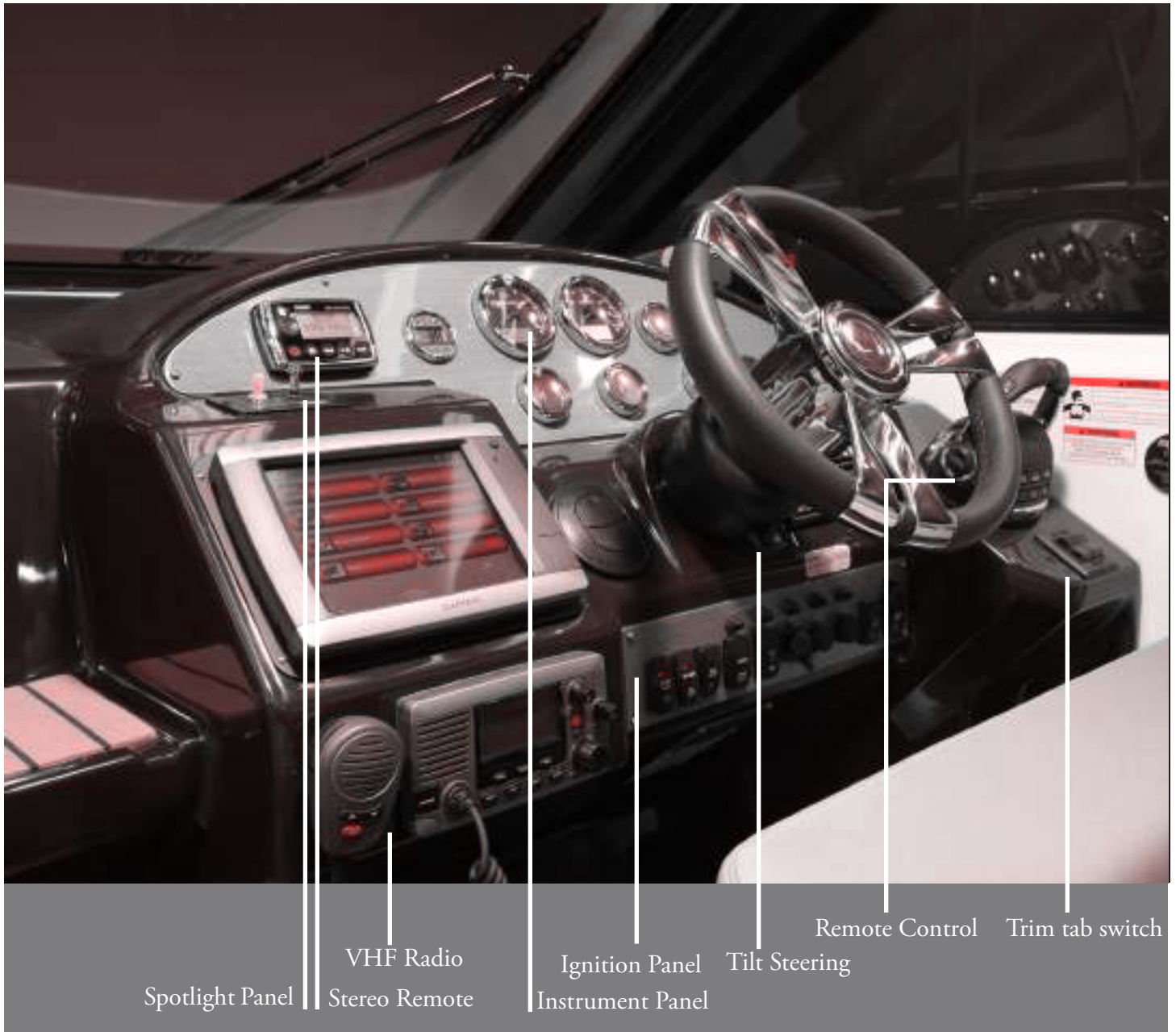

Note: The dash overview may include optional equipment and may not shown all available equipment.

REMOTE CONTROL (OUTDRIVE)

Your **stern drive** powered vessel uses a dual lever remote control (one handle for each engine) similar to the illustration. Each handle controls both throttle and gear shift operations.

Push the throttle lever (s) forward and the engine(s) will shift into forward gear. The engine rpm's will increase as the single lever control is pushed forward. **Pull** the single lever back from the neutral position toward the stern of the boat and the engine(s) will shift into reverse and the engine rpm's will increase.

The single lever must be in the neutral designated position for the engines to start. The remote control internally uses a neutral safety switch which permits starting in the neutral position only. The throttle only button (neutral position) allows you to advance the throttle without engaging the gear shift. This feature is useful when trying to start a cold engine. **Do not shift the remote control handles into or out of gear without the engines running as drive/shift malfunctions could occur.**

Notice that each engine has designated power trim and trailer functions controlled by switches normally mounted on the remote control box along with a dash gauge(s) that allows you to change and monitor trim angle. Do not confuse this with the trim tabs that may be mounted in the outer port and starboard transom.

The trailer switch raises the outdrive beyond the trim elevation. This feature is especially useful when inspecting or changing the drive propellers or hardware. Operate the trailer function only when the boat is stopped in the water or the engine could overheat from a lack of water being picked up by the outdrive. This control positions the trim switches for both engines on the port control handle for ease of operation. See the illustration for a brief description of the remote control.



WARNING

TO PREVENT BODILY INJURY
AND PROPERTY DAMAGE
DO NOT ATTEMPT TO ADJUST SHIFT OR
THROTTLE CONTROLS.
CONSULT A MARINE PROFESSIONAL.

NOTICE

TO PREVENT POSSIBLE CONTROL/STERN
DRIVE DAMAGE DO NOT SHIFT REMOTE
CONTROL IN OR OUT OF GEAR WITHOUT
THE ENGINE RUNNING.

Chapter 4

TYPICAL REMOTE CONTROL

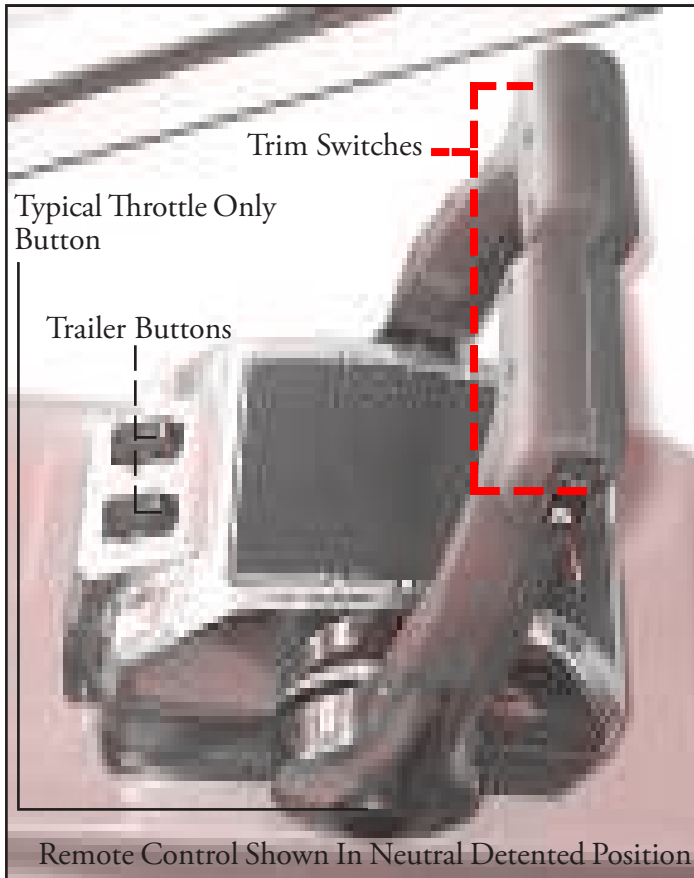

NOTICE

TO PREVENT POSSIBLE CONTROL/STERN DRIVE DAMAGE THE REMOTE CONTROL SYSTEM MUST BE LUBRICATED PERIODICALLY. REFER TO THE REMOTE CONTROL AND ENGINE MANUFACTURER'S OWNERS MANUAL.

When operating your vessel you may notice that even though the control handles are in the relatively same position the engine tachometers may not be exactly the same. This is a normal condition. Simply adjust the throttle handles to equalize the engine rpm's.

Avoid shifting into reverse while the boat is making forward headway. While docking make the best use of the twin engine feature by maneuvering using the gear shifts only in the idle throttle position. This will allow you to enter and exit a mooring or dock easier and helps keep the operator from over reacting in close quarters. For more specific information refer to the remote control manufacturer's owners manual.

Notes

Chapter 5

Systems

ELECTRICAL OVERVIEW

Your vessel uses both direct (DC) and alternating current (AC). You need to understand the basics of each type of electrical power used on board. Besides the general information in this manual refer to the various equipment manufacturer's literature located in the owner's information packet. Also, contact your closest Regal dealer or marine professional as required for troubleshooting and repairs. Your vessel may not contain all of the equipment or systems shown. **Regal has the right to change, update or add equipment and systems at anytime.**

DIRECT CURRENT (DC)

Your vessel utilizes 12 volt DC electricity otherwise known as direct current. It is called DC because it flows only one way in a circuit. Specific wiring harnesses, gauges, batteries, battery cables, engine electrical components, dash switches, lighting, fresh water, shower sump and bilge pumps, refrigerators, Vacuflush heads, along with any over current protection are all part of the low voltage system. In this system, the black wire is designated as the "hot" or conductor wire and the white wire is referred to as the ground wire. All other current carrying wires are color coded to identify their circuit. This is especially helpful in troubleshooting and adding additional equipment. Be sure to review the wiring schematics in the technical drawing section located in the technical chapter.

Direct current is produced through the engine alternator while the boat engines are running. The alternators charge the batteries and send current through the main distribution panel, battery isolator and battery switch via the required harnesses to the appropriate battery. Normal voltage on the dash volt meter is between 12 and 15 volts. Lower or higher readings could indicate a charging malfunction or weak battery.

The alternators are normally internally "excited" around 1200 revolutions per minute. At idle speeds below 1200, the volt meter will show around 12 volts.

Direct current is stored in the ship's wet cell batteries. There are 2 engine starting batteries and a "house" battery.

 **WARNING**

PREVENT INJURY OR DEATH!
USE ONLY APPROVED MARINE
REPLACEMENT PARTS
THAT ARE IGNITION PROTECTED.

 **WARNING**

PREVENT SEVERE INJURY OR DEATH!
BE SURE TO DISCONNECT
ALL ELECTRICAL POWER SOURCES
BEFORE ATTEMPTING TO REPAIR OR
REPLACE ELECTRICAL COMPONENTS.

Chapter 5

Each battery circuit uses a battery switch that provides positive battery disconnect, isolates all circuits and aids in protection against electrical fire and explosion.

At dockside a battery charger takes the place of the engines alternator to produce direct current.

The shore power cord sends house current through the battery charger and it is converted to direct current and charges the batteries through the battery isolator just as through the engine alternators. In this scenario the main DC distribution battery charger switch needs to be activated for the current to flow through to the ship's batteries.

Also, the optional generator away from the dock can send house current through the battery charging system and in turn charge up the ship's batteries.

Direct current circuit protection is located in several areas; dash, AC/DC distribution panel and engine.

The engine reset-able breaker powers the key switches as well as the dash gauges. It does **not** control the dash switches such as the blower, bilge pump, etc. Refer to the engine manufacturer's owner manual for location and particulars regarding the engine breaker.

Refer to the technical chapter for specific wiring schematics. Following is a brief description of selected DC components.

BATTERIES



PORT ENGINE
CRANKING
BATTERY

STARBOARD ENGINE
CRANKING & HOUSE
BATTERY

The port engine cranking battery serves the windlass and electronics circuitry. The starboard engine cranking-house battery serves the generator and dash functions.

The DC distribution center panel under the cockpit circular seat shuts the current off to each of the batteries through a battery switch. When replacing batteries make sure the correct size and capacity are used. Your Regal dealer will be able to assist you in obtaining the correct battery replacement battery for your boat.

Marine batteries are described and rated by the following terminology:

A. Battery cold cranking performance rating- The discharged amperes(pressure in a circuit) that a battery at 0 degrees Fahrenheit can transfer in 30 seconds and still maintain 1.2 volts per cell or higher.

B. Cranking performance- The discharge in ampres that a new completely charged battery at 32 degrees Fahrenheit can continually deliver for 30 seconds, and maintain a voltage at the terminals of 1.2 volts or higher.

C. Battery reserve capacity- A number in minutes that a completely charged battery at 80 degrees Fahrenheit can be continuously discharged at 25 ampres and hold a voltage of 1.75 volts or higher per cell (10.5 volts for 12 volt marine battery).

Since your vessel's battery system is one of the most important on board systems, refer to the maintenance section for proper battery servicing and storage procedures. All battery terminals must be kept tight and corrosion free. Battery electrolyte must be filled to the proper level to ensure a longer battery life. All fastening hardware must be kept tight to hold the batteries in place. Battery boots must cover the entire positive terminal to prevent any possible arcing from tools, etc.

ELECTRICAL HARDWARE

BATTERY PARALLEL RELAY



WINDLASS JUNCTION

In the engine sump at the forward bulkhead are a 2 black covers. These house the battery parallel relay solenoid and the windlass junction respectively. These parts are described for reference to location only. Under normal circumstances the only required periodic maintenance is to remove the covers and check the fasteners for tightness.

BATTERY CHARGER



A battery charger is located in the engine room. Its function is to keep the engine and house batteries fully charged to provide engine starting power and house DC circuit energy. The battery charger operates on 120 volt AC shore power or optional generator power to provide the AC source for the battery charger to function. The main AC and the battery charger breaker need to be energized for the batteries to be charged.

The battery parallel switch can be depressed and it will use the charged up battery to start each engine. See the dash illustration in chapter 4 for the parallel switch location. If the engine batteries are discharged the house battery will still allow the engines to be started. Once the engines are started the alternators can then be used to charge the engine batteries. It is critical to consider the warnings on carbon monoxide if the engines are run to charge the electrical system. The battery charger utilizes an amp meter on its face which displays the charger output. The battery charger is a self-limiting device which means the charger output remains at a value that will not damage the charger if a short circuit develops at the DC output terminals over a specified period of time.

BATTERY ISOLATOR



Some models use a battery isolator that automatically senses the charge needed by a specific battery and then sends current until that battery is fully charged. The isolator features a “gate” that closes when it senses the battery is fully charged and won’t allow current to discharge back through the system.

DC DISTRIBUTION CENTER



Your vessel features 2 battery switches. The port battery switch controls the port engine starting battery. In addition, the starboard battery

switch controls the starboard engine cranking & house batteries. See the technical section for schematics of the distribution center.

Chapter 5

Notice that each battery switch features an on and off position. Upon leaving the vessel it is recommended that each battery switch be turned to the “off” position. This will deactivate both engines and the house related circuits. The automatic bilge pumps will still operate with the battery switches turned off.

There are three reset-able circuit breakers mounted on the battery switch panel for each battery switch. At times when the battery charger or the alternators are not charging the batteries it protects the wiring from the battery isolator to the battery terminal. If a circuit breaker “pops” find the root cause of the problem before resetting the breaker.

NOTICE

AS A SAFETY FEATURE FORWARD AND AFT BILGE PUMP CIRCUITRY IS CONTINUOUSLY PROVIDING PROTECTION EVEN WITH THE BATTERY SWITCHES AND DC DISTRIBUTION CENTER OFF.

CAUTION

AVOID POSSIBLE FIRE AND/OR EQUIPMENT DAMAGE. DO NOT TURN THE BATTERY SWITCHES TO THE “OFF” POSITION WITH THE ENGINES RUNNING.

DC CIRCUIT PROTECTION



A source of engine circuit protection is located on the engine itself. Notice that the engine breaker is reset-able. The breakers are located on the engine close to the large cannon harness plug. Consult the engine manufacturer’s manual located in the owner’s information pouch for further information. The engine breaker powers the key switch as well as the dash gauges. It does not power the dash switches such as bilge pump, blower, etc. If the engine circuit breaker “pops” determine the cause of the malfunction before resetting the circuit breaker.

DASH COMPONENT OPERATION

Below is a description of the main dash switched components. This includes the helm and DC switch panel located to the starboard side of the helm seat. Read and understand their operation. **Your dash may not include some of the discussed control devices.** Refer to more in depth instructions to supplement this information which can be found in the owner’s document box.

Blower

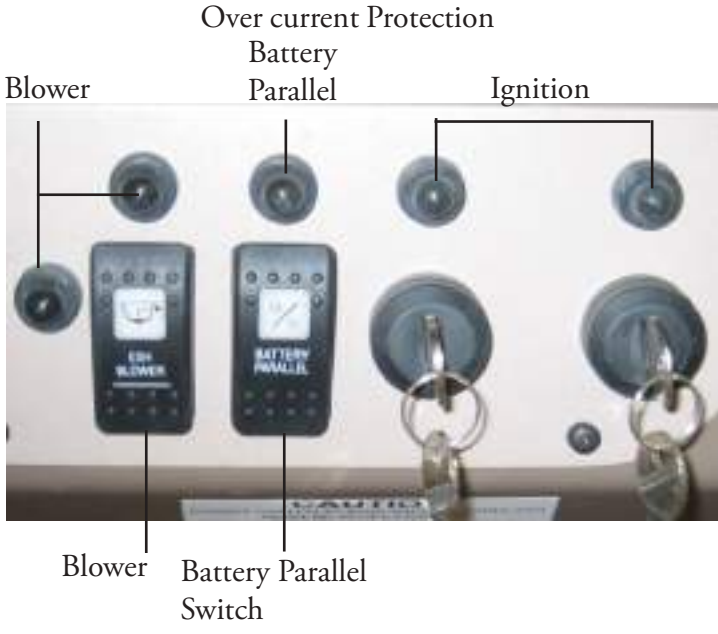

The blower switch controls the two bilge blowers. The blower must be activated to the “on” position at least 4 minutes prior to starting the engines. This procedure assists in evacuating any fumes in the bilge area. The blower should be used below cruising speeds. Besides activating the blower switch a visual check should be done before starting the engines by lifting the engine inspection hatch and “sniffing” for fumes in the bilge. Notice that each blower uses individual circuit protection as a safety measure. A red icon located in the center of the switch lights up when the blower is activated.

WARNING

**GASOLINE VAPORS CAN EXPLODE!
BEFORE STARTING ENGINES
RUN BLOWERS FOR AT LEAST 4 MINUTES
AND CHECK ENGINE COMPARTMENT
FOR GASOLINE LEAKS OR VAPORS.
RUN BLOWER(S) BELOW CRUISING SPEEDS.**

Ignition Switch

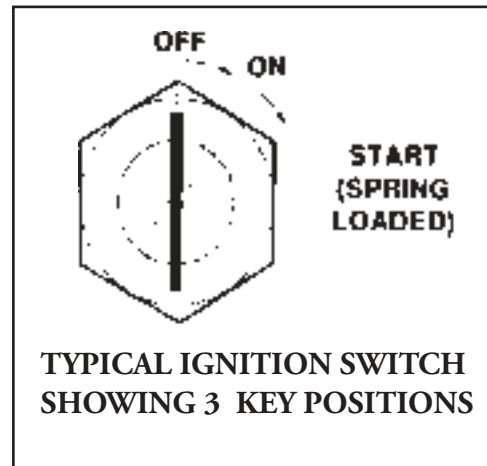

The ignition switches feature three positions; off, run, and start. The start position is spring loaded and the key should be held in this position to engage the

starter. Once the engine has started release the key from the start position. It will then be energized in the run position. Both key switches feature over current breakers. See the illustration on the opposite page. It is recommended that you remove the keys from the ignition switches when the engines are not running.

Battery Parallel Switch

The battery parallel switch provides starting power in the event one or more of the batteries are discharged. Press the momentary style parallel switch to energize the circuit. The switch will draw reserve power from the other battery bank. In the event the battery parallel switch is used make sure you investigate the reason the circuit was initially discharged. A breaker protects the parallel switch. See the illustration on the opposite page. The volt meter on the instrument cluster should show over battery voltage and is an indication the weak battery is being recharged.

Chapter 5

 **WARNING**

AVOID BODILY INJURY OR DEATH!
REMOVE KEYS FROM IGNITION
SWITCHES WHEN THE ENGINES
ARE NOT RUNNING.

Stereo Remote



Spotlight



The spotlight control features two functions. The left-sided switch center position is off. Other switch positions will deliver either flood or spot type lights.

The right-side button controls the directional pathway of the light. This is useful for docking or spotting objects in the water. The switch is lighted at night.

The stereo remote is normally dash mounted but may also be found in the aft cockpit. It features controls that permit operation of many stereo functions away from the main unit such as volume, stations, and selected modes of operation.

12 Volt Accessory Plug



The 12 volt (DC) accessory accepts items which feature male connectors similar to the ones you plug into your automobile cigar lighter. It is useful in charging up cell phones and low amperage equipment. Disconnect any equipment from the plug when not in use and attach the protection cap on the receptacle.

TYPICAL SWITCH PANEL OPERATION



The switch panel contains switches that control most of 12 volt electrical equipment. They are positioned for easy access by the skipper and lighted for night visibility.

Horn

The trumpet air horn is controlled by a toggle switch. Read and understand the horn signals explained in the Rules of the Road chapter.

Fwd Bilge

This switch controls the forward bilge pump. When the switch is depressed it bypasses the automatic float and activates the bilge pump. In the off position the automatic float feature monitors the pump. When the icon located in the middle of the switch is lighted red the automatic system is activated.

Aft Bilge

This switch controls the forward bilge pump. When the switch is depressed it bypasses the automatic float and activates the bilge pump. In the off position the automatic float feature monitors the pump. When the icon located in the middle of the switch is lighted red the automatic system is activated.

Nav/Anchor

The red and green navigation lights along with the masthead anchor light are controlled by this switch. Read and understand all the rules regarding use of navigation lights for night running.

Cockpit Lt

The cockpit lights are useful for accessing areas of the boat after dark. These lights are normally positioned at points such as entrances and stairways.

Arch Lt

The radar arch lights are controlled by this switch.

Foredeck Lt

This switch controls the light positioned at the forward deck work area. This light is a safety feature when working the lines, etc. after dark.

Panel Lt

The instrument panel gauges and switches are controlled by this light. This is especially useful for night time cruising.

Dimmer

This switch allows any lighting controlled by the gauge panel to be dimmed as a house light. The switch contains a rheostat that accomplishes this task. This feature cuts down on glare especially valuable for night cruising.

Electronics

This switch controls the operation of any electronics including GPS/Plotter, Depth Sounder & VHF radio.



Chapter 5

Helm Seat

This toggle switch permits the helm seat to be raised or lowered. The fore and aft seat positions use a lever found under the right hand portion of the seat.

Windshield Vent

The center windshield vent offered on selected models is opened with this switch.

Wiper

This switch controls the helm windshield wiper. Change the wiper periodically for maximum performance.

Permit



This two-way toggle switch features a red “lockout” button in the off position prevents the anchor from accidentally letting the anchor out even though the windlass switch is activated. The foot deck foot pedal is inoperative with this feature activated.

Windlass

This rocker style switch is used to adjust the anchor line after the anchor has been set. The bow pedals are used to commission the anchor as well as retrieving it. Do not use this switch to break the anchor from the bottom.

Engine Hatch

This switch opens the engine hatch for inspection and repair. The system is hydraulically controlled.

Eng. Rm Lts

This switch energizes the engine room lights for inspection and repairs.

Acc

This switch is available for adding equipment. Make sure the over current protection is not exceeded. Check equipment amperage draw and leave a safe margin.

Sunroof Hatch

This switch opens the sunroof hatch.

Auxillary Switch Panel



Located at the transom door is an auxiliary switch panel. This is convenient to open the engine hatch from the swim platform, activate the arch lights along with the option to energize the bilge lights for inspection and maintenance purposes. Each of the above switches is circuit breaker protected at the panel.

MAIN DC PANEL METER/SWITCH FUNCTIONS - DC AMP METER



The DC amp meter displays the amount of direct current draw in amperes on the house circuit. This varies on the amount of equipment being used at one particular time. With all the switches in the off position the meter should zero itself.

Fwd Cabin Lights

This switch controls the lights in the forward cabin. Once energized the cabin individual cabin lights can be operated.

Mid Cabin Lights

This switch controls salon cabin lights similar to the forward cabin.

Aft Cabin Lights

The mid or aft cabin lights are controlled by this single pole switch. Similar to mid & forward cabin design.

Macerator

This switch controls the optional overboard discharge pump also known as the macerator. With this switch on along with the key being turned to the on position at the monitor panel the waste tank can be pumped overboard or through a marina pump-out station. If pumping overboard make sure you are outside the legal limit to do so. Read and understand the laws regarding pumping out waste. Finally, once you determine is legal to pump waste overboard position the seacock to the open position before starting the macerator.

GENERAL INFORMATION

The main distribution panel is located in the salon. It controls many of the house related functions. It features both a direct current volt and amp meter.

DC VOLT METER

The DC volt meter displays the condition of the battery circuit. It should always show over 12 volts or a discharged condition may exist. Once a switch is energized a light shows itself as an on position. Always shut down all switches upon leaving the vessel.

Chapter 5

NOTICE

TO AVOID MACERATOR DAMAGE
SEACOCK MUST BE IN THE OPEN POSITION
FOR PUMPING OVERBOARD.

Fresh Water

This switch controls the water to the boats fresh water system through the fresh water tank. The system provides water to the galley, head, and cockpit faucets. Before energizing the switch be sure the fresh water tank on the monitor panel shows a safe level. Running the fresh water pump without sufficient water may cause water pump and system damage.

Refrigerator

The **main cabin** refrigerator is controlled by this switch. The refrigerator features 120/12 capacity. The refrigerator switches AC to DC automatically with the proper switches activated. With this switch energized the refrigerator is capable of operating on 12 volts DC should the shore power fail or you are away from the dock without a generator. Remember the refrigerator demands substantial amounts of DC current. The house battery will discharge steadily without it being charged through the engine alternators, battery charger or optional generator. The unit can set for several hours without defrosting.

Head

This switch energizes power for the vacuflush toilet.

Acc

This switch provides power for any additional 12 volt equipment added to the vessel.

Fwd TV

This switch controls the 12 volt television in the salon area.

DC Outlets

This switch controls the 12 volt accessory outlet located in the dash.

TV Antenna

This switch controls the television antenna located on the radar arch. The television reception is controlled by the A/B switch.

Head Vent

The head vent exits humidity and odors. This switch controls power to the wall vent switch.

Stereo

This switch controls the 12 volt stereo located on the vessel.

CO Detector

This switch controls the 12 volt CO detectors located in the aft and forward cabins. Notice there is a cover over the switch. Because of the importance in keeping this safety system operating at all times, it requires a two step thought process to turn the switch off.

Level Monitor

This switch controls the fresh and water tank monitor gauge. With this switch on the level monitor panel switches can be activated to determine their respective level.

ALTERNATING CURRENT (AC) GENERAL INFORMATION

Alternating current sometimes called AC is used on board your vessel. It is brought to the boat through the use of shore power cords or produced on board through a generator. Alternating voltage is normally measured at 120 volts. It is important to familiarize yourself and understand the various parts of the main AC panel. It is of prime importance to respect alternating current on a vessel just as you do your home electricity.

Typical Shore power Locker/Inlets



TYPICAL SHORE POWER
INLETS

REVERSED POLARITY INDICATORS
AND MAIN INLET BREAKERS

SHORE POWER WARNING PLACARD

The shore power locker stores the two 30 amp cords. Earlier production boats feature a telephone cable/TV cord. Since the popularity of cell phones the telephone cable has been eliminated.

When connecting the shore power cords be sure to twist the cord into the inlet plug first. The cord installs one way only. Align the pins, insert the cord into the inlet plug and twist in place. Then screw the fitting onto the threads to lock the cord in the inlet plug.

Plug the power cord into the marina receptacle last. This reduces the possibility of a shock hazard.

When disconnecting the shore power cord remove from the marina outlet first. Then remove the cord from the ship's power inlet.

Note that some dockside power boxes will not accept the male twist shore power cord. Some older power boxes use a 3 prong system similar to a house receptacle. You may need to buy an adapter that changes from twist to 3-way. They can be purchased at most marina supply houses. Make sure it is the same capacity as the shore power cord.

Note from the drawing there are shore power breakers located in the locker. After the dockside power cords are installed according to the placard instructions and there is no indication of reversed polarity on the indicators the main inlet breakers can be activated. Once the main AC shore power locker breakers are "on" 120 volts is available at the ship's main AC/DC panel.

When disconnecting the shore power system at the locker first make sure the main AC/DC panel is off. Then turn the shore power inlet breakers off **before** disconnecting the dockside power cords from their sockets. Always close the inlet covers to protect the system from the environment.

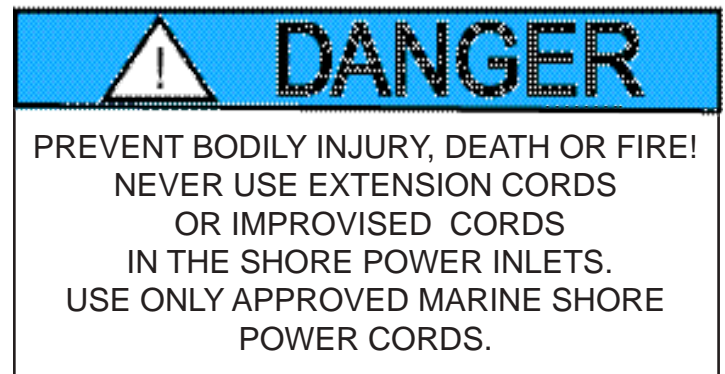



Chapter 5

GFIC Outlet

Sometimes current in a circuit escapes its normal route and finds a “ground fault”. If that vehicle ends up to be your body and the current passes through your heart the results could be deadly.

A ground fault interrupter (GFIC) senses this ground current before a fatal dose can be conducted and in a fraction of a second cuts the current.

The GFIC device marine speaking is not ignition protected which means the device can not be installed in the engine room or the fuel tank area of a gasoline powered boat because of increased explosion possibilities.

Your vessel has several 120 volt receptacles. A GFIC style outlet is found as the first receptacle in the circuit. By this placement all 120 outlets downline are protected.

You can identify the GFIC primary receptacle by the test and reset breaker in the center of the device. Check for GFIC protection monthly. If a problem develops with the GFIC circuitry call a marine electrician to access the situation.

GFIC outlets are especially useful when electrical equipment is used such as drills, curling irons and hair dryers. Never use any electrical devices when puddling water is present to prevent possible shock hazard.

Ignition Protected Devices

Many electrical devices in everyday use tend to “arc” or spark when being used. These include motors, fans, switches, relays, etc.

Vessels employ many of these same devices but they are protected from any sparking that may cause the device to ignite with any vapors such as found in the engine and/or fuel tank areas.

When replacing any electrical device in the engine compartment make sure it is ignition protected. This means it has been tested and normally the device is stamped with a marking making it safe to use. Do not install any electrical device before ensuring it is ignition protected.

Many automotive stores sell replacement parts such as alternators and starters. Normally they do not feature flame arrestors and therefore must not be used in the engine compartment. Use only the engine manufacturer’s approved replacement parts in the engine compartment.



MAIN AC PANEL METER/SWITCH FUNCTIONS

SHORE POWER 1 & 2 SWITCH
AC LINE VOLTAGE AC LOAD (AMPS)



REVERSED POLARITY INDICATORS

Note: A second set of reverse polarity indicators are found on the shore power inlets located inside the shore power locker. Refer to information found earlier in this chapter.

Line Voltage

This meter displays the alternating line voltage as read by the AC panel. Normal voltage should be around 120 volts. Sometimes the voltage reads lower because of spikes in the current or unusually long wire runs.

Load Current

This meter displays the amount of circuit load in amperes as equipment is used. Current load (amps) changes according to the type of device being used.

Shorepower Switch

This switch when activated to port displays all shore power 1 information at both the line voltage and load current meters. In the starboard position shorepower 2 information is displayed in a similar fashion.

Reverse Polarity

The reverse polarity icon on both shore 1 and shore 2 positions uses green and red indicator lights. With the shore power cord in place and the shore 1 and/or 2 main breakers in the “off” position the light will indicate green or red. As with a traffic light green is go and on board the vessel it means the power is connected properly. At this point the main shore 1 or shore 2 breakers can be activated. If the reverse polarity indicator on either shorepower shows red the hot conductor wire is reversed with another wire at some point. Do not attempt to energize either shore line main breaker at this point. Disconnect the shore power cords at the mooring dockside receptacle. There may be a problem with the dockside wiring. For your safety, contact the appropriate personnel.

NOTICE

TO PREVENT POSSIBLE ELECTRICAL SYSTEM DAMAGE OR FIRE DO NOT TRY TO ACTIVATE THE SHORE POWER BREAKERS IF THE REVERSE POLARITY LIGHT IS DISPLAYED.

Chapter 5

GENERATOR

Besides the shore power capability to deliver alternating current some vessels feature generators for supplying AC voltage at sea. Generators use their own ventilation and motor to produce AC electricity on board the vessel. The following illustration is part of the main DC panel discussed earlier in this chapter.

GENERATOR PORTION OF MAIN PANEL

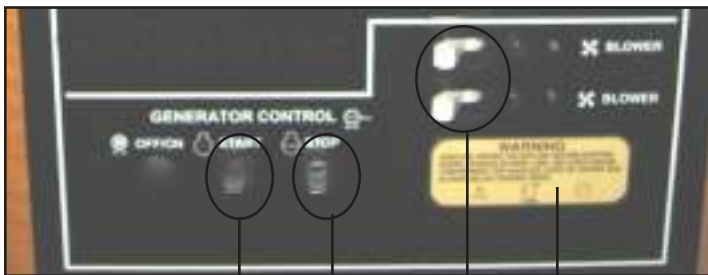

GENERATOR ON SWITCH

BLOWER LABEL
BLOWER SWITCHES

Generator Ventilation

Your vessel offers a generator as optional equipment. Before the generator is started both blower switches are to be activated. The blowers evacuate any fumes from the bilge area. Read and understand the blower label on the generator portion of the DC control panel.

NOTICE

TO PREVENT POSSIBLE GENERATOR DAMAGE ALL SHORE POWER BREAKERS AND AC SWITCHES ARE TO BE DEACTIVATED BEFORE STARTING OR STOPPING GENERATOR.

Before Activating Generator

Before starting the generator make sure all equipment switches and shore power breakers are in the “off” position. This procedure helps prevent any voltage surges when the generator starts. Refer to the AC panel illustration earlier.

Generator On Switch

After the blowers are activated and run for at least 4 minutes the generator can be started. Energize the toggle style on switch until the generator starts. At that point release the switch and the generator starter will disengage from the flywheel. The generator should continue to run on its own.

Generator Main Breaker

After the generator starts the current produced needs to be correctly routed to its final destination. Make sure the shore 1 switch is in the off position and slide the generator arm to the uppermost point. While holding it there, turn on the generator breaker. This will begin the AC current routing. The second portion of the process is accomplished with the transfer slider.

Generator Transfer

With the generator breaker in the on position energize the transfer breaker. At this point move the transfer slider down. Now you can complete the AC power routing by activating the shore 2 breaker. The appropriate equipment breakers can now be turned on. Monitor the AC load current display for total amperage draw as equipment is activated.

Generator Shutdown Procedure

To shut the generator down deactivate all AC equipment breakers. Move the transfer slider upward and deactivate the transfer breaker. Move the generator slider upward and deactivate the generator breaker. Finally, hold the generator stop toggle switch until the generator completely stops. Deactivate the blower breaker(s) at this time.

Fwd Outlets

This switch controls the AC outlets in the salon and forward cabins. These outlets are all GFIC protected.

Microwave

This switch controls the galley microwave.

Aft Outlets

This switch controls the AC outlets in the aft cabin which are GFIC protected.

Stove

This switch controls power to the electric stove.

Air Conditioner

This switch controls the air conditioner located in the main cabin. This breaker allows power to the A/C monitor panel located in the salon.

Battery Charger

This switch controls alternating current to the battery charger located in the bilge. When leaving the vessel the battery charger breaker should be activated to keep the batteries charged.

Icemaker

This switch controls the combination refrigerator/icemaker located in the cockpit.

Refrigerator

This switch controls the main cabin refrigerator alternating current circuit. Remember this device also operates off 12 volts direct current (DC) power.

Accessory

This switch controls the blank accessory switch . This allows additional aftermarket equipment to be added to the vessel. Make sure the amperage draw of the device does not exceed the over current capacity of the circuit.

Water Heater

This switch controls the alternating power to the water heater located in the bilge. Notice the warning on the panel that says the water heater must not be activated without the unit being filled with water. Once the fresh water switch is activated water will flow to the heater through the piping via the fresh water tank which can be monitored on the display panel.

Chapter 5

FUEL SYSTEM OVERVIEW

The fuel system used on your vessel features similar components regardless of being gas or diesel. The system consists of 2 fuel tanks, fittings, hoses, filters, anti-siphon valves, gauges and distribution systems. The fuel tank system has been inspected at several points during your vessel's construction.

Regal has the right to change, update or add equipment and systems at anytime.

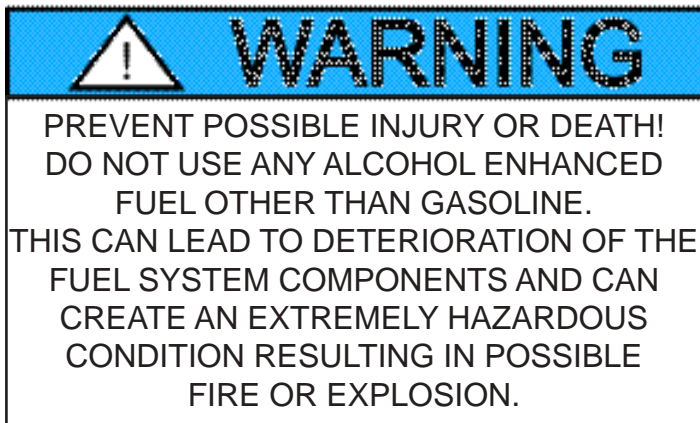

FUEL SYSTEM COMPONENTS

FUEL TANKS

Your vessel features aluminum fuel tanks. They are manufactured to rigorous standards. The fuel system fittings and hoses need to be periodically checked through access plates located in the cockpit or bilge area.

FUEL FILLS

The fuel fills are located on the port and starboard aft deck area. They are labeled for gas or diesel filling. Some boats use a "key" to open and close the fill caps. It fits in the slot or the 2 holes in the fuel cap. This key is usually found in the owner's document box.

FUEL VENTS

The gasoline fuel system produces vapors. These vapors are vented overboard. At the hull you will find a vent that displaces these vapors. See the illustration. As the fuel tank is being filled the vent will displace any fumes tank fumes. As the tank nears full you will hear a distinct sound of the gas vapors being displaced. Be careful to slow the pumping rate near the full mark so gas does not exit the boat through the vent and pollute the water. Periodically check the vent for a build up of spider webs, debris, etc. which can affect engine performance.

ANTI-SIPHON VALVE

The gasoline fuel system contains a device called an anti-siphon valve. It prevents fuel from siphoning out of the fuel tank in the event of a fuel hose rupture or leak. Never remove this valve from the fuel system. Should it become inoperative replace it. It is located at the fuel tank end of the fuel feed hose.

FUEL TANK GAUGE & SENDER

The dash fuel gauge is an indication of the fuel tank level as determined by the sending unit. These 2 calibrated instruments are not 100% accurate. Be sure to use the one third rule with regard to fuel reserves.

FUEL FILTER

Each engine regardless of brand uses a fuel filter. Some feature the cartridge type; others use a spin on filter. The purpose of these filters is to trap foreign particles and water in the filter element. Because of the possibility of leaking fuel in the bilge these filters need to be replaced periodically by a marine professional. Call your closest Regal dealer for more information.

FUEL DISTRIBUTION VALVES

Fuel valves direct the flow of fuel to and from the engine and optional generator to the fuel tanks.

DIESEL SYSTEM

Diesel engines use many fuel system components which are similar to gasoline systems. The major difference in the two systems is that with diesel you do not have the vapor and therefore the explosive characteristics of the gas system. Diesel systems use return lines which send back unused fuel to the tank for reuse.

DIESEL FILTERS

Many vessels use a special filter that separates water from diesel fuel and holds it in the bottom of the fuel filter. Normally these fuel filters feature a drain plug that can be loosened and drained to eliminate the impurities. Be sure to dispose of these materials properly. Unlike gas filters these filters use a glass bowl that can be visually inspected on a periodic maintenance schedule.

DIESEL TRANSFER PUMP

A fuel transfer pump is included within the diesel fuel system. The pump equalizes the volume of fuel between the two fuel tanks. The pump is located in the bilge. The fuel transfer pump is located near the helm seat or dash area. The transfer pump utilizes a three position, center off style switch. The dash breaker must be energized to activate the switch. Once activated press the fuel transfer switch toward the fuel tank you want the fuel to flow toward. Monitor the fuel gauges and continue to transfer fuel until the tanks are equalized.

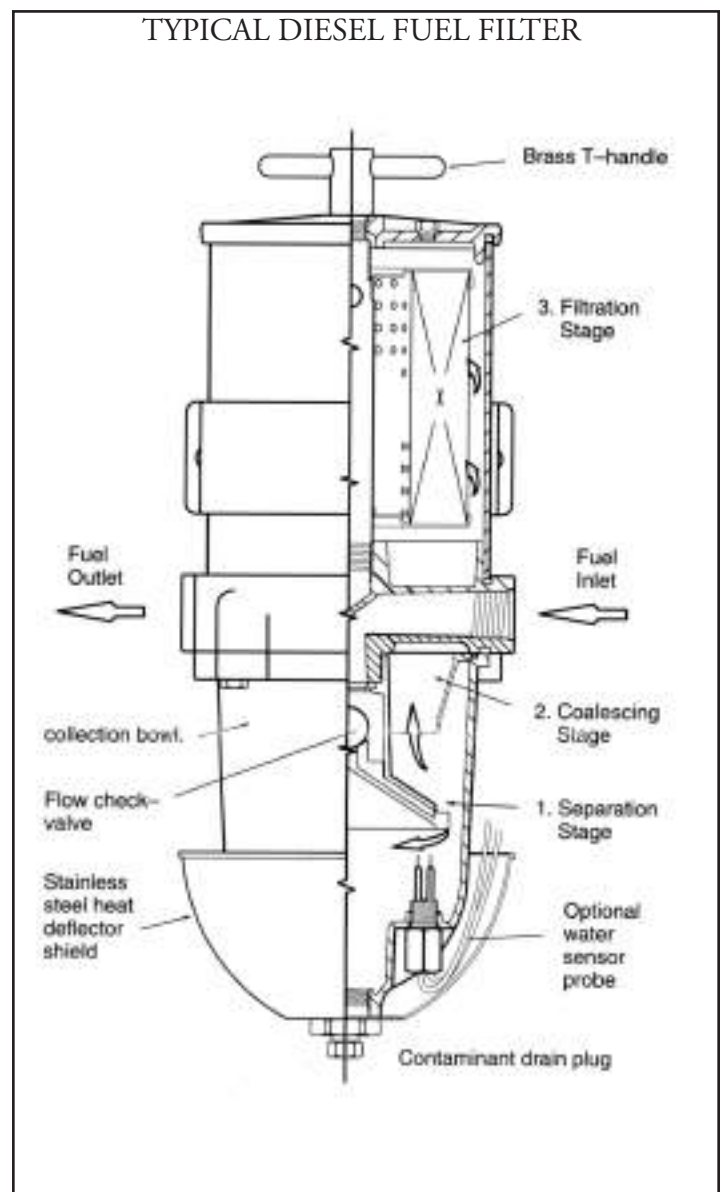

Chapter 5

STEERING SYSTEM OVERVIEW

CAUTION

PREVENT POSSIBLE INJURY AND/OR
PROPERTY DAMAGE!
LOOSE OR MISSING FASTENERS
COULD CAUSE DAMAGE TO THE STEERING
SYSTEM WHICH COULD RESULT IN
LOSS OF STEERING CONTROL.
PERIODICALLY CHECK ENTIRE SYSTEM.

HELM MOUNTING BRACKET

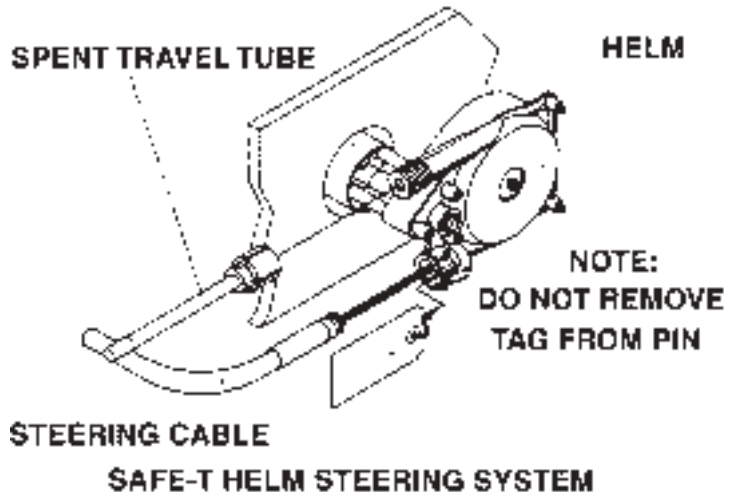

STERN DRIVE STEERING

Stern drive (outdrive) vessels use a rotary or rack style steering system. This system transfers helm mechanical energy to the engine. There is a hydraulic steering cylinder with the help of a steering pump which sends fluid force to the stern drive steering arm changing the course of the boat, depending on the direction the steering wheel is turned.

Since the steering system is the primary link for engine control it must be periodically inspected and maintained. The hardware at both the helm and engine locations must be checked regularly for tightness.

Refer to the steering manufacturer's literature in the owner's packet for more information along with the following illustration.

TRIM SYSTEM OVERVIEW

Your stern drive vessel features both an outdrive controlled power trim and a transom mounted trim tab system.

V-drive models use the trim tab system only. Both these systems use hydraulic cylinders which are driven electrically by a motor and valves which control the bow rise or port and starboard heeling angles depending on the particular system on your vessel.

Power Trim

The power trim system features 2 dash reference trim gauges. As the trim switches located on the remote control are activated the gauges will show a up or down resulting angle movement of the stern drives which effects bow rise.

TYPICAL POWER TRIM GAUGES



The power trim system features an electric motor, hydraulic pump, and reservoir. As the trim is activated fluid moves proportionally through the system. The pump reservoir needs to be periodically checked for hydraulic fluid levels. See the engine manufacturer's engine owner's manual for specifications and capacity of trim lubricant.

The power trim is normally used prior to accelerating onto a plane, after reaching the desired RPM or boat speed, and when there is a change in water or boating conditions. Position passengers and equipment in the boat so that the weight is balanced correctly fore and aft as well as side to side. Trimming will not compensate for an unbalanced load.

To operate the trim, push the switch until the desired bow position is reached. The trim may be operated at any boat speed or at rest. Avoid operating the trim system when running in reverse. Observe the trim/tilt gauge which indicates the boat's bow position achieved by the trim angle of the vertical drive unit. "Bow-Up" corresponds to the upper portion of the trim range on the gauge while "Bow Down" corresponds to the lower portion of the trim range on the gauge.

To determine the proper trim angle, experiment a little until you are familiar with the changes in your boat. The vessel will be properly trimmed when the trim angle provides the best boat performance for the particular operating conditions. A trim position that provides balanced steering load is most desirable.

To familiarize yourself with the power trim, make test runs at slower speeds and at various trim positions to see the effect of trimming. Note the time it takes for the boat to plane. Watch the tachometer and speedometer readings as well as the ride action of the boat.

Chapter 5

OPERATION IN “BOW UP” POSITION

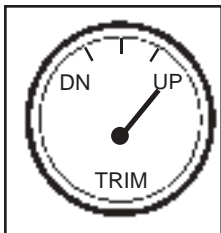

The “bow up” or out position is normally used for cruising, running with a choppy wave condition, or running at full speed. Excessive “bow up” trim will cause propeller ventilation resulting in propeller slippage. Use caution when operating in rough water or crossing another boat’s wake. Excessive “bow up” trim may result in the boat’s bow rising rapidly, creating a hazardous condition.

OPERATION IN “BOW DOWN” POSITION

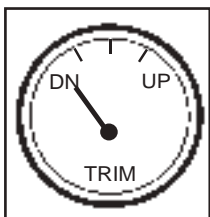

The “Bow Down” or in position is normally used for acceleration onto a plane, operating at slow planning speeds, and running against a choppy wave condition. It is also used when pulling water skiers, tubers, knee boarders, etc. In this position the boats bow will want to go deeper into the water. If the boat is operated at high speed and/or against high waves, the bow of the boat will plow into the water.

OPERATION IN “LEVEL” POSITION

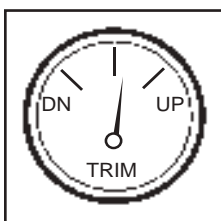

In normal running conditions, distribute passengers and gear so boat is level. At or below cruising speeds, trim the vessel for optimum performance. The trim gauge will show somewhere in the center of the gauge. This position will also enhance running visibility and overall stability. Again, each outing provides different wave, load and running conditions. Be prepared to make trim changes as needed.



CAUTION

THE BOAT TRIM SHOULD BE ADJUSTED TO PROVIDE BALANCED STEERING AS SOON AS POSSIBLE EACH TIME YOU GET UNDERWAY. SOME BOAT, ENGINE AND PROPELLER COMBINATIONS MAY CREATE BOAT INSTABILITY AND/ OR HIGH STEERING TORQUE WHEN OPERATED AT OR NEAR THE LIMITS OF THE “BOW UP” OR “BOW DOWN” POSITIONS. BOAT STABILITY AND STEERING TORQUE CAN ALSO VARY DUE TO CHANGING WATER CONDITIONS. IF YOU EXPERIENCE BOAT INSTABILITY AND/OR HIGH STEERING TORQUE, CONTACT YOUR AUTHORIZED REGAL DEALER



CAUTION

DO NOT RUN ENGINE ABOVE 1000 RPM WITH THE STERN DRIVE TRIMMED FOR SHALLOW WATER MANEUVERING SINCE THE STERN DRIVE IS OUT BEYOND THE GIMBAL RING SIDE SUPPORT BRACKETS. OPERATING IN ABOVE MANNER COULD PRODUCE A DANGEROUS STEERING CONDITION OR COULD DAMAGE STERN DRIVE COMPONENTS.

Trim Tabs

Trim tabs are installed on the hull lower transom area. Water is deflected and redirected as the trim tabs are raised and lowered from the dash switches. This change in water flow creates upper pressure under the tabs, and raises the stern. When the stern rises, the bow is lowered. Lowering the port tab will cause the port stern to rise, making the starboard bow lower. Lowering the starboard tab will cause the starboard stern to rise, making the port bow lower.

TRIM TAB DASH SWITCH

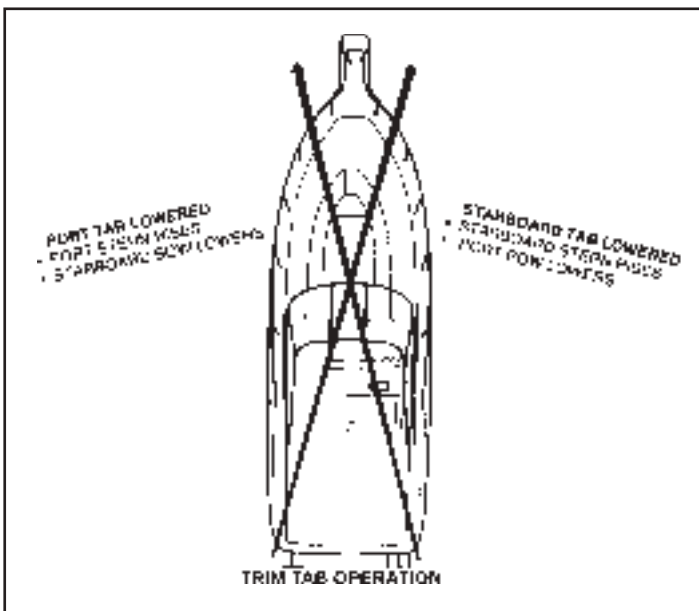
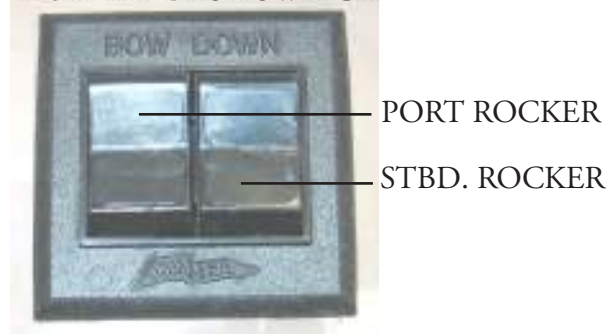

Obtaining A Trimmed Position

Your Regal boat will reach a planing position at a specific speed. This speed is determined by bottom design, weight distribution, water conditions, and on board equipment. As the throttle is advanced the stern squats and the bow rises initially. The trim tabs allow your boat to plane at a slower speed than natural conditions allow.

In short bursts both trim tab rocker switches are pushed simultaneously in the “bow down” position which causes the trim tabs to move down. As the boat breaks over the bow high attitude the boat speed accelerates and visibility increases.

If the boat is overtrimmed, it will plow the bow and the boat will lose maneuverability. If this occurs, simply short burst the “bow up” trim tab rocker switch simultaneously.

In the “learning curve” process, press the tab switches in half second bursts. You will notice a slight delay from the time the switches are pushed until the boat reacts depending on vessel speed. You will know after awhile the optimum planing angle and speed.

When running in heavy seas press the “bow down” position which will assist the vessel to cut through the waves. This will produce a drier and more comfortable ride. In a following sea especially with V-drives run the tabs in a fully retracted angle for maximum rudder response.

Sometimes you can watch the bow spray or stern wake and the rooster tail (mound of water produced by the rudders or stern drives). In a bow up position the spray is far aft to the hull, the wake is high and the rooster tail is high.

Using trim tabs in conjunction with the power trim will compensate for uneven weight distribution, listing, water conditions, and other factors that cause inefficient operation. Remember, that trim tabs are trimming the hull while power trim is trimming the engine drive.

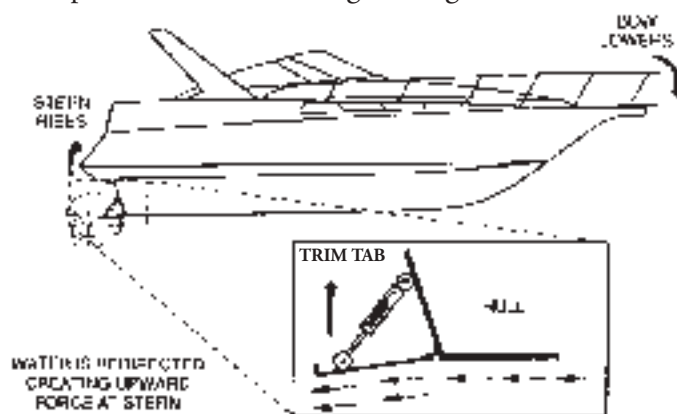



Chapter 5

When trimmed or in the bow down position, the bow spray is farther forward, the wake and rooster tail are smaller, and positioned further behind the vessel. Also, when trimmed you will notice that the tachometers show an increase in rpm's.

Rectifying A List

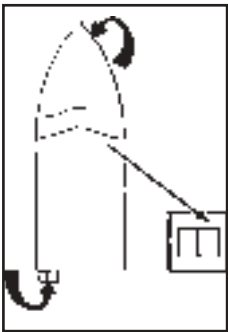

Your vessel can use the trim tabs to rectify a list. The trim tabs adjust the boat's attitude in the direction the helm rocker switch is pushed.

If the port bow is high, push the left-hand "bow down" direction on the dash rocker and the port bow will lower. If the starboard bow is high, push the right-hand "bow down" direction and the starboard bow is

lowered.

Using Stern Drive Power Trim With Trim Tabs

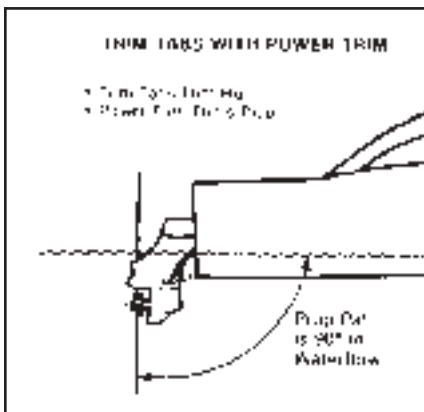

Adjust the **trim tabs** to achieve a planing attitude. Use the power trim to position the prop path parallel to the water flow. At this point the trim tabs may need a fine adjustment.

One advantage of the trim tab system

is that they allow trimming of the hull while the power trim results in trimming the props.

Porpoising

Porpoising is a running condition where the bow "bounces" up and down similar to a porpoise motion. Press "bow down" in one-half second bursts. As the trim tabs turn, the porpoising should recede and the vessel speed should increase. Only a small amount of "bow down" is normally necessary to make this change.

WATER/WASTE SYSTEM OVERVIEW

Fresh Water System

Your vessel is equipped with a fresh water supply system. It consists of a fresh water tank, deck fill/vent, monitor system, pressure water pump with filter, distribution system, dockside water pressure regulator and water heater. The system holds fresh water until it is needed and then with the pressure pump energized, or with the dockside water pressure regulator the system will supply water to the galley, head, and transom shower.

The system is winterized from the factory utilizing a product called “freeze ban”. It is best to completely drain the freeze ban before adding any water to the tank in order to minimize the taste of Freeze ban. Freeze ban will not harm you but it does have a peculiar taste. The system requires little maintenance except occasional cleaning of the water filter and winterizing during cold weather.

For more specific information on the water system see the equipment operation and troubleshooting chapters.

Waste Water System

Your vessel is equipped with various devices that make up the waste water system. They include the toilet, overboard discharge pump (optional), shower sump pump, monitor gauge, waste tank, deck fittings, drains, seacocks and waste tank. For more specific information on the waste system see the equipment operation, troubleshooting and maintenance chapters..

Notes



Chapter 6

Vessel Operation

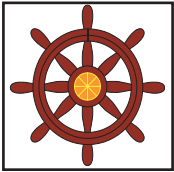

This chapter explores the many facets of running your vessel from casting off to docking and handling emergencies. We cover the basics but suggest you read other information on the chapter topics. Also, become familiar with your engine owner's manual since many of the items discussed are found there in more detail.

GETTING UNDERWAY

PRE-DEPARTURE QUESTIONNAIRE

- Have all fluid levels been topped off?
- Is the fuel tank full?
- Are the engines, transmissions, and propellers in good condition?
- Is the drain plug in place (Dry stored vessels)?
- Have all passengers been briefed on all emergency procedures and seated for departure? Is the boat load balanced?
- Is all safety equipment accounted for and easily accessible?
- Are navigation lights and horn in good working condition?
- Is the bilge free of water and do the bilge pumps operate?
- Is the operator sober, alert and ready to skipper the vessel?
- Have all passengers been fitted for life jackets?
- Has a float plan been filed and left with a component person?
- Has the bilge been sniffed and the fuel system leak checked?
- Are the appropriate seacocks open?
- Is all communication equipment in good operating condition?
- Has a second person been briefed on operational procedures should the skipper become disabled?

Chapter 6

- Are all gauges and electrical switches functioning properly?
- Has weather information been gathered and analyzed?

UNDERWAY QUESTIONNAIRE

- After casting off have all dock lines and fenders been stowed?
- Are all passengers seated?
- As skipper are you monitoring the dash gauges for changes?
- As skipper are you on the lookout for changing weather?
- As skipper are you checking for abnormal vibration or steering?

DISEMBARKING QUESTIONNAIRE

- Have you removed the keys from the ignition and secured them?
- Have all systems been checked for leaks?
- Has the battery switch been turned to the “off” position?
- Are all storage compartments and seacocks closed?
- Has the fuel tank been filled enough to assist in preventing condensation?
- Is the vessel properly tied and covered with equipment stored?

 **DANGER**

AVOID PERSONAL INJURY OR DEATH!
GASOLINE IS A HIGHLY FLAMMABLE
AND EXPLOSIVE MATERIAL.
PRACTICE “NO SMOKING” AND EXTINGUISH
ALL FLAMMABLE MATERIALS
WITHIN 75 FEET OF THE FUEL DOCK.

 **WARNING**

AVOID SERIOUS INJURY OR DEATH
FROM EXPLOSION OR FIRE
RESULTING FROM LEAKING FUEL.
INSPECT ENTIRE FUEL SYSTEM
AT LEAST ONCE A YEAR.

 **WARNING**

PREVENT INJURY OR DEATH!
USE ONLY APPROVED MARINE
REPLACEMENT PARTS
THAT ARE IGNITION PROTECTED

HULL DRAIN PLUG

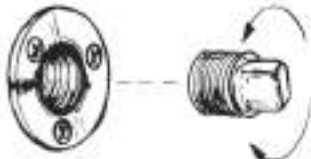

TIGHTEN-CLOCKWISE

Tighten the hull drain plug by turning clockwise.

Vessel Operation

NOTICE

SINCE GASOLINE IS AVAILABLE IN VARIOUS OCTANE LEVELS, REFER TO THE ENGINE MANUFACTURER'S OWNER'S MANUAL FOR THE CORRECT ONE FOR YOUR ENGINE. USING IMPROPER OCTANE FUEL CAN CAUSE ENGINE DAMAGE AND VOID THE WARRANTY.

BEFORE FUELING

- Make sure a working fire extinguisher is close.
- Stop engines and any device that can cause a spark.
- Disembark all passengers and crew not needed for fueling.
- Fuel if possible during the daylight hours.
- Check to ensure nobody is smoking in the boat or near the fueling dock.
- Close all enclosures to keep vapors from blowing aboard and settling in the bilge.
- Tie up your boat securely at the fuel dock.
- Identify the fuel fill.
- Inspect fuel system components before filling.
- Avoid using fuels with alcohol additives. They can attack and deteriorate fuel system components.

DURING FUELING

- Keep the fuel nozzle in contact with the fuel fill to guard against static sparks. The fuel fill pipe is grounded through the fuel system wiring to protect against static electricity.
- Avoid overfilling the fuel tank. Leave room for expansion.
- Avoid spilling any fuel. Clean up any fuel accidentally spilled with a clean rag and dispose of it properly.

AFTER FUELING

- Close all fuel fill openings tightly using the key.
- Open all hatches.
- Energize the blowers for a minimum of 4 minutes
- Sniff in the lower bilge and engine compartment for gas fumes. If fumes are detected continue to ventilate until the odor is gone. Look for any traces of fuel droplets or spillage.

Do not start the engines, smoke or run any electrical components until fumes can no longer be detected.

Chapter 6

STARTING & STOPPING

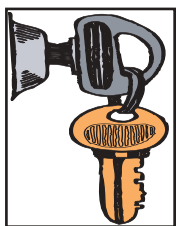

The following general information covers starting and stopping your engines. Read and understand all previous information on remote controls, fueling and operational procedures. Pay particular attention to all labels. Refer to the engine owner's manual for in depth propulsion system information.

Review all pre-departure information. Before starting your engines make sure all canvas is removed and stored. Start the engines only in a well ventilated location to avoid CO buildup. Make sure all battery switches are activated. Position the remote control handles in the neutral position. Advance the neutral throttle advance position as instructed in the engine owner's manual. Keep passengers seated and away from controls. Make sure the center windshield section is closed and locked.

STARTING GUIDELINES

The engines start much like an automobile. Turn the ignition key to the "ON" position. Then turn the key to the start position. You will hear the starter cranking over the engine. When the engine starts release the key switch. Duplicate the same procedure with the other ignition key. If the engine does not start, refrain from cranking the engine over 10-12 seconds. Allow the starter and battery a chance to recover. Advance the remote control in the neutral throttle position as recommended in the engine manual. Do not race the remote control in the neutral position. Refer to the engine and control chapter and the manufacturer's engine owner's manual for additional information.

 **WARNING**

AVOID PERSONAL INJURY OR DEATH!
WHEN ENGINE IS RUNNING
TRANSOM DOOR MUST
BE CLOSED AND LOCKED.
SWIM PLATFORM
AND LADDER MUST NOT BE IN USE.

 **CAUTION**

TO AVOID ENGINE DAMAGE!
CHECK THE OIL GAUGE
IMMEDIATELY AFTER STARTING.
IF LOW OR NO READING
SHUT DOWN ENGINE IMMEDIATELY
AND INVESTIGATE THE PROBLEM.

 **WARNING**

GASOLINE VAPORS CAN EXPLODE!
BEFORE STARTING ENGINE(S) OPERATE
BLOWER(S) 4 MINUTES
AND CHECK ENGINE COMPARTMENT
FOR GASOLINE LEAKS AND VAPORS.
RUN BLOWER BELOW CRUISING SPEED.

SHIFTING GUIDELINES

Before shifting into reverse or forward make sure the coast is clear. When shifting to either gear from neutral make sure the throttles are in the idle position. Do not pause but engage the shifter quickly into the desired gear. Allow your vessel to lose all headway before shifting into reverse or forward gear. Practice shifting! You will become more familiar with the procedure and self-confidence will build especially in tight docking situations. Most importantly, stay alert!

STOPPING GUIDELINES

Before stopping the engines make sure they are in neutral and at idle speed. After an outing let the engines cool down at idle speeds for a few minutes before turning the ignition off. Glance at the gauges one last time to monitor their readings. Never turn the engines off while in forward or reverse gear. Never back up in reverse at excessive speeds since water could enter the engine through the exhaust system and cause extensive damage. Above all, use common sense.

FENDERS

FENDER USAGE

Fenders are normally made of a rubberized plastic and are usually filled with air. Most have a fitting like a basketball so they can be inflated or deflated. Fenders are available in a wide range of sizes and shapes to fit both small and large vessels. Fenders are normally designated in inches. They are used between piers, docks, sea walls and the boat. They protect the topsides of the boat from rubbing against rough objects. Most fenders have eyes of attachment which allow a line to be inserted vertically or horizontally. This will permit the fender to be tied off to fit a variety of marina, dock and tidal situations. Be sure the fender is correct for the vessel size. It is a good idea to carry extra fenders but half a dozen is normally an acceptable number. Remember to store fenders on board so they can be easily accessed. Some people incorrectly call fenders “bumpers”.

FENDER TYPES



There is a variety of fender styles and types, each selected for specified uses. When choosing fenders, contact a marine dealer or supply house. Explain how you moor and use your vessel so they can recommend the best fender type for you. We suggest the type with a fill plug so you can inflate them with a hand pump like the ones used for bicycles.

Chapter 6

DOCK LINE BASICS

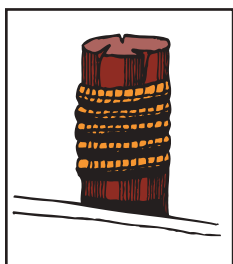

Most skippers use dock line terminology fairly loose but there is more to the basics than just bow or stern lines. There are several lines that can be secured to the bow and stern and depending on their direction and use, can be called other names. Remember that “forward” and “aft” refer to the direction that a spring line runs from the vessel, and not where it is secured on board.

BOW & STERN LINES

There is only one true bow line. It is secured to the forward cleat and run forward along the dock to prevent the vessel from moving to the stern. The stern line leads from a rear cleat to a piling or cleat on the dock astern of the vessel. This line keeps the boat from moving ahead. For small vessels these are the only lines needed for normal wind and current conditions. If located in a tidal environment, keep slack in the lines.

BREAST LINES

These lines are attached to the bow and stern that lead to nearly right angles from the center of the vessel to the dock. They help keep larger vessels from moving away from the dock, or are pulled in to help people board the vessel. Bigger vessels may use bow or quarter breast lines.

SPRING LINES

Most small boats use two spring lines although it is possible to have four. They are called the after bow spring and forward quarter spring.

Bow springs are secured at the vessels’ bow area. Forward spring lines lead forward from the boat to the dock and control movement sternward. After springs stem aft from the vessel, and stop movement ahead. Spring lines are used to prevent movement in a berth, ahead or astern. They are really useful in controlling the effects of a real active tidal surge. Spring lines are useful where fenders need to be kept in place against piles.

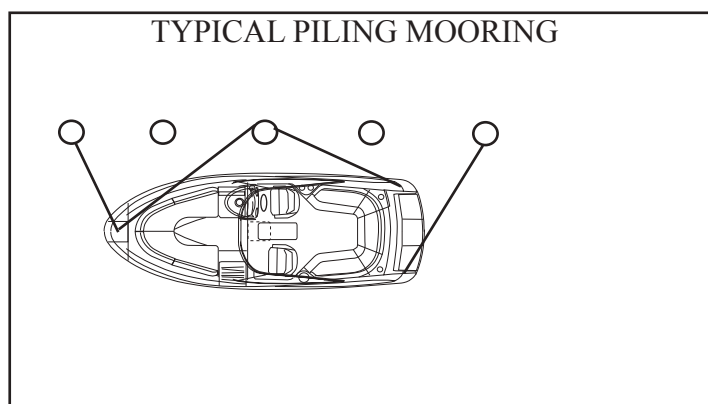
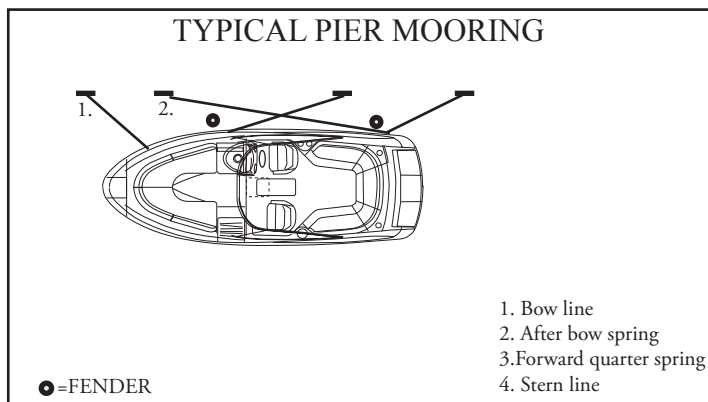

BOAT MOORING

Most boats can be secured to a dock using four lines. The after bow spring is crossed with the forward quarter spring and secured to individual dock cleats or pilings. This ensures longer springs and can be snugged up tighter for more efficient tidal control. Remember, if you only have one piling available, position the vessel so this point is opposite admidships. Run both spring lines to it. These lines will be shorter but still useful.

Vessel Operation

The bow and stern lines should be relatively at a 45 degree angle with the dock. The stern line can be attached to the near-shore quarter cleat, but will work more efficiently to the offshore quarter cleat. The longer line will allow the boat flow with the tide with less time checking the vessel.

DOCK LINE SIZING

Most dock lines today are made of nylon, either of twisted rope or braided core and cover. The most often used material is nylon because of its stretching abilities absorbing shock loads. It is chafe resistant for extended life and is easier on bare hands.

The line's size varies with the vessel. Normally, a vessel in the 20' to 40' boats will use 1/2" diameter nylon lines.

Dock lines need to have the strength to hold the vessel and have enough density to resist chafing. They shouldn't be too heavy that they lose their shock-absorbing capabilities. Use the right size line for the vessel since a line too large for the boat will pull hard against the vessel since it won't be forced to stretch. If the line is too small for the vessel, there is no margin for wear and chafe when under strain

SECURING LINES

When mooring your boat, make sure the dock lines are secured at both ends. Depending on your situation you may need to loop the eye splice of the dock line around a piling. Sometimes the mooring line will lead down sharply from the piling to the deck cleat. Loop the eye splice around the piling twice to keep it from being pulled up off the pile. Pull the line through the looped eye if the mooring line is too small to go around the piling twice or too small to fit over once.

If you must drop a line over a piling that already holds another boat's line, run the eye of the line up through the first eye from below, then loop it over the pile. This will allow either line to be removed without disturbing the other. If another line is dropped over yours, simply reverse the process.

Secure a little slack in the other dock line, then slip your eye up through its loop and over the top of the pile. Your line can be dropped through the other eye.

When debarking from a dock, it is easier to release the line from a cleat or piling, from on board the boat, as soon as you leave the dock. Loop a long line around the cleat or pier and leading both ends on board you can release the line easily. Slip one end around the cleat or pile, then pull it back on board. Release the line without the eye splice, so it will run freely from around the pile without hanging up on the splice.

Chapter 6

STEPS TO STERN DRIVE DOCKING

Inboard/Outboard powered boats are fairly easy to back up and maneuver with a little knowledge and docking practice. One of the most important aspects of the process is to keep your calm in the wake of a busy marina. Basically, the reversing propellers are turned in the direction you want to go by using the steering wheel.

Some boats tend to be influenced by the wind. When backing down in a crosswind, allow room to maneuver and watch the bow. Try not to overreact or get excited, but use your knowledge and experience. If the wind begins to swing the bow, you need to stop backing, turn the wheel to port and go forward to straighten the boat. Use a quick burst of power but not too much to knock your crew off balance.

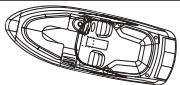

A. Stop the boat by shifting in reverse. Put the wheel over to the port and begin backing in. Slow down your speed by momentarily shifting into reverse.

*** Control in reverse idle position, Outdrives to port.**



B. Continue backing up the boat with the wheel hard to port. Keep an eye on the bow, and begin to straighten the wheel as the boat enters the slip.

*** Control in reverse idle position, Outdrives to port.**

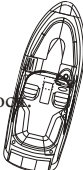

C. Center the wheel to align the boat parallel with the dock. If the stern is too far from the dock, shift to neutral, then put the wheel hard over to port and then go forward a second or two.

*** Control in neutral idle position. Drives centered.**

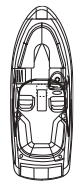

D. When the boat is completely into the dock, stop stern movement by shifting into forward. Put the wheel to port to kick the stern over close to the dock if necessary. Shift into neutral. Tie up the boat.

*** Control in forward idle position. Drives to port.**

 **CAUTION**

AVOID PERSONAL INJURY OR PROPERTY DAMAGE!
DO NOT USE THE SWIM PLATFORM CLEATS FOR TOWING OR ANY TYPE OF PERMANENT MOORING OR DOCKING.
USE BOW, STERN AND SPRING LINE CLEATS FOR MOORING.

STERN DRIVE MANEUVERING

Inboard/outboard, I/O or sometimes called stern drive boats do not have rudders. The boat uses a steering system that directs the propeller thrust, by turning the stern drive unit where the propeller is mounted. Normally maneuvering the I/O boat is easier than a V-drive vessel. Directing propeller energy (thrust) makes slower speed maneuvering easier. The propeller discharge current is turned from one side to the other which results in turning forces. Rudder boats need water to flow by the rudder to be efficient. Stern drive units are designed to have reduced shaft angle, so the propeller does not produce as much unequal blade thrust and resistance as does a propeller on a single screw boat. Large horsepower stern drive boats do produce more thrust and steering torque but your vessel has the advantage of power steering. Below is some basic information on how stern drive boats handle in normal conditions.

GATHERING HEADWAY

You may notice that if you advance the throttle quickly in initial takeoff (make sure you have a firm grip on the wheel), the boat has a tendency to pull the stern of the vessel to starboard. There is a trim tab (also serves as a sacrificial anode) located on the vertical drive housing just to the top of the propeller blade. This trim tab helps compensate for the low speed steering torque. Once the boat increases headway and the propeller is operating in a faster water flow this torque effect decreases.

Contact your Regal dealer for further information or consult your engine manufacturer's handbook.

TURNING

Once the boat has gathered headway, with the boat planing at the correct bow angle and the stern drive units and helm straight the boat tends to stay on a uniform course heading. To assure the boat trim angle is correct use the trim gauge as a guide while activating the trim button on the remote control panel.

When the helm wheel is turned to the right or starboard, the stern drive units are turned in the same direction. The propeller's discharge force is directed to starboard forcing the boats stern to port. Water flowing past the hull strikes the stern drive gear housings on their starboard side, creating additional turning torque. The stern starts a move to port, forcing the bow to starboard.

If the helm is turned to the left or port the stern drives turn to port, the stern of the boat goes starboard as the bow turns to port.

As the vessel operator gains experience, he will better gauge each maneuver and speed situation. In this way he will understand the handling characteristics of his boat. He needs to keep the safety of his passengers in the highest priority.

BACKING DOWN

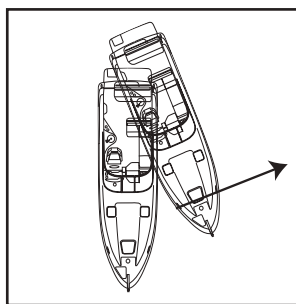

Inboard/Outboard (I/O) boats do not have rudders. The boat uses a steering system that directs the propeller thrust, by turning the stern drive unit where the propeller is mounted. Normally maneuvering the I/O boat is easier than a similar V-drive vessel.

If your boat has the steering wheel and stern drives straight with the control in reverse, the stern will be pushed a bit to port by the reversing propeller thrust. This tendency to back to port can be eliminated by turning the stern drive to starboard.

When the vessel begins to gather speed to stern, the water passing by the lower gear case housings will continue to increase steering torque. If the helm wheel is turned to starboard, and will direct the propeller thrust to port, tracking the stern to starboard.

Wind and current will affect how a vessel backs. Stern drive boats tend to be light displacements and when backing down in a strong crosswind, the bow will tend to fall toward the windward. This may cause steering problems.



Chapter 6

Once increased headway is gathered in reverse gear, the force of the lower hull moving through the water is enough to track straight. When backing, the stern will lead as it heads to port or starboard, before the vessel actually starts to turn. When the control is put in forward gear position, the stern is pushed to starboard; the amount of push depends on the hull design and the amount of throttle advance.

STOPPING

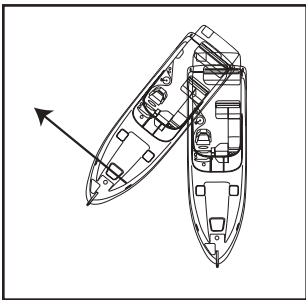

Remember that your boat does not have any brakes. It uses reverse thrust from the propeller to stop. If the vessel has headway, with the helm and propellers in reverse the propeller thrust is directed backwards, past the lower gear case of the stern drive.

Depending on how far the throttle is advanced, the discharged thrust may not be strong enough to reverse the water flowing by the gear case. As the power is increased, the propeller thrust becomes strong enough to stop the flow of water past the lower unit, and, as the throttle is advanced it reverses its flow more completely.

When water is flowing past the gear cases, steering torque is increased, but when the thrust stops the water flow, the boat will not respond to the helm. This is a short lived event and is overcome quickly when the water again flows past the gear case. Furthermore, added to the energy of the water hitting the lower gear case, the propeller thrust is directed by turning the stern drives, which can add to the steering torque.

The props tend to throw the stern to port. This is why experienced skippers undertake a portside landing when wind and current conditions permit. They allow the prop to move the stern to port toward the dock.

With a forward motion when the helm wheel is turned hard to one side, the vessel pivots around a point about 1/3 its length abaft to stern. See illustration.

STOPPING TWIN-SCREW VESSELS

A proven way to stop a twin-screw vessel is by reversing the propellers. This action will not push the stern to one side like other type powered vessels.

The skipper of a twin-screw boat can use the following approach idea in both port and starboard situations; with the boat stopped, the skipper can reverse the propeller so the stern will be pushed toward the dock. With the starboard approach, reverse the outboard engine propeller to check headway when approaching parallel to a dock, the stern will move in. With the port approach, the reversing starboard right-hand propeller will move the stern toward the port. When approaching to put the vessel's starboard side to the pier, the reversing port propeller will move the stern toward starboard.

ANCHORING



Selecting the correct anchor is an important decision. The anchor style in part depends on the usage and boat type. Regal boats designate an anchor type and or model. Some models incorporate chain, line with an optional windlass. Contact an

authorized Regal dealer for more information.

Anchoring is easier with another person on board. First be certain that the line for the anchor is properly attached, to avoid losing the anchor and anchor line overboard.

For most anchors to perform more efficiently, you should attach 3 to 6 feet of chain. The chain will stand up to the abrasion of sand, rock, or mud on the bottom much better than a nylon line. It should be galvanized to reduce corrosion. Next, attach a length of nylon line to the other end of the chain.

The nylon will stretch under a heavy strain cushioning the impact of waves or wind on both the boat and the anchor. To anchor, select a well protected area, preferably with a flat bottom. Contrary to modern belief, you do not throw the anchor over while the boat is making headway, or moving forward. In fact, the bow of the boat should be brought slowly backward, while easing the anchor slowly over the side of the boat until it hits the bottom. To “snub the line” means to stop its outward “pay” or movement. Usually the length of anchor line used should be 5 to 10 times the depth of the water.

After you have anchored, check your position with landmarks if possible. You need to continue to monitor these landmarks to make sure you are not drifting. Since anchoring can also be an emergency procedure, the anchor and line should be readily accessible.

For increased holding power in windy conditions, two anchors are sometimes set. If your primary anchor drags, you can run out your secondary anchor without picking up the primary one. The important thing is to lay them out at an angle. When setting two anchors, make sure they are fastened to separate ropes or cleats.

This is done in case you need to adjust one later so the line is accessible. If two anchors are used ahead of a boat, make sure to set the rodes at an angle than in a straight line to reduce the chances of tangling as the boat moves in wind and current. See the above illustration.

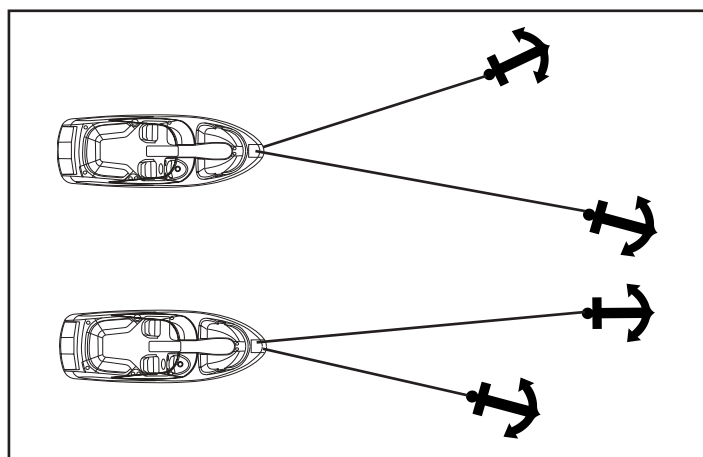



Chapter 6

TOWING

In case you find yourself aground or in need of a tow, or should you want to tow another vessel, keep in mind that you **never use deck hardware or cleats to secure lines for towing!**

Deck hardware is intended for mooring and anchoring, and is not designed to withstand the strain and pull of towing. Rather than tie the line to your cleats on deck, it is suggested that you tie a bridle by passing a line completely around the hull of your boat to avoid structural damage. When towing, always stand clear of a taut line, as any type of line breaking under stress can be extremely dangerous. The preferred line for towing is double-braided nylon, as it has sufficient elasticity to cushion shock loads. Move slowly and cautiously.

| |
|---|
|  DANGER |
| AVOID DEATH OR SERIOUS BODILY INJURY! DO NOT USE DECK HARDWARE INCLUDING CLEATS FOR TOWING. |

ADMIRALTY LAW

The Admiralty law sometimes referred to as the salvage law was founded primarily on English law fundamentals and basically says that a vessel distressed, in danger of flounder, if rendered assistance from a towing company or private agency, can be forced to relinquish a portion of the vessels' worth for the assistance received.

| |
|---|
| NOTICE |
| IN THE EVENT YOUR VESSEL IS IN DISTRESS, PRIOR TO ALLOWING ANY TOWING COMPANY OR PRIVATE AGENCY THE RIGHT TO PASS A LINE TO YOUR VESSEL, BE SURE TO ESTABLISH THAT YOU DO NOT AGREE TO ANY SALVAGE RIGHTS. ESTABLISH WITH THE CAPTAIN OR OPERATOR THAT YOU WISH TO BE ASSISTED IN A CONTRACT BASIS AND ESTABLISH A PRICE. OF COURSE IN CERTAIN SITUATIONS, YOU MAY NOT HAVE THIS OPTION. USE YOUR BEST JUDGEMENT! |

KNOTS

Knots are useful in docking, towing and other emergency situations. Learning to tie knots requires practice. As they say “Practice makes perfect”. Some of the knots used in boating are the square, bowline, anchor bend, clove hitch, figure eight and half hitch. There are several periodicals available that explain various knots and how to tie them effectively. An experienced skipper will know the basic nautical knots and will use them when on the water. Take the time to know the basic knots.

**Figure 8 Knot
Tied To Cleat**



A useful knot to learn for general docking is the figure eight with one end reversed. By turning the free end of the line back under, the knot can be released without disturbing the boat. After some practice one person can secure a vessel easily to a dock or pier in a variety of weather conditions. This knot normally is used to tie the bow and stern. Then the vessel can further be fastened by tying the spring lines in the figure eight knot. Wrap it around the cleat 2 or 3 times.

Chapter 6

EMERGENCIES

Always be ready to help others on the water if possible, but do not take any unnecessary risks. Use equipment to save a life, but do not risk a life to save equipment. Consult earlier information in this manual concerning accidents, etc. Also, read other literature concerning on the water emergencies. Be alert and prepared!

FIRE

Fire aboard a vessel can spread quickly and can cause tremendous alarm among everyone. Most fires can be prevented by keeping the bilge free from oil and debris. Keep all equipment stowed and maintained in working order. Carry a backup fire extinguisher on board. If something becomes a possible fire hazard, remove that possibility at once.

Never use water on gasoline, oil or electrical fires. When you dump water on an electrical fire a you can be shocked since water conducts electricity.

Follow these instructions if a fire breaks out:

1. Fit everyone aboard with a life jacket. Turn off the ignition.
2. Try to keep the fire downwind. If the fire is to the stern, head the bow toward the wind. If forward, put the stern to the wind.
3. If the engine should catch fire, shut off the fuel supply. Usually there is a fuel tank access that you can crimp the fuel feed line.
4. Use a hand fire extinguisher. Make sure to point it at the base of the flames. Use short bursts and sweep the extinguisher side to side. **Remember: (A 4 pound extinguisher discharges in 20 seconds)**

These actions help prevent the fire from spreading to other parts of the boat. You can extinguish fires quickly if you act swiftly. Have a plan of action in motion in case a fire breaks out.

FIRST AID

Knowing first aid can save lives. A first aid kit and the ability to use it are important ingredients for the safety of a skippers' passengers, crew and vessel. Having confidence and competence in handling medical emergencies on board is a must for the skipper. Invest your time in a first aid course available at the American Red Cross.

CPR (BASIC LIFE SUPPORT)

If someone is seriously injured have someone call for help while the injured person is being attended.

Check for possible danger signs; loss of breathing, unconsciousness, severe bleeding and heartbeat. If you determine the individual is not breathing or unconscious place the victim on their back on a hard surface and do the following:

1. If unconscious, open the airway. Neck lift, head lift or chin head lift.
2. If not breathing, begin artificial breathing. Pinch the nose. Give 4 quick breaths. If airway is blocked, try back blows, abdominal or chest thrusts and finger probe until airway is open.
3. Check for pulse. Begin artificial circulation. Depress sternum 2". Fifteen compressions rate 80 per minute. 2 quick breaths. Continue uninterrupted until advanced medical support is available.

HYPOTHERMIA

Hypothermia is a condition where the body temperature decreases because the body can't generate enough heat to maintain its normal temperature. It can be serious and usually occurs where victims have been immersed in water (under 68 degrees) for periods of time. If you encounter a possible hypothermia victim call for help on the radio and get the person out of the water.

Symptoms are:

1. Shivering that if condition is advanced may stop.
2. Confusion, clumsiness or slurred speech.
3. Rigid muscles.
4. Semiconscious to unconscious.

Treat hypothermia by the following:

- Remove wet clothing.
- Monitor the victim's pulse and breathing.
- Rapidly apply heat to the body core by using blankets, naked bodies or warm water.
- Do not give the person any food or drink.
- Do not warm the arms and legs. Warming of these extremities can be fatal.

Follow up immediately with medical authorities!

ENVIRONMENTAL AWARENESS

There are numerous vessels operating on our waterways on a daily basis. Each boat has an impact on our environment. Boat operation habits, marine sanitation, and maintenance all play a role in a delicate battle to keep the ecosystem clean. Each of us has a role in doing our part as an environmentally conscious skipper to conserve our waterways.

The National Marine Manufacturer's Association lists their top ten of Eco-Boating Practices as follows:

1. Observe all regulatory agency policies regarding marine toilets.
2. If equipped with a holding tank, use marina pump-out facilities.
3. If used, make sure bottom paints are legal and ecosystem friendly.
4. Use only biodegradable cleaning agents.
5. Dispose of all garbage and litter on shore properly, not on the water.
6. Don't top off fuel tanks. Leave expansion room. Clean up spills.
7. Watch your wake and propeller wash.
8. Make sure your engines are well tuned and maintained.
9. Control your bilge water.
10. When fishing, practice the "catch and release" principle.

Follow these basic practices when on the waterways. Treat the environment in a way that you would like to be treated.

Chapter 6

CALIFORNIA AIR RESOURCE BOARD (CARB) LABEL

Your Regal boat may have a star shaped label affixed to the bow, port hullside. It is located at the front of the state registration numbers. This label is part of the California Air Resource Board (Carb) SD/I rule. If your boat is operated in the state of California and/or bordering waters, this label **MUST** remain intact. The label shows that the engine installed as original equipment meets a currently approved California state regulatory emission level. See the example below which shows the current California ultra low 3 star label.



CALIFORNIA PROP 65

Proposition 65 relates to the state of California and is an additional requirement added to their Safe Drinking & Toxic Enforcement Act of 1986. Prop 65 basically summarized states that:

“No person in the course of doing business shall knowingly discharge or release a chemical known to the state to cause cancer or reproductive toxicity into water or onto land where such chemical passes or probably will pass into any source of drinking water” and it goes on to say “no person in the course of doing business shall knowingly and intentionally expose any individual to a chemical known to the state to cause cancer or reproductive toxicity without first giving clear and reasonable warning to such individual

For more information, contact the California Office of Environmental Health Hazard Assessment at 916-445-6900 or <http://www.oehha.ca.gov/prop65.html>.

WARNING

A wide variety of components used on this vessel contain or emit chemicals known to the State of California to cause cancer and birth defects and other reproductive harm.

EXAMPLES INCLUDE:

- * Engine and generator exhaust
- * Engine and generator fuel, and other liquids such as coolants and oil, especially used motor oil
- * Cooking fuels
- * Cleaners, paints, substances used for vessel repair
- * Waste materials that result from wear of vessel components
- * Lead from battery terminals and from other sources such as ballast or fishing sinkers

TO AVOID HARM:

- * Keep away from engine, generator, and cooking fuel exhaust fumes
- * Wash areas thoroughly with soap & water after handling the substances above

FUEL SPILLAGE

The federal water pollution control act prohibits the discharge of oil or oil waste (such as from the sump bilge pump) into or upon the navigable waters of the United States or the waters of the contiguous zone. Violators are subject to substantial civil fines and criminal sanctions.

A placard is normally found inside the engine hatch area or in the sump warning of overboard discharge of oil or oily waste.

MARPOL TREATY

The USCG now enforces the International Convention for the Prevention of Pollution from ships, referred to commonly as the MARPOL TREATY (marine pollution). This international treaty prohibits the overboard dumping of all oil, garbage, ship-generated plastic and chemicals. There is a placard on board your boat that explains the garbage and plastic dumping laws in detail. Normally this placard is found near a waste receptacle in the cabin or cockpit.

✓ 2

Chapter 7

Equipment Operation

There are many equipment features on the Regal 3360 Window Express™. Some are standard and others are optional. **For the most in depth information, refer to that particular equipment manufacturer's manual located in the owner's document packet.**

Equipment or vendors may change during a boat's life cycle. Therefore, some of the components discussed here may or may not be on your vessel or look the same visually or in description form. Regal retains the right to change vendors, equipment, specifications and other technical data at any time.

INTERIOR EQUIPMENT

AIR CONDITIONING OVERVIEW



If equipped, the marine air conditioning system included in this chapter applies only to factory installed equipment. The air conditioner relies upon a source of AC power supplied by shore power or an on board generator along with a supply of water (salt or fresh). The unit output is 16,000 BTU'S.

The unit features the ability to provide heat in a reverse cycle mode especially useful in extending the boating season in colder climates. This reverse cycle operation is affected by the temperature of the water.

As the water temperature decreases so does its ability to produce heat. It is recommended that the reverse cycle not be used when the water temperature is below 40 degrees Fahrenheit.

AIR CONDITIONER BASIC OPERATION

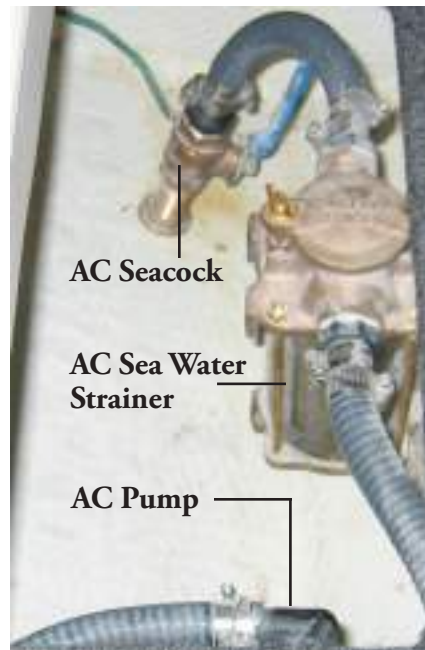

1. To use the air conditioner locate and open the through-hull seacock valve that supplies water to the air conditioner pump. The A/C seacock and pump are located beneath the mid berth cabin floor.

2. A strainer is installed between the seacock and the AC pump. This strainer stops foreign matter from being ingested into the AC pump or air conditioning system.

Periodically inspect and clean the strainer. See chapter 8.

3. The best way to activate the A/C system is to make sure both shorepower cords are plugged in and both dockside breakers and transom inlet breakers are energized. Refer to 1 the systems chapter for more information.

Chapter 7

An alternative method is to use one shore power cord and simply energize the transfer breaker on the main AC control panel. This sends 120 volts to both banks of the AC. If you employ this method you have 30 total amps availability verses dual 30 amps. You need to monitor the A/C load current meter as you energize various circuits especially using the air conditioner.

The A/C can be used while cruising through the generator. As optional equipment the generator supplies alternating current to operate the air conditioner. As above, once the generator is started, use the transfer switch to distribute current. See the systems chapter for operating the generator.

4. Activate the air conditioner breaker on the main A/C control panel.

5. Press the “on” button momentarily on the Passport II control panel to activate the system.

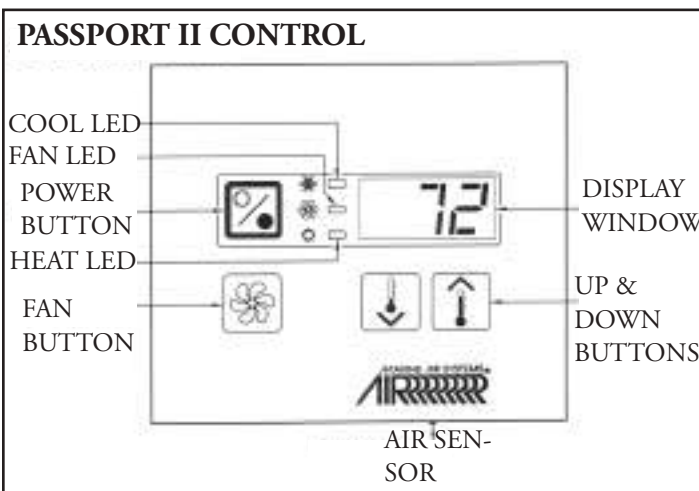

6. Press the fan button until a letter “A” appears indicating automatic mode or #1 (slow) through #6 (fast) for manual fan speed. Note: Fan may be used while A/C unit is off.

7. Press and hold the temperature buttons for the desired cabin temperature. Press either button momentarily to show current set point. Temperature range is from 60 to 85 degrees.

NOTICE

AVOID POSSIBLE EQUIPMENT FAILURE.
DO NOT TURN THE UNIT OFF/ON
IMMEDIATELY. ALLOW AT LEAST 30
SECONDS FOR REFRIGERANT PRESSURE
EQUALIZATION.

8. The switch LED panels refer to the following:

Cool- Lights when the compressor is running in cool mode or in automatic mode while cooling.

Fan- Lights when fan is on in manual mode.

Heat- Lights when the compressor is running in heat mode or in automatic mode while heating.

9. The air conditioning system is programmed for an automatic operation mode. See the Marine Air owner’s manual for changing the mode to heat or cool only. See chapter 8 for maintenance instructions.

10. Do not block the intake grill. It provides continued air for the A/C system. Clean the filter periodically. See Chapter 8 for more information.

Equipment Operation

CARBON MONOXIDE DETECTORS

Carbon Monoxide known as CO is indeed the silent killer. It is a by-product of combustion. CO is invisible, tasteless, odorless and is produced by all internal combustion engines, heating and cooking appliances.

The most common forms of CO on board vessels are the engines, generator and if applicable, propane heating and cooking devices.

Never operate these devices when people are sleeping. A slight amount of CO in the human body over several hours causes headaches, nausea and symptoms close to food poisoning, motion sickness or flu. High concentrations can be fatal within minutes.

HOW THE SYSTEM WORKS

The CO detector uses a mini computer to measure and accumulate CO levels. It uses the principle of "time-weighted averaging." The detector monitors CO concentrations, temperature, humidity and time to calculate COHb levels. To explain COHb, our bodies prefer to absorb CO to oxygen and COHb is the absorbed ratio stated in a percent. If the detector senses high levels of CO the alarm will sound in a few minutes. If lower levels are sensed, the detector will accumulate the data and sound an alarm when the appropriate level is reached. Read and understand the CO owner's manual in the information pouch.

To turn the CO detector system on:

1. Notice the CO breaker on the 12 volt main DC panel. It must be turned off in a two-step sequence. This is for safety purposes. The system should be always left on so you must flip back the switch before you are able to then deactivate the breaker.

The CO circuitry works to its best performance when continually activated plus it accords advanced warning when entering an area high in CO.

2. When power is applied to the detector, the power indicator (top) will flash on and off, followed by the (red) lower alarm indicator flashing off and on as part of a 8-14

minute warm-up period. The green (top) power indicator will indicate a solid green when the unit has reached correct operating temperature.

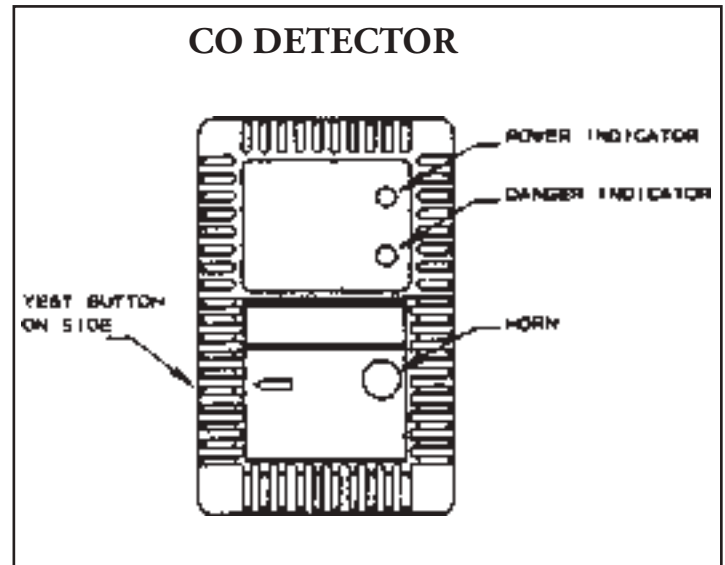

3. The test cycle should be activated frequently. Simply press the button. When it is released, the (top) power indicator will flash off and the lower indicator light will flash. Then, the lower indicator will flash off and the upper indicator light will come back on.

The top indicator light being on solid green indicates normal operation. Refer to the CO detectors owner's manual for an explanation of the test cycle indicators.

4. When an alarm sounds take action immediately. The danger alarm indicator flashes red and the horn beeps 4 times, pauses and repeats the cycle. This indicates a rate of 10% COHb has been reached.

- Operate reset/silence button.
- Call your emergency services (911)
- Immediately move to fresh air. Do not re-enter the vessel until emergency personnel have arrived, aired the vessel out and the alarm is in a normal condition.
- After following steps a-c and your alarm reactivates within a 24-hour period call a qualified technician to inspect the vessel. Note that the CO detector will clear when the CO concentration has dropped below 70 ppm.

Note: When the ship's batteries are disconnected at the battery terminals, the CO detectors will not operate.

Chapter 7

WATER/WASTE SYSTEM



To read either the fresh water or waste monitor panel the breaker on the main DC panel must be activated.

The fresh water monitor displays the amount of potable water in the system. There are sensors located in the tank itself that send a signal to the display when activated. Press the top portion of the toggle switch and read the gauge display.

The waste portion of the display shows the amount of waste water in the holding tank. Press the bottom portion of the toggle switch for determining the waste tank level. This portion of the system needs to be monitored periodically to prevent the tank from being overfilled which could cause equipment damage and/or a possible leak in the vessel.

If the waste system is determined to be full it can be emptied by connecting a marina pump-out hose to the waste fitting located on the deck. The pump out device will evacuate all the waste much like a vacuum cleaner operates. An alternative method **which can be used in International waters only** is to pump the waste overboard via a seacock. Notice the key switch portion of the monitor. If your vessel is equipped with an overboard discharge pump (macerator) you can use it to grind up the waste and send it through the hull bottom. **Make sure the waste seacock is open before energizing the macerator.**

Turn the macerator breaker on and then energize the monitor panel key switch. Be sure to turn the seacock off and secure it with a tie wrap after the pump-out cycle.

TYPICAL SHOWER SUMP PUMP

The gray water system is made up of sink, shower, or in some cases equipment run-off water. The system passes used water through the shower sump pump and eventually is discharged overboard via a thru-hull fitting. The different hoses routed to and from a typical shower pump are indicated below.

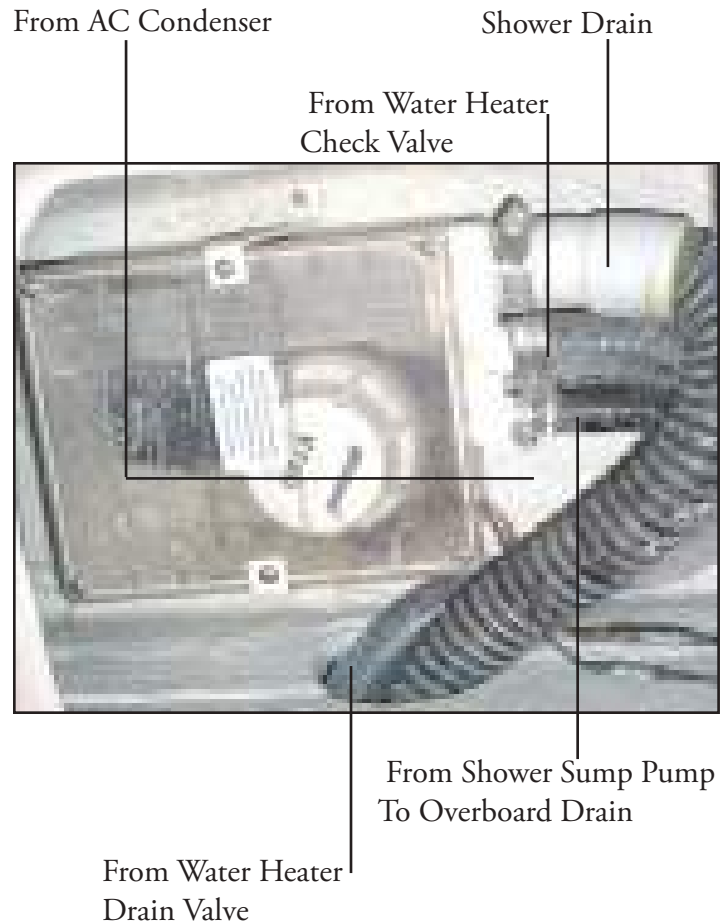

Equipment Operation

VACUFLUSH HEAD

The vacuflush head uses a combination of vacuum suction and water flow from the fresh water tank to clear the head of waste. Before using the Vacu-flush system turn the head circuit breaker to the “on” position at the main DC control panel.

Make sure that there is always a small amount of water left in the toilet head bowl. This acts as a trap and will reduce unwanted odors.

Before leaving the boat for an extended period, flush the head for at least 10 seconds. This ensures that waste has cleared the sanitation transfer hose and has entered the holding tank.

Waste left within the transfer hose tends to dry out and harden. This could restrict the internal size of the hose and hamper future operation. The system components including the hose are formulated for the transfer of sanitary waste only. **Do not allow the following items in the system:** Strong acid or caustics such as drain openers, petroleum solvents or fuels, alcohol based products such as antifreeze and pine oil products along with sanitary napkins and baby diapers.

System vacuum is monitored by a switch located on the outside of the vacuum generator’s tank. When the switch senses a vacuum drop, it automatically signals the pump to energize and bring the vacuum back to the operating level. This is normally a two minute process. In a properly operating system, the stored vacuum will “leak” down between flushes, causing the vacuum pump to run for a short period. This is normal. The pump should not run for more than once every (3) hours after the last flush.

To operate vacuflush head:

1. Activate the head breaker on the main DC panel.
2. Activate the fresh water system breaker on the main DC panel since the fresh water tank is the main source for the vacuflush system.
3. Lift the toilet lever until the desired water level is reached. Generally the system requires more water for solid liquid waste. **See figure 1.**

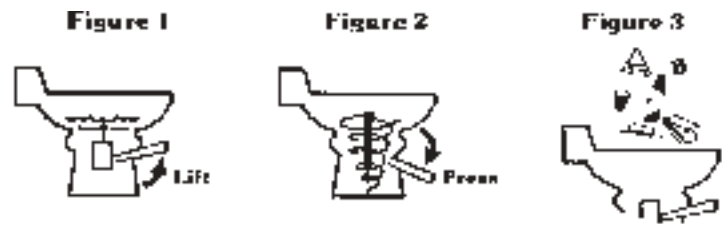

4. To flush the toilet, press the flush lever in one swift motion down to the floor until contents in the bowl disappear. A distinct popping noise is normal when flushing action begins and the vacuum seal is broken. Hold the lever down for at least 3 seconds. If flush lever is accidentally released before waste clears the bowl, do not try to flush toilet again until vacuum pump stops running. A small amount of water should remain in the bowl after flushing.

See figure 2.

5. Do not dispose of sanitary napkins or other non-dissolving items in the toilet. Do not attempt to flush facial tissue, wet strength tissue, paper towels, or excessive quantities of toilet paper down the toilet. These type items do not dissolve and cause plugging of the system. **See figure 3.**

6. Make sure all passengers are aware of the toilet operation.

7. If using a holding tank deodorant, use the approved ones for the system.

8. See the maintenance section for cleaning and routine inspection items such as the vent filter..



Chapter 7

FRESH WATER SYSTEM

Your vessel is equipped with a fresh water supply system. It consists of a water tank, deck fill vent, water monitor system, pressure water pump, distribution system, water filter, dockside water pressure regulator and water heater. The system holds fresh water until it is energized with the variable pressure pump or with the dockside water pressure regulator system. The system will supply water to the galley, head, cockpit and transom shower as needed.

The system is winterized from the factory utilizing a product called “freeze ban”. Completely drain the freeze ban before adding any water to the tank in order to minimize the taste of the Freezeban. Freezeban will not harm you but it does have a peculiar taste. The system requires little maintenance except occasional cleaning of the water filter and winterizing if in colder climates.

FRESH WATER TANK

The water system should be disinfected prior to use and at the beginning of each season. Your marina may have products designed specifically for this purpose. An alternative is to use common household bleach. The formula used by the U.S. Public Health Service is to multiply the gallon capacity of the system by 0.13 to get the ounces of common bleach to add to the system. Mix a solution of common bleach with a gallon of water and add to the water storage tank through the deck fill. Fill the tank with fresh water. All faucets should be turned on until a bleach odor is detected. The system will be sanitized in four hours at which time the system should be drained using the faucets and then refilled with fresh water. Flush system by draining the tank again. Fresh water can be added to the tank by using a hose. Make sure the dockside water supply is suitable for drinking.

OVERBOARD VENT

The overboard vent located on the port hullside is designed to relieve the air that is displaced by the water added to the water supply tank. As the tank nears full it is possible that water will be forced out of the vent. This should be considered normal. The screen on the vent should be occasionally inspected for insects or spider webs, etc. Blockage of this vent can cause the water tank to fill slowly or in extreme cases to blow water back out the fill tube as the water supply tank is being filled.



Equipment Operation

FRESH WATER PRESSURE PUMP

The fresh water pump is controlled by a breaker on the main DC control panel. Energizing the switch allows the pump to build the water pressure in the distribution lines to around 35 psi.

When the pump reaches this level it should automatically shut off. If the system drops below a certain pressure the variable speed pump will restart. If the pump cycles on and off with no water being used, a leak in the water system is likely. Periodically clean the water inlet filter and check the plumbing connectons for tightness. See the illustration below and the maintenance chapter for additional information.



TRANSOM SHOWER



Your vessel may feature a hot/cold combo or cold transom shower wash down. Note that the faucet controls are marked red for hot and blue for cold. A sprayer with sufficient hose is located in the faucet

center. This device is handy for rinsing off before entering the cockpit from the swim platform.

FRESH WATER WASHDOWN



The fresh water wash down is located on the forward deck

It consists of a cold water faucet and attached hose with a nozzle. When the vessel is hooked up through the dockside water inlet the fresh water washdown operates

using city water. At sea the fresh water tank is its source.

DOCKSIDE WATER INLET



This device is located on the transom. It allows a hose to be connected to the inlet pressure valve. The purpose of the regulator is to allow only water pressures up to 35 psi's to enter the boat. This device uses dockside water and a valve in the system allows the on board

fresh water supply to be bypassed.

This feature bypasses the boat's fresh water tank, filter, and pump which won't effect on board water supplies. It also eliminates excessive water pressure from bursting water lines and causing leaks in the boat's water system.

Chapter 7

HOT WATER HEATER:

The hot water heater features a 11 gallon capacity and has the ability to keep the water warm during cruising. This is accomplished by a set of hoses connected between the hot water tank and the circulating engine water pump. Engine coolant runs through a heat exchanger which keeps the tank water warm when the engines are running.

To initially fill the hot water heater, ensure the boat's fresh water tank is full. When the tank is full water will be ejected from the deck vent. At the DC side of the main ship's AC/DC panel, turn the fresh water pump to the "on" position. **Make sure the water heater is full by opening a hot water faucet until a steady stream flows out.** With the generator running or the shore power connected, switch on the hot water heater at the AC side of the ship's service panel. The heating element will now begin to heat the hot water tank. Should the hot water heater reset button need resetting, turn off the hot water breaker at the AC side of the main control panel. Then remove the panel cover to expose the reset button. Press the red reset button. After refastening the access panel, flip on the hot water breaker to continue the systems operation.

Should the need arise there is a drain valve located in the rear of the heater. Make sure the water is cold before attempting to open the valve. The valve runs through the shower sump pump and then overboard. Never try to adjust the thermostat or open the drain valve before turning off the AC breaker. Contact a marine professional for further information.

A T&P valve protects the system from overheating. If the temperature is too hot, the valve will open.

!

CAUTION

TO AVOID POSSIBLE BODILY INJURY DUE TO ELECTRICAL SHOCK DO NOT TRY TO OPEN UP THE HOT WATER TANK COMPONENTS WHILE THE AC POWER IS ACTIVATED. TURN HOT WATER BREAKER OFF AT THE MAIN AC PANEL.



!

CAUTION

TO AVOID POSSIBLE BODILY INJURY DUE TO HOT WATER, BE SURE TO CHECK THE WATER TEMPERATURE BEFORE USING IT. THIS IS ESPECIALLY TRUE AFTER CRUISING WHEN THE WATER HAS BEEN TRAVELING THROUGH THE HEAT EXCHANGER HOSES.

NOTICE

TO AVOID POSSIBLE EQUIPMENT DAMAGE, DO NOT TURN ON THE HOT WATER BREAKER WITHOUT THE WATER HEATER BEING FULL. DAMAGE TO THE HEATER ELEMENT COULD OCCUR.

Equipment Operation

GALVANIC ISOLATOR MONITOR SYSTEM

One of the most important elements in using shore power aboard a vessel is that while it is plugged into the dock the bonding system needs to be electrically connected to earth. Missing this earth connection allows the bonding system to be potentially “hot”. If this occurs, the chance for electrocution to anyone in the water or boarding the boat dramatically increases.

Your vessel utilizes a galvanic isolator. Its purpose is to allow the separation of the bonding system from the dock and other boats at low voltages (less than 1.4 volts) but to keep it connected to the shore ground at high voltage potentials. Remember, the zinc anodes installed on the vessel protect your boat only. For this reason the name “zinc saver” is a term sometimes used to describe the galvanic isolator.



This type of galvanic isolator connects to your electrical/bonding system for less than 20 seconds during a day. This limits the negative effects on the ship’s bonding system. The monitor performs various tests when connected to shore power or activated by the push to test button or every 6 hours after that. After it does a “self-test” then it tests the ground wire continuity and the galvanic isolator and shows the results on the monitor head. During the self test the LED’s will light on the panel. The isolator is normally found behind the AC/DC panel. It is considered a dealer serviceable item.

MONITOR PANEL



To use the monitor in the automatic mode, turn the main AC panel breaker and the transom shore power breaker to the off position. Turn the dockside breaker to the off position. Connect both ends of both shore power cords. Turn on the dockside breaker. The monitor will activate itself. It will perform the self-test. Then it will display the ground wire condition and the galvanic isolator in about 20 seconds. This test will be completed every 6 hours.

If the “fail” icon lights up on either the ground wire or galvanic isolator displays an ungrounded bonding system exists and **should be considered dangerous**. Disconnect the shore power cords after turning the dockside breaker off and call a professional electrical technician to troubleshoot and repair the situation.

To use the monitor in the manual mode, press the “test” button on the display panel. A sequential set of LED’s will light up indicating the status of the ground wire and galvanic isolator as either pass or fail.

If the “fail” icon lights up on either the ground wire or galvanic isolator displays an ungrounded bonding system exists and **should be considered dangerous**. Disconnect the shore power cords after turning the dockside breaker off and call a professional electrical technician to troubleshoot and repair the situation.

Note: The monitor will display both shore power 1 and 2 systems.

MONITOR LED DISPLAY ANALYSIS

Ground Wire “Normal”- The shore power ground wire has been tested and is connected to neutral through the shore side ground circuit.

Chapter 7

STEREO/CD PLAYER- FUSION



Regal boats feature Fusion® marine stereo audio systems. Fusion stereo systems are designed and engineered to perform to the highest standards in the harsh marine environment. The head units use easy to read displays, oversized rubber buttons and controls for easier operation on a moving vessel. Being at the leading edge in stereo technology the head unit opens to a truly unique internal iPod dock. The iPod dock handles many generations of iPods through a set of sleeves. These sleeves hold the iPod in position ensuring ease-of-use and protect the iPod from the marine environment.

The standard MS-IP600 provides 70 watts x 4 total output. All components including the speakers comply with the international IP waterproof standards. Selected optional system components include an amplifier and additional speakers.

The system utilizes a 15 amp automotive style fuse located behind the stereo head unit. See the amplifier and remote information for vessels equipped with the optional stereo performance package and remote controls.

Note: As standard equipment on Regal sport boats the stereo functions from the auxiliary key switch position which is located to the left of the normally “off” position. Here the stereo can be operated without the typical draw on the ignition circuit which normally occurs when the key switch is in the “on” position. Refer to the Fusion owner’s manual located in the owner’s information pouch for more detailed information.

Equipment Operation









BUTTON DESCRIPTION

| BUTTON | DESCRIPTION |
|--------|--|
| | <p>Power Press to turn the unit ON/OFF</p> |
| | <p>Menu Press to enter menu system and press again to return to previous screen</p> |
| | <p>Radio Press to access the Radio source FM - AM - SAT</p> |
| | <p>CD (MS-CD500 only) Press to access the CD/MP3 source</p> |
| | <p>AUX (MS-IP500 only) Press to access Auxiliary source</p> |
| | <p>iPod. Press to access the iPod source Press again to access AUX (MS-CD500)</p> |
| | <p>Back/Previous. Short Press: To select the previous track in CD/MP3 or iPod mode. Start automatic tuning down the frequency spectrum in the Tuner mode. Press and hold: Rewind in CD/MP3 or iPod mode. Start manual tuning down the frequency spectrum in the Tuner mode.</p> |



Chapter 7

| BUTTON | DESCRIPTION |
|--|--|
|  | Forward/Next Short Press: To select the next track in CD/MP3 or iPod mode. Start automatic tuning up the frequency spectrum in Tuner mode. Press and hold: Fast-forward in CD/MP3 or iPod mode. Start manual tuning up the frequency spectrum in the Tuner mode |
|  | Play/Pause Play/Pause track in CD/MP3 and iPod mode. |
|  | Mute Mutes all sound in all zones |
|  | Clock Displays the clock |
|  | Display Brightness Press to enter display brightness setting. Turn the Rotary Encoder to adjust. |
|  | Rotary Encoder The rotary encoder operates similar the click wheel on an iPod. Turn to adjust volume or move up or down a menu structure. Press the Rotary Encoder to select a highlighted option. |

RESET BUTTON

- Press the Reset button to reset the unit to the factory settings

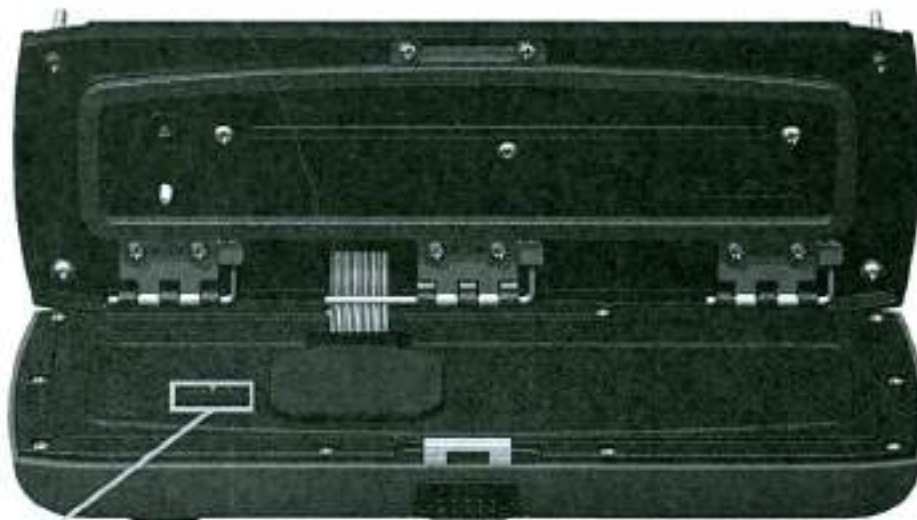

Reset Button

Equipment Operation

OPERATION

The MS-CD500 and MS-IP500 features Clock battery back up and Eprom technology, This allows ti to be completely disconnected from the vessels +12volt Voltage supply [Battery switch] with No settings lost.

Power

Press  to turn the unit ON/OFF

RADIO OPERATION

Region Selection

Press  and turn  to select setup - Press  to enter - turn the  to select tuner region
Press  to enter and press  to select region



Band Selection

Press the  to select band
FM - AM - SAT



Tuning

There are 15 presets available per band.

Seek Tuning

1. Press the  or  to scan to the next station.
2. The selected station will be auto saved into the station presets menu.

Manual Tuning

1. Press and hold the  or  for 3 seconds to enter. The manual tuning icon will flash on screen.
2. The selected station will be Auto saved into the presets menu.

Note: Once the station is selected the station will be stored into the pre-set menu and the manual tuning icon will be removed.

Auto Tuning

Press the  and turn the  to navigate to the "Search Station" function. Then press  to search and store.

Note: Automatic tuning mode will erase all other presets already stored for the selected band and will automatically store the station into the Preset menu in numerical order.

Recalling a Preset Station

1. Select the required band. FM - AM - Sat

2. Press the  and then turn the  select the "Presets" option and press  to enter.

3. Turn the  to select the desired preset and press  to select



Chapter 7

SIRIUS SATELLITE RADIO - USA only - SIRIUS TUNER NOT INCLUDED

SIRIUS ACTIVATION

Activating Your Sirius Tuner

You must activate the SIRIUS tuner before you can begin to receive the SIRIUS Satellite Radio Service. In order to activate your radio subscription, you will need the SIRIUS ID (SID) which uniquely identifies your tuner. The 12 digit SID is displayed on the LCD on initialization. MS-CD500 and MS-IP500 will display the SID on Channel 0.

Power on your system and make sure that you are receiving good signal you are able to hear audio on the SIRIUS Preview channel [Ch-184]

Note:

Have your credit card handy and contact SIRIUS on the internet at <https://activate.sirius.radio.com/> and follow the prompts to activate your subscription. You can also call SIRIUS toll-free at 1-888-539-SIRIUS [1-888-539-7474] Once activated, you will be able to begin enjoying SIRIUS Satellite Radio's digital entertainment and can tune to other channels.

SIRIUS OPERATION



Press the  to select Sat Radio

SIRIUS NAVIGATION

Press the  and enter the menu, turn the  to navigate the functions and press  to select.

- **Channels**
Select the desired channel (listed in channel order) and music preference
- **Category**
Select the desired genre type. [The unit will only play the selected option]
- **Favourites**
Add your favourite channel to your favourites list by selecting "add favourite".
[Maximum 15 channels]
Remove channels by selecting "Remove Favourite" select "ALL" or the individual channel and

push Enter 
Exit MNU by pressing 

- **Parental Mode**
Pin #

Turn  to select number and press to enter, repeat to enter the 4 digit code. [Default is 0 on 1st time use]
NOTE: Must be entered before the following items are operational.
Mode on/off
Turn On to initiate parental locking of selected channels etc, turn Off for full channel access
Lock / Unlock
Select the channel to be locked or unlocked
Skip / Un-skip
Select the channel to be bypassed from the menu
Change Pin
Personalise your Pin number. [4 digits max]

Equipment Operation

SELECTING A SOURCE

Press the desired source button:

- | | | |
|---|----------|--|
|  | Radio | AM/FM/Sat |
|  | CD | CD/MP3 [MS-CD500] |
|  | iPod/AUX | Press once for iPod [MS-IP500] Press twice for AUX [MS-CD500] |
|  | AUX | Aux direct [MS-IP500] |

ADJUSTING THE VOLUME

- Turn the  to adjust the volume [Zone 1 Default]

ZONE VOLUME

- Press the  to select zone. Press again to step through zones.
Zone 1 - All zones - Zone 2 - Zone 3 - Zone 4

GENERAL SETUP

- Press the  and rotate the  to select the Setup menu. Press to enter.
- Turn the  to select the function and press to enter
- Turn the  to adjust and press  to return.

SETTINGS

Treble

Adjusts the treble to the speakers

Bass

Adjusts the bass to the speakers

Balance

Adjusts the audio balance from left to right

Contrast

Adjusts the display contrast.

Key Sound

Press to turn ON / OFF

AUX Configuration

AUX ON/OFF - Select OFF if no auxiliary device is connected, this will remove the AUX feature from the source list.

AUX Name - Select the desired AUX name

AUX - TV - DVD - GAME - PORTABLE - COMPUTER

Clock Adjust

Adjusts the Clock time. 12/24 hour

- Turn the  to adjust the Hour. Press to confirm, repeat to adjust the minutes, Press to confirm.

Chapter 7

LOADING / EJECTING AN IPOD (MS-IP500 ONLY)



Note:

Failure to correctly insert your iPod will result in damage to your iPod and the FUSION Marine Stereo.

Selecting the correct iPod Sleeve

The MS-IP500 has 8 possible iPod solutions.

A different set of sleeves is used for each iPod model. The different sleeve combinations are outlined in chart below:

| iPod | Top sleeve | Bottom sleeve |
|----------------------------|------------|---------------|
| classic, 5th Gen [30Gb] | A | A |
| classic, 5th Gen [60/80Gb] | A | B |
| classic, 6th Gen [80Gb] | B | A |
| classic, 6th Gen [160Gb] | B | B |
| classic, 7th Gen | B | A |
| touch, 1st Gen, 2nd Gen | D | D |
| nano, 2nd Gen | C | C |
| nano, 3rd Gen, + Adapter | A | A |
| nano, 4th Gen | E | E |

Please note: For the iPod nano [3rd gen], the iPod must be placed inside the adaptor sleeve, and then placed inside Dock sleeve combination A.

Please note: Place the sleeves inside the Stereo Unit before inserting your iPod.

| BUTTON | DESCRIPTION |
|--------|--|
| | iPod. Press to access the iPod source. |
| | Play/Pause Play/Pause track in CD/MP3 and iPod mode. |
| | Forward/Next Short Press: To select the next track in CD/MP3 or iPod mode. Press and hold: Fast-forward in CD/MP3 or iPod mode. |
| | Back/Previous. Short Press: To select the previous track in CD/MP3 or iPod mode. Press and hold: Rewind in CD/MP3 or iPod mode. |

Equipment Operation

Press the  to enter the iPod menu, use the  to navigate the functions of your iPod. The rotary encoder operates similar to the click wheel on your iPod. Turn to navigate and press to enter.

Note: Press the  to return to the previous menu screen.

NO iPod Connected

If this appears on the display possible causes are

1. Ensure the iPod is correctly connected
2. Ensure the cable is not excessively bent
3. The iPod's battery remains low (refer to iPod manual and charge the battery)
4. The iPod's software version is not compatible (update software version to be compatible with this

AUX OPERATION

CONNECTING AN AUXILIARY AUDIO DEVICE

1. The Left & Right AUX RCA plugs are located at the rear of the unit.
2. Connect your auxiliary audio device.

Note: You may require an adapter cable to connect your device.

LISTENING TO YOUR AUXILIARY AUDIO DEVICE

1. Press the  on the main unit to select AUX mode (MS-IP500) or press  twice (MS-CD500)
2. Start playback on your auxiliary audio device. Use both the volume control on your auxiliary device (if available) and the volume control on the FUSION Marine Stereo to set the volume level.

AUXILIARY NAMING

See page 9

TYPICAL REMOTE CONTROL.











If equipped, the Fusion remote control is normally mounted at the transom area which makes it easier to use during water activities.

It is a plug and play device and uses the same function buttons and rotary encoder as the helm head unit. It features the ability to select various speaker zones on the vessel. Refer to the Fusion owner's manual for more detailed information.



Chapter 7

BUTTON DESCRIPTION

| BUTTON | DESCRIPTION |
|---|---|
|  | <p>Power Press to turn the unit ON/OFF</p> |
|  | <p>Source Press to select the desired source Radio [FM-AM-SAT] - CD/MP3 - iPod - AUX</p> |
|  | <p>Mute Press to Mute/Un-Mute sound in all zones</p> |
|  | <p>Menu Press to enter menu system. Press to return to previous screen</p> |
|  | <p>Play/Pause Play/Pause track in CD/MP3 and iPod mode.</p> |
|  | <p>Back/Previous Short Press: To select the previous track in CD/MP3 and iPod mode. Start automatic tuning down the frequency spectrum in the tuner mode. Press and Hold: Rewind in CD/MP3 and iPod mode. Start manual tuning down the frequency spectrum in the tuner mode.</p> |
|  | <p>Forward/Next Short Press: To select the next track in CD/MP3 and iPod mode. Start automatic tuning up the frequency spectrum in the tuner mode. Press and Hold: Fast forward in CD/MP3 and iPod mode. Start manual tuning up the frequency spectrum in the tuning mode.</p> |
|  | <p>Rotary Encoder The Rotary Encoder operates the same way as the Rotary Encoder on your FUSION Marine Stereo Unit</p> |

Equipment Operation

ALLOCATING ZONES FOR THE REMOTE.

Press and hold the Mute Button for 7-10 seconds then turn the  to select a [Z1, Z2, Z3, Z4, Z1234]. Press to select. The Remote will then shut down and will need to be turned on.

ZONE VOLUME

Turn the  to adjust the volume in the allocated zone.

GENERAL SETUP

1. Press the  and turn the  to select the Setup menu. Press to enter.
2. Turn the  to select the function and press to enter.
3. Turn the  to adjust and press  to return.

STEREO IPOD

An iPod adapter is located inside the face of the FUSION stereo as standard equipment. Using a set of top and bottom sleeves it is able to fit most iPod versions.

Refer to the FUSION stereo instruction manual for further information on sleeve specifications.

Note: There is a separate IPOD dock coupled with a CD/DVD player. This option requires Regal View. This optional player is not part of the Fusion system.

Chapter 7

STEREO PERFORMANCE PACKAGE

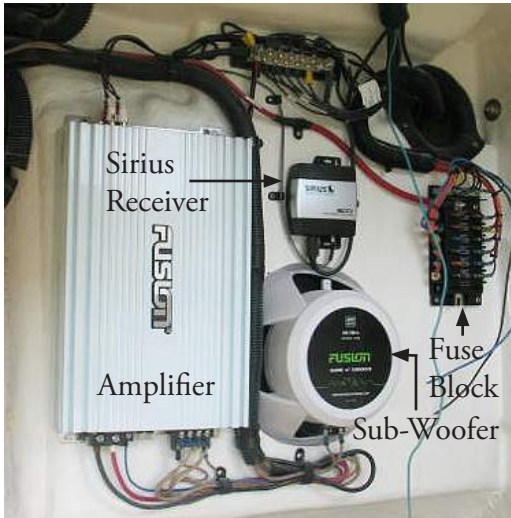

TYPICAL STEREO PERFORMANCE UNDER DASH COMPONENTS.

The stereo performance package features extra speakers including a sub-woofer and a 2 channel amplifier to provide leading edge performance in sound and power. The simplicity of design contributes to low distortion and high efficiency. Normally the amp is located under the starboard helm or may be in the cockpit refreshment center. The circuit is protected by twin 25 amp automobile type fuses. It is a good idea to carry extra fuses which are available at local marine or automotive stores. The amplifier does not require any type of maintenance other than periodic checking of the wiring connectors for tightness. Contact your Fusion owner's manual or closest Regal dealer for additional information.

Vessels with the optional power tower speakers use an additional 4 channel amplifier located under the helm or the cockpit refreshment center depending on the specific boat model.

Equipment Operation

TELEVISION SYSTEM OVERVIEW

Antenna



The antenna switch includes two buttons which choose the proper antenna for dockside and at sea operation.

1. At dockside, the shore antenna switch should be activated. For this switch to work the TV cord needs to be plugged into the vessel's transom cable inlet located inside the shore power locker and run to the dockside connection. With the shore antenna pressed the tv on board uses the local signal.



2. At sea, the ship's antenna switch is activated which inputs a signal from the saucer shaped antenna mounted on the radar arch. If the vessel does not have an arch, the TV antenna is in the AC/DC

panel. In addition to the switch being activated, turn on the TV antenna breaker at the main DC control panel. Also, this operation works well in temporary moorings or at a marina without complete hook-ups.

3. To deactivate either switch, simply depress the switch completely and release.

TELEVISION BASICS

Television sets on board your vessel are powered by the same TV breaker located on the 12 volt main DC control panel. Each television can be operated through the DVD player and each set can view the same DVD and hear the audio or operate independently.

This manual will point out the **basic operation** of the LCD (flat screen) salon television monitor. For detailed data on any of the on board sets refer to the manufacturer's manual located in the owner's pouch.

TYPICAL TV LCD MONITOR OPERATION

The flat screen salon television is connected to various audio and video connections for DVD enhancement. The unit has been pre-programmed at the factory.

The unit features a non-glare screen and remote control. to operate the television flat screen monitor (to be called monitor here).

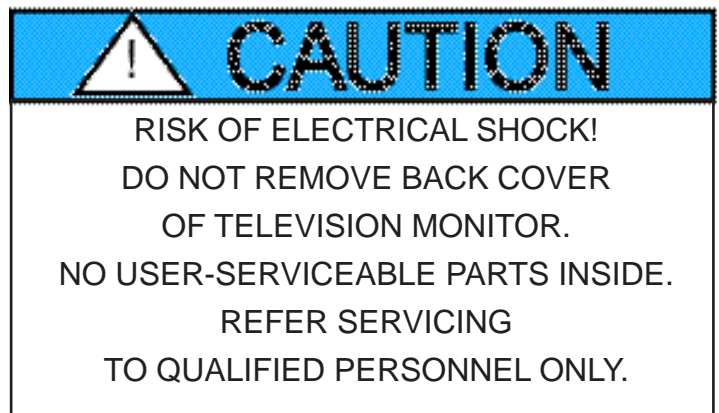

Chapter 7

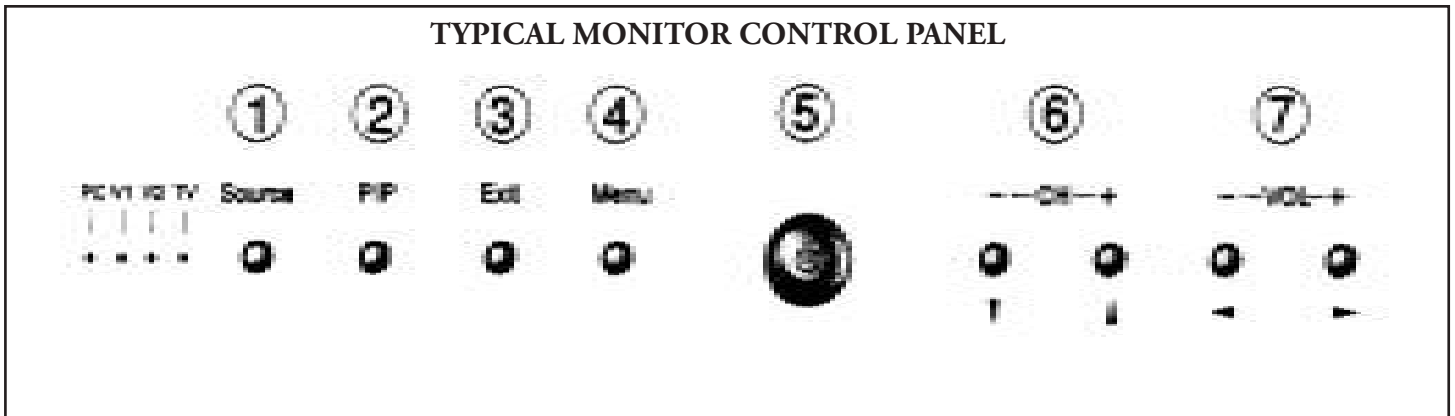

USER CONTROLS

The LCD monitor control panel features numerous adjustments in regards to the television image. As these buttons are being activated, an on-screen menu pictures their numeric values as changes occur.

1. Source

All video sources are chosen through this button. It displays the video 1 or video 2 choices. The DVD player is activated through video 1. The TV source is chosen to view various TV station signals. The PC portion of the monitor is not used with this system.

2. PIP

This button activates the picture in picture window, full-screen video or to PIP off.

3. Exit

Leaves various menus and sub-menus.
Exits from the OSD (on screen display) system.
Turns the picture in picture off

4. Menu

Opens the OSD and selects various functions.

5. Power

Turns the monitor on and off.
Indicated the monitor status.
Green: Normal operation
Amber: Power saving mode or disconnected signal cable.

6. Channel

Moves the selector up or down on the OSD display.
Raises or lowers the channels.

7. Volume

Moves the selector left or right on the OSD display. Raises or lowers the values of the selected function.
Changes the audio level up or down.

Direct Access Features

These features are found watching in the full screen or picture in picture mode.

Channel

When the OSD (on screen device) is not on the screen, push the down triangle or up triangle button to select the channel number.

1. Press the down triangle button to lower the channel number.
2. Press the up triangle button to raise the channel number.

Volume

When the OSD (on screen device) is not on the screen, push the < or > button to change the volume.

1. Press the < button to lower the volume.
2. Press the > button to raise the volume.

Equipment Operation

OSD Lock/Unlock

This function secures the current settings so that they cannot be unintentionally changed, while still accessing the brightness, contrast, channel, and volume.

By using the same process, you can unlock the OSD controls at any time.

With the OSD screen deactivated, press and hold the menu button for at least 5 seconds to lock or unlock the controls. When locked, a message saying locked will be displayed at the bottom of each OSD screens except the 4 settings mentioned above.

On Screen Display (OSD)

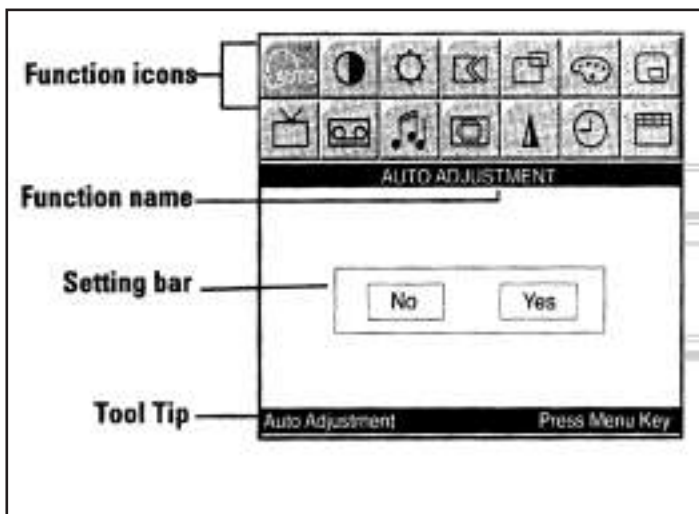

Menu System Access

1. With the OSD off, push the Menu button to display the main OSD menu.

2. Use the up, down and sideways triangle buttons to move from one function to another. When you move from icon to icon, the function name changes to reflect the mode or group of functions represented by that icon. Review the complete list of functions in the manufacturer's owner's manual.

3. Press the menu button once to activate the highlighted function, then follow the tool tips to select the function and adjust that particular value.

4. Use the up and down triangles to select the sub menu, and press the menu button once to activate the desired sub-menu.

5. After selecting a function, use the < or > buttons to make necessary adjustments. The setting bar moves and the numeric value indicator changes to reflect your changes. Note: The numeric value amount is provided as a point of reference only and has nothing to do with a real measurement.

6. Push the exit button a couple of times to return to the main menu to select another function or to exit from the on screen device.

Note: There are numerous other menus and sub-menus for adjusting the screen controls such as audio and visual control along with image sizes and effects. Refer to the manufacturer's owner manual for more information.

Remote Control

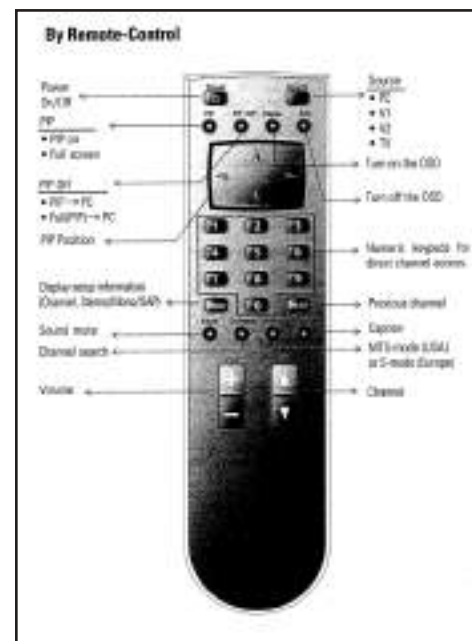

The remote control features the same functions found on the television control panel. The basic functions are found in the illustration. Be sure to install the batteries to the correct polarity. Refer to the manufacturer's owner's manual for additional information.



Chapter 7

Stopping Play

Press >> FF << REW during play. Each time the button is pressed, the speed of rapid forward/reverse changes according to the disc as follows:

Normal Playback -> 2X -> 4X -> 6X -> 8X
[] <- []

Ill (Illumination)

Press ILL to adjust the light of the VFD display in the following order:

4 --> 3 --> 2 --> 1
[] <- []

Skipping Track

1. Press skip up or down triangle during playback.
2. Press the up triangle to skip to the next track and the down triangle to go back one track.

Pause (still picture)

1. Press >II during playback.
2. Return to normal playback.
3. Press >II again.

Repeat

Press the REPEAT button to select repeat mode as below.

REPEAT 1 --> REPEAT --> REPEAT OFF
[] <-- []

DVD/CD DISC

1. Continuously repeat at the current chapter/track, when selected REPEAT 1 mode.
2. Select REPEAT mode to continuously repeat all chapters/track on the current disc.
3. When the player finish playback the current disc last chapter/track, it will stop and display the elapsed time. When selected REPEAT OFF mode (REPEAT & REPEAT disappear at VFD display).

Remote Sensor

Point the remote handset to the remote sensor. Receive the signal from remote handset.

Flash LED

If the front panel doesn't install in the DVD main panel, the LED will begin flashing.

Turning the Player Off

Press the power button.

Equipment Operation

TYPICAL REMOTE CONTROL

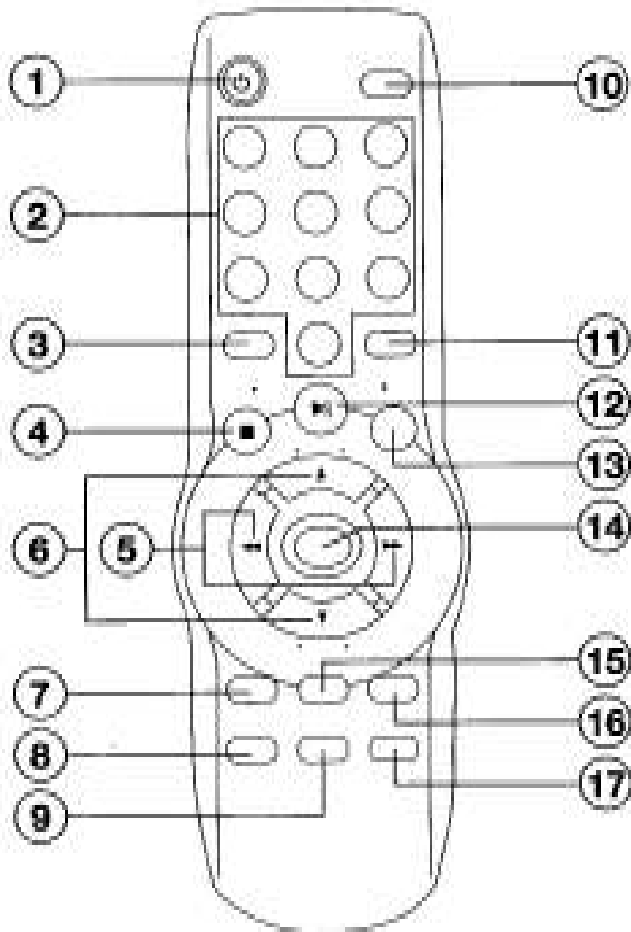

Using The Remote Control

1. Power Press POWER to turn unit ON & OFF
2. 0-9 Numeric Key buttons
3. ILL Choose the VFD Display brightness level
4. Press it to stop playback
5. <> Press > to start forward rapidly & < to reverse rapidly
6. Press the up triangle to skip to the next track & press the down triangle to skip back one track. In case of MENU mode, those buttons served as cursor buttons
7. SUBTITLE Changing of the SUBTITLE language on multi-subtitle language DVD disc
8. SETUP Display the SETUP menu
9. TITLE Display the TITLE menu that is stored in DVD disc
10. DISPLAY Display statistical disc information during playback
11. REPEAT Switch the Repeat mode, following by repeat, repeat 1 & repeat off
12. >II Press once to PAUSE a play, press again to resume continuous playback
13. AV Switch between the DVD & the external AUDIO/VIDEO
14. ENTER Confirm the Track/Chapter selected with the number key or selected with the cursor buttons on TV screen
15. AUDIO Changing of the AUDIO soundtrack on multi-audio soundtrack DVD disc
16. ANGLE Changing of the view angle on multi-angle DVD disc
17. MENU Display the root menu that is stored on the DVD disc

Preparing Remote Control

Open the cover on the rear of the remote control. Insert the batteries to align the correct + and - polarity with the marked areas on the display. Push the cover to lock.

The remote control works up to 30 degrees left or right of the DVD player. Do not expose remote control to excessive light or heat. Do not drop the unit or try to open the internal parts of the remote control.

Anti-Theft Panel

The DVD player features a removable front panel. To use this anti-theft deterrent, simply press the release button and remove the cover. When removed, there is no power to the unit.



Chapter 7

REFRIGERATOR

The cabin refrigerator operates on 120/12 volts. It is controlled by a breaker located on the main AC control panel. The refrigerator is fitted with a manually operated, infinitely-variable thermostat. Turn the knob clockwise to reduce the temperature and counterclockwise to increase the temperature. See the illustration. It may take a little fine tuning to reach the particular setting you desire.



TYPICAL REFRIGERATOR



When the ice layer approaches 1/8" the unit needs to be defrosted. Turn the thermostat off. Transfer all items from the refrigerator to keep them cold while the unit is defrosting. Do not use sharp or metal objects to remove the ice. When the defrosting cycle is complete, empty the drip pan under the freezer compartment. Clean the inside of any food residues with a damp cloth and a mild cleaner. Rinse and let dry.

Turn the thermostat back on and restock the unit with the cold storage items you removed. This will help the unit cool down much faster.

When left for extended periods of time, be sure to leave the door partially open for ventilation purposes.

For more detailed information, refer to the manufacturer's manual in the owner's pouch.

To turn off the galley refrigerator if equipped simply deactivate the refrigerator switch on the DC cabin panel or turn the knob inside the refrigerator to "off".

To turn off the cockpit refrigerator turn off the knob inside the refrigerator or turn the starboard battery switch to the "off" position. By turning off the starboard battery switch the shower sump pump is inactive.

Use the same procedure to deactivate the cockpit icemaker.

MICROWAVE



Since this unit operates the same as a household microwave, specific instructions can be found by referring to the manual located in the owner's pouch.

HATCHES/PORTLIGHTS



The hatch features removable screen/sunshades. To open a hatch, turn the hold down adjuster counterclockwise to unlock it. This permits the hatch to open when the three latches are turned to clear the hatch. Press the lock to the open position.

Push the hatch to the desired opening angle and then turn the hold down adjuster clockwise to secure hatch. To close the hatch, reverse the procedure. Make sure the latches are completely closed to prevent any possible leaks. Portlights open and close using the same procedure.

Equipment Operation

SALON DINETTE TO SLEEPER

The salon features a convertible dinette with storage under the cushions. The dinette table stores behind the starboard forward dinette backrest cushion.

To convert the dinette to a sleeper follow these steps:

1. Remove the backrest cushions from their ball & socket hardware. Pull straight out and the ball attached to the cushion will disengage from the fixed socket. See the illustration.



2. Remove the seat cushions by pulling up which will release the cushion ball from its socket hole. Continue until all seat cushions are removed. See the illustration.



3. After all the seat cushions are removed, pull the sleeper legs to a vertical position. Make sure each stanchion is completely engaged. See the illustration.



4. After all the sleeper legs are extended pull the sleeper framework up and over until it touches the cabin floor. See the illustration.



Chapter 7

5. Make sure all legs are setting firmly on the floor.



7. Place cushions in socket holes to form sleeper.

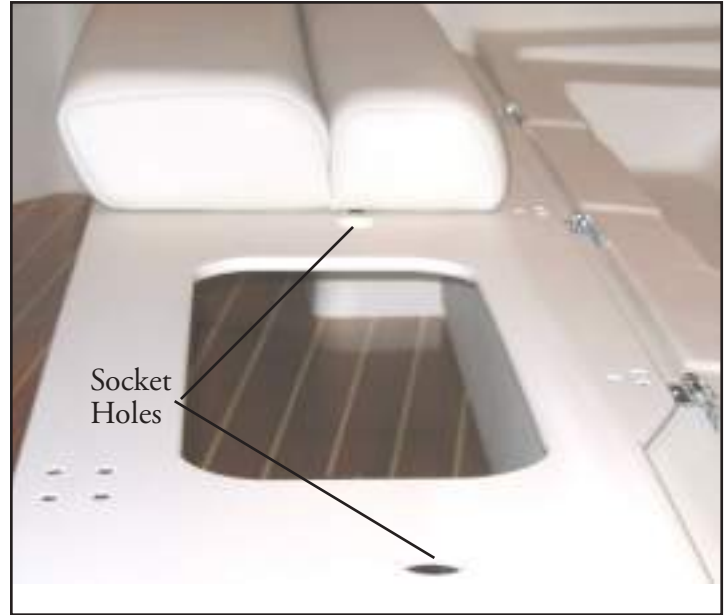

6. Notice the socket holes on the sleeper framework. They line up with the rubber ball set located on the bottom of each backrest. Push each backrest into the sleeper framework. Return seat cushions to their original locations. See the following illustrations.

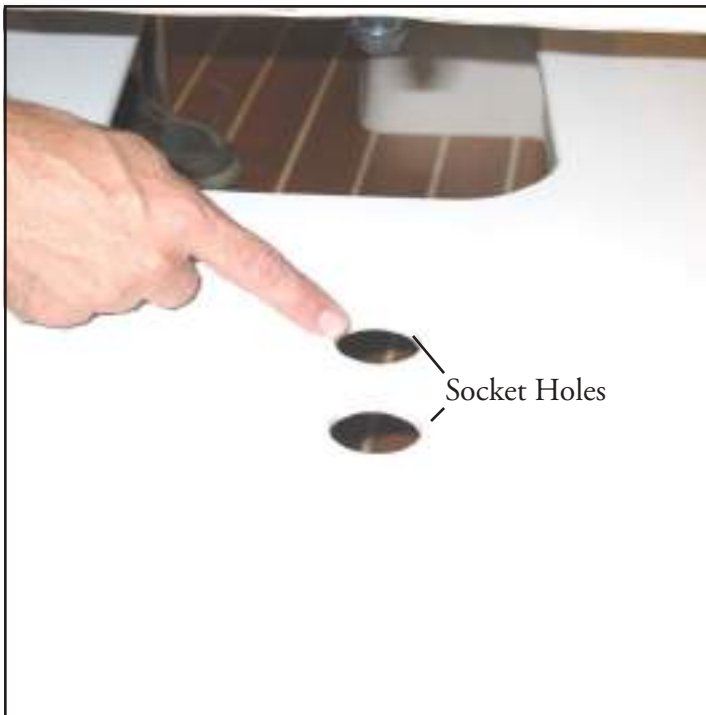

8. Sleeper complete shown below. Reverse the process to convert back to a dinette.



Equipment Operation

MID BERTH TO SLEEPER

The mid berth can be converted to a sleeper by following these steps.

1. **As you are looking at the stern** locate the right front cushion.



2. Pull the outside cushion edge up and it will hinge out of the way. At this point you will see the filler cushion.



3. Pull up on the filler cushion support bar and it will slide across the filler area and catch on the cleat under the left side cushion. Make sure it fully engages.



4. Final filler cushion location for sleeper. To convert back to mid berth seat reverse the process.



Chapter 7

FORWARD BILGE PUMP & SUMP PUMP

Note: The shower sump pump and forward bilge pump are located beneath the mid berth floor. Simply remove the carpeted access plate for a visual inspection. Also, the air conditioner seacock and motor are located beneath the black trunk liner. Remove the access cover to inspect components. See page 6 of this chapter for shower sump pump hose identification.



FORWARD WINDOW SHADES

The forward window shade tension can be changed by the use of adjuster clips. Use the following steps to change the tension.

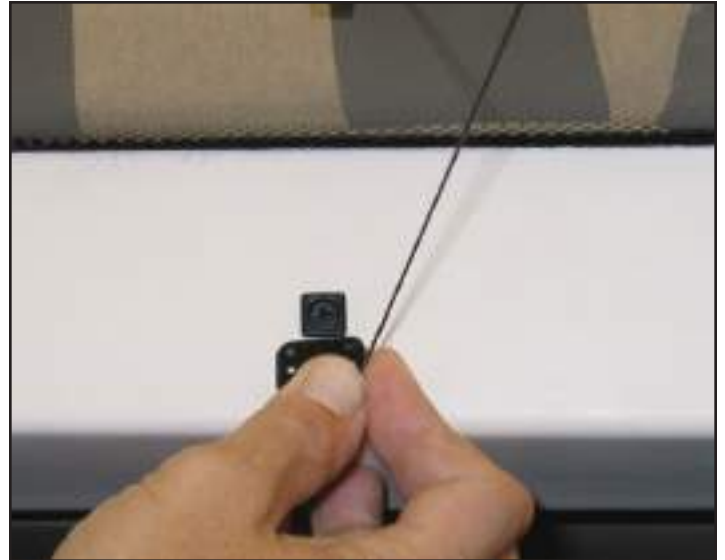

1. Remove the adjuster clip from the mount. Increase the shade tension by adjusting the knot.
2. Continue adjusting until the desired tension is reached. Lock the cord in place.
3. Reattach the adjuster clip to the mount.

Equipment Operation

EXTERIOR EQUIPMENT

There are several groups of equipment located on the deck and cockpit of your vessel. Some are standard and others are optional equipment. **For the most in-depth information, refer to that particular equipment manufacturer's manual located in the owner's document pouch.**

Equipment or vendors may change during a boat's life cycle. Portions of the components discussed here may or may not be on your vessel. They may vary visually or in description. Regal retains the right to change vendors, equipment, specifications and other technical data at any time.

WINDLASS

If equipped, the windlass is used for anchoring. It features a chain and anchor. There are dual operating foot controls on the forward deck. These foot controls operate the anchor up or down by stepping on the appropriate foot button. The deck foot controls **work independently** of the dash switch which is a two way toggle switch located on the dash panel featuring a red lock-out button. **Note that the lock-out button in the "off" position prevents the windlass from accidentally letting the anchor out.** Be sure to familiarize yourself with the windlass owner's manual before attempting to operate it.

Keep all body parts and loose clothing clear of the chain and gypsy to avoid personal injury. The windlass should not be the only means of releasing the anchor. **Never use the windlass under power with the emergency handle inserted into the clutch nut or gypsy cap.**

To let out the anchor make sure the gypsy is locked and the safety lanyard is off the anchor chain. Use the down foot control or the dash switch to let the anchor out while backing down slightly in reverse.

We recommend that the vessel's engines are used in reverse slightly to break the

anchor loose instead of the windlass. Once loose, press the up foot control switch or use the dash switch to retrieve the anchor. As the anchor approaches the boat slow the process down so the bow is not damaged by the rising anchor. Maintain sufficient chain tension to control the vessel and prevent the bow from swinging. Before maintenance is performed, remove the chain from the gypsy and rope from the drum. Periodically spray down the outer casting of the anchor windlass. Use only chain and spare parts as recommended by the manufacturer.

Note that the anchor features a safety lanyard that must be released for the anchor to be operated through the windlass controls. Reconnect lanyard after retrieving anchor.

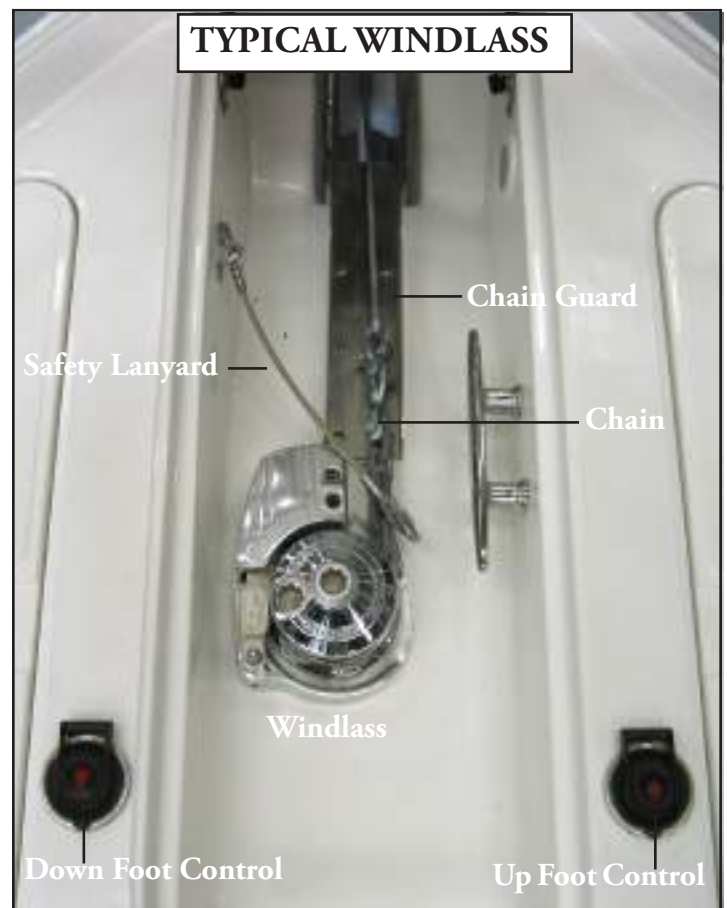
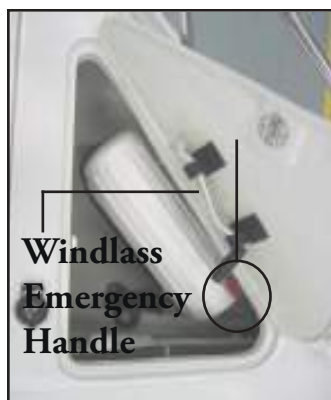

Chapter 7

To let out the anchor with the emergency handle, insert the handle in the gypsy. Unlock the gypsy just enough so the anchor will start to let out.

To retrieve the anchor, tighten the gypsy lock. Insert the handle into the other hexagon hole and crank the handle in a counterclockwise direction to bring the anchor up.

Be sure you use the engines to first break the anchor free from the bottom. Watch the anchor as it approaches the bow to avoid damage.

As a safety measure there is a windlass foot switch cut-out switch installed in the forward deck starboard locker. When the switch is in the "on" position the windlass foot controls are inoperative. In the "off" position the foot controls operate uninterrupted.



SUNPAD

To use the sunpad install the front binding through the vinyl sunpad retainer. Next, install all snaps.

When cruising, remove and store the sunpad. Do not use the sunpad while the boat is moving.



Equipment Operation

MASTHEAD LIGHT/RADAR ARCH



The masthead light hinges up from the radar arch. Simply tighten the knob to hold in a vertical position. When used as part of the navigation lights, the front is lighted. When anchoring, both front and rear positions are lighted for 360 degree visibility.



The radar arch offers an opportunity to mount the boat's antennas for the best reception. The round saucer looking antenna is the television antenna. The other antenna is for the GPS/Plotter and is mounted on the star-board radar arch. The arch contains speakers and lights controlled by the switch panel located in the shore-power locker. Vessels without a radar

arch use alternate locations to mount the various antennas.

WINDSHIELD WIPER



The vessel features a panographic wiper which keeps the blade forced against the tempered windshield glass for improved coverage. Do not operate the wiper with a dry windshield. The wiper motor is accessed by removing the vinyl access pad in the

salon headliner.

CENTER WINDSHIELD LATCH

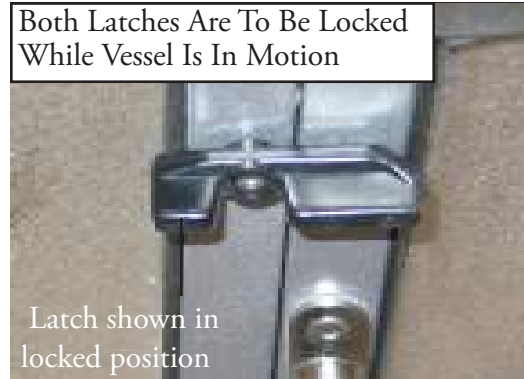

The center windshield needs to be latched while the vessel is in motion. To latch the center windshield, turn the two locks

to a full horizontal position. When the boat is at mooring open the center windshield and let it rest on the magnet to secure it.

COMPASS



The compass is set at the manufacturer to ensure its accuracy. If in doubt it can be zeroed in by using a non-magnetic type screwdriver and adjusting each of the compensator screws as recommended.

Refer to the compass manual in the owner's information pouch. Also, a compass can be checked while underway for variance and deviation by comparing your heading with a nautical chart. Compass error is part of the calculation.



Chapter 7

CABIN DOOR/DRAIN



Doorstop-
Locked Position

The cabin door features a lock and recessed screen door.

Keep the cabin door completely closed when the boat is moving. When docked, the cabin entry door can be held open by flipping the door stop 180 degrees.

This will prohibit the door from

accidentally closing, a great feature with children on board. To use the screen door, slide it into position and latch. It features a fine screen to detour insects but yet a large enough screen grid to promote cross ventilation. To provide the greatest seal protection, close screen and entrance doors when leaving your vessel.

Outside the cabin entrance door there is a fiberglass step screwed in place. Periodically check the drain for debris.

DECK WINDOWS (LOWER DECK)



CAUTION

AVOID BODILY INJURY!
DO NOT STEP ON WINDOW SURFACES
AS THEY MAY BE SLIPPERY AND
COULD CAUSE A FALL.

COCKPIT ICEMAKER



Typical Control

The cockpit icemaker is installed as optional equipment. On initial use make sure the water inlet valve is turned to the “on” position. The inlet water valve is located behind the icemaker. Remove the 4 screws holding the icemaker unit and carefully slide it forward to gain access. Secondary access to the icemaker is through the seat storage aft of the icemaker.



Behind Icemaker

Valve

Make sure the icemaker breaker is activated on the main AC control panel. Energize the on/off switch. Find the temperature control knob. Turn it clockwise for colder operation and counterclockwise for

warmer temperatures. Adjust the control knob a few times to arrive at the desired temperature.

Equipment Operation

TRANSOM SWITCH PANEL

Located near the transom door is a switch panel which controls the arch lights, engine hatch and bilge lights. These switches feature over current protection. With the engine hatch up the bilge light switch provides extra lighting for maintenance.



TYPICAL TRANSOM STORAGE



Typical Optional Cruise Package Equipment Shown

CRUISE PACKAGE

If equipped, a cruise package consists of fenders, tie-lines, life vests, boat hook, deck brush and first aid kit. Keep all equipment neatly stored for quick access such as approaching a mooring or dock.

AUXILIARY HATCH JUMPER BOX

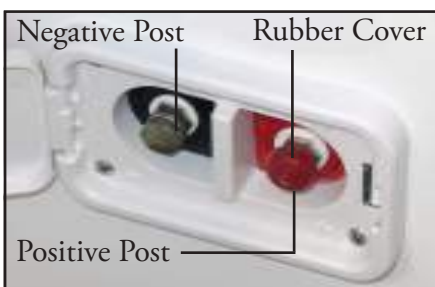

If the vessel's batteries are discharged the hatch will not open. A jumper box has been provided to enable the batteries to be energized for lifting the hatch. To use

simply follow the color coding on the studs.

Connect a jumper cable to the positive stud and to a jumper battery (make sure you remove the red rubber cover from the positive stud). Connect a jumper cable to the negative stud and to a jumper battery. Now energize the hatch switch. Make sure the cables do not touch and correct polarity is observed.

SLING MARKERS

Sling markers are located on the forward and aft deck near the rub rail. These markers provide a safe location for pulling the boat using approved slings. It is recommended that a safety line be tied between the slings on both sides to keep them for sliding forward or aft when hoisting the vessel.



Chapter 7

BILGE/SUMP

Bilge Overview

The bilge or sometimes referred to as the sump houses many of the equipment packages including the engines, generator, and batteries.

A portion of the equipment will be discussed. For more specific information, refer to the manufacturer's manual located in the owner's pouch. See the maintenance chapter for additional information.

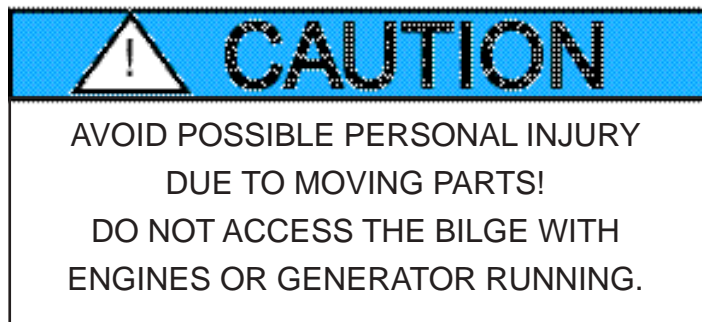

Engines/Generator

The engines are located in the bilge with easy access by lifting the hatch. Use the walkway to access the engine and generator dipsticks, lower unit and trim tab reservoirs. Also, periodically check the bilge for loose fasteners, leaks and defective hardware.

The generator uses a metal sound shield. Remove it to access critical maintenance areas. **Do not use the shield as a step.**

Refer to the manufacturer's owner's manual for more specific information located in the owner's pouch or document pouch.

Batteries

Your vessel uses 2 cranking & 1 house battery. They feature wet type cells. The engine cranking and house batteries are Group 31. All batteries require periodic inspection and maintenance.

The electrolyte and terminals need to be checked for looseness and corrosion. See the maintenance section for further detailed information.

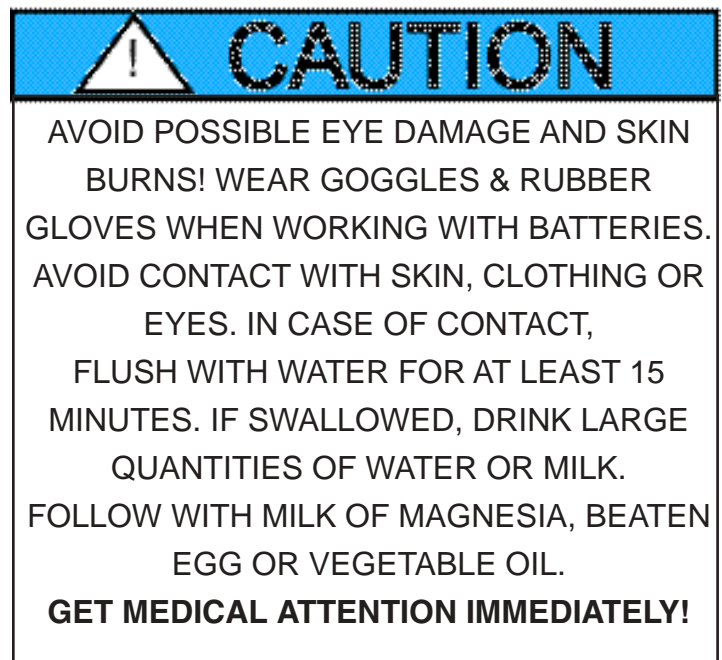

Bilge Pump & Float Switch

The aft bilge pump and automatic float are located in the sump. The pump grates should be checked periodically for debris. Remember if an icon lights up on the bilge pump dash switch, the automatic side of the bilge pump is activated. Investigate the cause of the problem immediately since using the pumps continuously could run down the batteries and may be a signal of a more serious situation.

Equipment Operation

BILGE/SUMP EQUIPMENT OVERVIEW



The sump features an electric ram to open the hatch. It hinges forward for easy bilge access. Many components are found here which need inspection periodically and some before each outing. Become familiar with each of the components by reading the individual owners manuals and equipment guides found in your document box. Checking the engine oil and power steering fluid levels must be done before each boating outing. Carry extra oil and power steering fluid as recommended by the engine manufacturer. If generator equipped, check the fluids before each outing. Also, it is recommended that you check the sump for leaks before disembarking.

Sump Entrance Step



For easier access to the sump there is an aluminum step at the rear of the compartment. The step is removable as needed. Be sure to reinstall the step if it has been removed. It is the only recommended access since stepping on equipment may cause damage or personal injury from falls.

Chapter 7

SWIM PLATFORM

WARNING!
MAXIMUM CAPACITY
OF SWIM PLATFORM
750 POUNDS
453 KG

The extended swim platform is used to enter and exit the water. Never dive from the platform. Make sure you do not exceed the platform weight capacity label found inside the ladder cover or in

the owner's pouch. Periodically inspect all swim platform fasteners for tightness and corrosion build-up.

 **CAUTION**

AVOID PERSONAL INJURY OR PROPERTY DAMAGE!
DO NOT USE THE SWIM PLATFORM CLEATS FOR TOWING OR ANY TYPE OF PERMANENT MOORING OR DOCKING.
USE BOW, STERN AND SPRING LINE CLEATS FOR MOORING.

SWIM LADDER

When using the swim ladder, open the hatch and slide the ladder out to the end of the travel. Then rotate the ladder over and let it down gently. Make sure you keep your hands and fingers clear of any moving ladder parts especially under the hinged top area between the ladder and swim platform. Rotate the ladder up and close the fiberglass hatch when returning to the vessel. **Insist that only one person use the ladder at a time and that people do not use the any part of the outdrive or propeller(s) to climb up on the swim platform or ladder. Bodily injury could occur from falling or body parts coming in contact with sharp metal objects such as propellers.**

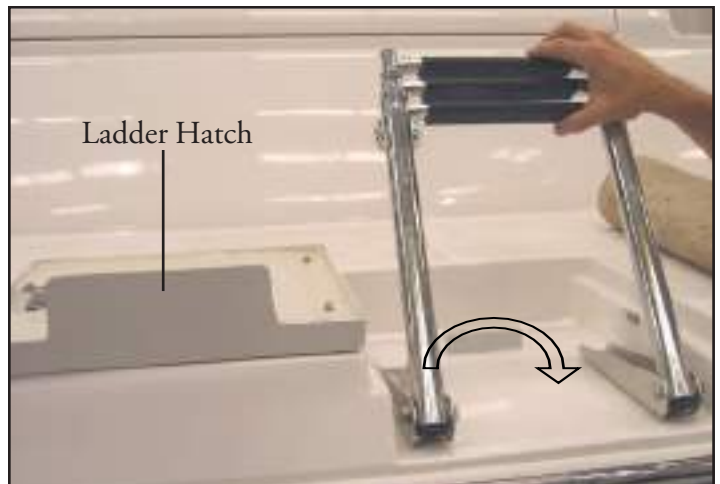

 **WARNING**

AVOID SERIOUS INJURY OR DEATH!
DO NOT OPERATE THE VESSEL WITH PEOPLE ON TOP OR HOLDING ON TO THE SWIM PLATFORM STRUCTURE OR HARDWARE.

 **WARNING**

AVOID SERIOUS INJURY OR DEATH!
DO NOT ALLOW ANYONE TO TEAK SURF BY USING THE SWIM PLATFORM AND/OR HARDWARE.

Equipment Operation



WARNING

AVOID BODILY INJURY!
TURN THE ENGINES AND GENERATOR OFF
AND REMOVE THE IGNITION KEYS
WHILE PEOPLE ARE SWIMMING
NEAR THE VESSEL, USING THE SWIM
PLATFORM OR LADDER.



Chapter 8

Cosmetic Care & Maintenance

COSMETIC CARE



This section covers the care and maintenance of your Regal 3360 Window Express™. Many cosmetic care topics including exterior hardware, upholstery, fiberglass and canvas are described. Also, major equipment and systems are covered. As always, refer

to the owner's information pouch and the manufacturer's owner's manual for detailed procedures.

UPHOLSTERY

Cockpit and interior vinyl require periodic cleaning to maintain a neat appearance and to prevent the build up of dirt and contaminants that may stain and reduce the vinyl life if they are not removed. The frequency of cleaning depends on the amount of use and conditions to which the vinyl is subjected.

Most common stains can be cleaned using warm, soapy water and clear rinses. Scrubbing with a soft bristle brush will help loosen soiled material from embossed surfaces and under welting. If the stains are not removed with the above method use a mild cleaner such as Fantastik. This cleaner should be used only as needed and not the normal means. With more stubborn stains, rubbing alcohol or mineral spirits may be tried cautiously. Widespread solvent use can severely damage or discolor vinyl.

Try to remove stains immediately before they have a chance to penetrate the surface of the vinyl.

Powdered abrasives, steel wool, or industrial strength cleaners are not recommended for cleaning our vinyl. Lacquer solvents will cause immediate damage. Dilute chlorine bleach before using. Do not wax the vinyl as it may cause cracking. Always wear protective gloves and make sure there is sufficient ventilation when cleaning vinyl. Wear eye protection.

Remember that suntan oil will damage vinyl. **Use suntan lotion instead of suntan oil.** Exposure to the sun is a natural enemy of vinyl upholstery. For maximum life, keep the vessel covered with a cockpit cover when not in use.

CARPET

Use approved carpet cleaners only. Always try on a test area first. Many spots and spills can be removed using a cleaner combined with a clean, white terry towel. Try not to soak an area excessively and do not use solvents because most interior marine carpet is rubber backed and glued in place. Solvents will break down the backing and fibers.

PLASTICS

Use plastic cleaners and polishes recommended for marine use only. Use proper applicators. Read all instructions carefully. Test the product in a small area first.

Chapter 8

Use a soft rag and always rinse the surface with water. Ammonia based cleaners and abrasives will damage plastic parts.

NOTICE

NEVER CLEAN PLASTIC SURFACES WITH A DRY CLOTH OR GLASS CLEANING SOLUTIONS CONTAINING AMMONIA. NEVER USE SOLVENTS OR WIPE WITH ABRASIVES.

INTERIOR FABRICS

Clean flat-good interior fabrics with dry cleaning fluid style cleaners approved for use with soft fabrics. Allow adequate ventilation and follow the label instructions carefully. Use a soft cleanser with feldspar to clean stubborn marks or stains on wallpaper. Normal interior vinyl such as the headliner and head need a mild soap and water solution. Rinse immediately with clean water and wipe dry. Always test an area with a cleaner before applying it to a larger area.

CORIAN®

Regal has chosen Corian counter top material because of its elegance and durability. Periodic maintenance will ensure its beauty. Corian withstands heat much better than ordinary counter top materials but you must still use a hot pad or trivet when taking materials directly out of the oven or stove top to protect from damaging the surface. Avoid cutting directly on the surface.

Another feature of Corian counter tops is that it is a non-porous. Therefore, dirt and germs do not penetrate it. Corian will not support the growth of germs and mildew. To disinfect, wipe the surface with diluted household bleach with a ratio of 1 part bleach to 1 part water. To clean the surface of water marks, wipe it down with soap and water and towel dry. For stains use soapy water or ammonia based cleaners.

You can use a Scotch-Brite pad to remove stubborn stains. The Corian is a matte or satin finish. To remove scratches and nicks, sand the surface with 180-220 grit sand paper until the nick is gone. To restore the finish use an abrasive cleanser and a green Scotch-Brite pad. If you wrap the sandpaper around a block of wood while sanding it will help sand the areas flat instead of creating hills and valleys.

FIBERGLASS & GELCOAT



CAUTION

AVOID BODILY INJURY!
WAXED GELCOAT SURFACES CAN BE VERY SLIPPERY. DO NOT WAX NORMALLY USED AREAS OF THE DECK, LINER, OR GUN-WHALES. DO NOT WAX ANY TEXTURED OR NON-SKID SURFACES SUCH AS FLOORS, WALKWAYS, STEPS, LADDERS OR SWIM PLATFORMS.
WEAR ANTI-SLIP FOOTWEAR AT ALL TIMES!

Routine maintenance is the only practical way to keep the surface of your boat looking shiny and new. Most objects left outdoors will gradually deteriorate from exposure to the sun, water, dust and pollution. Such outdoor exposure can cause your boat's gelcoated surface to change or fade. Darker colors tend to fade more rapidly than lighter colors because they absorb more of the sun's rays (ultraviolet and infrared).

Basic maintenance includes monthly washing of the boat's surface to remove normal accumulation of soil and stain. Use a mild detergent such as dishwasher powder or liquid. Do not use automatic dishwasher detergent. Avoid any kind of alkaline cleaners such as tri-sodium phosphate (TSP), abrasives, bleaches and ammonia. For best results use cleaners that are recommended for fiberglass.

Cosmetic Care & Maintenance

NOTICE

WIRE BRUSHES, SCOURING PADS, OR OTHER ABRASIVE TYPE MATERIALS AND SOLUTIONS SHOULD NEVER BE USED ON THE HULL OR DECK OF YOUR BOAT. THEY CREATE SMALL SCRATCH MARKS THAT COLLECT MARINE GROWTH AND OTHER FOREIGN MATERIALS.

It is recommended that you wax the gelcoat surface twice yearly to prevent loss of gloss and to protect the finish. Use only waxes for fiberglass and follow the label instructions. Apply a 3' x 3' section at a time using clean applicator cloths or a buffing bonnet. When a haze develops, use a power buffer at low speeds (1200-2000 rpm) to remove the haze. Keep the buffer moving to avoid heat build-up. Never wax gelcoat in the direct sun.

When the washing and waxing as recommended does not restore the shine it may be necessary to use a fine rubbing compound. Do not apply rubbing compound in direct sunlight. A power buffer at low speed does an excellent job to remove impurities from the gel coat that cause dulling. Use light pressure and keep the buffer moving. Re-wax after compounding to buff the surface.

“Hairline cracks” or “spider webbing” could develop in the gelcoat surface of a hull or deck. This can be caused by impact or other factors. Small air pockets or gouges may also occur through normal **wear**. These do not affect the strength of the hull or deck and can be repaired by yourself, a marine professional or a Regal dealer.

The affected area should be chipped or sanded away and a thin layer of color matched gelcoat applied. This layer is then sanded smooth and buffed to its original luster.

Most minor scratches, nicks, and dents can be removed by compounding the surface. Marine type compounds can be found at most auto body supply stores. Specify a number 25 which is a coarser compound up to a number

55 being less coarse. Various glazes and polishes are available as needed. Ask your marine professional or Regal dealer for more information. Fiberglass hulls are strong but they can be damaged. A fiberglass hull has virtually no internal stresses. Thus when a part is broken or punctured, the rest of the hull retains its original shape. A severe blow will either be absorbed or result in a definite localized break. A break of this nature should be checked and repaired by a marine professional or a Regal dealer.

MINOR REPAIRS

You will need the following materials for minor repairs:

- Gelcoat
- Clear Liquid Catalyst
- Putty Knife
- Razor Blade
- Fine Sandpaper (400,600,1000)
- Wax Paper (to cover repair area)



WARNING

AVOID BODILY INJURY!
GELCOAT & FIBERGLASS RESIN
ARE FLAMMABLE.
WORK IN A WELL VENTILATED AREA
FREE FROM OPEN FLAMES.
DO NOT SMOKE!

For minor repairs refer to the following procedure:

1. Clean the area to be repaired and get rid of any wax or grease residues.
2. Clean out scratches, chips, and nicks.
3. Sand area to be repaired so gelcoat will bond.

Chapter 8

4. In a separate container, measure only the amount of gelcoat you will need. Mix a ratio of 2% ratio of catalyst to the amount of gelcoat being used (a spoonful of gelcoat will require only a drop or two of catalyst). Do not pour any unused portions of the gelcoat/catalyst mixture back into either original container.
5. Apply gelcoat to area leaving a slight lift above the surface.
6. Cover the area with wax paper. It will help the mixture to set up faster.
7. Remove wax paper and shave off any extra gelcoat with a razor blade.
8. After the area is shaved smooth, start with the 400, 600, and finally 1000 grit sand papers.
9. Buff the area with compound, polish and a finish wax. You may notice a difference between the repaired area and the original finish due to the natural weathering process.

CANVAS

Boat canvas is in most cases subjected to more severe punishment than practically any other type of material. Moisture, dirt and chemicals from industrial fallout, heat, ultraviolet rays and salt water are all factors which accelerate the deterioration of your boat canvas.

These elements can cause serious damage if left unchecked. The boat top and other canvas supplied on your Regal boat are manufactured from top quality materials to provide you with years of trouble free service. The following information on the care, cleaning and proper storage of the fabrics and fasteners that make up your marine canvas is being provided to help you maintain the appearance and ease of operation.

Sunbrella is used on most Regal tops, aft curtains, camper enclosures, bow tonneaus and cockpit covers. Sunbrella is a woven fabric made from 100% solution dyed acrylic fiber. It is color fast and will withstand long term exposure to the sun (ultraviolet rays) without excessive fading.

Sunbrella is a woven fabric. Even though it is treated with water repellency some "misting" through the fabric is typical. With new canvas, the greatest potential for leakage is through the sewn seams. Because Sunbrella and the long term thread used is synthetic, the holes created by sewing will not swell up and seal when exposed to water as cotton does. Usually the movement of the fabric in use will move the fibers enough to seal the holes. You may apply Apseal or Uniseal to the seams to speed up this process.

When the canvas is new, the fit will normally be tight. It is designed this way because Sunbrella stretches as it ages. The initial tight fit allows for a suitable fit for the life of the canvas. The Sunbrella fit will vary slightly in the heat, cold, and rain.

SUNBRELLA CLEANING INSTRUCTIONS

Sunbrella should be cleaned regularly before substances such as dirt, roof particles, etc., are allowed to accumulate on and become embedded in the fabric. The fabric can be cleaned without being removed from the boat. Simply brush off any loose dirt, hose down, and clean with a mild solution of natural soap in lukewarm water. Rinse thoroughly to remove soap. **DO NOT USE DETERGENTS!** Allow to air dry.

For heavily soiled fabric, remove the top from the frame. Soak the fabric in a solution that has been mixed to the following proportions.: 1/2 cup of Clorox bleach and 1/4 cup of Ivory or Lux soap (liquid or soap) per each gallon of lukewarm water. Allow the fabric to soak until the bleach has killed the mildew and the stains can be brushed out with a common kitchen scrub brush. Rinse the fabric thoroughly in cold water to remove all the soap. This may require several rinsings. Incomplete rinsing can cause deterioration of sewing threads and prohibit the fabric from being properly retreated. Allow the fabric to dry completely.

DO NOT STEAM PRESS OR DRY IN AN ELECTRIC

Cosmetic Care & Maintenance

OR GAS DRYER! Excessive heat can damage and shrink the fabric since it is heat sensitive.

This method of cleaning may remove part of the water and stain repellents that was applied to the fabric during its manufacture. It is recommended to retreat with such water repellency products as Apsel and Uniseal. We do not recommend any wax based treatments such as Thompson's Water Seal or any of the silicone products such as SC-15 or Aqua-Tite. Wax based products prevent the fabric from breathing, and encourage mildew growth while the silicone products interact with the original fluorocarbon finish and seem to cause a rapid loss of water repellency. Scotchguard has not been found to be very effective for restoring water repellents to Sunbrella. It seems to work well in the short run, but doesn't maintain it's performance very long.

CLEAR VINYL, ZIPPER & SNAP CARE

Never store canvas wet or in an unventilated, moist area. Always roll the canvas instead of folding. This is of particular importance on side curtains or any other part with the clear vinyl "glass". Roll the top carefully around the bows and cover with the storage boot provided.

The clear vinyl "glass" used in side curtains, aft curtains, visors, and camper enclosures is very susceptible to heat and cold. Keep vinyl curtains from touching metal tubing to minimize burning the vinyl.

If the boat is stored with top, side curtains and aft curtain in place, heat build up inside the boat may discolor the vinyl.

To clean the clear "vinyl" glass, use a solution of Ivory or Lux soap, liquid or flakes, and lukewarm water. Allow to air dry. Never use any type of abrasive cleaner as it will scratch the "vinyl" glass. There are many cleaners and scratch removers on the market specifically for clear vinyl. Handle the clear curtains carefully. They are soft and prone to scratching.

Canvas parts are designed with zippers. When zippers are new they can be a little difficult to use. Zip carefully without forcing the zipper or the material. They will loosen with use. A zipper lubricant may be used to help new zippers as well as maintaining used ones. The most vulnerable part

of the zipper is the starts. Use care when starting the zipper. Canvas snap fasteners should be unsnapped as close to the button as possible. Never remove canvas by pulling roughly on the edge of the material. This can damage the canvas as well as the fasteners. Use petroleum jelly on snaps to keep them from developing corrosion especially in harsh environments.

METAL

Keep all stainless steel and other metal parts rinsed and wiped dry. To maintain their finish polish the stainless steel and other bright works at least annually. Use commercially available metal products and read the labels carefully before use. Refer to the flyer in the owners information pouch. Most marinas and boating retail outlets carry metal care products.

HULL BOTTOM

Never use wire brushes or highly abrasive scouring pads on your hull bottom. It could damage the gel coat surface or the bottom paint. The bottom of your boat needs to be clean since the build up of natural coatings from water or marine life can potentially create drag and affect your boat's performance. Contact a marine professional or Regal dealer for more information.

BOTTOM COATING/PAINT

If your hull has been fitted with a bottom coating/paint ensure there is no alga or barnacle growth on the bottom. In salt water areas it may be required to pull the boat and scrape the bottom periodically or divers can accomplish the task.

Touch up any scraped or abraded areas to keep growth from attaching to them. Touch up as required with the appropriate bottom coating per the manufacturer .

Chapter 8

| FREQUENT STAINS/CLEAN-UP STEPS | 1 | 2 | 3 | |
|--------------------------------|---|---|---|---|
| Coffee, Tea, Chocolate..... | B | | | |
| Permanent Marker*..... | E | B | C | |
| Household Dirt..... | A | B | | |
| Grease..... | | D | B | |
| Ketchup, Tomato Products..... | A | B | | |
| Latex Paint..... | | A | B | |
| Oil Base Paint..... | | D | B | |
| Mustard..... | | A | B | C |
| Suntan Oil..... | | A | B | |
| Asphalt/Road Tar..... | D | B | | |
| Crayon..... | | D | B | |
| Engine Oil..... | | B | | |
| Spray Paint..... | | B | | |
| Chewing Gum..... | | D | A | |
| Shoe Polish*..... | | D | B | |
| Ballpoint Pen*..... | | E | B | A |
| Lipstick..... | | A | B | |
| Eyeshadow..... | | E | B | |
| Mildew*..... | | C | B | A |
| Wet Leaves *..... | C | B | A | |

A= Soft brush; warm soapy water/rinse/ dry

B= Fantastik cleaner

C= One tablespoon ammonia, 1/4 cup of hydrogen peroxide, 3/4 cup of warm water/ rinse/dry

D= Scrape off residue (use ice to lift gum)

E= Denatured alcohol/rinse/dry

* These products contain dyes which leave permanent stains.

Cosmetic Care & Maintenance

MAINTENANCE (INTERIOR)

AIR CONDITIONER:

It is a good idea to inspect the thru-hull fitting for leaks before each outing and to make sure the seacock is open. Also, the sea water strainer located in the bilge should be checked periodically for foreign objects clogging the strainer. To clean the strainer, unscrew the seacock fasteners, remove the wire strainer, and blow it out if possible with compressed air. Reinstall the strainer, making sure the gasket on the top of the seacock is centered. Then tighten the fasteners. Check for leaks since sucking air into the system could cause the seawater pump to malfunction.

The air conditioner filter may be located in the return air grill framework or in some cases, on the a/c unit itself. Inspect the filter monthly. To clean the filter remove it and rinse with clean water. See the equipment operation chapter for more information.

Check the a/c hose output located on the hull side. Make sure there is a full discharge when the a/c pump is running. If there is little or no discharge shutdown the unit and find the cause of the problem immediately.

Periodically check the drain located at the compressor to make sure the entrance to the hose at the a/c pan is not clogged with foreign matter.

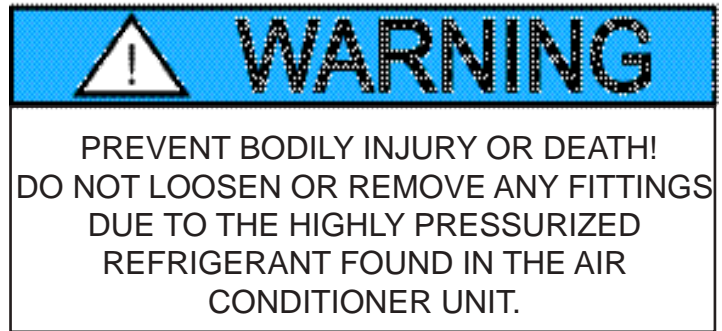

AIR FILTER REPLACEMENT

To replace the air conditioning system filter follow these steps.



1. Remove the grille cover by loosening the 2 grille latches. See the illustration.
2. Remove the filter. Replace with the exact replacement size. See your Regal dealer for further information.
3. Close the grille cover and reposition the grille latches.

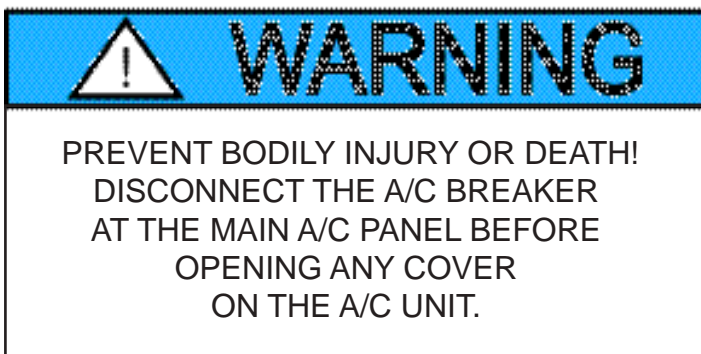

Chapter 8

A/C COMPRESSOR ACCESS

The AC main unit can be accessed through the 2 doors located on the cabinet. If service requires the complete unit to be removed the top cabinet shelf can be taken off in the following steps:

1. Turn off the power to the main AC panel.
2. Open the side door panel and you will see the wing nuts that hold the front cabinet door in place.
3. Disassemble the wing nuts. The front cabinet door can now be removed.

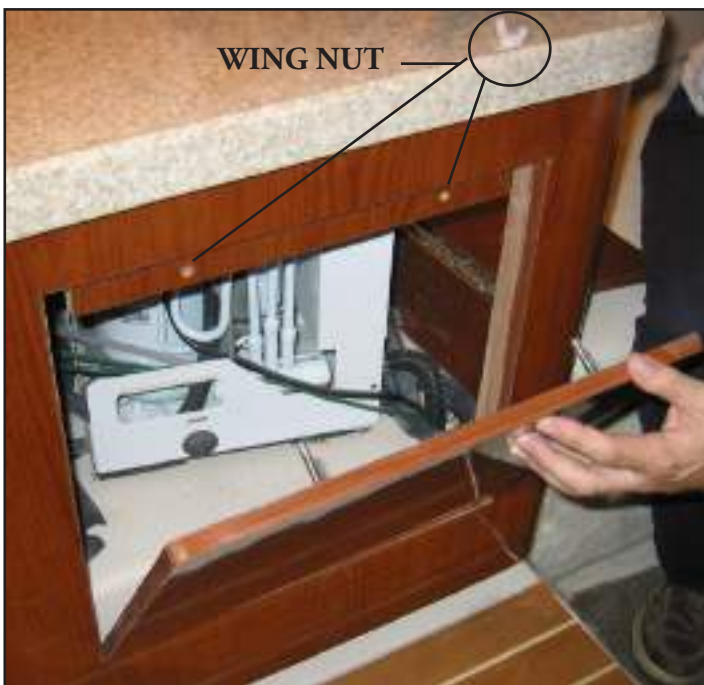

4. Reach under the cabinet top to locate the wing nuts that hold the cabinet top. Remove the wing nuts.
5. Remove the cabinet top.
6. To reassemble, reverse the process.

Cosmetic Care & Maintenance

CARBON MONOXIDE DETECTORS

We strongly recommend that you fully acquaint yourself with the total operation of the CO detector since it does measure accumulated levels. Normal maintenance should include frequent checking for the green power light glowing with the warning indicator and audible horn off. Each detector should be returned to the manufacturer each year for recertification. Refer to the owner's document box and chapter 1 for more information.

The CO detectors are located in the salon, forward and aft berths.

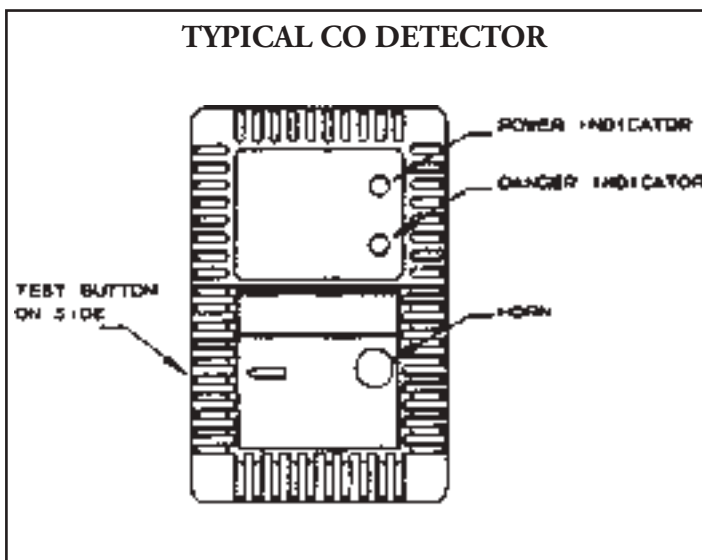

SHOWER SUMP PUMP (TYPICAL)



The shower sump pump shown above is used to collect gray water waste from the sinks or the shower itself. After the liquid reaches a designated height, the sump pump energizes through a float switch and exits waste to a manifold then overboard. This system helps to protect our water supply by not dumping used water overboard. Periodically check the sump pump grate for debris such as hair and soap build up. Check to make sure the automatic float operates freely at all times. Also, clean out the box with a bleach/water solution as needed to kill bacteria. You can back flush using the bleach/water procedure.



Chapter 8

VACUFLUSH HEAD

The VacuFlush® system needs to be cleaned periodically for maximum sanitation and operational efficiency. Clean the bowl with a cleaner such as Bon Ami which will not abrade the toilet bowl lining. Do not use chlorine solvents or caustic chemicals, such as the drain openers because the various system seals may be damaged.

Use the following procedure **monthly** or when leaving the vessel for extended periods.

1. Fill bowl with water.
2. Add 1 cup of biodegradable powdered laundry detergent.
3. Flush toilet by pressing the pedal for about 2 minutes. Release foot pedal to close flush ball.
4. Completely pump out holding tank. Most marinas use a vacuum hose connected to the deck waste fitting that pulls the waste from the tank. We suggest using a hose after the process and shoot a few bursts of fresh water down the waste fitting at the deck. This helps the residue left from the pump-out process from building up in the waste hose.

If an odor is apparent from the system try the following:

1. Clean the system out using the above procedure.
2. Check to see that the vent from the holding tank to thru-hull fitting is not clogged.
3. Add the correct holding tank deodorant either Secure liquid or Sealand. Periodically add as necessary.
4. Replace the in-line vent filter once per year. This filter can be ordered from a Regal dealer or your local marine supply store. See the illustration.
5. Carry a vacuflush repair kit on board which could save the day. They can be ordered through a local marine supply store.

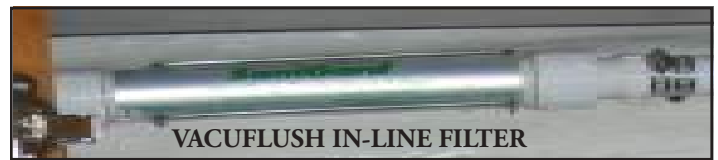

6. At least annually tighten all hose clamps, check all wire connections, check and tighten all water valve screws, and clean filter screen in water valve.

Cosmetic Care & Maintenance

FRESH WATER SYSTEM

The fresh water system in general requires very little maintenance.

1. See the equipment operation chapter defining the recommended seasonal disinfection procedure.
2. The fresh water filter need to be cleaned periodically. Simply remove the hose clamp and unscrew the fresh water filter to access the screen. Rinse the screen off to remove any foreign debris. Be sure to use teflon tape on the pump fitting threads before installing the filter. Reinstall the components and check for leaks.
3. Periodically check all fittings for leaks.
4. In colder climates, use Winterban or its equivalent in all the fresh water system components after draining the system.



HOT WATER HEATER

A. The most important maintenance factor with the hot water heater is that it is winterized with Winterban in colder climates. Use the water heater drain valve to vacate water from the tank. The water will automatically drain into the shower sump pump and then will be sent overboard. Make sure the water heater breaker is turned off before any winterization is started to prevent the element from being burned out.

B. If the system is constantly being used in warmer climates it is a good idea to periodically drain the hot water valve for 30 seconds or so to eliminate any scale that has built up inside the hot water heater. Turn the breaker off just as a precaution.

C. The hot water heater and heat exchanger parts are made of aluminum. If engine flushing is required by the manufacturer be sure to disconnect the heat exchanger from the system temporarily. The caustic chemicals will damage the hot water heater aluminum parts. Re-plumb the heat exchanger back after engine flushing.

D. Test the T&P valve periodically to make sure it works properly. Its purpose is to let off excess water vapor (steam) if the thermostat should stick and a critical temperature situation develops within the tank. With the water heater at operating temperature (use gloves) pull on the valve trigger top and raise the trigger to 90 degrees to test it. The water will vacate to the shower sump pump.

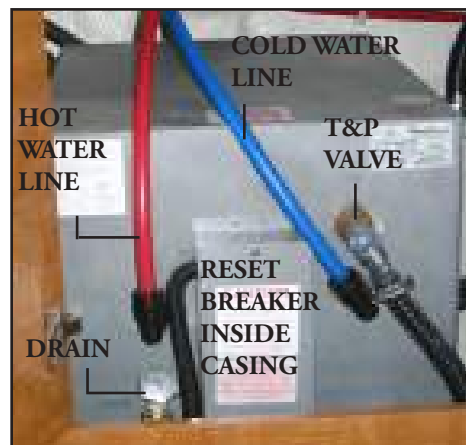

Chapter 8

FRESH WATER PLUMBING

Majority of the plumbing is located under the head and galley sinks for easier maintenance. This includes hot and cold water lines and various connectors. Cold water lines are blue and hot water lines are red. Periodic inspection of these areas is recommended.

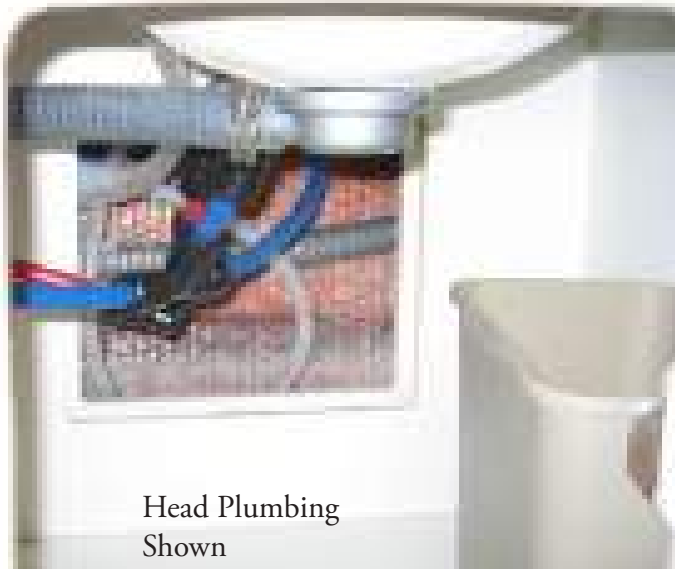

SHOWER HEAD ACCESS

Located at the cabin entrance head wall is an access cover. Remove the padded cover for shower head/hose inspection..



Cosmetic Care & Maintenance

PLUMBING CONNECTORS

All black plumbing connections to the red and blue fresh water lines require special instructions when they are to be removed or replaced. Be sure to turn off the water before starting any plumbing repairs.

1. To remove a tee, 90 degree, or straight fitting first remove the cap on the end of the fitting by using a slotted screwdriver. Insert the screwdriver in the cap slot and turn 90 degrees. Cap will release from the fitting.

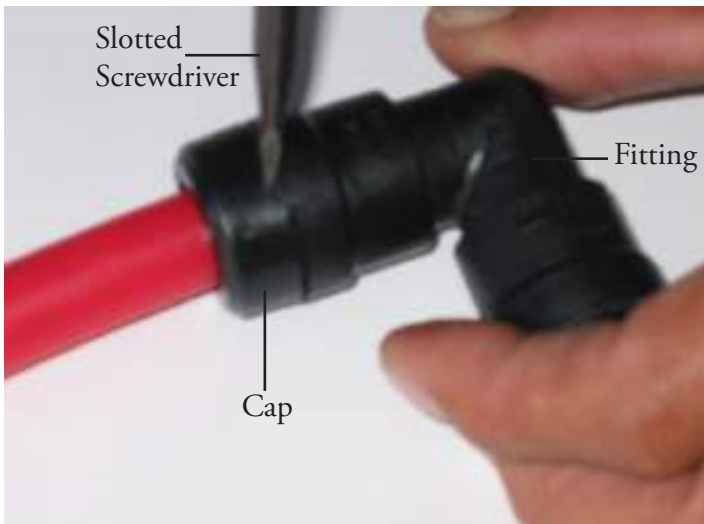

2. Push the connector and collar together. Hold the collar next to the connector with your finger. Pull and the connector/collar will release itself from the water line.

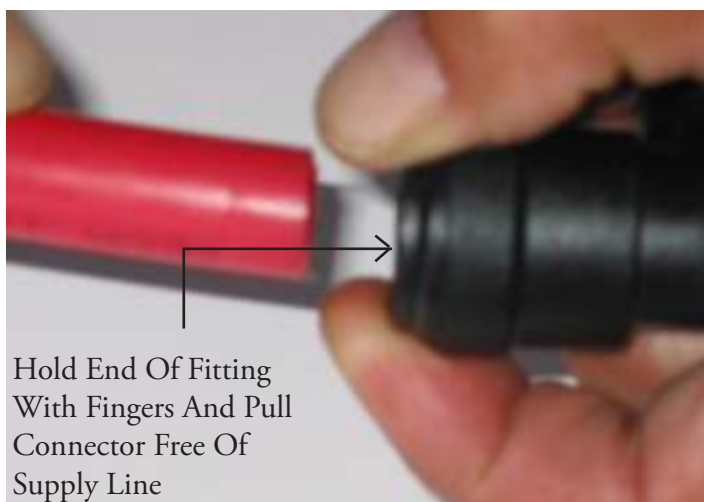

To reinstall a plumbing connection to a water line make sure the line is cut off square and the end is smooth. This will aid in ensuring a leakproof connection.

1. Install the cap on the supply line. You may need to use a slotted screwdriver to remove the cap from a new fitting.

2. Simply push the fitting on to the supply line until pressure is felt. This ensures it is completely in the fitting.

3. Push the cap on the collar until it snaps in place. Turn on the water pressure and check for leaks.

Note: With the connector in place, a movement between the line and connector is normal.



Chapter 8

GALVANIC ISOLATOR & BONDING SYSTEM MONITOR

1. The ground wire and galvanic isolator monitor is self-testing. To ensure it is operating correctly, press the “test” button and monitor its activity.

During the self-test process all four LED’s will light in this order:

Ground wire normal
Ground wire fail
Galvanic isolator normal
Galvanic isolator fail

Then it will pause and light again galvanic isolator fail. When the fail lights up on each component check you will also hear an audible alarm. If the LED’s do not light in this order or the alarm does not sound, the unit has failed its self-test and should be replaced.

2. Periodically, check the wire connections to ensure they are clean and tight.

STEREO/CD CHANGER/DVD PLAYER/ TELEVISION

Since most of the same cleaning and maintenance tips overlap on these entertainment components, they will be grouped together.

1. To clean the CD slots in stereos, DVD players use a dry or slightly water moistened swab to remove any buildup of debris. This monthly procedure will assist in preventing the CD discs from being scratched.

2. To clean the faceplates of the various units use a dry soft cloth. If the faceplate is stained badly, use a moist cloth with a neutral cleaner. Do not use harsh, caustic or alcohol based chemicals to keep the letters from coming off the faceplate. Do not use silicone spray or WD-40 since they could damage mechanical parts.

3. If these units will not play CD’s properly it they may have developed condensation. Wait 1 hour and retry.

4. Keep all remote controls out of extreme heat and high moisture environments. Change batteries often for best operation.

5. Periodically check CD discs for scratched and dirty ones. Clean the dirty ones with a cleaning kit which can be purchased at most electronic stores.

6. With flat screen televisions, do not attempt to service the unit yourself since high voltage exists.

7. To clean the flat screen display, dampen a soft cloth with water or a mild detergent. The best cleaner is a screen cleaning tissue specifically designed for antistatic coating. Never use flammable cleaning materials or glass cleaners with ammonia since they attack the television screen surface.

Cosmetic Care & Maintenance

REFRIGERATOR

The refrigerator periodically needs to have the compressor coils cleaned off. To accomplish this task, make sure the refrigerator circuit breaker is off and all food cleared out. You need to remove the 2 screws through the top of the cabinet and the 4 screws inserted in the bottom of the refrigerator. To access the 4 bottom screws, remove the drawer beneath the refrigerator and use a stubby Phillips screwdriver. Once all the screws are out, you will be able to access the coils at the rear of the unit by pulling it out of the cavity. You should be able to disconnect the plug at this point. Set the unit on a stool to clean the coils using a soft brush. Reinstall.

A good time to clean the inside of the refrigerator is just after defrosting the unit. Once it is to room temperature, clean all surfaces and trays with a soft cloth and mild cleaner. This will help remove any odors. After the unit is plugged back in insert a small box of baking powder to help move any odors produced by future stored food.

When leaving the boat for extended periods make sure the circuit breaker is off, all material is removed from the refrigerator and the door is wedged open.

CABIN DOOR TRACK

Periodically clean the cabin door track by using a vacuum with an upholstery nozzle. Then wipe off any residue with a damp cloth and warm water. Do not spray the door track with silicone spray or oil since a slippery surface could develop. Periodically clean step drain of debris.

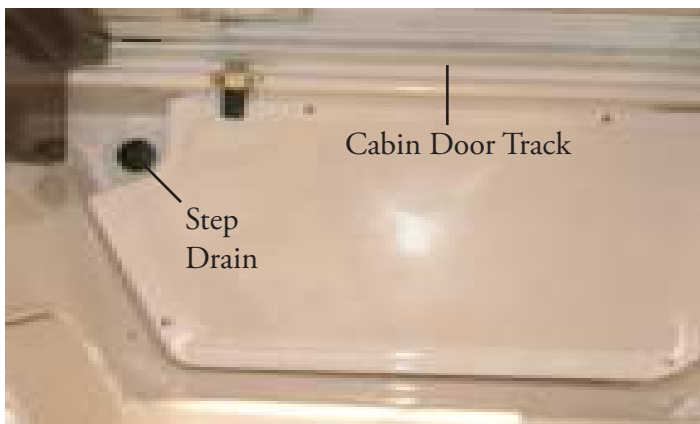

CENTRAL VACUUM

If installed, keep the vacuum central tank free of built-up debris. The hose connection is at the entrance steps. The main vacuum tank is located under the entrance steps. Periodically, clean the filter. Read the manufacturer's owner's manual for further information.



TEAK & HOLLY FLOORS

To maintain teak & holly floors clean with a mild detergent. Do not use any heavy abrasive cleaners since they could scratch and subsequently damage the polyurethane finish coat. For touch

GROUND FAULT OUTLET

Ground fault isolators should be tested monthly. To test, depress the reset button. Next, press the test button. The reset button should pop out. If it doesn't, contact a qualified electrician or marine professional.

Also, since all receptacles are connected through the GFI circuit they should show zero voltage when the GFI test button is pressed. A plug-in type tester can be obtained at most hardware stores for testing outlets.



Chapter 8

WINDSHIELD WIPER MOTOR ACCESS

At the salon headliner there is an upholstered access cover. Remove one side of the velcro and the access cover will pivot open. Inside is the windshield wiper motor and wiring connections. Periodically check the connectors for tightness. To reinstall, pivot the catch over the un-velcroed side and push the cover closed.



Cosmetic Care & Maintenance

MAINTENANCE (EXTERIOR)

WINDLASS

The most important maintenance especially for salt water environments is to spray off the outside casting with fresh water along with the chain, thimble and shackle parts. Also, make sure you spray off the gypsy area where the chain travels through. This prevents damaging corrosion build up. The manufacturer recommends that the gypsy and drum be disassembled at least once a year cleaned and lubricated as needed. Spray external parts with CRC or WD40. Make sure the gear housing is not leaking oil. Fill as needed with SAE 90 weight gear oil. Replace any leaking seals. Check all solenoids terminals for tightness. These parts may be located behind the salon television set rear panel or under the forward deck locker in a protective box or in the DC distribution center. Refer to the windlass maintenance manual for more information.



SPOTLIGHT

The spotlight lens should be wiped with a clean, dry soft cloth to remove any debris such as bugs, salt spray or general dirt. Read the manufacturer's literature for more information.

DECK HARDWARE

Inspect all mounted hardware often for tightness and deteriorated fasteners. Pay extra close attention to cleats and eyes since they are often under huge loads

TRIM TABS

Trim refers to the running angle of the boat while underway to achieve the most efficient planning angle. Check all electrical connections for tightness, corrosion, and chafing. All mechanical trim tab components should be checked periodically. If a malfunctioning tab is suspected, run each tab in and out while someone looks at each tab to make sure it is moving up and down the proper distance. **Replace zinc anodes when at one half their life as determined by size. Check anodes twice a month.**

Check the fluid in the hydraulic power unit (HPU) to make sure it is at the proper level. The pump is located in the bilge close to the transom. To refill, remove the lexan cover and filler plug. Fill with any type automatic transmission fluid (ATF). The fluid level should be 2" from the reservoir bottom.

The trim tabs may be painted for corrosion protection. **Do not paint the anodes.** Refer to the owner's document box for more information.

FIRE EXTINGUISHING SYSTEM

The fire extinguisher system canister located in the sump should be checked to make sure the hold down brackets are tight. The canister features a gauge that displays the level of agent left. The gauge should show a level in the green area. Any reading in the red area needs immediate attention or replacement. The dash monitor switch should show a green light indicating all systems are in the correct operation.

COCKPIT CARPET

Avoid cleaning carpet with harsh liquids or abrasives. Clean carpet stains with a well recognized product such as Resolve. Test an area before using the product. Follow the directions on the label. Use a terry towel in combination with the cleaner to remove stains. Avoid over wetting the carpet. When storing cockpit carpet make sure that it is completely dry and then roll each piece rather than fold it.

Chapter 8

ELECTRONICS

The electronic equipment manuals should be individually read for specific maintenance information.

Generally, avoid using any abrasive type cleaners on the main body or the screen surface of the equipment. This would include ammonia, alcohol based, or chemicals such as mineral spirits, acetone, and acid products.

Wipe with a soft rag to avoid scratching surfaces.

As with any electronic equipment, steer away from a hard direct spray from a hose nozzle.

REMOTE CONTROL

The remote controls at the dash control box and the cable attachment at the engine should be tight and shift without binding.

Shift and throttle controls at both the engine and helm areas must be checked on a periodic basis. At the engine end, make sure all control cable hardware is tight and control cable brackets are secure. An application of silicone spray on the cable ends periodically will keep control cables working freely and fights corrosion. At the helm end check to make sure the control box hardware is tightly secured.

GAS VAPOR DETECTOR

This item requires little maintenance. The dash light monitors the operation of the device. The sensor unit is located in the bilge area. Be careful not to step on the sensor unit.

COMPASS

The compass should light when the navigation switch is activated. Clean the dome with a soft cotton cloth or chamois dipped in fresh water and a mild detergent. Do not use abrasive cleaners or strong solvents as these will scratch or fog the dome. A soft non-abrasive wax can be used to protect the dome after cleaning. To protect the compass from excessive sunlight, the protective hood should be closed when the compass is not in use.

If the boat is left for extended periods of time such as over the winter remove the compass and store it in at room temperature.

After handling or cleaning the compass the card may appear to dip do to static electricity. This is a normal happening. It will return to normal quickly.

HORN



The air horn features an air pump located behind the AC/DC panel. It emits a sound that can be heard much louder than the typical electrical horn. This extra distance can be useful in ship to ship crossings especially when foul weather is present. Check the air pump periodically for loose fasteners. It is located in the cockpit wet bar.

HATCHES/ PORTLIGHTS

Your boat uses the finest hatches and port lights available. To care for the lens wash with mild soap and lukewarm water. Polish with a mild automotive type product. Scratches may be removed or minimized by using a mild automobile polish like Johnson's Paste Wax or Mirro Glaze Plastic Polish. Silicone spray is recommended to keep moving parts clean from salt build-up.

Cosmetic Care & Maintenance

BATTERIES

Frequently check your battery terminals for corrosion build-up. If you find a greenish, powdery substance, remove the cable connections and clean both the terminals and the connectors with a wire brush. When the cleaning is finished reconnect the battery cables and coat the terminal with an approved grease or petroleum jelly to help prevent further corrosion. Check the electrolyte level at least every 30 days, more often in hot weather. The level should be maintained between the top of the battery plates and the bottom of the fill cap opening. Add distilled water (does not contain minerals) only as needed after charging the batteries or periodically as needed. Do not overfill because sulfuric acid could run over and cause burns or an explosion. Extremely corroded batteries can be cleaned with baking soda and rinsed with warm water. Perform this procedure with the batteries removed from the boat.

Batteries should be charged outside the boat. Do not smoke or bring flames near a battery that is being or has recently been charged. The hydrogen gas generated by battery charging is highly explosive.

Set batteries on a block of wood rather than concrete since this procedure will help the batteries from losing their charge.

Do not allow a metal object or loose wires to spark across battery posts while working close to the battery. Contact across terminals will cause a short circuit and electrical burns or personal injury may result.

Tighten all battery connectors securely. Check their tightness by pulling on the connectors. They should not move from their tightened position. Be sure to reinstall the positive boot over the battery terminal after tightening the battery post connection. While using the boat, use the volt meters to monitor the charge level of each battery bank. Monitor the charge with the engines turned off (static condition).

The engine alternators recharge the batteries. A fully charged battery will indicate between 12.3 and 12.6 volts on the voltmeter. Readings below this could indicate a dead battery cell or a charging system malfunction which should be checked by a marine professional.



WARNING

PREVENT BODILY INJURY!
WEAR GOGGLES, RUBBER GLOVES
AND A PROTECTIVE APRON
WHEN WORKING WITH A BATTERY.
BATTERY ELECTROLYTE CAUSES SEVERE
EYE DAMAGE AND SKIN BURNS.
IN CASE OF SPILLAGE,
WASH AREA WITH A SOLUTION OF
BAKING SODA AND WATER.



WARNING

PREVENT BODILY INJURY!
BATTERIES CONTAIN SULFURIC ACID
(POISON)
WHICH ALSO CAN CAUSE BURNS.
AVOID CONTACT WITH THE SKIN,
EYES & CLOTHING.
IF CONTACTED, FLUSH WITH WATER AT
LEAST 15 MINUTES. IF SWALLOWED,
DRINK LARGE AMOUNTS
OF WATER OR MILK.
FOLLOW UP WITH MILK OF MAGNESIA,
BEATEN EGG OR VEGETABLE OIL.
GET MEDICAL ATTENTION IMMEDIATELY!

Chapter 8

BILGE PUMP/AUTOMATIC FLOAT SWITCH

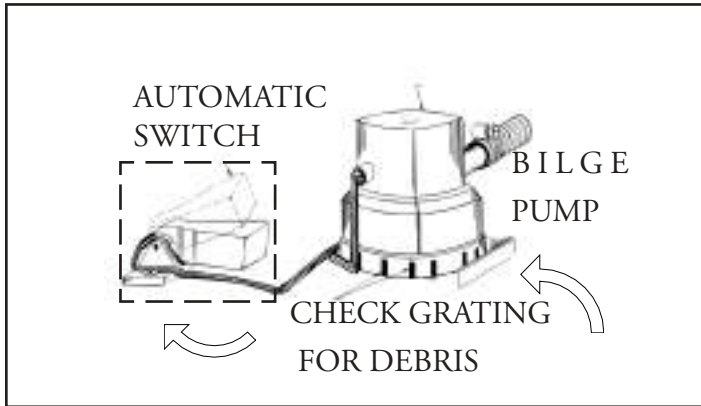

BILGE PUMP

Check for foreign materials stuck in the strainer area or discharge hose. Check all clamps and electrical connections for tightness. A quick check of the bilge pump automatic float switch is afforded by lifting up on the float and listening for the pump operating. Look around the float area for foreign debris and remove as necessary.

BLOWERS

Check the blower hoses to ensure they are fastened in the bilge properly and there are no holes in them. The hose connected to the blower needs to be 3/4 the way down in the bilge to evacuate fumes properly. All vents need to be checked for debris.

Make sure the blower motor is securely fastened and all hose clamps, tie wraps and electrical connections are tight.

TEAK INLAY SWIM PLATFORM

Periodically rinse off the teak platform to remove any salt or foreign material. Use a teak cleaner or conditioner as needed to enhance the finish. You can find these products at marinas or boating supply houses.

FUEL TANK & FITTINGS

Periodically inspect the fuel tank components for loose clamps at the vent, fill and feed locations. Examine each hose for signs of deterioration and leakage. Check the fuel sender for loose bolts, nuts, and leaks at all areas of contact. Also, inspect the fuel tank for signs of leakage or abrasion. Tighten all components as needed.

Never remove the spring and ball assembly in the anti-siphon valve. It can be cleaned with compressed air. Should the component be faulty (normally a fuel surge problem at mid to high speed ranges) contact a marine professional to replace it. Check the fuel fill pipe hose connection at the deck using the access plate which can be removed for inspection. Make sure the black ground wire is tightly secured. For further information, contact your closest Regal dealer.

TYPICAL FUEL TANK FITTINGS

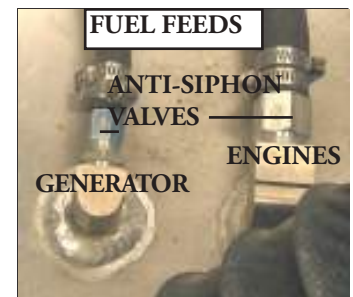
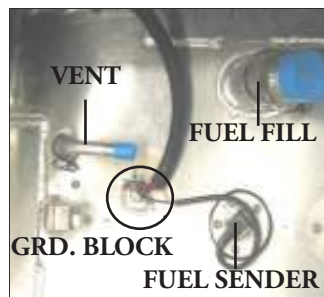

To locate the starboard fuel tank fittings first remove the cockpit refrigerator. Remove the access plate cover.

Cosmetic Care & Maintenance

FRESH WATER TANK

The fresh water tank is located under the mid berth floor. To remove the tank first undo all the fasteners holding the black trunk liner material. Remove the trunk liner. Next, remove the tank hoses and the aluminum bands holding the tank in place. Finally, remove the water tank.

OVERBOARD DISCHARGE PUMP

If your boat is equipped with an overboard discharge pump pay close attention to what materials are flushed through the waste system as it could become clogged. Do not pump garbage, rags, or sanitary napkins through the overboard discharge pump (macerator). Flush the waste tank and pump with fresh water with each pump out. Do not run the pump dry or for extended periods of time since the impeller can be damaged. Pump the waste system out at decommissioning time and rinse fresh water through the entire system before decommissioning.



Chapter 8

MAINTENANCE

ENGINE

Each engine package is unique and quite complex. A select portion of the maintenance items are covered in this chapter. Many times because of the advanced ignition and fuel injection systems used on marine engines it is best to use trained marine professionals. For more detailed information, refer to the manufacturer's engine owner's manual or call your closest Regal dealer.

STERN DRIVE

The stern drive unit should be checked before each outing. Tilt the drive unit up and check for any debris around the intake and fish line tangled in the propeller. Check your engine manual for stern drive maintenance schedules.

PROPELLERS

Out-of-balance or nicked props will effect performance or cause vibration. Damaged props should be replaced, but those that are chipped or bent can usually be reconditioned by a marine dealer or a propeller repair facility. When cruising, Regal recommends you carry a spare set of props on board because many marinas do not carry a full inventory of replacement propellers. Refer to the manufacturer's engine manual for appropriate stern drive and inboard propeller replacement procedures.

Be sure to make a note of the propeller diameter and pitch while the vessel is in dry dock. They are pressed into the prop for easy reading.

In an emergency an aluminum propeller blade can be straightened by laying the propeller blade on a 2 x 4 and hammering the bent portion of the blade until straight. This procedure will assist the operator in reaching port so he can have the propeller re-pitched.

Make sure the ignition keys are in the "OFF" position along with the battery switch.

It is recommended that you wear a pair of leather gloves to protect yourself from sharp propeller blades. With **dual** propeller units you may be able to use a piece of wood between the top of the gear housing and the propeller to hold it from turning while you are removing the prop nuts and hardware to access the props. Some of these units use 2 lock nuts, one for each propeller. You may need a special socket and ratchet set to remove the propeller nuts. Line up the hardware according to its disassembly for reassembly purposes. Below are drawings showing selected propeller shaft hardware for both Volvo and Mercruiser units. See the engine manufacturer's owners manual for further information.

VOLVO DUO PROP INSTALLATION

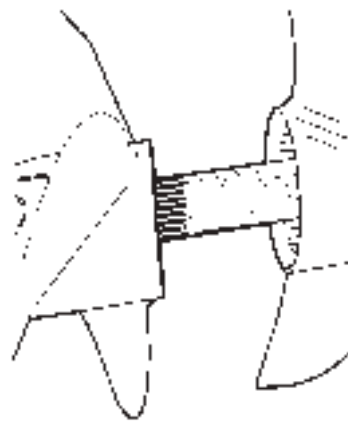

Coat both shafts with marine grease. Place the remote control in forward position to lock shafts. Install the front propeller.

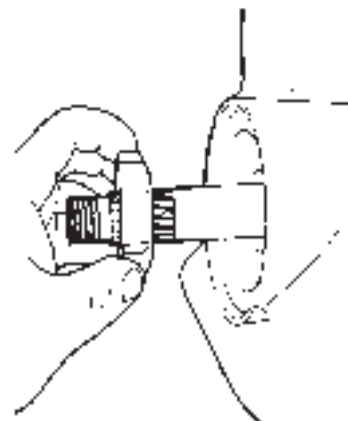

Install propeller nut. Tighten to 45 ft. lbs. (Use torque wrench) Make sure the chamfered edge of the prop nut is facing forward. Failure to install prop nut correctly could result in loss of prop or damage to lower unit.

Cosmetic Care & Maintenance

MERCURISER BRAVO THREE

STEERING

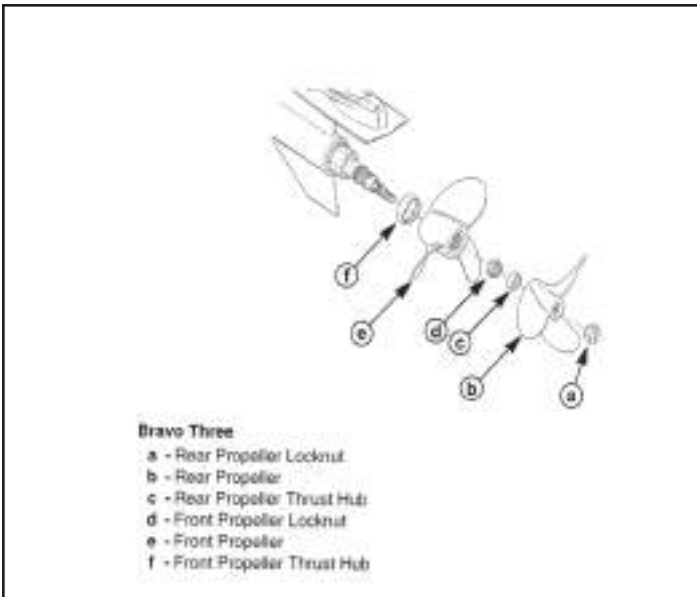

Regals feature rack or rotary style steering systems that utilize a cable with assistance through the engine power steering pump. As you turn the steering wheel force is applied through the system to a hydraulic cylinder attached at the engine rear and connected through the engine power steering pump hoses.

With the engine running, check the engine power steering pump levels before each outing. Add the appropriate power steering fluid. Periodically inspect the entire steering system for tightness and signs of wear and leaks including the steering wheel. Lubricate the steering shaft at the engine. Refer to the manufacturer's engine manual in the owner's pouch for additional information along with the maintenance chart in this chapter.



CAUTION

AVOID PERSONAL INJURY AND
PROPERTY DAMAGE!

LOOSENING OR LOSS OF ONE OR MORE
FASTENERS MAY CAUSE FAILURE OF THE
STEERING SYSTEM
OR DAMAGE TO THE STEERING CABLE,
RESULTING IN LOSS OF STEERING
CONTROL.

PERIODICALLY INSPECT THE STEERING
SYSTEM.

Chapter 8

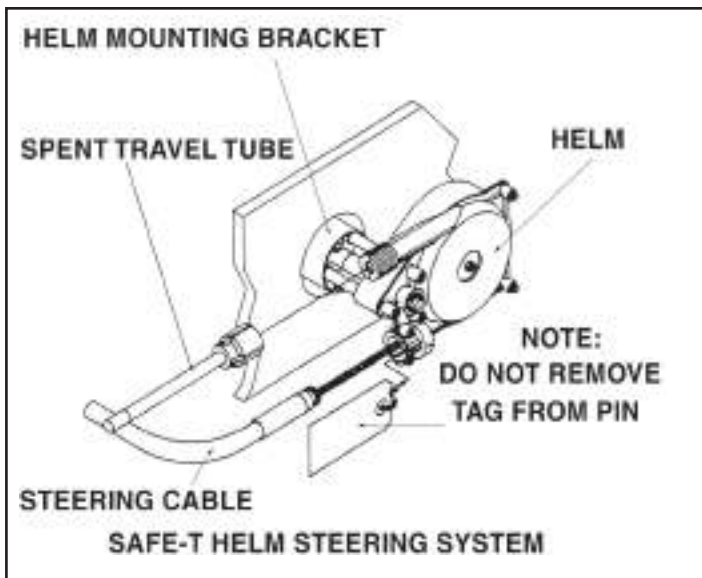

ELECTROLYSIS PROTECTION

Sacrificial zinc anodes usually found on the outdrive housing, trim cylinders or prop shaft to protect softer metals exposed to the water. Electrolysis attacks the least noble metals first. Because zinc is a less noble metal, it will decompose before other metals. Check these zinc anodes periodically and have them replaced when they are 50% gone.

Zinc is also used to protect metal that is exposed to saltwater. The salt causes a galvanic action that decomposes metals.



CAUTION

AVOID INJURY AND PROPERTY DAMAGE!
ABRUPT TURNS ABOVE 30 MPH
MAY RESULT IN LOSS OF CONTROL.
STEERING RESPONSE AT HIGH SPEEDS
CAN BE VERY SUDDEN.
ABRUPT TURNS MAY CAUSE YOU
TO CROSS YOUR OWN WAKE.
JUMPING A WAKE, SUDDEN TURNS, AND
INCREASES OR DECREASES IN SPEEDS MAY
BE DANGEROUS.
THE OPERATOR MUST ENSURE THAT ALL
PASSENGERS ARE SEATED SECURELY
BEFORE MAKING SPEED CHANGES.

Cosmetic Care & Maintenance



CAUTION

AVOID PERSONAL INJURY
AND PROPERTY DAMAGE!

**ABRUPT TURNS ABOVE 30 M.P.H. MAY
RESULT IN LOSS OF CONTROL.**

STEERING RESPONSE AT HIGH SPEEDS
CAN BE VERY SUDDEN.

ABRUPT TURNS MAY CAUSE YOU
TO CROSS YOUR OWN WAKE.

JUMPING A WAKE, SUDDEN TURNS, AND
INCREASES OR DECREASES IN SPEEDS
MAY BE DANGEROUS.

OPERATOR MUST MAKE SURE THAT ALL
PASSENGERS ARE SEATED SECURELY
BEFORE MAKING SPEED CHANGES.

SEA WATER STRAINER

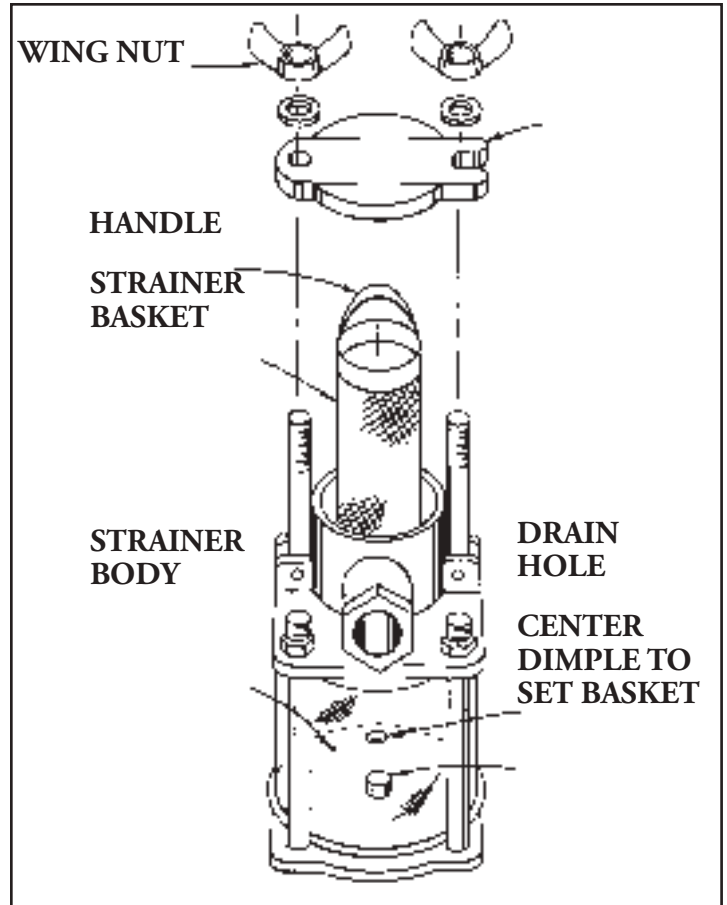

SEACOCKS

Inspect the thru-hull seacocks before and after each outing. Make sure the connections between the hose and the valve are tight. Look for water leaks around the area where the valve and hull meet.

Every 30 days open and close each thru-hull valve several times. This will guard against the valve seizing in the open or closed position. While doing this make sure the valve handle is tightly fastened. Tighten any loose valve handles. Ensure that all seacocks are closed upon leaving the vessel.

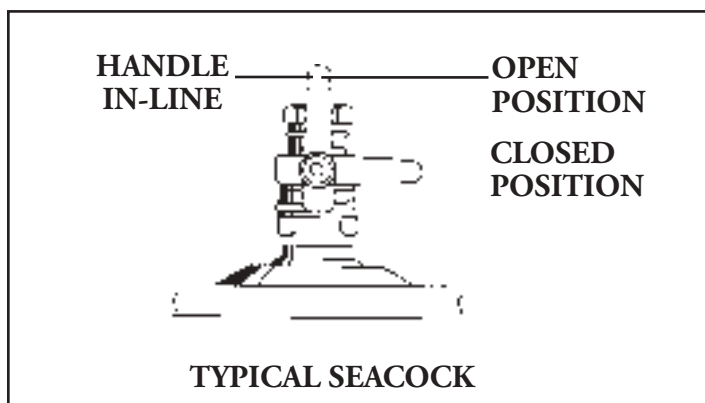

Before servicing the sea water strainer make sure the appropriate seacock has been closed to prevent water entering the boat. If possible blow out the strainer basket with compressed air or use a metal type brush to remove any accumulated material from the screening material. Make sure the strainer is aligned in the center dimple on reinstallation.

Check all parts for wear and possible leaks including any gasket surfaces. Do not overtighten the strainer wing nuts which could cause strainer body damage. Use original replacement marine parts only. After all parts are reassembled open the seacock and check for leaks.

Notice the drain hole in the bottom of the strainer body. Take the appropriate steps to ensure the strainer is winterized properly in colder climates.



Chapter 8

GENERATOR

Your vessel may be equipped with a generator. Read and become familiar with the generator owner's manual. It provides a variety of operational, safety and troubleshooting information.

The output voltage under a full load can be easily periodically checked by observing the AC voltage meter found on the AC/DC panel. The output voltage should be between 110 -120 volts AC (60 hertz-US), and 220-240 volts AC at (50 hertz- International). Voltages outside these specifications could indicate a generator malfunction. Make sure all fluid levels are checked before starting the generator. Check to make sure the generator seacock is open and the sea water strainer is cleaned periodically.

When starting the generator remember the generator on switch provides power to the start circuit. The start switch energizes the solenoid and starter which cranks the engine. Make sure **both** the on and start switches are depressed or the generator will not start. The generator features an automatic shut down system of sensors controlling high exhaust temperature, high water, low oil pressure, and high RPM. If one of these sensors engages, the generator will shut down. The source of the problem then needs to be determined. Use the owner's manual troubleshooting section as a reference.

There is a fuel filter at the carburetor that periodically needs cleaning. Service the fuel filter as recommended in the owner's manual. Check all fuel system connections periodically.

Disconnect the battery cables before doing any generator maintenance. Inspect and clean the carburetor flame arrestor periodically by blowing off with compressed air. Inspect all fuel system fittings for leakage periodically. Be sure proper ventilation is present when servicing the fuel system components. Inspect all water and heat exchanger fittings periodically for leaks. Repair or replace components as needed. Be sure the generator is completely cold before performing any maintenance on the water system due to possible hot water and or antifreeze filled components. Be sure to catch and dispose of any antifreeze coolant properly. Recommendations for type and mixture

Refer to the generator owner's manual regarding antifreeze concentrations.

There is a zinc anode located in the raw water part of the heat exchanger. Check it often for proper condition. Refer to the owner's manual for determining replacement status. It is self sacrificing thereby reducing the effects of electrolysis to the generator water system.

Check the drive belt deflection with the generator stopped. At the longest span, push down at the center. You should generate a movement of 3/8 to 1/2 inch. Refer to the generator manual for more information.

When refilling the crankcase with oil follow the specifications given in the owner's manual. Dispose of used oil properly. Use the attached sump hose to drain the generator used oil. Change the oil every 50 hours of operation. Use the specified oil type and weight.



Typical Generator w/Sound Blanket

GENERATOR FUEL FILTER

The optional generator utilizes a fuel filter located on the firewall. This filter should be serviced periodically. It requires a special wrench to loosen the filter. Make sure you use a metal drip pan to collect any spillage. Ventilate the area & change the filter. Tighten it to filter manufacturer recommendations and check for fuel leaks. With the hatch up run the bilge blowers, start the generator and check for fuel leaks. Shut down the system immediately if a leak occurs and investigate the cause of the leak. Make sure to dispose of any rags and fuel spillage properly.

Cosmetic Care & Maintenance

MAINTENANCE SCHEDULE

This maintenance schedule chart provides only general guidelines. Be sure to check specific areas periodically. Priority guidelines are listed by type.

Type A-maintenance after each use.

Type B-maintenance checks periodically.

Type C-maintenance performed after 25 hours of operation.

Type D- maintenance performed every 6 months /100 hours of operation.

| COMPONENT/SYSTEM | TYPE A | TYPE B | TYPE C | TYPE D |
|-------------------------------|--------------------------------|--------|--------|--------|
| Engine Compartment | | | | |
| Maintenance Per Engine Manual | As Recommended By Manufacturer | | | |
| Inspect Water Hoses | X | X | X | X |
| Check Propeller For Nicks | | | | X |
| Inspect Thru-Hulls For Leaks | X | X | X | X |
| Inspect Seacocks For Leaks | X | X | X | X |
| Check Exhaust For Leaks | X | X | X | X |
| Check Trim Reservoir Levels | X | X | | X |
| Check Engine Oil | X | X | X | X |
| Check Drive/Transmission Oil | X | X | X | X |
| Check Power Steering Fluid | X | X | X | X |

Chapter 8

| COMPONENT/SYSTEM | TYPE A | TYPE B | TYPE C | TYPE D |
|-----------------------------------|--------|--------|--------|--------|
| Remote Control System | | | | |
| Check Throttle/Shift Adjustment | | X | X | X |
| Test Neutral Safety Switch | | X | | X |
| Lubricate Control Cables | | | | X |
| Lubricate Remote Control Box | | | | X |
| Lubricate Shift Cable (I/O) | | | | X |
| Check Control Box Fasteners | | X | | X |
| Steering System | | | | |
| Check Steering Cable Helm Nut | | X | | X |
| Inspect Steering Cable For Cracks | | X | X | X |
| Lubricate Components | | X | | X |
| Check Steering Wheel Nut | | X | | X |
| Electrical System | | | | |
| Inspect/Clean Battery | | X | | X |
| Check 12 volt wiring connections | | X | | X |
| Fuel System | | | | |
| Clean Engine Fuel Filters | | X | X | X |
| Check Hoses/Chafing & Leaks | X | X | X | X |
| Check Static Ground Wire At Fill | | | | X |

Cosmetic Care & Maintenance

| COMPONENT/SYSTEM | TYPE A | TYPE B | TYPE C | TYPE D |
|--|-----------|-----------|-----------|-----------|
| Fresh Water & Waste System | | | | |
| Flush Entire System & Tank | | | | X |
| Clean Pressure Pump Filter | | X | | X |
| Inspect System For Leaks | | X | | X |
| Sanitize Waste System | | X | | X |
| Spray Down Pump-Out Hose (Optional Equipment) | | X | | X |
| Bilge System | | | | |
| Check Hull Drain Plug Tightness | X | X | X | X |
| Check Bilge Pump Operation | X | X | X | X |
| Check Automatic Float Operation | X | X | X | X |
| Check Bilge Blower Operation | X | X | X | X |
| Check Blower Hoses For Kinks | X | X | X | X |
| Check Auto Fire Ext. Operation (Optional Equipment) | | X | X | X |



Chapter 9

Troubleshooting

DIAGNOSTIC CHARTS

The following diagnostic charts will assist you in identifying minor electrical, electronic, fuel, and mechanical problems. Some of the items listed require technical training and tools. Additional assistance is available in the engine manufacturer's manual. Also, you can contact your closest Regal dealer or marine professional for more information. Many times the root cause of a problem can be found by a step by step process of elimination.

| |
|---|
|  CAUTION |
| AVOID BODILY INJURY AND PROPERTY DAMAGE! SOME EQUIPMENT CONTAINS HIGH VOLTAGE. USE CAUTION WHEN TROUBLESHOOTING ELECTRICAL COMPONENTS. |

| |
|--|
|  CAUTION |
| AVOID BODILY INJURY AND PROPERTY DAMAGE! USE ONLY APPROVED MARINE REPLACEMENT PARTS. |

| |
|--|
|  WARNING |
| AVOID BODILY INJURY AND DEATH! BEFORE PERFORMING ANY MAINTENANCE WORK TURN OFF THE BATTERY SWITCH AND REMOVE THE KEYS FROM THE IGNITION SWITCH. |

Chapter 9

| REMOTE CONTROL DIAGNOSTIC CHART | | |
|---|--|---|
| PROBLEM | POSSIBLE CAUSE | POSSIBLE FIX |
| Remote control stiff/inoperative | Corroded cable | Clean/lubricate cable |
| | Kinked cable | Replace cable |
| | Broken cable | Replace cable |
| | Remote control box jammed | Repair/Replace box |
| Throttle only control inoperative (neutral) | Worn throttle cable | Replace cable |
| | Binding cable | Follow cable routing; look for pinched cable |
| | Broken cable | Replace cable |
| | Control box worn or in need of lubrication | Refer to information supplied by control mfg. |

INSTRUMENT DIAGNOSTIC CHART

| PROBLEM | POSSIBLE CAUSE | POSSIBLE FIX |
|--|---|--|
| No reading on gauge or gauge reads wrong | Faulty gauge Wiring to gauge faulty Faulty sender | Replace gauge Inspect/repair wiring Replace sender |
| Gauge reads erratic | Loose ground or hot wire | Repair or replace wire and or connection |

Chapter 9

FUEL SYSTEM DIAGNOSTIC CHART

| PROBLEM | POSSIBLE CAUSE | POSSIBLE FIX |
|---|---------------------------------------|---|
| Engine won't start or not running right | Fuel tank vent obstructed | Clean vent hose or and fitting. Check for kinks. |
| | Fuel line blocked | Check for kinked hose |
| | Lack of fuel | Clean filter. Check for clogged anti-siphon valve (Call dealer) |
| | Water in fuel | Eliminate water |
| | Clogged engine water separator filter | Replace filter element |
| | No fuel reaching engine | Check fuel pump output. Clean filters. Check fuel tank gauge level. |

PERFORMANCE DIAGNOSTIC CHART

| PROBLEM | POSSIBLE CAUSE | POSSIBLE FIX |
|---------------------|--------------------------------|--|
| Excessive vibration | Material obstructing propeller | Remove material by reversing engine |
| | Bent propeller shaft | Call Regal dealer |
| | Bent propeller blade | Repair/replace propeller |
| | Bent rudder or strut | Call Regal dealer |
| | Loose motor mount | Call Regal dealer |
| Poor performance | Hull bottom has buildup | Clean bottom |
| | Uneven load distribution | Adjust boat load Adjust ballast tanks |
| | Engine problem | Call Regal dealer |

Chapter 9

DC ELECTRICAL DIAGNOSTIC CHART

| PROBLEM | POSSIBLE CAUSE | POSSIBLE FIX |
|---|----------------------------------|---------------------------------------|
| No 12 volt power | Battery switch in "off" position | Turn selector switch to "on" position |
| | Weak or dead battery | Charge or replace battery |
| Battery not charging; (Engine running) | Loose belt | Tighten belt |
| | Faulty alternator | Repair/Replace alternator |
| Battery will not hold charge | Faulty volt meter | Replace volt meter |
| | Faulty/Old battery | Replace battery |
| 12 volt equipment not working | Equipment switch "off" | Switch to "on" position |
| | Circuit breaker blown | Push reset on circuit breaker |
| | Weak or dead battery | Replace battery |
| | Corroded connection | Eliminate corrosion |
| | Loose wire | Tighten connection |
| Internal equipment short | Replace equipment | |

| AC ELECTRICAL DIAGNOSTIC CHART | | |
|---|--|--|
| PROBLEM | POSSIBLE CAUSE | POSSIBLE FIX |
| No AC power | Main shore power inlet breakers tripped or off Power at dock off Shore power cord not connected Faulty connection | Energize shore power inlet breakers Activate dock box power Plug in shore power: twist to lock Repair as needed |
| No power to AC outlets & equipment | Main breakers at AC control panel tripped or off Shore power not connected GFIC tripped | Activate main breakers or reset Plug in cord Reset GFIC |
| Main breaker continues to trip | Faulty main breaker | Contact dealer |
| Inadequate AC power with genset running | Electrical demand greater than electrical output | Turn off equipment as needed |

Chapter 9

FRESH WATER SYSTEM DIAGNOSTIC CHART

| PROBLEM | POSSIBLE CAUSE | POSSIBLE FIX |
|---|--|--|
| Air In System | Water Tank Empty | Fill Tank. With Pump On Bleed Air From Lines Until Water Flows Out. |
| Fresh Water Pump Cycles On And Off | Leak In Water System | Locate Water Leak And Repair. |
| No Water At Shower Or Sinks With Faucets On Water Tank Empty | Fresh Water Pump Breaker Off Fill Water Tank Blocked/Pinched Lines Loose Or Disconnected Wire | Switch Breaker To On Clear Obstruction Or Straighten Line. Check Connections: Tighten As Needed. Contact Your Dealer. |
| Low Water Pressure At All Sinks And Shower | Defective Pump | Contact Your Dealer. |
| Low Water Pressure At One Sink | Pinched Or Plugged Water Line | Straighten Or Blow Out Line |

| VACUFLUSH HEAD DIAGNOSTIC CHART | | |
|--|--|--|
| PROBLEM | POSSIBLE CAUSE | POSSIBLE FIX |
| Water will not stay in bowl. | Loose clamp ring. Improper seal around flush ball or debris on underside of Teflon seal. Worn or damaged seal or flush ball. | Tighten clamp ring adjusting nut Look for foreign objects at flush ball. Replace seal or flush ball. |
| Toilet overflows. | Dirt stuck in water valve seal or bad seal. Cam strap bent down holding valve open. | Clean water valve or replace. Bend front of strap up 1/16" |
| Water does not enter toilet bowl properly. | Low water pressure. Water valve clogged. | Check incoming pressure. Clean filter on water valve inlet. |
| Water leaking at water valve. | Loose connection. Worn or defective water valve. | Tighten cap, inlet fitting, clamp Replace water valve. |
| Water leaking at bowl rear. | Loose hose connection. Loose or worn vacuum breaker. | Tighten connection. Tighten/Replace vacuum bkr. |
| Pump runs alot between flushes. | Flush ball leaks. Vacuum line leaks. Duckbill valves in pump not sealing. Pump bellows in vacuum generator worn. | See problems 1 & 2. Tighten all hose connections at toilet and vacuum generator. Inspect all duckbill valves for poor sealing. Inspect for small hole or rip. |
| Toilet will not flush. | Plugged vacuum line, vacuum pump discharge or intake lines. Duckbill valves inverted to clogged discharge line or seacock | Clear line(s). Replace valves. |

Chapter 9

VACUFLUSH HEAD DIAGNOSTIC CHART CON'T.

| PROBLEM | POSSIBLE CAUSE | POSSIBLE FIX |
|---|--|--|
| Pump will not run. | No power. Loose or broken electric wire. Faulty vacuum switch. Faulty motor. | Check input power, breaker and fuse. Check wires at pump, vac. generator, vacuum switch (B terminal conn). Short across B terminals w/ jumper. Replace motor. |
| Pump will not shut off. | Insufficient vacuum. Excessive vacuum leak. See pump running between flushes. Faulty vacuum switch. | Check for 10 inches of vacuum. Check by removing one of B wires. |
| Pump running too slow, overheating, or blowing breaker. | Improper voltage. Loose or broken wire. Discharge line blocked causing back pressure. Plugged or defective duckbill valve. | Check input voltage. Find & replace wire. Check lines/seacock. Clean discharge line. Clean duckbill valve or replace parts. |
| Pump emits odor. | Loose or defective hose connection on pump. Loose intake or discharge fittings on pump. Worn, torn or punctured pump bellows or diaphragm. | Tighten connections or replace hose. Tighten all fittings on pump or replace all nipples & adapters if necessary. Replace pump bellows or diaphragm. |
| Blockage between toilet and vacuum generator. | Collapsed or kinked vacuum line. Flushing foreign objects down toilet. | Inspect & repair vacuum lines. Do not flush non-dissolving objects or excessive tissue down toilet. |

| AIR CONDITIONER DIAGNOSTIC CHART | | |
|---|--|--|
| FAULT | POSSIBLE CAUSE | POSSIBLE FIX |
| A/C will not start | Circuit breaker off | Turn on at ship's main AC panel |
| | Shorepower voltage at dock too low | Check AC input voltage at ship's main AC volt meter |
| No cooling or heating | Temperature set too low or too high | Raise or lower temperature as required |
| | Control program for heat or cool | Reprogram for heat, cool or automatic |
| | Obstructed sea water flow | Clean sea water strainer Check hose output flow |
| | Sea water pump has air lock | Remove hose from pump discharge to remove airlock |
| Fan is not running | Air flow blocked | Locate obstruction, clean return filter and grill |
| Coil is iced over | Thermostat set too low | Raise thermostat |
| | Improper air flow | Clean return air filter; remove obstructions, check for restricted ducting |
| HHH is displayed | High pressure switch open Not enough sea water flow | Check seacock, hoses, strainer, AC pump for restrictions |
| PPP is displayed | Low pressure switch is open | Restart AC unit |
| AC or heat runs continuously | Temperatures are set too low for cooling; too high for heating | Raise or lower set temperature |
| | Porthole, window, hatch or door open | Close all appendages |

Chapter 9

| REFRIGERATOR DIAGNOSTIC CHART | | |
|-------------------------------|--|---|
| PROBLEM | POSSIBLE CAUSE | POSSIBLE FIX |
| Refrigerator not cold | Compressor will not start | Make sure the breaker is activated at the main AC panel |
| | Thermostat set too high or on-off switch is off | Reset thermostat or activate on-off switch |
| | Compressor starts but does not cool fridge | Contact repair center |
| | Door latch not closing or seal not seated | Adjust latch or replace seal |
| | Condensor dirty | Remove fridge and clean coils with duster or vacuum |
| Not running on DC | Check for defective thermostat or converter, low battery | Replace thermostat, converter or battery |
| Not running on AC | Inadequate input voltage | Make sure proper voltage exists on ship's main AC panel |

DVD DIAGNOSTIC CHART

| PROBLEM | POSSIBLE CAUSE | POSSIBLE FIX |
|--------------------------------|--|--|
| No Sound | Poor connections at DVD player | Check to see DVD player is connected right |
| | TV not set up properly | Check TV settings |
| No picture | Poor connections at DVD player | Check to see DVD player is connected right |
| | AV 1 not selected on remote control | Select AV 1 |
| Unit does not play | No disc in player | Insert disc in player |
| | Disc installed upside down | Reinstall disc correctly |
| | Dics scratched, broke or excessively dirty | Replace disc |
| | Moisture in player | Dry out player by letting it stand 1 hour |
| Remote control not functioning | Object inbetween player and remote | Obtain clear pathway for remote |
| | Batteries weak or dead | Replace batteries |

Chapter 9

| TELEVISION DIAGNOSTIC CHART | | |
|--|---|--|
| PROBLEM | POSSIBLE CAUSE | POSSIBLE FIX |
| Screen is black. Power indicator is off. | TV breaker not activated | Activate TV breaker on ship's main AC panel. |
| | TV and/or DVD not turned on | Activate TV or DVD player |
| TV signal weak | TV antenna breaker not activated or wrong antenna button in use | Activate TV antenna breaker. Check antenna switch for proper signal button |
| Image too light or dark | Brightness or contrast improperly adjusted | Readjust brightness or contrast to owner's manual specs |
| Horizontal bars appear to flicker, jitter or shimmer on the image | Fine function not adjusted properly | Adjust fine function to owner's manual specs |
| Vertical bars appear to flicker, jitter or shimmer on the image | Coarse function not adjusted properly | Adjust coarse function Then adjust fine function |
| Screen is blank and power indicator light is steady amber or blinks every 1/2 or 1 seconds | Power management system being used | See power saver in owner's manual |
| Image not centered on screen | Horizontal or vertical adjustments off | Readjust horizontal or vertical controls |

✓ 2

Chapter 10

Storage & Winterization

NOTICE

YOUR WARRANTY DOES NOT COVER DAMAGE TO YOUR BOAT IF IT IS NOT PROPERLY STORED AND WINTERIZED. CHECK WITH A REGAL DEALER OR MARINE PROFESSIONAL ABOUT WINTERIZATION PROCEDURES.

NOTICE

REMOVE ALL BATTERIES WHEN VESSEL IS STORED FOR EXTENDED PERIODS.



WARNING

EXPLOSION, FIRE AND POLLUTION HAZARD!
DO NOT FILL FUEL TANK TO RATED CAPACITY. LEAVE ROOM FOR EXPANSION.

INTRODUCTION

Storage procedures are outlined in this chapter. These are general guidelines used over the winter months in colder climates. Be sure to familiarize yourself with all relevant information in the owner's packet. Special winterization procedures are necessary for the boat equipment and systems. Use the enclosed checklists to assist you in identifying areas of concern and maintenance. These lists cover land stored boats either inside or outside. Contact your Regal dealer for additional information.

DECOMMISSIONING CHECKLIST

ENGINE

- Run engine. Pour a fuel stabilizer/conditioner in the fuel tank. Allow time for it to circulate through the fuel system.
- Change all engine fluids as referenced in the engine manufacturer's owners manual.
- Drain cooling and exhaust system or have a marine professional "pickle" the engine with antifreeze and rust preventative.
- Spray all exterior parts with a rust preventative.



Chapter 10

STERN DRIVE

- Change engine and stern drive oil along with steering fluids.
- Remove drive. Perform maintenance as referenced in the manufacturer's owners manual including checking seals for vacuum and pressure at an authorized dealer.
- Check all belts for wear and tension.
- Remove propeller. Refurbish as needed.
- Touch up paint on stern drive upper and lower gear housings as required.
- Apply rust inhibitor to driveshaft & universal joints.
- Check exhaust, fuel, and cooling systems for leaks.
- Keep the unit trimmed down to assist in draining any water still in the exhaust system. Also, this position allows the universal to set without extra pressure on the bearings.

BOAT

- Check hull bottom for any fiberglass damage. Repair as needed.
- Apply marine wax to hull and deck surfaces.
- Pour a pint of 50/50 antifreeze into bilge pump.
- Remove batteries. Charge as needed.
- Remove all loose gear from boat such as life jackets, etc. Inspect and store in a cool, dry environment.
- Remove drain plug. Clean drain plug hole of debris as needed. Enclose drain plug in plastic bag and tie to steering wheel.
- Drain the waste system per instructions in this chapter. Make sure bow is higher than stern to permit proper drainage.
- Clean all upholstery and store in a dry environment.
- Conduct a visual inspection to ensure boat is balanced properly on the trailer, cradle or blocks.
- Cover boat with tarp. Tie down for wind protection if outside. Prop tarp up as needed to provide additional ventilation. Be sure not to cover up the fuel vents.
- Drain the fresh water system per instructions in this chapter

Storage & Winterization

ENGINES & GENERATOR:

The propulsion system is quite complex because of the numerous systems involved. It is recommended that your dealer or marina winterize your boat engines, generator and other systems. The Regal dealer has undergone extensive factory training covering a variety of Regal and related products. Also, the dealer is equipped with the parts and tools to perform the specialized winterization functions.

GENERAL NOTE ON ANTIFREEZE

Engine cooling fluids must be replaced with a marine antifreeze solution; mix antifreeze according to directions for the lowest expected temperature. The above method is much more reliable than just draining the engines and manifolds because sometimes pockets of water can form which can freeze in cold temperatures and cause engine damage. Draining the system fosters rust in engine parts. Remove the batteries and check the electrolyte level. Store in a cool, dry place. Monthly recharging or continuous trickle charging should be done to insure your batteries life during storage.

FUEL SYSTEM:

Fill the fuel tank below the capacity to minimize condensation but do not overfill. Leave enough space for fuel to expand and add a gasoline/fuel stabilizer to fuel prior to storage following the manufacturer's recommended procedures.

BATTERIES:

Remove the batteries and check the electrolyte level. Store in a cool, dry place. Monthly recharging or continuous trickle charging should be done to insure your batteries life during storage.

NOTICE

USE A SPECIAL NON-TOXIC ANTIFREEZE
IN THE FRESH WATER & WASTE SYSTEM
WHICH IS AVAILABLE AT RV &
MARINE DEALERS.

DO NOT USE AUTOMOVIVE TYPE
ANTIFREEZE. IT CAN BE HIGHLY
POISONOUS & CORROSIVE.



Chapter 10

FRESH WATER SYSTEM:

1. Turn on the fresh water pump switch.
2. Open all faucets including transom shower and allow tank to empty.
3. Drain the water heater; shut off water pump switch.
4. Mix nontoxic antifreeze with water in accordance with the manufacturer's recommendations.
5. Pour solution into the fresh water tank.
6. Turn on fresh water pump switch.
7. Open each cold water faucet one by one beginning with the one furthest away from the tank and purge the system until a steady stream flows from the faucet. Then close the faucet.
8. Repeat step 7 for hot water faucets.
9. Shut off water pump switch.
10. Pour a quart of antifreeze into shower drain. Run the shower pump until a steady stream flows from the discharge fitting.
11. Leave at least 2 gallons of antifreeze solution in the holding tank during storage.

WASTE/TOILET SYSTEM:

1. Pump out waste holding tank, flush the tank with fresh water and pump out again.
2. With antifreeze in the fresh water tank, operate head until antifreeze flows into bowl of head. Allow time between flushes for the vacuum to build up.
3. Operate macerator until antifreeze has a steady flow coming from the discharge fitting. Pour antifreeze solution in head and flush head as needed to produce enough flow to winterize the macerator.
4. Leave at least 2 gallons of antifreeze solution in the holding tank during storage.

AIR CONDITIONING:

1. Open seacock and allow water to drain if boat is out of the water. Clean out the seacock and close it.
2. Open top of strainer and fill with antifreeze solution.
3. Operate air conditioning pump refilling sea strainer with antifreeze as the level goes down.
4. Continue to operate pump until antifreeze flows out of thru-hull fitting.
5. Shut off air conditioning pump and install the sea strainer top.
6. Check all fasteners for proper tightness.



Chapter 11

Glossary & Index

Below is a brief list of nautical terms useful in everyday boating communications. For more detailed glossaries and nautical terminology, we recommend you check your local library.

GLOSSARY

Abeam: at right angles to the fore and aft line and off the boat

Aboard: on or in the boat

Above: the part of the boat on a bavin vessel which is above the interior of the boat

Aft, After: aft is the boat section toward the stern or back of the boat

Admidships: toward the center of the boat from either side to side or rear to front

Beam: the width of a boat at its widest part

Bilge: the lower interior of the hull of the boat

Bitter end: the end of a line also the end of an anchor line

Bow: the front, or forward part of the boat

Bulkhead: the vertical partition or wall of a boat

Cast off: to let go or release

Chine: the line fore and aft formed by the intersection of the side and bottom of the boat

Chock: deck fitting used to secure or guide anchor or tie lines

Cleat: deck fitting with protruding arms around which lines are secured

Cockpit: the seating space used to accommodate passengers

Cuddy: a small cabin in the fore part of the boat

Deck: the open flooring surface on which crew and passengers walk



Chapter 11

Draft: the depth from the waterline of the boat to the lowest part of the boat, which indicates how much water is required to float the boat

Fathom: a measurement of depth; one fathom equals six feet

Fender: a cushion hung from the side of a boat to prevent it from rubbing against a dock or against other boats

Fend off: to push off to avoid sharp contact with dock or other vessel

Fore: the part of the boat toward the bow or front

Freeboard: the height of the top side from the waterline to the deck at its shortest point. (The distance from the sheer or gunwale to the water)

Galley: cooking area

Gunwale: rail or upper edge of the side of the boat

Hatch: an opening in the deck to provide access below

Head: toilet

Hull: the part of the hull from the deck down

Keel: the lowest point of a boat; the backbone of the vessel

Knots: a measurement of speed indicating nautical miles per hour

Lee: the side opposite that from which the wind is blowing; the side sheltered from the wind

Leeward: the direction toward which the wind is blowing

PFD: personal Floatation device; required for each person aboard

Port: the left side of the boat when facing forward (an easy way to remember the difference between “port” and “starboard” is that both “port” and “left” have four letters)

Shank: the main body of an anchor

Sheer: the curve of the boat’s deck from fore to aft when seen from the side

Starboard: the right side of the boat when facing forward

Stern: the aft end of the boat

Stern drive: an inboard/outboard (IO) unit

Stringer: strengthening integral unit fastened from fore to aft inside the hull and fiberglass encapsulated for added strength: much like the skeleton system of our body

Top off: to fill up a tank

Transom: the vertical part of the stern.

Trim: the boat’s balance when properly loaded

Wake: the path of a boat left astern in the water

Glossary & Index

A

| | |
|-----------------------|------|
| AC Current | 5-10 |
| Accidents | 2-17 |
| Accident Reporting | 2-18 |
| Air Conditioner | 8-7 |
| Alcohol Myths & Facts | 2-17 |
| All Around Light | 7-25 |
| Amplifier | 7-14 |
| Anchoring | 6-11 |
| Audible Alarms | 4-2 |

B

| | |
|------------------|------|
| Battery | 5-1 |
| | 7-34 |
| | 8-18 |
| Battery Charger | 5-2 |
| Battery Isolator | 5-2 |
| Battery Switch | 5-2 |
| Bilge Pump | 5-6 |
| | 7-26 |
| | 7-34 |
| | 8-20 |
| Blower | 4-2 |
| | 5-4 |
| | 8-20 |
| Breakers | 5-8 |
| | 5-13 |
| Breast Lines | 6-6 |
| Bridge Clearance | 3-8 |

C

| | |
|-------------------------------|------|
| CD Changer | 7-15 |
| CD Player | 7-10 |
| Cabin Door | 7-33 |
| Canvas | 7-34 |
| | 8-4 |
| Carbon Monoxide | 2-14 |
| | 7-3 |
| | 8-7 |
| Carbon Monoxide Detector | 8-9 |
| Cardiopulmonary Resuscitation | 6-16 |
| Carpet | 8-1 |
| Center Windshield | 7-29 |
| Central Vacuum | 8-15 |
| Cockpit Aft Seating | 7-32 |
| Cockpit Forward Seating | 7-30 |
| Cockpit Table | 7-31 |
| Compass | 7-29 |
| Corian | 8-2 |
| Cosmetic Care | 8-1 |
| Controls | 4-3 |

D

| | |
|-------------------------------------|------|
| DVD Player | 7-19 |
| Dealer Responsibilities | 1-10 |
| Decommissioning | 10-1 |
| Depth Sounder | 4-4 |
| Diagnostic Charts (Troubleshooting) | 9-1 |
| Diesel Fuel Filter | 5-16 |
| Diesel Fuel Transfer Switch | 5-16 |
| Dinette To Sleeper Conversion | 7-23 |
| Direct Current (DC) | 5-1 |
| Direct Circuit Protection | 5-3 |
| Distress Signals | 2-7 |
| Diver's Flag | 2-19 |
| Docking | 6-8 |
| Dock Lines | 6-6 |
| Dockside Water Inlet | 7-7 |
| Door (Cabin) | 7-26 |
| Drain Plug | 6-2 |

E

| | |
|-------------------------|-----------|
| Electrical | 5-1 |
| | Technical |
| | 8-21 |
| Electrolysis | 8-18 |
| Electronics | 8-18 |
| Engine Alignment | 4-1 |
| Engine | 8-18 |
| | 9-1 |
| | 10-1 |
| Environmental Awareness | 6-15 |
| Equipment Operation | 7-1 |
| Exhaust | 2-14 |

F

| | |
|----------------------------------|------|
| Fenders | 6-5 |
| Fiberglass & Gelcoat Maintenance | 8-2 |
| Fire Extinguishers | 2-6 |
| Fire Extinguishing System | 8-17 |
| Fires | 6-14 |
| First Aid | 6-14 |
| Float Plan | 1-7 |
| Fresh Water System | 8-11 |
| Fresh Water Plumbing | 8-12 |
| Fresh Water Pressure Pump | 7-7 |
| Fresh Water Tank | 8-21 |
| Fresh Water Washdown | 7-7 |
| Fuel System | 5-16 |
| | 6-3 |
| | 7-32 |
| | 8-20 |
| | 9-1 |

G

| | |
|------------------------|------|
| Galvanic Isolator | 7-9 |
| | 8-14 |
| Gas Vapor Detector | 8-18 |
| Gathering Headway | 6-9 |
| Gelcoat Maintenance | 8-2 |
| General Boating Safety | 2-2 |
| Generator | 5-13 |
| | 8-25 |
| Getting Underway | 6-1 |
| Glossary | 11-1 |
| Grill | 7-32 |
| | 8-16 |
| GFIC | 8-15 |

H

| | |
|------------------------------|------|
| Hatch | 7-22 |
| Hatch (Auxillary Jumper Box) | 7-38 |
| Helm Seat | 7-30 |
| HIN | 1-3 |
| Horn | 2-10 |
| | 5-6 |
| | 3-2 |
| | 8-18 |
| Hot Water Heater | 7-8 |
| | 8-11 |
| Hull Bottom | 8-5 |
| Hypothermia | 6-15 |

I

| | |
|--------------------------------|------|
| Icemaker | 7-33 |
| Ignition Switch | 5-4 |
| Index | 11-1 |
| Instruments (Gauges) | 4-4 |
| International Distress Signals | 2-9 |

K

| | |
|-------|------|
| Knots | 6-13 |
|-------|------|

L

| | |
|---------------|------|
| Lights | |
| 2-10 | |
| | 5-6 |
| Ladder (Swim) | 7-41 |

M

| | |
|---------------------------------|------|
| Maneuvering | 6-9 |
| Maintenance Log | 8-30 |
| Maintenance Schedule | 8-27 |
| Maintaining PFD'S | 2-6 |
| Masthead Light | 7-29 |
| Mayday | 2-10 |
| Metal (Cleaning) | 8-5 |
| Mid Berth To Sleeper Conversion | 7-25 |
| Minimum Required Equipment | 2-13 |
| Monitor System | 7-4 |
| Mooring | 6-6 |

N

| | |
|-----------------------|------|
| Navigation Aids | 3-5 |
| Navigation Lights | 2-10 |
| Navigation Rules | 3-1 |
| Neutral Safety Switch | 4-8 |
| | 4-9 |

O

| | |
|----------------------------|------|
| Oil Spills | 2-10 |
| Overboard Discharge Pump | 8-21 |
| Overloading | 2-3 |
| Owner's Pouch/Document Box | 1-4 |
| Owner Responsibilities | 1-11 |

P

| | |
|-----------------------------|------|
| Personal Flotation Devices | 2-4 |
| Plastics | 8-1 |
| Playing a DVD Disc | 7-19 |
| Pollution Regulations | 2-10 |
| Porpoising | 5-21 |
| Portlight | 7-22 |
| Pre-departure questionnaire | 6-1 |
| Propellers | 4-3 |
| | 8-18 |
| Propulsion | 4-1 |
| | 8-22 |

R

| | |
|--------------------------|------|
| Refrigerator | 7-22 |
| | 7-26 |
| | 8-15 |
| Registration Information | 1-10 |
| Remote Control | 4-8 |
| | 4-9 |
| | 5-6 |
| | 8-13 |
| Right-Of-Way | 3-1 |
| Rules Of The Road | 3-1 |

S

| | |
|---------------------------|-----------|
| Safety Labels | 2-1 |
| Seawater Strainer | 8-25 |
| Seacocks | 7-1 |
| | 8-25 |
| Seating | 7-23 |
| | 7-26 |
| Shorepower | 5-10 |
| | 5-12 |
| | 7-9 |
| Shower Sump Pump | 8-9 |
| Shower head Access | 8-12 |
| Sling Markers | 7-38 |
| Sound Producing Devices | 2-10 |
| Specifications | Technical |
| Speedometer | 4-4 |
| Spotlight | 7-25 |
| | 8-17 |
| Spring Line | 5-11 |
| Strainer | 8-22 |
| Stern Line | 6-6 |
| Steering | 5-18 |
| | 8-21 |
| Stereo | 7-10 |
| Stereo Remote | 5-5 |
| Sunbrella Canvas Cleaning | 8-4 |
| Sump (Bilge) | 7-39 |
| Sun Pad | 7-28 |
| Swim Platform | 2-19 |
| | 7-41 |
| | 8-20 |
| Switches (DC) | 5-6 |
| | 5-8 |
| Switches (AC) | 5-14 |

T

| | |
|----------------------|------|
| Tachometer | 4-4 |
| Table | 7-23 |
| Technical Drawings | 12-3 |
| Television | 7-16 |
| Temperature Gauge | 4-4 |
| Towing | 6-12 |
| Transom Shower | 7-7 |
| Transom Switch Panel | 7-38 |
| Trim | 5-19 |
| Trim Tabs | 5-21 |
| Troubleshooting | 9-1 |

U

| | |
|------------|------|
| Upholstery | 7-23 |
| | 8-1 |

V

| | |
|--------------------------|------|
| VHF | 2-10 |
| VacuFlush Head | 8-10 |
| Ventilation | 4-2 |
| Vessel Information Sheet | 1-6 |
| Visual Distress Signals | 2-7 |
| Volt Gauge | 4-5 |

W

| | |
|------------------------|------|
| Warranty | 1-12 |
| Water Sports | 2-19 |
| Weather | 2-20 |
| Windlass | 7-27 |
| | 8-17 |
| Window Shades | 7-26 |
| Windshield Wiper/Latch | 7-29 |
| | 8-16 |
| Winterizing | 10-1 |

Z

| | |
|-------------|-----|
| Zipper Care | 8-5 |
|-------------|-----|

Notes



Chapter 12

Technical



TECHNICAL INFORMATION

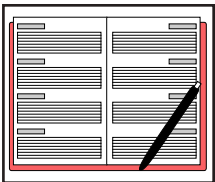

The following technical information is accurate up to the date of printing listed at the beginning of this manual. Note that all product specifications, models, standard and optional equipment, systems, along with the technical information is subject to change without notice. For more information contact your nearest authorized Regal dealer. For the location of your nearest authorized dealer call 407-851-4360 or you can contact Regal through the internet at : (www.regalboats.com). Your Regal dealer has received special factory training on the entire product line and his services should be employed to solve more technical problems.

Many of the technical drawings found in this chapter are actual product drawings from the Regal factory. These drawings should be of special interest in mechanical and electrical troubleshooting. The equipment in the drawings is discussed in various sections of this manual. Please read and understand the system and related drawings to help you solve a problem on your vessel. When all else fails contact your closest Regal dealer for assistance.



Chapter 12

| 35 SPORT COUPE SPECIFICATIONS | | |
|--|---------------|------------------|
| LENGTH OVERALL W/ PLATFORM | USA 36'10" | METRIC 11.23M |
| BEAM | 11' 4" | 3.45M |
| DEADRISE | 19 DEGREES | |
| APPROXIMATE DRY WEIGHT | 12,900LBS | 5851 Kg |
| BRIDGE CLEARANCE- TOP OF ARCH LIGHT | 9' 8" | 2.9 M |
| DRAFT-DOWN | 35" | 0.9M |
| FUEL CAPACITY | 168 GALS | 636 L |
| FRESH WATER CAPACITY | 50 GALS | 189 L |
| WASTE CAPACITY | 30 GALS | 114L |
| MAXIMUM CABIN HEADROOM | 6' 4" | 1.9 M |
| SLEEPING CAPACITY | 6 | |

Technical Information

3360 TYPICAL LABEL LOCATIONS

NOTICE
Retrieval of Windless Chain
 Winch operator may be required to periodically spread chain out within anchor locker

DANGER
 CARBON MONOXIDE (CO) IS A tasteless, colorless and invisible gas that can cause discomfort, severe illness and even death whenever carbon monoxide enters the cabin. CO is produced by engines in confined spaces or at improper air flow. NEVER ALLOW CO to accumulate in the cabin. CO detectors should be used to detect CO. NEVER TRAP IN AND AROUND THE COMBES OF YOUR BOAT, during use and when CO is not in use.

WARNING
 TRANSOM DOOR MUST BE CLOSED AND SECURE WHEN ENGINE IS RUNNING

CAUTION
 TO AVOID INJURY CENTER GLASS DOOR MUST BE SECURED IN A CLOSED AND LOCKED POSITION WHEN BOAT IS UNDERWAY. USE BOTH TURN LOCKS TO SECURE DOOR.



WARNING
 SECURE DOOR WHEN CRUISING
 DO NOT SIT, STAND OR PLACE HEAVY OBJECTS ON DOOR
 KEEP CABIN DOOR CLOSED WHEN ENGINES OR GENERATOR ARE RUNNING

POWER SWITCH AT BOW ANCHOR WINDLASS MUST BE IN OFF POSITION WHEN NOT IN USE.

Discharging of waste within the 3 mile U.S. coastal limit is prohibited by federal law. Shut off valve must be secured closed within U.S. Waters.

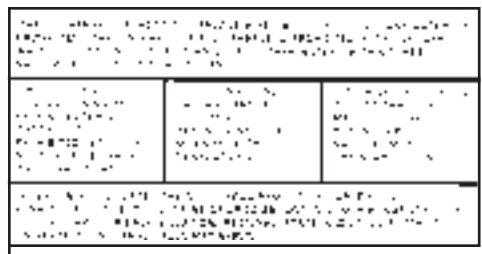

DISCHARGE OF OIL PROHIBITED
 THE FEDERAL WATER POLLUTION CONTROL ACT PROHIBITS THE DISCHARGE OF OIL OR OILY WASTE INTO OR UPON THE NAVIGABLE WATERS AND CONTIGUOUS ZONE OF THE UNITED STATES IF SUCH DISCHARGE CAUSES A FILM OR SHEEN UPON, OR DISCOLORATION OF THE SURFACE OF THE WATER, OR CAUSES A SLUDGE OR EMULSION BENEATH THE SURFACE OF THE WATER.
VIOLATORS ARE SUBJECT TO A PENALTY OF \$5,000

WARNING
 LEAKING FUEL IS A FIRE & EXPLOSION HAZARD. INSPECT SYSTEM REGULARLY.
 EXAMINE FUEL SYSTEM FOR LEAKS AT LEAST ANNUALLY

WARNING
 TO MINIMIZE SHOCK & FIRE HAZARDS:
 (1) TURN OFF THE BOAT'S SHORE CONNECTION SWITCH BEFORE CONNECTING OR DISCONNECTING SHORE CABLE.
 (2) CONNECT SHOREPOWER CABLE AT THE BOAT FIRST.
 (3) IF REVERSE POLARITY INDICATOR IS ACTIVATED, IMMEDIATELY DISCONNECT CABLE.
 (4) CLOSE SHOREPOWER INLET COVER TIGHTLY.
 (5) NEVER ALTER SHOREPOWER CABLE CONNECTIONS!

DANGER
 STOP ENGINE BEFORE BOARDING

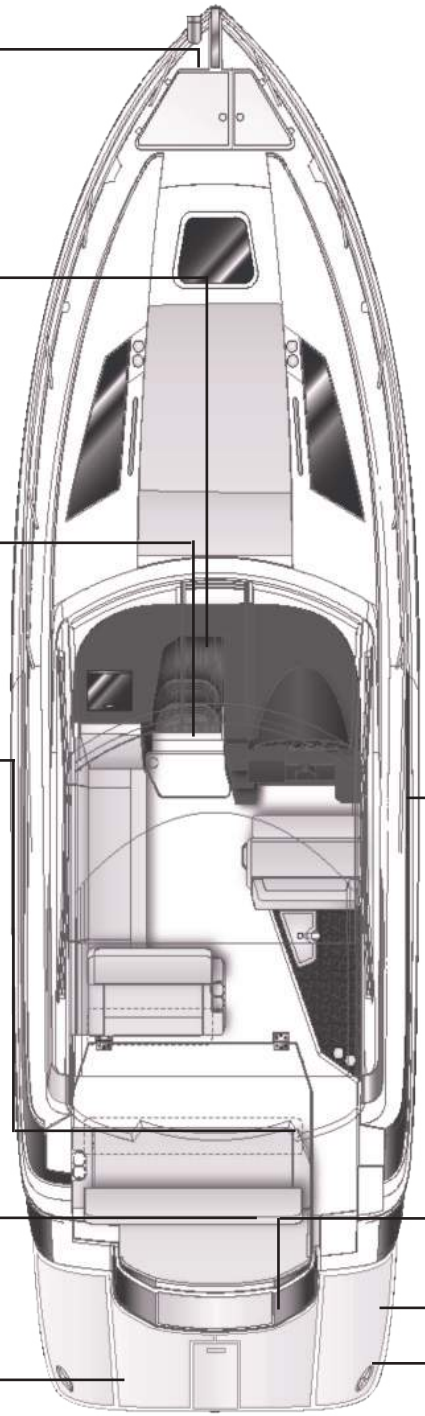

✓ Chapter 12

TYPICAL VACUFLUSH PLUMBING LAYOUT

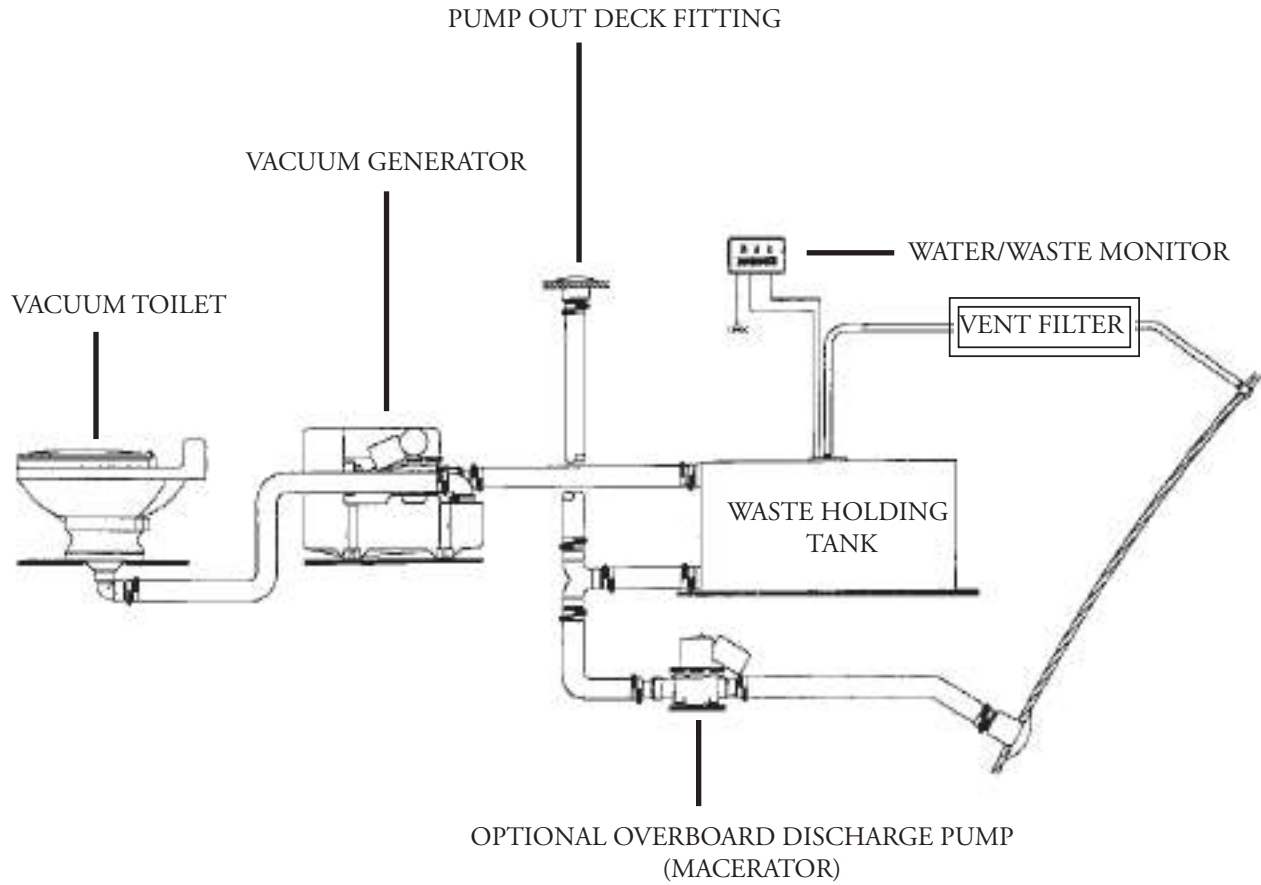

Technical Information

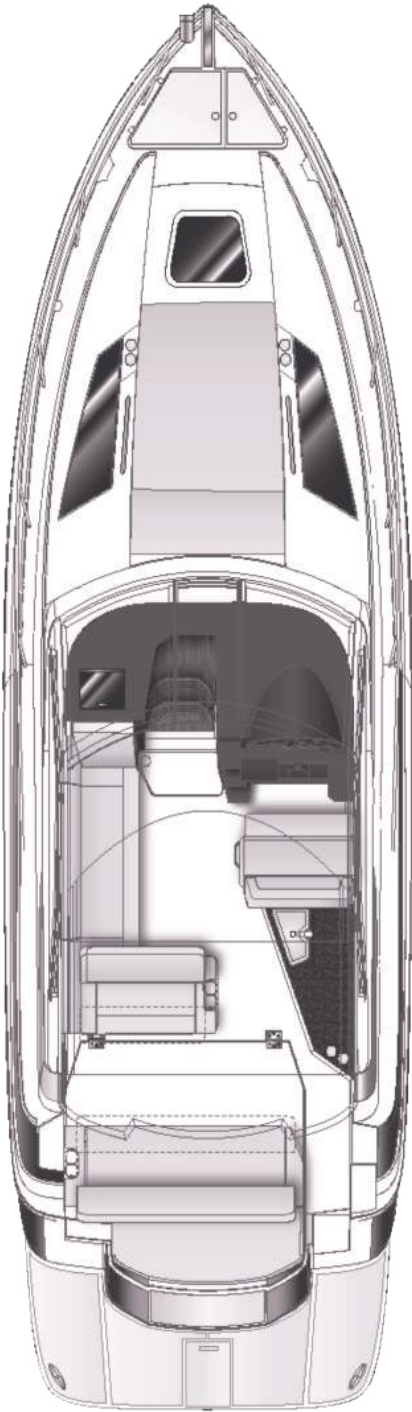

3360 Deck Overview

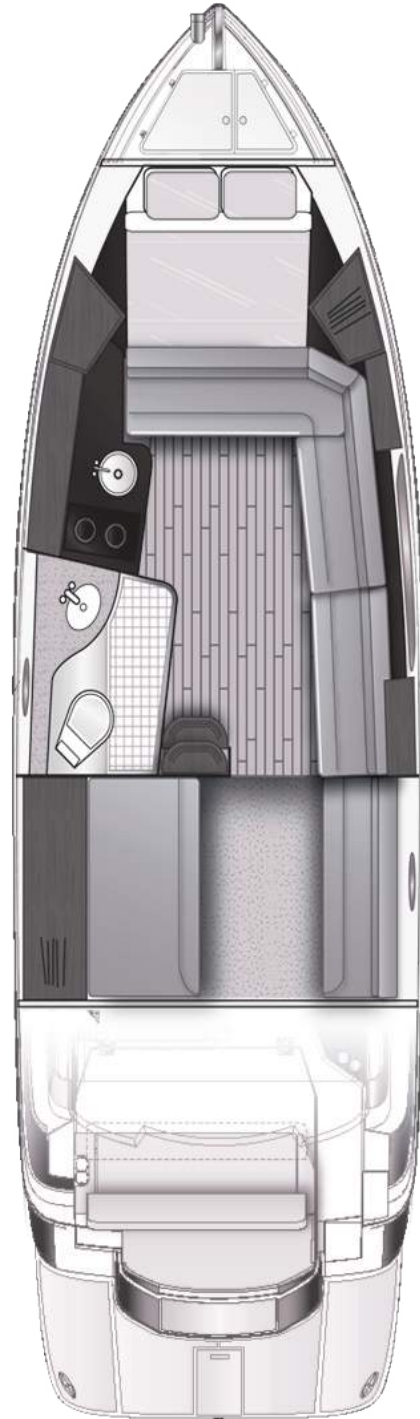

3360 Cabin Overview

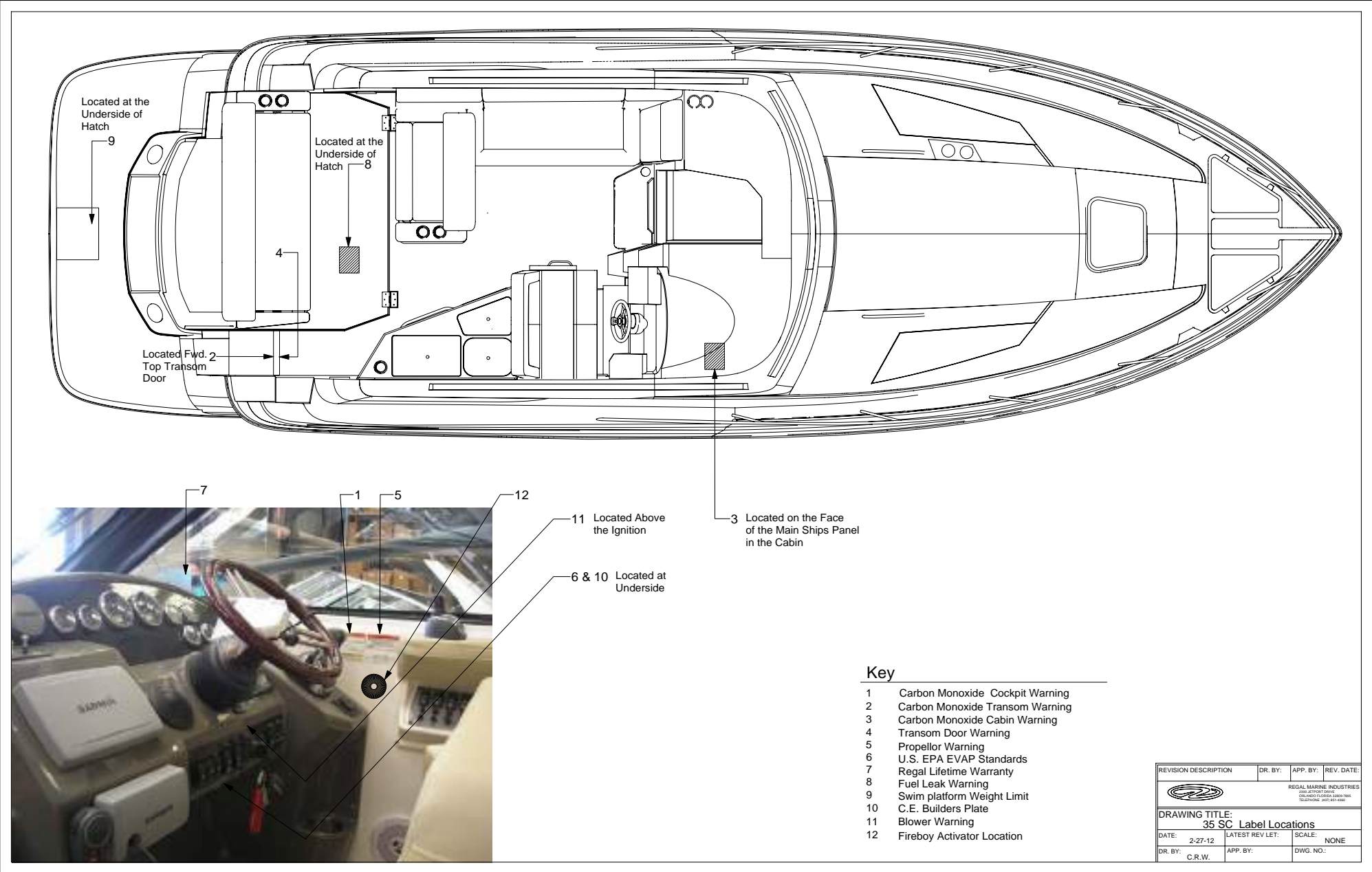

Key

- 1 Carbon Monoxide Cockpit Warning
- 2 Carbon Monoxide Transom Warning
- 3 Carbon Monoxide Cabin Warning
- 4 Transom Door Warning
- 5 Propellor Warning
- 6 U.S. EPA EVAP Standards
- 7 Regal Lifetime Warranty
- 8 Fuel Leak Warning
- 9 Swim platform Weight Limit
- 10 C.E. Builders Plate
- 11 Blower Warning
- 12 Fireboy Activator Location

| REVISION DESCRIPTION | DR. BY: | APP. BY: | REV. DATE: |
|--|-----------------|-------------|------------|
|  <small>REGAL MARINE INDUSTRIES 3801 WINDY HAVEN ORLANDO, FLORIDA 32835-7868 TEL: 407-321-5500</small> | | | |
| DRAWING TITLE: 35 SC Label Locations | | | |
| DATE: 2-27-12 | LATEST REV LET: | SCALE: NONE | |
| DR. BY: C.R.W. | APP. BY: | DWG. NO.: | |

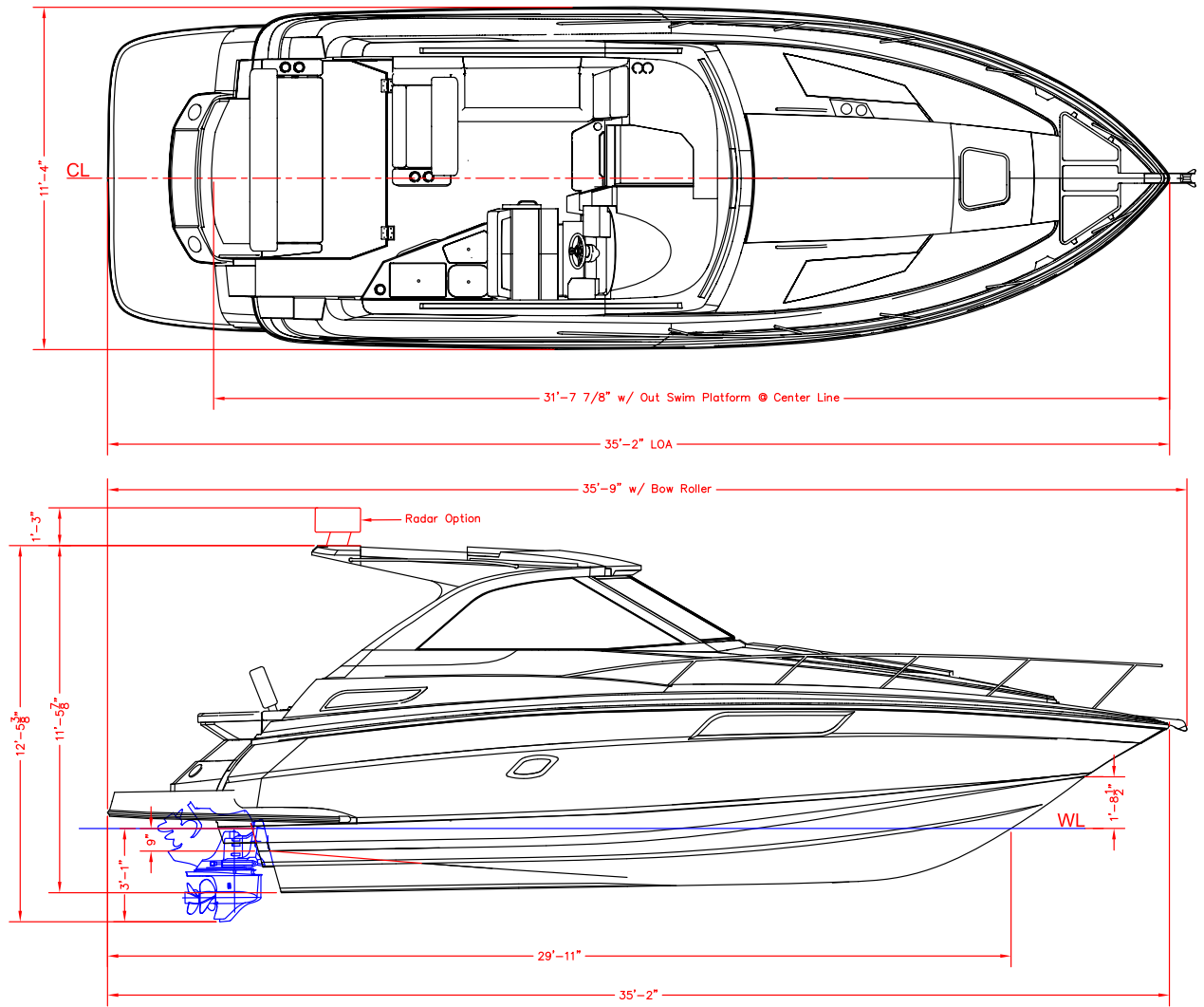

| REVISION DESCRIPTION | DR. BY: | APP. BY: | REV. DATE: |
|---|---------|---|-------------|
|  | | <small>REGAL MARINE INDUSTRIES 2500 KENNEDY BLVD. DADE COUNTY, FLORIDA 33024-9905 TELEPHONE: (407) 971-9300</small> | |
| DRAWING TITLE: 35 SC Overall Dimensions | | | |
| DATE: | 2-29-12 | LATEST REV LET: | SCALE: None |
| DR. BY: | C.W. | APP. BY: | DWG. NO.: |

Technical Information

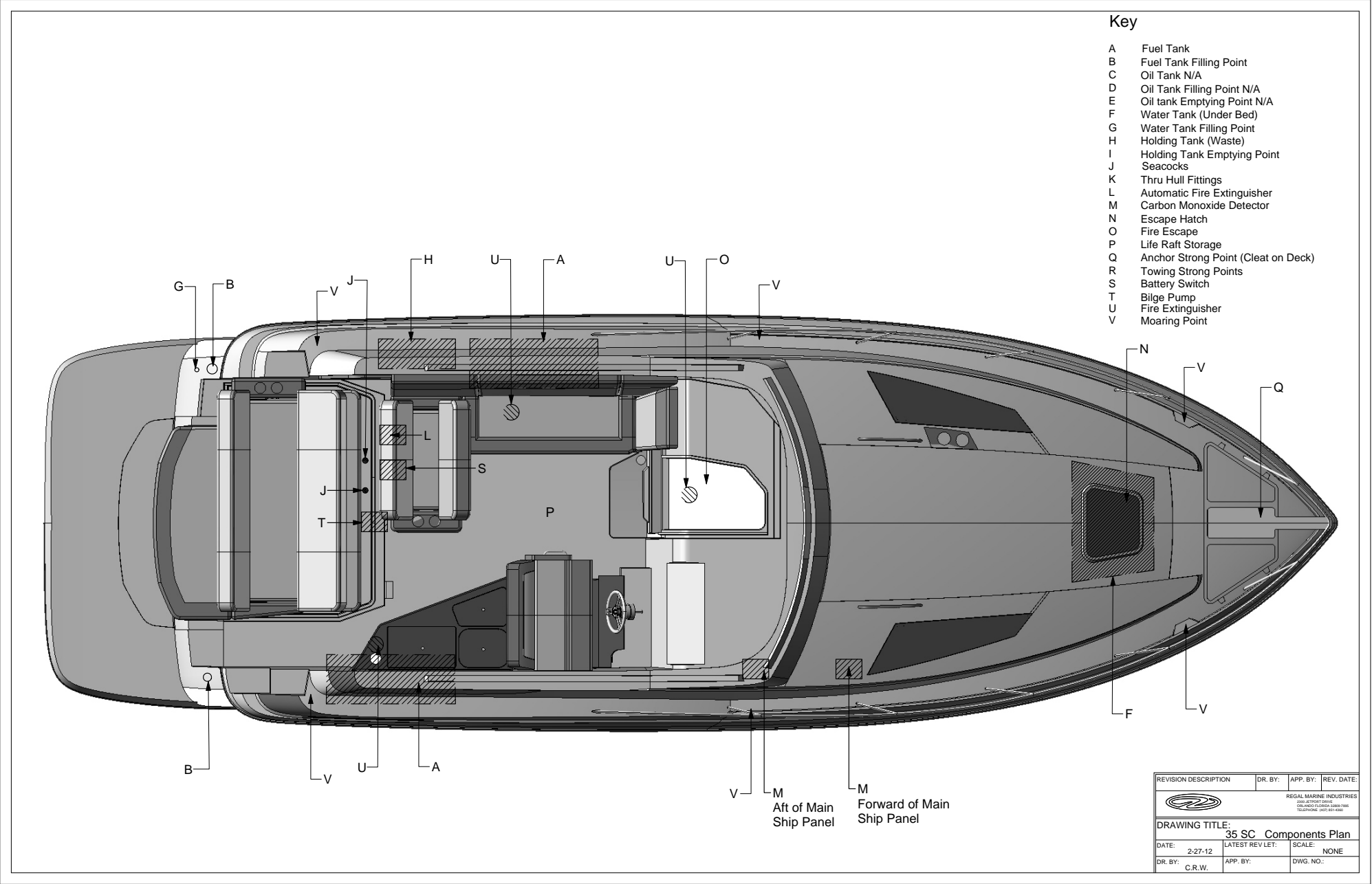

| REVISION DESCRIPTION | DR. BY: | APP. BY: | REV. DATE: |
|---|-----------------|-----------|------------|
|  REGAL MARINE INDUSTRIES 2001 AIRPORT DRIVE OCEANOGRAPHY, FLORIDA 32061-7000 TELEPHONE: (904) 851-4300 | | | |
| DRAWING TITLE: | | | |
| 35 SC Components Plan | | | |
| DATE: 2-27-12 | LATEST REV LET: | SCALE: | NONE |
| DR. BY: C.R.W. | APP. BY: | DWG. NO.: | |

Technical Information

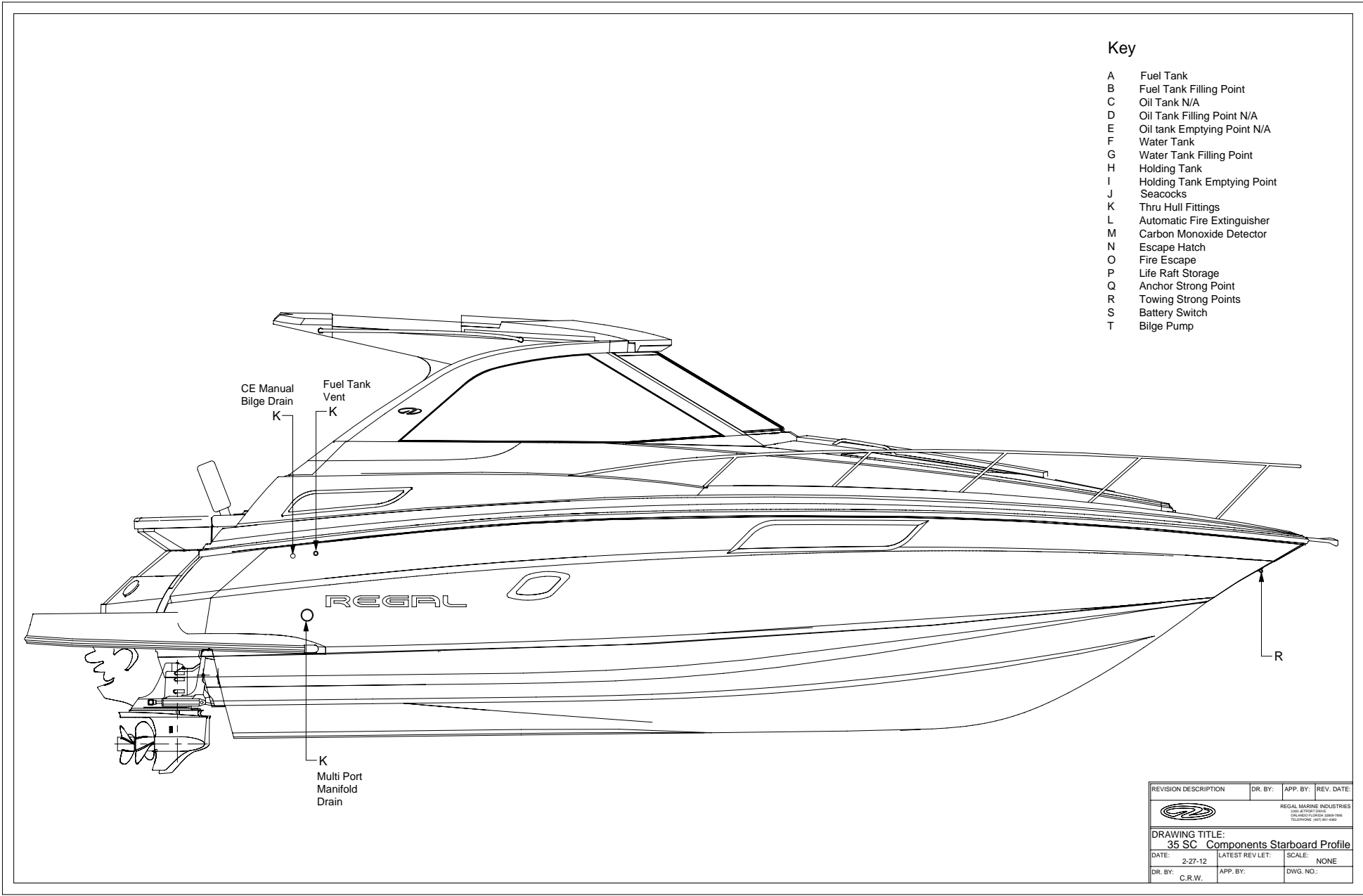

- Key**
- A Fuel Tank
 - B Fuel Tank Filling Point
 - C Oil Tank N/A
 - D Oil Tank Filling Point N/A
 - E Oil tank Emptying Point N/A
 - F Water Tank
 - G Water Tank Filling Point
 - H Holding Tank
 - I Holding Tank Emptying Point
 - J Seacocks
 - K Thru Hull Fittings
 - L Automatic Fire Extinguisher
 - M Carbon Monoxide Detector
 - N Escape Hatch
 - O Fire Escape
 - P Life Raft Storage
 - Q Anchor Strong Point
 - R Towing Strong Points
 - S Battery Switch
 - T Bilge Pump

| REVISION DESCRIPTION | DR. BY: | APP. BY: | REV. DATE: |
|--|------------------|-------------|------------|
|  REGAL MARINE INDUSTRIES 1000 WEST 12TH AVE. SUITE 1000 DENVER, CO 80202-1500 TELEPHONE (303) 861-6366 | | | |
| DRAWING TITLE: | | | |
| 35 SC Components Starboard Profile | | | |
| DATE: 2-27-12 | LATEST REV. LET: | SCALE: NONE | |
| DR. BY: C.R.W. | APP. BY: | DWG. NO.: | |

Technical Information

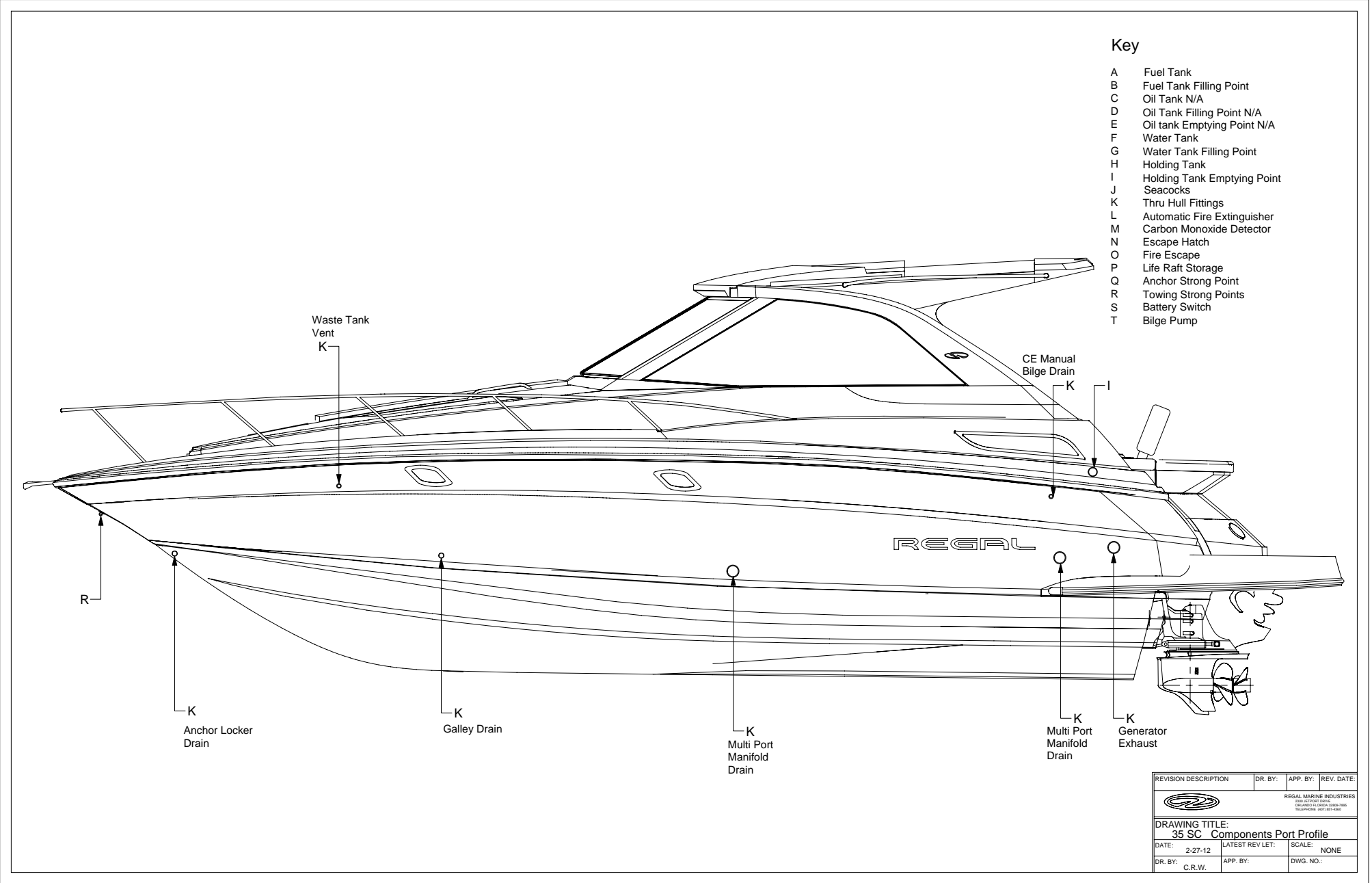

- Key**
- A Fuel Tank
 - B Fuel Tank Filling Point
 - C Oil Tank N/A
 - D Oil Tank Filling Point N/A
 - E Oil tank Emptying Point N/A
 - F Water Tank
 - G Water Tank Filling Point
 - H Holding Tank
 - I Holding Tank Emptying Point
 - J Seacocks
 - K Thru Hull Fittings
 - L Automatic Fire Extinguisher
 - M Carbon Monoxide Detector
 - N Escape Hatch
 - O Fire Escape
 - P Life Raft Storage
 - Q Anchor Strong Point
 - R Towing Strong Points
 - S Battery Switch
 - T Bilge Pump

| REVISION DESCRIPTION | DR. BY: | APP. BY: | REV. DATE: |
|--|-----------------|-----------|------------|
|  REGAL MARINE INDUSTRIES 200 W. 10TH STREET DELANDO FL 32020 3846-1100 TELEPHONE: 386-321-4841 | | | |
| DRAWING TITLE: | | | |
| 35 SC Components Port Profile | | | |
| DATE: | LATEST REV LET: | SCALE: | |
| 2-27-12 | | NONE | |
| DR. BY: | APP. BY: | DWG. NO.: | |
| C.R.W. | | | |

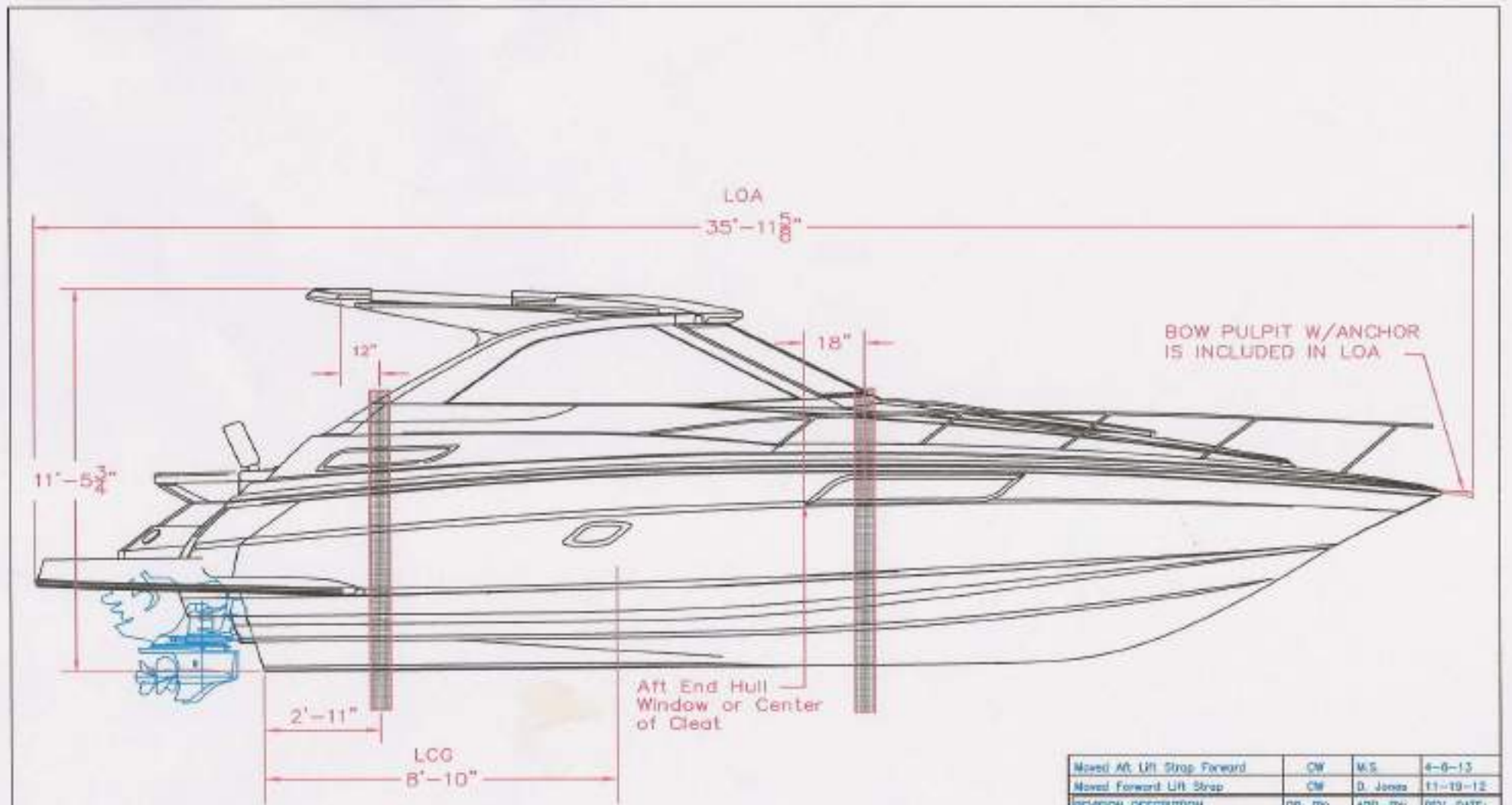

Note: Before lifting vessel ensure that all straps are located at the sling marker positions as found on the deck. Measure for the above strap width positions before lifting the vessel. Tie a line between front and rear straps on both sides to prevent the vessel straps from moving during the lift operation.

| | | | |
|---|-----------------|---|------------|
| Moved Aft Lift Strap Forward | CW | M.S | 4-9-13 |
| Moved Forward Lift Strap | CW | D. Jones | 11-19-12 |
| REVISION DESCRIPTION | DR. BY: | APP. BY: | REV. DATE: |
| | | <small>REGAL HOME INDUSTRIES 2200 JENNIFER DRIVE ORLANDO FLORIDA 32808-1982 TELEPHONE: (407) 871-4300</small> | |
| DRAWING TITLE: 35SC LIFT STRAP LOCATIONS | | | |
| DATE: 01-04-11 | LATEST REV LET: | SCALE: | NONE |
| DR. BY: C.W. | APP. BY: | OWC. NO.: | MVH250 |

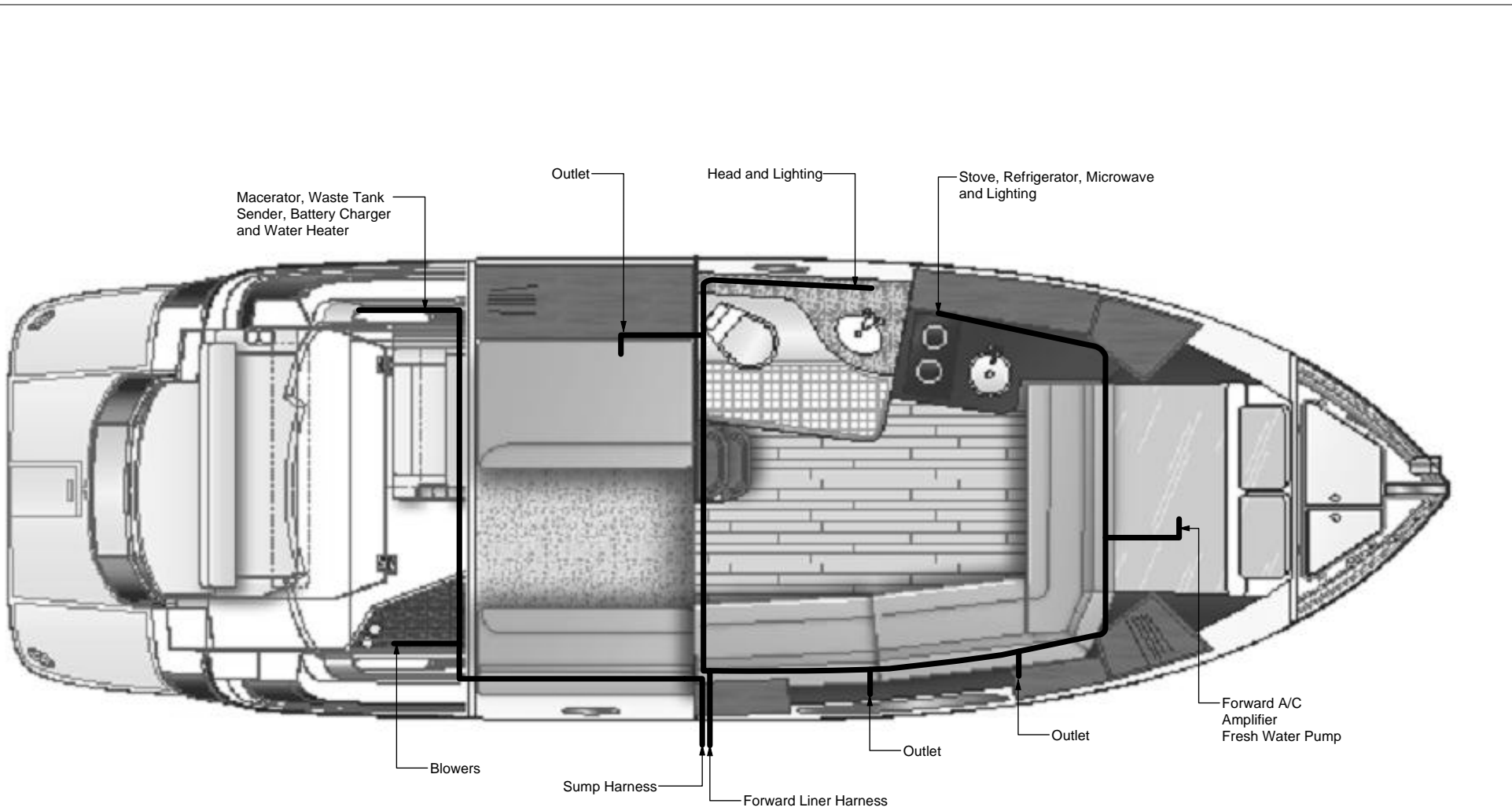

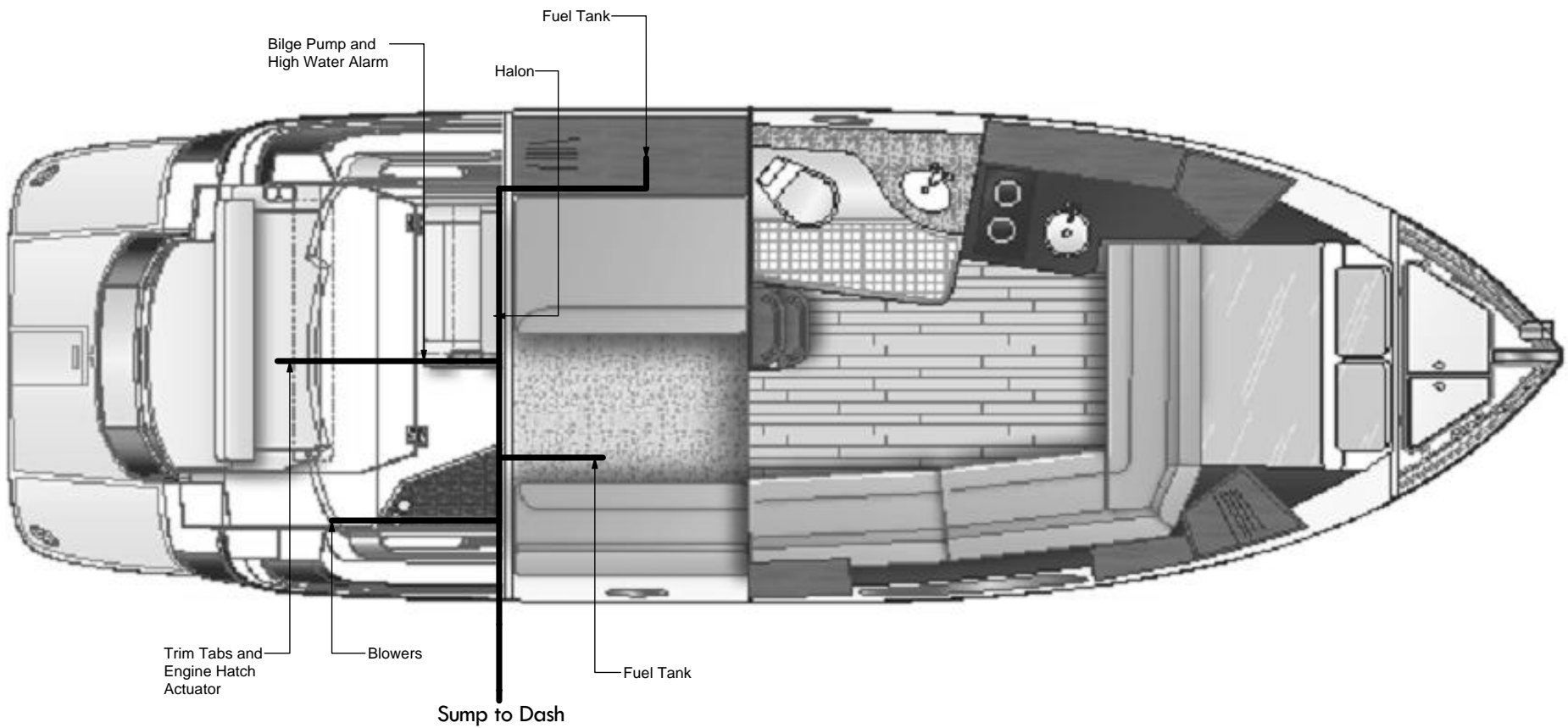

Main Distribution Panel

| REVISION DESCRIPTION | DR. BY: | APP. BY: | REV. DATE: |
|--|-----------------|----------------|--------------|
|  | | | |
| REGAL MARINE INDUSTRIES 2300 AIRPORT DRIVE ORLANDO FLORIDA 32803-7800 TELEPHONE: (407) 851-4300 | | | |
| DRAWING TITLE: 35SC Hull Electrical Harness Routing | | | SHEET 1 OF 2 |
| DATE: 8-22-12 | LATEST REV LET: | SCALE: None | |
| DR. BY: C.R.W. | APP. BY: MJ | DWG. NO.: | |

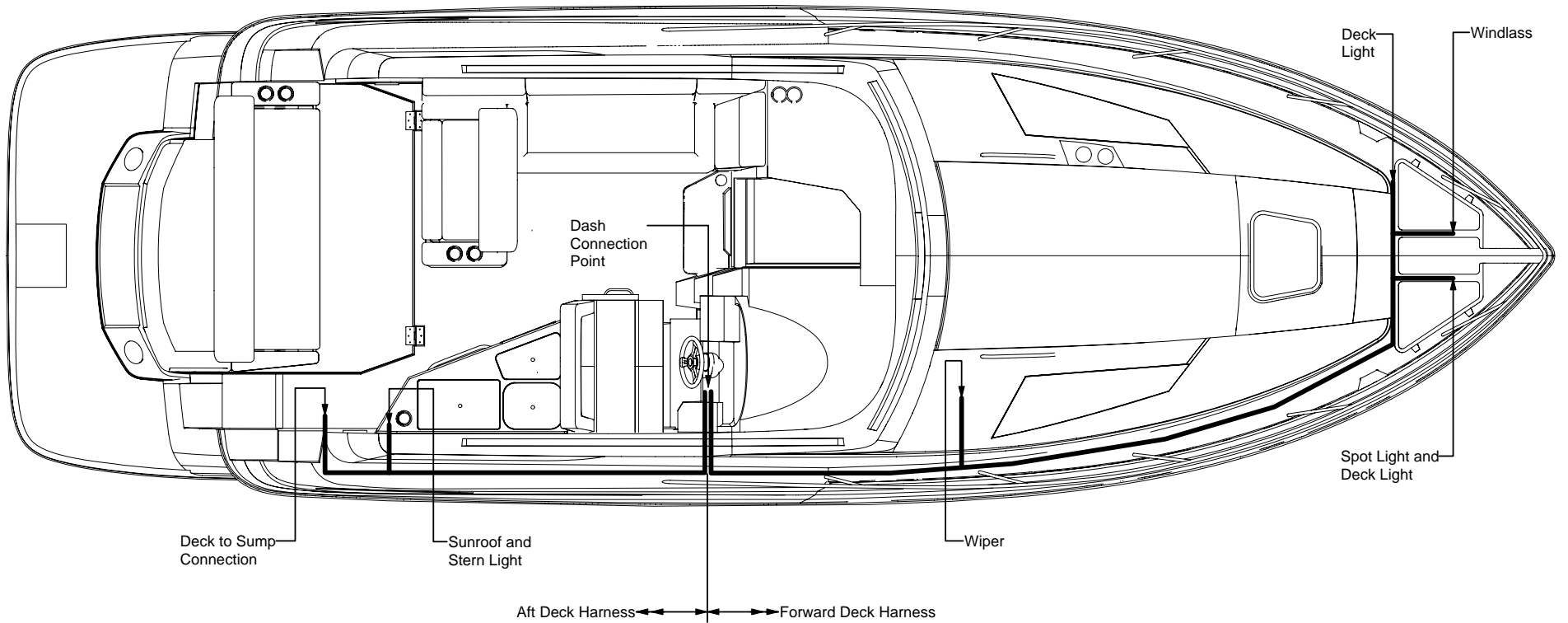

| REVISION DESCRIPTION | DR. BY: | APP. BY: | REV. DATE: |
|---|-----------------|--------------|------------|
|  | | | |
| <small>REGAL MARINE INDUSTRIES 2300 AIRPORT DRIVE ORLANDO, FLORIDA 32807-7855 TELEPHONE: (407) 811-4300</small> | | | |
| DRAWING TITLE: | | SHEET 2 OF 2 | |
| 35SC Hull Sump Electrical Harness Routing | | | |
| DATE: | LATEST REV LET: | SCALE: | |
| 8-22-12 | | None | |
| DR. BY: | APP. BY: | DWG. NO.: | |
| C.R.W. | MJ | | |



| REVISION DESCRIPTION | DR. BY: | APP. BY: | REV. DATE: |
|---|-----------------|-------------|------------|
|  REGAL MARINE INDUSTRIES 250 WEST 10TH AVE DELAND FL 32020-1100 TELEPHONE: 386-324-6600 | | | |
| DRAWING TITLE: | | | |
| 35 SC Deck Electrical Harness Routing | | | |
| DATE: 8-21-12 | LATEST REV LET: | SCALE: NONE | |
| DR. BY: C.R.W. | APP. BY: M.J. | DWG. NO.: | |

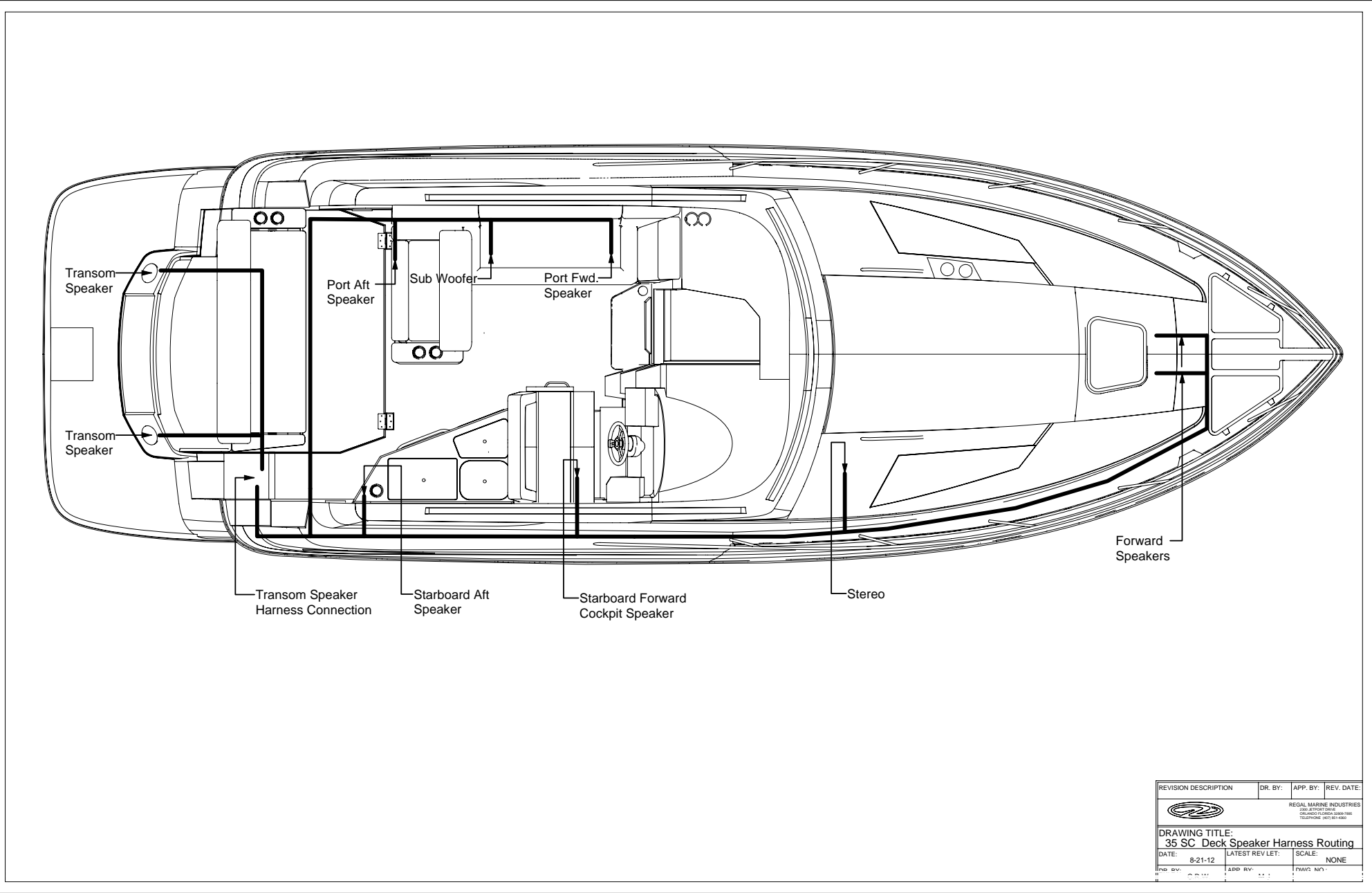

| REVISION DESCRIPTION | DR. BY: | APP. BY: | REV. DATE: |
|--|-----------------|----------|------------|
|  REGAL MARINE INDUSTRIES 230 ALBERT STREET DELAND, FLORIDA 32725 TELEPHONE: (407) 857-4300 | | | |
| DRAWING TITLE: | | | |
| 35 SC Deck Speaker Harness Routing | | | |
| DATE: | LATEST REV LET: | SCALE: | |
| 8-21-12 | | NONE | |
| DR. BY: | APP. BY: | FWC: N/A | |
| | | | |

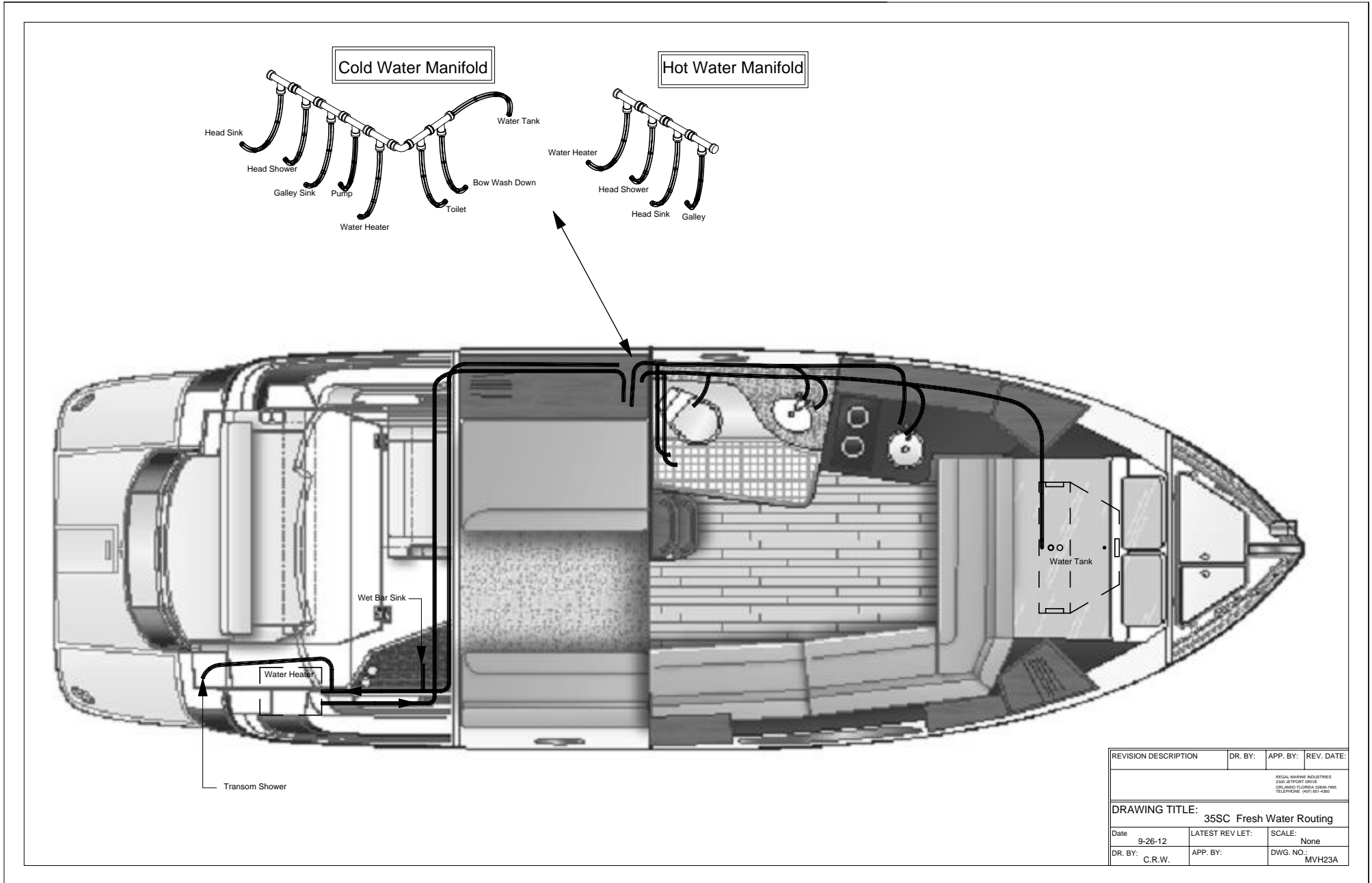

| REVISION DESCRIPTION | DR. BY: | APP. BY: | REV. DATE: |
|--|---------|-----------------|------------------|
| | | | |
| <small>REGAL MARINE INDUSTRIES 2300 AIRPORT DRIVE ORLANDO FLORIDA 32803-7895 TELEPHONE: (407) 851-1465</small> | | | |
| DRAWING TITLE: 35SC Fresh Water Routing | | | |
| Date | 9-26-12 | LATEST REV LET: | SCALE: None |
| DR. BY: | C.R.W. | APP. BY: | DWG. NO.: MVH23A |

35sc Visibility Compliance: *Vessel is Compliant*

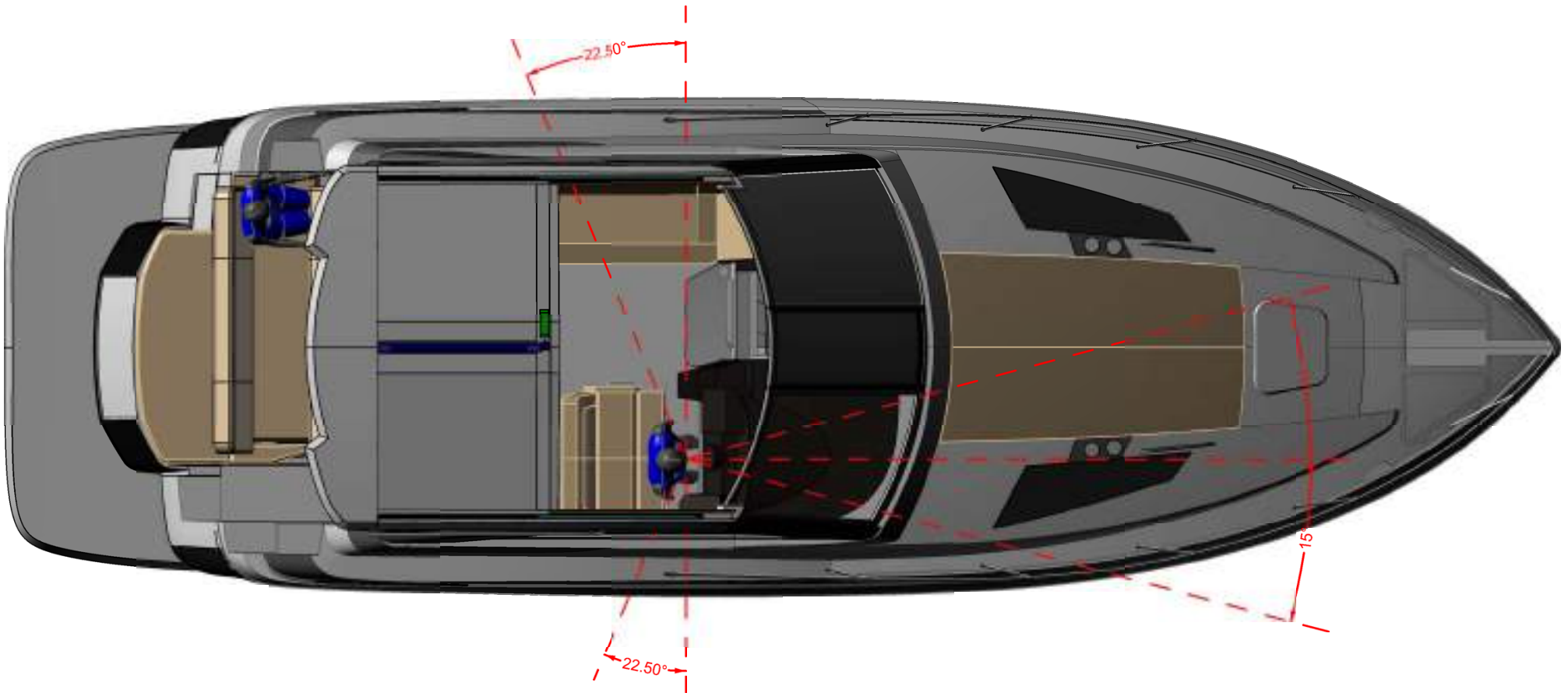

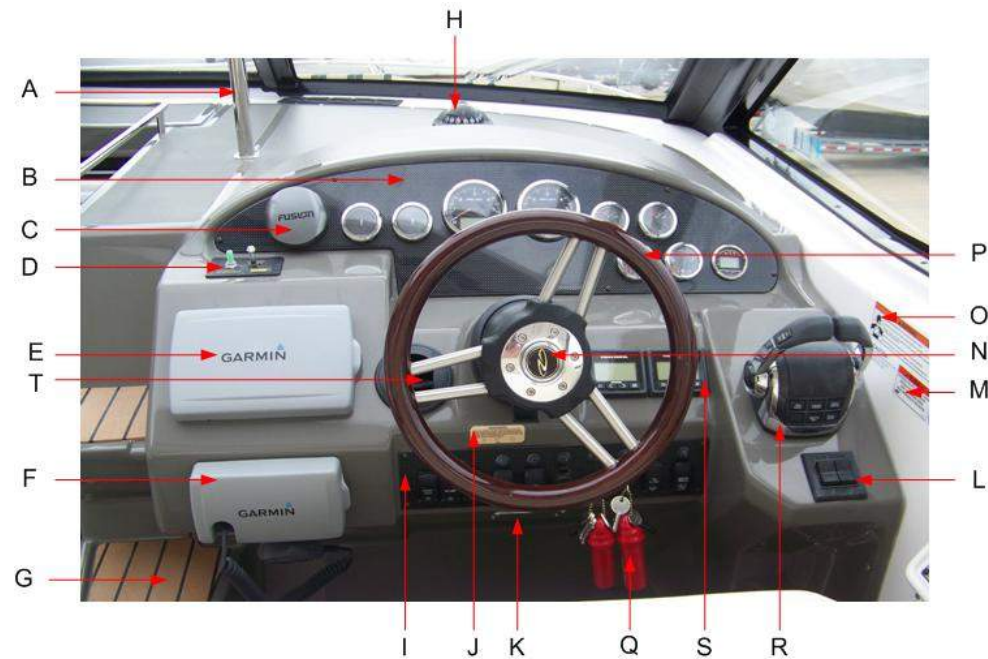

| Item | Description | Part# | Um | Qty | Item | Description | Part# | Um | Qty |
|------|---|------------------------|-----|-----|------|---|------------------------|----|-----|
| A | SUPPORT; WINDSHIELD STBD VH | 351229 | EA | | K | BIA PLATE, YACHT - ALUM. | 2421 | EA | |
| B | PANEL; INSTRUMENT GAS ANALOG CARBON, VH MY2013 | 211350 | EA | | L | SWITCH; TRIM TAB | 14899 | EA | |
| C | STEREO REMOTE;700SERIES 8 NEMA 2000 RECTANGULAR | 957589 | SET | | M | LABEL; WARNING-ROTATING PROPELLERS-WHT/RED PRINT | 3269 | EA | |
| D | SPOT LT. CONTROL SW. FLOOD/SPOT | 50602 | EA. | | N | LOGO;REGAL "R" DISC FOR STEERING WHEEL -SELF ADH. | 4956 | EA | |
| E | PLOTTER;5208 GPSMAP COLOR 8" TOUCHSCREEN - GARMIN | 957543 | EA | | O | LABEL; CO HELM WARNING (WHITE/RED PRINT) | 3260 | EA | |
| F | VHF; 100 GARMIN | 957517 | EA | | P | STEERING WHEEL; BROWN GENUINE LEATHER | 201301 | EA | |
| G | FLEXITEEK; HELM AND P/S DASH. STEPS (3PCS) VH | 351239 | SET | | Q | KEYBOB FLOATING KEY TAGS | 1013 | EA | |
| H | COMPASS - OFFSHORE 95 W/CONNECTOR | 64168 | EA | | R | MAIN STATION KIT-TWIN EVC | 13765 | EA | |
| I | PANEL; IGNITION EVC-D AND ANALOG BRUSHED SS,VH MY13 | 211351 | EA | | S | DISPLAY EVC D 2-1/2" AND BUTTON PANEL | 78861 | EA | |
| J | BLOWER WARNING LABEL LABEL W/ICONS | 3252 | EA | | T | AC GRILL EURO ROUND 3"BLACK | P1477 | EA | |

Add Selected Items To Cart

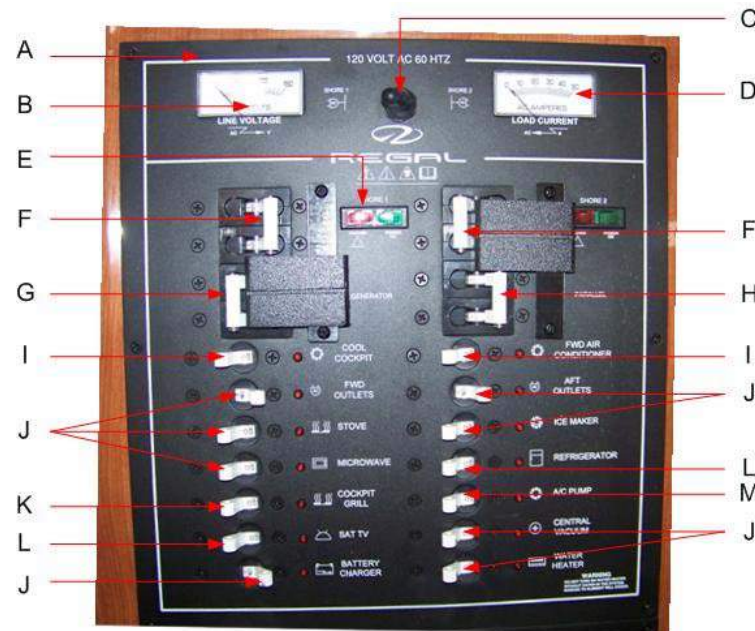

| Item | Description | Part# | Um | Qty | Item | Description | Part# | Um | Qty |
|------|--|------------------------|----|-----|------|--|------------------------|----|-----|
| A | PANEL;120v BLACK MAIN DISTRIBUTION PNP WIRING | 351213 | EA | | H | BREAKER;60 AMP CE WHT TOG DB PL DB TH REF#956957 | 14481 | EA | |
| B | AC VOLT METER-110V PANEL 0-150 VAC PRIME VOLTMETER | P1424 | EA | | I | BREAKER;30ampCE,WHT-TOGG LE-AIRPAX | 14484 | EA | |
| C | SILVER TOGGLE-ON/OFF/ON 9-POLE REF#956957 | 15617 | EA | | J | BREAKER;15ampCE,WHT-TOGG LE-AIRPAX | 957085 | EA | |
| D | AC AMP METER-110VOLT PANE 0-50 VAC PRIME AMP METER | P1453 | EA | | K | BREAKER;20ampCE,WHT-TOGG LE-AIRPAX | 957086 | EA | |
| E | RED/GREEN POLARITY LIGHT DUAL RECT LAMP 125VRED/GR | P1378 | EA | | L | BREAKER;10ampCE,WHT-TOGG LE-AIRPAX | 957084 | EA | |
| F | BREAKER;30AMP CE WHT-TOGG DOUBLE POLE-DOUBLE THROW | 14483 | EA | | M | BREAKER;5 AMP WHITE TOGGL 5A CB 1P A-SER | 14486 | EA | |
| G | BREAKER;50 AMP WHITE DBL POLE/DBL THROW TOGGLE | 144872 | EA | | | | | | |

Technical Information

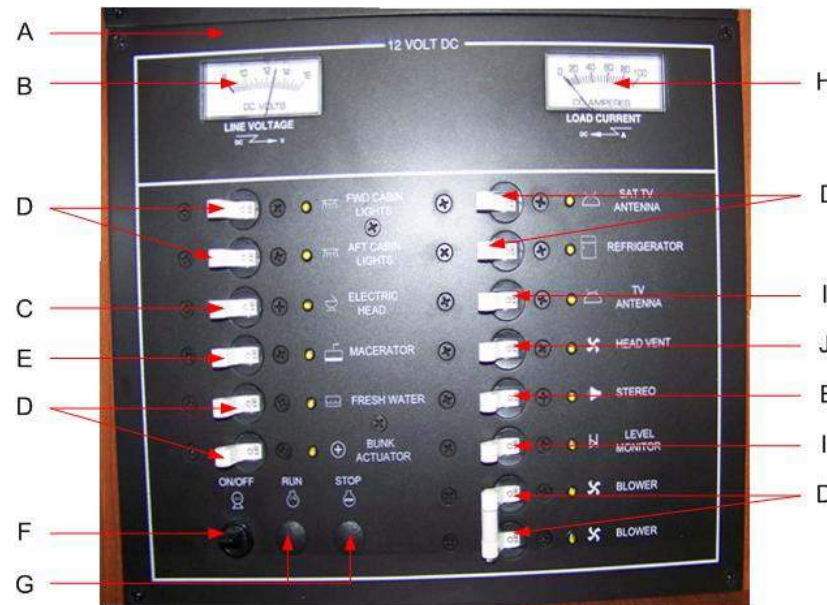

| Item | Description | Part# | Um | Qty | Item | Description | Part# | Um | Qty |
|------|--|------------------------|----|-----|------|---|------------------------|----|-----|
| A | PANEL;12v BLACK MAIN DISTRIBUTION PNP WIRING | 351212 | EA | | F | SWITCH;TOGGLE MOMENTARY ON/OFF BLACK REF#957990 | 15678 | EA | |
| B | DC VOLT METER 0-16 VDC ANALOG VOLT METER | P1423 | EA | | G | HOLEPLUG;5/8" BLACK- for BREAKER REMOVAL | 957087 | EA | |
| C | BREAKER;30ampCE,WHT-TOGG LE-AIRPAX | 14484 | EA | | H | DC AMP METER 0 TO 50 AMP A ANALOG DC AMP METER | P1454 | EA | |
| D | BREAKER;15ampCE,WHT-TOGG LE-AIRPAX | 957085 | EA | | I | BREAKER;3 AMP CE WHITE TOGGLE | 14482 | EA | |
| E | BREAKER;10ampCE,WHT-TOGG LE-AIRPAX | 957084 | EA | | J | BREAKER;5 AMP WHITE TOGGL 5A CB 1P A-SER | 14486 | EA | |

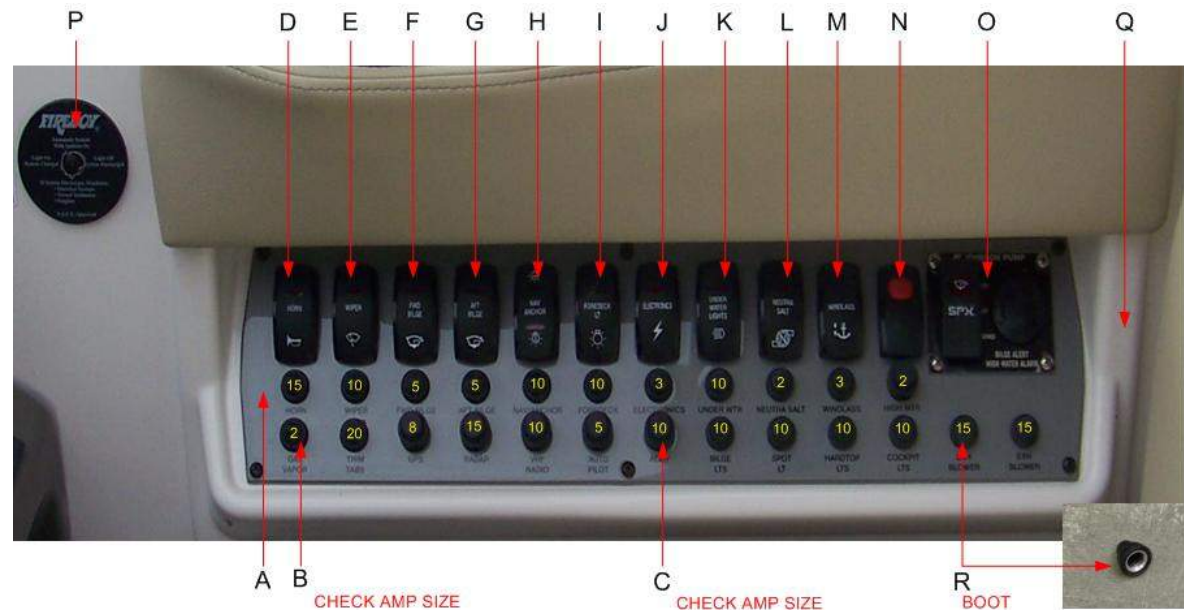

| Item | Description | Part# | Um | Qty | Item | Description | Part# | Um | Qty |
|------|---|------------------------|----|-----|------|------------------------------------|-----------------------|----|-----|
| A | PANEL; HELM SWITCH 35SC-VH | 302211 | EA | | | SWITCH COVER AFT BILGE | P1928 | EA | |
| * | | | | | H | SWITCH CONTRA NAV/ANC COMPLETE - | P1805 | EA | |
| B | 2 AMP PUSH BUTTON BREAKER | 1528 | EA | | | SWITCH COVER NAV/ANC LIGHT | P1806 | EA | |
| | 3 AMP PUSH BUTTON BREAKER | 1580 | EA | | I | SWITCH CONTRA FOREDECK LT COMPLETE | P1929 | EA | |
| | BREAKER,5A,PUSH BUTTON | 15865 | EA | | | SWITCH COVER FOREDECK LT | P1930 | EA | |
| | 7 AMP PUSH BUTTON BREAKER | 1581 | EA | | J | SWITCH CONTRA ELECTRONICS COMPLETE | P1931 | EA | |
| | BREAKER,10A,PUSH BUTTON | 14050 | EA | | | SWITCH COVER ELECTRONICS | P1932 | EA | |
| | BREAKER,15A,PUSH BUTTON 15A PUSH/RST CB | 14051 | EA | | K | SWITCH CONTRA V U/W LIGHT COMPLETE | P1821 | EA | |
| | BREAKER,20A,PUSH BUTTON | 15862 | EA | | | SWITCH COVER UNDERWATER | P1822 | EA | |
| C | FUSE HOLDER PANEL MOUNT | 15437 | EA | | L | SWITCH CONTRA NU/SALT COMPLETE | P1933 | EA | |
| | FUSE - AGC .5 AMP | 15438 | EA | | | SWITCH COVER NU/SALT | P1934 | EA | |
| | FUSE - 15 AMP | 15450 | EA | | M | SWITCH CONTRA WINDLESS COMPLETE | P1935 | EA | |
| | | | | | | SWITCH COVER WINDLESS | P1936 | EA | |
| D | SWITCH CONTRA V HORN COMPLETE | P1803 | EA | | N | SWITCH CONTRA W/PERMIT COMPLETE | P1937 | EA | |
| | SWITCH COVER HORN CONTRA V RED LENS | P1804 | EA | | | SWITCH COVER W/PERMIT | P1938 | EA | |
| E | SWITCH CONTRA V WIPER COMPLETE | P1801 | EA | | O | ALARM;HIGHWATER BILGE 12V KIT | 57675 | EA | |

Technical Information

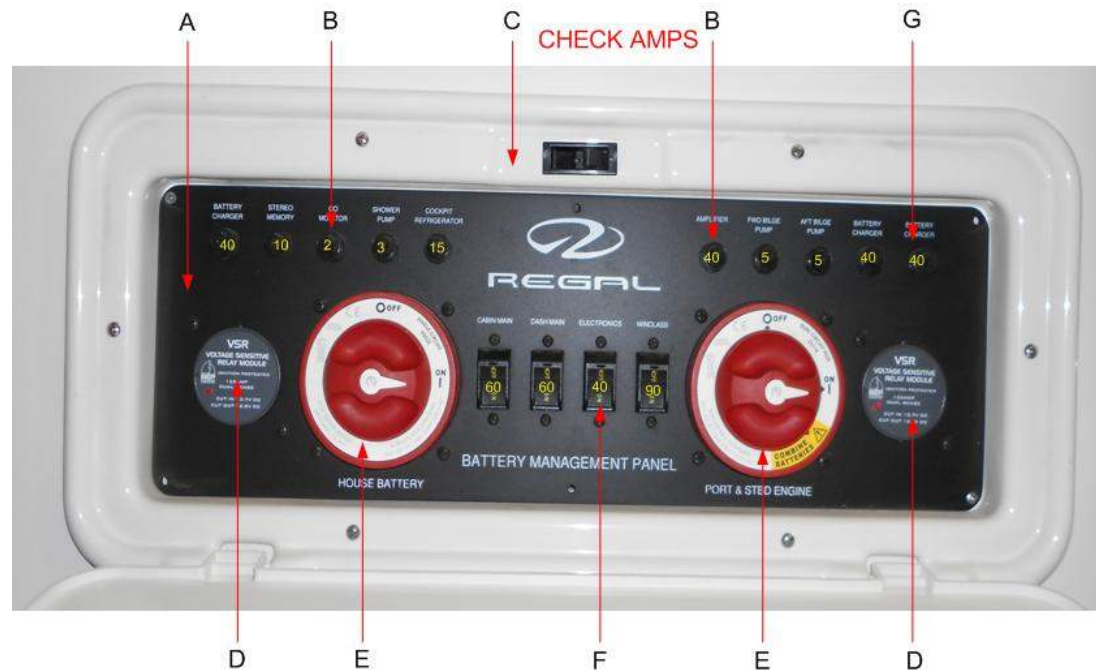

| Item | Description | Part# | Um | Qty | Item | Description | Part# | Um | Qty |
|------|---|------------------------|----|-----|------|--|------------------------|----|-----|
| A | PANEL; BATTERY MANAGEMENT W/BATT.SWITCHES MAIN BRKR | 350611 | EA | | C | BOX; BATT.SWITCH W/ VSR 19.75" X 6.5" PANEL-35SC | 350511 | EA | |
| * | PANEL ONLY ;BATTERY MAN REF # 350611 | P1940 | EA | | D | 12V D.C. VSR | 281254 | EA | |
| B | BREAKER;PUSH/RESET 2 AMP UF TERMINAL | 1528UFT | EA | | E | BLUE SEAS ON/OFF BATTERY SWITCH 9003E REF#957091 | 957091BS | EA | |
| * | BREAKER;3 AMP PUSH/RST 3A SCRW W/TRP | 1580ST | EA | | F | BREAKER;FLAT FRONT 40AMP REF# 350611 | P040 | EA | |
| * | BREAKER; 5AMP PUSH/RST REF# 350611 | P1943 | EA | | * | BREAKER;FLAT FRONT 60AMP 04-2401-060 CB ROC 1P | P060 | EA | |
| * | BREAKER;PUSH/RESET 10 AMP SCREW TERMINAL | 14050ST | EA | | * | BREAKER;FLAT FRONT 90AMP 04-2401-090 CB ROC 90A 1P | P090 | EA | |
| * | BREAKER;PUSH/RESET 15 AMP SCREW TERMINAL | 14051ST | EA | | | | | | |
| * | BREAKER;40AMP PUSH/RST REF# 350611 | P1946 | EA | | G | SWITCHES; BLACK BOOT FOR POP-OUT B | 15864 | EA | |

35 SC BATTERY MANAGEMENT PANEL W/ TYPICAL BREAKER SIZES
<https://www.boat-manuals.com/>



Regal Marine Industries, Inc.

2300 Jetport Drive

Orlando, FL 32809-7895

(407) 851-4360

www.regalboats.com

Regal@RegalBoats.com

<https://www.boat-manuals.com/>