

OWNER / OPERATOR MANUAL

Keep this manual with the boat at all times. All operators must read and fully understand the operational instructions before the boat is used.



- RT Series • RB Series • Deep V Series
- MPV™ Series • Ranger Trail® Trailers

Ranger
BOATS

rangerboats.com

<https://www.boat-manuals.com/>

Ranger® boats include a wide variety of advantages in quality, construction and performance. For even more details, visit us at www.rangerboats.com



RPM Performance™

GETTING TO KNOW AND HANDLE YOUR RANGER BOAT . . .

Your Ranger dealer should see that you have selected the proper horsepower engine for the rating range of the boat model you have chosen. The proper engine mounting height has been selected for optimum performance and the correct propeller has been chosen.

Since most boats spend more time on the trailer than in the water, a RangerTrail® trailer can extend the useful life of your new boat. The load **MUST** be evenly distributed on the properly fitting “bunks” or “pads” of the trailer. The boat should not rest on the loading rollers, but should properly cradle on the bunks.

Always park your rig so that the trailer tongue is higher than the stern of the boat, so that any water can drain from the hull when the drain plug is removed. All livewell valves should be placed in the “empty” position to properly drain your livewell plumbing.

A properly fitted boat cover will protect your investment from the damaging effects of the ultraviolet rays of sunlight, as well as from road film, rain and dirt abrasion while trailering. The cover also protects your accessory equipment and fishing tackle from “prying eyes” and helps to guard against pilferage.

Familiarize yourself with the instruments and indicators used with all installed equipment. Factory equipment manuals are included to assist you to properly operate your trolling motor; depth finders; engine tachometer; speedometer; and any additional accessories that you have installed. Naturally this Ranger manual is only complete when you have completely studied your engine operating manual and are familiar with engine operation.

Now you are ready for a ride in your new boat! This will be an exciting, fun experience if you exercise the proper caution and observe all safety rules and regulations.

Before launching your boat... stop on the ramp short of the water. Stop your vehicle's engine and set the parking brake. At the rear of the boat, install your transom drain plug and remove the trailering tie-downs, trailering arms, motor supports and/or support brackets. Slowly back the boat and trailer into the water and unhook the winch strap hook. When in the driver's seat, put on and secure your life vest and attach the engine emergency stop switch lanyard to your person. Start engine and back your boat off the trailer. You should experience no problem if the water is adequately deep for proper launching.



NOTICE

Failure to store/park your rig with the bow elevated could allow rain water to accumulate in the storage boxes.

While you are easing along within the “No Wake” zone you should trim your engine all the way down to its lowest position (in). Turn the steering right and left to insure that there is no undue slack and inspect the steering system. Look for any loose connections at the engine and beneath the driver's console (see pp. 24-25). Inspection of this crucial linkage system can be visually made at home or at the lake, but should be done at regular intervals. Before applying power and “opening it up”, insure that all passengers are properly seated and are wearing an approved Personal Flotation Device (PFD or Life vest). Check to see that there are no obstructions in your path. We recommend that the front pedestal seat be removed from the front deck base and positioned in the special base provided in the front floor of the boat. If your boat has non-adjustable pedestals, remove the extension pipe from the seat base and install the seat base directly into the front deck receptacle. If your boat has an optional deck extension and power pedestals, remove the lid in the deck extension and secure the pedestal in the receptacle provided in the floor. If the optional deck extension does not have a removable lid, store your seat securely in the floor of the boat. This will provide for an unobstructed view while driving. The power pedestal should be pushed down into the lowest position. Should there be no base provided in the floor, the seat should be removed and securely placed in the floor of the boat.

When you have cleared the “No Wake” zone it is time to accelerate and get your new boat “on plane”. Before applying power, insure that all passengers are properly and securely seated in appropriate locations. Move the throttle lever into the full open position (full forward). The bow of the boat will rise into the air for a moment... this is normal operation when a boat is “coming out of the hole” and is no cause for alarm. The bow will quickly come back down into a level running position. When the boat begins to accelerate rapidly, the throttle should be pulled back to obtain a comfortable running speed. Always increase your speed a little at a time until you are running at a speed

at which you feel safe and are in complete control...NEVER FASTER THAN YOUR EXPERIENCE DICTATES! At this moderate speed you should begin to trim your engine into a higher position (out). Please refer to your engine owner's manual for more information on power trim use and operations.



WARNING

Improper use of power trim may lead to excessive bow steer or steering torque (pull) and could lead to accidental injury or death.

Your speed will increase and the bow will lift. The boat will begin to run with the back rear portion of the hull in contact with the water and steering will become easier. Over-trimming will result in excessively high RPM (note your tachometer) and the steering can develop "torque" or a "pull" toward the right. Trim back down slightly for best operation. A different trim setting (see your trim indicator) will be required for different throttle settings. You will soon develop an instinctive feel for these settings. Your ear will become attuned to the sound of the proper engine RPM. Again, over trimming is to be avoided as excessive RPM can cause engine damage and can also cause your prop to "blow out" (lose its grip on the water because it is too near the surface). If the bow of your boat should begin to bob up and down (called porpoising) you will probably have over trimmed. Bump the trim button down a little until the motion stops.

If your boat should continue to "porpoise", a slight increase in throttle and speed will generally correct the condition. Proper distribution of the load in your boat will make a great difference in its operation. Moving tackle boxes or ice chests rearward or toward the front can greatly effect boat performance and handling.

When beginning a turn with the engine trimmed in the higher positions, the trim switch should be pressed to LOWER the engine further into the water just prior to and during the turning of the steering wheel. Practice and experience will determine just how far down you will need to trim for safely handling a turn at various speeds and water conditions. Just remember to MAKE SAFETY YOUR GUIDE when attempting any new or unfamiliar maneuver. Proceed ONLY AT SPEEDS AT WHICH YOU FEEL SAFE AND IN CONTROL!

Naturally, it is impossible to describe here all the different situations that you may encounter. Just remember that COMMON SENSE is your best safety precaution. Your new boat is built to safely carry you in NORMAL OPERATION, but it is up to you to stay alert and to avoid dangerous situations. Safe boating is in the hands of the operator.

Even the pleasant experience of the "first ride in your new boat" must sometime come to an end. The key to simple and effortless loading of your boat is having the trailer in the proper position. This "right" position is determined by the steepness of the ramp. Here, you will have to experiment with the proper depth to have your trailer in. The most common mistake is having the trailer too deep, so a little time spent experimenting with different depth positions can ultimately save you much time and embarrassment. To load at slow speed, position your boat to head directly between the guide bunks or guide rollers and use the thrust of your outboard engine to drive the boat forward until the bow contacts the roller on the bow stand block. Shut down your outboard and fasten the winch strap hook to the bow eye. Tighten the winch strap and lock winch before pulling the boat from the water. Your engine should be trimmed up into a higher position before the trailer is pulled up the ramp to prevent damage to the lower unit or propeller. Pull the rig up the ramp and park well out of the way of other boaters. Stop your vehicle engine and set parking brake. Remove the drain plug, open and drain the livewell systems, and stow all loose equipment. We recommend that you install a transom saver, or engine support brace, between the trailer frame and the lower unit of your engine to prevent damage to your transom while the boat is in transit.

For the most possible boating and fishing enjoyment familiarize yourself completely with your boat and with the instruction manuals for all additional equipment. If you are a novice, there are publications on good seamanship recommended to make your boating safe and enjoyable. We also recommend that you enroll and attend any of the excellent safe boating courses offered and conducted by your area Power Squadron or the U.S. Coast Guard Auxiliary.



WARNING

The operator (driver) is responsible for the correct and safe operation of the boat, the equipment aboard and the safety of all occupants aboard. We strongly recommend that the operator read this manual and thoroughly understand the operational instructions for the engine and all related accessories before the boat is used.

BE RESPONSIBLE FOR SAFER BOATING

- **ALCOHOL and DRUGS** - The debilitating effects of alcohol and other drugs reduces reaction time and detracts from judgment. The combined effect of the outdoor environment... sun, heat, wind, rough water, and noise can be more fatiguing than one would imagine and, combined with drugs or alcohol, can be very dangerous.
- **GAME PLAN** - Tell a friend, neighbor or another family member where you will be boating and when you plan to return. Be certain that this individual has a good description of your boat and any other identifying information that could be needed to help find you should an emergency arise.
- **TOOLS and SPARE PARTS** - Many people have been stranded by minor breakdowns that they could have repaired themselves. It is a good idea to carry a few tools and common spare parts and to be familiar with simple repairs that you can easily accomplish.
- **GASOLINE RESERVES** - Never push your boating range to the limit of your gas tank capacity... one-third of the fuel to go, one-third to come back and one-third to reserve.
- **GOOD BOAT KEEPING** - A clean boat is a safer boat. Take care to see that rods, lures, nets, gaffs and other potentially harmful gear are properly stowed so that it cannot blow or move around while the boat is underway. Perform all maintenance and safety checks regularly. Secure all icebox or cooler lids and place any trash or debris safely under cover until the trip is over.
- **SPEED and SKILL** - The fast and powerful boat can require the operator to exercise a high level of skill and attention to driving. Only go as fast as your skill and good judgment dictates is safe. You are in charge of the well being of your passengers and yourself. Be alert for any hazards in the water and operate your boat only in such a manner as would be appropriate for the water conditions. Be a good boating "neighbor" and do not create a hazard or annoyance to others. The best safety equipment is your own good judgment.
- **SKIERS and SWIMMERS** - Do not allow operation of the engine when anyone is in the water near the stern of the boat. Never back up to a down skier or anyone in the water. Never drive your boat directly behind a skier.
- **BOARDING LADDER** - Many models are equipped with a boarding ladder. Rotating propeller may cause serious injury or death. Do not approach the ladder when engine is running. Shut off the engine when near persons in the water. Make sure to stow the ladder after it is used and before starting the engine. Never use a damaged ladder. On certain aluminum models not equipped with a ladder, you can pull yourself into the boat by grabbing the passenger side rail and pulling yourself into the boat.

CARBON MONOXIDE

Carbon monoxide is a deadly gas that is odorless, tasteless and colorless. It is present in the exhaust of internal combustion engines. Inhaling sufficient concentrations of carbon monoxide can be fatal within minutes. Early signs of carbon monoxide poisoning may include headache, nausea, fatigue, drowsiness, confusion and vomiting. **DO NOT MISTAKE THESE SYMPTOMS FOR SEASICKNESS.** If any of these symptoms occur to you or any of your passengers, ventilate the boat by opening the side curtains or forward hatch to remove the fumes and immediately seek medical attention.

Carbon monoxide can be drawn into the cockpit area over the stern of the boat. When operating the engine, ventilate the cockpit area by removing side curtains or opening forward hatches to allow fresh air to flow through. Do not operate the engine if your boat is moored in a confined area.



WARNING

Exhaust from a running engine can cause an accumulation of carbon monoxide gas in the cockpit area when the canvas top and side curtains are installed. Provide adequate ventilation when these coverings are installed in their closed positions.

TABLE OF CONTENTS

Getting to Know and Handle Your Ranger Boat	1
Be Responsible for Safer Boating	3
Carbon Monoxide Warning	3
Special Information	5
Your Ranger Dealer's Responsibilities	5
Owner/Operator's Responsibilities	5-6
Warning and Cautions	6-7
Hazard Labeling	7-8
Hull Identification Plate	8
U.S. Coast Guard Capacity Information Plate	9
Recommended On-Plane Seating Locations	10
Gasoline Fuel System	10-14
Steering at Console	14
Cleaning Upholstery	15-16
Wiring Diagrams	17-19
Hook Up of Trolling Motor Leads	20
Electrical System	20
Fuse Panel Information	20
Safety and Maintenance Tips	20
Federal Requirements for Recreational Boats	21
Glossary of Terms	29
Boating Safety Checklist	34

YOUR RANGER TRAIL® TRAILER

General Information and Maintenance	22
Contained Oil Orbital Lubrication (COOL) Hubs	22
Reporting Safety Defects	22
Trailer Brakes	23
RangerTrail Wiring	24
Before Towing Your Ranger Trail Trailer	25
Towing Your Ranger Trail Trailer	25
Swing Hitch	25
Hitch Class Rating	26
Trailer Tire Safety, Care & Maintenance	26-29
Limited Warranty	30-33

SPECIAL INFORMATION

The following special information is intended to alert you to possible dangers and to information important to the safe operation of your boat and other equipment. Observe them carefully. However, simply being aware of the "WARNING", "CAUTION" AND "NOTICE" notations in this manual will not eliminate the dangers that they signal if you do not implement the information. These warnings, plus common sense operation will insure you a safe and fun boating or fishing outing.

Please take special note when you see one of the following signs:

 **WARNING** Failure to follow the advice of a "WARNING" may result in bodily injury or death.

 **CAUTION** Non-compliance with "CAUTION" instructions could result in failure of, or damage to, the product and/or equipment.

 **NOTICE** Draws special attention to installation, operation, or other important maintenance information.

ALL information or instructions in this manual could be necessary for proper operation and/or maintenance. If you do not understand any portion of this manual, please contact your Ranger dealer or our Customer Service Department for any additional information.

IMPORTANT: Your Ranger Dealer's Responsibilities...

Generally, it is the dealer's responsibility to the customer to make sure that the boat has been equipped as ordered with a properly installed and functioning engine that is within the horsepower rating specified for that model boat. The dealer should see that the engine is outfitted with the proper propeller for that boat model and for the load that the boat is normally expected to carry.

The dealer should help to familiarize the customer with the onboard equipment and explain operation of this equipment; the engine operation; and the proper functioning and operation of the boat itself.

Prior to delivery, the dealer should make certain that the product and equipment is completely operational; the proper propeller is installed; and that all oil, fuel system and lubrication systems are understood. The dealer should explain the operation of all instrumentation equipment, and the boat electrical and livewell systems.

The dealer should check for correct carburetor adjustment, throttle and steering functioning, and instrumentation accuracy. Engine cooling water should be properly circulating.

The dealer should test for maximum engine RPM as specified in the engine manufacturer's specification sheet(s) and/or engine owner's manual for proper operation of all equipment and for proper adjustment of steering effort and direction. All necessary adjustments for maximum efficiency should be made.

Owner/Operator's Responsibilities...

It is the owner/operator's responsibility to perform all safety checks and to ensure that all lubrication and maintenance instructions are complied with for maximum safety and proper operation.

It is also the owner/operator's responsibility to return the unit to the Ranger dealer for a periodic checkup.

The owner/operator is responsible for the correct operation of the boat and for the safety of its occupants. Be sure that all operators read this manual before attempting to operate the boat. Your passengers should be shown the location and use of all emergency equipment and one passenger should be instructed how to handle the boat

Special Information

in case of emergency. U.S. Coast Guard requirements for PFDs (Personal Flotation Devices, or Life vests) can vary, depending on the type of boat. Be sure to comply with the U.S. Coast Guard regulations that apply to your boat. The owner/operator should, however, make certain that all passengers in the boat are in possession of, and are securely wearing a PFD whenever the boat is in operation. We strongly recommend that an engine emergency stop switch be securely connected to the boat operator any time that the engine is in operation!

Learn the waterway rules of the locality in which you intend to operate your boat. Navigable waterways are controlled by Federal regulations while inland lakes and Canadian waters are controlled by local jurisdictions. Obey all regulations to protect yourself, your passengers, and fellow boating enthusiasts.

Before boating, obtain the weather forecast for your area. Familiarize yourself with the weather bureau warning system signal(s) and waterway traffic sign/markings information.

Contact your local U.S. Coast Guard Auxiliary and take advantage of their excellent boating and safety classes and seasonal boat inspections.



WARNING

Operating a boat with an engine of horsepower in excess of that specified on the boat's capacity plate can result in loss of control over the boat's operation and could lead to an accident resulting in injury or death of the boat's occupants.



WARNING

Imprudent operation of the boat, with or without the use of PFDs and an approved engine emergency stop switch, can lead to property damage, injury or death of the boat operator or passenger(s), or other(s), whether within the boat or outside the boat.



WARNING

The boat operator should insure that the lanyard connection to the emergency stop switch is of ample length to insure that the inadvertent activation of the switch is not likely. Accidental triggering of the emergency stop switch could result in loss of engine power at inopportune times, such as while docking or in heavy seas, strong currents or high winds and could lead to an accident resulting in injury or death.



WARNING

Do not exceed the maximum weight and persons capacity found on the U.S. Coast Guard capacity information plate located on your boat. Overloading severely affects the stability and handling of your boat and could lead to an accident causing injury or death.



WARNING

Sudden turns or striking waves or objects can eject person(s). Unmanned boat can circle and can repeatedly strike the person(s) with propeller. Attach the emergency stop lanyard and wear life jacket when operating the boat.



WARNING

Striking floating or submerged objects can cause outboard motor to break loose and flip into boat with propeller still spinning. Do not exceed minimum planing speed in areas likely to contain floating or submerged objects.

HAZARD LABELING

The following images are a partial list of warning/information decals that may be found in various locations on your boat and trailer. (Photos are not to scale) Some labels are not appropriate for every boat/trailer model, so your rig may not have them all. Check with your Ranger dealer to find out what labels your boat and trailer should have and ask them to order any necessary replacements.

WARNING

Fuel Tank located in this area. To avoid puncturing tank and causing fuel leakage, do not drill, screw, or modify this area. Leaking fuel is a fire and explosion hazard.

WARNING

To minimize shock and fire hazards:

- This device must be connected to a Ground Fault Circuit Interrupt (GFCI) protected AC outlet.
- When using an extension cord, connect the AC charger plug before connecting to the GFCI protected AC outlet.
- Make connection in an open atmosphere free of explosive fumes.
- Make connection in a secure manner that will avoid contact with water.

GM18548781

WARNING

Do not use ski tow fitting for lifting or parasailing. Fitting could pull out of deck resulting in serious injury or death.

GM1850801

FOR USE ONLY AFTER TOWING
WATER RESISTANT TAPE IS NOT EFFECTIVE
FOR USE ONLY AFTER TOWING

WARNING

Rotating propeller can cause serious injury or death. Never approach or use ladder when motor is running.

GM1851001

WARNING

Avoid serious injury or death from fire or explosion, resulting from leaking fuel. Inspect system for leaks at least once a year.

GM1850601

CAUTION

Parking brake is intended as a means of added security and should not be relied upon as the sole method of securing trailer. Continue to use wheel chocks or other traditional methods to ensure the trailer remains in desired parked position.

WARNING

BEFORE TOWING, ALWAYS INSTALL A PIN OR LOCK INTO COUPLER TO ENSURE THAT LATCH CANNOT OPEN AND COUPLER CANNOT COME OFF BALL.

BEFORE USE, PUSH UP ON TAB TO ASSURE BRAKES ARE RELEASED

32586

DANGER

Carbon monoxide (CO) can cause brain damage or death.

Engine and generator exhaust contains odorless and colorless carbon monoxide gas.

Carbon monoxide will be around the back of the boat when engines or generators are running.

Move to fresh air, if you feel nausea, headache, dizziness, or drowsiness.

GM 09010

WARNING

Carbon monoxide (CO) can cause brain damage or death.

Engine and generator exhaust contains odorless and colorless carbon monoxide gas.

Signs of carbon monoxide poisoning include nausea, headache, dizziness, drowsiness, and lack of consciousness.

Get fresh air if anyone shows signs of carbon monoxide poisoning.

See Owner's Manual for information regarding carbon monoxide poisoning.

GM 09010

CAUTION

CHECK TIGHTNESS OF OUTBOARD AND JACKPLATE MOUNTING BOLTS AFTER 1ST 10 HOURS AND AT EVERY 30 HOURS OF USE. TIGHTEN MOUNTING FASTENERS TO ENGINE MANUFACTURER'S SPECIFICATIONS.

WARNING

Rotating propeller can cause serious injury or death. Shut off motor when near persons in water.

GM1850901

WARNING

Install ski pylon securely before use. Insert pin thru receiver and ski tow pylon. Pushing pylon into mounting hole until red line is no longer visible. Install pin thru receiver and pylon to secure position. Failure to secure pylon may result in possible injury or death.

↓

WARNING

50 PSI

TIRE PRESSURE MUST BE MAINTAINED FOR PROPER LOAD CARRYING AND TO AVOID IRREGULAR WEAR!

WARNING

65 PSI

TIRE PRESSURE MUST BE MAINTAINED FOR PROPER LOAD CARRYING AND TO AVOID IRREGULAR WEAR!

CAUTION

CHECK ENGINE CLEARANCE BEFORE TRIMMING

WARNING

SUDDEN TURNS ABOVE 30 MPH MAY CAUSE LOSS OF BOAT CONTROL. AVOID SERIOUS INJURY OR DEATH. REDUCE SPEED BEFORE ATTEMPTING A SUDDEN SHARP TURN. READ OWNER'S MANUAL.

WARNING

Fuel vapors are a fire and explosion hazard. To avoid injury or death, do not store fuel or flammable liquids here.

GM1850701

CE RANGER BOATS
170 VS
MAXIMUM
3 + 1 + 1 = 485 kg
D ↑ = 86 kw

WARNING

BEFORE TOWING, ALWAYS INSTALL A PIN OR LOCK INTO COUPLER TO ENSURE THAT LATCH CANNOT OPEN AND COUPLER CANNOT COME OFF BALL.

WARNING

Engine mounting location preset at the factory. Adjustments can result in damage to control system equipment. Control system damage can result in serious injury or death. Regularly inspect control system and clearances at all trim angles.

WARNING

Avoid serious injury. Do not occupy platform above trolling speed. Make sure latches are closed securely.

056-0872

Hazardous Labeling

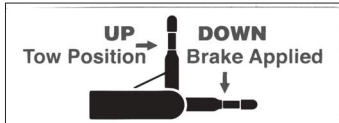

PARKING BRAKE EQUIPPED
Release brake before towing

AUSTRALIAN BUILDERS PLATE

MANUFACTURER: RANGER BOATS
MODEL: **SAMPLE**
BUILD DATE:
INFORMATION DETERMINED BY: ABYC STANDARDS

MAX OUTBOARD = 200 HP
256 kg

MAX PERSONS: 3 = 225 kg

MAX LOAD: = 612 kg

BUOYANCY: LEVEL FLOTATION
▲ WARNING

ALTERATION OF THE BOAT'S HULL OR PERMANENT FITTINGS MAY INVALIDATE THE PARTICULARS ON THIS PLATE

U.S. COAST GUARD
MAXIMUM CAPACITIES
5 PERSONS OR 725 LBS.
1500 LBS. PERSONS, MOTOR, GEAR
225 H.P. MOTOR

THIS BOAT COMPLIES WITH U.S. COAST GUARD SAFETY STANDARDS IN EFFECT ON THE DATE OF CERTIFICATION

MEETS U.S. EPA ENVP STANDARDS USING CERTIFIED COMPONENTS
MANUFACTURER: RANGER BOATS
MODEL: FLIPPIN, AR 72634

DESIGN COMPLIANCE WITH NMMA REQUIREMENTS IS VERIFIED. MANUFACTURER IS RESPONSIBLE FOR PRODUCTION CONTROL.

NMMA
NATIONAL MARINE MANUFACTURERS ASSOCIATION

◆ **WARNING** ◆

MAX. TRAILER GVWR 7,500 POUNDS
TONGUE LOAD RATING MIN. 5% GVWR
MAX. 750 POUNDS
FOR TRAILER CAPACITY SEE "VIN" LABEL

TO SECURE LATCH ALWAYS INSTALL A PIN OR LOCK INTO COUPLER SIDE HOLE

USE ONLY SAE 2" BALL WITH PROPER RATING
USE SAFETY CHAINS
CHECK FLUID LEVEL
READ OWNERS MANUAL BEFORE USE

SAE AND V5 CLASS 4
MODEL A-60 / A-75

UFP
SAN MARCOS, CA.
PATENTED
MADE IN USA 32206

Check lug nuts for proper tightness and read owner's manual before use.

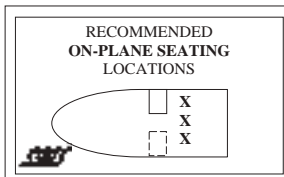

WARNING
AVOID SERIOUS INJURY OR DEATH

SEAT LOCATION NOT INTENDED FOR USE AT HIGHER SPEEDS

- DO NOT OCCUPY SEAT WHEN SPEED EXCEEDS 5 MPH.
- DISLODGED SEAT MAY STRIKE OCCUPANT OR CAUSE LOSS OF BOAT CONTROL.
- SECURE UNOCCUPIED SEAT

Class B **SPRINGFIELD** Class B LABEL # 0123006

WARNING
AVOID SERIOUS INJURY OR DEATH

- UNEXPECTED SEAT ROTATION MAY CAUSE EJECTION OF OCCUPANT
- LOCK SWIVEL WHEN SPEEDS EXCEED 5 MPH
- DISLODGED SEAT MAY STRIKE OCCUPANT OR CAUSE LOSS OF BOAT CONTROL.
- SECURE UNOCCUPIED SEAT

Class B **SPRINGFIELD** Class B LABEL # 0123006



WARNING

A wide variety of components used in this vessel contain or emit chemicals known to the State of California to cause cancer and birth defects and other reproductive harm.

EXAMPLES INCLUDE:

- Engine and generator exhaust
- Engine and generator fuel, and other liquids such as coolants and oil, especially used motor oil.
- Cooking fuels.
- Cleaners, paints, and substances used for vessel repair.
- Waste materials that result from wear of vessel components.
- Lead from battery terminals and from other sources such as ballast or fishing sinkers.

TO AVOID HARM:

- Keep away from engine, generator, and cooking fuel exhaust fumes.
- Wash areas thoroughly with soap and water after handling the substances above.

California Health & Safety Code §§ 25249.5-13

MANUFACTURED BY / FABRIQUE PAR: DATE

GVWR / PWBV KG () LB () GVW () PWBV ()

SAW (LASH CABLE) / PWBV (CHARGE EDGEE) KG () LB () THIS / PWBV

COLD WPT. PRESS. / PRESS. DE BOMEL. A PRODU PSI (LPS) SINGLE □ DOUBLE □ BULK

THIS VESSEL CONFORMS TO ALL APPLICABLE U.S. FEDERAL MOTOR VEHICLE SAFETY STANDARDS IN EFFECT ON THE DATE OF MANUFACTURE OR IMPORTATION.

THIS VESSEL CONFORMS TO ALL APPLICABLE CANADIAN PREScribed UNDER THE CANADIAN MOTOR VEHICLE SAFETY REGULATIONS IN EFFECT ON THE DATE OF MANUFACTURE. (S VESSEL NOT CONFORMING TO THESE REQUIREMENTS IS NOT ELIGIBLE FOR REGISTRATION IN ANY PROVINCE OR TERRITORY OF CANADA OR IN THE UNITED STATES OF AMERICA.)

V.I.N. / R.I.V.: TYPE / TYPE - TRAILER TRM / TRM

TIRE AND LOADING INFORMATION
RENSEIGNEMENTS SUR LES PNEUS ET LE CHARGEMENT

The weight of cargo should never exceed the weight of the cargo on each axle. / Le poids du chargement ne doit jamais dépasser le poids autorisé par pneu et par essieu.

TIRE PNEU	SIZE DIMENSIONS	LOADS TO BE CARRIED PER AXLE / PNEU ET PNEUS	SEE OWNER'S MANUAL FOR ADDITIONAL INFORMATION / VOIR LE MANUEL DE L'USAGRE POUR PLUS DE RENSEIGNEMENTS
FRONT AVANT			
REAR ARRIERE			
SPARE			
USE SECOURS			

HULL IDENTIFICATION PLATE



Year Mfg. Year Model

The hull I.D. Plate is located on the outboard side of the starboard transom, above the water line, and contains the following information:

- Hull Identification Number (Serial Number) - Should also be included in any inquiries or when ordering parts. The U.S.C.G. requires the H.I.N. number be permanently affixed and remain on the starboard transom of the boat. Do not alter this plate in any way.

U.S. COAST GUARD CAPACITY INFORMATION PLATE

FIGURE 2

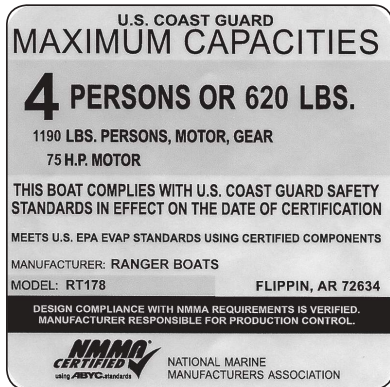

Familiarize yourself with your boat's maximum capacities. Do not exceed the maximum weight (in pounds) or persons capacity (number) found on the U.S.C.G. capacity information plate attached to your boat. **Know the ratings and load your boat accordingly. It is a must for safe boating.**

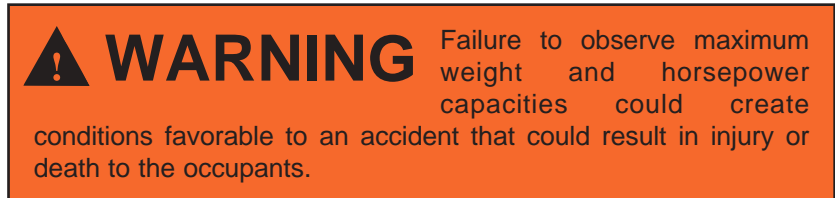

DESIGNATED OCCUPANT POSITIONS

The following pages show the designated occupant positions for each model with **X** for the recommended on-plane seating and **X** for additional occupant locations (up to planing speed only).

A decal similar to the one in figure 1 below can be found on your boat in the area of the capacity label (figure 2 above). The areas marked by X's are the areas of the boat considered safe and suitable for on-plane seating.

FIGURE 1

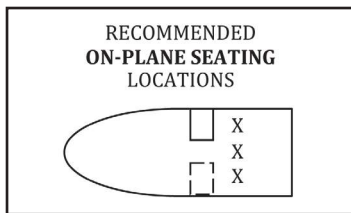

The operator of the boat should familiarize themselves with the seating locations that fit into this category. Be sure to read any warnings that may be affixed to the seat, base, or pedestal and follow those instructions.

Examples:

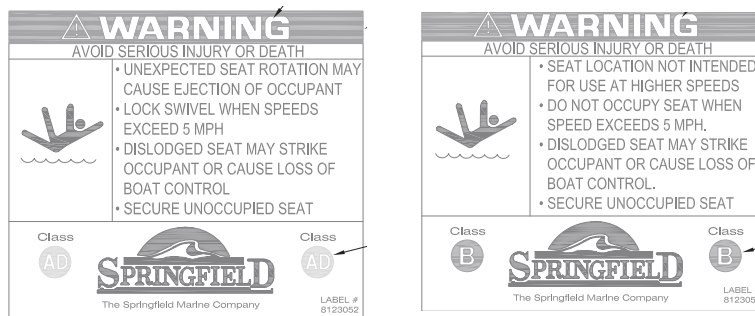

Type A: A seat designed for occupancy while the vessel is underway at any speed.

Type B: A seat designed for occupancy only at boat speeds not exceeding five miles per hour.

Do not sit in type B seats when boat speed exceeds five MPH.

Do not exceed the loading limits of the capacity plate on your boat (Example figure 2).

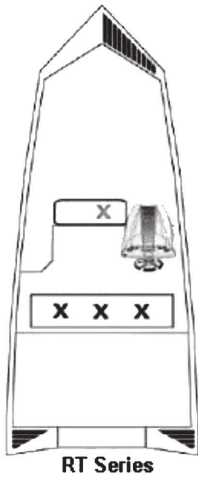

! WARNING Do not operate the boat on plane with persons located outside the on-plane seating locations shown on the decal. Failure to do so could cause a person(s) to be thrown overboard resulting in injury or death.

X RECOMMENDED ON-PLANE SEATING
X ADDITIONAL OCCUPANT SEATING LOCATIONS (UP TO PLANING SPEED ONLY)

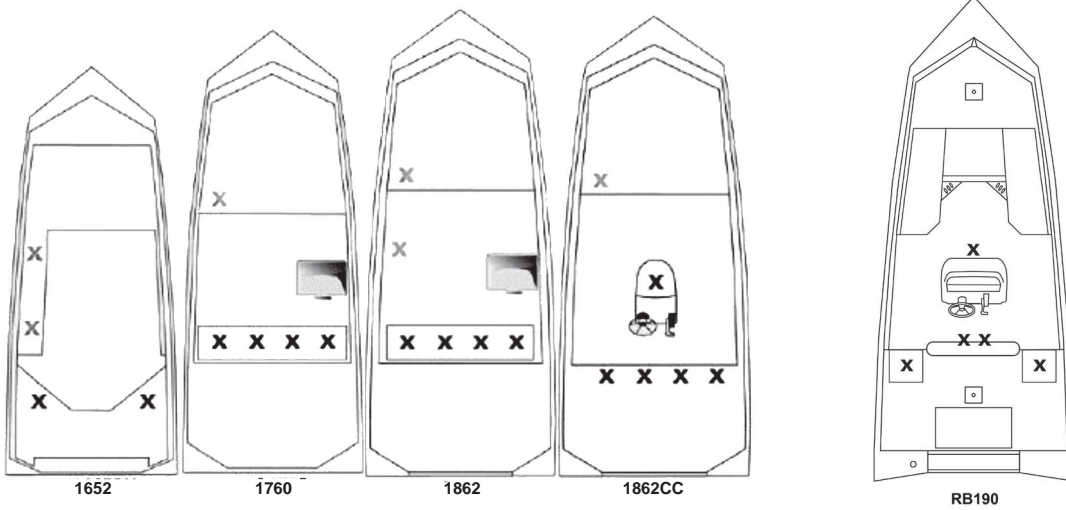

GASOLINE FUEL SYSTEMS

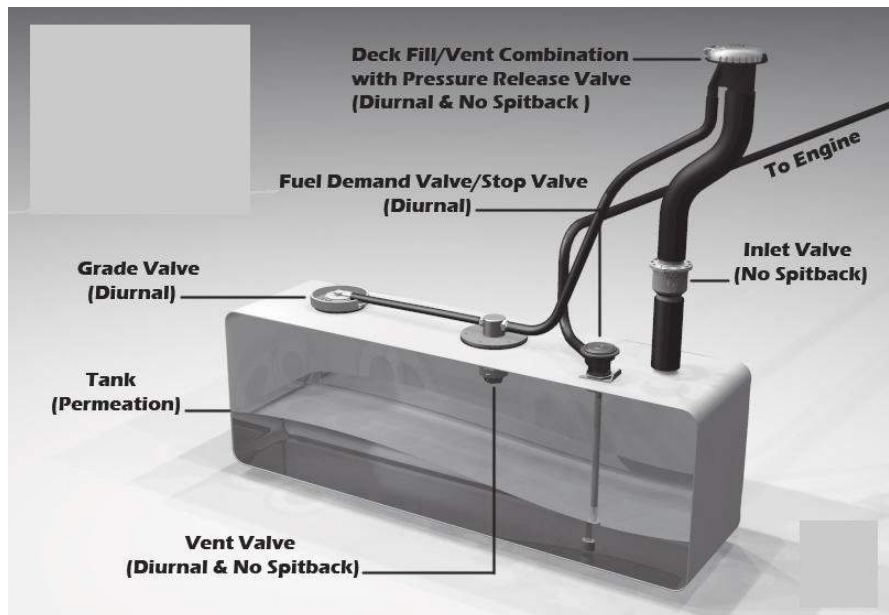

Gasoline fuel systems used in Ranger boats are designed to meet or exceed the requirements of the U.S. Coast Guard, the National Marine Manufacturers Association, the EPA, and the American Boat and Yacht Council at the time of manufacture.

All gasoline fuel systems have been factory inspected and pressure tested in accordance with regulations in effect at time of manufacture. Additionally, each fuel tank must pass rigid tests and inspections performed by the fuel tank manufacturer.

A. FUEL FILLS

Fuel fill deck plates are located on the port side deck, and are marked with the fuel pump symbol.

Most models are designed with the pressure relief system shown above. Under certain conditions the system will be under pressure.



Always open the cap slowly to allow pressure to escape. The vented deck fill is designed to maintain system pressure below 1 psi.

While filling the tank, the air displaced by the fuel escapes through the fill/vent. See Figure 1.

Figure 1: Fuel Fill



Periodically inspect the deck fill plate for damage. Be sure to use the exact fuel fill/vent used on your boat if replacement is required. Excessive pressure or vacuum in the fuel tank may damage the fuel system, if cap is substituted. (Fuel fill deck plate is not waterproof; water can be drawn into fuel tank during vent operation, if fill is submerged.)

After fueling, replace the fill cap, and wash the areas around the fuel fill plate, if any fuel is spilled. Residual fuel left on the deck and hull sides can be dangerous, and will yellow the fiberglass.

B. FUEL GAUGE

The fuel gauge indicates the amount of fuel in the tank. The fuel level is displayed on the console mounted gauge when the ignition switch is "on". On models with two tanks, a console mounted switch marked with a fuel pump symbol or just "fuel", is used to switch the gauge from one tank to the other. Push the fuel pump symbol switch to display the level in tank 1 (starboard) or tank 2 (port). Or, on some models, push the switch to the left to display the port tank fuel level and push to the right to display the starboard tank fuel level. The center position is "off".

C. FUEL SENDER(S)

Due to the mechanical nature of the fuel sender, variations in readings during various speeds of operation may occur. This system is merely a relative indication of the available fuel supply and not a calibrated instrument. With this type of sending unit a more accurate measurement of fuel level is obtained with the boat in a level position.

D. FUEL FILTER

Fuel filters are installed on each engine. (Yamaha has an additional fuel filter/water separator in the stern of the boat.) Filters should be changed frequently to assure an adequate supply of fuel to the engine. Refer to the engine manual for additional information. The engine manual is included in the owner's information packet. Fuel filters mounted in the vicinity of batteries, have a dielectric shield to protect against accidental short-circuiting. When servicing, remove any batteries in vicinity of filter, if shield is removed.



NOTICE

Canister-type filters should be changed annually.

E. FUEL STANDARDS

Be cautious when using gasoline that contains alcohol. Refer to the section on gasoline requirements in your engine manual for additional information. The use of alcohol additives in gasoline has become more widespread. Regulations on public notification of the existence of additives are currently controlled by the Environmental Protection Agency (EPA). Some states do require that gasoline pumps display information on additives (especially alcohol). If alcohol content is not posted, ask and avoid using fuel containing alcohol if possible.

Although alcohol boosts the octane level in gasoline, it also attacks the rubber fuel distribution lines and even metal fuel system components. Alcohol will permeate most fuel hoses and other components such as fuel pump, gaskets and seals, and can also contribute to fuel system contamination.

The hoses we use in our boats are alcohol-resistant as are the materials used by the engine manufacturers. If only fuel containing alcohol is available, you must perform more frequent inspections for leaks and abnormalities. Any sign of leakage or deterioration requires your immediate attention. Refer to the engine manufacturer's recommendations on fuel type and octane ratings.

F. SAFETY AND MAINTENANCE TIPS

The fuel system in your Ranger requires little or no maintenance. However, the periodic inspection outlined below is strongly recommended. Contact your Ranger dealer for proper fuel tank access for your model.

1. Check your fuel tank(s) for leakage, especially around the sending unit and fuel hose connections.
2. Inspect fuel hoses. A deteriorated hose containing alcohol blended fuels will normally be soft and swollen. A deteriorated hose containing no fuel will be hard and brittle. In both cases the hose(s) should be replaced.
3. Inspect the fuel system fittings at the deck fuel fill, fuel tank vent, tank(s), and (if equipped with more than one tank), the fuel switch valve for signs of leaks or corrosion. Visually inspect for deteriorating metal fittings at the fuel hose connections.
4. Check fuel tank hold down brackets, making sure they are secure.



WARNING

Avoid serious injury or death from fire or explosion, resulting from leaking fuel. Inspect system for leaks at least once a year.

Storage compartments are not designed to store flammable materials, as ventilation may not have been provided.



WARNING

Fuel vapors are a fire and explosion hazard. To avoid injury or death, do not store fuel or flammable liquids in boat. Ventilation has not been provided.

If areas are found within the fuel system that appear questionable, have your Ranger dealer inspect the system. A thorough fuel system examination should be made by an experienced marine technician at least once a year.



CAUTION

Maintenance or repairs should be performed by your Ranger dealer or other qualified personnel.

Naturally a leak-free fuel system is a **MUST** for proper operation and on-board safety. Always inspect for fuel leaks prior to connecting wiring to the battery or connecting a battery charger to the batteries or to the AC power.

ALWAYS inspect battery compartments before connecting battery charger to batteries and while battery compartments are ventilated. Battery compartment lids should always be open to ensure no explosive hydrogen gas is trapped in the compartment.



WARNING

Batteries produce hydrogen and oxygen gases when being charged. These explosive gases escape through the vent/fill caps and may form an explosive atmosphere around the battery if the ventilation is poor.

This gas may remain around the battery for several hours after charging. Sparks or flame can ignite the gas and cause an explosion.

G. FUELING INSTRUCTIONS

1. Secure boat to dock.
2. Boats on trailers need to be on a level surface to prevent air pockets.
3. Switch off all engine(s), pumps, lights, etc. that could produce a spark.
4. Do not smoke, strike matches, or throw an electrical switch.
5. Make certain all passengers are ashore.
6. Be sure the proper type and grade of fuel as recommended by your engine owner's manual is used.
7. Determine how much fuel is required to avoid overflow.
8. Ensure that a fire extinguisher is readily available.
9. Insert the fuel supply nozzle, keeping it in contact with the fuel fill deck plate to guard against static produced sparks.
10. Stand away from the fuel tank vent/fill during fueling. Splash-back may occur which could cause a fire hazard.
11. Make a habit of inspecting the bilge after pumping 5-10 gallons of fuel for any signs of leakage. If no problems are detected, resume fueling.
12. **DO NOT** top off fuel tank. Allow room for thermal expansion, to prevent fuel from sloshing out the vent. Allow no more than three automatic click-offs when filling.

H. AFTER FUELING

1. Replace all fill caps securely.
2. Wipe up any excess fuel immediately.
3. Determine that there is no odor of gasoline in the bilge, before turning on lights, pumps, or starting engine.

WARNING

Spilled fuel is a fire hazard. DO NOT overfill or overflow the tank, or allow fuel spills into the hull or bilge. If spillage occurs, clean up immediately and dispose of soiled rags in a proper container.

WARNING

Operating, servicing and maintaining a recreational marine vessel can expose you to chemicals including engine exhaust, carbon monoxide, phthalates, and lead, which are known to the State of California to cause cancer and birth defects or other reproductive harm. To minimize exposure, avoid breathing exhaust, services your vessel in a well-ventilated area and wear gloves or wash your hands frequently when servicing this vessel. For more information go to www.P65warnings.ca.gov/marine.

STEERING AT CONSOLE

WARNING

The steering in your boat is one of the most important items and should be checked by the driver every time the boat is used. You should school yourself and make it a habit to check the steering methodically.

Loose or worn steering could lead to an accident causing injury or death.

Your new Ranger Aluminum model may be equipped with no feed back steering. This is mechanical steering that is designed to help reduce engine torque, felt at the wheel, to a minimum. However, a firm grip on the steering wheel is required at all times.

You should familiarize yourself with the feel of the steering at various speeds and trim settings. **NEVER** exceed speeds beyond your comfort level.

WARNING

The driver must always keep a firm grip on the steering wheel. Failure to do so could lead to an accident causing injury or death.

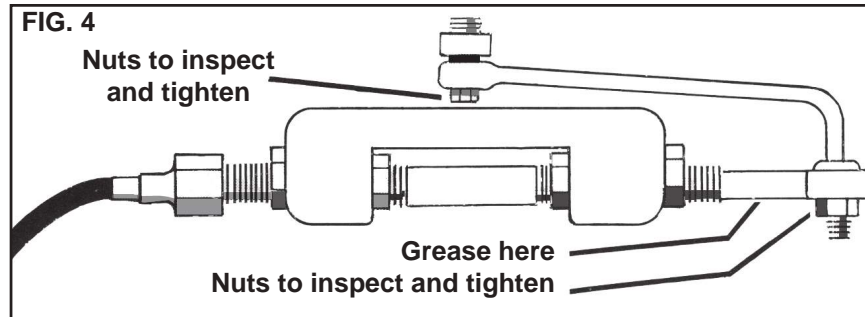

CAUTION

See engine owner's manual for proper greasing and maintenance of engine link rod and steering kit.

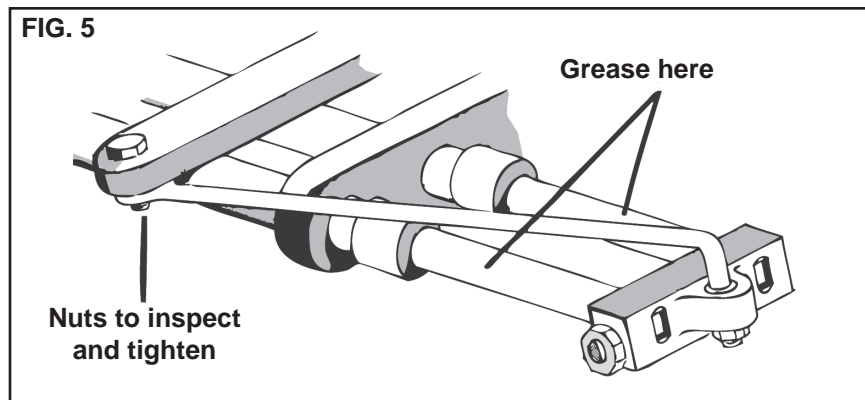

CLEANING UPHOLSTERY

For general purpose cleaning, use Fantastik, or warm water with a mild dish soap such as Dawn or Ivory. Gently scrub with a small soft bristle brush.

For dirt build-up, let soak for approximately 10 minutes, then gently scrub with a soft bristle brush. For specific stain removal, refer to the chart on page 16 or the staining agent's stain removal instructions.



CAUTION

- **DO NOT** use Formula 409 (the bottle states the product should not be used on vinyl.)
- **DO NOT** use kerosene, gasoline, or acetone, as they will remove the protective marine top coat on your vinyl.
- **DO NOT** use any silicone based protectants. They will extract the plasticizers, leaving the vinyl hard and brittle, and eventually cracking will occur.



CAUTION

For canvas seating areas, clean with medium soft brush and mild soap and water only.

USE	DO NOT USE	
<ul style="list-style-type: none"> • Dish Soap (Dawn, Ivory) • Fantastik • 303 Protectant 	<ul style="list-style-type: none"> • Formula 409 • Murphy's Oil Soap • Simple Green • DC Plus • ArmorAll • Top Kote Sealant • Son-of-a-Gun 	<ul style="list-style-type: none"> • Orange 88 Degreaser • Roll-Off • Bleach/Baking Soda • Turtle Wax Tar Remover • APCO • Harbor Mate

Certain household cleaners, powdered abrasives, steel wool, and industrial cleansers can cause damage and discoloration and are not recommended.

Dry cleaning fluids and lacquer solvents/acetone (for example, nail polish remover) should not be used as they will remove printed pattern and/or gloss.

Waxes should be used with caution as many contain dyes or solvents that can permanently damage the protective coating.

This chart contains methods for removing common stains and soils:

- A. Medium-soft brush, warm soapy water. Rinse. Dry.
- B. Household cleaner such as Fantastik.
- C. One tablespoon ammonia, one-fourth cup hydrogen peroxide, three-fourths cup water applied with medium soft brush. Rinse. Dry.
- D. Wipe or scrape off excess (chill gum with ice first).
- E. Denatured Alcohol. Rinse. Dry.
- F. Follow instructions of stain agent manufacturer.

	STEP 1	STEP 2	STEP 3
BALLPOINT INK*	E	B	A
CHEWING GUM	D	B	A
COFFEE, TEA, CHOCOLATE	B		
CRAYON	D	B	
GREASE	D	B	F
HOUSEHOLD SOIL	A	B	
KETCHUP	A	B	
MAKE UP (LIPSTICK, EYE SHADOW ETC.)	A	B	
MILDEW, WET LEAVES*	C	B	A
MOTOR OIL	B		
PAINT, DRIED OIL BASE	D	B	A
PAINT, FRESH OIL BASE	D	A	F
PAINT, LATEX	A	B	F
PERMANENT MARKER*	E	B	C
SHOE POLISH*	D	B	F
SPRAY PAINT	B	F	
SUNTAN LOTION*	A	B	
TAR/ASPHALT	D	B	
YELLOW MUSTARD	A	B	C

* Suntan lotion, tree pollen, wet leaves, and some other products contain dyes that stain permanently.

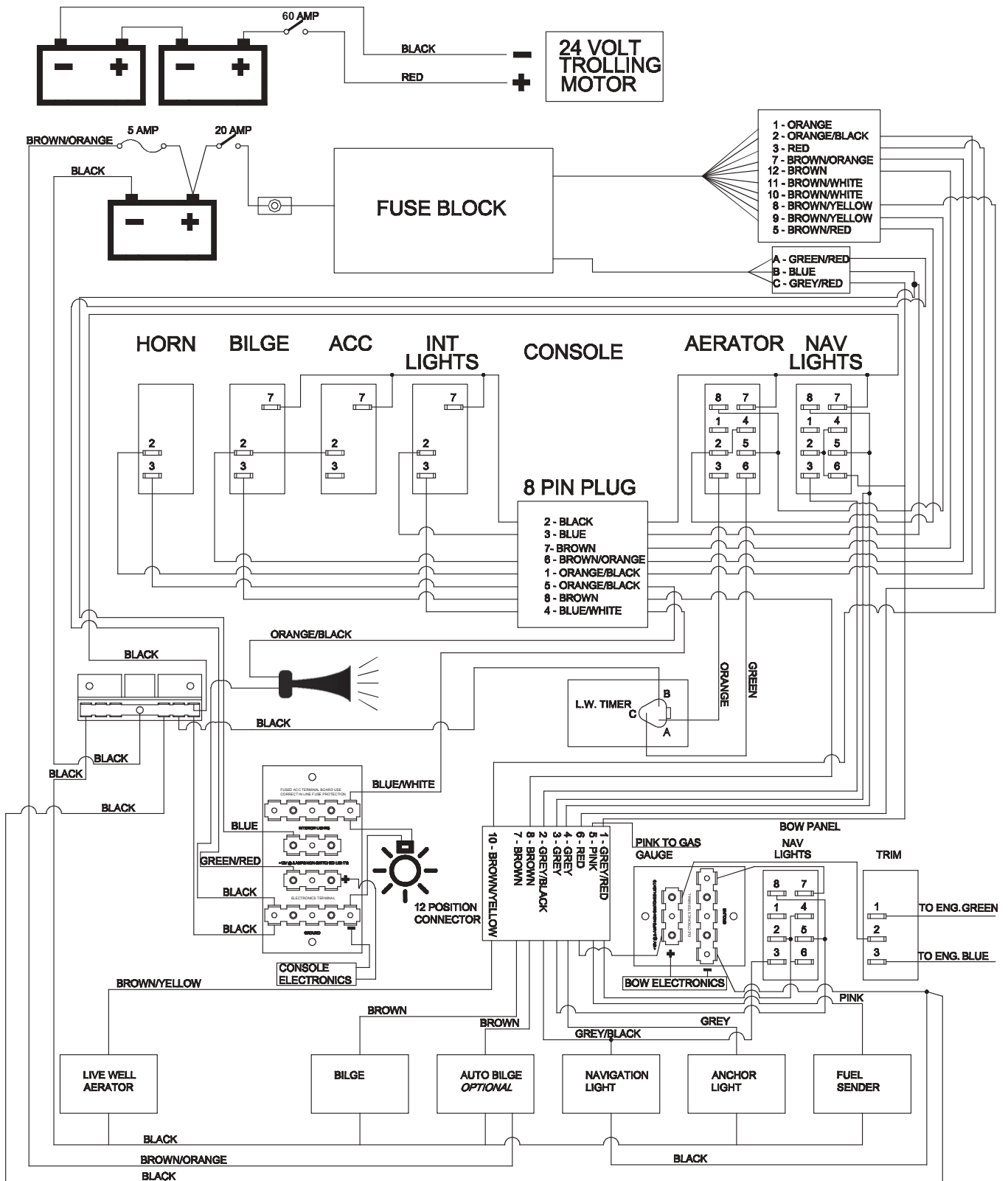

ALUMINUM BASS (RT Models)

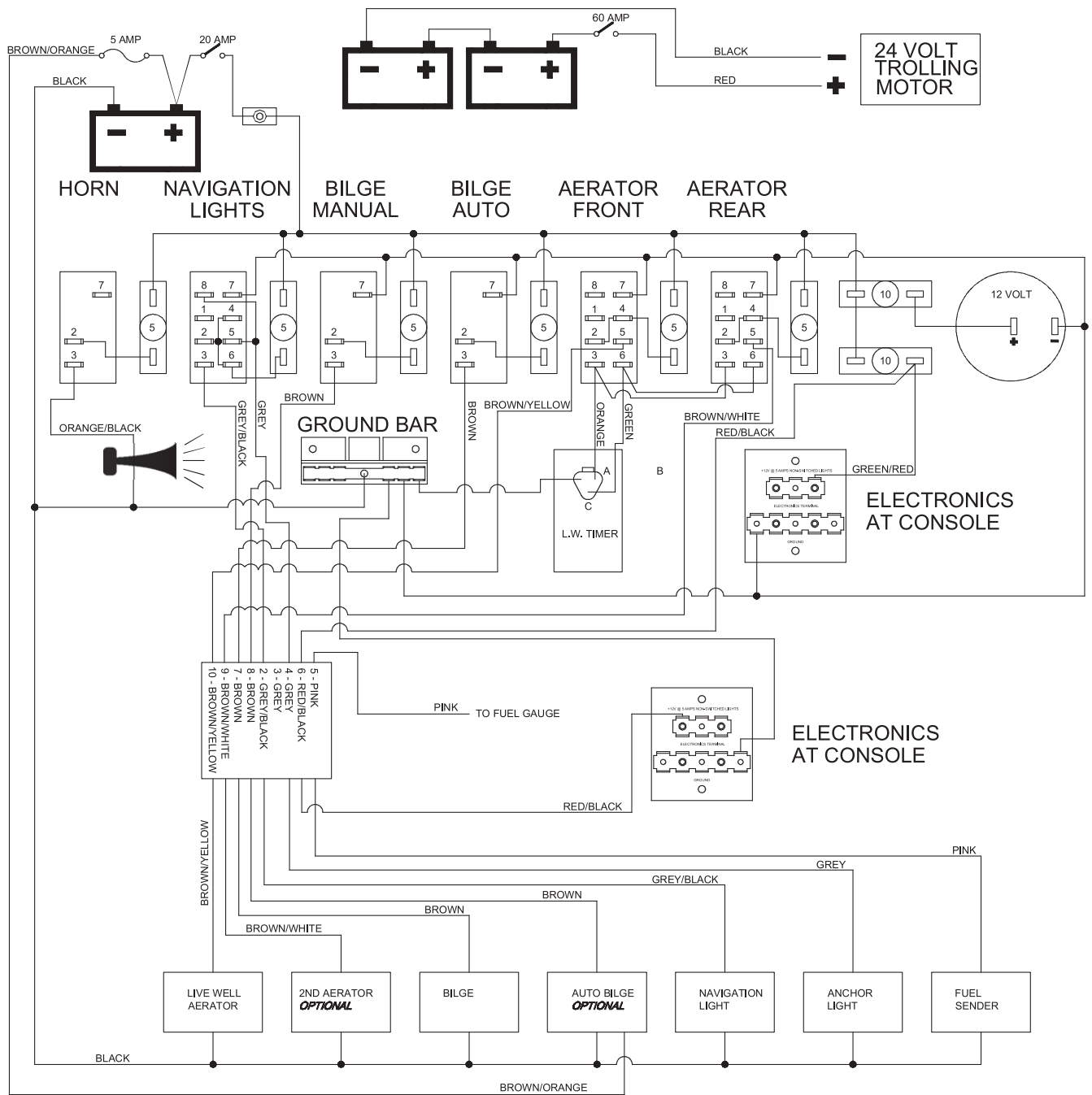

ALUMINUM CENTER CONSOLE

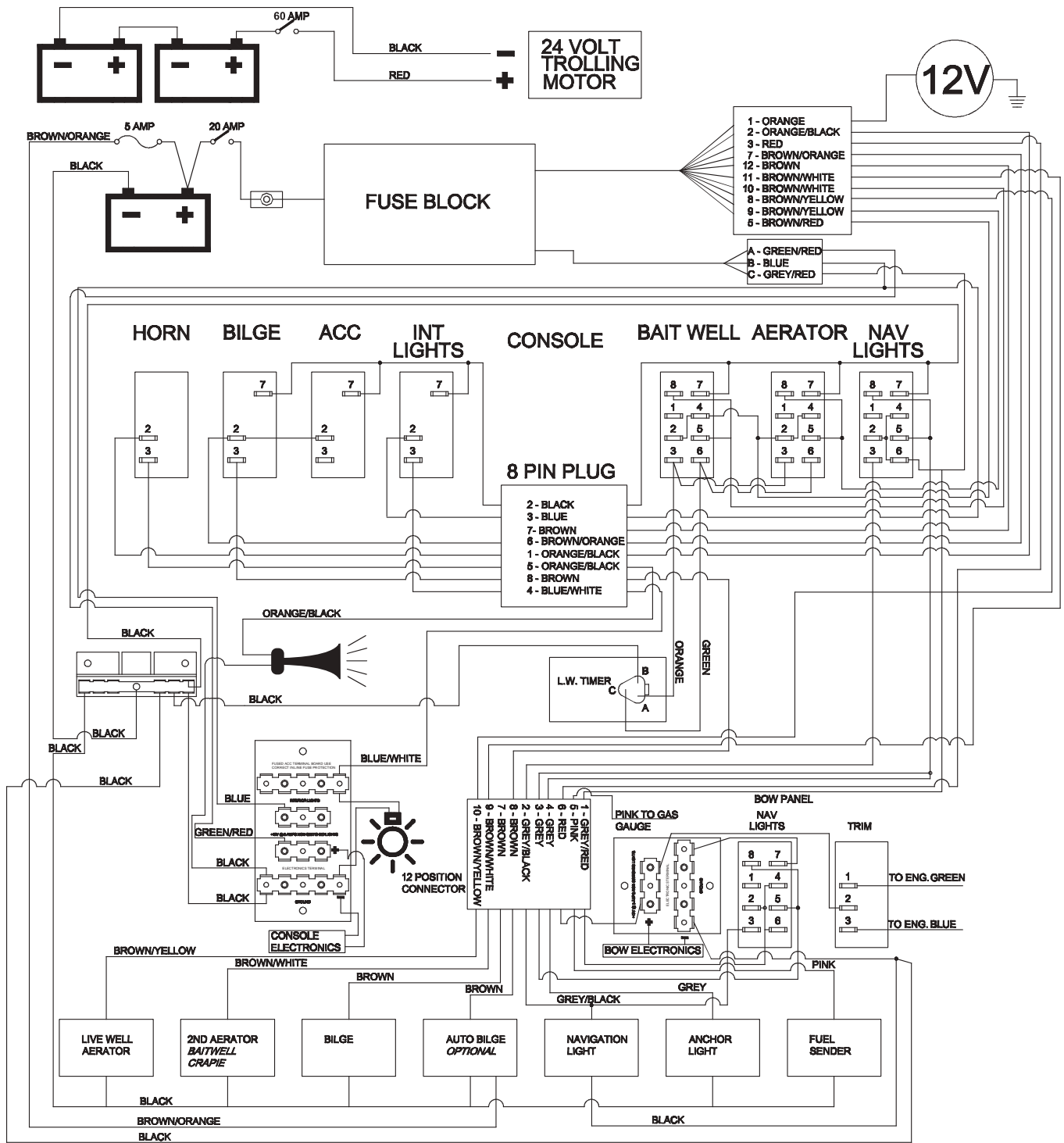

ALUMINUM CRAPPIE (RT-C MODELS)

HOOK UP OF TROLLING MOTOR LEADS:

2 WIRE 36 VOLT SYSTEM	RED to Battery	1 (+)	positive
	BLACK to Battery	3 (-)	negative
	JUMPER 1 (black sleeve) to Battery	1 (-)	negative
	JUMPER 1 (red sleeve) to Battery	2 (+)	positive
	JUMPER 2 (black sleeve) to Battery	2 (-)	negative
	JUMPER 2 (red sleeve) to Battery	3 (+)	positive
2 WIRE 24 VOLT SYSTEM	RED to Battery	1 (+)	positive
	BLACK to Battery	2 (-)	negative
	WHITE from Battery	1 (-)	negative
	to Battery	2 (+)	positive
2 WIRE 12 VOLT SYSTEM	RED to Battery	1 (+)	positive
	BLACK to Battery	1 (-)	negative

CAUTION

Hooking up leads to trolling motor in any other manner could result in severe damage to both batteries and panel.

Breakers are circuit protection (60 amp 12 volt) for the positive (+) leads in the trolling motor wiring (bow to stern). A problem in the system could result in the breaker(s) being tripped. Should this occur, the breaker(s) can be reset by pushing the switch. If this occurs again, disconnect battery leads and trace immediately, or take it to your Ranger dealer for repair.

An ignition protected circuit breaker is used for the accessories. Should a breaker trip, simply reset. **This switch should also be in the "off" position when trailering or storing the boat.** It acts as a master switch and turns off all accessories getting their power from the Ranger fuse panel. Remember, engine circuits will not be affected by these breakers/switches, but could have breakers or fuses of their own. Consult your engine owners manual for electrical particulars.

ELECTRICAL SYSTEM FUSE PANEL INFORMATION

On some models, the fuse panel features plug-in type ATC fuses. The fuses can be easily inspected and replaced. Circuits are reset as outlined in that model's Electrical System section. The Panel has a capacity of twelve to sixteen individual circuits. The particular accessory(ies) they operate are shown on the decal on the right side of the fuse panel or back side of the fuse panel cover.

CAUTION

Do not exceed recommended fuse sizes. Always install proper rated fuse when adding accessories to the fuse panel.

CAUTION

Inspect battery compartment(s) before plugging in AC power to charger. Inspect for loose wires, cracked battery, etc.

To improve the performance of the batteries, turn the master switch or breakers to the off position when the boat is not in use. Electronics, stereos and other items that the boat may be equipped with, could have a current draw even when those items are turned off.

SAFETY AND MAINTENANCE TIPS

- Check battery connections periodically to make sure they are corrosion free and TIGHT.
- Alteration of any part of the wiring system should be avoided! Such alterations could cause damage and/or electrical short.

- Inspect wiring connections and terminals periodically for damage, corrosion, etc. and replace as needed. Replacement should always be of equal or greater rating and quality. We recommend Ranger replacement parts available through your Ranger dealer.
- Always disconnect the positive and negative leads from the battery terminals before installing, removing, servicing, or troubleshooting any part of the electrical system.

 **WARNING** Batteries produce hydrogen and oxygen gases when charging. These explosive gases escape through the vent/fill caps and may form an explosive atmosphere around the battery if the ventilation is poor. This gas may remain around the battery for several hours after charging is completed. Sparks or open flames can ignite the gas and cause an explosion.

 **WARNING** Sulfuric acid in batteries can cause severe burns. Avoid contact with skin, eyes, or clothing. Wear goggles, rubber gloves and a protective apron when working with batteries.

FEDERAL REQUIRMENTS FOR RECREATIONAL BOATS

Boat operators are required to file a boating accident report when their boat is involved in certain boating accidents as follows:

Damage to property that exceeds \$500. Federal law requires the operator – or owner, if the operator is deceased or unable to make the report – to file a boating accident report with the State reporting authority when, as a result of an occurrence that involves a boat or its equipment:

- A person dies
- A person disappears from the vessel under circumstances that indicate death or injury
- A person is injured and requires medical treatment beyond first aid
- Damage to vessels and other property totals \$2,000 (lower amounts in some states and territories) or more
- Go to www.uscgboating.org to download the online accident forms.

EQUIPMENT	CLASS A (Under 16' in Length)	CLASS I (16', but under 26')
Whistle or Horn	Must have means of making an efficient sound signal.	
Visual Distress	None Required During Daytime	All recreational boats, when used on coastal waters, which includes the Great Lakes, the Territorial Seas, and those Waters directly connected to the Great Lakes and the Territorial Seas, up to a point where the waters are less than two miles wide, must be equipped with visual distress signals.
Inland and International Rules Navigational Lights	Proper light displays are required to be shown from sunset to sunrise.	
Fire Extinguishers	One B-1 U.S.C.G. or U.L. approved fire extinguisher unless the construction is such that explosive flammable vapors cannot be trapped, there are no closed compartments, no permanently installed fuel tanks on board.	
PFDS	Type I, II, III, or V for each person aboard.	Type I, II, III, or V for each person aboard and one Type IV.
Numbering	All undocumented vessels equipped with propulsion machinery must be numbered in the state of principal use.	
Certificate of Number	A valid certificate of number showing the numbers issued to a vessel must be on board whenever the vessel is in use.	
Display of Number	Number must be painted or permanently attached to each of the forward halves of the vessel, and no other number may be displayed thereon.	

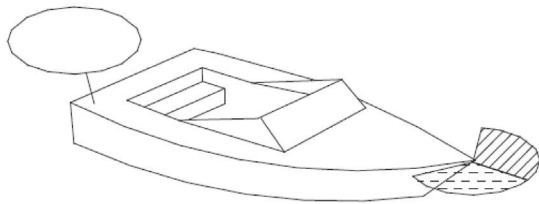

3A INTERNATIONAL OR INLAND

3B FOR INLAND ONLY

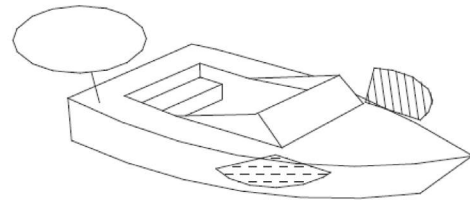

NOTE: The above information is not conclusive. The owner/operator should check all current Federal, State, and Local Regulations to insure compliance.

GENERAL INFORMATION AND MAINTENANCE

- Check all lights before each use of the trailer.
- Check the tires for wear, cuts or other damage before each use and replace as needed. Check tire pressure often. See tire sidewall for maximum pressure and maximum load.
- Check lug nuts for tightness before use. Torque lug nuts to 95-100 ft. lbs.
- Periodically check the winch strap and winch parts for any wear and replace worn parts.
- Remember... a small expense for preventive maintenance is much less expensive now than a road-side breakdown later!

Steps for Determining Correct Load Limit

CAUTION Trailer tires should be properly inflated and maintained! The load-carrying capacity of your trailer is based on the tire pressure. Inadequate tire pressures can void your tire and trailer warranty and could also lead to an accident damaging to people or equipment!

WARNING Lug nuts should be properly tightened before each use. Failure to do so could result in loss of a wheel and could lead to an accident causing injury or death.

CONTAINED OIL ORBITAL LUBRICATION (COOL) HUBS

Ranger Trail COOL hubs have a 3 year “No Touch” warranty. There is no required maintenance for three years from the original date of purchase. If for some unforeseen reason the hub develops an actual leak, it will be replaced under our limited warranty. It is normal for Hybrid Oil filled hubs to weep out small amounts of lubricant at the rear seal. When this happens, the oil will collect dirt and fall off onto the wheels as black spots. This is not a leak. Soap and water will remove this and clean your wheels. An oil leak will leave an oil film on the wheel that you will be able to see.

REPORTING SAFETY DEFECTS

If you believe that your vehicle has a defect which could cause a crash or could cause injury or death, you should immediately inform the National Highway Traffic Safety Administration (NHTSA) in addition to notifying Ranger Boats.

If NHTSA receives similar complaints, it may open an investigation, and if it finds that a safety defect exists in a group of vehicles, it may order a recall and remedy campaign. However, NHTSA cannot become involved in individual problems between you, your dealer, or Ranger Boats.

To contact NHTSA, you may call the Vehicle Safety Hotline toll-free at 1-888-327-4236 (TTY: 1-800-424-9153); go to <http://nhtsa.safercar.gov>; or write to: Administrator, NHTSA, 1200 New Jersey Avenue SE, Washington, DC 20590. You can also obtain other information about motor vehicle safety from <http://www.safercar.gov>.

TRAILER BRAKES

If your trailer is equipped with brakes, follow the safety and maintenance tips listed below for best service.

- Always hook up the brake breakaway cable securely to the tow vehicle (should the trailer come loose, cable will activate the brakes to help slow runaway trailer). Before towing, make sure that the emergency breakaway cable has not been inadvertently set. Reset to normal position by pushing the lever up. This will release the E-stop cable (see Fig. 6) on how to reset if indicator bead is exposed). **Always insert hitch pin after latching coupler to trailer ball.**
- Disc brake trailers are equipped with an electric solenoid valve to prevent the disc brakes from being activated while reversing your trailer. Disc brakes will operate at full capacity in either direction. It is therefore essential that the wire from the solenoid valve be connected to the reverse light wire of the tow vehicle. When the tow vehicle is put in reverse gear, the solenoid will deactivate the brakes and allow you to back up.

To check proper operation of solenoid valve, place tow vehicle gear shift in reverse (with engine shut off and ignition on). Backup lights should turn on and an audible “click” should be heard at the valve. If lights come on and no “click” is heard, check for an electrical wiring or connection problem. The reverse solenoid is located on the rear of the master cylinder.

- Check plug under cap to be sure it is seated fully.
- Follow routine maintenance and inspection for disc brakes as outlined in your Disc Brake Manual.

CAUTION Make sure back up lights **do not** come on when tow vehicle transmission is in any gear other than reverse.

To minimize corrosion, it is necessary for the disc brake calipers and rotors to be rinsed off with fresh water after trailer has been immersed in salt water.

CAUTION Saltwater model trailers, although designed for the saltwater environment, require specific cleaning and wash-down after each use. Failure to do so will cause excessive corrosion that could lead to trailer damage and part failure, which would not be covered under the limited warranty. Please see your Ranger dealer for proper trailer cleaning procedures.

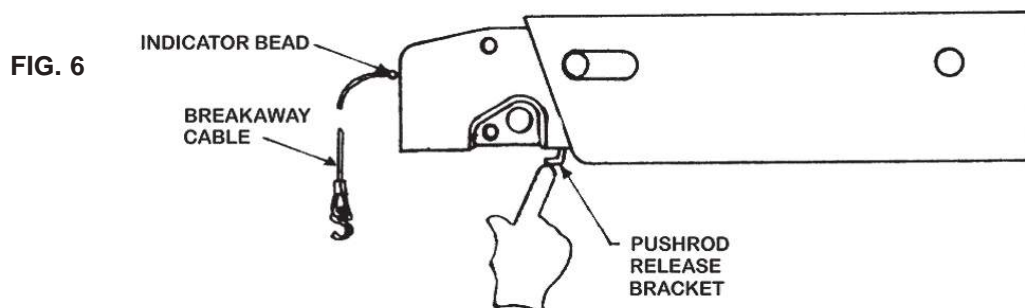

FIG. 7 RANGERTRAIL WIRING

WHITE - Ground
BROWN - Tail & Clearance Lights
YELLOW - Left stop & turn lights
GREEN - Right stop & turn lights
Red - to back-up light wire on vehicle

Main
Trailer
Plug

WHITE
BROWN
BROWN
YELLOW
GREEN
RED

INSPECTION

To assure continued proper operation of our trailer disc brakes, annual inspection is recommended.

PADS

Pads must be replaced when 1/16 inch (0.060") of pad friction material is left.



CAUTION

If not familiar with disc brake pad replacement, have work performed by a qualified individual or service shop.

ROTORS

Rotors should be resurfaced by a qualified brake specialist if extreme galling or wear marks are present.



CAUTION

Rotors must be replaced if distance between brake surfaces becomes less than 0.670 inches (17.0 mm) due to wear or machining.

RUST

Check for extreme rust on mounting bolts, flanges and welds, which may weaken the structural integrity of the system. Repair or replace as necessary.

LEAKS



CAUTION

Check for leaks in the brake lines and fittings. Leaks will lead to loss of trailer braking ability. Repair or replace as necessary.

REPLACEMENT PARTS

For questions and parts ordering, please contact: UFP, 135 Sunshine Lane, San Marcos, CA 92069, 800-854-1905. For warranty, please contact: UFP, 1041 Baxter Lane, Winchester, TN 37398, 800-835-9211 extension 16.



WARNING

The braking mechanism on this trailer is designed as an aid in slowing and stopping the trailer. The braking system on the tow vehicle is the primary slowing and stopping system. You will not be able to stop the tow vehicle and the towed trailer as quickly as you could stop the tow vehicle alone.

NEVER TOW YOUR TRAILER WITHOUT THE LOCK PIN INSTALLED!

BEFORE TOWING YOUR RANGERTRAIL® TRAILER . . .

Make sure that your tow vehicle is equipped with a **2-inch ball** of machined or forged steel! **Never** use a ball smaller than 1.97 inch diameter or larger than 2.0 inch diameter. Naturally, your tow vehicle should be equipped with a properly rated and substantial towing hitch, well braced and firmly connected to your vehicle. Make sure that your vehicle is properly wired for the trailer light connection.

The height of the towing ball above the ground will greatly influence the tongue weight and the towing characteristics of the trailer. With the trailer attached to the tow vehicle, the base of the ball should be 16" to 18" from the ground loaded.

TOWING YOUR RANGER TRAIL® TRAILER . . .

Back your tow vehicle into position so that the ball is directly under the trailer hitch ball socket. Stop your vehicle's engine and set parking brake. Make sure that the release handle on the trailer hitch is raised and pulled to the rear. This will show that the ball socket is open and ready to receive the tow ball. Then, by turning the tongue jack handle, lower the hitch until it seats fully on the tow ball. Be sure that the tongue jack wheel is slightly clear of the ground. Close the ball socket latch by pushing downward into the recess. The release handle should close smoothly if the ball has been seated correctly into the socket. If the release handle does not close, **DO NOT TOW THE TRAILER**. Insert safety pin through hole. To make sure that the connection is secure, lower the tongue jack until the ram has lifted the trailer hitch and trailer tongue connection 3 or 4 inches. If the ball does not disengage, you may be reasonably sure that the attachment is secure.



NOTICE

Aluminum wheels require careful wash down maintenance and are not warranted against surface corrosion.

Next, fully retract the jack into the full up position and latch. Connect the safety cables to the connection points on your tow vehicle hitch.

If your trailer is equipped with brakes, hook up the emergency breakaway cable and inspect to see that the breakaway cable button stop is not showing. Please refer to your brake owners manual. For questions and parts ordering, please contact: UFP, 135 Sunshine Lane, San Marcos, CA 92069, 800-854-1905; for warranty, please contact: UFP, 1041 Baxter Lane, Winchester, TN 37398, 800-835-9211 extension 16.

On swing hitch trailers, make sure the hitch is in the forward position and the locking pin is properly installed. Connect your trailer wire harness and test your vehicle lights to make sure that the trailer's brake and turn signals duplicate your vehicle's. Remove any trailer wheel chock and carefully pull away.

To unhitch your trailer from the tow vehicle, place the trailer on a level and paved surface and chock both trailer wheels to prevent any movement forward or backward. Unhook the safety cables, wiring harness and, if so equipped, the brake break-away cable. Then, using the trailer tongue jack, raise the hitch up and clear the ball. In this position the trailer tongue should be left somewhat bow high so that any water will run out through the drain hole in the stern of the boat.



CAUTION

Retract jack fully before towing! Replace coupler and ball if worn... do not attempt repair or adjustment.

All Ranger Trail trailers that have a GVWR of more than 5000 lbs. must use a Class IV hitch and 6000 lb. 2-inch trailer ball.

HITCH CLASS RATING	MID-SIZE CARS	FULL-SIZE CARS MINI-TRUCKS & VANS	FULL-SIZE TRUCKS VANS & SUV'S
Class II WC GTW - Up to 3,500 lbs. WC TW - up to 350 lbs.	Medium Duty	Medium Duty	Medium Duty
Class III WC GTW - Up to 5,000 lbs WC TW - up to 500 lbs.		Heavy Duty	Heavy Duty
Class IV WC GTW - Up to 7,500 lbs. WC TW - up to 750 lbs. WD GTW - Up to 12,000 lbs. WD TW - Up to 1,200 lbs.		Heavy Duty	Heavy Duty

INFORMATION CONTAINED ON THE SIDEWALL OF THE TIRE

Both U.S. and Canada Federal regulations require tire manufacturers to place standardized information on the sidewall of all tires. This information identifies and describes the characteristics of the tire.

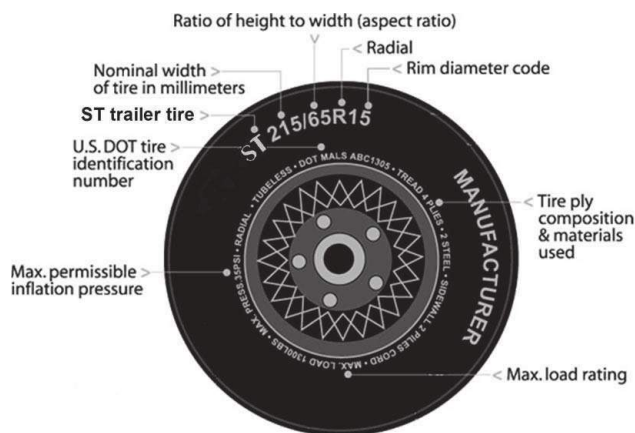

Maximum Permissible Inflation Pressure: Indicates the tire manufacturer’s maximum permissible pressure and/or the pressure at which the maximum load can be carried by the tire. Refer to the Certification Label on the port forward half of the trailer for the correct tire pressure for your trailer.

U.S. DOT Tire Identification Number (TIN)

This begins with the letters ‘DOT’ and indicates the tire meets all federal standards. The next two numbers or letters are the plant code designating where it was manufactured, the next two are the tire size code, and the last four numbers represent the week and year the tire was built. For example, the numbers 5110 mean the tire was built the 51st week of 2010. The numbers are identification codes used for traceability. This information is used to contact customers if a tire defect requires a recall.

ST: Indicates the tire is a special tire for trailers in highway service.

215: Indicates the nominal width of the tire in millimeters from sidewall edge to sidewall edge. In general, the larger the number, the wider the tire will be.

65: Indicates the aspect ratio which gives the tire’s ratio of height to width.

R: Indicates a “radial” type tire.

15: Indicates the wheel or rim diameter in inches.

Tire Ply Composition and Materials Used: Indicates the number of plies or the number of rubber-coated fabric in the tire tread and sidewall. Tire manufacturers also must indicate the ply materials in the tire and the sidewall, which include steel nylon, polyester, and others.

Maximum Load Rating: Indicates the maximum load in kilograms and pounds that can be carried by the tire. Refer to the Certification Label on the port forward half of the trailer for the correct tire pressure for your trailer.

NOTICE: Manufacturer’s Tire Registry; be sure to fill out the tire registration form provided with your owner’s packet. Mail it to the tire manufacturer for the purpose of Federal defect notification regulations.

SAMPLE TIRE REGISTRATION

B-193 (1-05)
701-100-298

IMPORTANT

In case of a recall, we can reach you only if we have your name and address. You **MUST** send in this card to be on recall list.
Do it today.

SHADED AREAS MUST BE FILLED IN BY SELLER

		TIRE IDENTIFICATION NUMBER											
		1	2	3	4	5	6	7	8	9	10	11	12
CUSTOMER'S NAME (PLEASE PRINT)	QTY	TIRE BRAND											
CUSTOMER'S ADDRESS													
CITY STATE ZIP CODE													
NAME OF DEALER WHICH SOLD TIRE													
DEALER'S ADDRESS													
CITY STATE ZIP CODE													
DEALER NON-SIG #													

8890480061

INFLATING YOUR TIRES

Safe operation of your trailer requires that your tires are properly inflated. Remember that a tire can lose up to half of its air pressure without appearing flat. Before each trip, check your tires with a tire gauge, including the spare (if equipped). Inflate all tires to the inflation pressure recommended on the Certification Label located on the port side of the forward half of the trailer. Failure to follow the tire pressure recommendations can cause uneven treadwear patterns and adversely affect the way your trailer handles.

Certification Label and Tire label

MANUFACTURED BY / FABRIQUE PAR: _____ DATE: _____ GVWR / PNBV _____ KG (LB) GAWR (EACH AXLE) / PNBG (CHAQUE ESSIEU) _____ KG (LB) Tires / Pneus _____ RIMS / JANTE _____ LOAD CAPACITY _____ KG (LB) COLD INFL. PRESS. / PRESS. DE GONFL. A FROID _____ KPA (PSI / LPS) <input type="checkbox"/> SINGLE <input type="checkbox"/> DUAL	<p>TIRE AND LOADING INFORMATION Total load should never exceed _____ kgs. or _____ lbs.</p> <table border="1" style="width: 100%; border-collapse: collapse;"> <thead> <tr> <th>TIRE</th> <th>SIZE</th> <th>COLD TIRE PRESSURE</th> <th rowspan="4" style="font-size: x-small; text-align: center;">SEE OWNER'S MANUAL FOR ADDITIONAL INFORMATION</th> </tr> </thead> <tbody> <tr> <td>FRONT</td> <td></td> <td></td> </tr> <tr> <td>REAR</td> <td></td> <td></td> </tr> <tr> <td>SPARE</td> <td></td> <td></td> </tr> </tbody> </table>	TIRE	SIZE	COLD TIRE PRESSURE	SEE OWNER'S MANUAL FOR ADDITIONAL INFORMATION	FRONT			REAR			SPARE		
TIRE	SIZE	COLD TIRE PRESSURE	SEE OWNER'S MANUAL FOR ADDITIONAL INFORMATION											
FRONT														
REAR														
SPARE														

THIS VEHICLE CONFORMS TO ALL APPLICABLE U.S. FEDERAL MOTOR VEHICLE SAFETY STANDARDS IN EFFECT ON THE DATE OF MANUFACTURE SHOWN ABOVE.
 THIS VEHICLE CONFORMS TO ALL APPLICABLE STANDARDS PRESCRIBED UNDER THE CANADIAN MOTOR VEHICLE SAFETY REGULATIONS IN EFFECT ON THE DATE OF MANUFACTURE. - CE VEHICULE EST CONFORME A TOUTES LES NORMES QUI LUI SONT APPLICABLES EN VERTU DU REGLEMENT SUR LA SECURITE DES VEHICULES AUTOMOBILES DU CANADA EN VIGUEUR A LA DATE DE SA FABRICATION.
 V.I.N. / N.L.V.: _____ TYPE / TYPE: TRAILER TRA / REM

When weather temperature changes occur, tire inflation pressures also change. A 10° F (6° C) temperature drop can cause a corresponding drop of 1 psi (7 kPa) in inflation pressure.

Under-inflation is the most common cause of tire failures and may result in severe tire cracking, tread separation or “blowout”, with unexpected loss of vehicle control and increased risk of injury. Under-inflation increases sidewall flexing and rolling resistance, resulting in heat buildup and internal damage to the tire. It also may result in unnecessary tire stress, irregular wear, loss of vehicle control and accidents. A tire can lose up to half its air pressure and not appear flat!

To check the pressure in your tire(s):

- 1: Check your tire(s) when they are “cold”. The term cold does not relate to the outside temperature. Rather, a cold tire is one that has not been driven for at least three hours. When you drive, your tires get warmer, causing the air pressure to increase. Therefore, to get an accurate tire pressure reading, you must measure the tire pressure when the tires are *cold* or compensate for the extra pressure in warm tires.
- 2: Remove the cap from the valve on one tire, then firmly press the tire gauge onto the valve and measure the pressure with the tire gauge.
- 3: Add (or remove) enough air to reach the recommended air pressure indicated on your Certification Label.
- 4: Replace the valve cap.
- 5: Repeat this procedure for each tire, including the spare.

TIRE CARE

Periodically inspect the tire treads for uneven or excessive wear and remove objects such as stones, nails, or glass that may be wedged in the tire grooves. Check for holes or cuts that may permit air leakage from the tire and make necessary repairs. Also inspect the tire sidewalls for cracking, cuts, bulges, and other signs of damage or excessive wear. If internal damage to the tire is suspected, have the tire demounted and inspected in case it needs to be repaired or replaced. For your safety, tires that are damaged or show signs of excessive wear should not be used because they are more likely to blow out or fail.

Improper or inadequate trailer maintenance can cause tires to wear abnormally. Inspect your tires, including the spare frequently, and replace them if one or more show signs of damage or excessive wear.

AGE
Tires degrade over time, even when they are not being used. It is recommended the tires generally be replaced after 6 years of normal service. Heat caused by hot climates or frequent high loading conditions can accelerate the aging process. You should replace the spare tire when you replace the other tires due to the aging of the spare tire.

LOAD CARRYING CAPACITY

The certification label shows the maximum load-carrying capacity and is located on the port forward side of the trailer.

GVWR is the Gross Vehicle Weight Rating. It is the total combined weight of the trailer and its maximum load-carrying capacity. DO NOT exceed the GVWR rating for the trailer.

Total Load is the maximum load-carrying capacity of the trailer minus the weight of the trailer.

Locate the statement “Total load should never exceed XXX kg or XXX lbs.” on your trailer’s tire label located on the port forward side of your trailer.

This figure equals the available amount of the boat with all equipment, gear, fuel, water, and luggage load capacity.

Determine the combined weight of the boat with all equipment, gear, fuel, water, and luggage being loaded on the trailer. That weight may not safely exceed the tire label’s total load.

Sample Tire Label



TIRE AND LOADING INFORMATION

Total load should never exceed
1719 kgs. or 3790 lbs.

Improper weight distribution can place excessive strain on the towing vehicle and trailer. It can also cause the trailer to “fishtail” (sway side to side). Be sure gear and luggage are distributed evenly in the boat.

TIRE	SIZE	COLD TIRE PRESSURE	SEE OWNER'S MANUAL FOR ADDITIONAL INFORMATION
FRONT	ST215/75R14C	50 PSI	
REAR	ST215/75R14C	50 PSI	
SPARE	ST215/75R14C	50 PSI	

GLOSSARY OF TIRE TERMINOLOGY:

Tire label: A label showing the tire sizes, recommended inflation pressure, and the maximum weight the trailer can carry.

Tire Identification Number (TIN): A number on the sidewall of each tire providing information about the tire brand, manufacturing plant, tire size, and date of manufacture. It is also referred as the DOT code.

Inflation pressure: A measure of the amount of air in a tire.

kPa: Kilopascal, a metric unit of air pressure.

PSI: Pounds per square inch, a standard unit of air pressure.

Cold tire pressure: The tire pressure when the trailer has been stationary and out of direct sunlight for an hour or more and prior to the trailer being pulled 1 mile (1.6 km)

Recommended inflation pressure: The cold inflation pressure found on the certification label or tire label located on the port forward side of the trailer.

Bead area of the tire: Area of the tire next to the rim.

Sidewall of the tire: Area between the bead area and the tread.

Tread area of the tire: Area of the perimeter of the tire that contacts the road when mounted on the trailer.

Rim: The metal support (wheel) for a tire upon which the tire beads are seated.

Notes:



NORTH AMERICAN

**RANGER® BOATS
LIMITED WARRANTY
RANGER ALUMINUM BOATS AND RANGER TRAIL® TRAILERS**

Fishing Holdings, LLC dba Ranger Boats (“Ranger”) warrants to you, the first North American retail purchaser of this Ranger aluminum boat and/or trailer, or a second North American retail purchaser as noted below (“you”), that it will repair or replace, at its sole discretion, defects in materials or workmanship that occur and are reported to Ranger, or its factory authorized aluminum dealer, within the applicable limited warranty periods, subject to the terms, conditions and exclusions set forth below. Your acceptance of delivery of the warranted Ranger aluminum boat and/or trailer constitutes your acceptance of the terms of this limited warranty. This limited warranty gives you specific legal rights and you may have other rights which may vary from state to state.

This limited warranty is the sole and exclusive express warranty from Ranger regarding your Ranger aluminum boat and/or trailer and there are no express warranties which extend beyond those outlined in this limited warranty. There are no implied warranties from Ranger, unless otherwise required under applicable law, and ALL IMPLIED WARRANTIES (INCLUDING ANY IMPLIED WARRANTY OF MERCHANTABILITY OR FITNESS FOR A PARTICULAR PURPOSE) ARE EXCLUDED AND DISCLAIMED WHERE ALLOWED BY APPLICABLE LAW. ANY IMPLIED WARRANTIES (IF APPLICABLE) ARE LIMITED TO THE MINIMUM PERIOD OF TIME ALLOWED UNDER APPLICABLE LAW. Some states do not allow limitations on how long an implied warranty lasts, so the above limitations may not apply to you.

Coverage Under This Limited Warranty:

Structural Hull Limited Warranty:

External Structural Hull Welds: For the first North American retail purchaser, the limited warranty period for Structural Hull Defects (defined below) in external structural hull welds runs for the duration of their period of ownership. For the second North American retail purchaser (if applicable), if properly transferred in compliance with the transfer requirements set forth in this document, the limited warranty period for Structural Hull Defects in the external structural hull welds runs for five (5) years from the date the limited warranty period began to run for the first North American purchaser.

Internal Structural Hull Components (stringers, ribs, bulkheads and transom): The limited warranty period for Structural Hull Defects in internal structural hull components runs for five (5) years.

A “Structural Hull Defect” shall mean a substantial defect in the aluminum boat hull’s external structural welds or internal structural hull components (stringers, ribs, bulkheads and transom) which causes the aluminum boat to be unfit or unsafe for general use as a pleasure craft under normal operating conditions.

Non-Structural Parts And Components Limited Warranty:

The limited warranty period runs for two (2) years for the following non-structural parts and components:

1. Carpet fade
2. Steering helm, cylinder, hoses and cables
3. Aeration pumps, valves and timers
4. Bilge pump
5. Aluminum boat electrical system
6. Seat pedestals
7. Fuel tanks
8. Deck hardware such as locks, cleats and fasteners
9. Factory installed battery charger(s)

The limited warranty period runs for one (1) year for the remaining non-structural parts and components.

Ranger Trail® Trailer Limited Warranty: The limited warranty period runs for three (3) years.

Exterior Cosmetic Painted Finish (Peeling or Fading) Of Aluminum Boats Limited Warranty: The limited warranty period runs for two (2) years.

The applicable limited warranty period for both the First and Second (if applicable) North American retail purchasers runs from the date of delivery of the aluminum boat and/or trailer to the first North American retail purchaser, provided that the aluminum boat and/or trailer is delivered to that first North American retail purchaser within twenty-four (24) months from the date of its manufacture. For an aluminum boat and/or trailer delivered to that first North American retail purchaser more than twenty-four (24) months after the date of its manufacture, the limited warranty period runs from the date of its manufacture, not from the date the aluminum boat and/or trailer was delivered to that first North American retail purchaser. All limited warranties run concurrently.

This limited warranty extends only to the first North American retail purchaser. However, it may be transferred to a second North American retail purchaser for a non-refundable recording fee of \$200 (made payable to your authorized aluminum dealer), which must be paid within fifteen (15) days of the purchase, provided the second North American retail purchaser purchases the aluminum boat and/or trailer from the original purchaser or an authorized Ranger aluminum dealer, and provided the transfer occurs within five (5) years of the original retail sale to the First North American

Warranty

retail purchaser. Proof of the purchase date is required. This limited warranty may only be transferred **once**. Ranger reserves the right to reject a limited warranty transfer request for a Ranger aluminum boat and/or trailer that has been damaged, neglected or otherwise previously excluded from limited warranty coverage.

THIS LIMITED WARRANTY DOES NOT COVER:

1. An aluminum boat and/or trailer purchased from any party other than an authorized Ranger aluminum dealer or the first North American retail purchaser.
2. An aluminum boat and/or trailer, including its components, that has been altered or modified so as to adversely affect its operation, performance or durability, as determined by Ranger, or an aluminum boat and/or trailer that has been salvaged, declared a total loss, or a constructive total loss, for any reason not covered in this limited warranty.
3. Any damage resulting from an accident or impact with another object or any damage caused by an act of nature.
4. Damage, breakage and leakage around windshields, hatches or other designed openings.
5. Painted (except as noted above) or gel coat finishes, including blistering, chalking, discoloration, cracking, crazing or stars; wood finishes (varnish, stains and paints); plastics; plated or painted metal; stainless steel finishes and anti-fouling bottom paint.
6. Damage (including due to rainwater leakage), deterioration, fraying, tearing, wearing or shrinkage of carpet, upholstery (including fabric and vinyl), exterior canvas, enclosures, weather covers or other soft goods.
7. An aluminum boat that has been overpowered, according to the aluminum boat's maximum recommended engine horsepower, or overloaded in excess of the maximum limits as stated on the U.S. Coast Guard Capacity Plate.
8. An aluminum boat with an engine setback plate that is not factory installed.
9. Estimated characteristics such as weight, speed and fuel consumption or other estimated performance characteristics.
10. An aluminum boat and/or trailer that has been misused or used in a negligent manner; an aluminum boat that has been used for racing, speed or endurance contests; used for rental; used without normal maintenance; operated contrary to any instruction furnished by Ranger, improperly lifted or trailered; improperly secured to a trailer or operated in violation of any federal, state, local, Coast Guard or other governmental agency laws, rules or regulations.
11. Dealer preparation, cleaning, final adjustments and alignments in preparing the aluminum boat and/or trailer for delivery.
12. Trailer tires; trailer paint chipping, rust/corrosion, and axle alignment; and trailer components manufactured by companies other than Ranger.
13. Damage to trailers from use in salt or brackish water, except those trailers designed for salt/brackish water use.
14. Damage caused by improper trailering or mismatching of a Ranger aluminum boat to a trailer; or failure to properly secure the aluminum boat to a trailer.
15. Damage to aluminum hulls from use in salt or brackish water unless that hull model is specifically designated for such use.
16. Engines, powertrains, outdrives, controls, propellers, batteries, trailers and other equipment, accessories or components that are not manufactured by Ranger, whether or not they are warranted by other manufacturers. **Note:** it is the purchaser's responsibility to complete any warranty registration procedure that may be applicable to these components.
17. Any failure or defect arising from a previous repair made by a non-authorized service provider, unless preapproved by Ranger.
18. Any defect that results in the redesign of the Ranger aluminum boat and/or trailer.

THE SOLE AND EXCLUSIVE REMEDY UNDER THIS LIMITED WARRANTY AND ANY APPLICABLE IMPLIED WARRANTY IS THE REPAIR OR REPLACEMENT, AT RANGER'S SOLE OPTION, OF WARRANTED PARTS AND COMPONENTS. RANGER EXCLUDES AND DISCLAIMS ANY LIABILITY FOR INCIDENTAL OR CONSEQUENTIAL DAMAGES INCLUDING LOSS OF TIME, INCONVENIENCE, INSTALLMENT PAYMENTS, INSURANCE PAYMENTS, MARINA FEES, RETAIL CHARGES, TRAVEL EXPENSES, LOSS OF USE, HAUL OUT, LAUNCH, TOWING AND/OR STORAGE CHARGES, LOSS OF OR DAMAGE TO PERSONAL PROPERTY OR OTHER SIMILAR COSTS AND EXPENSES, OR ANY CLAIM NOT SPECIFICALLY COVERED BY THIS LIMITED WARRANTY. Some states do not allow the exclusion or limitation of incidental or consequential damages, so the above limitation or exclusion may not apply to you. Any legal action alleging breach of any applicable warranty coverage must be brought within one (1) year from the date the alleged breach first occurred, or the shortest period allowed under applicable law, whichever is earlier.

In order to activate limited warranty coverage on their aluminum boat and/or a trailer, the first North American retail purchaser must warranty register the aluminum boat and/or trailer through an authorized Ranger aluminum dealer via Ranger's online dealer extranet, within fifteen (15) days of delivery of the aluminum boat and/or trailer. All information received by Ranger via the limited warranty registration or transfer process shall be the property of Ranger, and submission of information, directly or indirectly, via the limited warranty registration process shall, to the extent permitted by applicable law, be deemed to constitute consent by the purchaser and aluminum dealer to Ranger's use of such information at any time for all purposes allowed by law, including use of that information by third parties selected by Ranger. You may opt to not have your personal information disclosed to third parties and/or to not receive marketing materials from Ranger by sending a written request to: Ranger Boats Warranty Department, PO Box 179, Flippin, AR 72634. To obtain limited warranty service, you must return the aluminum boat and/or trailer, including any alleged defective part, to an authorized Ranger aluminum dealer. Ranger must receive written notice of all limited warranty claims prior to the expiration of this limited warranty and be allowed an opportunity to resolve them. The authorized Ranger aluminum dealer will carry out the limited warranty procedures (e.g. repairs, claims submissions to Ranger etc.) on the purchaser's behalf. All limited warranty work must be performed at an authorized Ranger aluminum dealer, at the Ranger factory or at another repair facility that Ranger selects. The purchaser is responsible for the

Warranty

expenses associated with transporting the aluminum boat and/or trailer to and from the repair facility.

DISPUTE RESOLUTION

RANGER'S GOAL IS TO RESOLVE ANY WARRANTY ISSUE AS QUICKLY AND FAIRLY AS POSSIBLE. PLEASE CONTACT OUR WARRANTY DEPARTMENT AT (870) 453-2222 IN THE EVENT YOU HAVE ANY QUESTIONS ABOUT THE TERMS, CONDITIONS AND LIMITATIONS CONTAINED IN THIS WARRANTY. THE PROCEDURE TO HAVE YOUR WARRANTY ISSUE RESOLVED IS SET FORTH ABOVE. IN THE EVENT THE RANGER DEALER CANNOT REMEDY THE DEFECT WITHIN A REASONABLE TIME, YOU AGREE TO WRITE US AT RANGER CUSTOMER SERVICE, 927 HIGHWAY 178 N, FLIPPIN, AR 72634, AND EXPLAIN THE ISSUE. IF RANGER'S RESPONSE TO YOUR WRITTEN EXPLANATION OF THE ISSUE IS NOT TO YOUR SATISFACTION, YOU AGREE THAT THE FOLLOWING BINDING ARBITRATION WILL APPLY.

BINDING ARBITRATION

a) You and Ranger agree to submit all disputes, claims, or controversies of any kind arising out of or related to this warranty and/or your purchase of a Ranger boat or trailer for resolution exclusively through binding arbitration. **You should review this provision carefully. This arbitration provision limits your and our ability to litigate claims in court. You and we each agree to waive your and our respective rights to a jury trial; ANY RIGHT TO A TRIAL BY JURY, WHETHER ON AN INDIVIDUAL OR A CLASS BASIS, IS HEREBY WAIVED. Any arbitration under this provision shall take place on an individual basis; class arbitrations and class actions are not permitted. You will not have the right to participate as a class representative, private attorney general, or member of any class of claimants for any claim subject to arbitration. A claim by, or on behalf of, other persons will not be considered in, joined with, or consolidated with the arbitration proceedings between you and us. Any dispute regarding the prohibitions in the prior sentence shall be resolved by the arbitrator in accordance with this arbitration provision.**

b) Arbitration is usually an informal proceeding in which disputes are decided by one or more neutral arbitrators who receive the evidence at a hearing and then issue a binding ruling in the form of an award. You and we understand that in an arbitration discovery is more limited than in a court, and review by courts is very limited.

c) A party who intends to seek arbitration must first send to the other, by certified mail, a written Notice of Dispute (a "Notice"). Any Notice to us should be addressed to General Counsel, Fishing Holdings LLC, 927 Highway 178 N, Flippin, AR 72634 (the "Notice Address"). Any Notice must (i) describe the nature and basis of the dispute, claim, or controversy and (ii) set forth the specific relief sought. If you and we do not reach an agreement to resolve the dispute, claim, or controversy within 30 days after the Notice is received, you or we may commence an arbitration proceeding. During the arbitration, the amount of any settlement offer made by you or we shall not be disclosed to the arbitrator until after the arbitrator determines the amount, if any, to which you or we are entitled.

d) You and we agree, upon written demand made by you or us, to submit to binding arbitration of any and all disputes, claims, and controversies between you and us, whether based on statute, regulation, constitution, common law, equity, or any other legal basis or theory, and whether pre-existing, present, or future, that arise out of or relate to this warranty and/or your purchase of a Ranger boat or trailer, including contract disputes, tort claims, fraud claims and fraud-in-the-inducement claims, misrepresentation, statutory claims and/or regulatory claims arising out of or relating to your Ranger boat or trailer or this warranty (including, to the fullest extent permitted by applicable law, relationships with third parties who are not parties to this warranty or this arbitration provision), or the scope or enforceability of this warranty, including the determination of the applicability of this agreement to arbitrate, and/or any other relationship or dispute between the parties (collectively, "Claims"). All parties retain the right to seek relief in a small claims court for Claims within the jurisdictional limits of the small claims court. The arbitration of any Claim shall be conducted by the American Arbitration Association (the "AAA") or any other arbitrator mutually agreed upon by you and us. In any event, the arbitration of any Claim shall be conducted in accordance with the Commercial Arbitration Rules and the Supplementary Procedures for Consumer Related Disputes (the "Rules"). The Rules are available online at www.adr.org or by calling 800.778.7879. In the event of any inconsistency between this arbitration provision and the Rules, such inconsistency shall be resolved in favor of this arbitration provision. This arbitration provision is made pursuant to a transaction involving interstate commerce, and the Federal Arbitration Act shall apply to the construction, interpretation, and enforceability of this warranty, notwithstanding any other choice of law provision contained in this warranty.

e) After the 30-day period in paragraph c) above has expired, either you or we may initiate arbitration by giving written notice of the intention to arbitrate to the other party and by filing notice with the AAA in accordance with the Rules in effect at the time the notice is filed. We may be given notice at the Notice Address.

f) A panel of no less than three (3) arbitrators shall decide all Claims. The arbitrators shall be active members in good standing of the bar for any state in the continental United States and shall be either actively engaged in the practice of law for at least five years or a retired judge.

g) You and we agree that the arbitrators shall: (i) limit discovery to non-privileged matters directly relevant to the Claim; (ii) grant only relief that is based upon and consistent with substantial evidence and applicable substantive law; (iii) have authority to grant relief only with respect to Claims asserted by or against you individually; and (iv) provide a written statement stating the disposition of each Claim and a concise written explanation of the basis for the award and shall make specific findings of fact and conclusions of law to support any arbitration award. Unless inconsistent with applicable law, and except as otherwise provided herein, each party shall bear the expense of its respective attorney, expert, and witness fees, regardless of which party prevails in the arbitration. We will pay to the AAA any portion of the arbitration filing fee that exceeds the cost of filing a lawsuit in the federal court where you live. If you are unable to pay the filing fee, we will pay it directly upon receiving a written request. We will pay all of the remaining administration fees and other costs, including the arbitrator's fees, for any non-frivolous Claim (measured by the standards set forth in Rule 11(b) of the Federal Rules of Civil Procedure) that does not exceed \$15,000. For all other Claims, the arbitrators will decide whether we or you will ultimately be responsible for paying any fees or other costs in connection with the arbitration under the Rules. Any arbitration proceedings shall be conducted in the federal judicial district of your residence, and you will be given the opportunity to attend the proceeding and be heard. If your Claim is for \$10,000 or less, we agree that you may choose whether the arbitration will be conducted solely on the basis of documents submitted to the arbitrators, through a telephonic hearing, or by an in-person hearing in accordance with the Rules. Judgment upon any award rendered in arbitration may be entered in any court having competent jurisdiction.

h) Demand for arbitration under this arbitration provision must be made before the date when any judicial action upon the same Claim would be barred under any applicable statute of limitations; otherwise, the Claim is also barred in arbitration. Any dispute as to whether any statute of limitations, estoppel, waiver, laches, or other doctrine bars the arbitration of any Claim shall be decided by arbitration in accordance with this arbitration provision.

Warranty

i) Nothing in this arbitration provision shall limit the right of you or us, whether before, during, or after the pendency of any arbitration proceeding, to exercise any self-help remedies, such as set-off, or to obtain provisional or ancillary remedies or injunctive or other traditionally equitable relief, such as filing an interpleader action or seeking enforcement of intellectual property rights. You and we agree that the taking of these actions or any other participation in such litigation by you or us does not waive any right that either you or we have to demand arbitration at any time with respect to any subsequent or amended Claim filed against you or us after commencement of litigation between you and us

j) You may choose to opt out of these arbitration procedures within 30 days from the date you purchase your Ranger product ("Opt-Out Deadline"). You may opt out of these arbitration procedures by completing the opt-out form located at www.rangerboats.com/arbitrationoptout and sending the opt-out form to the following notice address: Warranty Arbitration Director, Fishing Holdings, LLC, 927 Highway 178 N, Flippin, AR 72634. Any opt-out received after the Opt-Out Deadline will not be valid and you must pursue your Claims in arbitration or small claims court.

k) If any portion of this arbitration provision is deemed invalid or unenforceable, the remaining portions of this arbitration provision will remain valid and enforceable.

CHOICE OF LAW; JURISDICTION AND VENUE

Except as set forth in binding arbitration clause above, this warranty shall be governed exclusively by, and construed exclusively in accordance with, the internal laws of the state of Delaware without reference to the choice of law or conflicts of law principles thereof, and all claims relating to or arising out of this warranty, or the breach thereof, whether sounding in contract, tort or otherwise, shall likewise be governed exclusively by the laws of the state of Delaware without reference to the choice of law or conflicts of law principles thereof. To the extent any action is permitted under binding arbitration clause above to be heard in a court of competent jurisdiction, such action shall take place in the state or federal courts sitting in Kent County, Delaware, the parties hereby waiving any claim or defense that such forum is not convenient or proper. Each party agrees that any such court shall have in personam jurisdiction over it for any such action, and each party consents to service of process in any manner authorized by Delaware law.

OTHER NOTES

RANGER reserves the right to make changes in design of its products, and changes or improvements to its products, at any time, including during a product year, without imposing any obligation upon Ranger to alter any of its products that were previously manufactured.

This document contains the entire limited warranty provided by Ranger. Any questions concerning the scope of this limited warranty should be directed to Ranger. The terms and conditions contained in this limited warranty may not be modified, altered or waived by any action, inaction or representation, whether oral or in writing, except upon the express, written authority of a senior management level employee of Ranger. Ranger does not authorize any person or persons (except a senior management level employee of Ranger), including Ranger aluminum dealers, to change the terms of this limited warranty. (Note that your authorized Ranger aluminum dealer is an independent business, authorized to sell and service Ranger products, but is not an agent of Ranger.) Ranger reserves the right to change or improve the design or manufacture of Ranger aluminum boats and/or trailers without obligation to modify any aluminum boat and/or trailer previously manufactured.

Ranger Boats
927 Highway 178 North
Flippin, AR 72634
Telephone: 870-453-2222

Boating Safety Checklist

MUST HAVE ITEMS

As Required By Regulation

Personal Flotation Devices (Life Jackets)

- Type I, II, III, or V for each person onboard (wearable)
- One Type IV (Throwable)

Not Required on Non-Powered boats under 16'

Fire Extinguishers

Choose One	Boats without Fixed System	Boats with Fixed System
<input type="checkbox"/> Boats <26'	1 Size BI	-OR- Fixed System
<input type="checkbox"/> Boats 26 -<40'	2 Size BI*	-OR- Fixed System + 1 Size BI
<input type="checkbox"/> Boats 40 - 65'	3 Size BI*	-OR- Fixed System + 2 Size BI*

*One Size BI may be substituted for Two Size BI Extinguishers

Visual Distress Signals (VDS)

Choose One

- Combination Day/Night VDS (Flares or Flare Gun)
- Daytime VDS (Flags, Smoke Signal)
AND Nighttime VDS (Automated SOS Light)

Sound Signals

- Horn or Whistle
- Bell (Not required for vessels under 12m)

Ventilation (Boats with Gasoline Systems)

- Natural Ventilation
- Powered Ventilation

Backfire Flame Control

- Backfire Flame Arrestor (Gasoline Engines except outboards)

- The above represents minimum USCG Safety Requirements on-board vessels.
- Other Requirements may be necessary to comply with state laws.
- This is not intended to be an all-inclusive list but rather a baseline of items to make your boating adventure safe and fun.
- For Vessels over 65' refer to 33CFR 25.30-20 or ABYC A-4.



RECOMMENDED ITEMS

Items in Red May be Required in Some States

Boats on Inland Waters

Everything on Required List PLUS:

- First Aid Kit
- Anchor with Sufficient Line
- Boating Safety Education/Certificate
- Watersports Flag (Skier Down/Diver Down Flag)
- Bailing Device
- Sun Protection
- Alternate Propulsion (Paddles, Oars)

Boats on Nearshore Waters

Everything Above PLUS:

- Extra Food & Water
- GPS/Chartplotter
- Float Plan
- Depth Finder
- Compass
- Charts
- VHF Radio
- Spare Tool Kit

Boats on Offshore Waters

Everything Above PLUS:

- EPIRB
- Life Raft
- Searchlight
- List of CPR Instruction
- Radar
- Radar Reflector
- Radio Direction Finder
- Man-Overboard Recovery Gear
- AIS
- Sea Drogue
- Safety Knife
- Weather Information System
- Shore Landing Craft (Tender)
- Long Range Communications Gear

Boats on River Waters

Everything on Required List Plus:

- Throw Bag
- Helmet

Miscellaneous Items

Other Items That May be Recommended:

- Heaving Line
- Spare Keys
- Boat Hook/Pole
- Spare Propeller
- Extra Engine Oil
- Handheld Lead-line
- Strobe Light
- Carbon Monoxide Detector
- Extra Clothing
- Marine Hardware
- Masks & Fins (For Clearing Props)
- Storm Sails

RULES OF THE ROAD FOR OUTBOARDING



**DEAD
AHEAD**



**DANGER ZONE.
GIVE WAY
TO BOATS IN THIS
AREA**



**2 POINTS ABAFT
STARBOARD BEAM**

- Keep clear of sailing craft and rowboats. Yield right of way to slower boats.
- Always keep to the right.
- Do not use your motor near swimmers or skin divers.
- Learn the sign language of the various buoys and warning signals. These are your nautical traffic signs, posted for your safety and convenience.

KNOW THE SPORT DIVER FLAG...

...And be sure to obey the rules in the waters you travel regarding divers and maintaining a safe distance from them.



BUOYS... YOUR WATERWAY SIGNPOSTS



There are three basic types of buoys: NUN (cone shaped), SPAR (spar shaped) and CAN (cylindrical shaped).

Buoys marked with a contrasting band of color indicate that the channel splits. If the buoy is a can with a red band, then the preferred channel is to the starboard side of the buoy. If the buoy is a nun with a green band, then the preferred channel is to the port side of the buoy.

Going upstream, the RIGHT (Starboard) side of the channel is marked with even numbered RED buoys, nuns or spars: the LEFT (Port) side of the channel is marked with odd numbered GREEN buoys, cans or spars. RED and WHITE vertically striped buoys indicate the middle of a channel. Always pass close to these buoys.



**PREFERRED
CHANNEL**

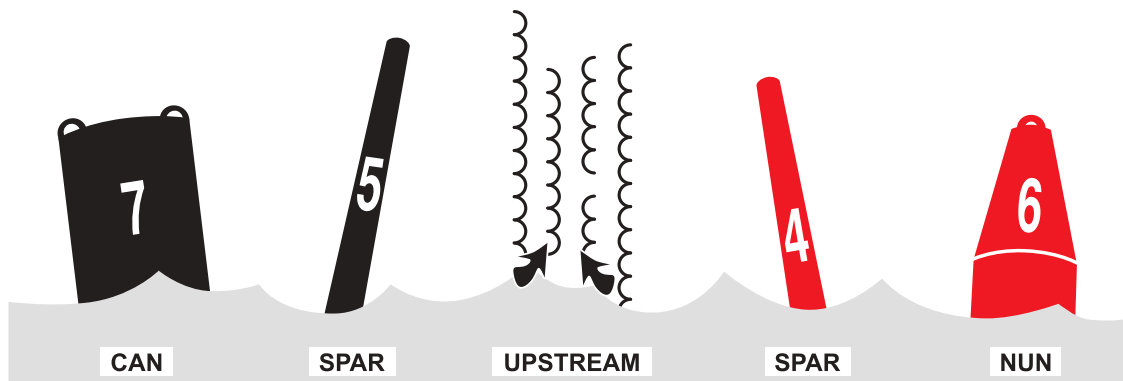



***Fishing Holdings, LLC
d/b/a Ranger® Boats***

P.O. Box 179 • Flippin, Arkansas • 72634 • 870-453-2222