



OS 255

OWNER'S MANUAL

FISHING BOATS
3901 St. Lucie Blvd.
Ft. Pierce, Florida 34946

© 2012 S2 Yachts, Inc.

PURSUIT® OS 255
Part Number 9213034WW
April 2012

<https://www.boat-manuals.com/>

Safety Information

Your Owner's Manual was written to include safety instructions to ensure safe operation and maintenance of your boat. Safety alerts symbols are used to alert potential personal injury hazards.

DANGER

Indicates a hazardous situation which, if not avoided, will result in death or serious injury.

WARNING

Indicates a hazardous situation which, if not avoided, could result in death or serious injury.

CAUTION

Indicates a hazardous situation which, if not avoided, could result in minor or moderate injury.

NOTICE

Indicates a potentially hazardous situation which, if not avoided, may result in property damage.

All instructions are viewed from the stern looking toward the bow, with starboard (to your right) and port (to your left). A glossary of boating terms is included.

Your boat produces carbon monoxide (CO) and uses flammable fuel. CO will cause BRAIN DAMAGE or DEATH. Carbon monoxide gas (CO) is colorless, odorless and extremely dangerous.

Every precaution has been taken by Pursuit Fishing Boats to reduce the risks associated with death, possible injury and damage from fire or explosion. Your own precaution and good maintenance procedures are necessary in order to enjoy safe operation of your boat.

DANGER

Exposure to carbon monoxide will cause death or serious injury. Avoid direct and prolonged exposure to CO.

Gasoline and other fuels are extremely flammable and highly explosive under certain conditions.

- DO NOT smoke or allow open flame or sparks nearby when fueling.
- DO NOT block fuel vents.
- DO NOT store fuel in any containers or compartments which are not designated for storing fuel.

Table of Contents

Safety Information

Specifications	1-8
Boat Information	9
Warranty and Warranty	
Registration Cards	11
Federal Boat Safety Act	11
Product Changes	11
Transferring the Warranty	11
Owner/Operator Responsibilities	11

Propulsion Systems

1.1 General	1-1
1.2 Outboard Saltwater Application	1-1
1.3 Engine Lubrication	1-1
1.4 Engine Cooling System	1-2
1.5 Propellers	1-2
1.6 Engine Instrumentation	1-2

Helm Systems

2.1 General	2-1
2.2 Engine Throttle and Shift Controls	2-1
2.3 Neutral Safety Switch	2-1
2.4 Engine Power Tilt and Trim	2-2
2.5 Engine Stop Switch	2-2
2.6 Steering System	2-3
2.7 Trim Tabs	2-3
2.8 Compass	2-4
2.9 Control Systems Maintenance	2-4

Fuel Systems

3.1 General	3-1
3.2 Fuel System	3-2
3.3 Fueling Instructions	3-2
3.4 Fuel System Maintenance	3-3

Electrical Systems

4.1 General	4-1
4.2 DC System	4-1
4.3 12-Volt DC Panels	4-3
4.4 Electrical System Maintenance	4-6

Plumbing Systems

5.1 Fresh Water System	5-1
5.2 Raw Water Washdown	5-1
5.3 Livewell	5-2
5.4 Drainage	5-3
5.5 Plumbing Systems Maintenance	5-4

Ventilation System

6.1 Cabin Ventilation	6-1
6.2 Carbon Monoxide and Proper Ventilation	6-1
6.3 Windshield Ventilation	6-1
6.4 Bilge Compartment Ventilation	6-1
6.5 Maintenance	6-1

Exterior Equipment

7.1 Deck	7-1
7.2 Cockpit	7-2

Interior Equipment

8.1 Cabin and V-Berth	8-1
8.2 Carbon Monoxide Detector	8-2
8.3 Audio and Video Systems	8-2

Table of Contents

Safety Equipment

9.1 General	9-1
9.2 Engine Alarms	9-1
9.3 Neutral Safety Switch	9-1
9.4 Engine Stop Switch	9-1
9.5 Automatic Fire Extinguishing System (with Optional Generator)	9-2
9.6 Carbon Monoxide Hazards	9-2
9.7 First Aid	9-5
9.8 Required Safety Equipment	9-5
9.9 Additional Safety Equipment	9-8

Operation

10.1 General	10-1
10.2 Homeland Security Restrictions	10-1
10.3 Rules of the Road	10-2
10.4 Pre-Cruise Check	10-3
10.5 Operating your Boat	10-4
10.6 Fishing	10-6
10.7 Tower Operation (Dealer Installation)	10-6
10.8 Docking, Anchoring and Mooring ...	10-7
10.9 Controls, Steering or Propulsion System Failure	10-8
10.10 Collision	10-9
10.11 Grounding, Towing and Rendering Assistance	10-9
10.12 Flooding or Capsizing	10-9
10.13 Transporting your Boat	10-10
10.14 Trailering your Boat	10-10
10.15 Water Skiing	10-11
10.16 Man Overboard	10-12
10.17 Trash Disposal	10-12

Routine Maintenance

11.1 General	11-1
11.2 Exterior Hull and Deck	11-1
11.3 Seats, Upholstery, Canvas and Enclosures	11-5
11.4 Cabin Interior	11-6
11.5 Bilge	11-6
11.6 Generator (Optional)	11-6

Seasonal Maintenance

12.1 Storage and Lay-up	12-1
12.2 Winterizing	12-2
12.3 Recommissioning	12-4

Appendixes

Glossary of Terms	A-1
Maintenance Schedule	B-1
Maintenance Log	B-2
Boating Accident Report	C-1
Float Plan	D-1
Troubleshooting Guide	E-1
Schematics	F-1

Specifications

Specifications

Specifications

7/31/2008

Boat Manufacturer/Model: OS 255		Costruttore/modello della barca: OS 255	
Boothersteller/Model: OS 255		Modelo/Fabricante de la Embarcación: OS 255	
Constructeur/Modèle du bateau: OS 255		Fabricante/Modelo do Barco: OS 255	
Design Category: C-Inshore Catégorie de conception: C-à proximité de la côte Categoría de Diseño: C-Costera Konstruktionskategorie: C-Küstennane Gewässer Categoria di progetto: C-Costeira Categoria de Design: C-Perto da Costa		Propulsion Type: Tipo di propulsione: Antriebsart: Tipo de propulsión: Type de propulsion: Tipo propulsão:	
		Outboard	
Intended Use:	Hull Identification Number:		
Verwendungszweck:	Rumpfunner:		
Usage prévu:	Nemero d'identification de coque:		
Utilizzo previsto:	Nemero identificazione scafo:		
Uso previsto:	Numero de Identificación del Casco:		
Utilização:	Número de Identificação do Casco:		
Recreation	HIN Label		
Maximum Recommended Load:			
Charge maximale recommandée:			
Carga Máxima recomendada:			
Empfohlene Beladung Maximum:			
Carico massimo ammesso:			
Carga Máxima Recomendada:			
Recommended Number of Persons:	Maximum Rated Engine Power:		
Nombre de personnes recommandé:	Puissance nominale maximale du moteur:		
Número recomendado de personas:	Potencia máxima del motor:		
Empfohlene Personenanzahl:	Maximale Motorleistung:		
Omologazione al trasporto di n. persone:	Massima potenza nominale motore:		
Número de Pessoas Recomendado:	Máxima potência nominal do motor:		
MAXIMUM = 6	MAXIMUM = 224 kw. 300 hp. kw.		
Engine Installed, Manufacturer, Model and Number(s):			
Moteur installé, Fabricant, modèle et numéros(s):			
Motor instalado, Fabricante, modelo y número(s):			
Motor installiert, Hersteller, modell, nummer(en):	1. _____		
Motore istallato, Costruttore, modello e numero(s):	2. _____		
Motor Instalado, Fabricante, Modelo e Número(s):			
Mass of Craft (Approximate)	With Largest Equipped Engine and permanently attached items, plus full water and fuel, plus maximum recommended load:		
Masses de Navire (Approximatives)	Avec le plus grand moteur équipé et systèmes en liaison permanente, plus pleine charge d'eau et de carburant, plus charge maximale recommandée:		
Peso de la embarcación (aproximado)	Con el mayor motor equipado y elementos permanentemente instalados, más combustible y agua, más la carga máxima recomendada:		
Gewicht des Bootes (Nährungswert)	Mit größter Motorausführung und fest installiertem Inventar sowie vollen Wasser- und Kraftstofftanks und empfohlener Maximalbeladung:		
Massa dell'imbarcazione (approssimativa)	Con il motore di maggiore cilindrata, attrezzature permanenti, più rifornimento di acqua e carburante e carico massimo ammesso:		
Massa da Embarcação (Aproximada)	Com o maior motor instalado e os equipamentos permanentes, mais a capacidade máxima de água e combustível, mais a carga máxima recomendada:		
With Largest Equipped Engine and permanently attached items:	3721 kg./ 8203 lbs.		
Avec le plus grand moteur équipé et systèmes en liaison permanente:	Trailerable Weight (engine, fuel and water, batteries and options):		
Con el mayor motor equipado y elementos permanentemente instalados:	Masse pour remorque (moteur, carburant et eau, batteries et options):		
Mit größter Motorausführung und fest installiert em Inventar:	Peso remolcable (motor, combustible y agua, baterías y opciones):		
Con il motore di maggiore cilindrata e attrezzature permanenti:	Auf Anhänger verladbares Gewicht (Motor, Kraftstoff und Wasser, Batterien und Sonderausstattung):		
Cim o maior motor instaldo e os equipamentos permanentes:	Peso rimorchiabile su strada (motore, combustible e acqua, batterie ed accessori):		
2767 kg./ 6100 lbs.	Peso Rebocável (motor, combustível e água, baterias e opções):		
	3211 kg./ 7079 lbs.		
Note: Information obtained from 2009 CE Certificate and/or Specification Sheet 1/22/09 rev. G			

Specifications

7/31/2008

Model: OS 255

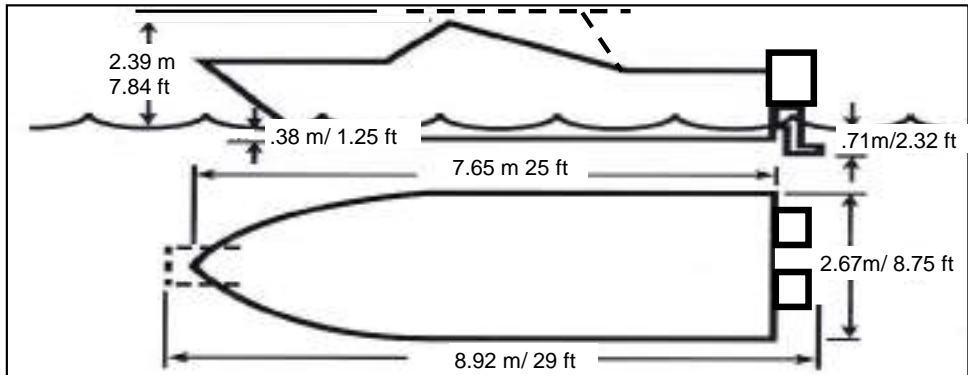

EN

DE

Fuel Tank Capacity (0.73kg/Liter):	492L/ 130 G	
Fuel Type: <input checked="" type="checkbox"/> Gasoline	N/A	Diesel
Oil Tank Capacity:	N/A	Liters
Oil Type:	10-40	
Water Tank Capacity (1kg/Liter):	76L/ 20 Gal	
Holding Tank Capacity:	49L/ 13 Gal	
Number and Type of Fire Extinguishers:	(2) B,C	
Number and Type of CO Detectors:	1	
N/A = Not Applicable		

Kraftstofftankkapazität (0,73 kg/Liter):	492	Liter
Kraftstoffart: <input checked="" type="checkbox"/> Benzin	N/A	Diesel
Öltankkapazität:	N/A	Liter
Ölsorte:	10-40	
Wassertankkapazität (1kg/Liter):	76	Liter
Speichertankkapazität:	49	Liter
Feuerlöscheranzahl und -typ:	(2) B,C	
Rauchdetektoranzahl und -typ:	1	
n.z. = nicht zutreffend		

FR

IT

Contenance réservoir carburant (0,73kg/litre):	492	litres
Type de carburant: <input checked="" type="checkbox"/> gasoil	N/A	diesel
Contenance réservoir d'huile:	N/A	litres
Type d'huile:	10-40	
Contenance réservoir de'eau (kg/litre)	76	litres
Contenance réservoir de rétention:	49	
Nombre et type d'extincteurs:	(2) B,C	
Nombre et type de détecteurs de fumée:	1	
N/A = non applicable		

Capacità serbatoio carburante (0,73kg/l):	492	litri
Tipo carburante: <input checked="" type="checkbox"/> Benzina	N/A	Diesel
Capacità serbatoio olio:	N/A	litri
Tipo oillio:	10-40	
Capacità serbatoio acqua (1kg/l):	76	litri
Capacità cassa di zavorra:	49	litri
Numero e tipo di estintori:	(2) B,C	
Numero e tipo di rivelatori di esalazioni:	1	
N/A = non pertinente		

ES

PT

Capacidad del Depósito de Combustible (73Kg/Litro):	492	Litros
Tipo de Combustible: <input checked="" type="checkbox"/> Gasolina	N/A	Diesel
Capacidad del Depósito de Aceite:	N/A	Litros
Tipo de Aceite:	10-40	
Capacidad del Depósito de Agua (1Kg/Litro):	76	Litros
Capacidad del Tanque de Retención:	49	Litros
Número y Tipo de Extintores de Incendios:	(2) B,C	
Número y Tipo de Detectores de Humos:	1	
N/A = no aplicable		

Capacidade do Depósito de Combustível: (0,73kg/Litro):	492	Litros
Tipo de Combustível: <input checked="" type="checkbox"/> Gasolina	N/A	Gasóleo
Capacidade do Depósito de Óleo:	N/A	Litros
Tipo de Óleo:	10-40	
Capacidade do Depósito de Água: (1kg/Litro):	76	Litros
Capacidade do Depósito Provisório:	49	Litros
Número e Tipo de Extintores de Incêndio:	(2) B,C	
Número e Tipo de Detectores de Fumo:	1	
N/A = Não Aplicável		

Note: Information obtained from 2009 CE Certificate and/or Specification Sheet 1/22/09 rev. G

Specifications

Specifications

7/31/2008
Model: OS 255

EN	ES	IT
Locate and Identify: A) Fuel Tank B) Fuel Tank Filling Point C) Oil Tank (N/A) D) Oil Tank Filling Point (N/A) E) Oil Tank Emptying Point (N/A) F) Water Tank G) Water Tank Filling Point H) Holding Tank I) Holding Tank Emptying Point J) Seacocks K) Through-Hull Fittings L) Fire Extinguisher M) Carbon Monoxide Detector N) Escape Hatch O) Fire Escapes P) Life Raft Stowage Q) Safety Equipment R) Anchor Strong Points S) Mooring Strong Points T) Towing Strong Points (N/A)	Localizar e identificar: A) Depósito de Combustible B) Punto de Carga del Depósito de Combustible C) Depósito de Aceite (N/A) D) Punto de Carga del Depósito de Aceite (N/A) E) Punto de Descarga del Depósito de Aceite (N/A) F) Depósito de Agua G) Punto de Carga del Depósito de Agua H) Tanque de Retención I) Punto de Descarga del Tanque de Retención J) Válvula de Toma de Agua de Mar K) Accesorios Pasantes del Casco L) Extintor de Incendios M) Detector de Monóxido de Carbono N) Escotilla de Seguridad O) Escalera de Incendios P) Almacenamiento de balsas salvavidas Q) Equipos de seguridad R) Puntos fuertes de anclaje S) Puntos fuertes de amarre T) Puntos fuertes de remolque (N/A)	Localizzazione e identificazione dei componenti: A) Serbatoio carburante B) Bocchettone di riempimento serbatoio carburante C) Serbatoio olio (N/A) D) Bocchettone di riempimento serbatoio olio (N/A) E) Scarico serbatoio olio (N/A) F) Serbatoio acqua G) Bocchettone di riempimento serbatoio acqua H) Cassa zavorra I) Scaric cassa zavorra J) Valvole di presa acqua dal mare K) Raccorderia passante nello scafo L) Estintore M) Rivelatore monossido di carbonio N) Boccaporto di sfuggita O) Uscite di sicurezza P) Stivaggio zattera di salvataggio Q) Dotazioni di sicurezza R) Punti di attacco per l'ancoraggio S) Punti di attacco per l'ormeggio T) Punti di attacco per il traino (N/A)

Specifications

7/31/2008

Model: OS 255

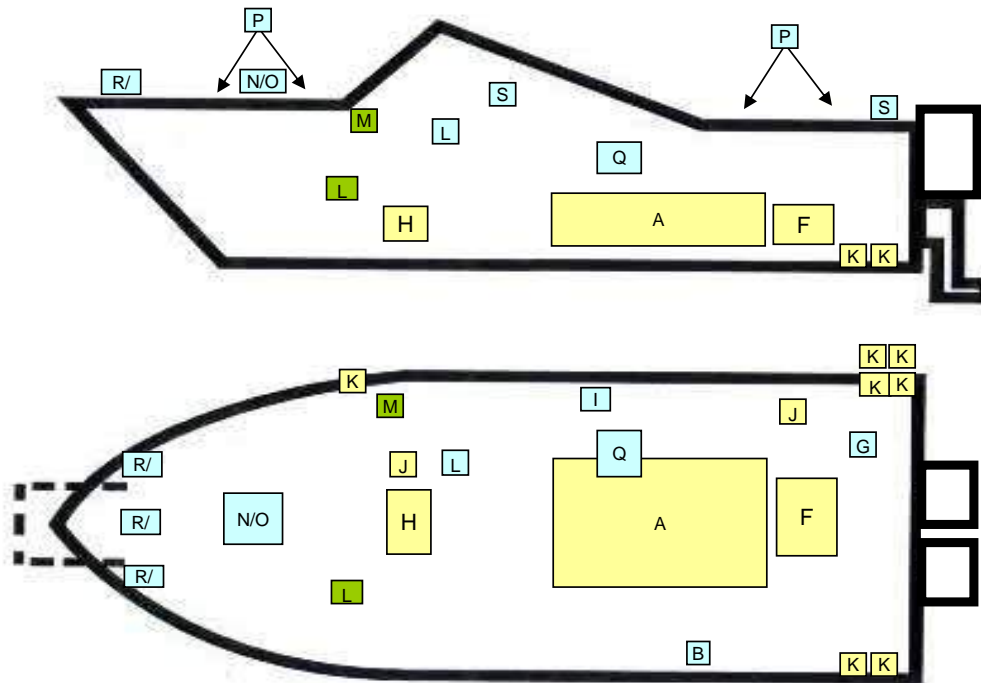

FR

Repérez et identifiez:

- A) Réservoir de carburant
- B) Point de remplissage réservoir de carburant
- C) Réservoir d'huile (N/A)
- D) Point de remplissage réservoir d'huile (N/A)
- E) Point de vidange réservoir d'huile (N/A)
- F) Réservoir d'eau
- G) Point de remplissage réservoir d'eau
- H) Réservoir de rétention
- I) Point de vidange réservoir de rétention
- J) Prises d'eau à la mer
- K) Raccords traversant la coque
- L) Extincteur
- M) Détecteur de monoxyde de carbone
- N) Ecouille d'évacuation
- O) Echelles de sauvetage
- P) Arrimage du radeau de sauvetage
- Q) Equipement de sécurité
- R) Points d'ancrage
- S) Points d'amarrage
- T) Points de remorquage (N/A)

DE

Position and Beschreibung:

- A) Kraftstofftank
- B) Kraftstofftankfüllpunkt
- C) Öltank (n.z.)
- D) Öltankfüllpunkt (n.z.)
- E) Öltankablasspunkt (n.z.)
- F) Wassertank
- G) Wassertankablasspunkt
- H) Speichertank
- I) Speichertankablaßpunkt
- J) Flutventile
- K) Rumpfdurchgangsbauten
- L) Feuerlöscher
- M) Kohlenmonoxid-detektor
- N) Notausstieg
- O) Reuerrettungswege
- P) Rettungsfloßunterbringung
- Q) Sicherheitsausrüstung
- R) Ankerpunkte
- S) Vertäuungspunkte
- T) Abschlepppunkte (n.z.)

PT

Localizar e Identificar:

- A) Depósito de Combustível
- B) Ponto de Enchimento do Depósito de Combustível
- C) Depósito de Óleo (N/A)
- D) Ponto de Enchimento do Depósito de Óleo (N/A)
- E) Ponto de Esvaziamento do Depósito de Óleo (N/A)
- F) Depósito de Água
- G) Ponto de Enchimento do Depósito de Água
- H) Depósito Provisório
- I) Ponto de Esvaziamento do Depósito Provisório
- J) Torneiras de tomada de água do mar
- K) Acessórios de Todo o Casco
- L) Extintor de Incêndios
- M) Detector de Monóxido de Carbono
- N) Escotilha de Fuga
- O) Saídas de Incêndio
- P) Acondicionamento do Barco
- Salva-vidas
- Q) Equipamento de Segurança
- R) Pontos Fortes da Ancoragem
- S) Pontos Fortes da Amarragem
- T) Pontos Fortes da Rebocagem (N/A)

Specifications

Working Deck Area

7/31/2008

Model: OS 255

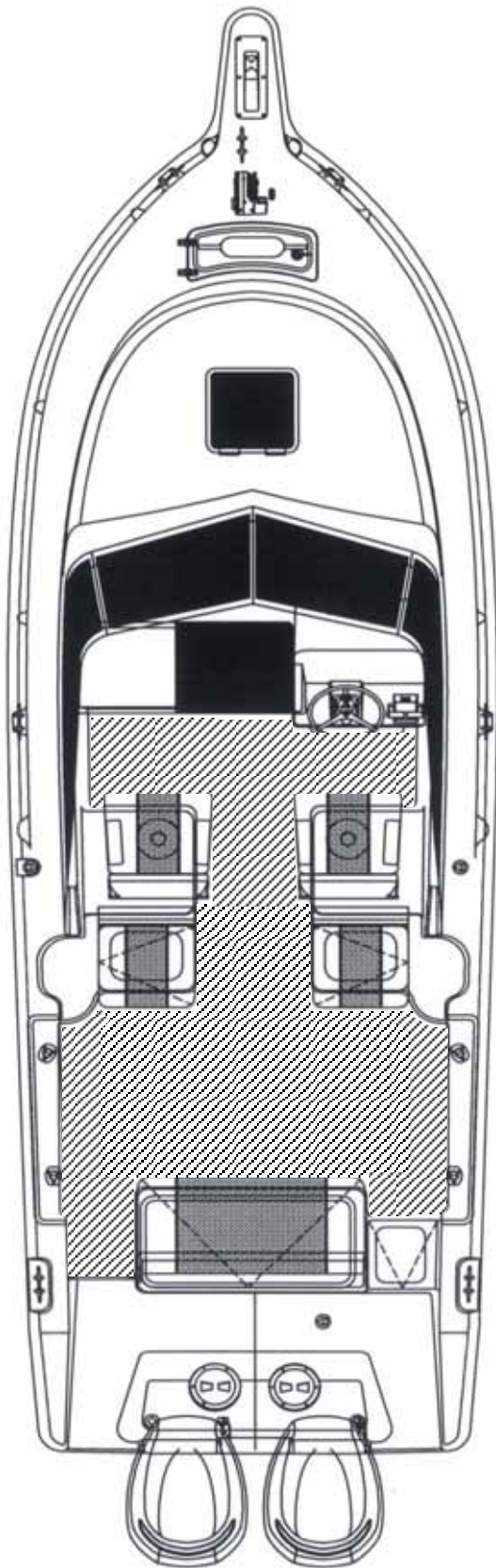

Working Deck
Areas for occupation during
normal operation of the boat

Warning Label Locations OS 255
1/28/2008

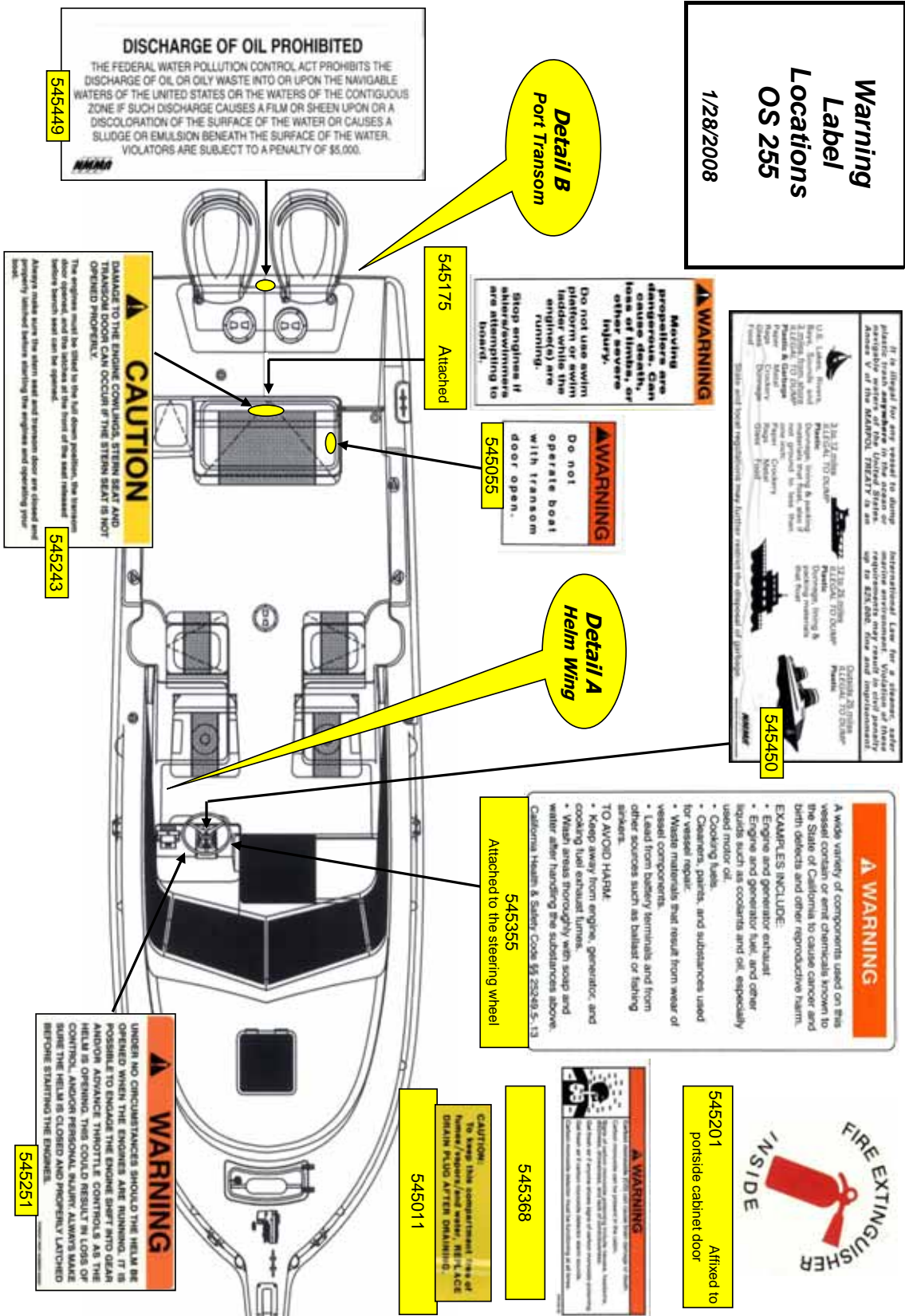

Specifications

Labels and Part Numbers:

- 545411:** CE S-2 YACHTS, INC. OS 255 MAXIMUM WEIGHT 6 persons = 937 kg 224 kW
- 545566:** NOTICE Keep cockpit hatches closed while underway
- 545006:** WARNING AVOID SERIOUS INJURY OR DEATH RESULTING FROM LEAKING FUEL. INSPECT SYSTEM FOR LEAKS AT LEAST ONCE A YEAR.
- 545118:** WARNING Moving propellers are dangerous. Do not use swim platform or swim ladder while the engine(s) are running. Stop engines if swimmers are attempting to board.
- 545055:** WARNING Do not use swim platform or swim ladder while the engine(s) are running. Stop engines if swimmers are attempting to board.
- 545012:** NOTICE BOATER'S CHECKLIST
- 545365:** WARNING DANGER Do not use swim platform or swim ladder while the engine(s) are running. Stop engines if swimmers are attempting to board.
- 545369:** WARNING (Labels include ESD) Do not use swim platform or swim ladder while the engine(s) are running. Stop engines if swimmers are attempting to board.

Detail A

Warning Label Locations OS 255
1/28/2008

Detail B

General Information

Boat Information

Fill out the following information and leave it in your PURSUIT Owner's Manual. This information will be important for you and PURSUIT service personnel to know, if and when you may need to call PURSUIT for technical assistance or service.

Boat	
Model:	Hull Serial #:
Purchase Date:	Delivery Date:
Ignition Keys #	Registration #:
Draft:	Weight:
Engine(s)	
Make:	Model:
Port Serial #:	Starboard Serial #:
Transmission(s) (Inboard)	
Make:	Model:
Port Serial #:	Starboard Serial #:
Ratio:	
Outdrive(s) (Inboard/Outboard)	
Make:	Model:
Port Serial #:	Starboard Serial #:
Propeller(s)	
Make:	Blades:
Diameter/Pitch:	Other:
Generator	
Make:	Model:
Serial #:	kW
Dealer	Pursuit
Name:	Phone:
Dealer/Phone:	Representative:
Salesman:	Address:
Service Manager:	
Address:	

PURSUIT Fishing Boats reserves the right to make changes and improvements in equipment, design and vendor supplied equipment at any time without notification.

General Information

Certifications & Specifications (For Export Only)

To be in compliance with European directives for recreational boats as published by the International Organization for Standardization (ISO) in effect at the time this boat was manufactured, we are providing the following information.

Manufacturer:

Name -----

Address -----

----- Zip Code: -----

Identification Numbers:

Hull Identification Number -----

Engine Serial Number -----

Transmission Serial Number -----

Intended Design Category:

- | | |
|-----------------------------------|---|
| <input type="checkbox"/> Ocean | <input type="checkbox"/> Inshore |
| <input type="checkbox"/> Offshore | <input type="checkbox"/> Sheltered Waters |

Weight and Maximum Capacities:

Unladen Weight - Kilograms (Pounds) -----

Maximum Load - Weight- Kilograms (Pounds) -----

Number of People -----

Maximum Rated Engine Horsepower - Kilowatts (Horsepower) -----

Certifications:

Certifications & Components Covered -----

General Information

Warranty and Warranty Registration Cards

The PURSUIT Limited Warranty Statement is included with your boat. It has been written to be clearly stated and easily understood. If you have any questions after reading the warranty, please contact PURSUIT Customer Relations.

PURSUIT, engine manufacturers, and the suppliers of major components maintain their own manufacturer's warranty and service facilities. It is important that you properly complete the warranty registration cards included with your boat and engine(s) and mail them back to the manufacturers to register your ownership. This should be done within 15 days of the date of purchase and before the boat is put into service. A form for recording this information is provided at the beginning of this manual. This information will be important for you and service personnel to know, if and when you may need service or technical information.

The boat warranty registration requires the **Hull Identification Number "HIN"** which is located on the starboard side of the transom, just below the rub rail. The engine warranty registration requires the engine serial number(s). Please refer to the engine owner's manual for the location of the serial number(s).

Federal Boat Safety Act

All boat manufacturers are required by the Federal Boat Safety Act of 1971 to notify first time owners in the event any defect is discovered "which creates a substantial risk of personal injury to the public." It is essential that we have your warranty registration card complete with your name and mailing address in our files so that we can comply with the law if it should become necessary.

Product Changes

PURSUIT is committed to the continuous improvement of our boats. As a result, some of the equipment described in this manual or pictured in the catalog may change or no longer be available.

PURSUIT reserves the right to change standard equipment, optional equipment and specifications without notice or obligation. If you have questions about the equipment on your PURSUIT, please contact PURSUIT Customer Relations.

Transferring the Warranty

For a Transfer fee, S2 Yachts will extend warranty coverage to subsequent owners of PURSUIT models for the duration of the original warranty period. Please refer to the PURSUIT Limited Warranty Statement for the procedure to transfer the warranty. To take advantage of this program, notification of the change of ownership, including the new owner's name, address and telephone number together with the appropriate fee, must be sent to PURSUIT Fishing Boats, Customer Relations Department, 3901 St. Lucie Boulevard, Ft. Pierce, Florida 34946, within 30 days of the date of resale.

S2 Yachts will confirm, in writing, that the transfer of the warranty has taken place. After which, the transferee will be treated as the original purchaser as outlined in the PURSUIT Limited Warranty Statement.

Owner/Operator Responsibilities

Registration and Documentation

Federal law requires all undocumented vessels equipped with propulsion machinery be registered in the state of principal use. A certificate of documentation will be issued upon registration. These registration numbers must be displayed on your boat. The owner/operator of a boat must carry a valid certificate of registration whenever the boat is in use. When moved to a new state of principal use, the certificate is valid for 60 days.

In order to be valid, the numbers must be installed to the proper specifications. Check with your dealer or state boating authority for numbering requirements. The Coast Guard issues the certificate of number in Alaska; all others are issued by the state.

Insurance

In most states the boat owner is legally responsible for damages or injuries the boat causes. Responsible boaters carry adequate liability and property damage insurance for their boat. You should also protect the boat against physical damage and theft. Some states have laws requiring minimum insurance coverage. Contact your dealer or state boating authority for information on the insurance requirements in your boating area.

Reporting Boating Accidents

All boating accidents must be reported by the owner or operator of the boat to the proper marine law enforcement authority for the state in which the accident occurred. Immediate notification is required if a person dies or disappears as a result of a recreational boating accident.

If a person dies or there are injuries requiring more than first aid, a formal report must be filed within 48 hours.

A formal report must be made within 10 days for accidents involving more than \$500.00 damage or the complete loss of a boat.

A "Boating Accident Report" form is located near the back of this manual to assist you in reporting an accident. If you need additional information regarding accident reporting, please call the Boating Safety Hotline, 800-368-5647 or uscgboating.org.

Education

If you are not an experienced boater, we recommend the boat operator and other people that normally accompany the operator, enroll in a boating safety course. Organizations such as the U.S. Power Squadrons, United States Coast Guard Auxiliary, State Boating Authorities and the American Red Cross offer excellent boating educational programs. These courses are worthwhile even for experienced boaters to sharpen your skills or bring you up to date on current rules and regulations. They can also help in providing local navigational information when moving to a new boating area. Contact your dealer, State Boating Authority or the Boat-

ing Safety Hotline, 800-368-5647 or uscgboating.org for further information on boating safety courses.

Required Equipment

U.S. Coast Guard regulations require certain equipment on each boat. The Coast Guard also sets minimum safety standards for vessels and associated equipment. To meet these standards some of the equipment must be Coast Guard approved. "Coast Guard Approved Equipment" has been determined to be in compliance with USCG specifications and regulations relating to performance, construction or materials. The equipment requirements vary according to the length, type of boat, and the propulsion system. Some of the Coast Guard equipment is described in the Safety Equipment Section of this manual. For a more detailed description, obtain "Federal Requirements and Safety Tips for Recreational Boats" by contacting the Boating Safety Hotline 800-368-5647, uscgboating.org or your local marine dealer or retailer.

Some state and local agencies go beyond USCG regulations or impose similar equipment requirements on waters that do not fall under Coast Guard jurisdiction. Contact your dealer or local boating authority, they can provide you with additional information for the equipment requirements for that boating area.

Propulsion Systems

1.1 General

Your Pursuit is powered using single or twin 2-cycle or 4-cycle outboard motors.

The manufacturer of the outboard motor provides an owner's manual. Carefully read the owner's manual to learn the proper care and operation of the motor and drive system.

Familiarize yourself with the warranty information included in the owner's manual.

WARNING

Do not attempt to service the engine or drive components without being completely familiar with the safe and proper service procedures. Moving parts are exposed and can be dangerous to someone unfamiliar with the operation and function of the equipment.

CAUTION

Use only clean, dry fuel of the type and grade recommended by the engine manufacturer. Use of incorrect or contaminated fuel can cause engine malfunction and serious damage.

1.2 Outboard Saltwater Application

Each outboard motor is a complete drive system with the gear case being just forward of the propeller and connected to the power head with a vertical drive shaft. Other than the routine maintenance outlined in the engine owner's manual, there is little to be concerned with unless the boat is stored in saltwater for extended periods. Then the main concerns with saltwater storage are marine growth and galvanic corrosion.

Marine growth occurs to saltwater exposed components of the motor and can cause poor performance or permanent damage. The water conditions in your area will determine the extent and type of marine growth. Water temperature, pollution, current, etc. can have an effect on marine growth.

Electrolytes, such as saltwater, cause galvanic corrosion. Protecting submerged engine components from saltwater is essential. Outboard motors are equipped with sacrificial anodes to prevent galvanic corrosion problems. Inspect anodes on a regular basis and replaced as necessary. You can find where to buy replacement anodes, along with maintenance instructions, in the owner's manual.

When leaving the boat in the water, tilt the motors to their highest pitch. This decreases the risk of marine growth around the cooling inlets, propeller and exhaust ports and helps prevent damage from galvanic corrosion.

CAUTION

Do not paint the outboard motors with antifouling paints designed for boat hulls. Many of these paints can cause severe damage to the engines. Contact your Pursuit dealer or engine manufacturer for information on the proper painting procedures.

1.3 Engine Lubrication

4-Cycle Engines

Check the engine oil level before each use by checking the engine's dipstick.

A sump in the engine's crankcase provides lubrication for the engine. 4-cycle engines do consume a small amount of oil during normal operation.

Maintain engine oil recommended fill level using only the type and grade of oil recommended by the engine manufacturer.

Change the oil at regular intervals according to the owner's manual instructions. Use only the type of oil specified by the engine manufacturer.

2-Cycle Engines

Check the engine oil level before each use by checking the gauge in the helm or visually checking the oil level using the reference marks on the tanks.

An oil injection system lubricates 2-cycle engines.

Use only the type of oil specified by the engine manufacturer to maintain proper oil level.

Refer to the engine owner's manual for oil specifications and additional information on the oil injection system. Refer to the Fuel System chapter.

NOTICE

Always monitor the oil level and only use the type of oil specified by the engine manufacturer.

1.4 Engine Cooling System

Outboard engines use raw water (seawater) to maintain proper operating temperatures.

Water inlets allow coolant water pump to circulate cooling water through the engine block. Used coolant water releases with the exhaust gases through the propeller hub.

The water pump uses a small impeller made of synthetic rubber. The impeller and water pump cannot run dry for more than a few seconds without damage occurring. In most outboard motors, some cooling water diverts through ports below the engine cowling. This allows visual inspection of the cooling system. With the engine running, always check for a steady stream of water coming out of these ports.

CAUTION

Never run an outboard motor without water flowing to the water pump. Serious damage to the water impeller or engine can occur.

If using the boat in salt or badly polluted water, flush the engines after each use. Refer to the engine owner's manual for the proper engine flushing procedure.

1.5 Propellers

Propellers convert the engine's power into thrust. They come in a variety of styles, diameters and pitches. The one that will best suit the needs of your Pursuit will depend somewhat on your application and expected load average.

Two numbers stamped on the prop in sequence identify propeller sizes. The 1st number in the sequence (for example 14 x 21) is the diameter of the propeller, and the 2nd number is the pitch.

The theoretical distance traveled by the propeller for each revolution is the pitch.

Always repair or replace a propeller immediately if damaged. A damaged, therefore out of balance propeller, can cause a noticeable vibration in the boat and can damage the engine gear assembly. Refer to the engine owner's manual for information on propeller removal, repair or replacement instructions.

1.6 Engine Instrumentation

The helm station is equipped with a set of engine instruments and alarms. Instruments allow the operator to monitor the engines' operational conditions. Close observation of these instruments allows the operator to use the engines efficiently and can prevent costly damages. The instrumentation is unique to the type of outboard motors installed on your Pursuit. Some or all of the following gauges may be present.

This model may be equipped with Yamaha Command Link Integrated Information System®. Please refer to Yamaha owner's manuals for information on system operation.

Tachometer

The tachometer displays the engine speed in revolutions per minute (RPM). This speed is not the boat speed or necessarily the propeller speed. The tachometer may not register zero with the key in the "OFF" position.

CAUTION

Never "redline" or exceed the maximum recommended operational RPM of the engine. Maintaining maximum or close to maximum RPM for extended periods can reduce the life of the engine.

Speedometer

The speedometer indicates the speed of the boat in miles per hour. Most speedometers measure the water pressure against a small hole in a pickup tube located in the engine's lower unit or mounted on the bottom of the transom.

Temperature Warning

The temperature warning indicates the temperature of the engine. A sudden increase in the temperature could indicate an obstructed water inlet or an impeller failure.

CAUTION

Continued operation of an overheated engine can result in engine seizure. If an unusually high temperature reading occurs, shut off the engine immediately. Investigate and correct the problem before starting the engine again.

Fuel Gauge

The fuel gauge indicates the amount of fuel remaining. This gauge is an approximate indication of fuel remaining and is not a calibrated instrument.

Voltmeter

The voltmeter displays the voltage of the battery and the charging system. Normal voltage is 11 to 12 volts with the engine(s) off and 13 to 14.5 volts with the engine(s) running.

Hour Meter

The hour meter keeps a record of the operating time for the engine.

Tilt/Trim Gauge

The tilt/trim gauge monitors the position of the outboard engine. The upper range of the gauge indicates the tilt, which is used for shallow water operation and when loading the boat on a trailer. The lower range indicates the trim position. This is the range used to adjust the hull angle while operating your boat on plane. Refer to the engine owner's manual for more information on the operation of the outboard power tilt and trim.

Engine Alarms

Most outboard boats are equipped with an audible alarm system mounted at the helm, monitoring selected critical engine systems. An alarm will sound if one of these systems begins to fail. Refer to the engine owner's manual for more information on alarms installed with your engines.

CAUTION

If an engine alarm sounds, shut off the engine immediately. Find and correct the problem before using the engine again.

Fuel Management

Fuel management systems are standard equipment on some outboard engines. On Yamaha® engines, the fuel management gauge is a multifunction gauge used to monitor aspects of the engine's fuel consumption. If you have a fuel management system installed on your boat, please refer to the engine or fuel management manual.

Instrument Maintenance

Circuit breakers or fuses, found on the engine, provide electrical protection for instruments and ignition circuitry. Protect ignition switches and all instruments, controls, etc. from the weather when not in use. Excessive exposure can lead to instrument and ignition switch failures.

Helm Systems

2.1 General

Helm controls consist of three systems: engine throttle and shift controls, steering control system and trim/tab control switches.

Manufacturers of control components provide an owner's manual with their products. Carefully read and familiarize yourself with the manuals, paying specific attention to the proper care and operation of control systems.

2.2 Engine Throttle and Shift Controls

Shift and throttle controls on your boat may vary depending on the type of engines used. The following control description is typical of most outboard controls. Refer to engine or control manuals for specific information on the controls installed on your Pursuit.

A binnacle-style control at the helm of your Pursuit has a single lever for each engine, operating as a gearshift and throttle. Three throttle positions are available: neutral (straight up and down); forward (1st detent forward of neutral); reverse (1st detent aft of neutral).

Advancing the control lever beyond the shift range advances the throttle in forward or reverse. Each control is equipped to permit the engine to operate at a higher-than-idle RPM while in neutral for cold starting and warm-up purposes.

The handles of dual lever controls may not always align with each other at all RPM settings due to variations in control cable routing, length and engine specific adjustments. Often, a selected RPM will have proper (side-by-side) alignment for the handles, but the alignment may vary at other RPM settings.

Control or cable adjustments may be required to correct this condition should it persist. See your Pursuit dealer for necessary control and cable adjustments.

CAUTION

Always return the engine throttle levers to the lowest possible speed position before shifting. Never shift the transmission at any throttle setting above idle RPM.

2.3 Neutral Safety Switch

Every control system has a neutral safety switch incorporated into it. This device prohibits the engine from starting while the shift lever is in any position other than neutral.

Test the neutral safety switches periodically to ensure they are operating properly. To test the neutral safety switches, tilt the engines down and move the shift levers to the forward position. Make sure the control levers are not advanced past the idle position.

Turn the ignition key to the start position just long enough to briefly engage the engine's starter. Do not keep the key in the start position long enough to start the engine. The starter should not engage for either engine. Repeat this test with the shift levers in reverse and the engine throttles at idle. Again, the starter should not engage for either engine.

If the starter for either engine does engage with the shift controls in any position other than the neutral position, then the neutral safety switch is not functioning properly. Contact your dealer and have the neutral safety switch repaired before using your boat.

If an engine starts in any gear during this test, immediately move the control levers to the neutral position and turn off the engine.

⚠ WARNING

In some situations, it may be possible to accidentally start the engines in gear with the throttles above idle if the neutral safety switch is not operating properly. This can cause the boat to accelerate unexpectedly in forward or reverse, and can result in loss of control, damage to the boat, and possible injury to passengers. Always test the neutral safety switch periodically and correct any problems before using the boat.

2.4 Engine Power Tilt and Trim

All outboard engines used on your boat have a tilt and trim feature. The engine shift and throttle controls usually have built-in tilt and trim switches, allowing the operator to control the position of the outboards from the helm.

Trimming “in” or “down” moves the outboards closer to the boat’s transom.

Trimming “out” or “up” moves the outboards further away from the boat’s transom

In most cases, the boat will run best with the outboards adjusted so the hull will run at a 3 to 5 degree angle to the water.

The term “trim” generally refers to the adjustment of the outboards for the first 20° of travel. This is the range used while operating your boat on plane.

The term “tilt” generally refers to adjusting the outboards further up for shallow water operation or loading on a trailer. For information on the proper use and maintenance of the power tilt and trim, please refer to the engine owner’s manual.

⚠ CAUTION

The engine hoses and cables or the transom gel-coat can be damaged by tilting the engines to the full-up position with the engines steered in the wrong direction. Most engine installations will benefit from turning the steering wheel completely one direction or the other before tilting the engines to the full-up position. Monitor the engines as they tilt to determine the best full tilt engine position for your boat.

2.5 Engine Stop Switch**⚠ WARNING**

Personal Injury Hazard – always keep the emergency-stop switch lanyard attached to operator while the boat is in use.

Your Pursuit is equipped with an engine stop switch and lanyard. The engines will automatically shut off by removing the lanyard from the emergency-stop switch.

An improperly inserted lanyard will prevent the engines from starting. Check the lanyard to ensure proper insertion of the engines will not start.

⚠ CAUTION

If the boat is equipped with an emergency-stop switch, wear the lanyard at all times when operating the boat but only use it to shut off the engines in an emergency. Do not use it to shut off the engine during normal operation.

Engine Stop Switch

Refer to the engine owner's manual for more information on the engine stop switch.



Engine Stop Switch

2.6 Steering System

The steering system is hydraulic and made of two main components: the helm assembly and the hydraulic cylinder. The helm unit acts as both a fluid reservoir and pump. Turning of the helm, or steering wheel, pumps the fluid through hydraulic hoses and activates the hydraulic cylinder causing the motors to turn. The opening and closing of valves in the helm unit may cause a clicking sound, this is normal. Refer to the steering manufacturer owner's manual for specific information on the steering system.

Dual engine outboards use tie bar to couple the tiller arms. Make sure the engines have proper alignment. Properly aligned engines provide maximum stability on straight runs and correct tracking through corners. Realign the engines and/or steering system if any damage has occurred.

CAUTION

Some autopilot systems have engine position sensors mounted to the hydraulic steering cylinder. Autopilot engine position sensor brackets can hit the transom when the engines are tilted to the full up position and cause damage to the engine rigging, the autopilot or the transom. If you have an autopilot installed on your boat, monitor the location of the engine cables and autopilot brackets when tilting the engines to determine the best engine position and maximum engine tilt for your application.

Tilt Helm

If your boat has a tilt helm, depress the lever located in the base of the helm to tilt the wheel. Make sure it locks into position.

WARNING

Do not attempt to adjust the helm wheel position while underway.

2.7 Trim Tabs

Trim tabs are recessed into the hull on the transom. Switches control the trim tabs. The labeled switches control the bow-up and bow-down movements. They also control starboard and port up and down movements. Bow-up and bow-down will control the hull's planing attitude, while port and starboard up and down tabs provide control for side-to-side hull trim.

Before leaving the dock, make sure that the tabs are in the full "UP" position by holding the control in the bow "UP" position for 10 seconds.

Always establish the intended heading and cruising speed before attempting to adjust the hull attitude with the trim tabs. After stabilizing the speed and direction, move the trim tabs to achieve a level side-to-side running attitude being careful not to over-trim.

After depressing a trim tab switch, always wait a few seconds for the change in the trim plane to take effect. Avoid depressing the switch while waiting for the trim plane reaction. By the time the effect is noticeable the trim tab plane may have moved too far and thus the boat may be in an overcompensated position.

When running at speeds resulting in the boat falling off plane, lowering the tabs slightly, bow down, will improve the running angle and operating efficiency. However, too much bow down trim can reduce operating efficiency and cause substantial steering and handling difficulties.

When running at high speeds be sure the tabs are in the full "UP" position. Use only enough trim plane action to compensate for any listing. Trim tabs are extremely sensitive at high speeds. Adjust for this and be prepared to slow down if difficulties arise.

Be extremely careful when operating in a following sea. Such conditions cause an amplified trim tab effect. Steering and handling difficulties can result from improper trim tab usage, particularly in a following sea. Always raise the tabs to the full bow "UP" position in these conditions.

When running into a chop, a slight bow down attitude will improve the ride. Be careful not to over trim. Handling difficulties may result.

2.8 Compass

The compass is on top of the helm. Read the instructions on "Compass Compensation" provided in the literature packet to adjust the compass. A factory-adjusted compass is inaccurate due to the influence of electrical instrumentation and equipment unique to your boat. Therefore, have the compass professionally adjusted after the electronics and additional electrical accessories installation and before operating the boat.

2.9 Control Systems Maintenance

Control Maintenance

Periodically inspect the control systems and all connections. Service any signs of rust, corrosion, wear, or other deterioration. Periodically lubricate all moving parts and connections using lightweight, waterproof grease.

Control system adjustments may become necessary periodically. If adjustments become necessary, see your Pursuit dealer.

Steering System Maintenance

Periodically inspect of all steering hoses, linkage and helm assemblies. Signs of corrosion, cracking, loosening of fastenings, excessive wear, or deterioration require immediate correction.

Frequently check and maintain proper fluid levels for hydraulic steering. Periodically lubricate all moving parts and connections using lightweight, waterproof grease. Failure to do so can lead to steering system failure, resulting in loss of control.

When new, or after repairs, hydraulic steering systems may need to have air purged from the system. Review the information provided by the steering manufacturer for proper specifications and details on system service and maintenance.

WARNING

Inspect and maintain control and steering systems regularly. Do not attempt adjustments unless you are familiar with steering control system service procedures. Control misadjustment can cause loss of control and severe engine or lower unit damage.

CAUTION

Follow instructions in the owner's information packet for hydraulic steering system operating, bleeding and maintenance procedures.

Trim Tab Maintenance

Marine growth can interfere with the proper operation of the trim tab planes and actuators. To reduce problems due to marine growth, always return the trim tabs to the full "UP" position after operating the boat and periodically inspect and clean marine growth from the actuators and planes.

Trim tabs are equipped with a zinc anode to prevent galvanic corrosion. Electrolytes, such as saltwater, cause galvanic corrosion with different metals. Properly protect submerged metal parts from seawater using zinc anodes. The factory installed zinc anodes, but replace the anodes when they are 75% of their original size.

Refer to the Routine Maintenance chapter of this manual for information on maintaining zinc anodes and the trim tab owner's manual for additional maintenance information, fluid specifications and operating instructions.

Fuel Systems

3.1 General

The fuel systems used in Pursuit boats are designed to meet the requirements of the U.S. Coast Guard, the National Marine Manufacturers Association (NMMA) and the American Boat and Yacht Council (ABYC) in effect at the time of manufacture.

The gasoline fuel system has been factory inspected and pressure tested in accordance with the regulations in effect at the time of manufacture. This inspection assures that the system is air tight, leak-proof and safe. It is the responsibility of the purchaser to maintain it in that condition. Make frequent inspections to assure that no deterioration or loosening of connections is resulting from vibration.

⚠ DANGER

Do not let the odor of gasoline go unchecked. If the odor of gasoline is noted, shut off all engines and electrical equipment. Have all passengers put on personal flotation devices and keep a fire extinguisher ready. Investigate and correct the situation immediately.

! NOTICE

Certain bulkhead areas are sealed in accordance with U.S. Coast Guard regulations that were in effect at the date of manufacture of the boat. Ensure any and all modifications to bulkheads meet U.S. Coast Guard regulations.

Fuel Tanks

The positioning of fuel withdrawal tubes in fuel tanks are set to achieve optimum fuel usage, fuel line routing, etc. At certain speeds and hull trim angles, the fuel supply at the withdrawal tube location can increase or decrease accordingly. Be extremely careful when attempting to operate the boat

when low on fuel. Though some fuel may be in the tank, the trim angle of the boat may cause the fuel to flow away from the withdrawal tube(s).

Fuel Gauge Senders

Fuel gauge senders are most accurate when the boat is stationary and level. Due to the ever-changing attitude of the boat when underway, variations in readings may occur. This system is merely a relative indication of the available fuel supply and not a calibrated instrument.

Fuel Fill

A fuel-fill deck plate is located on the gunwale and is marked "GAS." Open the fuel-fill by turning it counter clockwise with a special key. After fueling, install the fuel cap and tighten with the key. Only use the proper type and grade fuel. Refer to the engine owner's manual for additional information.



Fuel Fill

⚠ WARNING

Do not confuse fuel-fill deck plates with the water or waste-fill deck plates. Do not attempt to pump it out any accidentally pumped gas or diesel from water or waste tank. An explosion can result if using a water or waste pump to remove fuel due to their design. Professionally have the fuel removed replace fresh water components as necessary.

Fuel Vent

The fuel vent is located on the side of the hull. Air displaced while fueling escapes through the vent. After fueling, replace the fill cap and wash the areas around the fuel-fill plate and below the fuel vent. Residual fuel left on the deck and hull can be dangerous, and will yellow the fiberglass or damage the striping.

3.2 Fuel System

The fuel system on your Pursuit has one fuel tank, mounted in the center of the bilge. One or two withdrawal lines equipped with anti-siphon valves attach to the fuel tank. These valves prevent gasoline from siphoning out of the fuel tank should a line rupture. Single engine boats use one fuel withdrawal line. Twin-engine boats use two fuel withdrawal lines, one for each engine.

⚠ WARNING

Do not remove anti-siphon valves from the fuel system. Should an anti-siphon valve become clogged, clean and reinstall or replace. If a fuel line should leak, anti-siphon valves prevent a substantial amount of fuel from flowing into the bilge. The U.S. Coast Guard requires all gas-powered boats have anti-siphon valves.

Gasoline Fuel Filter

Fuel filter(s) are installed in the stern of the boat. The filters are the water separator type and there is one filter for each engine fuel line. Check each fuel filter for water frequently to assure an adequate supply of clean, dry fuel to the engines. Inspect the filters periodically and change the elements once a season.

⚠ DANGER

To reduce the possibility of a fire or explosion, make sure all electrical switches are in the "off" position before servicing the fuel system.

⚠ WARNING

Do not drain any fuel in the bilge. This can lead to a fire or explosion. Check all fuel line fittings for leaks before and after starting the engines following any fuel system service.



Fuel Filter

3.3 Fueling Instructions

⚠ WARNING

Fuel is very flammable and can cause a fire or an explosion. Be careful when filling the fuel tanks. No smoking! Never fill the tanks while the engines are running. Fill the fuel tanks in an open area. Do not fill the tanks near open flames.

CAUTION

To prevent damage to the fuel system, use only a good grade of gasoline. Do not use fuel that contains harsh additives or more than 10% ethanol. Do not use fuels containing methanol. Water or corrosion damage to the fuel system as a result of using alcohol-blended fuels is not covered by the Pursuit limited warranty. Refer to the engine owner's manual for specific fuel requirements for your engines.

To fill the fuel tank at a marina, follow this procedure:

1. Make sure all switches are in the "Off" position.
2. Make sure the boat is securely moored.
3. Make sure all passengers leave the boat.
4. A special key to open the fuel caps is supplied.
5. Turn the key counterclockwise to open the cap.
6. Remove the cap.
7. Put the nozzle in the fuel opening.

CAUTION

Static electricity may generate while fueling and can cause a fire or explosion. To prevent static sparks while filling the tank, make sure the nozzle is in contact with the fuel opening.

8. Do not completely fill (top-off) the fuel tanks to avoid spilling fuel out of the vents and fuel fills and to allow for expansion.

WARNING

Estimate how much fuel you need and avoid over filling the tank.

WARNING

Spilled fuel can cause a fire or an explosion. Make sure you do not spill any fuel. If you spill a small amount of fuel on the fiberglass, use a cloth to remove the fuel and properly dispose of the contaminated cloth. Exercise extreme caution if spilled on the water. Fuel floats on the surface of the water and can ignite. Immediately evacuate the area and notify the marina and the proper officials if a water spill occurs.

9. Remove the nozzle.
10. Install and tighten the fuel cap. Be careful not to over tighten the cap.
11. Check the fuel compartment and below deck for fuel odors. If you smell fuel, do not start the engine.

DANGER

To reduce the risk of a fire and/or explosion, do not start the engine(s) when fuel fumes are present. Fuel fumes are dangerous and harmful to your health. Investigate all gasoline odors immediately.

3.4 Fuel System Maintenance

WARNING

Periodically inspect all fuel filters, primer bulbs, connections, clamps and hoses for leakage and damage or deterioration. Replace as necessary.

 **WARNING**

After changing the filter element, prime the fuel system and check all fittings for leaks before and after starting the engines.

Spray the valves, fuel tank gauge sender and ground connections with a metal protector such as silicon spray.

Frequently inspect and lubricate the fuel fill cap o-ring seals with petroleum jelly or silicone grease. The o-ring seal prevents water from entering the fuel system through the fuel-fill cap. Replace immediately if any damage or deterioration is apparent.

The age of gasoline can affect engine performance. Chemical changes occur as the gasoline ages that can cause deposits and varnish the fuel system, as well as reduce the octane rating of the fuel. Severely degraded fuel can damage the engine, fuel tank, and lines. Therefore, if you do not run your boat enough to require at least one full tank of fresh fuel a month, add a fuel stabilizer to the gasoline to prevent fuel degradation.

Do not allow the boat to sit for an extended period with the fuel tanks less than full. Changes in temperature and weather can cause condensation in fuel tanks that are less than 3/4 full. Your dealer or the engine manufacturer can provide additional information on fuel degradation and fuel stabilizers recommended for your engine.

Improper marina fuel storage techniques, limited boat usage, etc. can cause the fuel to become contaminated. It may be necessary to periodically pump accumulated water and contaminated fuel from the bottom of the fuel tanks. If the fuel system on your boat becomes contaminated, contact your dealer or marina for assistance.

Avoid using fuels with alcohol additives. Gasoline/alcohol blends absorb moisture from the air, which can cause "phase separation". When this happens, the water and alcohol mixture becomes heavy enough to settle to the bottom of the tank. Since the fuel pick up tube is near the bottom of the tank, phase separation can cause the engine to run very poorly or not at all.

Methyl-alcohol gasoline mixtures are even worse as the alcohol content is greater. Water or a jelly like substance in the fuel filters is an indication of phase separation from the using alcohol blended fuels.

Diesel engine operation requires clean and dry diesel fuel. Algae can grow in the accumulated water in a diesel fuel tank. This condition is prevalent in warmer climates. Periodically adding a high-quality diesel fuel additive containing an algicide may be required to control algae in your area. Please contact your Pursuit dealer or engine manufacturer for additional information regarding fuels and additives.

Electrical Systems

4.1 General

Your Pursuit is equipped with a 12-volt DC electrical system and draws current from on-board batteries.

Electrical schematics are included in this manual to assist technicians when servicing the electrical systems. Pursuit does not recommend that you attempt to service or modify the electrical system yourself. We recommend that you take your boat to an authorized Pursuit dealer for service or installation of additional electrical equipment. Pursuit reserves the right to modify or update the electrical system at any time without notice to the consumer or obligation to make updates to boats built prior to the change.

CAUTION

Compartments on a Pursuit boat may be lighted for night use. Light bulbs generate heat and can ignite ordinary combustibles causing a fire. Do not place or store combustible materials in contact with light bulbs. Turn off all lighting prior to leaving the boat.

4.2 DC System

Batteries

The 12-volt batteries in your boat provide optimum performance for engine starting, house lights, and electronics loads. There are two, Group 31, lead-acid batteries located in the aft bilge. They require similar maintenance to those found in automobiles. A circuit breaker located on each engine protects the engine ignition systems and gauges. Please refer to the engine owner's manual for information on circuit breakers installed on your engines.

DC Distribution

The 12-volt DC system comprises of batteries that charge using the engine charging system. Twelve-volt power is distributed to the battery switches and main breakers, accessed through a hatch in the aft cockpit, that protect the Main Distribution Panel (MDP), electronics, 24-hour essential circuits and the windlass.

Circuit protection devices on each engine protect the engine, ignition systems, and gauges. Please refer to the engine owner's manual for information about your engines.

CAUTION

All new 12-volt equipment added to the boat needs additional circuitry protection. Do not overload the existing accessory circuit breakers or other circuitry using additional 12-volt equipment.



**Battery Switches and Main Breakers
Twin Engines (typical)**



**Battery Switches and Main Breakers
Single Engines (typical)**

Battery Switches

There are two battery switches and one parallel switch to manage the 12-volt power distribution. The starboard engine battery, controlled by switch number 1, provides engine-starting power only. The port engine battery, controlled by switch number 2, provides power to the helm, DC and electronics circuits. On single engine boats, the number 1 battery switch controls the battery for the engine.

The parallel switch connects the batteries for emergency starting if one of the batteries is dead or low. As long as the parallel switch remains in the "OFF" position, the starboard engine battery will not be discharged by the use of 12-volt accessories and equipment on the boat.

Make sure to activate the number 1 and 2 battery switches whenever the engine(s) are running to ensure that all 12-volt accessories will operate as needed. Current is supplied to the automatic float switches for the bilge pumps and stereo memory when the

batteries are connected and the battery switches are off.

⚠ CAUTION

Do not operate the boat on a continuous basis with the emergency parallel switch in the "on" position.

Main Breakers

The main breakers are located adjacent to the battery switches and provide protection for all DC power.

Helm Main

Supplies 12-volt current to the MDP located in the cabin.

DC Main

Reserved for electronics installations, the DC main supplies power to the buss bar located behind the helm.

24-Hour Essential Circuits

The stereo memory, aft bilge pump float switch and forward bilge pump float switch remain on, regardless of the battery switch position.

Windlass (Optional)

The breaker must be in the "ON" position to use the windlass. Turning off this breaker when the windlass is not in use reduces the possibility of accidentally activating the windlass.

Voltage Sensitive Relay (VSR)

The VSR allows the engine and house batteries to be charged by one engine in a single engine installation. The VSR prevents both batteries from being discharged by automatically isolating the engine battery from the house battery.

4.3 12-Volt DC Panels

Main Distribution Panel



Main Distribution Panel (MDP) (typical)

The following are descriptions of functions controlled by the MDP.

MDP devices are protected by "push to reset" breakers, normally in the "ON" position. Should any of the breakers trip, reset the breaker by pressing the plunger protected by the boot. Each breaker is labeled with the name of the device it protects.

CO Detector

This breaker supplies current to the carbon monoxide detector. The power indicator on the carbon monoxide detector should be lit whenever someone is occupying the cabin. If the breaker has tripped, it indicates that there is a problem with the carbon monoxide detector, the breaker or the wiring from the breaker panel to the detector. Always determine the cause of the problem and correct it before resetting the breaker.

⚠ DANGER

Carbon monoxide is a lethal, toxic gas that is colorless and odorless and can cause death at certain levels.

Helm Switch Panels

The following are descriptions of the accessories controlled by the helm switches.

Helm Panel Left

ACC (Accessory)

Unused and held for future additional accessories not to exceed 10 amps.

Underwater Lights (Optional)

Activates underwater lights. Use these lights only when the boat is in the water as they rely on water for cooling.

Windlass

Activate the switch to deploy and retrieve the anchor. See the Exterior chapter for proper use of the windlass.

Panel Lts

Activates instrument lighting. The compass light is also activated with this switch.

Hard Top

Depressing this switch activates the light mounted underneath the hardtop.

Spreader

Activates the flood lights located on the hardtop.

Cockpit

Activates lights that illuminate the cockpit area.

Nav Lts

Activates navigation and anchor lights.

Wiper

Activates windshield wipers.



Helm Switch Panel Left

Helm Switch Panel Right

Horn

Activates boat horn.

Aft Bilge

Activates bilge pump, which is located in the aft bilge. Depressing this switch activates the manual pump.

Fwd Bilge

Depressing this switch activates the manual pump. If the automatic pump activates, the automatic bilge pump indicator on the switch will illuminate.

Livewell

This switch activates the livewell circulating pump that supplies water to the livewell. The pump is protected by a circuit breaker and an automatically resetting breaker on the pump motor.

Raw Water

This switch activates the raw water wash-down pump. The pump is a pressure-demand type, protected by a circuit breaker on the MDP in addition to an automatically resetting breaker on the pump motor.

Fresh Water

Activates fresh water pump.

Bow Up/Down

These switches control the trim tab planes located on the transom of the boat. Please refer to the Helm Systems chapter for detailed information on the operation of the trim tab controls.



Helm Switch Panel Right

Cockpit Switch Panel

Fishbox Pump

The fishbox macerator switch is momentary switch that activates the overboard macerator pump for the fishbox; protected by a circuit breaker on the MDP.

Cabin switch panels

The following are controlled by the cabin switches.

Electric Head (Optional)

Operates the electric head. Refer to the head owner's manual for operating instructions.

Head Macerator

Activates the macerator for the holding tank overboard discharge. This breaker remains in the "OFF" position except when pumping out the holding tank.

Refer to the Interior Equipment chapter for additional information on the operation of the overboard macerator discharge system.

Miscellaneous Electrical Components

Cabin Lights

Lighting is controlled by a switch located adjacent to the companionway door and by switches on the cabin lights.

CAUTION

Halogen lighting contains a filament bulb that generates intense heat, is pressurized and could shatter if scratched or damaged. Protect glass halogen-cycle bulbs from contact with liquids when operating.

12-Volt Receptacle

Power is provided to the 12-volt accessory receptacle by a breaker located on the breaker panel.

4.4 Electrical System Maintenance

12-Volt DC Electrical System Maintenance

At least semi-annually, spray all exposed electrical components behind the helm and in the plugs, with a silicon-based protector. Remove exterior light fixture bulbs and coat the metal contact areas with a non-water soluble lubricant such as petroleum jelly or silicone grease. Spray the sockets with a silicon-based protector. Do not get any oil or petroleum jelly on the glass portion of the bulbs, as this will cause the bulb to overheat and burn out.

CAUTION

Always use a bulb with the same rating as the original when replacing light bulbs in marine light fixtures. Using a different bulb can cause the fixture to overheat and melt or short circuit.

Check all below deck wiring to ensure proper support, and that the insulation is sound, and there are no loose or corroded terminals. Thoroughly clean corroded terminals with sandpaper or replace them. Secure and spray with a metal and electrical protector. Inspect all engine wiring.

Check the electrolyte level in the batteries regularly and add distilled water as necessary. Check electrolyte level more often if frequently charged by a battery charger. The correct fluid level in the cells is usually approximately 1/4 to 1/2 inch above the plates. If fluid is needed, fill to the proper level with distilled water. **Do not over fill!**

Please note that some batteries are sealed and cannot be filled. Keep the battery tops clean and dry. Dirt and water can conduct electricity from one post to the other causing the battery to discharge.

Keep battery posts free of corrosion. Do not use wing-nut connections to attach battery cables. Remove the cables and clean the posts and cable clamps with a battery post cleaner or sandpaper as required. Coating the battery posts and cable clamps with petroleum jelly or silicone grease protects them and reduces corrosion. Replace battery cables if they show signs of corrosion or fraying. Deteriorated cables cause a considerable voltage loss when under load, such engine starting.

DANGER

Never use an open flame in the battery storage area. Avoid striking sparks near the battery. A battery can explode if a flame or spark ignites the hydrogen gas the battery emits while being charged.

WARNING

Corrosion allowed to build on the electrical connectors can cause a poor connection resulting in shorts, ground faults or poor ground connections. Check electrical connectors at least annually and cleaned as required. Do not allow corrosion to buildup on connections.

WARNING

Always disconnect AC and DC electrical systems from the power source before inspecting or servicing the system. Never service any component of an electrical system while it is energized.

Plumbing Systems

5.1 Fresh Water System

General

The fresh water system consists of a potable water tank, distribution lines and a distribution pump. The pump comes with an automatic pressure switch and is located in the stern bilge. An in-line strainer located near the pump protects the system from debris. A labeled deck plate located on the gunwale allows for filling the tank.

CAUTION

Do not fill the system with anything other than water. Contamination of the system with fuel or other toxic fluids may necessitate the replacement of components.

WARNING

Do not confuse fuel-fill deck plates with the water- or waste-fill deck plates. If gasoline or diesel accidentally is pumped into the water or waste tank, do not attempt to pump it out yourself. Water and waste pumps can cause a fire or explosion. Have the fuels professionally removed and the components of the fresh water system replaced as necessary.

Operation

Fill the water supply tank slowly through the labeled deck plate. After filling the water tank, partially open all faucets. The fresh water system switch on the helm panel should be "ON." Allow the pump to run until all the air is purged from the system and a steady stream of water flows from each outlet. Next, turn off the faucets one by one. As the pressure builds, the pump will automatically shut off.

After properly priming and activation, the water system will operate much like the water system in a home. An automatic pressure sensor keeps the system pressurized. Recently filled tanks or tanks used for an extended period may cause air accumulation at the pump and the system may need to be re-primed.

Whenever unattended, place the fresh water system switch in the "Off" position.

CAUTION

Do not allow the fresh water pump to run dry. Empty fresh water tanks will cause the pump to stay on as the pump works on-demand and will not shut off automatically. This can result in damage to the pump. Always turn the water pressure switch "Off" when not in use.

5.2 Raw Water Washdown

Hoses connected to a ball valve and thru-hull fitting located in the bilge supply the raw water washdown pump.

Operation

Always make sure the ball valve is open before attempting to operate the raw water washdown system. A switch on the helm activates the washdown pump. When activated, the pressure switch will automatically control the pump. As the pressure builds in the washdown hose, the pump will shut off. When the washdown hose is in use and the pressure drops, the pump will turn on. Turn off the washdown system off when not in use.

The raw water washdown system is equipped with a sea strainer on the intake side of the pump located in the aft bilge. Check the strainer frequently and clean as necessary.

Priming The System

Open the ball valve. Open the hose connector for the raw water washdown and activate the pressure pump. Run the pump until all the air is purged from the system. Close the thru-hull ball valve before removing the boat from the water to eliminate an air lock in the system. It may be necessary to re-prime the raw water system if not used for an extended period.

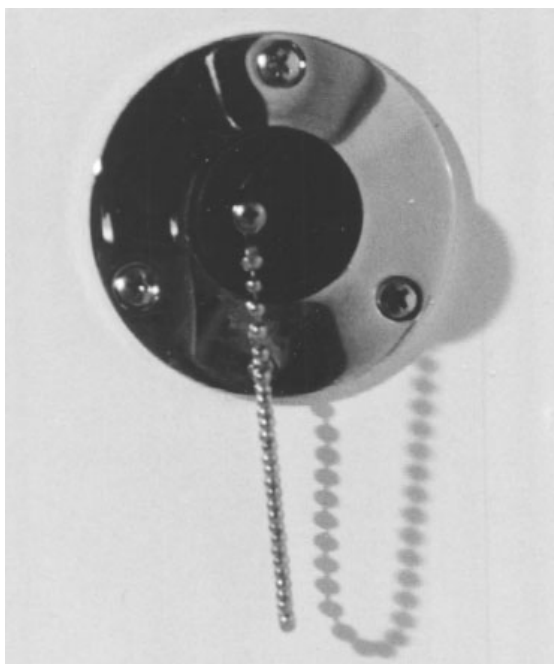

Washdown Hose Connector (Typical)

⚠ CAUTION

Always turn the raw water pump switch to the "off" position when leaving the boat unattended.

⚠ CAUTION

Do not run the high-pressure pump dry for extended periods as damage to the pump may result.

5.3 Livewell

A 12-volt circulating pump provides seawater to the livewell. This pump provides a constant flow of water to the livewell. Activate the pump using the livewell switch on the helm. An overflow built into the livewell automatically controls the water level in the livewell. Always turn the pump off at the switch panel when not in use.

To fill the livewell, insert the plug into the drain fitting at the bottom of the livewell. Make sure the ball valve at the intake thru-hull fitting is open and turn on the livewell pump. When the water reaches the overflow level, it will begin to circulate.

To drain the livewell, turn off the livewell pump and pull out the plug in the drain fitting. When the livewell has completely drained, use the washdown hose to flush the livewell and drain debris.

Close the livewell thru-hull ball valve when not in use. This prevents water from entering the livewell while cruising. The livewell pump is equipped with a sea strainer on the intake side of the pump located in the aft bilge. Check the strainer frequently and clean as necessary.

⚠ CAUTION

Do not use the livewell as a dry storage area when not in use. Seawater may accidentally enter the livewell from the thru-hull fitting and damage equipment stored there.

⚠ CAUTION

Do not run the livewell pump dry for extended periods as damage to the pump may result.

5.4 Drainage

General

Some drain thru-hull fittings are equipped with ball valves that are always open under normal operating conditions. In the event of an emergency, close the valves to prevent seawater from entering the boat through the drainage system. Check and operate the drain valves monthly to ensure their condition and proper operation. Also, check the drain system frequently to ensure it flows freely and the hoses on the thru-hull fittings are secure and not leaking.

Please review the drainage schematic to become familiar with the location of thru-hull drain valves.

WARNING

Situations requiring one or more drain valves closure can be potentially dangerous to the boat and your crew. If this occurs, distribute personal flotation devices to the crew and take all necessary safety precautions, including notifying the coast guard, until the locating problem and correcting it.

Bilge Drainage

Bilge pumps are located in the stern and forward bilge. All bilge pumps pump water out of thru-hulls located above the waterline. See Electrical Systems for additional information on bilge pump operations.

The aft bilge pump system consists of two pumps and an automatic float switch. The float switch activates one pump automatically. The other pump is controlled manually by a switch at the helm. The forward bilge pump has both automatic and manual functions.

Current goes to the automatic float switches whenever the batteries are connected. The bilge pump switches in the helm have current when the number 2 battery switch is in the "ON" position. Breakers for both the manual and the automatic functions are located on the MDP.

Activate the manual bilge pump briefly frequently to ensure pumps are operating properly. Activate the automatic switch manually to verify operation by placing a wet rag across the sensor and mounting bracket. There is a delay built into the switch before the pump will activate. The pump will continue to operate for a short time after removing the rag. Refer to the Water Witch manufacturer's information under "Plumbing" for more information.

Inspect the bilge area frequently for evidence of excessive water. Continuous operation of the bilge pump can mean excess water in the bilge. Debris can also prevent the pump from operating or make it operate continuously. Make sure no debris blocks the bilge pump float.

Bilge pumps and bilge pumping systems are not designed for damage control. Continuous operation of the bilge pump can mean a leak or an incorrectly installed drain plug; make sure all drain plugs are installed.

Excess water in the bilge area adversely affects the handling and maneuverability of the boat and can cause personal injury. DO NOT allow the bilge pump to operate after all the water has been cleared from the bilge area. Damage to the pump will occur.

A loose drain plug will allow seawater to enter the bilge and cause the boat to sink. Check the drain plug frequently to make sure it is secure. When the boat is out of the water, the drain the bilge using the thru-hull drain located in the transom, near the bottom of the hull.

Thoroughly clean and properly dispose of any oil spilled in the bilge before operating the bilge pump. The discharge of oil from the bilge is illegal and subject to fine.



Automatic Bilge Pump Switch

⚠ NOTICE

The federal water pollution control act prohibits the discharge of oil or oily waste into or upon the navigable waters of the United States or the waters of the contiguous zone if such discharge causes a film or sheen upon, or a discoloration of the surface of the water, or causes a sludge or emulsion beneath the surface of the water. Violators are subject to a penalty of \$10,000.

Exterior Drains

Your Pursuit has two scupper drains located in the rear of the cockpit. The drain rails for the compartments drain overboard by gravity. Scupper drains are equipped with check valves to minimize water backing up through the drains.

Fish Box drain

The fishbox is equipped with a macerator pump and drain plug. Removing the drain plug in the fishbox allows overboard pumping. Activate the macerator using a momentary switch on the switch panel in the cockpit. The macerator discharge pump only runs dry for a few seconds. Allowing the macerator pump to run after the fishbox is empty may cause damage to the pump. Clean and flush the fishboxes out after each use.

The cooler located under the port aft facing seat is drained by gravity to an overboard thru-hull.

The rope locker drains overboard through a drain fitting located in the hull side at the bottom of the rope locker. Inspect the drain frequently to remove any accumulated debris.

Interior Drains

The cabin's sink drains directly overboard through a thru-hull fitting located under the sink cabinet.

A drain plug in the cabin sole drains water that may accumulate on the cabin floor. This plug keeps the aft bilge isolated from the cabin. Remove the plug only to drain water from the cabin floor and reinstall after draining is complete.

⚠ CAUTION

To keep the cabin free of fumes, vapors and water, always replace and properly secure the drain plug in the cabin sole after draining.

5.5 Plumbing Systems Maintenance

The manufacturer of the water systems supplied information along with water system components and that information is included with this manual. Refer to this information for additional operation and service data.

Water Systems

Complete the following items routinely to maintain your fresh water system:

Remove the filter screens from faucet spouts and eliminate any accumulation of debris. A build-up of debris can cause the pump to cycle excessively.

The fresh water system is equipped with a strainer located on the intake line near the pump. Check annually and clean as necessary.

Periodically spray the pumps and metal components with a metal protector.

Properly maintain and charge the batteries. Operating the pressure pump from a battery with a low charge can lead to pump failure.

Add a commercially available potable water conditioner to the water tank to keep it fresh.

CAUTION

Place the fresh water system switch in the “off” position when not in use or when leaving the boat unattended.

Raw Water System

Complete the following items routinely to maintain your raw water system:

Check hoses, particularly the seawater supply lines, for signs of deterioration.

Remove and clean the seawater strainers for the livewell, air conditioner and wash-down pump, as needed.

Spray pumps and thru-hull valves with a protective oil periodically.

Drain and clean the fishboxes and livewells after each use.

Operate all thru-hull valves at least once a month to keep them operating properly.

CAUTION

Should a hose rupture, turn the pump off immediately. Always close the thru-hull valve when performing maintenance on a seawater pump.

CAUTION

Properly maintain and charge the batteries. Operating a pump from a battery with a low charge can lead to pump failure.

CAUTION

Properly winterize the fresh and raw water systems prior to winter lay-up. See the section on winterizing.

Drainage Systems

It is essential to complete the following items periodically to maintain proper drainage of your boat:

Clean the cockpit drains with a hose to remove debris that can block water drainage.

Clean the hardtop leg drain holes; especially important just before winter lay-up.

Clean the bilge pump and automatic float switch strainers of debris and check the bilge for foreign material that can cause the automatic switch to malfunction.

Test the rear automatic bilge pump switch and high water alarm float switch before using the boat every time to ensure proper operation. Operate the knob or lever on the side of the switch until the pump activates, or add water to the bilge until the water level is high enough to activate the pump.

Flush all gravity drains with fresh water to keep them clean and flowing freely.

Clean and inspect the shower and sink drain sump system. Remove accumulated debris and flush with fresh water. Frequently test the automatic pump switch for proper operation.

Clean and flush the fishbox and cooler/storage boxes with soap or a bilge cleaner and fresh water after each use to keep them clean and fresh.

Operate the thru-hull valves once a month and service as required.

Check the drain system frequently to ensure it is flowing freely and that hoses on the thru-hull fittings are secure and not leaking.

 **CAUTION**

Properly winterize all drains and pumps before winter layup.

 **CAUTION**

Never use harsh chemical drain cleaners in marine drain systems. Permanent damage to the hoses and fittings may result.

Ventilation System

6.1 Cabin Ventilation

A deck hatch and opening port windows provide ventilation to the cabin area.

Deck Hatch

A variable hatch adjuster supports the deck hatch in the open position. To close the hatch, loosen the hatch adjuster and lower the hatch. Secure in the closed position with the two cam levers on the inside of the hatch.

Port Lights

Adjustable dogs secure the port lights. Adjust the dogs so they are tight enough to seal the windows in the closed position, but not so tight that they are difficult to latch. Adjust the dogs by turning the screw. The screw increases or decreases the pressure on each dog. Remove the screen prior to closing the port light to ensure a water resistant seal.

6.2 Carbon Monoxide and Proper Ventilation

The Safety chapter in this manual contains important information on carbon monoxide and the carbon monoxide detector. Read the section entitled "Carbon Monoxide" in the Safety chapter of this Owner's Manual.

6.3 Windshield Ventilation

The windshield is equipped with an opening vent panel on each side. To open the vent, release the locking T-handle and rotate it outboard until it locks in place. To prevent vent glass damage, do not leave the T-handle in the unlocked position.

6.4 Bilge Compartment Ventilation

Four vents provide airflow into the bilge compartment, located on either side of the cockpit, under the gunwale boards. This provides adequate air movement in the bilge compartment.

6.5 Maintenance

- Periodically lubricate all hinges and latch assemblies with a light oil.
- Periodically clean and coat gasket materials with silicone to help keep them pliable.
- The opening cabin deck hatches and port windows are made of acrylic plastic. Acrylic plastic scratches easily. Never use a dry cloth or glass cleaning solutions on acrylic plastic. Use a soft cloth and mild soap and water for routine cleaning. Solvents and products containing ammonia can permanently damage acrylic plastic. Please refer to the Routine Maintenance chapter for more information on the proper maintenance of acrylic plastic.
- Many manufacturers of carbon monoxide detectors offer a testing and recertification program. We recommend that you contact the manufacturer of your carbon monoxide detector and have it tested and recertified periodically.

Exterior Equipment

7.1 Deck

Rails and Deck Hardware

The rail system and hardware fittings perform specific functions. Secure fenders and mooring lines to the cleats, not the rails or stanchions. Be sure a clear lead exists when running dock lines or anchor lines. A line inadvertently run around a stanchion or over the rail can cause damage.

CAUTION

Periodically inspect all fittings for loose fit or wear and damage. Correct any problems immediately.

WARNING

Pursuit boats are not equipped with hardware designed for towing purposes. Do not use the mooring cleats to towing another vessel or have this boat towed.

Bow Pulpit and Roller

The bow pulpit is built into the hull and is equipped with a roller assembly that allows anchor operation and storage. The pulpit roller is designed for a Delta® plow or a Danforth® style anchor. A chain binder is provided on the deck near the pulpit to secure the anchor. Always make sure the chain binder secures the anchor chain before getting underway.

Anchor/Rope Locker

The anchor locker is in the bow of the boat and accessed through a hatch in the deck. Danforth® style anchors use a recessed locker.

The anchor/rope locker drains by a thru-hull fitting in the hull side near the bottom of the locker. Check the drain frequently to make sure it is clean and free flowing.

WARNING

Position the anchor so it does not rest against the hull sides and be properly secured at all times when stored in the anchor locker. A loose anchor in the anchor locker will bounce and can damage the boat. Damage resulting from the anchor bouncing in the anchor locker is not covered by the Pursuit warranty.

Windlass (Optional)

Mounted to the deck near the rear of the pulpit, above the rope locker, is the windlass. The anchor is stored on the pulpit and is raised and lowered by the windlass. The anchor line is stored in the rope locker and routed through the windlass to the anchor chain.

The anchor is lowered by releasing the anchor from the cleat or chain binder on the pulpit and activating the “Deploy” switch at the helm. After the anchor is set, the windlass must not be left to take the entire force from the anchor line. Fast the line to the anchor line cleat to relieve the load on the windlass.

CAUTION

Do not use a windlass as a sole means of securing an anchor in the bow pulpit. Always secure the anchor line to a cleat or chain binder before operating your boat.



Anchor Line Secured to Cleat

The anchor is hauled in by releasing the line from the bow cleat and activating the “Retrieve” switch at the helm. Once the anchor is retrieved, independently secure the anchor to the chain binder or a cleat to prevent it from being accidentally released. This is especially important while the boat is under way.

Boats at anchor in a high swell will snub on the anchor line. This can cause slippage or apply excessive loads to the windlass.

Do not use the windlass as a winch to move the boat over the anchor. Move the boat under its own power to the anchor and to break the anchor loose.

Refer to the windlass owner's manual for use of the windlass.

⚠ WARNING

Use the windlass with care. It is extremely important that you read the owner's manual and become familiar with the safety instructions and proper operation of the windlass before using it with your boat. Always ensure that limbs, fingers, hair and clothing stay clear of the windlass and anchor line during operation.

Windshield

Your Pursuit is equipped with a vented heavy-duty aluminum windshield. The front and side wing panels are tempered safety glass. The curved glass panels on the port and starboard side of the windshield are made of tinted acrylic plastic. Refer to the Ventilation chapter for further information.

Acrylic plastic scratches easily. Please refer to the Routine Maintenance chapter for more information on the proper care and maintenance of acrylic plastic.

Downriggers (Dealer Installed)

Downriggers must be installed on the deck area aft of the gunwale board. Pursuit Boats reinforce this area especially for the installation of downriggers. Do not install or insert downriggers in the rod holders mounted in the gunwale boards as damage may occur.

7.2 Cockpit

Swim Platform

Your Pursuit is equipped with an integral swim platform and engine mounting system located in the stern of the boat. There are inspection deck plates in the splashwell to provide access to the stern bilge and engine mounting bolts. Always make sure these plates are secure before operating your boat.

The boarding ladder is mounted to the rear of the stern bench seat when it is in the stored position. To use the ladder, remove it from the storage clips and slide the studs into the bracket on the port side of the transom. The ladder floats and must be secured in the boarding position by turning the cam lock on the ladder so it catches the bottom of the transom ladder bracket. The ladder must be removed from the transom bracket and properly secured to the storage clips before starting the engine(s).

DANGER

Moving propellers are dangerous. They can cause death, loss of limb, or other severe injury. Do not use the swim platform or swim ladder while the engine(s) are running. Stop the engine(s) if divers or swimmers are attempting to board. Always remove and properly store the ladder before starting the engine(s).

CAUTION

In certain conditions, open exterior doors and hatches not secured properly can slam closed unexpectedly and cause injury to passengers or damage to the boat. Most doors and hatches are equipped with special fasteners, hatch lifters, or snaps and/or straps, to secure them in the open position. Always make sure that these hatches and doors are properly secured whenever they are in the open position.

Transom Door

The transom door should only be opened when the boat is not in motion. The door must be latched in either the full "OPEN" or full "CLOSED" position. Never leave the transom door unlatched.

DANGER

Close and properly latch the transom door whenever the engine(s) are running. Never open the transom door while underway or in rough sea conditions. In certain situations, an open transom door can allow a substantial amount of water to enter the cockpit creating a potentially dangerous condition. Operating the boat under power with the transom door/gate open may allow persons to fall overboard and into boat propellers or to be lost in open water.

CAUTION

Periodically inspect the transom door/gate fittings for wear, damage or loose fit. Inspect for and correct any problems immediately.

Helm Seat

The helm seat is a pedestal seat that swivels and adjusts fore and aft. A friction knob adjusts the tension of the seat base on the pedestal and is located on the side of the seat. Adjust it to eliminate play between the seat base and the pedestal.

WARNING

Serious or fatal injury can occur due to the rotation of the seat if the swivel is not locked. Lock the swivel when the boat speed exceeds 5 miles per hour.

Stern Bench Seat

The stern bench seat is hinged and opens to allow access to the removable fishbox. The engines must be tilted to the full 'DOWN' position, the transom door opened and the latches at the front of the seat released before bench seat can be opened. A hatch lifter holds the seat in the open position and prevents it from opening too far. Remove the fishbox underneath the seat to access the bilge. Refer to the Drainage section of the Plumbing Systems chapter.

WARNING

The stern bench seat is hinged and could open unexpectedly in certain conditions, such as hard acceleration or rough seas, if it is not properly closed and secured by the latches. This may allow persons to fall overboard and into boat propellers or to be lost in open water. In rough seas, an open bench seat may allow a substantial amount of water to enter the cockpit or the bilge, creating a potentially dangerous condition. Close and properly latch the stern seat before operating your boat.

CAUTION

Damage to the engine cowlings, stern seat and transom door can occur if the stern seat is not opened properly. The engines must be tilted to the full down position, the transom door opened, and the latches at the front of the seat released before the bench seat can be opened.

Removing Aft Seat

The batteries are located below the stern bench seat and fishbox. If the batteries are discharged and the engines are tilted in the full "UP" position, the bench seat cannot be

opened and must be removed to provide access to the batteries.

The bench seat is removed by releasing the latches at the front of the seat, removing the ladder, opening the transom door and removing the pins in the hinges at the rear of the seat. Two people will be required to tilt the seat forward and lift it off the fishbox. The gas hatch lifter is still attached to the seat and care must be taken to keep the weight of the seat from bending the adjuster. Hold the starboard end of the seat attached to the hatch gas hatch lifter and lower the other end of the seat to the cockpit floor. Use a small screwdriver or a knife to remove the plastic end cap from the hatch lifter ball hinge fitting on the seat. Fully extend the hatch lifter and pull the lifter off the ball hinge on the seat. The seat is now free and can be set in the cockpit.

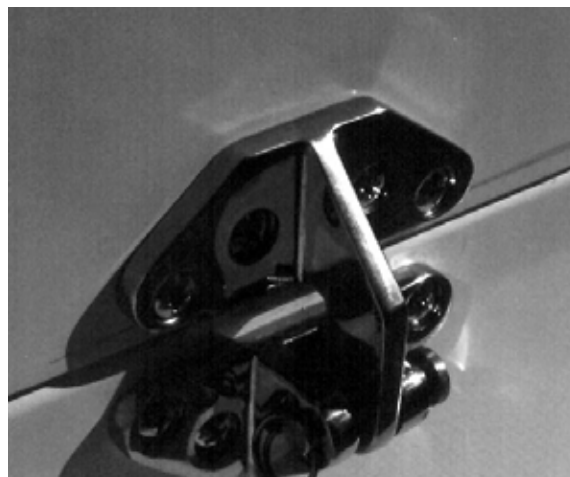

Stern Seat Hinge

To reinstall the seat, make sure the engines are down, the fishbox is installed, and the hatch lifter is lying in the trough next to the fishbox. Lift the seat into position on the seat landing in the closed position and install the hinge pins and cotter rings. Open the seat and snap the hatch lifter to the ball hinge fitting on the seat. Install the plastic end cap in the lifter ball hinge fitting to prevent the lifter from popping off the ball hinge.

Note: If the boat is out of the water with the engines tilted up and the batteries are discharged, the batteries and battery tray area

are accessed by using the manual valve screw on the engine tilt cylinder and tilting the engines down manually. Open the seat in the normal fashion. Please refer to the engine owner's manual for instructions on lowering the engines manually. Never use the manual tilt valve screw when the boat is in the water. Seawater can enter the power tilt system and cause damage to the unit.

Hard Top

The hard top consists of a laminated fiberglass top mounted to a welded aluminum frame bolted to the deck. It is designed to accommodate radio antennas, radar antennas and navigation lights. It could also be equipped with optional outriggers and/or rod holders.

The hard top is not designed to support the additional weight of items like an instrument locker or a life raft. Radar and electronics antennas must be mounted to the top between the front and rear legs. Do not mount any antennas or equipment to the brow area. The hard top frame is not designed to support the weight of accessories in this area and could be damaged. The starboard rear leg is the wire chase for lights and antennas mounted to the top.

The warranty for the hard top will be void if the top is modified in any way or heavy accessories like life rafts or electronics lockers are mounted to the top. Additionally, if items like radar antennas, spotlights and other accessories are mounted in the wrong location, the warranty can be voided. If you intend to add equipment or make modifications to the hard top, you should contact Pursuit Customer Relations to make sure the equipment you would like to add or the intended modification will not void the warranty on the top.

Hard Top Canvas

Because the aluminum frames vary slightly, the side curtains, front clear connector and drop curtain are custom made to each boat at the factory. Slide the front clear connector into the slide track at the front of the top and

snap it to the top of the windshield frame beginning with the center snaps. The clear connector will have to be stretched just enough to pull out the wrinkles to reach the snaps on the windshield.

Once the clear connector is installed, slide the side curtains into the slide tracks on the sides of the top and to the zippers on the front of the connector. Snap the curtains to the windshield and the deck beginning with the forward snaps on the windshield. The side curtains will have to be stretched slightly to pull out the wrinkles and reach the snaps.

If you have an optional drop curtain, slide it into the slide track on the back of the hard top and attach it to the rear of the side curtains. Snap the drop curtain to the deck and cockpit.

Cold weather can make the clear vinyl material on the curtains stiff and difficult to stretch to the snaps. This can be particularly difficult with new canvas that has been stored off the boat. Laying the curtains in the sun for 30 minutes during the heat of the day will make installing them much easier in cold weather.

There is a hole drilled in one of the leg bases to prevent water from being trapped within the leg and provide a wire chase for accessories. A small hole drilled in the tubing at the base of the other legs, which are not drilled for a wire chase, allows water to drain. Clean the hardtop leg drain holes. This is especially important just before winter lay-up.

Interior Equipment

8.1 Cabin and V-Berth

Companionway Door

Access the cabin through a sliding door. A lockable latch secures the door in the closed position. A vinyl-covered latch secures the door in the open position. It is very important to properly secure the cabin door in the open or closed position. The door is made of acrylic plastic. Acrylic plastic scratches easily and can chip. Please refer to the Routine Maintenance chapter for information on the proper care and maintenance of acrylic plastic.



⚠ CAUTION

Never leave the cabin door unlatched. The cabin door is heavy and slides easily. If left unlatched, it can slide unexpectedly as the boat rocks, damaging the door or causing an injury to a passenger. Always properly latch the door in the open or closed position.

Companionway Step

The companionway step is removable to allow access to the forward bilge. To remove the step, lift straight up out of the brackets and pull the steps forward. Always properly secure the steps before using.

Cabin

An overhead opening hatch provides daylight and fresh air to the cabin area. Individually controlled 12-volt lights provide additional lighting.

Located in the cabin are a storage compartment and fresh water sink that drains overboard. The fresh water system provides water to the sink.

An access panel in the cabin above the breaker panel and sink provides service access to the rear of the helm. The electronics buss bar is located behind this panel.

The access door to the holding tank, head system seacocks and forward bilge pump is located at the rear of the cabin below the companionway door.

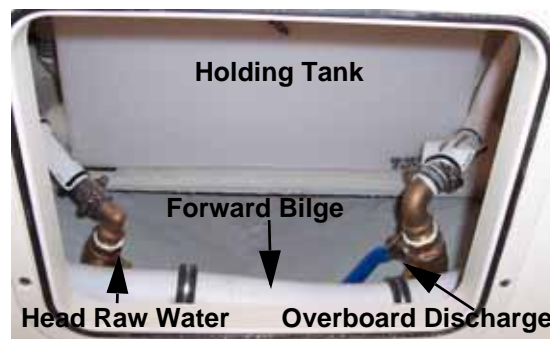

Forward Bilge Area

Marine Head System

The marine toilet is located under the V-berth. Flush water is supplied by a thru-hull fitting located in the forward bilge area. Before using, open the inlet valve on the head and pump to wet the inside of the bowl. After use, pump to discharge the waste to the holding tank, then close the inlet valve and pump the bowl dry. The waste remains in the holding tank until pumped out by a waste dumping station.

Holding Tank

The holding tank is located in the bilge. Monitor the waste level in the holding tank and have it pumped out before completely full. If

the holding tank overfills, the waste overflows out the tank vent and then overboard.

Emptying the Holding Tank

When the holding tank is full it must either be pumped out by an approved waste dumping station through the waste deck fitting or be pumped overboard with the macerator discharge pump, when legal to do so.

To operate the macerator pump, open the ball valve at the thru-hull fitting located in the forward bilge. Then activate the macerator switch until the tank empties. Release the switch and close the discharge ball valve when pumping is complete.

CAUTION

The macerator discharge pump can only be run dry for a few seconds. Allowing the macerator pump to run after the holding tank is empty may cause damage to the pump.

NOTICE

In some waters you can be fined for having an operable direct overboard discharge of waste. To avoid a fine, removing the seacock handle, in the closed position, or other means must be used.

Maintenance

Clean and inspect the head regularly for leaks. Periodically add chemical to the head to help control odor and chemically break down waste. See the manufacturer owner's manuals for additional operating and maintenance information.

CAUTION

Properly winterized the head and macerator discharge systems before winter lay-up. See the section on winterizing.

8.2 Carbon Monoxide Detector

The Safety chapter in this manual contains important information on carbon monoxide and the carbon monoxide detector. Read the section entitled "Carbon Monoxide" in the Safety chapter of this Owner's Manual.

8.3 Audio and Video Systems

Stereo (Optional)

The stereo is located in the overhead of the cabin. An iPod®/MP3 USB input jack is included with the stereo. An optional satellite radio system made up of a receiver and an antenna installed on the hard top is available. The satellite receiver is located in the starboard cabin locker. Refer to the stereo owner's manual.

Safety Equipment

9.1 General

Your boat and outboard engines have been equipped with safety equipment designed to enhance the safe operation of the boat and to meet U.S. Coast Guard safety standards. The Coast Guard or state, county, and municipal law enforcement agencies require certain additional accessory safety equipment on each boat. This equipment varies according to length and type of boat and type of propulsion. Most of the accessory equipment required by the Coast Guard is described in this Section. Some local laws require additional equipment. It is important to obtain "Federal Requirements And Safety Tips for Recreational Boats," published by the Coast Guard, and copies of state and local laws, to make sure you have the required equipment for your boating area. You should also read the book entitled "Sportfish, Cruisers, Yachts - Owner's Manual" included with this manual.

Your Pursuit boat could be equipped with engine alarms and cabin monitoring equipment. These systems are designed to increase your boating safety by alerting you to potentially serious problems in the primary power systems, the engine compartment and the cabin. Alarm systems are not intended to lessen or replace good maintenance and "Pre-Cruise System Check."

This Section also describes safety related equipment that could be installed on your boat. This equipment will vary depending on the type of engines and other options installed by you or your dealer.

9.2 Engine Alarms

Most outboards are equipped with an audible alarm system mounted in the helm area that monitors selected critical engine systems. The alarm will sound if one of these systems begins to fail. Refer to the engine owner's manual for information on the alarms installed with your engines and additional operating and maintenance information.

If the alarms sounds:

- throttle the engines back to idle immediately.
- shift to neutral.
- monitor the engine gauges to determine the cause of the problem.
- if necessary, shut off the engines and investigate until the cause of the problem is found.
- if the boat is equipped with water sensors in the fuel filters, make sure to check them for excessive water.

9.3 Neutral Safety Switch

Every throttle/shift control system has a neutral safety switch. The switch allows the engines to be started in NEUTRAL only. If engines will not start, make sure controls are in NEUTRAL. Control or cable adjustments may be required to correct this condition should it persist. See your Pursuit Dealer for necessary control and cable adjustments. Refer to the Helm Systems for more information on the neutral safety switch.

9.4 Engine Stop Switch

Your Pursuit boat is equipped with an engine stop switch, clip and lanyard. When the lanyard is pulled, it will shut off the engines.

WARNING

LOSS OF CONTROL AND UNSAFE BOAT HAZARD

An engine stop switch system that is not used or does not function correctly can cause death or serious injury. DO NOT operate the boat if the stop switch system does not function properly.

The stop switch will stop an engine whenever the lanyard is pulled far enough to disconnect the clip from the switch. Attach the lanyard to the boat operator whenever an engine is running, but be aware of loss of engine power if the switch is activated.

If the operator is thrown from the seat, or moves too far from the helm, the lanyard will disconnect the clip from the switch, shutting off the engine.

To attach a lanyard, connect the clip to the emergency stop switch and the hook to a strong piece of clothing on the operator, such as a belt loop.

If the engines will not start, the clip may not be inserted into the engine stop switch properly or the control is not in neutral. Make sure the clip is properly attached to the engine stop switch before attempting to start the engine.

Always carry a spare stop switch clip and lanyard and instruct at least one other person onboard the operation of the stop switch and location of the spare.

9.5 Automatic Fire Extinguishing System (with Optional Generator)

WARNING

FIRE/EXPLOSION HAZARD

The gas of the fire extinguisher system displaces oxygen to "smother" the fire. **DO NOT** open the hatch. Oxygen can feed a fire and flashback can occur which can cause death or serious injury. If the onboard fire system discharges, wait at least 15 minutes before opening engine hatch.

The generator is equipped with an automatic fire extinguishing system. The extinguisher has been chosen and located to provide sufficient coverage of the generator compartment. While the system helps ensure bilge fire protection, it does not eliminate the U.S. Coast Guard requirement for hand held fire extinguishers.

The system is equipped with an engine shut-down circuit to automatically shut down the generator. The red light on the fire extinguisher control panel will light and an alarm will sound if this should occur. When suffi-

cient time has elapsed for the fire to be extinguished and a flashback is no longer possible, find and fix the problem, then the override switch on the control panel can be moved to the "OVERRIDE" position and the engines can be restarted. Refer to the Automatic Fire Extinguisher System in the Helm Systems.

If the extinguisher system is activated, shut down all engines immediately. Turn off all electrical systems, powered ventilation and extinguish all smoking materials. **DO NOT** open the engine compartment hatch, this will feed oxygen to the fire and a flashback can occur. Allow the extinguishing agent to soak the generator compartment for at least 15 minutes and wait for hot metals or fuels to cool before inspecting for cause or damage. Have an approved portable fire extinguisher at hand and ready for use and **DO NOT** breathe fumes or vapors caused by the fire.

It is extremely important that you read, understand and know how this system works, refer to the manufacturer's literature.

9.6 Carbon Monoxide Hazards

DANGER

CARBON MONOXIDE HAZARD

Exposure to CO will cause death or serious injury. CO is colorless, odorless and extremely dangerous. Avoid CO exposure and make sure the CO detector is working properly.

Carbon monoxide (CO) poisoning is lethal and should not be confused with seasickness, intoxication or heat exhaustion. If someone complains of irritated eyes, headache, nausea, weakness or dizziness, or you suspect carbon monoxide poisoning, immediately move the person to fresh air, investigate the cause, and take corrective action. Seek medical attention if necessary.

All engines and fuel burning appliances produce CO as exhaust. Direct and prolonged exposure to CO will cause **BRAIN DAMAGE** or **DEATH**.

Other symptoms that may signal exposure to CO: dizziness, flushed face, ears ringing, headaches, tightness of chest or hyperventilation, drowsiness, fatigue or weakness, inattention or confusion, lack of normal coordination, nausea and unconsciousness. The victim's skin also may turn red. A slight buildup of CO in the human body over several hours causes headache, nausea and other symptoms similar to food poisoning, motion sickness or the flu. Anyone with these symptoms should immediately be moved to an area of fresh air. Have the victim breathe deeply and seek immediate medical attention. To learn more about CO poisoning, contact your local health authorities.

Carbon Monoxide Detector

If the carbon monoxide detector is activated, this indicates the presence of CO, which can be fatal. Evacuate the cabin immediately. Make sure all passengers are accounted for. DO NOT enter the cabin until you know it is safe and the problem found and corrected.

CO detectors warn occupants of dangerous accumulation of CO gas. It is automatically activated whenever the house battery switch panel feed breaker is "ON." When powered, the green indicator will flash for ten to fifteen minutes, indicating the unit is in its warm-up stage. The green power indicator will stop flashing when the sensor has reached optimum operating temperature. The indicator will then switch from flashing green to solid green, indicating the detector is activate.

Make sure the battery switch is on and the power light is lit whenever the cabin is occupied.

This device uses a micro controller to continuously measure and accumulate CO levels. Should a very high level of CO exist, the alarm will sound within a few minutes. If small quantities are present or high levels are short-lived, the detector will accumulate the information and determine when an alarm level has been reached.

While a CO detector enhances your protection from CO poisoning, it does not guaran-

tee it will not occur. Do not use CO detectors as a replacement for ordinary precautions or periodic inspections of equipment. Never rely on alarm systems to save lives; common sense is still the best form of protection. Remember, the boat operator carries the ultimate responsibility to make sure the boat is properly ventilated and passengers are not exposed to dangerous levels of CO. Be alert to the symptoms and early warning signs of carbon monoxide.

CO detectors are very reliable and rarely sound false alarms. If the alarm sounds, DO NOT think it is false. If anyone has been exposed to CO, move them into fresh air immediately. Never disable the CO detector because you think the alarm may be false.

Carbon Monoxide Poisoning

Carbon monoxide (CO) is a by-product of combustion, is invisible, tasteless, odorless and is produced by all engines and most heating and cooking appliances. It exists wherever fuels are burned to generate power or heat. The most common sources of CO on boats are combustion engines, auxiliary generators and propane or butane stoves.

These produce large amounts of CO and should never be operated while sleeping. High concentrations of CO can be fatal within minutes. Many cases of CO poisoning indicate that while victims are aware they are not well, they become so disoriented they are unable to save themselves by either exiting the area or calling for help. Also, young children, elderly persons and pets may be the first affected. Drug or alcohol use increases the effect of CO exposure. Individuals with cardiac or respiratory conditions are very susceptible to the dangers of CO. CO poisoning is especially dangerous during sleep while victims are unaware of any side effects.

Low levels of CO over an extended period of time can be just as lethal as high doses over a short period. Therefore, low levels of CO can cause the alarm to sound before persons notice any symptoms.

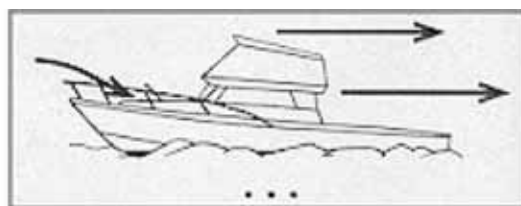

OPERATING SAFELY

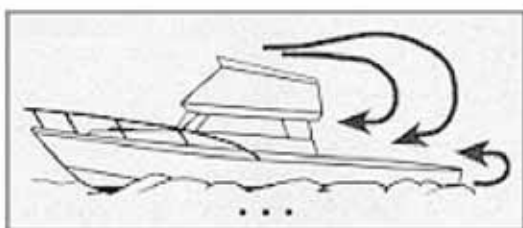

BACK DRAFTING / STATION WAGON EFFECT

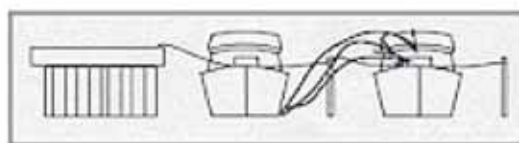

NEARBY BOAT GENERATOR EXHAUST

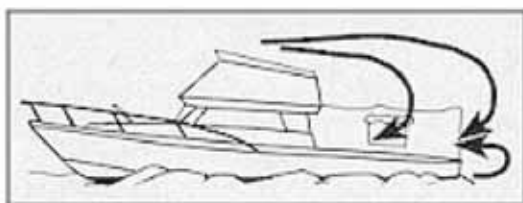

BACK DRAFTING / STATION WAGON EFFECT

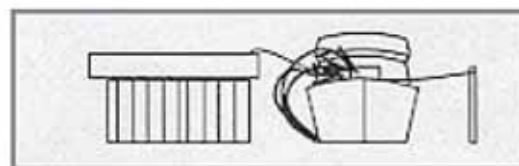

ONBOARD BOAT GENERATOR EXHAUST

Contact the detector manufacturer, the Pursuit Customer Relations Department or your local fire department for assistance in finding and correcting the situation.

In certain situations, boats can have a problem due to the "station wagon effect" where engine exhaust fumes are captured in the vessel by the vacuum or low pressure area, usually the cockpit, bridge deck and cabin, that can be created by the forward speed of the boat. Boats that are underway should close all aft facing portholes, hatches and doors. The forward facing deck hatches should be open whenever possible to help pressurize living spaces of the boat. Sleeping, particularly in aft cabins, should not be permitted while underway. Proper ventilation must be maintained on the bridge deck by opening a forward window or windshield to drive fumes away from the occupants. The canvas drop or aft curtain must be removed and side curtains should be opened or removed to increase airflow and maintain

proper ventilation whenever the engines are running.

DO NOT operate the engines with side curtains closed and the aft or drop curtain installed.

Use extreme caution while anchored or in a slip and an auxiliary power generator is operating. Calm wind nights can easily allow fumes to enter the boat. Inspect the exhaust systems of propulsion and the auxiliary generators, if equipped, frequently for possible leaks. High concentrations of CO in your boat can originate from an adjacent boat through open hatches or windows.

Failure to properly ventilate the boat while the engines are running can cause CO to accumulate within the cabin. Make sure to ventilate the boat and to avoid CO from accumulating in the boat whenever an engine is running.

Read the book entitled, "Sportfish, Cruisers, Yachts - Owner's Manual" and the owner's manual supplied by the CO detector manufacturer for additional information regarding the hazards and symptoms of CO gas, CO poisoning and operation instructions. If you did not receive these manuals, contact the Pursuit Customer Relations Department.

Many manufacturers of carbon monoxide detectors offer a testing and recertification program. We recommend that you contact the manufacturer of your CO detector and have it tested and recertified periodically. Certain electronic equipment have a limited life span, follow the CO detectors manufacturers recommendations on when the detector must be replaced.

9.7 First Aid

It is the boat operator's responsibility to be familiar with proper first-aid procedures and be able to care for minor injuries or illnesses of your passengers. In an emergency, you could be far from professional medical assistance, so be prepared. We recommend you be prepared by receiving training in basic first aid and CPR, through classes given by the Red Cross or your local hospital.



Equip your boat with at least a simple marine first-aid kit and a first-aid manual. The marine first-aid kit should be designed for the marine environment and be well supplied. Keep it accessible so each person onboard knows where it is located. As supplies are used, replace them. Some common drugs and antiseptics can lose their strength or become unstable as they age.

Ask a medical professional about the supplies you should carry and the safe shelf life of prescription drugs or other medical supplies you carry. Replace old supplies whether they have been used or not.

In many emergency situations, the Coast Guard can provide assistance in obtaining medical advice for treatment of serious injuries or illness. If you are within VHF range of a Coast Guard Station, make the initial contact on channel 16 and follow their instructions.

9.8 Required Safety Equipment

In addition to items installed by Pursuit, certain other equipment is required by the U.S. Coast Guard to help ensure passenger safety. Items like a sea anchor, working anchor, extra dock lines, flare pistol, life vests, a line permanently secured to your ring buoy, etc., could at some time save your passengers' lives, or save your boat from damage. Refer to the "Federal Requirements and Safety Tips for Recreational Boats" pamphlet for a more detailed description of the required equipment. You can also contact the U.S. Coast Guard Boating Safety Hotline, 800-368-5647, for information on boat safety courses and brochures listing the Federal equipment requirements. Also, check your local and state regulations.

The Coast Guard Auxiliary offers a "Courtesy Examination." This inspection will help ensure your boat is equipped with all of the necessary safety equipment.

The following is a list of the accessory equipment required on your boat by the U.S. Coast Guard:

Personal Flotation Devices (PFD's)

PFD's must be Coast Guard approved, in good and serviceable condition, and of appropriate size for the intended user. Wearable PFD's must be readily accessible, meaning you must be able to put them on in a reasonable amount of time in an emergency. Though not required, the Coast Guard emphasizes that PFD's should be

worn at all times when the vessel is underway. Throwable devices must be immediately available for use. All Pursuit boats must be equipped with at least one Type I, II or III PFD for each person onboard, plus one throwable device (Type IV).

Visual Distress Signals

All Pursuit boats used on coastal waters, the Great Lakes, territorial seas, and those waters connected directly to them, must be equipped with Coast Guard approved visual distress signals. These signals are either Pyrotechnic or Non-Pyrotechnic devices.

Pyrotechnic Visual Distress Signals

Pyrotechnic visual distress signals must be Coast Guard approved, in serviceable condition and readily accessible. They are marked with a date showing the service life, which must not have expired. A minimum of three are required. Some pyrotechnic signals meet both day and night use requirements. They should be stored in a cool, dry location. They include;

- pyrotechnic red flares, hand held or aerial.
- pyrotechnic orange smoke, hand-held or floating.
- launchers for aerial red meteors or parachute flares.

Pyrotechnics are universally recognized as excellent distress signals. However, there is potential for injury and property damage if not handled properly. These devices produce a very hot flame and the residue can cause burns and ignite flammable material. Pistol launched and hand-held parachute flares and meteors have many characteristics of a firearm and must be handled with caution. In some states they are considered a firearm and prohibited from use. Make sure you are careful and follow the manufacturer's instructions when using pyrotechnic distress signals.

WARNING

FIRE/EXPLOSION HAZARD
Pyrotechnic signaling devices can cause fire and/or explosion, death, serious injury and property damage if misused. Follow the manufacturer's directions in the use of these signaling devices.

Non-Pyrotechnic Devices

Non-Pyrotechnic visual distress signals must be in serviceable condition, readily accessible, and certified by the manufacturer as complying with U.S. Coast Guard requirements. They include:

Orange Distress Flag, day use only.

The distress flag is a day signal only. It must be at least 3 x 3 feet with a black square and ball on an orange background. It is most distinctive when attached and waved from a paddle or boat hook.

Electric Distress Light, night use only.

The electric distress light is accepted for night use only and must automatically flash the international SOS distress signal. Under Inland Navigation Rules, a high intensity white light flashing at regular intervals from 50-70 times per minute is considered a distress signal.

Sound Signaling Devices

The navigation rules require sound signals to be made under certain circumstances. Recreational vessels are also required to sound fog signals during periods of reduced visibility. Therefore, you must have some means of making an efficient sound signal.

Navigation Lights

Recreational boats are required to display navigation lights between sunset and sunrise and other periods of reduced visibility (fog, rain, haze, etc.) Navigation lights are intended to keep other vessels informed of

your presence and course. Your Pursuit boat is equipped with the navigation lights required by the U.S. Coast Guard at the time of manufacture. It is up to you to make sure they are visible, operational and turned on when required.

Fire Extinguishers

Pursuit Boats provides locations for two fire extinguishers on boats under 26 feet. Boats over 26 feet have provisions for up to three fire extinguishers. Boats equipped with cabins have one fire extinguisher located in the cabin, cockpit and helm areas. Center console boats have fire extinguishers mounted in the vicinity of the helm and passenger cockpit. Coast Guard approved fire extinguishers are hand-portable, either B-I or B-II classification and have a specific marine type mounting bracket. It is recommended the extinguishers be mounted in a readily accessible position.

Fire extinguishers require regular inspections to ensure:

- seals and tamper indicators are not broken or missing.
- pressure gauges or indicators read in the operable range.
- no obvious physical damage, corrosion, leakage or clogged nozzles.

For information on the type and size fire extinguisher required for your boat, refer to the "Federal Requirements and Safety Tips for Recreational Boats" pamphlet or contact the U.S. Coast Guard Boating Safety Hotline, 1-800-368-5647.

For instructions on the proper maintenance and use of your fire extinguisher, refer to the information provided by the fire extinguisher manufacturer.

Information for halon or agent FE-241 extinguishers is provided by the manufacturer. It is extremely important that you read, understand and know how this system works; refer to the manufacturer's literature.

Bilge And Fuel Fires

Fuel compartment and bilge fires or explosions are dangerous because of the presence of fuel. You must make the decision to fight the fire or abandon the boat. If the fire cannot be extinguished quickly or it is too intense to fight, abandoning the boat may be your only option. You must consider your safety, the safety of your passengers, the intensity of the fire and the possibility of an explosion in your decision.

If you find yourself in this situation, make sure all passengers have a life preserver on and go over the side and swim well upwind of the boat, to keep clear of any burning fuel that could be released and spread on the water as the boat burns or in the event of an explosion. When clear of the danger, check and account for all passengers who were onboard. Give whatever assistance you can to anyone in need or in the water without a buoyant device. Keep everyone together for morale and to aid rescue operations.

WARNING

BURN HAZARD

Fuel floating on water which is ignited can cause death or serious injury. Fuel will float on top of water and can burn. If the boat is abandoned, swim upwind, far enough to avoid fuel that can spread over the surface of the water.

9.9 Additional Safety Equipment

Besides meeting the legal requirements, prudent boaters carry additional safety equipment. This is particularly important if you operate your boat offshore. You should consider the following items, depending on how you use your boat.

Satellite EPIRB 'S

EPIRB's (Emergency Position Indicating Radio Beacon) operate as part of a world wide distress system. When activated, EPIRB's will send distress code homing beacons that allow Coast Guard aircraft to identify and find them quickly. The satellites that receive and relay EPIRB signals are operated by the National Oceanic and Atmospheric Administration (NOAA) in the United States. The EPIRB should be mounted and registered according to the instructions provided with the beacon, so the beacon's unique distress code can be used to quickly identify the boat and owner.

Additional Equipment to Consider:

- VHF Radio
- Life Raft
- Spare Anchor
- Spare Keys
- Heaving Line
- Fenders
- First Aid Kit
- Portable Radio
- Flashlight and Batteries
- Mirror
- Searchlight
- Sunburn Lotion
- Tool Kit
- Ring Buoy
- Whistle or Horn
- Anchor
- Chart and Compass
- Boat Hook
- Spare Propellers
- Mooring Lines
- Food and Water
- Binoculars
- Sunglasses
- Marine Hardware
- Extra Clothing
- Spare Parts

Operation

10.1 General

Before you start, become familiar with the various component systems and their operation, and perform a "Pre-Cruise System Check." A thorough understanding of the component systems and their operation is essential to operate the boat safely. This manual and the associated manufacturers' information have been provided to enhance your knowledge of your boat. Read them carefully, and also, read the book titled "Sportfish, Cruisers, Yachts - Owner's Manual."

Your boat must have the necessary safety equipment onboard and be in compliance with the U.S. Coast Guard, local and state safety regulations. There should be one Personal Floatation Device (PFD) for each person. Non-swimmers and small children should wear PFD's at all times. You should know and understand the "Rules of the Road" and have had an experienced operator brief you on the general operation of your new boat. At least one other person should be instructed on the proper operation of the boat in case the operator is suddenly incapacitated.

The operator is responsible for his safety and the safety of his passengers. When boarding or loading the boat, always step onto the boat, never jump.

 **WARNING**

DROWNING OR LOSS OF CONTROL HAZARD

Ejection or sudden loss of control can cause death or serious injury from improper use of seating. DO NOT stand while driving above engine idle speeds and make sure cockpit seat is locked/secured and all passengers are seated when boat is underway.

DO NOT allow passengers to sit on the seat backs, gunwales, bows, transoms or on fishing seats whenever the boat is underway.

Passengers should be seated to properly balance the load and must not obstruct the operator's view, particularly to the front.

Overloading and improper distribution of weight can cause the boat to become unstable and are significant causes of accidents. Know the weight capacity and horsepower rating of your boat. Do not overload or overpower your boat.

 **WARNING**

OVERLOAD HAZARD

Overloading the boat beyond maximum load or altering the stability, buoyancy or center-of-gravity can result in death or serious injury. DO NOT exceed the maximum load or alter the center-of-gravity of the boat.

Remember, it is the operator's responsibility to use good common sense and sound judgment in loading and operating the boat.

 **WARNING**

SLIPPERY SURFACE HAZARD

Wet surfaces can generate slippery conditions which can result in death or serious injury. Use caution on wet surfaces.

10.2 Homeland Security Restrictions

- Recreational boaters have a role in keeping our waterways safe and secure. Violators of the restrictions below can expect a quick and severe response:
- Do not approach within 100 yards, and slow to minimum speed within 500 yards of any U.S. Naval vessel. If you need to pass within 100 yards of a U.S. Naval vessel, for safe passage you must contact the U.S. Naval vessel or the Coast Guard escort vessel on VHF-FM channel 16.
- Observe and avoid all security zones. Avoid commercial port areas, especially those that involve military, cruise-line or

petroleum facilities. Observe and avoid other restricted areas near dams, power plants, etc.

- Do not stop or anchor beneath bridges or in channels.

America's Waterway Watch

America's Waterway Watch, a combined effort of the Coast Guard and its Reserve and Auxiliary, wants your help in keeping America's waterways safe and secure. America's Waterway Watch urges you to adopt a heightened sense of sensitivity toward unusual events or individuals you may encounter in or around ports, docks, marinas, riversides, beaches or waterfront communities. To report suspicious activities, call the National Response Center at 1-877-24WATCH or 1-800-424-8802. If there is immediate danger to life or property call 911 or call the Coast Guard on Marine channel 16.

10.3 Rules of the Road

As in driving an automobile, there are a few rules you must know for safe boating operation. The following information describes the basic navigation rules and action to be taken by vessels in a crossing, meeting or overtaking situation while operating in inland waters. These are basic examples and not intended to teach all the rules of navigation. For further information consult the "Navigation Rules" or contact the Coast Guard, Coast Guard Auxiliary, Department of Natural Resources, or your local boat club. These organizations sponsor courses in boat handling, including sponsor rules of the road. We strongly recommend such courses. Books on this subject are also available from your local library.

When two motor boats are crossing, the boat on the right has the right of way and should maintain its course and speed. The other vessel should slow down and permit it to pass. Both boats should sound appropriate signals.



CAUTION

Avoid collisions by following navigation rules. If a collision appears unavoidable, both vessels must act. Prudence takes precedence over right-of-way rules if a crash is imminent. Less maneuverable boats generally have the right of way. Steer clear of the right-of-way boat and pass to its stern.

When two motor boats are crossing, the boat on the right has the right of way and should maintain its course and speed. The other vessel should slow down and permit it to pass. Both boats should sound appropriate signals.

Crossing situations

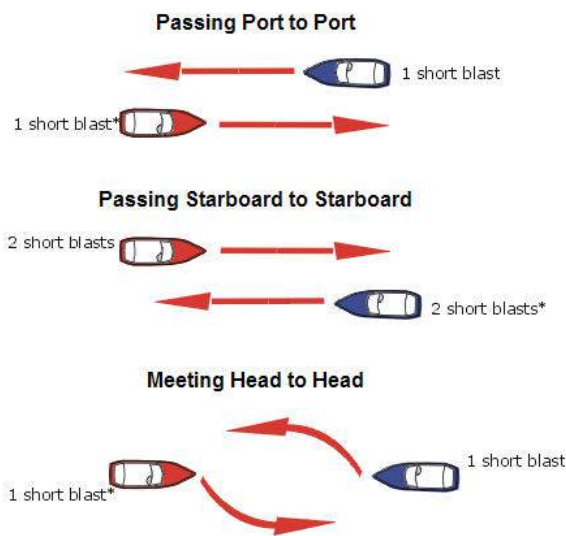

* Response not sounded on International Waters

Meeting Head-On Or Nearly-So Situations

When two motorboats are approaching each other head-on or nearly head-on, neither boat has the right of way. Both boats should reduce their speed and turn to the right, passing port side to port side and provide enough clearance for safe passage. Both boats should sound appropriate signals.

Overtaking Situations

When one motorboat is overtaking another motorboat, the boat being passed has the right of way. The overtaking boat must make adjustments necessary to provide clearance for a safe passage of the other vessel and should sound appropriate signals.

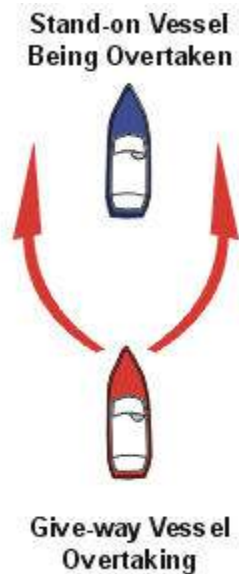

The General Prudential Rule

In obeying the Rules of the Road, due regard must be given to all dangers of navigation and collision and to any special circumstances, including the limitations of the vessels, which may justify a departure from the rules that is necessary to avoid immediate danger or a collision.

Navigation Aids

Aids to navigation are placed along coasts and navigable waters as guides to mark safe water and to assist mariners in determining their position in relation to land and hidden dangers. Each aid to navigation is used to provide specific information. Become familiar with these and any other markers used in your boating area.

Port Side Lateral System As seen entering from seaward (Green Light Only Odd Numbered Aids)		Starboard Lateral System As seen entering from seaward (Red Light Only Even Numbered Aids)	
	Green Light Chart Symbol "1" Fl G 6s		Red Light Chart Symbol "2" Fl R 6s
	Green Lighted Buoy Chart Symbol G "9" Fl G 4s		Red Lighted Buoy Chart Symbol R "8" Fl R 4s
	Can Chart Symbol G C "7"		Nun Chart Symbol R N "6"
	Daymark Chart Symbol G "1"		Daymark Chart Symbol R "2"

CAUTION

Storms and waves can move buoys, do not rely on buoys alone to determine your position.

10.4 Pre-Cruise Check

Before Starting The Engines:

- Check the weather forecast. Decide if your planned cruise can be made safely.
- Make sure all required documents are onboard.
- Make sure all necessary safety equipment is onboard and operative; items like running lights, spotlight, life saving devices, etc. Refer to Safety Equipment for additional information.

Each person onboard must have at least one personal flotation device onboard and one throwable device. Check the U.S. Coast Guard standards for the correct type required for your boat.

- Make sure signal kits are onboard and are in good operating condition and are not expired.
- Make sure you have sufficient water and other provisions for the planned cruise.
- Leave a written message listing details of your planned cruise (Float Plan) with a close friend ashore. Include a description of your boat, where you intend to cruise, schedule of your arrival in the cruising area and when you expect to return. Keep the person informed of any changes in your plan to prevent false alarms. This information can tell authorities where to look and your boat type in the event you fail to arrive.
- Check the amount of fuel onboard. Observe the “rule of thirds”: one third of the fuel for the trip out, one third to return and one third in reserve. An additional 15% may be consumed in rough seas.
- Check the water separating fuel filters for water.
- Turn on the battery switches.
- Check for bilge water and for other signs of potential problems. Monitor for the scent of fuel fumes.
- Test the automatic and manual bilge pump switches to make sure the system is working properly.
- Have a tool kit and spare parts onboard.

The kit should include basic tools:

- Spark Plug Wrench
- Hammer
- Spark Plug Gap Gauge
- Electrician’s Tape
- Screwdrivers
- Lubricating Oil
- Pliers
- Jackknife
- Adjustable Wrench
- Vise Grip Pliers
- Needle Nose Pliers
- Wire Crimping Tool
- End Wrench Set
- Wire Connector Set

The spare parts kit should include:

- Extra Light Bulbs
 - Spark Plugs
 - Fuses and Circuit Breakers
 - Flashlight and Batteries
 - Drain Plugs
 - Engine Oil
 - Propellers
 - Fuel Filters
 - Propeller Nuts
 - Fuel Hose and Clamps
- Make sure all fire extinguishers are in position and in good operating condition.
 - Make sure the shift control is in NEUTRAL.
 - Make sure the emergency engine stop lanyard is attached to the operator and the stop switch.

10.5 Operating your Boat

The operator must be seated, and ready with the controls (steering/throttle) when the engine is started or running.

After Starting the Engines:

- Check engine gauges. Make sure all are reading normally.
- Visibly check engines to be sure there are no apparent water, fuel or oil leaks.
- Check operation of engine cooling systems.
- Check controls and steering for smooth and proper operation.
- Allow engines to warm up for 10 to 15 minutes before operating them above idle speeds.
- Make sure all lines, cables, anchors, etc. for securing the boat are onboard and in good condition. All lines should be coiled, secured and off the decks when underway.
- Have a safe cruise and enjoy yourself.

REMEMBER:

When operating a boat, you accept the responsibility for the boat, safety of passengers and others out enjoying the water.

- Alcohol and any mind altering chemicals can severely reduce your reaction time and affect your better judgment.
- Alcohol reduces the ability to react.
- Alcohol makes it difficult to judge speed and distance or track moving objects.
- Alcohol reduces night vision and ability to distinguish red from green.

STAY ALERT. The use of alcohol or any other mind altering chemicals that impair judgment, pose a serious threat to you and others. The boat operator is responsible for their consequences and behavior of passengers.

⚠ WARNING

IMPAIRED OPERATION HAZARD
Operating any boat while intoxicated or under the influence of other drugs can cause death or serious injury. DO NOT operate any boat under the influence of any mind-altering chemical.

Avoid sea conditions that are beyond the skill and experience of you and your crew.

Make sure at least one other person onboard is instructed in the operation of the boat and it is operated in compliance with all state and local laws.

DO NOT operate the boat unless it is completely assembled. Make sure all fasteners are tight and adjustments are to specifications.

Before operating the boat for the first time, read the engine break-in procedures. Refer to the engine owner's manual. Since different types of engines are used, have your dealer describe the operating procedures for your boat. For more instructions on "How to Operate the Boat," read the instructions given to you for your engines.

For more instructions on safety, equipment and boat handling, enroll in one of the several free boating courses offered. For information on the courses offered in your area, call the "Boating Safety Hotline," 800-368-5647.

If the drive unit hits an underwater object, stop the engine. Inspect drive unit for damage. If damaged contact your dealer for a complete inspection and repair of the unit.

Stopping the Boat

- Allow engines to drop to the idle speed.
- Shift controls to NEUTRAL.

If the engines have been run at high speed for a long period of time, allow engines to cool by running at idle for 3 to 5 minutes.

- Turn the ignition keys "OFF."
- Raise the trim tabs to full "UP" position.

⚠ CAUTION

Turn off engines at idle speed. Racing the engine before switching it off can draw water into the engine through the exhaust, resulting in internal damage.

After operation:

- If operated in saltwater, wash the boat and all equipment with soap and water. Flush the engines using fresh water. Refer to the engine owner's manual for instructions on flushing.
- Check the bilge area for debris and excess water.
- Fill the fuel tanks to near full to reduce condensation. Allow room in the tanks for the fuel to expand without being forced out the vent.
- Turn off all electrical equipment except the automatic bilge pumps.
- If you are going to leave the boat unattended for a long period of time, put the battery main switches to "OFF" and close all seacocks.
- Make sure the boat is securely moored.

 **CAUTION**

To prevent damage, close all sea-cocks before leaving the boat.

10.6 Fishing

Fishing can be very exciting and distracting for the operator of the boat when the action gets intense. Be conscious that your primary responsibility is operating the boat safely to protect yourself, your passengers and other boats around you. Make sure the helm is properly manned and is never left unattended while trolling.

If you are fishing in an area that is crowded with other fishing boats, it may be difficult to follow the rules of the road. This situation can become especially difficult when most boats are trolling. Be courteous and exercise good common sense. Avoid trying to assert your right of way and stay clear to preventing tangled or cut lines and other unpleasant encounters. Also, keep in mind that fishing line wrapped around a propeller shaft can cause damage to the lower unit seal.

10.7 Tower Operation (Dealer Installation)

Operation of the Tower Controls

Start engines at the lower helm. Monitor gauges to make sure all systems are normal and engines are warmed up before proceeding to the tower helm. The ignition or restart switches on the tower are only used to restart an engine in the event it should stall. The shift controls must be in neutral for the restart switches to be functional.

Safety precautions for tower operation:

- Do not operate boat from tower in rough sea conditions. Motions of the boat are exaggerated in the tower and may become excessive in rough seas.
- Be careful when using the trim tabs from the tower. The reaction of the trim tabs will be exaggerated in the tower. Use small tab corrections and wait ten (10) seconds for the tabs to react. Keep making small corrections until the hull is at the desired attitude.
- Do not overload the tower. Most towers are designed for two average-sized people and weight in the tower affects the center of gravity and motion of the boat is greatly exaggerated for the people in a tower, too much weight can make the boat unstable.
- Do not operate the boat in tight quarters, such as marinas, from the tower. The operator is isolated from the boat while in the tower and will not be able to assist in docking procedures.
- Avoid using the tower in wet or rough weather, your grip and footing on the tower ladders is reduced.
- Operating the boat from the tower in unfamiliar waters or where running aground, can eject the operator or passengers.
- Be alert for waves and boat wakes; the motion of the boat is exaggerated in the tower.
- Exercise good common sense and judgment when operating a boat from the tower.
- If the engine alarm sounds, put the boat in NEUTRAL and shut "OFF" the engine immediately until the problem is found.
- Always put the boat in NEUTRAL before moving to and from the tower helm and cockpit.

Use common sense, judgment and exercise caution when operating the boat with someone in the tower. DO NOT allow anyone in the tower when the water is rough or when operating in unfamiliar waters where running aground is a possibility. Remember, weight in the tower affects center of gravity and motion of the boat is greatly exaggerated for people in the tower.

10.8 Docking, Anchoring and Mooring

Docking and Docklines

Maneuvering a boat near a dock and securing it requires skill and techniques that are unique to water and wind conditions, and the dock layout. If possible, position a crew member at the bow and stern to assist with the lines and docking. While maneuvering close to the dock, compensate for wind and current, and anticipate how you can use them to help docking. Practice in open water using an imaginary dock to develop a sense for how the boat handles in different scenarios. You must be able to understand docking techniques before problems occur.

Approaching a dock or backing into a slip in high winds or strong currents requires skill. If you are new to handling a boat, take lessons from an experienced pilot and learn to maneuver in tight quarters in less than ideal conditions. Also, practice away from the dock during windy conditions.

Dock lines are generally twisted or braided nylon. Nylon is strong and stretches to absorb shock. Nylon also has a long life and is soft and easy on the hands. The size of the line, will vary with the size of the boat. Typically a 30 to 40 foot boat will use 5/8-inch line and a 20 to 30 foot boat will use 1/2-inch line. The number of lines and their configuration will vary depending on the dock, the range of the tide, and other factors. Usually a combination of bow, stern and spring lines is used to secure the boat.

Maneuvering to the Dock

Approach the dock slowly at a 30 to 40 degree angle. When possible, approach against the wind or current. Turn the engines straight and shift to neutral when you feel you have enough momentum to reach the dock. Use reverse to slow the boat and pull the stern toward the dock as the boat approaches. If you approached properly, the boat will lightly touch the pilings at the same time forward momentum is stopped. Have the dock lines ready and secure the boat as

soon at it stops. Use fenders to protect the boat while it is docked. Keep the engines running until the lines are secured.

Backing into a Slip

Approach the slip with the stern against the wind or current and the engines straight ahead. Use the engines and turn the steering wheel to maneuver the boat into alignment with the slip. Reverse the engines and slowly back into the slip. Shift from reverse to neutral frequently at idle to prevent the boat from gaining too much speed. Move the stern right and left by shifting the engines in and out of gear or turning the wheel. When nearly in the slip all the way, straighten the engines and shift to forward to stop. Keep the engines running until the lines are secured.

Securing Docklines

Securing a boat along side the dock typically requires a bow and stern line and two spring lines. The bow and stern lines are usually secured to the dock at a 40 degree angle aft of the stern cleat and forward of the bow cleat. The after bow spring line is secured to the dock at a 40 degree angle aft of the after bow spring cleat. The forward quarter spring is secured to the dock at a 40 degree angle forward of the stern cleat. The spring lines keep the boat square to the dock and reduce fore and aft movement while allowing the boat to move up and down with the tide.

Securing a boat in a slip is somewhat different. It typically requires two bow lines secured to pilings on each side of the bow, two stern lines secured to the dock and two spring lines that prevent the boat from hitting the dock. The bow lines are typically secured with enough slack to allow the boat to ride the tide. The stern lines are crossed. One line runs from the port aft boat cleat to the starboard dock cleat and the other line runs from the starboard aft boat cleat to the port cleat on the dock. The stern lines center the boat, control the forward motion and allow the boat to ride the tide. Two forward quarter spring lines typically are secured to the stern cleats and to mid ship pilings or

cleats. The spring lines keep the boat from backing into the dock while allowing it to ride the tide.

Leaving the Dock

Start the engines and let them warm up for 10 to 15 minutes before releasing the lines. Boats steer from the stern and it is important you achieve enough clearance at the stern to maneuver the boat as quickly as possible. Push the stern off and maneuver to gain stern clearance quickly. Proceed slowly until the boat has cleared the dock and other boats.

Mooring

Approach the mooring buoy heading into the wind or current. Shift to neutral when you have just enough headway to reach the buoy. Position a crew member on the bow to retrieve the buoy with a boat hook and secure the line. Keep the engines running, until the line is secure.

Leaving a Mooring

Start the engines and let them warm up before releasing the mooring line. The boat will already be headed into the wind, so move it forward enough to loosen the line and untie it. Back the boat away until you can see the buoy and slowly move away.

Anchoring

Make sure the bitter end of the anchor rode is attached to the boat before dropping the anchor. Bring the bow into the wind or current and put the engine in neutral. When the boat comes to a stop, lower the anchor over the bow. Allow enough rode so that it is at least 5 to 7 times the depth of the water and secure the line to a cleat. Use caution to avoid getting your feet or hands tangled in the line. Additional scope of 10 times the depth may be required for storm conditions. Check landmarks on shore to make sure the anchor is not dragging. If it is dragging, start over. It is prudent to use two anchors if you are anchoring overnight or in rough weather.

WARNING

SINKING OR DROWNING HAZARD
Anchoring at the stern can pull a boat under water. **DO NOT** anchor at the stern.

Releasing the Anchor

Release the anchor by traversing to the point where the anchor line becomes vertical. It should release when you pass that point. If the anchor does not release, stop the boat directly above the anchor and tie the line to a cleat as tight as possible. The up and down movement of the boat will usually loosen the anchor. Make sure the anchor is secured and stowed before getting underway.

10.9 Controls, Steering or Propulsion System Failure

WARNING

MOVING PARTS HAZARD
Contact with moving parts can entangle, cut and cause death or serious injury. **DO NOT** come close enough to make contact with any running machinery moving parts, i.e., engine or propeller. Contact can result in loss of body parts, strangulation, burns and/or severe loss of blood resulting in serious injury or death.

The engine covers are machinery guards and must be in place whenever the engines are running. **DO NOT** operate the boat without the covers in place unless you are performing a check or maintenance.

If the propulsion, control or steering system fails while you are operating the boat, bring both throttles to idle and shift to neutral. Determine if the boat should be anchored to prevent the boat from drifting or to hold the bow into the seas. Investigate and correct the problem if possible. Make sure the engines are off before investigating the prob-

lem. If you are unable to correct the problem, call for help.

If only one engine has failed, you can operate on one engine. Do not to apply too much power to the running engine. When running one engine to power a twin engine boat, the engine is "over propped" and can be overloaded if too much throttle is applied. Contact your dealer or the engine manufacturer for the maximum power settings when running on one engine.

10.10 Collision

If your boat is involved in a collision with another boat, dock, piling or a sandbar, your first priority is to check passengers for injuries and administer first aid if necessary. Once all passengers' situations are stabilized, thoroughly inspect the boat for damage. Check below decks for leaks and all control systems for proper operation. Plug all leaks or make the necessary repairs to the control systems before proceeding. Operate slowly and carefully, but take all necessary precautions to be safe. Request assistance if necessary. Haul the boat and make a thorough inspection of the hull, lower unit and control system for damage.

10.11 Grounding, Towing and Rendering Assistance

The law requires the owner or operator of a vessel to render assistance to any individual or vessel in distress, as long as his vessel is not endangered in the process.

If the boat should become disabled, or if another craft that is disabled requires assistance, be careful. The stress applied to a boat during towing can become excessive. Excessive stress can damage the structure and create a safety hazard for all onboard.

Freeing a grounded vessel, or towing a disabled boat requires specialized equipment and knowledge. Line failure and structural damage caused by improper towing have resulted in fatal injuries. To safely accomplish the towing task, we recommend this to be reserved for those with the right equip-

ment and knowledge, e.g., the U.S. Coast Guard or a commercial towing company.

The mooring cleats or bow/stern eyes on Pursuit boats are not designed or intended to be used for towing or lifting. These cleats are designed as mooring cleats for securing the boat to a dock, pier, etc. only. DO NOT use these fittings for towing, lifting or attempting to free a grounded vessel.

When towing operations are underway, have everyone on both vessels stay clear of the tow line and surrounding area. DO NOT allow anyone to be in line with the tow rope; a dangerous, recoil can occur if the rope should break or pull free.

Running aground can cause serious injury to passengers and damage the boat and its underwater gear.

If your boat runs aground, evaluate the damage, then proceed at low speed to the nearest service facility and have an immediate inspection made before further use. A damaged boat can also take on water; keep all life saving devices close while heading to a dock area. If the boat cannot be immediately removed from the water, thoroughly inspect the bilge area for leaks.

10.12 Flooding or Capsizing

Boats can become unstable if they become flooded or completely swamped. Always be aware of the position of the boat to the seas and the amount of water in the bilge. Water entering the boat over the transom can usually be corrected by turning the boat into the waves. If the bilge is flooding because of a hole in the hull, the engine bracket or a defective hose, you may be able to plug it with rags, close the thru-hull valve or assist the pumps by bailing with buckets. Put a mayday call into the Coast Guard or nearby boats and distribute life jackets as soon as you discover your boat is in trouble.

If the boat becomes swamped and capsizes, you and your passengers should stay with the boat as long as you can. It is much easier for the Coast Guard, aircraft, or other boats to spot, than people in the water.

10.13 Transporting your Boat

Your Pursuit boat is a large boat and should only be trailered by professionals with the right equipment and knowledge to transport large boats without causing damage. Contact your dealer or the Pursuit Customer Relations Department if you are planning to transport your boat and have any questions in regard to the proper equipment and support for the hull.

Damaged from trailers can occur if the boat hull is not supported properly. Make sure the trailer bunks and pads are adjusted so they provide enough support for the hull and are not putting excessive pressure on the lifting strakes. Hull damage resulting from improper trailer support is not covered by the Pursuit warranty.

10.14 Trailering your Boat

The boat trailer is an important part of your boating package. The trailer must be matched to the weight of the boat. A trailer with a capacity too low will be unsafe on the road and cause abnormal wear. A trailer with a capacity too high, can damage the boat. Contact your dealer to evaluate your towing vehicle and hitch, and to make sure you have the correct trailer for your boat.

IMPORTANT

Your Pursuit is heavy and the selection of your trailer is very important. We recommend using a bunk style trailer that incorporates a combination of heavy duty rollers to support the keel and long bunks running under and parallel to the stringers to support the hull. Trailers without bunks can cause damage and have a tendency to put extreme pressure points on the hull, especially on the lifting strakes. The situation worsens when launching or retrieving. Damage resulting from improper trailer support or the use a full roller trailer will not be covered by the Pursuit Warranty.

If you trailer your boat, make sure your tow vehicle is capable of towing the weight of the trailer, boat and equipment and the weight of the passengers and equipment inside the vehicle. This may require the tow vehicle to be specially equipped with a larger engine, transmission, brakes and trailer tow package.

The following safety tips and a book titled "Sportfish, Cruisers, Yachts - Owner's Manual," included in your literature packet, provide additional information you should know before trailering your boat.

DO NOT use bow or stern eyes, cleats or any other hardware for the purpose of towing, being towed or lifting, they are not designed for that purpose.

Contact your dealer to evaluate your towing vehicle and hitch, and to make sure you have the correct trailer for your boat.

- Make sure the trailer is a match for the weight and hull design of the boat. More damage can occur by the stresses of road travel than by normal water operation. A boat hull is designed to be supported evenly by water. So, when it is transported on a trailer it should be supported as evenly across the hull as possible allowing for even distribution of the weight of the hull, engine and equipment.
- Make sure the trailer bunks and rollers properly support the hull and do not put pressure on the lifting strakes. The rollers and bunks must be kept in good condition to prevent scratching and gouging of the hull.
- The capacity rating of the trailer should be greater, but not to an extreme, than the combined weight of the boat, motor, and equipment. The gross vehicle weight rating must be shown on the trailer. Make sure the weight of the boat, engine, gear and trailer is not more than the gross vehicle weight rating.
- DO NOT use your boat and trailer as a means for hauling excess gear.
- Make sure the boat is securely fastened on the trailer to prevent movement between the boat and trailer. The bow

rope, chain or turnbuckle in addition to the winch cable. Additional straps may be required across the beam of the boat. If these types of straps are used, protect your boat from chaffing or from the straps "slapping" the gelcoat. Cover area where straps are secured and twisting the straps before they are secured will help reduce the "slapping" affect. Your dealer can provide instructions on how to load, fasten and launch your boat.

Before Going out on the Highway

- **Canvas Enclosures** - must be removed when trailering. Canvas enclosures will be damaged, they are not designed to withstand the extreme wind pressure encountered while trailering. Remove and properly store enclosures before trailering.
- **Tow Ball And Trailer Coupler** - make sure they are the same size and bolts and nuts are tightly secured.

The coupler **MUST BE** completely over the ball and the latching mechanism **LOCKED DOWN**.

- **Load Trailer Evenly** - make sure load is evenly distributed from front to rear, as well as side to side and has the correct distribution of weight on the hitch. Too much weight on the hitch will cause the rear of the tow vehicle to drag and may make steering more difficult. Too little weight on the hitch will cause the rig to fishtail and will make controlling the tow vehicle difficult. Contact your Pursuit dealer or the trailer manufacturer for the correct weight on the hitch for your trailer.
- **Safety Chains** - attach crisscrossing under the coupler to the frame of the tow vehicle. If the ball breaks, the trailer would follow in a straight line and prevent the coupler from dragging on the road. Make sure the trailer emergency brake cable or chain is also installed to the tow vehicle frame.
- **Lights** - make sure they are functioning properly.
- **Brakes** – check on a level parking area; roll forward and apply the brakes several

times at increasing speeds to determine if the brakes on the tow vehicle and trailer are working properly.

- **Side View Mirrors** - make sure the tow vehicle mirrors are large enough to provide an unobstructed rear view on both sides of the vehicle.
- **Tires and Wheel Bearings** – check before getting on the road.

Make sure your tow vehicle and trailer are in compliance with all state and local laws for the area you will be trailering. Contact your state motor vehicle bureau for laws governing the towing of trailers.

10.15 Water Skiing

Your Pursuit can be equipped for water skiing. If you have never pulled skiers, you should observe, learn and practice from an experienced driver. If you are an experienced driver, become familiar with the boat and the way it handles before pulling a skier. The driver should also know the ability of the skiers and drive accordingly. The following safety precautions should be observed while towing water skiers.

- Water ski only in safe areas, away from other boats and swimmers, out of channels and in water free of underwater obstructions and water ski only during daylight hours.
- Make sure that anyone who skis can swim. **DO NOT** allow people who cannot swim to water ski.
- Make sure all skiers wear a proper life jacket. A water skier is considered onboard the boat and a Coast Guard approved life jacket is required. A skier should wear a flotation device designed to withstand the impact of hitting the water at high speed. A second person must be onboard to observe the skier so your attention can be directed to the safe operation of the boat.
- Approach a skier in the water from the downwind side and **STOP THE ENGINE** and forward motion of the boat before coming in close proximity to the skier.
- Give immediate attention to a fallen skier. A fallen skier is very hard to see by other boats and is extremely vulnerable.

When a skier falls, be prepared to turn the boat immediately and return to the skier. Never leave a fallen skier alone in the water for any reason.

For additional information on water skiing, including hand signals and water skiing manuals, contact the American Water Skiing Association - 863-324-4341 or visit their Web Site at www.usawaterski.org.

DANGER

CARBON MONOXIDE POISONING AND/OR ROTATING PARTS HAZARD
Poisonous CO gases are present at the rear of the boat when an engine is running. A rotating propeller can cut or entangle swimmers, both of these hazards will cause death or serious injury. DO NOT use the swim/boarding platform when the engine is running.

Remove and store the ladder properly before starting the engines.

10.16 Man Overboard

If someone falls overboard, be prepared to react quickly, especially when you are off-shore. The following procedures will help you in recovering a person that has fallen overboard.

- Immediately stop the boat and sound a man overboard alarm and have all passengers point to the person in the water.
- Circle around quickly and throw a throwable PFD, cushion or life jacket to the person and if possible, another to use as a marker.
- Keep the person on the driver side of the boat to keep them in sight.
- Approach the person from the downwind side and maneuver the boat so the propellers are well clear of the person in the water.
- Turn off the engines when person is alongside and use a ring buoy or a boat cushion with a line attached, a paddle or boathook to assist person to the boat;

make sure you do not hit them with the ring buoy or the boat.

- Pull person to the boat and assist onboard.
- Check person for injuries and administer first aid if necessary, if the injuries are serious, call for help immediately.

Refer to Safety Equipment for more information on first aid and requesting emergency medical assistance.

10.17 Trash Disposal

The discharge of plastic trash or trash mixed with plastic is illegal anywhere in the marine environment. It is also illegal to discharge garbage in the navigable waters of the United States including the great lakes.

Regional, State, and local restrictions on garbage discharges also may apply. Vessels of 26 feet or longer must display in a prominent location, a durable placard at least 4 by 9 inches notifying the crew and passengers of the discharge restrictions.

Responsible boaters store refuse in bags and disposed of it properly on shore. Make sure your passengers are aware of the local waste laws and the trash management procedure on your boat.

Routine Maintenance

11.1 General

WARNING

FIRE/EXPLOSION/ASPHYXIATION HAZARD

Cleaning agents and paint ingredients can be flammable and/or explosive, or dangerous to inhale. Make sure ventilation is adequate, wear proper personal protection and dispose of rags properly ashore.

Vapors from flammable solvents can cause fire, explosion or asphyxiation resulting in death or serious injury. Keep open flame or spark away from work area. **DO NOT** paint unless in a well-ventilated area.

Before using a cleaning product, refer to the product directions and specifications.

If urethane foam is used in the construction of your boat, be careful with high temperatures or flames in these areas. Urethane foam can ignite. **DO NOT** smoke, weld or burn. Avoid the use of space heaters and lights in areas where urethane foam is present. If ignited, urethane foam burns rapidly, produces extreme heat, releases hazardous gases and consumes much oxygen.

11.2 Exterior Hull and Deck

Hull Cleaning - Below the Waterline

When the boat is removed from the water, clean the outer bottom surface immediately. Algae, grass, dirt and other marine growth can be removed easier while the hull is still wet. Use a pressure cleaner or a hard bristle brush to clean the surface.

Bottom Painting

If the boat is to be left in saltwater for extended periods, protect it from marine growth by applying an antifouling paint. Because of variations in water temperature,

marine growth and pollution in different regions, your dealer and/or a qualified boat yard in your area should be consulted when deciding what bottom paint system to apply to your hull, because pollution and marine growth can damage fiberglass hulls.

Sanding or sandblasting the hull bottom will damage the fiberglass. Only use standard antifouling paints and fiberglass wax removers and primers recommended by the antifouling paint manufacturer when preparing the hull for bottom paint. Sanding or sandblasting and the use of a coating other than standard antifouling paint or epoxy barrier coatings are not recommended and will void the hull blister warranty.

DO NOT allow antifouling paint to contact the outboard engine. Most antifouling paints contain copper which will cause severe galvanic damage to the motor. Leave a 1/2" (12.7 mm) barrier between the hull bottom paint and outboard engine.

Most bottom paints require maintenance, especially when the boat is in saltwater or not used for extended periods, or after dry storage. If the hull bottom has been painted with antifouling paint, contact your dealer for the recommended maintenance procedures.

Sacrificial Anodes

Sacrificial zinc anodes are installed on the trim tabs, transom and outboard engines. The transom anode is connected to the bonding system and protects the underwater hardware that is bonded.

The anodes are less noble than copper based alloys and aluminum and will deteriorate first, protecting the more noble underwater hardware against galvanic corrosion. Anodes should be checked monthly and changed when they are 75% of their original size. When replacing the anodes, make sure the contact surfaces are clean, shiny metal and free of paint and corrosion. Never paint over the anode or protect it.

Boats stored in saltwater will require anodes to be replaced at least every 6 months to one year. Anodes requiring replacement

more frequently may indicate a stray current problem within the boat or at the slip or marina. Anodes that do not need to be replaced after one year may not be providing the proper protection. Loose or low quality anodes could be the problem. Contact your dealer for the proper size and type of anodes to be used and the specific installation procedure.

Fiberglass Gelcoat Surfaces

Normal maintenance requires only washing with mild soap and water. A stiff brush can be used on the nonskid areas. Kerosene or commercially prepared products will remove oil and tar which could be a problem on trailered boats. DO NOT use harsh abrasive and chemical cleaners because they can damage or dull the gelcoat, reducing its life and making it more susceptible to stains. When the boat is used in saltwater, wash it thoroughly with soap and water after each use.

Sudden changes in temperature can affect gelcoat. When planning on moving your boat from outdoors to a heated location, allow the change of temperature to be gradual. Warm the location slowly after the boat is brought inside to allow the boat to change temperature slowly as the location is warmed. Or, if you are moving your boat from a warmer area to a colder one, wait for the temperature to be closer to the temperature of the warmer area or allow the warmer area and the boat to cool down.

At least once a season, wash and wax all exposed fiberglass surfaces. Use a high quality automotive or boat wax. Follow the procedure recommended by the wax manufacturer. Washing and waxing of your boat will have the same beneficial effects as they have on an automobile finish. The wax will fill minute scratches and pores which help prevent soiling and will extend the life of the gelcoat.

After the boat is exposed to the direct sunlight for a period of time, the color in the gelcoat tends to fade, dull or chalk from oxidation of the gel. This condition will be more apparent with dark colors, which

require more frequent maintenance. A heavier buffing is required to bring the gelcoat back to its original luster. For power cleaning use a light cleaner. To clean the boat by hand, use a heavier automotive cleaner. Before cleaning the surfaces, read the instructions given with the cleaner. After cleaning the surfaces, apply wax and polish all fiberglass surfaces except the nonskid areas.

If the fiberglass should become damaged and need repair, contact your dealer for an authorized repair person to make the repairs.

WARNING

SLIPPERY SURFACE HAZARD
Cleaning surfaces can generate slippery conditions which can result in death or serious injury. Use caution when cleaning with detergents. Rinse thoroughly.

Be careful when walking on wet gelcoat surfaces.

DO NOT wax nonskid surfaces, these could make them slippery and increase the possibility of injury.

Stainless Steel Hardware

When using the boat in saltwater, wash hardware with soap and water after each use. When your boat is used in a higher corrosive environment, such as saltwater, water with a higher sulfur content or polluted water, stainless steel will periodically develop surface rust stains; this is normal under these conditions.

Clean and protect by using a high quality boat or automotive wax or a commercial metal cleaner and protectant.

DO NOT use citrus-based, abrasive materials such as sandpaper, bronze wool, or steel wool on stainless steel as damage will result.

Anodized Aluminum Surfaces

Wash periodically with soap and water to keep it clean. If the boat is used in saltwater or polluted water, wash with soap and water after each use. Saltwater allowed to remain on anodized aluminum will penetrate the anodized coating and attack the aluminum.

Hardtops with aluminum frames, bimini tops and towers with canvas and/or fiberglass tops require special attention to the anodized aluminum just below the top. This area is subject to salt build-up from salty condensation and sea spray. It is often overlooked when the boat is washed and will not be rinsed by the rain. The aluminum just below the top is more likely to become pitted than the exposed aluminum on the structure. Make sure these areas are washed frequently with soap and water and rinsed thoroughly. Pay particular attention to places where the top material and lacing contact the frame. Coat the entire frame with a metal protector made for anodized aluminum once a month to protect against pitting and corrosion caused by the harsh effects of saltwater. The anodized aluminum used on your Pursuit was coated with a metal protector called Aluma Guard at the factory. Aluma Guard is a nonabrasive marine metal protector that protects anodized aluminum, stainless steel, brass and chrome. It also protects color anodizing from fading and discoloring due to harmful ultraviolet rays. Aluma Guard is available from your dealer or Rupp Marine Inc., 4761 Anchor Avenue, P.O. Drawer F, Port Salerno, FL 34992.

Aluma Guard and other metal protectors can make the metal slippery and should not be used on tower ladders, steering wheels and other areas for gripping or stepping.

Stains can be removed with a metal polish or fine polishing compound. To minimize corrosion, use a caulking compound to bed hardware and fasteners mounted to aluminum fabrications. If the anodized coating is badly scratched it can be touched up with paint. With proper care, anodized aluminum will provide many years of service.

Contact Pursuit Customer Relations before making any modifications to aluminum fabrications. Unauthorized modifications can void the warranty.

Powder Coated (Painted) Aluminum Surfaces

Regular care is necessary to maintain the appearance of the powder coat finish. Build-up of salt and grime can hold moisture and damage powder coatings. This buildup can cause a corrosive condition that can damage the coating, especially in a salt air or coastal environment.

- Wash the finish regularly with warm water containing a pH neutral detergent (i.e. mild dish soap).
- Use a non-abrasive fiber cloth.
- Rinse thoroughly after cleaning.

Chrome Hardware

Rinse with fresh water and wipe dry with towel or chamois after each use. Use a good chrome cleaner and polish on all chrome hardware. Clean and wax chrome prior to extended storage. In saltwater or other harsh environments, clean and wax more often.

Acrylic Plastic

Acrylic plastic scratches easily. DO NOT use a dry cloth or glass cleaning solutions on acrylic. Use a soft cloth and mild soap and water for routine cleaning. Solvents and products containing ammonia can permanently damage acrylic plastic.

Fine scratches can be removed with a fine automotive clear coat polishing compound. A coat of automotive or boat wax is beneficial to protect the surface.

DO NOT use the following on acrylic plastic:

- Abrasive cleaners
- Acetone
- Solvents
- Alcohol
- Glass cleaners
- Cleaners containing ammonia

Engines

Proper engine maintenance is essential to performance and reliability of your outboard engines. Maintenance schedules and procedures are outlined in your engine owner's manual, follow them exactly.

Flush the system when the boat is out of the water. If the boat is used in saltwater, flush daily.

The age of gasoline can affect engine performance. Chemical changes occur as the gasoline ages, causing deposits and varnish in the fuel system and reduces the octane rating of the fuel. Degraded fuel can damage the engine and boat fuel tank and lines. If your boat does not require at least one full tank of fresh fuel a month, add a fuel stabilizer to the gasoline to protect the fuel from degradation. Use only a fuel stabilizer recommended by your dealer or the engine manufacturer. Operate the boat at least 15 minutes after adding the stabilizer to allow the treated fuel to reach the engine. Your dealer or engine manufacturer can provide additional information on fuel degradation. For more recommendations for your specific area, check with your local Pursuit dealer.

Avoid using fuels with alcohol additives. Gasoline, extended with an alcohol blend, will absorb moisture from the air which can reach such concentrations that "phase separation" can occur where the water and alcohol mixture becomes heavy enough to settle out of the gasoline to the bottom of the tank. Since the fuel pick-up tube is near the bottom of the tank, phase separation can cause the engine to run poorly or not at all. This condition is more severe with methyl alcohol and will worsen as the alcohol content increases. Water or a jelly like substance in the fuel filters is an indication of possible

phase separation from the use of alcohol blended fuels.

Contact your Pursuit dealer or engine manufacturer for additional information regarding fuels and additives.

Corian® Surfaces

Corian® is resistant to heat, but you should always use a hot pad or a trivet with rubber feet to protect Corian®. Avoid exposing Corian® to strong chemicals, such as paint removers, oven cleaners, etc. If contact occurs, flush the surface with water immediately. Soapy water or ammonia-based cleaners will remove most dirt and stains from all types of finishes.

DO NOT use the Corian® countertop as a cutting board.

Minor damage, scratches, general or chemical stains, scorching or burns and minor impact marks can be repaired on-site with a light abrasive cleanser and a product such as a Scotch-Brite® pad. For heavier damage, light sanding may be necessary. Heavy damage should be repaired by a Corian® licensed professional.

Tempered Glass Sink

For best results:

- DO NOT use strong/abrasive cleaner. Test your cleaning solution on an unnoticeable area first, before applying to the entire surface.
- Wipe surfaces clean, immediately after applying cleaner.
- DO NOT allow cleaner to sit or soak on the surface.
- DO NOT use an abrasive brush or scouring pad to clean surfaces as damage will occur. Use only a soft, dampened sponge and cloth.
- Rinse and wipe the fixtures to prevent soap build-up.

11.3 Seats, Upholstery, Canvas and Enclosures

Seat Slides and Swivel Bases

Perform the following periodically:

- Inspect and tighten mounting screws between seat slides and seat bottom.
- Inspect and tighten the mounting screws attaching seat bases to boat.
- Keep a light film of grease on manual seat slides.
- Keep a light film of grease on manual seat adjusting mechanism.
- Clean electric seat slides. DO NOT use harsh chemicals or abrasives. Lubrication is not required.

Vinyl Upholstery

The vinyl upholstery used on the exterior seats and bolsters and headliner in the cabin should be cleaned with soap and water periodically. Stains, spills or soiling should be cleaned up immediately to prevent the possibility of permanent staining. When cleaning, rub gently. DO NOT use products containing ammonia, powdered abrasive cleaners, steel wool, strong solvents, acetone and lacquer solvents or other harsh chemicals as they can permanently damage or shorten the life of vinyl. Never use steam heat, heat guns or hair dryers.

Stronger cleaners, detergents and solvents may be effective in stain removal, but can cause either immediate damage or slow deterioration. Lotions, sun tan oil, waxes and polishes, etc., contain oils and dyes that can cause stiffening and staining of vinyls.

- Dry soil, dust and dirt - remove with a soft cloth.
- Dried on dirt - wash with a soft cloth dampened with water.
- Variations in surface gloss - wipe with a water-dampened soft cloth and allow to air dry.
- Stubborn dirt - wash with a soft cloth, dampened with Ivory Flakes® and water. Rinse with clean water.

- Stubborn spots and stains - spray with either Fantastik Cleaner® or Tannery Car Care Cleaner® and rub with a soft cloth. Rinse with clean water.
- Liquid spills - wipe with a clean absorbent cloth immediately. Rinse with clean water.
- Food grease and oily stains - spray with either Fantastik Cleaner® or Tannery Car Care Cleaner®, wiping with a soft cloth immediately. Be careful not to extend the area of contamination beyond its original boundary. Rinse with clean water.

Canvas and Side Curtains

Acrylic canvas should be cleaned periodically by using a mild soap and water. Scrub lightly and rinse thoroughly to remove the soap. Do not use detergents. The top or accessories should never be folded or stored wet.

After several years, the acrylic canvas may lose some of its ability to shed water. If this occurs, wash the fabric and treat it with a commercially available water proofing designed for this purpose. Some leakage at the seams is normal and unavoidable with acrylic enclosures.

Side curtains and clear connectors can be cleaned with mild soap and water. Do not allow them to become badly soiled. Dirt, oil, mildew, and cleaning agents containing ammonia will shorten the life of the vinyl that is used for clear curtains. After cleaning the curtains and allowing them to dry, apply a non-lemon furniture polish or an acrylic plastic and clear plastic protector to extend the life of the curtains.

Vinyl curtains should be stored either rolled or flat, without folds or creases. Folding the curtains will make permanent creases that could cause the vinyl to crack.

DO NOT use any polish containing lemon or lemon scents; lemon juice attacks vinyl and shorten its life.

Lubricate snaps periodically with petroleum jelly or silicone grease. Lubricate zippers with silicone spray or paraffin.

Remove the bimini top, side curtains, clear connector, back drop and aft curtain when trailering. Canvas enclosures are not designed to withstand the extreme wind pressure encountered while trailering and will be damaged. Always remove and store properly before trailering.

11.4 Cabin Interior

Clean cabin interior just like you would clean a home interior.

- Teak woodwork - use teak oil.
- Carpeting - use a vacuum cleaner.
- Vinyl headliner - clean as previously explained.

Air and sunlight are very good cleansers. Periodically, place cushions, sleeping bags, etc. on deck, under the sun and fresh air to dry and air out. If cushions or equipment get wet with saltwater, remove and use clean, fresh water to rinse off the salt crystals. Salt retains moisture and will cause damage. Dry thoroughly and reinstall.

If you leave the boat for a long period of time, put all cushions on their sides, open all interior cabin and locker doors, and hang a commercially available mildew protector in the cabin.

Read the label carefully on mildew protectors and remove the protector and allow the cabin to ventilate completely before using the cabin.

11.5 Bilge

To keep the bilge clean and fresh, use a commercial bilge cleaner regularly. Follow the directions carefully. All exposed pumps and metal components should be sprayed with a protector periodically to reduce the corrosive effects of the high humidity present in these areas.

WARNING

FIRE/EXPLOSION OR ASPHYXIATION HAZARD!

Fumes from flammable solvents can cause fire, explosion or asphyxiation resulting in death or serious injury. DO NOT use flammable solvents to clean the bilge.

11.6 Generator (Optional)

The engine maintenance required on the generator is similar to an inboard engine. The engine incorporates a pressure-type lubrication system and a fresh water cooled engine block which is thermostatically controlled. The most important factors to the longevity of the generator is proper ventilation and maintenance of the fuel system, ignition system, cooling system, lubrication system and the AC alternator.

Maintenance schedules and procedures are outlined in the generator owner's manual; follow them exactly.

Seasonal Maintenance

12.1 Storage and Lay-up

Before Hauling:

- Pump out the head. Flush the holding tank using clean soap, water, deodorizer and pump out cleaning solution.
- Leave the fuel tank nearly full to reduce condensation that can accumulate in the tank. Allow enough room for fuel to expand without leaking from the vents. Algae can grow in the accumulated water in diesel fuel tanks, especially in warm climates. Adding a high quality diesel fuel additive containing an algaecide may be required to control algae during storage in your area.
- Drain fresh water system.
- Refer to the engine owner's manual for detailed information on preparing the engines for storage.

Lifting

It is essential that care be used when lifting your boat. Make sure the spreader bar at each sling is at least as long as the distance across the widest point of the boat that the sling will surround. Put the slings in position. Refer to the drawing in the Schematics for the correct position of the lifting slings. The positions are marked with small labels on each side of the boat under the rubrails. Tie fore and aft slings together to prevent slings from sliding on the hull.

Elevating lifts are commonly used to store boats for extended periods. To provide proper support, the bunks that support the hull should be aligned with and run parallel to the hull stringers. The bow and stern eyes, if equipped should not be used as sole support for storage.

Your boat can be damaged from improper lifting and rough handling when being transported by lift trucks. Care and proper handling procedures must be used when using a lift truck to move your boat. DO NOT attempt to lift boat with a substantial amount of water in the bilge.

Severe gelcoat cracking or more serious hull damage can occur during hauling and launching if pressure is created on the gunwales (sheer) by the slings. Use flat, wide slings and spreaders long enough to keep pressure from the gunwales. DO NOT allow your boat to be hauled when the spreaders on the lift are not wide enough to take the pressure off the gunwales.

Supporting The Boat for Storage

A trailer, elevating lift or a well-made cradle is the best support for your boat during storage.

When storing the boat on a trailer for a long period:

- Make sure the rollers and pads support the hull of the boat and the trailer is on a level surface with the bow high enough so water will drain from the bilge and cockpit. The trailer must properly support the hull. The bunks and rollers should match the bottom of the hull and should not be putting pressure on the lifting strakes.
- Make sure the hitch is properly supported.
- Check the tires once each season. Add enough air for the correct amount of inflation for the tires.
- Make sure the engines are in the down position.

When storing the boat on a lift or cradle:

- The cradle must be specific for boat storage. Make sure lift or cradle is well supported with the bow high enough to provide proper drainage of the bilge. The cradle or lift must be in the proper fore and aft position to properly support the hull. When the cradle or lift is in the correct location, the bunks should match the bottom of hull and should not be putting pressure on the lifting strakes.
- Make sure the engines are in the down position.
- Make sure bunks and rollers are adjusted so they are not putting pressure on lifting strakes and are providing enough support for the hull. Hull damage

resulting from improper cradle or trailer support is not covered by the Pursuit warranty.

Preparing The Boat For Storage:

- Remove the bilge drain plug(s), if installed.
- Thoroughly wash fiberglass exterior, especially the antifouling portion of the bottom. Remove as much marine growth as possible. Lightly wax the exterior fiberglass components.
- Remove all oxidation from the exterior hardware and apply a light film of moisture displacing lubricant.
- Remove propellers and grease the propeller shafts using light waterproof grease.
- Remove batteries and clean using clear, clean water. Make sure batteries have sufficient water and terminals are clean. Keep the batteries charged and stored in a cool, dry place and safe from freezing throughout the storage period.
- Refer to the Electrical System for information on the maintenance of the AC and DC electrical systems.
- Coat all faucets and exposed electrical components in the cabin and cockpit with a protecting oil.
- Clean, drain and completely dry the fish-boxes, sinks and livewells.
- Thoroughly clean the interior of the boat; vacuum all carpets and dry clean drapes and upholstery.
- Remove cushions, open the refrigerator/cooler door and as many locker doors as possible. Leaving as many of these areas open as possible will improve fresh air ventilation during the storage period.
- Place a mildew preventive system in the cabin area before it is closed for storage.
- Clean the exterior upholstery with a good vinyl cleaner and dry thoroughly. Spray the weather covers and boat upholstery with a spray disinfectant. Enclosed areas such as the refrigerator, shower basin, storage locker areas, etc. should also be sprayed with a disinfectant.

12.2 Winterizing

Fresh Water System

The entire fresh water system must be completely drained. Disconnect all hoses, check valves, etc. and blow all the water from the system. Make sure the water heater and fresh water tank are completely drained. Use very low air pressure only when blowing water from the system to prevent damage to components. The check valve mechanism built in the fresh water pump will not remove the water from the pump. Remove the outlet hose on the pump, turn it on and allow it to pump out any remaining water, approximately a cupful.

An alternate method is to use commercially available nontoxic, fresh water system antifreeze. After draining the potable water tank, lines and water heater, pour the antifreeze mixture into the fresh water tank, prime and operate the pump until the mixture flows from all fresh water faucets. Be sure to open ALL faucets, including the fresh water spray head in the stern bait station sink and the water supply valve for the head. Make sure antifreeze has flowed through all of the fresh water drains. Allow the antifreeze to fill the sink traps to trap odors from the waste tank.

The shower/cabin drain sump system must be winterized also. Clean debris from the drain and sump and flush for several minutes with fresh clean water. After the system is clean, pump the drain sump as dry as possible. Then pour a potable water antifreeze mixture into the shower drain until antifreeze has been pumped through the entire system and out of the thru-hull.

For additional information, refer to Plumbing Systems.

Raw Water System

Drain the raw water systems completely. Disconnect all hoses and blow the water from the system. Use very low air pressure only when blowing water from the system to prevent damage to components. The check valve mechanism built in the raw water

washdown pump, will not remove the water from the pump. Remove the outlet hose on the pump, turn it on and allow it to pump out any remaining water, approximately a cupful.

An alternate method is to use commercially available nontoxic, potable water system antifreeze. If antifreeze is used, pour the mixture into a pail and put the raw water intake lines into the solution. Run the pumps one at a time until the antifreeze solution is visible at all raw water faucets, discharge fittings and drains. Make sure antifreeze has flowed through all of the raw water drains.

Run the stern fishbox macerator pump until all the water is removed from the fishbox and the pump. To avoid damage to the pump, DO NOT run pump dry for more than ten seconds.

Generator Raw Water Systems

Drain sea strainer, heat exchangers and raw water supply and discharge lines for the optional generator raw water supply pumps. Make sure all sea water has drained from the exhaust system. Some generator engine mufflers have a drain plug that must be removed to properly drain the muffler. Once this is accomplished, pour a nontoxic marine engine antifreeze mixture into a large pail and put the generator raw water intake lines into the solution. Run the generator until the antifreeze solution is visible at the exhaust port, then shut the engine off.

Winterize the generator engine and fuel system by following the generator manufacturer's winterizing procedures. Refer to generator's owner's manuals or contact a Pursuit dealer.

Marine Toilet

Winterize the marine toilet following the manufacturer's winterizing procedures; follow the procedures exactly. Refer to the toilet owner's manual. Drain the intake and discharge hoses completely using low air pressure if necessary. The head holding tank and macerator discharge pump must be pumped dry and one gallon of potable water antifreeze poured into the tank

through the deck waste pumpout fitting. After the antifreeze has been added to the holding tank, open the overboard discharge valve and activate the macerator pump until the antifreeze solution is visible at the discharge thru-hull.

Air Conditioner

Disconnect and drain the air conditioner intake and discharge hoses. Remove all water from the sea strainer and thru-hull fitting. Allow all water to drain from the system. An alternate method is the use of commercially available nontoxic, potable water system antifreeze. If antifreeze is used, drain the sea strainer and pour the mixture into a pail and put the raw water intake line into the solution. Run the air conditioner until the antifreeze solution is visible at the discharge fitting on the hull side.

Air conditioner components must be winterized also; follow winterizing procedure in the air conditioner owner's manual.

The air conditioning, engine control system, head, and steering systems have specific lay-up requirements. Refer to the owner's manuals for recommended winterizing procedures.

Bilge

Coat all metal components, wire busses, connector plugs (in the bilge), all strainers, seacocks and steering components with a protecting oil. The bilge pumps and bilge pump lines must be completely free of water and dried out when the boat is laid up for the winter in climates where freezing occurs. Compartments in the bilge that will not drain completely should be pumped out and then sponged until completely free of water. Dry the hull bilge and self-bailing cockpit troughs. Water freezing in these areas could cause damage.

Hardtop

Makes sure all drain holes in the legs are open and legs are completely free of water. Remove the canvas and thoroughly clean

and store in a safe, dry place. Remove all electronics. Coat all wire connectors and bus bars in the helm compartment with a protecting oil.

Clean the aluminum frame with soap and water and dry thoroughly. Apply an aluminum metal protector to the entire frame to reduce corrosion and pitting.

NOTICE

Make sure the leg drain holes are clear when the boat is laid up for the winter. Water trapped inside the hardtop, tower or radar arch legs can freeze and cause the legs to split.

Tower (if installed)

Make sure all holes in the tower and hardtop legs are open and completely free of water. Check and clear tower basket drains of debris. Remove the tower sun shade, if installed, the belly band or other upholstery, thoroughly clean and store in a safe, dry place. Remove all electronics. Coat all wire connectors and bus bars in the helm compartment with a protecting oil. Cover the tower basket with a tarp and secure it properly.

Clean the aluminum frame with soap and water and dry thoroughly. Apply an aluminum metal protector to the entire frame to reduce corrosion and pitting.

Covering for Winter Storage

Proper storage is very important to prevent serious damage to the boat. If the boat is stored outside, support and secure a storage cover properly over the boat. It is best to have a frame built over the boat to support the canvas. It should be a few inches wider than the boat so the canvas will clear the rails and allow passage of air. If this cover is fastened too tightly there will be inadequate ventilation and can lead to mildew, moisture accumulation, etc. Fasten the canvas down securely so wind cannot remove it or cause chafing of the hull superstructure. DO NOT

store the boat in a damp storage enclosure. Excessive dampness can cause electrical problems, corrosion, and excessive mildew.

DO NOT use the bimini top or convertible top canvas in place of the winter storage cover. The life of these tops can be shortened if exposed to harsh weather elements for long periods.

DO NOT use an electric or fuel burning heating unit in the bilge area.

If the boat is to be stored indoors, make sure the building has enough ventilation and there is enough ventilation both inside the boat and around the boat. If the boat is to be stored indoors or outdoors, open all drawers, clothes lockers, cabinets, and doors a little. If possible, remove the upholstery, mattresses, clothing, and rugs.

12.3 Recommissioning

DO NOT operate the boat unless it is completely assembled. Keep all fasteners tight. Keep adjustments according to specifications.

Before launching the boat, make sure to install hull drain plug(s).

Reactivating The Boat After Storage

- Charge and install the batteries.
- Install hull drain plug(s).
- Check the engines and generator for damage and follow the manufacturer's instructions for recommissioning.
- Check the mounting bolts of engines to make sure they are tight.
- Perform all routine maintenance.
- Check all hose clamps for tightness.
- Pump antifreeze from any systems winterized with antifreeze and flush several times with fresh water. Make sure all antifreeze is flushed from the water heater and it is filled with fresh water before it is activated.
- Check and lubricate the steering system.
- Clean and wash the boat.
- Install all upholstery, cushions and canvas.

After Launching:

- Check all water systems and the engine mounting bolts for leaks. Operate each system one at a time and check for leaks and proper operation.
- Check the bilge pump, manual and automatic switches.
- When the engines start, check the cooling system port below the engine cowling for a strong stream of water to ensure cooling pump is operating.
- Carefully monitor the gauges and check for leakage and abnormal noises.
- Operate boat at slow speeds until engine temperature stabilizes and all systems are operating normally.

Glossary of Terms

Aft: In, near, or toward the stern of a boat.

Aground: A boat stuck on the bottom.

Amidships: In or toward the part of a boat midway between the bow and stern.

Anchor: A specially shaped heavy metal device designed to dig efficiently into the bottom under a body of water and hold a boat in place.

Anchorage: An area specifically designated by governmental authorities in which boats may anchor.

Ashore: On shore.

Astern: Behind the boat, to move backwards.

Athwartship: At right angles to the center line of the boat.

Barnacles: Small, hard-shelled marine animals which are found in salt water attached to pilings, docks and bottoms of boats.

Beam: The breadth of a boat usually measured at its widest part.

Bearing: The direction of an object from the boat, either relative to the boat's direction or to compass degrees.

Berth: A bunk or a bed on a boat.

Bilge: The bottom of the boat below the flooring.

Bilge Pump: A pump that removes water that collects in the bilge.

Boarding: Entering or climbing into a boat.

Boarding Ladder: Set of steps temporarily fitted over the side of a boat to assist persons coming aboard.

Boat Hook: Short shaft of wood or metal with a hook fitting at one end shaped to aid in extending one's reach from the side of the boat.

Bow: The front end of a boat's hull.

Bow Line: A line that leads forward from the bow of the boat.

Bow Rail: Knee high rails of solid tubing to aid in preventing people from falling overboard.

Bridge: The area from which a boat is steered and controlled.

Bridge Deck: A deck forward and usually above the cockpit deck.

Broach: When the boat is sideways to the seas and in danger of capsizing; a very dangerous situation that should be avoided.

Bulkhead: Vertical partition or wall separating compartments of a boat.

Cabin: Enclosed superstructure above the main deck level.

Capsize: When a boat lays on its side or turns over.

Chock: A deck fitting, usually of metal, with inward curving arms through which mooring or anchor lines are passed so as to lead them in the proper direction both onboard and off the boat.

Cleat: A deck fitting, usually of metal with projecting arms used for securing anchor and mooring lines.

Closed Cooling System: A separate supply of fresh water that is used to cool the engine and circulates only within the engine.

Coaming: A vertical piece around the edges of cockpit, hatches, etc. to stop water on deck from running below.

Cockpit: An open space, usually in the aft deck, outside of the cabin.

Companionway: Opening in the deck of a boat to provide access below.

Compartment: The interior of a boat divided off by bulkheads.

Cradle: A framework designed to support a boat as she is hauled out or stored.

Cutlass Bearing: A rubber bearing in the strut that supports the propeller shaft.

Deck: The floor-like platform of a boat that covers the hull.

Displacement: The volume of water displaced by the hull. The displacement weight is the weight of this volume of water.

Draft: The depth of water a boat needs to float.

Dry Rot: A fungus attack on wood areas.

Dry-dock: A dock that can be pumped dry during boat construction or repair.

Electrical Ground: A connection between an electrical connector and the earth.

Engine Beds: Sturdy structural members running fore and aft on which the inboard engines are mounted.

EPIRB: Emergency Position Indicating Radio Beacon. Operates as a part of a worldwide satellite distress system.

Even Keel: When a boat floats properly as designed.

Fathom: A measure of depth. One Fathom = 6 feet.

Fender: A soft object of rubber or plastic used to protect the topsides from scarring and rubbing against a dock or another vessel.

Fend off: To push or hold the boat off from the dock or another boat.

Flying Bridge: A control station above the level of the deck or cabin.

Flukes: The broad portions of an anchor which dig into the ground.

Following Sea: A sea that comes up from the stern and runs in the same direction that the boat is going.

Fore: Applies to the forward portions of a boat near the bow.

Foundering: When a boat fills with water and sinks.

Freeboard: The height from the waterline to the lowest part of the deck.

Galley: The kitchen of a boat.

Grab Rail: Hand-hold fittings mounted on cabin tops or sides for personal safety when moving around the boat, both on deck and below.

Ground Tackle: A general term including anchors, lines, and other gear used in anchoring.

Grounds: A boat touches the bottom.

Gunwale: The upper edge of a boat's side.

Hand Rail: Rail mounted on the boat, for grabbing with your hand, to steady you while walking about the boat.

Harbor: An anchorage which provides reasonably good protection for a boat, with shelter from wind and sea.

Hatch: An opening in the deck with a door or lid to allow for access down into a compartment of a boat.

Head: A toilet on a boat.

Heat Exchanger: Used to transfer the heat that is picked up by the closed cooling system to the raw cooling water.

Helm: The steering and control area of a boat.

Hull: The part of the boat from the deck down.

Inboard: A boat with the engine mounted within the hull of the boat. Also refers to the center of the boat away from the sides.

Inboard/outboard: Also stern drive or I/O. A boat with an inboard engine attached to an outboard drive unit.

Keel: A plate or timber plate running lengthwise along the center of the bottom of a boat.

Knot: Unit of speed indicating nautical miles per hour. 1 knot = 1 nautical mile per hour (1.15 miles per hour). A nautical mile is equal to one minute of latitude: 6076 feet. Knots times 1.15 equals miles per hour. Miles per hour times .87 equals knots.

Lay-up: To decommission a boat for the winter (usually in northern climates).

Leeward: The direction toward which the wind is blowing.

Length On The Waterline (l.w.l.): A length measurement of a boat at the waterline from the stern to where the hull breaks the water near the bow.

Limber Hole: A passage cut into the lower edges of floors and frames next to the keel to allow bilge water to flow to the lowest point of the hull where it can be pumped overboard.

Line: The term used to describe a rope when it is on a boat.

Lists: A boat that inclines to port or starboard while afloat.

L.O.A.: Boat length overall.

Locker: A closet, chest or box aboard a boat.

Loran: An electronic navigational instrument which monitors the boat's position using signals emitted from pairs of transmitting stations.

Lunch hook: A small light weight anchor typically used instead of the working anchor. Normally used in calm waters with the boat attended.

Midships: The center of the boat.

Marina: A protected facility primarily for recreational small craft.

Marine Ways or Railways: Inclined planes at the water's edge onto which boats are hauled.

Moored: A boat secured with cables, lines or anchors.

Mooring: An anchor permanently embedded in the bottom of a harbor that is used to secure a boat.

Nautical Mile: A unit of measure equal to one minute of latitude. (6076 feet)

Nun Buoy: A red or red-striped buoy of conical shape.

Outboard: A boat designed for an engine to be mounted on the transom. Also a term that refers to objects away from the center line or beyond the hull sides of a boat.

Pad Eye: A deck fitting consisting of a metal eye permanently secured to the boat.

Pier: A structure which projects out from the shoreline.

Pile or Piling: A long column driven into the bottom to which a boat can be tied.

Pitching: The fore and aft rocking motion of a boat as the bow rises and falls.

Pitch: The measure of the angle of a propeller blade. Refers to the theoretical distance the boat travels with each revolution of the propeller.

P.F.D: Personal Flotation Device.

Port: The left side of the boat when facing the bow.

Porthole (port): The opening in the side of a boat to allow the admittance of light and air.

Propeller: A device having two or more blades that is attached to the engine and used for propelling a boat.

Propeller Shaft: Shaft which runs from the back of the engine gear box, aft, through the stuffing box, shaft log, struts, and onto which the propeller is attached.

Pyrotechnic Distress Signals: Distress signals that resemble the brilliant display of flares or fireworks.

Raw Water Cooled: Refers to an engine cooling system that draws sea water in through a hull fitting or engine drive unit, circulates the water in the engine, and then discharges it overboard.

Reduction Gear: Often combined with the reverse gear so that the propeller turns at a slower rate than the engine.

Reverse Gear: Changes the direction of rotation of the propeller to provide thrust in the opposite direction for stopping the boat or giving it sternway.

Roll: A boat's sideways rotational motion in rough water.

Rope Locker: A locker, usually located in the bow of a boat, used for stowing the anchor line or chain.

Rubrail: Railing (often rubber or hard plastic) that runs along the boat's sheer to protect the hull when coming alongside docks, piers, or other boats.

Rudder: A moveable flat surface that is attached vertically at or near the stern for steering.

Sea anchor: An anchor that does not touch the bottom. Provides drag to hold the bow in the most favorable position in heavy seas.

Scupper: An opening in the hull side or transom of the boat through which water on deck or in the cockpit is drained overboard.

Seacock: Safety valves installed just inside the thru-hull fittings and ahead of the piping or hose running from the fittings.

Shaft Log: Pipe through which the propeller shaft passes.

Sheer: The uppermost edge of the hull.

Sling: A strap which will hold the boat securely while being lifted, lowered, or carried.

Slip: A boat's berth between two pilings or piers.

Sole: The deck of a cockpit or interior cabin.

Spring Line: A line that leads from the bow aft or from the stern forward to prevent the boat from moving ahead or astern.

Starboard: The right side of a boat when facing the bow.

Steerageway: Sufficient speed to keep the boat responding to the rudder or drive unit.

Stem: The vertical portion of the hull at the bow.

Stern: The rear end of a boat.

Stow: To pack away neatly.

Stringer: Longitudinal members fastened inside the hull for additional structural strength.

Strut: Mounted to the hull which supports the propeller shaft in place.

Strut Bearing: See “cutlass bearing.”

Stuffing Box: Prevents water from entering at the point where the propeller shaft passes through the shaft log.

Superstructure: Something built above the main deck level.

Swamps: When a boat fills with water from over the side.

Swimming Ladder: Much the same as the boarding ladder except that it extends down into the water.

Taffrail: Rail around the rear of the cockpit.

Thru-hull: A fitting used to pass fluids (usually water) through the hull surface, either above or below the waterline.

Topsides: The side skin of a boat between the waterline or chine and deck.

Transom: A flat stern at right angles to the keel.

Travel Lift: A machine used at boat yards to hoist boats out of and back into the water.

Trim: Refers to the boat's angle or the way it is balanced.

Trough: The area of water between the crests of waves and parallel to them.

Twin-Screw Craft: A boat with two propellers on two separate shafts.

Underway: When a boat moves through the water.

Wake: Disrupted water that a boat leaves astern as a result of its motion.

Wash: The flow of water that results from the action of the propeller or propellers.

Waterline: The plane of a boat where the surface of the water touches the hull when it is afloat on even keel.

Watertight Bulkhead: Bulkheads secured so tightly so as not to let water pass.

Wharf: A structure generally parallel to the shore.

Working Anchor: An anchor carried on a boat for most normal uses. Refers to the anchor used in typical anchoring situations.

Windlass: A winch used to raise and lower the anchor.

Windward: Toward the direction from which the wind is coming.

Yacht Basin: A protected facility primarily for recreational small craft.

Yaw: When a boat runs off her course to either side.

Maintenance Schedule

Maintenance	Each Use	Weekly	Monthly	Semi-Annually	Yearly	As Nedeed
Clean hull below the waterline				X		
Bottom paint					X	X
Check sacrificial anodes			X			
Replace sacrificial anodes					X	
Wash boat canvas & hardware	X		X			
Wax exterior gelcoat				X		X
Clean & protect hardware						X
Polish & protect plastic glass					X	X
Clean exterior upholstery	X					X
Clean cabin & interior upholstery						X
Flush engine with fresh water	X					
Spray metal components in bilge with a protector			X			
Clean bilge				X		X
Check bilge for leaks	X		X			
Inspect & operate thru-hull valves			X			
Inspect steering & control systems	X					
Service steering & control systems				X		
Inspect fuel system for leaks	X					
Inspect & service fuel system				X		
Inspect fuel tank vents & screens					X	
Replace fuel filters					X	
Lubricate fuel fill O-rings			X			
Inspect fire extinguisher			X			
Test bilge pump auto switches	X					
Inspect & protect electrical components, wire & battery connections				X		
Check battery electrolyte & service			X			
Test and inspect AC electrical system & shore power cord				X		
Inspect water systems for leaks				X		
Check neutral safety switch	X					
Check trim tab fluid level			X			

Date	Hours	Dealer	Service/Repairs

Boating Accident Report

DEPARTMENT OF TRANSPORTATION U.S. COAST GUARD CG-1365 (REV. 1-88)		BOATING ACCIDENT REPORT			FORM APPROVED OMB NO 211-0010	
<p>The operation of a vessel used for recreational purposes is required to file a report in writing whenever an accident results in: loss of life or disappearance from a vessel, or an injury which requires medical attention beyond first aid, or property damage in excess of \$200 or complete loss of the vessel. Reports of death and injury cases must be submitted within 48 hours. Reports in other cases may be submitted within 10 days. Reports may be submitted in preparing authority in the time when the accident occurred. This form is provided to assist the operator in filing the required written report.</p>						
COMPLETE ALL BLOCKS (indicate those not applicable by "NA")						
NAME AND ADDRESS OF OPERATOR		AGE OF OPERATOR DATE OF BIRTH		OPERATING EXPERIENCE? This type of boat: Other boat operating trip <input type="checkbox"/> Under 20 Hours <input type="checkbox"/> Under 20 Hours <input type="checkbox"/> 20 to 100 Hours <input type="checkbox"/> 20 to 100 Hours <input type="checkbox"/> 100 to 500 Hours <input type="checkbox"/> 100 to 500 Hours <input type="checkbox"/> Over 500 Hours <input type="checkbox"/> Over 500 Hours		
OPERATION TYPE (SIC) NUMBER		OWNER TYPE (SIC) NO.				
NAME AND ADDRESS OF OWNER		RENTED BOAT <input type="checkbox"/> YES <input type="checkbox"/> NO		NUMBER OF PERSONS ON BOARD		
NORMAL INSTRUCTION IN BOATING SAFETY <input type="checkbox"/> None <input type="checkbox"/> State <input type="checkbox"/> U.S. Power Squadrons <input type="checkbox"/> USCG Auxiliary <input type="checkbox"/> American Red Cross <input type="checkbox"/> Other (Specify): _____						
VESSEL NO. (this vessel)						
BOAT REGISTER NO.	BOAT NAME	BOAT MAKE	BOAT MODEL	VHICL IDENTIFICATION NO.		
TYPE OF BOAT <input type="checkbox"/> Open Motorboat <input type="checkbox"/> Cabin Motorboat <input type="checkbox"/> Auxiliary Sail <input type="checkbox"/> Sail (only) <input type="checkbox"/> Rowboat <input type="checkbox"/> Tug <input type="checkbox"/> Other (Specify): _____	HULL MATERIAL <input type="checkbox"/> Wood <input type="checkbox"/> Aluminum <input type="checkbox"/> Steel <input type="checkbox"/> Fiberglass <input type="checkbox"/> Rubber/vinyl <input type="checkbox"/> Other (Specify): _____	ENGINE <input type="checkbox"/> Outboard <input type="checkbox"/> Inboard gasoline <input type="checkbox"/> Inboard diesel <input type="checkbox"/> Inboard-diesel <input type="checkbox"/> Jet <input type="checkbox"/> Other (Specify): _____		PROPULSION No. of engines _____ Horse Power (total) _____ Type of fuel _____ Has boat had a Safety Examination? <input type="checkbox"/> Confirmed <input type="checkbox"/> NO For current year? <input type="checkbox"/> YES <input type="checkbox"/> NO Year _____ Indicate whether: <input type="checkbox"/> USCG Auxiliary Course; Marine Exam <input type="checkbox"/> State/Local examination <input type="checkbox"/> Other _____		
ACCIDENT DATA						
DATE OF ACCIDENT	TIME am pm	NAME OF BODY OF WATER		LOCATION (Give location precisely) Lat Long		
STATE	NEAREST CITY OR TOWN			CITY		
WEATHER <input type="checkbox"/> Clear <input type="checkbox"/> Fair <input type="checkbox"/> Cloudy <input type="checkbox"/> Snow <input type="checkbox"/> Fog <input type="checkbox"/> Hazy	WATER CONDITIONS <input type="checkbox"/> Calm (waves less than 6") <input type="checkbox"/> Choppy (waves 6" to 2') <input type="checkbox"/> Rough (waves more than 6") <input type="checkbox"/> Strong Current		TEMPERATURE (Celsius) Air _____ °F Water _____ °F		WIND <input type="checkbox"/> None <input type="checkbox"/> Light (6 - 10 mph) <input type="checkbox"/> Moderate (7 - 14 mph) <input type="checkbox"/> Strong (15 - 25 mph) <input type="checkbox"/> Storm (Over 25 mph)	
OPERATION AT TIME OF ACCIDENT (Check all applicable) <input type="checkbox"/> Commercial Activity <input type="checkbox"/> Cruising <input type="checkbox"/> Manoeuvring <input type="checkbox"/> Approaching Dock <input type="checkbox"/> Leaving Dock <input type="checkbox"/> Water Skiing <input type="checkbox"/> Racing <input type="checkbox"/> Towing <input type="checkbox"/> Other (Specify): _____		TYPE OF ACCIDENT (Check all applicable) <input type="checkbox"/> Grounding <input type="checkbox"/> Collisions with Fixed Object <input type="checkbox"/> Collisions with Floating Object <input type="checkbox"/> Falls Overboard <input type="checkbox"/> Falls in Boat <input type="checkbox"/> Hit by Buoy or Propeller <input type="checkbox"/> Other (Specify): _____		WHAT TYPE OF EQUIPMENT CAUSED ACCIDENT? (Check all applicable) <input type="checkbox"/> Weather <input type="checkbox"/> Excessive speed <input type="checkbox"/> No Proper Lookout <input type="checkbox"/> Restricted Vision <input type="checkbox"/> Overloading <input type="checkbox"/> Improper Loading <input type="checkbox"/> Racing <input type="checkbox"/> Hazardous Waters <input type="checkbox"/> Other (Specify): _____		
PERSONAL FLotation DEVICES (PFD'S)			PROPERTY DAMAGE		FIRE EXTINGUISHERS	
Were the boat adequately equipped with (CHECK ALL APPLICABLE) PFD'S? Were they accessible? <input type="checkbox"/> Yes <input type="checkbox"/> No Were they serviceable? <input type="checkbox"/> Yes <input type="checkbox"/> No Were they used by survivors? <input type="checkbox"/> Yes <input type="checkbox"/> No What type? <input type="checkbox"/> I <input type="checkbox"/> II <input type="checkbox"/> III <input type="checkbox"/> IV <input type="checkbox"/> V (Specify) _____ Were PFD's property used? Adjusted <input type="checkbox"/> Yes <input type="checkbox"/> No Sized <input type="checkbox"/> Yes <input type="checkbox"/> No			Was the vessel carrying NSM approved flotation devices? <input type="checkbox"/> Yes <input type="checkbox"/> No Were they accessible? <input type="checkbox"/> Yes <input type="checkbox"/> No Were they used? <input type="checkbox"/> Yes <input type="checkbox"/> No If Yes, indicate kind: _____		Estimated amount: This boat \$ _____ Other boat \$ _____ Other Property \$ _____ WERE THEY USED? (If yes, list type(s) and number used.) <input type="checkbox"/> Yes <input type="checkbox"/> No <input type="checkbox"/> NA Type: _____	
DESCRIBE PROPERTY DAMAGE: _____ _____ _____			NAME AND ADDRESS OF OWNER OF DAMAGED PROPERTY: _____ _____ _____			
Include any comments of PHD's under ACCIDENT DESCRIPTION or other pile of form						

If more than 1 boat/life and/or injuries attach additional form(s)					
DECEASED					
NAME	ADDRESS	DATE OF BIRTH	WAS VICTIM? <input type="checkbox"/> Swimmer <input type="checkbox"/> Non-Swimmer	DEATH CAUSED BY <input type="checkbox"/> Drowning <input type="checkbox"/> Other <input type="checkbox"/> DISAPPEARANCE	WAS PFD WORN? <input type="checkbox"/> Yes <input type="checkbox"/> No What Type?
NAME	ADDRESS	DATE OF BIRTH	WAS VICTIM? <input type="checkbox"/> Swimmer <input type="checkbox"/> Non-Swimmer	DEATH CAUSED BY <input type="checkbox"/> Drowning <input type="checkbox"/> Other <input type="checkbox"/> DISAPPEARANCE	WAS PFD WORN? <input type="checkbox"/> Yes <input type="checkbox"/> No What Type?
NAME	ADDRESS	DATE OF BIRTH	WAS VICTIM? <input type="checkbox"/> Swimmer <input type="checkbox"/> Non-Swimmer	DEATH CAUSED BY <input type="checkbox"/> Drowning <input type="checkbox"/> Other <input type="checkbox"/> DISAPPEARANCE	WAS PFD WORN? <input type="checkbox"/> Yes <input type="checkbox"/> No What Type?
INJURED					
NAME	ADDRESS	DATE OF BIRTH	NATURE OF INJURY		MEDICAL TREATMENT
NAME	ADDRESS	DATE OF BIRTH	NATURE OF INJURY		MEDICAL TREATMENT
NAME	ADDRESS	DATE OF BIRTH	NATURE OF INJURY		MEDICAL TREATMENT
ACCIDENT DESCRIPTION					
DESCRIBE WHAT HAPPENED (Sequence of events. Include failure of equipment. If diagram is needed, attach separately. Continue on additional sheet(s) as necessary. Include any information regarding the involvement of alcohol and/or drugs in causing or contributing to the accident. Include any descriptive information about the use of PFD's.)					
WITNESS #1 (if more than 2 vessels, attach additional form(s))					
Name of Operator	Address		Boat Number		
Telephone Number			Boat Name		
Name of Owner	Address				
WITNESSES					
Name	Address			Telephone Number	
Name	Address			Telephone Number	
Name	Address			Telephone Number	
WITNESSES					
SIGNATURE	Address			Telephone Number	
QUALIFICATION (Check One) <input type="checkbox"/> Operator <input type="checkbox"/> Owner <input type="checkbox"/> Investigator <input type="checkbox"/> Other				Date Submitted	
(do not use) - FOR REPORTING AUTHORITY REVIEW (use agency date stamp)					
Cause based on (check one) <input type="checkbox"/> This report <input type="checkbox"/> Investigation and this report <input type="checkbox"/> Investigation <input type="checkbox"/> could not be determined		Name of Reviewing Office		Date Received	
Primary Cause of Accident		Secondary Cause of Accident		Reviewed By	

Float Plan

Pursuit recommends filling out a float plan each time you use your boat for an offshore day trip or a longer cruise. Leave this information with a responsible person ashore, like a close friend or relative that you know well.

1. Name of person reporting and telephone number.

2. Description of boat.

Type _____ Color _____ Trim _____
 Registration No. _____ Length _____
 Name _____ Make _____ Other Info _____

3. Engine type _____ H.P. _____

No. of Engines _____ Fuel Capacity _____

4. Survival equipment: (Check as appropriate)

- | | | |
|--|---|---------------------------------------|
| <input type="checkbox"/> PFDs | <input type="checkbox"/> Flares | <input type="checkbox"/> Mirror |
| <input type="checkbox"/> Smoke Signals | <input type="checkbox"/> Flashlight | <input type="checkbox"/> Food |
| <input type="checkbox"/> Paddles | <input type="checkbox"/> Water | <input type="checkbox"/> Others _____ |
| <input type="checkbox"/> Anchor | <input type="checkbox"/> Raft or Dinghy | <input type="checkbox"/> EPIRB |

5. Radio Yes No Type _____

6. Automobile license _____

Type _____ Trailer License _____
 Color _____ and make of auto _____

7. Persons aboard _____

Name _____ Age _____ Address & telephone No. _____

8. Do any of the persons aboard have a medical problem?

Yes No If yes, what? _____

9. Trip Expectations: Leave at _____

From _____ Going to _____
 Expect to return by _____ (time)
 and no later than _____

10. Any other pertinent info. _____

11. If not returned by _____ (time)

call the COAST GUARD, or (Local authority) _____

12. Telephone Numbers.

Troubleshooting Guide

Problem	Cause and Solution
Control Systems	
<p>Hydraulic Steering is slow to respond and erratic.</p>	<ul style="list-style-type: none"> • Steering system is low on fluid. Fill and bleed system. • Steering system has air in it. Fill and bleed system. • A component in the steering system is binding. Check and adjust or repair binding component. • Engine steering cylinder is binding. Grease spindle.
<p>The boat wanders and will not hold a course at cruise speeds.</p>	<ul style="list-style-type: none"> • There could be air in the steering system. Fill & bleed the system. • The engine steering tab is corroded or out of adjustment. Replace or adjust steering tab. • Engine steering cylinder is binding. Grease spindle.
<p>The engine will not start with the shift control lever in neutral.</p>	<ul style="list-style-type: none"> • The control cable is out of adjustment & not activating the neutral safety cut out switch. • The shift control lever is not in the neutral detent. Try moving the shift lever slightly. • There is a loose wire on the neutral safety switch on the transmission. Inspect wires and repair loose connections. • The starter or ignition switch is bad.
Performance Problems	
<p>Boat is sluggish and has lost speed and RPM.</p>	<ul style="list-style-type: none"> • The boat may be need to have marine growth cleaned from hull and running gear. • Propeller may be damaged & need repair. • Weeds or line around the propeller. Clean propeller. • Boat is overloaded. Reduce load. • Check for excessive water in the bilge. Pump out bilge & find & correct the problem. • The throttle adjustments has changed and the engine is not getting full throttle. Adjust the throttle cable.

Problem	Cause and Solution
The boat vibrates at cruising speeds.	<ul style="list-style-type: none"> • Propeller may be damaged and need repair. • The propeller or propeller shaft is bent. Repair or replace damaged components. • The running gear is fouled by marine growth or rope. Clean running gear. • The engine is not trimmed properly. Trim the engine.
Engine Problems	
The engine is running too hot.	<ul style="list-style-type: none"> • The engine raw water pick-up strainer up is clogged with marine growth. Clean pick-up. • The engine raw water pump impeller is worn or damaged. Repair the pump. • The engine thermostat is faulty and needs to be replaced.
The engine alternator is not charging properly.	<ul style="list-style-type: none"> • The battery cable is loose or corroded. Clean and tighten battery cables. • The alternator is not charging and must be replaced. • The engine battery isolator in the charging system is not working properly. Replace the isolator. • The battery is defective. Replace the battery.
The engine suddenly will not operate over 2000 RPM.	<ul style="list-style-type: none"> • The engine emergency system has been activated. The onboard computer has sensed a problem and has limited the RPM to protect the engine. Find & correct the problem. • The tachometer is bad and needs to be replaced.

Problem	Cause and Solution
<p>The engine is loosing RPM. The boat is not overloaded and the hull bottom and running gear are clean and in good condition.</p>	<ul style="list-style-type: none"> • The engine may be having a problem with a sticky anti-siphon valve, located in the fuel line near the fuel tank, that is restricting the fuel flow. Remove & clean or replace the anti-siphon valve. • The remote gasoline fuel filter could be dirty. Inspect and replace the fuel filter. • The primary fuel filter on the engine may be dirty. Inspect and replace the fuel filter. • The electronic engine control system on the engine is malfunctioning. Repair the engine control system. • The fuel injection system on the engine is malfunctioning. Repair the fuel injection system.
<p>Accessory Problems</p>	
<p>The livewell pump runs, but does not pump water.</p>	<ul style="list-style-type: none"> • The strainer on the intake scoop is clogged preventing the water from getting to the pump. Put the boat in reverse to clean the strainer. • There is an air lock in the system. Run the boat above 15 m.p.h. and the pick-up scoop will force the air lock past the pump and prime the system. • The thru-hull valve is not open. Open valve. • The valve in the livewell is not open. Open the valve in the livewell.
<p>The automatic float switch on the bilge pump raises but does not activate the pump.</p>	<ul style="list-style-type: none"> • The in-line fuse near the battery switch has blown. Replace the fuse. • The pump impeller is jammed by debris. Clean pump impeller housing. • The pump is defective. Replace pump.

Schematics

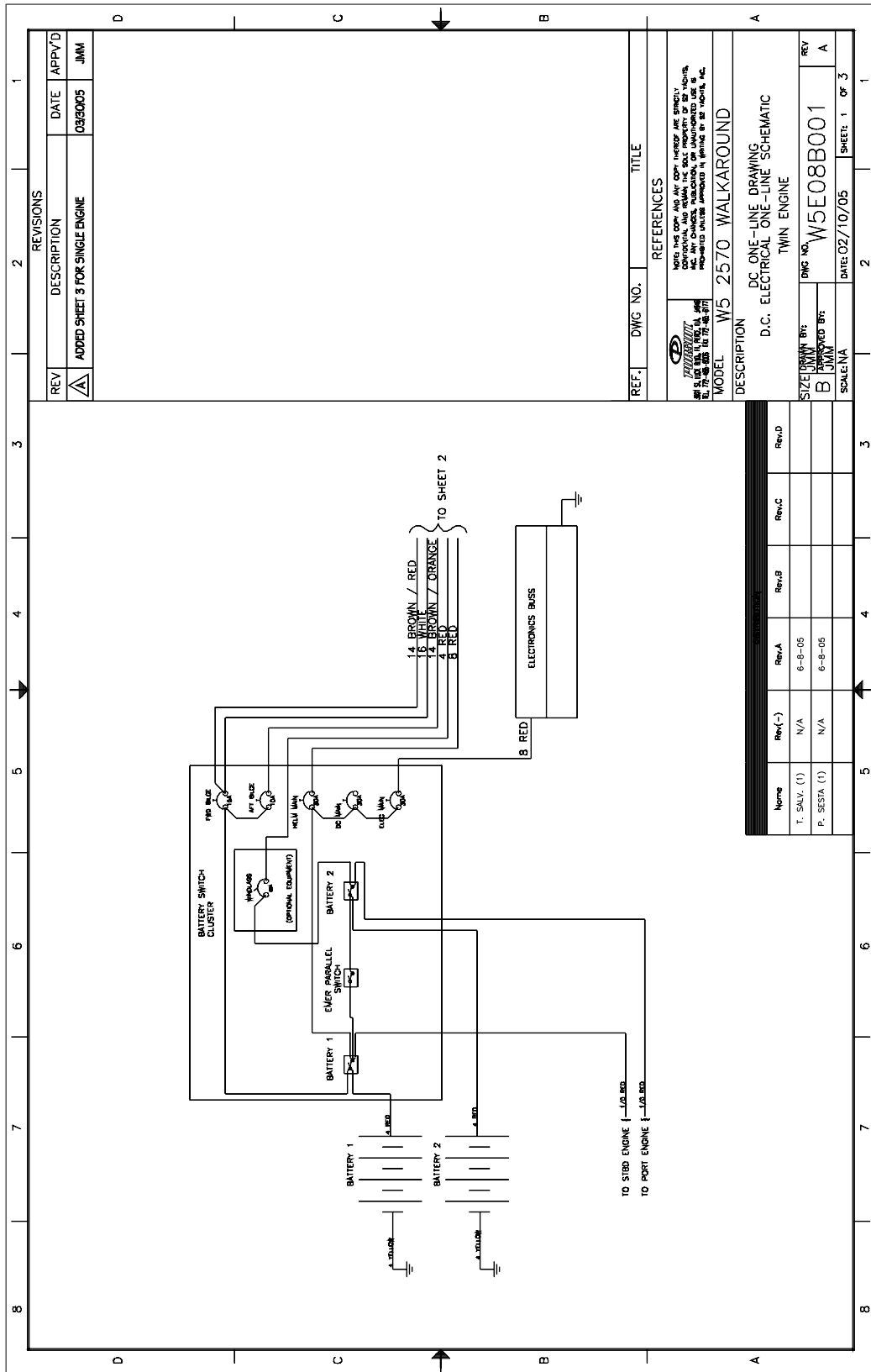

REV	DESCRIPTION	DATE	APPV'D
A	ADDED SHEET 3 FOR SINGLE ENGINE	03/30/05	JMM

REV.	DWG NO.	TITLE
	W5 2570	WALKAROUND

NAME	REV.	REV.A	REV.B	REV.C	REV.D
T. SALV. (1)	N/A	6-8-05			
P. SESTA (1)	N/A	6-8-05			

REV	DESCRIPTION	DATE	APPV'D
A	ADDED SHEET 3 FOR SINGLE ENGINE	03/30/05	JMM

REV.	DWG NO.	TITLE
	W5 2570	WALKAROUND

NAME	REV.	REV.A	REV.B	REV.C	REV.D
T. SALV. (1)	N/A	6-8-05			
P. SESTA (1)	N/A	6-8-05			

REV	DESCRIPTION	DATE	APPV'D
A	ADDED SHEET 3 FOR SINGLE ENGINE	03/30/05	JMM

REV.	DWG NO.	TITLE
	W5 2570	WALKAROUND

NAME	REV.	REV.A	REV.B	REV.C	REV.D
T. SALV. (1)	N/A	6-8-05			
P. SESTA (1)	N/A	6-8-05			

REV	DESCRIPTION	DATE	APPV'D
A	ADDED SHEET 3 FOR SINGLE ENGINE	03/30/05	JMM

NOTES: THIS DRAWING AND ANY COPY THEREOF ARE STRICTLY CONFIDENTIAL AND NOT TO BE REPRODUCED OR TRANSMITTED IN ANY FORM OR BY ANY MEANS, ELECTRONIC OR MECHANICAL, INCLUDING PHOTOCOPYING, RECORDING, OR BY ANY INFORMATION STORAGE AND RETRIEVAL SYSTEM. ANY UNAUTHORIZED USE IS PROHIBITED. ALL RIGHTS RESERVED BY P. SESTA, INC.

MODEL: W5 2570 WALKAROUND

DESCRIPTION: DC ONE-LINE DRAWING SCHEMATIC TWIN ENGINE

SIZE: DRAWN BY: JMM DWG NO.: W5E08B001 REV: A

SCALE: N/A DATE: 02/10/05 SHEET: 1 OF 3

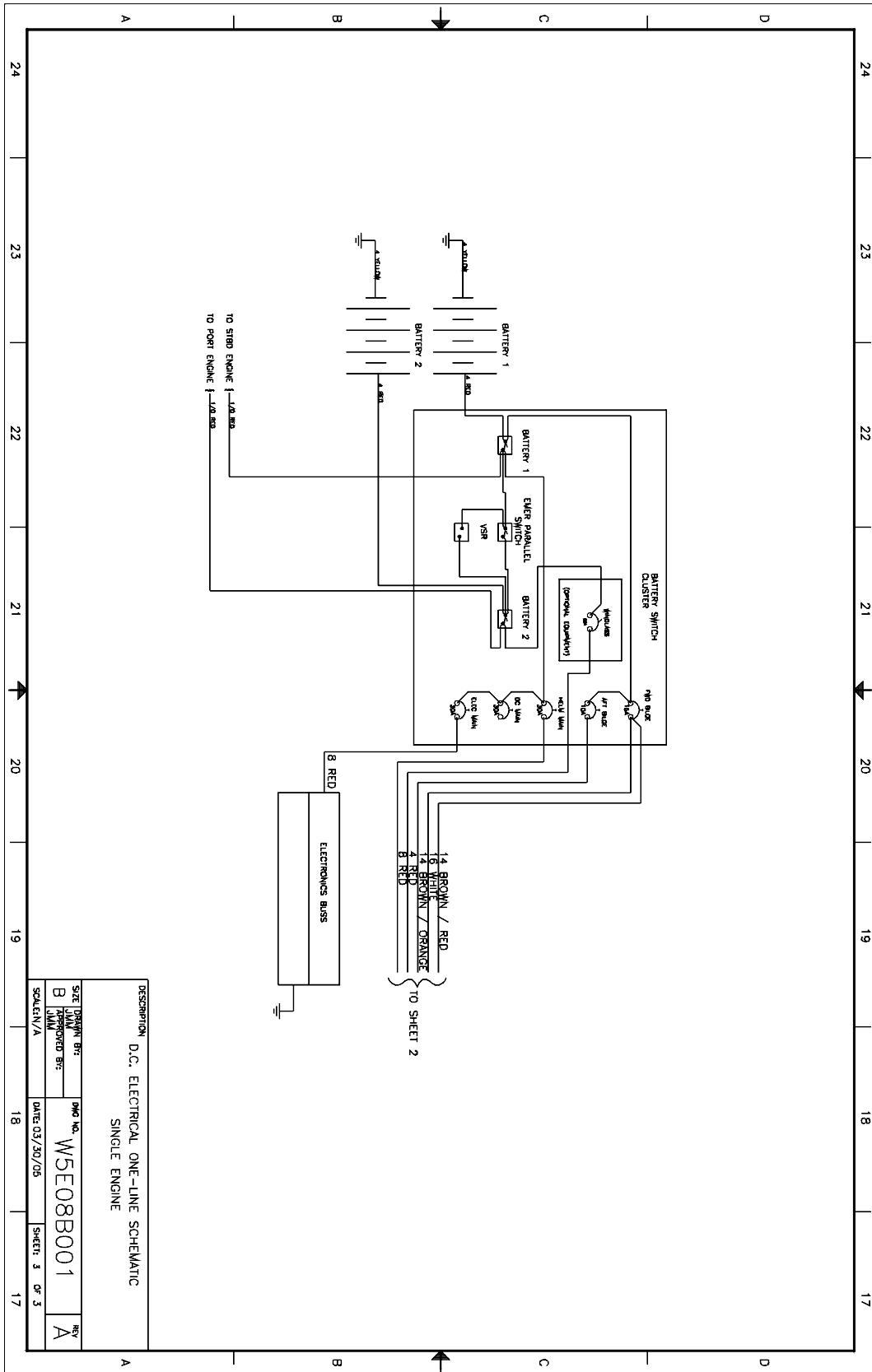

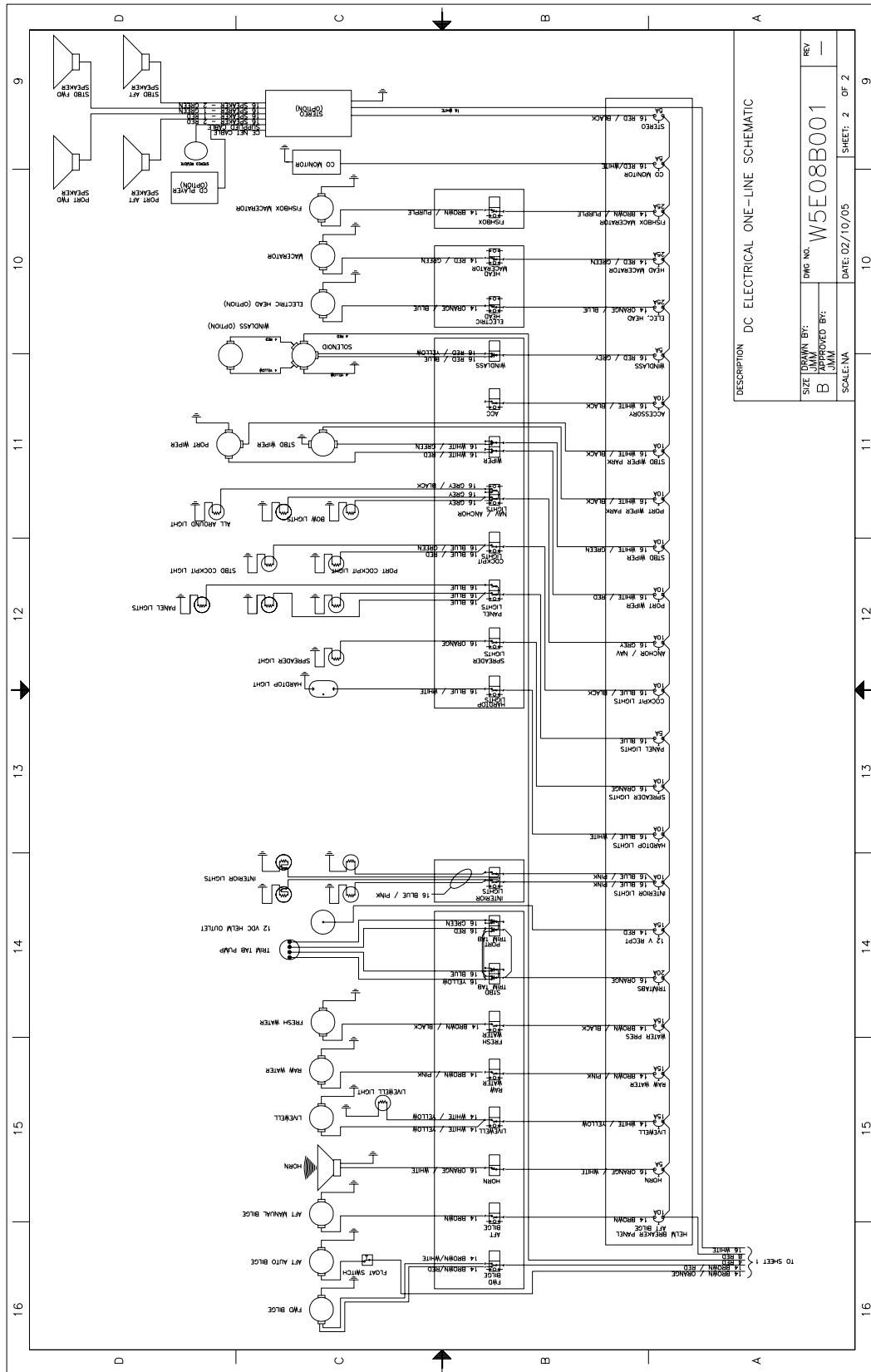

DESCRIPTION: DC ELECTRICAL ONE-LINE SCHEMATIC

SIZE	REV
B	1
DRAWN BY: J.M.W.	
CHECKED BY: J.M.W.	
DATE: 02/10/05	
SCALE: NA	
SHEET: 2 OF 2	
PWC NO. W5E08B001	

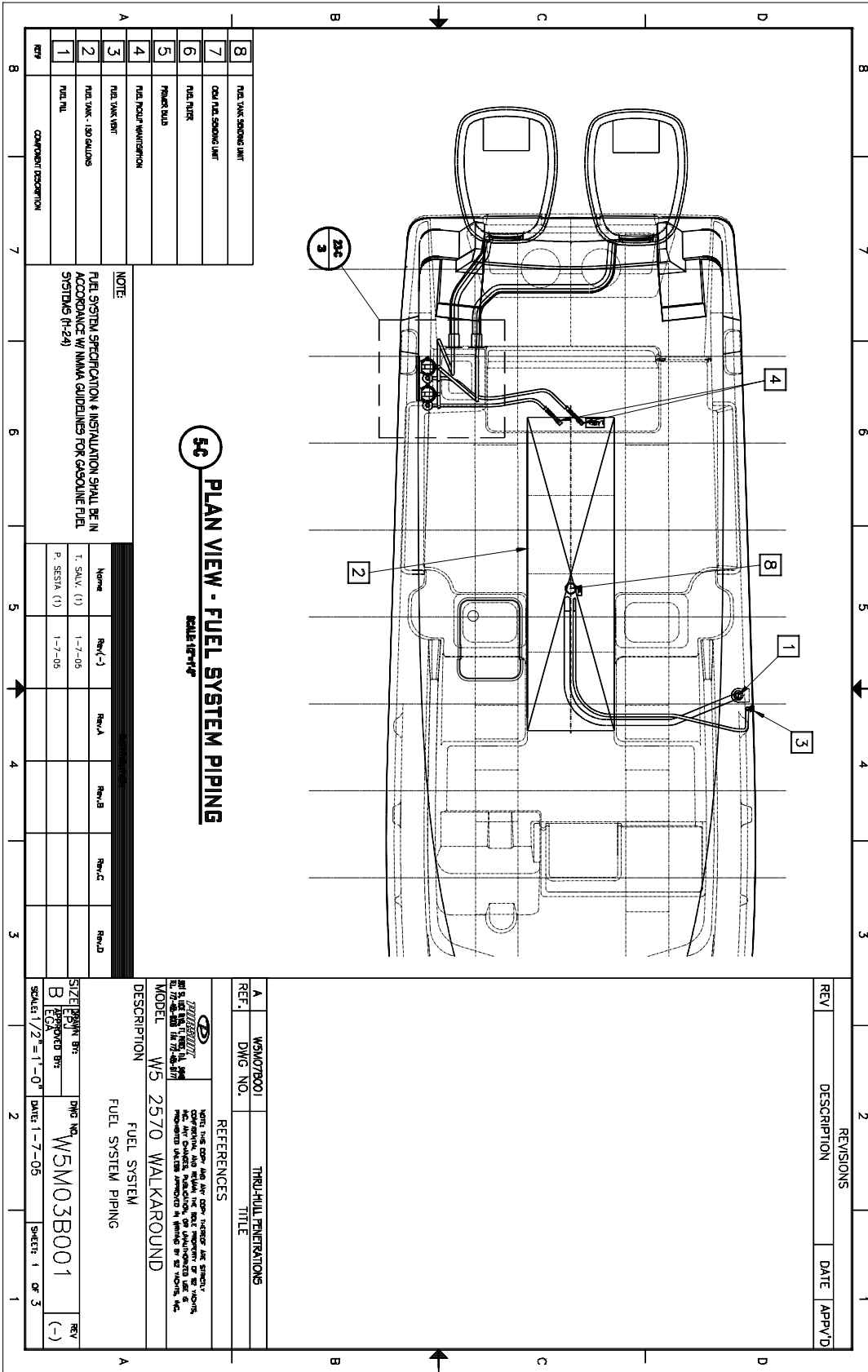

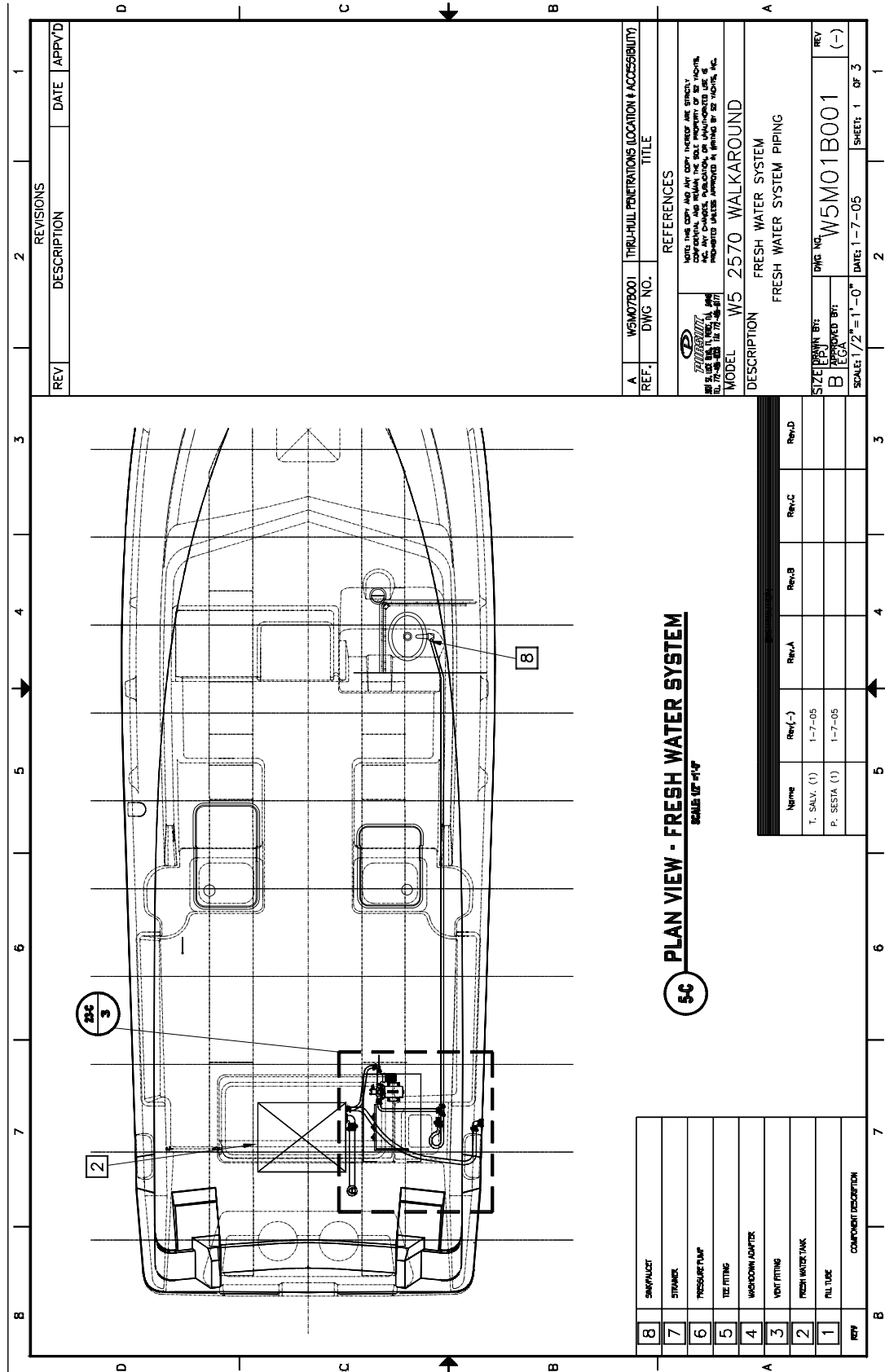

REF. A	W5M07B001	THRU-HULL PENETRATIONS (LOCATION & ACCESSIBILITY)
	DWG NO.	TITLE
<p>REFERENCES</p> <p>NOTE: THIS DRAWING AND ANY OTHER DRAWINGS ARE HEREBY CONSIDERED TO BE PART OF THE SAME PROJECT OF THE VENDOR. NO AIR CHANGES, MODIFICATIONS, OR UNAUTHORIZED USE OF THIS DRAWING SHALL BE PERMITTED WITHOUT THE WRITTEN PERMISSION OF THE VENDOR.</p> <p>MODEL W5 2570 WALKAROUND</p> <p>DESCRIPTION FRESH WATER SYSTEM FRESH WATER SYSTEM PIPING</p>		
	SIZE	REV
	1/2" = 1'-0"	(-)
	DATE: 1-7-05	SHEETS: 1 OF 3

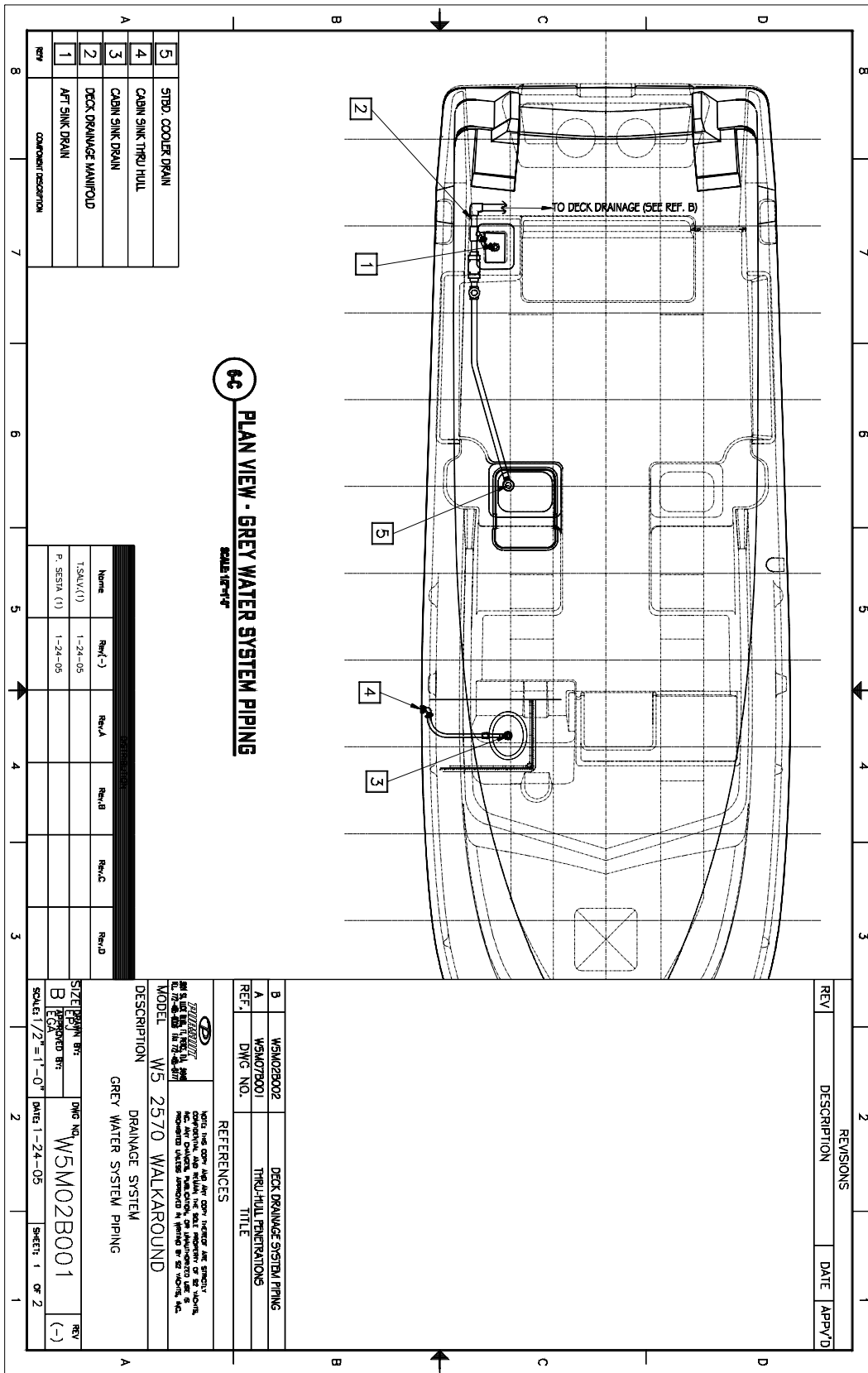

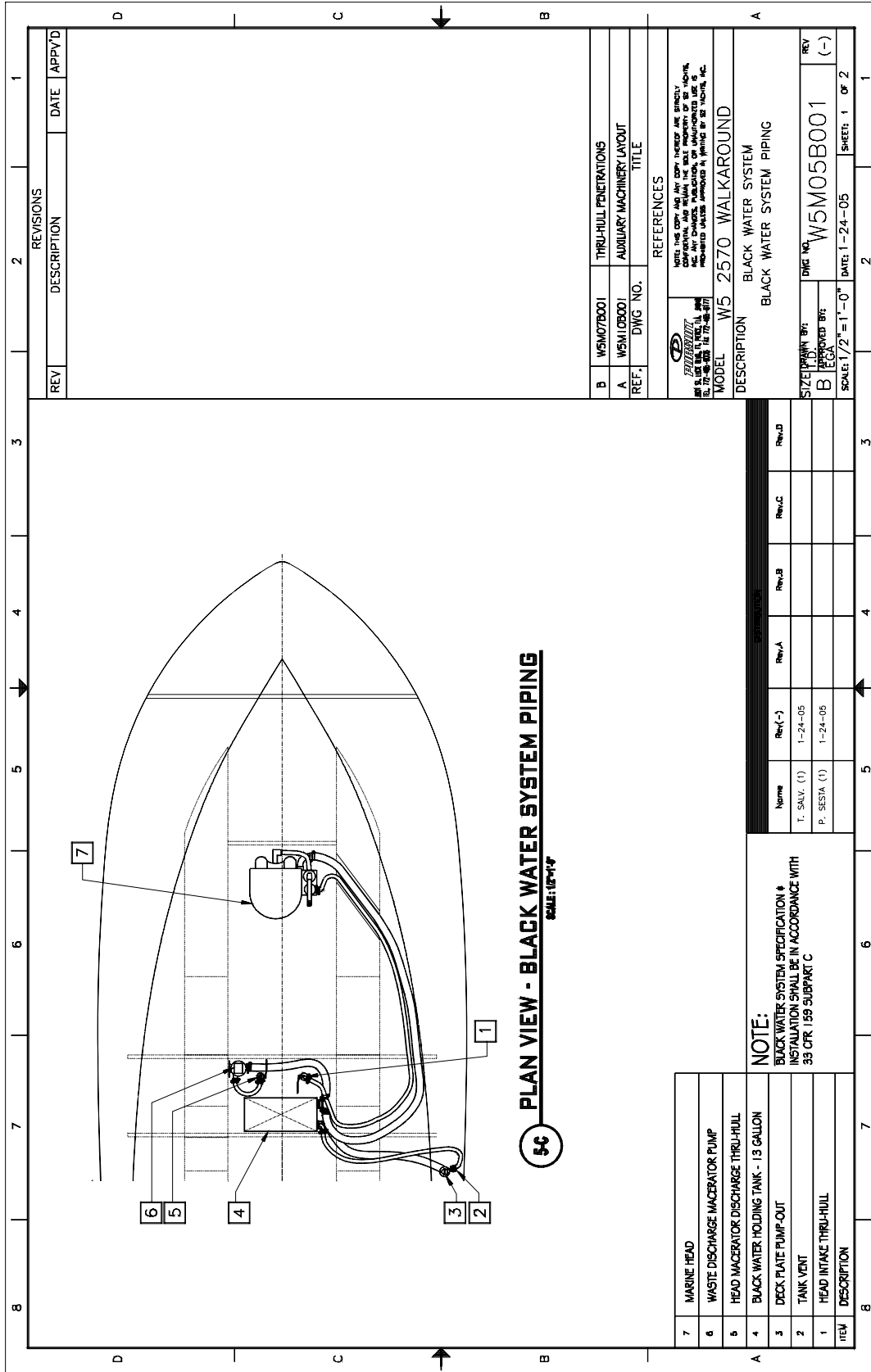

REV	DESCRIPTION	DATE	APPLY'D

REF.	DWG. NO.	TITLE
B	W5M07B001	THRU-HULL PENETRATIONS
A	W5M05B001	AUXILIARY MACHINERY LAYOUT

REFERENCES

W5 2570 WALKAROUND
BLACK WATER SYSTEM
BLACK WATER SYSTEM PIPING

NOTE: THE OWNER HAS BEEN ADVISED BY THE MANUFACTURER THAT THIS SYSTEM IS NOT DESIGNED TO BE USED IN A MARINE ENVIRONMENT. THE MANUFACTURER HAS ADVISED THAT THIS SYSTEM IS NOT DESIGNED TO BE USED IN A MARINE ENVIRONMENT. THE MANUFACTURER HAS ADVISED THAT THIS SYSTEM IS NOT DESIGNED TO BE USED IN A MARINE ENVIRONMENT.

SIZE	DRYER	DWG. NO.	REV
1/2"	1/2"	W5M05B001	(-)

Name	Rev.(-)	Rev.A	Rev.B	Rev.C	Rev.D
T. SALV. (1)	1-24-05				
P. SISTA (1)	1-24-05				

NOTE:
BLACK WATER SYSTEM SPECIFICATION & INSTALLATION SHALL BE IN ACCORDANCE WITH 35 CFR 189 SUBPART C

ITEM	DESCRIPTION
7	MARINE HEAD
6	WASTE DISCHARGE MACERATOR PUMP
5	HEAD MACERATOR DISCHARGE THRU-HULL
4	BLACK WATER HOLDING TANK - 13 GALLON
3	DECK PLATE PUMP-OUT
2	TANK VENT
1	HEAD INTAKE THRU-HULL

