



FOUNTAINE PAJOT.
SAILING CATAMARANS

Share your emotions

OWNER'S MANUAL

40

LUCIA





Contents

1	Technical specifications	page 5 /	5	Manoverboard prevention and man recovery	page 47 /
	› Manufacturer's plate	6	6	Fire protection	page 51 /
	› Identity sheet	6	7	Preparing the winter season & Handling	page 55 /
	› Design category	6		› Water circuit	56
	› Characteristics	7		› Outside	56
2	Sailing	page 9 /		› Engines	56
	› Entrance door	10		› Preparation	56
	› Leaving the harbour	10 - 12		› Craning	56
	› Starting the engines	13 - 14	8	Maintenance	page 59 /
	› Sailing	15 - 16		› Drainage	60
	› Arriving in a harbour	17		› Running rigging, sheets and ropes	61
	› Anchorage	17 - 18		› Periodic maintenance chart	62 - 64
	› Mooring and towing	19			
3	Equipments	page 21 /			
	› Deck	22 - 24			
	› Hull/saloon	25 - 29			
4	Systems	page 31 /			
	› Steering system	32			
	› Electricity	33 - 35			
	› Gas circuit	36			
	› Water	37 - 45			



Technical Specifications



- › Manufacturer's plate 6
- › Identity sheet 6
- › Design category 6
- › Characteristics 7

Technical Specifications

MANUFACTURER'S PLATE



IDENTITY SHEET

CIN NUMBER	057
BUILDER	FOUNTAINE PAJOT Industrial area 17 290 Aigrefeuille d'Aunis
TYPE OF BOAT	CATAMARAN
SERIES	LUCIA

DESIGN CATEGORY

DESIGN CATEGORIES	NAVIGATION TYPE	WIND FORCE (BEAUFORT SCALE)	WIND SPEED	WAVE HEIGHT TO TAKE INTO CONSIDERATION
A	Ocean-going	> 8	≤ 28 m/s	> 4 m
B	Off the coast	≤ 8	≤ 21 m/s	≤ 4 m
C	Near the coast	≤ 6	≤ 17 m/s	≤ 2 m
D	Protected water	≤ 4	≤ 13 m/s	≤ 0,5 m

Your LUCIA 40 belongs to the « **OCEAN-GOING** » category (category A).

A pleasure boat of design category A is considered as designed for winds which can exceed force 8 (in the Beaufort scale) and for waves which can exceed a height of 4metres, excluding exceptional conditions such as thunderstorms, violent storms, tornadoes and extreme maritime conditions or huge waves.

The navigation ability also depends on the crew's skills. Their physical abilities, the condition of the boat and hardware.

Be very careful before going to sea. Fountaine Pajot cannot guarantee the perfect operation of the boat in exceptional sea conditions (violent storms, hurricanes, cyclones, tornadoes, etc.)

The LUCIA 40 is a **boat susceptible to capsize** and to stay inverted if there are excessive sails. This is why it is important to respect the sail reduction table.

CHARACTERISTICS

General

LENGTH (LH)	11,73 m / 38,4 ft
HULL WIDTH (BH)	6,63 m / 21,7 ft
DRAUGHT	1,20 m / 4,1 ft
AIR DRAUGHT	19,45 m / 63,8 ft
LIGHT DISPLACEMENT	9 525 kg
MAXIMUM LOAD DISPLACEMENT	12 848 kg

The maximum load recommended includes the weight of all members on board, the provisions and personal belongings, all equipment not included in the weight of the light displacement of the boat, the cargo and the all consumable liquids (water, fuel, etc.)

Inboard engines

BRAND	REFERENCE	POWER	CRUISING RATE	MAX. RATE
Volvo	D1-20	2x20 cv / 2x13,8 kW	2300 rpm	3000 rpm
Volvo	D1-30	2x30 cv / 2x20,9 kW	2300 rpm	3000 rpm
Yanmar	3YM20	2x20 cv / 2x13,8 kW	2200 rpm	3000 rpm
Yanmar	3YM30 AE	2x30 cv / 2x20,9 kW	2000 rpm	3200 rpm

Electricity

STARBOARD ENGINE/ SERVICE BATTERY PACK	12 V	3 x 115 Ah + 1 x 115 Ah (Optional)
PORT ENGINE BATTERY PACK	12 V	1 x 50 Ah

Weight

DESIGNATION	WEIGHT
Fuel weight	255 kg - 300 L
Fresh water weight	530 kg - 530 L
Black and grey water weight	180 kg
Liquids total weight	965 kg

Surface of sails

MAINSAIL	GENOA	GENAKER (OPTIONAL)
58 m ² / 624,3 ft ²	37 m ² / 398,26 ft ²	68 m ² / 223,09 ft ²

Dinghy

MAXI DINGHY LENGTH	3,10 m
MAX. LOAD PER DAVIT	100 kg

Life raft

MAX. LIFE RAFT DIMENSIONS	800 x 500 x 310 cm
---------------------------	--------------------



LUCIA
40

Sailing

2

- › Entrance door..... 10
- › Leaving the harbour..... 10 - 12
- › Starting the engines..... 13 - 14
- › Sailing..... 15 - 16
- › Arriving in a harbour..... 17
- › Anchorage..... 17 - 18
- › Mooring and towing..... 19

ENTRANCE DOOR

The sliding door used as the entrance door has a locking system in the open position. It is possible to **lock it from the inside** with a latch on the frame. The **locking from the outside** is done with a 1/4 turnkey.



LEAVING THE HARBOUR

1 Close all the hull portholes (safety hatches included), covers, deck hatches and windscreen panels.

The safety hatches are mentioned « NEVER OPEN WHEN SAILING » always respect this warning. Sailing means that the boat is neither anchored, moored or grounded.

2 Unlock all the doors and lockers. Then check that the bilges are empty of water.

3 Check that the life raft is installed (accessible at the starboard aft of the cockpit) and hang outside the security fittings (buoy...). A second life raft can be installed at the port aft of the cockpit.



4 Filling:

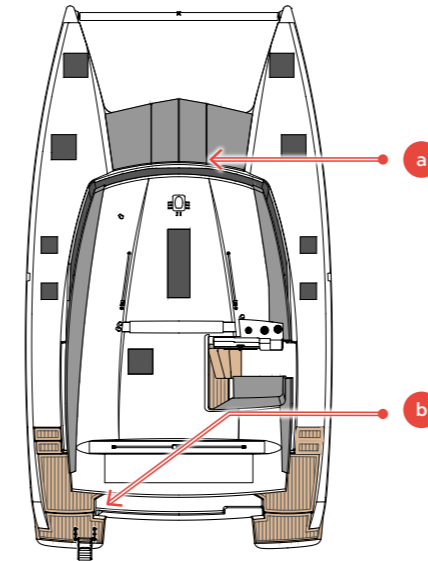

- a** > The **fresh water tanks** from the starboard front deck filler.
- b** > The **diesel tank** from the deck filler on the port aft locker of the cockpit.

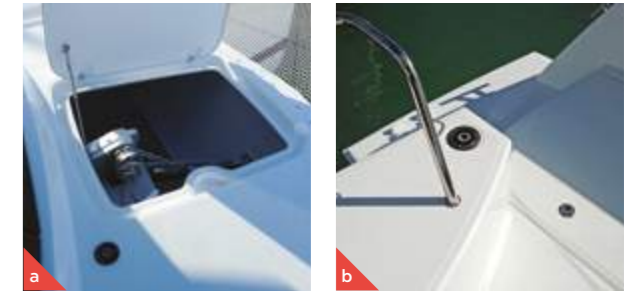

5 Connect engines circuit breakers (port and starboard engine compartments) and check that the **windlass circuit breaker** and the **service circuit breaker** are switched on.

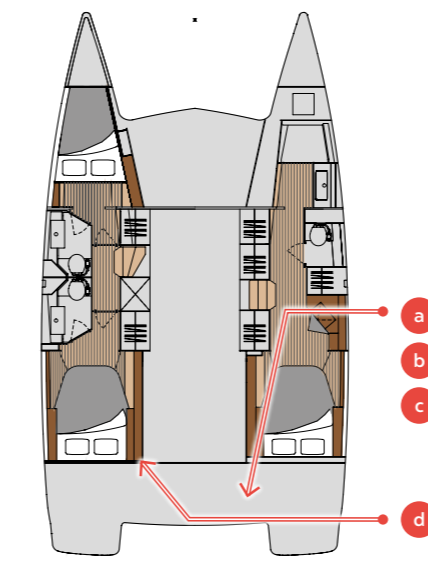

- a** > Starboard battery circuit breaker
- b** > Service circuit breaker
- c** > Windlass circuit breaker
- d** > Port battery circuit breaker

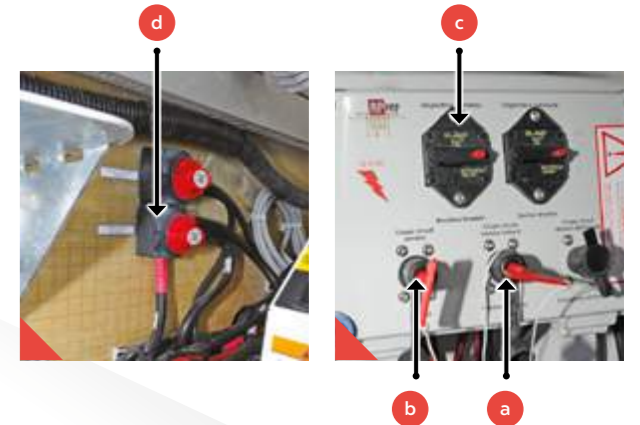

LEAVING THE HARBOUR (NEXT)

- 6 Check the water and diesel levels on the dashboard (« Navigation instr » switch on the electrical panel).
- 7 Check that there are no fuel or gas vapours inside the engine compartments.
- 8 Switch on the electronic appliances on the electrical panel (a).
- 9 Check that the switch for the bilge pumps, at the electrical panel, is in the position "AUTO".
- 10 Open all gas valves (bottle (d) and appliances (b)).
- 11 Open the diesel tanks valves (c). Located under the bed frame on the port aft.
- 12 Check the navigation lights work before night sailings:
 - › Mast (e)
- 13 In strong winds, fix all mobile elements.

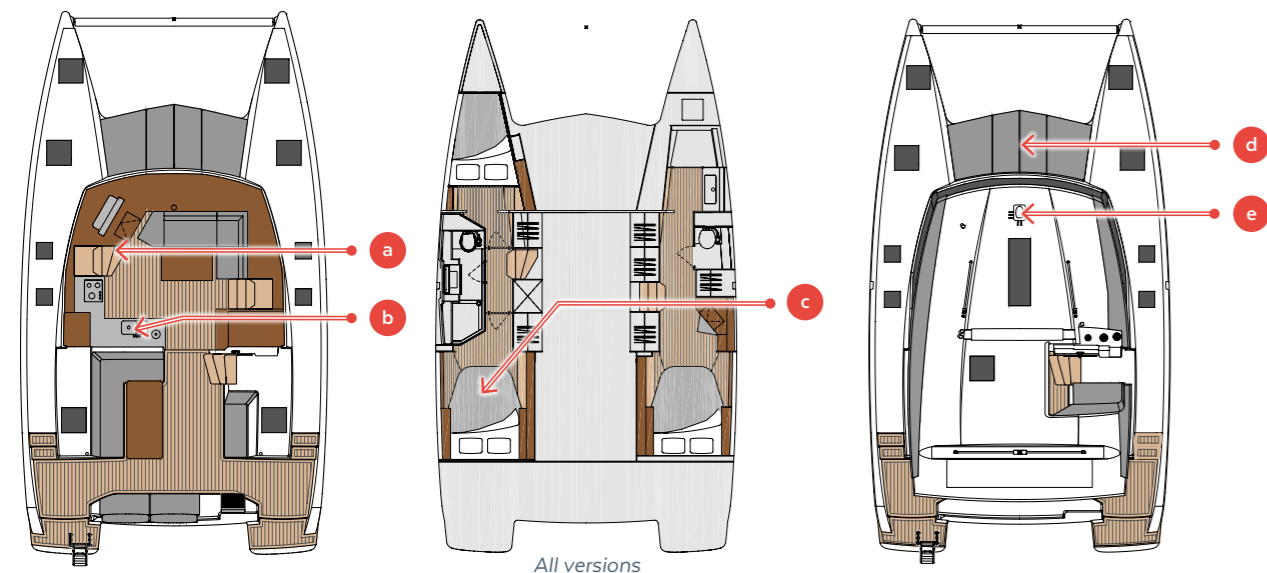

- a › Electrical panel
- b › Gas valves
- c › Diesel valves
- d › Gas locker
- e › Mast

STARTING THE ENGINES

- 1 Check the engine and base levels every month. (See paragraph maintenance)
- 2 Check the opening of the seawater intake valve on the engine base in the engine compartments.
- 3 Volvo engines: EVC System:
 - › Activate the EVC system by pressing on the ON/OFF button.



WARNING

The EVC control panel cannot be deactivated if an engine is running.



STARTING THE ENGINES (NEXT)

Common maneuvers to different engines:

- 4 Clutch, position the lever 1/2 forward.
- 5 Start by pressing the START button and let the engines run for 5 min at 1000 rpm (reduced speed) to warm up the engines.

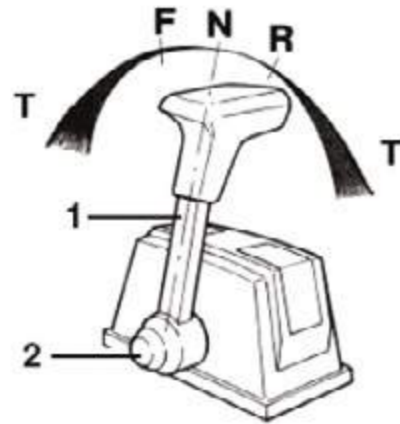

- N : Neutral position
- F : Forward
- R : Reverse
- T : Acceleration
- 1 : Lever
- 2 : Clutching

WARNING

- › Never activate the motor starter more than ten seconds to start up the engines as water may get into the exhaust and damage the engines.
- › Before starting a sails navigation, consult the engine supplier's manual.
- › Ensure that the ventilation openings are clear.
- › When navigating, the lever must be in neutral position (N)

- 6 Check that the cooling system is coming out of the exhaust.



SAILING

Sail reduction table according to apparent wind

		Beating and close reaching	Tailwind and broad reaching		Beating and close reaching	Tailwind and broad reaching	
MAXIMUM SAIL AREA		0 - 18 knots	0 - 15 knots	MAINSAIL 3 REEF GENOA 1/3		30 - 35 knots	25 - 30 knots
MAINSAIL 1 REEF GENOA 2/3		18 - 25 knots	15 - 20 knots	MAINSAIL 3 REEF GENOA 1/5		35 - 40 knots	30 - 35 knots
MAINSAIL 2 REEF GENOA 1/2		25 - 30 knots	20 - 25 knots	MAINSAIL DOWN GENOA 1/10		> 40 knots	> 35 knots

Using the asymmetrical spinnaker or the genaker (optional):

The asymmetrical spinnaker and the genaker are sails that are designed to be used in downwind and apparent wind blow 15 knots.

They must be stored:

- In apparent winds, over 15 knots
- When docked
- When anchored
- When not used whilst sailing

WARNING

Never attach on the front points but on the bowsprit.

SAILING (NEXT)

Reefing

Automatic reef system (reef 1):

- 1 Release slightly the mainsail sheet.
- 2 Release the mainsail's halyard to lower the tack of the reef 1 at 20cm of the boom.
- 3 Haul up the furling line.
- 4 Haul up the mainsail's halyard if it is necessary so that the tack point is at 10cm approximatively above the boom.

Classic reef system (reef 2 et 3):

- 1 Release the mainsail sheet.
- 2 Release the mainsail's halyard.
- 3 Strap the tack point.
- 4 Haul up the mainsail's halyard.
- 5 Haul up the reef.

WARNING

The topping lift must be haul up in order to have an angle between the boom and the mast of 90°**max**.

For more information, please refer to the drawings:
 - DDF_ACC_057_001
 - DDF_LDV_ACC_057
 - DDF_PIE_057_036

ARRIVING IN A HARBOUR

- 1 **Turn-off the engines**
Switch-off the engines by pushing the STOP button, then press the ON/OFF button to deactivate the system.
- 2 **Disconnect all the functions** on the electrical panel.
- 3 **Close all the gas supply valves** (bottle and appliances).
- 4 Check that the water has been drained from the bilges.
- 5 **Disconnect the battery circuit breaker** when stopped for a long period.
- 6 **Close the diesel tank valves** when stopped for a long period.

ANCHORAGE

Start the starboard engine (1500 rpm).

The windlass is controlled using the remote control in the anchor well.

Setting up the anchor

- 1 **Unhook the safety hoist**.
- 2 **Drop the anchor and chain** to a few meters from the final length desired.
- 3 **Hook the chain to the bridle snap hook** available in the anchor well.
- 4 **Drop the end of the length of chain desired** until the anchoring tension is picked up by the bridle.

WARNING

Always let the engines run idle for a few minutes before shutting them down completely.



ANCHORAGE (NEXT)

Raising the anchor

- 1 Start the starboard engine.
- 2 Raise the anchor to the bridle snap hook and undo the snap hook from the bridle.
- 3 When raising, check that the chain enters the well properly in order to avoid the chain blocking.
- 4 Raise the anchorage slowly, checking that the anchor is placed correctly in its davit.
- 5 When the anchor is close to the davit, check that the tip moves into the roller in the right direction.
- 6 Block the chain by pulling hard on the security hoist: this will jam the anchor on the davit and prevent it to damage davit or hulls.
- 7 Clamp the hoist to avoid the anchor moving on the davit.

WARNING

During the operation, stay away from the windlass and the chain and make sure that you protect your hands and feet.
Keep an eye whilst rising the chain in order to not damage the hull.

WARNING

If the force required by the windlass is too important, the breaker is triggered. Reset it to restart the windlass (accessible in starboard engine compartment).

MOORING AND TOWING

For mooring, the anchor points are the 6 cleats (a) :

- 2 x front
- 2 x middle
- 2 x aft

The cleats have a resistance of around 6000kg. They are designed for a Ø18 polyamide rope.

For towing, use the 2 front cleats to attach a Ø18 polyamide rope like a snap rope.

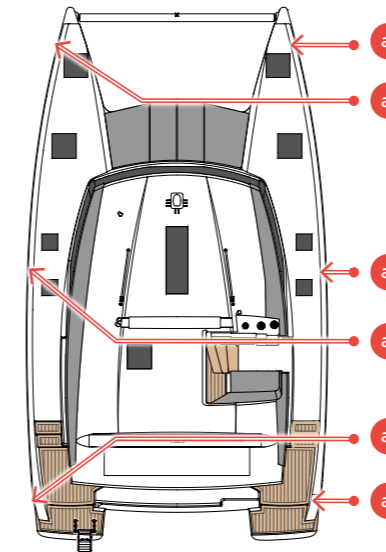

a > Mooring cleats





Equipments

3

- › Deck 22 - 24
- › Hull/saloon 25 - 29

Equipments

3

DECK

Deck shower

The deck shower (a) is located on the starboard transom. It is switched on by two valves (b) and activated by a mixer just beside it.

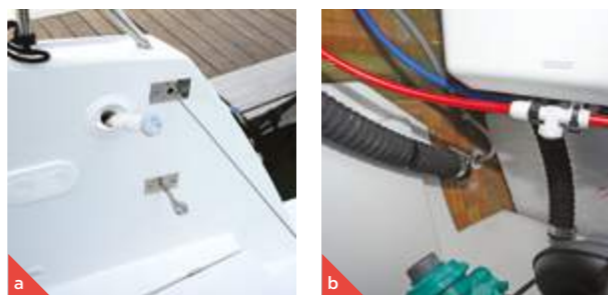
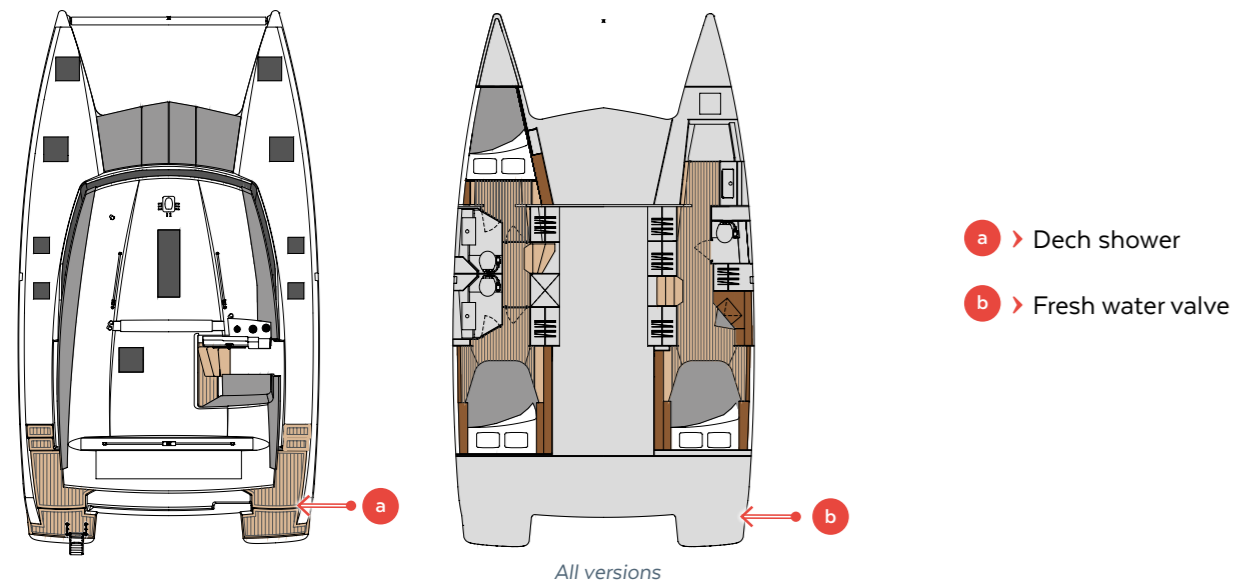

Solar panels (optional)

The boat can be fitted with 3 solar panels (a), fixed behind the mainsail rail, on the bimini.

The 12V connection is done on the service battery pack (b). The solar panels are protected by a specific circuit-breaker (c).

For use and maintenance, please refer to the manufacturer's manual.

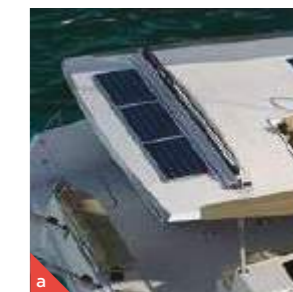
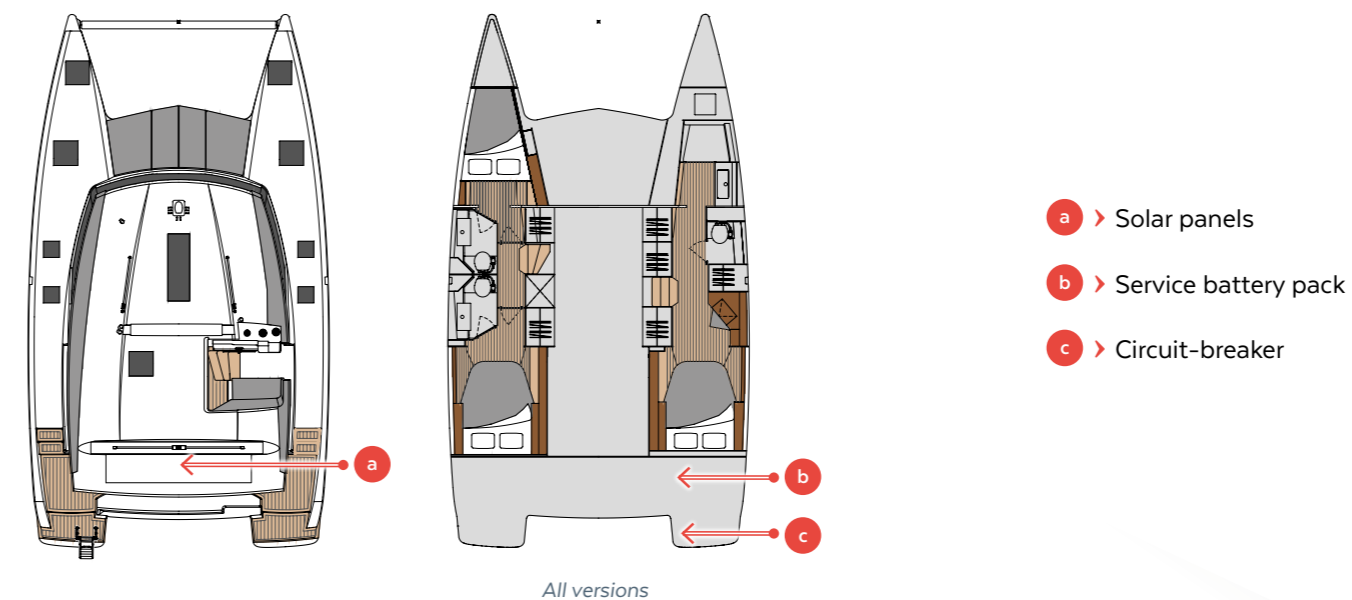

Equipments

3

DECK (NEXT)

Electric winches (optional)

MAINSAIL HALYARD WINCH

This winch is connected to the service battery pack and run on the 12V network. It is protected by a 120A circuit-breaker.

DAVIT WINCH

This winch is connected to the service battery pack and runs on the 12V network. It is protected by a 120A circuit-breaker.

For use and maintenance, please refer to the manufacturer's manual.

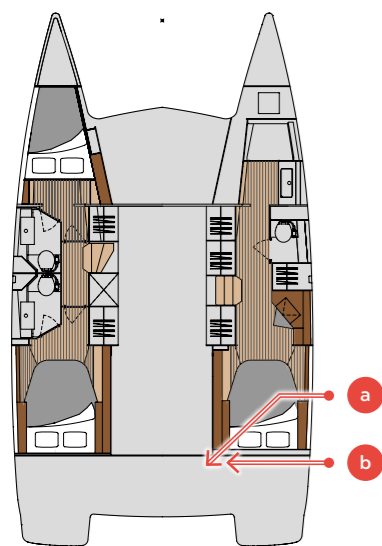

All versions

- a > Davit winch circuit breaker
- b > Mainsail winch circuit breaker

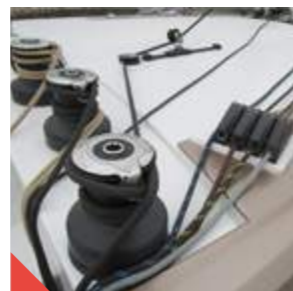

HULL/SALOON

2-drawer galley refrigerator 190L

Check the service battery pack charge status on the battery controller at the chart table.

Turn on the « refrigerator » switch on the electrical panel (g).

Set the cooling thermostat to the temperature required.

The fuse box is located under the saloon bench (d).

For use and maintenance, see the manufacturer's manual.

90L galley freezer or 130L refrigerator (optional)

Turn on the « refrigerator » switch on the electrical panel.

Set the freezer thermostat to the temperature required.

The fuse box is located under the chart table in the saloon (e).

For use and maintenance, see the manufacturer's manual.

Additional cockpit refrigerator 30L (optional)

This is turned on via the thermostat.

Set the refrigerator thermostat to the temperature required.

The fuse box is located under the saloon bench (f).

For use and maintenance, see the manufacturer's manual.

For more information, please refer to the drawing DDF_ELC_057_733

WARNING

If the service battery charge level is $\leq 11.7V$, the refrigerator switches to safety.

Follow these instructions to minimize the 12V energy consumption:

- > Set the refrigerator thermostat to the minimum necessary.
- > Minimise door opening.
- > Keep the refrigerator well filled.
- > Defrost the refrigerator regularly.

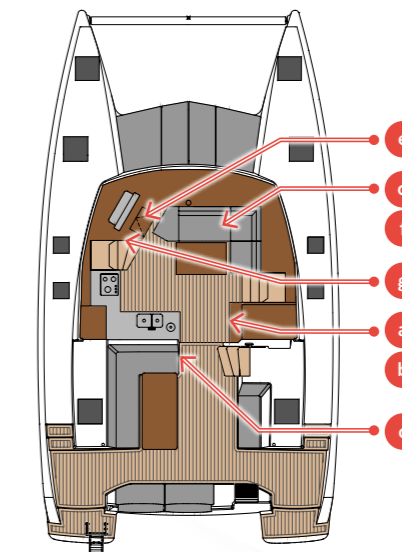

- a > Galley refrigerator
- b > Galley refrigerator / freezer (optional)
- c > Cockpit refrigerator (optional)
- d > Galley refrigerator fuse
- e > Galley refrigerator / freezer fuse (optional)
- f > Cockpit refrigerator fuse (optional)
- g > Electrical panel

Equipments

3

HULL/SALOON (NEXT)

Power generator (optional)

The boat can be fitted with a power generator (c). The power generator is powered with the port diesel tank.

The generator runs using a 12V independent battery. The battery is charged by the generator.

- 1 Switch on the generator's circuit breaker (a) before starting it.
- 2 The generator can be started in the port engine compartment or at the chart table in the saloon beside the electrical panel.

The generator always has priority over the dock line.

The dock/generator switch is selected automatically.

For use and maintenance, see the manufacturer's manual.

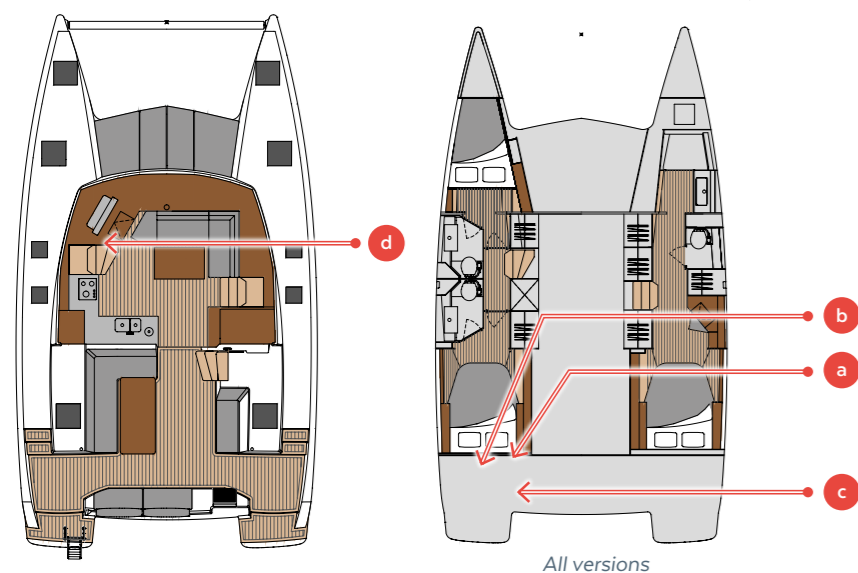

- a > Circuit breaker
- b > Sea water valves
- c > Power generator
- d > Remote control

WARNING

The power generator must not run empty as it may destroy the pump.



Air conditioning (optional)

The boat can be fitted with air conditioning. Before getting started, open the sea water valves then check that the boat is connected to the dock or that the power generator is running.

Each station is supplied by a specific line added on the AC network circuit breaker.

For use and maintenance, please refer to the manufacturer's manual.

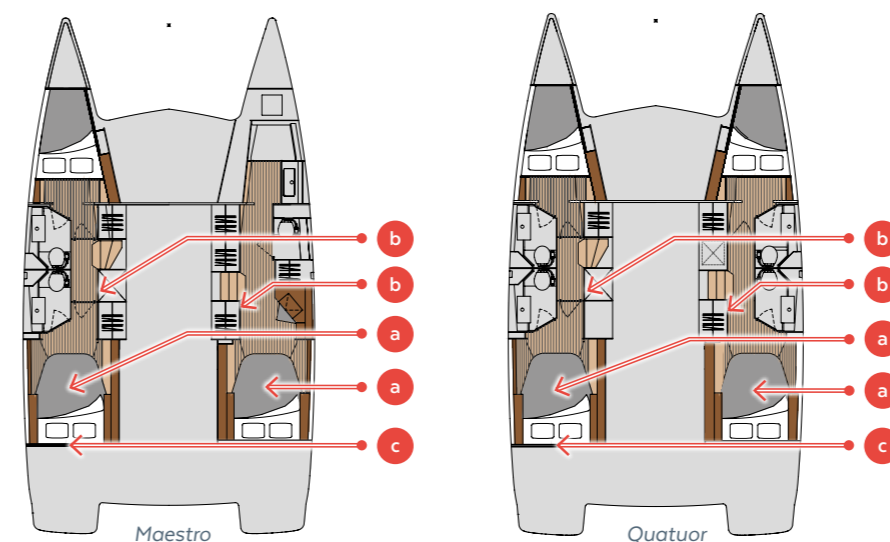

- a > Air conditioning station
- b > Control panel
- c > Circuit breakers

WARNING

The air conditioning must not run empty as it may destroy the pumps.

Equipments

3

HULL/SALOON (NEXT)

Heating (optional)

The boat can be fitted with a diesel heating by heat transfer fluid in option. Before getting started, check the opening of the port diesel tank supply valve.

Switch on the heater tank via the switch on the electrical panel.

Each cabin is fitted with a control panel and can manage its heating.

For use and maintenance, please refer to the manufacturer's manual.

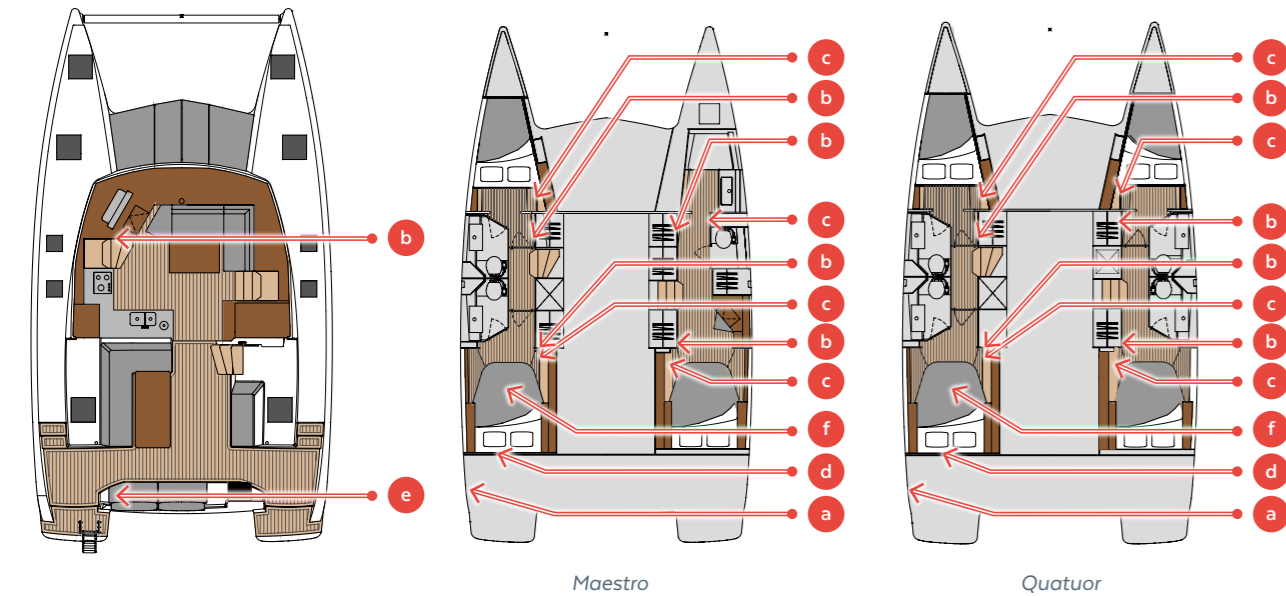

- a > Heater tank
- b > Heating control
- c > Heaters
- d > Heater tank circuit breaker
- e > Diesel tank deck filler
- f > Diesel tank

Watermaker (optional)

The boat can be fitted with a watermaker, located in the starboard engine compartment.

A 12V specific line supplies the watermaker. This line is connected to the service circuit breaker in the starboard engine compartment.

For use and maintenance, please refer to the manufacturer's manual.

WARNING

Using the watermaker at the harbor may damage filters/membranes.

The watermaker must not run empty as it may destroy the low-pressure pump.

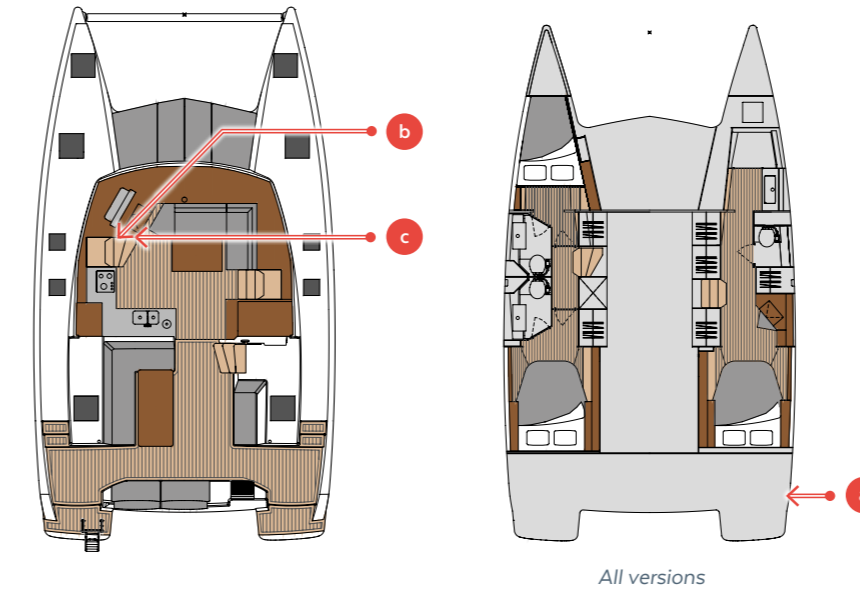

- a > Watermaker
- b > Remote control
- c > Electrical panel





LUCIA
40

Systems

4

- › Steering system..... 32
- › Electricity..... 33 - 35
- › Gas circuit..... 36
- › Water..... 37 - 45

STEERING SYSTEM

- › The steering system is a pull/pull system consisting of a steering wheel which activates two cables connected to the starboard rudder which is joined to the rudder head.
- › The port rudder is linked to the starboard rudder via a transverse link tiller.
- › Periodic check to be performed: Check the slack of the different parts (rudder head, rudder, crossbar, tension of the steering cables) and grease balls joints if necessary.
- › **Setting of the tension of the steering cables are done at the cupboard above the starboard staircase.**

The emergency tiller is secured at the top of the port OR starboard rudder head.

It is only designed for sailing at reduced speed in the event of a damaged helm.

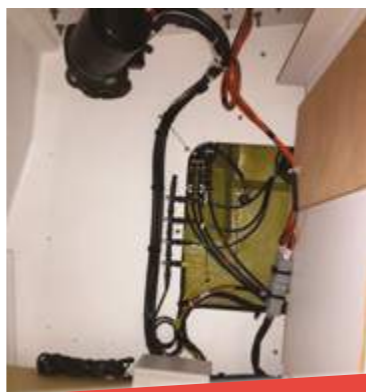

Hatch of the helm

WARNING

The emergency tiller is stored in a locker and must be easy accessible in all conditions.

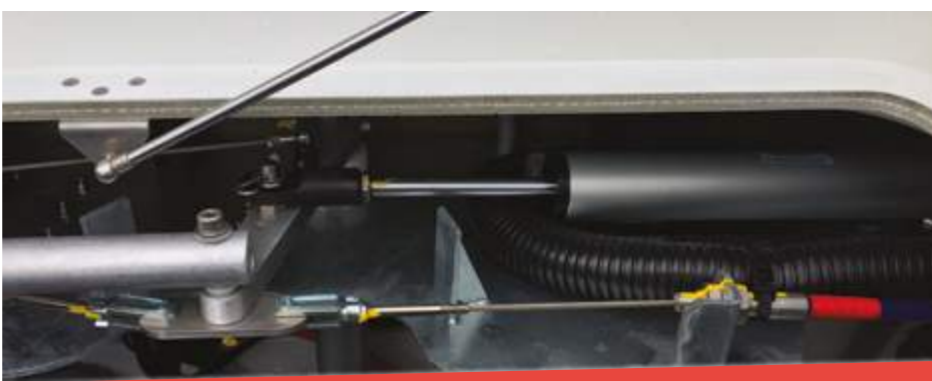

Automatic pilot

For more information, please refer to the drawing DDF_ACC_057_007

Automatic pilot GARMIN (optional): The boat can be fitted with an automatic pilot GARMIN. The pilot fuse is located in the management box in the starboard engine compartment. The fuse of the control screen at the chart table is located under the chart table and the fuse of the control screen of the helm station is located under the saloon bench.

ELECTRICITY

12V DC engines network

The on-board power is produced by the engine alternators (115Ah) and stored by 12V DC batteries.

The batteries are separated into 2 separate packs:

- › Starboard engine/service battery pack = 4 x 115 Ah + 1 x 115 Ah (optional)
- › Port engine battery pack = 1 x 50 Ah

The port engine battery powers:

- › The port engine only.

The starboard engine battery pack powers:

- › The starboard engine.
- › All the 12V functions on the electrical panel.

The 2 fuses panels are positioned as follows:

- › 1 under the saloon bench.
- › 1 under the chart table in the saloon.

The content of each box is detailed on the lid.

For more information, please refer to the drawing DDF_ELC_057_733

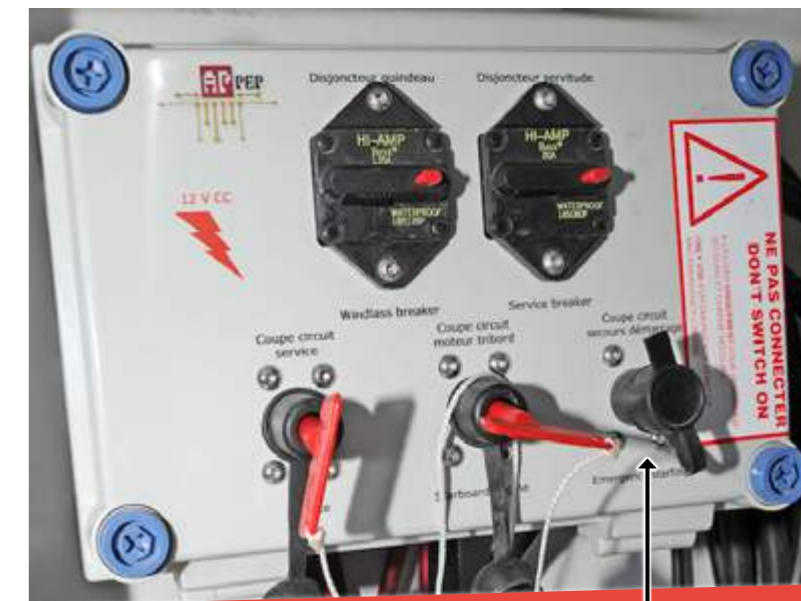

Backup/start-up circuit breaker

WARNING

Battery coupling :

- › The coupling between the service battery pack and the engine battery is triggered when the voltage on one of the packs exceeds 13,2V.
- › The coupling is maintained until the pack voltage falls below 12,8V.
- › When the voltage is below 12,8V, the coupling is interrupted and the port engine battery is then isolated from the service pack.
- › The BACKUP/START-UP circuit breaker (for right) permits the coupling of the battery packs. If one of the engines doesn't start, switch on the circuit breaker. When the engine is running, switch off directly the circuit breaker.

ELECTRICITY (NEXT)

220V / 110V AC network (optional)

The 220V or 110V AC network is powered by:

- Either a dock extension
- Either a power generator (optional)

The switching choice is automatic. The whole network is protected by a 30mA differential circuit breaker.

Each function is protected by a specific circuit breaker.

Connection of the dock extension:

- 1 Check the cable's condition. If the cable is damaged, replace it with an identical cable.
- 2 Connect the dock extension by rolling it out fully or start the power generator.
- 3 Check that the current is flowing using the light indicator on the 220V unit (or 110V depending on the chosen option).
- 4 Switch on the differential circuit breaker and the circuit breaker(s) for the function required.

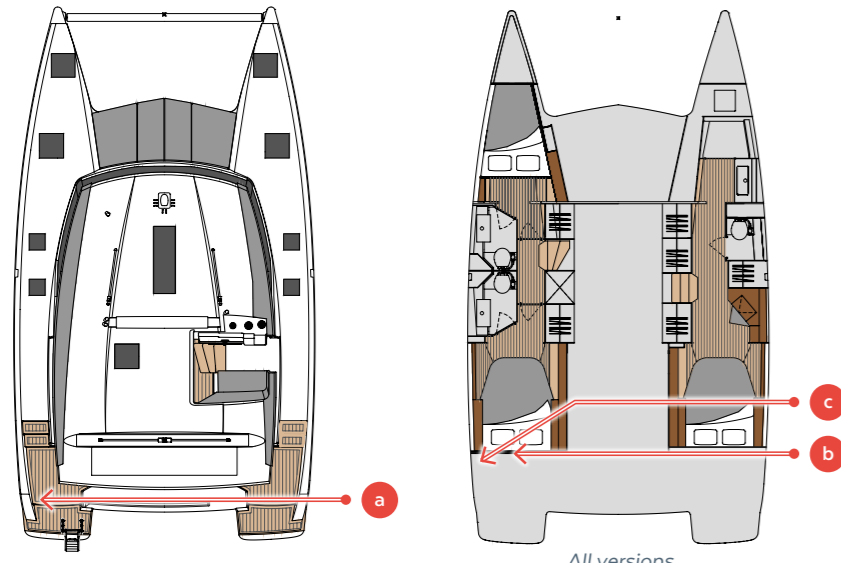

- a > Dock line
- b > 220 V circuit breakers panel
- c > 110 V circuit breakers panel
(depending on the chosen option)



WARNING

Never connect an extension with a damp plug.

Inverter charger 12V/220V or 12V/110V (optional)

The boat can be fitted with an inverter charger.

This inverter charger is powered with 12V by a service battery pack and protected by a circuit breakers panel.

For use and maintenance, refer to the manufacturer's manual

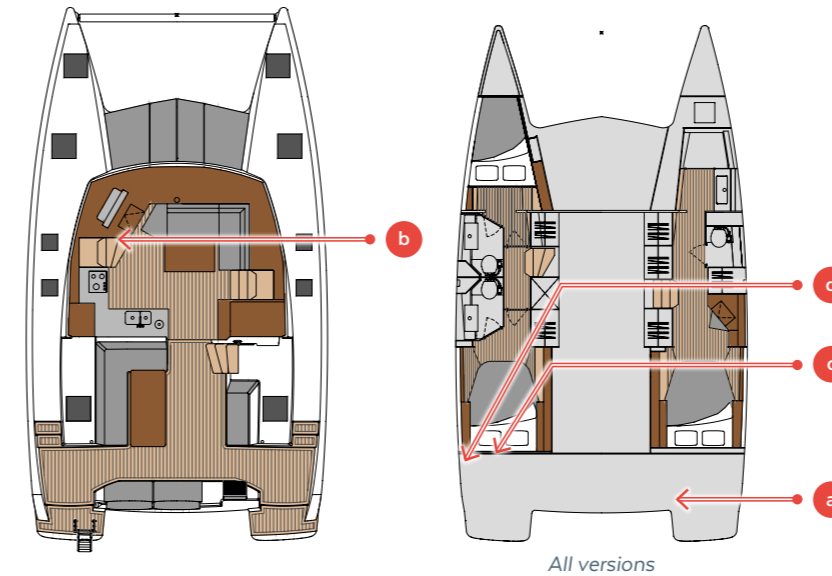

- a > Inverter charger
- b > Control panel
- c > 220V circuit breakers panel
- d > 110V circuit breakers panel



WARNING

During a long stop, put the loader on OFF mode on the chart table next to the electric panel.

GAS CIRCUIT

- 1 Open the pressure reducer shut-off valve (pressure reducer not supplied) attached directly to the gas bottle.
- 2 Open the shut-off valves of appliances (a) to used. They are located in the kitchen cupboard under the sink (valves open in the direction of the pipe).

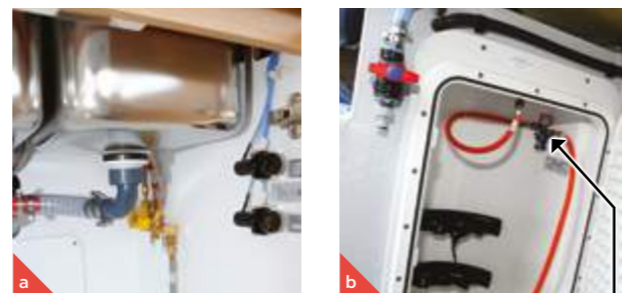
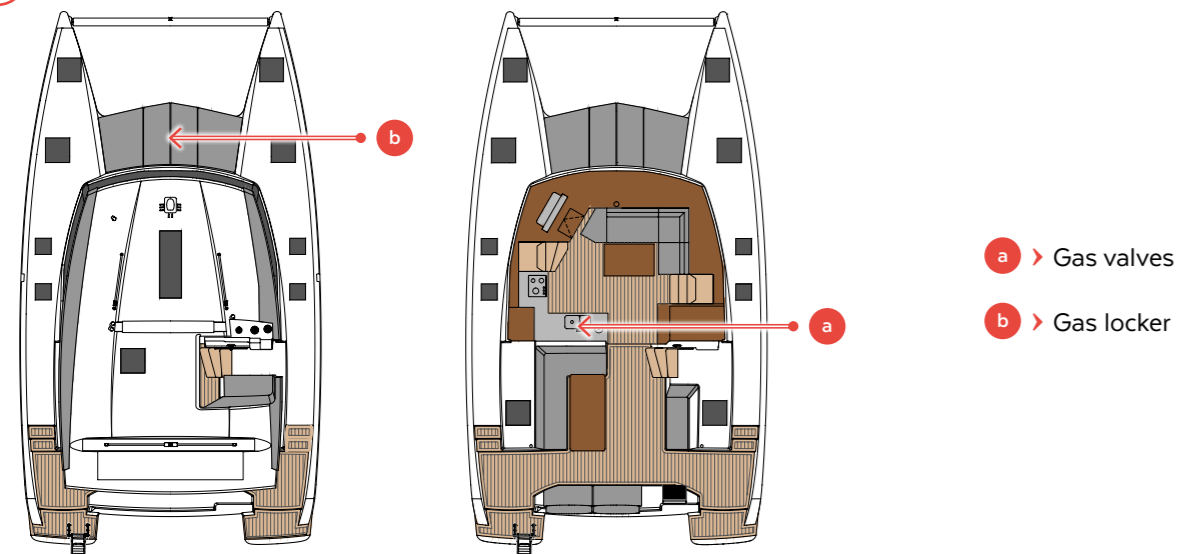

Gas leak detector

Each gas appliance has a safety system. To switch on, hold the button down.

A gas leak detector is installed in the fore technical compartment.

When all valves are shut-off, push on the top of the detector (as on the scheme), if bubbles appear, there is a leak in the gas circuit.



WARNING

- > The bottles are butane.
- > Ventilate well when using the cooking hob.

For more information, please refer to the drawing DDF_PLB_057_870

WATER

Fresh water circuit

- 1 Open circuit's main valve for the tanks to supply the water circuit (accessible in the anchor well).
- 2 Check that the hot water tank supply valve (a) is open at all times.
- 3 Switch on the fresh water pump function on the electrical panel.

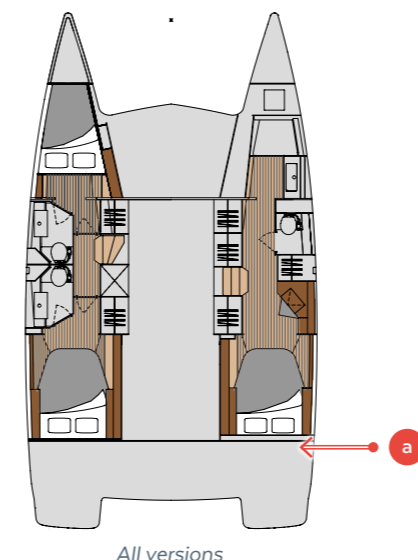

WARNING

The hot water tank must not run empty.

For more information, please refer to drawings DDF_PLB_057_805 and DDF_PLB_057_807

WATER (NEXT)

Sea water circuit (optional)

The boat can be fitted with an optional sea water circuit which supplies the kitchen sink and the anchor well with sea water.

Process :

- 1 Open the sea water intake valve located at the bottom of the port staircase. (the floor hatches open using suction cups.)
- 2 Switch on the sea water pump function on the electrical panel at the chart table.



Seawater intake valve



Using the toilets

The toilets are fitted with a holding tank.

MANUAL WC

- 1 The evacuation valve must be closed while in the harbour.
- 2 Check that the sea water intake valves are opened (the floor hatches open using suction cups).
- 3 Set the WC lever into « water intake » position.
- 4 Pump at least 10 times to flush and dilute the black water.
- 5 Set the WC lever into « flushing » position.
- 6 Pump a few times to empty the bowl completely.
- 7 Repeat the operation at least twice.



1 Evacuation valve



2 Seawater intake valve



5 WC lever into position « water intake »



3 WC lever into position « flushing »

WATER (NEXT)

SEA WATER SUPPLY

1 valve (a) in each toilet located under staircase floor.

EVACUATION

1 evacuation valve (b) per bathroom, accessible by the hatches located in each shower.

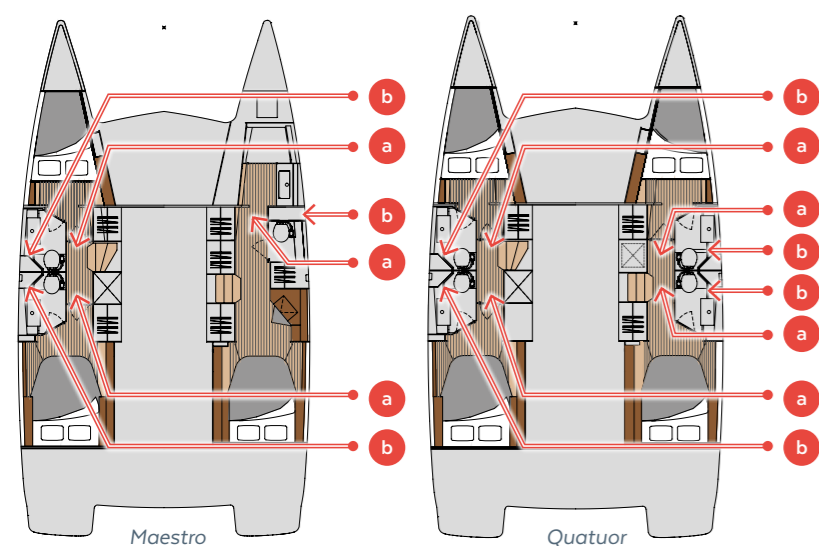

- a** > Seawater intake valves
- b** > Evacuation valves

ELECTRICAL WC (OPTIONAL)

The boat can be fitted with electrical WC. These WC are protected by a 25 A circuit breaker.

The starting-up is initiated by a switch beside each toilets.

For more information, please refer to drawings DDF_PLB_057_805 or (depending to the layout version) DDF_PLB_057_807 and DDF_ELC_057_733

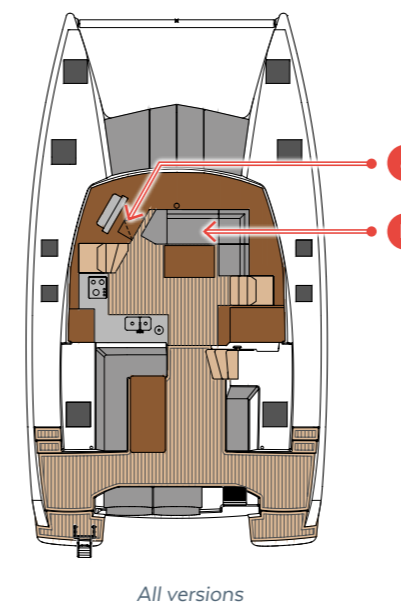

- a** > Port toilets fuses box
- b** > Starboard toilets fuses box



WARNING

Do not throw anything in the WC as it may block the check valves.

WATER (NEXT)

Using the holding tank

The black waters are stored into a holding tank.

Each WC is connected to its own holding tank.

DRAIN THE HOLDING TANK REGULARLY :

- 1 **In High sea**
By evacuating the black water into the sea : open the evacuation valve.
- 2 **When docked:**
By pumping the "waste" deck fillers.

For more information, please refer to the drawing DDF_PLB_057_808

WARNING

Never force the pump.
Storage capacity : 45L.

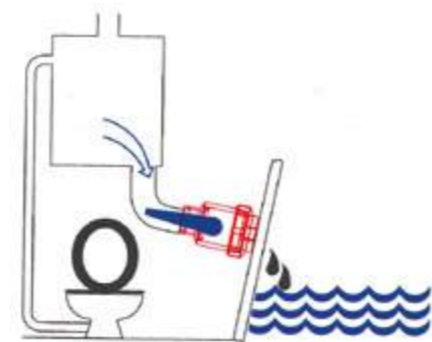

OFFSHORE SAILING DRAINING
HOLDING TANK OPENED

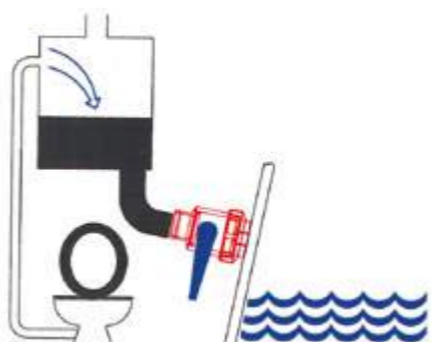

HARBORS AND MOORINGS CLEAN
HOLDING TANK CLOSED

Shower drainage

Each hull is fitted with a lift pump (a).
These pumps are protected by a 10A circuit breaker.

The shower drains automatically. The grey water is stored in a tank under the staircase floors which evacuates directly into the sea.

The necessary cleaning of these tanks and their sensors is done thanks to a screwed hatch.

For more information, please refer to drawings
DDF_PLB_057_805 ou (selon la version) DDF_PLB_057_807 et
DDF_ELC_057_733

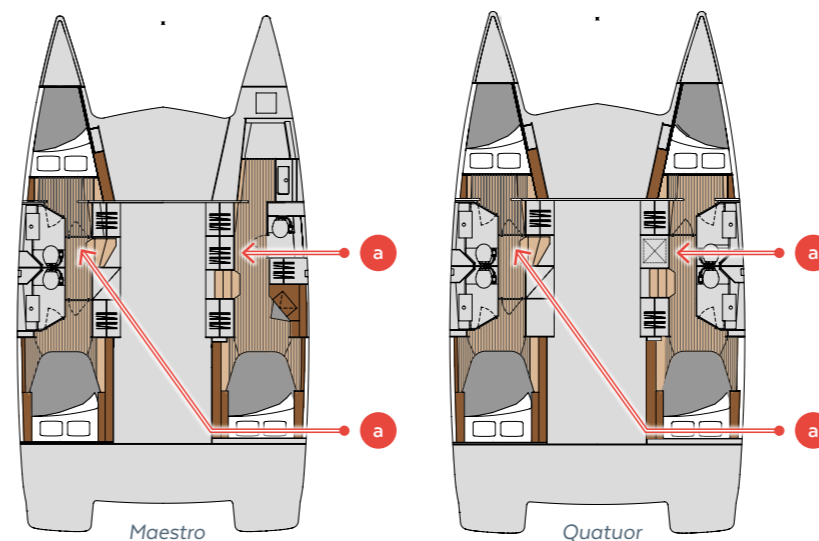

a > Grey water lift pumps

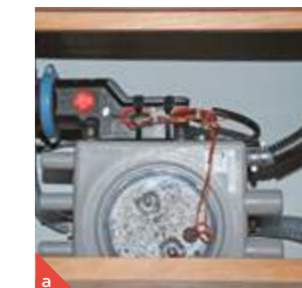

WATER (NEXT)

Sink evacuation

1 drain valve per sink, accessible by a hatch beside the toilets.

The bathrooms sink drains directly out to the sea.

For more information, please refer to drawings DDF_PLB_057_805 or (depending to the layout version) DDF_PLB_057_807

Bilge pumping

MANUAL BILGE PUMP (STORED IN THE PORT AFT COCKPIT LOCKER)

The manual pump is located on the front of the port aft cockpit bench. A pipe connected inside the locker must be unrolled in order to drain the desired areas. When the pipe is connected to the desired strainer, pumping can be done by using the manual pump. (See diagram p45)

For more information, please refer to drawing DDF_PLB_057_806

ELECTRICAL BOAT PUMP

Check operation before navigation.

The boat is fitted with 4 electric bilge pumps with an automatic trigger:

- > 1 per engine compartment
- > 1 per hull

Activate the switch on the electrical panel (2 possible positions):

1 / AUTO position:

The bilge pumps are triggered automatically if any water gets in and their operation is indicated by an alarm. In this position, the pumps can start even if the circuit-breakers are open.

2 / FORCED RUN position:

The bilge pumps are triggered manually by activating the switch on the electrical panel.

Set the switch back into AUTO position when draining is completed.

(See diagram p45)

Bilge pumps diagram

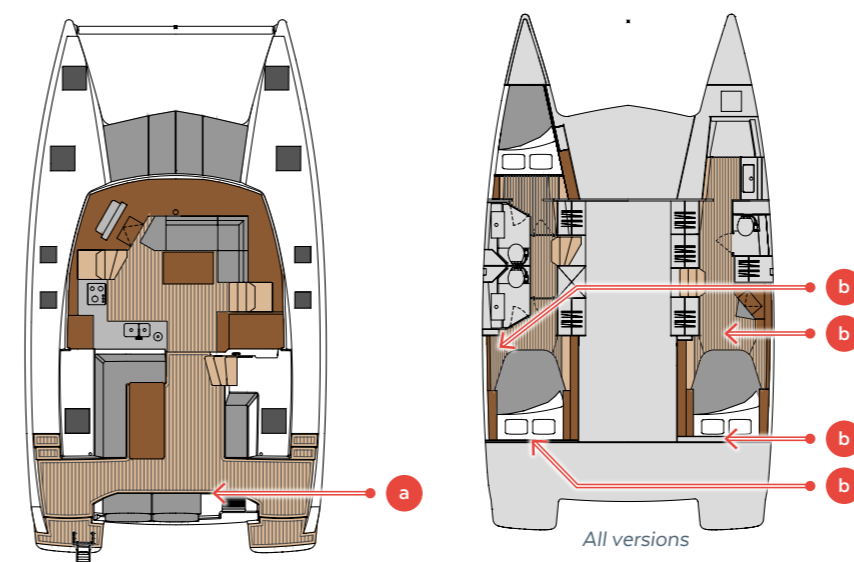

For more information, please refer to drawings DDF_PLB_057_806

a > Manual pump

b > Electrical pumps

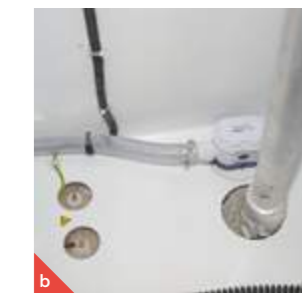



LUCIA
40

Manoverboard prevention and man recovery

5

Manoverboard prevention and man recovery

5

While navigating, it is recommended to move around only in the deck areas designed for this purpose. These areas (sidewalks, cockpit, roof, mast step, etc.) are covered with an antiskid surface or teak covering which allows the crew to move on the boat in a secure way.

It is also recommended, according to sea or wind conditions, to wear safety harnesses and use the various securing points on the deck that are mentioned in the deck drawing DDF_ACC_057_018 available in annex.

The LUCIA is fitted with a stern ladder designed to allow a person to climb back on board.





LUCIA
40

Fire protection

6

Fire protection

6

Fire extinguishers are subject to national regulations; therefore, they are not supplied with the boat.

While in use, the boat must be fitted with portable extinguishers.

For more information, please refer to drawings DDF_AME_057_014 or (depending to the layout version) DDF_AME_057_015

WARNING

If you choose to install a carbon dioxide extinguisher, it can only be installed in areas with powered up electrical equipment (for example electrical engines, battery compartment, electrical panels, etc.) or flammable liquids (like in the galley).

Only compatible replacement parts should be used for the fire protection system. They must have the same indications and be technically equivalent.

The engine compartment's fire extinguisher outlets are situated at the bed heads in the two rear cabins (behind the mattresses).

In order to access this outlet, it is necessary to move the mattress. Then punch through the outlet with the fire extinguisher's hose and trigger the extinguisher according to the manufacturer's instructions.



Fire extinguisher outlet port engine compartment



Fire extinguisher outlet starboard engine compartment



Preparing the winter season & Handling

7

- › Water circuit.....56
- › Outside.....56
- › Engines.....56
- › Preparation.....56
- › Craning.....56

Preparing the winter season & Handling

7

PREPARING THE WINTER SEASON

WATER CIRCUIT

- › Empty all water circuits and protect the boat from the rain.
- › Check that the batteries are fully charged.
- › Drain fresh water and waste tanks and the water heater in order to prevent frost and pollution problems.
- › Should the waste tank not be used for more than a month, drain it, rinse it, and fill it with fresh water and antibacterial product.

HANDLING

PREPARATION

For more information, please refer to drawing DDF_ACC_057_011.

CRANING

During the craning, check that the straps are neither located on any equipment (sounder, speedo...) nor on the propellers.

OUTSIDE

- › Drain the deck shower.
- › Rinse the hull and deck thoroughly.
- › Prevent rubbing of ropes and moorings.

ENGINES

- › To protect the engines, please refer to the manufacturer's recommendation.
- › The wintering of the engines must be carried out by a professional.
- › Depending on the location of the boat (on land or afloat) wintering is different.

WARNING

For any craning operation, call on a professional crane operation.
Never park under the boat.
Masting and bringing down the mast must be carried out by a professional.





LUCIA
40

Maintenance

8

- › Drainage.....60
- › Running rigging, sheets and ropes.....61
- › Periodic maintenance chart.....62 - 64

Maintenance

8

PERIODIC MAINTENANCE CHART

Deck/Deck fittings/Hulls

	MAINTENANCE
Carreening and antifouling, rudder's checking	ANNUALLY
Cleaning stainless steel parts	MONTHLY
Cleaning the hulls	QUARTERLY
Cleaning the teck and checking the seals	MONTHLY
Disassembling, cleaning and greasing the winches	QUARTERLY
Rinsing/greasing sliding doors and hatches	QUARTERLY
Check structural partitions and ring frames	ANNUALLY
Check the tightening of mooring cleats	In the first 3 months then ANNUALLY

Running rigging, sheets and ropes

	MAINTENANCE
Maintenance of the mainsail rail and trolleys	MONTHLY
Check tips of arrow bars	ANNUALLY
Check and greasing pulleys	MONTHLY
Check ends of halyards	ANNUALLY
Check the turnbuckles and crimping of shrouds	ANNUALLY
Check shackles and blockers	IN USE/QUARTERLY

Saddlery and protection

	MAINTENANCE
Cleaning outer canvases	ANNUALLY
Check pillows and canvases fixing	IN USE
Cleaning plastic windows	AFTER USE
Drying outer saddlery before storage	AFTER USE
Check the full length of the shroud's sheaths	ANNUALLY

	MAINTENANCE
Check the running rigging (wear points)	IN USE/QUARTERLY
Cleaning - rinsing the running rigging	ANNUALLY
Check and rinsing of sails	IN USE
Complete check of the rigging	ANNUALLY
Check the blocking of the mainsail's shackle	ANNUALLY
Check and tightening gardrails	QUARTERLY

WARNING

Never use the mainsail's halyard but the lift's halyard for climbing the mast.

Anchorage / windlass

	MAINTENANCE
Check the brake system and windlass sprocket	IN USE
Fresh water rinsing of the anchorage line and the anchor well	AFTER USE
Check the anchorage lights	IN USE
Check the mooring line and fenders	IN USE
Check the windlass relay and electrical connections	ANNUALLY
Check the tightening of windlass	BI-ANNUALLY
Check the davit	ANNUALLY
Check the chain swivel	QUARTERLY
Reverse the chain	QUARTERLY

Refrigeration system

	MAINTENANCE
Defrost refrigerators and freezers	IN USE
Check door seals	QUARTERLY

Engines

	MAINTENANCE
Check fluid levels (oil, cooling)	IN USE
Clean sea water filters	MONTHLY
Check fuel filters - decanters	IN USE
Check tensions and the belts' condition	IN USE
Check hull anodes, engine bases and propellers	MONTHLY
Complete check	SEE MANUFACTURER'S INSTRUCTIONS

Steering system

	MAINTENANCE
Check the cable level	MONTHLY
Greasing of steering system	QUARTERLY
Check rudder bearings	ANNUALLY
Check the oil level of autopilot	MONTHLY
Change the autopilot oil	SEE MANUFACTURER'S INSTRUCTIONS

Electricity

	MAINTENANCE
Check/tightening/greasing cable lugs and power connectors	QUARTERLY
Check navigation lights and outdoor lighting	IN USE/IN THE BEGINNING
Clean of speedo - sounder- loch	MONTHLY

Power generator (optional)

	MAINTENANCE
Clean sea water filters	MONTHLY
Check fluid levels (oil, cooling)	IN USE
Check belts	IN USE
Check leaks and fumes	IN USE
General check by manufacturer	SEE MANUFACTURER'S INSTRUCTIONS

Maintenance

8

Air conditioning (optional)

MAINTENANCE	
Clean suction strainers	IN USE
Clean sea water filters	MONTHLY
Check function pressures	IN USE
Clean condensers' collecting tanks	QUARTERLY
Check AC compressors	SEE MANUFACTURER'S INSTRUCTIONS

Water maker (optional)

MAINTENANCE	
Check leaks and water quality	IN USE
Check sea water suction filters	MONTHLY
General check by manufacturer	SEE MANUFACTURER'S INSTRUCTIONS
Clean suction strainers	ANNUALY

Plumbing

MAINTENANCE	
Test electrical and manual bilge pumps	IN THE BEGINNING/IN USE
Check water groups under pressure (leaks)	MONTHLY
Clean grey water collecting tanks' filters and suction strainers	IN THE BEGINNING/MONTHLY
Check/handling/greasing of ¼ turn valves	MONTHLY
Clean grey water collecting tanks' sensors	QUARTERLY
Rince black and grey water tanks	QUARTERLY
Clean suction strainers	MONTHLY
Check water heaters	SEE MANUFACTURER'S INSTRUCTIONS



FONTAINE PAJOT.
SAILING CATAMARANS

Share your emotions