

We've created a web site, just for YOU!

- Technical tips
- New product introductions
- Event schedules
- Parts and Service Manual information
- Exciting details about The Way Out

Check it out...

www.polarisindustries.com/owner



POLARIS®
The Way Out.

Copyright 2003 Polaris Sales Inc. All information contained within this publication is based on the latest product information at the time of publication. Due to constant improvements in the design and quality of production components, some minor discrepancies may result between the actual vehicle and the information presented in this publication. Depictions and/or procedures in this publication are intended for reference use only. No liability can be accepted for omissions or inaccuracies. Any reprinting or reuse of the depictions and/or procedures contained within, whether whole or in part, is expressly prohibited. Printed in U.S.A.

WELCOME

Thank you for purchasing a Polaris vehicle, and welcome to our world-wide family of Polaris owners. We proudly produce an exciting line of utility and recreational products.

Polaris Recreational Vehicles

- Snowmobiles
- All-terrain vehicles (ATVs)
- Watercraft
- *RANGER* utility vehicles
- Victory motorcycles

Polaris Professional Series Workmobiles™

- Utility Task Vehicles™ (UTVs)
- Personal Task Vehicles™ (PTVs)
- All-Surface Loaders (ASLs)

We believe Polaris sets a standard of excellence for all utility and recreational vehicles manufactured in the world today. Many years of experience have gone into the engineering, design, and development of your Polaris watercraft, making it the finest vehicle we've ever produced.

For safe and enjoyable operation of your watercraft, be sure to follow the instructions and recommendations in this owner's manual. Your manual contains instructions for minor maintenance, but information about major repairs is outlined in the Polaris Service Manual and should be performed only by a Factory Certified Master Service Dealer (MSD) Technician.

Your Polaris dealer knows your vehicle best and is interested in your total satisfaction. Be sure to return to your dealership for all of your service needs during, and after, the warranty period.

We also take great pride in our Parts Apparel and Accessories (PAA) products, available through our online store at www.purepolaris.com. Have your accessories and clothing delivered right to your door!

POLARIS and POLARIS THE WAY OUT are registered trademarks of Polaris Industries Inc.

WORKMOBILES, UTILITY TASK VEHICLE and PERSONAL TASK VEHICLE are trademarks of Polaris Industries Inc.

LOCTITE is a registered trademark of Loctite Corporation.

TABLE OF CONTENTS

WELCOME	3
TABLE OF CONTENTS	5
OPERATOR WARNING	6
IDENTIFICATION NUMBERS	8
SAFETY	9
CONTROLS	26
FEATURES	28
EMISSIONS REGULATION	44
OPERATION	46
MAINTENANCE AND LUBRICATION	82
SPECIFICATIONS	104
POLARIS PRODUCTS	108
ENGINE TROUBLESHOOTING	109
WARRANTY	112
INDEX	119

NOTE: Illustrations used in this manual are for general representation only. Your model may differ.

OPERATOR WARNING

Follow the recommended maintenance program outlined in your owner's manual. This preventive maintenance program is designed to ensure that all critical components on your vehicle are thoroughly inspected at specific intervals.

All information in this manual is based on the latest product data and specifications available at the time of printing. Polaris Industries Inc. reserves the right to make product changes and improvements that may affect illustrations or explanations. No part of this manual shall be reproduced or used without the written permission of Polaris Industries Inc.

WARNING

Failure to follow the warnings contained in this manual can result in severe injury or death. A Polaris watercraft is not a toy. It's a high performance powerboat and can be hazardous to operate. A collision or overturn can occur quickly if you fail to take proper precautions. Read and understand your owner's manual and all warnings before operating a Polaris watercraft.

Age Restrictions

This vehicle is an **ADULT VEHICLE ONLY**. Operation by anyone under 16 years of age is not recommended.

Know Your Vehicle

As the operator of the vehicle, you are responsible for your personal safety, the safety of others, and the protection of our environment. Read and understand your owner's manual, which discusses all aspects of your vehicle, including safe operating procedures. Familiarize yourself with all boating laws and regulations concerning the operation of the vehicle in your area.

OPERATOR WARNING

Safety Training

When you purchased your new Polaris watercraft, your dealer provided a watercraft safety video and this Owner's Manual. Please review this information on a regular basis. All operators and passengers should read and understand the owner's manual before riding.

Store the manual in a *waterproof bag* in one of the storage areas on the watercraft. If the vehicle is sold, the owner's manual and video tape should remain with it. If your owner's manual is lost or missing, see a Polaris dealer for a replacement.

Octane Watercraft

The information in this owner's manual applies to the safe operation of all personal watercraft, especially those designed for recreational use. The Polaris Octane engine and watercraft, however, were designed and built by Polaris solely for use in competition by qualified racers. Octane features, operating procedures, and maintenance practices will vary from those outlined in this owner's manual, and experienced and qualified racers should already understand the key differences related to the service and safe operation of a Polaris Octane watercraft. Octane owners may refer to the *Polaris Octane Service Manual* for more service-related information.

IDENTIFICATION NUMBERS

Your watercraft's hull and engine identification numbers are important for model identification when registering your watercraft, when obtaining insurance, and when ordering replacement parts. The hull ID is located on the rear boarding platform (1) (under the rub rail on the Octane). The engine ID number is located at the front of the engine near the stator cover (2).

Record your vehicle's ID numbers in the spaces provided and in another location away from the vehicle. If the vehicle is destroyed or stolen, you'll have the ID numbers required by insurance and/or law enforcement.

NOTE: Check with your insurance agent about obtaining insurance coverage for your watercraft, or see your Polaris dealer.

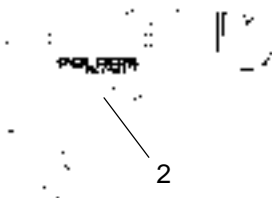
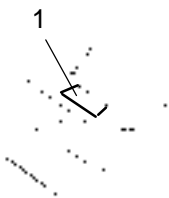

Purchase Date:

Vehicle Model Number:

Engine ID Number:

Hull ID Number:

Signal Words and Symbols

The following signal words and symbols appear throughout this manual and on your vehicle. Your safety is involved when these words and symbols are used. Become familiar with their meanings before reading the manual.



The *safety alert symbol*, on your vehicle or in this manual, alerts you to the potential for personal injury.

WARNING

The *safety alert warning* indicates a potential hazard that may result in serious injury or death.

CAUTION

The *safety alert caution* indicates a potential hazard that may result in minor personal injury or damage to the vehicle.

CAUTION

A *caution* indicates a situation that may result in damage to the vehicle.

NOTE:

A *note* will alert you to important information or instructions.

SAFETY

Safety Decals

Important warning and instruction decals have been placed on the watercraft for your protection. Read and follow the instructions on each decal carefully. If any of the decals depicted in this manual differ from the decals on your watercraft, always read and follow the instructions of the decals *on the watercraft*. If any decal becomes illegible or comes off, contact your Polaris dealer for a replacement. Any *safety* decal needing replacement will be provided by Polaris at no charge.

The warning decals summarize and highlight key safety and operational information. Be sure to read *all* of the owner's manual for details that affect safe operation of this watercraft.

General Safety/Warning Decal

This decal is located at the rear of the watercraft.



Octane Only



Safety Decals

General Safety/Warning Decal Text

To reduce the risk of SEVERE INJURY or DEATH:

WEAR A PERSONAL FLOTATION DEVICE (PFD). All riders must wear a Coast guard approved PFD that is suitable for personal watercraft (PWC) use.

WEAR PROTECTIVE CLOTHING. Severe internal injuries can occur if water is forced into body cavities as a result of falling into water or being near jet thrust nozzle. Normal swimwear does not adequately protect against forceful water entry into rectum or vagina. All riders must wear a wet suit bottom or clothing that provides equivalent protection (see Owner's Manual). Footwear, gloves and goggles/glasses are recommended.

KNOW BOATING LAWS. Polaris Industries Inc. recommends a minimum operator age of 16 years old. Know the operator age and training requirements for your state. A boating safety course is recommended and may be required by your state.

ATTACH ENGINE SHUT-OFF CORD (LANYARD) to wrist and keep it free from handlebars so that engine stops if operator falls off. After riding, remove cord from PWC to avoid unauthorized use by children or others.

(Octane decal only) **AVOID EXCESSIVE JET THRUST AND LIMITED VISIBILITY WHILE REBOARDING.** Get to riding position quickly and do not expose yourself to excessive jet thrust.

RIDE WITHIN YOUR LIMITS AND AVOID AGGRESSIVE MANEUVERS to reduce the risk of loss of control, ejection, and collision. This is a high performance boat-not a toy. Sharp turns or jumping wakes or waves can increase the risk of back/spinal injury (paralysis), facial injuries, and broken legs, ankles and other bones. *Do not jump wakes or waves.*

DO NOT APPLY THROTTLE WHEN ANYONE IS AT REAR OF PWC. Turn engine off or keep engine at idle. Water and/or debris exiting jet thrust nozzle can cause severe injury.

DO NOT OVERLOAD. It will significantly reduce stability and control. Never exceed rider or weight capacity. See capacity decal.

KEEP AWAY FROM INTAKE GRATE while engine is on. Items such as long hair, loose clothing, or PFD straps can become entangled in moving parts resulting in severe injury or drowning.

NEVER RIDE AFTER CONSUMING DRUGS OR ALCOHOL.

READ AND FOLLOW OWNER'S MANUAL. If Owner's Manual is missing, contact a Polaris Dealer for a replacement.

SAFETY

Safety Decals

Gasoline Warning Decal

The gasoline warning decal is located near the fuel tank fill cap.

⚠ WARNING	CAUTION
<p>Gasoline and its vapors are highly flammable and explosive.</p> <p>To avoid fire or explosion:</p> <ul style="list-style-type: none"> • Stop engine before refueling. • Refuel in a well-ventilated area away from open flames or sparks. • Do not overfill tank. • Pull up seat and open engine compartment before starting engine. Push down and latch compartment cover and replace seat before restarting engine. • Do not start engine if gasoline or vapors are present. 	<p>Every time you refuel, check engine oil. Running engine without oil will cause major engine damage.</p> <p style="text-align: right;">7170215</p>

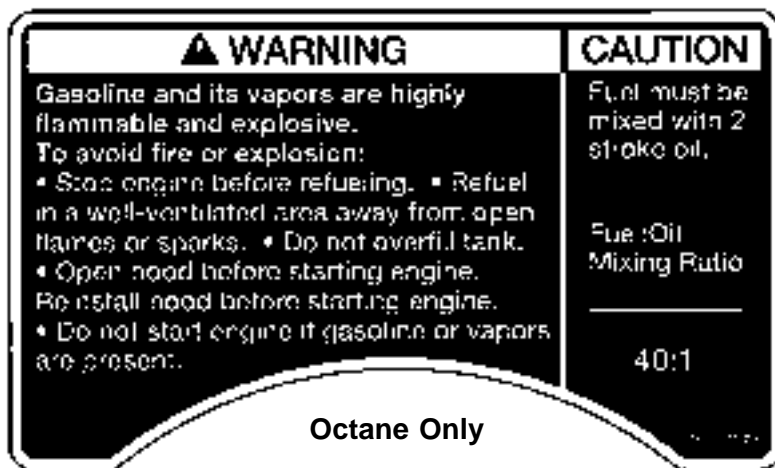

Safety Decals Collision Decal

The collision decal is located on the dash of your watercraft.



Octane Only

Collision Decal Text

Collisions result in more **INJURIES AND DEATHS** than any other type of accident for personal watercraft (PWC).

TO AVOID COLLISIONS:

SCAN CONSTANTLY for people, objects and other watercraft. Be alert for conditions that limit your visibility or block your vision of others.

OPERATE DEFENSIVELY at safe speeds and keep a safe distance away from people, objects, and other watercraft.

- Do not follow directly behind PWCs or other boats.
- Do not go near others to spray or splash them with water.
- Avoid sharp turns or other maneuvers that make it hard for others to avoid you or understand where you are going.
- Avoid areas with submerged objects or shallow water.

TAKE EARLY ACTION to avoid collisions. Remember PWCs and other boats do not have brakes.

DO NOT RELEASE THROTTLE WHEN TRYING TO STEER away from objects - you need throttle to steer. Always check throttle and steering controls for proper operation before starting PWC.

Follow navigation rules and state and local laws that apply to PWCs.

See Owner's Manual for more information.

SAFETY

Safety Decals

Capsize Warning Decal

The capsized warning decal is located at the rear of the watercraft and is positioned upside down so the operator can read it when the boat is capsized.

⚠ WARNING

RIGHTING CAPSIZED BOAT



- To prevent injury, do not place hands or objects into pump inlet, intake grate or nozzle.
- To prevent major engine damage: Make sure engine is stopped by pulling lanyard from engine stop switch and turn boat to upright position in a clockwise direction.

7073865

Coast Guard Decal

Polaris Industries Inc.
2100 Highway 55
Medina, Minnesota
55340-9770

This Boat Is Not Required To
Comply With The Following U.S.
Coast Guard Safety Standards In
Effect On The Date Of Certification.

- Display of Capacity Information
- Safe Loading
- Flotation
- Electrical System
- Fuel System
- Powered Ventilation

As Authorized By U.S. Coast Guard.
Grant Of Exemption (CGB 91-013).

Safety Decals

Located on the electrical box:



Located on the front compartment door/hood:



Located on coupler shroud of Genesis i only:

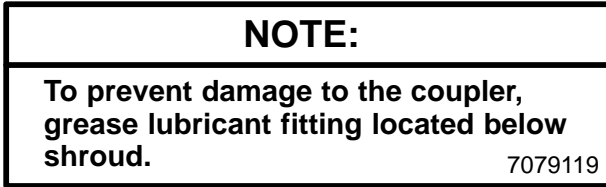

Located on the engine water manifold:

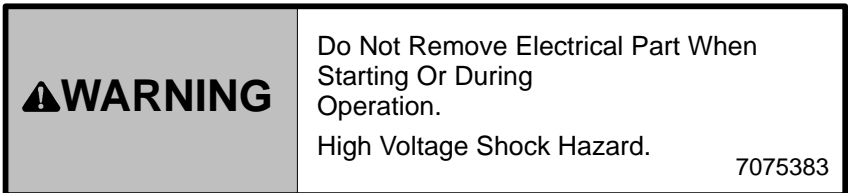

SAFETY

Operator Safety

WARNING

Failure to follow the warnings and instructions contained throughout this manual and on your vehicle can result in severe injury or death.

Read and understand your owner's manual and all warning decals before operating a Polaris watercraft.

Any operator of a Polaris watercraft must know and practice the following guidelines for personal safety and the safety of passengers. Never permit a guest to operate this watercraft unless the guest has read and understands all warning decals and the owner's manual.

Operator Guidelines

This watercraft is not a toy. It's a high performance powerboat, and operating it requires learned and practiced skills. All operators and passengers should become familiar with proper operating techniques before attempting maneuvers. Always operate the watercraft at a speed appropriate for water conditions and for your level of experience.

The minimum operator age for a Polaris watercraft is 16 years of age, but operators between 16 and 18 years of age require close adult supervision. Obey all applicable boating rules and regulations.

The watercraft does not have brakes. The watercraft is stopped by releasing the throttle. The vehicle will glide to a stop due to the natural drag of the water. *Allow a minimum of 300 feet (90 m) to coast to a stop from full throttle.*

Jet thrust is required to steer and turn the vehicle. Never completely release the throttle and attempt to turn at more than a trolling speed. The watercraft will not turn. Practice until you're comfortable with turning and stopping, and be sure you've mastered the skills before carrying a passenger (passenger models only).

Learn and observe all local, state, and federal boating regulations and speed limits. Boating laws and navigational rules are designed for the safety of everyone sharing the waterways.

Operator Safety

Three- or four-passenger Polaris watercraft are capable of towing water skiers, kneeboards, wake boards and tubes. However, towing can cause reduced steering control. Be extremely careful when towing other watercraft, skiers or objects behind this watercraft, as they have a significant impact on handling and steering. Observe local and state laws regarding water skiing and towing.

Do not tow with the Octane. Towing can cause loss of steering control and will create a hazardous condition that could result in severe injury or death.

Do not allow passengers to stand on the boarding platform while the watercraft is running or in motion. Passengers should always remain seated (passenger models only). Never carry a passenger on the Octane.

Never travel over a ski jump or attempt to jump waves, wakes or other objects in the water. Doing so may severely damage the watercraft and cause personal injury due to the hard impact, a temporary loss of visibility, possible loss of control and reduced reaction time.

Always securely attach the lanyard cord (1) to the operator's left wrist or PFD before starting the watercraft. If the operator falls off, the engine will immediately lose power.

Be sure the lanyard is free and not wrapped around the handlebars or controls. When the watercraft is not in service, disconnect the lanyard from the engine stop switch to prevent accidental starting of the engine.



SAFETY

Operator Safety

⚠ WARNING

Failure to wear protective clothing while operating a watercraft can result in serious injury. The jet pump emits a forceful stream of water that can injure body orifices. Falling off the watercraft while operating at higher speeds may also lead to injury. Always wear the recommended protective gear while riding on any watercraft.

Safe Riding Gear

Always wear protective clothing when operating or riding a personal watercraft. Consider attaching a whistle to your lanyard to summon help in emergency situations.

1 - Personal Flotation Device

The operator and passenger must always wear an approved personal flotation device (PFD) at all times to prevent accidental drowning. Polaris recommends a vest-type PFD (U.S. Coast Guard type 1, 2, or 3). **NOTE:** The seat of the watercraft *is not* a flotation device.

2 - Eye Protection

Wear adequate eye protection to protect against water spray, sun, insects and other objects. To protect prescription eyewear and sunglasses against loss or damage, wear goggles that fit securely over them.

3 - Suit/Shoes/Gloves

We recommend that all riders wear a wet/dry suit and watercraft shoes to protect against the force of the water, as well as exposure and unknown hazards in the water, such as debris and hidden objects. Riding gloves may also be considered.

NOTE: A helmet may provide increased personal injury protection in some situations, such as impact with the watercraft or during a collision with other watercraft or an obstacle. However, a helmet may not provide adequate protection against all foreseeable impacts and may aggravate some injuries. For example, if a rider falls off a moving watercraft while wearing a helmet, the helmet could catch the water and cause choking, severe and permanent injuries or death. A helmet may also increase the possibility of an accident if it reduces your visibility or ability to hear or if its weight contributes to fatigue.

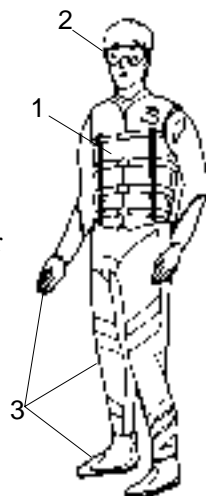

Operator Safety Overloading the Watercraft

⚠️ WARNING

Overloading a watercraft will significantly reduce vehicle stability and control, which could result in an accident and lead to severe injury or death. Never allow more than the specified rider capacity on the watercraft.

Polaris watercraft are designed to carry one operator and up to three passengers, depending on the model. Check the specifications section beginning on page 104 to determine your model's rider capacity. Never exceed the stated capacity for your model.



When more than one person is riding, a watercraft handles differently, which means that the operator must have enough prior riding experience to handle the watercraft with one or more passengers aboard.

Fire Safety

Federal regulation requires that all watercraft carry an approved fire extinguisher. Do not operate the watercraft without a fire extinguisher on board. Know how to reach the fire extinguisher quickly in case of fire, and know how to use it before you operate the personal watercraft.

If you have any doubts about your ability to extinguish a fire, swim away from the craft as quickly as possible. Immediately seek help from other boaters or people on shore.

SAFETY

Operator Safety

Weather and Darkness

Be aware of severe weather conditions. Observe weather forecasts and conditions before venturing out, and do not operate the watercraft when visibility is poor and when the water is rough. Operation of the watercraft in poor weather conditions can result in an accident and lead to severe injury, hypothermia or death.

Never operate the watercraft after sunset, before sunrise or in any condition of darkness. The vehicle is not equipped with lights, which makes it unsafe and illegal to operate in darkness.

Always ride with another watercraft when operating in remote areas or in large areas of open water. Carry a flare gun on board to signal for help if necessary.

Protective Apparel

Normal swimming attire may not provide adequate protection while riding a watercraft. At the rear of the watercraft, the jet pump emits a forceful stream of water that can injure body orifices, such as mouth, eyes, ears, rectum and vagina. In addition, falling off the watercraft while operating at higher speeds may lead to injury due to impact with the water. All riders must wear wet suit bottoms or clothing that provides equivalent protection.

NOTE: If a passenger falls from the watercraft, release the throttle immediately. Do not exceed idle speed if any person is within 50 feet (15 m) of the rear of the watercraft.



Operator Safety Obstacles and Shallow Water

Always be on the lookout for dangerous obstacles above and below the water surface, especially in shallow water. Use extra caution when riding in unfamiliar areas.

Never ride in water that is less than two feet (60 cm) deep, and do not operate at more than an idle speed in water that is less than six feet

deep. Colliding with an underwater object could result in severe injury or death. Ingesting sand into the cooling system will also cause the engine to overheat, which could lead to serious mechanical damage.

If the watercraft has been beached or has been sitting in shallow water, clear out any sand or small rocks before boarding and restarting the watercraft. Remove the particles by bouncing the back of the machine up and down in at least two feet of water. If the craft has been beached, flush the cooling system.

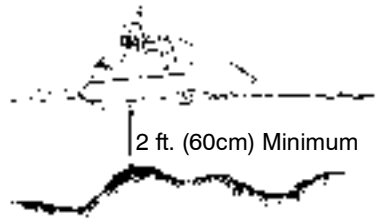

CAUTION

Failure to flush the cooling system after the watercraft has been beached could result in serious engine damage. Always follow the recommended flushing procedures and flush the cooling system any time the watercraft has been beached.

Turning and Accelerating

Turning and accelerating without checking for other boats and objects in your path can cause an accident and result in severe injury or death. *Always look behind the watercraft and to each side before accelerating and before making sudden turns.* Always be aware of obstacles, swimmers and other watercraft.

Quick turns or abrupt changes in speed can cause passengers to lose their balance and be ejected from the vehicle, which could result in injury. The operator should always alert any passengers before making sudden turns or changes in speed.

SAFETY

Operator Safety

Pre-Operation Inspection

Always perform the pre-operation inspection (beginning on page 46) before starting and riding the watercraft. Make sure all critical components are operating correctly. Check fuel and oil levels and all controls, especially the throttle lever, handlebars, and steering nozzle. Failure of these critical components can result in an accident and lead to severe injury or death.

Service and Maintenance

Routine service and adjustments to the watercraft are critical for the safe operation and extended life of the watercraft. Follow the maintenance and service recommendations outlined in this manual.

Jet Pump Water Intake Safety

Contact with the jet pump or driveline components of the watercraft can result in severe injury, death or drowning. Do not allow hands, feet, ropes, straps, clothing or long hair to come in contact with the jet pump water intake (1) on the bottom of the watercraft while the engine is running.

Never insert any object into the intake or outlet (2) of the jet pump, and never start or operate the watercraft with the inlet grate, ride plate (3), or any guards or shields removed.

To prevent serious injury due to accidental starter engagement, be sure the engine is off and the safety lanyard is disconnected before removing weeds or debris that may have collected in or around the jet pump intake.

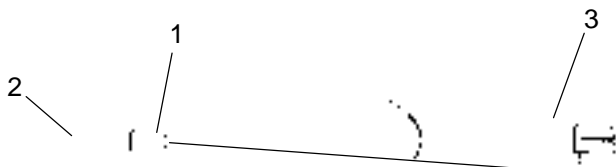

Operator Safety

Electrical Shock Hazard

Never touch or remove electrical parts while starting or during operation of the watercraft. Severe injury or death could result from electrical shock.

Safe Riding Position

Falling off a watercraft can result in serious injury. The operator and any passengers should always keep both feet firmly planted on the floorboards while the watercraft is in motion. The passenger should face forward and firmly hang on to the operator's waist, except in towing situations, when the spotter faces the rear and uses the grab handle to hold on.

Lifting the Watercraft

Severe back injury or other injury could result from attempting to lift the watercraft without assistance. Never attempt to lift the watercraft without the aid of a trailer and winch or another heavy lifting device.

Operator Awareness

A collision can cause severe injury or death. Always be aware of other watercraft, swimmers and other obstacles while operating the watercraft. Always maintain a safe distance, especially if you're an inexperienced operator. Do not exceed idle speed if any person is within 50 feet (15 m) of the rear of the watercraft.

SAFETY

Operator Safety

Operator Fitness

Safe operation of this rider-active craft requires good judgement and physical skills. Persons with cognitive or physical disabilities who operate this vehicle have an increased risk of overturns and loss of control, which could result in serious injury or death.

Riding personal watercraft is strenuous. All riders should be in good physical condition. Pregnant women should consult their physicians before riding any watercraft.

Reboarding the watercraft in deep water can also be strenuous. Operators and passengers should be physically fit enough to reboard the watercraft in deep water. Practice boarding in chest-deep water to be sure you are physically able to reboard if the need arises.

Boating Under the Influence

Operating any watercraft while under the influence of alcohol or drugs could result in an accident and lead to severe injury or death.

More than half of all the people who drown have consumed alcohol prior to their accident. Even if you're not intoxicated, any amount of alcohol can be a threat to your safety and the safety of others. The equivalent of one beer will impair your balance, vision, judgment and reaction time, making you a potential danger to yourself and others.



Do not operate any watercraft while under the influence of alcohol or drugs.

Vehicle Modifications

Modifications to this machine could create safety hazards and reduce vehicle reliability as well as make it unsafe or illegal to operate. *Do not modify this watercraft or any of its components.* Any modifications to the watercraft will void your warranty.

Operator Safety

Operator Fatigue and Dehydration

Long hours of boating with exposure to noise, vibration, sun, glare and wind can result in operator fatigue and dehydration. These conditions can affect your balance, vision, judgment and reaction time. Fatigue and dehydration can increase your risk of an accident resulting in bodily injury or death. Combining alcohol consumption with this condition greatly increases your risk of causing an accident.

Learn to recognize the early symptoms of fatigue, and allow your body to recover by taking a break from operating the watercraft. Drink plenty of non-alcoholic beverages to prevent dehydration, and wear protective riding gear to protect against exposure to weather elements.

Hypothermia

Your life may depend on a clear understanding of the effects of cold water on the human body. Many suspected drowning victims actually died from cold exposure (hypothermia) rather than drowning.

Hypothermia can begin in water as warm as 80°F (27°C). It's a condition in which the body loses heat faster than it can produce it. Violent shivering develops, which may give way to confusion and a loss of body movement. Hypothermia can result in severe injury or death in a very short time.

To avoid hypothermia:

- Dress warmly
- Wear proper gear and stay as dry as possible
- Seek a warm environment at the first sign of hypothermia (mild shivering)

If you fall into the water:

- Do not discard clothing
- While wearing your life jacket, draw your knees up toward your chest and hold them there with your arms in the Heat Escape Lessening Posture (HELP)

CONTROLS

NOTE: Illustrations used in this manual are for general representation only. Your model may differ.

1. **Starter Button** - Depress and hold the starter button to start the engine. Release it as soon as the engine starts. Do not depress the starter button for more than ten seconds at a time. **NOTE:** The lanyard and lock plate must be attached to the engine stop switch or the engine will not start. After the engine starts, pressing this button again will stop the engine.
2. **Choke** - The choke is used to help in starting a cold engine (carb models only). Do not use the choke when starting a warm engine.
3. **Throttle** - The throttle controls the speed of the watercraft. When squeezed, the engine accelerates; when fully released, the engine returns to an idle.
4. **Lanyard Stop Switch** - The lock plate end of the lanyard cord is attached to the engine stop switch on the left handlebar.
5. **Instrumentation** - MFI (Genesis and Virage), fuel gauge with warning LED (Freedom). See page 39 for a detailed explanation of multi-function instrument (MFI).
6. **Bilge Button** - The bilge button is the gray button on top of the switch assembly. Whenever the engine is running, the bilge pump will be running. When the engine is shut down, pushing and holding this button will operate the bilge pump. This should be used if water is discovered in the hull during the pre-operation inspection and prior to restarting the engine after capsizing. Push the bilge button when the engine is not running to raise or lower the reverse gate. Press and hold the bilge button when using the PERC™ controls.
7. **Polaris Electric Reverse Control (PERC™)** - On Genesis i models, these two buttons are used to raise or lower the reverse gate. See page 70 for a detailed explanation of the PERC™ feature.
8. **Hand Hold** - The hand hold is a soft, flexible handle for front passengers to use.
9. **Jet Pump Intake Grate** - The grate protects the impeller and drive shaft and protects riders from contact with components.
10. **Drive Shaft** - The drive shaft is located beneath the intake grate and transmits power from the engine to the impeller.
11. **Ride Plate** - The ride plate covers and protects the jet pump and provides leveling control for the watercraft.

CONTROLS

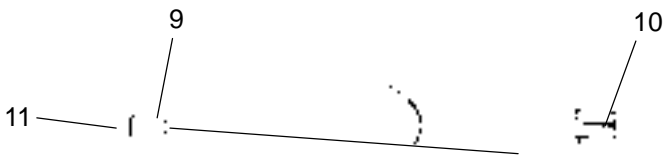
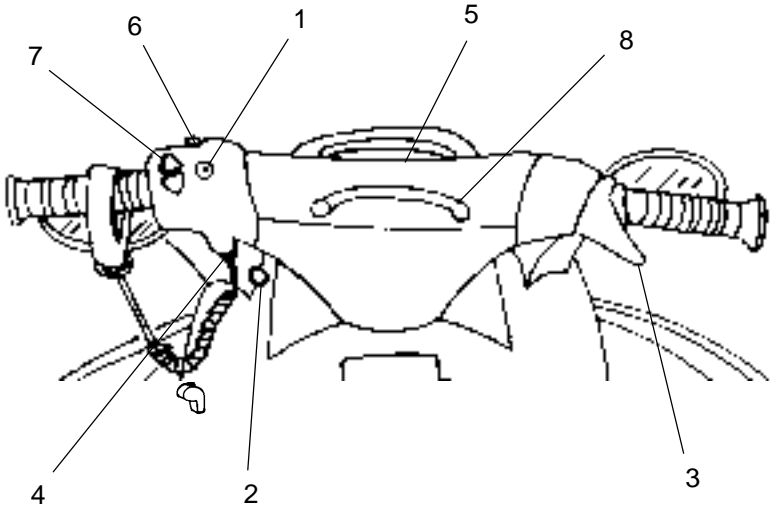

FEATURES

1. **Jet Pump Outlet Nozzle** - The nozzle is the exit for the jet output. The orientation of the nozzle is controlled by the handlebars, and determines the direction of craft movement.
2. **Safety Lanyard Wrist Cord** - The lock plate end is fastened to the engine stop switch on the handlebar. The wrist band end is fastened to the operator's wrist or PFD. The engine will not start if the lanyard lock plate and switch are not engaged. If disengaged during operation, the engine will stop.
3. **Seat Latch** - The seat latch secures the seat (if equipped) in position. When released, it provides access to the engine compartment. **NOTE:** The number of latches will depend on the model. Some boats have one latch and others have two latches.
4. **Boarding Platform/Footwell Pads** - The boarding platform assists riders while boarding. The footwell pads are the place for the operator's and passenger's feet while riding the watercraft.
5. **Drain Plug(s)** - When water gets into the bilge, it can be drained through this plug. Remove the watercraft from the water before draining the bilge. Be sure the plug is securely closed before launching the watercraft.
6. **Exhaust Outlet**
7. **Reverse Gate (shown engaged)**

Freedom, Virage, Virage i

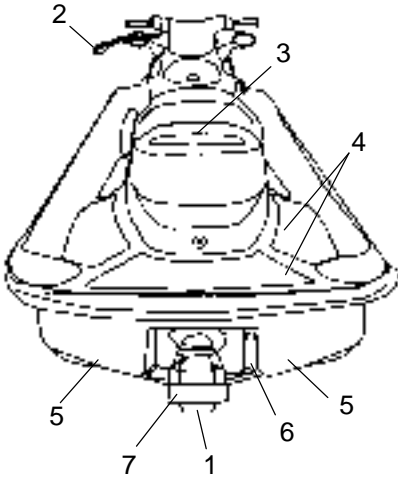

FEATURES Octane

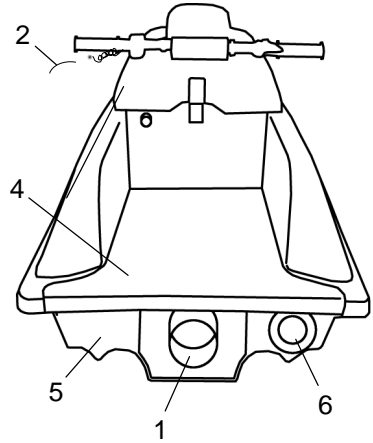

Genesis i

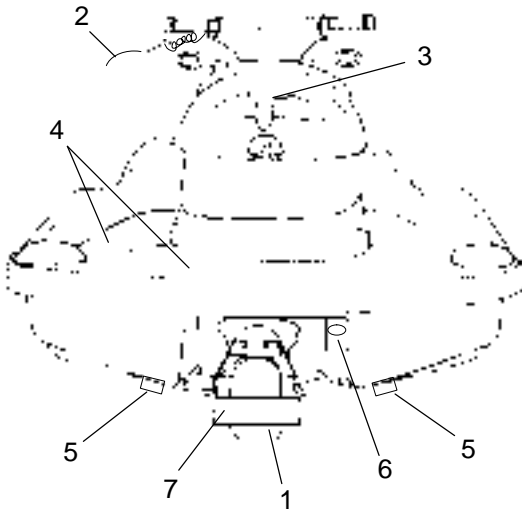

FEATURES

Freedom and Virage Models

1. **Seat/Engine Compartment** - Removing the seat provides access to the engine, battery, electrical box, exhaust system, and other components.
2. **Handlebars** - The handlebars control the orientation of the jet pump outlet nozzle, which in turn controls the direction of craft movement.
3. **Fire Extinguisher Compartment** - The compartment provides secure storage for the required fire extinguisher. It's located under the front compartment door.
4. **Front Compartment Door (Hood)** - The hood provides access to the fire extinguisher, oil tank, fuel valve, and main storage space.
5. **Air Intake Openings** - Air enters to supply the engine and ventilate the engine compartment.
6. **Fuel Tank Fill** - Turn the cap counterclockwise to remove and clockwise to replace.
7. **Grab Handle** - The grab handle assists riders while boarding the craft or riding as a passenger.
8. **Warning Light** - All models are equipped with an oil level gauge on the multi-function instrument (MFI) panel. The red light will illuminate (Freedom) or flash (Virage) if oil is low. On the Virage, the MFI will also provide an LCD message: "LOW OIL".
9. **Fuel Valve (if equipped)** - ON allows fuel to operate the watercraft; OFF stops the fuel supply to the carburetor. The valve is located under the front compartment door.
10. **Sponson** -The sponson enhances vehicle stability and turning ability in water.
11. **Seat Strap** - The seat strap aids in boarding and provides a passenger hand hold while riding.
12. **Reverse Operation Handle (Virage)**
13. **Instrumentation** - MFI (Virage) or Fuel Gauge with warning LED (Freedom). See page 39 for MFI operation.
14. **Oil Fill** - Turn the cap counterclockwise to remove and clockwise to replace. The cap is located under the front compartment door.
15. **Console Storage**

Freedom and Virage Models

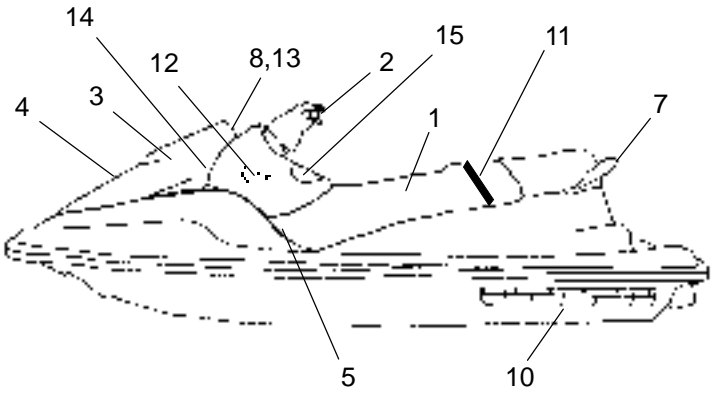
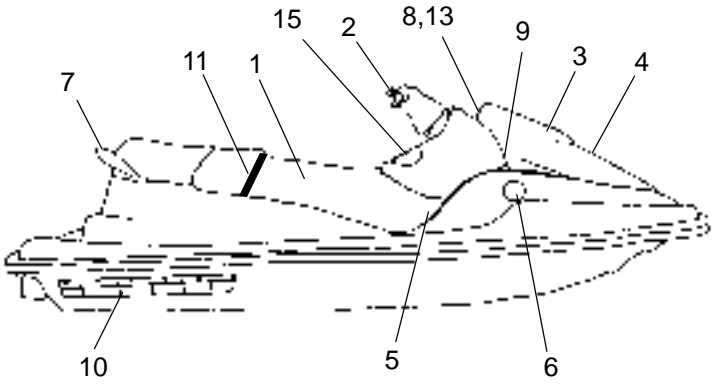

FEATURES

Genesis i

1. **Engine Compartment** - Removing the seat provides access to the engine, battery, electrical box, exhaust system, and other components.
2. **Handlebars** - The handlebars control the orientation of the jet pump outlet nozzle, which in turn controls the direction of craft movement.
3. **Fire Extinguisher Container** - The container provides secure storage for the required fire extinguisher.
4. **Front Compartment Door (Hood)** - The hood provides access to fire extinguisher, oil tank, fuel valve, and main storage space.
5. **Air Intake Openings** - Air enters to supply the engine and ventilate the engine compartment.
6. **Fuel Tank Cap** - Turn cap counterclockwise to remove, clockwise to replace.
7. **Grab Handle** - The grab handle assists a rider while boarding or while riding as a passenger.
8. **Warning Light** - The warning light alerts the operator to check instrumentation. All models are equipped with an oil level gauge on the multi-function instrument (MFI) panel. The red light will flash if oil is low. The MFI will also provide an LCD message: "LOW OIL".
9. **Sponson** -The sponson enhances vehicle stability and turning ability.
10. **Seat Strap** - The seat strap aids in boarding and provides a passenger hand hold while riding.
11. **Multi-Function Instrument** - See page 39.
12. **Console Storage**

Octane

1. **Hood/Engine Cover** - Engine components are located under the hood.
2. **Engine Compartment** - The engine components are located under the hood.
3. **Handlebars** - The handlebars control the orientation of the jet pump outlet nozzle, which in turn controls the direction of craft movement.
4. **Fuel Tank Cap** - Turn cap counterclockwise to remove, clockwise to replace.

FEATURES

Genesis i

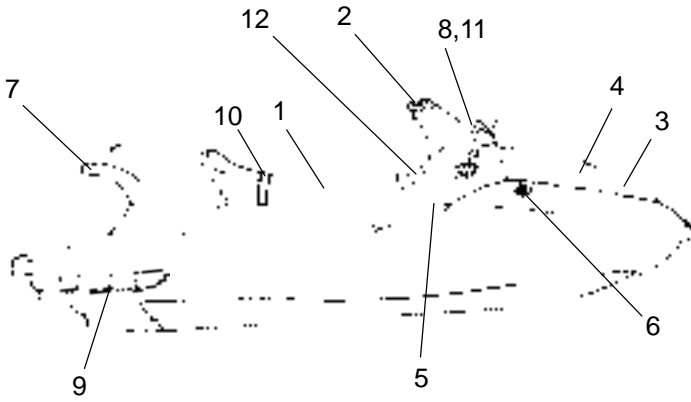

Octane

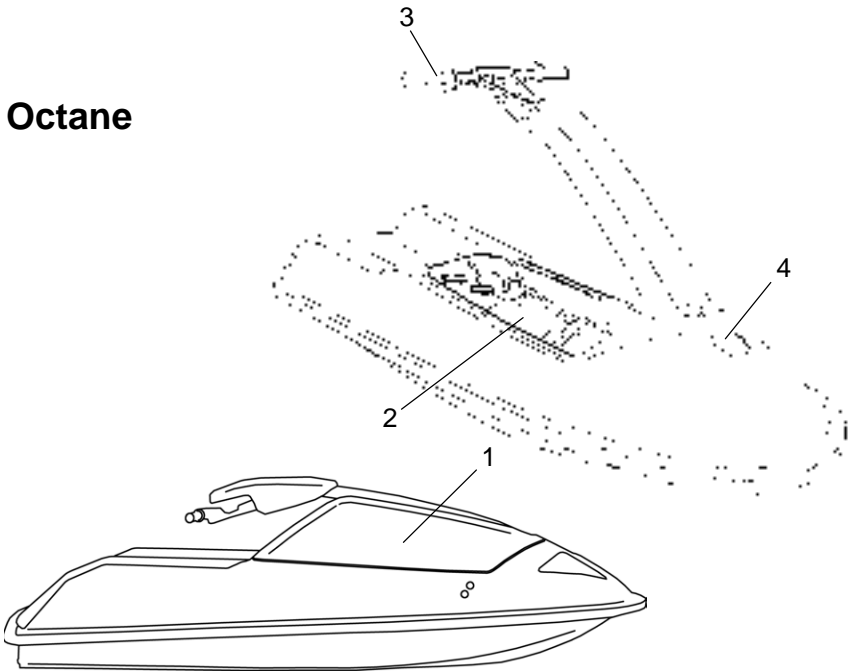

FEATURES

Engine Components

Engine Compartment

1. Spark plugs
2. Air intake cover
3. Exhaust pipe
4. Water temperature sensor
5. Exhaust cooling hose
6. Exhaust silencer
7. Engine water outlet hose (underneath thermostat assembly)
8. Water manifold
9. Thermostat assembly
10. Electrical box (circuit breaker and fuses)
11. Fuel/water separator
12. Exhaust coolant filter
13. Air filter
14. Battery
15. Bilge pump
16. Starter solenoid

Engine Components

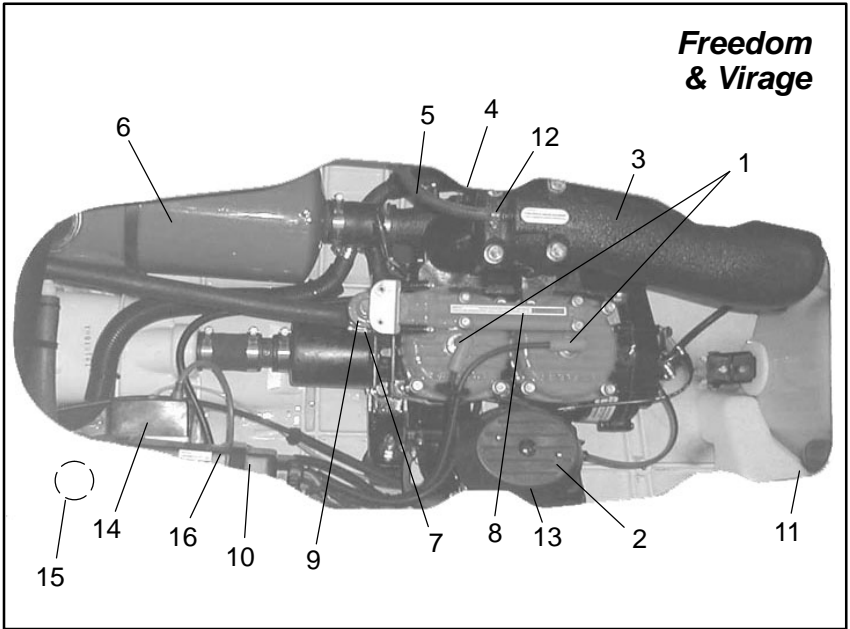

FEATURES

Engine Components

Engine Compartment

1. Spark plugs
2. Air intake cover
3. Exhaust pipe
4. Water temperature sensor
5. Exhaust cooling hose
6. Exhaust silencer
7. Engine water outlet hose (underneath thermostat assembly)
8. Water manifold
9. Thermostat assembly
10. Exhaust coolant filter
11. Air filter
12. Battery
13. Capacitor
14. Starter solenoid
15. EMM - Engine Management Module - (found only on Direct Injected models)

Engine Components

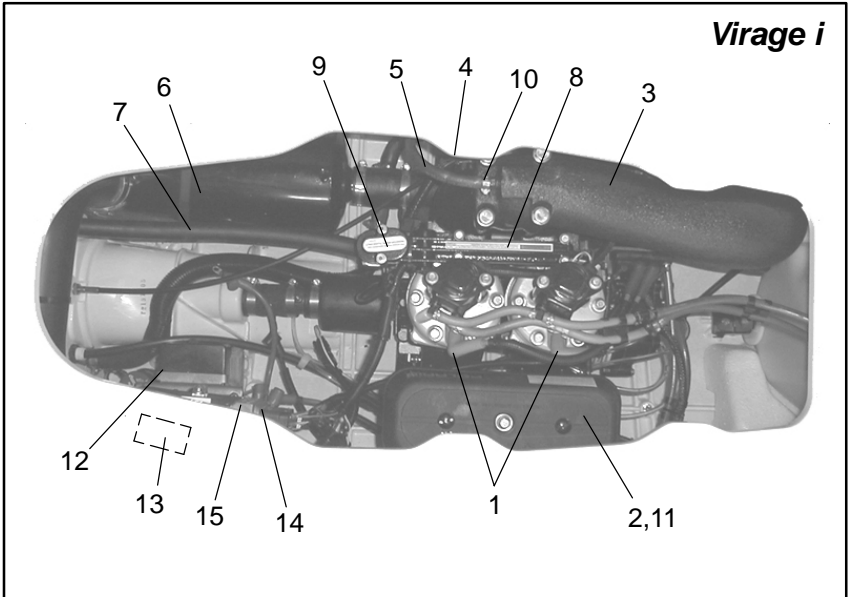
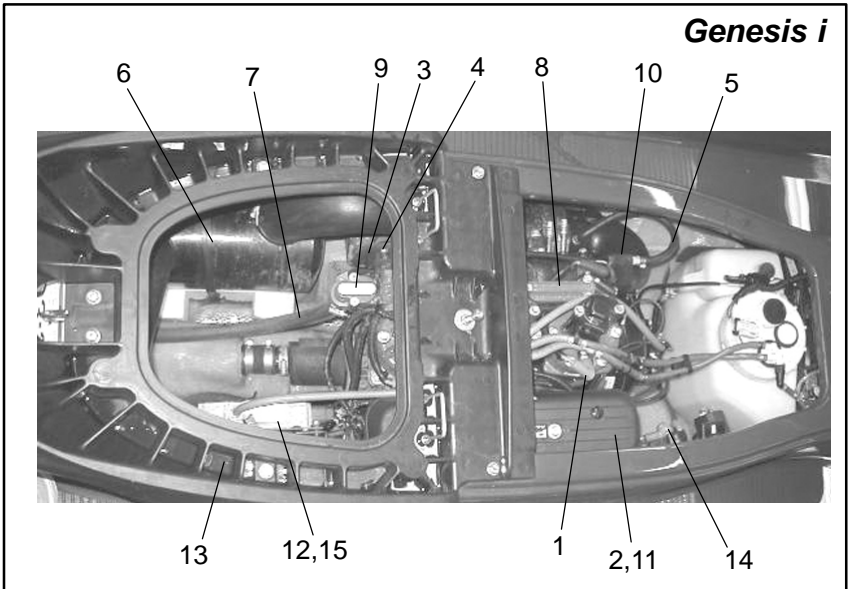

FEATURES

RPM Limiter

CAUTION

A clogged intake and/or impeller can cause overheating and/or damage to the jet pump and impeller parts. Always keep the intake and/or impeller free of debris and weeds.

Some Polaris watercraft are equipped with a device that will limit engine RPM if the engine overheats. This feature is designed to help prevent engine damage caused by engine overheating.

If the high temperature indicator light or “hot” warning message displays (and the engine RPM is limited), stop the engine immediately.

Clean the jet pump and impeller as outlined on page 52. If the cause of the overheating is identified and corrected, normal operation can be resumed by releasing and reapplying the throttle.

If the engine continues to overheat after cleaning the jet pump and impeller, take the watercraft to an authorized Polaris dealer for service.

Multi-Function Instrument (MFI)

Operation Summary

Your model may not have all of the features listed. Underlined features are only found on 24 and 25 function versions of the MFI found on Genesis models.

The MFI simultaneously displays a great deal of important vehicle information such as speed, RPM, fuel and oil levels, clock, compass heading, engine hours, and warning conditions. Additionally, the MFI acts as a command center for security and interfaces to an optional depth sensor to provide a built in digital depth gauge.

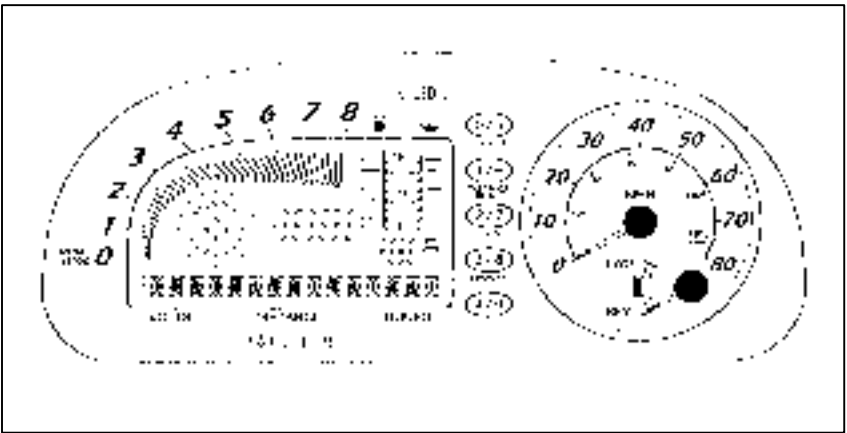

Display Summary

The MFI is configured with a Liquid Crystal Display (LCD) display on the left, a function/numeric keypad in the center, and an electronically driven analog speedometer and reverse (PERC™) indicator on the right. The LCD contains a highly responsive analog tachometer, fuel and oil gauges, a 16-point compass, clock, battery voltmeter, resettable distance meter, and non-volatile engine hour meter. To the right and under the fuel and oil gauges is a digital depth gauge, which automatically activates if the optional depth sensor is installed.

The bottom row of alphanumeric characters is a versatile display that normally displays battery voltage, distance traveled, and engine hours. These displays will be overwritten in the event of a warning condition, or if an optional function is selected, such as security lock, speed limit, or real time digital display.

FEATURES

Multi-Function Instrument (MFI)

Primary Functions

ON/AUTO: The MFI will automatically “wake-up” when the engine start button is pressed or alternately by pressing and holding any button for 1 second.

AUTO OFF: The MFI will return to sleep mode after 5 minutes of inactivity. While in sleep mode, the clock continues to show time, and the fuel level, oil level, and the compass rose are displayed. If the SECURITY LOCK is active, the display will also show “LOCKED.”

TACHOMETER: The analog tachometer visually displays the revolutions per minute (RPM) of the engine in 200 rpm increments from 0 to 8000 rpm. For more accurate RPM readings, see “DISPLAY” below.

FUEL GAUGE: Displays fuel level in exact 1/8 tank increments. Toggles “LOW FUEL” warning and flashes the warning LED when fuel reaches 1/8 level. Pressing any key will disable the flashing LED for 15 minutes.

OIL GAUGE: Displays oil level in exact 1/4 tank increments. Toggles “LOW OIL” warning and flashes the warning LED when oil reaches 1/4 level. Pressing any key will disable the flashing LED for 15 minutes.

DEPTH GAUGE: (An optional transducer kit is required.) Before activating the DEPTH GAUGE function, the depth sensor must first be installed. After installation is complete, press and hold both the 3/8 and 4/9 buttons simultaneously for several seconds to activate the DEPTH GAUGE function. The display will read “SONAR ON”, and the depth digits under the fuel and oil gauges will display depth in either feet or meters. If the sensor is not found, the MFI will automatically cancel the DEPTH GAUGE function. The DEPTH GAUGE will display water depth below the hull from 0 to 199 feet (0 to 75 meters). The readout is accurate to approximately 45 mph (70 kph). The display will flash “- -” if tracking is lost. To disable the DEPTH GAUGE, simply press and hold the 3/8 and 4/9 buttons simultaneously for several seconds until “SONAR OFF” IS displayed.

CLOCK: The center of the LCD display contains a digital clock. To set the clock, simply press and hold the “CLOCK SET” button until the clock digits begin to flash. Each subsequent press of the CLOCK button advances the time by 1 minute. Pressing and holding the button will automatically advance the digits more rapidly. Once the intended time is reached, simply release the button. After 5 seconds, the MFI will automatically exit the “clock set” mode.

Multi-Function Instrument (MFI)

COMPASS: The compass displays true vehicle heading relative to magnetic north with a resolution of 16 points per revolution. The triangular pointer rotates to indicate the direction of travel.

VOLTMETER: The left side of the multi-purpose display contains the battery VOLTMETER. Battery voltage is displayed from 5 to 18 volts in .1 volt increments. A battery voltage of less than 10.9 volts will trigger the “LOW POWER” warning message, indicating battery voltage is approaching a “no start” condition.

DISTANCE METER: The center of the MFI contains a resettable DISTANCE METER. Distance is displayed from 0 to 999.9 miles (0-999.9 km) in .1 increments. To reset the DISTANCE METER, simply press and hold the DISTANCE RESET button until the distance displayed returns to “000.0”.

HOUR METER: The right side of the multi-purpose display contains the engine HOUR METER. Actual engine operating hours are displayed in .1 hour increments from 0 to 999.9 hours. The HOUR METER cannot be reset, and is retained even when power is removed due to nonvolatile EEPROM memory.

SPEEDOMETER: The right side of the MFI contains an analog speedometer. While the speedometer is traditional in appearance, it is actually controlled by the system microprocessor, and is extremely accurate.

SECURITY LOCK: Briefly pressing and releasing the LOCK button will cause the lock status to be displayed, either “LOCKED” or “UNLOCKED”. Pressing and holding the LOCK button for several seconds initiates the SECURITY LOCK function. The MFI will display “ENTER CODE _ _ _”. Enter the code using the 5-button keypad. The factory set default code is “1234”. An asterisk (*) will appear with each press of a numeric button. If the proper code has been entered, the display will show the new lock status. If previously “LOCKED”, the security lock will switch to “UNLOCKED” and the vehicle may be started normally. If previously “UNLOCKED”, the security lock will switch to “LOCKED” and the vehicle will not start.

If starting the engine is attempted while the security lock is set to “LOCKED”, the warning LED will flash, the engine will not start, and the MFI will indicate “LOCKED”, followed by “ENTER CODE _ _ _”. If an improper code entered, the MFI will display “INVALID CODE”, and exit code entry mode.

FEATURES

Multi-Function Instrument (MFI)

DIRECTION: The lower portion of the analog display contains a forward/reverse direction indicator. The pointer on the gauge moves in synchronization with the reverse gate as it is lowered over the jet nozzle when actuated by the electric thumb switch. The indicator is useful in establishing a “neutral” position between forward and reverse. The LED will flash when the reverse gate is not fully forward. Pressing any key will disable the LED for 5 minutes.

CODE SET MODE: The factory set default security code is “1234”, however, the code may be changed to any 4 digit number. To select your own code, enter CODE SET mode by pressing and continuing to hold the LOCK button for several seconds until “CHANGE CODE” is displayed (the display will first show the lock status, followed by “ENTER CODE _ _ _ _”, and finally “CHANGE CODE”. The MFI will then display “OLD CODE _ _ _ _”. Enter the code as if locking or unlocking the vehicle. If the correct code is entered, the display will then show “NEW CODE _ _ _ _”. Select any 4-digit code. The display will then read “CONFIRM CODE _ _ _ _”. Enter the same code to confirm your selection. “CODE CONFIRMED” will display for several seconds if the second entry of the new code matches the first. If the second code entered does not match the first, “INVALID CODE” will be displayed and the CODE SET MODE is cancelled.

DISPLAY: Pressing the DISPLAY button toggles the MFI between NORMAL DISPLAY mode and DIGITAL DISPLAY mode. The lower display will show VOLTS/DISTANCE/HOURS when in NORMAL mode, and real-time digital RPM and SPEED when in DIGITAL mode. When first entering DIGITAL DISPLAY mode, the MFI briefly displays the last recorded peak RPM and SPEED. While the peak values are being displayed, holding the DISPLAY button for several seconds will reset the peak values. Pressing the DISPLAY button while in DIGITAL DISPLAY mode toggles the display back to the standard VOLT/DISTANCE/HOURS display.

ENGLISH/METRIC: To change units between English and metric, press and hold the 1/6 button and the 2/7 button simultaneously for several seconds. When in metric mode, “km” appears in the distance meter, and the “MTRS” icon will illuminate in the depth gauge if activated.

WARNING INDICATIONS: LOW FUEL - 1/8 tank or less of fuel remaining; LOW OIL: 1/4 tank or less of oil remaining; ENGINE OVERHEAT - overheated engine; LOW BATTERY - battery voltage below 10.9 volts; REVERSE indicates reverse has been initiated; CHECK ENGINE (DI models) - indicates a warning condition from the computer engine management system.

Standard Equipment

- Watercraft Owner's Safety and Maintenance Manual
- Watercraft Safety Video PN 9916475
- Lanyard with wristband, lock plate and whistle
- Tool Kit containing: wrench, flat screwdriver, Allen wrench, spark plug wrench with Phillips head screwdriver

Contact an authorized Polaris dealer for replacement parts and equipment. Provide part numbers when possible.

Optional Equipment

See page 108 for a list of Polaris products for servicing your watercraft.

- U.S. Coast Guard-approved fire extinguisher (UL 5-B:C Rating) PN 2871012
- Registration numbers (see your Polaris watercraft dealer)
- Tow rope (for emergency use) PN 2871310
- Safety and riding gear, including approved personal flotation devices for operator and passenger (see your Polaris watercraft dealer)

Accessories and Apparel

Polaris has a wide range of watercraft accessories, from wetsuits and life vests to accessory mirrors, touring and towing gear, and performance parts. Contact your Polaris dealer or visit www.polarisindustries.com to see our full line of available products.

EMISSIONS REGULATION

EPA Emissions Compliance

All direct injection equipped engines manufactured by Polaris Industries are certified to the United States Environmental Protection Agency regulations for the control of air pollution. For this reason, factory procedures for servicing must be strictly followed, and wherever practicable, returned to the original intent of the design.

Maintenance, replacement, or repair of the emission control devices and systems may be performed by any marine spark ignition (SI) engine repair establishment or individual.

NOTE: The Octane does not meet federal emission requirements and is sold for competition use only.

California Consumer Environmental Label

A California Consumer Environmental label (star label) has been applied to Virage i and Genesis i watercraft in accordance with the requirements of the California Air Resources Board. This star label means *cleaner marine engines*. Refer to the California Emission Control System Limited Warranty beginning on page 117.

Cleaner Air and Water - for healthier lifestyle and environment.

Better Fuel Economy - burns up to 30-40 percent less gas and oil than conventional carbureted two-stroke engines, saving money and resources.

Longer Emission Warranty - protects California consumers for worry free operation.

The **Virage i** engine has been certified as:



The **Genesis i** engine has been certified as:



EMISSIONS REGULATION

California Consumer Environmental Label

One Star - Low Emission



The one-star label identifies engines that meet the Air Resources Board's 2001 exhaust emission standards. Engines meeting these standards have 75% lower emissions than conventional carbureted two-stroke engines. These engines are equivalent to the U.S. EPA's 2006 standards for marine engines.

Two Stars - Very Low Emission



The two-star label identifies engines that meet the Air Resources Board's 2004 exhaust emission standards. Engines meeting these standards have 20% lower emissions than One Star - Low Emission engines.

Three Stars - Ultra Low Emission



The three-star label identifies engines that meet the Air Resources Board's 2008 exhaust emission standards. Engines meeting these standards have 65% lower emissions than One Star - Low Emission engines.

OPERATION

Pre-Operation Inspection

WARNING

If a proper inspection is not performed before each use, severe injury or death could result. Always inspect the vehicle as outlined in the checklist before each use to ensure it's in proper and safe operating condition. See page 82 for additional inspection information. Always remove the lanyard from the engine stop switch before performing the pre-operation inspection.

WARNING

Starting or operating the watercraft with a fuel leak can result in an explosion, causing serious injury or death. If you smell fuel in the hull of the craft, *do not start the vehicle*. Take it to your dealer immediately for inspection.

Use the Pre-Operation checklist on page 47 to verify that your watercraft is in proper operating condition before each use. Procedures are outlined in further detail on the pages following the checklist.

Pre-Operation Inspection

Item	What To Do
Fuel/water separator (carb models)	Visually inspect for water and drain if present
Fuel/oil tank levels	Check fuel/oil; add as necessary; visually inspect for presence of water
Jet pump water intake	Inspect and remove debris if present; be sure intake grate is secure; push rear of watercraft up and down in the water to flush sand out of water intake before starting
Throttle	Check for proper operation.
Steering	Check for proper operation; visually inspect control cable
Fire extinguisher	Inspect condition and expiration date
Seat/Hood/Engine Cover	Check for secure latching
Battery	Check fluid level and condition; vent hose must be clear and open
Hull	Inspect hull for damage or cracks; clean off marine growth
Drain plugs/bilge	Inspect and clean; it should not leak; be sure it is tight and secure
Loose parts/hoses	Inspect for loose parts/hoses and connections
Seat	Check that seat is securely fastened
Loose ropes/straps/clothing/long hair	Be sure that there are no loose ropes, straps, clothing, etc.; Long hair is tied back and secured
Riding gear	Check operator and passenger for complete gear and proper fit
Switches/buttons	Check operation
Lanyard cord/stop switch	Check condition and operation
Reverse System	Check operation
Bilge	Pump out any water (button on switch pad)

OPERATION

Pre-Operation Inspection

Fuel

WARNING

Gasoline is highly flammable and explosive under certain conditions.

- Always check for fumes prior to starting engine.
- Always exercise extreme caution whenever handling gasoline.
- Always refuel with the engine stopped and outdoors or in a well ventilated area.
- Do not smoke or allow open flames or sparks in or near the area where refueling is performed or where gasoline is stored.
- Do not overfill the tank. Do not fill the tank neck.
- If gasoline spills on your skin or clothing, immediately wash it off with soap and water and change clothing.
- Never start the engine or let it run in an enclosed area. Gasoline powered engine exhaust fumes are poisonous and can cause loss of consciousness and death in a short time.
- Turn the fuel valve off (if equipped) whenever the vehicle is stored, parked or transported.

WARNING

The engine exhaust from this product contains chemicals known to cause cancer, birth defects or other reproductive harm.

Operate this vehicle only outdoors or in well-ventilated areas.

Pre-Operation Inspection Fuel

CAUTION

Using a non-recommended fuel may cause serious engine damage. We recommend the use of 87 octane non-oxygenated or 89 octane oxygenated fuel only for your Polaris watercraft.

Refer to the specifications section beginning on page 104 for fuel octane and oil requirements for Polaris watercraft.

Your Polaris watercraft (except the Octane) features an oil injection system, so it's not necessary to pre-mix the gasoline and oil, except during the engine break-in period (see page 59).

Octane Fuel Ratio

The Octane *is not* equipped with oil injection. Fuel must be pre-mixed with oil. See page 51 for oil recommendations.

1. The preferred method for mixing fuel and oil is to have a fuel container half full of the amount of fuel to be mixed.
2. Measure the appropriate amount of recommended oil in a plastic cup, then pour it into the fuel container.
3. After mixing, add the remaining fuel.

Fuel/Oil Premix Chart

Fuel	Oil @ 32:1	Oil @ 40:1
Gallons (Liters)	Ounces (Liters)	Ounces (Liters)
1 (3.8)	4 (.12)	3.2 (.09)
5 (18.9)	20 (.59)	16 (.47)
10 (37.9)	40 (1.18)	32 (.95)

OPERATION

Pre-Operation Inspection

WARNING

Failure to follow proper refueling instructions can result in fire or explosion, causing severe injury or death.

Always stop the engine and disconnect the lanyard from the engine stop switch before refueling.

Refueling

Keep the watercraft horizontal while fueling. Shut off the fuel valve (if equipped) and carefully remove the fuel cap.

Use fresh, seasonal gasoline that has been stored in a clean container. For the best performance from gasoline, purchase only what is needed for a month or less of operation.

The use of a funnel or flexible spout will help avoid gasoline spillage on the watercraft. Always wipe up spills immediately.

NOTE: If the fuel or oil levels become low, the Multi-Function Instrument (MFI) will display a flashing warning light (if equipped). Proceed to shore and refuel. Refer to the specifications section beginning on page 104 to determine if your model is equipped with this feature.

Pre-Operation Inspection Oil

While other 2-cycle TC-W3 marine oils may be used, Polaris recommends the use of Polaris Nature Oil Biodegradable 2-Cycle Oil, which is specially formulated to work with your Polaris marine 2-cycle engine to provide maximum performance and reliability. Nature Oil reduces harmful carbon deposits and is also environmentally friendly. See page 108 for a list of Polaris products.

CAUTION

Mixing oil brands or using a non-recommended oil may cause serious engine damage. Polaris recommends the use of Polaris Nature Oil Biodegradable 2-Cycle Oil for all Polaris watercraft engines. Never mix oil brands.

The oil fill cap (1)(if equipped) is located under the hood. Check the oil level before each use and add oil as necessary. Make sure the engine is off and the safety lanyard is removed from the engine stop switch before adding oil.

1. Place the watercraft in a level position.
2. Remove the oil fill cap and check the oil level (or remove the storage bucket or seat and check the oil level).
3. Add the recommended oil as necessary. **NOTE:** Do not overfill. Wipe up any oil spills immediately.
4. Visually inspect the oil for water or foreign matter. If either is present, change the oil.

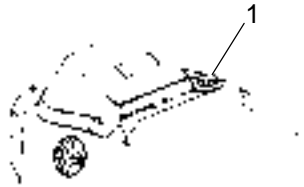

All models are equipped with an oil level gauge on the instrumentation. The gauge will flash a red light if oil is low (1/8 tank or less). Add oil immediately.

See the oil recommendations on page 59 for proper lubrication during the break-in period.

CAUTION

Severe engine damage will occur if the engine is run without oil or if water becomes mixed into the oil. If you discover an empty oil tank, have the watercraft serviced immediately by an authorized Polaris dealer. Always tighten the oil fill cap securely to prevent water from contaminating the oil.

OPERATION

Pre-Operation Inspection

Jet Pump Intake

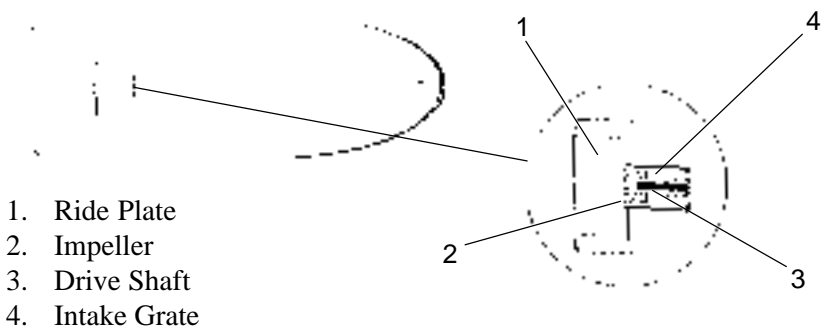

⚠ WARNING

Improperly connecting or disconnecting battery cables can result in an explosion and cause serious injury or death. When disconnecting cables, always disconnect the negative (black) cable first. When reconnecting, always connect the negative (black) cable last.

1. Remove the lanyard lock plate from the stop switch and disconnect the battery cables before inspecting the jet pump intake.
2. Carefully check the jet pump intake and remove any weeds, shells or other debris that may restrict the intake of water.
3. After launching, walk the watercraft into water at least two feet (60 cm) deep and bounce the back of the craft up and down several times to flush out any sand and debris that may be in the pump.

CAUTION

A clogged intake or the ingestion of sand into the cooling system will cause engine overheating and result in jet pump or engine damage. If any obstruction cannot be removed, have an authorized Polaris dealer service it immediately. Clear the pump of sand after operating in shallow water or after beaching the watercraft.

Pre-Operation Inspection Loose Parts

Inspect the watercraft for any loose nuts, bolts, fasteners and hoses. Be sure that all hose clamps are tight. Replace cracked or deteriorating hoses.

Steering Inspection

Check the handlebars for free movement throughout their full range. Make sure the jet pump outlet nozzle changes direction as the handlebars are turned from left to right and vice versa.

Be sure the handlebars and handlebar grips fit snugly. Visually inspect the control cable to ensure that it's in working condition.

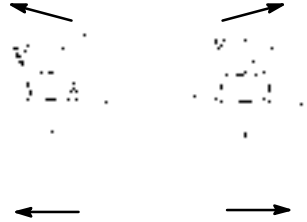

Throttle Inspection

Always check throttle operation prior to starting the engine.

Pull or squeeze the throttle several times to be sure the throttle lever moves freely through its full range. It should spring back to its original position when released.

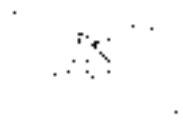

Engine and Storage Compartments

If the craft is operated in salt water, we recommend that you spray the inside of the hull (engine and components) with waterproof lubricant spray (PN 2871064) after every use. The engine compartment (1) is located beneath the seat (2) or hood/engine cover (Octane).

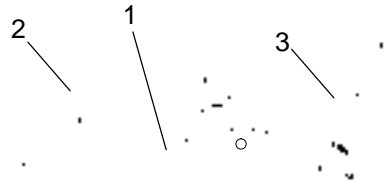

Be sure the seat, hood (3) and/or engine cover are properly positioned and securely latched before operating the watercraft.

OPERATION

Pre-Operation Inspection

Seat

NOTE: The illustration is a general representation of a watercraft, provided only to help the operator locate the seat latches.

To access the engine/storage compartment, disengage the rear seat latch (1). Genesis models have a latch on the rear of each seat.

Properly position and secure all seats before operating the watercraft.

NOTE: The seat is not a Personal Flotation Device (PFD) and will not provide life-saving flotation. Always wear a PFD when operating or riding a watercraft.

Battery

⚠WARNING

Causing sparks while servicing the battery or servicing the battery when gas fumes are present can result in an explosion, causing serious injury or death.

Never create a spark while servicing the battery. If you smell fuel in the craft, *do not service the battery*. Take the watercraft to your dealer immediately for inspection.

Confirm that the battery terminal connections are tight, and make sure the battery is securely fastened in its mounting position. Inspect the battery for leaks, and check the vent hose for kinks or blockage.

Check the battery fluid level and add only distilled water if the level is low. Tap water contains minerals that are harmful to a battery.

Maintain the fluid level between the upper and lower marks (1) on the battery.

Keep the battery in good condition and fully charged at all times, as a weak battery can leave you stranded. Never operate the watercraft with a battery that's too weak to start the engine on its own or shows signs of loss of power.

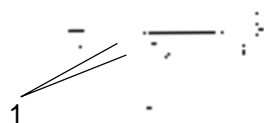
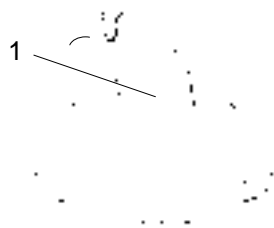

Pre-Operation Inspection Fire Extinguisher

The operator of the watercraft is required by law to carry a fire extinguisher on board. Always keep a fully charged and working fire extinguisher inside the fire extinguisher holder (1), which is located inside the storage area under the hood.

A fire extinguisher is not standard equipment with this watercraft. Contact your Polaris dealer or a fire extinguisher dealer to purchase a U.S. Coast Guard-approved fire extinguisher with a UL 5-B:C rating.



Hull

Inspect the hull for cracks or damage. Do not operate the watercraft if the hull is damaged. Use a non-abrasive cleaner to remove any marine growth.

Drain Plugs and Bilge

Turn the bilge drain plug (1) counterclockwise and remove it. Clean the plug and plug hole of any sand and debris before reinstalling.

NOTE: Some models have more than one drain plug.

When the watercraft is out of the water, remove the drain plug(s) and carefully flush out the bilge with fresh water. Allow the bilge to drain completely. Wipe out the bilge with dry shop towels and reinstall the drain plug(s). After launching the craft, remove the seat and check for leaks.



Riding Gear

Be sure all operators and passengers have the appropriate riding gear, including a PFD. See page 18. Make sure all trailing objects are securely tied back or stowed.

⚠WARNING

Objects trailing from a person in the water or from the watercraft can easily become tangled in the jet pump impeller and cause severe injury or death. Make sure long hair, straps, ropes, clothing and similar objects are tied back and secured.

OPERATION

Pre-Operation Inspection

Switches/Buttons

- 1 Lanyard
2. PERC™ Reverse (if equipped)
3. Lock Plate
4. PERC™ Forward (if equipped)
5. Bilge, Manual Override
6. Start
7. Stop Button

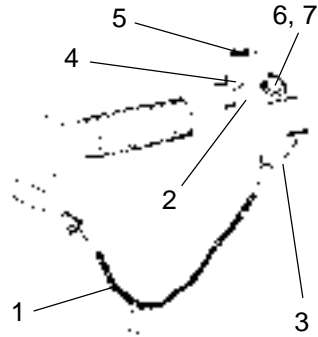

Perform the following checks while the watercraft is in the water:

1. Engage the bilge pump to pump water out of the engine compartment. See page 26.
2. Check the inside of the engine compartment for fuel or water leaks. Do not operate the watercraft until any leaks have been repaired.
3. Start the engine and let it run for a few seconds. Remove the lanyard lock plate from the engine shut-off switch to test operation. The engine should stop immediately. If it doesn't, press the stop button or pull the choke knob out until the engine stops. Do not ride the watercraft. Have it serviced by an authorized Polaris dealer before operating it again.
4. If removing the lanyard lock plate successfully stopped the engine in the previous step, start the engine again and allow it to run for a few seconds. Depress the engine stop button until the engine stops. If the engine doesn't stop, pull the choke knob out until the engine stops. Do not ride the watercraft. Have it serviced by an authorized Polaris dealer before operating it again.

Pre-Operation Inspection Fuel/Water Separator

The fuel/water separator (if equipped) is located either under the front compartment door behind the storage bucket on the starboard side or inside the engine compartment. Inspect the separator *only when the watercraft is out of the water.*

1. Deck
2. Fuel/Water Separator

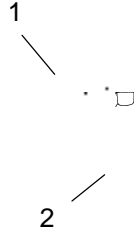

NOTE: The fuel/water separator is integral to the fuel pump module on Direct Injected models. It is *not serviceable*.

1. Visually inspect the fuel/water separator bowl (1). If water is present at the bottom of the bowl, it will appear as a clear liquid.
2. Turn off the fuel valve and remove the bowl by turning it counterclockwise. **NOTE:** Use care to avoid spilling fuel when removing the bowl. Wipe up any spills immediately with a shop towel.
3. Empty the bowl and dispose of the fluid properly. Follow all gasoline handling precautions as outlined on page 48.
4. Re-install the separator bowl, making sure the o-ring is in place. Hand tighten securely.



OPERATION

Principles of Operation

The engine is directly coupled to a driveshaft. When running, the driveshaft rotates the impeller. The impeller is positioned so that water is drawn up from beneath the watercraft. The water travels through the impeller and is accelerated, producing thrust to move the watercraft forward. Pulling or squeezing the throttle lever increases engine speed (watercraft speed).

Turning the handlebar pivots the jet pump nozzle (water outlet) which controls the watercraft's direction. The throttle must be applied in order to turn the watercraft.

Engine Break-in Procedure

The break-in period for your new Polaris watercraft is defined as the time it takes to use the first full tank of gasoline. No single action on your part is as important as following the procedures for a proper break-in. Careful treatment of a new engine will result in more efficient performance and longer life for the engine. Perform the following procedures carefully.

CAUTION

Excessive heat build-up during the first three hours of operation will damage close-fitted engine parts. Do not operate at full throttle or high speeds for extended periods during the break-in period. Do not carry passengers during the break-in period.

Use of any oils other than those recommended by Polaris may cause serious engine damage. Always use Polaris-recommended oils in your watercraft. See *Specifications*, beginning on page 104.

Engine Break-in Procedure

1. When filling the fuel tank for the first time (carb models only), use a 40:1 gas/oil premix (32:1 for Octane) to provide additional lubrication during the break-in period. (See the fuel/oil premix chart on page 49.) After the break-in period, the oil injection system will provide the necessary engine lubrication without the need to premix.



NOTE: The Octane does not have oil injection. Always premix the fuel used in the Octane (32:1 during break-in, 40:1 after break-in).

NOTE: Do not premix fuel for direct injection models.

CAUTION

If the engine is run while the watercraft is in very shallow water, sand, weeds and debris may be sucked into the jet intake and could cause damage to the impeller or injury to bystanders. Ingesting sand into the cooling system will cause the engine to overheat, which could lead to engine damage.

Whenever starting the engine, always be sure the watercraft is in water at least two feet (60 cm) deep.

2. Launch the watercraft.
3. Push the rear of the watercraft up and down several times in the water. Check the throttle for free operation and start the engine. Let the engine warm up for about a minute before departing.
4. The lowest possible speed should be used for the first five minutes of operation.
5. Gradually open the throttle to half speed.
6. Vary throttle speeds up to 3/4 speed during the break-in period.

OPERATION

Navigational Rules

This watercraft must be operated in accordance with all navigational rules and regulations governing it and the waterway on which it's operated. These rules are used and enforced internationally, as well as by the U.S. Coast Guard and local law enforcement. Any operator of this watercraft should be aware of these rules and should obey them when encountering other vessels.

The following rules are condensed and are provided only for your convenience. Consult a U.S. Coast Guard Auxiliary or Department of Motor Vehicles for a complete set of rules governing the waters where you'll be riding. You may also obtain this information when registering your watercraft.

Right-of-way and Give-way

In nautical terms the stand-on (privileged) vessel has the right-of-way and the give-way (burdened) vessel must yield or give way.

Stand-on Vessel

The vessel with the right-of-way has the duty to continue its course and speed, except to avoid an immediate collision. By maintaining course and speed, other vessels should be able to determine how best to avoid interfering with its course.

Give-way Vessel

The give-way vessel is responsible for taking positive action to stay clear of the stand-on vessel. Give-way vessels should not cross in front of stand-on vessels. The give-way vessel should slow down or change direction briefly and cross behind the stand-on vessel. The give-way vessel's actions should be clear and understandable by the stand-on vessel.

Rule 2

Rule 2 is "The General Prudential Rule" of the International Rule. This rule states that all operators have the responsibility of taking action to avoid a collision. All vessels involved in a potential collision become give-way vessels.

Navigational Rules Encountering Vessels

There are three main situations in which you may encounter other vessels:

- Overtaking (passing)
- Meeting (approaching another vessel head-on)
- Crossing (traveling across another vessel's path)

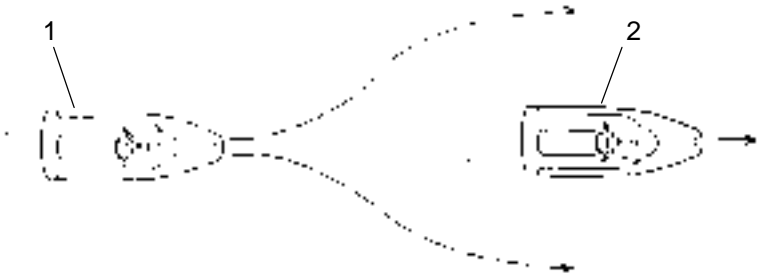

Overtaking Vessels

If your watercraft is passing another vessel, your craft is the give-way vessel. The other vessel is expected to maintain its course and speed. You must not interfere with its course of travel.

If your craft is the stand-on vessel, maintain your course and speed until the other vessel has passed you.

OPERATION

Navigational Rules

Meeting Vessels

When meeting another power vessel head-on and a collision appears likely, neither vessel has the right-of-way. Both vessels are obligated to alter course to avoid an accident. Keep the other vessel to your port (left) side and take evasive action to the starboard (right) side (1). This rule does not apply if you'll be clear of the other vessel by maintaining your course and speed (2).

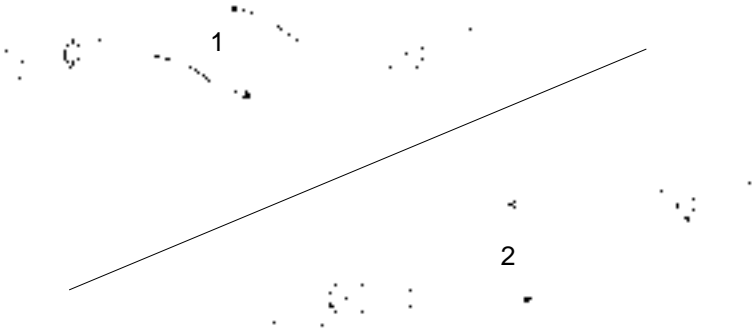

Crossing Paths

When two power vessels are crossing each other's path close enough to run the risk of collision, the vessel having the other on the starboard (right) side must give way. For example, if the other vessel (4) is on your vessel's (3) starboard (right) side, you must give way. If the other vessel is on your port (left) side, your vessel is the stand-on vessel and should maintain its course and direction. The other vessel must give way. However, always drive defensively in case the give-way vessel fails to give your vessel the proper right-of-way. Always be prepared to stop quickly or take evasive action.



Navigational Rules

Non-Motorized Craft

Non-motorized craft (sailboats, canoes, etc.) are normally given the right-of-way, with the following exceptions:

- When a non-motorized craft is overtaking a power vessel, the power vessel has the right-of-way.
- Non-motorized craft should stay clear of fishing vessels.
- In a narrow channel, a non-motorized craft should not interfere with the safe passage of a power vessel.

Fishing Vessel Right-of-Way

All vessels that are fishing with nets, lines or trawls are considered “fishing vessels” under International Rules. Vessels with trolling lines are not considered fishing vessels. Fishing vessels have the right-of-way, regardless of position. However, they must not interfere with the passage of other vessels in narrow channels.

OPERATION

Navigational Rules

Avoid Collisions

SCAN CONSTANTLY for people, objects and other watercraft. Be alert for conditions that limit your visibility or block your vision of others.

OPERATE DEFENSIVELY at safe speeds, and keep a safe distance away from people, objects and other watercraft.

- Do not follow directly behind PWCs or other boats.
- Do not go near others to spray or splash them with water.
- Avoid sharp turns or other maneuvers that make it hard for others to avoid you or understand your course of travel.
- Avoid shallow water and areas with submerged objects.

TAKE EARLY ACTION to avoid collisions. Personal watercraft and other boats do not have brakes.

DO NOT RELEASE THROTTLE WHEN TRYING TO STEER away from objects. You need throttle for proper steering. Always check throttle and steering controls for proper operation before starting the craft.

Follow navigation rules and all state and local laws that apply to personal watercraft.

Reading Buoys and Markers

United States waters are marked for safe navigation through the use of buoys and markers with various shapes, colors, numbers and lights to guide boaters. The same is true for waters in particular states. Marking may vary by geographic location. Consult local authorities before riding your watercraft in unfamiliar waters.

Launch Ramp Etiquette

Be considerate and efficient when launching your watercraft at a public landing. Prepare your craft in advance, and perform all safety checks before arriving at the landing area. Launch as quickly as possible.

Launching the Watercraft

1. Launch the watercraft in an area free of weeds and debris. Make sure the craft is in at least two feet of water before starting the engine.
2. Push the rear of the watercraft up and down several times to flush out any sand that could be trapped in the pump.
3. Turn the fuel valve on, if applicable.
4. Carefully board the watercraft and sit down on the seat (if equipped).
5. Start the engine as outlined on page 66.



Stopping the Engine

Do not turn off the engine until the watercraft has stopped moving. Your craft requires engine power for steering. After the engine has stopped, you'll lose all steering control.

1. Release the throttle lever. When the engine has slowed to an idle and the watercraft has stopped moving, push in the stop button (1) with your left thumb. The engine should stop immediately. You may also stop the engine by pulling the lanyard lock plate (2) off the engine stop switch.
2. Be sure the water is at least two feet (60 cm) deep when stopping. This will prevent debris from being sucked into the impeller or cooling system.
3. Remove the lanyard lock plate. Never leave the lanyard attached to an unattended watercraft.

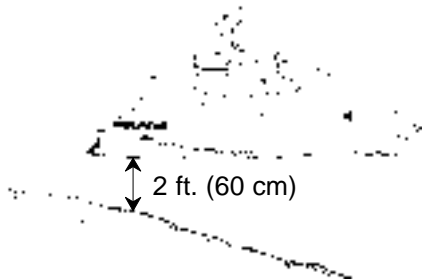
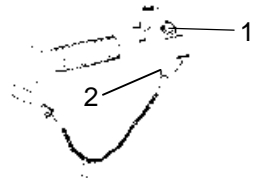

OPERATION

Before Starting the Engine

Before starting the engine:

1. View the *Watercraft Safety Video* provided with the watercraft.
2. Read and understand this owner's manual.
3. Be familiar with all controls and functions of the watercraft.
4. Perform the pre-operation check found on page 47.

If you have any questions about the features or controls of this watercraft, see your Polaris dealer.

CAUTION

If the engine is run while the watercraft is in very shallow water, sand, weeds and debris may be sucked into the jet intake and could cause damage to the impeller or injury to bystanders. Ingesting sand into the cooling system will cause the engine to overheat, which could lead to engine damage.

Whenever starting the engine, always be sure the watercraft is in water at least two feet (60 cm) deep.

Starting the Engine

1. Attach the lanyard wrist band (1) to your left wrist or PFD.
2. Fasten the lanyard lock plate to the engine stop switch on the handlebars by pushing the lock plate around the barrel of the switch. Be sure the lanyard is not tangled around the handlebars or controls.



NOTE: The engine will not start if the lanyard lock plate is removed from the engine stop switch.

3. On carb models, pull the choke knob out. If the engine is already warm, do not use the choke.

Starting the Engine

WARNING

Starting the engine immediately generates a forward thrust, which could cause an unprepared operator to fall from the machine, causing serious injury or death. Always be seated and alert when starting the watercraft. Never hold the throttle open while starting.

4. On DI models, push the starter button with your left hand while feathering the throttle (very slight open and close motion) with your right hand. As soon as the engine starts, release the starter button and throttle. Apply just enough throttle to keep the engine running.
5. On carb models, do not squeeze the throttle while starting. Push the starter button, and as soon as the engine starts, release the button, push the choke knob in and feather the throttle (very slight open and close motion) to aid in warm-up.

NOTE: If the engine was run out of fuel or if the fuel/water separator bowl was drained, it may take two or three attempts to start the engine. Do not run the starter for more than ten seconds at a time or damage to the starter may result.

CAUTION

Engaging the starter improperly may cause starter wear and eventual failure. Do not depress the starter button while the engine is running or while the starter is spinning.

If the Engine Doesn't Start

If the engine does not start within 10 seconds, release the starter button. Wait 10 seconds before trying again to avoid damaging the starter.

If your model is equipped with manual choke, pull the choke knob out and repeat the starting process. **NOTE:** If the engine is already warm, do not use the choke.

If the engine does not start after several attempts, refer to the troubleshooting section beginning on page 109.

OPERATION

Boarding the Watercraft

Practice boarding the watercraft before riding in deep water. Any passengers should also practice boarding in shallow water before riding on the watercraft.

Boarding and Starting in Deep Water (Operator Only)

Make sure the watercraft engine is turned off when boarding in deep water.

1. Swim to the rear of the watercraft. Grip the boarding handle near the rear of the seat.
2. Pull yourself up onto the boarding platform. If your model is equipped, use the seat strap for assistance.

NOTE: Some models are equipped with a boarding step for boarding convenience.

3. Move up to the seat and straddle it.
4. Attach the lanyard lock plate to the engine stop switch and see that the lanyard wrist band is secure on your left wrist before starting the engine.

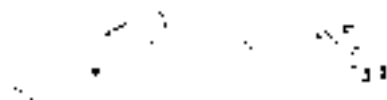

Step 1

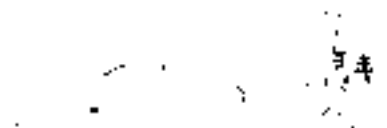

Step 2



Step 3

Boarding the Watercraft Boarding With a Passenger

A watercraft behaves differently with a passenger on board, requiring more operator skill. Practice operating skills alone, before taking a passenger on board. Make sure the watercraft engine is turned off when boarding with a passenger. Never carry a passenger on the Octane.

1. The operator should board first as outlined on page 68. Attach the lanyard lock plate to the engine stop switch and fasten the lanyard wrist band to the left wrist or PFD. *Do not start the engine yet.*

NOTE: During boarding, the passenger should steady the watercraft while the operator boards. The operator can then help balance it while the passenger boards.

2. The passenger should move (or swim) to the rear of the vehicle.
3. The passenger should pull him/herself on board using the grab handle. Both operator and passenger should try to balance the watercraft while the passenger is boarding.
4. The operator should see that the passenger is holding on tightly and that both feet are on the footrests before starting the engine.



Step 1

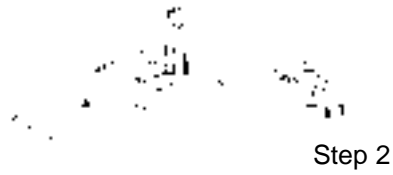

Step 2



Step 3

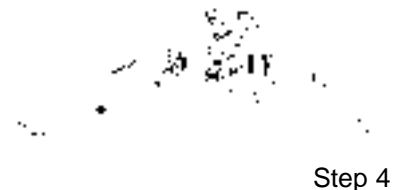

Step 4

OPERATION

Reverse Operation

Some Polaris watercraft have reverse capabilities. If equipped, your model may have either a reverse lever or a reverse switch. See the specifications section beginning on page 104 to determine if your watercraft has this feature.

NOTE: Engine RPM is limited during reverse operation. While in reverse, the multi-function gauge will flash a warning light and the corresponding LCD message “REVERSE” will be visible. *Be sure the reverse gate is in the full forward position before resuming normal operation or your speed will be limited by the RPM limiter.*

⚠WARNING

Activating reverse while the craft is moving forward could cause loss of control and result in damage to the watercraft or severe personal injury to the operator or passenger(s). Do not attempt to activate reverse while moving forward above planing speed.

Reverse Lever

1. To activate reverse, pull the reverse lever (1) all the way up. The lever will remain in the full up position.
2. Turn the handlebars and apply throttle carefully as required to maintain steering control of the watercraft.
3. To return to forward, return the reverse lever to the forward position.



Polaris Electric Reverse Control (PERC™)

1. To activate reverse, depress the reverse switch (2) (labeled RVS). Varying degrees of reverse engagement are possible, depending on the duration the reverse button is depressed.
2. Turn the handlebar and apply throttle carefully to maintain steering control of the watercraft.
3. To return to forward, depress the forward button (labeled FWD) until the reverse gate is in the full up position.

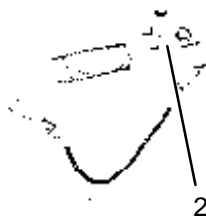

NOTE: The reverse gate can be activated without the engine running by depressing the bilge button and operating the up/down button for reverse actuation.

Stopping the Watercraft

⚠ WARNING

Colliding with an object in the water can result in serious injury to the operator or passengers. All riders must keep feet, arms and hands inside the watercraft at all times, and especially while approaching a dock, vessel or other object. Do not turn off the engine while approaching an object. Engine power is required for steering.

The operator of the watercraft should practice stopping to become familiar with the procedure. Stopping is affected by gross weight (watercraft and rider), vehicle speed, wind direction, and water surface conditions.

The watercraft is not equipped with a brake system. When the throttle is released, the natural drag of the water slows and stops the watercraft.

Always keep a safe distance from other vessels, swimmers, objects in the water and the shoreline. Allow yourself plenty of room for stopping. When operating at full speed (1), it could take the watercraft as much as 300 feet (90 m) to come to a stop after the throttle is released. *This distance is approximate and is supplied only for reference.*

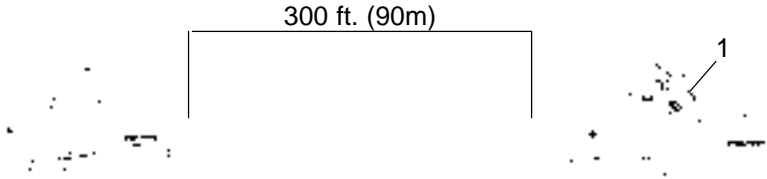

After releasing the throttle, coast toward the desired stopping area with the engine idling. You may need to use the throttle again for steering control.

NOTE: Push the engine stop button before entering shallow water to prevent sand and debris from entering the pump and cooling system.

OPERATION

Turning the Watercraft

Turning the watercraft requires using the throttle (thrust from the jet pump) and turning the handlebars at the same time. Do not release the throttle when trying to steer.

High thrust makes the watercraft turn more sharply. Lower thrust makes the watercraft turn less sharply.

Making sharp turns at high speeds may cause the watercraft to “spin out” and may cause rider(s) to be ejected from the watercraft. Make gradual turns when operating at higher speeds.

Always look behind the craft before turning to avoid collisions.



CAUTION

Sand, pebbles, weeds and debris can enter the jet pump and cause severe damage to components. Ingestion of sand into the cooling system may cause the engine to overheat and could result in severe engine damage. Never beach the watercraft while the engine is running. Shut off the engine when entering water less than two feet (60 cm) deep.

Beaching the Watercraft

1. *Slowly* approach the beaching area and stop the engine in no less than two feet (60 cm) of water. Make sure there are no swimmers, boats or other obstacles close to the watercraft, as it will be impossible to turn the watercraft after stopping the engine.
2. Dismount the watercraft and guide it to the beach.
3. Before restarting, inspect the impeller/jet pump area for sand and debris.
4. Move the watercraft to at least two feet (60 cm) of water and push the rear of the watercraft up and down in the water to help flush sand and debris out of the pump.

Step 2

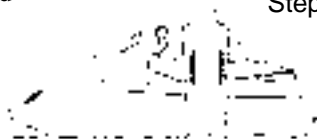

Step 4



Operating in Rough Conditions

⚠️WARNING

Riding the watercraft in rough water conditions could cause loss of control, resulting in severe injury or death to the operator and/or passenger. Avoid riding in rough water and/or adverse weather conditions. Do not jump waves with the watercraft.

Operating the watercraft in rough water conditions is not recommended, and it's illegal in some states to operate the watercraft in or near the surf line.

If riding in rough conditions, it's possible for the operator to hit his/her chest or face on the watercraft or handlebars and be injured. If the operator is ejected from the craft, injuries may make it difficult to reboard.



CAUTION

Operating with excessive throttle can result in cavitation damage to the impeller or pump. Do not operate at high throttle settings for extended periods while the watercraft is out of the water, which includes operation in extremely rough water.

Towing the Watercraft

If the watercraft becomes inoperable in the water, it can be towed. Tie about 20 feet (6 m) of tow rope to the eye located on the bow. Slowly tow the watercraft to shore.

NOTE: Before towing, use a pliers to close off the cooling water inlet hose located at the bottom of the watercraft hull (hose from pump box to exhaust pipe) to prevent hydrolock.

OPERATION

⚠️ WARNING

This watercraft does not right itself if it has been capsized. If the operator is unable to right a capsized watercraft, operator and passengers may be stranded, which could lead to serious injury or death. Follow the procedures outlined in the owner's manual and on the capsize decal, which is found on the rear of the craft.

CAUTION

Failure to right a capsized craft promptly *and correctly* may result in severe engine damage if the engine is operated with air or water in the lines. A capsized watercraft must be uprighted in a *clockwise* direction as viewed from the rear. If the watercraft has remained in a 180° (capsized) position for more than two minutes, all fuel and oil lines must be inspected for water and/or air.

Righting a Capsized Watercraft

After righting the craft, follow the procedures for a submerged (waterlogged) engine on page 80 to prevent engine damage.

1. Be sure the engine is stopped immediately after capsizing. The engine will overheat if it continues to run while the craft is capsized.
2. Upright the vehicle immediately by turning it in a clockwise direction *only* (as viewed from the rear).
3. Board the craft from the rear and operate the bilge pump to pump out any water in the hull. Start the engine.
4. If the engine fails to start shortly after being uprighted, make no further attempts to start it. Severe engine damage could result. Follow the procedures for a submerged (waterlogged) engine on page 80.



Operating With Passengers

⚠ WARNING

Overloading a watercraft will significantly reduce vehicle stability and control, which could result in an accident and lead to severe injury or death. Never exceed the load capacity for the watercraft.

Some Polaris watercraft are designed to carry an operator and up to three passengers, depending on the model. Refer the capacity decal on your craft and the specifications section beginning on page 104 to determine your model's rider capacity. Never exceed the stated capacity for your model.



When more than one person is riding, the watercraft handles differently, which means that the operator must have enough prior riding experience to handle the watercraft with one or more passengers aboard. The operator should be skilled in operation and maneuvers before carrying any passenger.

All passengers should read the owner's manual and follow all safety warnings. Passengers must wear an approved personal flotation device and other recommended safety gear. They should be good swimmers and they should be in good physical condition, as reboarding in deep water can be strenuous.

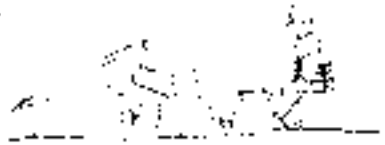

A passenger should firmly hang on to the operator's PFD or the seat strap and keep both feet on the footwell pads in the gunnel.

The operator should make sure any passenger is properly seated and holding on before accelerating. The operator should also communicate sudden maneuvers to a passenger in advance to prevent an ejection from the craft.

Passengers should sit behind the operator and face toward the bow of the watercraft. A passenger riding as a spotter in towing situations should hold on to the rear grab handle.

No person should operate or ride on a watercraft unless both feet reach the footrests when sitting on (straddling) the seat.

OPERATION

Post Operation Maintenance

Daily Care

Remove the watercraft from the water every day to inhibit marine organism growth on the hull.

1. Remove the watercraft from the water.
2. Purge residual water from the exhaust system by starting the engine and revving it repeatedly at partial throttle for about ten seconds until water no longer comes out. **NOTE:** If the craft is towed up or down a steep hill after removing it from the water, this procedure may be repeated.

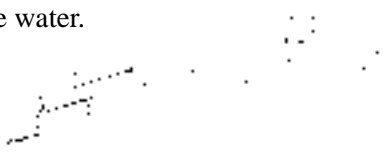

CAUTION

The engine may overheat and seize if operated out of water. Never operate the engine for more than 15 seconds or hold the engine at full throttle while the watercraft is out of the water.

3. Wash the hull, jet pump intake and outlet with fresh water.
4. Remove the drain plug(s) to drain any water in the bilge.
5. Remove the seat (or hood/engine cover) and rinse the engine compartment with a generous amount of fresh water. After the water has drained, wipe the engine compartment and bilge dry with clean towels.
6. If the craft is used in salt water, Polaris recommends that the inside of the hull (engine and components) be sprayed with T 9 metal protectant after each use. See page 108.
7. Reinstall the seat (or hood/engine cover).
8. Clean the drain plug(s) and opening(s) and reinstall the plug(s).
9. Drain the engine and flush the cooling system. See page 100.
10. Turn the fuel valve off (if equipped).

Post Operation Maintenance Daily Care

WARNING

Serious injury and damage to the watercraft will result if the jet pump and impeller are cleaned while the engine is running. Always stop the engine, remove the lanyard lock plate and disconnect the battery before servicing the jet pump and impeller.

11. Stop the engine and disable all starting mechanisms. Clean the jet pump and impeller of any weeds and debris that may have collected during operation. See page 26 for locations.
12. Inspect the area for damage. If damage is found, see your Polaris dealer for service.

NOTE: Whenever possible, avoid operating the watercraft in weedy areas. If it's unavoidable, vary the watercraft speed, as weeds tend to accumulate more rapidly at steady and trolling speeds.

OPERATION

Post Operation Maintenance

Temporary Storage

If the watercraft is going to be stored temporarily (less than 30 days), perform the daily maintenance procedures beginning on page 76 and also perform the following temporary storage procedures.

1. Block the engine compartment open about 1/2" (1.3 cm) to provide air circulation and to prevent condensation from forming. If the seat is saturated with water, stand it on end and allow it to dry out.
2. When storing the watercraft, make sure the nose is positioned upward at a 10° angle for drainage.

WARNING

Serious injury and damage to the watercraft will result if the jet pump and impeller are cleaned while the engine is running. Always stop the engine, remove the lanyard lock plate and disconnect the battery before servicing the jet pump and impeller.

3. Check the screen in the pump stationary nozzle for plugging. See instructions on page 99.

CAUTION

Operation of the engine with the intake system removed could result in serious engine damage. Never operate the engine with the intake system removed.

Post Operation Maintenance Transporting The Watercraft

Do not route ropes or tie downs over the seat as they could cause permanent damage to the seat. Protect the watercraft body by placing padding or similar material between the ropes or cables and the watercraft body.

Be sure the trailer matches the watercraft's weight and design and that it meets trailer laws and regulations in your area.

We recommend the use of a Polaris watercraft cover for protection from rocks and other debris while transporting.

1. Turn the fuel valve off (if equipped).
2. Tie the watercraft securely to the trailer at the bow and stern. Use additional cables if necessary. There should be no movement between the watercraft and trailer.
3. Make sure the seat and hood are secure.



OR

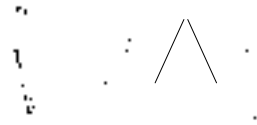

OPERATION

Post Operation Maintenance

WARNING

A weak battery may not be able to start the engine and could leave you stranded, which could result in severe injury or death. Never operate the watercraft with a weak battery.

Battery Information

If the watercraft battery is run down, remove it and have it recharged. Refer to battery charging recommendations and service procedures beginning on page 95.

CAUTION

Severe engine damage could result if the engine is operated with air or water in the lines. If the watercraft has remained in a 180° (capsized) position for more than two minutes, all fuel and oil lines must be inspected for water and/or air. Do not attempt to start the engine.

Submerged (Waterlogged) Engine

If the engine becomes water-flooded, tow the craft to shore and immediately perform the following procedures.

1. Remove the watercraft from the water.
2. Remove the drain plug and drain the water from the bilge. Bring the watercraft to an authorized Polaris dealer for service.

NOTE: Only mechanically experienced individuals should attempt to remove water from a waterlogged engine. Use the procedure on page 81. All others should take the watercraft to an authorized Polaris dealer for service. If this is not possible, call your Polaris dealer for further instructions.

Post Operation Maintenance Engine Water Removal Procedure

Use the following procedure for removing water from a submerged engine. Attempt this procedure only if you are mechanically experienced and have adequate assistance for lifting and supporting the watercraft.

WARNING

Accidental starting during the water removal procedure could cause severe personal injury. Before removing water from a submerged engine, make sure the lanyard cord and lock plate are removed from the engine stop switch.

1. Remove the watercraft from the water. Remove the lanyard cord from the engine stop switch and place the watercraft on a flat surface, allowing room to roll it onto its side later.
2. Remove the drain plug(s) and drain the water from the bilge.
3. Remove the seat and remove the air intake to drain the flame arrestor. Remove the spark plugs.
4. Tip the watercraft on its right side (to starboard) until the spark plug holes are just below horizontal. While assistants hold the watercraft in this position, turn the driveshaft by hand to rotate the engine and allow the water to run out.
5. Upright the watercraft and inspect and dry the spark plug holes. Install new spark plugs.
6. Install the air intake.
7. Check the battery vent hose for obstructions and drain any water from the hose.
8. Check the fuel and oil for the presence of water. If water is present, take the watercraft to an authorized Polaris dealer for immediate service. Do not run the craft if water is present in the fuel or oil.
9. Verify that no air is present in the oil line.
10. Grease the driveshaft and bearing housing following the instructions on page 88.
11. Reinstall the drain plug(s) and the seat.

MAINTENANCE AND LUBRICATION

Post Operation Maintenance

Anti-Corrosion Treatment

Spray all the metal components in the engine compartment with a lubricating type rust inhibitor. We recommend T9 metal protectant.

Apply dielectric grease on battery terminals and connections.

NOTE: Never leave shop cloths or tools in the engine compartment or bilge.

General Maintenance

Refer to page 108 for part numbers of Polaris products.

Replace pop-off valve, spring, and seals every 100 hours only.

Replace water separator filter element and o-ring every 100 hours only.

Replace inlet and outlet hoses and clamps every 100 hours only.

After washing the engine compartment of the watercraft, protect the metal components with a T9 Metal Protectant or another *non-flammable* metal protectant. Do not use flammable sprays or protectants in the engine compartment. Do not use petroleum based protectants or lubricants in the engine compartment, as most are flammable and may also deteriorate rubber components.

Periodic Maintenance Schedule

NOTE: Maintenance intervals are based upon average operating conditions. Watercraft operated in saltwater require daily corrosion protection and engine flushing, and more frequent maintenance and lubrication.

Fogging kits should be added to all Polaris watercraft. The engine should be fogged if the watercraft will not be used for more than 48 hours.

Maintenance Schedule Key

I - Inspect, adjust, service, or replace if necessary

A - Adjust

C - Clean

R - Replace item

L - Lubricate with recommended lubricant

MAINTENANCE AND LUBRICATION

Periodic Maintenance Schedule

DESCRIPTION	Pre-ride	Pre-season	Monthly or 25 hrs.	3 mos. or 50 hrs.	6 mos. or 100 hrs.	Tune up item
ENGINE						
Engine corrosion protection/fogging(daily-salt water)	L**	L	L			
Cooling system flushing (daily after use in salt water)	I**	I				•
Water injection solenoid (Virage i)			C			
Exhaust cooling hose screen		I/C		I/C		•
Exhaust hose condition		I		I		
Engine mounts (Replace if removed for engine service)		I			I	•
Thermostat/popoff valve assembly/spring		I/C	I/C*		R	•
Water inlet and outlet hoses and clamps		I	I	I	R	
Spark plugs/Compression test		I			I	•
Spark Plugs (DI models replace every 100 hours)		R		I	R	
Engine fastener re-torque (cyl head/cyl base, exhaust)		I			I	•
Oil pump adjustment (where applicable)		I		I		•
FUEL SYSTEM						
Fuel/water separator (drain water)	I/C	I/C				•
Inspect and clean fuel water separator/filter	I	I			R	
Fuel filter and oil filter		R	I			•
Throttle and choke cables	I	I/L/A		L		•
Carburetor (see engine fogging procedure) synchronize		A/C			A	•
Fuel cap/oil cap gaskets	I	I	I	I	R	

I - Inspect, adjust, service, or replace if necessary

A - Adjust

C - Clean

R - Replace item

L - Lubricate with recommended lubricant

MAINTENANCE AND LUBRICATION

Periodic Maintenance Schedule

DESCRIPTION	Pre-ride	Pre-season	Monthly or 25 hrs.	3 mos. or 50 hrs.	6 mos. or 100 hrs.	Tune up item
FUEL SYSTEM (Cont.)						
Fuel lines, oil lines, related hose clamps, check valves and hose inspection, fuel system pressurization		I			I	•
Vent system (oil and fuel) check-valves; hose routing		I				•
Fuel system pressure/vacuum test		I				
Fuel system (treat with Carbon Clean Plus)		I	I			
Air intake silencer drain line(s)		I/C				•
JET PUMP						
Drive shaft coupler and bearing housing		I/L	I/L		I/L	•
Drive shaft shroud condition		I	I			•
Bilge system pick-up screens and hoses	I/C	I/C				•
Cooling water inlet screen/hoses, clamps	I/C	I/C				•
Jet pump intake grate fasteners and condition		I		I		•
Impeller condition and impeller clearance		I			I	•
Pump Sacrificial Anode		I		I		•
Reverse mechanism		I/A		I/A		•
ELECTRICAL						
Battery condition, fluid level	I	I				•
Battery vent hose condition/routing (must be clear)		I		I		•
Battery and starter cables (clean connections / tight)		I		I	I	•
Ground cables-condition, corrosion, fastener torque		I		I	I	

MAINTENANCE AND LUBRICATION

Periodic Maintenance Schedule

DESCRIPTION	Pre-ride	Pre-season	Monthly or 25 hrs.	3 mos. or 50 hrs.	6 mos. or 100 hrs.	Tune up item
ELECTRICAL (cont.)						
Engine overheat warning/ tone/electrical connections		I			I	
Lanyard cord/engine stop switch	I	I				•
HULL / DECK / STEERING / CONTROLS						
Steering support hub bushings/fasteners/handgrips		I/L			I/L	•
Steering cable		I/L/A		I/L		•
Steering Nozzle Bushings	I				R	
Reverse cable inspection, lubrication	I	I/L/A		I/L/A		
Handlebar/steering operation (turns fully/freely/fasteners)	I	I				•
Hull, clean and inspect for cracks, damage, or leaks	I	C/I				
Drain Plug Condition	I	I				•
Bilge system inspection, should not leak	I	I			I	
Seat and compartment seals (condition of seal)		I/A	I/A			•
Fire extinguisher		I			I	•
Inspect and tighten all fasteners, including carburetor mounts engine mounts, exhaust system, all hose clamps; inspect muffler, battery, oil and fuel tank fastening devices, pump, steering fasteners. Aggressive riding requires more frequent service.		I	I			•

I - Inspect, adjust, service, or replace if necessary

A - Adjust

C - Clean

R - Replace item

L - Lubricate with recommended lubricant

MAINTENANCE AND LUBRICATION

Lubrication

Proper lubrication and corrosion protection are necessary to maintain optimum performance and ensure years of service from your watercraft. We recommend the use of Polaris All Season Premium Grease. See page 108 for part numbers of Polaris products.

Throttle and Choke Cables

1. Lubricate the throttle cable and choke cable inner cables (if equipped).
2. Depress the throttle lever and squirt grease onto the cable.
3. Push and release the throttle several times to work the grease down the cable.

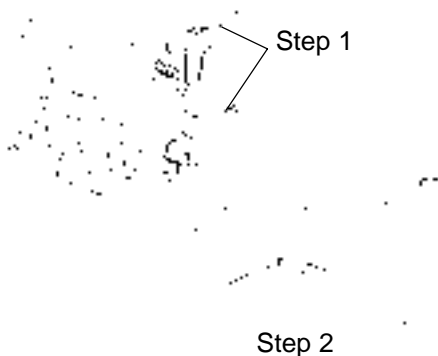

Steering Cable Joints and Inner Wire

1. Lubricate the steering cable joints on the steering nozzle end.
2. Expose the steering cable inner cable and apply grease. Lubricate the steering nozzle end and the handlebar end.

NOTE: Cable seals can be moved to allow grease into the cable. Make sure the seals are put back in the proper location after applying grease.

MAINTENANCE AND LUBRICATION

Lubrication

Steering Nozzle Pivot Shaft

Lubricate the steering nozzle shaft pivot connections (1).

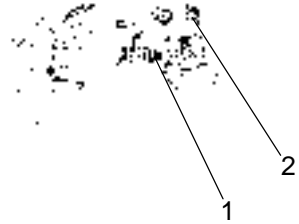

Steering Handle Pivot Shaft

Lubricate the handle pivot shaft and bushing (2). If the steering shaft has loosened, tighten it.

Choke (Carb Models)

Pull the choke knob out and apply grease to the shaft.

Seat Latch And Hooks

Grease the locking mechanism of the seat latch at the rear of the seat opening.

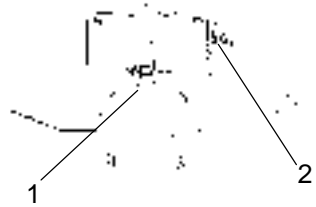

Carburetor And Oil Injection Pump

Grease springs, exposed portions of cable and shafts at the carburetor(s) or throttle bodies. Grease often if used in salt water.

Electrical Connections

Apply dielectric grease to battery posts and exposed cable connections.

MAINTENANCE AND LUBRICATION

Lubrication

Drive Shaft Lubrication

To grease the drive shaft and coupler splines, the pump assembly must be removed. This maintenance procedure should be performed by your dealer on an annual basis. If the boat is frequently used in salt water, this procedure should be done semi-annually.

Bearing Housing

Using a grease gun, lubricate the bearing housing at the grease fitting (1) until grease purges past the seals. Use Polaris All Season Premium Grease.

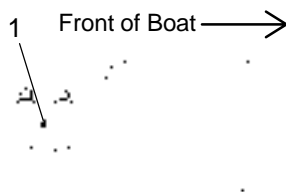

CAUTION

Any time water has been at or above the coupler level, grease the drive shaft coupler to prevent damage to these parts. Lubrication after every 25 hours of operation is also recommended.

MAINTENANCE AND LUBRICATION

Spark Plugs

Always use the spark plugs and gap recommended for your watercraft. Gap thickness (1) should be measured with a wire thickness gauge.

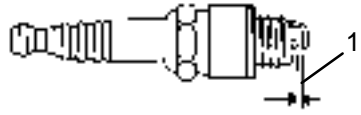

CAUTION

Engine damage could occur if a non-recommended spark plug is used. If the engine in your boat requires a resistor plug, never substitute a non-resistor spark plug (in BPR8ES, the R indicates a resistor plug).

A slightly brownish tip is considered good. The engine is running properly and the carburetor is adjusted correctly.

NOTE: If the spark plug tip is black or grey, have the watercraft serviced by an authorized Polaris dealer as soon as possible.

A black tip indicates several potential problems: the wrong spark plug (wrong heat range) is being used; excessive idling occurs; the carburetor idle speed mixture or high speed mixture is too rich; or there is a malfunction with the RPM limiter.

A light grey or white tip indicates that the wrong spark plug (wrong heat range) is being used; the carburetor idle speed mixture is too lean; there is a plugged fuel filter; or there is a leaking engine seal or gasket.

A yellow tip is caused by salt water mist ingestion. This is a conductive coating which will eventually cause fouling. This is a normal situation.

MAINTENANCE AND LUBRICATION

Spark Plugs

A spark plug with cracked porcelain or damaged threads should be changed immediately. If the electrodes are badly worn or burned the plug should also be replaced.

If the spark plug is in good condition, clean it with a clean shop cloth and/or wire brush. Adjust the gap to the proper dimension using a wire thickness gauge.

WARNING

Removing a spark plug while the engine or exhaust system is hot could result in serious burns. Wait until the engine has cooled or wear protective gloves while removing the spark plug.

WARNING

High tension voltage is present in the spark plug wires when the engine is running. Contacting the wires could cause serious injury. Never touch spark plug wires when the engine is being cranked or run.

Wipe any water from the spark plug and the inside of the cap. Install the spark plug and torque to 18 ft. lbs. If a torque wrench is not available, 1/4 to 1/2 turn beyond finger-tight is close to the correct torque. Push the cap down on the plug until it clicks. Use dielectric grease on the inside of the spark plug cap to prevent corrosion.

Before installing a *used* plug, wipe off the threads and apply dielectric grease. Also clean the gasket surface.

MAINTENANCE AND LUBRICATION

⚠WARNING

Failure to heed gasoline warnings can result in fire or explosion, which could cause serious injury or death. See gasoline warnings on page 48.

If your machine is equipped with a fuel valve, shut it off before servicing fuel components.

Fuel System (DI Models)

To prevent carbon buildup behind the piston ring, the fuel systems of direct injection models must be treated every 25-30 hours, or seasonally if accumulated hours are less than 25. Add Carbon Clean Plus to the fuel tank at a ratio of two ounces per gallon of fuel.

For the best performance and extended life of your watercraft, Polaris recommends the use of Nature Oil Biodegradable 2-Cycle Oil in Polaris watercraft engines. See page 108 for the part numbers of Polaris products.

Fuel Tank

When the fuel tank needs cleaning, or if water is found in the fuel tank, turn the fuel valve off and have the watercraft serviced immediately by an authorized Polaris dealer.

Fuel Lines

The fuel lines should be inspected regularly. Special attention should be given to fuel system line condition after periods of storage. Normal deterioration from weathering and fuel compounds can occur. See your dealer if you suspect any deteriorated components.

Oil Filter

CAUTION

Substituting a non-recommended oil filter could result in damage to the watercraft. The in-line oil filter is a special type and must not be substituted. The filter should be changed annually by an authorized Polaris dealer during the pre-season inspection. Do not attempt to clean this filter.



MAINTENANCE AND LUBRICATION

EPA Emission Regulation Compliance

All Polaris Direct Injection equipped engines manufactured by Polaris Industries are certified to the United States Environmental Protection Agency regulations for the control of air pollution. For this reason, factory procedures for servicing must be strictly followed, and wherever practicable, returned to the original intent of the design.

Maintenance, replacement, or repair of the emission control devices and systems may be performed by any marine SI engine repair establishment or individual.

Octane Emissions Statement

The Octane watercraft has a 777cc engine that is excluded from coverage under the U.S. Environmental Protection Agency (EPA) emission regulations for marine engines. The engine and watercraft were designed and built solely for use in competition by qualified racers. As defined by the EPA, used solely for competition means exhibiting features that are not easily removed and that would render its use other than in competition unsafe, impractical, or highly unlikely.

The Octane engine's competition features include:

- No idle stop
- No idle adjustment mechanism

Modifications to this engine for non-competition use by an engine owner, operator, or repair facility are not authorized by Polaris Industries, Inc. Such modifications may constitute a violation of the Clean Air Act and could subject the engine owner, operator, or repair facility to non-compliance penalties.

The Emission Control Information label located on the engine flywheel cover (A) must not be removed or destroyed. This label verifies that the engine as built by Polaris Industries, Inc. is excluded from coverage under the U.S. EPA marine engine emission regulations.



POLARIS INDUSTRIES, INC. P.N. 7171194 EMISSION CONTROL INFORMATION

THIS 777cc POLARIS OCTANE ENGINE IS EXCLUDED FROM COVERAGE UNDER THE U.S. EPA REGULATIONS FOR MARINE SI ENGINES, PURSUANT TO SECTION 216 (10) OF THE CLEAN AIR ACT. THIS ENGINE IS AUTHORIZED SOLELY FOR USE IN COMPETITION WITH NUMEROUS COMPETITION FEATURES, INCLUDING NO IDLE STOP AND NO IDLE ADJUSTMENT MECHANISM.

MAINTENANCE AND LUBRICATION

Carburetor Adjustment

The carburetor is vital to engine operation and performance. Adjustment of the carburetor should only be done by an authorized Polaris dealer. Idle speed can also be adjusted by your dealer.

CAUTION

Changing the settings on the carburetor could result in excessive exhaust emissions, poor performance or engine damage. Do not attempt to change the carburetor settings.

NOTE: If the watercraft will be used at a high altitude, above 3000 feet (1000 m), have an authorized Polaris dealer adjust the carburetor to allow for the thinner atmosphere. Polaris Direct Injected engines compensate for high altitude automatically.

Steering Cable Inspection

1. The handlebars and steering nozzle should operate smoothly. If movement is stiff, see your authorized Polaris dealer for service.
2. Turn the handlebars from lock to lock and check to be sure that the clearances between the steering nozzle and the rear hull are even on both sides. If the alignment is not even, see your authorized Polaris dealer for service.

Throttle Cable Inspection

1. Depress and release the throttle lever. It should return to its initial position smoothly. If it doesn't, see your authorized Polaris dealer for service.
2. Throttle lever free-play should not exceed .020"-.060" (.5-1.5 mm). If it does, see your authorized Polaris dealer for service.

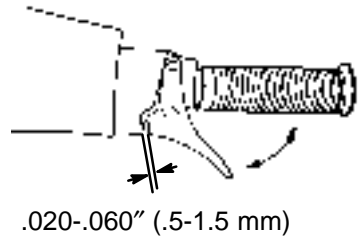

MAINTENANCE AND LUBRICATION

Choke Cable Inspection

Pull the choke knob out to fully close the choke valve (1). Make sure the choke cable is operating smoothly. In this position, the choke is on. Reverse the procedure to open the choke valve (turn the choke off)(2).

There should be minimal choke cable slack. If the choke is not functioning properly, have it serviced by your authorized Polaris dealer.

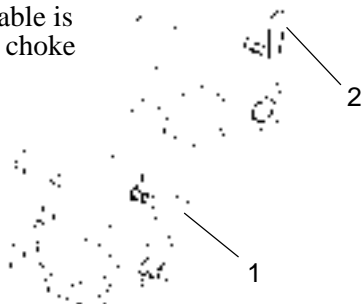

Circuit Breaker (Virage/Freedom)

The electrical system is protected with a 15 amp circuit breaker. To reset the circuit breaker, locate and push the reset buttons (A) on top of the electrical box.

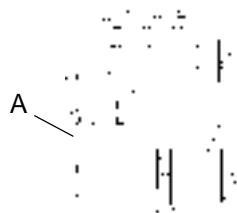

Fuses

Carb Models

The MFI is protected by a 1/4 amp fuse (B) and the bilge pump is protected by a 3 amp fuse (C).

Inspect the fuses every season to ensure fuses are not blown. There are spare fuses in the electrical box.

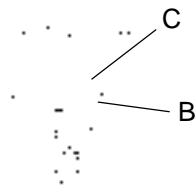

DI Models

The MFI is protected by a 2 amp fuse and the bilge pump is protected by a 3 amp fuse.

NOTE: DI models have two 15 amp in-line fuses located on the chassis harness.

MAINTENANCE AND LUBRICATION

Battery

Battery Maintenance and Charging

Keep the battery terminals and connections free of corrosion. If cleaning is necessary, remove the corrosion with a stiff wire brush. Wash with a solution of one tablespoon baking soda and one cup water. Rinse well with tap water and dry off with clean shop towels. Coat the terminals with dielectric grease or petroleum jelly.

Be careful not to allow cleaning solution or tap water into the battery.

⚠WARNING

Battery electrolyte is poisonous. It contains sulfuric acid. Serious burns can result from contact with skin, eyes or clothing.

Antidote:

External: Flush with water.

Internal: Drink large quantities of water or milk. Follow with milk of magnesia, beaten egg, or vegetable oil. Call physician immediately.

Eyes: Flush with water for 15 minutes and get prompt medical attention.

Batteries produce explosive gases. Keep sparks, flame, cigarettes, etc. away. Ventilate when charging or using in an enclosed space. Always shield eyes when working near batteries. **KEEP OUT OF REACH OF CHILDREN.**

Replenishing Battery Fluid

A poorly maintained battery will deteriorate rapidly. Check the battery fluid level often. The fluid level should be kept between the upper and lower level marks (1).

To refill use only distilled water. Tap water contains minerals that are harmful to a battery.



MAINTENANCE AND LUBRICATION

Battery

⚠ WARNING

Improperly connecting or disconnecting battery cables can result in an explosion and cause serious injury or death. When removing the battery, always disconnect the negative (black) cable first. When reinstalling the battery, always connect the negative (black) cable last.

Battery Removal

1. Release the battery by loosening the fasteners and removing the bar/EMM bracket (1).
2. If applicable, move the electrical box out of the way. It does not have to be opened for battery removal. **NOTE:** Some wiring may have to be removed from the wire clips for access to the battery.
3. Remove the battery vent tube from the battery.
4. Disconnect the black (negative) battery cable first.
5. Disconnect the red (positive) battery cable next.
6. Lift the battery out of the watercraft, being careful not to tip it sideways and spill any electrolyte.

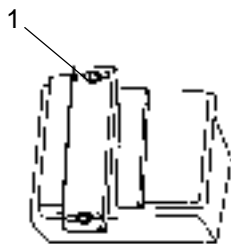

⚠ CAUTION

If electrolyte spills, immediately wash it off with a solution of one tablespoon baking soda and one cup water to prevent damage to the vehicle.

MAINTENANCE AND LUBRICATION

Battery

Battery Charging

Do not connect the charger cables to the battery unless the charger is unplugged.

When using a battery charger, connect the battery to the charger *before* plugging in and turning on the charger. This prevents the possibility of sparks at the terminals, which could ignite the battery gases.

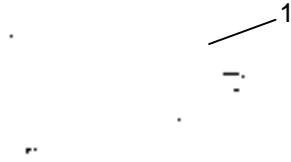

1. Remove the caps from the cells (1). Add distilled water if necessary to bring the electrolyte up to the proper level.
2. Connect the battery to the charger. Set the charging rate at 1.9 amps, plug in the charger and charge the battery for ten hours.

NOTE: If the electrolyte temperature rises above 115°F (45°C) during charging, reduce the charging rate to lower the temperature. Increase the charging time.

3. After the battery is charged, check the fluid level. If it dropped, add distilled water to bring the electrolyte up to the proper level.
4. Check the results of charging. The specific gravity of each cell must be 1.26 at room temperature. The voltage should be 14.5 - 15.5 V during charging and 12.2 - 12.8 V after charging.

MAINTENANCE AND LUBRICATION

Battery

Battery Installation

1. Set the battery in the battery holder.
2. Install the battery vent tube (1).
NOTE: It must be free of obstructions and securely installed. If not, battery gases could accumulate and cause an explosion. The tube should be routed away from the frame and body to prevent corrosion. Avoid skin contact with electrolyte, which can cause severe burns.
3. First connect and tighten the red (positive) cable.
4. Second connect and tighten the black (negative) cable.
5. Apply dielectric grease to each cable.
6. Reinstall the battery cover and attach the hold-down strap(s).
7. Verify that cables are properly routed.

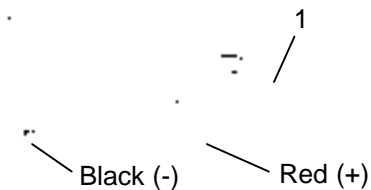

NOTE: When installing a new battery, make sure it's fully charged prior to its initial use. Using a new battery that has not been fully charged can damage the battery and result in a shorter life. It can also hinder vehicle performance.

Battery Storage

1. Remove the battery. Clean the casing and terminals with baking soda and water (one tablespoon of baking soda to one cup water). Apply dielectric grease or petroleum jelly to battery terminals and all exposed cable connectors.
2. Top off the battery with distilled water and charge it to a specific gravity of 1.26. Recharge monthly as required to prevent battery discharge and sulfating.
3. Store the battery in a cool, dry place out of direct sunlight.

MAINTENANCE AND LUBRICATION

Salt Water and Unclean Water Care

When the watercraft is operated in salt water or water with impurities like silt, sand and other particulates, additional cleaning and maintenance is mandatory after each use. Clean the jet pump water inlet screen and all other affected areas of the watercraft. Flush the cooling system.

CAUTION

Failure to perform additional cleaning and maintenance when the watercraft is operated in unclean or salt water will result in damage and corrosion to the watercraft. Clean all affected areas of the watercraft after every use in salt water or unclean water.

Jet Pump Water Inlet Screen

The water inlet screen (1) is located inside the stationary nozzle of the jet pump. Its purpose is to screen out grass and debris that could enter the coolant system.

After using the watercraft, visually inspect the screen for buildup of contaminants. Clean as required by flushing engine and/or screen with fresh water. See flushing procedure on page 100.

If the screen cannot be cleaned by flushing, see your Polaris dealer for additional cleaning.

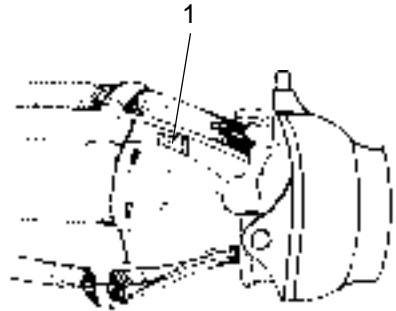

MAINTENANCE AND LUBRICATION

Cooling System Flushing

The watercraft uses water for propulsion and for cooling. Flushing the cooling system with fresh water (never anti-freeze) will neutralize the corroding effects of salt water or water with impurities like silt, sand, alkali and other particulates. Flushing will also clean out other residue left in the water passages of the watercraft cooling system. Flush the water passages every day the watercraft is used, any time the craft has been beached and before storing the craft for an extended time.

CAUTION

Failure to follow the recommended flushing procedure or flushing the engine while it's hot could result in serious engine damage. Always follow the recommended flushing procedures. Always allow the engine to cool sufficiently before flushing. Always flush the cooling system any time the watercraft has been beached.

Polaris recommends the use of Flush Kit PN 2871443 (carb models) or Flush Kit PN 2873623 (DI models) when flushing the cooling system.

1. Attach a garden hose to the female coupler/hose attachment.
2. Snap the male and female coupler together.
3. Start the watercraft engine and immediately turn on the water faucet.
4. Rev the engine intermittently for one minute to completely flush the cooling system.
5. Turn off the water faucet.
6. When all water has exited the cooling system, turn off the engine.
NOTE: This step should not take longer than 10 seconds.
7. Press the button on the female coupler/hose attachment and separate from male coupler.

MAINTENANCE AND LUBRICATION

Extended Storage

When the watercraft will not be used for a month or more, preventative maintenance is required to keep components from deteriorating. An authorized Polaris dealer can do the required preventative maintenance or you can do it yourself with a minimum of tools. Perform all of the procedures outlined in this section of your owner's manual before storing the watercraft for an extended period of time. Refer to page 108 for part numbers of Polaris products.

Clean the cooling system according to instructions on page 100.

Engine and Exhaust System Draining

Engine draining is automatic. You will, however, need to make sure the exhaust system is drained.

1. Start the engine and briefly rev it.
2. When preparing your watercraft for off-season storage, add Carbon Clean Plus to the fuel tank, then top off with fresh fuel. See page 108 for the part numbers of Polaris products.
3. Fog the engine with rust-preventing oil. Follow the recommended procedures on page 102.

NOTE: Using a fuel stabilizer and topping off the fuel tank eliminates the need to drain the fuel system. If you prefer to drain the fuel tank, use the following procedure.

WARNING

Gasoline is highly flammable and explosive under certain conditions. Always exercise extreme caution whenever handling gasoline. Read and heed all gasoline warnings found on page 48.

1. Drain the fuel tank with a siphon or pump.
2. Leave the fuel cap loose to prevent condensation from forming in the fuel tank.

NOTE: Perform the next two steps simultaneously.

3. Fog the engine with rust-preventing oil. Follow the instructions on the can.
4. Start the engine and run it at partial throttle to dry out the carburetors. Do not run the engine for more than 15 seconds while the watercraft is out of the water. Wait five minutes between 15 second running periods.

MAINTENANCE AND LUBRICATION

Extended Storage

CAUTION

Failure to fog the engine can result in serious engine corrosion during off season or extended storage. Always fog the engine as outlined before storing the watercraft for extended periods.

Watercraft Engine Fogging Procedure

Polaris recommends the use of Polaris fogging oil to prevent rust and corrosion on internal engine parts (i.e. crankshaft, bearings, pistons, rings, cylinder walls). The fogging oil coats all internal parts for prevention of rust and corrosion, which in turn will extend the life of the engine. Refer to page 108 for part numbers of Polaris products.

1. Remove the bolt(s) securing the air intake cover.
2. Remove intake cover and air filter element.

CAUTION

Operating the engine while the watercraft is out of the water will cause the engine to overheat and seize. Never operate the engine for more than 15 seconds while the watercraft is out of the water.

3. Start the engine and spray Polaris fogging oil into each carburetor throat to ensure that all internal parts are properly coated. Spray fogging oil for two to three seconds in each intake throat and repeat until the engine is flooded with fogging oil. Then stop the engine immediately.
4. Reinstall filter element(s) and air intake covers.

MAINTENANCE AND LUBRICATION

Extended Storage

CAUTION

Never clean the watercraft with strong detergents, abrasives, degreasers, paint thinner, acetone, window cleaners, ammonia or products containing alcohol. They can damage finishes, decals, vinyl and plastics and accelerate UV breakdown, which could cause color change and premature deterioration of parts.

Cleaning

1. Remove the drain plug and clean the bilge and engine area with hot water and mild detergent (such as dish soap) or with bilge cleaner. Rinse and drain thoroughly. Wipe up remaining water with clean, dry shop cloths. Do not use abrasive cleaners.

NOTE: Store the watercraft with the drain plug removed and the engine compartment propped open slightly to inhibit condensation from forming in the compartment.

2. Wash the exterior of the watercraft with fresh water and a mild detergent. Rinse thoroughly.
3. Inspect and thoroughly clean the jet pump intake, outlet and impeller area. If damage to these areas is visible see your Polaris dealer for service.
4. After cleaning, protect and polish the watercraft with a regular furniture polish or non-abrasive silicone wax. Protect the seat and handlebar unit with a vinyl protector.
5. Spray the exterior of the engine with T9 metal protectant.
6. Cover the watercraft with an opaque tarp or Polaris watercraft cover and store it in a clean, dry place.

NOTE: When storing the watercraft, make sure the nose is positioned upward at a 10° angle to allow water drainage.

Lubrication

1. Remove the spark plugs and pour about one tablespoon of the recommended 2-cycle oil into each cylinder.
2. Inspect and grease the spark plug threads. Replace if necessary.
3. Lubricate the choke (if equipped), throttle and steering cables. See page 86.
4. Lubricate all areas recommended in the maintenance section beginning on page 86.
5. Remove and store the battery as outlined on pages 95-98.

SPECIFICATIONS

	Virage	Virage I	Genesis I
CAPACITIES / DIMENSIONS			
Fuel Tank	17.8 gal. (67.4 l)	17.8 gal. (67.4 l)	17.8 gal. (67.4 l)
Oil Reservoir	6.0 qt. (5.68 l)	6.0 qt. (5.68 l)	6.0 qt. (5.68 l)
Rider Quantity	1-3 people	1-3 people	1-4 people
Load Limit, Riders	500 lbs. (227 kg)	500 lbs. (227 kg)	600 lbs. (273 kg)
Load Limit, Total	565 lbs. (256 kg)	565 lbs. (256 kg)	625 lbs. (282kg)
Length	120.3 in. (305.6 cm)	120.3 in. (305.6 cm)	131.1 in. (330.5 cm)
Width	49.3 in. (125 cm)	49.3 in. (125 cm)	49.3 in. (125 cm)
Dry Weight	600 lbs. (272 kg)	610 lbs. (275 kg)	735 lbs. (334 kg)
Hull Material	SMC *	SMC *	FRC **
ELECTRICAL			
Alternator Output	5 amp/ 60watt @ 4500 rpm	12 amp/ 160watt @ 4500 rpm	12 amp/ 160watt @ 4500 rpm
Ignition System	Digital CDI	FICHT™ EMM	FICHT™ EMM
Spark Plug Type	NGK BPR8ES	NGK PZFR6H	NGK PZFR6H
Spark Plug Gap	.028 (.7mm)	.032 (.8mm)	.032 (.8mm)
Starting System	Electric Starter	Electric Starter	Electric Starter
Battery	12V, 19A	12V, 19A	12V, 19A
COOLING			
Engine Cooling	Water cooled, thermostat pop off	Water cooled, thermostat pop off	Water cooled, thermostat pop off
Overheat Warning	Warning Light/RPM Limit	Warning Light/RPM Limit	Warning Light/RPM Limit
ENGINE			
Engine Type	Polaris Marine 700 LE	Polaris Marine 800 DI	Polaris Marine 1200 DI
Induction Type	Case Reed	Case Reed	Case Reed
Exhaust System	Water Cooled/Injected 700 H	Water Cooled/Injected 700 H	Water Cooled/Injected
Lubrication	Oil Injected	Oil Injected	Oil Injected
Oil Type	Nature Oil Biodegradable 2-Cycle Oil	Nature Oil Biodegradable 2-Cycle Oil	Nature Oil Biodegradable 2-Cycle Oil
Cylinders	2	2	3
Bore x Stroke	81 x 68 mm	84 x 70 mm	84 x 70 mm
Displacement	701cc	777cc	1165cc
Rated Horsepower	95	100	135
RPM Limiter Operation	7200±100	7200±100	7200±100

SPECIFICATIONS

	Virage	Virage I	Genesis I
FUEL DELIVERY			
Fuel Type	87 Octane Non-oxygenated or 89 Octane Oxygenated	87 Octane Non-oxygenated or 89 Octane Oxygenated	87 Octane Non-oxygenated or 89 Octane Oxygenated
Carburetor Quantity and Type	1 40mm	2 Ram Injectors	3 Ram Injectors
PROPULSION			
Impeller, Stainless Steel	3 Blade (+)	3 Blade (<)	3 Blade (<)
Propulsion	Jet Drive	Jet Drive	Jet Drive
Jet Pump Type	Extended Big Mouth, Single Stage Axial Flow	Extended Big Mouth, Single Stage Axial Flow	Dominator Short, Single Stage Axial Flow
Transmission	Direct Drive	Direct Drive	Direct Drive
Minimum Water Level for Jet Pump	2 feet (60 cm)	2 feet (60 cm)	2 feet (60 cm)
Impeller Diameter	5.83 in. (14.80 cm)	5.83 in. (14.80 cm)	5.83 in. (14.80 cm)
FEATURES			
Instrumentation	22 Function MFI	23 Function MFI	25 Function MFI
Fuel Gauge	On MFI	On MFI	On MFI
Oil Level Sensor	Multi-Level	Multi-Level	Multi-Level
Tachometer	On MFI	On MFI	On MFI
Reverse System	Standard	Standard	PERC™
Voltage Meter	On MFI	On MFI	On MFI
Trip Meter	On MFI	On MFI	On MFI
Speedometer	On MFI	On MFI	On MFI
Temperature Switch	Standard	Standard	Standard
Sponsons	Standard, 28"	Standard, 28"	Standard, Genesis
Electric Bilge Pump	Automatic, Electric with manual override	Automatic, Electric with manual override	Automatic, Electric with manual override

(+) - Large Overlap Progressive Pitch

(<) - Radial Blade Progressive Pitch

PERC - Polaris Electric Reverse Control

MFI - Multi-Function Instrument

* SMC - Sheet Molded Compound

** FRC - Fiberglass Reinforced Composite

SPECIFICATIONS

	Freedom	Octane
CAPACITIES / DIMENSIONS		
Fuel Tank	17.8 gal. (67.4 l)	4.5 gal. (17 l)
Oil Reservoir	6.0 qt. (5.68 l)	N/A (Premix)
Rider Quantity	1-3 people	1 person
Load Limit, Riders	500 lbs. (227 kg)	N/A
Load Limit, Total	565 lbs. (256 kg)	N/A
Length	120.3 in. (305.6 cm)	90 in. (228.6 cm)
Width	49.3 in. (125 cm)	29.5 in. (74.9 cm)
Dry Weight	590 lbs. (268 kg)	330 lbs. (149.7 kg)
Hull Material	SMC *	FRC **
ELECTRICAL		
Alternator Output	5 amp/ 60watt @ 4500 rpm	5 amp/ 60watt @ 4500 rpm
Ignition System	Digital CDI	Digital CDI
Spark Plug Type	NGK BPR8ES	NGK BPR9ES
Spark Plug Gap	.028 (.7mm)	.024-.028 (.6-.7mm)
Starting System	Electric Starter	Electric Starter
Battery	12V, 19A	12V, 19A
COOLING		
Engine Cooling	Water cooled, thermostat pop off	Water cooled
Overheat Warning	Warning Light/RPM Limit	Overboard Water Outlets (Visual)
ENGINE		
Engine Type	Polaris Marine 700 LE	Polaris Marine 777 Twin
Induction Type	Case Reed	Case Reed
Exhaust System	Water Cooled/Injected 700 H	Factory Pipe - Water Cooled/Injected
Lubrication	Oil Injected	40:1 Gas-to-Oil
Oil Type	Nature Oil Biodegradable 2-Cycle Oil	Nature Oil Biodegradable 2-Cycle Oil
Cylinders	2	2
Bore x Stroke	81 x 68 mm	84 x 70 mm
Displacement	701cc	777cc
Rated Horsepower	95	100
RPM Limiter Operation	7200±100	7200

SPECIFICATIONS

	Freedom	Octane
FUEL DELIVERY		
Fuel Type	87 Octane Non-oxygenated or 89 Octane Oxygenated	87 Octane Non-oxygenated or 89 Octane Oxygenated
Carburetor Quantity and Type	1 40mm	2 40mm Keihin
PROPULSION		
Impeller, Stainless Steel	3 Blade (+)	3 Blade (<)
Propulsion	Jet Drive	Jet Drive
Jet Pump Type	Extended Big Mouth, Single Stage Axial Flow	Aggressor Pump, Single Stage Axial Flow
Transmission	Direct Drive	Direct Drive
Minimum Water Level for Jet Pump	2 feet (60 cm)	2 feet (60 cm)
Impeller Diameter	5.83 in. (14.80 cm)	5.51 in. (140 mm)
FEATURES		
Instrumentation	3 Function Gauge	N/A
Fuel Gauge	Standard	N/A
Oil Level Sensor	Single Level	N/A
Tachometer	N/A	N/A
Reverse System	N/A	N/A
Voltage Meter	N/A	N/A
Trip Meter	N/A	N/A
Speedometer	N/A	N/A
Temperature Switch	Standard	N/A
Sponsons	Standard, 28"	N/A
Electric Bilge Pump	Automatic, Electric with manual override	N/A

(+) - Large Overlap Progressive Pitch

(<) - Radial Blade Progressive Pitch

PERC - Polaris Electric Reverse Control

MFI - Multi-Function Instrument

* SMC - Sheet Molded Compound

** FRC - Fiberglass Reinforced Composite

POLARIS PRODUCTS

Oil and Lubricants		
Premium Gold Synthetic 2-Cycle Oil		
Quart		2871721
Gallon		2871722
2.5 Gallon		2872347
16 Gallon		2871723
55 Gallon		2871884
Nature Oil Biodegradable 2-Cycle Oil		
Gallon		2872607
55 Gallon		2872926
Fuel System Maintenance Products		
Carbon Clean Plus		2871326
Isopropyl Fuel De-Icer		2870505
Premium Fuel Stabilizer		2870652
Grease		
Grease Gun Kit		2871312
All Season Premium Grease		
3 oz. / 4 pack		2871322
14 oz. Tube		2871423
Starter Grease		2871460
Nyogel Grease		2871329
General Maintenance Products		
Fogging Oil		
12 oz. Aerosol		2870791
1 Quart		2871517
Carb & Throttle Body Cleaner		2872890
Multi-Purpose Lubricant		2872891
Electrical Contact Cleaner		2872892
Engine Degreaser		2872893
Revival / Detailing Kit		2871589
Restore Swirl / Scuff Eliminator		2871966
Finish Wax		2871965
Vinyl and Rubber Protectant		2871964
T 9 Metal Protectant		2871064
Retaining / Sealing Products		
Loctite™ Products		
Threadlock 242		2871950
Threadlock 262		2871952
Threadlock 271		2871954
Loctite™ 518		2871961
Marine-Grade Silicone		8560054

ENGINE TROUBLESHOOTING

Engine Doesn't Turn Over

Possible Cause	Solution
Tripped circuit breaker	Reset the breaker
Low battery voltage	Recharge battery to 12.5 VDC
Loose battery connections	Check all connections and tighten
Hydrolock	See your Polaris dealer
Security lock or MFI code is activated	Unlock/deactivate
Loose solenoid connections	Check all connections and tighten
Lanyard lock plate not in place	Install lock plate under shut-off switch

Engine Turns Over But Doesn't Start

Possible Cause	Solution
Out of fuel	Refuel
Water in fuel (carb models)	Drain the fuel/water separator
Fuel valve is turned off (carb models)	Turn the fuel valve on
Old or non-recommended fuel	Replace with new fuel
Fouled or defective spark plugs	Inspect plugs, replace if necessary
Crankcase filled with water or fuel	See your Polaris dealer
Overuse of choke	Inspect, clean and/or replace spark plugs
Clogged fuel filter	Replace the filter
Low battery voltage	Recharge battery to 12.5 VDC
Mechanical failure	See your Polaris dealer

Engine Overheats

Possible Cause	Solution
Clogged jet pump intake	Clean intake
Use of non-recommended fuel or oil	Replace with recommended fluids
Sand or debris in cooling system	Flush the cooling system
Plugged thermostat assembly	Disassemble and clean thermostat
Plugged cooling system	Inspect and clean cooling system
Clogged exhaust pipe screen fitting	Clean screen fitting

ENGINE TROUBLESHOOTING

Engine Runs Irregularly, Stalls or Misfires

Possible Weak Spark Cause	Solution
Fouled or defective spark plugs	Inspect, clean and/or replace spark plugs
Worn or defective spark plug wires	See your Polaris dealer
Incorrect spark plug gap or heat range	Set gap to specs or replace plugs
Loose spark plug connections	Check all connections and tighten
Water present in fuel	Replace with new fuel
Clogged exhaust pipe screen fitting	Clean screen fitting
Water in exhaust pipe (Virage i)	Drain exhaust
Low battery voltage	Recharge battery to 12.5 VDC
Possible Lean Fuel Mixture Cause	Solution
Low or contaminated fuel	Add or change fuel, clean the fuel system
Low octane fuel	Replace with recommended fuel
Clogged fuel filter	Replace filter
Incorrect jetting	See your Polaris dealer
Possible Rich Fuel Mixture Cause	Solution
Overuse of choke	Inspect, clean and/or replace spark plugs
Fuel is very high octane	Replace with lower octane fuel
Incorrect jetting	See your Polaris dealer

Engine Backfires

Possible Cause	Solution
Weak spark from spark plugs	Inspect, clean and/or replace spark plugs
Incorrect spark plug gap or heat range	Set gap to specs or replace plugs
Old or non-recommended fuel	Replace with new fuel
Incorrectly installed spark plug wires	See your Polaris dealer
Broken reed petals/valves	See your Polaris dealer
Incorrect ignition timing	See your Polaris dealer
Mechanical failure	See your Polaris dealer

ENGINE TROUBLESHOOTING

Engine Pings or Knocks

Possible Cause	Solution
Poor quality or low octane fuel	Replace with recommended fuel
Incorrect ignition timing	See your Polaris dealer
Incorrect spark plug gap or heat range	Set gap to specs or replace plugs

Engine Loses Power

Possible Cause	Solution
Weak spark	Replace spark plugs and/or wires
Incorrect fuel or fuel mixture	Replace with recommended fuel
Water present in fuel or oil tank	Replace with recommended fluids
Clogged fuel filter	Replace filter
Clogged jet pump intake	Clean intake
Clogged exhaust and/or cooling system	Clean exhaust, flush cooling system
Hydrolock	See your Polaris dealer
Too much load/weight on craft	Reduce load per vehicle specifications
Mechanical failure	See your Polaris dealer

Engine RPM is Too High With Limited Speed

Possible Cause	Solution
Clogged jet pump intake	Clean intake
Cavitation, impeller damaged or worn	See your Polaris dealer

Unusual Noise or Vibration From Propulsion System

Possible Cause	Solution
Weeds or debris lodged in impeller	Clean the impeller
Damaged driveshaft	See your Polaris dealer
Damaged pump bearings	See your Polaris dealer
Lack of lubrication on coupler or bearing carrier	See your Polaris dealer

WARRANTY

Obtaining Service and Warranty Assistance

Read carefully and understand the service data and the Polaris Warranty contained in this manual. Contact your Polaris dealer in matters pertaining to replacement parts, service, or warranty. Your dealer is constantly kept up-to-date on changes, modifications, and tips on personal watercraft maintenance that may supersede information contained in this manual. Your dealer is familiar with Polaris policies and procedures and will be happy to assist you.

When inquiring about parts, service, or warranty, always include the following information:

1. Serial number
2. Model number
3. Dealer name
4. Date of purchase
5. Details of trouble experienced
6. Length of time and conditions of operation
7. Indicate previous correspondence

WARRANTY

Warranty Policy

NO WARRANTY FOR OCTANE MODEL

The Polaris Octane engine and watercraft were designed and built by Polaris solely for use in competition by qualified racers. NO POLARIS WARRANTY COVERAGE IS PROVIDED FOR WATERCRAFT USED FOR RACING OR OTHER COMPETITION. As such, the Polaris Octane is sold as is, with NO WARRANTY, EXPRESS OR IMPLIED, AGAINST DEFECTS, OBVIOUS OR CONCEALED. Polaris will not be responsible if the product malfunctions or is defective.

LIMITED WARRANTY

Polaris Sales Inc., 2100 Highway 55, Medina, MN 55340, gives a ONE YEAR LIMITED WARRANTY on all components of the Polaris personal watercraft against defects in material or workmanship. This warranty covers the parts and labor charges for repair or replacement of defective parts which are covered by this warranty. This warranty begins on the date of purchase. This warranty is transferrable to another consumer during the warranty period through a Polaris dealer.

REGISTRATION

At the time of sale, the Warranty Registration Form must be completed by your dealer and submitted to Polaris within ten days. Upon receipt of this registration, Polaris will record the registration for warranty. No verification of registration will be sent to the purchaser as the copy of the Warranty Registration Form will be the warranty entitlement. If you have not signed the original registration and received the "customer copy", please contact your dealer immediately. NO WARRANTY COVERAGE WILL BE ALLOWED UNLESS YOUR PERSONAL WATERCRAFT IS REGISTERED WITH POLARIS AND YOU HAVE CONFIRMED THAT YOU HAVE WATCHED THE SAFETY AND OPERATION VIDEO AND REVIEWED THE SUMMARY TRAINING POINTS.

Initial dealer preparation and set-up of your personal watercraft is very important in ensuring trouble-free operation. Purchasing a machine in the crate or without proper dealer set-up will void your warranty coverage.

WARRANTY

Warranty Policy

WARRANTY COVERAGE AND EXCLUSIONS: LIMITATIONS OF WARRANTIES AND REMEDIES

This Polaris limited warranty covers all parts and components except for impeller damage caused by ingestion of rocks, sand, or gravel or any other damage caused by operation in shallow water. The warranty also excludes any other failures that are not caused by a defect in material or workmanship.

This warranty does not cover accidental damage, normal wear and tear, abuse or improper handling. This warranty also does not cover any personal watercraft that has been altered structurally, modified, neglected, improperly maintained, used for racing, or used for purposes other than for which it was manufactured, or for any damages which occur during trailer transit or as a result of unauthorized service or the use of unauthorized parts. In addition, this warranty does not cover physical damage to paint or finish, gel coat stress cracks, tearing or puncturing of upholstery material, corrosion, or defects in parts, components or personal watercraft due to fire, explosions or any other cause beyond Polaris' control.

This warranty does not cover the use of unauthorized lubricants, chemicals, or fuels that are not compatible with watercraft. In addition this warranty does not cover stress cracks, submersion, or growth of marine organisms on hull and deck.

The exclusive remedy for breach of this warranty shall be, at Polaris' exclusive option, repair or replacement of any defective materials, or components or products. **THE REMEDIES SET FORTH IN THIS WARRANTY ARE THE ONLY REMEDIES AVAILABLE TO ANY PERSON FOR BREACH OF THIS WARRANTY. POLARIS**

SHALL HAVE NO LIABILITY TO ANY PERSON FOR INCIDENTAL, CONSEQUENTIAL OR SPECIAL DAMAGES OF ANY DESCRIPTION, WHETHER ARISING OUT OF EXPRESS OR IMPLIED WARRANTY OR ANY OTHER CONTRACT, NEGLIGENCE, OR OTHER TORT OR OTHERWISE. Some states do not permit the exclusion or limitation of incidental or consequential damages or implied warranties, so the above limitations or exclusions may not apply to you if inconsistent with controlling state law.

ALL IMPLIED WARRANTIES (INCLUDING BUT NOT LIMITED TO THE IMPLIED WARRANTIES OF MERCHANTABILITY AND FITNESS FOR A PARTICULAR PURPOSE) ARE LIMITED IN DURATION TO THE ABOVE ONE YEAR WARRANTY PERIOD. POLARIS FURTHER DISCLAIMS ALL EXPRESS WARRANTIES NOT STATED IN THIS WARRANTY. Some states do not allow limitations on how long an implied warranty lasts, so the above limitation may not apply to you if inconsistent with controlling state law.

WARRANTY

Warranty Policy

HOW TO OBTAIN WARRANTY SERVICE

If your personal watercraft requires warranty service, it must be taken to a Polaris dealer authorized to repair Polaris personal watercraft. When requesting warranty service you must present your copy of the Warranty Registration form to the dealer. (The cost of transportation to and from the dealer is your responsibility.) Polaris suggests that you use your original selling dealer; however, you may use any Polaris Servicing Dealer to perform warranty service.

Please work with your dealer to resolve any warranty issues. Should your dealer require any additional assistance they will contact the appropriate personnel at Polaris.

This warranty gives you specific legal rights, and you may also have other rights which vary from state to state.

If any of the above terms are void because of state or federal law, all other warranty terms will remain in effect.

Engine Oil

1. Mixing oil brands or using non-recommended oil may cause engine damage. We recommend the use of Polaris Nature Oil Biodegradable 2-Cycle Oil in Polaris watercraft engines.

2. Damage resulting from the use of non-recommended lubricants may not be covered by warranty.

EPA Emission Warranty

Polaris warrants to the ultimate purchaser and each subsequent purchaser that this engine is designed, built, and equipped to conform at the time of sale with applicable regulations under section 213 of the Clean Air Act. Polaris warrants that this engine is free from defects in materials and workmanship that would cause the engine to fail to conform with applicable regulations for the U.S. EPA emission warranty period, which is two (2) years from the date of purchase, or 200 hours, whichever occurs first, for the emission-related components in this engine.

Maintenance, replacement, or repair of the emission control devices and systems may be performed by any marine SI engine repair establishment or individual.

WARRANTY

Exported Vehicles

EXCEPT WHERE SPECIFICALLY REQUIRED BY LAW, THERE IS NO WARRANTY OR SERVICE BULLETIN COVERAGE ON THIS VEHICLE IF IT IS SOLD OUTSIDE THE COUNTRY OF THE SELLING DEALER'S AUTHORIZED LOCATION.

This policy does not apply to vehicles that have received authorization for export from Polaris Industries. Dealers may not give authorization for export. You should consult an authorized dealer to determine this vehicle's warranty or service bulletin coverage if you have any questions.

This policy does not apply to vehicles registered to government officials or military personnel on assignment outside the country of the selling dealer's authorized location.

This policy does not apply to Safety Recalls.

How to Get Service

In the Country where your vehicle was purchased:

Warranty or Service Bulletin repairs must be done by an authorized Polaris dealer. If you move or are traveling within the country where your vehicle was purchased, Warranty or Service Bulletin repairs may be requested from any authorized Polaris dealer who sells the same line as your vehicle.

Outside the Country where your vehicle was purchased:

If you are traveling temporarily outside the country where your vehicle was purchased, you should take your vehicle to an authorized Polaris dealer. You must show the dealer photo identification from the country of the selling dealer's authorized location as proof of residence. Upon residence verification, the servicing dealer will be authorized to perform the warranty repair.

If You Move:

If you move to another country, be sure to contact Polaris Customer Assistance and the customs department of the destination country before you move. Vehicles importation rules vary considerably from country to country. You may be required to present documentation of your move to Polaris Industries in order to continue your warranty coverage. You may also be required to obtain documentation from Polaris Industries in order to register your vehicle in your new country.

How to Get Service

If Purchased From A Private Party:

If you purchase a Polaris product from a private citizen outside of the country in which the vehicle was originally purchased, all warranty coverage will be denied.

Notice

If your vehicle is registered outside of the country where it was purchased, and you have not followed the procedure set out above, your vehicle will no longer be eligible for warranty or service bulletin coverage of any kind. (Vehicles registered to Government officials or military personnel on assignment outside of the country where the vehicle was purchased will continue to be covered by the basic warranty.)

For questions call Polaris Customer Assistance:

United States: 1-763-417-8650

Canada: 1-204-925-7100

CALIFORNIA EMISSION CONTROL SYSTEM LIMITED WARRANTY

POLARIS DIRECT INJECTION WATERCRAFT ENGINES (CALIFORNIA CONSUMERS ONLY)

YOUR WARRANTY RIGHTS AND OBLIGATIONS

The California Air Resources Board and Polaris Industries, Inc. (Polaris) are pleased to explain the California emission control system limited warranty on your Model Year 2004 or later Polaris watercraft engine. In California, new watercraft engines must be designed, built and equipped to meet the State's stringent anti-smog standards. Polaris must warrant the emission control system on your watercraft engine for the periods of time listed below provided there has been no abuse, neglect, or improper maintenance of your watercraft engine.

Your emission control system includes the direct fuel injection system and the ignition system. Also included may be other emission-related assemblies as indicated in the list of warranted parts. Where a warrantable condition exists, Polaris will repair your watercraft engine at no cost to you, including diagnosis, parts, and labor. This includes diagnostic labor that is directly associated with a defective emission-related warranted part. The diagnosis and repair must be performed at an authorized Polaris dealer.

MANUFACTURER'S WARRANTY COVERAGE:

Polaris warrants to the ultimate California purchaser and each subsequent California purchaser thereafter that this new watercraft engine sold in California to a California resident is:

- Designed, built, and equipped so as to conform, at the time of sale, to all applicable regulations adopted by the California Air Resources Board.
- Free from defects in material and workmanship that cause the failure of a warranted part to be identical in all material respects to that part as described in Polaris' application for certification. In practical terms, a defect exists when a deficiency in materials or workmanship causes an emission-related part to not function as designed.

The limited warranty begins on the date the watercraft is delivered to the ultimate California purchaser or, as in the case of a demonstration engine or watercraft, on the date it is first put in service. The warranty period of the watercraft engine will be 4 years or 250 hours of use, whichever occurs first.

Select emission control parts from model year 2004 and later watercraft engines are warranted for 4 years, or for 250 hours of use, or for the period prior to the first scheduled replacement of the warranted part as required by the maintenance schedule in the owner's manual or other written instructions provided by Polaris, whichever occurs first. However, warranty coverage based on the hourly period is only permitted for watercraft engines equipped with appropriate hour meters or their equivalent. The electronic engine management module in your watercraft engine contains a very accurate clock (i.e., hour meter) that accumulates engine run time. This clock will be used by Polaris to limit warranty coverage to 250 hours of use, within the first 4 years. Warranty coverage expires after 4 years, regardless of the hours of use. If any emission-related part is defective under warranty, the part will be repaired or replaced by Polaris.

CALIFORNIA EMISSION CONTROL SYSTEM LIMITED WARRANTY

OWNER'S WARRANTY RESPONSIBILITIES:

As the watercraft engine owner, you are responsible for performance of the required maintenance listed in your owner's manual. Polaris recommends that you retain all receipts covering maintenance on your watercraft engine, but Polaris cannot deny warranty coverage solely for lack of receipts or your failure to ensure the performance of all scheduled maintenance. As the watercraft engine owner, you should however be aware that Polaris may deny you warranty coverage if your watercraft engine or a part has failed due to abuse, neglect, improper maintenance, or unapproved modifications. Receipts and records pertaining to regular scheduled maintenance may be relevant in the event questions arise concerning maintenance. The receipts should be transferred to each subsequent owner of this watercraft.

You are responsible for presenting your watercraft engine to a Polaris authorized dealer as soon as a problem exists. Notice must be given to an authorized Polaris dealer of any apparent defect(s) within a reasonable time after discovery. The warranty repairs should be completed in a reasonable amount of time, not to exceed 30 days. It is recommended that any replacement part(s) used for maintenance, replacement, or repair of emission control systems be Polaris parts. Replacement parts equivalent to Polaris parts may be used in the performance of warranty repairs and will be provided without charge to the owner, and with no reduction in Polaris' warranty obligation. Use of parts that are not equivalent to Polaris parts which causes the warranted part(s) to fail may constitute abuse and/or improper service, thereby invalidating Polaris' warranty liability.

If you have any questions regarding your warranty rights and responsibilities, or to identify the nearest Polaris authorized dealer, you should contact Polaris at 1-800-POLARIS (1-800-765-2747).

WARRANTED PARTS:

1. Fuel Metering System

- Fuel injection system
- Cold start enrichment system
- Intake valves

2. Air Induction System

- Intake manifold
- Air filter

3. Ignition System

- Spark plugs
- Magneto or electronic ignition system
- Spark advance / retard system
- Ignition coil and/or control module
- Ignition wires

NOTE: The original spark plugs are warranted for the period of replacement indicated in the owner's manual, not for the warranty period of the watercraft engine.

4. Lubrication System

- Oil pump and internal parts

5. Exhaust System

6. Miscellaneous parts included in above systems

- Hoses, clamps, fittings, tubing, sealing, gaskets or devices, and mounting hardware
- Vacuum, temperature, check, and time sensitive valves and switches
- Electronic controls

7. Engine components with damage proximately caused by a failure under warranty of any warranted emission-related part.

INDEX

A

Accessories	43
Age Restrictions	6
Anti-corrosion Treatment	82
Apparel	43
Avoid Collisions	64

B

Battery	54, 95-98
Battery Charging	97
Battery Fluid	95
Battery Information	80
Battery Installation	98
Battery Maintenance	95
Battery Removal	96
Battery Storage	98
Beaching the Watercraft	72
Before Starting the Engine	66
Bilge	55
Boarding In Deep Water	68
Boarding the Watercraft	68-69
Boarding With A Passenger	69
Boating Under the Influence	24
Break-In Procedure	58-59
Buoys And Markers	64

C

California Consumer Environmental Label	44-45
Capsize Warning Decal	14
Capsize Watercraft	74
Carburetor Adjustment	93
Choke Cable	86
Choke Cable Inspection	94
Circuit Breaker	94
Cleaning	103
Collision Decal	13
CONTROLS	26-27
Cooling System Flushing	100
Crossing Paths	62

D

Daily Care	76-77
Drain Plugs	55

E

Electrical Shock Hazard	23
EMISSIONS REGULATION	44-45
Encountering Vessels	61
Engine Draining	101
Engine Compartment	34, 36, 53

E

Engine Components	34-37
Engine Doesn't Start	67
Engine Fogging Procedure	102
Engine Oil	115
ENGINE TROUBLESHOOTING	109-111
Engine Water Removal Procedure	81
EPA Emissions Regulation Compliance	92
EPA Emissions Warranty	115
EPA Emissions Compliance	44
Equipment	43
Exhaust System Draining	101
Extended Storage	101-103

F

FEATURES	28-43
Fire Extinguisher	55
Fire Safety	19
Fishing Vessel Right-of-Way	63
Footwell Pads	28
Fuel	48-49
Fuel Lines	91
Fuel System	91
Fuel Tank	91
Fuel/Water Separator	57
Fuses	94

G

Gasoline Warning Decal	12
General Maintenance	82
Give-way	60
Give-way Vessel	60
Glove Box	32

H

Hull	55
Hypothermia	25

I

IDENTIFICATION NUMBERS	8
------------------------	---

J

Jet Pump Intake	52
Jet Pump Water Intake Safety	22

L

Launch Ramp Etiquette	64
Launching the Watercraft	65
Lifting the Watercraft	23
Loose Parts	53
Lubrication	86-88, 103

INDEX

M

MAINTENANCE and LUBRICATION	82-103
Meeting Vessels	62
MFI	39
Multi-Function Instrument	39

N

Navigational Rules	60-64
Non-motorized Craft	63

O

Obstacles and Shallow Water	21
Octane Watercraft	7
Oil	51
Oil Filter	91
Operating in Rough Conditions	73
Operating With Passengers	75
OPERATION	46-81
Reverse Operation	70
Stopping the Engine	65
Operator Awareness	23
Operator Fatigue and Dehydration	25
Operator Fitness	24
Operator Guidelines	16
Operator Safety	16-24
OPERATOR WARNING	6-7
Overloading the Watercraft	19
Overtaking Vessels	61

P

PERC	70
Periodic Maintenance Schedule	82-85
POLARIS PRODUCTS	108
Post Operation Maintenance	76-82
Pre-Operation Inspection	22, 46-57
Principles of Operation	58
Protective Apparel	20

R

Refueling	50
Reverse Lever	70
Riding Gear	55
Right-of-way	60
RPM Limiter	38
Rule 2	60

S

Safe Riding Gear	18
Safe Riding Position	23
SAFETY	9-25
Safety Decals	10-15
Safety Training	7
Salt Water and Unclean Water Care	99
Seat	54
Service and Maintenance	22
Signal Words and Symbols	9
Spark Plugs	89-90
SPECIFICATIONS	104-107
Stand-on Vessel	60
Starting in Deep Water	68
Starting the Engine	66-67
Steering Cable	86
Steering Cable Inspection	93
Steering Inspection	53
Stop Switch	26
Stopping the Watercraft	71
Storage	78, 101
Storage Compartment	53
Submerged Engine	80
Switches/Buttons	56

T

TABLE OF CONTENTS	5
Temporary Storage	78
Throttle Cable	86
Throttle Cable Inspection	93
Throttle Inspection	53
Towing	73
Transporting The Watercraft	79
Turning and Accelerating	21
Turning the Watercraft	72

V

Vehicle Modifications	24
-----------------------	----

W

WARRANTY	112-115
Water Inlet Screen	99
Weather and Darkness	20
WELCOME	3