

# WATERCRAFT 2002



## Owner's Safety and Maintenance Manual



**POLARIS**<sup>®</sup>

<https://www.boat-manuals.com/polaris/>

 **WARNING**

The engine exhaust from this product contains chemicals known to cause cancer, birth defects or other reproductive harm.

We've created a web site, just for YOU!!

- Technical tips
- New product introductions
- Event schedules
- Parts and Service Manual information
- Exciting details about The Way Out

**Check it out...**

**[www.polarisindustries.com/owner](http://www.polarisindustries.com/owner)**



**POLARIS<sup>®</sup>**  
**The Way Out.**

# - NOTES -

# WELCOME

Congratulations and thank you for choosing Polaris Watercraft! It has been engineered, tested, and manufactured with your riding enjoyment and safety in mind.

This Owner's Manual provides safety, operating, care and maintenance information that you and all operators and passengers of the watercraft should be familiar with before operating this watercraft. Once you've read and understand the information, permanently store this manual in a **waterproof bag** and place with the watercraft in one of the storage areas. If the watercraft is sold, the Owner's Manual and video tape should remain with it.

When you purchased this watercraft, your dealer provided you with this Owner's Safety and Maintenance Manual which covers important aspects of watercraft safety. In addition you received a video tape pertaining to watercraft safety. Review this information on a regular basis. If you have purchased this vehicle from someone other than a Polaris dealer, you can still obtain information and service from any authorized Polaris dealer. If your Owner's Manual is misplaced, you should get a replacement copy from your Polaris dealer.

Anyone who operates this watercraft must read this Owner's Manual. Failure to follow the warnings and precautions contained in the manual when operating and riding this watercraft can result in severe injury or death to the operator, passenger and/or bystanders.

If you have questions about the operation or maintenance of this watercraft or need training, consult an authorized Polaris watercraft dealer.

The information contained in this manual is deemed accurate at the time of publication, however, it is our intention to continually strive for improved product quality and performance. Therefore, Polaris Industries Inc. reserves the right to change specifications without notice or obligation.

**Illustrations included in this manual are general representations of parts having a similar function. Your model may differ.**

# TABLE OF CONTENTS

<b>Vehicle Identification Numbers</b> .....	<b>6 - 7</b>
<b>Specifications</b> .....	<b>8 - 14</b>
Freedom, Virage, Virage i .....	8
Virage TX, Virage TXI, Genesis, Genesis i .....	11
<b>Safety</b> .....	<b>15 - 33</b>
Understanding Warnings .....	15
Decals .....	16
Operator Safety .....	23
<b>Controls and Features</b> .....	<b>34 - 47</b>
Controls .....	34
Features .....	37
Engine Components .....	42
Accessories .....	47
Watercraft Equipment .....	48
<b>Operation</b> .....	<b>49 - 89</b>
Fuel and Oil Recommendations .....	49
Pre-Operation Check .....	52
Vehicle Break-In Period .....	65
Navigational Rules .....	67
Stopping the Engine .....	72
Starting the Engine .....	73
Reverse Operation .....	77
Boarding the Watercraft .....	79
Safe Operation .....	81
Post Operation Check and Care .....	88

# TABLE OF CONTENTS

<b>Special Procedures</b> .....	<b>90 - 101</b>
Cleaning .....	90
Launching .....	92
Capsized Watercraft .....	93
Waterlogged Engine .....	94
Transporting .....	96
MFI Operation .....	97
<b>Maintenance and Lubrication</b> .....	<b>102 - 133</b>
Periodic Maintenance Schedule .....	102
Lubrication Recommendations .....	105
Minor Maintenance .....	109
Cleaning and Storage .....	128
<b>Trouble Shooting</b> .....	<b>134 - 137</b>
<b>Warranty</b> .....	<b>138 - 141</b>
Obtaining Warranty Assistance .....	138
Warranty Policy .....	139
<b>Index</b> .....	<b>142 - 143</b>

## IDENTIFICATION NUMBERS

Record your watercraft I.D. numbers in the spaces provided. This will help when ordering spare parts. Also record these numbers in another place in the event your watercraft is stolen. See page 7 for location of numbers.

PURCHASE DATE

POLARIS MODEL NUMBER

DEALER IMPRINT

HULL I.D. NUMBER

ENGINE I.D. NUMBER

**POLARIS INDUSTRIES INC.**

### **Insurance**

Check with your own insurance agent regarding insurance coverage of your personal watercraft. Your dealer may have marine insurance available. He or she should know the requirements of your state, and can help you with the proper policy to protect yourself.



# IDENTIFICATION NUMBERS

The engine I.D. number and hull I.D. number are used to register the boat. These identification numbers uniquely distinguish this watercraft. If the watercraft is ever stolen, these numbers will help identify it. Keep a record of these numbers in a place separate from the watercraft as well as in the spaces provided on page 6 of this manual. The hull I.D. locations are outside on the rear boarding platform (1) and one inside (2), either next to the pump inlet or in the front under the storage bucket.

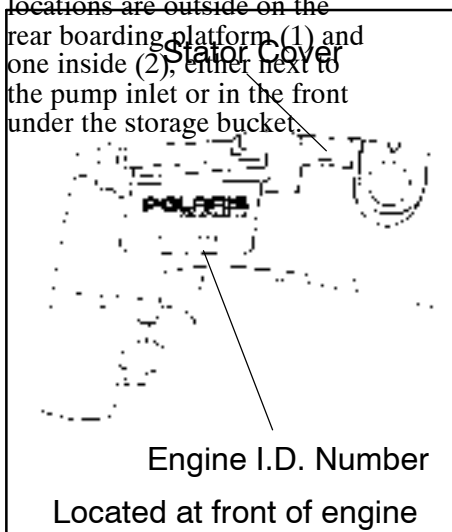

# SPECIFICATIONS

	Freedom	Virage	Virage i
<b>CAPACITIES / DIMENSIONS</b>			
Fuel Tank (U.S. Gal.)	17 (64.4 L)	17 (64.4 L)	17 (64.4 L)
Oil Reservoir Capacity (U.S. Quarts)	6.0 (5.68 L)	6.0 (5.68 L)	6 (5.68 L)
Rider Capacity	1-3 people	1-3 people	1-3 people
Load Limit (Riders) (lbs.)	500 (227 L)	500 (227 L)	500 (227 kg)
Load Limit (Total) (lbs.)	565 (256 L)	565 (256 L)	565 (256 L)
Length (inches)	120.3 (305.6 cm.)	124.3 (315.7 cm.)	122.3 (310.6 cm.)
Width (inches)	49.3 (125 cm.)	49.3 (125 cm.)	49.3 (125 cm)
Dry Weight (lbs.)	590 (268 kg)	600 (272 kg)	595 (270 kg)
Hull Material	SMC *	SMC *	SMC *
<b>ELECTRICAL</b>			
Alternator Output	5 amp/ 60watt @ 4500 rpm	5 amp/ 60watt @ 4500 rpm	12 amp/ 160watt @ 4500 rpm
Ignition System	Digital CDI	Digital CDI	FICHT™ EMM
Spark Plug Type	NGK BPR8ES	NGK BPR8ES	NGK PZFR6H
Spark Plug Gap	.028 (.7mm)	.028 (.7mm)	032 (.8mm)
Starting System	Electric Starter	Electric Starter	Electric Starter
Battery	12V, 19A	12V, 19A	12V, 19A
<b>COOLING</b>			
Engine Cooling	water cooled, thermostat pop off	water cooled, thermostat pop off	water cooled, thermostat pop off
Overheating Warning	Warning Light/ RPM Limit	Warning Light/ RPM Limit	Warning Light/ RPM Limit

# SPECIFICATIONS

	Freedom	Virage	Virage i
<b>ENGINE</b>			
Engine Type	Polaris Marine 700 LE	Polaris Marine 700 LE	Polaris Marine 800 DI
Induction Type	Case Reed	Case Reed	Case Reed
Exhaust System	Water Cooled/ Injected 700 H	Water Cooled/ Injected 700 H	Water Cooled/ Injected 700 H
Lubrication	Oil Injected	Oil Injected	Oil Injected
Oil Type	TC-W3 or Synthetic	TC-W3 or Synthetic	TC-W3 or Synthetic
Engine Cylinders	2	2	2
Bore (mm)	81	81	84
Stroke (mm)	68	68	70
Engine Displacement	701	701	777
Max. Power/Horsepower (approx.)	135	135	135
RPM Limiter Operation	7200±100	7200±100	7200±100
<b>CARBURETION</b>			
Gas Type	87 Octane Non-oxygenated or 89 Octane Oxygenated	87 Octane Non-oxygenated or 89 Octane Oxygenated	87 Octane Non-oxygenated or 89 Octane Oxygenated
Carburetor Type and Number	1-40mm	1-40mm	2 Ram Injectors
<b>PROPULSION</b>			
Impeller, Stainless Steel	3 Blade (+)	3 Blade (+)	3 Blade (<)
Propulsion System	Jet Drive	Jet Drive	Jet Drive

# SPECIFICATIONS

	<b>Freedom</b>	<b>Virage</b>	<b>Virage i</b>
<b>PROPULSION (Cont.)</b>			
Jet Pump Type	Extended Big Mouth Single Stage Axial Flow	Extended Big Mouth Single Stage Axial Flow	Extended Big Mouth Single Stage Axial Flow
Transmission	Direct Drive	Direct Drive	Direct Drive
Minimum Water Level for Jet Pump	2 feet (60 cm)	2 feet (60 cm)	2 feet (60 cm)
Impeller Diameter	5.83 (14.80 cm)	5.83 (14.80 cm)	5.83 (14.80 cm)
<b>FEATURES</b>			
Instrumentation	3 Function Fuel Gauge	22 Function - MFI	23 Function - MFI
Fuel Level	Standard	Standard	Standard
Oil Level Sensor	Single	Multi-Level	Multi-Level
Tachometer	Not Available	On MFI	On MFI
Reverse System	Optional	N/A	Std
Voltage Meter	Not Available	On MFI	On MFI
Trip Meter	Not Available	On MFI	On MFI
Speedometer	Optional	On MFI	On MFI
Temperature Switch	Standard	Standard	Standard
Sponsons	Standard - 28"	Standard - 28"	Standard - 28"
Electric Bilge Pump	Electric with manual override	Electric with manual override	Electric with manual override

PERC - Polaris Electric Reverse Control

MFI - Multi-Function Instrument

# SPECIFICATIONS

	Virage TX	Virage TXI	Genesis	Genesis i
<b>CAPACITIES / DIMENSIONS</b>				
Fuel Tank (U.S. Gal.)	17 (64.26 L)	17 (64.26 L)	17 (64.26 L)	17 (64.26 L)
Oil Reservoir Capacity (U.S. Quarts)	6 (5.68 L)	6 (5.68 L)	6 (5.68 L)	6 (5.68 L)
Rider Capacity	1-3 people	1-3 people	1-4 people	1-4 people
Load Limit (Riders) (lbs.)	500 (227 kg)	500 (227 kg)	600 (273 kg)	600 (273 kg)
Load Limit (Total) (lbs.)	565 (256kg)	565 (256kg)	625 (282kg)	625 (282kg)
Length (inches)	124.3 (315.7 cm)	124.3 (315.7 cm)	131.1 (330.5 cm)	131.1 (330.5 cm)
Width (inches)	49.3 (125 cm)	49.3 (125 cm)	49.3 (125 cm)	49.3 (125 cm)
Dry Weight (lbs.)	625 (284 kg)	635 (288 kg)	725 (329 kg)	735 (334 kg)
Hull Material	SMC *	SMC *	FRC **	FRC **
<b>ENGINE</b>				
Engine Type	Polaris Marine 1200	Polaris Marine 1200 DI	Polaris Marine 1200	Polaris Marine 1200 DI
Induction Type	Case Reed	Case Reed	Case Reed	Case Reed
Exhaust System	Water Cooled/Injected	Water Cooled/Injected	Water Cooled/Injected	Water Cooled/Injected
Lubrication	Oil Injected	Oil Injected	Oil Injected	Oil Injected
Oil Type	TC-W3 or Synthetic	TC-W3 or Synthetic	TC-W3 or Synthetic	TC-W3 or Synthetic
Engine Cylinders	3	3	3	3
Bore (mm)	84	84	84	84
Stroke (mm)	70	70	70	70

\* SMC - Sheet Molded Compound Reinforced Composite

\*\* FRC - Fiberglass

<https://www.boat-manuals.com/polaris/>

# SPECIFICATIONS

	Virage TX	Virage TXI	Genesis	Genesis i
<b>ENGINE (CONT.)</b>				
Engine Displacement	1165	1165	1165	1165
Peak Horsepower (approx.)	135	135	135	135
RPM Limiter Operation	7200±100	7200±100	7200±100	7200±100
<b>COOLING</b>				
Engine Cooling	water cooled, thermostat pop off	water cooled, thermostat pop off	water cooled, thermostat pop off	water cooled, thermostat pop off
Overheating Warning	Warning Light/RPM Limit	Warning Light/RPM Limit	Warning Light/RPM Limit	Warning Light/RPM Limit
<b>ELECTRICAL</b>				
Alternator Output	5 amp/ 60watt @ 4500 rpm	12 amp/ 60watt @ 4500 rpm	12 amp/ 60watt @ 4500 rpm	12 amp/ 160watt @ 4500 rpm
Ignition System	CDI	FICHT™ EMM	CDI	FICHT™ EMM
Spark Plug Type	NGK BR9ES	NGK PZFR6H	NGK BR9ES	NGK BR9ES
Spark Plug Gap	.028 (.7mm)	.032 (.8mm)	.028 (.7mm)	.032 (.8mm)
Starting System	Electric Starter	Electric Starter	Electric Starter	Electric Starter
Battery	12V, 19A	12V, 19A	12V, 19A	12V, 19A

# SPECIFICATIONS

	Virage TX	Virage TXI	Genesis	Genesis i
<b>CARBURETION</b>				
Gas Type	87 Octane Non-oxygenated or 89 Octane Oxygenated	87 Octane Non-oxygenated or 89 Octane Oxygenated	87 Octane Non-oxygenated or 89 Octane Oxygenated	87 Octane Non-oxygenated or 89 Octane Oxygenated
Carburetor Type and Number	3-40mm	3 Ram Injectors	3-40mm (CDK)	3 Ram Injectors
<b>PROPULSION</b>				
Impeller, Stainless Steel	3 Blade (<)	3 Blade (<)	3 Blade (<)	3 Blade (<)
Propulsion System	Jet Drive	Jet Drive	Jet Drive	Jet Drive
Jet Pump Type	Dominator Single Stage Axial Flow	Dominator Single Stage Axial Flow	Dominator Short Single Stage Axial Flow	Dominator Short Single Stage Axial Flow
Transmission	Direct Drive	Direct Drive	Direct Drive	Direct Drive
Minimum Water Level for Jet Pump	2 feet (60 cm)	2 feet (60 cm)	2 feet (60 cm)	2 feet (60 cm)
Impeller Diameter	5.83 (14.80 cm)	5.83 (14.80 cm)	5.83 (14.80 cm)	5.83 (14.80 cm)

(+) - Large Overlap Progressive Pitch

(<) - Radial Blade Progressive Pitch

# SPECIFICATIONS

	Virage TX	Virage TXI	Genesis	Genesis i
<b>FEATURES</b>				
Instrumentation	22 Function MFI	23 Function MFI	24 Function MFI	25 Function MFI
Fuel Gauge	Gauge on MFI	Gauge on MFI	Gauge on MFI	Gauge on MFI
Oil Level Sensor	Multi-Level	Multi-Level	Multi-Level	Multi-Level
Tachometer	On MFI	On MFI	On MFI	On MFI
Reverse System	Standard	Standard	PERC™	PERC™
Voltage Meter	Included on MFI	Included on MFI	Included on MFI	Included on MFI
Trip Meter	Included on MFI	Included on MFI	Included on MFI	Included on MFI
Speedometer	Included on MFI	Included on MFI	Included on MFI	Included on MFI
Temperature Switch	Standard	Standard	Standard	Standard
Electric Trim	N/A	N/A	N/A	N/A
Sponsons	Standard - 28"	Standard - 28"	Standard - Genesis	Standard - Genesis
Electric Bilge Pump	Electric with manual override	Electric with manual override	Electric with manual override	Electric with manual override

PERC - Polaris Electric Reverse Control

MFI - Multi-Function Instrument



## Understanding Warnings

The following two pages identify signal words and symbols that appear in this manual. Your safety is involved when these words and symbols are used. Become familiar with their meanings before reading the manual.



The safety alert symbol, on your vehicle or in this manual, alerts you to the potential for personal injury.

### **WARNING**

Indicates a potential hazard that could result in serious injury or death.

### **CAUTION**

Indicates a potential hazard that may result in minor personal injury or damage to the machine.

### **CAUTION**

Indicates a situation that may result in damage to the machine.

### **NOTE**

“NOTE:” will alert you to important information or instructions.

# SAFETY

## Decals

**NOTE:** Important warning and instruction labels have been placed on the watercraft for your protection. Read and follow the instructions on each label carefully. In the event any label becomes illegible or comes off, contact your Polaris watercraft dealer for a replacement. Any safety decal needing replacement will be provided by Polaris at no charge.

The warning labels summarize and highlight key safety and operational information. Be sure to read all of the owner's manual for details that affect safe operation of this watercraft.

**WARNING**

To prevent the risk of **SEVERE INJURY or DEATH**,  
**WEAR A PERSONAL FLOTATION DEVICE (PFD)** at all times and make sure it fits. Use appropriate PFD that is suitable for serious watercraft travel.  
**WEAR AN OPERATIVE GLOTTIS TUBE.**  
Serious watercraft injuries can occur if water is forced into your lungs as a result of falling into the water or being struck by the boat. Normal breathing does not allow quickly passing air and trapped water in the lungs can cause lung failure. All boats must wear a tube and fasten the sliding top for persons who fall overboard in a panic. Review your boat's manual, PFD, and goggle instructions and recommendations.

**KNOW BOATING LAWS.**  
Polaris Industries has the responsibility to ensure that you, the rider, are safe. You should know the operating age and licensing requirements for your state. A boating safety course may be required for your state or local watercraft safety course. LAWRYAN 12-10-10 and know the laws in all states that regulate watercraft use. Make sure that you are not under the influence of alcohol.

**RIDE WITHIN YOUR LIMITS AND AVOID AGGRESSIVE MANEUVERS** to reduce the risk of loss of control, capsizing, and collision. This is a high performance recreational watercraft. Excessive speeds or sharp turns or waves can increase the risk of capsizing. Not all participants have the same skills and knowledge. Avoid and control speed. Do not pump waves or waves.

**DO NOT APPLY THE THROTTLE WHEN ANYONE IS AT REAR.** OFF-PILOT engine oil or keep engine at idle. Water and fuel do not come out of the fuel tank. Water can cause severe injury.

**KEEP AWAY FROM TAKE-UP SPRINGS** with engine at idle. Keep away from take-up springs or moving parts. Knowledge of the location of the take-up springs is essential for safety.

**READ AND FOLLOW OWNER'S MANUAL.**  
Owner's Manual is a critical source of Polaris information. Contact your Polaris Dealer for a replacement.

This decal is located at the rear of the watercraft, just below the seat. The text found on this decal is provided on the following pages.

## Decals

### Safety/Warning Decal Text

To reduce the risk of SEVERE INJURY or DEATH:

### Wear A Personal Flotation Device (PFD)

All riders must wear a Coast guard approved PFD that is suitable for personal watercraft (PWC) use.

### Wear Protective Clothing

Severe internal injuries can occur if water is forced into body cavities as a result of falling into water or being near jet thrust nozzle. Normal swimwear does not adequately protect against forceful water entry into rectum or vagina. All riders must wear a wet suit bottom or clothing that provides equivalent protection (see Owner's Manual). Footwear, gloves and goggles/glasses are recommended.

### Know Boating Laws

Polaris Industries Inc. recommends a minimum operator age of 16 years old. Know the operator age and training requirements for your state. A boating safety course is recommended and may be required by your state.

**Attach Engine Shut-off Cord (Lanyard)** to wrist and keep it free from handlebars so that engine stops if operator falls off. After riding, remove cord from PWC to avoid unauthorized use by children or others.

**Ride Within Your Limits And Avoid Aggressive Maneuvers** to reduce the risk of loss of control, ejection, and collision. This is a high performance boat-not a toy. Sharp turns or jumping wakes or waves can increase the risk of back/spinal injury (paralysis), facial injuries, and broken legs, ankles and other bones. Do not jump wakes or waves.

# SAFETY

## Decals

**Do Not Apply Throttle When Anyone Is At Rear Of PWC**-turn engine off or keep engine at idle. Water and/or debris exiting jet thrust nozzle can cause severe injury.

## Do Not Overload

It will significantly reduce stability and control. Never exceed rider or weight capacity. See capacity label.

**KEEP AWAY FROM INTAKE GRATE** while engine is on. Items such as long hair, loose clothing, or PFD straps can become entangled in moving parts resulting in severe injury or drowning.

## Never Ride After Consuming Drugs Or Alcohol

## Read And Follow Owner's Manual

If Owner's Manual is missing, contact a Polaris Dealer for a replacement.

## Decals

### Gasoline Warning

Located near gas tank fill location.

<b>⚠️WARNING</b>	<b>CAUTION</b>
<p>Gasoline and its vapors are highly flammable and explosive.</p> <p>To avoid fire or explosion:</p> <ul style="list-style-type: none"> <li>• Stop engine before refueling.</li> <li>• Refuel in a well-ventilated area away from open flames or sparks.</li> <li>• Do not overfill tank.</li> <li>• Pull up seat and open engine compartment before starting engine. Push down and latch compartment cover and replace seat before re-starting engine.</li> <li>• Do not start engine if gasoline or vapors are present.</li> </ul>	<p>Every time you refuel, check engine oil. Running engine without oil will cause major engine damage.</p> <p style="text-align: right;">7170215</p>

<b>⚠️WARNING</b>	
<b>RIGHTING CAPSIZED BOAT</b>	
	<ul style="list-style-type: none"> <li>• To prevent injury, do not place hands or objects into pump inlet, intake grate or nozzle.</li> <li>• To prevent major engine damage: Make sure engine is stopped by pulling lanyard from engine stop switch and <u>turn boat</u> to upright position in a <u>clockwise direction</u>.</li> </ul> <p style="text-align: right;">7073865</p>

Located at rear of watercraft and positioned upside down allowing the operator to read it when the boat is in the capsized position.

# SAFETY

## Decals

This decal is located on the dash of your watercraft. The illustration is provided for shape identification only. The text is found below.



Collisions result in more **INJURIES AND DEATHS** than any other type of accident for personal watercraft (PWC).

### To Avoid Collisions:

**Scan Constantly** for people, objects and other watercraft. Be alert for conditions that limit your visibility or block your vision of others.

**Operate Defensively** at safe speeds and keep a safe distance away from people, objects, and other watercraft.

- Do not follow directly behind PWCs or other boats.
- Do not go near others to spray or splash them with water.
- Avoid sharp turns or other maneuvers that make it hard for others to avoid you or understand where you are going.
- Avoid areas with submerged objects or shallow water.

**Take Early Action** to avoid collisions. Remember PWCs and other boats do not have brakes.

**Do Not Release Throttle When Trying To Steer** away from objects - you need throttle to steer. Always check throttle and steering controls for proper operation before starting PWC.

Follow navigation rules and state and local laws that apply to PWCs.

See Owner's Manual for more information.

## Decals

Polaris Industries Inc.  
2100 Highway 55  
Medina, Minnesota  
55340-9770

This Boat Is Not Required To  
Comply With The Following U.S.  
Coast Guard Safety Standards In  
Effect On The Date Of Certification.

- Display of Capacity Information
- Safe Loading
- Flotation
- Electrical System
- Fuel System
- Powered Ventilation

As Authorized By U.S. Coast Guard.  
Grant Of Exemption (CGB 91-013).

**PUSH BUTTON TO  
RESET ELECTRICAL SYSTEM**



7077691

Located on electrical box  
(inside engine compartment).  
See page 115 for exact location.

# SAFETY

## Decals

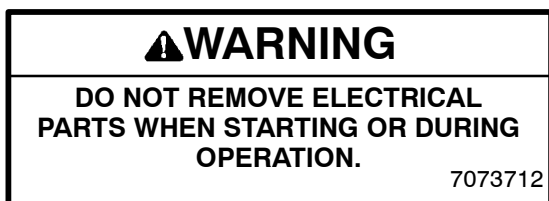

Located on the engine water manifold.



Located on the hood

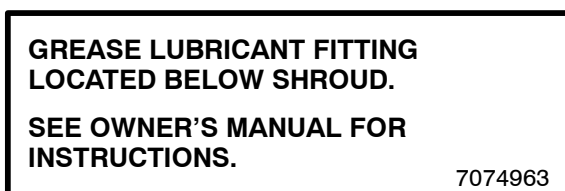

Located on coupler shroud.

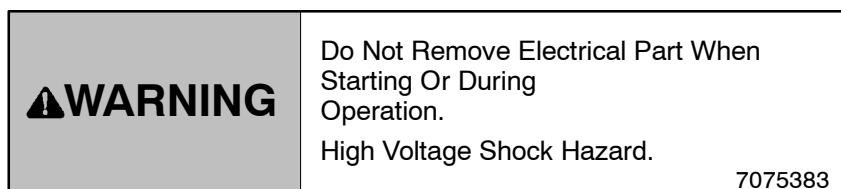

Located on the engine water manifold



## Operator Safety

### **WARNING**

Read the entire manual to have a thorough understanding of this watercraft and its operation. Read and understand all warning labels before operation.

Severe injury or death can result from failure to follow these instructions as well as the warning labels on the watercraft.

► Any operator of a Polaris watercraft must know and practice the following guidelines for personal safety and the safety of their passenger(s). Never permit a guest to operate this watercraft unless the guest has read and understands all warning labels and the Owner's Manual.

► This watercraft is not a toy. It is a high performance powerboat. Operating it requires learned and practiced skills. All operators and passengers should become familiar with the necessary techniques before attempting maneuvers. Always run the watercraft at a speed which is proper for the water conditions and your level of experience.

► The minimum operator age for this watercraft is 16 years of age. Operators between 16 and 18 years of age require close adult supervision. Operation must be in accordance with all applicable boating rules and regulations.

► **This watercraft does not have brakes.** The watercraft is stopped by releasing the throttle and gliding to a stop by the natural drag of the water. **Allow a minimum of 300 feet (90 m) to coast to a stop from full throttle.**

► **Jet thrust is required to steer and turn the vehicle.** Never completely release the throttle and attempt to turn at more than a trolling speed because the watercraft will not turn. Practice until you are comfortable with turning and stopping, and always before carrying a passenger.

► Know and observe all local, state, and federal boating regulations and speed limits. Boating laws and navigational rules are designed for the safety of everyone sharing the waterways.

# SAFETY

## Operator Safety

▶ **Do Not Tow If your machine is not a three or four passenger model. Do not tow** water-skiers, kneeboards, or any object or person behind the watercraft. Towing can cause loss of steering control and will create a hazardous condition which could result in severe injury or death.

▶ **Three or four person models are capable of towing.** However, be aware of the following: towing can cause reduced steering control. Be extremely careful when towing other watercraft, skiers, or objects behind this watercraft as they have a significant impact on handling and steering. Observe local and state laws regarding water-skiing and other towable objects

▶ Do not allow passengers to stand on the boarding platform while the watercraft is running or in motion. Passengers should always remain seated.

▶ Never go over a ski jump or attempt to jump waves, wakes, or other objects in the water. You can severely damage the watercraft and injure yourself due to impact, loss of visibility, watercraft control and reduced reaction time.

▶ **Before starting the watercraft the operator must always attach the lanyard cord to his/her left wrist or PFD ensuring it's snug.**

This will immediately stop the engine if the operator falls off. **Be sure the lanyard is free and not wrapped around the handlebars or controls.** When the watercraft is not in service be sure to disconnect the lanyard from the engine stop switch. This will prevent accidental starting of the watercraft.

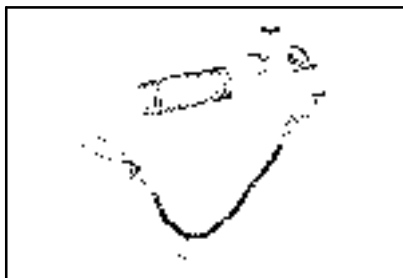

## Operator Safety

►The operator and passenger must wear an approved personal flotation device (PFD) at all times because of the drowning hazards associated with boating. Polaris recommends a vest-type PFD (U.S. Coast Guard type 1, 2, or 3). The seat of the watercraft IS NOT a flotation device.

A helmet may not provide adequate protection against all foreseeable impacts and may aggravate some injuries. For example, if you fall into the water and are wearing a helmet, the helmet could catch the water and could cause choking, severe and permanent injuries or death. A helmet also could increase the possibility of an accident if it reduces your visibility or ability to hear or if its weight increases fatigue. A helmet may provide increased personal injury protection, in some situations. For example, a helmet might provide head protection from impact with the watercraft or during a collision with other watercraft or an obstacle.

It is recommended that all riders of the watercraft wear additional personal protection including watercraft booties and a wet/dry suit. These items will protect riders from exposure and potential hazards in the water such as debris and hidden objects. Adequate eye protection should be worn at all times because of water spray, sun, insects and other objects.

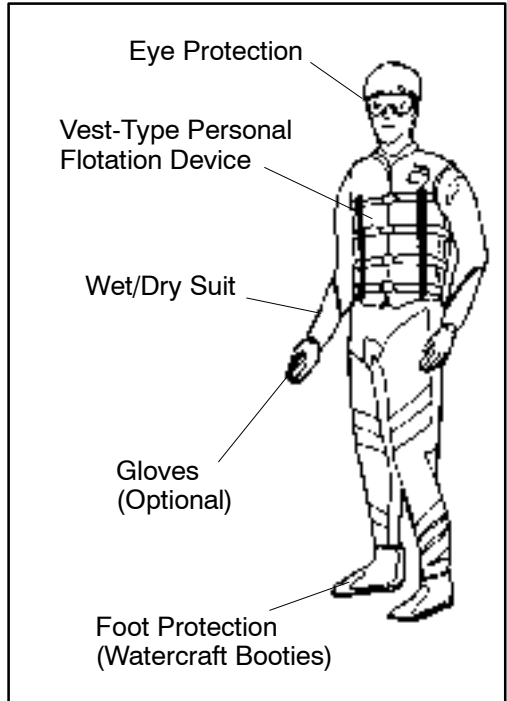

# SAFETY

## Operator Safety

► The Polaris watercraft are designed to carry up to 3 passengers (depending on the model) in addition to the operator. Check the specifications on pages 8-14 to determine your boat's rider capacity. Never allow more than the specified rider capacity on the watercraft. Overloading the watercraft significantly reduces

watercraft stability and control which could result in an accident. When

more than one person is riding, the watercraft handles differently, which means that the operator must have enough prior riding

experience to handle the watercraft with a passenger(s) aboard. **NOTE:**

Check the specifications on pages 8-14 for the maximum watercraft load capacity for your watercraft.

► Do not use the watercraft unless it has an approved fire extinguisher on board. This is a federal regulation. Know how to reach your fire extinguisher quickly in case of fire, and know how to use it before you go out on the water. If you have any doubts about your ability to extinguish the fire, swim away from the craft as quickly as possible. Immediately seek help from other boats or those ashore.

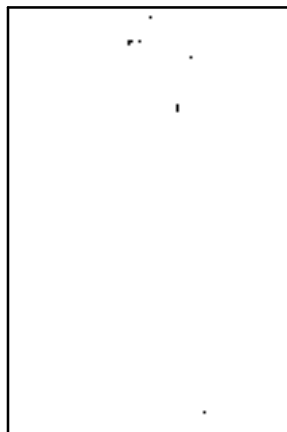
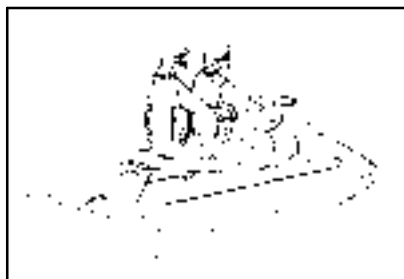

## Operator Safety

►Be aware of severe weather conditions. Observe weather forecasts and conditions before venturing out. Do not operate the watercraft when visibility is poor. Operation of the watercraft in bad weather can result in severe injury or death due to exposure (hypothermia) or accidents due to rough water conditions and poor visibility.

►Be aware of the danger of hypothermia (sub-normal body temperature) which can result in severe injury or death in a very short time. Hypothermia can begin in water as warm as 80°F (27°C). Ride with another watercraft when going into remote areas or large areas of open water. Take along a flare gun when going into remote areas to 4 signal for help if necessary.

►Re-boarding the watercraft in deep water can be strenuous. Practice boarding in chest-deep water to be sure you are physically able to re-board.

►The stream of water produced by the jet pump, and falling into the water at high speed can cause severe personal injury, especially to body orifices (eyes, mouth, ears, rectum, etc). Normal swimming attire may not provide adequate protection. All riders must wear a wet suit bottom or clothing that provides equivalent protection. The jet pump output is especially dangerous if a passenger falls to the rear from a moving watercraft; and to persons behind a moving watercraft. If a passenger falls from the watercraft, release the throttle immediately to avoid injury. Do not exceed idle speed if any person is within 50 feet (15 m) of the rear of the watercraft.

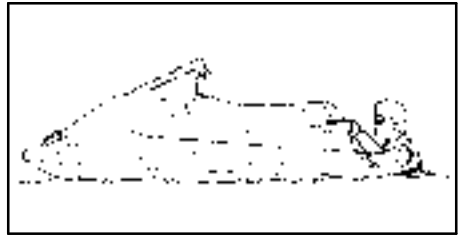

# SAFETY

## Operator Safety

► Watch for dangerous obstacles above and below the water surface at all times and especially in shallow water. Use extra caution when riding in unfamiliar areas. Never ride in water that is less than two feet (60 cm) deep. Do not operate at more than an idle speed in water that is less than six feet deep. If you are thrown from the watercraft you could hit an underwater object which could result in severe injury or death.

Collision with underwater obstacles or people could cause severe injury or death.

► Never ride in water that is less than two feet (60 cm) deep. Do not operate at more than an idle speed in water that is less than six feet deep. Ingesting sand into the cooling system will cause the engine to overheat, resulting in possible severe engine exhaust system or pump damage.

► Always perform the pre-operation check (beginning on page 52) before starting and riding the watercraft. Check fuel and oil levels and all controls, especially the throttle lever, handlebars, and steering nozzle. This can protect you from accidents and the machine from damage in the event something is not functioning properly.

► Riding personal watercraft is strenuous. All riders should be in good physical condition. If you are pregnant consult your physician before riding any watercraft.

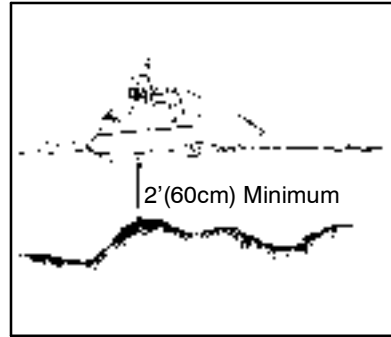

## Operator Safety

►If the watercraft has been beached or sitting in shallow water, it will be necessary to clear out any sand or small rocks before boarding and restarting the watercraft. Remove the particles by bouncing the back of the machine up and down in at least 24" of water.

►Starting, turning, and accelerating without checking for other boats and objects in your path can cause an accident.

**Always look behind you and to each side when starting out and before making sudden turns.**

Always be aware of obstacles, swimmers and other watercraft around you. A collision can cause severe injury or death.

►Quick turns or abrupt changes in speed can cause a passenger to lose his/her balance, fall off and/or become injured. The operator should alert the passenger before making sudden moves.

►Routine service and adjustments to the watercraft are critical for the safe operation and life of the watercraft. Follow the prescribed maintenance and service recommendations in this manual. Have an authorized Polaris dealer perform the service work.



# SAFETY

## Operator Safety

► While the engine is running, do not allow hands, feet, ropes, straps, clothing, or long hair to come in contact with the jet pump water intake on the bottom of the watercraft.

Never insert any object into the intake or outlet of the jet pump. Never start or operate the watercraft with the inlet grate, ride plate, or any guards or shields removed. Severe injury, death or drowning could result from coming in contact with the jet pump or driveline components of the watercraft.

To prevent serious injury due to accidental starter engagement, be sure the engine is off, the safety lanyard is disconnected before removing weeds or debris which may have collected in or around the jet pump intake.

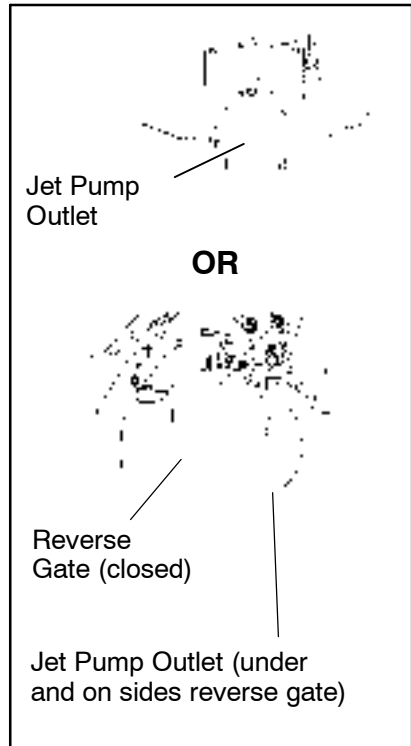



## Operator Safety

▶ Never touch or remove electrical parts when starting or during operation of the watercraft. Severe injury or death could result from electrical shock.

▶ If the watercraft is capsized it must be uprighted in a clockwise direction as viewed from the rear in order to minimize the possibility engine damage.

**Important:** Follow engine draining procedure found on page 93 and 94. Be sure the lanyard is removed from the engine stop switch.



▶ Operator and passenger should keep their feet firmly on the floorboards while the watercraft is in motion. It is possible to lose your balance, fall overboard, or possibly injure your feet from objects in the water. **The passenger should face forward and firmly hang onto the operator's waist except in towing situations** where the spotter faces the rear and uses the grab handle to hold on.

▶ Never operate the watercraft after sunset or before sunrise. It is NOT equipped to be ridden in the dark, which makes it unsafe and illegal to operate.

▶ Be aware of other watercraft, people swimming, and other obstacles while operating the watercraft and maintain a safe distance. This is especially important for an inexperienced operator. A collision can cause severe injury or death.

▶ Never attempt to lift the watercraft without the aid of a trailer and winch or other heavy lifting device. Severe back injury or other injury could result.

# SAFETY

## Operator Safety

▶ Do not modify this watercraft or any of its components. Modifications to this machine could create safety hazards and reduce machine reliability as well as make it unsafe or illegal to operate. Any modifications to this watercraft will void your warranty.

▶ Safe operation of this rider-active craft requires good judgement and physical skills. Persons with cognitive or physical disabilities who operate this vehicle have an increased risk of overturns and loss of control which could result in serious injury or death.

▶ Do not operate this watercraft while under the influence of alcohol or drugs.

### ▶ **Sobering Facts About Boating Under the Influence**

More than half of all the people who drown had consumed alcohol prior to their accident.

Even if you are not intoxicated, any amount of alcohol can be a threat to your safety. Just one beer will impair your balance, vision, judgment and reaction time, thus making you a potential danger to yourself and others.

So remember, don't drink alcohol or take drugs if you are planning to have fun in or on the water.



### ▶ **Outdoor Exposure**

Long hours of boating, exposure to noise, vibration, sun, glare and wind can produce a human fatigue and dehydration condition that can affect your balance, vision, judgment and reaction time and can increase your risk of an accident that may cause bodily injury or death. If you combine alcohol consumption with this condition, you can increase your risk of an accident that may cause bodily injury or death.

## Operator Safety

### ▶ Cold Water Survival

Your life may depend on a better understanding of cold water. Many suspected drowning victims actually die from cold exposure or hypothermia.

Hypothermia is a condition in which the body loses heat faster than it can produce it. Violent shivering develops which may give way to confusion and a loss of body movement.

### ▶ To Avoid Hypothermia:

- Dress warmly
- Wear proper gear and stay as dry as possible
- Seek a warm environment at the first sign of hypothermia (mild shivering)

### ▶ If You Fall In The Water:

- Don't discard clothing
- While wearing your life jacket, draw your knees up toward your chest and hold them there with your arms in the HELP (Heat Escape Lessening Posture) posture

# CONTROLS AND FEATURES

## Controls

Refer to illustrations on following pages.

1. **Starter Button** - Depress and hold the starter button to start engine. Release it as soon as the engine starts. Do not depress the starter button for more than ten seconds at a time. **NOTE:** Lanyard and lock plate must be attached to the engine stop switch or engine will not start. Once the engine starts, pressing this button again will stop the engine.
2. **Choke** - The choke is used to help in starting a cold engine. It is not to be used when starting a warm engine. (Does not apply to Direct Injected models.)
3. **Throttle** - Controls the speed of the watercraft. When squeezed, the engine accelerates; when fully released the engine returns to an idle.
4. **Lanyard Stop Switch** - The lock plate end of the lanyard cord is attached to the engine stop switch on the left handlebar.
5. **Multi-Function Instrument (Virage Models)** - See pages 97-101 for detailed explanation of multi-function instrument.
6. **Bilge Button** - The gray button on top of the switch assembly. Whenever the engine is running, the bilge pump will be running. When the engine is shut down, pushing and holding this button will operate the bilge pump. This should be used if water is noted in the hull during the pre-operation inspection and **prior to restarting the engine after capsizing.**
7. **Fuel Gauge** (Freedom)

# CONTROLS AND FEATURES

## Controls

8. **Polaris Electric Reverse Control (PERC™** Genesis Models) - two buttons used to raise or lower the reverse gate. Refer to page 77 for a detailed explanation of the PERC™ feature.
9. **Hand Hold** - A soft, flexible handle for front passengers to use.

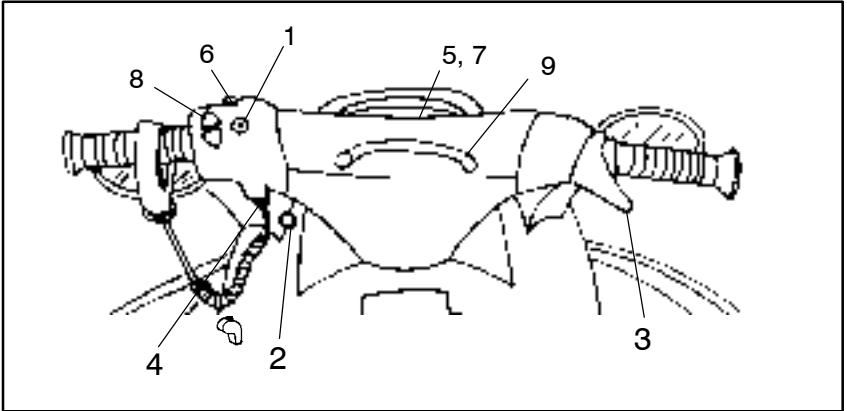

# CONTROLS AND FEATURES

## Controls

1. **Jet Pump Outlet Nozzle** - Controls the direction of the craft via the handlebars and is the exit for the jet output.
2. **Safety Lanyard Wrist Cord** - The lock plate end is fastened to the engine stop switch on the handlebar. Wrist band end is fastened to operator's wrist or PFD. Engine will not start if lanyard lock plate and switch are not engaged. If disengaged during operation the engine will stop.
3. **Seat Latch** - Secures the seat in position. When released, provide access to engine compartment. **NOTE:** The number of latches will depend on the model. Some boats have 1 latch and some have 2.
4. **Boarding Platform/Footwell Pads** - To assist riders while boarding. The place for operator and passenger's feet while riding the watercraft.
5. **Drain Plug(s)** - When water gets into the bilge it can be drained through this plug. Remove the watercraft from the water before draining the bilge. Be sure the plug is securely closed before launching the watercraft.
6. **Exhaust Outlet**
7. **Reverse Gate (shown engaged)**

# CONTROLS AND FEATURES

## Features

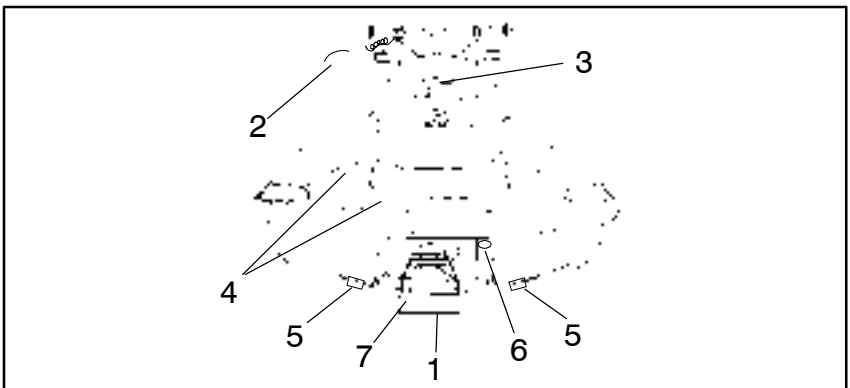
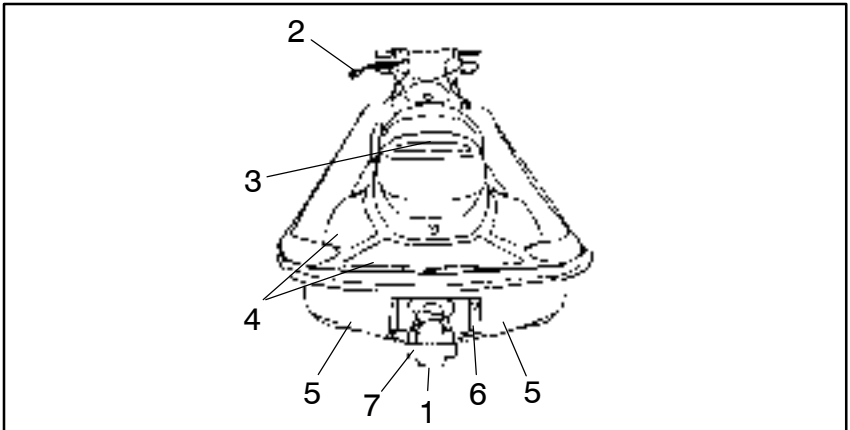

# CONTROLS AND FEATURES

## Features

### Virage and Freedom Models

Refer to illustrations on following pages.

1. **Seat/Engine Compartment** - Removing seat provides access to the engine, battery, electrical box, exhaust system, and other components.
2. **Handlebars** - Control the direction of the watercraft.
3. **Fire Extinguisher Compartment** - Provides secure storage for required fire extinguisher.
4. **Hood** - Provides access to fire extinguisher, oil tank, fuel valve, and main storage space.
5. **Air Intake Openings** - Air enters here to supply engine and ventilate engine compartment.
6. **Fuel Tank Cap** - Turn the cap counterclockwise to remove and clockwise to replace.
7. **Grab Handle** - Used to assist the riders while boarding or riding as a passenger.
8. **Warning Light** - All models are equipped with an oil level gauge on the multi-function instrument (MFI) which will flash a red light if low. The MFI will also provide a LCD message that will say "Low Fuel".
9. **Fuel Valve - Two Position Rotating Valve** - ON allows fuel to operate the watercraft; OFF stops the fuel supply to the carburetor.
10. **Sponson** -Enhances vehicle stability and turning ability in water
11. **Seat Strap** - To be used to aid in boarding. Allows a passenger to hang on while riding.
12. **Reverse Operation Handle** - This has "PERC"
13. **Multi-Function Instrument** - (Virage Models) or Fuel Gauge with warning LED (Freedom)



# CONTROLS AND FEATURES

## Features

### Virage and Freedom Models

14. **Oil Fill Cap** - Turn the cap counterclockwise to remove and clockwise to replace.

15. **Glove Box**

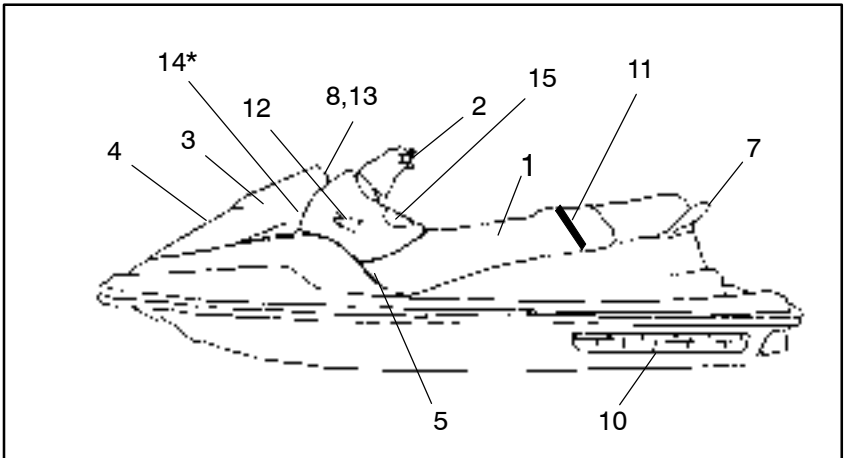
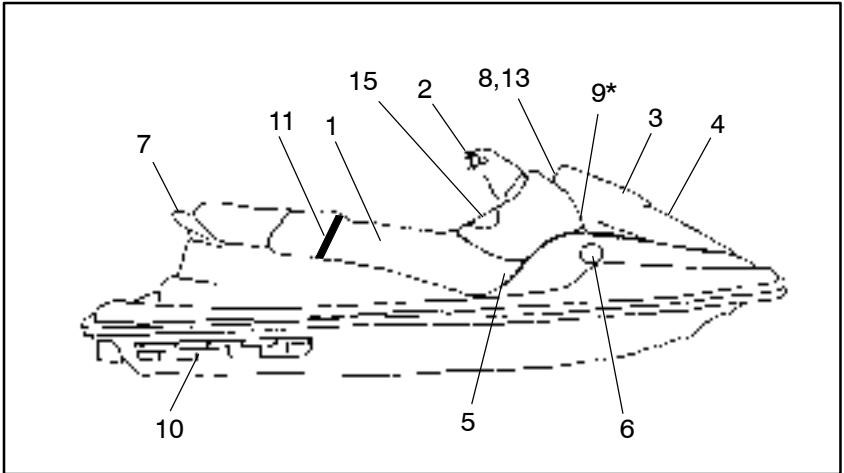

\* Under Hood

# CONTROLS AND FEATURES

## Features

### Genesis Models

Refer to illustrations on following pages.

1. **Seat/Engine Compartment** - Removing seat provides access to the engine, battery, electrical box, exhaust system, and other components.
2. **Handlebars** - Control the direction of the watercraft.
3. **Fire Extinguisher Container** - Provides secure storage for required fire extinguisher.
4. **Hood** - Provides access to fire extinguisher, oil tank, fuel valve, and main storage space.
5. **Air Intake Openings** - Air enters here to supply engine and ventilate engine compartment.
6. **Fuel Tank Cap** - Turn the cap counterclockwise to remove and clockwise to replace.
7. **Grab Handle** - Used to assist the riders while boarding or riding as a passenger.
8. **Warning Light** - All models are equipped with an oil level gauge on the multi-function instrument (MFI) which will flash a red light if low. The MFI will also provide a LCD message that will say "Low Fuel".
9. **Fuel Valve - Two Position Rotating Valve** - ON allows fuel to operate the watercraft; OFF stops the fuel supply to the carburetor. Turn the fuel valve "OFF" whenever storing or trailering.
10. **Sponson** -Enhances vehicle stability and turning ability in water
11. **Seat Strap** - To be used to aid in re-boarding. Also allows a passenger to hang on while riding.
12. **Reverse** - Polaris Electric Reverse Control (PERC™) - two buttons used to raise or lower the reverse gate. Refer to page 77 for a detailed explanation of the PERC™ feature.

# CONTROLS AND FEATURES

## Features

### Genesis Models

13. **Multi-Function Instrument** - 24-25 modes of information.

14. **Glove Box**

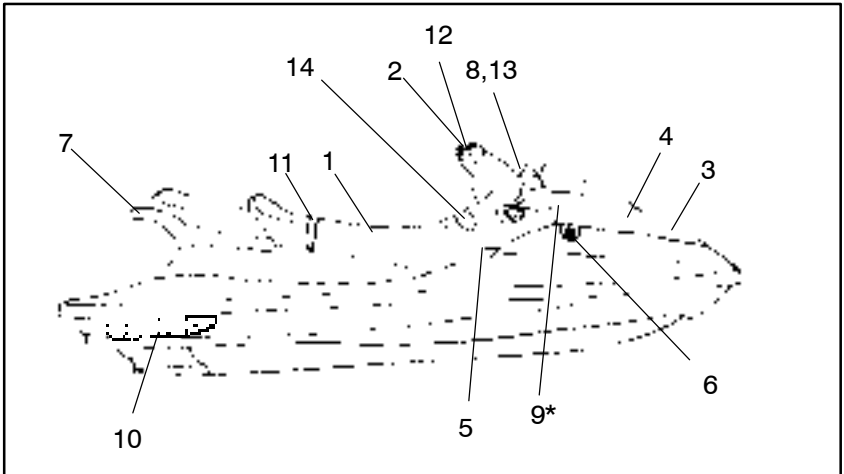

\* Under Hood

# **CONTROLS AND FEATURES**

## **Engine Components**

Refer to illustrations on following pages.

### **Under Seat Engine Compartment**

1. Spark plugs
2. Airbox cover
3. Exhaust pipe
4. Water temperature sensor
5. Exhaust cooling hose
6. Exhaust silencer
7. Engine water outlet hose (underneath thermostat assembly)
8. Water manifold
9. Thermostat assembly
10. Electrical box (circuit breaker and fuses)
11. Fuel/water separator
12. Exhaust Coolant Filter
13. Air filter
14. Battery
15. Bilge Pump
16. Starter Solenoid

# CONTROLS AND FEATURES

## Engine Components

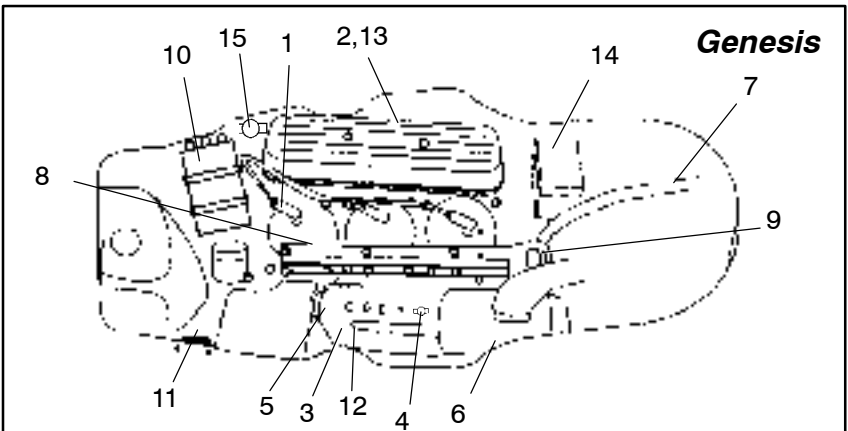
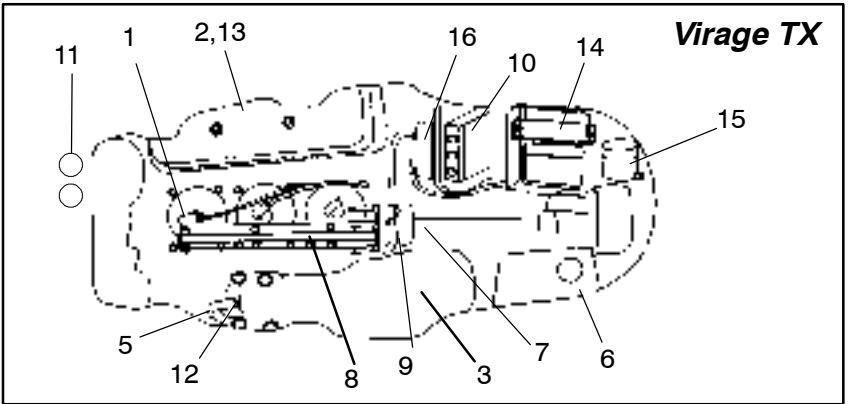
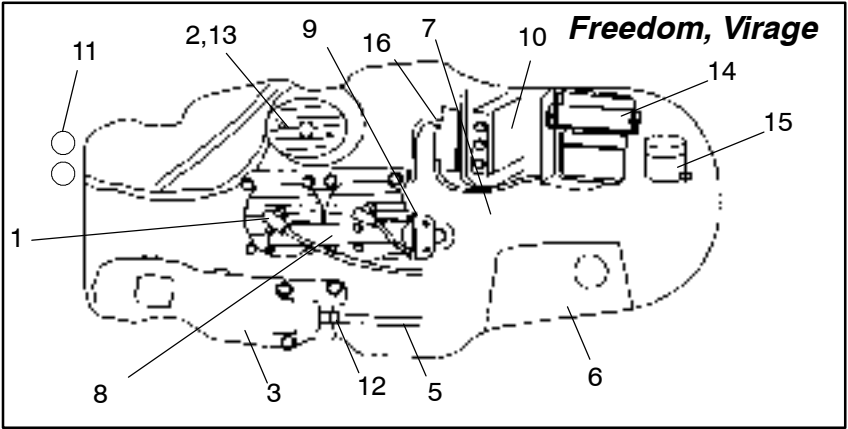

# CONTROLS AND FEATURES

## Engine Components

Refer to illustrations on following pages.

### Under Seat Engine Compartment

1. Spark plugs
2. Airbox cover
3. Exhaust pipe
4. Water temperature sensor
5. Exhaust cooling hose
6. Exhaust silencer
7. Engine water outlet hose (underneath thermostat assembly)
8. Water manifold
9. Thermostat assembly
10. Electrical box (battery underneath on some models)
11. Exhaust Coolant Filter
12. Air filter
13. Battery
14. Capacitor
15. Starter Solenoid
16. EMM - Engine Management Module - (found only on Direct Injected models).

# CONTROLS AND FEATURES

## Engine Components

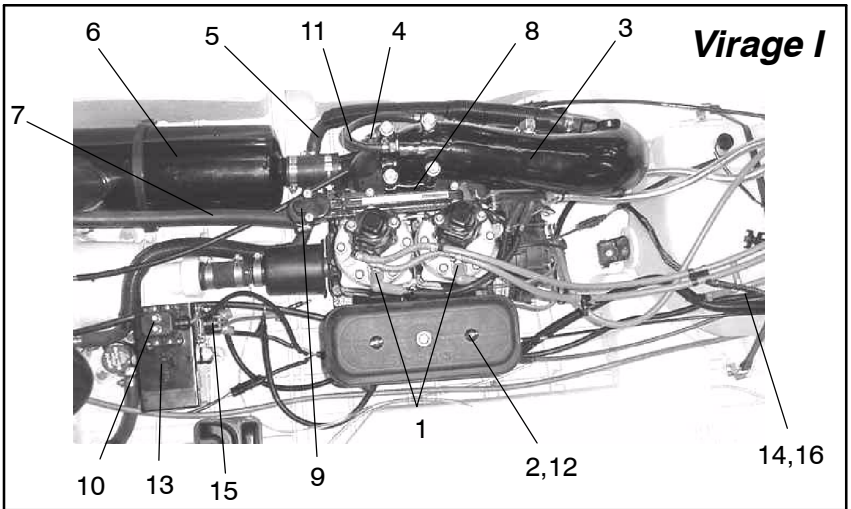
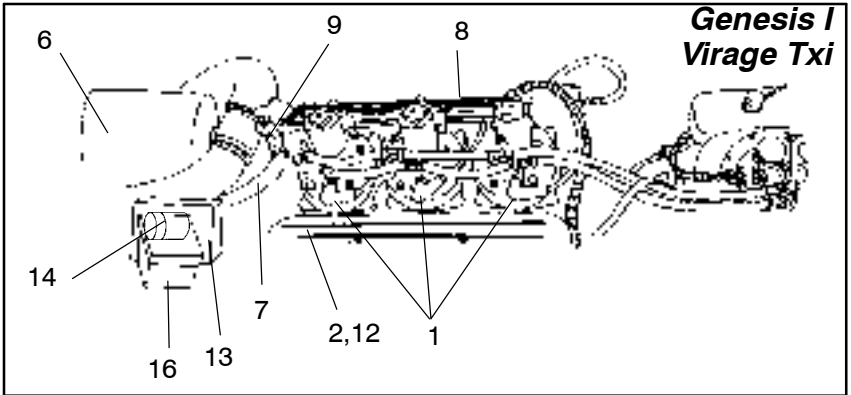

# CONTROLS AND FEATURES

## Controls

1. **Jet Pump Intake Grate** - The grate protects the impeller and drive shaft as well as riders of the watercraft.
2. **Drive Shaft** - Located underneath the intake grate. Transmits the power from the engine to the impeller.
3. **Ride Plate** - Covers and protects the jet pump and provides leveling control for the watercraft.

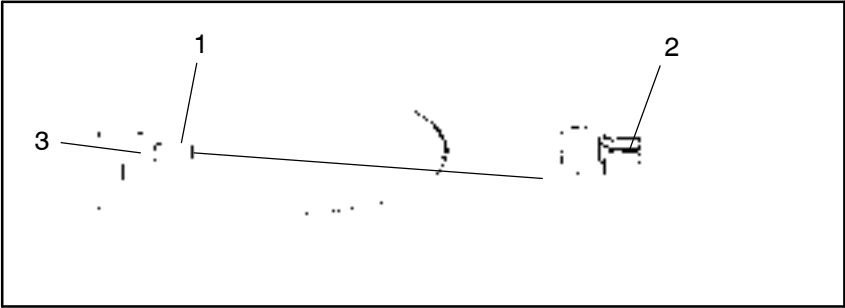



# CONTROLS AND FEATURES

## Features

### Engine Overheat

#### CAUTION

A clogged intake and/or impeller can cause overheating and/or damage to jet pump and impeller parts.

Some Polaris watercraft are equipped with a device which will limit engine RPM if the engine overheats. This feature is designed to help prevent engine damage due to engine overheating.

If the high temperature indicator light or “hot” warning message displays (and the engine RPM is limited) stop the engine immediately.

Clean the jet pump and impeller as outlined on page 90.

If the engine still overheats after cleaning the jet pump and impeller, take the watercraft to an authorized Polaris dealer for immediate service.

When the cause of the of the overheat is identified and corrected, normal operation can be resumed by releasing and reapplying the throttle.

## Accessories

Polaris has a wide range of watercraft accessories, from wetsuits and life vests to accessory mirrors, touring and towing gear, and performance parts. Contact your Polaris dealer for visit [www.polarisindustries.com](http://www.polarisindustries.com) or a full line of available products.

# CONTROLS AND FEATURES

## Watercraft Equipment

### Standard Equipment

- Watercraft Owner's Safety and Maintenance Manual
- Watercraft Safety Video tape PN 9916475
- Lanyard with wristband, lock plate and whistle
- Tool Kit containing:
  - wrench
  - flat screwdriver
  - Allen wrench
  - spark plug wrench with Phillips head screwdriver

### Replacement Parts

If replacement of parts becomes necessary contact an authorized Polaris dealer. Whenever possible provide part numbers.

### Optional Equipment

- U.S. Coast Guard approved fire extinguisher (UL 5-B:C Rating) PN 2871012
- Registration numbers (See your Polaris Watercraft Dealer)
- Tow rope (for emergency use) PN 2871310
- Flare gun (for emergency use) PN 2871533
- Safety and riding gear, including approved personal flotation devices for operator and passenger (See your Polaris Watercraft Dealer)
- Polaris Premium or Polaris Premium Gold Synthetic or Polaris Nature-Oil (biodegradable Synthetic two-cycle oil)
- Polaris cable lubricant PN 2870510
- Polaris dielectric grease, 2 oz. bottle PN 2871027
- Polaris grease, premium marine PN 2871066
- Waterproof lubricant spray, 12 oz. PN 2871064
- Emergency Signal Kit PN 2871206
- Emergency Survival Kit PN 2871204

## Fuel and Oil Recommendations

*Gasoline is extremely flammable and explosive under certain conditions.*

### **WARNING**

- Always check for fumes prior to starting engine.
- Always exercise extreme caution whenever handling gasoline.
- Always refuel with the engine stopped; and outdoors or in a well ventilated area.
- Do not smoke or allow open flames or sparks in or near the area where refueling is performed or where gasoline is stored.
- Do not over fill the tank. (Do not fill the tank neck).
- If you get gasoline on your skin or clothing, immediately wash it off with soap and water and change clothing.
- Never start the engine or let it run in an enclosed area. Gasoline powered engine exhaust fumes are poisonous and can cause loss of consciousness and death in a short time.
- Shut off fuel valve whenever the watercraft is stored, parked, or being transported.

### **WARNING**

The engine exhaust from this product contains chemicals known to cause cancer, birth defects or other reproductive harm.

# OPERATION

## Fuel and Oil Recommendations

### Fuel

Refer to the specifications on pages 8-14 for the proper fuel octane requirement for your boat.

### CAUTION

The use of non-recommended fuel or oil could result in engine component and fuel system deterioration and will void your warranty.

Since this watercraft features an oil injection system it is not necessary to pre-mix the gasoline and oil. The only deviation from this is during the engine break-in period (see page 65).

### Refueling

Keep the watercraft horizontal while fueling. If your machine is equipped with a fuel valve, shut it off. Carefully remove the gas cap.

Use fresh, seasonal gasoline which has been stored in a clean container. To get the best performance from gasoline only purchase what is needed for a month or less of operation.

### WARNING

Always stop the engine and disconnect the lanyard lock plate from the engine stop switch before refueling.

If you do not, you run the risk of igniting the gasoline, causing an explosion that would cause serious injury or death.

The use of a funnel or flexible spout will help avoid gasoline spillage on the watercraft. Always wipe spills off immediately.

## Fuel and Oil Recommendations

### Use only Polaris 2-cycle oil.

The oil fill is located under the front door. Check the oil level every time you go boating and add oil as necessary. Do this with the engine off and the lanyard lock plate removed from the engine stop switch.

To check the oil, first make sure the watercraft is level. Remove the oil tank cap and look at the oil level, or remove the storage bucket or seat and check the oil level. Add recommended oil as necessary. Do not overfill. Wipe up any oil spillage immediately. Visually inspect the oil for water or foreign matter. If either is present change the oil.

All models are equipped with an oil level gauge on the instrumentation. The gauge will flash a red light if low. Other models emit a “low oil tone” when oil is low. Add oil immediately when your machine indicates the need.

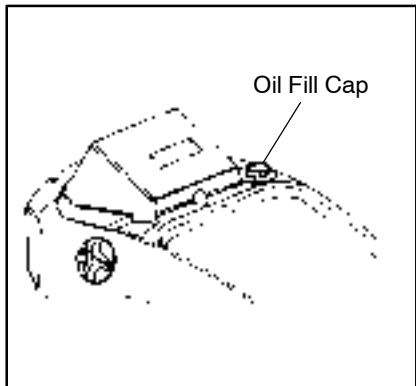

## CAUTION

The use of unrecommended oil could result in engine damage or poor performance. It will also void your warranty.

If the engine is run without oil, severe engine damage will occur. If you discover an empty oil tank, have the watercraft serviced immediately by an authorized Polaris dealer.

Always tighten cap securely to prevent water from contaminating oil. Severe engine damage will occur if water becomes mixed into the oil.

# OPERATION

## Pre-Operation Check

### **WARNING**

Inspect the watercraft each time before starting and riding to ensure it is in proper working order. If proper inspection is not done severe injury or death could result. See page 126 for additional inspection information.

If you smell fuel in the hull of the craft, *do not operate the craft*. Instead, take it to your dealer immediately for inspection.

Before inspection, remove lanyard and lock plate from the engine stop switch located on the handlebars.

Following is a check list that should be performed before riding the watercraft. The next few pages contain detailed information regarding these checks.

Item	What To Do	See Page
Fuel/water separator	Visually inspect for water and drain if present	64
Fuel/oil tank levels	Check fuel/oil; add as necessary; visually inspect for presence of water	54
Jet pump water intake	Inspect and remove debris if present; be sure intake grate is secure; push rear of watercraft up and down in the water to flush sand out of water intake before starting	55
Throttle	Check for proper operation.	56
Steering	Check for proper operation; visually inspect control cable	56
Fire extinguisher	Inspect condition and expiration date	57
Storage compartment	Check for secure latching	58
Engine Cover	Check for secure latching	58

## Pre-Operation Check

<b>Item</b>	<b>What To Do</b>	<b>See Page</b>
Battery	Check fluid level and condition; vent hose must be clear and open	60
Hull	Inspect hull for damage or cracks; clean off marine growth	61
Drain plugs/bilge	Inspect and clean; it should not leak; be sure it is tight and secure	61
Loose parts/hoses	Inspect for loose parts/hoses and connections	57
Seat	Check that seat is securely fastened	59
Loose ropes/straps/ clothing/long hair	Be sure that there are no loose ropes, straps, clothing, etc.; Long hair is tied back and secured	61
Riding gear	Check operator and passenger for complete gear and proper fit	62
Switches/buttons	Check operation	63
Lanyard cord/stop switch	Check condition and operation	63
Reverse System	Check operation	77
Bilge	Pump out any water (button on switch pad)	63

# OPERATION

## Pre-Operation Check

### ✓ Fuel And Oil Tank Levels

Remove fuel cap. With watercraft horizontal and fuel valve off (if equipped), fill the fuel tank with gasoline recommended on pages 8-14 of this manual. Heed the warnings about gasoline found on page 49.

**NOTE:** If the fuel or oil levels become low, the Multi-Function Instrument will display a flashing warning light. Proceed to shore and refuel. Refer to the specifications found on pages 8- to determine if your boat is equipped with this feature. **Know your machine before riding.**

To check the oil level, turn the cap counterclockwise and remove it to look inside the oil tank. You can also remove the storage tray inside the storage compartment or seat to view the oil level in the oil tank. Add recommended oil as necessary.

Visually inspect the oil for water or other contaminants. If either of these is present, have the oil changed and bleed the system to remove all contaminants.

Read the oil recommendations found on page 65 for proper lubrication during the break-in period.

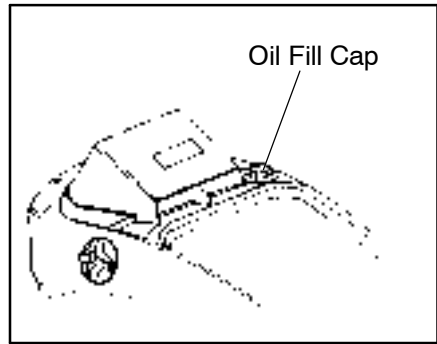



## Pre-Operation Check

### ✓ Jet Pump Intake

1. Ride Plate
2. Impeller
3. Drive Shaft
4. Intake Grate

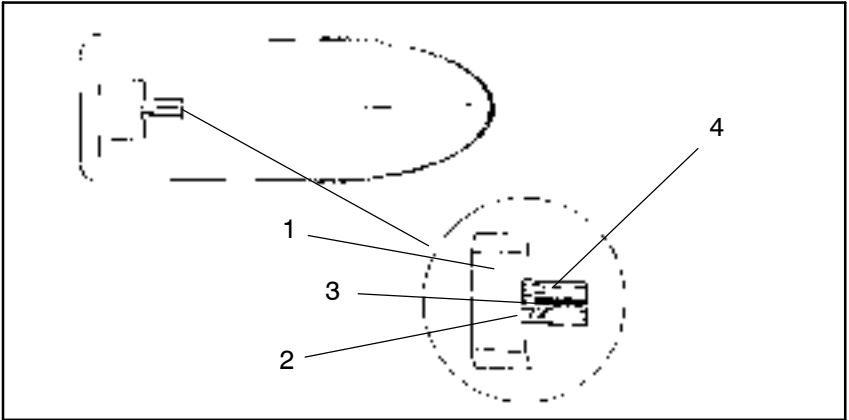

The lanyard lock plate must be removed from the stop switch. Battery cables must also be disconnected before continuing this inspection.

Carefully check the jet pump intake for debris such as weeds, shells or anything which may restrict the intake of water. Damage could occur if the intake is clogged, causing engine overheating and jet pump damage. If any obstruction cannot be removed have an authorized Polaris dealer service it immediately.

After launching, walk the watercraft into water at least 2 feet (60 cm) deep and bounce the back of the watercraft up and down several times to flush out any sand and debris that may be in the pump.

## CAUTION

Ingestion of sand into the cooling system will cause the engine to overheat, resulting in possible severe engine damage.

# OPERATION

## Pre-Operation Check

### ✓ Throttle

Always check throttle operation prior to starting the engine.

Pull or squeeze the throttle several times to be sure the throttle lever moves freely through its full range. It should spring back to its original position when released.



### ✓ Steering

Check handlebars for free movement throughout their full range. Make sure the jet pump outlet nozzle changes direction as handlebars are turned from left to right and vice versa.

Be sure handlebars and handlebar grips are not loose. Visually inspect the control cable to insure that it is in working condition.

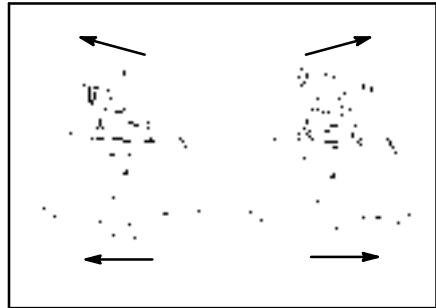

## Pre-Operation Check

### ✓ Loose Parts/Hoses

Inspect the watercraft for any loose nuts, bolts, fasteners and hoses. Be sure that all hose clamps are tight. Replace cracked or deteriorating hoses.

### ✓ Fire Extinguisher

The operator of this watercraft is required by law to carry a fire extinguisher on board. Be sure a fire extinguisher is inside the container designed for its containment (inside the front storage area under the front hood). Be sure it is in working condition and fully charged.

A fire extinguisher is not standard equipment with this watercraft. If you do not have one, contact your Polaris dealer or a fire extinguisher dealer to purchase one which meets UL5-B:C rating and is Coast Guard approved.

Fire Extinguisher Holder



Storage inside the storage area under the front hood

# OPERATION

## Pre-Operation Check

### ✓ Engine Compartment

Be sure the seat and engine cover are properly positioned and securely latched before operating the watercraft.

If used in salt water, Polaris recommends the inside of the hull (engine and components) be sprayed with waterproof lubricant spray PN 2871064 after every use.

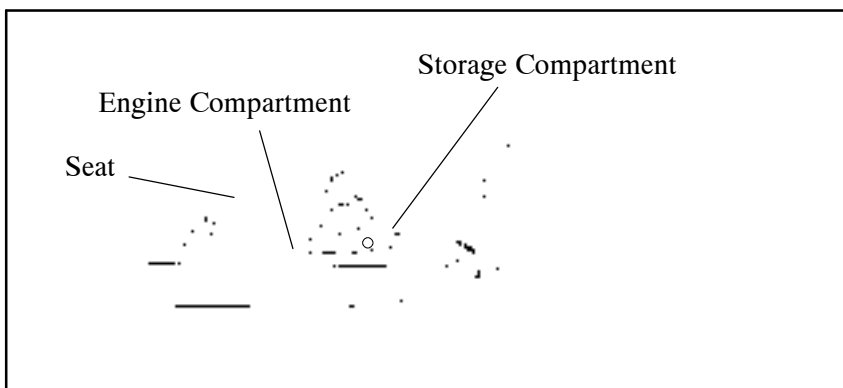

### ✓ Storage Compartment

Be sure the storage compartment door is in place and securely latched.

## Pre-Operation Check

### ✓ Seat

**NOTE:** This illustration is a general representation provided only to help the operator locate the seat latches.

To access the engine/storage compartment of all other models, disengage the seat latch. On Genesis models there is a latch on the rear of each seat.

Be sure the seat(s) is (are) properly positioned and secured before operating the watercraft.

The seat is not a Personal Flotation Device (PFD) and will not provide life saving flotation. Always wear a PFD when operating or riding watercraft.

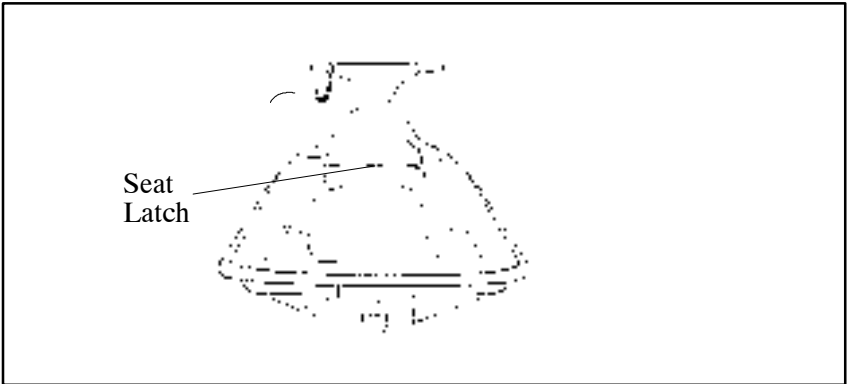

# OPERATION

## Pre-Operation Check

### ✓ Battery

Never remove or tighten battery cables or attempt to change a battery if you smell fuel fumes. Instead, take the craft to your dealer for immediate inspection.

It is very important that the battery is in good condition and fully charged. A weak battery can leave you stranded. Never operate the watercraft with a battery that is too weak to start the engine on its own or shows signs of loss of power.

Be sure the battery is securely fastened in its mounting position.

Check the battery fluid level and add distilled water if level is low. It should be between the “upper” and “lower” level.

See that terminal connections are tight and that there are no leaks. Inspect vent hose for kinks or blockage.

Never allow a spark to occur while charging or removing the battery, or when tightening the cables. This could cause an explosion, resulting in severe personal injury or death.

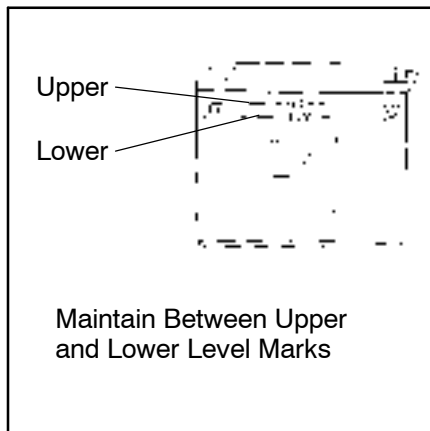

## Pre-Operation Check

### ✓Hull

Inspect the hull for cracks or damage. Do not ride the watercraft if the hull is damaged. Remove marine growth if present using non-abrasive cleaner.

### ✓Drain Plugs/Bilge

To remove the drain plug turn the plug counterclockwise until loose and remove. To install, clean the plug and plug hole of sand and debris, insert the plug and turn clockwise until tight.

**NOTE:** Some models have more than one drain plug.

While the watercraft is out of the water remove the drain plug. Carefully flush out the bilge with fresh water. Allow the bilge to drain completely. Wipe out the bilge with dry shop cloths and reinstall the drain plug.

Once the watercraft is launched, remove the seat, and check for leaks.

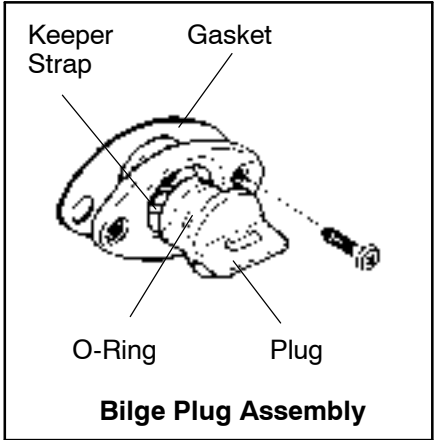

### ✓ Loose Straps/Ropes/Clothing/Long Hair

Be sure there are no loose straps, ropes, cords or belt-like objects hanging from the watercraft or riders. Long hair should be tied back and secured.

## **⚠WARNING**

Make certain any long straps, ropes, clothing, long hair or anything similar are tied back and secured.

These objects can become tangled in the jet pump impeller and cause severe injury or death.

# OPERATION

## Pre-Operation Check

### ✓Riding Gear

The operator and passenger should wear a Coast Guard approved personal flotation device (life jacket or vest) which fits properly; as well as eye and foot protection. A wet/dry suit is also recommended.

Normal swimming attire may not provide adequate personal protection. Wear heavy, well constructed swimwear for body orifice protection.

A whistle attached to your lanyard is a good idea in case you need to summon help.

To protect prescription eyewear and sunglasses against loss or damage wear goggles that fit securely over them.



## Pre-Operation Check

### ✓ Switches/Buttons

When the watercraft is in the water perform the following checks:

- Pump water out of the engine compartment using the bilge pump (gray button). Refer to page 34 for more information. Look inside the engine compartment for fuel or water leaks and have them repaired if present. Do not ride the watercraft until leaks are repaired.
- Start the engine and let it run for a few seconds. Remove the lanyard lock plate from the engine shut-off switch. The engine should stop immediately. If it doesn't, press the stop button or pull the choke lever knob the engine dies. Do not ride the watercraft, and have it serviced by an authorized Polaris dealer before riding it again.
- Start the engine again and run it for a few seconds. Then depress the engine "stop" button until the engine stops.

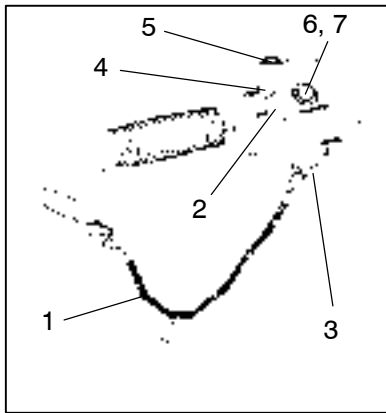

1. Lanyard
2. PERC™ (If Equipped)
3. Lock Plate
4. Forward
5. Bilge
6. Start
7. Stop Button

# OPERATION

## Pre-Operation Check

### ✓ Fuel/Water Separator

Visually inspect the bowl for water collected at the bottom of the bowl (1). (See illustration). If water is present it will appear as a clear liquid at the bottom of the bowl. Turn off fuel valve and remove bowl by turning counterclockwise. Take care not to spill fuel while removing. Wipe up spills immediately with a shop cloth. Dispose of fuel properly and follow all gasoline handling precautions as outlined on page 49. Re-install separator bowl making sure the O-ring is in place. Hand tighten securely.

**NOTE:** The fuel/water separator is located either under the front compartment door behind the storage bucket on the starboard side or inside the engine compartment. See illustration. Inspect only when the watercraft is **not** on water.

**NOTE:** The fuel/water separator is integral to the fuel pump module on Direct Injected models. It is **not serviceable**.



1. Deck
2. Fuel/Water Separator

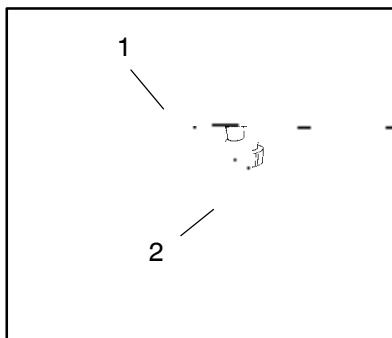

## Engine Break-in Procedure

### CAUTION

Failure to follow the recommended break-in procedure can severely damage the engine.

Careful treatment of a new engine will result in more efficient performance and longer life for the engine.

Polaris recommends the use of a 50:1 gas/oil premix in the fuel tank for the **first tank full** of fuel to provide additional lubrication during the break-in period. A 50:1 ratio is one pint (.5 l) oil to six gallons (23 l) gas.

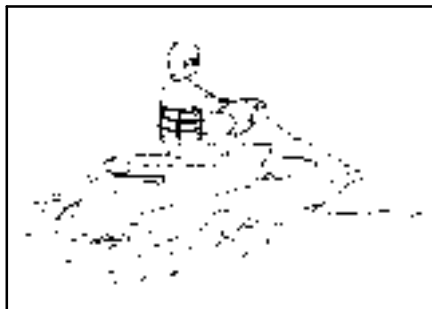

After the break-in period the oil injection system provides the necessary engine lubrication without the need for pre-mixed fuel.

During the break-in period varying throttle speeds will contribute to good engine break-in. Do not subject a new engine to heavy loads or full-throttle operation for extended periods. Do not carry a passenger during the break-in period.

### CAUTION

When starting the engine, be sure the watercraft is in water at least 2 feet (60 cm) deep. If the engine is run in water less than two feet deep, sand, weeds and debris may be sucked into the jet intake and damage the impeller or injure bystanders. Ingestion of sand into the cooling system will cause the engine to overheat, resulting in possible severe engine damage.

# OPERATION

## Engine Break-in Procedure

1. Launch the watercraft. Push the rear of the watercraft up and down several times. Check the throttle for free operation and start the engine. Let the engine warm up for about a minute before departing.
2. The lowest possible speed should be used for the first five minutes of operation.
3. Gradually open the throttle to half speed.
4. Vary throttle speeds up to 3/4 speed during the break-in period.

## Navigational Rules

This watercraft must be operated in accordance with all rules and regulations governing it and the waterway on which it is operated.

These rules are used and enforced internationally as well as by the U.S. Coast Guard and local law enforcement. Any operator of this watercraft should be aware of these rules and obey them when encountering other vessels.

The following rules are condensed and are provided only for your convenience. Consult a U.S. Coast Guard Auxiliary or Department of Motor Vehicles for a complete set of rules governing the waters where you will be riding. You may also obtain this information when registering your watercraft.

### Right-of-way And Give-way

In nautical terms the “stand-on” (privileged) vessel has the right-of-way and the “give-way” (burdened) vessel must yield or give-way.

#### Stand-on Vessel

The vessel with the right-of-way has the duty to continue its course and speed, except to avoid an immediate collision. By maintaining course and speed other vessels should be able to determine how best to avoid you.

#### Give-way Vessel

The vessel which does not have the right-of-way is responsible to take positive action to stay out of the way of the stand-on vessel. Normally, you should not cross in front of the stand-on vessel. You should slow down or change direction briefly and pass behind the stand-on vessel. Your actions should be clear and understandable by the stand-on vessel.

### Rule 2

Rule 2 is “The General Prudential Rule” in the International Rule. It tells the operator to follow standard procedures except when a collision will occur, unless both vessels try to avoid the collision. In this case, both vessels become “give-way” vessels.

# OPERATION

## Navigational Rules

### Encountering Vessels

There are three main situations in which you may encounter other vessels:

- Overtaking (passing);
- Meeting (approaching another vessel head-on) and
- Crossing (travelling across another vessel's path).

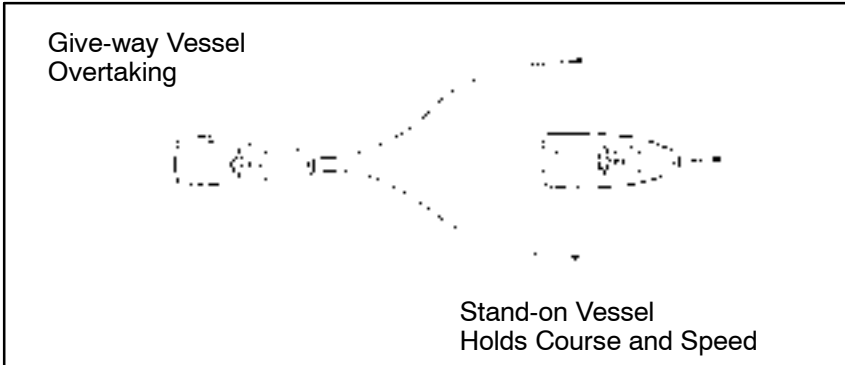

### Overtaking Vessels

If you are passing another vessel, you are the “give-way” vessel. The other vessel is expected to maintain its course and speed. You must stay out of its way until you are past it.

If you are the “stand-on” vessel, maintain your course and speed until the other vessel has passed you.

## Navigational Rules



### Meeting Vessels

If you are meeting another power vessel head-on, and you are close enough to possibly collide, neither vessel has the right-of-way. Both vessels must alter course to avoid an accident. You should keep the other vessel to your port (left) side. This rule does not apply if you will be clear of the other vessel by maintaining your course and speed.

# OPERATION

## Navigational Rules

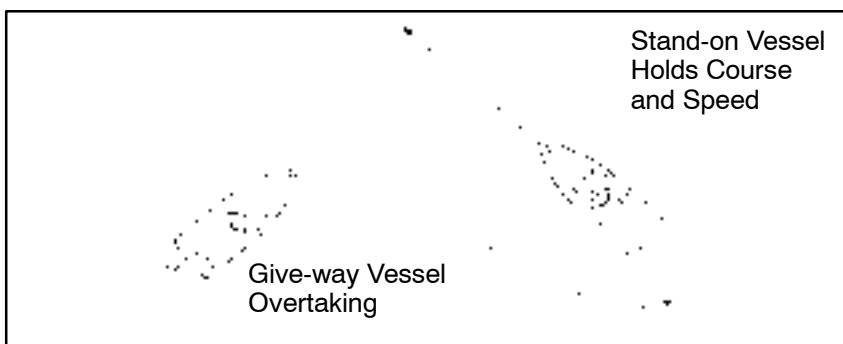

### Crossing Paths

When two power vessels are crossing each other's path close enough to run the risk of collision, the vessel having the other on the starboard (right) side must avoid the other. If the other vessel is on your starboard (right) you must keep out of its way as you are the "give-way" vessel. If the other vessel is on your port (left) side, maintain your course and direction as you are the "stand-on" vessel. This is providing that the "give-way" vessel gives you the proper right-of-way.

### Non-motorized Craft (Sailboats, Canoes, Etc.)

Non-motorized craft are normally given the right-of-way except:

- When a non-motorized craft is overtaking a power vessel the power vessel has the right-of-way.
- Non-motorized craft should stay clear of fishing vessels.
- In a narrow channel a non-motorized craft should not interfere with the safe passage of a power vessel.

### Fishing Vessel Right-of-way

All vessels which are fishing with nets, lines or trawls are considered "fishing vessels" under International Rules. Vessels with trolling lines are not considered fishing vessels. Fishing vessels have the right-of-way regardless of position. They cannot interfere with the passage of other vessels in narrow channels.



## Navigational Rules

### TO AVOID COLLISIONS:

**SCAN CONSTANTLY** for people, objects and other watercraft. Be alert for conditions that limit your visibility or block your vision of others.

**OPERATE DEFENSIVELY** at safe speeds and keep a safe distance away from people, objects, and other watercraft.

- Do not follow directly behind PWCs or other boats.
- Do not go near others to spray or splash them with water.
- Avoid sharp turns or other maneuvers that make it hard for others to avoid you or understand where you are going.
- Avoid areas with submerged objects or shallow water.

**TAKE EARLY ACTION** to avoid collisions. Remember PWCs and other boats do not have brakes.

**DO NOT RELEASE THROTTLE WHEN TRYING TO STEER** away from objects - you need throttle to steer. Always check throttle and steering controls for proper operation before starting PWC.

Follow navigation rules and state and local laws that apply to PWCs.

## Reading Buoys And Markers

United States waters are marked for safe navigation through the use of buoys and markers with various shapes, colors, numbers and lights to show the boater the proper course. The same is true for waters in particular states.

Marking may vary by geographic location. Consult local authorities before riding your watercraft in unfamiliar waters.

## Launch Ramp Etiquette

Be considerate and efficient when launching your watercraft. Prepare your craft beforehand, and perform all safety checks before you get to the water. Launch as quickly as possible.

# OPERATION

## Stopping The Engine

To keep directional control of the watercraft the engine should be kept running until the watercraft has quit moving.

Release the throttle lever. When the engine has slowed to an idle, push in the stop button (1) with your left thumb. When the button is pushed, the engine stops immediately. Another way to stop the engine is by pulling the lanyard lock plate (2) off the engine stop switch.

Once the engine has stopped, you will lose all steering control of the watercraft.

Be sure there is at least 2 feet (60 cm) of water under the watercraft when stopping to make sure damaging debris isn't sucked into the impeller or cooling system.

Remove the lanyard lock plate. Never leave the lanyard attached to an unattended watercraft.

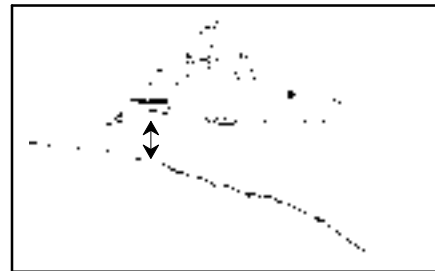
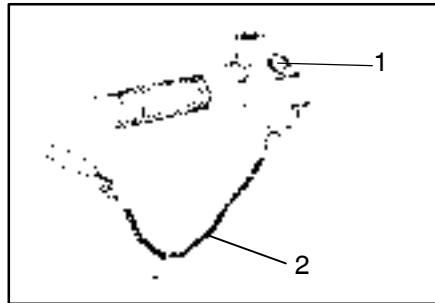
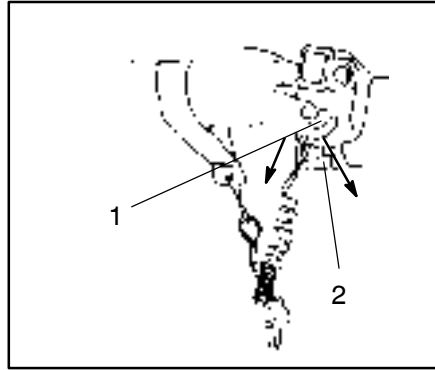

## Starting the Engine

Before operating this watercraft you should:

1. Have viewed the Watercraft Safety Video tape provided with the watercraft (PN 9916475);
2. Have read and understand this Owner's Manual;
3. Be familiar with all controls and functions of the watercraft;
4. Have performed the pre-operation check found on page 52.

If you have any questions about the features or controls of this watercraft consult your local Polaris dealer.

### **CAUTION**

When starting the engine, be sure the watercraft is in water at least 2 feet (60 cm) deep. If the engine is run in water less than two feet deep, sand, weeds and debris may be sucked into the jet intake and damage the impeller or injure bystanders. Ingestion of sand into the cooling system will cause the engine to overheat, resulting in possible severe engine damage.

# OPERATION

## Starting The Engine

1. Always launch the watercraft in water at least 2 feet (60 cm) (A) deep, which is free of weeds and debris that could be sucked into the impeller. Be aware of swimmers, other boats and obstacles in order to avoid contact with them.
2. Push the rear of the watercraft up and down several times to flush out any sand that could be trapped in the pump.
3. Turn the fuel valve to “on”, if applicable.
4. Carefully board the watercraft and sit down.
5. Attach the lanyard (B) wrist band to your left wrist or PFD.
6. Fasten the lanyard lock plate to the engine stop switch on the handlebars by pushing the lock plate around the barrel of the switch.

Be sure the lanyard is not tangled around the handlebars or controls.

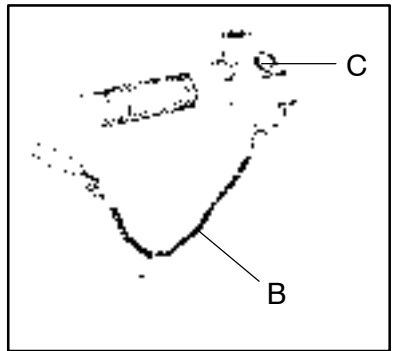
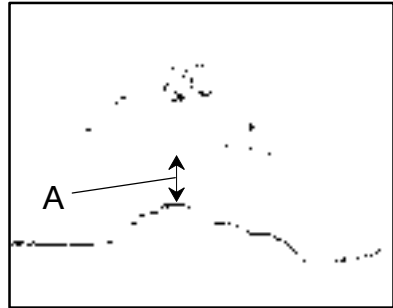

## Starting The Engine

**NOTE:** The engine will not start if the lanyard lock plate is removed from the engine stop switch.

7. Move/pull the choke lever (if equipped, not shown) all the way out. If the engine is already warm do not use the choke.  
**IMPORTANT:** The choke is located near the mirror of some models.
8. Push the starter switch (B) with your left hand while easing the throttle open with your right hand.
9. As soon as the engine starts, release the starter switch and throttle. Only enough throttle should be applied to keep the engine running.
10. After the engine starts, slowly reduce the amount of choke until the engine is warm and choking is no longer required.

**NOTE:** The choke system functions best with the throttle partially opened. This will aid in cold starting. Release the throttle as soon as the engine starts.

**NOTE:** If the engine was run out of gas or the fuel/water separator bowl drained, it may take two or three attempts to start. Do not run the starter for more than ten seconds at a time as damage to the starter may result.

**NOTE:** Direct injected models do not have a manual choke.

# OPERATION

## Starting The Engine

### **WARNING**

Be seated and alert when starting the watercraft. Starting the engine immediately generates forward thrust which could cause the operator to fall from the machine causing serious injury or death.

### **If The Engine Does Not Start**

If the engine does not start within 10 seconds, release the starter switch. Wait 10 seconds before trying again to avoid damaging the starter.

### **CAUTION**

Do not depress the starter switch while the engine is running or while the starter is still spinning. This causes starter wear and may cause the starter to fail.

Depending on your model, either pull the choke lever out or push choke lever in a clockwise direction. If the engine is already warm do not use the choke. If the engine does not start after several attempts see the troubleshooting section of this manual beginning on page 134.

**NOTE:** Direct Injected models are not equipped with a manual choke.

## Reverse Operation

Some Polaris watercraft have reverse capabilities. See page 10 to determine if your watercraft has this feature.

### Reverse Lever

1. To activate reverse, pull reverse lever (A) all the way up. Lever will remain in full up position.
2. Turn the handlebar and apply throttle carefully as required to maintain steering control of the watercraft.
3. To return to forward, push reverse lever to “forward” position.

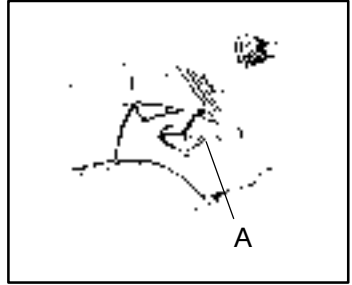

### Polaris Electric Reverse Control (PERC™)

1. To activate reverse, depress the reverse switch (B) (labeled RVS). Varying degrees of reverse engagement are possible, depending on the duration the reverse button is depressed.
2. Turn the handlebar and apply throttle carefully as required to maintain steering control of the watercraft.
3. To return to forward, depress the forward button (labeled FWD) until the reverse gate is in the full up position.

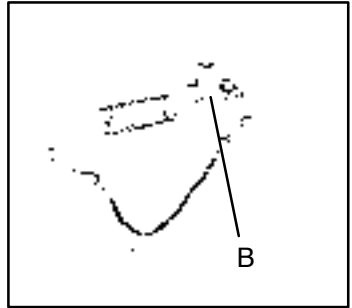

**NOTE:** The reverse gate can be activated without the engine running by depressing the bilge button and operating the u/down button for reverse actuation.

# OPERATION

## Reverse Operation

**NOTE:** Engine RPM is limited during reverse operation. While in reverse, the multi-function gauge will flash a warning light and the corresponding LCD message “REVERSE” will be visible. **Be certain reverse gate is in the full forward position before resuming normal operation or your speed will be limited by the RPM limiter.**

### CAUTION

Do not operate at high throttle settings for long periods. Cavitation damage could occur to impeller or pump.

### WARNING

Do not attempt to activate reverse while moving forward above planing speed. Loss of control could occur resulting in damage to the watercraft or severe personal injury to the operator or passenger(s).



## Boarding the Watercraft

**Practice boarding the watercraft before riding in deep water.**

Anyone who is a passenger should also practice boarding in shallow water.

## Boarding And Starting In Deep Water (Operator Only)

Watercraft engine must be turned off.

1. Swim to the rear of the watercraft. Grip the boarding handle near the rear of the seat and pull yourself up onto the boarding platform. The seat strap will aid in boarding.

**NOTE:** Not all models are equipped with a seat strap. Refer to pages 8-14 for your model's specifications.

**NOTE:** Some models are equipped with a boarding step for boarding convenience. Refer to pages 8-14 for your model's specifications.

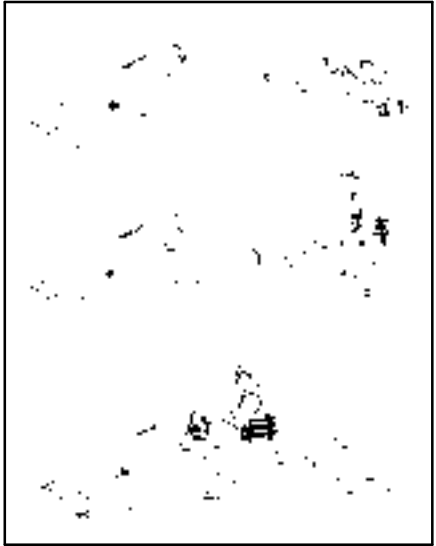

2. Move up to the seat and straddle it.
3. Attach the lanyard lock plate to the engine stop switch and see that the lanyard wrist band is secure on your left wrist.
4. Engage the choke knob completely. If the engine is already warm do not use the choke.
5. Push the starter switch with your left hand.
6. As soon as the engine starts, release the starter switch and throttle, decreasing the choke gradually until the engine is fully warmed. Only enough throttle should be applied to keep the engine running.
7. Ease the throttle open and be prepared for acceleration.

# OPERATION

## Boarding the Watercraft

### Boarding With A Passenger (In Shallow Or Deep Water)

Watercraft engine must be turned off.

1. The operator should climb on board as previously explained and straddle the seat. Attach the lanyard lock plate to the engine stop switch and fasten the lanyard wrist band to his/her left wrist or PFD. **Do not start the engine yet.**
2. The passenger should move (or swim) to the rear of the vehicle.
3. The passenger should pull him/herself on board using the grab handle. Both operator and passenger should try to balance the watercraft while the passenger is boarding.
4. The operator should see that the passenger is holding on tightly and that their feet are both on the footrests. Once this is done, start the engine.

## Safe Operation

### Principles Of Operation

The engine is directly coupled to a driveshaft which, when running, rotates the impeller. The impeller is situated where the water is drawn up underneath the watercraft. The water travels through the impeller and is accelerated producing thrust to move the watercraft forward. Pulling or squeezing the throttle lever increases engine speed (watercraft speed).

Turning the handlebar pivots the jet pump nozzle (water outlet) which controls the watercraft's direction. The throttle must be applied in order to turn the watercraft.



### Safety Notes

- ✔ You must have thrust to turn. Keep the throttle depressed to maintain thrust and control, to aid in steering and avoiding potential contact with objects or people in the water.
- ✔ The more the throttle is depressed while turning the sharper the turn will be. Practice these maneuvers in open water to understand and acquire a feel for turning.
- ✔ The watercraft behaves differently with a passenger on board, requiring more operator skill. Practice these skills alone before taking a passenger on board.

# OPERATION

## Safe Operation

### Load Limit

The heavier the combined weight of operator and passenger, the more difficult it is to balance the watercraft while boarding. The combined weight of operator and passenger should never exceed the recommended weight. Check page 8 for your boat's load limit.

During boarding the passenger should steady the watercraft while the operator boards. The operator can then help balance it while the passenger boards.

### Rough Water Operation And Jumping

#### **WARNING**

Whenever possible avoid riding in rough water and/or adverse weather conditions. Riding the watercraft in these conditions could cause loss of control which could result in injury or death to the operator and/or passenger.

**The watercraft should not be used to jump waves.** It is not recommended (and is illegal in some states) to operate the watercraft in or near the surf line.

When riding in rough conditions it is possible for the operator to hit his/her chest or face on the watercraft or handlebars and be injured. It is also possible to be thrown from the watercraft in rough conditions which could make it difficult to get back to and re-board the watercraft.



## Safe Operation

### Turning

Turning the watercraft requires using the throttle (thrust from the jet pump) and turning the handlebars.

High thrust makes the watercraft turn more sharply. Lower thrust makes the watercraft turn less sharply.

Remember, do not release the throttle when trying to steer. You need the throttle to steer.

✓ Making sharp turns at high speeds may cause the watercraft to “spin out” and possibly throw the rider(s) from the watercraft. Make gradual turns at high speeds.

✓ Always look behind you before turning to avoid collision with other watercraft.

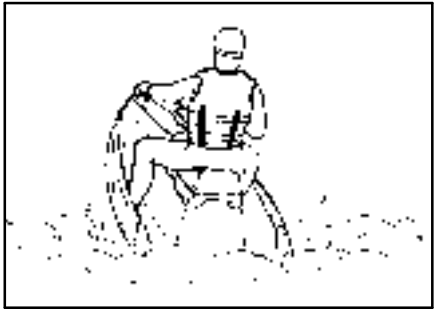

# OPERATION

## Safe Operation

### Stopping

The operator of the watercraft should experiment with stopping in order to become familiar with this procedure. Stopping is affected by gross weight (watercraft and rider), wind direction, and water surface conditions.

The watercraft is not equipped with a brake system. It is stopped by using the natural drag of the water when the throttle is released. Coast toward the desired stopping area with the engine idling.

From full speed it can take the watercraft as much as 300 feet (90 m) after the throttle is released to come to a stop. This distance is approximate and is supplied only for reference.

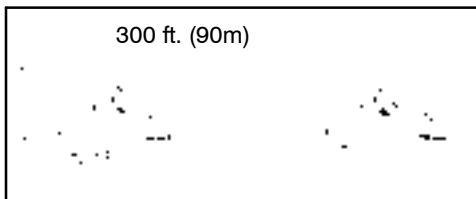

Slow watercraft to an idle before stopping the engine. Push the engine stop button when approaching shore and you are close to your intended stopping area. This will help prevent sand and debris from entering the pump and cooling system, causing damage.

### **⚠️ WARNING**

Do not release the throttle when trying to steer away from objects. You need the throttle to steer.

Riders should keep feet, arms and hands inside the watercraft while approaching a dock or other fixed or floating object or injury could result.

## Safe Operation

### Beaching

#### CAUTION

**Never run the watercraft up onto a beach with the engine running.** Sand, pebbles, weeds and debris can enter the jet pump and cause severe damage to it and the impeller. Ingestion of sand into the cooling system will cause the engine to overheat, resulting in possible severe engine damage.

1. Slowly approach the beach and stop the engine in no less than 2 feet (60 cm) of water. Make sure there are no swimmers, boats or other obstacles close to the watercraft. Remember, turning the watercraft is impossible if the engine is stopped.
2. Get off the watercraft and guide it to the beach.
3. Before restarting, inspect the impeller/jet pump area for sand and debris. Move the watercraft to at least 2 feet (60 cm) of water and push the rear of the watercraft up and down in the water to help flush sand and debris out of the pump.

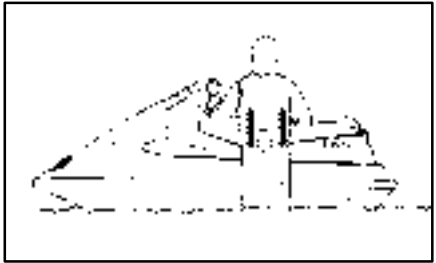

# OPERATION

## Safe Operation

### Riding With Passenger(s)

Passenger capacity varies between models. Check your capacity label and refer to page 8 to determine passenger capacity. Never exceed the recommended load limit.

The watercraft handles differently with more than one person on board and is not as easy to maneuver. The operator must have had enough practice riding alone to acquire the necessary skills to take a passenger for a ride.

✓ Any passenger should read the Owner's Manual and follow all safety warnings. Passengers must wear an approved personal flotation device and other recommended safety gear. They should be good swimmers and in good physical condition as reboarding in deep water can be strenuous.

✓ The passenger should firmly hang onto the operator's PFD or seat strap and should keep both feet on the footwell pads in the gunnel.

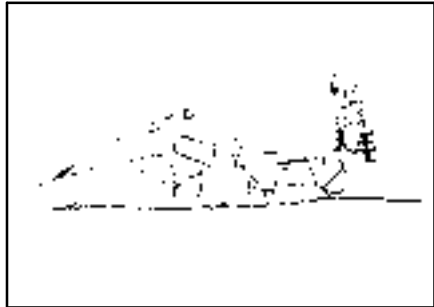



## Safe Operation

- ✓ Do not give a ride to a person whose feet do not reach the footrests when seated straddling the seat.
- ✓ Passengers should sit behind the operator and be facing toward the bow of the watercraft, unless riding as a spotter in towing situations or when using the handle bar grab handle.
- ✓ The operator should make sure his/her passenger is properly situated and holding on before taking off. The operator should also communicate sudden maneuvers to the passenger to create a safer and more enjoyable ride.

# OPERATION

## Post Operation Check And Care

**NOTE:** Remove the watercraft from the water every day to inhibit marine organism growth on the hull.

1. Remove the watercraft from the water.
2. Purge the residual water from the exhaust system by starting the engine and revving the engine repeatedly at partial throttle for about ten seconds until water stops coming out of the exhaust system.

### CAUTION

Never operate the engine for more than 15 seconds or hold the engine at full throttle while the watercraft is out of the water. The engine may overheat and seize.

3. Wash down the hull, jet pump intake and outlet with fresh water.
4. Remove the drain plug(s). Allow any water in the bilge to drain out. Rinse the engine compartment with a generous amount of fresh water. After the water has drained, wipe the engine compartment (bilge) dry. Install the seat. Install the drain plugs once you are sure the opening is clean.

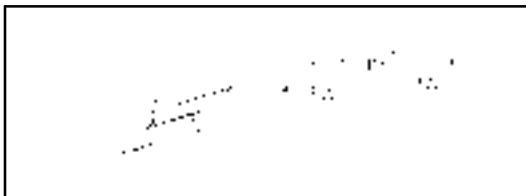

## Post Operation Check And Care

**NOTE:** If the watercraft is going to be stored, block the seat (engine compartment) open about 1/2" (1.3 cm) to provide air circulation and prevent condensation from forming. If the seat is saturated with water, stand it on end to drain. When storing the watercraft, make certain the nose is at a 10° angle, allowing water to drain.

**NOTE:** Drain and flush the engine. See instructions on page 128.

5. Clean the impeller of weeds or other debris it may have collected during the ride. Be sure lanyard lock plate is removed from engine stop switch on handlebars and that the battery cables are disconnected.

### **WARNING**

Serious injury will result if the jet pump is cleaned with the engine running.

Stop the engine, remove the lanyard lock plate from the engine stop switch and disconnect battery cables. Make sure the starter switch cannot be activated while performing this operation. Turning the engine while removing debris from the pump can cause severe personal injury and/or damage to the watercraft.

If used in salt water, Polaris recommends that the inside of the hull (engine and components) be sprayed with waterproof lubricant spray PN 2871064 after each use.

# SPECIAL PROCEDURES

## Cleaning

### Cleaning The Jet Pump And Impeller

Never attempt to clean the jet pump intake and impeller while the engine is running. Always shut off the engine and remove the lanyard lock plate from the engine stop switch.

Clean the jet pump intake and impeller and flush the cooling system. Check the screen in the pump stationary nozzle for plugging.

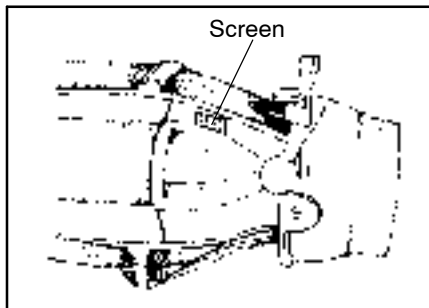

## CAUTION

Operation of the engine with the intake system removed could damage the engine.

## CAUTION

Whenever possible avoid running the watercraft in weedy areas. If this is unavoidable, vary the watercraft speed. Weeds tend to accumulate more rapidly at steady and trolling speeds.

# SPECIAL PROCEDURES

## Cleaning

### On Land Cleaning

1. Ride Plate
2. Drive Shaft
3. Impeller
4. Intake Grate

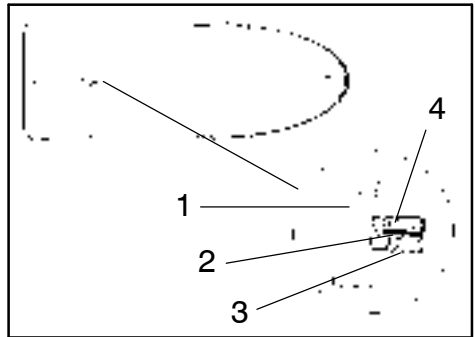

1. Shut off the engine and remove the watercraft from the water.
2. Remove the lanyard lock plate from the engine stop switch and disconnect the battery cables.
3. Carefully clean the jet pump intake area. Inspect the area for damage. If damaged, take the watercraft to an authorized Polaris dealer for service.

# SPECIAL PROCEDURES

## Launching The Watercraft

### **WARNING**

Before launching be aware of weather conditions; make sure there are no boats, swimmers or other obstructions nearby. Failure to be aware of these details could cause an accident, resulting in severe injury or death.

## Launching In Shallow Water

1. Never operate the watercraft in less than 2 feet (60 cm) of water. Guide the watercraft to an area that is deep enough, bounce the rear of the watercraft up and down to flush out the pump, then board it from the side or rear.
2. Attach the lanyard lock plate to the engine stop switch and fasten the lanyard wrist band to your left wrist or PFD.
3. Grasp the right handlebar grip. With both feet on the footrests, start the engine, and ease the throttle open.

# SPECIAL PROCEDURES

## Capsized Watercraft

### **⚠️ WARNING**

This watercraft does not right itself if it has been capsized. The operator and passenger must know how to right the watercraft or they could become stranded which could result in severe injury or death.

Severe engine damage could also result from not righting a capsized watercraft as soon as possible.

1. To prevent major engine damage when the watercraft is capsized, be sure the engine is stopped immediately. The engine will overheat if running while capsized.
2. Upright the vehicle immediately by turning it in a clockwise direction (as viewed from rear) only!
3. Swim to the rear of the vehicle; board and start it according to directions. **NOTE:** Before starting, push bilge pump button to pump out any water in the hull.
4. If the engine does not start shortly after being uprighted make no further attempts to start it. Severe engine damage could result.
5. Follow the procedures for submerged (waterlogged) engine.



# SPECIAL PROCEDURES

## Submerged (Waterlogged) Engine

### CAUTION

If the watercraft has remained in a 180° (capsized) position for more than two minutes all fuel and oil lines must be inspected for presence of water and/or air. Severe engine damage could result if the engine is operated with air or water in the lines.

If the engine becomes water-flooded, follow these procedures immediately. If water is left in the engine it will cause severe engine damage.

1. Remove the watercraft from the water. Remove the drain plug and empty the water out of the bilge.
2. Take the watercraft to an authorized Polaris dealer immediately. If this is not possible call him/her immediately.

### WARNING

Before removing water from a submerged engine, make sure the lanyard cord and lock plate are removed from the engine stop switch. Accidental starting during this procedure could cause severe personal injury.

Following are procedures for removing water from a submerged engine. Only attempt this if you are mechanically experienced and have assistance lifting the watercraft.

1. Remove the watercraft from the water. Remove the lanyard cord from the engine stop switch. Put the watercraft onto a flat surface, leaving room to roll it.
2. Remove the drain plug and empty the water out of the bilge. Remove the seat. Remove the air intake to drain the flame arrestor. Remove the spark plugs.
3. Tip the watercraft clockwise (starboard) until the spark plug holes are just below horizontal.
4. While holding the watercraft in this position, turn the driveshaft by hand to rotate engine until the water has run out.



# SPECIAL PROCEDURES

## Submerged (Waterlogged) Engine

5. Upright the watercraft.
6. Inspect, dry and install new spark plugs. Install the air intake.
7. Check the battery vent hose for obstruction; drain water from the hose if present.
8. Check gas and oil for the presence of water. If water is present take the watercraft to an authorized dealer for immediate service. Do not run the watercraft if water is present in the gas or oil. Verify that no air is present in the oil line.
9. Grease driveshaft and bearing housing following instructions on page 108.
10. Reinstall drain plug. Reinstall the seat.
11. Follow starting procedures as described on page 74.

## Towing The Watercraft In Water

If the watercraft becomes inoperable in the water it can be towed. Tie about 20 feet (6 m) of tow rope to the eye located on the bow. Slowly tow the watercraft to shore at idle speed.

## Battery Information

If the watercraft battery is run down, it should be removed and charged. See the maintenance section of this manual for battery charging recommendations, pages 116 to 120.

### **WARNING**

A weak battery can leave you stranded which could result in severe injury or death. Never operate the watercraft with a battery that is very weak and may not start the engine on its own.

### **WARNING**

If your watercraft has a fuel valve, always turn it off when transporting or storing the watercraft. Fuel valve location varies with certain models. Know your machine before operating.

# SPECIAL PROCEDURES

## Transporting The Watercraft

Tie the watercraft at the bow and stern so it is firmly restrained on the trailer and does not move. Use additional cables if necessary. There should be no movement between the watercraft and trailer. Do not route ropes or tie downs over the seat because they could cause permanent damage to the seat. Protect the watercraft body from ropes by putting padding or something similar between the rope and body.

Make sure the seat is securely latched.

Be sure the trailer matches the watercraft's weight and design and that it meets trailer laws and regulations in your area.

When transporting the watercraft it is recommended that it be protected by a Polaris watercraft cover.

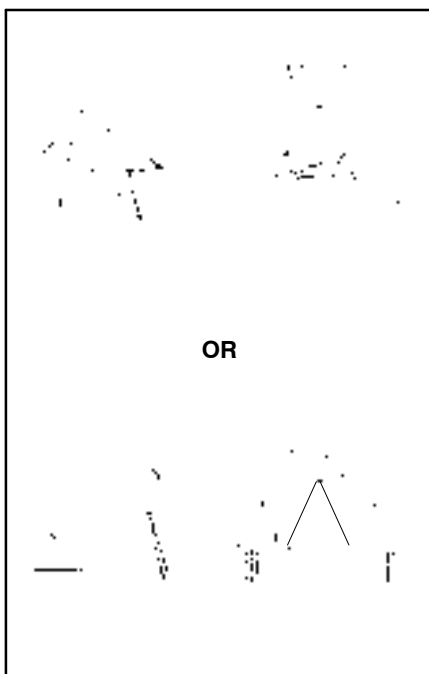

# SPECIAL PROCEDURES

## MFI Operation

### Multi-Function Instrument (MFI) Operation Summary

Your model may not have all of the features listed. Underlined features are only found on 24 and 25 function versions of the MFI found on Genesis models.

The MFI simultaneously displays a great deal of important vehicle information such as speed, RPM, fuel and oil levels, clock, compass heading, engine hours, and warning conditions. Additionally, the MFI acts as a command center for security and interfaces to an optional depth sensor to provide a built in digital depth gauge.

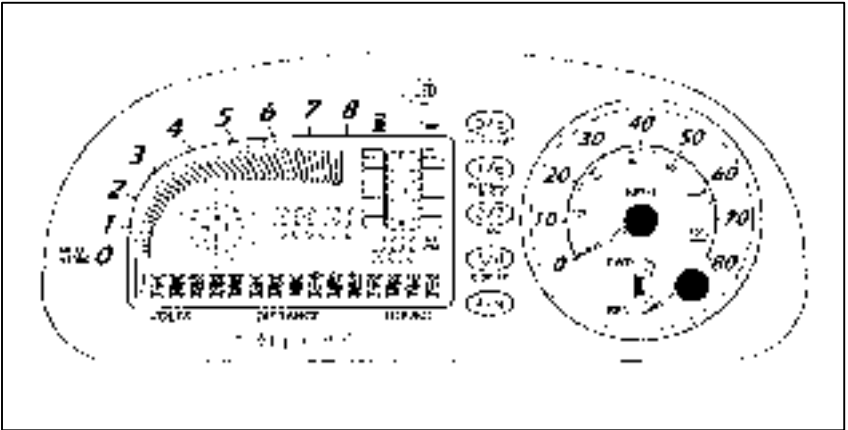

### DISPLAY SUMMARY

The MFI is configured with a Liquid Crystal Display (LCD) display on the left, a function/numeric keypad in the center, and an electronically driven analog speedometer and reverse (PERC™) indicator on the right. The LCD contains a highly responsive analog tachometer, fuel and oil gauges, a 16-point compass, clock, battery voltmeter, resettable distance meter, and non-volatile engine hour meter. To the right and under the fuel and oil gauges is a digital depth gauge, which automatically activates if the optional depth sensor is installed.

# SPECIAL PROCEDURES

## MFI Operation

The bottom row of alphanumeric characters is a versatile display that normally displays battery voltage, distance traveled, and engine hours. These displays will be overwritten in the event of a warning condition, or if an optional function is selected, such as security lock, speed limit, or real time digital display.

## PRIMARY FUNCTIONS

**ON/AUTO:** The MFI will automatically “wake-up” when the engine start button is pressed or alternately by pressing and holding any button for 1 second.

**AUTO OFF:** The MFI will return to sleep mode after 5 minutes of inactivity. While in sleep mode, the clock continues to show time, and the fuel level, oil level, and the compass rose are displayed. If the SECURITY LOCK is active, the display will also show “LOCKED.”

**TACHOMETER:** The analog tachometer visually displays the revolutions per minute (RPM) of the engine in 200 rpm increments from 0 to 8000 rpm. For more accurate RPM readings, see “DISPLAY” below.

**FUEL GAUGE:** Displays fuel level in exact 1/8 tank increments. Toggles “LOW FUEL” warning and flashes the warning LED when fuel reaches 1/8 level. Pressing any key will disable the flashing LED for 15 minutes.

**OIL GAUGE:** Displays oil level in exact 1/4 tank increments. Toggles “LOW OIL” warning and flashes the warning LED when oil reaches 1/4 level. Pressing any key will disable the flashing LED for 15 minutes.

**COMPASS:** The compass displays true vehicle heading relative to magnetic north with a resolution of 16 points per revolution. The triangular pointer rotates to indicate the direction of travel.

**CLOCK:** The center of the LCD display contains a digital clock. To set the clock, simply press and hold the “CLOCK SET” button until the clock digits begin to flash. Each subsequent press of the CLOCK button advances the time by 1 minute. Pressing and holding the button will automatically advance the digits more rapidly. Once the intended time is reached, simply release the button. After 5 seconds, the MFI will automatically exit the “clock set” mode.

# SPECIAL PROCEDURES

## MFI Operation

**DEPTH GAUGE:** Before activating the DEPTH GAUGE function, the depth sensor must first be installed. After installation is complete, press and hold both the 3/8 and 4/9 buttons simultaneously for several seconds to activate the DEPTH GAUGE function. The display will read “SONAR ON”, and the depth digits under the fuel and oil gauges will display depth in either feet or meters. If the sensor is not found, the MFI will automatically cancel the DEPTH GAUGE function. The DEPTH GAUGE will display water depth below the hull from 0 to 199 feet (0 to 75 meters). The readout is accurate to approximately 45 mph (70 kph). The display will flash “- -” if tracking is lost. To disable the DEPTH GAUGE, simply press and hold the 3/8 and 4/9 buttons simultaneously for several seconds until “SONAR OFF” IS displayed.

**VOLTMETER:** The left side of the multi-purpose display contains the battery VOLTMETER. Battery voltage is displayed from 5 to 18 volts in .1 volt increments. A battery voltage of less than 10.9 volts will trigger the “LOW POWER” warning message, indicating battery voltage is approaching a “no start” condition.

**DISTANCE METER:** The center of the MFI contains a resettable DISTANCE METER. Distance is displayed from 0 to 999.9 miles (0-999.9 km) in .1 increments. To reset the DISTANCE METER, simply press and hold the DISTANCE RESET button until the distance displayed returns to “000.0”.

**HOUR METER:** The right side of the multi-purpose display contains the engine HOUR METER. Actual engine operating hours are displayed in .1 hour increments from 0 to 999.9 hours. The HOUR METER cannot be reset, and is retained even when power is removed due to nonvolatile EEPROM memory.

**SPEEDOMETER:** The right side of the MFI contains an analog speedometer. While the speedometer is traditional in appearance, it is actually controlled by the system microprocessor, and is extremely accurate.

**DIRECTION:** The lower portion of the analog display contains a forward/reverse direction indicator. The pointer on the gauge moves in synchronization with the reverse gate as it is lowered over the jet nozzle when actuated by the electric thumb switch. The indicator is useful in establishing a “neutral” position between forward and reverse. The LED will flash when the reverse gate is not fully forward. Pressing any key will disable the LED for 5 minutes.

# SPECIAL PROCEDURES

## MFI Operation

**SECURITY LOCK:** Briefly pressing and releasing the LOCK button will cause the lock status to be displayed, either “LOCKED” or “UNLOCKED”. Pressing and holding the LOCK button for several seconds initiates the SECURITY LOCK function. The MFI will display “ENTER CODE \_ \_ \_ \_”. Enter the code using the 5-button keypad. The factory set default code is “1234”. An asterisk (\*) will appear with each press of a numeric button. If the proper code has been entered, the display will show the new lock status. If previously “LOCKED”, the security lock will switch to “UNLOCKED” and the vehicle may be started normally. If previously “UNLOCKED”, the security lock will switch to “LOCKED” and the vehicle will not start.

If starting the engine is attempted while the security lock is set to “LOCKED”, the warning LED will flash, the engine will not start, and the MFI will indicate “LOCKED”, followed by “ENTER CODE \_ \_ \_ \_”. If an improper code entered, the MFI will display “INVALID CODE”, and exit code entry mode.

**CODE SET MODE:** The factory set default security code is “1234”, however, the code may be changed to any 4 digit number. To select your own code, enter CODE SET mode by pressing and continuing to hold the LOCK button for several seconds until “CHANGE CODE” is displayed (the display will first show the lock status, followed by “ENTER CODE \_ \_ \_ \_”, and finally “CHANGE CODE”). The MFI will then display “OLD CODE \_ \_ \_ \_”. Enter the code as if locking or unlocking the vehicle. If the correct code is entered, the display will then show “NEW CODE \_ \_ \_ \_”. Select any 4-digit code. The display will then read “CONFIRM CODE \_ \_ \_ \_”. Enter the same code to confirm your selection. “CODE CONFIRMED” will display for several seconds if the second entry of the new code matches the first. If the second code entered does not match the first, “INVALID CODE” will be displayed and the CODE SET MODE is cancelled.

**DISPLAY:** Pressing the DISPLAY button toggles the MFI between NORMAL DISPLAY mode and DIGITAL DISPLAY mode. The lower display will show VOLTS/DISTANCE/HOURS when in NORMAL mode, and real-time digital RPM and SPEED when in DIGITAL mode. When first entering DIGITAL DISPLAY mode, the MFI briefly displays the last recorded peak RPM and SPEED. While the peak values are being displayed, holding the DISPLAY button for several seconds will reset the peak values. Pressing the DISPLAY button while in DIGITAL DISPLAY mode toggles the display back to the standard VOLT/DISTANCE/HOURS display.

# SPECIAL PROCEDURES

## MFI Operation

**ENGLISH/METRIC:** To change units between English and metric, press and hold the 1/6 button and the 2/7 button simultaneously for several seconds. When in metric mode, “km” appears in the distance meter, and the “MTRS” icon will illuminate in the depth gauge if activated.

**WARNING INDICATIONS:** LOW FUEL - 1/8 tank or less of fuel remaining; LOW OIL: 1/4 tank or less of oil remaining; ENGINE OVERHEAT - overheated engine; LOW BATTERY - battery voltage below 10.9 volts; REVERSE indicates reverse has been initiated; CHECK ENGINE (DFI only) - indicates a warning condition from the DFI engine control.

# MAINTENANCE AND LUBRICATION

## Periodic Maintenance Schedule

DESCRIPTION	Pre-ride	Pre-season	Mont hly or 25 Hrs	3 Mont hs or 50 Hrs	6 Mont hs or 100 Hrs	Tune Up Item
<b>ENGINE</b>						
Engine corrosion protection/fogging (daily-salt water)	L**	L	L			
Cooling system flushing (daily after use in salt water)	I**	I				•
Exhaust cooling hose screen		I/C		I/C		•
Exhaust hose condition		I		I		
Engine mounts (Replace if removed for engine service)		I			I	•
Thermostat/popoff valve assembly/spring		I/C	I/C*		R①	•
Water inlet and outlet hoses and clamps		I	I	I	R③	
Spark plugs/Compression test		I			I	•
Spark Plugs		R		I	R	
Engine fastener re-torque (cyl head/cyl base, exhaust)		I			I	•
Oil pump adjustment (where applicable)		I		I		•
<b>FUEL SYSTEM</b>						
Fuel/water separator (drain water)	I/C	I/C				•
Inspect and clean fuel water separator/filter	I	I			R②	
Fuel filter and oil filter		R	I			•
Throttle and choke cables	I	I/L/A		L		•
Carburetor (see engine fogging procedure) synchronize		A/C			A	•
Fuel cap/oil cap gaskets	I	I	I	I	R	
Fuel lines, oil lines, related hose clamps, check valves and hose inspection, fuel system pressurization		I			I	•



# MAINTENANCE AND LUBRICATION

## Periodic Maintenance Schedule

DESCRIPTION	Pre-ride	Pre-season	Monthly or 25 Hrs	3 Months or 50 Hrs	6 Months or 100 Hrs	Tune Up Item
<b>FUEL SYSTEM (Cont.)</b>						
Vent system (oil and fuel) check-valves; hose routing		I				•
Fuel system pressure/vacuum test		I				
Air intake silencer/water separator drain line(s)		I/C				•
<b>JET PUMP</b>						
Drive shaft coupler and bearing housing		I/L	I/L		I/L	•
Drive shaft shroud condition		I	I			•
Bilge system pick-up screens and hoses	I/C	I/C				•
Cooling water inlet screen/hoses, clamps	I/C	I/C				•
Jet pump intake grate fasteners and condition		I		I		•
Impeller condition and impeller clearance		I			I	•
Pump Sacrificial Anode		I		I		•
Reverse mechanism		I/A		I/A		•
<b>ELECTRICAL</b>						
Battery condition, fluid level	I	I				•
Battery vent hose condition/routing (must be clear)		I		I		•
Battery and starter cables (clean connections / tight)		I		I	I	•
Ground cables-condition, corrosion, fastener torque		I		I	I	
Engine overheat warning/tone/electrical connections		I			I	
Lanyard cord/engine stop switch	I	I				•

# MAINTENANCE AND LUBRICATION

## Periodic Maintenance Schedule

DESCRIPTION	Pre-ride	Pre-season	Monthly or 25 Hrs	3 Months or 50 Hrs	6 Months or 100 Hrs	Tune Up Item
<b>HULL / DECK / STEERING / CONTROLS</b>						
Steering support hub bushings/fasteners/handgrips		I/L			I/L	•
Steering cable		I/L/A		I/L		•
Steering Nozzle Bushings	I				R	
Reverse cable inspection, lubrication	I	I/L/A		I/L/A		
Handlebar/steering operation (turns fully/freely/fasteners)	I	I				•
Hull, clean and inspect for cracks, damage, or leaks	I	C/I				
Drain Plug Condition	I	I				•
Bilge system inspection, should not leak	I	I			I	
Seat and compartment seals (condition of seal)		I/A	I/A			•
Fire extinguisher		I			I	•
Inspect and tighten <i>all</i> fasteners, including carburetor mounts engine mounts, exhaust system, all hose clamps; inspect muffler, battery, oil and fuel tank fastening devices, pump, steering fasteners. Aggressive riding requires more frequent service.		I	I			•

I=Inspect, adjust, service, or replace if necessary

A=Adjust

C=Clean

R=Replace item

L=Lubricate with recommended lubricant

# MAINTENANCE AND LUBRICATION

## Lubrication

As with all watercraft, proper lubrication and corrosion protection are necessary to maintain performance and ensure years of service.

For greasing the Polaris watercraft use a marine grease (water-resistant/salt-resistant E/P type, PN 2871066).

## Throttle Cable And Choke Cables

1. Lubricate the throttle cable and choke cable inner cables using Polaris cable lube PN 2870510.
2. Depress the throttle lever and squirt Polaris cable lube onto the cable.
3. Push and release the throttle several times to work the lubricant down the cable.

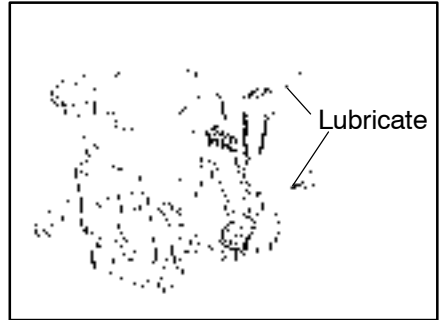

# MAINTENANCE AND LUBRICATION

## Lubrication

### Steering Cable Joints And Inner Wire

1. Lubricate the steering cable joints on the steering nozzle end using Polaris cable lube PN 2870510.
2. Lubricate the steering cable joints on the steering nozzle end using Polaris cable lube PN 2870510.
3. Expose the steering cable inner cable and apply Polaris cable lube to it. Lubricate the steering nozzle end and the handlebar end.

**NOTE:** Cable seals can be moved to allow oil into the cable. Make sure seals are put back in proper location after oiling.

# MAINTENANCE AND LUBRICATION

## Lubrication

### Steering Nozzle Pivot Shaft

Lubricate the steering nozzle shaft pivot connections using Polaris cable lube PN 2870510.

### Steering Handle Pivot Shaft

Lubricate the handle pivot shaft and bushing using lubricant PN 2871066. If the steering shaft has loosened, tighten it.

### Choke (if equipped)

Turn the choke lever and apply Polaris cable lube PN 2870510 to the knob shaft. **NOTE:** On some models, the choke is located on the console.

### Seat Latch And Hooks

Grease the locking mechanism of the seat latch at the rear of the seat opening.

### Carburetor And Oil Injection Pump

Grease springs, exposed portions of cable and shafts at the carburetor(s) or throttle bodies. Grease often if used in salt water.

### Electrical Connections

Apply a dielectric grease on battery posts and exposed cable connections (Polaris PN 2871027), supplied with watercraft.

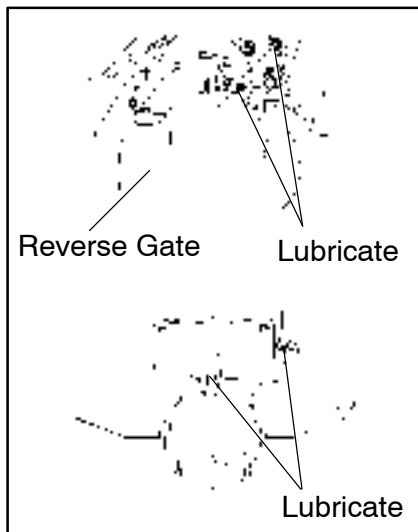

# MAINTENANCE AND LUBRICATION

## Lubrication

### Drive Shaft Lubrication

To grease the drive shaft and coupler splines, the pump assembly must be removed. This maintenance procedure should be performed by your dealer on an annual basis. If the boat is frequently used in salt water, this procedure should be done semi-annually.

### Bearing Housing

Using a grease gun, lubricate the bearing housing at the grease fitting until grease purges past the seals. Use premium marine grease PN 2871066.

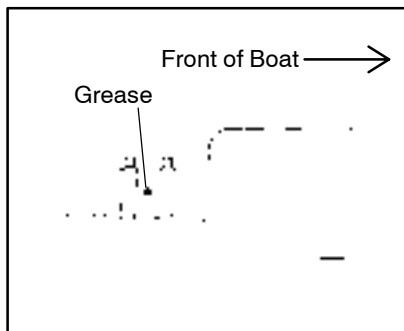

## CAUTION

Any time water has been at or above the coupler level, grease the drive shaft coupler to prevent damage to these parts. Lubrication after every 25 hours of operation is also recommended.

# MAINTENANCE AND LUBRICATION

## Minor Maintenance

### Spark Plugs

Always use the spark plugs and gap recommended on page 12. Gap thickness (1) should be measured with a wire thickness gauge.

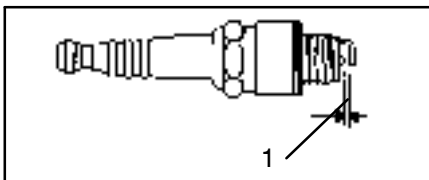

### CAUTION

If the engine in your boat requires a resistor plug, (For Example: in BPR8ES, the R indicates it is a resistor plug), never substitute a non-resistor spark plug.

A slightly brownish tip is considered good. The engine is running properly and the carburetor is adjusted correctly.

A black tip indicates several potential problems: the wrong spark plug (wrong heat range) is being used; excessive idling; carburetor idle speed mixture or high speed mixture is too rich; or there is a malfunction with the RPM limiter.

A light grey or white tip indicates: the wrong spark plug (wrong heat range) is being used; carburetor idle speed mixture is too lean; there is a plugged fuel filter; or there is a leaking engine seal or gasket.

A yellow tip is caused by salt water mist ingestion. This is a conductive coating which will eventually cause fouling. This is a normal situation.

### CAUTION

If the spark plug tip is black or grey have the watercraft serviced by an authorized Polaris dealer as soon as possible.

# MAINTENANCE AND LUBRICATION

## Minor Maintenance

### Spark Plugs

A spark plug with cracked porcelain or damaged threads should be changed immediately. If the electrodes are badly worn or burned the plug should also be replaced.

If the spark plug is in good condition, clean it with a clean shop cloth and/or wire brush. Adjust the gap to the proper dimension using a wire thickness gauge.

### Spark Plugs

#### CAUTION

Never attempt to remove the spark plug with a warm engine. The exhaust system or engine could burn you causing injury.

When installing or removing spark plugs be careful not to damage the porcelain insulator.

#### WARNING

High tension voltage is present in the spark plug wires when the engine is running. Never touch spark plug wires when the engine is being cranked or run.

Wipe off any water on the spark plug or inside the cap. Push the cap down on the plug until it clicks. Use dielectric grease PN 2871066 on the inside of the spark plug cap to prevent corrosion.

Before installing a **used** plug, wipe off threads and apply dielectric grease PN 2871066. Also clean the gasket surface. Install the spark plug and torque to 18 ft. lbs. If a torque wrench is not available 1/4 to 1/2 turn past finger-tight is close to the correct torque.



# MAINTENANCE AND LUBRICATION

## Minor Maintenance

### **⚠ WARNING**

If your machine is equipped with a fuel valve, shut it "off". Gasoline is extremely flammable and explosive under certain conditions. Do not smoke or allow flames or sparks in the work area. Be sure the work area is well ventilated. See gasoline warnings on page 49.

### **Fuel Tank**

When the fuel tank needs cleaning or if water is found in the gas tank have the watercraft serviced immediately by an authorized Polaris dealer.

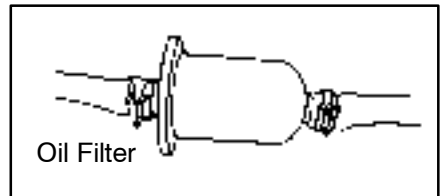

# MAINTENANCE AND LUBRICATION

## Minor Maintenance

### Oil Filter

#### CAUTION

The in-line oil filter is a special type and must not be substituted. The filter should be changed annually by an authorized Polaris dealer during the pre-season inspection. Do not attempt to clean this filter.

#### CAUTION

The fuel lines should be inspected regularly. Special attention should be given to fuel system line condition after periods of storage. Normal deterioration from weathering and fuel compounds can occur. See your dealer if you suspect any deteriorated components.

### Carburetor Adjustment

The carburetor is vital to engine operation and performance. Adjustment of the carburetor should only be done by an authorized Polaris dealer. Idle speed can also be adjusted by your dealer.

#### CAUTION

The carburetor was set at the factory and is very sensitive if adjusted. Do not attempt to change the settings or engine damage and poor performance could result.

**NOTE:** If the watercraft will be used at a high altitude, above 3000 feet (1000 m), have an authorized Polaris dealer adjust the carburetor to allow for the thinner atmosphere. Polaris Direct Injected engines compensate for high altitude automatically.

# MAINTENANCE AND LUBRICATION

## Minor Maintenance

### Steering Cable Inspection

1. The handlebars and steering nozzle should operate smoothly. If movement is stiff have your authorized Polaris dealer service it.
2. Turn the handlebars from lock to lock and check to be sure that the clearances between the steering nozzle and the rear hull are even on both sides. If the alignment is not even, have your authorized Polaris dealer service it.

### Throttle Cable Inspection

1. Depress and release the throttle lever. It should return to its initial position smoothly. If it does not, have your authorized Polaris dealer service it.
2. Throttle lever free-play should not exceed  $.020\text{''}-.060\text{''}$  (.5-1.5 mm). If it does, have it corrected by your authorized Polaris dealer.

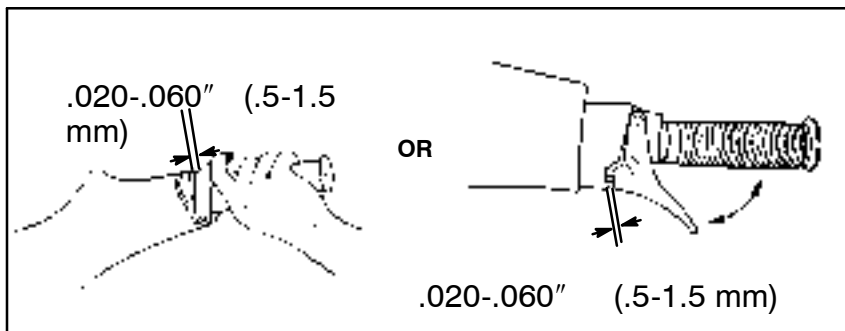

# MAINTENANCE AND LUBRICATION

## Minor Maintenance

### Choke Cable Inspection

Pull the choke knob to make sure the choke cable is operating smoothly.

When the knob is pulled out the choke valve is fully closed; when the knob is in, the valve is fully open. There should be minimal choke cable slack. If the choke is not functioning properly, have it serviced by your authorized Polaris dealer.

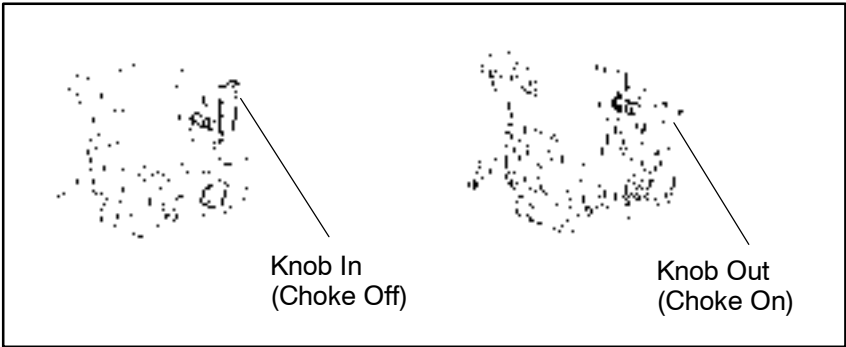

# MAINTENANCE AND LUBRICATION

## Minor Maintenance

### Circuit Breaker

The electrical system is protected with a 15A circuit breaker. **NOTE:** DFI models have both a 15A and 5A circuit breakers. In order to reset the circuit breaker, locate and push the reset button (A) on top of the electrical box.

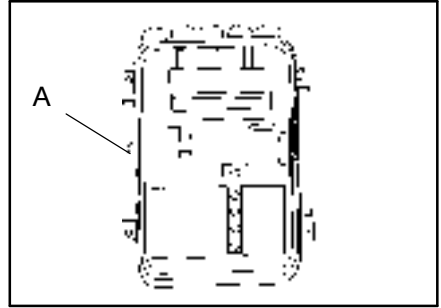

### Fuses

The MFI and Bilge Pump are protected by fuses. The MFI is protected by a 1/4 amp fuse (B) and the bilge pump is protected by a 3 amp fuse (C). Inspect the fuses every season to ensure fuses are not blown. There are spare fuses in the electrical box.

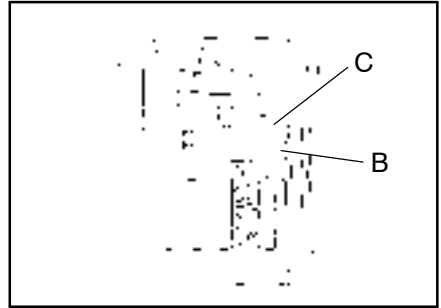

# MAINTENANCE AND LUBRICATION

## Minor Maintenance

### Battery Maintenance And Charging

#### **WARNING**

Battery electrolyte is poisonous. It contains sulfuric acid. Serious burns can result from contact with the skin, eyes or clothing.

#### **WARNING**

Crossing the terminals of a battery with a tool or a body part can cause severe shock.

Antidote:

**EXTERNAL - Flush with water.**

**INTERNAL - Drink large quantities of water or milk. Follow with milk of magnesia, beaten egg or vegetable oil. Call a physician immediately.**

**EYES - Flush with water for 15 minutes and get prompt medical attention.**

**Batteries produce explosive gases. Keep sparks, flame, cigarettes, etc. away. Ventilate when charging or using in closed space. Always shield eyes when working near batteries. KEEP OUT OF THE REACH OF CHILDREN.**

# MAINTENANCE AND LUBRICATION

## Minor Maintenance

### ⚠ CAUTION

The battery must be removed from the watercraft for maintenance and charging. Battery electrolyte may spill and damage the watercraft.

Always disconnect the black (negative) cable first. Electrolyte or fuel vapors may be present in the engine compartment and a spark could ignite them which could cause personal injury. When re-installing battery connect black (negative) cable last.

### Battery Removal

1. Release the battery by removing the strap(s) or loosening the fasteners and removing the bar.
2. If applicable, move the electrical box out of the way. It does not have to be opened for battery removal. **NOTE:** Some wiring may have to be removed from wire clips for access to battery.
3. Remove the battery vent tube from the battery.
4. Disconnect the black (negative) battery cable first.

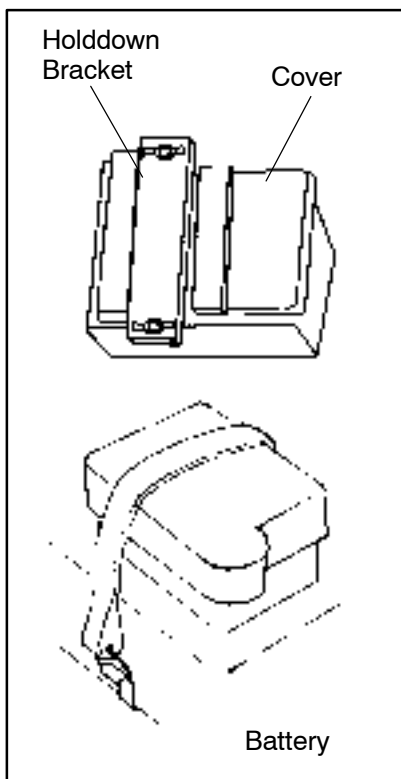

# MAINTENANCE AND LUBRICATION

## Minor Maintenance

5. Disconnect the red (positive) battery cable next.
6. Lift the battery out of the watercraft, being careful not to tip it sideways and spill any electrolyte.

### CAUTION

If an electrolyte spill occurs, apply a generous amount of baking soda to the area and then rinse with fresh water.

## Replenishing Battery Fluid

A poorly maintained battery will deteriorate rapidly. Check the battery fluid level each day the watercraft is ridden.

The fluid level should be kept between the upper and lower level marks.

To refill use only distilled water. Tap water contains minerals which are harmful to a battery.

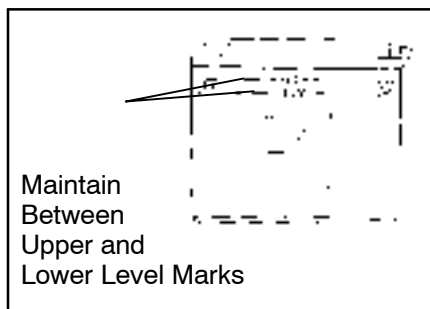

### CAUTION

Do not allow cleaning solution or tap water to enter the battery. It will shorten the life of the battery.



# MAINTENANCE AND LUBRICATION

## Minor Maintenance

### Battery Connections

Battery terminals and connections should be kept free of corrosion. If cleaning is necessary, remove the corrosion with a stiff wire brush. Wash them off with a solution of baking soda and water (One tablespoon of baking soda to one cup of water). Rinse well with tap water and dry off with clean shop cloths. Coat the terminals with dielectric grease PN 2871066.

### Battery Charging

When using a battery charger connect the battery to the charger before turning on the charger. This prevents the possibility of sparks at the terminals which could ignite the battery gases.

Do not connect charger cables to the battery unless the charger is unplugged.

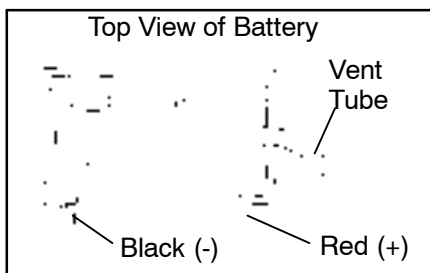

1. Remove the caps from the cells. Add distilled water if necessary to bring the electrolyte up to the proper level.
2. Connect the battery to a charger. Set the charging rate at 1.9 amps and charge the battery for ten hours.

### **⚠️ WARNING**

Keep the battery away from sparks and open flames during charging because the battery gives off gases which are explosive.

If you smell fuel do not attempt to charge the battery. Take the craft to your dealer for immediate inspection.

# MAINTENANCE AND LUBRICATION

## Minor Maintenance

**NOTE:** During charging, if the electrolyte temperature rises above 115°F (45°C) reduce the charging rate to lower the temperature. Increase the charging time.

3. After the battery is charged, check the fluid level. If it has dropped add distilled water to bring the electrolyte up to the proper level.
4. Check the results of charging. The specific gravity of each cell must be 1.26 at room temperature. The voltage should be 14.5 - 15.5 V during charging; 12.2 -12.8 V after charging.

## Battery Installation

Always connect battery cables in the order specified. Red (positive) cable first, black (negative) cable last.

1. Install the battery in its holder.
2. Install the battery vent tube. It must be free from obstructions and securely installed. If not, battery gases could accumulate and cause an explosion. Avoid skin contact with electrolyte, severe burns could result.

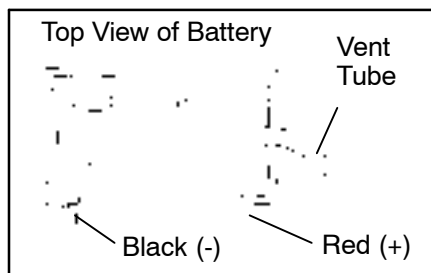

3. First connect and tighten the red (positive) cable.
4. Second connect and tighten the black (negative) cable.
5. Apply dielectric grease PN 2871066 to each cable.
6. Reinstall the battery cover and electrical box over the battery and reconnect straps.

# MAINTENANCE AND LUBRICATION

## Minor Maintenance

7. Verify that cables are properly routed.
8. Verify that the vent hose is not kinked.

## Battery Storage

1. Remove the battery. Clean the casing and terminals with baking soda and water (one tablespoon of baking soda to one cup water). Apply dielectric grease PN 2871066 or petroleum jelly to battery terminals and all exposed cable connectors.
2. Top off the battery with distilled water and charge it to a specific gravity of 1.26. Recharge monthly as required to prevent battery discharge and sulfating.
3. Store the battery in a cool, dry place out of direct sunlight.

# MAINTENANCE AND LUBRICATION

## Minor Maintenance

### Salt Water And Unclean Water Care

When the watercraft is operated in salt water or water with impurities like silt, sand and other particulates, additional care is required to protect it.

#### **CAUTION**

Failure to perform the additional maintenance required when the watercraft is operated in unclean or salt water will result in damage and corrosion to the watercraft and may void your warranty.

# MAINTENANCE AND LUBRICATION

## Minor Maintenance

### Jet Pump Water Inlet Screen

The water inlet screen is located inside the stationary nozzle of the jet pump. Its purpose is to screen out grass and debris which could enter the coolant system.

After using the watercraft, visually inspect the screen for build up of contaminants. Clean as required by flushing engine and or screen with fresh water. See flushing procedure below.

If the screen cannot be cleaned by flushing, see your Polaris Dealer for additional cleaning.

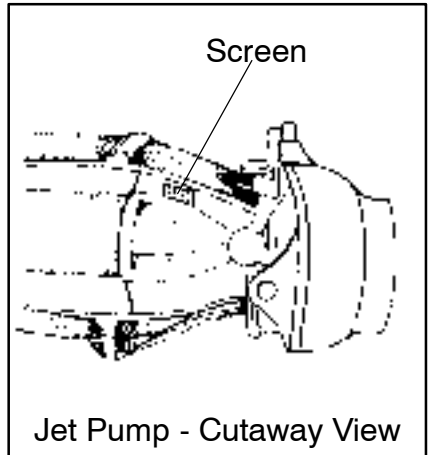

### Cooling System Flushing

The watercraft uses water for propulsion and cooling.

Flushing the cooling system with fresh water (never anti-freeze) is necessary to neutralize the corroding effects of salt water or water with impurities like silt, sand, alkali and other particulates; as well as to flush out other residue left in the water passages of the watercraft cooling system.

Flush water passages when the watercraft is not going to be ridden again that day or if the watercraft is expected to be stored for an extended time.

# MAINTENANCE AND LUBRICATION

## Minor Maintenance

If you beach your craft you must flush the cooling system or severe engine damage may occur.

### CAUTION

Always follow the recommended flushing procedure when flushing the watercraft cooling system to avoid engine damage.

Never flush a hot engine. Severe engine damage could result.

### WARNING

Do not touch any electrical part when the engine is running. Severe personal injury or death could result.

## EPA Emissions Regulations

Maintenance, replacement, or repair of the emission control devices and systems may be serviced at any Marine SI engine repair establishment or individual.

# MAINTENANCE AND LUBRICATION

## Minor Maintenance

### Flushing Procedure

Flushing the cooling system with fresh water is necessary to neutralize the corroding effects of salt water or water with impurities like silt, sand, alkali and other particles as well as to flush out other residue left in the water passages of the watercraft cooling system.

Flush water passages when the watercraft is not going to be ridden again that day or if the watercraft is expected to be stored for an extended time.

Use Flush Kit PN 2871443.

1. Attach garden hose to Female Coupler/Hose attachment
2. Snap the male and female together coupler
3. Snap the male and female together coupler
4. Start watercraft engine.
5. immediately turn on the water faucet
6. Rev the engine intermittently for one minute to completely flush the cooling system.
7. Turn off the water faucet.
8. When all water has exited the cooling system, turn off the watercraft engine. **NOTE:** This step should not take longer than 10 seconds.
9. Press button on female coupler/hose attachment to separate from male coupler.

# MAINTENANCE AND LUBRICATION

## Minor Maintenance

### Anti-corrosion Treatment

Spray all the metal components in the engine compartment with a lubricating type rust inhibitor PN 2871064.

Apply dielectric grease on battery terminals and connections PN 2871066.

**NOTE:** Never leave shop cloths or tools in the engine compartment or bilge.

### Periodic Maintenance Schedule

**NOTE:** Maintenance intervals are based upon average operating conditions. Watercraft operated in saltwater require daily corrosion protection and engine flushing, and more frequent maintenance and lubrication.

Fogging kits should be added to all Polaris watercraft. The engine should be fogged if the watercraft will not be used for more than 48 hours.

### KEY

- \* Perform every 15 hrs. or one month when operated in salt water.
- \*\* Perform daily when operated in salt water.
- \*\*\*Bonded rubber couplers-Pre-Season (Annually), 50 hrs., or when pump is disassembled for maintenance.



# MAINTENANCE AND LUBRICATION

## Minor Maintenance

Replace pop-off valve, spring, and seals every 100 hours only (not every 6 months).

Replace water separator filter element and o-ring every 100 hours only (not every 6 months).

Replace inlet and outlet hoses and clamps every 100 hours only.

After washing the engine compartment of the watercraft, protect the metal components with a heavy duty silicone based spray lube or other *non-flammable* metal protectant. Do not use flammable sprays or protectants in the engine compartment. Do not use petroleum based protectants or lubricants in the engine compartment, as most are flammable and also may deteriorate rubber components.

## EPA Emissions Regulations

All Polaris Direct Injection equipped engines manufactured by Polaris Industries are certified to the United States Environmental Protection Agency regulations for the control of air pollution. For this reason factory procedure for servicing must be strictly followed, and wherever practicable, returned to the original intent of the design. Maintenance, replacement, or repair of the emission control devices and systems may be performed by any marine SI engine repair establishment or individual.

# MAINTENANCE AND LUBRICATION

## Extended Storage

When the watercraft will not be used for a month or more, preventative maintenance is required to keep watercraft parts from deteriorating. This procedure also ensures the operator that the next time it's used it will be in top condition.

An authorized Polaris dealer can do the required preventative maintenance for you or you can do it yourself with a minimum of tools.

## Engine And Cooling System Flushing

Clean the cooling system according to instructions found on page 123 - 125.

## Engine/Fuel System Draining

Engine draining is automatic. You will, however, need to make sure the exhaust system is drained. To do this start the engine and briefly rev it.

### **WARNING**

Gasoline is highly flammable and explosive under certain conditions.

Read and heed gasoline warnings found on page 49.

1. When preparing your watercraft for off-season storage we recommend that you add 10 oz. of fuel conditioner/stabilizer such as Gold Eagle brand STA-BIL® (Polaris PN 2870652) to the fuel tank, then top off with fresh fuel.
2. Fog the engine with rust preventative oil (PN 2870791). Follow the recommended procedures on page 130.

**NOTE:** Using a fuel stabilizer and topping off the fuel tank eliminates the need to drain the fuel system.

# MAINTENANCE AND LUBRICATION

## Extended Storage

If you prefer to drain the fuel tank, use the following procedure:

1. Drain the fuel tank with a siphon or pump.
2. Leave the fuel cap loose to prevent condensation from forming in the fuel tank.

Perform steps 3 and 4 simultaneously.

3. Fog the engine with rust preventative oil (PN 2870791), available from your Polaris dealer. Follow the recommended procedures indicated on the can.
4. Start the engine and run it at part throttle to dry out the carburetors. Do not run the engine for more than 15 seconds while the watercraft is out of the water. Wait five minutes between 15 second running periods.

# MAINTENANCE AND LUBRICATION

## Extended Storage

### Watercraft Engine Fogging Procedure

**Important:** Failure to perform the following preventive maintenance can result in serious engine corrosion during off season or extended storage. In order to prevent rust and corrosion on internal engine parts (i.e. crankshaft, bearings, pistons, rings, cylinder walls). Polaris highly recommends the use of Polaris fogging oil (PN 2870791) as a recommended storage procedure.

The fogging oil coats all internal parts for prevention of rust and corrosion, which in turn will extend the life of the engine.

1. Remove the bolt(s) securing the air intake cover and remove the cover.
2. Remove intake cover and air filter element.
3. Start the engine and spray Polaris fogging oil into each carburetor throat to ensure that all internal parts are properly coated. Spray fogging oil for two to three seconds in each intake throat and repeat until the engine is flooded with fogging oil. Then stop the engine immediately.

### CAUTION

Never operate the engine for more than 15 seconds while the watercraft is out of the water. The engine may overheat and seize.

4. Reinstall filter element(s) and air intake covers.

# MAINTENANCE AND LUBRICATION

## Extended Storage

### Cleaning

1. Remove the drain plug and clean the bilge and engine area with hot water and mild detergent (such as dish soap) or with bilge cleaner. Rinse and drain thoroughly. Wipe up remaining water with clean dry shop cloths. Do not use abrasive cleaners. Store the watercraft with the drain plug removed and the seat propped open slightly to inhibit condensation from forming in the engine compartment.
2. Wash the exterior of the watercraft with fresh water and a mild detergent. Rinse thoroughly.
3. Inspect and thoroughly clean the jet pump intake, outlet and impeller area. If damage to these areas is visible have it serviced by an authorized Polaris dealer.

### CAUTION

Never clean the watercraft with strong detergents, abrasives, degreasers, paint thinner, acetone, window cleaners, ammonia or products containing alcohol. They can damage finishes, decals, vinyl and plastics and accelerate UV breakdown which could cause color change and premature deterioration of parts.

4. After cleaning, protect and shine the watercraft using a regular furniture polish or non-abrasive silicone wax. Protect the seat and handlebar unit with a vinyl protector.
5. Spray the exterior of the engine with a protector and lubricant PN 2871064.

# MAINTENANCE AND LUBRICATION

## Extended Storage

6. Cover the watercraft with an opaque tarp or your Polaris watercraft cover and store it in a clean, dry place. When storing the watercraft, make certain the nose is at a 10° angle, allowing water to drain.

## Lubrication

1. Remove the spark plugs and pour about one tablespoon of Polaris Premium 2-cycle oil or Polaris Premium Gold Synthetic 2-cycle oil into each cylinder.
2. Inspect (change if necessary) and grease the spark plug threads and install the spark plugs.
3. Lubricate choke, throttle, and steering cables. See page 105.
4. Lubricate all areas recommended in the maintenance section beginning on page 105.
5. Remove and store the battery properly. See recommendations on pages 116-120.

# MAINTENANCE AND LUBRICATION

## Extended Storage

### Pre-season Preparation

See the chart on the next page for the necessary procedures to be performed when taking the watercraft out of storage and prior to starting it. Have an authorized Polaris dealer perform their portion or all of the pre-season service work. You may do parts of it yourself if you have the proper skills and tools. You must still perform the “Pre-Operation Check” before riding the watercraft each day.

### **WARNING**

Observe all warnings and cautions mentioned throughout this manual which pertain to the work being performed.

Your **safety** is involved!

### Additional Inspections

To keep your watercraft safe and performing in top condition be sure to follow the additional recommended inspections as shown on the following chart.

Have an authorized Polaris dealer perform their portion or all of the recommended inspections. You may do parts of it yourself if you have the proper skills and tools.

### Daily Pre-operation Inspection

Items included in the “Pre-Operation Inspection” (pages 52 -64 ) are not necessarily included in the following inspection chart.

# TROUBLESHOOTING

The following information is provided to help you identify probable causes for questions you may have about the operation of the engine. See your Polaris dealer with any additional questions you may have.

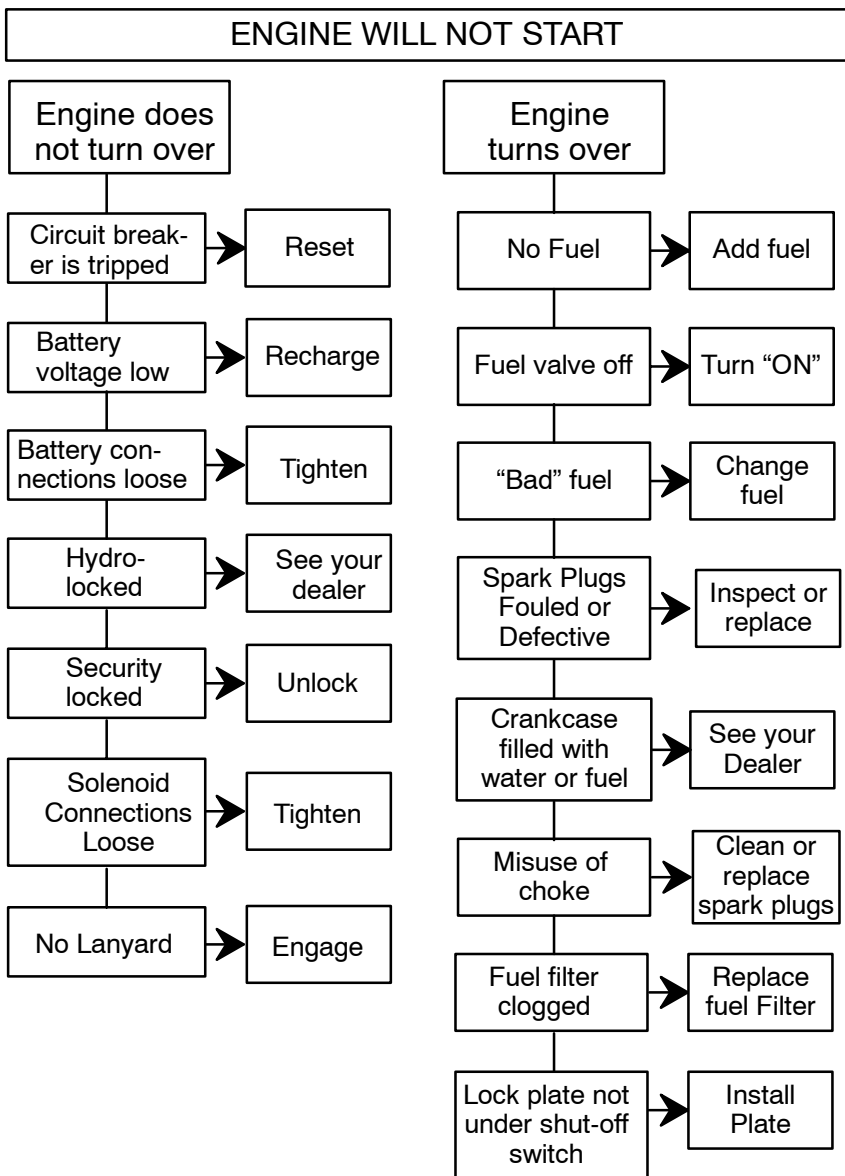



# TROUBLESHOOTING

## Engine Runs Irregularly, Stalls, Or Misfires

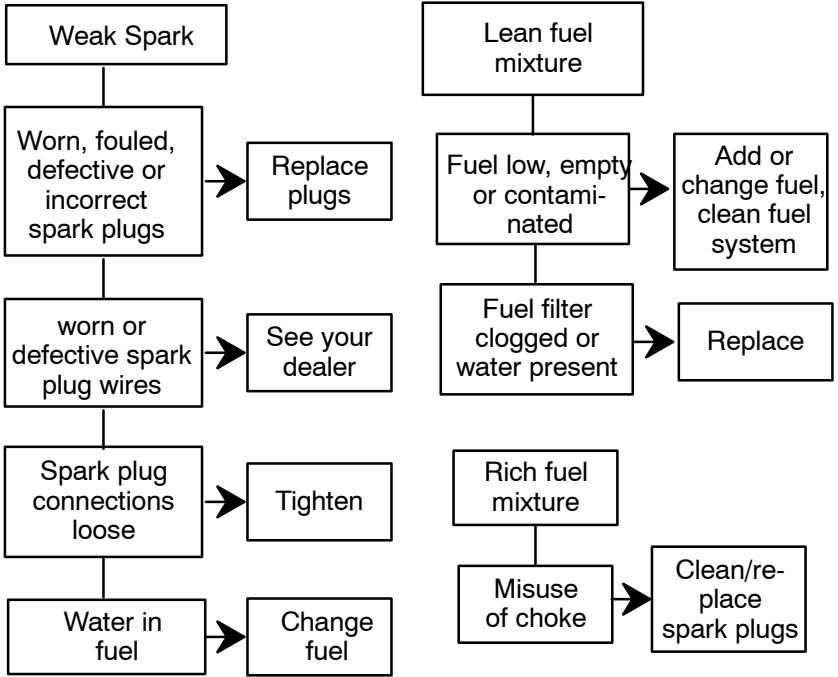

## Engine Overheats

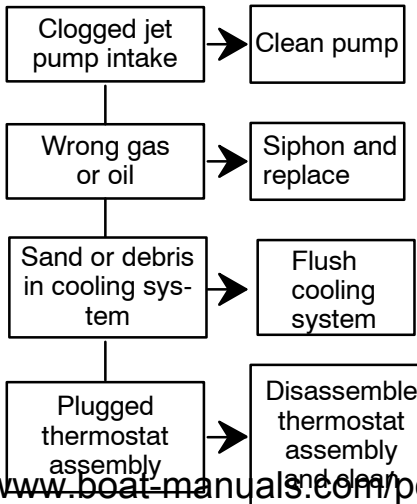

# TROUBLESHOOTING

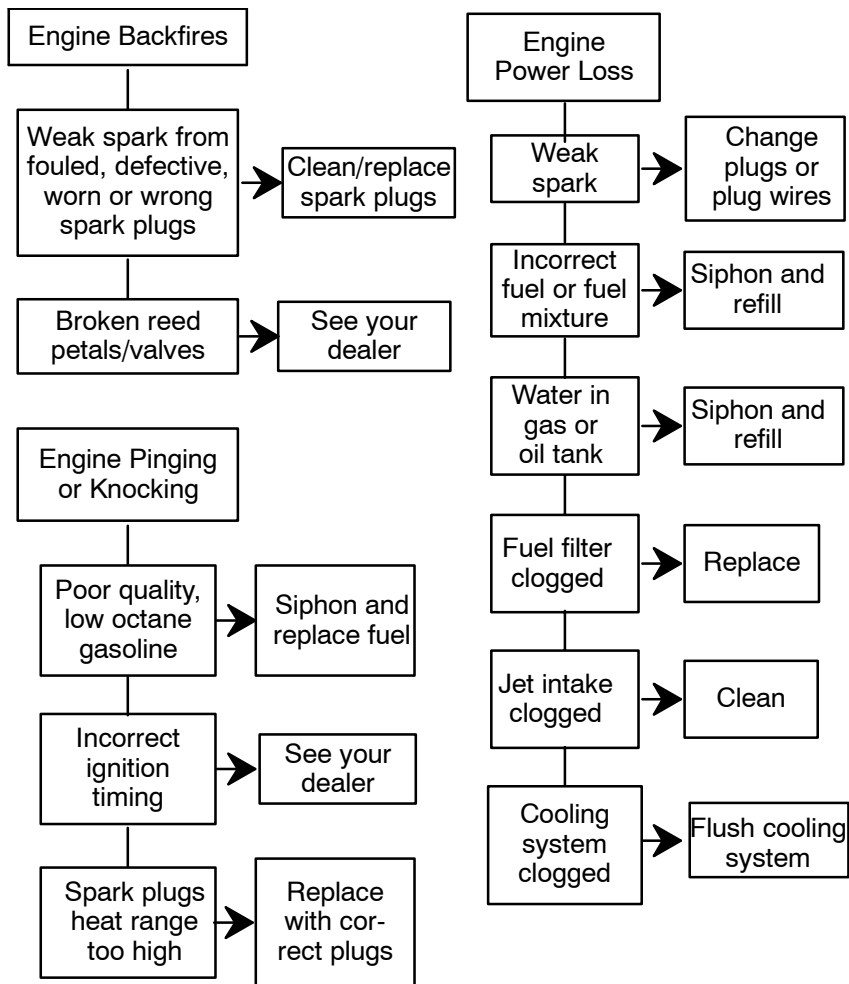

# TROUBLESHOOTING

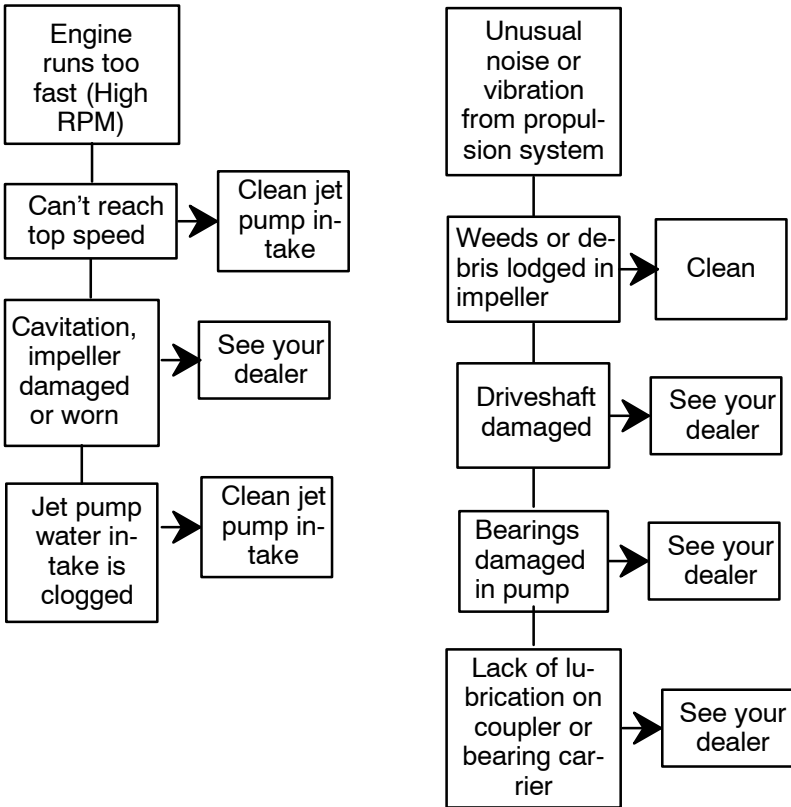

## **Polaris Acknowledges the Following Products Mentioned in This Manual:**

STA-BIL, Registered Trademark of Gold Eagle

Loctite, Registered Trademark of Loctite Corporation

# WARRANTY

## Obtaining Service and Warranty Assistance

Read carefully and understand the service data and the Polaris Warranty contained in this manual. Contact your Polaris dealer in matters pertaining to replacement parts, service, or warranty. He/She is constantly kept up-to-date on changes, modifications, and tips on personal watercraft maintenance which may supersede information contained in this manual. He/She is familiar with our policies and procedures and will be happy to assist you.

When writing about parts, service, or warranty, always include the following information:

1. Serial number
2. Model number
3. Dealer name
4. Date of purchase
5. Details of trouble experienced
6. Length of time and conditions of operation
7. Indicate previous correspondence

# WARRANTY

## Warranty Policy

### LIMITED WARRANTY

Polaris Industries Inc., P.O. Box 47700, Hamel, MN 55340-9960, gives a ONE YEAR LIMITED WARRANTY on all components of the Polaris personal watercraft against defects in material or workmanship. This warranty covers the parts and labor charges for repair or replacement of defective parts which are covered by this warranty. This warranty begins on the date of purchase. This warranty is transferrable to another consumer during the warranty period through a Polaris dealer. There is a charge of \$35.00 payable to Polaris Industries Inc.

### REGISTRATION

At the time of sale, the Warranty Registration Form must be completed by your dealer and submitted to Polaris within ten days. Upon receipt of this registration, Polaris will record the registration for warranty. No verification of registration will be sent to the purchaser as the copy of the Warranty Registration Form will be the warranty entitlement. If you have not signed the original registration and received the “customer copy”, please contact your dealer immediately. **NO WARRANTY COVERAGE WILL BE ALLOWED UNLESS YOUR PERSONAL WATERCRAFT IS REGISTERED WITH POLARIS.**

Initial dealer preparation and set-up of your personal watercraft is very important in ensuring trouble-free operation. Purchasing a machine in the crate or without proper dealer set-up will void your warranty coverage.

### WARRANTY COVERAGE AND EXCLUSIONS:

#### LIMITATIONS OF WARRANTIES AND REMEDIES

This Polaris limited warranty covers all parts and components except for impeller damage caused by ingestion of rocks, sand, or gravel or any other damage caused by operation in shallow water. The warranty also excludes any other failures that are not caused by a defect in material or workmanship.

# WARRANTY

## Warranty Policy

This warranty does not cover accidental damage, normal wear and tear, abuse or improper handling. This warranty also does not cover any personal watercraft that has been altered structurally, modified, neglected, improperly maintained, used for racing, or used for purposes other than for which it was manufactured, or for any damages which occur during trailer transit or as a result of unauthorized service or the use of unauthorized parts. In addition, this warranty does not cover physical damage to paint or finish, gel coat stress cracks, tearing or puncturing of upholstery material, corrosion, or defects in parts, components or personal watercraft due to fire, explosions or any other cause beyond Polaris' control.

This warranty does not cover the use of unauthorized lubricants, chemicals, or fuels that are not compatible with watercraft. In addition this warranty does not cover stress cracks, submersion, or growth of marine organisms on hull and deck.

The exclusive remedy for breach of this warranty shall be, at Polaris' exclusive option, repair or replacement of any defective materials, or components or products. **THE REMEDIES SET FORTH IN THIS WARRANTY ARE THE ONLY REMEDIES AVAILABLE TO ANY PERSON FOR BREACH OF THIS WARRANTY. POLARIS SHALL HAVE NO LIABILITY TO ANY PERSON FOR INCIDENTAL, CONSEQUENTIAL OR SPECIAL DAMAGES OF ANY DESCRIPTION, WHETHER ARISING OUT OF EXPRESS OR IMPLIED WARRANTY OR ANY OTHER CONTRACT, NEGLIGENCE, OR OTHER TORT OR OTHERWISE.** Some states do not permit the exclusion or limitation of incidental or consequential damages or implied warranties, so the above limitations or exclusions may not apply to you if inconsistent with controlling state law.

**ALL IMPLIED WARRANTIES (INCLUDING BUT NOT LIMITED TO THE IMPLIED WARRANTIES OF MERCHANTABILITY AND FITNESS FOR A PARTICULAR PURPOSE) ARE LIMITED IN DURATION TO THE ABOVE ONE YEAR WARRANTY PERIOD. POLARIS FURTHER DISCLAIMS ALL EXPRESS WARRANTIES NOT STATED IN THIS WARRANTY.** Some states do not allow limitations on how long an implied warranty lasts, so the above limitation may not apply to you if inconsistent with controlling state law.

## Warranty Policy

### HOW TO OBTAIN WARRANTY SERVICE

If your personal watercraft requires warranty service, you must take it to a Polaris dealer authorized to repair Polaris personal watercraft. When requesting warranty service you must present your copy of the Warranty Registration form to the dealer. (THE COST OF TRANSPORTATION TO AND FROM THE DEALER IS YOUR RESPONSIBILITY). Polaris suggests that you use your original selling dealer; however, you may use any Polaris Servicing Dealer to perform warranty service.

Please work with your dealer to resolve any warranty issues. Should your dealer require any additional assistance they will contact the appropriate person at Polaris.

This warranty gives you specific legal rights, and you may also have other rights which vary from state to state.

If any of the above terms are void because of state or federal law, all other warranty terms will remain in effect.

### Engine Oil

1. Always use Polaris engine oil.
2. Never substitute or mix oil brands as serious engine damage and voiding of warranty can result.

Polaris warrants to the ultimate purchaser and each subsequent purchaser, that this engine is designed, built, and equipped so as to conform at the time of sale with applicable regulations under section 213 of the Clean Air Act. Polaris warrants that this engine is free from defects in materials and workmanship which would cause the engine to fail to conform with applicable regulations for the U.S. EPA emission warranty period, which is one (1) year from the date of purchase for the emission-related components in this engine.

# INDEX

Accessories	47	Features	10, 14, 37-47
Additional Inspections	133	Fire Extinguisher	57
Air Intake	38	Fire Extinguisher Compartment	38
Anti-corrosion Treatment	126	Fire Extinguisher Container	40
Avoid Collisions	71	Fishing Vessel Right-of-Way	70
Battery	60	Flushing the Engine	128
Battery Charging	119	Footwell Pads	36
Battery Connections	119	Fuel	50
Battery Fluid	118	Fuel and Oil Recommendations	49-51
Battery Information	95	Fuel Gauge	34
Battery Installation	120	Fuel Tank	111
Battery Maintenance	116	Fuel Tank Cap	40
Battery Removal	117	Fuel Tank Levels	54
Battery Storage	121	Fuel Valve	38
Beaching	85	Fuel/Water Separator	64
Bilge Button	34	Fuses	115
Boarding in Deep Water	79	Gasoline Warning	19
Boarding Platform	36	Give-Way	67
Boarding the Watercraft	79-80	Give-Way Vessel	67
Boarding With A Passenger	80	Glove Box	39, 41
Boating Laws	17	Grab Handle	38, 40
Boating Under the Influence	32	Hand Hold	35
Break-In Procedure	65-66	Handlebars	38
Buoys and Markers	71	Hood	38, 40
Capacities	8, 11	Hull	61
Capsized Boat	19	Hypothermia	33
Capsized Watercraft	93	Identification Numbers	6-7
CARBURETION	9, 13	Insurance	6
Carburetor Adjustment	112	Jet Pump	36
Choke	34	Jet Pump Intake	55
Choke Cable Inspection	114	Lanyard	17, 34
Circuit Breaker	115	Launch Ramp Etiquette	71
Cleaning	90-91, 131	Limited Warranty	139
Cleaning on Land	91	Lubrication	105-108
Cold Water Survival	33	Meeting Vessels	69
Controls	34-36, 46	MFI Operation	97-101
Cooling	8, 12	Minor Maintenance	109-127
Cooling System Flushing	123-125, 128	Navigational Rules	67-71
Crossing Paths	70	Non-Motorized Craft	70
Daily Pre-operation Inspection	133	Oil Fill Cap	39, 51
Decal Text	17	Oil Filter	112
Decals	16-22	Oil Tank Levels	54
Dimensions	8, 11	Cleaning the Pump and Impeller	90
Drain Plug(s)	36	If the Engine Does Not Start	76
Drain Plugs/Bilge	61	Jumping	82
Drugs Or Alcohol	18	Launching in Shallow Water	92
Encountering Vessels	68	Launching the Watercraft	92
Engine Compartment,	38, 42-44, 58	Load Limit	82
Engine Components	42-45	Reverse Operation	77-78
Engine Draining	128	Rough Water Operation	82
Engine Fogging Procedure	130	Starting the Engine	74-76
Engine Oil	141	Stopping	84
Engine Overheat	47	Stopping the Engine	72
EPA Regulations	124, 127, 141	Turning	83
Equipment	48	Operator Safety	23-32
Exhaust Outlet	36	Overtaking Vessels	68
Exposure	32	PERC	35
Extended Storage	128-133		



# INDEX

Periodic Maintenance Schedule	102-104	Sponson	40
Personal Flotation Device	17	Sponson	38
PFD	17	Stand-on Vessel	67
Polaris 2-Cycle	51	Standard Equipment	48
Polaris Electric Reverse Control	35	Starter Button	34
Post Op. Check and Care	88-89	Starting in Deep Water	79
Pre-Operation Check	34-64	Starting the Engine	73
Pre-season Preparation	133	Steering	56
Principles of Operation	81	Steering Cable	106
Propulsion	9, 13	Steering Cable Inspection	113
Protective Clothing	17	Steering Handle Pivot Shaft	107
Refueling	50	Stop Switch	34
Registration	139	Storage Compartment	58
Replacement Parts	48	Submerged Engine	94-95
Reverse	38, 40	Switches/Buttons	63
Reverse Gate	36	Throttle	34, 56
Riding Gear	62	Throttle Cable Inspection	113
Riding With Passenger(s)	86	Towing	95
Right-of-Way	67	Transporting the Watercraft	96
Rule 2	67	Troubleshooting	134-137
Safe Operation	81-87	Understanding Warnings	15
Safety Lanyard	36	Warning Light	38, 40
Safety Notes	81	Warranty Assistance	138
Salt Water and Unclean Water Care	122	Warranty Coverage	139
Seat	59	Warranty Exclusions	139
Seat Latch	36	Warranty Limitations	139
Seat Strap	38, 40	Warranty Policy	139-141
Spark Plugs	109-110	Warranty Service	141
		Water Inlet Screen	123

# WARNING

Read and understand all warning labels and Owner's Manual before operation. Severe injury or death can result from ignoring warnings or improper use. Never permit a guest to operate this watercraft unless the guest has read and understands all warning labels and the Owner's Manual.

**THIS MANUAL SHOULD REMAIN WITH THE WATERCRAFT IN ITS STORAGE BAG AT ALL TIMES.**



**POLARIS**<sup>®</sup>  
The Way  Out.

**Part No. 9917128**

PRINTED IN THE U.S.A.

<https://www.boat-manuals.com/polaris/>