



TOURNAMENT INBOARD BOATS

2004 Owner's Manual



SKIER'S CHOICE, INC.

1717 Henry G. Lane Street, Maryville, Tennessee 37801 — 865-983-9924

Trademarks

Moomba, the Moomba Logo, Outback, Outback LS, Outback LSV, Mobius LS, Mobius LSV and Mobius XLV are registered trademarks of Skier's Choice, Inc. All other product names are copyright and registered trademarks/trade names of their respective owners.

Skier's Choice, Inc. reserves the right to change product specifications at any time without incurring obligation.

© 2004 Skier's Choice, Inc.



Table of Contents

Section I	Introduction	3
Section II	Boating Safety	5
Section III	Boating Rules	11
Section IV	Boat Specifications	15
Section V	Operating Information	19
Section VI	Starting & Operation	21
Section VII	Instrument Panel	25
Section VIII	Equipment & Options	37
Section IX	Service & Maintenance	51
Section X	Cleaning, Care & Storage	57
Section XI	Winterization & Dry Storage	59
Section XII	Technical Information	61
Section XIII	Trailer Your Boat	63
Section XIV	Moomba Warranty	67
Section XV	Index	71

Boat Information

Hull Identification Number: _____

Date of Purchase: _____

Dealership: _____

Dealer's Phone Number: _____

Registration Number: _____

Engine Serial Number: _____

Trailer Serial Number: _____

Introduction

Moomba inboard ski boats are manufactured by Skier's Choice, Inc. in Maryville, Tennessee and distributed throughout the United States and the world.

This manual provides an overview for operating your Moomba boat. It should be considered a permanent part of your Moomba boat and contains important information on Safety, Boating Rules, Proper Operation and Maintenance of your boat. Should the boat be sold, this manual will provide the same important information to the next owner.

Be sure to read and understand all aspects of Boating Safety and Operation before using your boat. If you have any questions, your dealer can provide the information you need to have a safe and pleasurable boating experience.

All information, illustrations and specifications in this manual are based on the latest product information available at the time of printing. Moomba may discontinue models and equipment or change specifications and designs without any notice and without incurring obligation.



This manual contains information about several Moomba models. Some information may not apply to your boat since standards and optional equipment may vary from model to model.

As you read through this manual, you will find **CAUTION**, **WARNING** and **DANGER** symbols which require special attention. Please read them carefully! They may tell you how to avoid problems and/or endangering yourself, your passengers, and other boaters.

PLEASE REVIEW ALL SAFETY INFORMATION.



A maintenance schedule and accessory information are included to assure trouble-free operation of your boat. Should service problems arise, remember that your Moomba dealer knows your boat best and is interested in your total satisfaction.

Thank you for purchasing a Moomba boat. We hope your ownership results in an enjoyable and rewarding boating experience. Be safe and enjoy the fun!

Daily Check List



- Drain Plugs (Securely in place?)
- Life-Saving Devices (One for every person on board?)
- Steering System (Working smoothly and properly?)
- Fuel System (Adequate fuel? Leaks? Fumes?)
- Battery (Fully charged? Cable terminals clean and tight?)
- Engine (In Neutral?)
- Capacity Plate (Are you overloaded or overpowered?)
- Weather Conditions (Safe to go out?)
- Electrical Equipment (Lights, horn, pump, etc.?)
- Emergency Gear (Fire extinguisher, bailer, paddle, anchor & line, signaling device, tool kit, etc.?)
- Bilge Pump (Working properly?)

NOTE: Bilge pump should be checked prior to each use to ensure proper operation!

Check **BEFORE** running (where applicable)

- Engine Oil level
- Transmission Lubricant level
- Engine Drain Plug, Transom Drain Plug and Center Drain Plug
- Leakage (Fuel, water lines and connections)

⚠ CAUTION DO NOT operate engine without cooling water flowing through water pump, otherwise pump will sustain damage and subsequent engine damage may result!

Check **BEFORE** running

- Oil Pressure: Refer to Engine Owner's Manual
- Water Temperature: 160 degrees to 180 degrees for raw water systems (water is not recirculated), and 180 degrees to 200 degrees for closed cooling systems (water is recirculated).
- Idle RPM: (650-750) in gear.
- Maximum Forward RPM: See Engine Owner's Manual.
- Shifting Linkage (Forward, Neutral and Reverse).

⚠ WARNING GASOLINE VAPORS CAN EXPLODE! It is very important to check for fuel spillage or leaks prior to each use of your boat.

- Check engine compartment for gasoline vapors.
- Operate blower for four minutes before starting the engine.
- Always operate blower below cruising speed.

NOTE: Please refer to your Engine Owner's Manual for maximum RPM and engine break-in procedure.



Important Safety Information!

Your safety, as well as the safety of others with and around you, is a direct result of how you operate and maintain your boat. Read and comprehend this manual. Make sure that you understand all the controls and operating instructions before attempting to operate the boat. Improper operation is extremely dangerous.

The basic safety rules are outlined in this section of the manual. Additional precautions throughout the manual are noted by the following symbols:



This symbol indicates a potentially hazardous circumstance, which, if not avoided, may result in *minor or moderate injury*. It may also be used to alert against unsafe practices.



This symbol indicates a potentially hazardous situation, which, if not avoided, could result in *death or serious injury*.



This symbol indicates an imminently hazardous situation, which, if not avoided, will result in *death or serious injury*. This is limited to the most extreme situations.

The precautions listed in this manual and on the boat are not exhaustive. If a procedure, method, tool or part is not specifically recommended by Skier's Choice, you must satisfy yourself that it is safe for you and others, and that the boat will not be damaged or made unsafe as a result of your decision.

REMEMBER: ALWAYS USE COMMON SENSE WHEN OPERATING, SERVICING OR REPAIRING THE BOAT!

In addition to everyday safety, failure to observe safety recommendations may result in severe personal injury or death to you or to others. Use caution and common sense when operating your boat. Don't take unnecessary chances!

Be certain that all boat passengers are aware of this information and conform to boat safety principles.

Boating Safety

Boating Safety starts with a thorough understanding of your equipment and its proper operation. In addition to careful review of this manual, you should be aware as well that there are many sources of information available. Skier's Choice urges you to pursue additional training, such as safety and seamanship courses offered by the U.S. Coast Guard Auxiliary and the U.S. Power Squadron.

Section II Boating Safety

The following is a listing of just some of the agencies and organizations that offer safety training or information:

American Red Cross, National HQ
17th & D Streets NW
Washington, DC 20006
(202) 639-3686
www.redcross.org

USA Waterski
799 Overlook Drive
Winter Haven, FL 33884
(941) 324-4341
www.usawaterski.org

Boat Owners Association of the United States (BOAT/US)
880 South Pickett Street
Alexandria, VA 22304
(703) 823-9550
www.boatus.com

National Safe Boating Council
2550 M Street NW, Suite 425
Washington, DC 20037
(202) 296-4588
www.safeboatingcouncil.org

U.S. Coast Guard Auxiliary Commandant (G-NAB)
2100 Second Street SW
Washington, DC 20593-0001
(800) 336-2628
www.cgaux.org

U.S. Power Squadron
www.usps.org

On-Line Basic Boating Safety Course
www.boatsafe.com

National Marine Manufacturers Association
200 E. Randolph Dr. Suite 5100
Chicago, IL 60601
(312) 946-6200
www.nmma.org

Federal law requires certain safety equipment to be onboard at all times. In addition, responsible boaters carry other equipment in case of emergency. Check with the local boating authorities for any additional requirements over and above the federal stipulations.

Safety Equipment

Your Moomba has been equipped at the factory with most of the federally required safety equipment for **inland waters** (Class 1, 16'-to-26'). This equipment includes:

- UL-approved Marine Fire Extinguisher, Type A-BC (2 lbs.), good for solids, liquids, and electrical fire
- ABYC-approved Marine Mufflers with water injection
- USCG-approved Marine Flame Arrestor
- USCG-approved Engine Box Ventilation with sparkless power blower
- ABYC-approved Electric Horn sound warning device
- USCG-approved inland lighting

Federal law also requires at least one Type I, II or III Personal Flotation Device (PFD) for each person on board or being towed on water skis or other recreational equipment. In addition, one throwable Type IV PFD must also be on board. **As the owner, obtaining the appropriate PFDs is your responsibility.** Your Moomba dealer can and will be happy to assist you.

NOTE: Requirements for coastal waters and inland waters differ. Check with the local authorities for more information.

A smart owner will avoid potential problems on an outing by having additional equipment on board. Normally, this equipment is dependent on the body of water and the length of the trip.

We suggest the following—as a minimum. Your Moomba dealer can also assist you with additional recommendations.

- An anchor with at least 75 feet of line
- A manual bailing device for removing water
- A combination oar/boat hook
- A day-and-night visual distress signal
- A first aid kit and manual
- An airway breathing tube
- A waterproof flashlight
- A set of local navigation charts
- Mooring lines and fenders
- Extra engine oil
- A tool kit
- A portable AM/FM radio or weather radio

Boating-related accidents are generally caused by the operator's failure to follow basic safety rules or written precautions. Most accidents can be avoided if the operator is completely familiar with the boat, its operation, and can recognize potentially hazardous situations before an accident occurs.

General Safety Precautions

Failure to adhere to these precautions may result in severe injury or death to you and/or others.



- Improper operation is extremely dangerous. Operators must read and understand all operating manuals supplied with the boat before operation.
- Remain seated at all times while boat is in motion.
- Never stand or allow passengers to stand while the boat is moving. You or others may be thrown from the boat.
- Children in the bow of the boat should be accompanied by an adult at all times.
- Never operate the boat while under the influence of alcohol or drugs.
- On-board equipment must always conform to the governing federal, state, and local regulations.
- Gasoline vapors can explode. Before starting engine, open engine box, check engine compartment for gasoline vapors, and operate blower for at least four minutes. Run blower below cruising speed.
- Leaking fuel is a fire and explosion hazard. Inspect system regularly. Examine fuel tanks for leaks or corrosion at least annually.
- Never override or modify the engine safety shut-off switch or engine neutral starting safety switch in any way.
- Never remove or modify components of the fuel system in any way except for maintenance by qualified personnel. Tampering with fuel components may cause a hazardous condition.
- Never allow any type of spark or open flame on board. It may result in fire or explosion.
- It is the owner's responsibility to check tightness of the Rad-A-Cage Tower bolts BEFORE each use.
- The Rad-A-Cage Tower is designed to pull a single (1) individual. DO NOT climb or sit on the Rad-A-Cage Tower. Rope may loop on inverted tricks. DO NOT sit behind the pulling point of the Rad-A-Cage Tower.



- To avoid serious personal injury, DO NOT be on or about the swim platform while engine is running and keep away from rear of boat while engine is running.
- To avoid serious personal injury, DO NOT operate engine while anyone is on or about the swim platform or in the water near the boat.



General Safety Precautions (continued)

CAUTION

- The tow bar is not designed for vertical extensions. Any modifications to the tow bar or its mountings may result in damage to the boat and injury to the user.
- Rear storage area is located above the gas tank and is not designed for ballast. Weight limit is 150 lbs. equally distributed.
- The Rad-A-Cage Tower may strike low objects. Check clearance height around docks, shore, overhanging objects, bridges and power lines.
- Do not pull past 45 degrees of the centerline of the boat. Failure to follow this rule could result in the boat capsizing.

CAUTION

- It is the driver's responsibility to ensure all passengers are seated when boat is underway.

WARNING

Failure to adhere to these warnings may result in severe injury or death to you and/or others.

- This boat is a high-performance boat and capable of quick and tight turns and changes in direction. It is the driver's responsibility to operate the boat in a manner to ensure the safety of all passengers.

WARNING

Boaters must continuously be aware of weather conditions.

- Sudden storms, wind, lightning, etc., can unexpectedly put boaters in grave danger. Always check the local weather report before going boating.

WARNING

It is the driver's responsibility to determine if weather or other factors have created an unsafe boating environment.

- The driver is solely responsible for the consequences of their actions.

Skiing Safety

Skiers are obligated to be as aware of the fundamental safety rules as well as the boat operator. If you are new to water skiing, seek certified training before starting. You will find it especially helpful to join a local ski club and USA Waterski when possible.

Always remember that the majority of water skiing injuries are the result of impacts with other objects, so always look where you are going and be aware of what is going on around you.

WARNING

Failure to adhere to these warnings may result in severe injury or death to you and/or others.

- Every skier must always wear a USCG-approved personal flotation device.
- Maintain a distance of at least 100 feet from all other objects, including other boats, piers, rafts, mooring and navigational buoys, pilings, abutments, or any other items.
- Always have an experienced driver and observer in the boat when skiing.
- Never ski in shallow water, close to shore, or in water where you do not know the depth or what is beneath the surface.
- Never put your arm, head, or any other part of your body through the handle-bridle of the ski line nor wrap the line around any part of the body at any time.
- Never ski at night, or directly in front of other boats.
- Never jump from a boat that is moving at any speed, nor enter or exit the water when the engine is running (ON).
- Make sure that everyone knows and uses approved skiing hand signals and common skiing courtesies.

Ski Pylon Extensions

The use of a ski pylon extension or extensions in excess of 7-feet vertical is not recommended by Moomba on our products. If you elect to use merchandise such as these, be aware that they could create excessive stress on your boat and subjectively cause damages not covered by the warranty.

Carbon Monoxide (CO) Safety



Carbon monoxide is a colorless, odorless and tasteless gas. It is produced by gasoline engines and is a component of exhaust fumes.

Shut off the engine when people are on the swim platform or in the water around the rear of the boat.

Do not teak surf, wake surf, or do any other activities which puts people in close proximity of the transom when the engine is running.

For the most current information on carbon monoxide, you may call, write or visit on-line any of the following:

United States Coast Guard

Office of Boating Safety (G-OPB-3)
2100 Second Street SW
Washington, DC 20593-0001
www.uscgboating.org
1-800-368-5647

NMMA

National Marine Manufacturers Association

200 East Randolph Drive, Suite 5100
Chicago, IL 60601-6528
www.nmma.org
312-946-6200

American Boat & Yacht Council, Inc.



3069 Solomon's Island Road
Edgewater, MD 21037-1416
www.abycinc.org
410-956-1050

If you have questions regarding the operation of your boat, accessory or options or questions in regard to Boat Safety, contact your dealer or Skier's Choice, Inc. at 865-983-9924.



Warning Plates and Labels

Read and note **ALL** warning plates and labels from bow to stern that appear on the boat, including these!

 CAUTION	
<ul style="list-style-type: none"> • Owner and operators must read and understand ALL product manuals before use. • The driver is responsible for operating boat in a manner that ensures the safety of passengers. 	
 WARNING	
<ul style="list-style-type: none"> • All occupants must remain seated at all times while boat is in motion. • Boat is capable of quick and tight turns. Such maneuvers can cause unseated occupants to be thrown around or out of the boat. • Gasoline vapors can explode. Before starting engine, open engine box, check engine compartment for gasoline vapors, and operate blower for at least 4 minutes. Run blower below cruising speed. 	
 DANGER	
<ul style="list-style-type: none"> • To avoid serious personal injury from propeller and/or carbon monoxide, DO NOT operate engine while anyone is on or about the swim platform or in the water near the boat. 	
<small>WLC00003</small>	

 WARNING	
<ul style="list-style-type: none"> • AVOID SERIOUS INJURY OR DEATH. • CHILDREN SHOULD BE SUPERVISED BY AN ADULT AT ALL TIMES. • REMAIN SEATED AT ALL TIMES WHILE BOAT IS IN MOTION. • DO NOT STAND UP OR MOVE ABOUT WHILE THE BOAT IS IN MOTION. 	
<small>WLC00002</small>	

 WARNING	
<ul style="list-style-type: none"> • AVOID SERIOUS INJURY OR DEATH. • TOW PYLON SHOULD BE USED ONLY FOR TOWABLE WATER SPORTS DEVICES. • DO NOT USE TOW PYLON FOR OTHER TOWABLE OBJECTS OR TOWING BOATS. • TOW PYLON IS NOT DESIGNED FOR VERTICAL EXTENSIONS. ANY MODIFICATIONS TO THE TOW PYLON OR ITS MOUNTINGS MAY RESULT IN DAMAGE TO THE BOAT AND INJURY TO THE USER. • DO NOT SIT BEHIND THE TOW PYLON WHEN IN USE. 	
<small>WLS00002</small>	

 CAUTION	
	<ul style="list-style-type: none"> • AVOID SERIOUS INJURY OR DEATH.
	<ul style="list-style-type: none"> • FIRE, EXPLOSION AND SPLASHING FUEL HAZARD. • DO NOT OVERFILL. FUEL WILL DISCHARGE OUT THIS PORT WHEN TANK IS FULL.
<small>WLT00002</small>	

 WARNING	
<ul style="list-style-type: none"> • AVOID SERIOUS INJURY OR DEATH. • TOW EYE SHOULD BE USED ONLY FOR TOWABLE WATER SPORTS DEVICES WITH 1 OR 2 INDIVIDUALS. TOW EYE WEIGHT LIMIT IS 800 LBS. • DO NOT USE TOW EYE FOR OTHER TOWABLE OBJECTS OR TOWING BOATS. • DO NOT USE TOW EYE TO LIFT BOAT. 	
<small>WLT00002</small>	

 CAUTION	
<ul style="list-style-type: none"> • AVOID SERIOUS INJURY OR DEATH. • REAR STORAGE AREA NOT DESIGNED FOR BALLAST. • GAS TANK LOCATED UNDER FLOOR OF STORAGE AREA. • STORAGE AREA WEIGHT CAPACITY IS 150 LBS. 	
<small>WLR00002</small>	

 DANGER	
<ul style="list-style-type: none"> • AVOID SERIOUS INJURY OR DEATH. • PROPELLER AND CARBON MONOXIDE HAZARD. • DO NOT BE ON OR ABOUT THE SWIM PLATFORM WHILE ENGINE IS RUNNING OR BOAT IS IN MOTION. • KEEP AWAY FROM REAR OF BOAT WHILE ENGINE IS RUNNING. 	
<small>WLS00002</small>	

 WARNING	
<ul style="list-style-type: none"> • AVOID SERIOUS INJURY OR DEATH. • THE TOWER IS DESIGNED TO PULL A SINGLE (1) WAKE BOARDER. • DO NOT CLIMB OR SIT ON THE TOWER. • DO NOT SIT BEHIND THE PULLING POINT OF THE TOWER TO AVOID CONTACT WITH ROPE. • THE TOWER MAY STRIKE LOW OBJECTS. CHECK CLEARANCE HEIGHTS DURING OPERATION AND TOWING. 	
<small>WLT00002</small>	

 WARNING	
	<ul style="list-style-type: none"> • AVOID SERIOUS INJURY OR DEATH.
	<ul style="list-style-type: none"> • LEAKING FUEL IS A FIRE AND EXPLOSION HAZARD. • INSPECT SYSTEM REGULARLY. EXAMINE FUEL SYSTEM FOR LEAKS AND CORROSION AT LEAST ANNUALLY.
<small>WLT00002</small>	

If your warning decals should become damaged in any way, please contact your Moomba Dealer or write to Skier's Choice, Inc., 1717 Henry G. Lane Street, Maryville, Tennessee 37801 to request replacement warning decals. The decals will be provided free of charge. Your boat's serial number (located on the transom) must be included for warning decal requests.

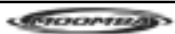
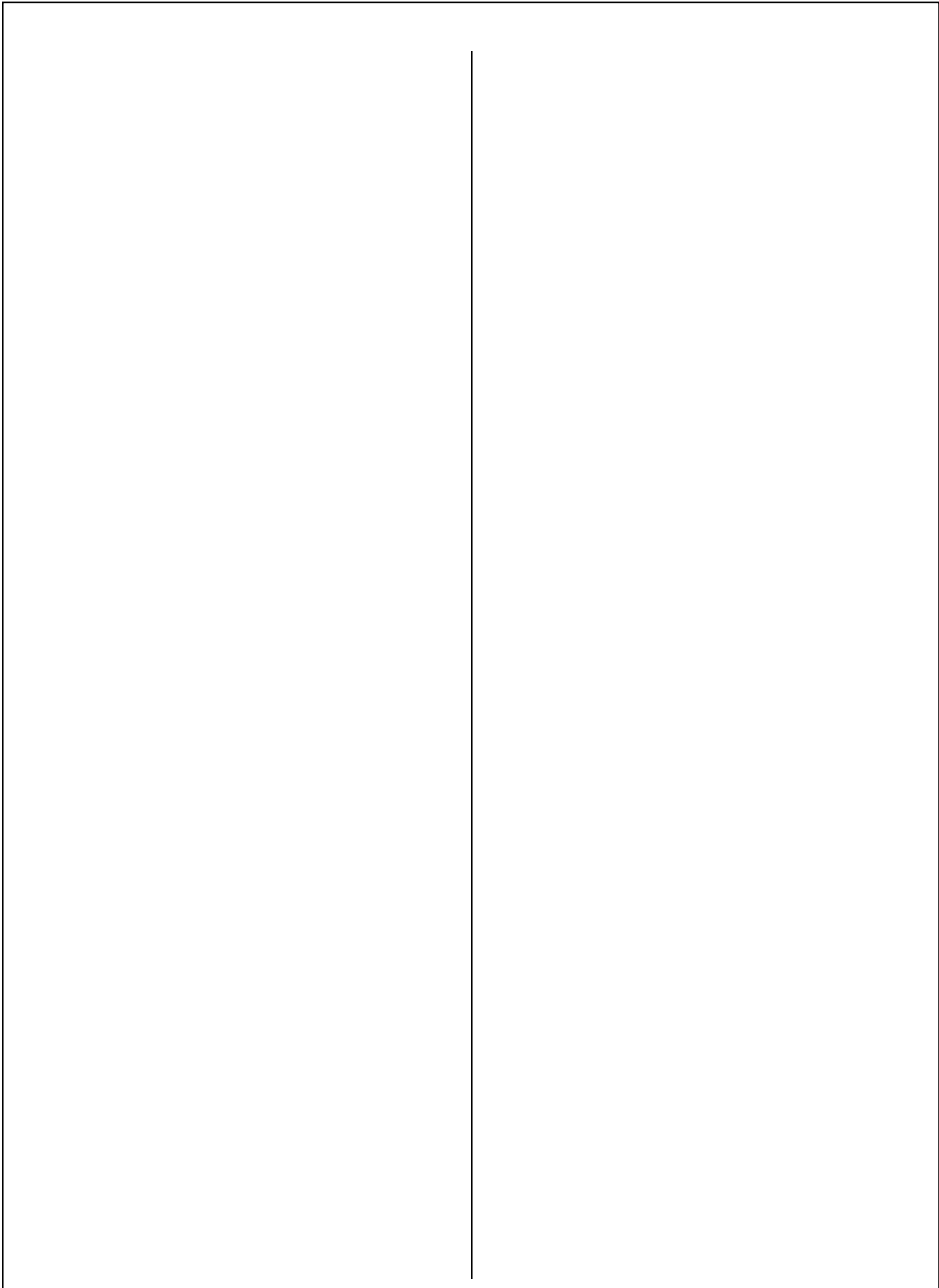

Basic Boating Rules

You should be aware of these rules and follow them whenever you encounter another vessel on the water.

The rules presented in this manual are condensed and have been provided as a convenience only. Consult your local U.S. Coast Guard Auxiliary (USCGA) or Department of Motor Vehicles (DMV) for a complete set of rules governing the waters in which you will be using your boat. If you plan to travel—even for a short trip—you would be well served to contact the regional USCGA or DMV in the area where you will be boating.

Review and understand all local and state laws.

Any time two vessels on the water meet one another, one vessel has the right-of-way. It is called the *stand-on* vessel. The vessel which does NOT have the right-of-way is called the *give-way* or *burdened* vessel.

These rules determine which vessel has the right-of-way, and accordingly, what each vessel should do.

The vessel with the right-of-way has the duty to continue its course and speed, except to avoid an immediate collision. When you maintain your direction and speed, the other vessel will be able to determine how best to avoid you.

The vessel which does not have the right-of-way has the duty to take positive and timely action to stay out of the way of the *stand-on* vessel. Normally, the *give-way* vessel should not cross in front of the *stand-on* vessel. Slow down or change directions briefly and pass behind the other vessel. You should always move in such a way that the *stand-on* operator can see what you are doing.

This rule is called Rule 2 in the International Rules and says, “*In obeying and construing these rules due regard shall be had to all dangers of navigation and collision, and to any special circumstances, which may render a departure from the above rules necessary in order to avoid immediate danger.*”

Encountering Other Vessels

There are three main situations in which you may encounter other vessels and you must observe the Steering Rules in order to avoid a collision. These are:

- **Meeting** (you are approaching another vessel head-on)
- **Crossing** (you are traveling across the other vessel's path)
- **Overtaking** (you are passing or being passed by another vessel)

Using the following illustration in which you are the boat in the center, you should give right-of-way to all vessels shown in the white area. In this instance, you are the give-way vessel. All vessels in the shaded area must yield to you as you are the stand-on vessel. Both you and the meeting vessel must alter course to avoid each other.

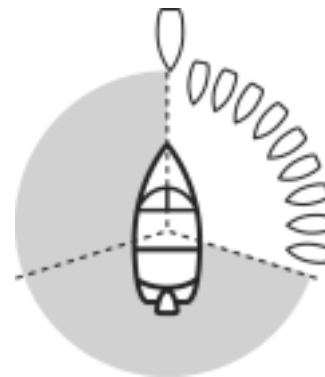

If you are meeting another power vessel head-on, and you are close enough to run the risk of collision, neither of you has the right-of-way. Both of you should alter course to avoid an accident. You should keep the other vessel on your port (left) side. This rule doesn't apply if both of you can clear each other by continuing your set course and speed.

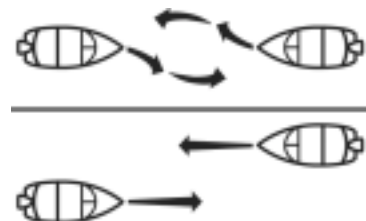

When two power-driven vessels are crossing each other's path close enough to run the risk of collision, the vessel that views the crossing vessel to the starboard (right) side must give-way.

If the other vessel is to the port (left) side, maintain your course and direction, provided the other vessel gives you the right-of-way as it should.

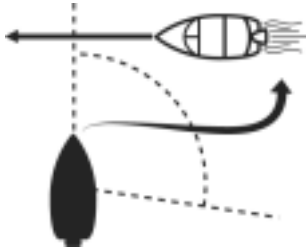

If you are passing another vessel, you are the give-way vessel. This means that the other vessel is expected to maintain its course and speed. You must stay out of its way as you clear it, altering course and speed as necessary.

Conversely, if you are being passed by another vessel, you should maintain your speed and direction so that the other vessel can steer itself around you.

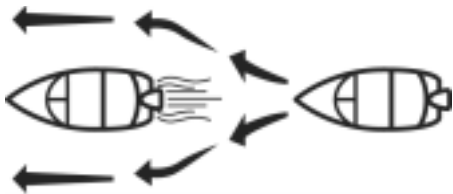

There are three other rules to always remember when driving your boat around other vessels.

When navigating in narrow channels, you should keep to the right when it is safe and practical to do so. If the operator of a power-driven vessel is preparing to go around a bend that may obstruct the view of other water vessels, the operator should sound a prolonged blast on the whistle or horn—four to six seconds.

If another vessel is around the bend, it too should sound the whistle or horn. Even if no reply is heard, however, the vessel should still proceed around the bend with caution.

If you navigate these type of waters, you should carry a portable air horn, which are available from local marine supply stores.

All vessels which are fishing with nets, lines or trawls are considered under International Rules to be fishing vessels. Boats with trolling lines are not considered fishing vessels.

Fishing vessels have the right-of-way, regardless of position. These vessels, however, cannot impede the passage of other vessels in narrow channels.

Sailing vessels should normally be given the right-of-way. The exceptions to this are:

- When the sailing vessel is overtaking the power-driven vessel, the power-driven vessel has the right-of-way.
- Sailing vessels should keep clear of any fishing vessel.
- In a narrow channel, a sailing vessel should not hamper the safe passage of a power-driven vessel which can navigate only in such a channel.

The waters of the United States are marked for safe navigation by the lateral system of buoyage. The markers and buoys you will encounter have an arrangement of shapes, colors, numbers and lights to show which side of the buoy a boater should pass when navigating in a particular direction.

The markings on these buoys are oriented from the perspective of being entered from seaward while the boater is going towards the port. This means that red buoys are passed on the starboard (right) side when proceeding from open water into port, and black buoys are to port (left) side. When navigating out of port, your position to the buoys should be reversed: red buoys to port and black buoys to starboard.

Many boating bodies of water are entirely within the boundaries of a single state. The Uniform State Waterway Marking Systems has been devised for these waters. This system uses buoys and signs with distinctive shapes and colors to show regulatory or advisory information.

These markers are white with black letters and orange borders. The information signifies speed zones, restricted areas, danger areas and general information.

Remember: Markings may vary by geographic location. Always consult local boating authorities before driving your boat in unfamiliar waters.

(See examples of buoys and markers next page.)

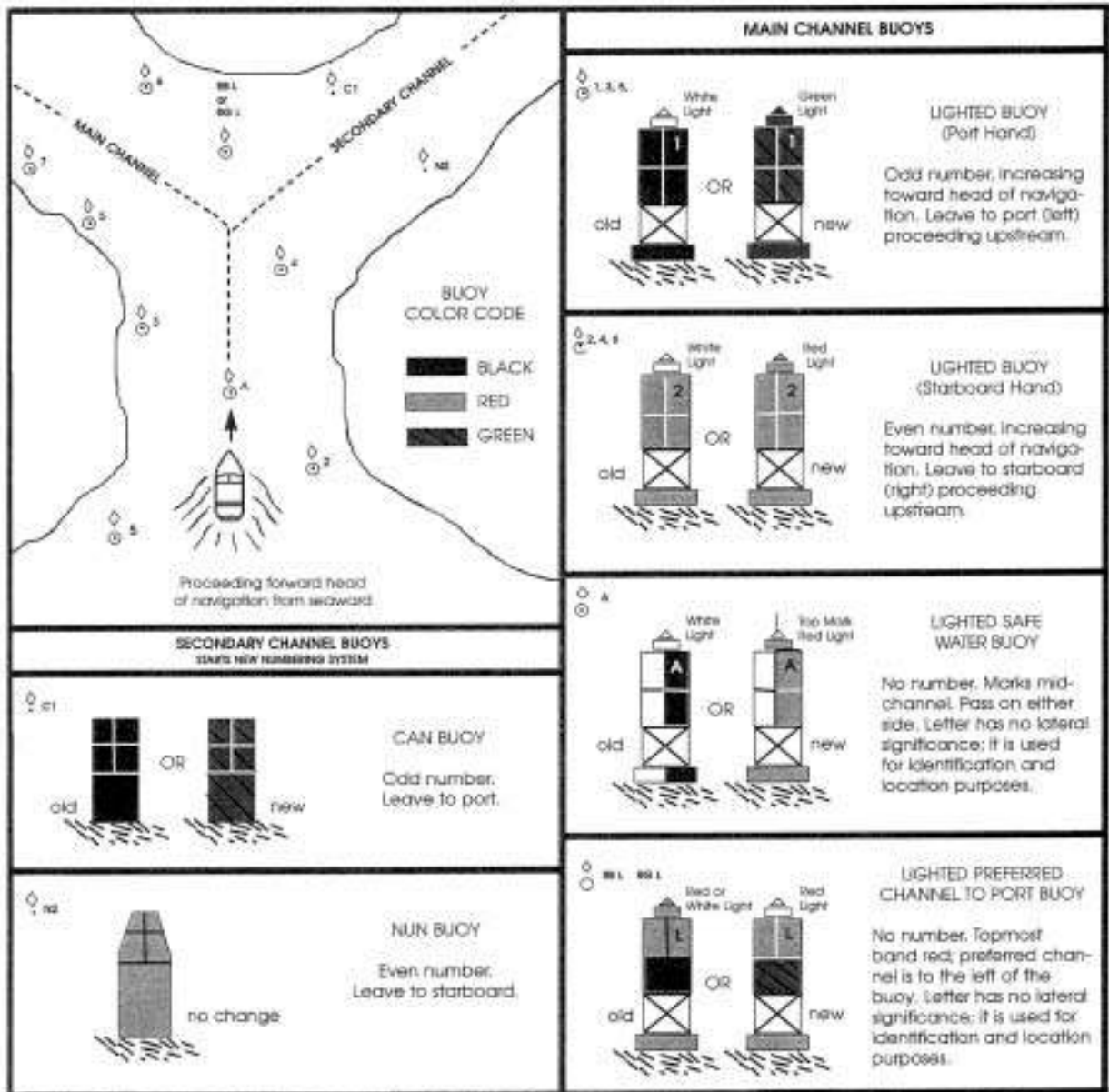

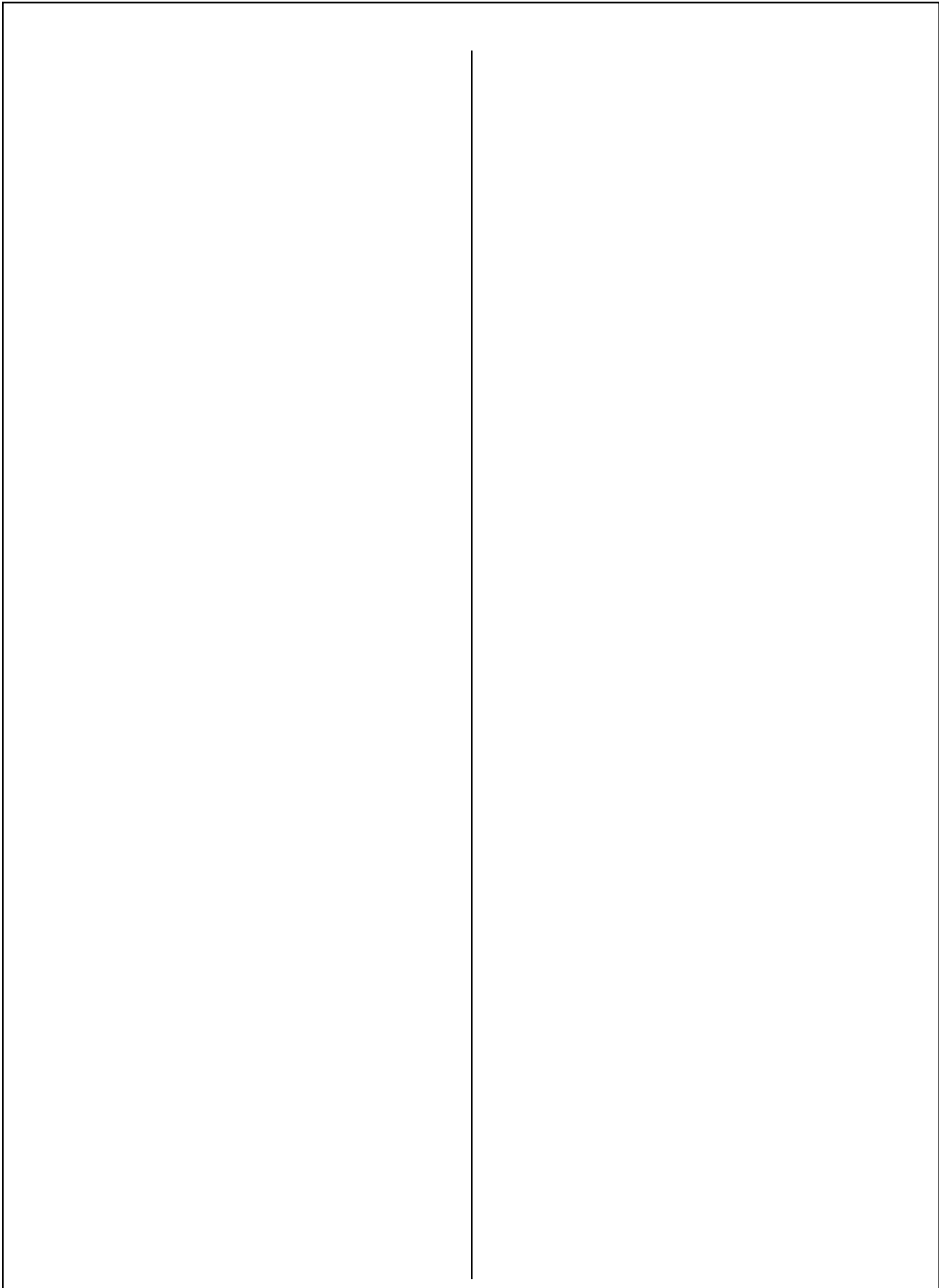

Section IV

Boat Specifications

Outback



Specifications:

Length without Platform:	20' 6"
Length with Platform:	22' 4"
Length with Trailer:	23' 10"
Width (Beam):	95"
Overall Width with Trailer	102"
Draft:	22"
Weight (Boat Only):	2,750 lbs.
Weight (Boat & Trailer)	3,600 lbs.
Capacity - Passenger	10 persons
Capacity - Weight	1,400 lbs.
Capacity - Fuel:	28 gals.
Standard power:	310 HP, V-8

Outback LS



Specifications:

Length without Platform:	20' 8"
Length with Platform:	22' 8"
Length with Trailer:	24' 5"
Width (Beam):	95"
Overall Width with Trailer	102"
Draft:	22"
Weight (Boat Only):	2,950 lbs.
Weight (Boat & Trailer)	3,800 lbs.
Capacity - Passenger	10 persons
Capacity - Weight	1,430 lbs.
Capacity - Fuel:	34 gals.
Standard power:	310 HP, V-8

Outback LSV



Mobius LS



Specifications:

Length without Platform:	20' 8"
Length with Platform:	22' 8"
Length with Trailer:	24' 5"
Width (Beam):	95"
Overall Width with Trailer	102"
Draft:	24"
Weight (Boat Only):	3,000 lbs.
Weight (Boat & Trailer)	3,850 lbs.
Capacity - Passenger	10
Capacity - Weight	1,480 lbs.
Capacity - Fuel:	40 gals.
Standard power:	310 HP, V-8

Specifications:

Length without Platform:	20' 8"
Length with Platform:	22' 8"
Length with Trailer:	24' 5"
Width (Beam):	95"
Overall Width with Trailer	102"
Draft:	22"
Weight (Boat Only):	2,950 lbs.
Weight (Boat & Trailer)	3,800 lbs.
Capacity - Passenger	10
Capacity - Weight	1,430 lbs.
Capacity - Fuel:	34 gals.
Standard power:	310 HP, V-8



Mobius LSV



Specifications:

Length without Platform:	20' 8"
Length with Platform:	22' 8"
Length with Trailer:	24' 5"
Width (Beam):	95"
Overall Width with Trailer	102"
Draft:	24"
Weight (Boat Only):	3,000 lbs.
Weight (Boat & Trailer)	3,850 lbs.
Capacity - Passenger	10
Capacity - Weight	1,480 lbs.
Capacity - Fuel:	40 gals.
Standard power:	310 HP, V-8

Mobius XLV

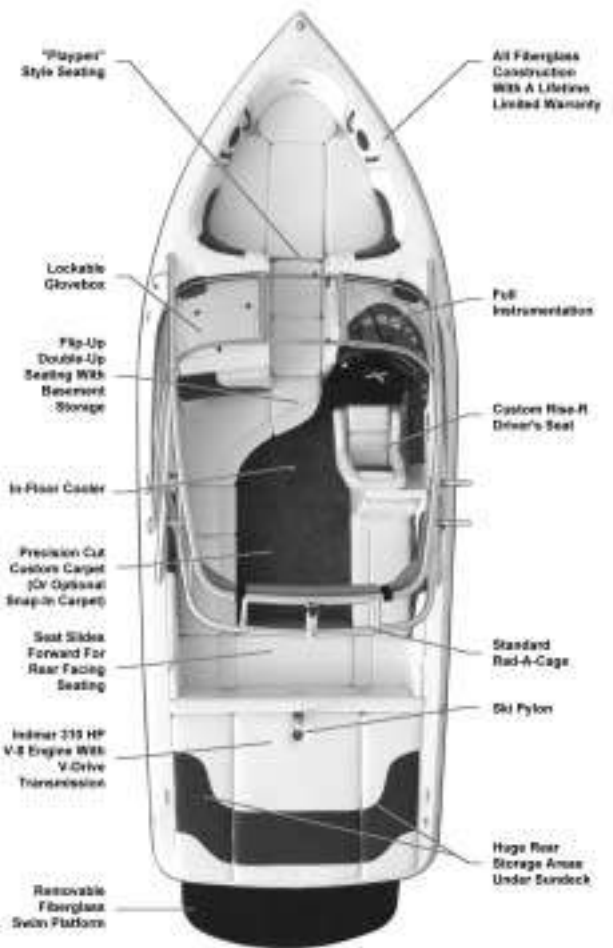

Specifications:

Length without Platform:	23'
Length with Platform:	25'
Length with Trailer:	26' 8"
Width (Beam):	98"
Overall Width with Trailer	102"
Draft:	26"
Weight (Boat Only):	4,100 lbs.
Weight (Boat & Trailer)	5,200 lbs.
Capacity - Passenger	16
Capacity - Weight	2,300 lbs.
Capacity - Fuel:	40 gals.
Standard power:	310 HP, V-8

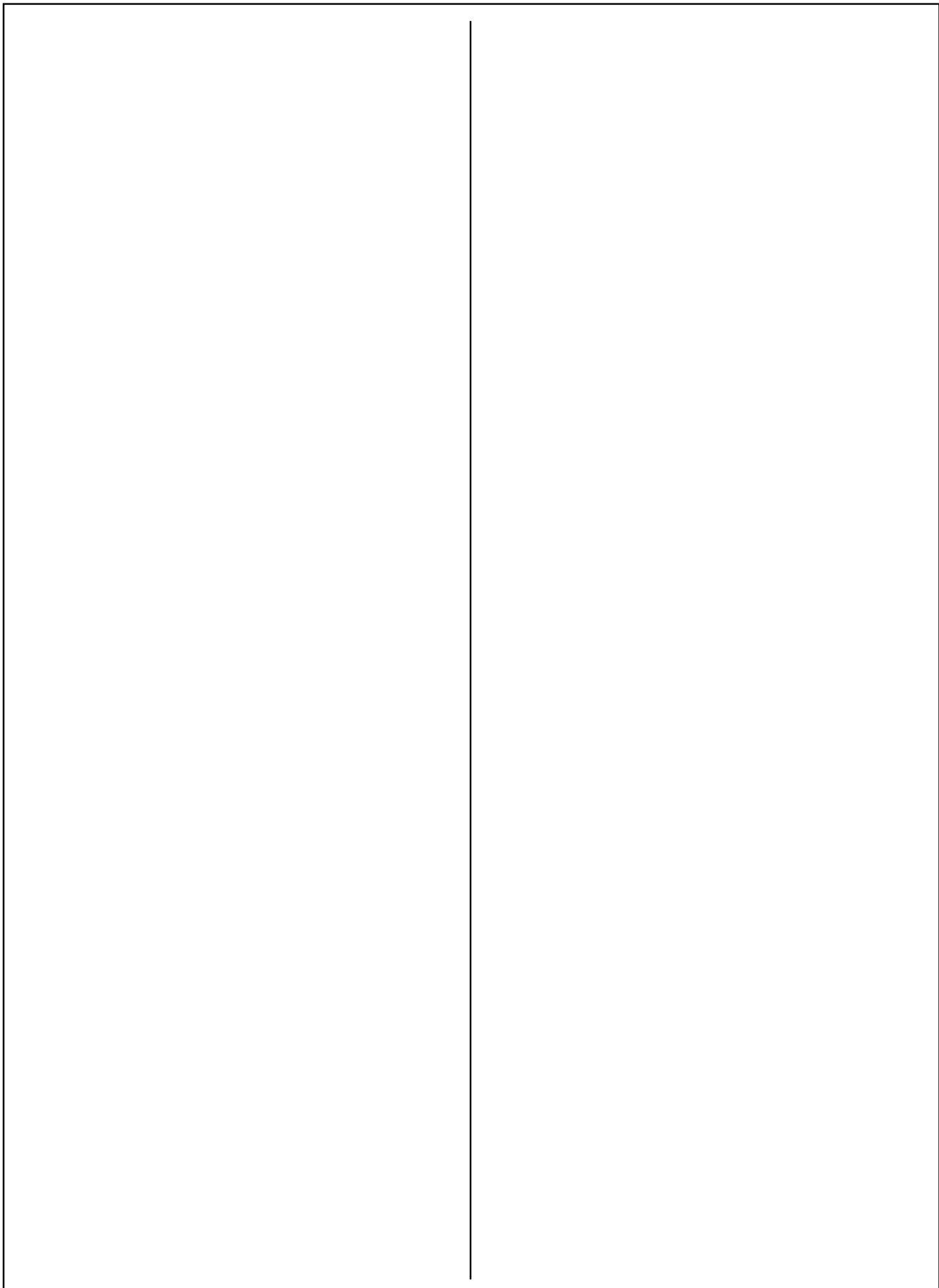



BREAK IN

Taking care to properly break in your new engine will pay off in the long run. In our years of field testing, we have proven that an Indmar engine, when properly broken in according to our simple procedures, will last longer, run better and have fewer repairs over its lifetime.

Your new engine does not require an elaborate break-in procedure. Just follow these simple instructions and you are off to a great start.

The three (3) most important aspects of new engine break-in are:

1. Avoid running engine at high speeds.
2. Do not carry a heavy load (passengers, gear, etc.).
3. Vary your boat speed during break-in, do not run at the same RPM for a long period of time.

BREAK-IN STEPS

- For the first hour, do not exceed 2,000 RPM.
- For the second hour, do not exceed 3,000 RPM.
- For the next five hours, do not exceed 4,000 RPM.

BREAK-IN TIPS

- Avoid fast accelerations and do not carry (or pull) a heavy load during this period.
- Always let engine warm up gradually before acceleration.
- Check oil frequently. During the first 50 to 100 hours, an engine can use more oil than usual. Maintain oil at a proper level at all times (do not overfill).
- Monitor transmission fluid levels.
- Report abnormal noises or vibrations to your dealer.
- Keep an eye out for loose mountings, fittings, nuts, bolts, and clamps.

During the BREAK-IN process, engine temperature should be carefully monitored and speed should be reduced if overheating is evident. **ALSO, PLEASE REFER TO ENGINE OWNER'S MANUAL FOR BREAK-IN INFORMATION.**

NOTICE: PLEASE REFER TO ENGINE OWNER'S MANUAL for maximum RPM and engine break-in procedure.

After the first 10 to 20 hours of operation, take your boat to the dealer for its first oil and filter change, as well as an engine checkup. Remember to keep a sharp eye on all gauges and warning lights during these first hours of operation. Report anything unusual to your dealer.

After the break-in procedure is over, your boat may be operated continuously at any speed.

⚠ CAUTION

Do not exceed maximum RPM recommended for your engine. Exceeding the maximum RPM may result in damage to the engine.

⚠ DANGER

Before starting your engine you must open the engine box and check engine compartment and bilge for gasoline and oil vapors.

Maximum Capacities



In compliance with United States Coast Guard Regulations, Moomba Boats meet or exceed all safety standards designed for recreational boats. To ensure safe handling and performance, each Moomba boat displays a maximum capacity sticker (see sample), stating the maximum passenger weight load allowable.

NOTICE: Refer to the Maximum Capacity Sticker on your boat for allowable loading.



WARNING
Do not exceed the maximum capacity of the boat.

Coast Guard Regulations

The United States Coast Guard boating regulations prescribe minimum standards of safety to be met and maintained by all watercraft. It is necessary that your boat remain in compliance with these regulations.

The staff at Skier's Choice, Inc. recommend that all boat operators complete a Coast Guard approved boating safety course.

Canvas Cover



Your Moomba boat cover is made from the finest canvas and webbing to ensure that your boat will be protected in the off season. The cover has been designed to fit securely around each boat. If your new cover does not seem to be snug, a shrinkage allowance has been sized in.

Use the following procedure when covering the boat:

1. Be sure that the cover fits snugly at the bow then unfold from front to back.
2. Be sure to install cover pole(s) and adjust to proper height, using set screw on pole(s). This will keep water from gathering in the center, which can damage the cover.
3. Secure all fastening straps around the trailer frame.
4. Pull the draw cord equally from both sides and tie off to the lifting eyes on the stern in accordance with the illustration.

Folding Cover

When folding the cover for storage, be sure the cover is dry. Take care not to scratch the canvas finish against rough surfaces. Store in a dry location.

Cover Repair

If the cover becomes damaged, immediately patch and reseal the area. Use a tent seam sealer to reseal any new stitches. Spray fabric guard on scraped or worn surfaces. Canvas tears should be repaired professionally and stitches sealed to prevent leakage.



CAUTION
Your mooring cover is not designed for trailering. Trailering with your cover installed may cause premature cover failure and boat damage. This damage is not warrantable.

A standard pre-starting procedure should be always be followed before the first start-up of the day.

1. Check the engine oil level.
2. Check for gasoline fumes in bilge or engine compartment.
3. Operate engine blower for four minutes before starting the engine to remove any fumes.
4. Check manual operation of bilge pump. Make sure bilge areas are empty.

Other items might also be inspected, depending on the boat and its use. It is advisable to formulate a check list particular to the equipment and operation of your boat.

REFER TO THE BOATMAN’S CHECKLIST OF THIS MANUAL.

Consult the local Coast Guard Auxiliary or Power Squadron for full details on boating safety.

NOTE: Add-on electrical accessories should never be connected to the ignition terminal or ignition circuit.

IMPORTANT: DO NOT continue to operate the starter for more than 30 seconds at a time without pausing to allow the starter motor to cool down for at least two minutes. This will also allow the battery to recover between starting attempts. PLEASE REFER TO ENGINE OWNER’S MANUAL FOR ADDITIONAL DETAILS.



Do not start engine if gas fumes are present!



BEFORE STARTING ENGINE, BE SURE THAT THE SHIFT SELECTOR IS IN NEUTRAL.

The correct starting procedure depends upon the type of engine. Please refer to the engine manual before starting.

To Start Electronic Fuel Injection (EFI) Engine

1. Place shift selector in Neutral with the throttle in the upright (zero) position. (If throttle is not in the idle position, the throttle position sensor will not allow the engine computer to proceed with a normal starting procedure).
2. Turn Ignition Key to Start Position to operate the starter.
3. Release the key when engine starts (key will return to run position).
4. Allow the engine to establish a good idle (30 to 60 seconds) before getting underway.
5. Shift slowly into forward or reverse, allowing the transmission time to engage before powering up.

NOTE: It is normal for the idle to speed up in cold start conditions.



DO NOT continue to operate the starter for more than 30 seconds at a time without pausing to allow the starter motor to cool down for at least two minutes. This will also allow the battery to recover between starting attempts. PLEASE REFER TO ENGINE OWNER’S MANUAL FOR ADDITIONAL DETAILS.

NOTE: Should the EFI engine become “flooded” use the following procedure to start:

1. Place shift selector in Neutral and disengage the transmission by pushing the transmission lockout button located at the bottom of the lever.

2. With the transmission disengaged push the lever forward to full throttle position. (This will cause the computer to shut off the fuel injectors which will allow the engine to clear of excess fuel during starting).
3. Turn the Ignition Key to Start Position and operate the starter for no more than 15 seconds at a time until the engine starts.
4. When the engine starts, back off the throttle and allow the engine to establish a good idle (30 to 60 seconds).
5. Return the throttle to idle position and the transmission lockout will automatically reengage the transmission in neutral position.
6. When ready to get underway, shift slowly into forward or reverse, allowing the transmission time to engage the gearing before powering up.

EFI Phased Warm-Up

Always let engine warm up to normal operating temperature before accelerating. EFI engines are programmed with a phased warm up to ensure that the engine is warm before full RPM is possible; refer to Table 1-1.

Table 1-1. EFI Phased Warm-Up

TEMPERATURE	TIME	RPM LIMIT
103° F (40° C) or less	_____	3000 RPM
104° to 139° F (41° to 59° C)	+ 10 seconds	4200 RPM
140° (60° C) and higher	+ 10 seconds	Full RPM



To Start Carburetor Engine

1. Place shift selector in Neutral with the throttle in the upright (zero) position and push the transmission lockout button at the bottom of the lever to disengage the transmission.
2. Turn the ignition key to the start position to operate the starter.
3. When the engine starts, release the key and it will return to the run position.
4. With the transmission disengaged, push the throttle lever forward to increase the engine idle to 1200 to 1500 RPM.
5. When the engine idle smooths out, return the throttle to idle position and the transmission lockout will automatically reengage the transmission in neutral position.
6. When ready to get underway, shift slowly into forward or reverse, allowing the transmission time to engage the gearing before powering up.

If Carburetor Engine Does Not Start

- 1B. Place shift selector in Neutral with the throttle in the upright (zero) position and push the transmission lockout button at the bottom of the lever to disengage the transmission.
- 2B. With the transmission disengaged, push the throttle lever forward about one-fourth (to slow run position).
- 3B. Turn ignition key to start position to operate starter.
- 4B. When the engine starts operate the throttle lever to establish an engine idle of 1200 to 1500 RPM.
- 5B. When the engine idle smooths out, return the throttle to idle position and the transmission lockout will automatically reengage the transmission in neutral position.
- 6B. When ready to get underway, shift slowly into forward or reverse, allowing the transmission time to engage the gearing before powering up.

If Carburetor Engine Still Does Not Start

- 1C. Place shift selector in Neutral with the throttle in the upright (zero) position and push the transmission lockout button at the bottom of the lever to disengage the transmission.
- 2C. With the transmission disengaged, move the throttle lever back and forth from one-fourth to one-third throttle.
- 3C. While moving the throttle lever turn the ignition key to Start Position to operate the starter.

NOTE: Do not operate the starter for more than 15 seconds at a time. Allow the starter to rest for a full minute before attempting this starting procedure again.

- 4C. When the engine starts, operate the throttle lever to establish an engine idle of 1200 to 1500 RPM.

If Carburetor Engine Floods

- 1D. Place shift selector in Neutral with the throttle in the upright (zero) position and push the transmission lockout button at the bottom of the lever to disengage the transmission.
- 2D. Push the throttle lever to the full throttle (wide open) position.
- 3D. Turn Ignition Key to operate starter.

NOTE: Do not operate the starter for more than 15 seconds at a time. Allow the starter to rest for a full minute before attempting this starting procedure again.

- 4D. When the engine starts, back off the throttle, but allow the engine to idle at 1500 RPM until it smooths out.



Throttle Lever



The throttle lever controls both the throttle and the transmission. The idle position (normally vertical) is the zero throttle position and the neutral position for the transmission. A safety ring (umbrella) keeps the lever from being accidentally moved to engage the transmission.

To place the transmission into gear, with your hand placed over the lever ball, pull up on the safety ring (umbrella) and slowly push the lever into forward gear or slowly pull the lever back into reverse gear.

CAUTION

Never shift the lever directly from the neutral (vertical) position into a speed position.

- To prevent damage to the transmission always allow the transmission time to engage before accelerating the engine.
- Once the transmission is engaged, you may accelerate as quickly as you like.

Transmission Lockout Button



The Transmission Lockout button allows the transmission to be disengaged while giving the throttle full operating range. With the lever in the idle position (normally vertical) push the button located at the bottom of the lever to disengage the transmission. The throttle may then be operated in any open position (forward of neutral or back of neutral upright position). Return the throttle to idle position, and the transmission lockout will automatically reengage the transmission in neutral position.

Bilge Area Drain Plug



The bilge area drain plug is located at the front of the motor well, in the center under the engine.

It is extremely important that the drain plug is always checked before starting the engine. The drain plug should be secured in place using a wrench.

NOTE: Not all Moomba models have center drains.

WARNING

DO NOT start engine until center drain plug is checked and secured in place. DO NOT try to install center drain plug while engine is running.

CAUTION

Some Moomba models DO NOT have mechanical devices to hold the motor box cover in the open position. Please use caution to prevent accidental closing.

Rear Drain Plug (if applicable)

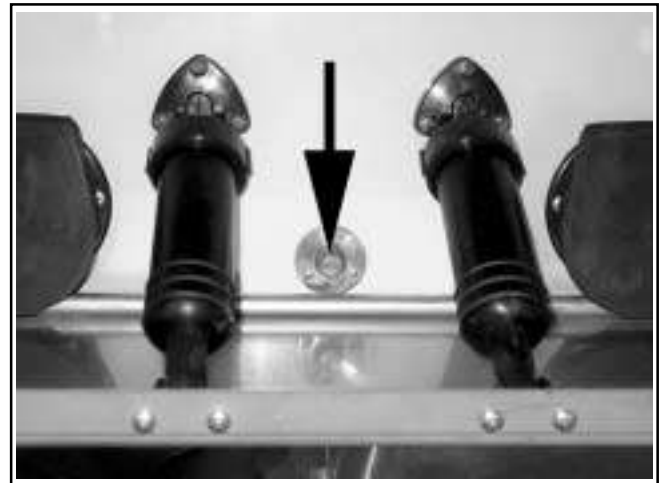

The rear drain plug is located at the back of the boat, near the bottom of the transom. It is extremely important that the drain plug is always checked before starting the engine. The drain plug should be secured in place using a wrench.

CAUTION

DO NOT start the engine until the drain plug is checked and secured in place. DO NOT try to install the drain plug while the engine is running!

Fuel Precautions



Use a gasoline with a minimum octane rating of 89.

WARNING

DO NOT use gasoline containing methyl alcohol (methanol) or ethyl alcohol (ethanol). Methanol and ethanol can damage your boat's fuel system.

CAUTION

Gasoline stabilizer should be added to the fuel tank when the boat is used infrequently or whenever your boat will not be used for two weeks or more. During storage always add Gasoline stabilizer to reduce gumming or tank sludge.

Filling the Tank

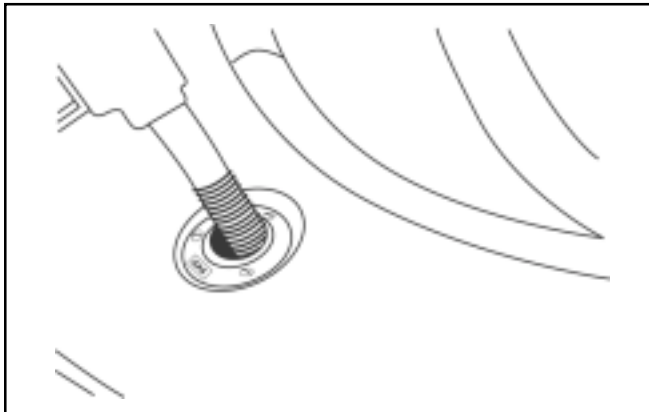

CAUTION

Be especially careful when filling the fuel tank. DO NOT over fill the tank. Fuel may empty through the fuel vent and damage to finishes could result.

If fuel is spilled on stripes or decals, apply a common bath cleaner (nonabrasive) and wipe with a damp cloth. Rinse the spill area with clean water.

Fueling



WARNING

Sparks while fueling could cause an explosion!

Before Fueling:

1. Turn off engine.
2. Turn off ignition.
3. Extinguish cigarettes or any open flame.

While Fueling:

1. Keep hose nozzle in contact with fill pipe to provide a ground against static sparks.
2. Fill tank at a slow rate to avoid any spillage.

Fuel Cap & Key



The fuel cap is located on the rear deck near the stern. A special fuel key is provided to open the cap.

NOTE: The cap is sealed by a rubber O-ring. Please do not over tighten.

Section VII

Instrument Panel & Controls

Moomba Dash



Speed Calibration



Speed may be checked using a stopwatch and a standard slalom course. Adjust the speedometer needle by twisting the adjuster knobs located next to the tachometer.

Slalom Course Speeds

(Times are from start gate to end gate)

MPH	SECONDS	ALLOWABLE
+ or - 1/2 MPH		TIMES / (SECS)
18	32.19	32.0 - 32.6
20	28.97	28.0 - 28.6
30	19.31	19.0 - 19.6
32	18.11	17.9 - 18.3
34	16.95	16.8 - 17.2
36	16.08	15.9 - 16.3

Warning Stickers

Always heed the dash mounted warning stickers.



GASOLINE VAPORS CAN EXPLODE!

BEFORE STARTING ENGINE:

- Check engine compartment for gasoline or vapors.
- Operate blower for four minutes before starting engine.
- Run blower below cruising speed.
- Turn off engine before using swimming ladder.

Speedometer



The speedometer indicates the water speed of the boat in miles per hour. It is recommended that the speedometer be checked for accuracy after each 100 engine hours.

Speed may be checked using a stopwatch and a standard slalom course. Adjust the speedometer needle by turning the knob at the bottom of the gauge.

NOTE: If the speedometer registers erratically, check speedometer pickups.

Speedometer Pickups

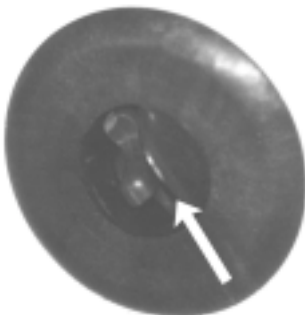

The speedometer pickup is located on the bottom of the hull. The pickup measures the speed of water passing the paddlewheel. Poor water conditions or foreign material may clog the pickup causing the speedometer to register incorrectly.

Inspect the paddlewheel and remove any foreign material only when engine is off. Please see paddlewheel owner manual in the Boat Owner's Packet for more information.

Tachometer

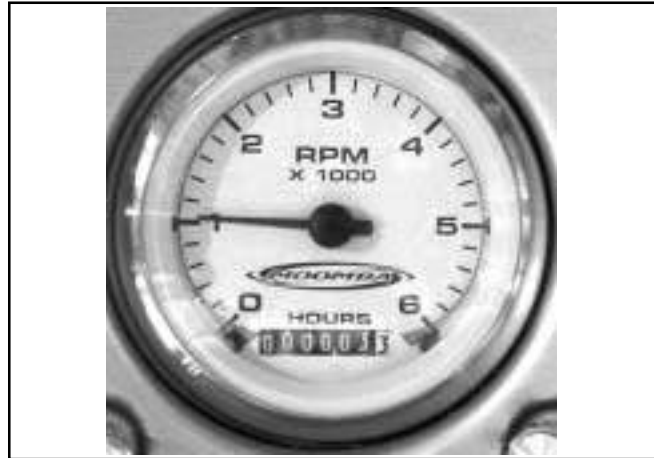

The tachometer registers the operating speed of the motor's shaft output and may be used as an alternative to speedometer if weight and water conditions permit.

DO NOT exceed the recommended RPM during break-in and normal operation of your motor. Exceeding the manufacturer's suggested RPM may cause damage to the engine.

Engine Hours



ENGINE HOURS are shown on the face of the tachometer. The engine hour gauge acts as an odometer for the engine.

Engine hours should always be noted and documented so that required maintenance and lubricant changes may be performed at the proper intervals.



Voltmeter (Inboard)



The voltmeter indicates whether the battery is charging or discharging. The needle should be located in the normal range while the engine is running.

If the voltmeter does not register in the normal range, there may be a problem within the electrical system. It is normal for the voltmeter needle to fall when starting the engine. Normal range is 12 to 14 volts.

Temp Gauge



The temperature gauge indicates the engine coolant temperature while the coolant is circulating inside the engine. Engine operating temperatures will vary depending on the weather conditions and engine load. Normal operating temp range is between 160 degrees and 180 degrees.

NOTICE: Refer to your Engine Owner's Manual for additional details.

Oil Pressure Gauge



CAUTION
Running the engine with low oil pressure may cause severe engine damage.

The oil pressure gauge indicates the oil pressure in the engine while the engine is running.

If the oil pressure remains below the normal range of 20 to 80 psi, stop the engine immediately. If engine is allowed to run while oil pressure is too low, permanent engine damage may occur.

Fuel Gauge



This gauge indicates the approximate quantity of fuel remaining in the tank when the ignition switch is in the "ON" position.

NOTICE: DO NOT run the tank to empty. To prevent condensation from forming in the tank, it is recommended that the tank be filled when the gauge indicates 1/4 tank of fuel remaining.

Depth Sounder



Setting Units

The depth sounder can display depth in either standard or metric units.

Perform the following steps to change the display units:

1. Simultaneously press the up and down buttons. Either the FT or M units indicator display text will flash.

THEN...

2. To set feet units, press the up button. The FT indicator display text will flash for five seconds and return to normal mode display with feet as the current units.

OR...

3. To set Meter units, press the down button. The M indicator display text will flash for five seconds and return to normal mode display with Meters as the current units.

NOTE: When power is applied or removed and reapplied, the units display defaults to feet units.



Setting Deep Alarm

The deep alarm function can be set for depths ranging from 3 feet (1.0 Meter) to 200 feet (60.9 Meters). An alarm triggers when the water depth is greater than the set value.

Setting Deep Alarm (continued)

To set the Deep Alarm, perform the following:

1. Press the down button. The current deep alarm depth setting will display.
2. Press the up or down button to increase or decrease respectively the deep alarm depth value. Pressing either button once will change the depth value in 1-foot or 0.1 Meter increments. Holding either button will change the depth value in 9-foot or 1-Meter increments per second.
3. After setting the depth value, the alarm and down arrow icons will blink for five seconds then the display will return to normal operating mode with the alarm and down arrow icons displayed.

When triggered, an audible alarm sounds for ten seconds while flashing the warning LED, alarm and down icons on the display. After ten seconds, the audible alarm mutes but the LED and display icons continue to flash.

NOTE: When power is removed from the instrument, all depth settings are returned to "000".

Setting Shallow Alarm

The shallow alarm function can be set for depths ranging from 3 feet (1.0 Meter) to 200 feet (60.9 Meters). An alarm triggers when the water depth is less than the set value.

To set the shallow alarm, perform the following:

1. Press the up button. The current shallow alarm depth setting will display.
2. Press the up or down button to increase or decrease respectively the shallow alarm depth value. Pressing either button once will change the depth value in 1-foot or 0.1 Meter increments. Holding either button will change the depth value in 9-foot or 1-Meter increments per second.
3. After setting the depth value, the alarm and up arrow icons will blink for five seconds then the display will return to normal operating mode with the alarm and up arrow icons displayed.

When triggered, an audible alarm sounds for ten seconds while flashing the warning LED, alarm and up icons on the display. After ten seconds, the audible alarm mutes but the LED and display icons continue to flash.

NOTE: When power is removed from the instrument, all depth settings are returned to "000".





Out of Range Display

If the display indicates three horizontal bars as shown, the depth sounder indicates an out of range, inaccurate or incomplete data condition.

An out of range condition occurs when the depth reading is less than 2.5 feet (3.0 Meters) or greater than 200 feet (60.9 Meters).

Inaccurate or incomplete data will cause an out of range condition when operating in extremely dirty water, very soft bottom or at high speeds. A faulty or improper transducer connection can also cause an out of range error condition.

Troubleshooting

INSTRUMENT DOES NOT TURN ON

1. If applicable, check main power supply fuse to the unit. If it is blown, replace it with a 1 amp, normal blow fuse. If in-line fuse is used, clean all corrosion from the fuse.

Troubleshooting

INSTRUMENT DOES NOT TURN ON (continued)

- housing or replace the fuse holder assembly if necessary.
2. Check the power cable connection. Be sure that the unit is connected to a known power source: RED wire to positive, BLACK wire to negative or ground.
3. Ensure that the power source is powered using a test light or some other reliable form of testing 12 volt power.
4. If you are sure that the unit is receiving power and is still not functioning, please contact Customer Service for assistance.

RANDOM OR FLASHING BOTTOM READING

1. Under certain circumstances, the depth sounder may not perform at the best of its ability. Extremely dirty water, very soft bottom, high speeds, deep water, or a combination of the above will result in incomplete or inaccurate readings.
2. Check the transducer cable connection on the back of the unit.
3. Contact Customer Service for assistance if you are unable to correct the problem.

User Interface/Display Features



Stereo



Please refer to your stereo owner's manual for proper operation instruction.

NOTE: Stereo unit is connected to the STEREO switch on the dash. The ACC switch must be in the "ON" position before the stereo can be turned on.

⚠ CAUTION The stereo cannot be turned off by the remote. The "SRC" button on the stereo unit must be held down for three seconds to completely turn the stereo off. Continue to hold the SRC button until display goes blank or turn off the ACC switch on the dash..

⚠ CAUTION If the face displays "ALL OFF", your stereo is in standby mode and drawing battery power which will drain the battery and may lead to a dead battery.

STANDARD MOOMBA PACKAGE

NAVIGATION LIGHTS SWITCH

The Navigation Light switch supplies power to the Bow Light, the Stern Light and the Pole Light.

Operation (Refer to illustration Below):

When underway during night time operation, set the switch in the NAV position to activate all of the running lights.

When docked or at anchor, set the switch, in the ANC position to activate only the pole light.

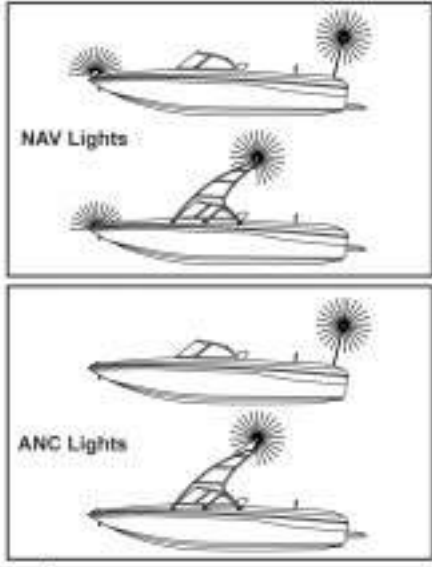

BILGE PUMP SWITCH

The bilge pump switch operates in two positions. The manual position is used to verify that the pump is operational.

The automatic pump function is engaged at all other times so that any excess water in the bilge may automatically be pumped out.

BLOWER SWITCH

The Blower switch activates the blower motor. The fan removes fumes from bilge area and also draws fresh air into the engine compartment. Use blower fan a minimum of 4 minutes before starting the engine.

STEREO SWITCH

The Stereo switch supplies power to the stereo unit. The switch must be turned on before the stereo can be played.

NOTICE

If any lights, bilge, stereo, courtesy lights, or accessories fail to operate, press the appropriate circuit breaker located under the switch.

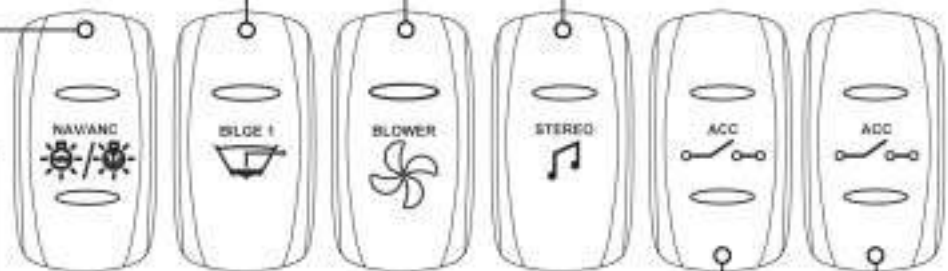

ACCESSORY SWITCH (2 POSITIONS)

The Accessory switch supplies power to an extra circuit for accessories that may be added (such as heaters, hot water showers, optional stereo, etc.)

ACCESSORY SWITCH (3 POSITIONS)

The Accessory switch supplies power to an extra circuit for accessories that may be added (such as heaters, hot water showers, optional stereo, etc.)

Switch configuration may vary slightly based on options. If you have any questions regarding operation, please contact your dealer or Skier's Choice, Inc.

MOBIUS PACKAGE

NAVIGATION LIGHTS SWITCH

The Navigation Light switch supplies power to the Bow Light, the Stern Light and the Pole Light.

Operation (Refer to Illustration Below):

When underway during night time operation, set the switch in the NAV position to activate all of the running lights.

When docked or at anchor, set the switch, in the ANC position to activate only the pole light.

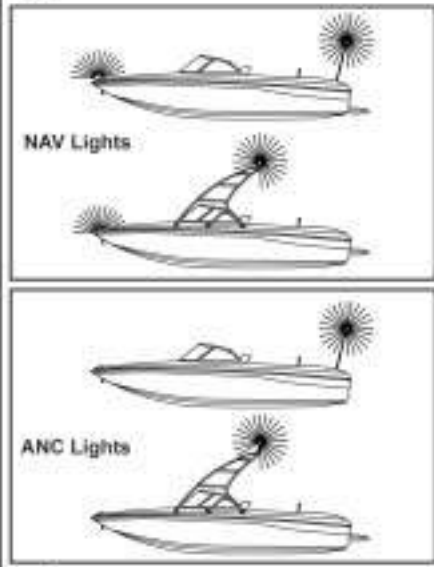

BILGE PUMP SWITCH

The bilge pump switch operates in two positions. The manual position is used to verify that the pump is operational.

The automatic pump function is engaged at all other times so that any excess water in the bilge may automatically be pumped out.

BLOWER SWITCH

The Blower switch activates the blower motor. The fan removes fumes from bilge area and also draws fresh air into the engine compartment. Use blower fan a minimum of 4 minutes before starting the engine.

STEREO SWITCH

The Stereo switch supplies power to the stereo unit. The switch must be turned on before the stereo can be played.

NOTICE

If any lights, bilge, stereo, courtesy lights, or accessories fail to operate, press the appropriate circuit breaker located under the switch.

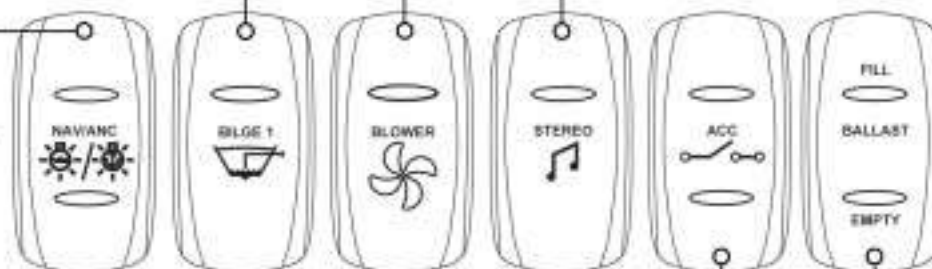

ACCESSORY SWITCH (2 POSITIONS)

The Accessory switch supplies power to an extra circuit for accessories that may be added (such as heaters, hot water showers, optional stereo, etc.)

BALLAST SWITCH

To fill the ballast system press the upper part of the Ballast switch labeled FILL. To empty, press the lower part of switch labeled EMPTY.

Switch configuration may vary slightly based on options. If you have any questions regarding operation, please contact your dealer or Skier's Choice, Inc.



Ignition Switch



Located on the port side of the dashboard, the ignition switch has three positions. In the vertical position the ignition is OFF. With the key in, turn the ignition switch one notch to the right to check all electrical equipment, including blower, pump, and lights. Turn the ignition all the way to the right to operate the starter.

NOTE: All electrical equipment should be turned off when the boat is in storage.

Tilt Steering

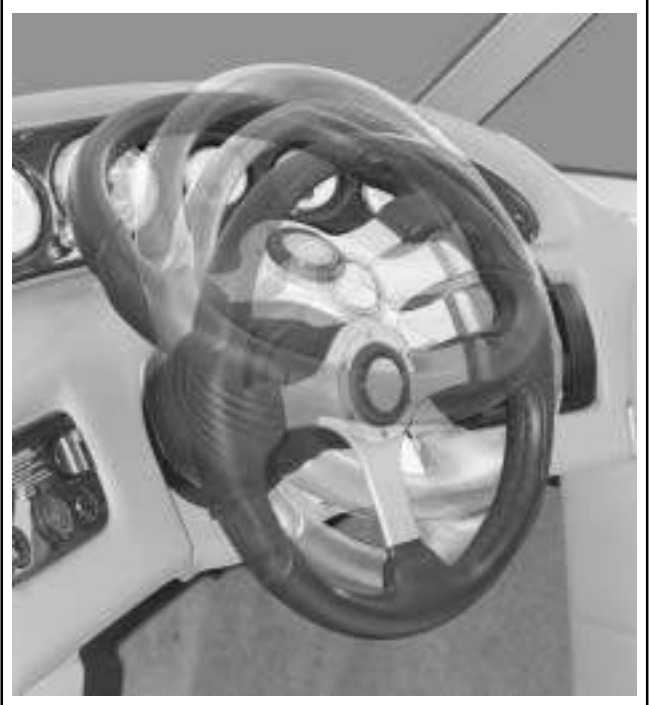

Tilt steering may be adjusted up or down in five different locking positions. To adjust, depress the tilt lever located beneath the bezel and move the steering wheel to the desired position. Release the lever to lock the wheel into place.

Horn

Horn Button

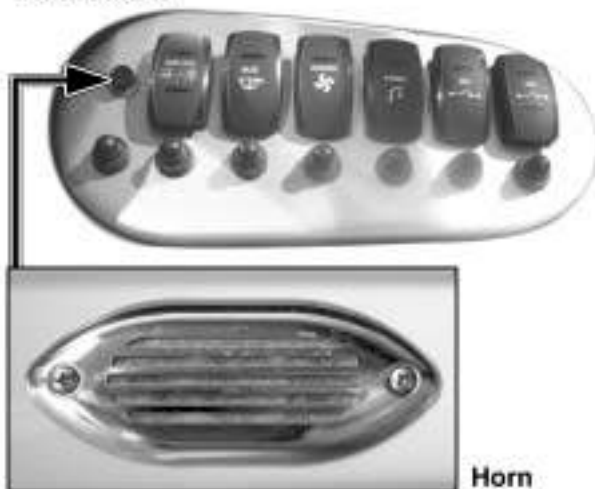

The Horn Switch is located on the switch panel to the right of the steering wheel.

Horn / Whistle Signals

One Long Blast:

Warning Signal (Coming out of slip)

One Short Blast:

Pass on my Port Side

Two Short Blasts:

Pass on my Starboard Side

Three Short Blasts:

Engines in Reverse

Four or More Blasts:

Danger Signal

- 1. OVERTAKING / PASSING:** Boat being passed has the right-of-way. KEEP CLEAR.
- 2. MEETING HEAD-ON:** Keep to the right.
- 3. CROSSING:** Boat on the right has the right-of-way. slow down and permit him to pass.

Warning Light (V-Drives Only)



The warning light should be "on" at idle. If the light remains "on" when the engine is above 1200 RPM, shut the engine off and check V-Drive oil level.

Optional Bertha Ballast System

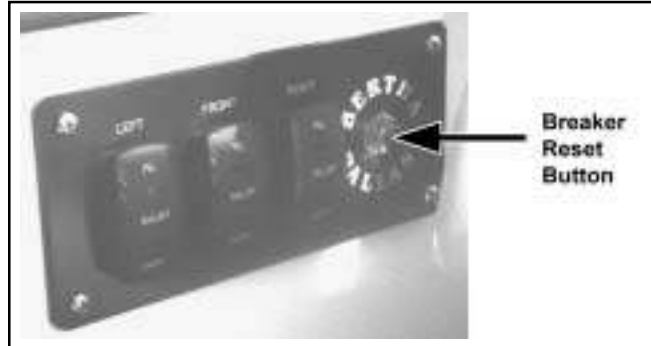

The optional Bertha Ballast System is an electronically controlled ballast system that can be operated from the driver's seat. The Bertha system is available in a 1, 2 or 3 position system. The switch panel to the 2 and 3 position systems is located directly below the shifter mechanism, and the 1 position system is operated from a switch on the dash. Each switch allows independent filling and draining of each ballast container by simply hitting the fill or drain switch. If the system fails to fill or drain, you may check the resettable breaker on the switch panel, or the separate ballast fuse block located under the dash area. The ballast bags or tanks can be found in the front ski locker, under the rear seat, or in the rear v-drive storage areas depending on the the model and ballast system.



Care should be taken that the ballast bags are situated properly with the fill hose on top and drain hose on bottom and that all fittings are installed securely. The bags should not be twisted and the bags should be free to expand and drain completely. Care should be taken to prevent sharp objects from coming in contact with the bags. Cuts and punctures to the bags are not warrantable.

Optional Bertha Ballast System (continued)



Each Bertha Ballast system also includes a manual shut off valve in case of emergencies. If closed, the valve will prevent any water from entering the system and is only used in emergency situations. Under normal use the valve should remain open to allow full flow of water into system.

Priming the System

To allow water into the system, the Bertha Ballast system utilizes a scooped intake stainer to force water into the system. This allows the ballast system to be filled while running or sitting still. If air becomes trapped in the system, it may be necessary to run the boat at planing speeds to force water into the system and allows the fill pump to prime fully. Once the pump has primed it is no longer necessary to run the boat for filling. This situation may occur if the boat is trailered.

CAUTION

When bags begin to vent, shut off!

WARNING

DO NOT OVERFILL BALLAST BAGS!

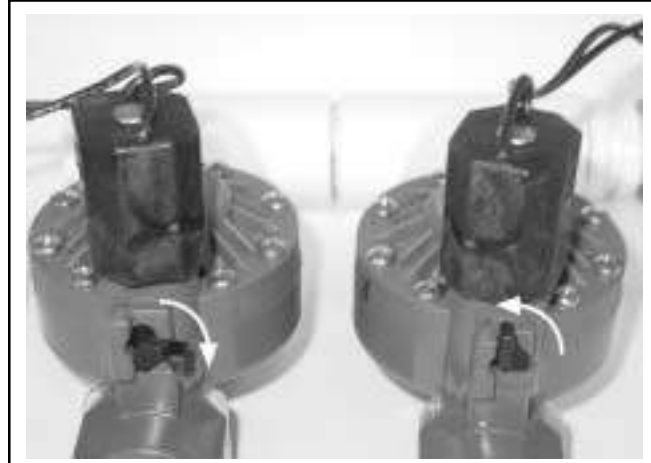

The Bertha Ballast system utilizes a manifold and a solenoid valve to independently fill each bag or tank. The solenoid valves have a small toggle switch that can manually override the opening of the valve. The manual toggle switch needs to be in the “down” position to allow the system to be controlled by the switches in the dash area. If the manual toggle switch is turned to the “up” position, the valve will be open all the time and cannot be controlled by switches in the dash area. If the ballast system fills continuously while running the boat, check to make sure the manual override toggle switch is in the “down” position. If it continues to fill and the manual toggle switch is in the “down” position, check for debris that may have clogged the solenoid valve forcing the valve to stay open. If the valves continue to fill, closing the manual emergency shut-off valve will prevent any water from entering the system.



Each Bertha Ballast system also includes an in-line water strainer before the manifold. This strainer will keep debris out of the solenoid valve and should prevent the valve from getting clogged up and forced open. The strainer cover should be removed periodically and the filter screen cleaned to prevent debris buildup on the mesh screen. Be careful when

removing the cover not to lose the O-ring used to seal the cover. Also, the strainer should be removed and drained during winterization.

To fill the ballast system, press the fill switch. To empty, press the empty switch. With the ballast full, the boat may porpoise at speeds above 25 mph.

WARNING

Empty ballast before trailering the boat. DO NOT trailer boat with ballast full!

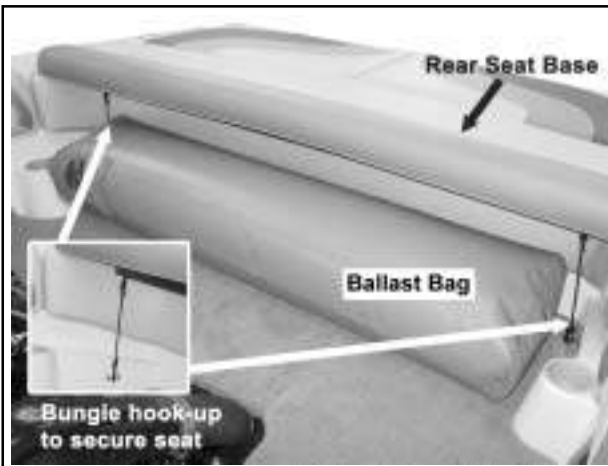

Outback Optional Bertha Ballast System

NOTE: When filling the rear ballast bag in the Outback, the rear seat should be raised to the upper position to allow the bag to expand freely.

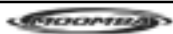

Section VIII

Equipment & Options

Ignition Keys



Two ignition keys are provided with the boat. Key entry into the ignition may sometimes be difficult due to the rubber boot protector. Please do not unduly force the key into the ignition. Key tumblers are located vertically, so the key should be vertical when placed into the switch.

Mirror

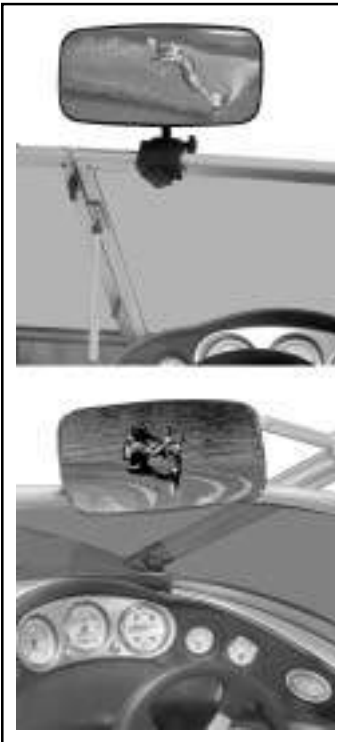

The rear view mirror is installed as a standard item. The mirror is adjustable so that it may be set for each driver.

- Mirror should always be checked before driving.
- Mirror angle will change with each new driver.

Fuel Cap Key



To prevent tampering with the fuel system, your boat is supplied with a gas cap which may be opened only with a special key.

NOTE: The gas cap is sealed by a rubber O-ring. Please do not over tighten.

CAUTION

Always attach the ignition key and gas key to a floating key chain to prevent loss overboard.

Driver's Seat & Seat Adjustment

The Rise-R Seat is a unique driver seat enhancement. The front edge of the driver's seat cushion lifts up to give the driver a taller sightline. To switch the seat to the raised position, use two hands to lift and push the front edge of the seat cushion up and back until it is sitting on the rear half of the driver's seat cushion. To switch to the lower position, use two hands to push the Rise-R seat cushion forward and down.



CAUTION

Be careful of the articulating hinge. Do not place fingers or other objects in the hinge mechanism during use.

The driver's seat may be adjusted forward or backward by moving the lever below the front of the seat. Use body pressure to move the seat to the desired position. Release the lever then check to feel the seat lock into place.

CAUTION

After adjusting the seat, be sure that it has locked into place by pushing forward and backward until it has securely latched.

DO NOT attempt to adjust the driver's seat while the boat is moving.

Motor Box Cover



The motor box encloses the inboard engine and quiets engine noise. When opening, stand on either side, grasp the handle and pull up and back at an angle. If the engine requires maintenance, open the box lid until it rests open.

WARNING

Never open the Motor Box while the boat is moving!

CAUTION

Some Moomba models **DO NOT** have mechanical devices to hold the motor box cover in the open position. Please use caution to prevent accidental closing.

V-Drive Engine Compartment

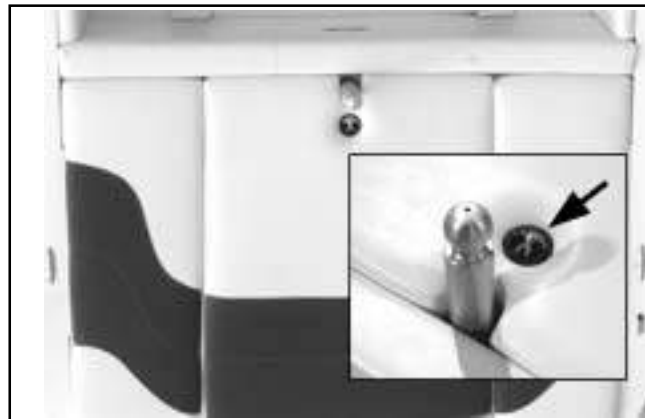

To access the engine compartment, turn latch and pull to raise the center sun deck lid. When the ski lockers and engine compartment lids are closed, the upholstered lids double as a cushioned sun deck.



Fire Extinguisher



A standard Coast Guard approved fire extinguisher is provided on all Moomba boats. The fire extinguisher is located on the port side of the interior under the observer's seat.

(Refer to label instructions for use.)

Glove Box



To open the glove box, press the black round cylinder down while lifting the black finger tab. Once open, the lid is supported by a spring. To close the lid, push the middle of the spring toward the rear of the glove box with one hand as you guide the lid closed with the other.

Ski Pylon



The ski pylon is only to be used to pull skiers. **DO NOT use the ski pylon to hoist the boat.** Only use the lifting rings for this purpose.

NOTE: With use the ski pylon may loosen. Should this occur, see your Moomba Dealer for service.

WARNING

The use of pylon extensions can severely effect the overall handling of the boat. Follow pylon extension manufacturers directions for mounting.

DO NOT mount any Pylon Extension on the rear pylon (located at the rear sundeck).

Rad-A-Cage

The Mobius models are equipped with a Moomba Rad-A-Cage towing tower. The cage is designed as a stable tower to enhance wakeboarding. It is **NOT** intended to be used to tow skiers, barefooters, or multiple wakeboarders. Such use will void any warranties written or implied.

WARNING

Be sure that all bolts are tightly in place before use.

WARNING

Be aware of and avoid low overhead objects such as bridges, power lines, overhanging trees, etc.



To Lower Cage for Storage:

Tools required: 5/16" Allen wrench (for stainless steel 3/8-16 X 1-14" Allen head bolt)

- Loosen, but DO NOT remove front leg allen bolts.
- Loosen and remove the hand-knob bolts that connect the rear legs to the feet.
- Place the hand-knob bolts somewhere for safe storage.
- While standing in the bow area, pull the cage forward, gently placing it against the bow of the boat.

CAUTION

Place padding between the cage and the boat to protect the gel coat.

Pop-Up Cleat



To use the cleat, pull center up.

WARNING

DO NOT tow objects with the cleats.

To Raise Cage:

- Lift and rock the tower back into place until the rear legs align with the rear feet. (Some manipulation of the cage may be required to get the legs to line up with the feet.)
- Install and tighten the rear head-knob bolts
- Tighten the front leg's allen bolts.

CAUTION

The threads in the aluminum foot could be damaged if the bolts are not aligned and threaded correctly.

WARNING

The Rad-A-Cage is designed to pull single (1) wakeboarder, trick skier, or kneeboarder.

Bow Light



The bow light is located on the forward deck. To alert other boaters to your position and direction while underway at night, the light is green on the starboard side and red on the port side. To replace the bulb, remove Phillips screw to lift cover.

Tower Pole Light

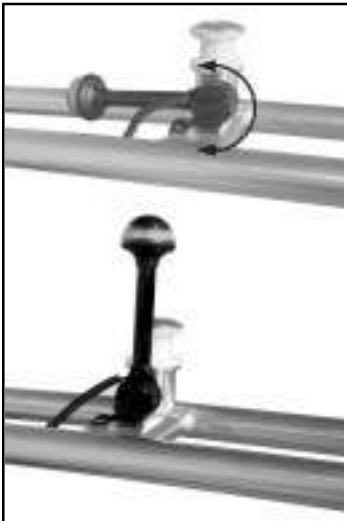

Boats equipped with factory installed towers, the 360° White Pole Light is mounted on the tower. To raise the light, turn knob on front of light to the left and then carefully raise the light to a vertical position. Re-tighten the knob. Always lower the light after use and before trailering to avoid hitting low overhangs.

NOTE: If using tower pole light, do not use stern pole light.

Stern Pole Light



The removable pole light is stored in the bow. Always check for proper alignment when inserting the pole light into the receptacle.

The pole light must always be in place and illuminated when visibility is limited. The pole light must be displayed while under way from sunset to sunrise. The pole light must also be illuminated while at anchor from sunset to sunrise.

CAUTION

DO NOT pull skier with tow rope attached to ski pylon while pole light is in place.

Pole Light Receptacle



The pole light receptacle is located on the port side deck near the stern. To install the pole light, open the cover completely and with the plug correctly aligned, slide it into the socket until the electrical contacts are firmly in place.

Bow Eye

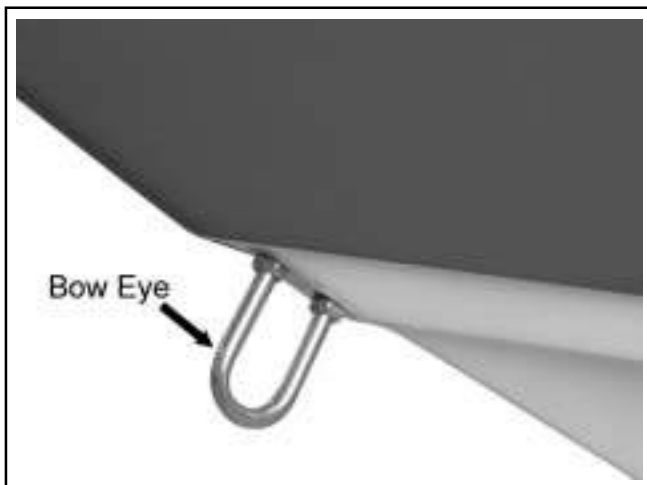

The bow eye is located at the front of the hull below the rub rail. It is the point of attachment to lead the boat onto the trailer and to secure the boat to the trailer or to a tie-off when docking.

NOTE: See Hoisting Instructions before using the bow eye to hoist the boat.

WARNING

DO NOT use the bow eye **ONLY** to hoist the boat. You must use a sling with the bow eye when hoisting the boat. Use only the designated lifting rings to hoist the boat. (See Hoisting Instructions.)

Ski Platform Detachable Bracket

The ski platform is fastened to the boat with detachable brackets. The platform may be removed from the boat by pulling the retaining pins from the brackets.

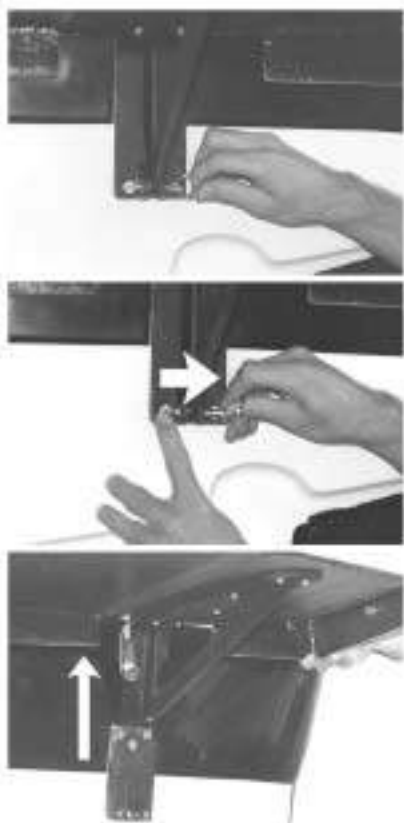

Lifting Rings



Two lifting rings are located on the transom.

NOTE: The lifting rings should be the only point of attachment for lifting cables. (See Hoisting Instructions.)

Ski Platform



All Moomba models are equipped with a ski platform on the stern. The platform allows easy access to and from the water for skiers and swimmers.

It is recommended that all entries to and exits from the water be made from the platform to avoid accidents. (The fiberglass deck can become slippery when wet.)

DANGER

Shut Engine OFF when people are on the platform or in the water near the platform.

DANGER

Exhaust fumes contain carbon monoxide. Direct or prolonged exposure to carbon monoxide will cause brain damage or death.

Propeller

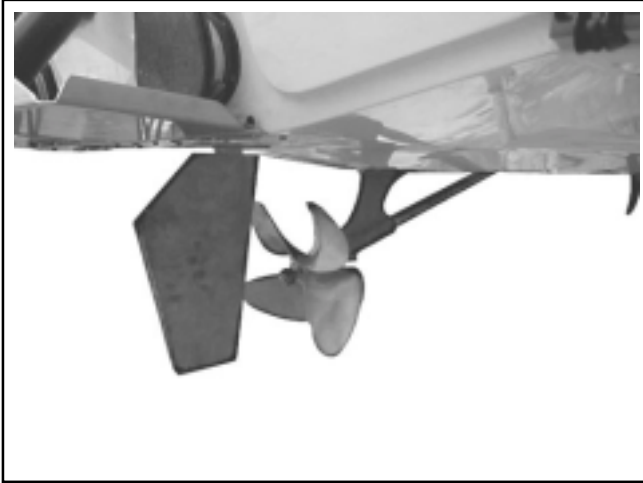

The research and design team at Skier's Choice has carefully explored and tested many different propellers and pitch angles for use on Moomba boats. All tests indicate that the current propeller installed on your model is the best for the variety of boating performance required, whether skiing competitively or for pleasure.

It is strongly recommended that your Moomba dealer be notified before changing the propeller. In general, changing to a lower pitched propeller may increase acceleration, but will decrease top speed. Changing to a higher pitched propeller may achieve higher top speed with a light load, while acceleration and power may decrease.

Propeller Precaution

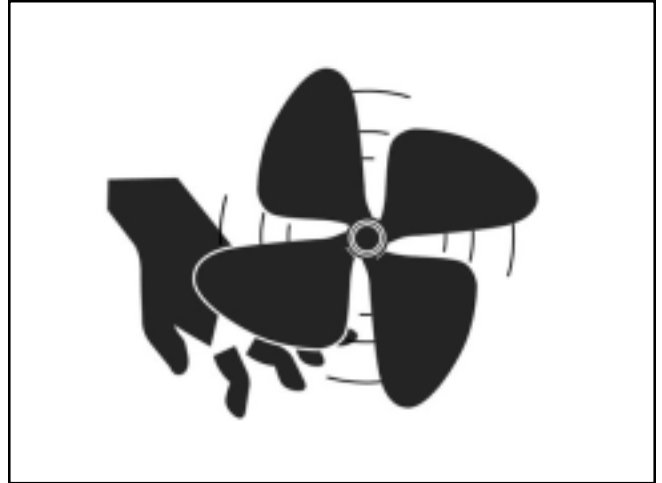

WARNING

Moving propeller will cause injury. Propeller may rotate with boat in neutral. Shut off the engine when people are on the platform or in the water near the platform to avoid injury from the prop rotation.

NOTE Under no circumstances should a propeller which allows the engine to surpass recommended RPMs be installed.

Outback Hi-Low Rear Seat



The Outback features a convertible rear seat that can be placed in normal seat cushion setting or in an upper sundeck setting. To move the seat from the low to high position, pull the seat cushion forward toward the motor box, then place the cushion on top of the rear seat sides. Be sure to install the locking straps when the cushion is in the upper position.

WARNING

DO NOT exceed 45 MPH with the sundeck in the upper position. DO NOT trailer the boat with cushion in the upper position. Loss of a seat cushion or damage associated to the seat coming out of the boat IS NOT covered by your boat warranty.

Optional Trim Switch and Gauge

Optional Hydraulic Wakeplate

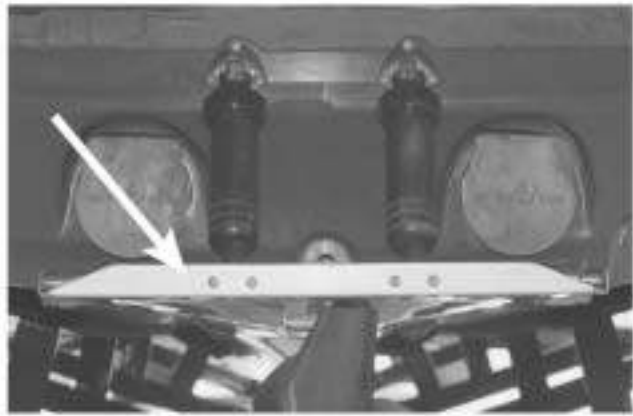

This switch controls the optional hydraulic wakeplate. The gauge indicates the position of the wakeplate. The gauge will only read from 0 degrees to 50 degrees due to limited hydraulic movement.

The optional hydraulic wakeplate allows the driver to control the running attitude of the boat.

Battery Box



The battery box is mounted on the inside of the observer's seat storage compartment.

NOTE: It is recommended that the battery cables be disconnected from the battery when the boat is placed in storage. (Refer to Battery Cable Installation and Precautions)

Fueling Conditions



The following conditions may be considered normal operation of the fuel gauge and fuel system:

- Gas station pumps may shut off before the fuel gauge indicates FULL.
- The amount of fuel required for fill-up may not exactly correspond to the gauge.
- The gauge needle may not move away from FULL until some time after fill-up.
- The gauge needle may move during turns, stops, and acceleration.

NOTICE: Become familiar with engine hourly fuel consumption at various speeds and know when to check the fuel gauge.

Walk-Through Windshield



The moveable center windshield panel allows access to and from the bow area on some models. To open, turn safety latches to vertical and push. Carefully lay the hinged windshield panel back against the fixed side panel.

Fuel Vent

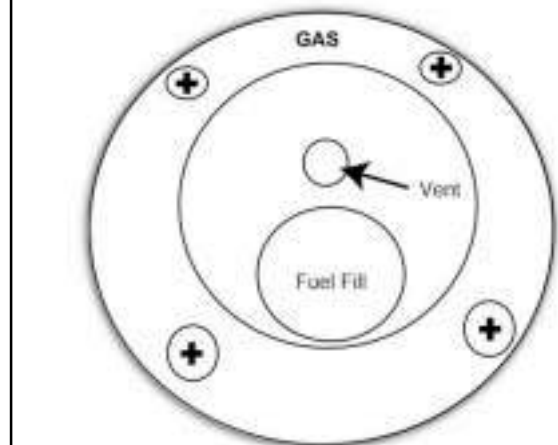

The fuel vent is a part of the gas filler neck. This vent is connected to the fuel tank via the vent hose, which releases gasoline fumes from the fuel tank.

 **DANGER**

Gasoline vapors are highly explosive!

Double-Up Seating



Some Moomba models offer Double-Up seating. This unique seating can be stored flat for easy access to the bow or flipped up for extra rear and forward facing seating. To use this seating, lift and pull the seat back into the locked position. Be sure that the metal arms are locked straight before applying pressure. To lay seat back down, simply push down on the middle section of the metal support arm.

Optional Wakeboard Racks

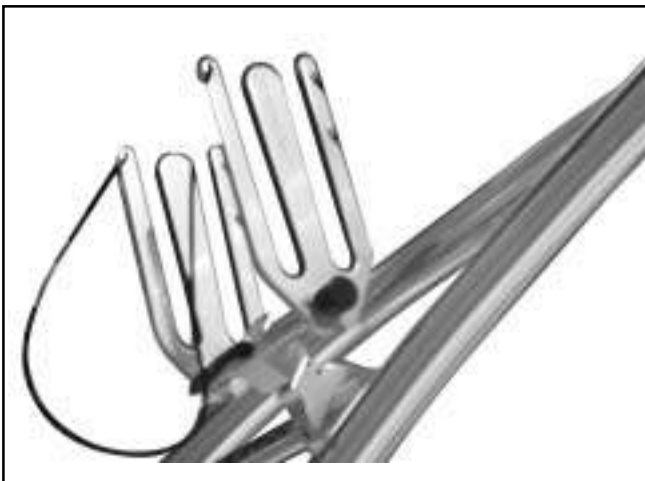

Wakeboard racks are a convenient way to transport and store wakeboards while using your boat.

⚠ CAUTION

Check tightness of all mounting hardware before each use.

⚠ CAUTION

DO NOT trailer the boat with wakeboards mounted in the rack.

Optional Bimini Top

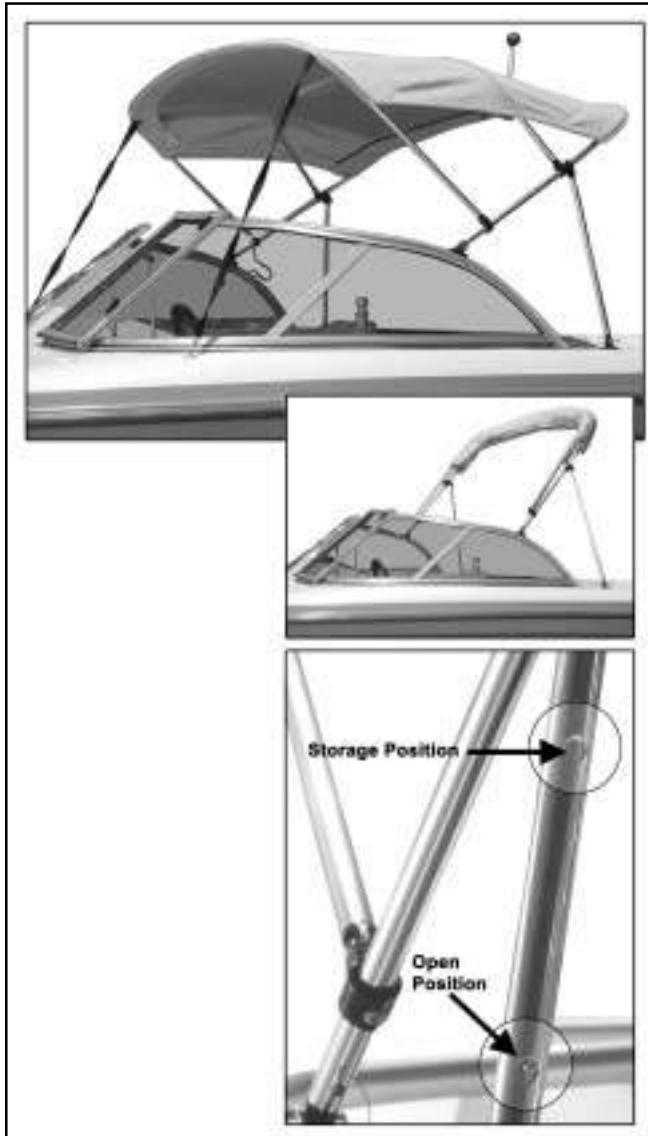

The bimini top is designed as a sunshade. Please see the mooring cover section for instructions on cleaning and caring for your bimini top. When opening and latching the straps to the eye hooks, twist the strap one to two times to prevent them from vibrating in the wind.

⚠ CAUTION

DO NOT operate the boat above 45 MPH with the bimini top open.

Optional Boat Heater



The boat heater is a forced air heater that uses hot engine water as a heat source. To use the heater, simply turn the heater switch to the selected fan speed. In order for the heater to work, the engine must be at operating temperature. One of the features of the heater are the snorkel vents, which can be pulled out to direct heat to specific areas.

Optional Shower



The hot water shower is a convenient way to warm wet-suits or wash down your boat. It uses water from the lake and water that has been warmed by the engine as its water source. The shower nozzle is located in the rear storage trunk. The master on/off switch for the shower is located next to the shower nozzle. The pump is controlled by a pressure switch and will shut off when the pump reaches proper pressure. The master switch for the shower should be turned off after each use.

Cooler



Some Moomba models offer built-in coolers. They are foam insulated and have drain holes that drain water into the bilge. Be sure to thoroughly clean the cooler and allow it to dry after each use to prevent mold and mildew.

NOTE: Damage from mildew and mold IS NOT covered under your boat warranty.

Optional Satellite Radio



The optional satellite radio option is designed to give the user music access anywhere they go in North America. The system is a 100 channel system which is broken down into different music types such as: oldies, hard rock, easy listening, alternative, 80's, jazz, big bands, etc. This system does have a minimal subscription fee that must be paid annually to continue service. Please see satellite radio owner's manual for more information.

NOTE: Location of satellite antenna may vary.

Optional Perfect Pass



Perfect Pass is a marine approved cruise control system. It is an accurate and simple way to ensure consistent speed. It is controlled by the driver via a gauge on the dash.

CAUTION

Be sure to read and understand the Perfect Pass Owner's Manual before using this feature. If you did not receive a Perfect Pass Owner's Manual, please contact your selling dealer.

Optional Walk-Through Curtain

Some Moomba models offer an optional Walk-Through Curtain that snaps into the front walk-through to help prevent cool air from flowing into the cockpit area.

Optional Kill Switch

The optional kill switch is located by the throttle. The lanyard must be in place for the engine to start and the lanyard must be attached to the driver. The engine will shut off if the lanyard clip is detached from the kill switch.

Optional Water Strainer

The optional water strainer is mounted in the bilge and designed to keep debris out of the engine. The clear bowl should be checked before each use. To remove debris, unscrew the clear bowl and empty out the debris. When reassembling, be sure the rubber gasket and the screen are seated properly.

Optional Tower Speakers



The optional tower speakers are an additional set of speakers designed to allow the rider to be able to hear the music. The tower speakers require the addition of an amplifier to power the speakers.

CAUTION

Some lakes have noise restriction ordinances. The use of tower speakers may not be allowed in your area. Please check all applicable laws in your area regarding noise level restrictions.

Optional Subwoofer

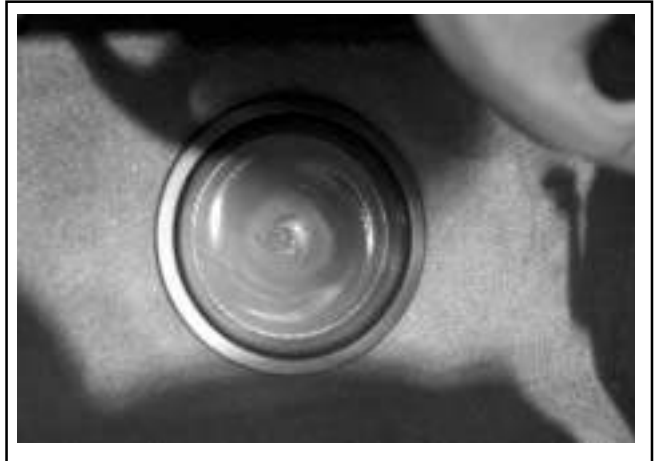

The optional sub-woofer is designed to increase the sound level of the bass notes. The optional amplifier powers the sub-woofer. The bass level can be adjusted on the amplifier. Please see stereo amplifier owner's manual for more information.

Optional Stereo Amp



The stereo amplifier is an optional piece of stereo equipment that is designed to increase the wattage of the signal going to the speakers while minimizing distortion of this signal. Please see stereo amplifier owner's manual for more information.

CAUTION

Using a stereo amplifier without boat engine running may drain the battery to the point where the boat will not restart. This condition may happen very quickly, depending on the size of the battery!

Optional CD Changers

The optional 10-disk CD changer is mounted to the floor of the boat and is controlled using the stereo controls. It can also be controlled by the stereo remote. Please see CD changer owner's manual for more information.

Optional Tonneau Cover

The optional tonneau cover is designed to snap over the bow of the boat. Its purpose is to minimize air flow into the cockpit area when the boat is in use and as a storage cover when used in combination with the optional cockpit cover.

CAUTION

DO NOT trailer the boat with the tonneau cover installed. The tonneau cover is not designed as a trailer cover and may come unsnapped or rip. This type of damage IS NOT covered by your boat warranty!

Optional Cockpit Cover

The optional cockpit cover is a snap down storage cover designed to help protect the interior of your boat. To install the cover, start at the windshield and work towards the transom. Be sure to install the cover poles to prevent water pocketing.

CAUTION

DO NOT trailer the boat with the cockpit cover installed. The cockpit cover IS NOT designed as a trailer cover and may come unsnapped or rip. This type of damage IS NOT covered by your boat warranty!

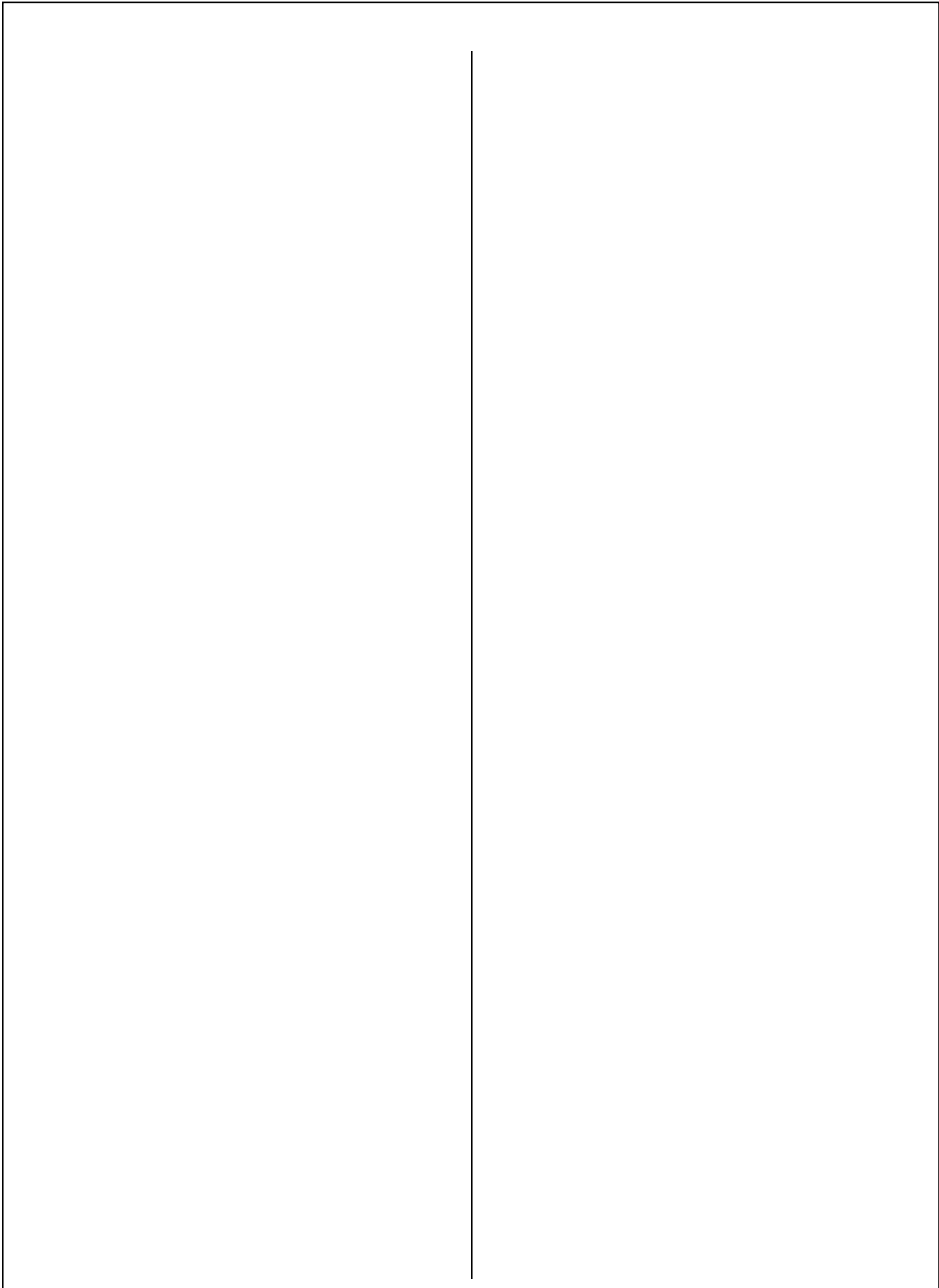

Section IX

Service & Maintenance

Typical Inboard

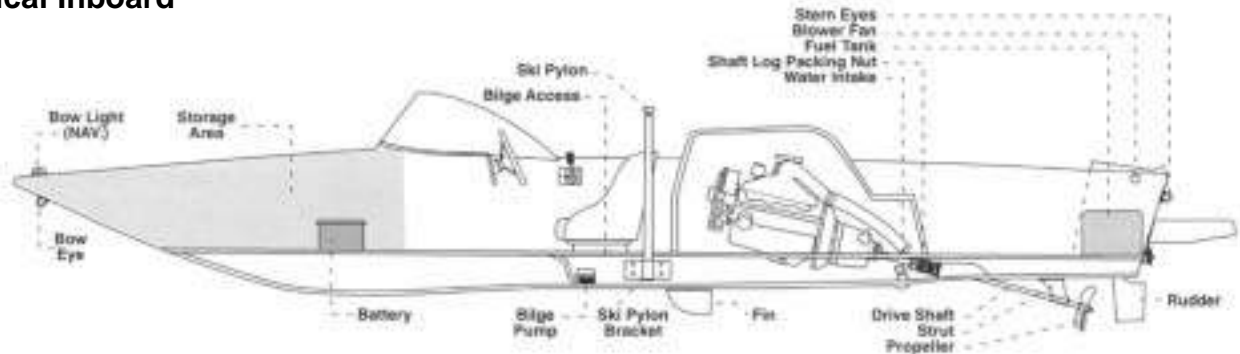

Typical V-Drive

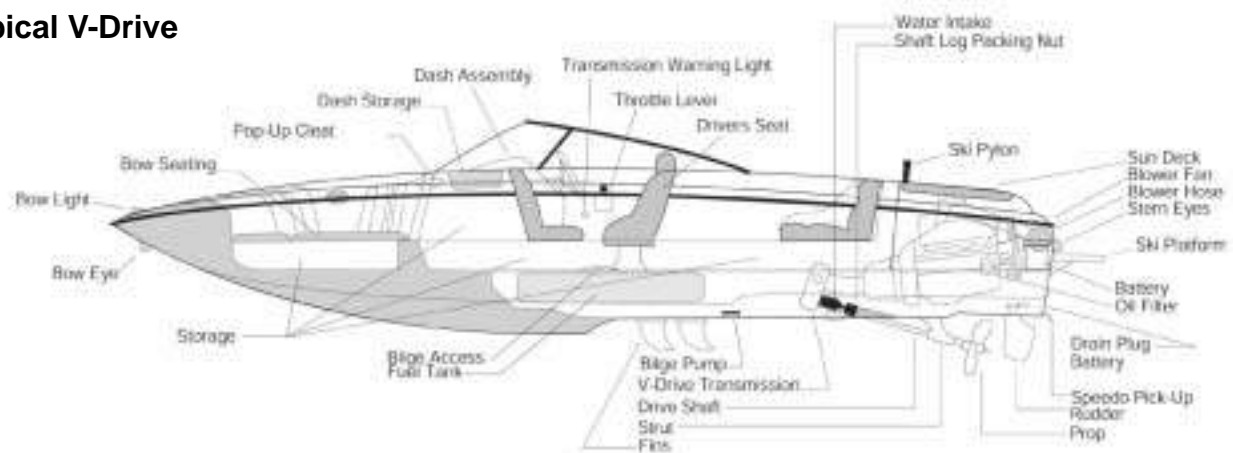

The illustrations above denotes the areas which may need to be accessed or may require cleaning or maintenance. It is important to have a basic understanding of the parts and their location on the boat. However, it is recommend that any service beyond routine maintenance be performed by an authorized Moomba dealer.

Service & Maintenance

For your convenience a maintenance chart has been included in this manual. The chart indicates when to perform safety checks, lubrication, and general service to the boat. Engine hours or elapsed time determine when service is necessary.

It is recommended that any replacement parts used during maintenance or for repair be supplied by an authorized Moomba dealer.

NOTE: You are responsible for keeping records of all maintenance on your boat. To maintain your new boat warranty, you may be asked to show that required maintenance was performed.

Maintenance Chart

Maintenance Intervals @ Engine Hours

	Weekly	1 st 25	50 Hrs.	100 Hrs.	Yearly
Change Engine Oil		✓	✓	✓	✓
Replace Oil Filter		✓	✓	✓	✓
Clean Oil Filler Cap		✓	✓	✓	✓
Check Transmission fluid Level	✓	✓	✓	✓	✓
Change Transmission fluid		✓	✓	✓	✓
Check Water Strainer (if applicable)	✓	✓	✓	✓	✓
Clean flame Arrestor		✓	✓	✓	✓
Clean Crankcase Ventilating System		✓	✓	✓	✓
Check Water Pump & Alternator Belt Tension	✓	✓	✓	✓	✓
Change Fuel Filter		✓	✓	✓	✓
Check Fuel Lines & Connections for Leaks	✓	✓	✓	✓	✓
Clean Carburetor Fuel Inlet Filter		✓	✓	✓	✓
Clean Transmission Oil Strainer Screen *		✓	✓	✓	✓
Lubricate Distributor Cam		✓	✓	✓	✓
Shaft Packing Log		✓	✓	✓	✓
Check Condition of Spark Plugs		✓	✓	✓	✓
Check Battery Electrolyte Level		✓	✓	✓	✓
Check All Electrical Connections		✓	✓	✓	✓
Check Cooling System Hoses for Leaks	✓	✓	✓	✓	✓
Tighten Engine Mount Fasteners		✓	✓	✓	✓
Lubricate Throttle and Shift Linkage Pivot Points		✓	✓	✓	✓
Check for Loose, Damaged or Missing Parts	✓	✓	✓	✓	✓
Check Engine to Propeller Shaft Alignment		✓	✓	✓	✓
Lubricate Rudder Port		✓	✓	✓	✓
Check V-Drive Fluid Level**	✓	✓	✓	✓	✓
Change V-Drive & Transmission Fluid**		✓	✓	✓	✓

*If engine overheats, visually check. If clogged, remove debris.

**Pertains to V-Drives only.

This inspection and maintenance schedule is recommended for average operating conditions in normal service. Under severe operating conditions or service, intervals should be shortened.

Cooling Systems

Fresh Water Cooling System

The standard cooling system for Moomba boats is an open circulating cooling system with water intake. This is preferred for lakes and reservoirs with low salt content. If the engine is occasionally operated in salt water, the cooling system should be flushed with fresh water periodically and always before storage. If your boat is regularly operated in salt water, it should be equipped with the optional salt water package.

Salt Water Cooling System

The optional cooling system for use on salt water is a closed system with a solution of 50% antifreeze and 50% fresh water. The coolant is left in the closed system and replaced once a year.

Body Lubrication

Normal use of your Moomba causes metal to metal movement at some parts in the boat. Driver seat track should be lubricated with a water resistant chassis lubricant such as silicon grease.

Lubricate rudder grease fitting once annually.



Engine Oil & Filter

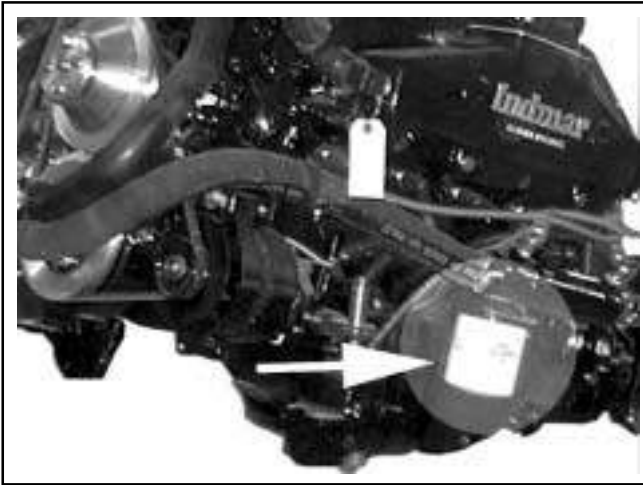

The oil filter is located below the engine. The engine manufacturer recommends that you change the oil and oil filter after the first 10-20 hours use of your new boat. Thereafter, to maximize engine life, change oil and filter after every 50 hours of use (See Engine Manual.)

REFER TO ENGINE MANUAL for more information.

V-drive remote oil filter is mounted on the ski pylon bracket.



Dipstick

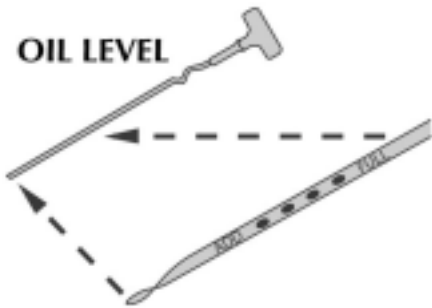

If the oil pressure indication is too high or too low, stop the engine immediately and check the oil level on the dipstick.

NOTE: The oil pressure varies with engine temperature and speed. If oil pressure does not increase when throttle is increased, shut off the engine immediately.

Continued operation while oil level is incorrect or without pressure may result in serious engine damage. Report any problem to your dealer as soon as possible, and do not operate engine until corrected.

Engine Oil

The engine crankcase oil should be selected to deliver the highest performance for your operating conditions and climate. In general engine oils with lower viscosity ratings are used when outdoor temperature remains low. Oils with higher viscosity are used when outdoor temperature is warmer and when higher performance is expected from the engine.

Indmar recommends 15W-40 Pennzoil Marine in their engines. If not available, for general use in summer conditions, 10W-40 high grade automotive oil with an A.P.I. classification of "SE" is recommended. Synthetic oils are not recommended until after the engine has been run for 100 hours.

Refer to Engine Manual for more information. For filter and capacity information, see the Engine Data table in this manual.

Transmission



Transmission Fluid Check

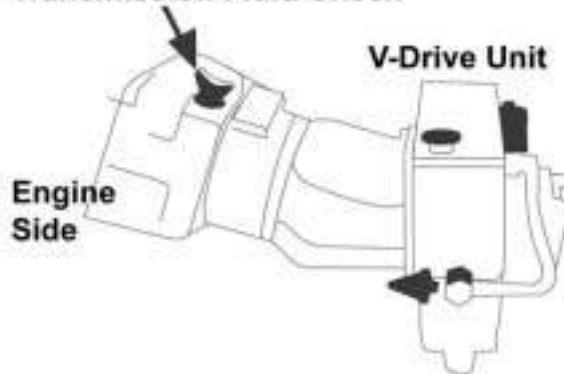

Transmission fluid level should be checked regularly (such as every ten engine hours) and fluid added if necessary. Maintain fluid level as follows:

- Boat must be at rest.
- Engine should be at operating temperature but turned off while checking level.
- Remove transmission fluid dipstick.
- Wipe fluid clean from dipstick and replace.
- Remove dipstick and note level indicated by the upper and lower marks.
- If required, add fluid to bring the level to the upper mark.

Maintaining Fluid Level

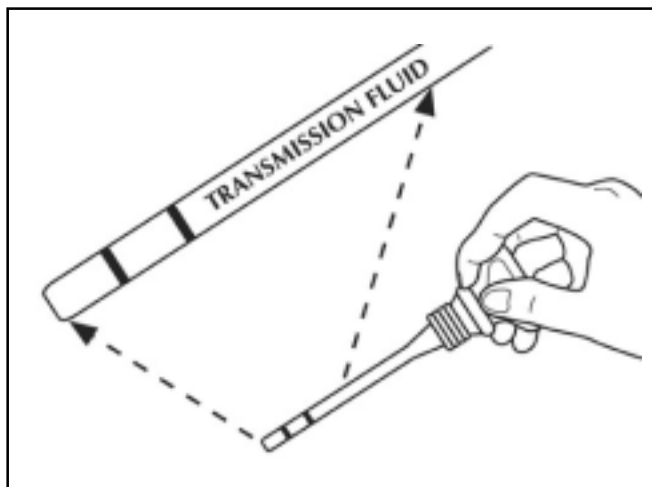

Use only Dextron III transmission fluid in transmissions with 1:1 drive train. To check fluid level refer to Engine Manual.

Change Frequency:

Change transmission fluid every year (refer to Engine Manual).

Shaft Log Packing Nut

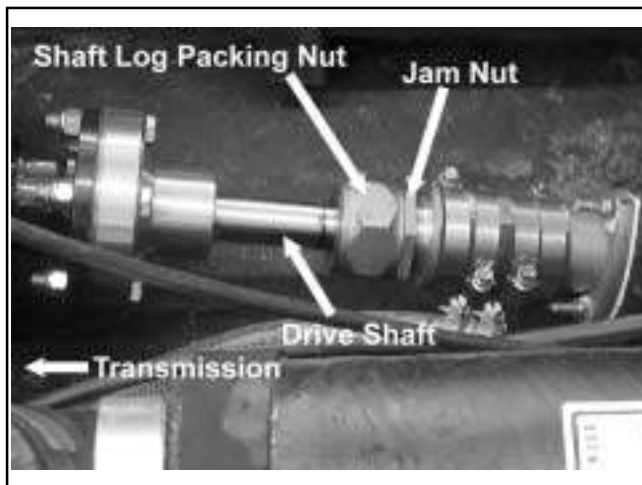

The Shaft Log Packing Nut should be checked periodically and adjusted if needed.

Adjust as follows:

1. Loosen the jam nut a few turns.
2. Tighten the shaft log packing nut by hand. DO NOT over tighten.
3. Tighten the jam nut against the packing nut.
4. Check for leaks.

NOTE: It is normal for the Packing Log to drip water at a slow rate of one drop every 15 to 30 seconds. Overtightening the packing nut may disturb the packing and cause excessive dripping.

V-Drive Location

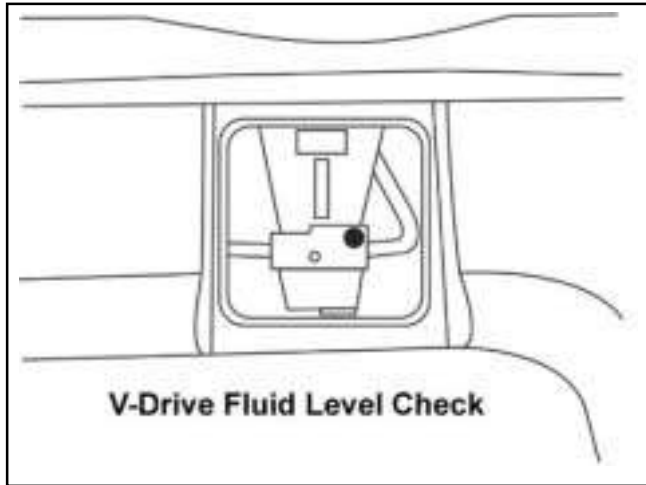

The fluid level can be checked by using the oil level dipstick, which is located on top of the V-Drive transmission. This unit is located under the center cushion of the rear seat. Pull out the cushion to access the transmission.

V-Drive Fluid Check

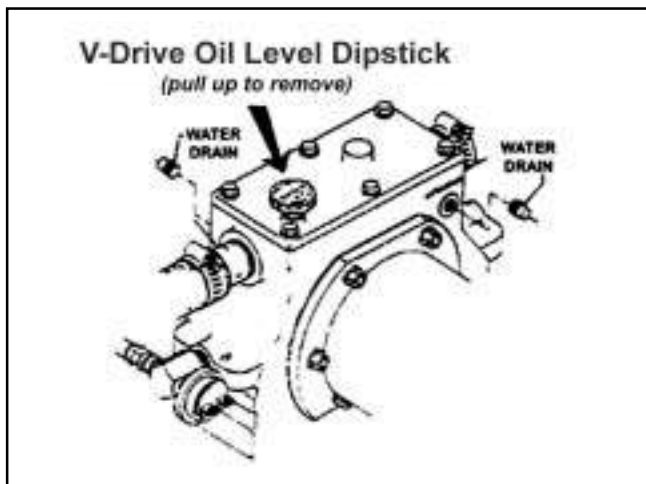

Pull the V-Drive Oil Level dipstick to check the fluid level. If the level is low, add fluid to the correct mark on the dip stick. Use SAE 30 motor oil.

NOTE: Only a trained and qualified technician should perform the oil change on your V-Drive unit.

Change Frequency

The oil should be changed in the V-Drive transmission after the first 100 hours of operation, then each year at the end of your boating season.

Maintaining Fluid Level

V-Drive oil level should be checked regularly (such as every ten engine hours) and fluid added if necessary.

Maintain fluid level as follows:

- Boat must be at rest.
- Engine should be at operating temperature but turned off while checking level.
- Remove transmission fluid dipstick.
- Wipe fluid clean from dipstick and replace.
- Remove dipstick and note level indicated by the upper and lower marks.
- If required, add fluid to bring the level to the upper mark.

Propeller Warning

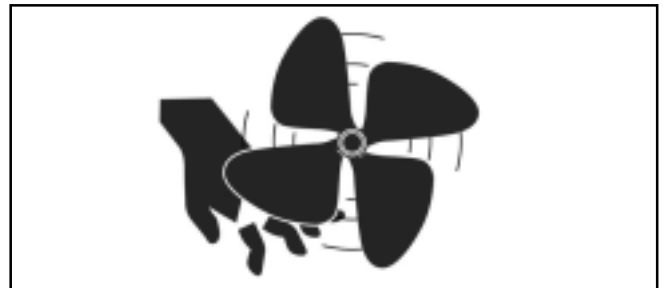

⚠ WARNING

Moving propeller will cause injury. Propeller may rotate with boat in neutral. Shut off the engine when people are on the platform or in the water near the platform to avoid injury from the prop rotation.

Battery Cable Installation & Precautions

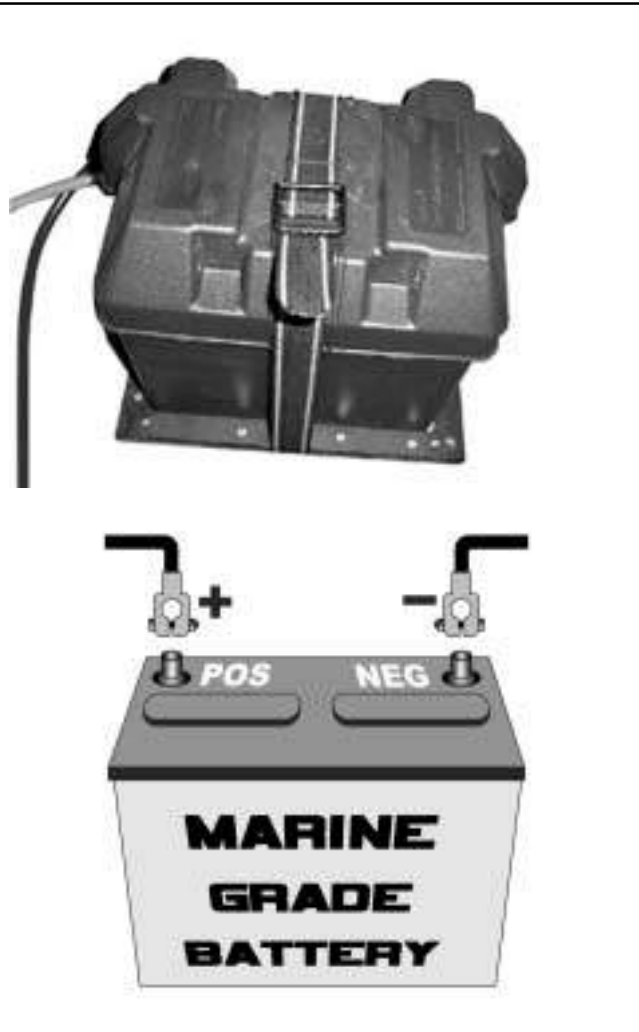

Your Moomba electrical system is negative ground. The negative battery cable is grounded on the engine block. The positive battery cable is connected to the starter solenoid.

Connect the positive (+) battery cable to the positive (+) post on the battery. Connect the negative (-) battery cable to the negative (-) post on the battery.

CAUTION

Failure to connect battery cables as outlined will damage the system and void the warranty.

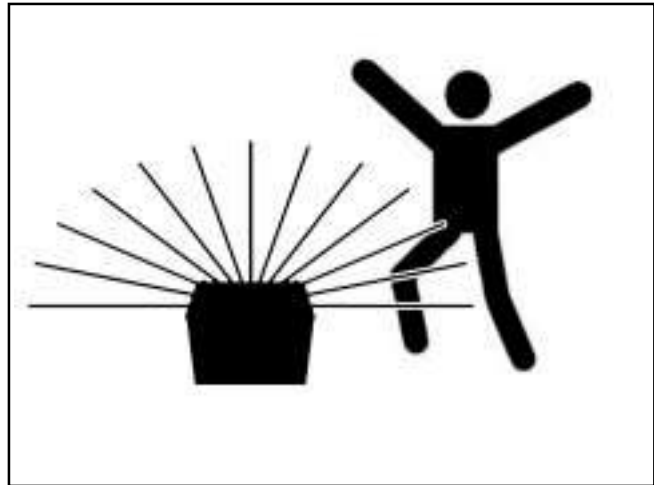

WARNING

Hydrogen and oxygen gases are produced during normal battery operation and charging. Sparks or flames near the battery vent openings can cause the mixture to ignite and explode.



WARNING

Sulfuric acid in the battery can cause serious burns. If spilled on skin or in the eyes, flush with clean water immediately, then seek medical attention.

Section X

Cleaning, Care & Storage

Fiberglass Care

Washing and waxing the boat hull and deck regularly will extend the life and beauty of your Moomba. It is a good routine to rinse your boat with fresh water after each day's use.

It is recommended that the hull and deck be cleaned and waxed after every 50 hours of use. This will decrease water friction and lessen the potential for staining or spotting on the gelcoat surface.

When the original gelcoat shine cannot be restored by waxing, the shine may be restored by hand buffing with a commercial polishing compound. Be sure to apply a new coat of wax containing Carnauba over the area that has been polished.

IMPORTANT: Porcelain cleaning powders are too abrasive for use on gelcoat and may cause permanent discoloration if used. Household detergents containing ammonia or chlorine should not be used on gelcoat. Never use acetone or ketone solvents to clean your boat finish.

Washing Your Moomba



The easiest way to preserve the beauty of your boat is to keep it clean by frequent washing. Wash the boat with luke warm or cold water. Wipe the boat down immediately after washing to avoid water spots. Avoid using hot water or washing your boat in direct sunlight. Avoid using strong soaps or chemical detergents. To avoid spotting, all cleaning agents should be thoroughly rinsed from the surface promptly and not allowed to dry on the finish.

Rub Rail Care



Use a sponge or other soft material to wash and wax the rub rail.

To wax, use a commercial automotive bumper wax.

NOTE: When tying up to a dock or another boat, always use cushioned fenders (dock bumpers) to protect your boat from hard surfaces.

Windshield Care



Clean the windshield regularly to ensure that visibility is not obstructed.

Use a commercial glass cleaner to remove any spotting or stubborn stains that develop on the windshield.

Never use abrasive cleaners on glass or plastic surfaces as they may cause scratches.

Upholstery Cleaning

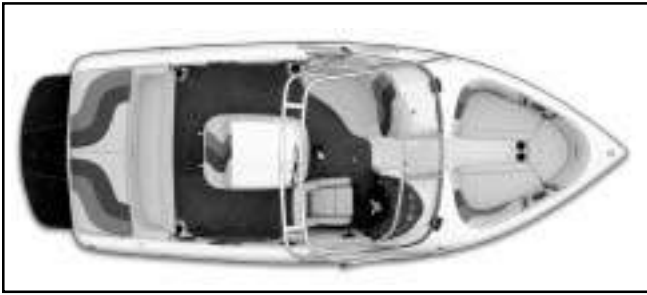

All upholstery items on your boat are made of tough marine grade vinyl that is easily cleaned with a mild detergent.

Strong detergents and cleaners may shorten the life of the vinyl. PLEASE SEE VINYL MANUFACTURER'S RECOMMENDED CARE GUIDE INCLUDED IN YOUR OWNER'S PACKAGE.

Drying Upholstery



It is important to provide for the drying of all upholstery and carpet after each use of the boat. Open all storage compartments and slide all removable cushions out about an inch to allow air to circulate behind.

Foreign Deposits

Tree sap, bird droppings, air borne chemicals, petroleum products and other foreign matter may damage the gelcoat surface if not removed promptly (See Washing Instructions).

Boat Hull Protection

If your Moomba is to remain in the water for an extended period, the hull below the water line should be painted with a marine bottom paint. Boats left in the water for extended periods of time without bottom paint may experience blistering or discolorization. This type of damage is not covered by your boat's warranty.

Teakwood Care

If teak wood has been installed on your Moomba, a small amount of maintenance will be required to retain the natural beauty. Teak wood should not be varnished. Instead, teak oil or mineral oil should be applied. Oil should be applied three to four times per year. If teak has been allowed to become gray and dry, sand with fine grit paper and reapply teak oil.

CAUTION

Damage caused by improper care, cleaning agents, conditioner oils, waxes, gasoline, etc., IS NOT covered under your boat's warranty. Use only the recommended vinyl cleaner as listed on the Vinyl Care Instruction Sheet.

Please refer to www.marinespecialtiesgroup.com for more information regarding vinyl care.

Section XI

Winterization & Dry Storage

When the boating and ski season comes to a close, it is important to have your boat professionally winterized.

If your boat is exposed to temperatures below 32 degrees F (0 degrees C) it is possible for water in the engine, ballast system, heater core, etc., to freeze. As this water freezes, it expands and can crack pumps, valves, heat exchangers, engine blocks, etc. This type of damage usually requires the replacement of the cracked item and can be very expensive to repair.

CAUTION

It is extremely important to follow the proper winterizing procedure. The engine must be correctly winterized for safe storage in your climate. This should be done by a professional. Your Moomba dealer will know exactly what must be done to ensure the longest possible life for your boat.

In addition to having your boat professionally winterized, the following tasks should be done to protect your boat during storage:

1. Remove the center drain plug from the boat.
2. Thoroughly clean the boat inside and out. Inspect the hull for any residue or algae growth and remove if required.
3. Clean the bilge area thoroughly and operate the bilge pump to remove any water from the bilge hose.
4. Remove all seat cushions and open all storage areas to allow air circulation in the boat interior. When thoroughly dry, replace cushions and close storage areas.
5. Top off fuel tank to prevent any condensation from accumulating in the fuel system. Use a commercially available fuel stabilizer to remove water and prevent gumming.
6. If the boat is stored on its trailer, insure that the boat is properly positioned. If possible lift the tongue so that the bow is slightly raised to promote drainage from the center drain hole.
7. Install the canvas cover and secure the straps in accordance with cover instructions.

NOTE: During the winter months, water is a boat's worst enemy. Always store the boat when the interior is completely dry. Periodically check on the condition of the stored boat.

CAUTION

Damage due to improper winterization IS NOT covered under your boat's warranty.

Hoisting

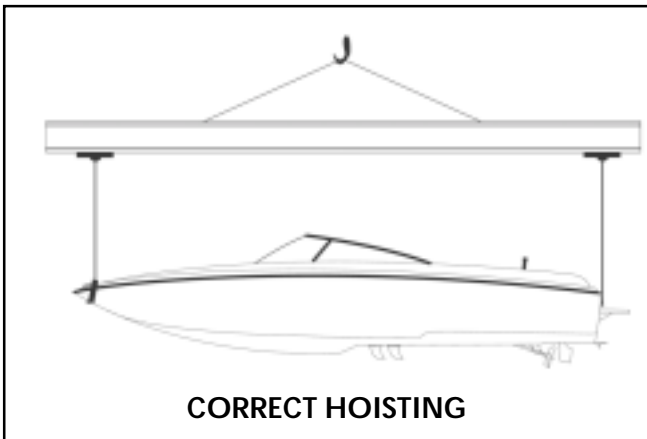

If the boat ever needs to be hoisted, special attention should be given to the following recommendations:

- Hoist the boat using a horizontal lifting bar only.
- Never attempt to lift the boat by means of a cable sling from bow to stern lifting eyes.
- Hoist operator should slowly and smoothly lift the boat without jerking to avoid damage to the lifting eyes.
- Use a clevis inserted through the lifting eye since a hook may damage the lifting eye edges.

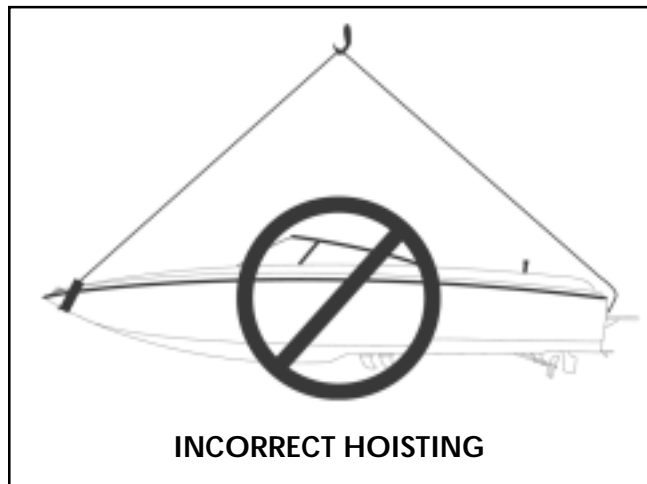

WARNING

DO NOT use the ski pylon to hoist the boat. Incorrect hoisting may invalidate the warranty on the boat.

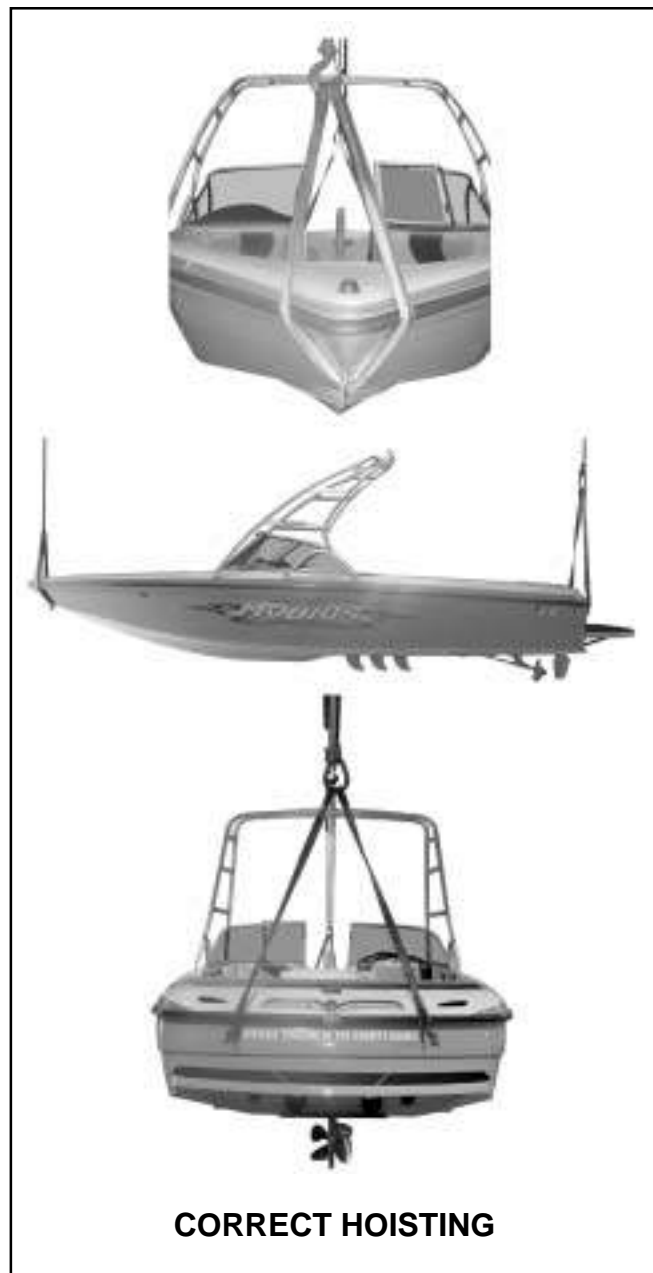

WARNING

DO NOT use the bow eye to hoist boat. Use only a proper sized sling in the designated lifting rings to hoist the boat.

Section XII

Technical Information

Identification Number

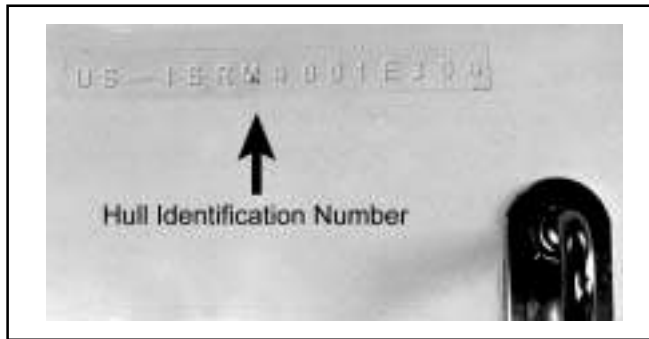

The hull identification number is located on the upper right hand side of the transom below the rub rail.

Battery Specifications

12 Volt Marine Type with Tapered Post Connectors

Engine Size:	Cold Crank @ 0° F(-18° C)
350	650 Amps

WARNING

Hydrogen and oxygen gases are produced during normal battery operation or charging. Sparks or flames can cause this mixture to ignite and explode if it comes near the vent openings. Sulfuric acid in the battery can cause serious burns if spilled on skin or in eyes. Flush with clear water immediately!

Engine & Transmission Data

Engine Model:	Indmar Assault MPI-HO	Indmar Assault MPI	Indmar Assault TBI	Indmar Assault Carb
Fuel Delivery	Multi Port Fuel Injection	Multi Port Fuel Injection	Throttle-Body Fuel Injection	Holley Carb.
Horsepower:	380-HP	340-HP	320-HP	310-HP
Displacement:	350 CI	350 CI	350 CI	350 CI
Bore (in):	4.00	4.00	4.00	4.00
Stroke (in):	3.48	3.48	3.48	3.48
Compression Ratio:	9.4 to 1	9.4 to 1	9.4 to 1	9.4 to 1
Electrical System:	12-V Neg Ground	12-V Neg Ground	12-V Neg Ground	12-V Neg Ground
Ignition Type:	Electronic Distributor	Electronic Distributor	Electronic Distributor	Electronic Distributor
Alternator Output:	70 Amps @ 1,200 RPM	70 Amps @ 1,200 RPM	70 Amps @ 1,200 RPM	70 Amps @ 1,200 RPM
Thermostat:	162 Degrees F	162 Degrees F	162 Degrees F	162 Degrees F
Firing Order:	1-8-4-3-6-5-7-2	1-8-4-3-6-5-7-2	1-8-4-3-6-5-7-2	1-8-4-3-6-5-7-2
Initial Timing:	10 Degrees / Service Mode	10 Degrees / Service Mode	10 Degrees / Service Mode	10 Degrees / Timing Shunt
Oil Filter:	Pennzoil PZ-3	Pennzoil PZ-3	Pennzoil PZ-3	Pennzoil PZ-3
Oil Capacity:	5-Quarts	5-Quarts	5-Quarts	5-Quarts
Oil Type:	Pennzoil 15W-40 Marine	Pennzoil 15W-40 Marine	Pennzoil 15W-40 Marine	Pennzoil 15W-40 Marine
Spark Plugs:	AC 41-932	AC 41-932	AC 41-932	AC MR43LTS
Gap:	0.060	0.060	0.060	0.020
RPM Range @ WOT:	4,600 - 5,200 RPM	4,600 - 5,200 RPM	4,400 - 4,800 RPM	4,400 - 4,800 RPM

V-Drive: Walters

Model: RV-26 D
Ratio: 1.48 to 1
Oil Type: SAE-30
Oil Capacity: 2 pints

Transmission: ZF Hurth

Model: 450 D
Ratio: 1 to 1
Oil Type: ATF Dextron III
Oil Capacity: 2 qts.



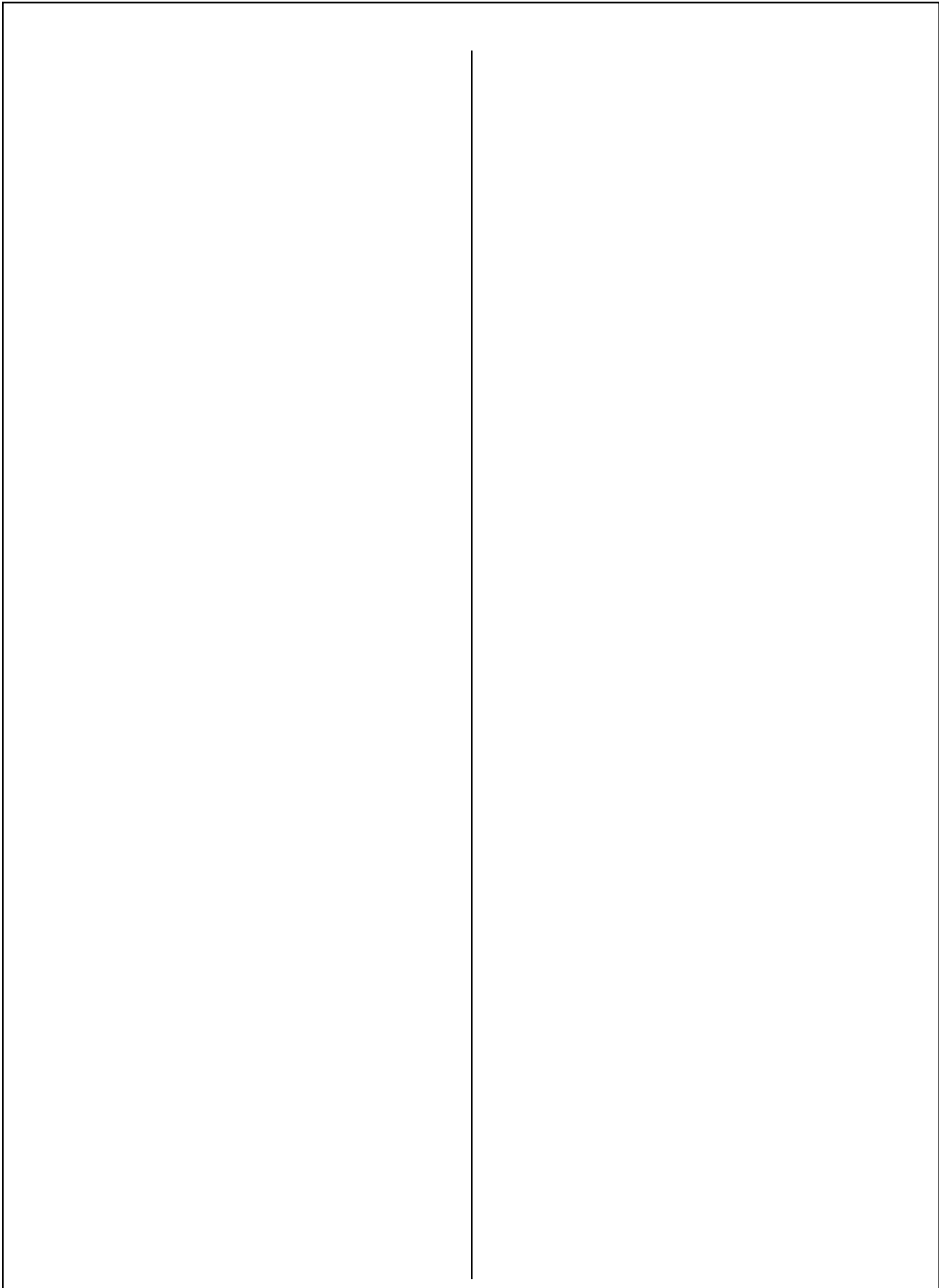

Trailer & Towing



The trailer supplied with your Moomba model was designed especially for the boat with your convenience in mind. Please be sure that you have an appropriate tow vehicle before attempting to trailer your boat. Your vehicle must be capable of towing 3,500 — 6,000 lbs. depending on the model.

CAUTION

Read the trailer towing section of your vehicle owner's manual before towing your trailer.

All Moomba trailers require a 2" ball and a five (5) pin marine grade trailer wiring connector. The standard height from the ground to the top of the hitch ball should be about 20 inches. With the trailer attached to the tow vehicle, the trailer should stand level.

Trailer Plug Wire Schematic

White: Ground
Green: Right Turn / Brake
Yellow: Left Turn / Brake
Brown: Running Lights
Blue: Reverse Lights

NOTE: Moomba trailers feature disk brakes. The fifth wire (blue) on the wire connector needs to be connected to your vehicles reverse lights to be operative. This wire (blue) provides power to a solenoid which deactivates the brakes while in reverse. You may still tow your trailer without the blue wire connected, however, you may experience difficulty backing the trailer.

WARNING

BEFORE USE, READ ALL INFORMATION SUPPLIED WITH THE TRAILER BY THE MANUFACTURER.

The following guidelines will prolong the life of the boat and trailer:

1. Always secure the boat to the trailer with tie-downs. Do not place straps around fenders or lights.
2. Always verify that the winch hook is securely in the bow eye, the strap is tight and the winch handle locked in place before trailering.
3. Check the recommended pressure displayed on the side of the tires and assure that it is maintained. Under-inflated tires could cause trailer sway and excessive tire wear.
4. Verify that the trailer hitch on the tow vehicle is the proper class and size to support the tongue weight and the trailer load.
5. Check wheel bearing lube (Bearing Buddy®).

Section XIII

Trailering Your Boat

Connecting the Trailer



When connecting the trailer to your tow vehicle use the following procedure:

1. Raise the tongue with the trailer jack, position the trailer tongue directly over the 2" ball, and lower the jack until the tongue goes all the way down over the ball.

2. Press down on the latch until it locks on the ball with a "click."

NOTICE: If your hitch ball has an excessive flat spot on top, the latch may not engage properly. If the latch does not catch, check with your dealer or hitch installer before trailering.

3. Insert the locking pin into the tongue. Lock pin hole is on the side of the tongue.

4. When all weight is off the trailer jack, pull the jack lock pin and rotate the jack to the horizontal position and re-lock the pin.

5. Attach the safety cables to the tow vehicle hitch. Cross the cables and wrap them around each other once or possibly twice allowing just enough slack to permit tight turns of the vehicle and trailer.

6. Plug the trailer lights connector to the vehicle harness.

7. Clip the brake lockout cable to the vehicle hitch.

Unloading Procedure



NOTICE: DO NOT attempt to use excessive power to free the boat from dry carpet runners. Power off of the trailer only when the boat has floated free.

CAUTION

If the trailer is not submerged to the correct depth, the bow of the boat could drop when powering off incorrectly, possibly damaging the boat.

NOTICE: Before operating your Moomba, refer to the Daily Check List and the Boatman's Check List.

To unload the boat use the following procedure as a guide:

1. Make sure that all drain plugs are securely in place.
2. Unplug light cord before backing into the water.
3. With Bow Eye Hook fastened, back the trailer until the water level is approximately one inch below the top of the trailer fenders.

NOTE: Ramp slopes vary, so actual level of water on trailer may be different.

CAUTION

Make sure that the engine water intake is fully submerged.

4. Follow the cold start procedure recommended in this manual.
5. With engine idling, center the steering wheel, engage the transmission into reverse (pull back on lever,) then ease back on the throttle.

NOTE: Because your Moomba is a direct drive inboard, when backing the stern will have a tendency to drift left or right depending on propeller rotation. This condition will self-correct as the rudder reaches control speed.

Loading Procedure



To re-trailer the boat, position the trailer in the water with approximately 1 inch of the top of the fender showing as in step 3. UNLOADING.

Idle/coast the boat onto the trailer using as little power as possible keeping it centered between the guide poles.

NOTE: DO NOT Power onto the trailer during rough conditions.

When correctly positioned on the trailer turn off ignition. Use the Hook and Trailer Winch to pull the boat up to the Roller Stop.

When using the Boat Buddy® to load the boat:

Position the trailer in the water with approximately 1 inch of the top of the fender showing (as in step 3. UNLOADING):

1. Set the Boat Buddy® for loading by pulling trigger or latch mechanism into "set" position.
2. Idle/coast the boat onto the trailer using as little power as possible, while keeping it centered between the guide poles.
3. Power slowly forward until the bow eye solidly contacts the Boat Buddy® and the latch is triggered.
4. Winch hook must be attached to bow eye and tightened before trailering.

CAUTION

The trailer must be positioned for the correct water depth for loading or you may damage the boat. Varying ramp angles require different procedures. In general, the steeper the ramp, the more shallow the trailer should be positioned in the water. Your local dealer can help you understand this, should you require additional assistance.



Trailer Alignment



When pulling the boat onto the trailer, be sure that it is centered on the trailer.

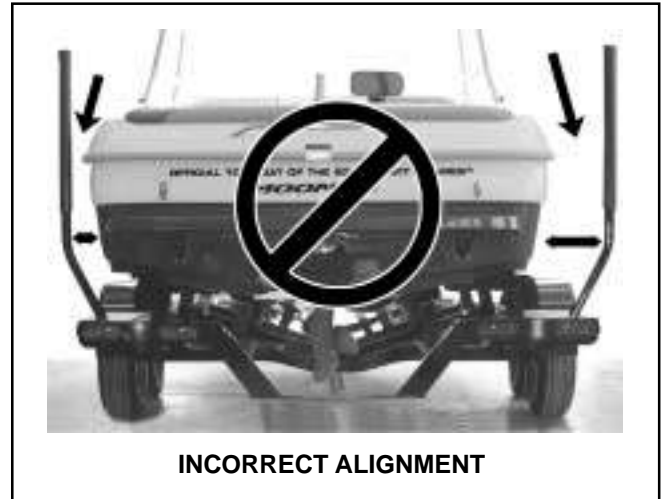

The distance between the boat and the wheel runner board should be about equal on both sides.

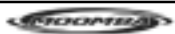

Moomba Limited Warranty

Taking care of our product after it becomes yours has always been "standard policy" at Skier's Choice, Inc., the proud manufacturer of the Moomba line of boats. And to further prove our point, we offer the following limited warranty.

Terms of Warranty

During the applicable Warranty Period (as defined below), Skier's Choice, Inc. ("Skier's Choice" or the "Company") warrants to the original retail purchaser (the "First Owner") that the components and parts manufactured by Skier's Choice (the "Covered Components") of each new Skier's Choice boat are free from any defects in material and workmanship, under normal use and when operated and maintained according to boat's instructions ("Normal Use and Operation").

- This Limited Warranty applies to all Covered Components other than the deck, hull, floor and stringers for a period of one year (the "One-Year Warranty Period") from the original date of purchase by the First Owner (the "Original Purchase Date"). Exclusions do apply.
- This Limited Warranty applies to the deck, hull, floor (excluding carpet) and stringers for the lifetime of the boat (the "Lifetime Warranty Period"). Exclusions do apply.
- This Limited Warranty applies to the gel coat for a period of one year (The "One-Year Warranty Period") from the original date of purchase by the First Owner (The "Original Purchase Date"). Exclusions do apply.

Subject to the terms of this Limited Warranty, Skier's Choice will repair or replace, at its sole option, any Covered Component which is returned during the applicable Warranty Period to the Skier's Choice factory or to any other Moomba authorized repair facility (an "Authorized Moomba Facility"), provided that:

- Only the Covered Components that are declared defective upon examination by Skier's Choice will be repaired or replaced under this Limited Warranty;
- Transportation of the boat, parts or components to and from the Skier's Choice factory or the Authorized Moomba Facility must be prepaid by the owner;
- Notice of any claim under this Limited Warranty must be provided to Skier's Choice by the Authorized Moomba Facility no later than sixty (60) days after the owner becomes aware of the defect.

Notification of a claim or defect must be properly made directly to an Authorized Moomba Facility, who subsequently must submit the claim information to Skier's Choice, Inc. at 1717 Henry G. Lane Street, Maryville, Tennessee 37801. Information needed for processing a claim includes (1) Name and address of the owner; (2) Serial number of the boat; (3) Original retail purchase date; (4) Detailed explanation of the defect; and (5) Estimated repair cost.

Section XIV Moomba Warranty

Note: Warranty repair or replacement cannot be made until this information is approved by Skier's Choice.

In case of defect of a Covered Component, Skier's Choice will use its reasonable best efforts to repair or replace the Covered Component within ninety (90) days of receipt thereof at its factory or an Authorized Moomba Facility. Any warranty on replaced or repaired components pursuant to this Limited Warranty shall remain in effect only for the remainder of the original Warranty Period. The repair or replacement of Covered Components will be made by Skier's Choice without charge to the owner for parts or labor. The replacement or repair of the defective part or component as stated in this Limited Warranty shall be the sole remedy of the owner and the sole liability of the Company under this Warranty and any implied warranties.

There are no express or implied warranties on the parts and components manufactured or sold by Skier's Choice except as set forth in this Limited Warranty.

Exclusions

Claims or assertions relating to the following are specifically excluded from coverage under this Limited Warranty and Skier's Choice disclaims any liability or obligation with respect to the following:

1. Defects in or damage caused by or relating to the engine or any part thereof. (Note: The engine may be covered by warranty of the engine manufacturer. Please see engine manufacturer warranty for details.)
2. Defects in or damage caused by or relating to the trailer or any part thereof. (Note: The trailer may be covered by warranty of the trailer manufacturer. Please see trailer manufacturer warranty for details.)
3. Covered Components of a boat that has been sold or transferred by the First Owner .
4. Damage caused by, related to, or resulting from failure of components or parts which are not manufactured by Skier's Choice, including but not limited to bilge pump failure.
5. The Limited Lifetime Warranty on the deck, hull, floor (excluding carpet) and stringers does not include hardware or other components fastened or adhered to the hull, deck, floor or stringers.
6. Normal maintenance and upkeep relating to the boat or any part thereof, including but not limited to, alignment, adjustments, connectors, tune-ups and wear items, such as, shaft packing, belts, hoses, filters, seals, gaskets, strut bushing, etc.

7. Damage to or malfunction of a boat, or any component thereof, resulting from owner use, lack of maintenance, improper maintenance, impact, misuse, negligence, collision, delay in repair, improper hoisting or cradling of the boat.
8. Any and all consequential damages including, but not limited to, costs incurred for haul-out, launching, towing and storage charges, telephone or rental charges of any type, inconveniences, loss of use, or loss of time or income.
9. Equipment installed by anyone other than authorized factory personnel at the Company's production facility. Equipment replaced at an Authorized Moomba Facility pursuant to this warranty agreement remains under warranty until the expiration of the Limited Warranty period.
10. Any boat which is: (a) used for rental or other commercial, military or industrial purposes; (b) used in boat racing, demonstrations, ski school, or similar events; (c) altered, modified, repaired or replaced so as to increase the cubic inch capacity or horsepower output of the engine and boat as originally manufactured; (d) not properly stored or maintained.
11. Speeds, fuel consumption and other performance characteristics because they are estimated and may vary.
12. Damage to or defects in paints, varnishes, gelcoat surfaces and colors, finish distortions, chrome plated or anodized finishes, floor covers and any other surface coatings.
13. Gelcoat discoloration, blisters or bubbles, including, but not limited, to those which may result from a boat being left in the water for long periods of time.
14. Upholstery cracks, mildew, stains or tears resulting from owner use, lack of maintenance, improper maintenance, impact, misuse, negligence, delay in repair, use of improper cleaners or conditioners.
15. Skier's Choice reserves the right to improve its products through changes in design or material without being obligated to incorporate such changes in products of prior manufacture.

OTHER LIMITATIONS

1. THIS LIMITED WARRANTY LIMITS THE DURATION OF ANY IMPLIED WARRANTY OF MERCHANTABILITY OR IMPLIED WARRANTY OF FITNESS FOR A PARTICULAR PURPOSE TO THE PERIODS SPECIFIED HEREIN. Some states do not allow limitations on how long an Implied Warranty lasts, so this limitation may not apply to you.

2. THE REMEDIES OF REPAIR OR REPLACEMENT AT THE OPTION OF SKIER'S CHOICE, AS SET FORTH HEREIN, ARE THE ONLY REMEDIES AVAILABLE UNDER THIS WARRANTY. SKIER'S CHOICE DISCLAIMS ANY OBLIGATION OR LIABILITY FOR COSTS OR CHARGES DERIVED FROM INCONVENIENCE OF LOSS OF USE, COMMERCIAL OR MONETARY LOSS DUE TO LOSS OF TIME, INCONVENIENCE, OR ANY OTHER CONSEQUENTIAL, SPECIAL OR INCIDENTAL DAMAGES. Some states do not allow the exclusion or limitation of incidental or consequential damages, so the above limitations or exclusions may not apply to you.
3. THIS WARRANTY IS IN PLACE OF ANY OTHER EXPRESS WARRANTIES.
4. THIS WARRANTY APPLIES TO THE FIRST OWNER ONLY AND IS NOT TRANSFERABLE.
5. THIS WARRANTY GIVES YOU SPECIFIC LEGAL RIGHTS, AND YOU MAY ALSO HAVE OTHER RIGHTS WHICH VARY FROM STATE TO STATE.
6. THIS WARRANTY IS EXPRESSLY IN LIEU OF ANY CONTRACTUAL LIABILITIES, INCLUDING PRODUCT LIABILITIES.
7. THE DEALER IS NOT THE AGENT OF SKIER'S CHOICE AND SKIER'S CHOICE DOES NOT AUTHORIZE THE DEALER, OR ANY OTHER PERSON, TO ASSUME ON BEHALF OF SKIER'S CHOICE ANY LIABILITY OR EXPENSE INCURRED IN THE COURSE OF REPAIRING ITS PRODUCTS OTHER THAN THOSE EXPRESSLY AUTHORIZED IN THIS LIMITED WARRANTY. THE DEALER MAY NOT EXTEND OR IN ANY WAY CHANGE OR AMEND THIS LIMITED WARRANTY .



Owner's Responsibility

1. Before operating your Moomba, it is necessary to read and fully understand this Owner's Manual and all other information delivered with the boat.
2. It is the owner's responsibility to take the boat to an authorized Moomba dealer to obtain warranty service.
3. It is the owner's responsibility to properly operate and maintain the boat in accordance with this manual and all other information delivered with the boat.
4. The owner should keep maintenance records should it be necessary to show that required maintenance has been performed on the boat.

Dealer's Responsibility

1. The Dealer should provide the buyer with an adequate orientation in the general operation of the boat and review all systems and accessories included with the boat.
2. The Dealer should deliver a complete owner's manual packet with the boat consisting of Owner's Manual, Registration Engine Manual, Stereo Manual, Moomba Warranty and all warranties for separately warranted items aboard the boat.
3. The Dealer should review all warranty information with the buyer and assist in filling out warranty cards if necessary.
4. The Dealer should insure that any information or obligation from either Skier's Choice, Inc. or from the dealership is clearly understood by the buyer.
5. The Dealer should instruct the buyer in obtaining local service and out-of-area service for a Moomba boat.

Customer Assistance

The staff at Skier's Choice, Inc. is concerned with your complete satisfaction. This includes the prompt resolution of any problems that may arise during the warranty period. Normally, problems encountered may be efficiently and effectively resolved by your Moomba Dealer. However, if a problem cannot be handled by the Dealer or if a solution is not satisfactory to you as an Owner, please follow these steps to get the matter resolved:

Step One

Discuss the problem with a member of your Moomba Dealer's management staff. It is most likely that the problem will be resolved at this level.

Step Two

If the Dealer management does not resolve the problem to your satisfaction, please have the problem and all action taken, documented by the Dealer, then contact the factory Customer Service Representative at Skier's Choice, Inc.

Skier's Choice, Inc.
1717 Henry G. Lane Street
Maryville, TN 37801
Tel: (865) 983-9924
Fax: (865) 983-9950

Describe the original problem in detail to the Customer Service Representative. Be prepared to furnish appropriate documentation and the reasons why service by the Dealer was unsatisfactory. If further action is required to resolve the problem, the Customer Service Representative will dictate the appropriate action.

Step Three

Finally, if after following these steps and providing documentation and after obtaining necessary authorization from the Customer Service Representative to take additional action, the problem is still not resolved to your satisfaction, the President of Skier's Choice, Inc. will personally review the problem and make a determination concerning final resolution.



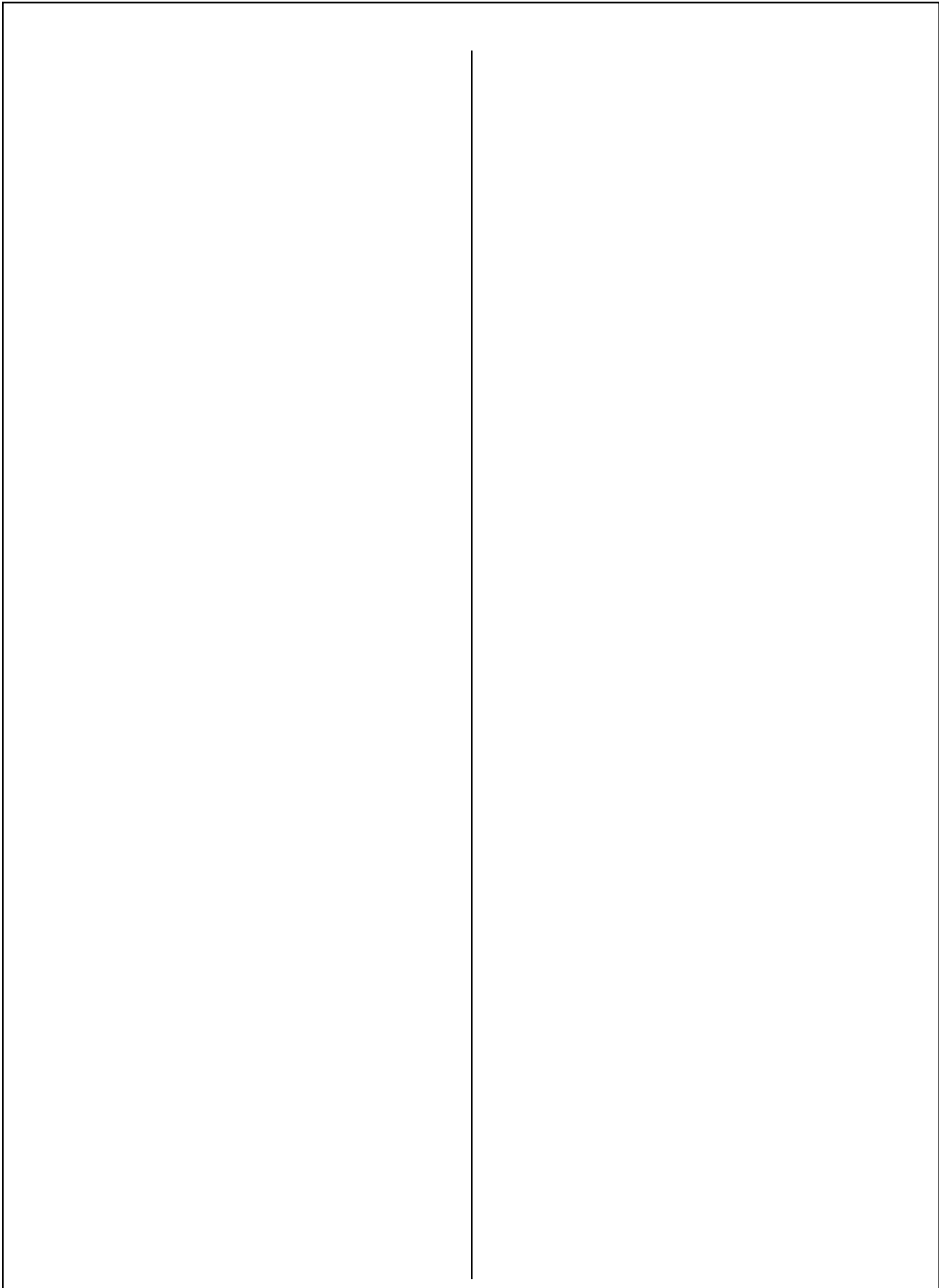

Section XV

Index

A		G	
Accessory Power Switch	31, 32	Glove Box	39
B		H	
Ballast Switch (Optional)	32	Heater (Optional)	47
Battery & Cable Installation	56	Hoisting	60
Battery Box	44	Horn	33
Battery Specifications	61	Hull Identification Number	61
Bertha Ballast System (Optional)	34-36	Hull Protection	58
Bilge Area Drain Plug	23	I	
Bilge Pump Switch	31, 32	Ignition	33
Bimini Top (Optional)	46	Ignition Key	37
Blower Switch	31, 32	Instrument Panel	25
Boating Rules	11	K	
Boating Safety	5	Kill Switch (Optional)	48
Boat Specifications	15	L	
Bow Eye	42	Lifting Rings	42
Bow Light	41	M	
Break-In	19	Maintenance Chart	52
C		Maximum Capacities	20
Canvas Cover	20	Mirror	37
Cleats	40	Motor Box Cover	38
Coast Guard Regulations	11	N	
Cockpit Cover (Optional)	49	Navigation Lights	31, 32
Cooler	47	Neutral Lock Out	23
Cooling Systems	52	O	
Customer Assistance	69	Oil Dipstick	53
D		Oil Level Check	53
Daily Checklist	4	Oil Pressure Gauge	27
Dealer's Responsibilities	69	Oil Specifications	53
Depth Sounder	28-29	Outback Hi-Low Rear Seat	43
Drain Plug Bilge Area	23	P	
Drain Plug Rear	23	Perfect Pass Cruise Control (Optional)	48
Driver's Seat	38	Pole Light Receptacle	41
Driver's Rise-R Seat	48	Propeller	43
E		Propeller Precaution	55
EFI Phased Warm-Up	21	Pulley & Belt Warning	38
Engine Data	61	R	
Engine Hour Gauge	26	Rad-A-Cage	40
Engine Hours	26	Rear Drain Plug	23
F		Rub Rail	57
Fiberglass Care	57	S	
Filling Fuel Tank	24	Safety Procedures	5-8
Fire Extinguisher	39	Satellite Radio (Optional)	47
Foreign Material Deposits	58	Seat Adjustment	38
Fuel	24	(Continued Next Page)	
Fuel Cap Key	24, 37		
Fuel Filter	49		
Fuel Gauge	27		
Fuel Information	22, 45		
Fuel Precautions	24		
Fuel Vent	45		

Index (continued)

S (continued)

Service & Maintenance	51
Shaft Log Packing Nut	54
Shower (Optional)	47
Ski Platform	42
Ski Pylon	39
Slalom Course Speeds	25
Speedometer	26
Speedometer Paddle Wheel	26
Starting & Operation	21
Stern Light	41
Stereo	30
Stereo Switch	31, 32
Stereo Amp (Optional)	49
Subwoofer (Optional)	48

T

Tachometer	26
Technical Information	61
Teakwood Care	58
Temperature Gauge	27
Throttle Lever	23
Tilt Steering	33
Tonneau Cover (Optional)	49
Tower Pole Light	41
Tower Speakers (Optional)	48
Trailer	63
Boat Buddy	64
Boat Hook Up	63
Loading Procedure	64
Trailer Alignment	65
Unloading Procedure	64
Transmission	54
Fluid Level Check	54
Fluid Specifications	55
Trim Switch & Gauge (Optional)	44

U

Upholstery Care	58
-----------------	----

V

V-Drive	
Change Frequency	55
Fluid Check	55
Maintaining Fluid Level	55
Location	55
Remote Oil Filter	53
Warning Light	34
Voltmeter	27

W

Wakeboard Racks (Optional)	46
Wakeplate, Hydraulic (Optional)	44
Walk-Thru Windshield	45
Walk-Thru Curtain (Optional)	48
Warning Plates & Labels	9
Warranty Information	67
Washing Boat	57
Water Strainer (Optional)	48
Windshield Care	57
Winterization	59

