



SKIER'S *Choice, Inc.*

5820 Hwy 411 South, Maryville, Tennessee 37801 — 865-856-3035

Trademarks

Moomba, the Moomba Logo, Kanga, Outback, Outback LS, Outback LSV, Kamberra, Mobius, Mobius LSV, and Mobius V are registered trademarks of Skier's Choice, Inc.

All other product names are copyright and registered trademarks/trade names of their respective owners.

© 2002 Skier's Choice, Inc.

Table of Contents

Section I	Introduction	3
Section II	Boating Safety	5
Section III	Boating Rules	9
Section IV	Boat Specifications	13
Section V	Operating Information	19
Section VI	Starting & Operation	21
Section VII	Instrument Panel	25
Section VIII	Equipment & Options	33
Section IX	Service & Maintenance	43
Section X	Cleaning, Care & Storage	49
Section XI	Winterization & Dry Storage	51
Section XII	Technical Information	53
Section XIII	Trailer Your Boat	55
Section XIV	Moomba Warranty	59
Section XV	Index	65

Boat Information

Hull Identification Number: _____

Date of Purchase: _____

Dealer's Phone Number: _____

Registration Number: _____

Engine Serial Number: _____

Trailer Serial Number: _____

Introduction

Moomba inboard ski boats are manufactured by Skier's Choice, Inc. in Maryville, Tennessee and distributed throughout the United States and the world.

This manual provides an overview for operating your Moomba boat. It should be considered a permanent part of your Moomba boat, and contains important information on Safety, Boating Rules, Proper Operation and Maintenance of your boat. Should the boat be sold, this manual will provide the same important information to the next owner.

Be sure to read and understand all aspects of Boating Safety and Operation before using your boat. If you have any questions, your dealer can provide the information you need to have a safe and pleasurable boating experience.

All information, illustrations and specifications in this manual are based on the latest product information available at the time of printing. Moomba may discontinue models and equipment or change specifications and designs without any notice and without incurring obligation.



This manual contains information about several Moomba models. Some information may not apply to your boat since standards and optional equipment may vary from model to model.

As you read through this manual, you will find **CAUTION**, **WARNING** and **DANGER** symbols which require special attention. Please read them carefully! They may tell you how to avoid problems and/or endangering yourself, your passengers, and other boaters. **PLEASE REVIEW ALL SAFETY INFORMATION.**

 **CAUTION**

 **WARNING**

 **DANGER**

A maintenance schedule and accessory information are included to assure trouble-free operation of your boat. Should service problems arise, remember that your Moomba dealer knows your boat best and is interested in your total satisfaction.

Thank you for purchasing a Moomba boat. We hope your ownership results in an enjoyable and rewarding boating experience. Be safe and enjoy the fun!

Daily Check List

Boatman's Check List

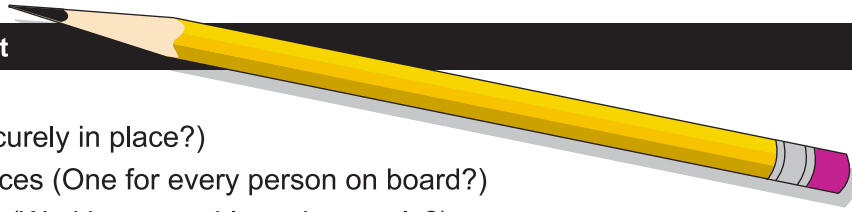

- Drain Plugs (Securely in place?)
- Life Saving Devices (One for every person on board?)
- Steering System (Working smoothly and properly?)
- Fuel System (Adequate fuel? Leaks? Fumes?)
- Battery (Fully charged? Cable terminals clean and tight?)
- Engine (In neutral?)
- Capacity Plate (Are you overloaded or overpowered?)
- Weather Conditions (Safe to go out?)
- Electrical Equipment (Lights, horn, pump, etc?)
- Emergency Gear (Fire extinguisher, bailer, paddle, anchor & line, signaling device, tool kit, etc?)
- Bilge Pump (Working properly?)

NOTE: Bilge pump should be checked prior to each use to ensure proper operation!

Check BEFORE RUNNING (where applicable)

- Engine Oil Level
- Transmission Lubricant Level
- Engine Drain Plug, Transom Drain Plug and Center Drain Plug
- Leakage (Fuel and Water Lines and Connections)

⚠ CAUTION DO NOT operate engine without cooling water flowing through water pump, otherwise pump will sustain damage and subsequent engine damage may result.

Check WHILE RUNNING

- Oil Pressure: Refer to Engine Owner's Manual
- Water Temperature: 160 degrees to 180 degrees for raw water systems (water is not recirculated), and 180 degrees to 200 degrees for closed cooling systems (water is recirculated).
- Idle RPM: (550 - 600) in gear
- Maximum Forward RPM: See Engine Manual
- Shifting linkage (Forward, Neutral and Reverse)

⚠ WARNING Gasoline Vapors Can Explode!

It is very important to check for fuel spillage or leaks prior to each use of your boat.

- Check engine compartment for gasoline vapors.
- Operate blower for 4 minutes.
- Always operate blower below cruising speed.

NOTE: Please refer to your Engine Owner's Manual for maximum RPM and engine break-in procedure.

Important Safety Information!

Your safety, as well as the safety of others with and around you, is a direct result of how you operate and maintain your boat. Read and comprehend this manual. Make sure that you understand all the controls and operating instructions before attempting to operate the boat. Improper operation is extremely dangerous.

The basic safety rules are outlined in this section of the manual. Additional precautions throughout the manual are noted by the following symbols.

CAUTION

This symbol indicates a potentially hazardous circumstance, which, if not avoided, may result in *minor or moderate injury*. It may also be used to alert against unsafe practices.

WARNING

This symbol indicates a potentially hazardous situation, which, if not avoided, could result in *death or serious injury*.

DANGER

This symbol indicates an imminently hazardous situation, which, if not avoided, will result in *death or serious injury*. This is limited to the most extreme situations.

The precautions listed in this manual and on the boat are not all-inclusive. If a procedure, method, tool or part is not specifically recommended by Skier's Choice, you must satisfy yourself that it is safe for you and others, and that the boat will not be damaged or made unsafe as a result of your decision.

REMEMBER: ALWAYS USE COMMON SENSE WHEN OPERATING, SERVICING OR REPAIRING THE BOAT!

In addition to everyday safety, failure to observe safety recommendations may result in severe personal injury or death to you or to others. Use caution and common sense when operating your boat. Don't take unnecessary chances!

Be certain that all boat passengers are aware of this information and conform to boat safety principles.

Boating Safety

Boating Safety starts with a thorough understanding of your equipment and its proper operation. In addition to careful review of this manual, you should be aware as well that there are many sources of information available. Skier's Choice urges you to pursue additional training, such as safety and seamanship courses offered by the U.S. Coast Guard Auxiliary and the U.S. Power Squadron.

The following is a listing of just some of the agencies and organizations that offer safety training or information:

- American Red Cross, National HQ
17th & D Streets NW
Washington, DC 20006
(202) 639-3686
www.redcross.org
- USA Waterski
799 Overlook Drive
Winter Haven, FL 33884
(941) 324-4341
www.usawaterski.org
- Boat Owners Association of the United States (BOAT/US)
880 South Pickett Street
Alexandria, VA 22304
(703) 823-9550
www.boatus.com
- National Safe Boating Council
2550 M Street NW, Suite 425
Washington, DC 20037
(202) 296-4588
www.safeboatingcouncil.org
- U.S. Coast Guard Auxiliary Commandant (G-NAB)
2100 Second Street SW
Washington, DC 20593-0001
(800) 336-2628
www.cgaux.org
- U.S. Power Squadron
www.usps.org
- On-Line Basic Boating Safety Course available
at:www.boatsafe.com

Federal law requires certain safety equipment to be on-board at all times. In addition, responsible boaters carry other equipment in case of emergency. Check with the local boating authorities for any additional requirements over and above the federal stipulations.

Safety Equipment

Your Moomba has been equipped at the factory with most of the federally required safety equipment for **inland waters** (Class 1, 16'-to-26'). This equipment includes:

- UL-approved Marine Fire Extinguisher, Type A-BC (2 lbs.), good for solids, liquids, and electrical fire
- ABYC-approved Marine Mufflers with water injection
- USCG-approved Marine Flame Arrestor
- USCG-approved Engine Box Ventilation with spark-less power blower
- ABYC-approved Electric Horn sound warning device
- USCG-approved inland lighting

Federal law also requires at least one Type I, II or III Personal Flotation Device (PFD) for each person on board or being towed on water skis or other recreational equipment. In addition, one throwable Type IV PFD must also be on board.

As the owner, obtaining the appropriate PFDs is your responsibility. Your Moomba dealer can—and will be happy to assist you.

NOTE: Requirements for coastal waters and inland waters differ. Check with the local authorities for more information.

A smart owner will avoid potential problems on an outing by having additional equipment on board. Normally, this equipment is dependent on the body of water and the length of the trip.

We suggest the following—as a minimum. Your Moomba dealer can also assist you with additional recommendations.

- An anchor with at least 75-feet of line
- A manual bailing device for removing water
- A combination oar/boat hook
- A day-and-night visual distress signal
- A first aid kit and manual
- An airway breathing tube
- A waterproof flashlight
- A set of local navigation charts
- Mooring lines and fenders
- Extra engine oil
- A tool kit
- A portable AM/FM radio or weather radio

Boating-related accidents are generally caused by the operator's failure to follow basic safety rules or written precautions. Most accidents can be avoided if the operator is completely familiar with the boat, its operation, and can recognize potentially hazardous situations before an accident occurs.

General Safety Precautions

Failure to adhere to these precautions may result in severe injury or death to you and/or others.

WARNING

- Improper operation is extremely dangerous. Operators must read and understand all operating manuals supplied with the boat before operation.
- On-board equipment must always conform to the governing federal, state, and local regulations.
- Small children in the bow of the boat should be accompanied by an adult at all times.
- Never stand or allow passengers to stand while the boat is moving. You or others may be thrown from the boat.
- Never operate the boat while under the influence of alcohol or other drugs.
- Gasoline vapors can explode. Before starting engine, open engine box, check engine compartment for gasoline vapors, and operate blower for at least 4 minutes. Run blower below cruising speed.
- Leaking fuel is a fire and explosion hazard. Inspect system regularly. Examine fuel tanks for leaks or corrosion at least annually.
- Never override or modify the engine safety shut-off switch or engine neutral starting safety switch in any way.
- Never remove or modify components of the fuel system in any way except for maintenance by qualified personnel. Tampering with fuel components may cause a hazardous condition.
- Never allow any type of spark or open flame on board. It may result in fire or explosion.
- It is the owner's responsibility to check tightness of the Rad-A-Cage Tower bolts **BEFORE** each use.
- The Rad-A-Cage Tower is designed to pull a single (1) individual. **DO NOT** climb or sit on the Rad-A-Cage Tower. Rope may loop on inverted tricks. **DO NOT** sit behind the pulling point of the Rad-A-Cage Tower.

DANGER

- To avoid serious personal injury, **DO NOT** be on or about the swim platform while engine is running and keep away from rear of boat while engine is running.
- To avoid serious personal injury, **DO NOT** operate engine while anyone is on or about the swim platform or in the water near the boat.

General Safety Precautions *(continued)*

CAUTION

- The tow bar is not designed for vertical extensions. Any modifications to the tow bar or its mountings may result in damage to the boat and injury to the user.
- Rear storage area is located above the gas tank and is not designed for ballast. Weight limit is 150 lbs. equally distributed.
- The Rad-A-Cage Tower may strike low objects. Check clearance height around docks, shore, overhanging objects, bridges and power lines.
- **DO NOT** pull past 45 degrees of the centerline of the boat. Failure to follow this rule could result in the boat capsizing.

Skiing Safety

Skiers are obligated to be as aware of the fundamental safety rules as well as the boat operator. If you are new to water skiing, seek certified training before starting. You will find it especially helpful to join a local ski club and USA Waterski when possible.

Always remember that the majority of water skiing injuries are the result of impacts with other objects, so always look where you are going and be aware of what is going on around you.

WARNING

Failure to adhere to these warnings may result in severe injury or death to you and/or others.

- Every skier must always wear a USCG-approved personal flotation device.
- Maintain a distance of at least 100 feet from all other objects, including other boats, piers, rafts, mooring and navigational buoys, pilings, abutments, or any other items.
- Always have an experienced driver and observer in the boat when skiing.
- Never ski in shallow water, close to shore, or in water where you do not know the depth or what is beneath the surface.
- Never put your arm, head, or any other part of your body through the handle-bridle of the ski line nor wrap the line around any part of the body at any time.
- Never ski at night, or directly in front of other boats.
- Never jump from a boat that is moving at any speed, nor enter or exit the water when the engine is running (ON).
- Make sure that everyone knows and uses approved skiing hand signals and common skiing courtesy.

Ski Pylon Extensions

The use of a ski pylon extension or extensions in excess of 7-feet vertical is not recommended by Moomba on our products. If you elect to use merchandise such as these, be aware that they could create excessive stress on your boat and subjectively cause damages not covered by the warranty.

Warning Plates and Labels

Read and note **ALL** warning plates and labels from bow to stern that appear on the boat, including these!

(Labels apply to Outback LS & Mobius only)

REAR STORAGE AREA NOT DESIGNED FOR BALLAST. WEIGHT LIMIT FOR REAR STORAGE AREA = 150 LBS. EQUALLY DISTRIBUTED.

(Labels apply to all models)

BOATMAN'S CHECK LIST

For maximum enjoyment and safety, check each of these items

- ✓ BEFORE you start your engine:
- ✓ DRAIN PLUG (Securely in place?)
- ✓ LIFE-SAVING DEVICES (One for every person on board?)
- ✓ STEERING SYSTEM (Working smoothly and properly?)
- ✓ FUEL SYSTEM (Adequate fuel? Leaks? Fumes?)
- ✓ BATTERY (Fully charged? Cable terminals clean and tight?)
- ✓ ENGINE (In neutral?)
- ✓ CAPACITY PLATE (Are you overloaded or overpowered?)
- ✓ WEATHER CONDITIONS (Safe to go out?)
- ✓ ELECTRICAL EQUIPMENT (Lights, horn, pump, etc.?)
- ✓ EMERGENCY GEAR (Fire extinguisher, bailer, paddle, anchor & line, signaling device, tool kit, etc.?)
- ✓ PERIODICALLY INSPECT Bilge pump prior to operation of boat to ensure water is exiting boat and pump is free of debris.

DANGER



**AVOID SERIOUS INJURY
DO NOT BE ON OR ABOUT PLATFORM
WHEN MOTOR IS RUNNING**

WARNING



LEAKING FUEL IS A FIRE AND EXPLOSION HAZARD. INSPECT SYSTEM REGULARLY. EXAMINE FUEL TANKS FOR LEAKS OR CORROSION AT LEAST ANNUALLY.

(Labels apply to models with RAD-A-CAGES)

**WARNING:
IT IS THE OWNER'S
RESPONSIBILITY
TO CHECK THE
TIGHTNESS
OF THE
RAD-A-CAGE BOLTS
BEFORE EACH USE**

**WARNING: THE RAD-A-CAGE IS DESIGNED TO PULL A SINGLE (1) WAKEBOARDER, TRICK SKIER OR KNEE BOARDER
DO NOT CLIMB OR SIT ON THIS RAD-A-CAGE.**

ROPE MAY LOOP ON INVERTED TRICKS. DO NOT SIT BEHIND THE PULLING POINT OF THE TOWER.

CAUTION: THIS TOWER MAY STRIKE LOW OBJECTS. CHECK CLEARANCE HEIGHT AROUND DOCKS, SHORE, OVERHANGING OBJECTS, BRIDGES AND POWERLINES.

CAUTION: DO NOT PULL PAST 45 DEGREES OF THE CENTERLINE OF THE BOAT. FAILURE TO FOLLOW THIS RULE COULD RESULT IN THE BOAT CAPSIZING.

Basic Boating Rules

You should be aware of these rules and follow them whenever you encounter another vessel on the water.

The rules presented in this manual are condensed and have been provided as a convenience only. Consult your local U.S. Coast Guard Auxiliary (USCGA) or Department of Motor Vehicles (DMV) for a complete set of rules governing the waters in which you will be using your boat. If you plan to travel—even for a short trip—you would be well served to contact the regional USCGA or DMV in the area where you will be boating.

Review and understand all local and state laws.

Any time two vessels on the water meet one another, one vessel has the right-of-way. It is called the *stand-on* vessel. The vessel which does NOT have the right-of-way is called the *give-way* or *burdened* vessel.

These rules determine which vessel has the right-of-way, and accordingly, what each vessel should do.

The vessel with the right-of-way has the duty to continue its course and speed, except to avoid an immediate collision. When you maintain your direction and speed, the other vessel will be able to determine how best to avoid you.

The vessel which does not have the right-of-way has the duty to take positive and timely action to stay out of the way of the *stand-on* vessel. Normally, the *give-way* vessel should not cross in front of the *stand-on* vessel. Slow down or change directions briefly and pass behind the other vessel. You should always move in such a way that the *stand-on* operator can see what you are doing.

This rule is called Rule 2 in the International Rules and says, "*In obeying and construing these rules due regard shall be had to all dangers of navigation and collision, and to any special circumstances, which may render a departure from the above rules necessary in order to avoid immediate danger.*"

Encountering Other Vessels

There are three main situations in which you may encounter other vessels and you must observe the Steering Rules in order to avoid a collision. These are:

- **Meeting** (you are approaching another vessel head-on)
- **Crossing** (you are traveling across the other vessel's path)
- **Overtaking** (you are passing or being passed by another vessel)

Using the following illustration in which you are the boat in the center, you should give right-of-way to all vessels shown in the white area. In this instance, you are the give-way vessel. All vessels in the shaded area must yield to you as you are the stand-on vessel. Both you and the meeting vessel must alter course to avoid each other.

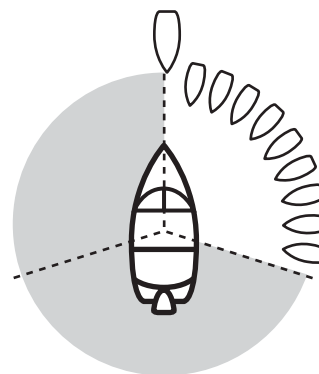

If you are meeting another power vessel head-on, and you are close enough to run the risk of collision, neither of you has the right-of-way. Both of you should alter course to avoid an accident. You should keep the other vessel on your port (left) side. This rule doesn't apply if both of you can clear each other by continuing your set course and speed.

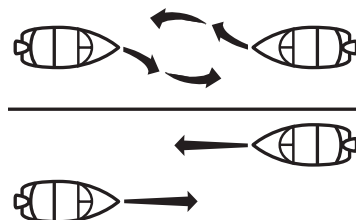

When two power-driven vessels are crossing each other's path close enough to run the risk of collision, the vessel that views the crossing vessel to the starboard (right) side must give-way.

If the other vessel is to the port (left) side, maintain your course and direction, provided the other vessel gives you the right-of-way as it should.

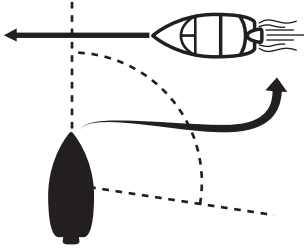

If you are passing another vessel, you are the give-way vessel. This means that the other vessel is expected to maintain its course and speed. You must stay out of its way as you clear it, altering course and speed as necessary.

Conversely, if you are being passed by another vessel, you should maintain your speed and direction so that the other vessel can steer itself around you.

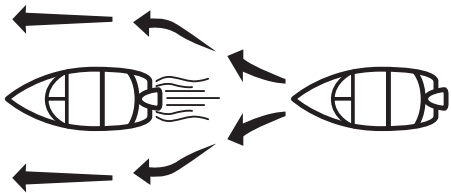

There are three other rules to always remember when driving your boat around other vessels.

When navigating in narrow channels, you should keep to the right when it is safe and practical to do so. If the operator of a power-driven vessel is preparing to go around a bend that may obstruct the view of other water vessels, the operator should sound a prolonged blast on the whistle or horn—four to six seconds.

If another vessel is around the bend, it too should sound the whistle or horn. Even if no reply is heard, however, the vessel should still proceed around the bend with caution.

If you navigate these type of waters, you should carry a portable air horn, which are available from local marine supply stores.

All vessels which are fishing with nets, lines or trawls are considered under International Rules to be fishing vessels. Boats with trolling lines are not considered fishing vessels.

Fishing vessels have the right-of-way, regardless of position. These vessels, however, cannot impede the passage of other vessels in narrow channels.

Sailing vessels should normally be given the right-of-way. The exceptions to this are:

- When the sailing vessel is overtaking the power-driven vessel, the power-driven vessel has the right-of-way.
- Sailing vessels should keep clear of any fishing vessel.
- In a narrow channel, a sailing vessel should not hamper the safe passage of a power-driven vessel which can navigate only in such a channel.

The waters of the United States are marked for safe navigation by the lateral system of buoyage. The markers and buoys you will encounter have an arrangement of shapes, colors, numbers and lights to show which side of the buoy a boater should pass when navigating in a particular direction.

The markings on these buoys are oriented from the perspective of being entered from seaward while the boater is going towards the port. This means that red buoys are passed on the starboard (right) side when proceeding from open water into port, and black buoys are to port (left) side. When navigating out of port, your position to the buoys should be reversed: red buoys to port and black buoys to starboard.

Many boating bodies of water are entirely within the boundaries of a single state. The Uniform State Waterway Marking Systems has been devised for these waters. This system uses buoys and signs with distinctive shapes and colors to show regulatory or advisory information.

These markers are white with black letters and orange borders. The information signifies speed zones, restricted areas, danger areas and general information.

Remember: Markings may vary by geographic location. Always consult local boating authorities before driving your boat in unfamiliar waters.

(See examples of buoys and markers next page.)

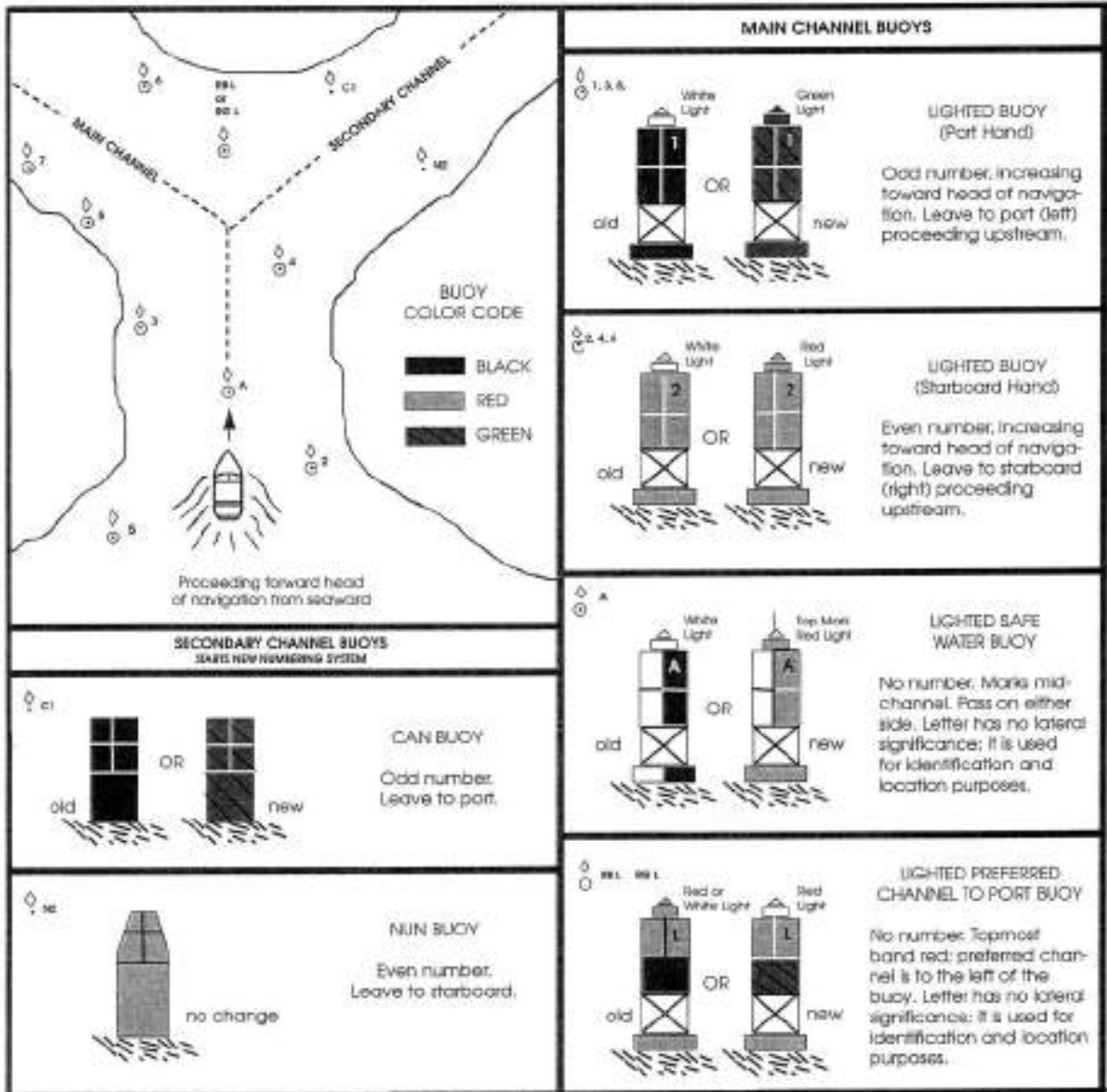

Outback

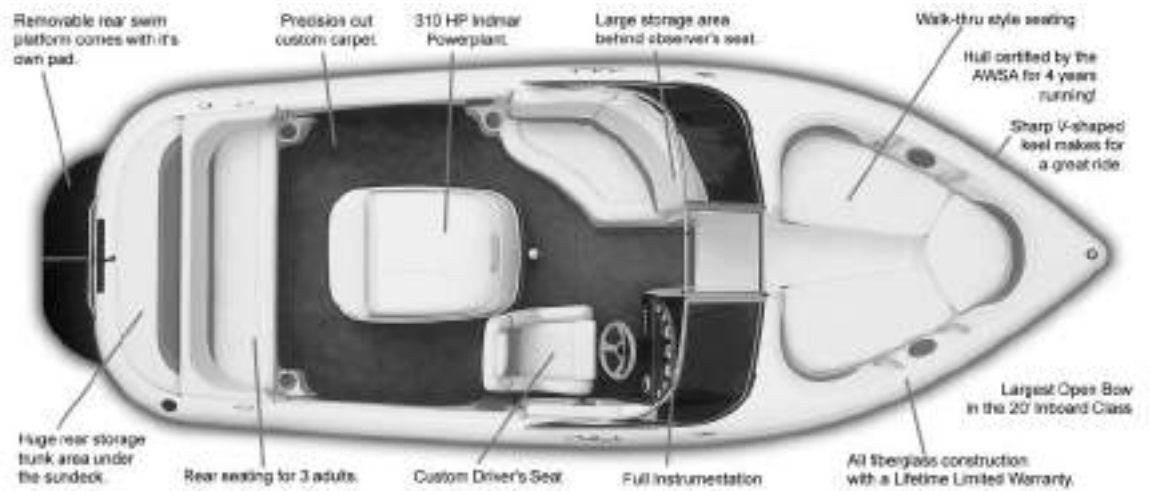

Specifications

Length without Platform:	20'-6"
Length with platform:	22'-0"
Beam:	7' 8"
Draft:	22"
Weight:	2450 lbs.
Fuel Capacity:	27 gal.
Standard power:	310 hp
Optional Power:	320 to 330 hp

Outback LS

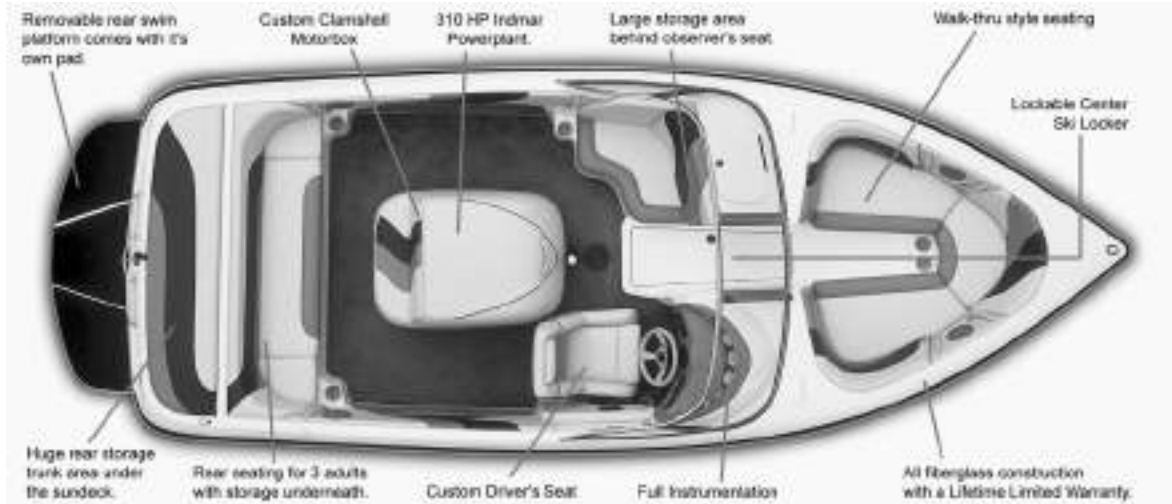

Specifications

Length without Platform:	20'-8"
Length with platform:	22'-8"
Beam:	95"
Draft:	22"
Weight:	2650 lbs.
Fuel Capacity:	28 gal.
Standard power:	310 hp
Optional Power:	320 to 330 hp

Outback LSV

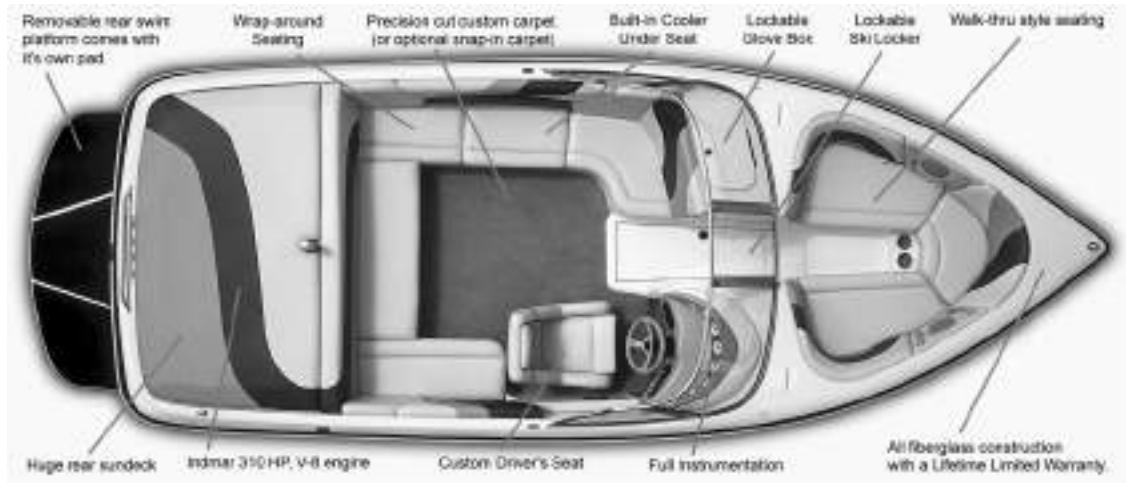

Specifications

Length without Platform:	20'-8"
Length with platform:	22'-8"
Beam:	95"
Draft:	24"
Weight:	3,000 lbs.
Fuel Capacity:	40 gal.
Standard power:	310 hp
Optional Power:	320 to 330 hp

Kamberra Walkabout

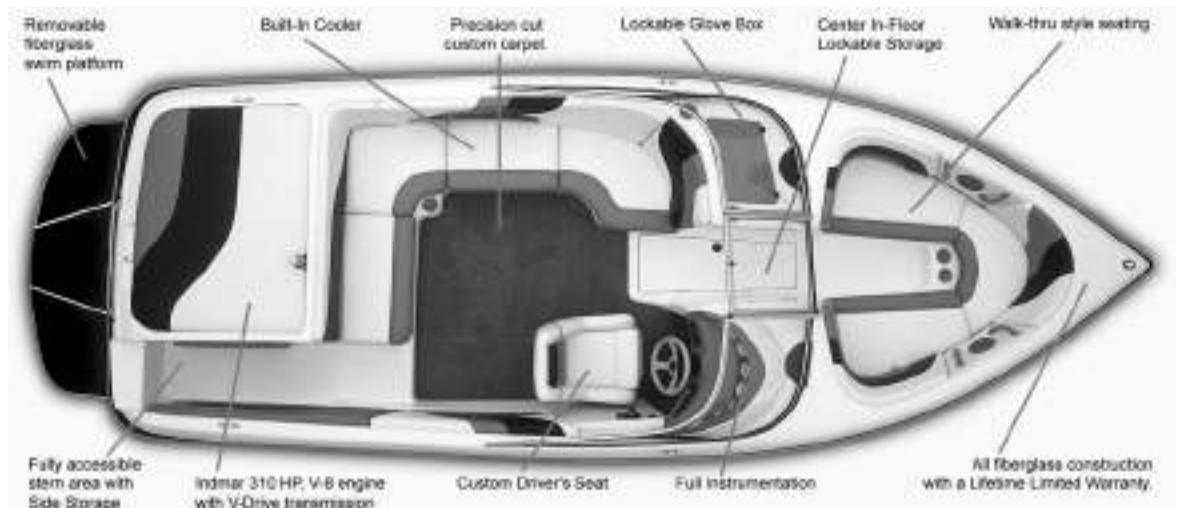

Specifications

Length without Platform:	22'
Length with platform:	24'-2"
Beam:	95"
Draft:	24"
Weight:	3,250 lbs.
Fuel Capacity:	40 gal.
Standard power:	310 hp
Optional Power:	320 to 330 hp
Seating Capacity:	12 persons

Mobius

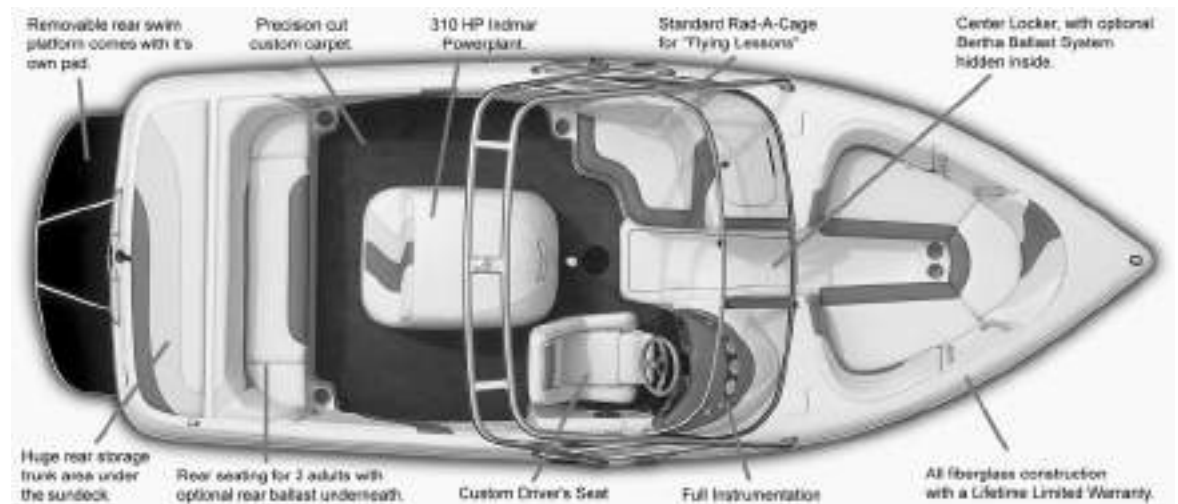

Specifications

Length without Platform:	20'-8"
Length with platform:	22'-8"
Beam:	95"
Draft:	22"
Weight:	2650 lbs.
Fuel Capacity:	28 gal.
Standard power:	310 hp
Optional Power:	320 to 330 hp

Mobius LSV

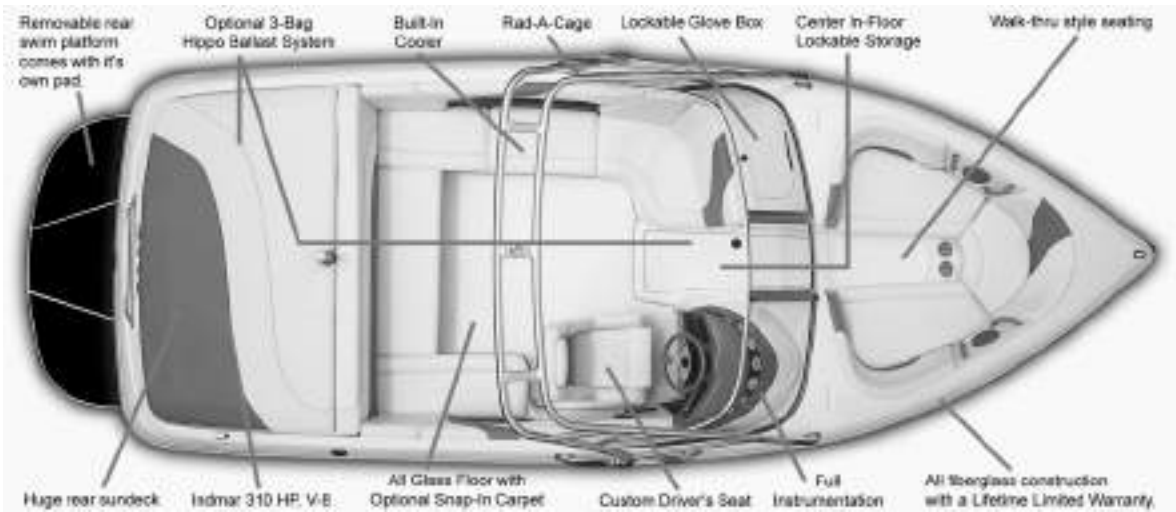

Specifications

Length without Platform:	20'-8"
Length with platform:	22'-8"
Beam:	95"
Draft:	24"
Weight:	3000 lbs.
Fuel Capacity:	40 gal.
Standard power (MPI):	310 hp
Optional Power:	320 to 330 hp

Mobius V

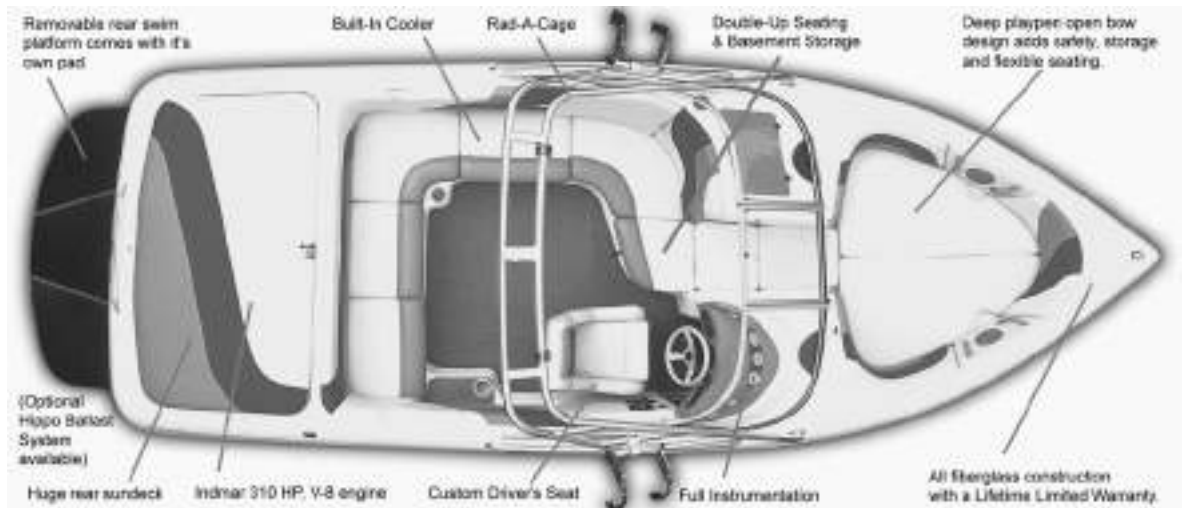

Specifications

Length without Platform:	22'
Length with platform:	24'-2"
Beam:	95"
Draft:	24"
Weight:	3250 lbs.
Fuel Capacity:	40 gal.
Standard power (MPI):	310 hp
Optional Power:	320 to 330 hp

Kanga

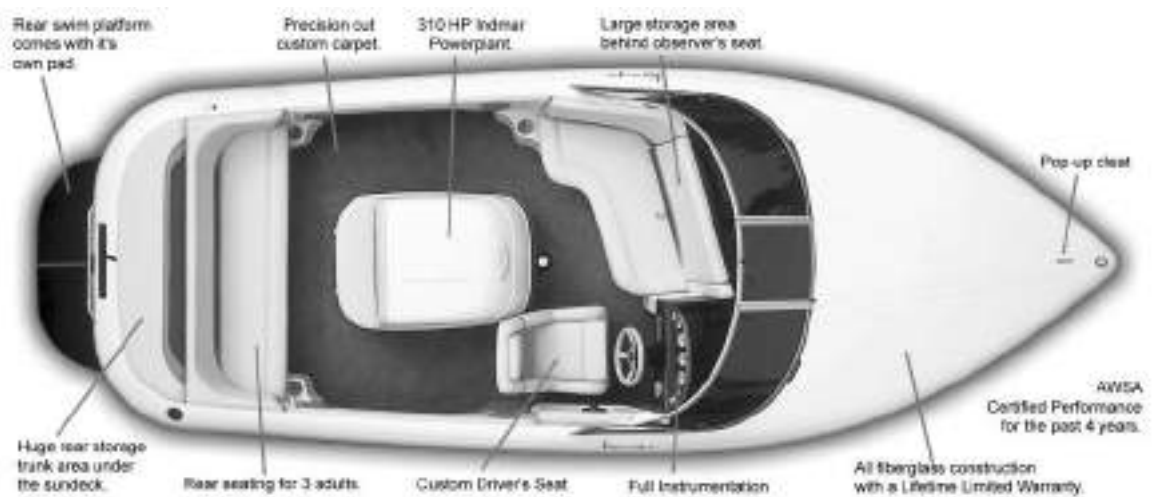

Specifications

Length without Platform:	20'-6"
Length with platform:	22'-0"
Beam:	7' 8"
Draft:	22"
Weight:	2450 lbs.
Fuel Capacity:	27 gal.
Standard power:	310 hp
Optional Power:	320 to 330 hp



BREAK IN

Taking care to properly break in your new engine will pay off in the long run. In our years of field testing, we have proven that an Indmar engine, when properly broken in according to our simple procedures, will last longer, run better and have fewer repairs over its lifetime.

Your new engine does not require an elaborate break-in procedure. Just follow these simple instructions and you are off to a great start.

The three (3) most important aspects of new engine break-in are:

1. Avoid running engine at high speeds.
2. Do not carry a heavy load (passengers, gear, etc.).
3. Vary your boat speed during break-in, don't run at the same RPM for a long period of time.

BREAK-IN STEPS

- For the first hour, do not exceed 2,000 RPM.
- For the second hour, do not exceed 3,000 RPM.
- For the next five hours, do not exceed 4,000 RPM.

BREAK-IN TIPS

- Avoid fast accelerations and don't carry (or pull) a heavy load during this period.
- Always let engine warm up gradually before acceleration.
- Check oil frequently. During the first 50 to 100 hours, an engine can use more oil than usual. Maintain oil at a proper level at all times (do not overfill).
- Monitor transmission fluid levels.
- Report abnormal noises or vibrations to your dealer.
- Keep an eye out for loose mountings, fittings, nuts, bolts, and clamps.

During the BREAK-IN process, engine temperature should be carefully monitored and speed should be reduced if overheating is evident. **ALSO, PLEASE REFER TO ENGINE OWNER'S MANUAL FOR BREAK-IN INFORMATION.**

NOTICE: PLEASE REFER TO ENGINE OWNER'S MANUAL for maximum RPM and engine break-in procedure.

After the first 10 to 20 hours of operation, take your boat to the dealer for its first oil and filter change, as well as an engine checkup. Remember to keep a sharp eye on all gauges and warning lights during these first hours of operation. Report anything unusual to your dealer.

After the break-in procedure is over, your boat may be operated continuously at any speed.

⚠ CAUTION

Do not exceed maximum RPM recommended for your engine. Exceeding the maximum RPM may result in damage to the engine.

⚠ DANGER

Before starting your engine you must open the engine box and check engine compartment and bilge for gasoline and oil vapors.

Maximum Capacities



In compliance with United States Coast Guard Regulations, Moomba Boats meet or exceed all safety standards designed for recreational boats. To ensure safe handling and performance, each Moomba boat displays a maximum capacity sticker (see sample), stating the maximum passenger weight load allowable.

NOTICE: Refer to the Maximum Capacity Sticker on your boat for allowable loading.

Coast Guard Regulations

The United States Coast Guard boating regulations prescribe minimum standards of safety to be met and maintained by all watercraft. It is necessary that your boat remain in compliance with these regulations.

The staff at Skier's Choice, Inc. recommend that all boat operators complete a Coast Guard approved boating safety course.

Canvas Cover



Your Moomba boat cover is made from the finest canvas and webbing to insure that your boat will be protected in the off season. The cover has been designed to fit securely around each boat. If your new cover does not seem to be snug, a shrinkage allowance has been sized in.

Use the following procedure when covering the boat:

1. Be sure that the cover fits snugly at the bow then unfold from front to back.
2. Be sure to install cover pole(s) and adjust to proper height, using set screw on pole(s). This will keep water from gathering in the center, which can damage the cover.
3. Secure all fastening straps around the trailer frame.
4. Pull the draw cord equally from both sides and tie off to the lifting eyes on the stern in accordance with the illustration.

Folding Cover

When folding the cover for storage, be sure the cover is dry. Take care not to scratch the canvas finish against rough surfaces. Store in a dry location.

Cover Repair

If the cover becomes damaged, immediately patch and reseal the area. Use a tent seam sealer to reseal any new stitches. Spray fabric guard on scraped or worn surfaces. Canvas tears should be repaired professionally and stitches sealed to prevent leakage.

CAUTION

Your mooring cover is not designed for trailering. Trailering with your cover installed may cause premature cover failure and boat damage. This damage is not warrantable.

A standard pre-starting procedure should always be followed before the first start-up of the day.

1. Check the engine oil level.
2. Check for gasoline fumes in bilge or engine compartment.
3. Operate engine blower for 4 minutes to remove any fumes.
4. Check manual operation of bilge pump. Make sure bilge areas are empty.

Other items might also be inspected, depending on the boat and its use. It is advisable to formulate a check list particular to the equipment and operation of your boat.

REFER TO THE BOATMAN'S CHECKLIST OF THIS MANUAL.

Consult the local Coast Guard Auxiliary or Power Squadron for full details on boating safety.

NOTE: Add-on electrical accessories should never be connected to the ignition terminal or ignition circuit.

IMPORTANT: DO NOT continue to operate the starter for more than 30 seconds at a time without pausing to allow the starter motor to cool down for at least 2 minutes. This will also allow the battery to recover between starting attempts. PLEASE REFER TO ENGINE OWNER'S MANUAL FOR ADDITIONAL DETAILS.

DANGER

BEFORE STARTING ENGINE, BE SURE THAT THE SHIFT SELECTOR IS IN NEUTRAL.

The correct starting procedure depends upon the type of engine. Please refer to the engine manual before starting.

To Start Electronic Fuel Injection (EFI) Engine

1. Place shift selector in Neutral with the throttle in the upright (zero) position. (If throttle is not in the idle position, the throttle position sensor will not allow the engine computer to proceed with a normal starting procedure).
2. Turn Ignition Key to Start Position to operate the starter.
3. Release the Key when engine starts (key will return to run position).
4. Allow the engine to establish a good idle (30 to 60 seconds) before getting underway.
5. Shift slowly into forward or reverse, allowing the transmission time to engage before powering up.

NOTE: It is normal for the idle to speed up in cold start conditions.

CAUTION

DO NOT continue to operate the starter for more than 30 seconds at a time without pausing to allow the starter motor to cool down for at least 2 minutes. This will also allow the battery to recover between starting attempts. PLEASE REFER TO ENGINE OWNER'S MANUAL FOR ADDITIONAL DETAILS.

NOTE: Should the EFI engine become "flooded" use the following procedure to start:

- 1F. Place shift selector in Neutral and disengage the transmission by pushing the transmission lockout button located at the bottom of the lever.

- 2F. With the transmission disengaged push the lever forward to full throttle position. (This will cause the computer to shut off the fuel injectors which will allow the engine to clear of excess fuel during starting).
- 3F. Turn the Ignition Key to Start Position and operate the starter for no more than 15 seconds at a time until the engine starts.
- 4F. When the engine starts, back off the throttle and allow the engine to establish a good idle (30 to 60 seconds).
- 5F. Return the throttle to idle position and the transmission lockout will automatically reengage the transmission in neutral position.
- 6F. When ready to get underway, shift slowly into forward or reverse, allowing the transmission time to engage the gearing before powering up.

To Start Carburetor Engine

1. Place shift selector in Neutral with the throttle in the upright (zero) position and push the transmission lockout button at the bottom of the lever to disengage the transmission.
2. Turn the ignition key to the start position to operate the starter.
3. When the engine starts, release the key and it will return to the run position.
4. With the transmission disengaged, push the throttle lever forward to increase the engine idle to 1200 to 1500 RPM.
5. When the engine idle smooths out, return the throttle to idle position and the transmission lockout will automatically reengage the transmission in neutral position.
6. When ready to get underway, shift slowly into forward or reverse, allowing the transmission time to engage the gearing before powering up.

If Carburetor Engine Does Not Start

- 1B. Place shift selector in Neutral with the throttle in the upright (zero) position and push the transmission lockout button at the bottom of the lever to disengage the transmission.
- 2B. With the transmission disengaged, push the throttle lever forward about one-fourth (to slow run position).
- 3B. Turn ignition key to start position to operate starter.
- 4B. When the engine starts operate the throttle lever to establish an engine idle of 1200 to 1500 RPM.
- 5B. When the engine idle smooths out, return the throttle to idle position and the transmission lockout will automatically reengage the transmission in neutral position.
- 6B. When ready to get underway, shift slowly into forward or reverse, allowing the transmission time to engage the gearing before powering up.

If Carburetor Engine Does Not Start

- 1C. Place shift selector in Neutral with the throttle in the upright (zero) position and push the transmission lockout button at the bottom of the lever to disengage the transmission.
- 2C. With the transmission disengaged, move the throttle lever back and forth from one-fourth to one-third throttle.
- 3C. While moving the throttle lever turn the ignition key to Start Position to operate the starter.

NOTE: Do not operate the starter for more than 15 seconds at a time. Allow the starter to rest for a full minute before attempting this starting procedure again.

- 4C. When the engine starts, operate the throttle lever to establish an engine idle of 1200 to 1500 RPM.

If Carburetor Engine Floods

- 1D. Place shift selector in Neutral with the throttle in the upright (zero) position and push the transmission lockout button at the bottom of the lever to disengage the transmission.
- 2D. Push the throttle lever to the full throttle (wide open) position.
- 3D. Turn Ignition Key to operate starter.

NOTE: Do not operate the starter for more than 15 seconds at a time. Allow the starter to rest for a full minute before attempting this starting procedure again.

- 4D. When the engine starts, back off the throttle, but allow the engine to idle at 1500 RPM until it smooths out.

Throttle Lever



The throttle lever controls both the throttle and the transmission. The idle position (normally vertical) is the zero throttle position and the neutral position for the transmission. A safety ring (umbrella) keeps the lever from being accidentally moved to engage the transmission.

To place the transmission into gear, with your hand placed over the lever ball, pull up on the safety ring (umbrella) and slowly push the lever into forward gear or slowly pull the lever back into reverse gear.

CAUTION

Never shift the lever directly from the neutral (vertical) position into a speed position.

- To prevent damage to the transmission always allow the transmission time to engage before accelerating the engine.
- Once the transmissions engaged, you may accelerate as quickly as you like.

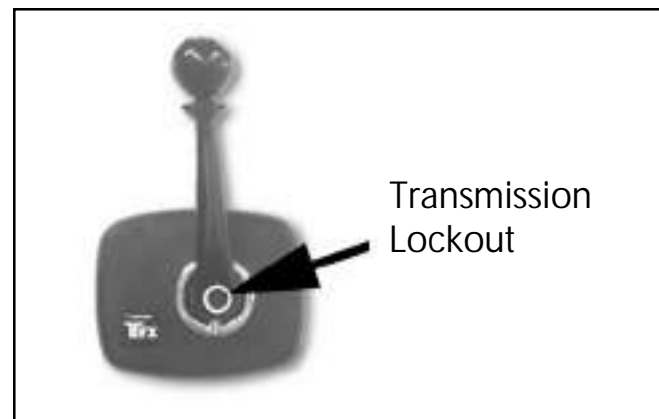

The Transmission Lockout button allows the transmission to be disengaged while giving the throttle full operating range. With the lever in the idle position (normally vertical) push the button located at the bottom of the lever to disengage the transmission. The throttle may then be operated in any open position (forward of neutral or back of neutral upright position). Return the throttle to idle position, and the transmission lockout will automatically reengage the transmission in neutral position.

Bilge Area Drain Plug

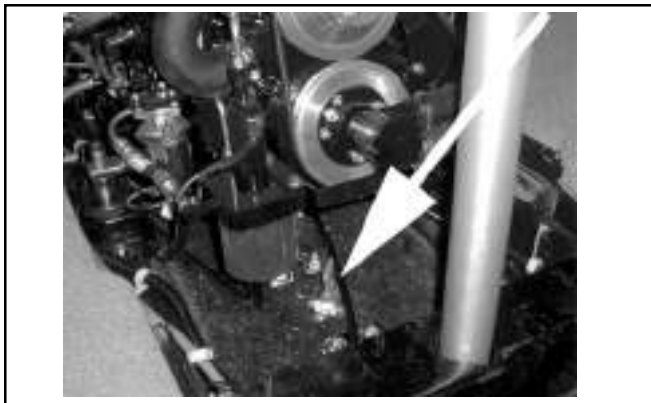

The bilge area drain plug is located at the front of the motor well, in the center under the engine.

It is extremely important that the drain plug is always checked before starting the engine. The drain plug should be secured in place using a wrench.

WARNING

DO NOT start engine until center drain plug is checked and secured in place. DO NOT try to install center drain plug while engine is running.

Rear Drain Plug (if applicable)



The rear drain plug is located at the back of the boat, near the bottom of the transom. It is extremely important that the drain plug is always checked before starting the engine. The drain plug should be secured in place using a wrench.

CAUTION

DO NOT start the engine until the drain plug is checked and secured in place.

DO NOT try to install the drain plug while the engine is running!

Fuel Precautions

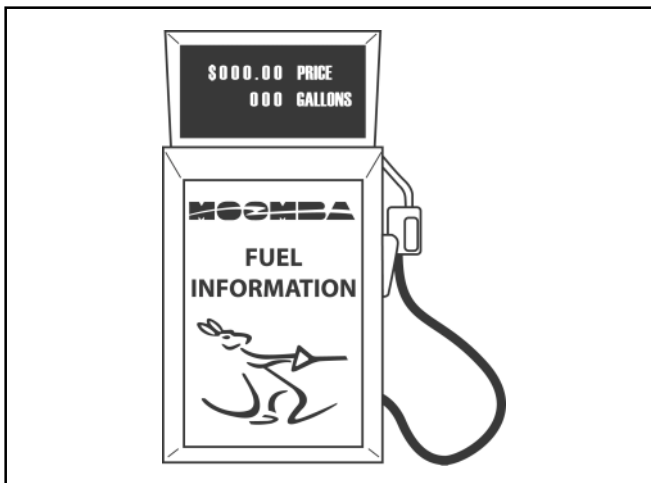

Use a gasoline with a minimum octane rating of 89.

WARNING

DO NOT use gasoline containing methyl alcohol (methanol) or ethyl alcohol (ethanol). Methanol and Ethanol can damage your boat's fuel system.

CAUTION

Gasoline Stabilizer should be added to the fuel tank when the boat is used infrequently or whenever your boat will not be used for two weeks or more. During storage always add Gasoline Stabilizer to reduce gumming or tank sludge.

Filling the Tank

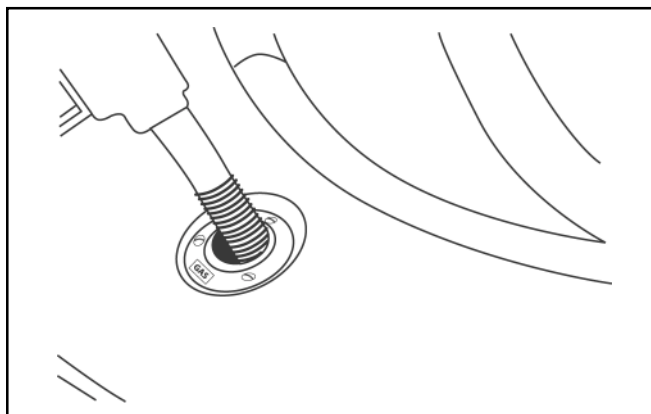

CAUTION

Be especially careful when filling the fuel tank. DO NOT over fill the tank. Fuel may empty through the fuel vent and damage to finishes could result.

If fuel is spilled on stripes or decals, apply a common bath cleaner (nonabrasive) and wipe with a damp cloth. Rinse the spill area with clean water.

Fueling



WARNING

Sparks while fueling could cause an explosion!

Before Fueling:

1. Turn off engine.
2. Turn off ignition.
3. Extinguish cigarettes or any open flame.

While Fueling:

1. Keep hose nozzle in contact with fill pipe to provide a ground against static sparks.
2. Fill tank at a slow rate to avoid any spillage.



The fuel cap is located on the rear deck near the stern. A special fuel key is provided to open the cap.

NOTE: The cap is sealed by a rubber O-ring. Please do not over tighten.

Section VII

Instrument Panel & Controls

Outback & Kanga



Outback LS, Outback LSV,
Mobius, Mobius LSV, Mobius V,
Kamberra Walkabout



Speed Calibration



Speed may be checked using a stopwatch and a standard slalom course. Adjust the speedometer needle by twisting the adjuster knobs located next to the tachometer.

Slalom Course Speeds
(Times are from start gate to end gate)

MPH	SECONDS	ALLOWABLE
+ or - 1/2 MPH		TIMES / (SECS)
18	32.19	32.0 - 32.6
20	28.97	28.0 - 28.6
30	19.31	19.0 - 19.6
32	18.11	17.9 - 18.3
34	16.95	16.8 - 17.2
36	16.08	15.9 - 16.3

Warning Stickers

Always heed the dash mounted warning stickers

WARNING

GASOLINE VAPORS CAN EXPLODE!

BEFORE STARTING ENGINE:

- Check engine compartment for gasoline or vapors
- Operate blower for 4 minutes
- Run blower below cruising speed
- Turn off engine before using swimming ladder

Speedometer

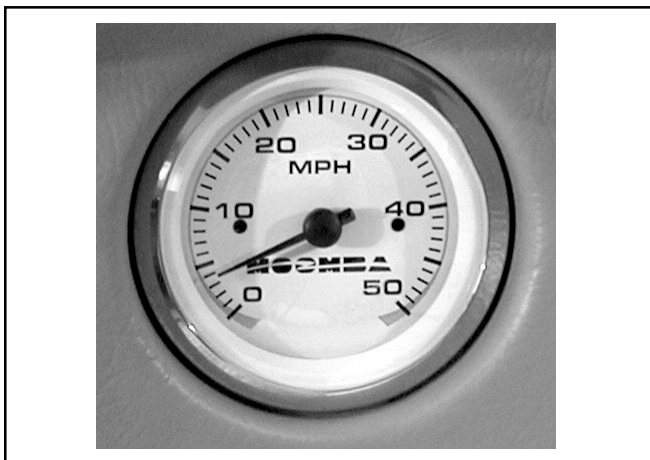

The speedometer indicates the water speed of the boat in miles per hour. It is recommended that the speedometer be checked for accuracy after each 100 engine hours.

Speed may be checked using a stopwatch and a standard slalom course. Adjust the speedometer needle by turning the knob at the bottom of the gauge.

NOTE: If the speedometer registers erratically, check speedometer pickups.

Tachometer

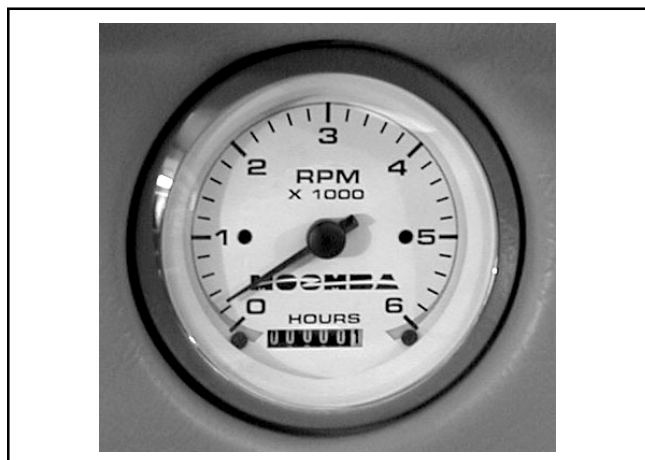

The tachometer registers the operating speed of the motor's shaft output and may be used as an alternative to speedometer if weight and water conditions permit.

DO NOT exceed the recommended RPM during break-in and normal operation of your motor. Exceeding the manufacturer's suggested RPM may cause damage to the engine.

Engine Hours



ENGINE HOURS are shown on the face of the Tachometer. The engine hour gauge acts as an odometer for the engine.

Engine hours should always be noted and documented so that required maintenance and lubricant changes may be performed at the proper intervals.

Speedometer Pickups



The speedometer pickup is located on the bottom of the hull. The pickup measures the speed of water passing the paddlewheel. Poor water conditions or foreign material may clog the pickup causing the speedometer to register incorrectly.

Inspect the paddlewheel and remove any foreign material. Please see paddlewheel owner manual in the Boat Owner's Packet for more information.

Voltmeter (Inboard)



The voltmeter indicates whether the battery is charging or discharging. The needle should be located in the normal range while the engine is running.

If the voltmeter does not register in the normal range, there may be a problem within the electrical system. It is normal for the voltmeter needle to fall when starting the engine. Normal range is 12 to 14 volts.

Temp Gauge

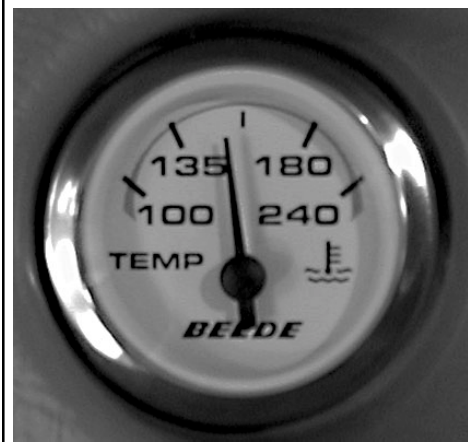

The temperature gauge indicates the engine coolant temperature while the coolant is circulating inside the engine. Engine operating temperatures will vary depending on the weather conditions and engine load. Normal operating temp range is between 160 degrees and 180 degrees.

NOTICE: Refer to your Engine Owners Manual for additional details.

Oil Pressure Gauge

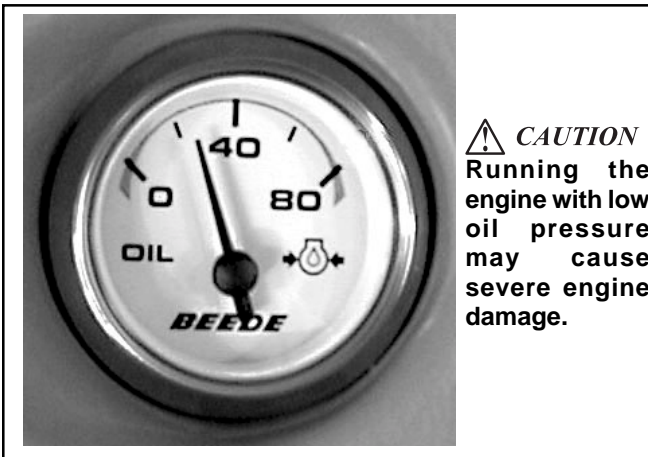

CAUTION
Running the engine with low oil pressure may cause severe engine damage.

The oil pressure gauge indicates the oil pressure in the engine while the engine is running.

If the oil pressure remains below the normal range of 20 to 40 psi, stop the engine immediately. If engine is allowed to run while oil pressure is too low, permanent engine damage may occur.

Fuel Gauge



This gauge indicates the approximate quantity of fuel remaining in the tank when the ignition switch is in the "ON" position.

NOTICE: DO NOT run the tank to empty. To prevent condensation from forming in the tank, it is recommended that the tank be filled when the gauge indicates 1/4 tank of fuel remaining.

Depth Sounder



General Description

1. The depth finder will read to 199 ft., or the corresponding number of meters or fathoms. If the reading is less than 19.9 ft., meters or fathoms, 1/10th increments will be displayed. If the reading is more than 19.9 ft., all readings will be in whole numbers.
2. The depth finder has an audible and LCD displayed depth alarm with adjustable shallow and deep limits and a depth below keel offset feature. The settings once made are stored in memory and will remain even if the battery is disconnected.

Operation:

1. **Power On.** The depth sounder will activate automatically when the power to it is initially turned on. You do not have to press the combination "ON/OFF MODE" keypad. The LCD will illuminate showing the depth and will also show the type of units selected, feet (FT), meters (M), or fathoms (F). To turn the depth sounder off, press and hold the "ON/OFF MODE" keypad for 4 seconds. Pressing the "ON/OFF MODE" keypad again will reactivate the unit.
NOTE: The instrument is designed to have the internal LED lighting remain on as long as power is supplied even if the unit is turned "OFF" at the keypad.
2. **Depth Alarm.** Shallow mode: Pressing the "ON/OFF MODE" keypad again displays the "SH" shallow depth alarm setting. This is the shallowest water that will activate the alarm. Press and hold the up or down arrow keypads to adjust the reading to the desired depth.
Deep mode: Pressing the "ON/OFF MODE" keypad again displays the "DP" deep depth alarm setting. This is the deepest water that will activate the alarm. Press and hold the up or down arrow keypads to adjust the reading to the desired depth. When the shallow depth setting is read by the depth sounder, the "SH" will flash on the LCD and the audible alarm will sound rapidly. When the deep depth setting is read by the depth sounder, the "DP" will flash on the LCD and the audible alarm will sound at 2 beeps per second.

NOTE: To fully deactivate an alarm, reset it to zero. Pressing the "ON/OFF MODE" keypad temporarily deactivates the alarm. To reactivate the alarm press the "ON/OFF MODE" keypad until the depth reading appears.

3. **Keel Offset.** Pressing the "ON/OFF MODE" keypad again displays the "KL" keel offset setting. This can be set so that the depth sounder either shows the depth below the keel or the depth below the transducer. Press the up or down arrow keypads to adjust the reading to the desired depth no more than 19.9 ft. For example if the bottom of the keel is 2 ft below the transducer and you want the depth sounder to read the depth below the keel, the display should be adjusted to read 2.0 ft

NOTE: Once a keel offset is programmed, the shallow and deep alarms will be activated by the depth below the keel.

4. **Units.** Pressing the "ON/OFF MODE" keypad again displays "Un" on the LCD indicating the units mode. Press either the up or down arrow keypads to set the units desired to feet (FT), meters (M), or fathoms (F). These units, once set, will remain the same for all modes. Pressing the "ON/OFF MODE" keypad again returns the depth sounder to normal operation.

Stereo



Remote Control Pad

Please refer to your stereo owner's manual for proper operation instruction.

CAUTION The stereo cannot be turned off by the remote. The "SRC" button on the stereo unit must be held down for 3 seconds to completely turn the stereo off. Continue to hold the SRC button until display goes blank.

CAUTION If the face displays "ALL OFF", your stereo is in standby mode and drawing battery power which will drain the battery and may lead to a dead battery.

Navigation Lights

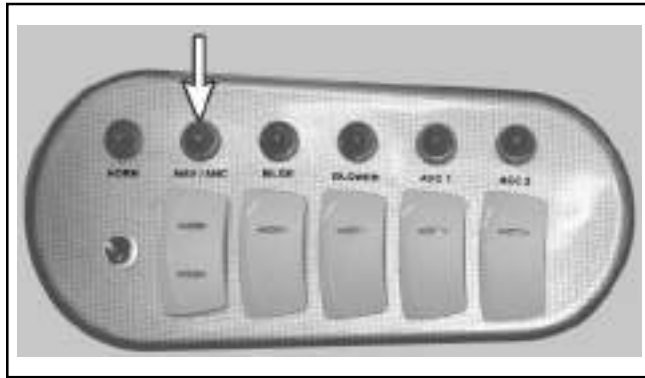

The navigation light switch supplies power to the Bow Light, the Stern Light and the Pole Light.

Operation: When under way at night install the Pole Light and set the switch in the NAV position to activate all of the running lights. When docked or at anchor at night set the switch in the ANC position to illuminate only the pole light.

NOTE: If lights fail to operate, press the circuit breaker reset button located above or beside the lights switch.

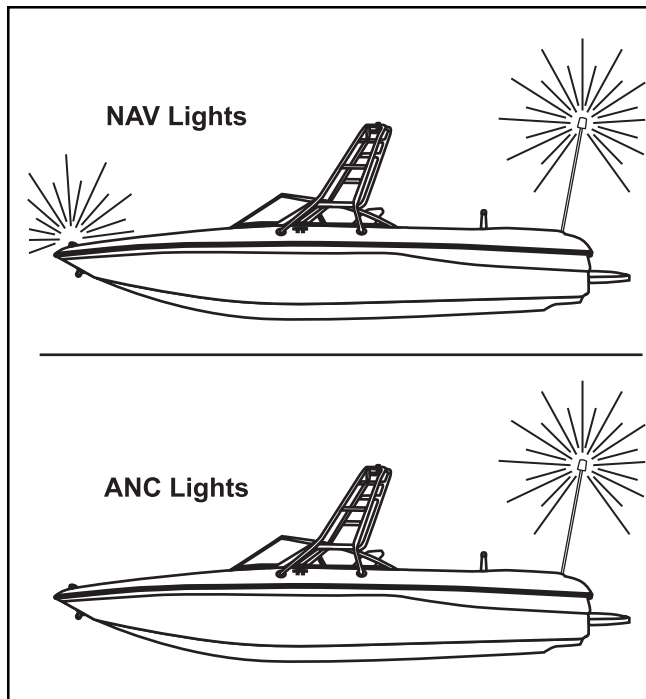

Bilge Pump Switch

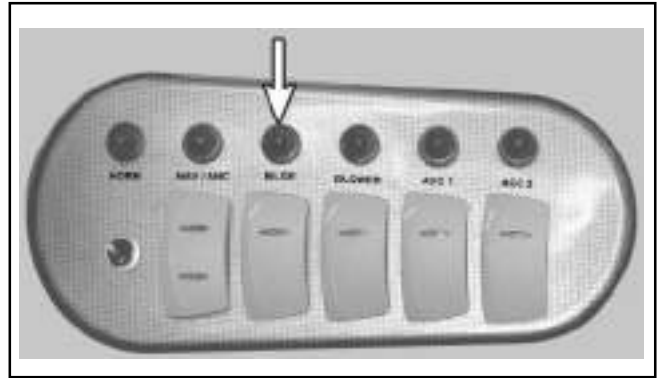

The bilge pump switch operates in two positions. The manual position is used to verify that the pump is operational.

The automatic pump function is engaged at all other times so that any excess water in the bilge may automatically be pumped out.

NOTE: If the Bilge Pump fails to operate in the manual position, press the circuit breaker reset button labeled BILGE on the circuit breaker panel under the dashboard. If the bilge pump still does not operate, notify your Moomba dealer.

Optional Bertha Ballast Switch

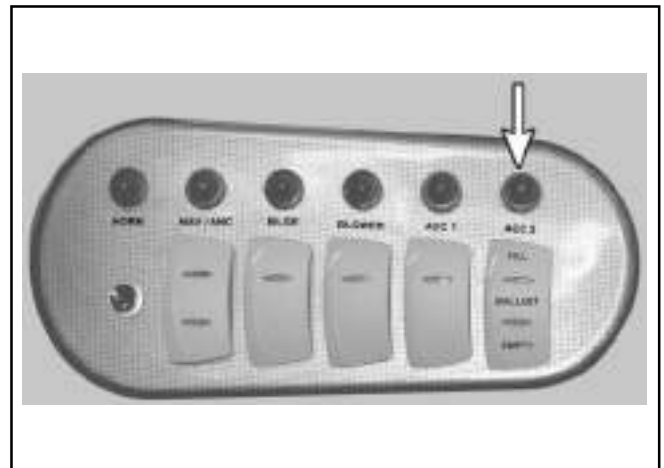

To fill the ballast system press the fill switch. To empty, press the empty switch. With the ballast full, the boat porpoises at speeds above 25 mph.

⚠ WARNING
DO NOT tow boat on trailer with ballast full.

Blower Switch

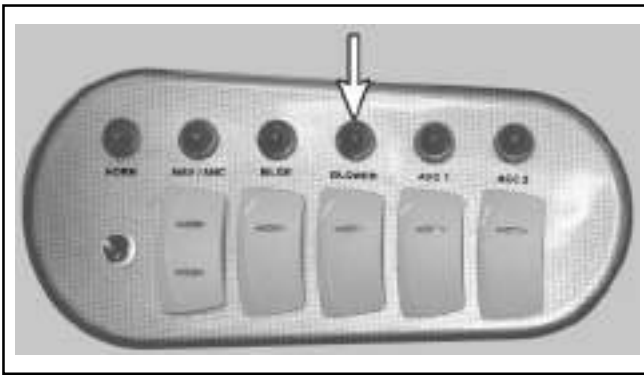

The blower switch activates the blower motor. The primary function of the blower fan is to remove any fumes from the bilge area. The blower also draws fresh air into the engine compartment.

Never depend solely on the blower to eliminate dangerous fumes. Before starting the engine, always open the motor box to check if fumes are present.

Switch on the blower fan a minimum of four minutes before starting the engine.

NOTE: If the blower fails to operate, reset the circuit breaker located on the circuit breaker panel under the dashboard. If the blower still does not operate, notify your Moomba dealer.

Ignition Switch



Located on the port side of the dashboard, the ignition switch has three positions. In the vertical position the ignition is OFF. With the key in, turn the ignition switch one notch to the right to check all electrical equipment, including blower, pump, and lights. Turn the ignition all the way to the right to operate the starter.

NOTE: All electrical equipment should be turned off when the boat is in storage.

Accessory Switches

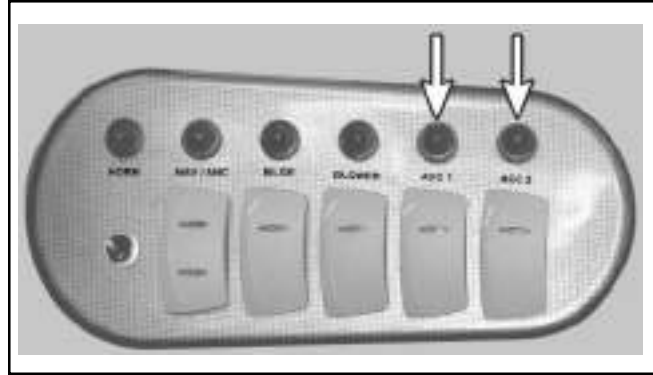

The accessory switch supplies power to an extra circuit for accessories that may be added (such as heaters, hot water showers, etc.)

NOTE: If accessories fail to operate, press the circuit breaker under the dash. If the accessory still does not operate, notify your Moomba dealer.

Tilt Steering



Tilt steering may be adjusted up or down in five different locking positions. To adjust, depress the tilt lever located beneath the bezel and move the steering wheel to the desired position. Release the lever to lock the wheel into place.

Horn Switch

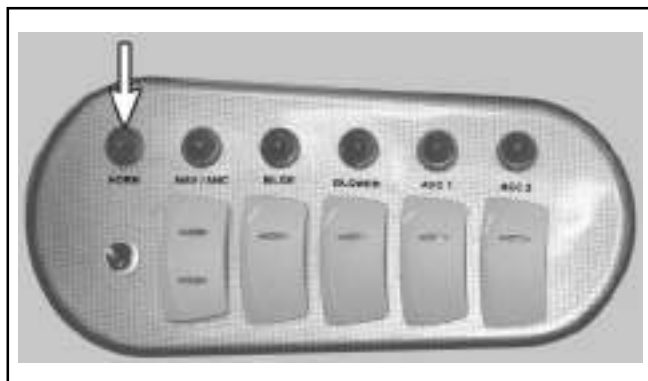

The Horn Switch is located on the port dash near the ignition. Sound the horn by depressing the button.

Horn / Whistle Signals

One Long Blast:

Warning Signal (Coming out of slip)

One Short Blast:

Pass on my Port Side

Two Short Blasts:

Pass on my Starboard Side

Three Short Blasts:

Engines in Reverse

Four or More Blasts:

Danger Signal

1. OVERTAKING / PASSING: *Boat being passed has the right-of-way. KEEP CLEAR.*
2. MEETING HEAD-ON: *Keep to the right.*
3. CROSSING: *Boat on the right has the right-of-way. slow down and permit him to pass.*

Warning Light (V-Drives Only)



The warning light should be "on" at idle. If the light remains "on" when the engine is above 1200 RPM, shut the engine off and check V-Drive oil level.

Optional Hippo Ballast System



The optional Hippo Ballast System is an electronically controlled 3 bag ballast system that can be operated from the driver's seat. The switch panel is located directly below the shifter mechanism and allows independent filling and draining of each ballast bag. If bags fail to fill or drain, you may check the hippo fuse block located under the dash area to insure fuses have not blown. The 3 ballast bag system is located in the front ski locker, starboard rear storage compartment, and port rear storage compartment.



Care should be taken that the ballast bags are situated properly with the fill hose on top and drain hose on bottom and that all fittings are installed securely. The bags should not be twisted and the bags should be free to expand and drain completely. Care should be taken to prevent sharp objects from coming in contact with the bags. Cuts and punctures to the bags are not warrantable.

Optional Hippo Ballast System (continued)



Each Hippo system also includes a manual shut off valve in case of emergencies. If closed, the valve will prevent any water from entering the system and is only used in emergency situations. Under normal use the valve should remain open to allow full flow of water into system.

To allow water into the system, Hippo ballast systems utilize a scooped intake strainer to force water into the system whether the boat is sitting still or underway. If air becomes trapped in the system, it may be necessary to run the boat at planing speeds to force air through the system and allow the fill pump to prime fully. Once the pump has primed it is no longer necessary to run the boat for filling. This situation may occur if the boat is trailered for long distances.

To fill the ballast system press the fill switch. To empty, press the empty switch. With the ballast full, the boat porpoises at speeds above 25 mph.

 **WARNING**

DO NOT tow boat on trailer with ballast full.

Ignition Keys

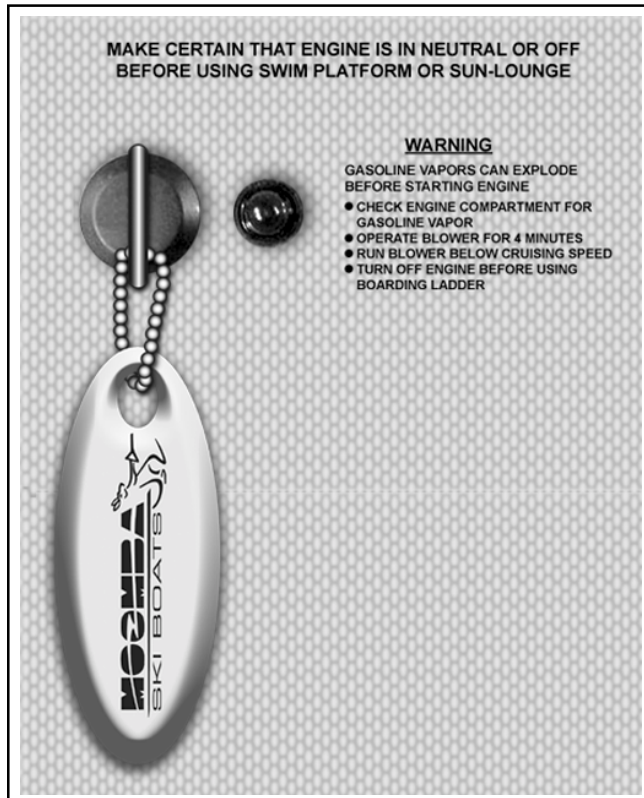

Two ignition keys are provided with the boat. Key entry into the ignition may sometimes be difficult due to the rubber boot protector. Please do not unduly force the key into the ignition. Key tumblers are located vertically, so the key should be vertical when placed into the switch.

Mirror



The rear view mirror is installed as a standard item. The mirror is adjustable so that it may be set for each driver.

- Mirror should always be checked before driving.
- Mirror angle will change with each new driver.

Fuel Cap Key

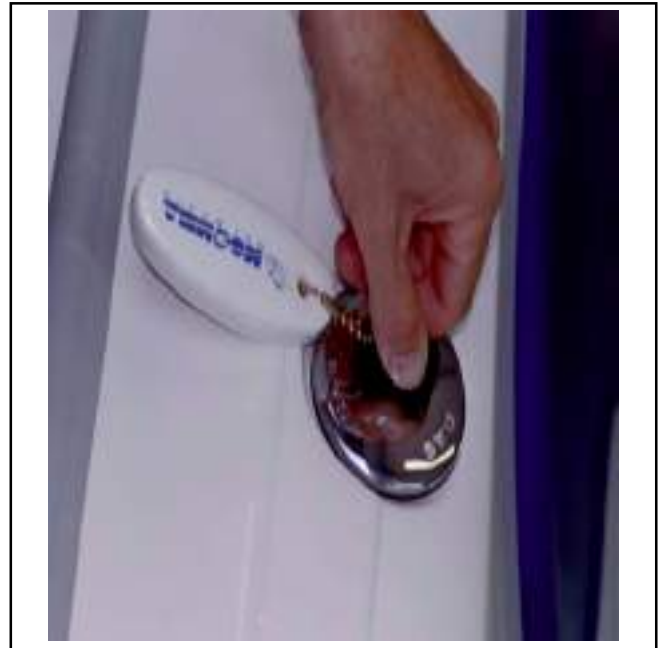

To prevent tampering with the fuel system, your boat is supplied with a gas cap which may be opened only with a special key.

NOTE: The gas cap is sealed by a rubber O-ring. Please do not over tighten.

CAUTION

Always attach the ignition key and gas key to a floating key chain to prevent loss overboard.

Driver's Seat & Seat Adjustment



The driver's seat may be adjusted forward or backward by moving the lever below the front of the seat. Use body pressure to move the seat to the desired position. Release the lever then check to feel the seat lock into place.

CAUTION

After adjusting the seat, be sure that it has locked into place by pushing forward and backward until it has securely latched.

DO NOT attempt to adjust the driver's seat while the boat is moving.

Motor Box Cover

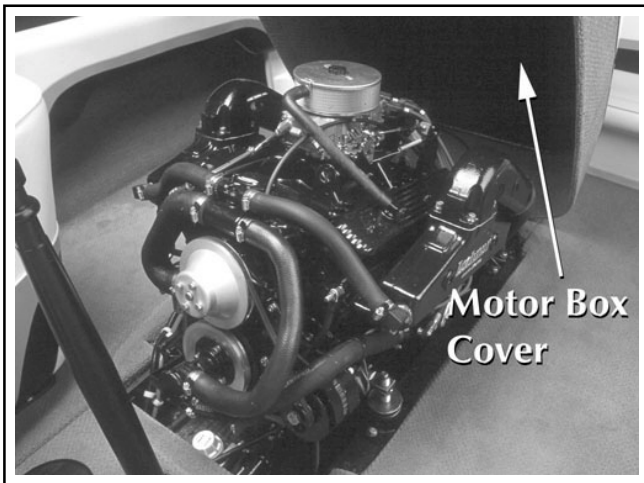

The motor box encloses the inboard engine and quiets engine noise. When opening, stand on either side, grasp the handle and pull up and back at an angle. If the engine requires maintenance, open the box lid until it rests open.

WARNING

Never open the Motor Box while the boat is moving!

Pulley & Belt Warning

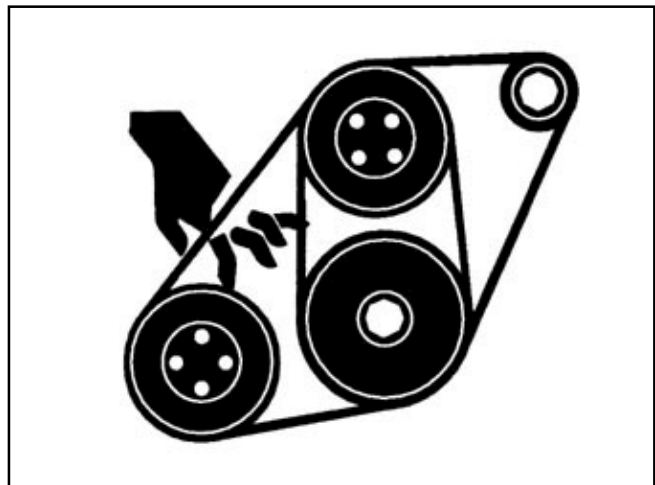

WARNING

Pulleys and belts can cause severe injury. Never open the motor box while the boat is under way!

After running, the engine is hot and should not be touched or repaired until it has cooled!

Fire Extinguisher



A standard Coast Guard approved fire extinguisher is provided on all Moomba boats. The fire extinguisher is located on the port side on the interior under the observer's seat.

(Refer to label instructions for use.)

Ski Pylon



The ski pylon is only to be used to pull skiers. **DO NOT use the ski pylon to hoist the boat.** Only use the lifting rings for this purpose.

NOTE: With use the ski pylon may loosen. Should this occur, see your Moomba Dealer for service.

WARNING

The use of pylon extensions can severely effect the overall handling of the boat. Follow pylon extension manufacturers directions for mounting.

DO NOT mount any Pylon Extension on the rear pylon (located at the rear sundeck).

Rad-A-Cage

The Mobius models are equipped with a Moomba Rad-A-Cage towing tower. The cage is designed as a stable tower to enhance wakeboarding. It is **NOT** intended to be used to tow skiers, barefooters, or multiple wakeboarders. Such use will void any warranties written or implied.

WARNING

Before use, be sure that all Allen bolts are tightly in place.

WARNING

Be aware of and avoid low overhead objects such as bridges, power lines, overhanging trees, etc.



To Lower Cage for Storage:

Tools required: 5/16" Allen wrench (for stainless steel 3/8-16 X 1-14" Allen head bolt)

- Loosen and remove the Allen head bolts that connect the rear legs to the feet.
- Place the bolts somewhere for safe storage.
- While standing in the bow area, pull the cage forward, gently placing it against the bow of the boat.

CAUTION

Place padding between the cage and the boat to protect the gel coat.

To Raise Cage:

- Lift and rock the tower back into place until the rear legs align with the rear feet. (Some manipulation of the cage may be required to get the legs to line up with the feet.)
- Install and tighten the bolts.

CAUTION

The threads in the aluminum foot could be damaged if the bolts are not aligned and threaded correctly.

WARNING

Rad-A-Cage is designed to pull - single (1) wakeboarder, trick skier, or kneeboarder.

Pop-Up Cleat



To use the cleat, pull center up.

WARNING

DO NOT tow objects with the cleats.

Bow Light



The bow light is located on the forward deck. To alert other boaters to your position and direction while underway at night, the light is green on the starboard side and red on the port side.

To replace the bulb, remove phillips screw to lift cover.

Stern Pole Light



The removable pole light is stored in the bow. Always check for proper alignment when inserting the pole light into the receptacle.

The pole light must always be in place and illuminated when visibility is limited. The pole light must be displayed while under way from sunset to sunrise. The pole light must also be illuminated while at anchor from sunset to sunrise.

 **CAUTION**

DO NOT pull skier with tow rope attached to ski pylon while pole light is in place.

Pole Light Receptacle



The pole light receptacle is located on the port side deck near the stern. To install the pole light, open the cover completely and with the plug correctly aligned, slide it into the socket until the electrical contacts are firmly in place.

Bow Eye

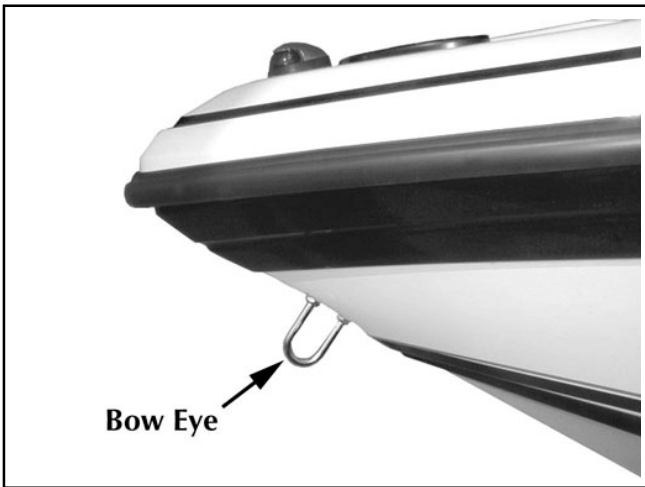

The bow eye is located at the front of the hull below the rub rail. It is the point of attachment to lead the boat onto the trailer and to secure the boat to the trailer or to a tie-off when docking.

NOTE: See Hoisting Instructions before using the bow eye to hoist the boat.

WARNING

DO NOT use the bow eye **ONLY**, to hoist the boat. You must use a sling with the bow eye when hoisting the boat. Use only the designated lifting rings to hoist the boat. (See Hoisting Instructions.)

Ski Platform Detachable Bracket

The ski platform is fastened to the boat with detachable brackets. The platform may be removed from the boat by pulling the retaining pins from the brackets.



Lifting Rings

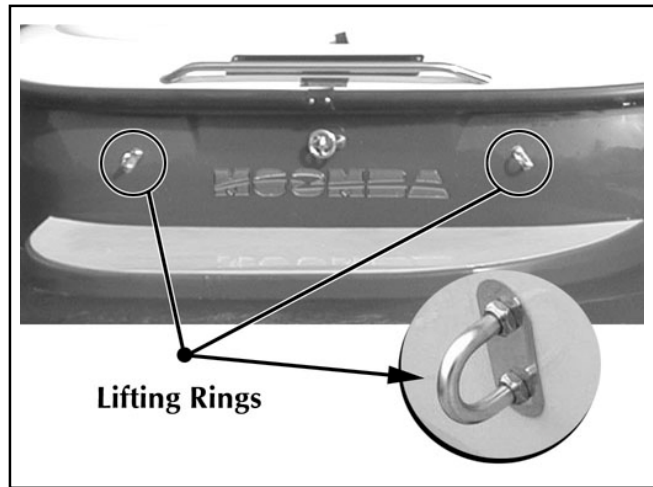

Two lifting rings are located on the transom.

NOTE: The lifting rings should be the only point of attachment for lifting cables. (See Hoisting Instructions.)

Ski Platform

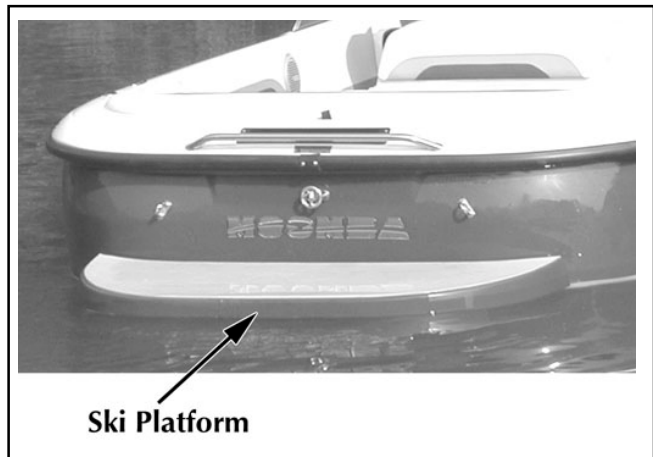

All Moomba models are equipped with a ski platform on the stern. The platform allows easy access to and from the water for skiers and swimmers.

It is recommended that all entries to and exits from the water be made from the platform to avoid accidents. (The fiberglass deck can become slippery when wet.)

DANGER

Shut Engine OFF when people are on the platform or in the water near the platform.

DANGER

Exhaust fumes contain carbon monoxide. Direct or prolonged exposure to carbon monoxide will cause brain damage or death.

Propeller

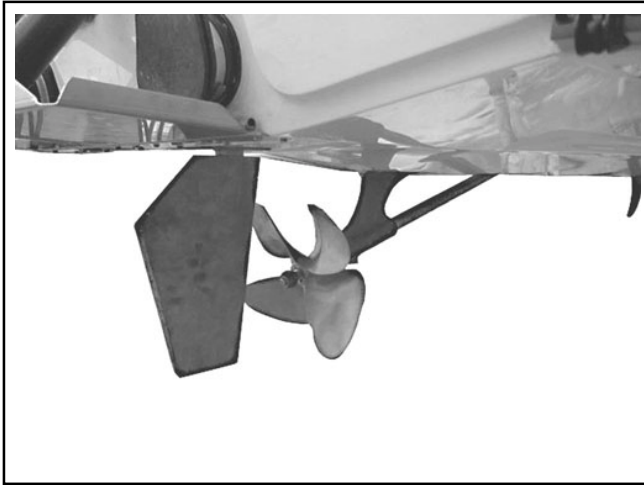

The research and design team at Skier's Choice has carefully explored and tested many different propellers and pitch angles for use on Moomba boats. All tests indicate that the current propeller installed on your model is the best for the variety of boating performance required, whether skiing competitively or for pleasure.

It is strongly recommended that your Moomba dealer be notified before changing the propeller. In general, changing to a lower pitched propeller may increase acceleration, but will decrease top speed. Changing to a higher pitched propeller may achieve higher top speed with a light load, while acceleration and power may decrease.

Propeller Precaution

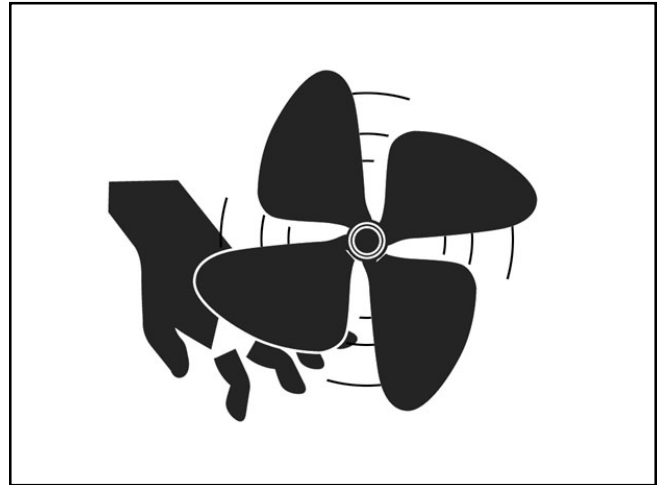

WARNING

Moving propeller will cause injury. Propeller may rotate with boat in neutral. Shut off the engine when people are on the platform or in the water near the platform to avoid injury from the prop rotation.

NOTE Under no circumstances should a propeller which allows the engine to surpass recommended RPMs be installed.

Ski Locker/Sun Deck



Outback and Kanga boats are equipped with a storage locker with upholstered lid which serves as a sun deck. To open, grasp the strap and pull up and forward. After storing wet gear in the locker, prop the lid open for air circulation during drying.

Walk-Through Windshield

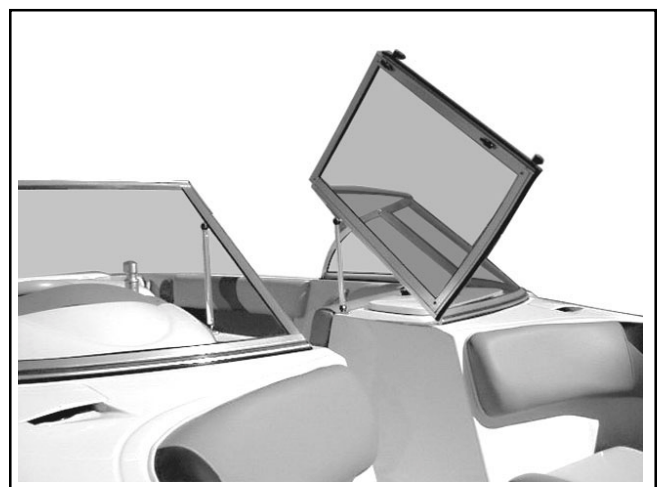

The moveable center windshield panel allows access to and from the bow area on some models. To open, turn safety latches to vertical and push. Carefully lay the hinged windshield panel back against the fixed side panel.

Optional Trim Switch and Gauge



Trim Switch

This switch controls the optional hydraulic wakeplate. The gauge indicates the position of the wakeplate. The gauge will only read from 0 degrees to 50 degrees due to limited hydraulic movement.

Optional Hydraulic Wakeplate



The optional hydraulic wakeplate allows the driver to control the running attitude of the boat.

Battery Box

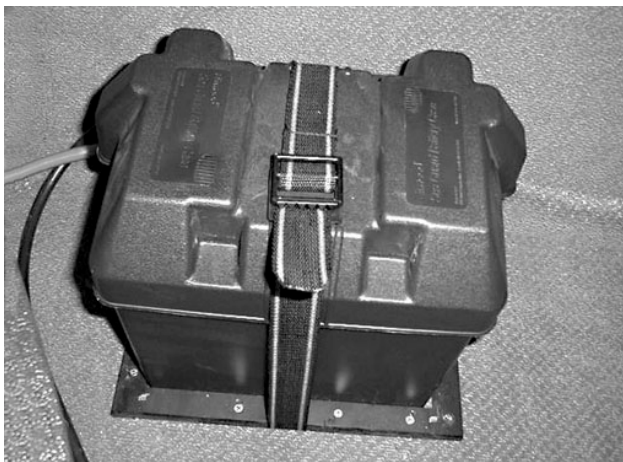

The battery box is mounted on the inside of the observer's seat storage compartment on all inboard models and the Outback LSV (V-Drive) model.

To access the battery box on V-Drive models (with the exception of the LSV), open the port side storage compartment hatch and pull the cloth handle on the battery access door located in the rear of this compartment.

NOTE: It is recommended that the battery cables be disconnected from the battery when the boat is placed in storage. (Refer to Battery Cable Installation and Precautions)

Fueling Conditions



The following conditions may be considered normal operation of the fuel gauge and fuel system:

- Gas station pumps may shut off before the fuel gauge indicates FULL.
- The amount of fuel required for fill-up may not exactly correspond to the gauge.
- The gauge needle may not move away from FULL until some time after fill-up.
- The gauge needle may move during turns, stops, and acceleration.

NOTICE: Become familiar with engine hourly fuel consumption at various speeds and know when to check the fuel gauge.

Fuel Vent

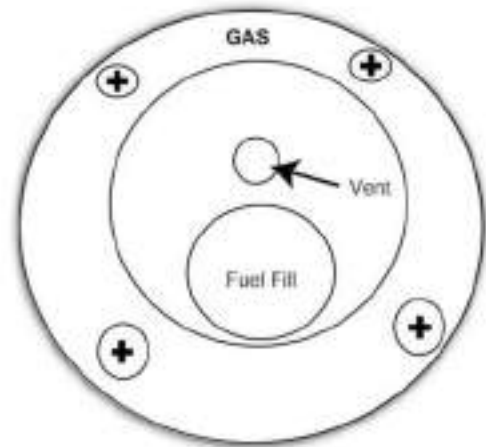

The fuel vent is a part of the gas filler neck. This vent is connected to the fuel tank via the vent hose, which releases gasoline fumes from the fuel tank.

⚠ DANGER

Gasoline vapors are highly explosive!

Typical Inboard

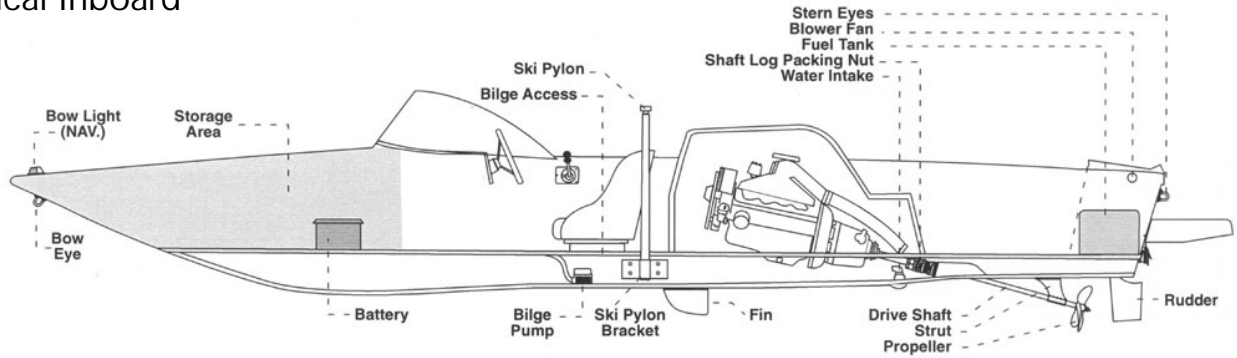

Typical V-Drive

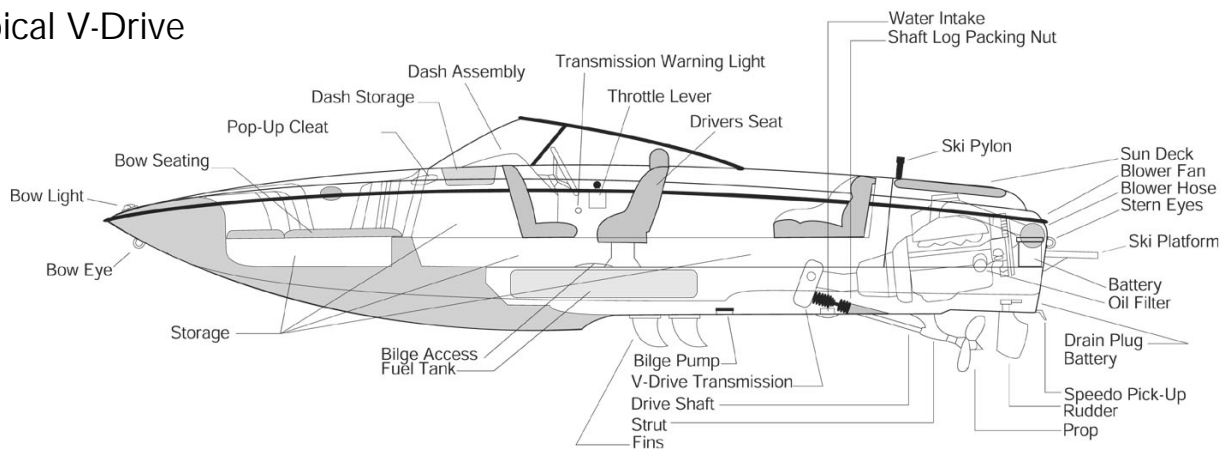

The illustrations above denotes the areas which may need to be accessed or may require cleaning or maintenance. It is important to have a basic understanding of the parts and their location on the boat. However, it is recommend that any service beyond routine maintenance be performed by an authorized Moomba dealer.

Service & Maintenance

For your convenience a maintenance chart has been included in this manual. The chart indicates when to perform safety checks, lubrication, and general service to the boat. Engine hours or elapsed time determine when service is necessary.

It is recommended that any replacement parts used during maintenance or for repair be supplied by an authorized Moomba dealer.

NOTE: You are responsible for keeping records of all maintenance on your boat. To maintain your new boat warranty, you may be asked to show that required maintenance was performed.

Maintenance Chart

Maintenance Intervals @ Engine Hours

	Weekly	1 st 25	50 Hrs.	100 Hrs.	Yearly
Change Engine Oil		✓	✓	✓	✓
Replace Oil Filter		✓	✓	✓	✓
Clean Oil Filler Cap		✓	✓	✓	✓
Check Transmission fluid Level	✓	✓	✓	✓	✓
Change Transmission fluid		✓	✓	✓	✓
Check Water Strainer (if applicable)	✓	✓	✓	✓	✓
Clean Flame Arrestor		✓	✓	✓	✓
Clean Crankcase Ventilating System		✓	✓	✓	✓
Check Water Pump & Alternator Belt Tension	✓	✓	✓	✓	✓
Change Fuel Filter		✓	✓	✓	✓
Check Fuel Lines & Connections for Leaks	✓	✓	✓	✓	✓
Clean Carburetor Fuel Inlet Filter		✓	✓	✓	✓
Clean Transmission Oil Strainer Screen -		✓	✓	✓	✓
Lubricate Distributor Cam		✓	✓	✓	✓
Shaft Packing Log		✓	✓	✓	✓
Check Condition of Spark Plugs		✓	✓	✓	✓
Check Battery Electrolyte Level		✓	✓	✓	✓
Check All Electrical Connections		✓	✓	✓	✓
Check Cooling System Hoses for Leaks	✓	✓	✓	✓	✓
Tighten Engine Mount Fasteners		✓	✓	✓	✓
Lubricate Throttle and Shift Linkage Pivot Points		✓	✓	✓	✓
Check for Loose, Damaged or Missing Parts	✓	✓	✓	✓	✓
Check Engine to Propeller Shaft Alignment		✓	✓	✓	✓
Lubricate Rudder Port		✓	✓	✓	✓
Check V-Drive Fluid Level**	✓	✓	✓	✓	✓
Change V-Drive & Transmission Fluid**		✓	✓	✓	✓

*If engine overheats, visually check. If clogged, remove debris.
 **Pertains to V-Drives only.
 This inspection and maintenance schedule is recommended for average operating conditions in normal service.
 Under severe operating conditions or service, intervals should be shortened.

Cooling Systems

Fresh Water Cooling System

The standard cooling system for Moomba boats is an open circulating cooling system with water intake. This is preferred for lakes and reservoirs with low salt content. If the engine is occasionally operated in salt water, the cooling system should be flushed with fresh water periodically and always before storage. If your boat is regularly operated in salt water, it should be equipped with the optional salt water package.

Salt Water Cooling System

The optional cooling system for use on salt water is a closed system with a solution of 50% antifreeze and 50% fresh water. The coolant is left in the closed system and replaced once a year.

Body Lubrication

Normal use of your Moomba causes metal to metal movement at some parts in the boat. Driver seat track should be lubricated with a water resistant chassis lubricant such as silicon grease.

Lubricate rudder grease fitting once annually.

Engine Oil & Filter

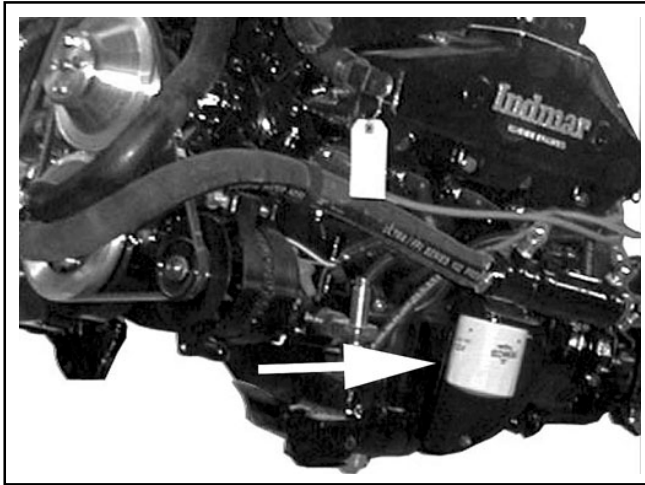

The oil filter is located below the engine. The engine manufacturer recommends that you change the oil and oil filter after the first 10-20 hours use of your new boat. Thereafter, to maximize engine life, change oil and filter after every 50 hours of use (See Engine Manual.)

REFER TO ENGINE MANUAL for more information.

V-drive remote oil filter is mounted on the ski pylon bracket.



Fuel Filter - Water Separator (V-Drives)

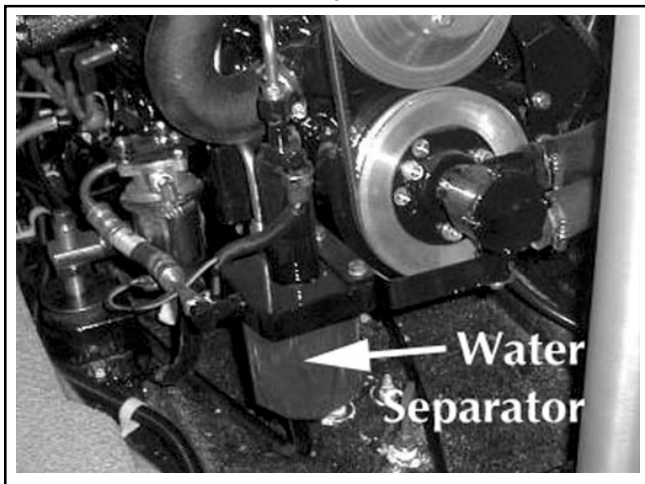

Depending on the model of your engine, you will have either a water separator filter, or a fuel filter. If your engine has a water separator filter, it will be located on the front of the engine. If your engine has a fuel filter, it will be located on the stringer under the engine.

Dipstick

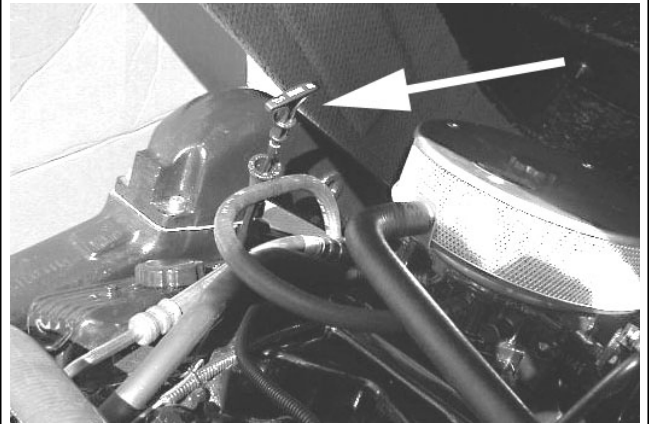

OIL LEVEL

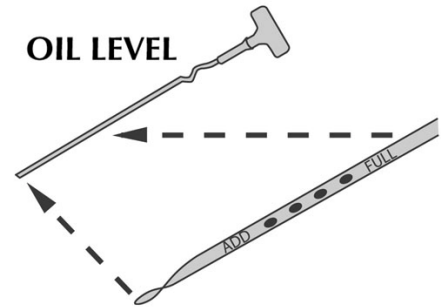

If the oil pressure indication is too high or too low, stop the engine immediately and check the oil level on the dipstick.

NOTE: The oil pressure varies with engine temperature and speed. If oil pressure does not increase when throttle is increased, shut off the engine immediately.

Continued operation while oil level is incorrect or without pressure may result in serious engine damage. Report any problem to your dealer as soon as possible, and do not operate engine until corrected.

Engine Oil

The engine crankcase oil should be selected to deliver the highest performance for your operating conditions and climate. In general engine oils with lower viscosity ratings are used when outdoor temperature remains low. Oils with higher viscosity are used when outdoor temperature is warmer and when higher performance is expected from the engine.

Indmar recommends 15W-40 Pennzoil Marine in their engines. If not available, for general use in summer conditions, 10W-40 high grade automotive oil with an A.P.I. classification of "SE" is recommended. Synthetic oils are not recommended until after the engine has been run for 100 hours.

Refer to Engine Manual for more information. For filter and capacity information, see the Engine Data table in this manual.

Transmission



Transmission Fluid Check

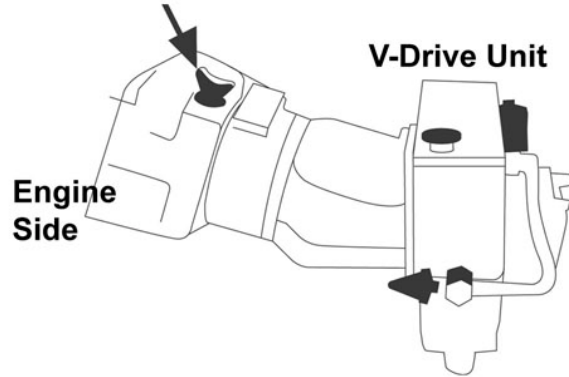

Transmission fluid level should be checked regularly (such as every 10 engine hours) and fluid added if necessary.

Maintain fluid level as follows:

- Boat must be at rest.
- Engine should be at operating temperature but turned off while checking level.
- Remove transmission fluid dipstick.
- Wipe fluid clean from dipstick and replace.
- Remove dipstick and note level indicated by the upper and lower marks.
- If required, add fluid to bring the level to the upper mark.

Maintaining Fluid Level

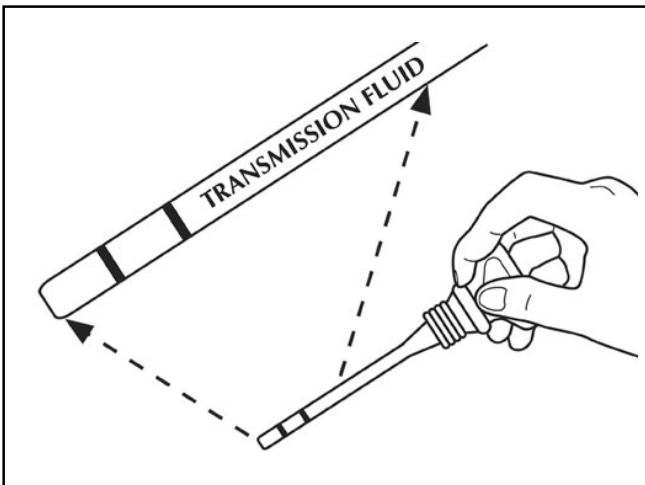

Use only Dextron III transmission fluid in transmissions with 1:1 drive train. To check fluid level refer to Engine Manual.

Change Frequency:

Change transmission fluid every year (refer to Engine Manual).

Shaft Log Packing Nut

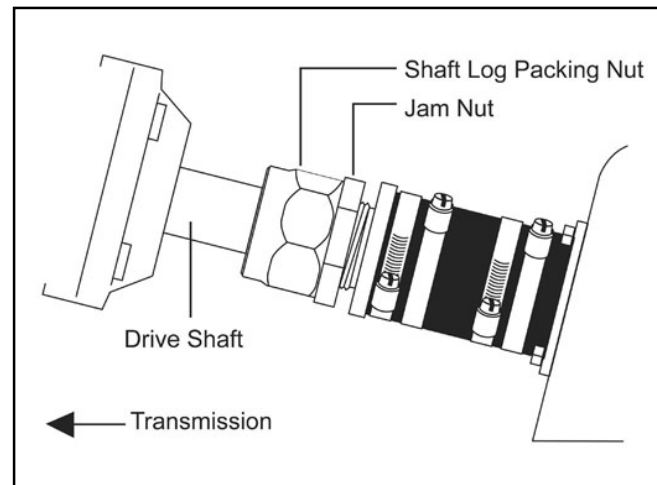

The Shaft Log Packing Nut should be checked periodically and adjusted if needed.

Adjust as follows:

1. Loosen the jam nut a few turns.
2. Tighten the shaft log packing nut by hand. DO NOT over tighten.
3. Tighten the jam nut against the packing nut.
4. Check for leaks.

NOTE: It is normal for the Packing Log to drip water at a slow rate of one drop every 15 to 30 seconds. Overtightening the packing nut may disturb the packing and cause excessive dripping.

V-Drive Location

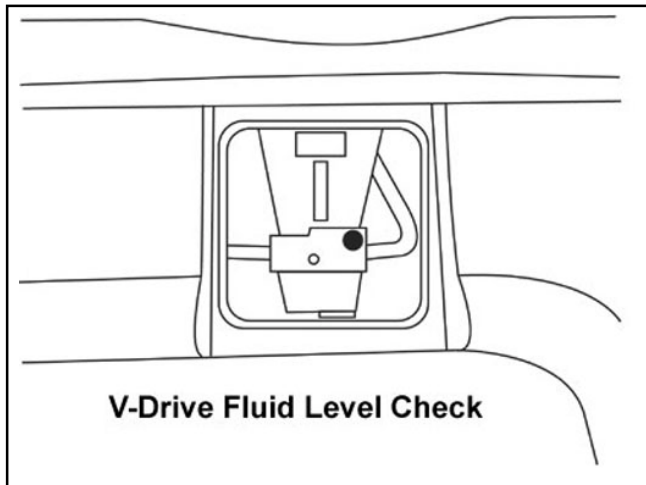

The fluid level can be checked by using the oil level dipstick, which is located on top of the V-Drive transmission. This unit is located under the center cushion of the rear seat. Pull out the cushion to access the transmission.

V-Drive Fluid Check

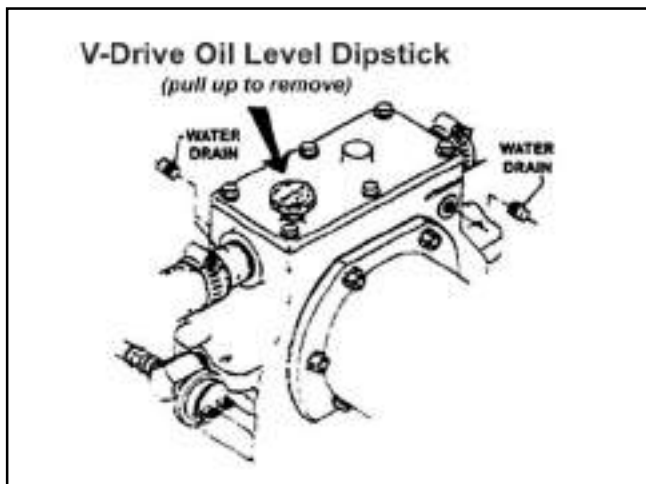

Pull the V-Drive Oil Level dipstick to check the fluid level. If the level is low, add fluid to the correct mark on the dip stick. Use SAE 30 motor oil.

NOTE: Only a trained and qualified technician should perform the oil change on your V-Drive unit.

Change Frequency

The oil should be changed in the V-Drive transmission after the first 100 hours of operation, then each year at the end of your boating season.

Maintaining Fluid Level

V-Drive oil level should be checked regularly (such as every 10 engine hours) and fluid added if necessary.

Maintain fluid level as follows:

- Boat must be at rest.
- Engine should be at operating temperature but turned off while checking level.
- Remove transmission fluid dipstick.
- Wipe fluid clean from dipstick and replace.
- Remove dipstick and note level indicated by the upper and lower marks.
- If required, add fluid to bring the level to the upper mark.

Propeller Warning



⚠ WARNING

Moving propeller will cause injury. Propeller may rotate with boat in neutral. Shut off the engine when people are on the platform or in the water near the platform to avoid injury from the prop rotation.

Battery Cable Installation & Precautions

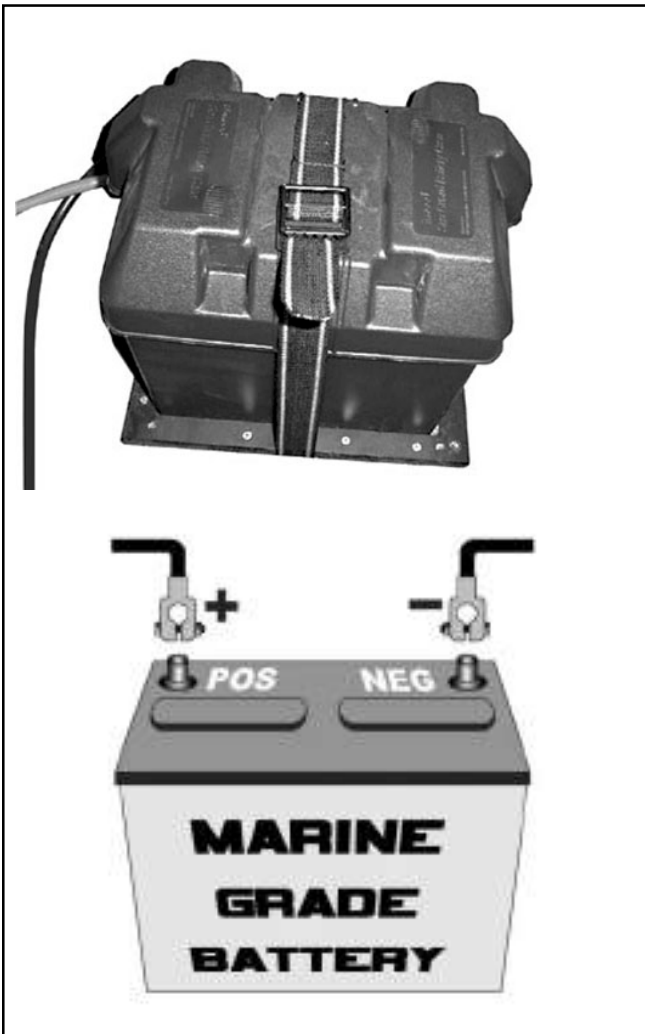

Your Moomba electrical system is negative ground. The negative battery cable is grounded on the engine block. The positive battery cable is connected to the starter solenoid.

Connect the positive (+) battery cable to the positive (+) post on the battery. Connect the negative (-) battery cable to the negative (-) post on the battery.

CAUTION

Failure to connect battery cables as outlined will damage the system and void the warranty.

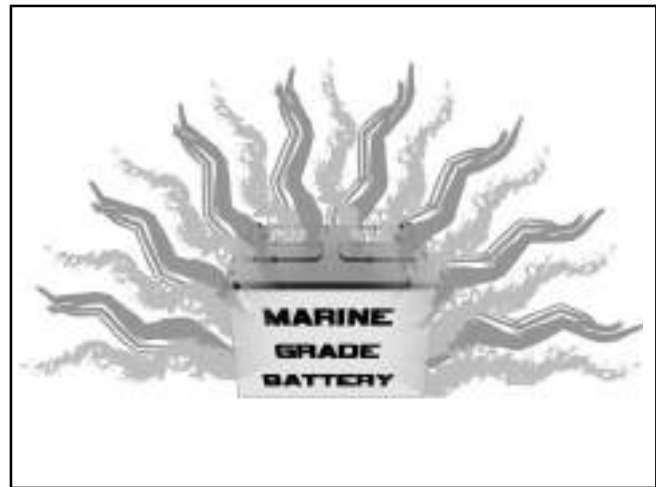

WARNING

Hydrogen and oxygen gases are produced during normal battery operation and charging. Sparks or flames near the battery vent openings can cause the mixture to ignite and explode.



WARNING

Sulfuric acid in the battery can cause serious burns. If spilled on skin or in the eyes, flush with clean water immediately, then seek medical attention.

Fiberglass Care

Washing and waxing the boat hull and deck regularly will extend the life and beauty of your Moomba. It is a good routine to rinse your boat with fresh water after each day's use.

It is recommended that the hull and deck be cleaned and waxed after every 50 hours of use. This will decrease water friction and lessen the potential for staining or spotting on the gelcoat surface.

When the original gelcoat shine cannot be restored by waxing, the shine may be restored by hand buffing with a commercial polishing compound. Be sure to apply a new coat of wax containing Carnauba over the area that has been polished.

IMPORTANT: Porcelain cleaning powders are too abrasive for use on gelcoat and may cause permanent discoloration if used. Household detergents containing ammonia or chlorine should not be used on gelcoat. Never use acetone or ketone solvents to clean your boat finish.

Washing Your Moomba



The easiest way to preserve the beauty of your boat is to keep it clean by frequent washing. Wash the boat with luke warm or cold water. Wipe the boat down immediately after washing to avoid water spots. Avoid using hot water or washing your boat in direct sunlight. Avoid using strong soaps or chemical detergents. To avoid spotting, all cleaning agents should be thoroughly rinsed from the surface promptly and not allowed to dry on the finish.

Rub Rail Care



Use a sponge or other soft material to wash and wax the rub rail.

To wax, use a commercial automotive bumper wax.

NOTE: When tying up to a dock or another boat, always use cushioned fenders (dock bumpers) to protect your boat from hard surfaces.

Windshield Care



Clean the windshield regularly to ensure that visibility is not obstructed.

Use a commercial glass cleaner to remove any spotting or stubborn stains that develop on the windshield.

Never use abrasive cleaners on glass or plastic surfaces as they may cause scratches.

Upholstery Cleaning



All upholstery items on your boat are made of tough marine grade vinyl that is easily cleaned with a mild detergent.

Strong detergents and cleaners may shorten the life of the vinyl. PLEASE SEE VINYL MANUFACTURER'S RECOMMENDED CARE GUIDE INCLUDED IN YOUR OWNER'S PACKAGE.

Drying Upholstery



It is important to provide for the drying of all upholstery and carpet after each use of the boat. Open all storage compartments and slide all removable cushions out about an inch to allow air to circulate behind.

Foreign Deposits

Tree sap, bird droppings, air borne chemicals, petroleum products and other foreign matter may damage the gelcoat surface if not removed promptly (See Washing Instructions).

Boat Hull Protection

If your Moomba is to remain in salt water for an extended period, the hull below the water line should be painted with a marine bottom paint. Bottom paint is also recommended for fresh water locations where the boat is left in the water for extended periods of time.

Teakwood Care

If teak wood has been installed on your Moomba, a small amount of maintenance will be required to retain the natural beauty. Teak wood should not be varnished. Instead, teak oil or mineral oil should be applied. Oil should be applied 3 to 4 times per year. If teak has been allowed to become gray and dry, sand with fine grit paper and reapply teak oil.

Section XI

Winterization & Dry Storage

When the boating and ski season comes to a close, it is recommended that your Moomba boat be removed from the water and stored for the winter months.

CAUTION

It is extremely important to follow the proper winterizing procedure. The engine must be correctly winterized for safe storage in your climate. This should be done by a professional. Your Moomba dealer will know exactly what must be done to insure the longest possible life for your boat.

In addition to preparing the engine the following tasks should be done to winterize the boat:

1. Remove the center drain plug from the boat.
2. Thoroughly clean the boat inside and out. Inspect the hull for any residue or algae growth and remove if required.
3. Clean the bilge area thoroughly and operate the bilge pump to remove any water from the bilge hose.
4. Remove all seat cushions and open all storage areas to air circulation in the boat interior. When thoroughly dry, replace cushions and close storage areas.
5. Top off fuel tank to prevent any condensation from accumulating in the fuel system. Use a commercially available fuel stabilizer to remove water and prevent gumming.
6. If the boat is stored on its trailer, insure that the boat is properly positioned. If possible lift the tongue so that the bow is slightly raised to promote drainage from the center drain hole.
7. Install the canvas cover and secure the straps in accordance with cover instructions.

NOTE: During the winter months, water is a boat's worst enemy. Always store the boat when the interior is completely dry. Periodically check on the condition of the stored boat.

Hoisting

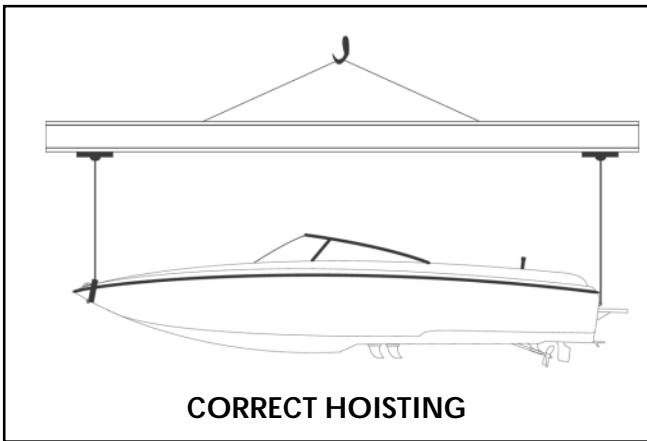

If the boat ever needs to be hoisted, special attention should be given to the following recommendations:

- Hoist the boat using a horizontal lifting bar only.
- Never attempt to lift the boat by means of a cable sling from bow to stern lifting eyes.
- Hoist operator should slowly and smoothly lift the boat without jerking to avoid damage to the lifting eyes.
- Use a clevis inserted through the lifting eye since a hook may damage the lifting eye edges.

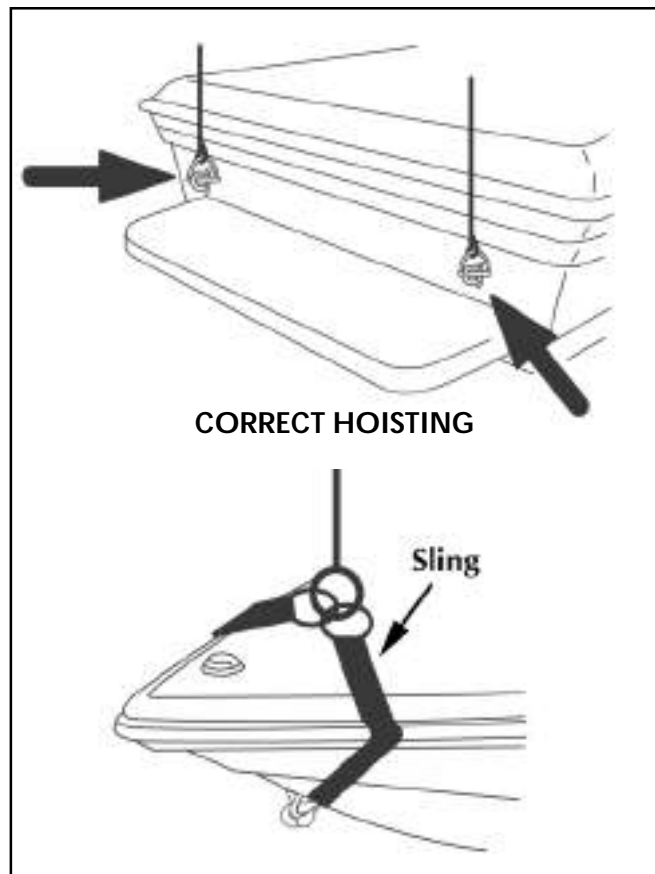

WARNING

DO NOT use the bow eye to hoist boat. Use only a proper sized sling in the designated lifting rings to hoist the boat.

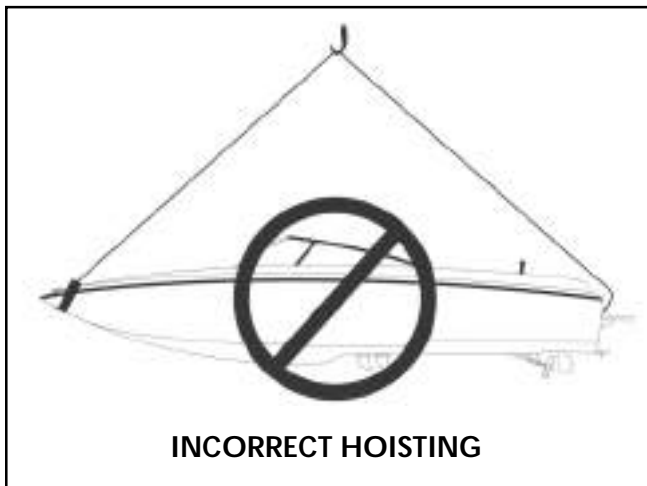

WARNING

DO NOT use the ski pylon to hoist the boat. Incorrect hoisting may invalidate the warranty on the boat.

Identification Number

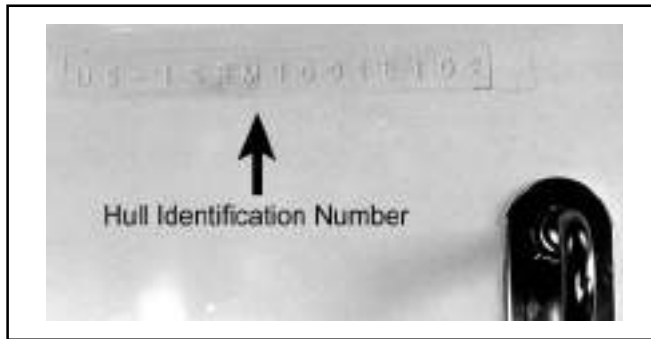

The hull identification number is located on the upper right hand side of the transom below the rub rail.

Battery Specifications

12 Volt Marine Type with Tapered Post Connectors

Engine Size:	Cold Crank @ 0° F (-18° C)
--------------	-------------------------------

350	650 Amps
-----	----------

⚠ WARNING Hydrogen and oxygen gases are produced during normal battery operation or charging. Sparks or flames can cause this mixture to ignite and explode if it comes near the vent openings. Sulfuric acid in the battery can cause serious burns, if spilled on skin or in eyes. Flush with clear water immediately!

Engine & Transmission Data

Engine Model:	Indmar Assault MPI	Indmar Assault TBI	Indmar Assault Carb
Fuel Delivery	Multi Port Fuel Injection	Multi Port Fuel Injection	Holley Carb
Horsepower:	330-HP	320-HP	310-HP
Displacement:	350 CI	350 CI	350 CI
Bore (in):	4.00	4.00	4.00
Stroke (in):	3.48	3.48	3.48
Compression Ratio:	9.4 to 1	9.4 to 1	9.4 to 1
Electrical System:	12-V Neg Ground	12-V Neg Ground	12-V Neg Ground
Ignition Type:	Electronic Distributor	Electronic Distributor	Electronic Distributor
Alternator Output:	70 Amps @ 1,200 RPM	70 Amps @ 1,200 RPM	70 Amps @ 1,200 RPM
Thermostat:	143 Degrees F	143 Degrees F	143 Degrees F
Firing Order:	1-8-4-3-6-5-7-2	1-8-4-3-6-5-7-2	1-8-4-3-6-5-7-2
Initial Timing:	10 Degrees / Service Mode	10 Degrees / Service Mode	10 Degrees / Service Mode
Oil Filter:	Pennzoil PZ-3	Pennzoil PZ-3	Pennzoil PZ-3
Oil Capacity:	5-Quarts	5-Quarts	5-Quarts
Oil Type:	Pennzoil 15W-40 Marine	Pennzoil 15W-40 Marine	Pennzoil 15W-40 Marine
Transmission Fluid:	Dextron III-Mercon	Dextron III-Mercon	Dextron III-Mercon
Spark Plugs:	AC 41-932	AC 41-932	AC MR43LTS
Gap:	0.060	0.060	0.028
Max RPM's:	5,200 RPM	4,850 RPM	4,850 RPM

V-Drive: **Walters**

Model: RV-26 D
 Ratio: 1.46 to 1
 Oil Type: SAE-30
 Oil Capacity: 2 pints

Trailer & Towing



The trailer supplied with your Moomba model was designed especially for the boat with your convenience in mind. Please be sure that you have an appropriate tow vehicle before attempting to trailer your boat. Your vehicle must be capable of towing 3,500 — 5,000 lbs. depending on the model.

CAUTION

Read the trailer towing section of your vehicle owner's manual before towing your trailer.

All Moomba trailers require a 2" ball and a five (5) pin marine grade trailer wiring connector. The standard height from the ground to the top of the hitch ball should be about 20 inches. With the trailer attached to the tow vehicle, the trailer should stand level.

Trailer Plug Wire Schematic

White: Ground
Green: Right Turn / Brake
Yellow: Left Turn / Brake
Brown: Running Lights
Blue: Reverse Lights

NOTE: Moomba trailers feature disk brakes. The fifth wire (blue) on the wire connector needs to be connected to your vehicles reverse lights to be operative. This wire (blue) provides power to a solenoid which deactivates the brakes while in reverse. You may still tow your trailer without the blue wire connected, however, you may experience difficulty backing the trailer.

WARNING

BEFORE USE, READ ALL INFORMATION SUPPLIED WITH THE TRAILER BY THE MANUFACTURER.

The following guidelines will prolong the life of the boat and trailer:

1. Always secure the boat to the trailer with tie-downs. Do not place straps around fenders or lights.
2. Always verify that the winch hook is securely in the bow eye, the strap is tight and the winch handle locked in place before trailering.
3. Check the recommended pressure displayed on the side of the tires and assure that it is maintained. Under-inflated tires could cause trailer sway and excessive tire wear.
4. Verify that the trailer hitch on the tow vehicle is the proper class and size to support the tongue weight and the trailer load.
5. Check wheel bearing grease (Bearing Buddy®).

Section XIII

Trailering Your Boat

Connecting the Trailer



When connecting the trailer to your tow vehicle use the following procedure:

1. Raise the tongue with the trailer jack, position the trailer tongue directly over the 2" ball, and lower the jack until the tongue goes all the way down over the ball.

2. Press down on the latch until it locks on the ball with a "click."

NOTICE: If your hitch ball has an excessive flat spot on top, the latch may not engage properly. If the latch does not catch, check with your dealer or hitch installer before trailering.

3. Insert the locking pin into the tongue. Lock pin hole is on the side of the tongue.

4. When all weight is off the trailer jack, pull the jack lock pin and rotate the jack to the horizontal position and re-lock the pin.

5. Attach the safety cables to the tow vehicle hitch. Cross the cables and wrap them around each other once or possibly twice allowing just enough slack to permit tight turns of the vehicle and trailer.

6. Plug the trailer lights connector to the vehicle harness.

7. Clip the brake lockout cable to the vehicle hitch.

Unloading Procedure



NOTICE: DO NOT attempt to use excessive power to free the boat from dry carpet runners. Power off of the trailer only when the boat has floated free.

CAUTION

If the trailer is not submerged to the correct depth, the bow of the boat could drop when powering off incorrectly, possibly damaging the boat.

NOTICE: Before operating your Moomba, refer to the Daily Check List and the Boatman's Check List.

To unload the boat use the following procedure as a guide:

1. Make sure that all drain plugs are securely in place.
2. Unplug light cord before backing into the water.
3. With Bow Eye Hook fastened, back the trailer until the water level is approximately 1 inch below the top of the trailer fenders.

NOTE: Ramp slopes vary, so actual level of water on trailer may be different.

CAUTION

Make sure that the engine water intake is fully submerged.

4. Follow the cold start procedure recommended in this manual.
5. With engine idling, center the steering wheel, engage the transmission into reverse (pull back on lever,) then ease back on the throttle.

NOTE: Because your Moomba is a direct drive inboard, when backing the stern will have a tendency to drift left or right depending on propeller rotation. This condition will self-correct as the rudder reaches control speed.

Loading Procedure



To re-trailer the boat, position the trailer in the water with approximately 1 inch of the top of the fender showing as in step 3. UNLOADING.)

Idle/coast the boat onto the trailer using as little power as possible keeping it centered between the guide poles.

NOTE: DO NOT Power onto the trailer during rough conditions.

When correctly positioned on the trailer turn off ignition. Use the Hook and Trailer Winch to pull the boat up to the Roller Stop.

When using the Boat Buddy® to load the boat:

Position the trailer in the water with approximately 1 inch of the top of the fender showing (as in step 3. UNLOADING):

1. Set the Boat Buddy® for loading by pulling trigger or latch mechanism into "set" position.
2. Idle/coast the boat onto the trailer using as little power as possible, while keeping it centered between the guide poles.
3. Power slowly forward until the bow eye solidly contacts the Boat Buddy® and the latch is triggered.
4. Winch hook must be attached to bow eye and tightened before trailering.

CAUTION

The trailer must be positioned for the correct water depth for loading or you may damage the boat. Varying ramp angles require different procedures. In general, the steeper the ramp, the more shallow the trailer should be positioned in the water. Your local dealer can help you understand this, should you require additional assistance.

Trailer Alignment



When pulling the boat onto the trailer, be sure that it is centered on the trailer.

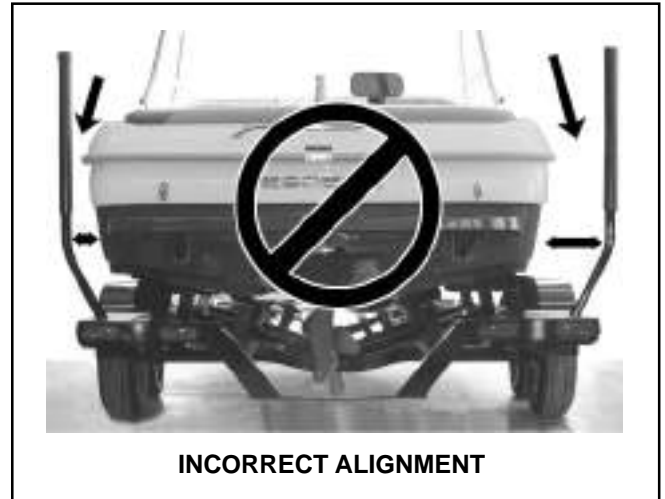

The distance between the boat and the wheel runner board should be about equal on both sides.

Moomba Limited Warranty

Taking care of our product after it becomes yours has always been "standard policy" at Skier's Choice, Inc., the proud manufacturer of the Moomba line of boats. And to further prove our point, we offer the following limited warranty.

Terms of Warranty

During the applicable Warranty Period (as defined below), Skier's Choice, Inc. ("Skier's Choice" or the "Company") warrants to the original retail purchaser (the "First Owner") that the components and parts manufactured by Skier's Choice (the "Covered Components") of each new Skier's Choice boat are free from any defects in material and workmanship, under normal use and when operated and maintained according to boat's instructions ("Normal Use and Operation").

- This Limited Warranty applies to all Covered Components other than the deck, hull, floor and stringers for a period of one year (the "One-Year Warranty Period") from the original date of purchase by the First Owner (the "Original Purchase Date").
- This Limited Warranty applies to the deck, hull, floor (excluding carpet) and stringers for the lifetime of the boat (the "Lifetime Warranty Period").

Subject to the terms of this Limited Warranty, Skier's Choice will repair or replace, at its sole option, any Covered Component which is returned during the applicable Warranty Period to the Skier's Choice factory or to any other Moomba authorized repair facility (an "Authorized Moomba Facility"), provided that:

- Only the Covered Components that are declared defective upon examination by Skier's Choice will be repaired or replaced under this Limited Warranty;
- Transportation of the boat, parts or components to and from the Skier's Choice factory or the Authorized Moomba Facility must be prepaid by the owner;
- Notice of any claim under this Limited Warranty must be provided to Skier's Choice by the Authorized Moomba Facility no later than sixty (60) days after the owner becomes aware of the defect.

Notification of a claim or defect must be properly made directly to an Authorized Moomba Facility, who subsequently must submit the claim information to Skier's Choice at 5820 US 411 South, Maryville, Tennessee 37801. Information needed for processing a claim includes (1) Name and address of the owner; (2) Serial number of the boat; (3) Original retail purchase date; (4) Detailed explanation of the defect; and (5) Estimated repair cost.

Note: Warranty repair or replacement cannot be made until this information is approved by Skier's Choice.

In case of defect of a Covered Component, Skier's Choice will use its reasonable best efforts to repair or replace the Covered Component within ninety (90) days of receipt thereof at its factory or an Authorized Moomba Facility. Any warranty on replaced or repaired components pursuant to this Limited Warranty shall remain in effect only for the remainder of the original Warranty Period. The repair or replacement of Covered Components will be made by Skier's Choice without charge to the owner for parts or labor. The replacement or repair of the defective part or component as stated in this Limited Warranty shall be the sole remedy of the owner and the sole liability of the Company under this Warranty and any implied warranties.

There are no express or implied warranties on the parts and components manufactured or sold by Skier's Choice except as set forth in this Limited Warranty.

Exclusions

Claims or assertions relating to the following are specifically excluded from coverage under this Limited Warranty and Skier's Choice disclaims any liability or obligation with respect to the following:

1. Defects in or damage caused by or relating to the engine or any part thereof. (Note: The engine may be covered by warranty of the engine manufacturer. Please see engine manufacturer warranty for details.)
2. Defects in or damage caused by or relating to the trailer or any part thereof. (Note: The trailer may be covered by warranty of the trailer manufacturer. Please see trailer manufacturer warranty for details.)
3. Covered Components of a boat that has been sold or transferred by the First Owner.
4. Damage caused by, related to, or resulting from failure of components or parts which are not manufactured by Skier's Choice, including but not limited to bilge pump failure-
5. The Limited Lifetime Warranty on the deck, hull, floor (excluding carpet) and stringers does not include hardware or other components fastened or adhered to the hull, deck, floor or stringers.
6. Normal maintenance and upkeep relating to the boat or any part thereof, including but not limited to, alignment, adjustments, connectors, tune-ups and wear items, such as, shaft packing, belts, hoses, filters, seals, gaskets, strut bushing, etc.
7. Damage to or malfunction of a boat, or any component thereof, resulting from owner use, lack of maintenance, improper maintenance, impact, misuse, negligence, collision, delay in repair, improper hoisting or cradling of the boat.
8. Any and all consequential damages including, but not limited to, costs incurred for haul-out, launching, towing and storage charges, telephone or rental charges of any type, inconveniences, loss of use, or loss of time or income.
9. Equipment installed by anyone other than authorized factory personnel at the Company's production facility. Equipment replaced at an Authorized Moomba Facility pursuant to this warranty agreement remains under warranty until the expiration of the Limited Warranty period.
10. Any boat which is: (a) used for rental or other commercial, military or industrial purposes; (b) used in boat racing, demonstrations, ski school, or similar events; (c) altered, modified, repaired or replaced so as to increase the cubic inch capacity or horsepower output of the engine and boat as originally manufactured; (d) not properly stored or maintained.
11. Speeds, fuel consumption and other performance characteristics because they are estimated and may vary.
12. Damage to or defects in paints, varnishes, gelcoat surfaces and colors, finish distortions, chrome plated or anodized finishes, floor covers and any other surface coatings.
13. Gelcoat discoloration, cracks, blisters or bubbles, including, but not limited, to those which may result from a boat being left in the water for long periods of time.
14. Upholstery cracks, mildew, stains or tears resulting from owner use, lack of maintenance, improper maintenance, impact, misuse, negligence, delay in repair, use of improper cleaners or conditioners.
15. Skier's Choice reserves the right to improve its products through changes in design or material without being obligated to incorporate such changes in products of prior manufacture.

OTHER LIMITATIONS

1. THIS LIMITED WARRANTY LIMITS THE DURATION OF ANY IMPLIED WARRANTY OF MERCHANTABILITY OR IMPLIED WARRANTY OF FITNESS FOR A PARTICULAR PURPOSE TO THE PERIODS SPECIFIED HEREIN. Some states do not allow limitations on how long an Implied Warranty lasts, so this limitation may not apply to you.
2. THE REMEDIES OF REPAIR OR REPLACEMENT AT THE OPTION OF SKIER'S CHOICE, AS SET FORTH HEREIN, ARE THE ONLY REMEDIES AVAILABLE UNDER THIS WARRANTY. SKIER'S CHOICE DISCLAIMS ANY OBLIGATION OR LIABILITY FOR COSTS OR CHARGES DERIVED FROM INCONVENIENCE OF LOSS OF USE, COMMERCIAL OR MONETARY LOSS DUE TO LOSS OF TIME, INCONVENIENCE, OR ANY OTHER CONSEQUENTIAL, SPECIAL OR INCIDENTAL DAMAGES. Some states do not allow the exclusion or limitation of incidental or consequential damages, so the above limitations or exclusions may not apply to you.
3. THIS WARRANTY IS IN PLACE OF ANY OTHER EXPRESS WARRANTIES.
4. THIS WARRANTY APPLIES TO THE FIRST OWNER ONLY AND IS NOT TRANSFERABLE.
5. THIS WARRANTY GIVES YOU SPECIFIC LEGAL RIGHTS, AND YOU MAY ALSO HAVE OTHER RIGHTS WHICH VARY FROM STATE TO STATE.
6. THIS WARRANTY IS EXPRESSLY IN LIEU OF ANY CONTRACTUAL LIABILITIES, INCLUDING PRODUCT LIABILITIES.
7. THE DEALER IS NOT THE AGENT OF SKIER'S CHOICE AND SKIER'S CHOICE DOES NOT AUTHORIZE THE DEALER, OR ANY OTHER PERSON, TO ASSUME ON BEHALF OF SKIER'S CHOICE ANY LIABILITY OR EXPENSE INCURRED IN THE COURSE OF REPAIRING ITS PRODUCTS OTHER THAN THOSE EXPRESSLY AUTHORIZED IN THIS LIMITED WARRANTY. THE DEALER MAY NOT EXTEND OR IN ANY WAY CHANGE OR AMEND THIS LIMITED WARRANTY .

Owner's Responsibility

1. Before operating your Supra, it is necessary to read and fully understand this Owner's Manual and all other information delivered with the boat.
2. It is the owner's responsibility to take the boat to an authorized Supra dealer to obtain warranty service.
3. It is the owner's responsibility to properly operate and maintain the boat in accordance with this manual and all other information delivered with the boat.
4. The owner should keep maintenance records should it be necessary to show that required maintenance has been performed on the boat.

Dealer's Responsibility

1. The Dealer should provide the buyer with an adequate orientation in the general operation of the boat and review all systems and accessories included with the boat.
2. The Dealer should deliver a complete owner's manual packet with the boat consisting of Owner's Manual, Registration Engine Manual, Stereo Manual, Supra Warranty and all warranties for separately warranted items aboard the boat.
3. The Dealer should review all warranty information with the buyer and assist in filling out warranty cards if necessary.
4. The Dealer should insure that any information or obligation from either Skier's Choice, Inc. or from the dealership is clearly understood by the buyer.
5. The Dealer should instruct the buyer in obtaining local service and out-of-area service for a Supra boat.

Customer Assistance

The staff at Skier's Choice, Inc. is concerned with your complete satisfaction. This includes the prompt resolution of any problems that may arise during the warranty period. Normally, problems encountered may be efficiently and effectively resolved by your Supra Dealer. However, if a problem cannot be handled by the Dealer or if a solution is not satisfactory to you as an Owner, please follow these steps to get the matter resolved:

Step One

Discuss the problem with a member of your Supra Dealer's management staff. It is most likely that the problem will be resolved at this level.

Step Two

If the Dealer management does not resolve the problem to your satisfaction, please have the problem and all action taken, documented by the Dealer, then contact the factory Customer Service Representative at Skier's Choice, Inc.

Skier's Choice, Inc.
5820 Highway 411 South
Maryville, TN 37801
Tel: (865) 856-3035
Fax: (865) 856-3241

Describe the original problem in detail to the Customer Service Representative. Be prepared to furnish appropriate documentation and the reasons why service by the Dealer was unsatisfactory. If further action is required to resolve the problem, the Customer Service Representative will dictate the appropriate action.

Step Three

Finally, if after following these steps and providing documentation and after obtaining necessary authorization from the Customer Service Representative to take additional action, the problem is still not resolved to your satisfaction, the President of Skier's Choice, Inc. will personally review the problem and make a determination concerning final resolution.

A

Accessory Power Switch 30

B

Ballast Switch (Optional) 29
 Battery & Cable Installation 48
 Battery Box 40
 Battery Specifications 53
 Bilge Pump Switch 29
 Blower ?
 Blower Switch 30
 Boating Rules 9
 Boating Safety 5
 Boat Specifications 13
 Bow Eye 38
 Bow Light 37
 Break-In 19

C

Canvas Cover 20
 Cleats 36
 Coast Guard Regulations 20
 Cooling Systems 44
 Customer Assistance 61

D

Daily Checklist 4
 Dealer's Responsibilities 60
 Depth Sounder 28
 Drain Plug Bilge Area 23
 Drain Plug Rear 23
 Driver's Seat 34

E

Engine Data 53
 Engine Hour Gauge 26
 Engine Hours 26

F

Fiberglass Care 49
 Filling Fuel Tank 24
 Fire Extinguisher 35
 Foreign Material Deposits 50
 Fuel 24
 Fuel Cap Key 24, 33
 Fuel Filter 45
 Fuel Gauge 27
 Fuel Information 24
 Fuel Precautions 24
 Fuel Vent 41

H

Hippo Ballast System (Optional) 31
 Hoisting 52
 Horn 31-32
 Hull Identification Number 53
 Hull Protection 51

I

Ignition 30
 Ignition Key 33
 Instrument Panel 25

L

Lifting Rings 38

M

Maintenance Chart 44
 Maximum Capacities 20
 Mirror 33
 Motor Box Cover 34

N

Navigation Lights 29
 Neutral Lock Out 22

O

Oil Dipstick 45
 Oil Level Check 45
 Oil Pressure Gauge 27
 Oil Specifications 45

P

Pole Light Receptacle 37
 Propeller 39
 Propeller Precaution 39, 47
 Pulley & Belt Warning 34

R

Rad-A-Cage 36
 Rub Rail 49

S

Safety Procedures 5-7
 Seat Adjustment 34
 Service & Maintenance 43
 Shaft Log Packing Nut 46
 Ski Locker 39
 Ski Platform 38
 Ski Pylon 35
 Slalom Source Speeds 25
 Speedometer 26
 Speedometer Paddle Wheel 26
 Starting & Operation 21
 Stern Light 37
 Stereo 28

Index (continued)

S (continued)

T

Tachometer	26
Teakwood Care	51
Temperature Gauge	27
Throttle Lever	22
Tilt Steering	30
Trailer	55
Boat Buddy	56
Boat Hook Up	55
Loading Procedure	55
Trailer Alignment	57
Unloading Procedure	56
Transmission	46, 53
Fluid Check	46
Fluid Specifications	53
Trim Switch & Gauge (Optional)	40

U

Upholstery Care	50
-----------------	----

V

V-Drive	
Change Frequency	47
Fluid Check	47
Maintaining Fluid Level	47
Location	47
Remote Oil Filter	45
Warning Light	27
Voltmeter	27

W

Wakeplate, Hydraulic (Optional)	40
Walk-Thru Windshield	39
Warning Plates & Labels	8
Warranty Information	59
Washing Boat	49
Windshield Care	49
Winterization	51

Registration of Your Boat Is Important!

The **dealer** should complete the **Dealer Boat Registration** card and mail to Skier's Choice, Inc.

The **owner** may do one of the following to ensure or verify that the boat is properly registered:

1. Complete the remaining registration card and mail to Skier's Choice, Inc.,
2. Call our Customer Service Department at 865-856-3035, or
3. Email our Customer Service Department at customerservice@skierschoice.com. Please include date of purchase, boat serial number, dealer name, and your name, mailing address and email address.

If the boat is sold, the new owner is encouraged to contact Skier's Choice and update the ownership records. While this will not affect the terms of the warranty, you will receive certain product, service, company and promotional information at various times.

Thanks for your help in keeping this important information up-to-date!

SKIERS' Choice, Inc.

Owner Boat Registration

(Owner may complete and mail to Skier's Choice)

Date: _____ Date of Purchase: _____

Identification Numbers:

Hull: _____ Engine: _____
Transmission: _____ Trailer: _____

Dealer's Name: _____

Address: _____
Street: _____ Phone: _____
City: _____ State: _____
Zip Code: _____ Email: _____

Owner's Name: _____

Address: _____
Street: _____ Phone: _____
City: _____ State: _____
Zip Code: _____ Email: _____

Dealer Boat Registration

(Dealer should complete and mail to Skier's Choice)

Date: _____ Date of Purchase: _____

Identification Numbers:

Hull: _____ Engine: _____
Transmission: _____ Trailer: _____

Dealer's Name: _____

Address: _____
Street: _____ Phone: _____
City: _____ State: _____
Zip Code: _____ Email: _____

Owner's Name: _____

Address: _____
Street: _____ Phone: _____
City: _____ State: _____
Zip Code: _____ Email: _____



SKIERS
Choice, Inc.

5820 US 411 South, Maryville, Tennessee 37801

Skier's Choice, Inc.
5820 US 411 South
Maryville, Tennessee 37801

PLACE
STAMP
HERE

SKIERS
Choice, Inc.

5820 US 411 South, Maryville, Tennessee 37801

Skier's Choice, Inc.
5820 US 411 South
Maryville, Tennessee 37801

PLACE
STAMP
HERE

<https://www.boat-manuals.com/>