

INTRODUCTION

Please read this Owner's Manual completely prior to operating the engine and boat for the first time. The Owner's Manual contains information critical for safe operation, and to activate and keep the limited warranty statement in effect throughout the applicable warranty period. Continuing the appropriate maintenance and care going forward can ensure long-term enjoyment of the MV8 engine. **DO NOT OPERATE THE ENGINE WITHOUT FIRST READING THE ENTIRE MV8 OWNER'S MANUAL AND ALL SUPPORTING DOCUMENTATION, AS WELL AS THE BOAT OWNER'S MANUAL.**

WELCOME

Ilmor Marine, LLC, is pleased to welcome you to boating enjoyment available only through use of the extraordinary MV8 engines. Ilmor is a recognized leader in the marine industry, having originated through championship-caliber, high-performance engines. Our experience inevitably led to the development of the MV8, offering 5.7, 6.0, 6.2 and 7.4 liter versions. The MV8 provides the kind of horsepower necessary to plane with pulse-pounding quickness while equally ensuring the reliability and smoothness necessary for just-above-idle investigation of interesting coves and shorelines. It's all here.



ILMOR MV8 OWNER'S MANUAL

This Owner's Manual reflects the most recent product information available at press printing. Nonetheless, Ilmor retains the right to make changes to the engine and/or components as a result of continually improving the MV8. Ilmor reserves the right to make changes to the engine specifications at any time, without prior notice, and to discontinue product. Changes may be made without obligation on Ilmor's part to provide or equip previously manufactured engines with updated specifications. If the retail purchaser determines that updated equipment can be retrofitted on existing product, such changes are at the sole discretion and cost to the retail purchaser. Ilmor bears no responsibility in these instances. Consumers are encouraged to check www.ilmor.com regularly for additional information. The website will also track service bulletins and other technical information that may have impact on the consumer's engine operation. Ilmor's obligation regarding such matters is delineated within the Ilmor Limited Warranty Statement.

Because of Ilmor's commitment to continual product improvement, some alterations may occur to the current model MV8 after the publication of this Owner's Manual. Realistically, this Owner's Manual also cannot address every potential issue that may arise from the operation and use of the MV8. A reasonable effort was made to make this Owner's Manual as accurate and complete as possible, but photographs and drawings may be only representational. Suppliers may also change or alter product. The information provided discusses the topics and issues most critical to ensuring a successful, long-term ownership of the MV8 engine.

Most questions and discussions about the MV8 are best directed to your certified Ilmor dealer. However, it may be necessary or desirable to contact Ilmor directly. Please forward inquiries to the following:

Ilmor Marine, LLC
186 Penske Way
 Mooresville, NC 28115
(704) 360-1900
Fax (704) 360-1901

Online contact: service@ilmormarine.com

Product updates and technical bulletins: www.ilmor.com

TRADEMARKS

All non-Ilmor trademarks, service marks, logos, slogans and trade names are the properties of their respective owners. The following is a list of trademarks that may be used throughout this manual.

Chevrolet Racing
Diacom PC Software
Dodge Viper
Formula 1
GM
Indianapolis 500
IndyCar
Pennzoil
Quaker State
Sierra
STA-BIL

NOTES

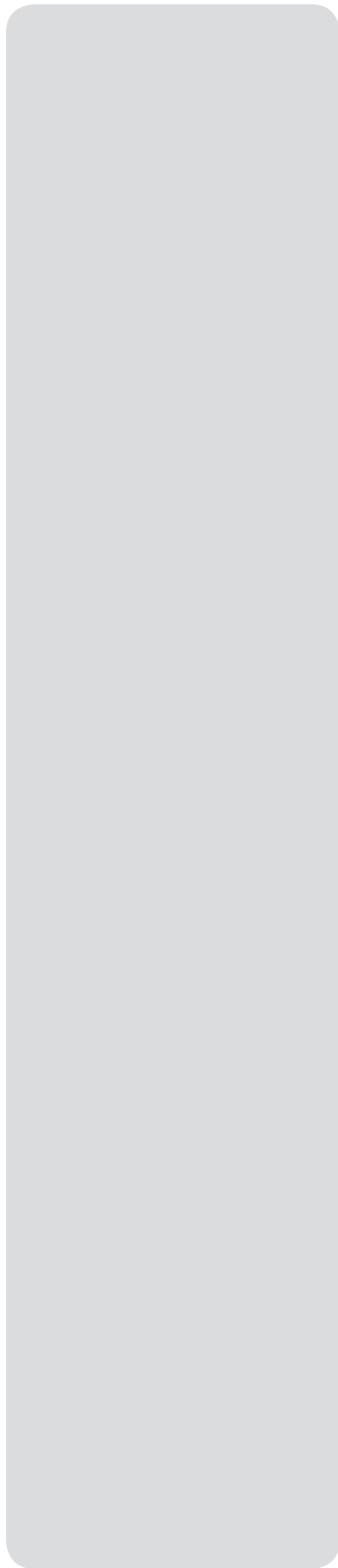

TABLE OF CONTENTS

INTRODUCTION.....	i
WELCOME.....	i
TRADEMARKS.....	iii
SAFETY	1-1
DIRECT SAFETY CONCERNS	1-3
DANGERS, WARNINGS, CAUTIONS AND NOTICES.....	1-4
INTRODUCING THE MV8.....	2-1
EXHAUST SYSTEM.....	2-2
FUEL SYSTEM	2-3
COOLING SYSTEM	2-3
Open Cooling System	2-4
Closed Cooled System	2-4
ELECTRICAL SYSTEM	2-5
Fuse Box	2-5
Boat/Engine Interface Wiring	2-6
ENGINE SENSORS	2-6
ALARMS	2-7
Water Temperature	2-7
Oil Pressure	2-7
FUELING THE MV8	3-1
FUEL REQUIREMENTS.....	3-2
Oxygenated Gasoline or Gasoline Containing Alcohol	3-3
When the Boat Is Not Used for A While	3-3
Fuels Outside the United States and Canada	3-3
BEFORE EACH USE.....	4-1
CHECK THE ENGINE OIL LEVELS PRE-ENGINE START-UP	4-1
CHECK THE SEA STRAINER – PRE-ENGINE START-UP.....	4-2
CHECK THE COOLANT LEVEL	4-3
CHECK THE POWER STEERING FLUID FOR ENGINES WITH INTEGRAL RESERVOIR (IF EQUIPPED).....	4-4
CHECK THE SERPENTINE BELT FOR LOOSENESS OR DAMAGE.....	4-5
INSPECT THE BATTERY CONNECTIONS AND HOLD-DOWNS	4-5
INSPECT THE ENGINE FOR LOOSE OR MISSING HARDWARE	4-6
INSPECT THE THROTTLE AND SHIFT CABLES FOR KINKS, WEAR AND INTERFERENCE	4-6
INSPECT THE FUEL AND EXHAUST SYSTEMS FOR LEAKS	4-6
CHECK THE SEA STRAINER – POST-ENGINE START-UP	4-7



ILMOR MV8 OWNER'S MANUAL

CHECK THAT THE BATTERY IS FULLY CHARGED	4-7
CHECK THE TRANSMISSION FLUID/OIL LEVEL	4-8
CHECK THE ENGINE OIL LEVEL	4-8
AFTER EACH USE	5-1
CHECK THE RAW WATER PICK-UP	5-1
FLUSH THE RAW WATER/SEA PUMP SYSTEM.....	5-1
CHECK FOR LEAKS	5-2
CLEAN ANY RESIDUE	5-2
STARTING, STOPPING AND NEW ENGINE	
BREAK-IN.....	6-1
FIRST HOURS OF OPERATION	6-2
AFTER INITIAL HOURS OF OPERATION	6-3
BEFORE THE ENGINE IS STARTED	6-3
STARTING THE ENGINE	6-4
SHIFTING GEARS	6-5
STOPPING THE BOAT	6-5
OTHER CONSIDERATIONS.....	6-5
MAINTENANCE	7-1
CHANGE THE ENGINE OIL AND FILTER	7-3
CHECK THE POWER STEERING FLUID FOR ENGINES WITH INTEGRAL RESERVOIR	7-5
CHANGE THE FUEL/WATER SEPARATOR.....	7-6
REPLACE THE HIGH-PRESSURE FUEL FILTER.....	7-7
CHANGE THE TRANSMISSION FLUID/OIL AND FILTER	7-8
CHECK THE TRANSMISSION COOLER	7-8
REPLACE THE RAW WATER IMPELLER/SEA PUMP IMPELLER	7-9
DRAIN RAW WATER (SEA WATER)	7-10
CHECK THE ENGINE COOLANT LEVEL	7-11
DRAIN THE ENGINE COOLANT.....	7-11
FILL THE ENGINE COOLANT	7-12
FLUSH THE COOLERS	7-12
REPLACE THE SERPENTINE BELT	7-13
REPLACE THE ZINC ANODES.....	7-13
CLEANING THE ENGINE COMPARTMENT AND PREVENTING CORROSION	7-14
INSPECTING AND CLEANING THE BATTERY CONNECTIONS AND HOLD-DOWNS	7-15
STORAGE AND WINTERIZATION	8-1
FUEL SYSTEM TREATMENT	8-1
OIL STORAGE/WINTERIZATION	8-2
COOLING SYSTEM STORAGE AND WINTERIZATION	8-2
BATTERY WINTERIZATION	8-4
RECOMMISSIONING AFTER STORAGE/WINTERIZATION	8-4

TABLE OF CONTENTS

EMISSIONS.....	9-1
EMISSIONS CONTROL INFORMATION LABEL.....	9-1
EMISSIONS CONTROL SYSTEM INFORMATION	9-2
STAR LABEL	9-2
ENVIRONMENTAL LABEL	9-3
ON-BOARD DIAGNOSTICS-MARINE (OBD-M)	9-3
CALIFORNIA AND U.S. EPA EMISSION CONTROL WARRANTY STATEMENT	9-4
Your Warranty Rights and Obligations	9-4
Manufacturer’s Warranty Coverage	9-4
Owner’s Warranty Responsibilities	9-5
General Emissions Warranty Coverage.....	9-5
Emission Control System Warranty.....	9-6
Mechanical Emission-Related Components Warranty.....	9-6
Electronic Emission-Related Control Parts Warranty.....	9-7
Direct Emission-Related Control Parts Warranty.....	9-7
TROUBLESHOOTING	10-1
SPECIFICATIONS AND SERVICE LOG	11-1
ENGINE SPECIFICATIONS	11-1
Requirements and Recommendations	11-2
SERVICE LOG	11-3

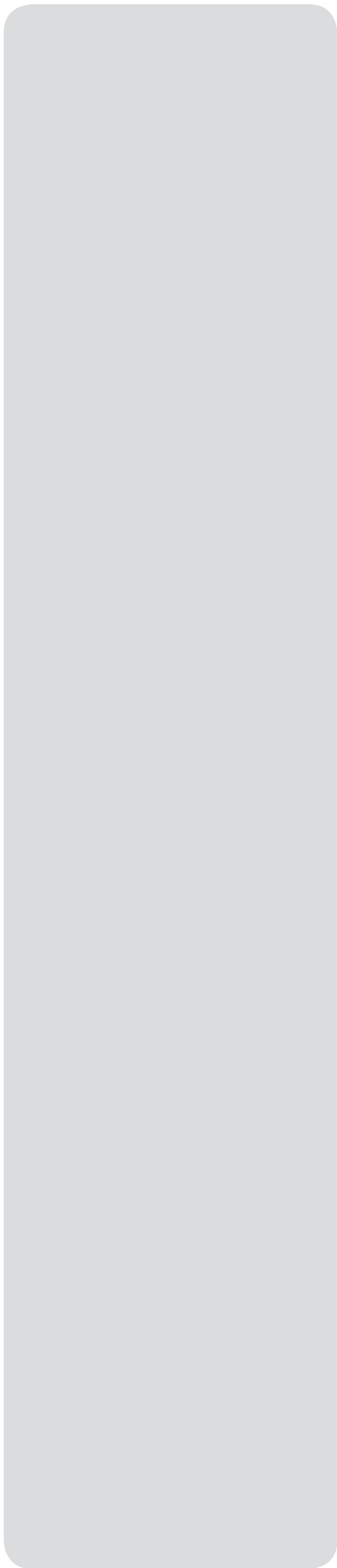

ILMOR MV8 OWNER'S MANUAL

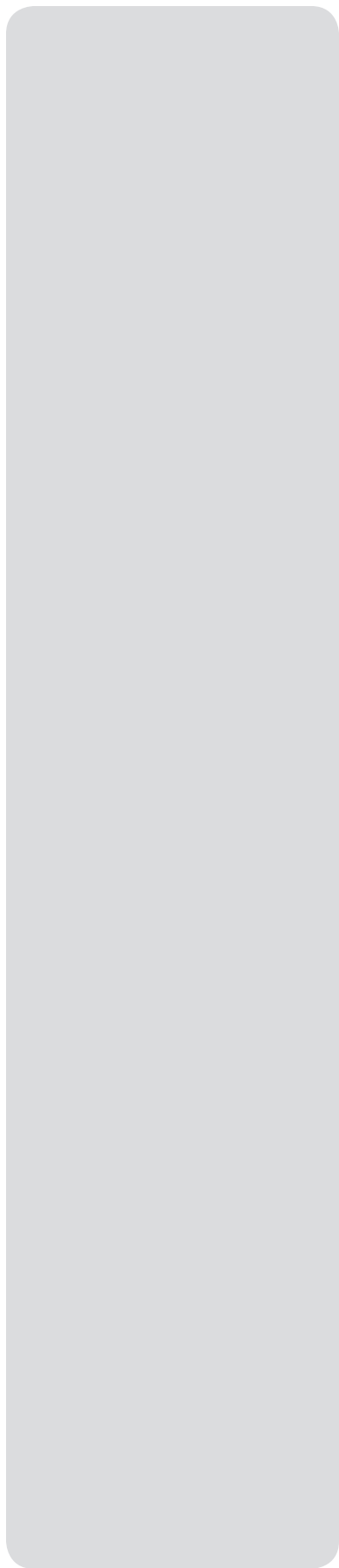

Section 1

SAFETY

Prior to operating the boat for the first time, boat operators **MUST** read this Owner's Manual in its entirety. It is also recommended to reread it prior to the first outing each boating season. Keeping the Owner's Manual on-board the boat in a dry, secure location such as a glove box is highly recommended for referral purposes. Be sure to also read the boat Owner's Manual, with particular attention to proper operation and safety concerns addressed within that publication.

It is the boat owner's and the operator's responsibility to be aware of safety issues and concerns in the proper operation of the boat. All people on-board, regardless of age, physical limitations and/or previous boating experience (or lack of experience), bear responsibility for determining the appropriate behavior and safety precautions, including care around the engine, engine compartment, transmission and all moving parts.

Key to safety is the prescribed maintenance of the engine and drive train as described in this Owner's Manual, on **www.ilmor.com**, and through information and directives provided by the suppliers of parts for the drive train. A properly prepared and maintained engine is less likely to stall, misfire or otherwise operate in a manner that could place the boat occupants, as well as others on the same body of water, in unsafe situations.



SECTION 1 ILMOR MV8 OWNER'S MANUAL

Throughout the MV8 Owner's Manual, specific safety information will be highlighted with symbols designed to draw particular attention to specific information. These will include:



This safety alert symbol appears with most safety statements. It means attention, become alert, your safety is involved! Please read and abide by the message that follows the safety alert symbol.

⚠ DANGER! *Indicates an imminently hazardous situation which, if not avoided, will result in death or serious injury.*

⚠ WARNING! *Indicates a potentially hazardous situation which, if not avoided, could result in death or serious injury.*

⚠ CAUTION! *Indicates a hazardous situation which, if not avoided, could result in minor or moderate injury.*

NOTICE: *Indicates a situation which can cause damage to the engine, personal property and/or the environment, or cause the equipment to operate improperly.*

NOTE: *Indicates a procedure, practice or condition that should be followed in order for the engine or component to function in the manner intended.*

The precautions listed in this Owner's Manual are not all-inclusive. Ilmor cannot anticipate any or all safety issues, nor fully anticipate the extent to which injury may occur. Information contained in this Owner's Manual reflects a consensus of opinion within the marine industry.

DIRECT SAFETY CONCERNS

Whenever an MV8 engine is operated within the confines of an engine compartment, it is extremely important to follow the boat manufacturer's instructions regarding venting of the engine compartment prior to or during low-speed/idle operation.

One of the most critical safety matters affecting boaters is the matter of carbon monoxide emission. This is a colorless, odorless and poisonous gas that accumulates rapidly, both within confined areas and even within the open air. Exposure to carbon monoxide can be fatal within minutes, even in low concentrations. Avoid exhaust vent areas of the boat, particularly during slow-speed operation.

▲ DANGER! Always avoid exhaust areas and the engine compartment during the venting of engine exhaust. The engine exhaust emits carbon monoxide, which is colorless, odorless and poisonous even in small concentration. Carbon monoxide can cause serious injury or death in short periods of time.

All persons on-board must exhibit special care and concern whenever the engine is running and the engine compartment is open. Everyone should avoid all moving parts. If the engine or anything accessible from the engine compartment requires adjustment while the engine is running, the adjustment should be done by a certified Ilmor dealer or authorized boat manufacturer dealer if at all possible. If adjustments are necessary while the boat is underway or in preparation for boating, extreme care should be used.

▲ WARNING! Never attempt to stop or slow rotating parts. Keep away from rotating parts. The engine compartment serves as a guard. Always have the engine off whenever the compartment is open, except as directed by the boat manufacturer to vent exhaust fumes or during maintenance. Use extreme care whenever operating the engine with the compartment open. Clothing or body parts can get caught in moving parts, which could result in serious injury or death.

It is the owner's and/or operator's responsibility to perform all safety checks to the engine(s) prior to, during and after operating the boat. When properly adhered to, the maintenance schedules listed in this Owner's Manual will ensure long-term operation and performance of the engine. When service and maintenance are required, return the boat to a certified Ilmor dealer. Failure to follow procedures outlined in this Owner's Manual or through published technical information at www.ilmor.com may void the warranty.

SECTION 1 ILMOR MV8 OWNER'S MANUAL

The precautions listed in this Owner's Manual, as well as published technical information are not all-inclusive. Any replacement part, fluid or substance that is not specified as recommended should not be used as it may result in engine failure. This could lead to voiding the warranty, as well as placing people in an unsafe situation.

⚠ WARNING! Always use genuine Ilmor Marine, LLC, replacement parts intended for the MV8 engine. The electrical and ignition components have been designed to comply with U.S. Coast Guard regulations intended to minimize the possibility of fire and/or explosion. The use of nonapproved replacement parts from aftermarket or other sources will void the warranty and could result in fire and/or explosion.

DANGERS, WARNINGS, CAUTIONS AND NOTICES

The following safety precautions are published for your information. Ilmor does not, by the publication of these precautions, imply or in any way represent that they are the sum of all dangers present. If you are installing, operating, or servicing an Ilmor product, it is your responsibility to ensure full compliance with all applicable safety codes and requirements. All requirements of the Federal Occupational Safety and Health Act must be met when Ilmor products are operated in areas that are under the jurisdiction of the United States of America. Ilmor products operated in other countries must be installed, operated and serviced in compliance with any and all applicable safety requirements of that country.

For details on safety rules and regulations in the United States, contact your local office of the Occupational Safety and Health Administration (OSHA).

The words DANGER, WARNING, CAUTION and NOTICE are used throughout this manual to highlight important information. Be certain that the meanings of these alerts are known to all who work on or near the equipment.

Failure to adhere to and comply with the safety dangers, warnings, cautions and notices that appear in this manual can lead to serious illness, injury or even death and/or damage to your boat or the property of others. Beyond these warnings, boaters have a personal responsibility to utilize a common sense approach to the boating experience, including keeping individuals off or away from the swim platform and the stern area of the boat during the engine operation. Personal flotation devices ("PFDs") save lives and ensure positive experiences. Ilmor offers many proactive approaches to the boating experience, but the consumer is ultimately responsible for the positive and safe involvement in boating.

Please note that the safety information statements presented below are categorized for information purposes only, and are not presented in any particular order of importance. Each of the statements referenced below and in the other sections of this manual provide you with important safety-related information and must be read and followed to avoid injury or damage, as applicable. We strongly encourage you to read the dangers, warnings, cautions and notices within the context in which they are presented by reading and reviewing those sections.

⚠ DANGER! *Always avoid exhaust areas and the engine compartment during the venting of engine exhaust. The engine exhaust emits carbon monoxide, which is colorless, odorless and poisonous even in small concentration. Carbon monoxide can cause serious injury or death in short periods of time.*

⚠ DANGER! *Never start the engine if a gasoline odor is present or if gasoline can be seen at any point along the fuel line, along the fuel tank, in the bilge or at the engine. Remove the key from the ignition switch and call an authorized boat and/or certified Ilmor dealer for service. Take care not to spill gasoline when fueling. If gas is spilled accidentally, wipe up all traces with dry rags immediately and dispose of rags properly on-shore. Gasoline and its vapors can cause an explosion.*

⚠ DANGER! *Always open the engine compartment and check for fumes, leaks or the presence of fluids in the bilge and operate the bilge blower for at least 4 minutes before starting the engine, and always when at idle or slow-running speed. Explosive gasoline and/or battery fumes may be in the engine compartment. Failure to operate the bilge blower as directed may result in explosion or fire, resulting in serious injury or death.*

⚠ WARNING! *Never attempt to stop or slow rotating parts. Keep away from rotating parts. The engine compartment serves as a guard. Always have the engine off whenever the compartment is open, except as directed by the boat manufacturer to vent exhaust fumes or during maintenance. Use extreme care whenever operating the engine with the compartment open. Clothing or body parts can get caught in moving parts, which could result in serious injury or death.*

⚠ WARNING! *Always use genuine Ilmor Marine, LLC, replacement parts intended for the MV8 engine. The electrical and ignition components have been designed to comply with U.S. Coast Guard regulations intended to minimize the possibility of fire and/or explosion. The use of nonapproved replacement parts from aftermarket or other sources will void the warranty and could result in fire and/or explosion.*

SECTION 1 ILMOR MV8 OWNER'S MANUAL

⚠ WARNING! Replacement of any part of the fuel system must be done with Ilmor-authorized parts only. If the fuel system supplying the MV8 engine requires attention, any adjustment or replacement, the procedure must be done by a certified Ilmor dealer. The fuel lines are pressurized and can only be disconnected with specialized tools. Failure to follow this directive will void the warranty and can result in damage to the boat and/or serious injury or death.

⚠ WARNING! Never operate the engine without an adequate and uninterrupted amount of water flowing through the cooling system. This requires the boat to be in an operational-sized body of water or hooked up to the suction side of a raw water pump by an Ilmor-approved water supply in a dealership. If the engine operates without water in the cooling system, the exhaust system will overheat and could potentially create an on-board fire. The water pump impeller will also fail. Damage caused to the boat under these circumstances will void the warranty and could result in serious injury and/or death.

⚠ WARNING! Always connect the positive (+) battery cable first. After the positive cable is connected, then the negative (-) battery cable can be attached. This minimizes the possibility of electrical contact.

⚠ WARNING! Always disconnect the negative battery cable (-) first before disconnecting the positive battery cable (+). After the negative battery cable is disconnected, the positive battery cable can be disconnected. This minimizes the possibility of electrical contact.

⚠ WARNING! Never realign the wiring or in any way alter the wiring of the MV8 engine. Doing so may result in damage to the engine, which is not covered under warranty, and sufficient voltage may be present to cause serious injury and/or death.

⚠ WARNING! Always inspect the entire fuel system for leaks and/or deterioration prior to each outing. This inspection becomes even more critical after substantial periods of nonuse or storage. Be certain the inspection includes the fuel tank, fuel lines, fuel pump, regulator, fuel rails, carbon canisters and all fittings in the system. Never operate the engine when any component shows even slight signs of corrosion, leakage, deterioration, swelling, hardening or softening. This must be brought to the attention of a certified Ilmor and/or boat manufacturer's dealer for replacement prior to using the boat.

⚠ WARNING! Never allow battery electrolyte to be spilled or placed on any part of the human body. Battery electrolyte fluid is dangerous. It contains sulfuric acid, which is poisonous, corrosive and caustic. If exposed to battery electrolyte, flush the area with large amounts of clean water and immediately seek medical attention.

⚠ WARNING! Always keep all sparks, flames and smoking materials away from the battery charging area. When charging, batteries generate small amounts of dangerous hydrogen gas which is highly explosive. Failure to follow instructions when charging a battery can cause an electrical charge or even an explosion of the battery. This could result in serious injury or death.

⚠ WARNING! Always follow the boat manufacturer's instructions on how to properly winterize the fuel tank prior to storage. Leaking of fuel into the boat and potentially into the storage area could result in substantial damage to the boat, and contact with any spark (such as a flame-producing pilot light in a heater) could also result in property damage and serious injury or death.

⚠ WARNING! Always replace parts of the fuel system with Ilmor-authorized parts only. All fuel system lines and connections must meet the requirements of U.S. Coast Guard (USCG) regulations. This means that hoses must meet or exceed SAE Standard J1527 DEC85, and hoses used for fuel delivery must meet or exceed specification in USCG regulations, Sec. 183.540 for recreational boating. Additionally, all fuel hose must meet the 15 g/m² limit for fuel permeation. All plumbing for the fuel system on Ilmor engines, and the boats in which Ilmor authorizes placement, meet or exceed all requirements.

⚠ WARNING! Always allow the engine to cool down completely before attempting to service the fuel/water separator filter in order to avoid fire or explosion. The fuel system is under pressure.

⚠ WARNING! Always be sure that the ignition key is in the OFF position, the main battery power switch is in the OFF position, and that no spark or flame are present when servicing the fuel/water separator.

⚠ WARNING! Always make sure that no fuel leaks exist and that the engine compartment is well ventilated with no gasoline vapors present to avoid fire or explosion hazard before performing any fuel system maintenance.

⚠ WARNING! Always allow the engine to cool down completely before attempting to service the high-pressure fuel filter in order to avoid fire or explosion.

⚠ WARNING! Always be sure that the ignition key is in the OFF position, the main battery power switch is in the OFF position, and that no spark or flame are present when servicing the high-pressure fuel filter.

⚠ WARNING! Always use the special tools to replace the high-pressure fuel filter. Do not attempt to replace fuel filter without special tools. Doing so may damage fuel line or filter. A damaged fuel line or filter may leak and cause a fire or explosion.

SECTION 1 ILMOR MV8 OWNER'S MANUAL

⚠ CAUTION! *Never allow excessive exhaust temperatures as they will damage the exhaust hose and are symptomatic of a leak or restriction in the cooling system. The engine should be shut off immediately in the presence of too much heat, whether by odor, touch or sight. Failure to do so may result in more serious consequences, including but not limited to damage to the engine, which is not covered under warranty, and/or damage to the boat that may result in personal injury, as well.*

⚠ CAUTION! *Always be certain that there is ample room around the boat when trying to start the engine in forward position as the boat will move forward when the engine starts. Contact with other boats, docks, shallow waterway bottoms, or debris may result in damage to the boat that is not covered under warranty, and may also result in serious injury.*

NOTICE: Always pay attention to the audio and visual alarms. Boats are equipped with a variety of audible and visual alarms that alert operators to potential performance issues. No alarm, whether it sounds an alert or provides information on the gauges, should ever be ignored. The drive train's sensors are often the earliest indication of problems, and if ignored, may result in serious damage to the equipment. This is not covered under warranty.

NOTICE: Always use a high-quality gasoline from a reputable source. Damage to the engine by use of low-quality gasoline or gasoline with an octane rating below the minimum level listed for Ilmor MV8 engines will void the warranty on the engine.

NOTICE: Always perform the proper storage procedures when storing the boat. Extended storage with fuel in the system can affect fuel stability and may require system inspection and fuel filter replacement when the boat returns to service. Fuel systems on all boats equipped with Ilmor MV8 engines MUST be properly prepared for storage periods exceeding 1 month, as outlined in this Owner's Manual. Owners are encouraged to seek assistance from a certified Ilmor dealer to properly prepare the drive train for periods of inactivity exceeding 1 month. Damage due to improper storage or winterization preparations is not covered under warranty.

NOTICE: Always use the recommended transmission fluid/oil. Damage to the engine by use of low-quality or nonrecommended transmission fluid/oil as listed for V-Drive and direct drive transmissions will void the warranty. Overfill or underfill may also result in serious damage to the engine and is not covered under warranty.

NOTICE: Marine growth occurs in brackish and salt water, and even in what is referred to as "fresh" or salt-free water. Therefore, it is important to flush the boat's cooling system with fresh water after each use.

NOTICE: This is a critical function of routine maintenance. Even clean-appearing waterways may have debris such as pine needles or moss that can enter the cooling system and create a blockage. Failure to perform this function can result in serious overheating of the engine. Damage to the engine and/or transmission caused by overheating is not covered by warranty. Always pay attention to your temperature gauge, even if you are carefully performing this check. Failure of the raw water impeller or blockage of the transmission cooler are frequent causes of overheating.

NOTICE: Always use the recommended engine oil. Failure to follow the engine oil recommendation listed in this Owner's Manual can result in accelerated engine wear and engine component failure. Engine damage due to incorrect oil usage, oil changes and oil levels, or other failure to follow engine oil procedures can be costly and may void the warranty.

NOTICE: Always pay attention to any gauges or warning lights. Ignoring elevated temperatures on a temperature gauge or any other evidence of the engine operating at temperatures above recommended levels can result in serious damage to the engine. Any resulting damage will not be covered by the warranty.

NOTICE: Always maintain the correct coolant level. Failure to maintain coolant at the proper level will cause potentially serious engine damage. The warranty does not cover engine damage due to overheating or any other cause associated with improper coolant levels.

NOTICE: Never install accessories or add-on equipment that is not approved by Ilmor. Add-on equipment may adversely affect the alternator output or overload the electrical system. Any damage caused as a result will not be covered by the warranty.

NOTICE: Failure to follow the break-in and operating procedures as described in this Owner's Manual will void the warranty. Before operating the boat for the first time, you must read this Owner's Manual completely, as well as the boat manufacturer's Owner's Manual.

NOTICE: Do not remove the factory break-in oil until after a minimum of 10 hours proper operation, but not later than 25 hours. At that time, an oil change should be performed by a certified Ilmor dealer, who will be able to "read" the oil and filter to determine if the proper break-in of the engine components appears to be occurring.

NOTICE: Never operate the starter motor continuously for more than 15 seconds without allowing the starter motor to cool for at least 2 minutes. The ignition key must be released after the engine has started to avoid damage to the starter motor and drive. Failure to do so may result in the starter overheating, which is damage not covered under warranty.

NOTICE: Never move between forward-neutral-reverse when the engine is above 800 rpm. Always allow the speed to decrease to 600–800 rpm before completing the shift. Failure to do so may result in damage that is not covered under warranty.

SECTION 1 ILMOR MV8 OWNER'S MANUAL

NOTICE: Always properly clean the engine and transmission if exposed to salt water. Exposure to salt water causes corrosion, leading to significant damage to metal, including stainless steel. If evidence of corrosion shows on the engine, carefully clean the engine and transmission with fresh water and a mild soap solution after use in salt water. A protective marine oil may be applied to exposed metal to halt the acceleration of corrosion. Failure to properly clean boat or pay attention to corrosion matters will void the warranty.

NOTICE: Air in the system could cause the raw water impeller to fail, causing severe engine problems. If air in the system is persistent, visit your local Ilmor service center.

NOTICE: If the serpentine belt comes off or wears through, catastrophic engine failure may occur. Do not operate the engine without a properly installed serpentine belt. Any resulting damage will not be covered by the warranty.

NOTICE: Make sure the seacock is back in the ON position. If this operation is skipped, the engine will overheat, failing the raw water pump impeller and causing severe engine problems. Make sure that the cap/lid has been installed correctly and has not pinched the sealing o-ring. This will cause air to be introduced into the system and could cause the raw water impeller to fail, causing severe engine problems.

NOTICE: Any exposure to brackish or salt water requires a closed cooling system. Operating your open cooled engine in brackish or salt water can and will void your warranty.

NOTICE: If power steering fluid is not visible, contact your Ilmor service center immediately. Severe engine damage could occur.

Section 2

INTRODUCING THE MV8



⚠ WARNING! Always connect the positive (+) battery cable first. After the positive cable is connected, then the negative (-) battery cable can be attached. This minimizes the possibility of electrical contact.

⚠ WARNING! Always disconnect the negative battery cable (-) first before disconnecting the positive battery cable (+). After the negative battery cable is disconnected, the positive battery cable can be disconnected. This minimizes the possibility of electrical contact.

⚠ WARNING! Replacement of any part of the fuel system must be done with Ilmor-authorized parts only. If the fuel system supplying the MV8 engine requires attention, any adjustment or replacement, the procedure must be done by a certified Ilmor dealer. The fuel lines are pressurized and can only be disconnected with specialized tools. Failure to follow this directive will void the warranty and can result in damage to the boat and/or serious injury or death.

⚠ WARNING! Never operate the engine without an adequate and uninterrupted amount of water flowing through the cooling system. This requires the boat to be in an operational-sized body of water or hooked up to the suction side of a raw water pump by an Ilmor-approved water supply in a dealership. If the engine operates without water in the cooling system, the exhaust system will overheat and could potentially create an on-board fire. The water pump impeller will also fail. Damage caused to the boat under these circumstances will void the warranty and could result in serious injury and/or death.

⚠ WARNING! Never realign the wiring or in any way alter the wiring of the MV8 engine. Doing so may result in damage to the engine, which is not covered under warranty, and sufficient voltage may be present to cause serious injury and/or death.

⚠ CAUTION! Never allow excessive exhaust temperatures as they will damage the exhaust hose and are symptomatic of a leak or restriction in the cooling system. The engine should be shut off immediately in the presence of too much heat, whether by odor, touch or sight. Failure to do so may result in more serious consequences, including but not limited to damage to the engine, which is not covered under warranty, and/or damage to the boat that may result in personal injury, as well.



EXHAUST SYSTEM

Ilmor MV8 engines are equipped with “wet” marine exhaust systems. In a wet marine exhaust system, raw water enters the exhaust elbows (also referred to as “downturn adapters”), where it mixes with the exhaust gases. The mixing of the water and exhaust gases is important because it provides cooling to the rubber hose that connects the exhaust elbow to the muffler. After the water-exhaust gas mixture passes through the mufflers it exits back into the body of water.

Water-exhaust gas mixture temperatures will be less than 250°F (121°C). If the temperatures are greater than that, the rubber exhaust hose will burn. If the hose has an odor of burning rubber, immediately shut down the engine. Check for leaks or restrictions in the cooling system.

CAUTION! Never allow excessive exhaust temperatures as they will damage the exhaust hose and are symptomatic of a leak or restriction in the cooling system. The exhaust manifolds are water-cooled. Water temperatures in the exhaust manifolds range from 158°F to 194°F (70°C to 90°C). If the engine exhaust manifold temperature reaches 199°F (93°C) in an open cooled engine or 239°F (115°C) in a closed cooled engine, the system is malfunctioning, and as with the situation involving the hoses explained above, the engine should be shut OFF. Check the cooling system for leaks or restrictions. It will not be unlikely that overheating will affect both the manifolds and hoses, as a symptom of cooling system problems.

Ilmor engines are equipped with a catalytic converter system. The catalyst bricks are press fit into one-piece exhaust manifolds. If needed, the catalyst bricks can be removed and replaced within the original exhaust header. However, a special tool is needed to remove the catalyst brick and install a new one. Ilmor strongly recommends that this function be performed by a certified Ilmor dealer.

See additional important information in Section 9, Emissions.

FUEL SYSTEM

Ilmor's MV8 engines are equipped with multi-port sequential fuel injection system, the most up-to-date system available in the industry, featuring E-Controls engine controller that is capable of meeting all emission, with On-Board Diagnostics Marine (OBD-M) and driveability requirements of marine applications.

WARNING! Replacement of any part of the fuel system must be done with Ilmor-authorized parts only. All fuel system lines and connections must meet the requirements of U.S. Coast Guard (USCG) regulations. This means that hoses must meet or exceed SAE Standard J1527 DEC85, and hoses used for fuel delivery must meet or exceed specification in USCG regulations, Sec. 183.540 for recreational boating. Additionally, all fuel hose must meet the 15 g/m² limit for fuel permeation. All plumbing for the fuel system on Ilmor engines, and the boats in which Ilmor authorizes placement, meet or exceed all requirements. See Section 3, Fueling the MV8, for additional information.

COOLING SYSTEM

Unlike automotive cooling systems that use radiators (air-to-fluid heat exchangers) for cooling, marine engines use fluid-to-fluid heat exchangers. Cooling is provided by the body of water in which the boat is operated. A raw water pump (rubber impeller pump) draws water into the boat where it is distributed to the engine, exhaust system, and heat exchangers for maintaining the engine at an acceptable heat-operating temperature range.

There are two main types of cooling systems used in Ilmor engines, one of which will be found with each engine depending upon the type selected:

1. Open Cooling System

(Raw water from a body of water flows through the engine and exhaust manifolds.)

2. Closed Cooled System (also known as Ocean Performance Series)

(Engine coolant flows through the engine and exhaust manifolds.)

WARNING! Never operate the engine without an adequate and uninterrupted amount of water flowing through the cooling system.

Ensure that the raw water pick-up remains clear of debris at all times. Even small amounts can clog or block the pick-up, which is located beneath the boat. The raw water pick-up **MUST** have an uninterrupted input of water whenever the engine is running.

NOTICE: Marine growth occurs in brackish and salt water, and even in what is referred to as "fresh" or salt-free water. Therefore, it is important to flush the boat's cooling system with fresh water after each use.

SECTION 2 ILMOR MV8 OWNER'S MANUAL

NOTICE: Any exposure to brackish or salt water requires a closed cooling system. Operating your open cooled engine in brackish or salt water can and will void your warranty.

Open Cooling System



The open cooling system was designed for fresh water use only. Whenever the boat is operated in brackish or salt water, particular care, without fail, must be taken to flush the system with fresh water after every use. However, even if boating in salt-free, apparently clean fresh water, flushing the cooling system following use is recommended. This helps eliminate marine growth or fouling of the cooling system.

In an open cooling system, raw water is drawn into the boat by the raw water pump. (The intake is on the back of the boat where it will be submerged and can draw water continuously; the pump is located on the engine block.)



Closed Cooled System

The closed cooled system is the required application for boats operating in consistently brackish or salt water. The system provides maximum protection for the engine against corrosion, fouling and marine growth. As noted above, it is extremely important to keep the system flushed after each use.

In a closed cooled system raw water is drawn into the boat by the raw water pump, where it is distributed to the heat exchangers and then to the exhaust downturn adapters before being returned to the body of water. The engine recirculation pump recirculates coolant through the engine and exhaust manifolds. Raw water never enters the engine or exhaust manifolds.

ELECTRICAL SYSTEM

The electrical system on the MV8 is a 12-volt negative ground system. As a result, it is important to keep in mind that operators must avoid reverse polarity, which could lead to extensive damage of the electronics. Any damage occurring as a result of reverse polarity will not be covered by warranty.

Reversed polarity also presents a serious shock risk. Turning off a breaker appears to remove power from the circuit because it turns off whatever is connected to that circuit. But with reversed polarity you have disconnected from ground, not from power. The circuit is live.

WARNING! Always connect the positive (+) battery cable first. The battery positive cable (+) connects at the starter motor battery post.

The positive post of the battery is connected to the large post provided on the starter motor with marine grade single ought (1/0) starter wire and appropriate eyelet. After the connection is made, all other positive engine circuits will be connected to the battery positive from this junction. The supplied heavy rubber boot (red) must be used on the starter motor terminal to shield the terminal and prevent accidental contact.

WARNING! Always disconnect the negative battery cable (-) first before disconnecting the positive battery cable (+). The battery negative (-), or ground, connects to the stud at the engine bell-housing.

Fuse Box

In addition to circuit breakers in the boat that may impact the engine functionality or ancillary equipment and electronics that borrow power from the engine, the engine is also equipped with a fuse box that adds control over various electronic functions of the engine. The fuse box is mounted on the rear of each MV8 engine.

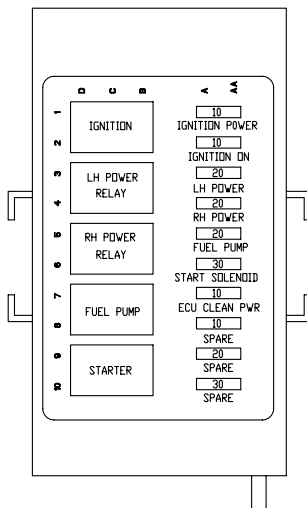

Boat/Engine Interface Wiring

WARNING! Never realign the wiring or in any way alter the wiring of the MV8 engine. The electrical system of the MV8 is primarily self-contained in a preassembled unit. The interface with boat wiring follows established practices and conforms to regulatory guidelines. Every reasonable effort has been made to make the electrical connection simplified and straightforward. Consumers are strongly encouraged to seek assistance from certified Ilmor dealers when dealing with electrical issues.

ENGINE SENSORS

The MV8 is a reliable, well-running engine with several sensors that monitor performance while the engine is running. Among the sensors are the throttle position, manifold absolute pressure (MAP), camshaft position, crankshaft position, coolant temperature, knock, oxygen, catalytic converter exhaust, oil pressure and oil temperature.

Often issues will be brought to the consumer's attention by way of alarms. Most sensors trip alarms, whether audible or visual on the gauges. No warning should be ignored. Consumers are urged to take the boat to a certified Ilmor dealership for analysis if or when a malfunction is suspected.

NOTICE: Always pay attention to the audio and visual alarms. Boats are equipped with a variety of audible and visual alarms that alert operators to potential performance issues. No alarm, whether it sounds an alert or provides information on the gauges, should ever be ignored. The drive train's sensors are often the earliest indication of problems, and if ignored, may result in serious damage to the equipment. This is not covered under warranty.

ALARMS

Read the accompanying boat owner's manual for important information regarding alarms and gauges.

The Ilmor engine alarm system utilizes a visual alarm to indicate a condition in which any of the monitored engine parameters fall out of the nominal operating range. In all cases, the proper response to the alarm is to throttle back immediately and check the gauges to see which system is out of range. The method of alarm varies from boat model to boat model, usually by way of a centrally mounted gauge with specific engine response. In boats equipped with more than one engine, there will be separate alarms for each engine.

The alarm activation will display if the following conditions occur:

- Water temperature over 215°F (102°C)
- Low oil pressure

NOTE: The engine monitor alarm will display when the ignition is turned to the running position. The alarm will shut off momentarily. After the engine is started the alarm will not go off again. If the alarm sounds or displays at any other time or for any other reason, contact a certified Ilmor dealer before restarting the engine.

Water Temperature

The alarm appears if the engine coolant exceeds preprogrammed limits. If this occurs, return the engine or engines to idle for cool-down. If the temperature is still increasing, shut engine off immediately. Confirm that the seacock is open and that the sea strainer is clear. If neither of these are the cause take the boat to a certified Ilmor dealer.

Oil Pressure

The alarm appears if the engine oil pressure falls below the recommended value for the current engine speed. If this occurs, shut engine off immediately. Check the oil level and return to normal conditions if it is not already. Running the boat at this point represents an unknown risk. It would be best to have the boat serviced with no further running.

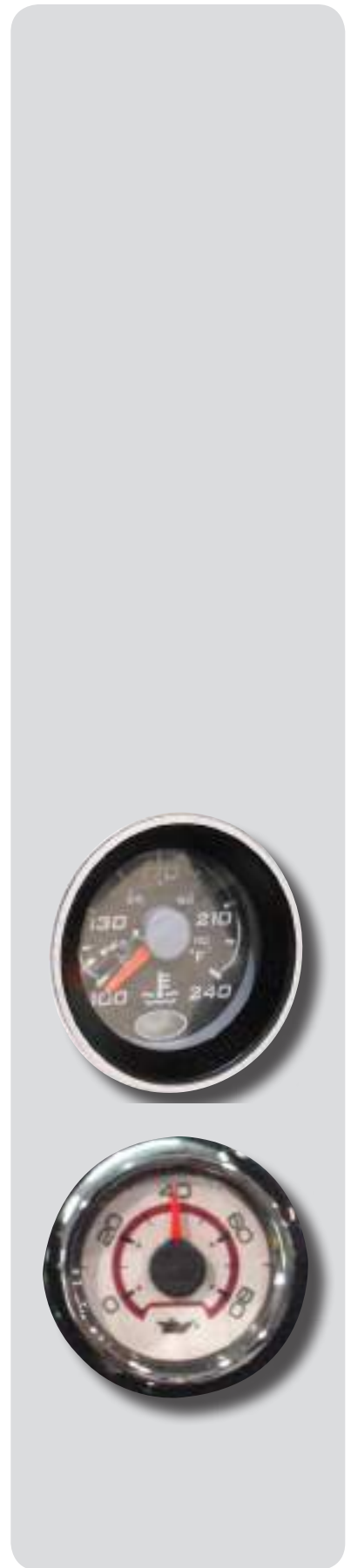

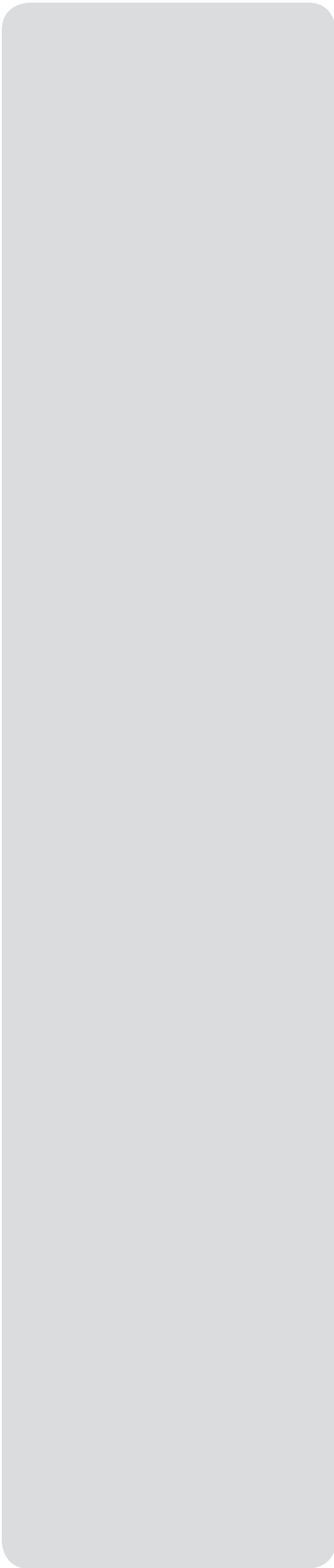

NOTES

Section 3

FUELING THE MV8

⚠ DANGER! *Never start the engine if a gasoline odor is present or if gasoline can be seen at any point along the fuel line, along the fuel tank, in the bilge or at the engine. Remove the key from the ignition switch and call an authorized boat and/or certified Ilmor dealer for service. Take care not to spill gasoline when fueling. If gas is spilled accidentally, wipe up all traces with dry rags immediately and dispose of rags properly on-shore. Gasoline and its vapors can cause an explosion.*

⚠ WARNING! *Always replace parts of the fuel system with Ilmor-authorized parts only. All fuel system lines and connections must meet the requirements of U.S. Coast Guard (USCG) regulations. This means that hoses must meet or exceed SAE Standard J1527 DEC85, and hoses used for fuel delivery must meet or exceed specification in USCG regulations, Sec. 183.540 for recreational boating. Additionally, all fuel hose must meet the 15 g/m² limit for fuel permeation. All plumbing for the fuel system on Ilmor engines, and the boats in which Ilmor authorizes placement, meet or exceed all requirements.*

⚠ WARNING! *Always inspect the entire fuel system for leaks and/or deterioration prior to each outing. This inspection becomes even more critical after substantial periods of nonuse or storage. Be certain the inspection includes the fuel tank, fuel lines, fuel pump, regulator, fuel rails, carbon canisters and all fittings in the system. Never operate the engine when any component shows even slight signs of corrosion, leakage, deterioration, swelling, hardening or softening. This must be brought to the attention of a certified Ilmor and/or boat manufacturer's dealer for replacement prior to using the boat.*

WARNING! Always inspect the entire fuel system for leaks and/or deterioration prior to each outing. Because the system found on your boat has been developed for use specifically in a marine environment, a number of safety measures are incorporated in the entire fuel system from tank to lines to connections. Please note that, as a result of the pressurized fuel lines, there are no user-serviceable parts.

WARNING! Always replace parts of the fuel system with Ilmor-authorized parts only. Any service required in the fuel system must be performed by authorized service personnel only as they will have the specialized tools and replacement parts that meet the manufacturer's OEM specifications.

Ilmor recommends a daily inspection to ensure that no fuel lines are leaking. Never start the boat if there is evidence of fuel leaks or fumes.



SECTION 3 ILMOR MV8 OWNER'S MANUAL

Be certain to read carefully the boat manufacturer's Owner's Manual section on fueling for additional information and details. This is a critical component of safe and enjoyable boating.

DANGER! Never start the engine if a gasoline odor is present or if gasoline can be seen at any point along the fuel line, along the fuel tank, in the bilge or at the engine.

FUEL REQUIREMENTS

The Ilmor MV8 engine (5.7L, 6.0L, 6.2L and 7.4L) requires a minimum of 87 octane fuel. The octane number is based on the pump octane number, which is $(R + M)/2$, where R is the research octane number and M is the motored octane number.

For better performance, 93 octane fuel is recommended.



Fuels other than specified will negatively alter performance and emissions, and could damage the engine. Use of lower octane fuels will cause spark knock (pinging). Continued heavy spark knock can cause severe engine damage. The engines have knock detection systems that offer the best engine performance by controlling knock through precise ignition timing. The higher octane fuel will cause less knock for the ignition system to process and adjust for.

Poor-quality or old fuels can cause problems such as loss of performance, rough idling, hard starting and hesitation. If the engine experiences any of these symptoms, first try another brand of gasoline and/or replace the old gasoline with fresh gasoline.

Many engine manufacturers believe the U.S. Environmental Protection Agency's (EPA's) detergent levels in gasolines do not provide sufficient deposit controls to allow for optimal engine performance. As a result, TOP TIER Detergent Gasoline standards were created to ensure gasolines have all the necessary additives and detergents to reduce the buildup of deposits in an engine. Ilmor recommends purchasing fuel from a supplier that confirms its fuel meets TOP TIER specifications. For a list of TOP TIER retailers, check www.toptiergas.com, and click on "Retailers."

NOTICE: Always use a high-quality gasoline from a reputable source. Damage to the engine by use of low-quality gasoline or gasoline with an octane rating below the minimum level listed for Ilmor MV8 engines will void the warranty on the engine.

Oxygenated Gasoline or Gasoline Containing Alcohol

E-85 fuels are not to be used. Use of this fuel may cause engine performance to suffer and may damage vital fuel system components.

Leaded fuels may NOT be used in the MV8 engine.

Gasoline containing levels higher than 10% ethanol or gasoline containing any methanol is **NOT TO BE USED** in the MV8 engine. If the presence of alcohol in the gasoline is unknown, frequent inspections of the fuel system are required.

When the Boat Is Not Used for A While

Ilmor recommends the use of STA-BIL fuel stabilizer if the boat consumes less than a tank of fuel every 30 days. Today's fuels are more susceptible to degradation, and the use of a quality stabilizer helps ensure fewer problems if the boat is used only on a limited basis.

If the boat has not been run for more than 30 days and fuel remains in the tank—even stabilized fuel—the engine may run with reduced performance until the existing fuel has been used. The manufacturer will not pay for repairs to components that are damaged from poor-quality fuel as this is not covered under the engine warranty.

*NOTICE: Always perform the proper storage procedures when storing the boat. Extended storage with fuel in the system can affect fuel stability and may require system inspection and fuel filter replacement when the boat returns to service. Fuel systems on all boats equipped with Ilmor MV8 engines **MUST** be properly prepared for storage periods exceeding 1 month, as outlined in this Owner's Manual. Owners are encouraged to seek assistance from a certified Ilmor dealer to properly prepare the drive train for periods of inactivity exceeding 1 month. Damage due to improper storage or winterization preparations is not covered under warranty.*

Fuels Outside the United States and Canada

If the boat is operated outside the United States or Canada, it may be more difficult to obtain lead-free fuel. As the engine components are manufactured to function properly only with unleaded gasoline, it may be necessary to search for refined unleaded gasoline.



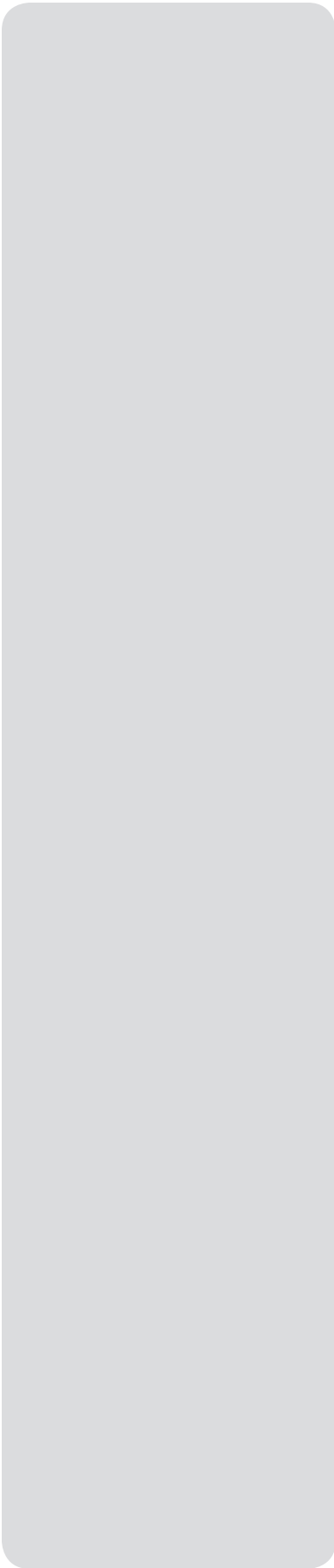

NOTES

Section 4

BEFORE EACH USE

⚠ WARNING! *Never allow battery electrolyte to be spilled or placed on any part of the human body. Battery electrolyte fluid is dangerous. It contains sulfuric acid, which is poisonous, corrosive and caustic. If exposed to battery electrolyte, flush the area with large amounts of clean water and immediately seek medical attention.*

⚠ WARNING! *Always keep all sparks, flames and smoking materials away from the battery charging area. When charging, batteries generate small amounts of dangerous hydrogen gas, which is highly explosive. Failure to follow instructions when charging a battery can cause an electrical charge or even an explosion of the battery. This could result in serious injury or death.*

CHECK THE ENGINE OIL LEVELS PRE-ENGINE START-UP

Although a more accurate engine oil level reading will happen only after the engine has run long enough to thoroughly warm up, it is still important to check the engine oil level prior to starting the engine.

1. Open the engine compartment. The engine oil dipstick is located on the side of the engine.
2. Remove the dipstick and wipe it off on a clean rag. Insert it fully and immediately remove. Check that the oil level is between the FULL and ADD marks on the dipstick.
3. Add oil if necessary through the oil fill neck and only enough to bring oil between the ADD and FULL marks. Overfill may result in damage to the engine that may not be covered by the warranty. Use oil as specified in Engine Specifications on page 11-1. **DO NOT USE OIL ADDITIVES AT ANY TIME.**

Before boating, be sure to also follow the procedure for checking the oil level after engine start-up. See Check the Engine Oil Level on page 4-8.



TYPICAL SEACOCK AND STRAINER

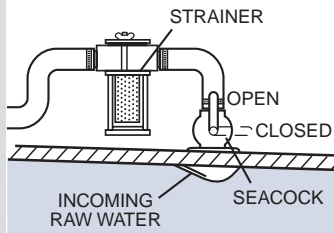

CHECK THE SEA STRAINER – PRE-ENGINE START-UP

Because this process should be completed while the engine is cool (in order to avoid burns), it is recommended that this check be completed prior to starting the engine. If checking during an outing, allow the engine to cool. Be very careful to avoid burns from contact with hot engine parts.

1. Ensure the engine is OFF and the engine safety starting switch is disconnected. Leave the throttle/shift control lever in neutral.
2. Open the engine compartment and locate the seacock. Make sure this is in the CLOSED position before proceeding.
3. Locate the sea strainer. Remove the cap/lid and check the screen for debris. Remove any debris and rinse with water if necessary.
4. Reinstall the screen and screw on the cap/lid. Make sure the o-ring is in place and do not overtighten.
5. Move the seacock into the OPEN position.

NOTICE: Make sure the seacock is back in the ON position. If this operation is skipped, the engine will overheat, failing the raw water pump impeller and causing severe engine problems. Make sure that the cap/lid has been installed correctly and has not pinched the sealing o-ring. This will cause air to be introduced into the system and could cause the raw water impeller to fail, causing severe engine problems.

NOTICE: Always pay attention to any gauges or warning lights. Ignoring elevated temperatures on a temperature gauge or any other evidence of the engine operating at temperatures above recommended levels can result in serious damage to the engine. Any resulting damage will not be covered by the warranty.

NOTICE: This is a critical function of routine maintenance. Even clean-appearing waterways may have debris such as pine needles or moss that can enter the cooling system and create a blockage. Failure to perform this function can result in serious overheating of the engine. Damage to the engine and/or transmission caused by overheating is not covered by warranty. Always pay attention to your temperature gauge, even if you are carefully performing this check. Failure of the raw water impeller or blockage of the transmission cooler are frequent causes of overheating.

CHECK THE COOLANT LEVEL

This procedure applies to boats equipped with closed cooled cooling system. Because this process should be completed while the engine is cool (in order to avoid burns), it is recommended that this check be completed prior to starting the engine.

1. Ensure the engine is OFF and the engine safety starting switch is disconnected. Leave the throttle/shift control lever in neutral. Open the engine compartment. Locate the closed cooling system tank adjacent to the engine.
2. Remove the cap and check the level. Verify that the fluid is at the FULL COLD line. (When the engine heats, the water will expand; that is the reason the tank should not be full when the engine is cold.) If the level is at or below that, add 5-year extended warranty propylene glycol coolant premixed 50/50 with water. The cooling system will take between 5.8 gal (22 L) and 6.8 gal (26 L) of coolant in total.
3. If the tank was completely or nearly empty, see your certified Ilmor dealer for immediate assistance as the engine cooling system will likely require purging. This function should be completed only by a trained Ilmor service technician.

NOTICE: Always maintain the correct coolant level. Failure to maintain coolant at the proper level will cause potentially serious engine damage. The warranty does not cover engine damage due to overheating or any other cause associated with improper coolant levels.

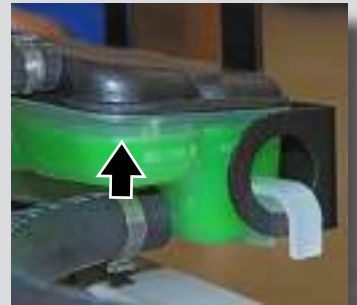

SECTION 4 ILMOR MV8 OWNER'S MANUAL

CHECK THE POWER STEERING FLUID FOR ENGINES WITH INTEGRAL RESERVOIR (IF EQUIPPED)

This procedure applies to boats equipped with power steering systems. Because this process should be completed while the engine is cool (in order to avoid burns), it is recommended that this check be completed prior to starting the engine.

1. Center the steering and stop the engine.
2. Locate the power steering pump at the port side, front of the engine and remove the fill cap with integrated dipstick (level gauge).
3. Proper fluid level is at the FULL mark.
4. If necessary, add fluid to specified level. Use only fluid as outlined in Engine Specifications on page 11-1.



- 1) FULL HOT Mark
- 2) FULL COLD Mark
- 3) ADD Mark

NOTICE: If power steering fluid is not visible, contact your Ilmor service center immediately. Severe engine damage could occur.

NOTE: Power steering fluid does not require changing.

For remote power steering reservoir systems, see the boat manufacturer's manual for proper maintenance instructions, or contact your authorized Ilmor service center for assistance.

CHECK THE SERPENTINE BELT FOR LOOSENESS OR DAMAGE

Because this process should be completed while the engine is cool (in order to avoid burns), it is recommended that this check be completed prior to starting the engine. On engines with serpentine belt systems, however, no change is necessary. Belt tension is maintained by the automatic belt tensioner.

1. Ensure the engine is OFF and the engine safety starting switch is disconnected. Leave the throttle/shift control lever in neutral. Open the engine compartment and locate the serpentine belt.
2. Check the serpentine belt tension at the top, midway between the circulating pump pulley and the alternator pulley. The belt should be tight enough so that it will deflect no more than 1/4 to 1/2 in. (6 to 13 mm) when pressed with the thumb or finger.

NOTE: If the belt is too tight, excessive belt and bearing wear can occur. If the belt is too loose, slippage can occur, resulting in low alternator output and rapid belt wear.

3. Too-loose or too-tight tension is indicative that it is time for service on the belt. This should be done by a trained Ilmor service technician.
4. Check the underside of the belt that runs in contact with the pulleys. Watch for signs of excessive wear, cuts or weakness across or in the grooves. If there are any signs, have the belt replaced.

INSPECT THE BATTERY CONNECTIONS AND HOLD-DOWNS

Because this process should be completed while the engine is cool (in order to avoid burns), it is recommended that this check be completed prior to starting the engine.

1. Ensure the engine is OFF and the engine safety starting switch is disconnected. Leave the throttle/shift control lever in neutral. Locate the battery(ies). Batteries are placed in a variety of locations, depending upon the model. Refer to the boat manufacturer's Owner's Manual for details.
2. **WARNING! Never allow battery electrolyte to be spilled or placed on any part of the human body.** Check that the battery post connections are clean and tight. If not, see Inspecting and Cleaning the Battery Connections and Hold-Downs on page 7-15 for proper maintenance procedures.



INSPECT THE ENGINE FOR LOOSE OR MISSING HARDWARE



Because this process should be completed while the engine is cool (in order to avoid burns), it is recommended that this check be completed prior to starting the engine.

1. Ensure the engine is OFF and the engine safety starting switch is disconnected. Leave the throttle/shift control lever in neutral. Open the engine compartment and visually inspect the engine.
2. Systematically check the entire engine for loose and missing hardware. Attempt to shake components by hand, such as the alternator and the motor mounts. If a looseness problem exists, it is important to see a certified Ilmor dealer.

INSPECT THE THROTTLE AND SHIFT CABLES FOR KINKS, WEAR AND INTERFERENCE



Because this process should be completed while the engine is cool (in order to avoid burns), it is recommended that this check be completed prior to starting the engine.

1. Ensure the engine is OFF and the engine safety starting switch is disconnected. Leave the throttle/shift control lever in neutral. Open the engine compartment and locate the throttle/shift cables.
2. Follow each cable back under the floorboards and feel for any kinks or wear on the outer jacket. Any sign of cable damage is cause for immediate replacement. See a certified Ilmor dealer for assistance.

INSPECT THE FUEL AND EXHAUST SYSTEMS FOR LEAKS

These inspections should initially be done before the engine has been started. Recognize that this is a preliminary inspection only and care should be taken throughout the boating experience to be alert for any signs of fuel or exhaust leaks.

1. Ensure the engine is OFF and the engine safety starting switch is disconnected. Open the engine compartment and visually check as much of the fuel and exhaust systems as possible.
2. If at any time during operation there is an unexplained odor, or if anyone on-board shows signs of unexplained drowsiness or sleepiness, immediately shut down the engine and determine if the odor or unexplained behavior is the result of malfunctions in the fuel or exhaust systems.

NOTE: Perform the next pre-checks after the engine has been run for several minutes and then shut off.

CHECK THE SEA STRAINER – POST-ENGINE START-UP

1. Start the engine.
2. Open the engine compartment and locate the sea strainer.
3. After 20 seconds of run time, check the sea strainer to make sure it is full of water with minimal air bubbles. If you have too much air in the strainer, check to make sure the cap/lid is securely closed and sealed. Check for leaks leading up to the oil/transmission cooler.
4. Close the engine compartment.

NOTICE: Air in the system could cause the raw water impeller to fail, causing severe engine problems. If air in the system is persistent, visit your local Ilmor service center.

CHECK THAT THE BATTERY IS FULLY CHARGED

As the boat is started, check all gauges but pay particular attention to the voltmeter.

With the key on, but before starting the engine, the voltmeter should read above 12 volts. After starting the engine, check to see that the voltmeter reads between 12.8 and 14 volts. An erratic reading can be a sign of low voltage. The voltmeter is the best indication of the state of the battery. However, it is not foolproof. While the reading will indicate that the battery is producing current, if in a previous outing there was reason to suspect a problem with the battery(ies), check with a certified Ilmor dealer.

If the charge has fallen too low or if the battery is older or fails to hold a charge at the expected level, the boat may not start. For additional questions about your battery(ies), contact your boat manufacturer's authorized dealer.

WARNING! Always keep all sparks, flames and smoking materials away from the battery charging area. In the event of a dead battery, charge it with a battery charger before attempting to start the engine. Jump-starting from another boat or battery is dangerous. Charging a dead battery with the alternator on the boat will put undue stress on the alternator, and that, in turn, may cause it to fail.

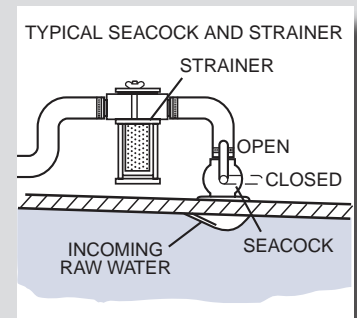

CHECK THE TRANSMISSION FLUID/OIL LEVEL



Transmissions require lubrication to function properly. Your dealer can verify the type of transmission in the boat. The amount of transmission fluid/oil varies according to the product. See the requirements for transmission fluid/oil in the transmission manufacturer's manual.

NOTICE: Always use the recommended transmission fluid/oil. Damage to the engine by use of low-quality or non-recommended transmission fluid/oil as listed for V-drive and direct drive transmissions will void the warranty. Overfill or underfill may also result in serious damage to the engine and is not covered under warranty.

CHECK THE ENGINE OIL LEVEL



An accurate engine oil level reading will happen only after the engine has run for at least 3 minutes at idle. This should be one of the last checks performed prior to an outing. Run the engine with the boat in the body of water.

1. After operating the engine at idle for at least 3 minutes, turn the engine OFF and disconnect the engine safety starting switch. Open the engine compartment. The engine oil dipstick is located on the side of the engine.
2. Allow approximately 2 minutes before checking. Remove the dipstick and wipe it off on a clean rag. Insert it fully and immediately remove. Check that the oil level is between the ADD and FULL marks on the dipstick. (Oil will expand as it is heated.)
3. Add oil if necessary through the oil fill neck and only enough to bring oil within the two marks. Overfill may result in damage to the engine that may not be covered by the warranty. Use oil as specified in Engine Specifications on page 11-1. **DO NOT USE OIL ADDITIVES AT ANY TIME.**



Section 5

AFTER EACH USE

CHECK THE RAW WATER PICK-UP

For all Ilmor equipped boats, a check of the raw water pick-up is necessary. Located beneath the boat, under the water line on the hull is the raw water pick-up. Even when boating on clean-appearing bodies of water, a check of this pick-up should be done after every outing to determine if there is any debris. This should be rinsed with fresh water prior to storage, even of short duration. It will be easier to clean following an outing than waiting and possibly allowing debris to dry.

FLUSH THE RAW WATER/SEA PUMP SYSTEM

1. Place a flushing device on the raw water pick-up on the bottom of the hull. Turn the garden hose ON and start the engine.
2. Cycle engine speed from idle to 2,000 rpm in 10-second intervals, allowing the engine to reach operating temperature. The engine needs to be at its operating temperature for 15 minutes. The garden hose flow rate may need to be adjusted if engine will not warm up; it must warm up to open the thermostat, which is required for proper flushing. If the engine will not warm up, remove thermostat and flush engine with fresh water for 5 minutes while cycling the engine speed from idle to 2,000 rpm in 10-second intervals.

Fresh water boats should be flushed when going to storage or not being used for periods in excess of 1 month.

Salt water boats should be flushed with fresh water after every use.

Boat-in-water flushing can be achieved with a flushing device. The seacock will need to be closed while supplying fresh water to the inlet of the sea pump and allowing it to circulate through the engine.



CHECK FOR LEAKS

Since gaseous and/or fluid leaks are more likely to be apparent at the conclusion of an outing, the operator should open the engine compartment and check for any odor or discoloring of components. Any sign of leakage should be brought to the attention of a certified Ilmor dealer immediately.

CLEAN ANY RESIDUE

Normal operations will still result in a small amount of ambient fluids. If a small amount of oil or other innocuous fluids are found on the engine, on the transmission or within the engine compartment, wipe down the residue with a clean rag. Keeping the engine compartment pristine helps to determine if an engine develops a more significant issue later on.

Section 6

STARTING, STOPPING AND NEW ENGINE BREAK-IN

⚠ DANGER! Always open the engine compartment and check for fumes, leaks or the presence of fluids in the bilge and operate the bilge blower for at least 4 minutes before starting the engine, and always when at idle or slow-running speed. Explosive gasoline and/or battery fumes may be in the engine compartment. Failure to operate the bilge blower as directed may result in explosion or fire, resulting in serious injury or death.

⚠ WARNING! Never operate the engine without an adequate and uninterrupted amount of water flowing through the cooling system. This requires the boat to be in an operational-sized body of water or hooked up to the suction side of a raw water pump by an Ilmor-approved water supply in a dealership. If the engine operates without water in the cooling system, the exhaust system will overheat and could potentially create an on-board fire. The water pump impeller will also fail. Damage caused to the boat under these circumstances will void the warranty and could result in serious injury and/or death.

⚠ CAUTION! Always be certain that there is ample room around the boat when trying to start the engine in forward position as the boat will move forward when the engine starts. Contact with other boats, docks, shallow waterway bottoms, or debris may result in damage to the boat that is not covered under warranty, and may also result in serious injury.

NOTICE: Failure to follow the break-in and operating procedures as described in this Owner's Manual will void the warranty. Before operating the boat for the first time, you must read this Owner's Manual completely, as well as the boat manufacturer's Owner's Manual.

Proper break-in of the engine and transmission is critical to ensuring a long life for the drive train. The first 25 hours, when properly completed, will ensure maximum performance as well. The break-in period allows the engine and transmission components to properly seat and begins the wearing process properly.



SECTION 6 ILMOR MV8 OWNER'S MANUAL

Although your Ilmor engine and V-drive and direct drive transmissions may have been lake-tested by the boat manufacturer, the break-in period is considered to have started when the retail consumer takes possession of the boat and follows the instructions provided in this Owner's Manual.

NOTICE: Do not remove the factory break-in oil until after a minimum of 10 hours proper operation, but not later than 25 hours. At that time, an oil change should be performed by a certified Ilmor dealer, who will be able to "read" the oil and filter to determine if the proper break-in of the engine components appears to be occurring.

During the break-in period, maintain the correct oil level to ensure that the internal affected components are well lubricated. Watch the gauges on the instrument panel closely, as they are the first line of defense. Well before serious damage occurs to an engine, gauges can alert the operator to circumstances that can lead to major damage.

Any abnormal vibrations or unusual noises may be symptomatic of additional problems that are not registered by gauges or alarms. Do not ignore them. Have a certified Ilmor dealer check out anything that seems unusual. It may be a minor issue that requires a simple tightening of screws or bolts, but it may also signal serious internal issues.

Plane the boat quickly, as low speeds can place more strain on the engine operation. This does not mean to slam the throttle/shift control lever forward; rather a steady, quick hand will help achieve the goal.

Adjusting and varying engine speeds can also help the engine during break-in. Keeping the engine at a constant revolutions per minute (rpm) for more than 3 or 4 minutes at a time places undue stress on the rings and bearings inside the engine.

FIRST HOURS OF OPERATION

1. **DANGER!** Always open the engine compartment and check for fumes, leaks or the presence of fluids in the bilge and operate the bilge blower for at least 4 minutes before starting the engine, and always when at idle or slow-running speed. Start the engine and allow it to warm up to the normal operating temperature range of 140°F (60°C) to 190°F (87°C), depending on model. See Engine Specifications on page 11-1 for specific operating temperatures of each engine model. This should be done in the idle (600 to 800 rpm as measured on the tachometer) mode.
2. Move the throttle/shift control lever forward, smoothly and quickly, to planing speed. Then return the throttle back to a slower speed, but one that continues the plane. Vary the engine speed but do not exceed 3,000 rpm for the first hour, and carry only a light load. After the first hour, the rpm may not exceed 5,200 rpm for the 5.7L, 5,400 rpm for the 6.0L and 6.2L, or 5,800 rpm for the 7.4L engines. Reduce the throttle/shift control lever to idle (neutral) occasionally for a cool-down period.

STARTING, STOPPING AND NEW ENGINE BREAK-IN

3. The boat **MUST** be returned to the certified Ilmor dealer for a mandatory oil change between 10 and 25 hours of operation. This ensures the service staff will be able to determine whether any internal issues may be apparent.

AFTER INITIAL HOURS OF OPERATION

1. After the break-in and oil change have been completed, the engine may be operated more continuously at speed, but never beyond the maximum, and it is always advisable to give the engine an occasional cool-down period. For the 5.7L engine, the maximum is 5,200 rpm; for the 6.0L, the maximum is 5,400 rpm; for the 6.2L, the maximum is 5,600 rpm; and for the 7.4L, the maximum is 5,800 rpm.
2. Throughout the life of the engine, always allow it a warm-up period before operation. Abuse of the engine and transmission are never covered under warranty. Regular maintenance as outlined in this Owner's Manual is very important to ensuring a long, trouble-free engine life.
3. Subsequent oil changes should be done every 50 hours or quarterly if the boat is not used regularly. See Section 7, Maintenance, for more details.

NOTICE: Always use the recommended engine oil. Failure to follow the engine oil recommendation listed in this Owner's Manual can result in accelerated engine wear and engine component failure. Engine damage due to incorrect oil usage, oil changes and oil levels, or other failure to follow engine oil procedures can be costly and may void the warranty.

BEFORE THE ENGINE IS STARTED

1. After performing all the checks and inspections outlined in this Owner's Manual, lift the engine compartment cover.
2. **DANGER!** Always, before starting the engine, open the engine compartment and check for fumes, leaks or the presence of fluids in the bilge. Operate the bilge blower for at least 4 minutes with the engine compartment cover open. Leave the bilge blower ON throughout the starting process and until the boat has planed.

NOTE: Always start the engine with the throttle/shift control lever in the neutral position. The boat is equipped with a neutral-start safety switch that will not allow engines to start while in gear.

3. **WARNING!** Never operate the engine without an adequate and uninterrupted amount of water flowing through the cooling system. The boat is likely to be equipped with sea strainer valves and seacocks. Ensure these are open prior to starting the engine.

STARTING THE ENGINE

1. Attach the engine safety starting switch tether (also known as a lanyard) between an article of the operator's clothing and the switch, whose location will be identified in the boat manufacturer's Owner's Manual.
2. Leave in or move the throttle/shift control lever to the neutral position. This allows the electronic controls within the engine to correctly meter the fuel and air flows automatically.
3. Insert the ignition key in the ignition slot and turn to the start position. Hold on for no more than 3 to 5 seconds per try. Release the ignition key as soon as the engine starts. If the engine does not start within 10 to 15 seconds total, pull out the neutral detent or push the switch on the control lever (however the boat model may be equipped) and advance the throttle to wide-open throttle. Crank the engine. When the engine fires, quickly return the throttle to the idle position to avoid over-revving the engine and/or losing control of the boat.

CAUTION! Always be certain that there is ample room around the boat when trying to start the engine in forward position as the boat will move forward when the engine starts. Starting the engine with the throttle/shift control lever in any position other than neutral places undue strain on the entire boat and drive train. There are no circumstances under which the engine should ever be started with the lever in reverse. With the lever forward should only be used in exceptional circumstances such as those listed immediately above. Whenever the boat is started with the engine in forward, the lever must immediately be returned to neutral when the engine fires to prevent damage to the engine and to avoid losing control of the boat.

NOTICE: Never operate the starter motor continuously for more than 15 seconds without allowing the starter motor to cool for at least 2 minutes. The ignition key must be released after the engine has started to avoid damage to the starter motor and drive. Failure to do so may result in the starter overheating, which is damage not covered under warranty.

Always allow the engine to warm up to normal operating temperature range of 140°F (60°C) to 190°F (87°C), depending on model (see Engine Specifications on page 11-1 for specific operating temperatures of each engine model) prior to placing the boat in gear. Electronics will act as a governor, or rev-limiter, to prevent the boat from reaching higher rpm before the engine has warmed up. Also ensure that the engine oil pressure is greater than 10 psi (70 kPa), according to the gauge on the instrument panel.

STARTING, STOPPING AND NEW ENGINE BREAK-IN

SHIFTING GEARS

When shifting gears, always move the throttle/shift control lever smoothly and quickly into gear. Hesitations and slow gear movement can damage the shifting mechanism in the transmission. Always allow the engine speed to fall to idle (600 to 800 rpm) before making a gear shift.

The throttle/shift control lever must move forward from neutral to engage forward gear. Because the lever controls both gearing and throttle response, continuing to move forward will increase speed.

Reverse occurs when the throttle/shift control lever is pulled back from neutral.

NOTICE: Never move between forward-neutral-reverse when the engine is above 800 rpm. Always allow the speed to decrease to 600–800 rpm before completing the shift. Failure to do so may result in damage that is not covered under warranty.

STOPPING THE BOAT

This is not a land vehicle. There are no brakes to be applied. To stop a boat requires advance planning and operations that must be completed before reaching the dock or bank.

1. Bring the throttle/shift control lever to neutral.
2. If the boat has been operated for an extended period of time, or at high rpm, allow the engine a cool-down period at idle (600 to 800 rpm) for several minutes.
3. Turn the key to the OFF position to stop the engine and drive train.
4. Coast into the dock or bank, following instructions provided by the boat manufacturer's Owner's Manual to properly stop the boat without damaging the hull.

OTHER CONSIDERATIONS

Never operate the boat at continuous wide-open-throttle. This places undue strain on the engine components. Wide-open-throttle exists to allow boaters to get out of dangerous encounters or situations, but it represents the upper limit of the engine's capacity.

See also the boat manufacturer's Owner's Manual for operational hints and tips that can enhance the enjoyment of the boat's and drive train's integration.

NOTES

A large, vertical, gray rounded rectangular area intended for the user to write notes. It occupies the left side of the page.

Section 7

MAINTENANCE

⚠ WARNING! Always allow the engine to cool down completely before attempting to service the fuel/water separator filter in order to avoid fire or explosion. The fuel system is under pressure.

⚠ WARNING! Always be sure that the ignition key is in the OFF position, the main battery power switch is in the OFF position, and that no spark or flame are present when servicing the fuel/water separator.

⚠ WARNING! Always make sure that no fuel leaks exist and that the engine compartment is well ventilated with no gasoline vapors present to avoid fire or explosion hazard before performing any fuel system maintenance.

⚠ WARNING! Always use the special tools to replace the high-pressure fuel filter. Do not attempt to replace fuel filter without special tools. Doing so may damage fuel line or filter. A damaged fuel line or filter may leak and cause a fire or explosion.



SECTION 7 ILMOR MV8 OWNER'S MANUAL

In addition to the routine matters addressed earlier, there are a number of other maintenance matters that require periodic attention. The following table indicates the maintenance schedule:

Item	Service	First 25 hrs	Every 50 hrs	Every 100 hrs	Every 300 hrs/ Annually#	Every Two Years
Engine oil and filter	Change	X	X*			
Engine coolant	Change					X
Power steering fluid** (if equipped)	Check					X
Transmission fluid	Change	X			X	
Serpentine belt	Inspect	X		X***	X***	
Raw water impeller/sea pump	Inspect	X	X***		X***	
Raw water impeller	Replace			X	X***	
Fuel/water separator – (if equipped)	Replace	X			X	
High-pressure fuel filter – (if equipped)	Replace			X	X	
Air filter/flame arrestor	Change				X	
Engine timing**	Check	X			X	
Spark plugs**	Replace				X	
Spark plug wires**	Inspect				X	
Shaft alignment**	Check	X			X	
Engine and transmission coolers	Inspect				X	
Zinc anodes	Clean/Inspect		X			

Whichever comes first.

* If the engine is subject to heavy use, it is recommended to change oil and filter every 25 hours.

** Services best accomplished by a certified Ilmor dealer.

*** Replace sooner if regular checks indicate wear or damage.

Ilmor recommends that the maintenance requirements be performed by a certified Ilmor dealer. Service technicians there have the proper equipment, training and resources to best meet your service needs. Please note that routine maintenance is not covered by the Ilmor Marine Limited Warranty. For details, consult the limited warranty statement.

CHANGE THE ENGINE OIL AND FILTER

The following service must be performed while the engine and boat are out of the water. However, in order to thoroughly and properly drain all the old oil, the boat engine needs to reach at least 140°F (60°C) first. Since the engine must be supplied with water to function, it is recommended to run the engine while the boat is in a body of water, then promptly remove the boat from the water and immediately perform the service. If you cannot place the boat in a body of water or do not have access to a professional off-shore hook-up to protect the engine and drive train components (as some dealerships do), have a certified Ilmor dealer perform this service

A list of recommended oil for use in each MV8 engine can be found in Engine Specifications on page 11-1.

In areas where these recommended oils are not available, please contact your local authorized service center for appropriate equivalents. Use of supplemental oil additives is not recommended.

1. Ensure the engine is OFF and the engine safety starting switch is disconnected. Leave the throttle/shift control lever in neutral. The engine must be warm.
2. Open the engine compartment and locate the oil drain hose, which runs from the bottom of the oil pan along the port side of the engine. At the end of the oil drain hose is a brass plug.

NOTE: Never drain oil into the bilge or into the water. Wipe up any spilled oil immediately and dispose of the rags and drained oil in a proper manner on-shore. Many bodies of water are environmentally protected by law. Dumping in the water can result in significant fines.

3. Remove the engine oil cap located on the oil fill neck. (This access to air will speed up the oil draining process.)
4. Remove the bilge drain plug to drop the drain hose through the hole. Drain the oil into a container on the ground. (On some V-drive models, you will thread the line through a hole that runs through the lower edge of the transom.) Alternatively, a suction pump can be hooked up to the oil drain hose to remove the engine oil.
5. Loosen the brass end cap at the end of the drain hose to allow the oil to drain. Be careful to avoid rounding off the edges of the brass end cap during loosening and tightening.
6. The oil filter is located at the rear of the engine. Remove the oil filter and dispose of it properly on-shore.
7. Lightly lubricate the oil filter gasket and spin the new filter on until the gasket makes contact. Hand-tighten the filter three-quarter to one turn after contact. **DO NOT** use a filter wrench to tighten.



SECTION 7 ILMOR MV8 OWNER'S MANUAL



8. Reattach the oil drain plug to the end of the hose and refill the crankcase through the oil cap opening on the fill neck. Hand-tighten the oil cap.
9. Check the oil level with the dipstick. Check that the oil level is between the FULL and ADD marks on the dipstick. If the oil drain hose and water lines are on the port side of the engine as it came from the factory, cable-tie the lines to keep them from coming in contact with hot areas in the engine compartment.
10. After the warm-up period the first time after the oil change, turn OFF the engine. Disconnect the engine safety starting switch and leave the throttle/shift control lever in neutral. Open the engine compartment cover and verify that there are no leaks around the new oil filter and fitting, the drain line or the valve covers.
11. Add more oil as necessary and recheck levels if oil is added.

NOTICE: Always use the recommended engine oil. Failure to follow the engine oil recommendation listed in this Owner's Manual can result in accelerated engine wear and engine component failure. Engine damage due to incorrect oil usage, oil changes and oil levels, or other failure to follow engine oil procedures can be costly and may void the warranty.

CHECK THE POWER STEERING FLUID FOR ENGINES WITH INTEGRAL RESERVOIR

This procedure applies to boats equipped with power steering systems. Because this process should be completed while the engine is cool (in order to avoid burns), it is recommended that this check be completed prior to starting the engine.

1. Center the steering and stop the engine.
2. Locate the power steering pump at the port side, front of the engine and remove the fill cap with integrated dipstick (level gauge).
3. Proper fluid level is at the FULL mark.
4. If necessary, add fluid to specified level. Use only fluid as outlined in Engine Specifications on page 11-1.



- 1) FULL HOT Mark
- 2) FULL COLD Mark
- 3) ADD Mark

NOTICE: If power steering fluid is not visible, contact your Ilmor service center immediately. Severe engine damage could occur.

NOTE: Power steering fluid does not require changing.

For remote power steering reservoir systems, see the boat manufacturer's manual for proper maintenance instructions, or contact your authorized Ilmor service center for assistance.



CHANGE THE FUEL/WATER SEPARATOR

WARNING! Always allow the engine to cool down completely before attempting to service the fuel/water separator filter in order to avoid fire or explosion.

WARNING! Always be sure that the ignition key is in the OFF position, the main battery power switch is in the OFF position, and that no spark or flame are present when servicing the fuel/water separator.

1. Be sure that the key is in the OFF position and that the engine is completely cooled down.
2. Close the fuel supply valve, if applicable.
3. Locate and remove the fuel/water separator and sealing ring, turning counterclockwise, being careful not to spill any fuel. Be sure to clean any spilled fuel immediately.
4. Properly dispose of the used water separator and sealing ring.
5. Coat the new fuel/water separator sealing ring with engine oil.
6. Install the new water separator hand-tight by threading and turning clockwise.

NOTE: Do not overtighten the fuel/water separator. Never use a filter wrench to install the fuel/water separator.

7. Open the fuel supply valve, if applicable.
8. Run bilge blower and be sure that the engine compartment is properly ventilated and free of fuel vapor.
9. Be sure that cooling water is supplied to the engine, and start the engine.

WARNING! Always make sure that no fuel leaks exist and that the engine compartment is well ventilated with no gasoline vapors present to avoid fire or explosion hazard before performing any fuel system maintenance. Inspect the fuel/water separator for any leaks. Correct any leak if found, clean spilled fuel immediately and repeat steps 8 and 9.



REPLACE THE HIGH-PRESSURE FUEL FILTER

WARNING! Always allow the engine to cool down completely before attempting to service the high-pressure fuel filter in order to avoid fire or explosion.

WARNING! Always be sure that the ignition key is in the OFF position, the main battery power switch is in the OFF position, and that no spark or flame are present when servicing the high-pressure fuel filter.

WARNING! Always use the special tools to replace the high-pressure fuel filter. Do not attempt to replace fuel filter without special tools. Doing so may damage fuel line or filter. A damaged fuel line or filter may leak and cause a fire or explosion.

NOTE: System may be pressurized. It is a good idea to perform the high-pressure fuel filter service and the fuel/water separator service together. After removing the fuel/water separator, the system will be “open” and this is an optimal time to remove the high-pressure fuel filter. Install new filters as instructed in the following procedure.

1. Be sure that the key is in the OFF position and that the engine is completely cooled down.
2. Close the fuel supply valve, if applicable.
3. Locate the in-line high-pressure fuel filter. Before removal, note the direction of flow on filter by referencing the black arrow on the filter body.
4. Using a 3/8" automotive-style, quick-disconnect fuel line tool (must be plastic version), carefully remove one fuel line. The tool may need to be split in half for easier removal. If possible, let filter drain into a small pan or bucket before removing the second fuel line.
5. Remove the second fuel line and properly dispose of filter and excess drained fuel.
6. Visually inspect fuel line ends to make sure internal o-rings are still in place, retaining clips are not bent, and no visual obstructions are present. If any components appear to be worn or damaged, contact your authorized Ilmor service center for additional assistance.
7. Install new high-pressure fuel filter, in the previously noted flow direction, inside the mounting clip on the engine.
8. Install both fuel lines onto the new filter. The lines will click when fully engaged.
9. Once system is fully reassembled, with the bilge blowers running, cycle ignition (letting the fuel pump run a full cycle) 3–5 times to prime fuel system and check for leaks. There is no need to start the engine as 3–5 ignition cycles will prime the fuel system.



10. Once you have verified the system is leak-free, start the engine and let it run for approximately 1 minute. Then, turn the engine off and perform a final check of the bilge for any fluid leaks.

WARNING! Always make sure that no fuel leaks exist and that the engine compartment is well ventilated with no gasoline vapors present to avoid fire or explosion hazard before performing any fuel system maintenance. Inspect the high-pressure fuel filter for any leaks. Correct any leak if found, clean spilled fuel immediately and repeat steps 9 and 10.

CHANGE THE TRANSMISSION FLUID/OIL AND FILTER

Refer to the transmission service manual for specific service instructions and oil/filter requirements.

NOTE: It is recommended that this service be performed by a certified Ilmor dealer.

CHECK THE TRANSMISSION COOLER

This applies to all MV8 engines except the 7.4L.

Because this process should be completed while the engine is cool (in order to avoid burns), it is recommended that this check be completed prior to starting the engine.

1. Ensure the engine is OFF and the engine safety starting switch is disconnected. Leave the throttle/shift control lever in neutral. Open the engine compartment. The transmission cooler is located either near the top or on the side of the engine.
2. Loosen the clamp surrounding the water intake hose at the back of the transmission cooler and slide off the hose.
3. Check the inside for signs of debris. Even small amounts of debris must be removed to prevent the material from clogging the cooler and preventing it from functioning properly. The boat must not be operated with any foreign materials blocking the flow of water through the cooler.
4. After cleaning, reattach the hose and clamp.



NOTICE: This is a critical function of routine maintenance. Even clean-appearing waterways may have debris such as pine needles or moss that can enter the cooling system and create a blockage against the screen. Failure to perform this function can result in serious overheating of the transmission. Damage to the engine and/or transmission caused by overheating is not covered by warranty. Always pay attention to your temperature gauge, even if you are carefully performing this check. Failures of the raw water impeller or blockage of the transmission cooler are frequent causes of overheating. Water in the transmission oil as a result of cooler failure may also void the warranty.

REPLACE THE RAW WATER IMPELLER/SEA PUMP IMPELLER

Because this process should be completed while the engine is cool (in order to avoid burns), it is recommended that this check be completed prior to starting the engine. If checking during an outing, allow the engine to cool. Be very careful to avoid burns from contact with hot engine parts.

1. Ensure the engine is OFF and the engine safety starting switch is disconnected. Leave the throttle/shift control lever in neutral. Open the engine compartment and locate the raw water impeller housing. (This is also sometimes referred to as a sea pump.)
2. Disconnect the intake and outflow hoses on the raw water impeller housing. Remove any debris found inside the hoses and then reconnect.
3. Remove the serpentine belt.
4. Remove the two bolts which hold the sea pump onto the engine and remove the sea pump.
5. On open cooled engines remove the screws on the impeller cover and very carefully break the gasket seal. On closed cool engines remove the screws from the front of the impeller housing and carefully separate the impeller housing from the bearing carrier.

NOTICE: Always pay attention to any gauges or warning lights. Ignoring elevated temperatures on a temperature gauge or any other evidence of the engine operating at temperatures above recommended levels can result in serious damage to the engine. Any resulting damage will not be covered by the warranty.

6. Inspect the inside of the impeller housing. If any rubber extrusions on the end of the arm appear frayed or worn, it should be replaced. If there is not a slight bend to the paddle-wheel arms, replace it. Debris entering the impeller inevitably will damage it. However, the impeller serves its purpose in deflecting debris and keeping it out of much more expensive internal engine parts.



Open Cooled

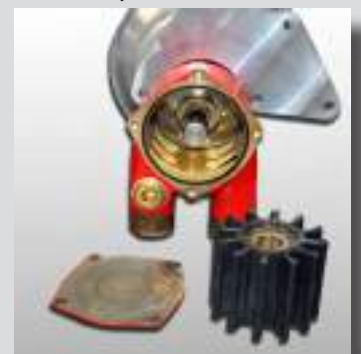

Closed Cooled and 7.4L



SECTION 7 ILMOR MV8 OWNER'S MANUAL

- Any uncertainty about the condition of the impeller means that it should be removed and inspected. The impeller fits very snugly and will require some care in removing and reinstalling or installing a new one. This ensures proper operation. The use of soap or water-based petroleum jelly will help with installation. Note that proper placement on the gear results in a squeeze on the arms. This is the correct installation.
- Ensure that the gasket or O-ring surfaces are smooth and clean. Place a gasket between the housing and the cover. Reinstall with the screws loosened with the face plate was removed earlier. Do not overtighten the brass screws as it will cause them to break.

DRAIN RAW WATER (SEA WATER)

See also the instructions for Flush the Raw Water/Sea Pump System on page 5-1. For closed cooling systems, see Drain the Engine Coolant on page 7-11 and Fill the Engine Coolant on page 7-11.

NOTE: Filling and air bleeding is automatic when the raw water pump is operating, i.e., pumping fresh water from the lake or garden hose. There is no need to leave any caps, drain plugs or hoses open for air bleeding.

For open cooling systems:

- Drain exhaust manifolds of raw water by removing the two lower cooling hoses connected to the 90° fittings.
- Drain engine block of raw water.
 - For open cooled 5.7L applications:** Remove knock sensors/drain plugs from both sides of the engine block.
 - For all open cooled 6.0L, 6.2L and 7.4L applications:** Remove drain plugs from both sides of engine drain hoses.
- Drain heat exchangers of raw water.
 - Open cooled systems will have an oil/transmission heat exchanger. Remove the drain plug and allow the cooler to completely drain.
 - Closed cooled systems will have an oil/transmission and engine heat exchanger. Remove the drain plug and allow the cooler to completely drain.
- Reinstall cooling hoses, engine block drain plugs and heat exchanger end caps/drain plugs after all the raw water has been drained. Drain other components that contain raw water, such as the water heater.
- Torque knock sensor retaining nut to 15 ft-lb (20 N·m).

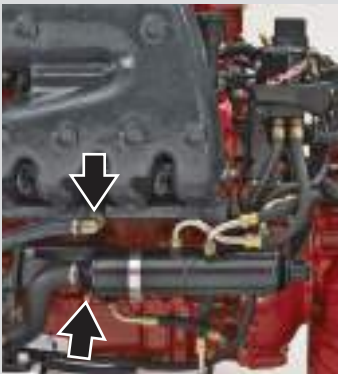

CHECK THE ENGINE COOLANT LEVEL

This procedure applies to boats equipped with closed cooled cooling system. Because this process should be completed while the engine is cool (in order to avoid burns), it is recommended that this check be completed prior to starting the engine.

1. Ensure the engine is OFF and the engine safety starting switch is disconnected. Leave the throttle/shift control lever in neutral. Open the engine compartment. Locate the closed cooling system tank adjacent to the engine.
2. Remove the cap and check the level. Verify that the fluid is at the FULL COLD line. (When the engine heats, the water will expand; that is the reason the tank should not be full when the engine is cold.) If the level is at or below that, add 5-year extended warranty propylene glycol coolant premixed 50/50 with water. The cooling system will take between 5 gal (19 L) and 7 gal (26 L) of coolant in total. If your engine is equipped with a vertical tank with a clear sight tube near the front of the engine, verify that the coolant reaches the lowest support rung on the clear sight tube.

If the tank was completely or nearly empty, see your authorized Ilmor dealer for immediate assistance as the engine cooling system will likely require purging. This function should be completed only by a trained Ilmor service technician.

NOTICE: Always maintain the correct coolant level. Failure to maintain coolant at the proper level will cause potentially serious engine damage. The warranty does not cover engine damage due to overheating or any other cause associated with improper coolant levels.

DRAIN THE ENGINE COOLANT

For closed cooled systems:

1. Remove the coolant cap to allow for an air bleed.
2. Remove the STBD exhaust manifold feed hoses to the thermostat to allow for an air bleed. Remove the 1-1/4 in. hose between the engine and heat exchanger. Allow all the coolant to drain.
3. Drain both exhaust manifolds by removing the lower rubber hose on the exhaust manifolds.
4. Reinstall all hoses once all coolant has drained.

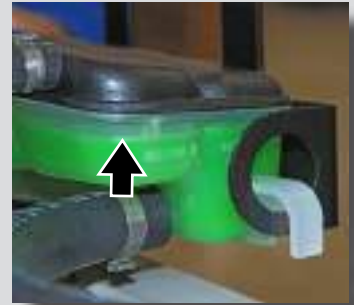



FILL THE ENGINE COOLANT

Use a 50/50 mix of 5-year extended warranty propylene glycol coolant and water. The cooling system will take between 5 gal (19 L) and 7 gal (26 L) of coolant.

1. With the coolant cap off, cycle the engine speed from idle to 2,000 rpm in 10-second intervals while engine temperature is below 104°F (40°C). Refill the coolant reservoir as needed.
2. Install coolant cap.
3. In NEUTRAL, cycle engine speed from idle to 3,000 rpm in 30-second intervals until the coolant temperature reaches 169°F (76°C).
4. Shut off the engine.
5. Top off coolant reservoir as needed.
6. Cycle engine speed from idle to 3,000 rpm in 30-second intervals until the coolant temperature reaches 169°F (76°C).
7. Top off coolant reservoir as needed.
8. Check coolant level after first complete warm-up and cool-down cycle. Additional coolant may need to be added.

FLUSH THE COOLERS

1. Drain heat exchangers of raw water.
 - Open cooled systems will have a transmission heat exchanger, an oil heat exchanger, or both. Remove heat exchanger drain plugs and allow draining.
 - Closed cooled systems will have an engine heat exchanger, as well as a transmission heat exchanger, an oil heat exchanger, or both. Remove heat exchanger drain plugs and allow draining.
2. Flush fresh water through the coolers from the raw water fittings. An adapter may be needed. It is better to flush water from one end of the cooler and then from the other end. This should flush out any foreign particulates.

REPLACE THE SERPENTINE BELT

NOTE: A properly installed serpentine belt will be automatically adjusted by the belt tensioner. When the belt is off, attention should also be given to the quality of wear of the grooves on the underside of the belt where it makes contact with the pulleys. If you are unsure of the wear pattern, check against a new belt. If there is any uncertainty, seek assistance from your authorized Ilmor service center. If the belt is too loose and or is too tight, it will cause the electrical system to malfunction. This could occur during an outing and strand the boaters. Therefore, take this maintenance function very seriously.

NOTICE: If the serpentine belt comes off or wears through, catastrophic engine failure may occur. Do not operate the engine without a properly installed serpentine belt. Any resulting damage will not be covered by the warranty.

1. The serpentine belt is located on the front of the engine.
2. Using an appropriately sized socket wrench, remove tension from the belt by moving the tensioner to its maximum travel position.
3. Remove the serpentine belt by unwrapping it from each of the pulleys.
4. Check the wear on the inside grooves. If this is part of the annual maintenance, most likely the serpentine belt will need to be replaced.
5. To install a new belt or to reinstall the existing belt, wrap the belt around the pulleys as shown, and using the appropriate socket wrench rotate the tensioner to its maximum travel. This should allow enough slack to slide the belt over the smooth, water pump pulley.
6. Ease the tensioner back into place and ensure that the belt is properly wrapped around all of the pulleys.

REPLACE THE ZINC ANODES

1. Locate the zinc anodes.
2. Using an 11/16 in. socket wrench, remove the zinc anode from the lower end of the heat exchanger.
3. Inspect the anode for wear. If the anode exhibits signs of excess wear or has reduced to half of its original size, it will need to be replaced.



CLEANING THE ENGINE COMPARTMENT AND PREVENTING CORROSION

The engine compartment should receive a good, general cleaning of the interior as well as the engine and transmission exteriors. There is reward in the cleaning beyond enhancing the overall value of the boat. Cleaning with simple soap and water may reveal if any corrosion has occurred.

Corrosion can occur in any type of water and on any metal surface, even when the type of metal, such as stainless steel, has been chosen for components. But corrosion is of particular concern for boats that will be operated in salt water, even if the system is closed cooling. Salt water may still enter the engine compartment due to the engine compartment cover being open to vent carbon monoxide and prevent explosive fumes. The exhaust system will always be subject to contact with salt water in these conditions, too.

Galvanic corrosion, or electrolysis, is the decomposition of metal due to the effects of electrolytic action. When two dissimilar metals are immersed in a conductive fluid such as salt water, an electric current is produced, much like the action of a battery. As the current flows, it takes with it tiny bits of the softer metal. If left unchecked, severe damage may occur over time.

A boat properly prepared for operation in salt water will have self-sacrificing zinc anodes mounted on the transom, and possibly elsewhere underwater. These anodes are intended to reduce the effects of galvanic corrosion to critical metal areas of the boat. The zinc anodes should be checked regularly, and when significant erosion is shown, the anodes should be replaced. More information regarding the zinc anodes is contained in the boat manufacturer's Owner's Manual.

NOTICE: Always properly clean the engine and transmission if exposed to salt water. Exposure to salt water causes corrosion, leading to significant damage to metal, including stainless steel. If evidence of corrosion shows on the engine, carefully clean the engine and transmission with fresh water and a mild soap solution after use in salt water. A protective marine oil may be applied to exposed metal to halt the acceleration of corrosion. Failure to properly clean boat or pay attention to corrosion matters will void the warranty.

INSPECTING AND CLEANING THE BATTERY CONNECTIONS AND HOLD-DOWNS

1. Check that the battery post connections are clean and tight. If not, loosen and remove the negative terminal connection first. Be careful to avoid touching the positive terminal with the wrench or negative connection. Then loosen and remove the positive terminal connection. Remove the battery hold-downs and remove the battery from the boat. Clean corrosion from the battery posts with a battery terminal cleaner. Clean the battery with a water-and-baking-soda solution. Use care to avoid allowing the solution to enter the battery vents. Rinse the battery with fresh water. Note that this is a generic cleaning method. Battery manufacturers may specify other methods of cleaning. Verify with the battery manufacturer's website the correct cleaning method before undertaking any cleaning.
2. Use a battery terminal cleaning brush to remove corrosion from the inside of the battery terminals. Clean the terminals with a water-and-baking-soda solution and rinse.
3. Reconnect the positive terminal first, and then the negative. Tighten the terminals. Coat both terminals completely with a thin covering of marine grease to protect against water or any potentially corrosive substance. Be sure that the rubber boot covers the positive terminal completely.

NOTICE: Never install accessories or add-on equipment that is not approved by Ilmor. Add-on equipment may adversely affect the alternator output or overload the electrical system. Any damage caused as a result will not be covered by the warranty.

The boat manufacturer specifies a type of marine battery with a certain level of cold-cranking amps at 0°F (-18°C). Check the boat manufacturer's Owner's Manual to determine what this specification is.

Before disconnecting the battery, be sure that the ignition key and all accessories are in the OFF position. Also, take care to reattach battery cables correctly to avoid reversed polarity, which is addressed in Electrical System on page 2-5.

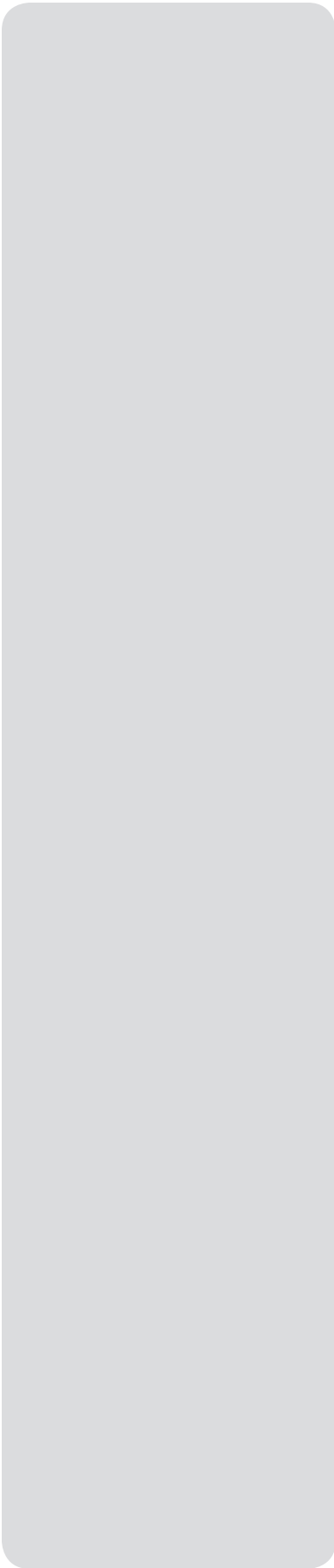

NOTES

Section 8

STORAGE AND WINTERIZATION

⚠ WARNING! Always follow the boat manufacturer's instructions on how to properly winterize the fuel tank prior to storage. Leaking of fuel into the boat and potentially into the storage area could result in substantial damage to the boat, and contact with any spark (such as a flame-producing pilot light in a heater) could also result in property damage and serious injury or death.

Proper storage and/or winterization preparations are just as important as how a drive train is maintained in use. Since special preparations are necessary, the boat owner should have the work done by a certified Ilmor dealer. Damage that occurs from improper storage and/or winterization is not covered under warranty and must be avoided.

Engine winterization requires changing the engine oil/filter, draining all raw water from the cooling system and adding marine/RV antifreeze to all raw water engine components.

NOTICE: Always perform the proper storage procedures when storing the boat. Extended storage with fuel in the system can affect fuel stability and may require system inspection and fuel filter replacement when the boat returns to service. Fuel systems on all boats equipped with Ilmor MV8 engines **MUST** be properly prepared for storage periods exceeding 1 month, as outlined in this Owner's Manual. Owners are encouraged to seek assistance from a certified Ilmor dealer to properly prepare the drive train for periods of inactivity exceeding 1 month. Damage due to improper storage or winterization preparations is not covered under warranty.

FUEL SYSTEM TREATMENT

Boats that are going to be stored for extended periods (more than 1 month) or winterized should have attention for the fuel system. Always follow the boat manufacturer's instructions on how to properly winterize the fuel tank prior to storage:

WARNING! Always follow the boat manufacturer's instructions on how to properly winterize the fuel tank prior to storage. A fuel stabilizer, such as STA-BIL, may also be used during long-term storage and winterization of the engine. Follow the directions provided by the stabilizer's manufacturer.



NOTICE: Always perform the proper storage procedures when storing the boat. Extended storage with fuel in the system can affect fuel stability and may require system inspection and fuel filter replacement when the boat returns to service. Fuel systems on all boats equipped with Ilmor MV8 engines MUST be properly prepared for storage periods exceeding 1 month. Owners are encouraged to seek assistance from a certified Ilmor dealer to properly prepare the drive train for periods of inactivity exceeding 1 month. Damage due to improper storage or winterization preparations is not covered under warranty.

OIL STORAGE/WINTERIZATION

Contaminants in used oil can cause engine damage during storage. Perform an oil change and run the engine to operating temperature to allow new oil recirculation.

COOLING SYSTEM STORAGE AND WINTERIZATION

Cooling system storage/winterization requires draining and flushing raw water components with marine/RV antifreeze. Engines with closed cooling systems using 50/50 propylene glycol/water mix DO NOT REQUIRE DRAINING. The 50/50 coolant will provide freeze protection down to -26°F (-32°C). All components which raw water flows through must be drained. The following steps are recommended for draining of raw water components:

Because this process should be completed while the engine is cool (in order to avoid burns), it is recommended that this check be completed prior to starting the engine.

1. Drain exhaust manifolds of raw water by removing the two lower cooling hoses connected to the 90° fittings.
2. Drain engine block of raw water.
 - **For open cooled 5.7L applications:** Remove knock sensors/drain plugs from both sides of the engine block.
 - **For 6.0L, 6.2L and 7.4L applications:** Remove drain plugs from both sides of engine drain hoses.
3. Drain heat exchangers of raw water.
 - Open cooled systems will have an oil/transmission heat exchanger. Remove the drain plug and allow the cooler to completely drain.
 - Closed cooled systems will have an oil/transmission and engine heat exchanger. Remove the drain plug and allow the cooler to completely drain.

STORAGE AND WINTERIZATION

4. Reinstall cooling hoses, engine block drain plugs, and heat exchanger end caps/drain plugs after all raw water has been drained. Drain other components that contain raw water, such as the water heater.
5. Fill all components of raw water system with a nontoxic -50°F (-45°C), -60°F (-51°C) or -100°F (-73°C) marine/RV antifreeze. Freeze protection level will depend on climate location. Marine/RV antifreeze will provide freeze protection to water pockets that did not drain and necessary corrosion protection. See Engine Specifications on page 11-1 for coolant capacity specifications per engine. There are two methods for filling your engine with antifreeze:
 - **Open Cooled System**
 1. Close thru-hull water pick-up seacock.
 2. Fill engine block and heads from thermostat housing. Remove both exhaust header feed hoses. Lift either the port or starboard hose as high as possible and fill until full. The other removed hose allows air to purge.
 3. Fill port and starboard exhaust manifolds by removing thermostat hose ends. Lift hose end as high as possible and fill until full.
 4. Fill sea strainer if not full.
 - **Closed Cooled System**
 1. Close thru-hull water pick-up seacock.
 2. Fill raw water components by removing both 1 in. hoses from exhaust downturn adapters. Lift either the port or starboard hose as high as possible and fill until full. This should fill the raw water side of the engine heat exchanger, oil/transmission heat exchanger, raw water pump and sea strainer. The sea strainer may need to be opened to purge air.
 3. Fill sea strainer if not full by end of procedure.
 4. Fill downturn exhaust adapters with 1/4 to 1/2 gal (1 to 2 L) of antifreeze.
 5. Reinstall hoses.



BATTERY WINTERIZATION

Check the battery and/or boat manufacturer's requirements.

RECOMMISSIONING AFTER STORAGE/ WINTERIZATION

Properly preparing the engine and drive train after a period of storage and/or winterization is equally important. Equal attention must be paid to the same components during recommissioning as during the winterization process.

NOTE: When putting the engine back into service after winterization or long-term storage, perform the procedures listed in Section 4, Before Each Use.

1. Remove raw water pump impeller and check it carefully. If it appears to have weathered or there are any doubts about its ability to function properly, replace it. See the instructions for correctly installing a raw water impeller in Section 7, Maintenance. The raw water impeller should be replaced once a year or at any time during routine maintenance that it shows wear.
2. Check all fluids: oil, transmission, cooling.
3. Reinstall battery(ies) and check the battery voltage. It should be 12–14 volts. If it is less, charge the battery(ies).
4. Visually inspect the fuel system. If there appears to have been undue weathering or any leaks have appeared over the storage/winterization period, contact your certified Ilmor dealer for correction. **DO NOT** start the engine if there is any appearance of leakage or rupture of any component of the fuel system.
5. Install boat hull drain plugs.
6. Marine/RV antifreeze should be drained and recycled. It is best accomplished by running the boat on the garden hose and collecting the antifreeze into buckets as it comes out of the exhaust.
7. Review the boat manufacturer's storage and winterization recommissioning directions to ensure that all requirements have been met, prior to launching the boat.

Section 9

EMISSIONS

It is extremely important that attention be given to the gaseous emissions throughout the life of the engine. It is the owner/operator's responsibility to ensure that the engine maintenance is performed as described in this Owner's Manual, in order to maintain emissions levels within the certified standards. The owner/operator(s) must never modify the engine in any manner that alters the allowable gaseous emission levels to exceed the certified specifications.

EMISSIONS CONTROL INFORMATION LABEL

At the time of manufacture, each engine is affixed with a tamper-resistant Emission Control Information (ECI) label. This label affirms the required emissions statement, along with the engine "family" name, as well as the engine displacement. The engine serial number is stamped on a flat boss surface on the rear block, near the corner of the cylinder head. The date of manufacture is indicated by punch holes at the bottom of the ECI label.

ECI labels must not be removed or tampered with by anyone.

If replacement decals are needed, contact Ilmor Marine, LLC, promptly.

Engines with the CE mark (present in the lower right corner of the ECI label) affirm that the Declaration of Conformity applies. The Declaration of Conformity attests the engine's conformance to the appropriate European Community Directive. The ECI label is located on the electrical component mounting bracket on the rear of the engine.



EMISSIONS CONTROL SYSTEM INFORMATION

The emission control system information for all engines having the ECI label are as follows: positive crankcase ventilation (PCV), sequential multiport fuel injection (SFI), three-way catalytic converter (TWC), heated oxygen sensors (HO2S), naturally aspirated (NAT), On-Board Diagnostics Marine (OBD-M), low-permeation fuel line (HOSE), electronic throttle control (ETC) and electronic engine control (electronic EC).

STAR LABEL

Beginning January 1, 2009, any boat sold or registered in California must have a Star Label affixed to the port side of the hull either forward or aft of the vessel registration as shown in the following illustration.



A Star Label is also placed on the intake manifold plenum of each certified Ilmor Marine, LLC, engine. A conventional power (373 kW / 500 bhp or less) Ilmor Marine MV8 engine has a Four Star - Super Ultra Low Emission rating. This indicates that the engine has 90% lower emissions than One Star - Low Emission engines. The Four Star Label identifies the engine as meeting the California Air Resources Board's sterndrive/inboard marine Tier 4 engine exhaust emission standards. A high-performance (>373 kW / 500 bhp) Ilmor Marine MV8 engine has a Three Star - Ultra Low Emission rating. This indicates that the engine has 65% lower emissions than One Star - Low Emission engines. The Three Star Label identifies the engine as meeting the California Air Resources Board's sterndrive/inboard marine Tier 3 engine exhaust emission standards.

ENVIRONMENTAL LABEL

Each boat equipped with an Ilmor MV8 engine will have an Environmental Label with the appropriate Star Label box check-marked according to the engine's emissions standards compliance level. It is the responsibility of the selling dealer to include the Environmental Label, and it must be marked in the correct box to match the Star label on the engine and the boat.

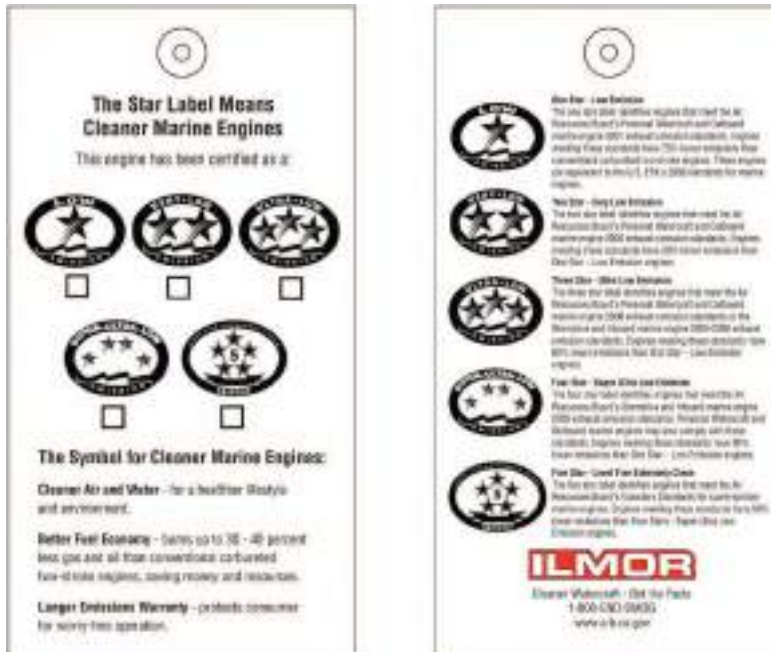

ON-BOARD DIAGNOSTICS-MARINE (OBD-M)

All Ilmor MV8 engines are equipped with marine on-board diagnostics to comply with the 2009 California-mandated OBD-M specification. The Malfunction Indicator Lamp (MIL) or a Check Engine warning will appear on the dash when emission system problems occur on the boat.

If the MIL is set due to an emissions-related fault, a Diagnostic Trouble Code (DTC) will register. The MIL functions to notify the operator that a problem has occurred so that the owner/operator can arrange for service as soon as possible. DTCs are stored in the Engine Control Unit memory and can be retrieved with a diagnostic scan tool or through Diacom PC Software.

This information about system malfunction assists the service technician in quickly diagnosing system issues. When the MIL lights, the owner/operator should contact a certified Ilmor dealer to arrange a diagnostic scan at the earliest possible opportunity.

The diagnostic scan tool will be connected to the Data Link Connector (DLC), a flat 6-pin connector. The connector is located at the flywheel side near the top of the engine. Note that the protective DLC cover must be removed prior to connecting the scan tool.



CALIFORNIA AND U.S. EPA EMISSION CONTROL WARRANTY STATEMENT

Your Warranty Rights and Obligations

The California Air Resources Board, U.S. Environmental Protection Agency and Ilmor Marine, LLC are pleased to explain the emission control system warranty on your 2013 model year and later sterndrive/inboard engine. In the United States, new sterndrive/inboard engines must be designed, built and equipped to meet all State and Federal mandated anti-smog standards.

Ilmor Marine, LLC must warrant the emission control system on your sterndrive/inboard engine for the periods of time listed below provided there has been no abuse, neglect or improper maintenance of your sterndrive/inboard engine. Your emission control system may include parts such as the carburetor or fuel injection system, the ignition system, and catalytic converter. Also included may be hoses, belts, connectors and other emission-related assemblies.

Where a warrantable condition exists, Ilmor Marine, LLC will repair your sterndrive/inboard engine at no cost to you, including diagnosis, parts and labor.

Manufacturer's Warranty Coverage

Select electronic emission-related control parts from model year 2009 and later sterndrive/inboard engines are warranted for 3 years or 480 hours, whichever first occurs. Select mechanical emission-related components are warranted for 3 years or 480 hours, whichever first occurs, for engines with maximum power less than or equal to 373 kW (500 bhp); or 3 years or 150 hours of operation, whichever first occurs, for engines with maximum power greater than 373 kW (500 bhp) but less than or equal to 485 kW (650 bhp).

Warranty coverage based on the hourly period is only permitted for engines that are equipped with hour meters as defined in § 2441(a)(13) or their equivalent. If any emission-related part on your engine is defective under warranty, the part will be repaired or replaced by Ilmor Marine, LLC.

Owner's Warranty Responsibilities

As the sterndrive/inboard engine owner, you are responsible for the performance of the required maintenance listed in your owner's manual. Ilmor Marine, LLC recommends that you retain all receipts covering maintenance on your sterndrive/inboard engine, but Ilmor Marine, LLC cannot deny warranty solely for the lack of receipts or your failure to ensure the performance of all scheduled maintenance.

Ilmor Marine, LLC may deny you warranty coverage if your sterndrive/inboard engine or a part has failed due to abuse, neglect, improper maintenance or unapproved modifications.

You are responsible for presenting your sterndrive/inboard engine to an Ilmor Marine, LLC authorized service center as soon as a problem exists. The warranty repairs will be completed in a reasonable amount of time, not to exceed 30 days.

If you have any questions regarding your warranty rights and responsibilities, you should contact Ilmor Marine, LLC at 1-704-360-1900.

General Emissions Warranty Coverage

Ilmor Marine, LLC must warrant that the engine is:

1. Designed, built and equipped so as to conform with all applicable regulations adopted by the Air Resources Board pursuant to its authority in Chapters 1 and 2, Part 5, Division 26 of the Health and Safety Code, and by the U.S. Environmental Protection Agency pursuant to 40 CFR 1045; and
2. Free from defects in materials and workmanship that cause the failure of a warranted part to be identical in all material respects to that part as described in the engine manufacturer's application for certification.

Exclusions:

Failures other than those resulting from defects in material or workmanship are not covered by this warranty. This warranty does not extend to emission control systems or parts which are affected or damaged by owner abuse, neglect, improper maintenance, the incorporation of, or use of, add-on(s) or modified part(s), or the unapproved modification of any part.

This warranty does not cover replacement of expendable maintenance items made in connection with required maintenance service as listed in the maintenance section of the product Owner's Manual, examples of which include: spark plugs and filters. If a part is repaired or replaced under this warranty, the life of the warranty is not extended beyond its original expiration date.

SECTION 9 ILMOR MV8 OWNER'S MANUAL

Disclaimer:

This warranty is applicable only where the California and U.S. EPA emission control system warranty regulation is in effect. The use of add-on(s) or modified part(s) not exempted by the California Air Resources Board or the U.S. EPA may be reason for not warranting a claim, at the discretion of Ilmor Marine, LLC. In the case of non-exempted add-on(s) or modified part(s) causing failure to a warranted part, the warranted part will not be covered.

Emission Control System Warranty

Ilmor Marine, LLC will warranty select emission-related control components for 3 years or 480 hours of operation, whichever first occurs; for engines with maximum power greater than 373 kW (500 bhp) but less than or equal to 485 kW (650 bhp), select mechanical emission-related components will be warranted for 3 years or 150 hours of operation, whichever first occurs.

Mechanical Emission-Related Components Warranty

Systems Covered by this Warranty	Parts Description
Fuel Metering	Intake valve(s)
Air Induction	Intake manifold Air filter*
Lubrication	Oil pump (includes internal parts)
Crankcase Ventilation	PCV pipe Fresh air pipe PCV hose connector Valve cover grommet Oil filler cap
Exhaust	Exhaust manifold (tailpipe not included) Exhaust valve(s)
Miscellaneous Items	Hoses Clamps Fittings Tubing Sealing gaskets or devices Mounting hardware Pulleys/Idlers Serpentine Belt

* Covered up to, but not including, the first required replacement only. See the Maintenance Schedule in the Owner's Manual.

Electronic Emission-Related Control Parts Warranty

Systems Covered by this Warranty	Parts Description
Fuel Metering	Fuel injectors Air/fuel ratio feedback and control system Pressure regulator (when installed)
Ignition	Electronic ignition system Spark plugs* Ignition coil(s) Ignition wire(s) Distributor**
Miscellaneous Items	Camshaft Position sensor Crankshaft Position sensor Engine Coolant Temperature sensor Intake Air Temperature sensor Knock sensor Manifold Absolute Pressure sensor Throttle Position sensor Electronic Control Unit Electronic Throttle Control Camshaft Position actuator solenoid valve*** Oil Pressure sensor****

* Covered up to, but not including, the first required replacement only. See the Maintenance Schedule in the Owner's Manual.

** MV8 5.7L only

*** MV8 6.0L and 7.4L only

Direct Emission-Related Control Parts Warranty

Systems Covered by this Warranty	Parts Description
Catalytic Converter	Catalytic converter(s) Oxygen sensor
Evaporative	Carbon canister Fuel tank Purge valve (if installed) Low-permeation (non-metal) fuel hose(s)

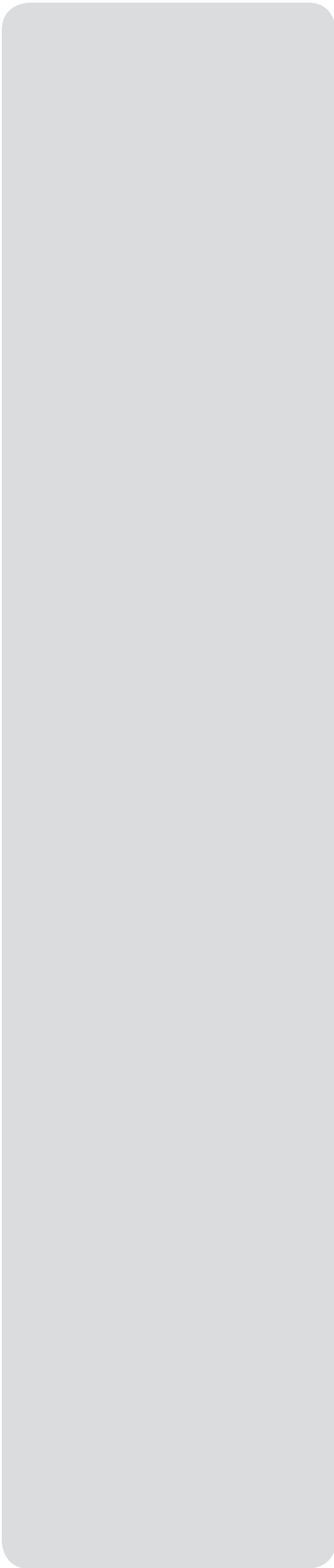

NOTES

Section 10

TROUBLESHOOTING

The following chart is offered as assistance in identifying and correcting minor issues that may occur. Problems are listed in the order of most-likely to least-likely. Not all possible problems, causes and solutions can be listed here.

When experiencing problems, check surroundings before shutting down the engine. If suddenly stopping the power would result in placing other boats and boaters in jeopardy, continue until it is safe(r) to slow or stop and analyze the situation.

Always be aware of surroundings and how your actions may impact others.



Problem	Possible Cause	Potential Solution
Engine will not turn over.	Safety switch tether not connected. Throttle/shift control in gear. Main circuit breaker open. 50A circuit breaker open. Battery terminal corroded. Battery weak or worn out. Loose or corroded battery wiring connectors. Defective starter solenoid. Defective neutral safety switch. Defective starter motor.	Connect the safety switch tether. Shift to neutral. Reset the circuit breaker. Reset the circuit breaker. Clean the battery terminals. Charge or replace the battery. Clean and tighten the battery wiring connectors. Replace the starter solenoid. Replace the neutral safety switch. Replace the starter motor.
Engine turns over, but will not start.	Safety switch tether not connected. No fuel in the tank. Fuel filter clogged. Contaminated fuel. Weak or shorted ignition coil. No fuel to the engine.	Connect the safety switch tether. Fill the fuel tank. Have dealer replace the fuel filter. Drain fuel properly and have dealer replace the filter. Replace the ignition coil. See certified Ilmor dealer.
Engine misses or idles rough.	Fouled spark plugs. Loose or defective high-tension leads. Plugged PCV valve. Weak ignition coil. Vacuum leak.	Have dealer replace the spark plugs. Have dealer tighten or replace the high-tension leads. Have dealer replace the PCV valve. Have dealer replace the ignition coil. See certified Ilmor dealer.

SECTION 10 ILMOR MV8 OWNER'S MANUAL

Problem	Possible Cause	Potential Solution
Poor boat performance.	<p>Fouled spark plugs.</p> <p>Contaminated fuel.</p> <p>Plugged flame arrestor.</p> <p>Weak ignition coil.</p> <p>Fuel filter clogged.</p> <p>Ignition problems.</p>	<p>Have dealer replace the spark plugs.</p> <p>Drain fuel properly and have dealer replace the filter.</p> <p>Clean the flame arrestor.</p> <p>Have dealer replace the ignition coil.</p> <p>Have dealer replace the fuel filter.</p> <p>See certified Ilmor dealer.</p>
Poor gas mileage.	<p>Fouled spark plugs.</p> <p>Plugged flame arrestor.</p> <p>Inefficient driving habits.</p> <p>Plugged PCV valve.</p> <p>Ignition problems.</p>	<p>Have dealer replace the spark plugs.</p> <p>Clean the flame arrestor.</p> <p>Plane the boat quickly, then slow down to desired speed.</p> <p>Have dealer replace the PCV valve.</p> <p>See certified Ilmor dealer.</p>
Belt noise.	<p>Alignment of the Front End Accessory Drive (FEAD).</p>	<p>Spray the serpentine belt riding surface between the alternator and raw water pump with water.</p> <p>Replacement of the FEAD bracket and belt.</p> <p>Inspect and/or replace belt tensioner.</p>

Section 11

SPECIFICATIONS AND SERVICE LOG



ENGINE SPECIFICATIONS

Engine Model	MV8 5.7L	MV8 6.0L	MV8 6.2L	MV8 7.4L
Number of Cylinders	V-8	V-8	V-8	V-8
Displacement	5.73L	5.978L	6.16L	7.4L
Compression Ratio	9.4:1	9.6:1	10.7:1	10.7:1
Firing Order	1-8-4-3-6-5-7-2	1-8-7-2-6-5-4-3	1-8-7-2-6-5-4-3	1-8-7-2-6-5-4-3
Fuel Type	Unleaded 87-93 octane	Unleaded 87-93 octane	Unleaded 87-93 octane	Unleaded 87-93 octane
Rev Limit	5,200 rpm	5,400 rpm	5,600 rpm	5,800 rpm
Engine Weight (incl. V-Drive Transmission) Open Cooled	996 lb (452 kg)	1,084 lb (492 kg)	959 lb (435 kg)	1,075 lb (488 kg)
Engine Weight (incl. V-Drive Transmission) Closed Cooled	1,094 lb (496 kg)	1,161 lb (527 kg)	1,036 lb (470 kg)	–
Engine Oil	Pennzoil Platinum 5W-30 full synthetic 5 qt (4.7 L)	Pennzoil Platinum 5W-30 full synthetic 4.5 qt (4.3 L)	Pennzoil Platinum 5W-30 full synthetic 4.5 qt (4.3 L)	Quaker State synthetic 5W-50 5.5 qt (5.2 L)
Coolant Type and Quantities	5-year extended warranty propylene glycol/ water 50/50 mix 5 gal (18 L) to 6 gal (22 L)	5-year extended warranty propylene glycol/ water 50/50 mix 5 gal (18 L) to 6 gal (22 L)	5-year extended warranty propylene glycol/water 50/50 mix 5 gal (18 L) to 6 gal (22 L)	5-year extended warranty propylene glycol/ water 50/50 mix 5 gal (18 L) to 6 gal (22 L)
Normal Operating Temperature Range	140°F (60°C) – 190°F (88°C)	140°F (60°C) – 190°F (88°C)	140°F (60°C) – 190°F (88°C)	140°F (60°C) – 190°F (88°C)

SECTION 11 ILMOR MV8 OWNER'S MANUAL

Requirements and Recommendations

Battery(ies) Recommended	See boat manufacturer for suggestions
Coolant in Closed Cooling System Required	Sierra 5-year extended warranty propylene glycol/water 50/50 mix antifreeze
Spark Arrestor	PE01908
Fuel Required	Unleaded gasoline, 87 or higher octane, maximum of 10% alcohol
Fuel Recommended	TOP TIER gasoline, 93 octane
Fuel System Stabilizer Recommended	STA-BIL
Oil Required	<p>Pennzoil Platinum 5W-30 full synthetic for 5.7L, 6.0L and 6.2L engines.</p> <p>Quaker State synthetic 5W-50 for 7.4L only. No oil additives.</p> <p>In areas where these recommended oils are not available, please contact your local authorized service center for appropriate equivalents.</p>
Oil Filter	Single filter – MV8V-1021
Raw Water Impeller Kit	5.7L, 6.0L and 6.2L Open Cooled – MV8V-1178 5.7L, 6.0L and 6.2L Closed Cooled, 7.4L Open Cooled – MV8V-1179
Serpentine Belt	5.7L – PV06396 6.0L, 6.2L, 7.4L – PV06493
Transmission Oil	See manufacturer's owner manual
Transmission Filter	See manufacturer's owner manual

SPECIFICATIONS AND SERVICE LOG

SERVICE LOG

Service	Date	Date	Date	Date	Date	Date
Engine oil and filter						
Engine coolant						
Power steering fluid						
Transmission fluid						
Serpentine belt						
Raw water impeller						
Sea pump						
Spark arrestor						
Engine timing (5.7L only)						
Spark plugs						
Spark plug wires						
Shaft alignment						
Heat exchanger(s)						
Zinc anodes						

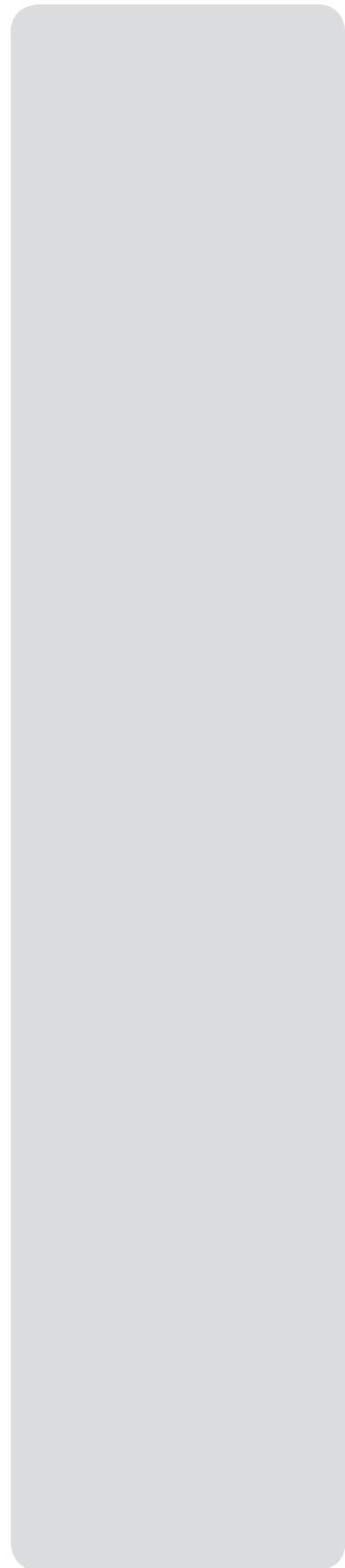

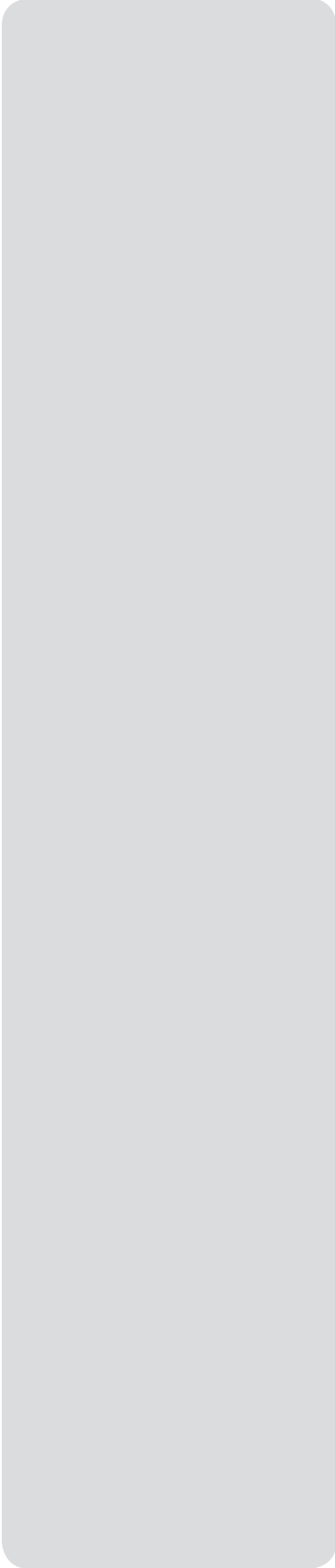

NOTES