



5.7

PARTS

MANUAL



17506 Marine Power Industrial Park
Ponchatoula, LA 70454
Parts Direct Line: (504) 386-3571 or (877) 388-9555
Parts Direct Fax: (504) 386-0076

TL57V-0500

TABLE OF CONTENTS

| | |
|--|--------------|
| BASIC ENGINE BLOCK - INTERNAL / LOWER END | 1-2 |
| BASIC ENGINE BLOCK - INTERNAL / UPPER END | 3-4 |
| FLYWHEEL, STARTER & DRIVE GROUP | 5-6 |
| - FLYWHEELS | |
| - STARTERS | |
| - BELLHOUSINGS | |
| - COUPLERS, DAMPER PLATES | |
| - ENGINE MOUNTS | |
| - DUST COVERS, DRIVE LINE | |
| LUBRICATION GROUP | 7-8 |
| - OIL PANS | |
| - DIPSTICK TUBES, DIPSTICKS, ETC. | |
| - OIL FILTERS | |
| - COOLERS, COOLER BRACKETS | |
| - OIL LINES & OIL BYPASS | |
| - DUAL OIL BASE, OIL BASE BRACKETS | |
| COOLING GROUP | 9-17 |
| - HOSES | |
| - THERMOSTAT HOUSINGS | |
| - FRESH WATER TANKS, BRACKETS | |
| - THERMOSTATS, RECOVERY BOTTLE | |
| - GASKETS, BLOCK-OFF PLATES | |
| - COOLERS, FRESH WATER TEES | |
| - WATER PUMPS, BRACKETS, ACCESSORIES | |
| - LIFT BRACKETS, PULLEYS | |
| - SEAWATER PUMP & ACCESSORIES | |
| - RAW WATER & FRESH WATER FLOW DIAGRAMS | |
| ELECTRICAL GROUP | 18-24 |
| - ALTERNATOR, BRACKETS, BELTS | |
| - DISTRIBUTOR, COIL, ELECTRICAL REPLACEMENT PARTS | |
| - SENDERS, SWITCHES, RELAYS | |
| - IGNITION WIRES, WIRE LEADS | |
| - HARNESSSES | |
| - INSTRUMENT PANEL, GAUGES | |
| - WIRING DIAGRAMS | |
| EXHAUST GROUP | 25-26 |
| - MARINE POWER MANIFOLD, RISER, GASKETS | |
| - MERC STYLE MANIFOLD, RISER, GASKETS | |
| - MARINE POWER 2000 ALUMINUM MANIFOLD, RISER, GASKET | |
| - VOLVO VR1 MANIFOLD, RISER, GASKETS | |
| - VOLVO VR2 MANIFOLD, RISER, GASKETS | |

TABLE OF CONTENTS
(Continued)

| | |
|---|--------------|
| CARBURETION | 27-30 |
| <ul style="list-style-type: none"> - ROCHESTER CARBURETOR, FUEL LINES, ETC. - FUEL PUMPS, BRACKETS, FUEL/WATER SEPARATOR - HOLLEY CARBURETORS, FUEL LINES - INTAKE MANIFOLDS - GASKETS, BRACKETS - FLAME ARRESTORS, WEATHER COVER - CONTROL CABLE CLIPS, MISCELLANEOUS - ELECTRIC FUEL PUMP KITS | |
| EFI - THROTTLE BODY INJECTION | 31-34 |
| <ul style="list-style-type: none"> - THROTTLE BODY DIAGRAM, INTAKE MANIFOLDS - FUEL LINES - GASKETS - BRACKETS - HARNESSSES - FUEL PUMPS - SENSORS, SENDERS, ECM MODULES - FLAME ARRESTORS, WEATHER COVERS, FITTINGS, ETC. | |
| EFI - MULTIPOINT FUEL INJECTION | 35-42 |
| <ul style="list-style-type: none"> - PFI THROTTLE BODY DIAGRAM, INTAKE MANIFOLD - FUEL LINES - GASKETS - BRACKETS - HARNESSSES - FUEL PUMPS - SENSORS, SENDERS, ECM MODULES - HOSES - FUEL RAIL, FILTERS, FUEL INJECTOR, FUEL PRESSURE REGULATOR - FITTINGS, PLUGS, ETC. - WIRING DIAGRAMS | |
| POWER STEERING GROUP | 43-44 |
| <ul style="list-style-type: none"> - PUMPS & ACCESSORIES - POWER STEERING DIAGRAM | |
| MOUNTING GROUP | 45 |
| <ul style="list-style-type: none"> - ENGINE MOUNTS - GEAR MOUNTS - ISOLATOR MOUNT, TRUNION PINS | |
| TRANSMISSIONS | 46-47 |
| <ul style="list-style-type: none"> - VELVET DRIVE & HURTH TRANSMISSIONS - GEAR LINES, COOLERS, SHIFT BRACKETS | |
| CATALOG ALPHABETICAL INDEX | 48-58 |
| CATALOG NUMERICAL INDEX | 59-69 |

| | | |
|------------------|--------------|--------------------------------------|
| MARINE POWER | Direct Phone | 504 - 386 - 3571 or 877 - 388 - 9555 |
| PARTS DEPARTMENT | Direct Fax | 504 - 386 - 0076 |

HOW TO USE THIS BOOK

This 5.7L Vortec Parts Book has been designed to assist our distributors, dealers and customers in locating the correct replacement part for their Marine Power engine. This manual is sorted in specific groups for easy reference. Please refer to the Table of Contents, Alphabetical or Numerical Index to locate a particular Marine Power part.

This manual also contains many commonly used parts for the 350 CID Pre-Vortec engine. Most parts fit both the 5.7L Vortec and the 350 CID engine.

As a reference, Marine Power utilizes 5.7V when referring to the Vortec engine and 350 when referring to the Pre-Vortec engine.

If the part you are looking for is not listed, please contact your nearest Marine Power distributor or dealer for further assistance.

Thank you for purchasing Marine Power products.

Happy Boating!

| | | |
|--|-----------------|---|
| <i>Marine Power Engine Descriptions:</i> | Base | Base Engine or Long Block |
| | ParPac | Partial Package - Base Engine with Additional Equipment |
| | SportPac | Complete Inboard Engine |
| | EnPac | Complete Inboard/Outboard Engine |
| | JetPac | Complete Inboard Jet Engine |

///MARINEPOWER™
The Force Behind The Fun.™



BASIC ENGINE BLOCK - INTERNAL / LOWER END**350/5.7V**

| Ref | Part # | Description | Ref | Part # | Description |
|-----|------------|--------------------------------------|-----|----------|---|
| 1 | 0014-348 | Ring Set: Piston 181/350 Deep | 24 | 0009-009 | Bearing: Crankshaft #5 SB 91-95 |
| 1 | 0017-348 | Ring Set: Piston SB Vortec 95> | 24 | 0017-189 | Bearing: Crankshaft #1,2,3,4 5.7V 96> |
| 2 | 0009-037LK | Piston: 4.3V / 5.7V | 24 | 0017-191 | Bearing: Crankshaft #5 5.7V 96> |
| 2 | 0020-037 | Piston: | 25 | 0004-094 | Key: Crankshaft Balancer |
| 3 | 0007-036 | Connecting Rod: 181/350/5.7V | 26 | 0007-021 | Crankshaft: 350 NR 91-95 |
| 4 | 0007-066 | Bolt: Connecting Rod 350/5.7V | 26 | 0017-021 | Crankshaft: 5.7V NR 96> |
| 5 | 0007-038 | Bearing: Connecting Rod 181/350/5.7V | 27 | 0017-002 | Bolt: Harmonic Balancer |
| 6 | 0060-067 | Nut: Connecting Rod 350/5.7V/BB | 28 | 0007-004 | Balancer: Harmonic 350 |
| 7 | 0009-208 | Plug: Camshaft Rear Bearing Hole | 28 | 0017-004 | Balancer: Harmonic 5.7V 96> |
| 8 | 0000-032 | Bolt: Oil Filter Adapter | 29 | 0010-081 | Gear Kit: Camshaft/Crankshaft 350/5.7V |
| 9 | 0007-042 | Adapter: Oil Filter | 30 | 0011-154 | Bolt: Crankshaft Bearing Cap |
| 10 | 0017-090 | Bearing: Camshaft #1 350/5.7V | 31 | 0007-964 | Stud: Crankshaft Bearing Cap |
| 10 | 0017-091 | Bearing: Camshaft #2, #5 350/5.7V | 32 | 0025-610 | Gasket: Crank Rear Oil Seal SB |
| 10 | 0017-092 | Bearing: Camshaft #3, #4 350/5.7V | 33 | 0007-963 | Stud: Crankshaft Rear Oil Seal 350/5.7V |
| 11 | 0007-089 | Camshaft: 350 Flat Tappet NR 91-95 | 34 | 0025-910 | Pin: Crankshaft Rear Oil Seal Housing |
| 11 | 0008-089 | Camshaft: 350 Flat Tappet OR 91-95 | 35 | 0009-033 | Seal: Crank Rear Oil NR 350 91-95 |

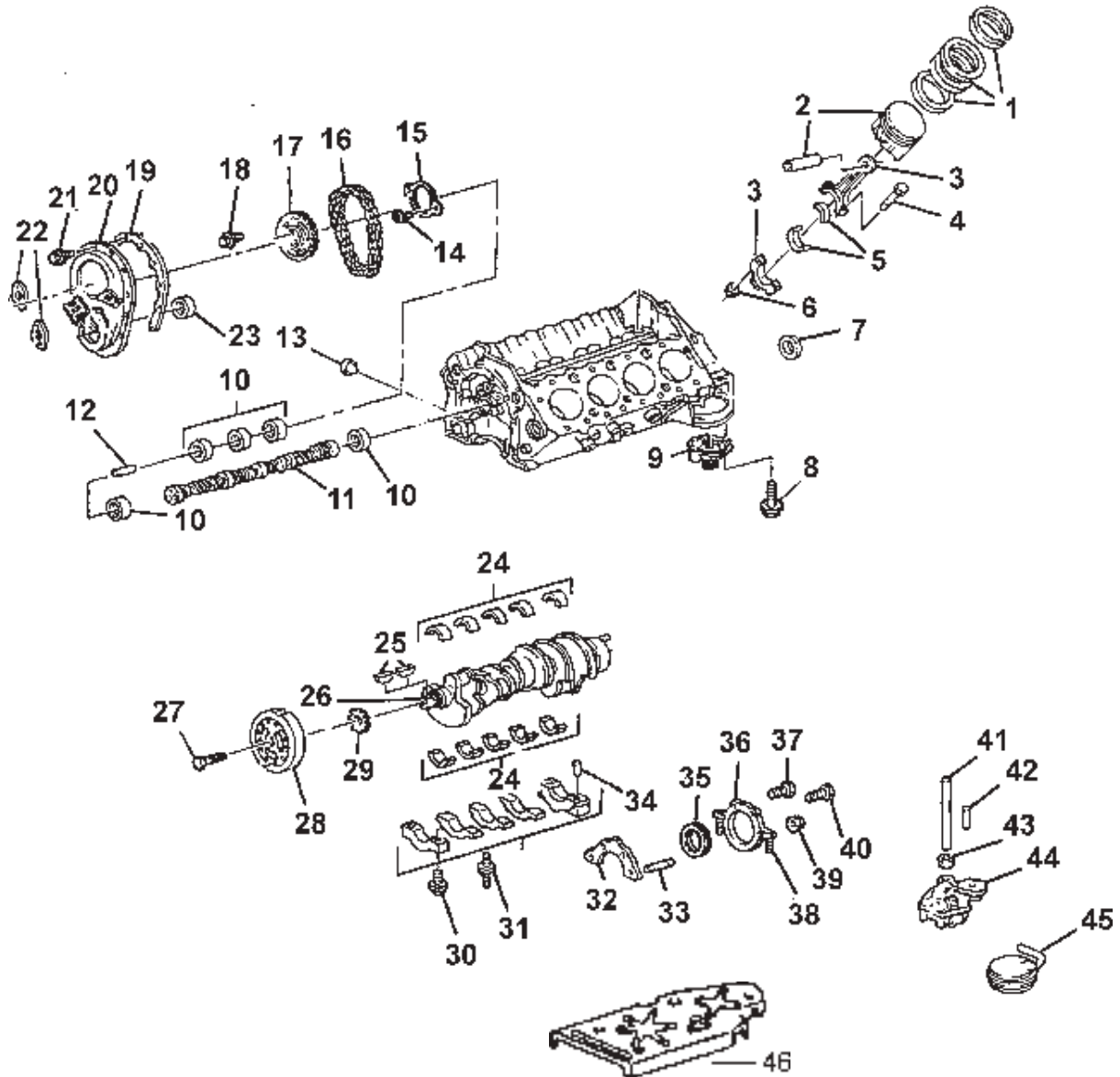

BASIC ENGINE BLOCK - INTERNAL / UPPER END**350/5.7V**

| Part # | Description | Ref | Part # | Description |
|-----------|-------------------------------------|-----|-----------|--------------------------------------|
| 0007-100D | Valve Cover: 350/5.7V | 15 | 0025-815 | Plug: Cylinder Head Core 181/350/5.7 |
| 0009-102 | Cap: Oil Fill 90> 350/5.7V | 16 | 0007-025 | Gasket: Cylinder Head 350/5.7V |
| 0011-102 | Cap: Oil Fill 89< 350 | 17 | 0007-024 | Head: Cylinder Bare 350 91-95 |
| 0009-107 | Bolt: Valve Cover 262/350/5.7V | 17 | 0017-024 | Head: Cylinder Bare 5.7V 96> |
| 0007-101B | Gasket: Valve Cover 350/5.7V | 17 | 0017-024Z | Head: Cylinder Complete 5.7V |
| 0007-027 | Bolt: Cylinder Head Long 350/5.7V | 18 | 0007-178 | Seal: Exh Valve Stem Oil 350 91-95 |
| 0007-028 | Bolt: Cylinder Head Medium 350/5.7V | 18 | 0017-178 | Seal: Exh Valve Stem Oil 5.7V 96> |
| 0007-029 | Bolt: Cylinder Head Short 350/5.7V | 19 | 0007-176 | Spring: Valve 350 91-95 |
| 0009-862 | Plug: Cylinder Head Core SB 91-95 | 19 | 0017-176 | Spring: Valve 5.7V 96> |

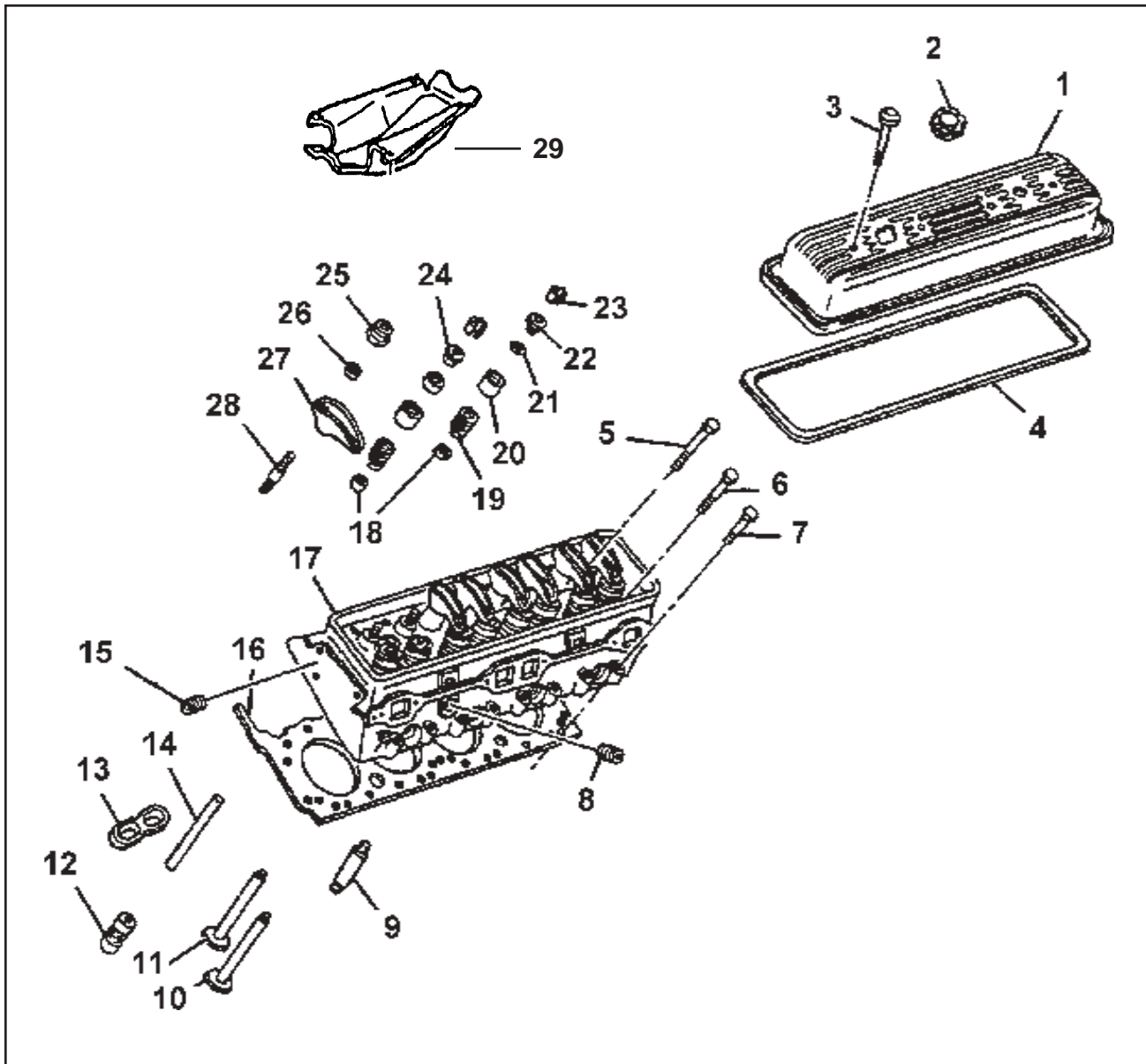

Note: Engine Serial Number or GM Engine Block Number required to assure correct parts.

To locate engine block number:

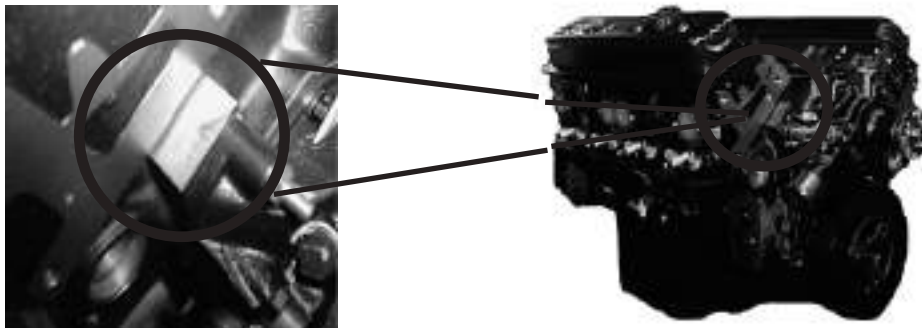

FLYWHEELS



0007-140
FLYWHEEL: 14"
TOP MOUNT 350/5.7



0007-141
FLYWHEEL: 14"
BM MOUNT 350/5.7



0007-142B
FLYWHEEL: 12-3/4"
BM MOUNT 350/5.7



0007-143G1
FLYWHEEL: 14"
FLEXPLATE JET 5.7

STARTERS



0170-000
STARTER: 14"
TOP MOUNT NR
SPORTPAC/JETPAC



0171-000
STARTER: 14"
TOP MOUNT OR
SPORTPAC



0172-000
STARTER: 12-3/4"
BOTTOM MOUNT NR
ENPAC
(REQUIRES
[1] 0180-000 BOLT &
[1] 0181-001 BOLT)



0174-000
STARTER: 14"
BOTTOM MOUNT NR
ENPAC/JETPAC
(REQUIRES
[2] 0181-001 BOLTS)

BELLOUSINGS & COUPLERS



0100-000
BELLHOUSING:
INBOARD GAS



0102-538
BELLHOUSING:
CAL JET 14" TM

BELLOUSINGS & COUPLERS



0102-537
PLATE: ACCESS
CAL JET BELLHSG



0105-000
ADAPTER: CONE
BERKLEY STYLE



0017-999N6
COUPLER: 14" VOLVO
VR2



0071-000
DAMPER PLATE: SB 14"
0072-000
DAMPER PLATE: SB
12-3/4"



0025-990F7
COUPLER: FLEXPLATE
12-3/4"
(YOKE ASSEMBLY
INCLUDED)



0007-990F7
COUPLER: FLEXPLATE
14"
(YOKE ASSEMBLY
INCLUDED)

DUST COVERS - STARTER PLATE - DRIVE LINE



0150-000
COVER: DUST REAR ENTRY



0151-000
COVER: DUST 12-3/4"



0151-014
COVER: DUST FORWARD ENTRY
14" FLYWHEEL



0151-538
COVER: DUST CAL JET
14" FLYWHEEL



0151-010
PLATE: STARTER BELLHOUSING



7909-005
DRIVE LINE: NW JET / CAL JET

/// MARINEPOWER™
The Force Behind The Fun.™

OIL PANS



0007-246
OIL PAN: 350/5.7 6 QT PLASTISOL

**TO BE REPLACED BY
#0007-241P10 ALUM OIL PAN**



0007-241
OIL PAN: SB JET DOOLEY



0007-241P10
OIL PAN: 350/5.7 ALUMINUM

DIPSTICKS & DIPSTICK TUBES



0407-002
DIPSTICK TUBE: SB/BB/6.5
PLASTISOL OIL PAN
SPORTPAC REVERSIBLE



0307-002N5
DIPSTICK TUBE: 5.7
(JETPAC/ENPAC)
(Overall Length 28.5")



0307-001N5
DIPSTICK: 5.7
(JETPAC/ENPAC)
(Overall Length 34")



0307-001
DIPSTICK: 350/5.7
ALL PLASTISOL OIL PANS
(SPORTPAC/PRE-VORTEC
& BASE ENGINES)
(Overall Length 26.5")



0007-310
DIPSTICK TUBE: 350/5.7
ALUMINUM OIL PAN
(Pre 0007-241P10 Alum Oil Pan)



0007-311
DIPSTICK: 350/5.7 ALUMINUM OIL
PAN
(Pre 0007-241P10 Alum Oil Pan)



0400-801
FITTING: BANJO METRIC
(FOR #0407-002 TUBE)
0400-800
FITTING: BANJO STANDARD



0307-002
DIPSTICK TUBE: 350
(PRE-VORTEC & BASE ENGINES)
(Overall Length 19.25")



0007-312
CLAMP: DIPSTICK TUBE 5.7
(Pre 0007-241P10 Alum Oil Pan)

NOT PICTURED
1005-000
CLAMP: DIPSTICK TUBE
RUBBER COATED 3/8"



0407-200
BRACKET: DIPSTICK TUBE ANCHOR @
PAN RAIL
FOR SPORTPAC REVERSIBLE DIPSTICK TUBE

FILTERS - COOLER



0904-000
 FILTER: OIL SPORTPAC
 (2 REQUIRED)



0905-000
 FILTER: OIL ENPAC



0440-001
 COOLER: ENGINE OIL
 5 X 1-1/4"



0440-549G3
 COOLER: DUAL
 ENGINE/GEAR



0791-000
 CLAMP: OIL
 COOLER 2"

MISCELLANEOUS



0900-001
 BASE: SINGLE REMOTE OIL



0900-100
 BASE: DUAL REMOTE OIL
0000-871
 FITTING: OIL BASE



0791-006
 BRACKET: OIL
 COOLER 6"



1440-001
 BRACKET: GEAR
 COOLER TWIST



0007-245A
 GASKET: OIL PAN 350/5.7



0007-042
 ADAPTER: OIL
 BYPASS
0000-032
 BOLT: ADAPTER
 (2 REQUIRED)



1256-019
 OIL LINE: 19.5" 90-90
1250-002E3
 OIL LINE: 28" 90-90
1250-051F8
 OIL LINE: 51" 90-90



0901-538
 BRACKET: DUAL OIL BASE
 CAL-JET



0901-350
 BRACKET: DUAL OIL
 SB / NW JET
 (ALSO REPLACES #0720-250)



0520-000
 KIT: OIL BYPASS
 (Includes Bypass, O-Ring, & Fittings)
0520-001
 BYPASS: OIL SB
0520-002
 O-RING: BYPASS COVER
0000-871
 FITTING: OIL BYPASS (2)



0900-400
 KIT: OIL EXCHANGE
 (Includes Pump, Mounting
 Bracket, EZ Oil
 Drain)



1460-001
 OIL DRAIN: EZ METRIC THREAD
1460-000
 OIL DRAIN: EZ STD THREAD

HOSES



1458-003
HOSE: SEAWATER PUMP TO FW TANK V6/V8



1452-000F11
HOSE: CIRC PUMP



1455-017G8
HOSE: FW TANK TO MANIFOLD SB



1458-005
HOSE: SEAWATER PUMP TO COOLER



1458-004
HOSE: RISER TO FW TANK SB



1455-003
HOSE: CIRC PUMP TO TANK RM



1456-000
HOSE: SEAWATER PUMP TO T-STAT RW SB/BB



1458-101P10
HOSE: MANIFOLD TO T-STAT HOUSING MERC STARBOARD



1458-102P10
HOSE: MANIFOLD TO T-STAT HOUSING MERC PORT

FW BYPASS

0506-006N5
KIT: FW BYPASS SB



1. 0720-852 FITTING: 3/8" X 1/4"
2. 0720-851 FITTING: 3/8" 90°
3. 0000-847 BUSHING: 3/4" X 1/4" (4.25.7)
- 0000-855 BUSHING: 1/2" X 1/4" (7.45.2)
4. HCD0-006 CLAMP HOSE #8
5. HPW5-006 HOSE: 3/8"
6. 0730-862 BUSHING: 3/8" X 1/4" (IF NECESSARY)



HWRP-016
HOSE: SEAFLEX 1" (Per Ft)

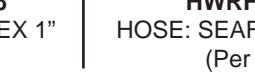

HWRP-020
HOSE: SEAFLEX 1-1/4" (Per Ft)

REFER TO DIAGRAMS ON PAGES 15-17 FOR HOSE LOCATIONS

HOUSINGS



0210-000
HOUSING: T-STAT RAW WATER



0212-001
HOUSING: T-STAT MERC RW



0506-009F4
HOUSING: FW T-STAT HOUSING



0509-004N11
HOUSING: T-STAT FWS



0790-000
CLAMP: PREFORM SEAPUMP HOSE 1-1/2"



0505-009
BASE: T-STAT HOUSING FWS REAR MT SB



0505-002
CAP: T-STAT HOUSING FWS REAR MT SB

TANKS & BRACKETS

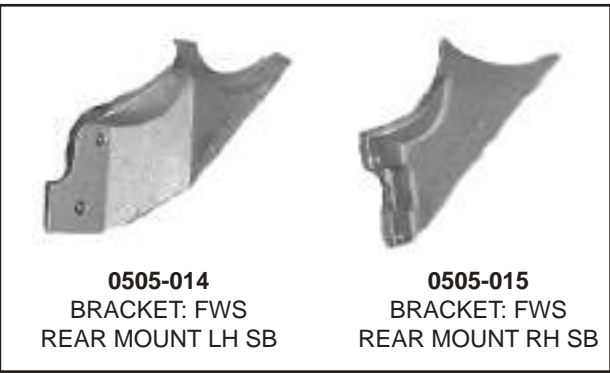
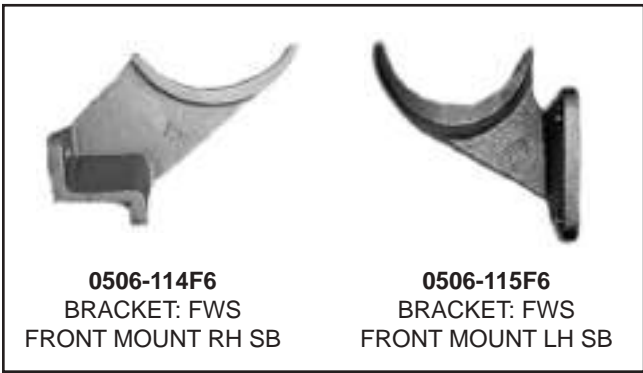

THERMOSTATS & RECOVERY BOTTLE



GASKETS & BLOCK-OFF PLATES

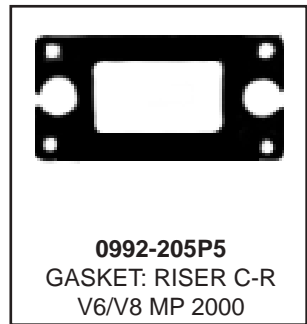

COOLERS - FW TEES



WATER PUMPS & ACCESSORIES



0017-071
 PUMP: CIRC WATER 350/5.7
0307-050
 GASKET: CIRC WATER PUMP (RE-
 QUIRES 2)



0566-000P8
 PUMP: SEAWATER SB/BB



0573-000
 BRACKET: SEAWATER PUMP SB
0572-001
 BUSHING: SEAWATER

JABSCO PUMP



0566-001P8
 IMPELLER: JABSCO SEA-
 WATER PUMP



0566-002P8
 GASKET: JABSCO
 SEAWATER PUMP

JOHNSON PUMP

0563-020
 IMPELLER KIT: JOHNSON F5B
 KIT INCLUDES:
 (1) 0563-001 IMPELLER
 (1) 0562-002 GASKET
 (1) 0563-013 WASHER
 (1) 0563-010 O-RING
 (1) 0563-009 BEARING
 (1) 0563-008 LIPSEAL
 (1) 0563-012 SCREW
 (4) 0563-011 SCREW



0566-003P8
 COVER: JABSCO
 SEAWATER PUMP
0566-011P8
 SCREW: JABSCO
 SEAWATER PUMP
 COVER (6 Required)



0566-004P8
 CAM: FULL JABSCO
 SEAWATER PUMP
0566-005P8
 SCREW: JABSCO CAM

0562-020
 IMPELLER KIT: JOHNSON F6B
 KIT INCLUDES:
 (1) 0562-001 IMPELLER
 (1) 0562-002 GASKET
 (1) 0563-013 WASHER
 (1) 0563-010 O-RING
 (1) 0563-009 BEARING
 (1) 0563-008 LIPSEAL
 (1) 0563-012 SCREW
 (4) 0563-011 SCREW



0566-008P8
 LIPSEAL: JABSCO
 SEAWATER PUMP



0566-006P8
 SEAL: SPACER
 JABSCO

JOHNSON PUMP REPLACEMENT PARTS



0563-001
IMPELLER: JOHNSON
SEAWATER PUMP F5B



0562-001
IMPELLER: JOHNSON
SEAWATER PUMP F6B



0562-002
GASKET: JOHNSON
SEAWATER PUMP



0563-003
COVER: JOHNSON
SEAWATER PUMP F5B/F6B



0563-008
LIPSEAL: JOHNSON
SEAWATER PUMP F5B/F6B



0563-009
BEARING: JOHNSON
SEAWATER PUMP F5B/F6B



0563-013
WASHER: JOHNSON
SEAWATER PUMP F5B/F6B



0563-011
SCREW: JOHNSON
SEAWATER PUMP COVER F5B/F6B



0563-012
SCREW: JOHNSON
SEAWATER PUMP CAM F5B/F6B



0563-002
CAM: JOHNSON
SEAWATER PUMP F5B



0562-003
CAM: JOHNSON
SEAWATER PUMP F6B

NOTE:
JOHNSON SEAWATER
PUMPS ARE NO LONGER
IN SERVICE ON MARINE
POWER ENGINES. RE-
PLACEMENT PARTS ARE
STILL AVAILABLE.

FITTINGS - BUSHINGS - PLUGS

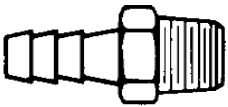

0000-800H7
FITTING: BRASS STRAIGHT
3/4" NPT X 1"

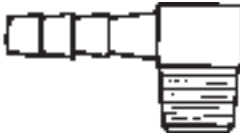

0000-815H7
FITTING: BRASS 90D
3/4" NPT X 1"



0720-852
FITTING: BRASS 1/4" X 3/8" STR

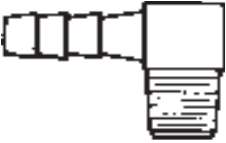

0720-851
FITTING: BRASS 3/8" 90D



0000-845
FITTING: 3/4" PIPE X
5/8" HOSE 90D



0000-847
BUSHING: 3/4" X 1/4"



0000-878
PLUG: PIPE 3/8"

LIFT BRACKETS & PULLEYS



0053-700F10
BRACKET: LIFT REAR LONG



0053-701F10
BRACKET: LIFT REAR SHORT



0009-700F10
BRACKET: LIFT FRONT SB



0028-701
BRACKET: LIFT
SB VORTEC RW



0053-702
BRACKET: LIFT REAR
TBI SB/BB
(AZ SP FW FRONT)



0307-007
PULLEY: CIRC PUMP
2-GROOVE 181/SB/BB



0307-028
PULLEY: CRANKSHAFT
2-GROOVE 350 / 5.7V



0307-038
PULLEY: CRANKSHAFT
3-GROOVE 350 / 5.7V



1210-002
PULLEY: DUAL ALTERNATOR
(FOR PRESTOLITE
& LEECE-NEVILLE)

RAW WATER COOLING DIAGRAM

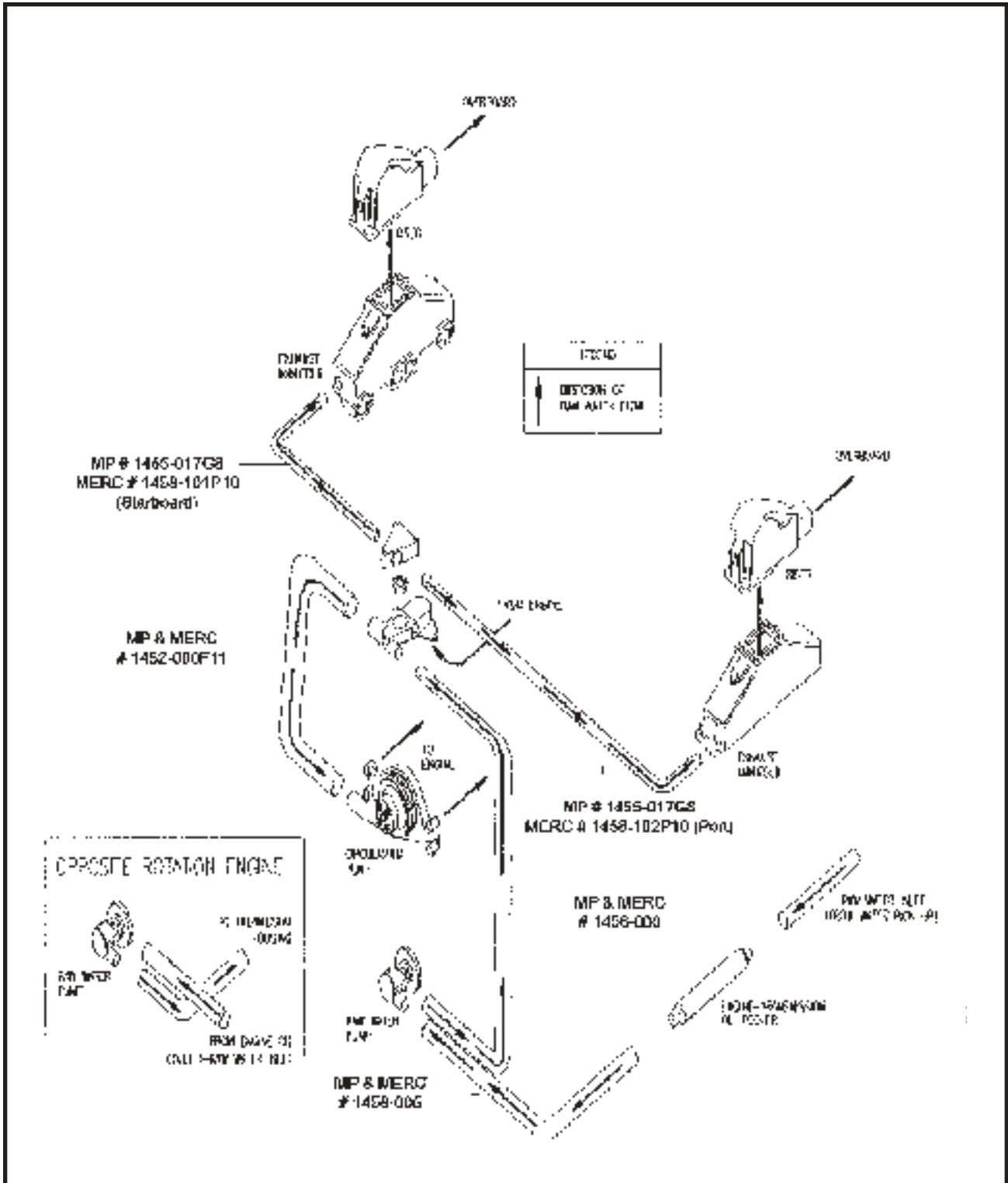

HOSE NUMBERS LISTED ARE FOR MARINE POWER ENGINES EQUIPPED WITH MARINE POWER OR MERC STYLE MANIFOLDS

FRESH WATER COOLING DIAGRAM

FRONT MOUNTED SYSTEM

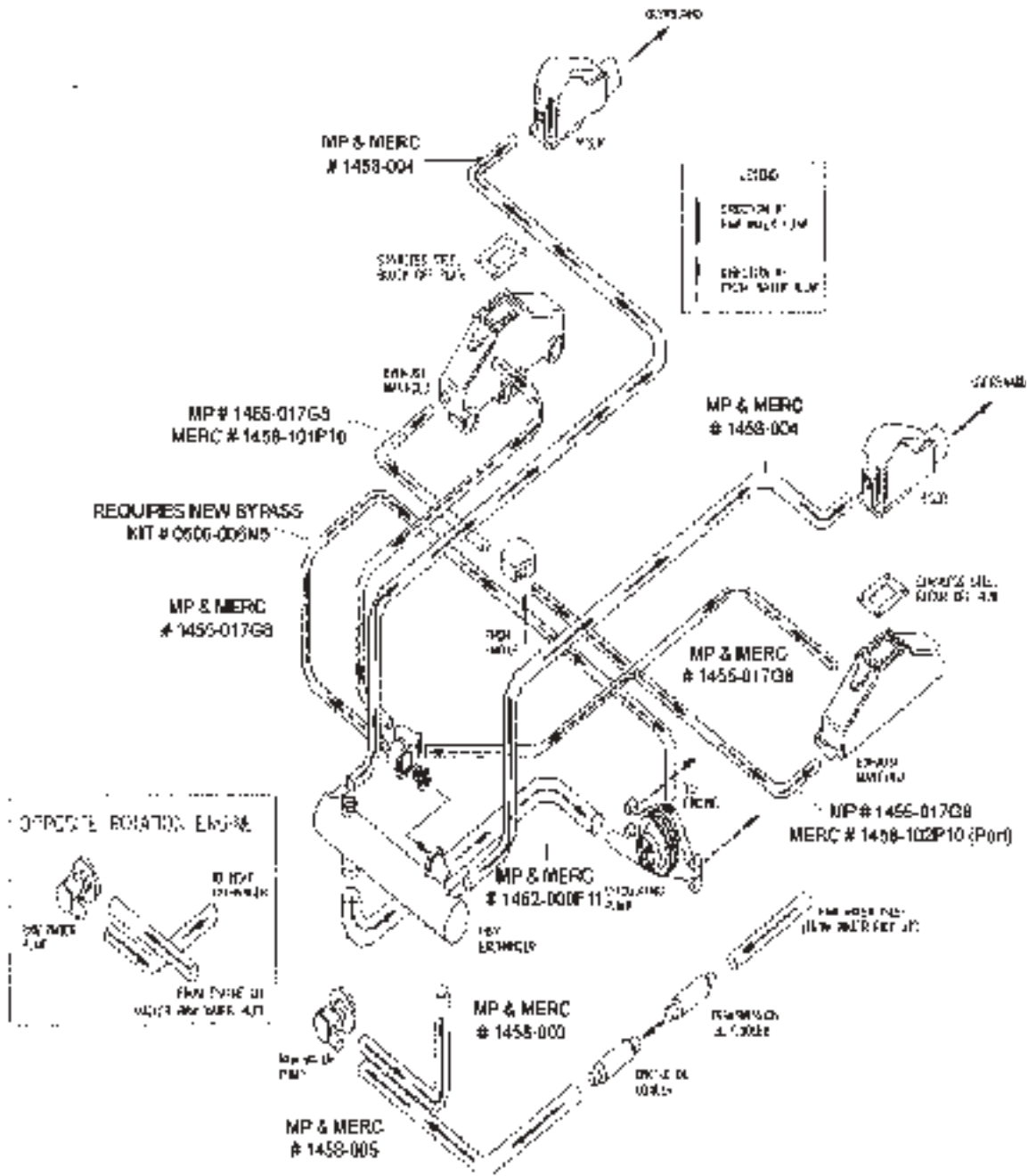

HOSE NUMBERS LISTED ARE FOR MARINE POWER ENGINES EQUIPPED WITH MARINE POWER OR MERC STYLE MANIFOLDS

ALTERNATOR & ACCESSORIES

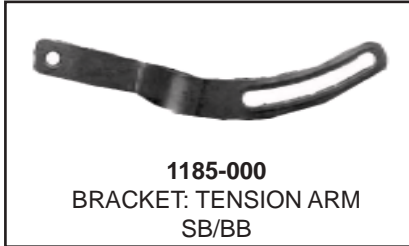

DISTRIBUTOR - COILS - ETC



SENDERS - SWITCHES - RELAYS



0940-002
SENDER: OIL SINGLE

0940-102
SENDER: OIL DUAL



1140-102F5
RELAY: HARNESS
40 AMP



0940-201
SWITCH: WATER
TEMP 3/8"



0940-202
SWITCH: OIL
PRESS 1/8" 7PSI



0303-017F3
SWITCH: HOBBS
OIL /FUEL PUMP
CUT-OFF

IGNITION WIRES



1110-000E5
WIRE SET: IGNITION V8
YELLOW

1110-000N2
WIRE SET: IGNITION V8
BLACK

1110-000BLK
WIRE SET: IGNITION V8
HI-PERF BLACK

NOTE:
**NO WARRANTY ON
ELECTRICAL ITEMS**



0940-001
SENDER: WATER SINGLE 1/2"

0940-011
SENDER: WATER SINGLE 3/8"



1140-004
CIRCUIT BREAKER:
IGNITION



1140-011N4
RELAY: STARTER
70 AMP
(>April 99)



0940-111
SENDER: WATER DUAL 3/8"

0940-101
SENDER: WATER DUAL 1/2"



6754-850N4
RELAY: ELEC
FUEL PUMP



1140-006
RELAY: STARTER OLD
STYLE
(< March 99)

WIRE LEADS



0811-020F8
WIRE LEAD: HOBBS OIL SWITCH



0811-018
WIRE LEAD: COIL TO DIST
+ FILTER



0811-016
WIRE LEAD: COIL TO HARNESS
(Purple & Gray Wires)



0811-019
WIRE LEAD: IGNITION SHIFT
INTERRUPT



9000-001
TOOL: TIMING



0811-027
WIRE LEAD SET:
ELECTRIC FUEL
PUMP



1110-001
CLIP: IGNITION WIRE



1110-903
BOLT: LOOM SS SB

ENGINE HARNESSSES & EXTENSION HARNESSSES



1140-240N7
HARNESS: CARBURETED
3.0 - 8.2L



0947-003 HARNESS: 3 FT EXTENSION
0947-010 HARNESS: 10 FT EXTENSION
0947-016 HARNESS: 16 FT EXTENSION
0947-025 HARNESS: 25 FT EXTENSION
0947-035 HARNESS: 35 FT EXTENSION

INSTRUMENT PANEL & GAUGES



0945-000 PANEL: INSTRUMENT WITH GAUGES
0945-002 * GAUGE: WATER TEMP
0945-003 * GAUGE: VOLTMETER
0945-004 * GAUGE: TACHOMETER GAS
0945-005 * GAUGE: OIL PRESSURE
0945-015 GAUGE: FUEL
0945-476 GAUGE: HOUR METER

* Gauge Included With Panel



PRIMARY ENGINE HARNESS DIAGRAM

CARBURETED/ELECTRIC FUEL PUMP ENGINES
181 (SPORTPAC), 4.3, 5.7, 454, 502

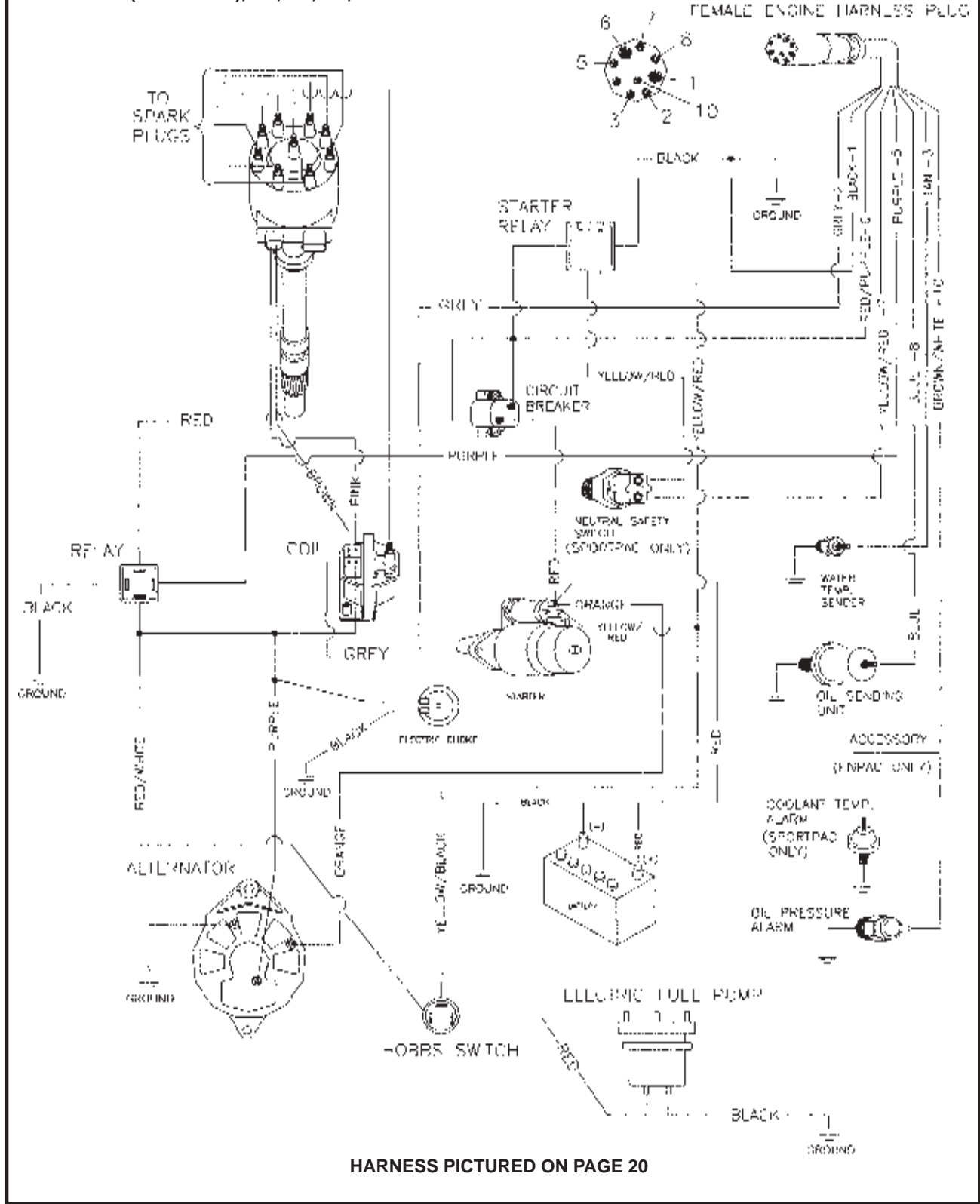

PANEL WIRING DIAGRAM

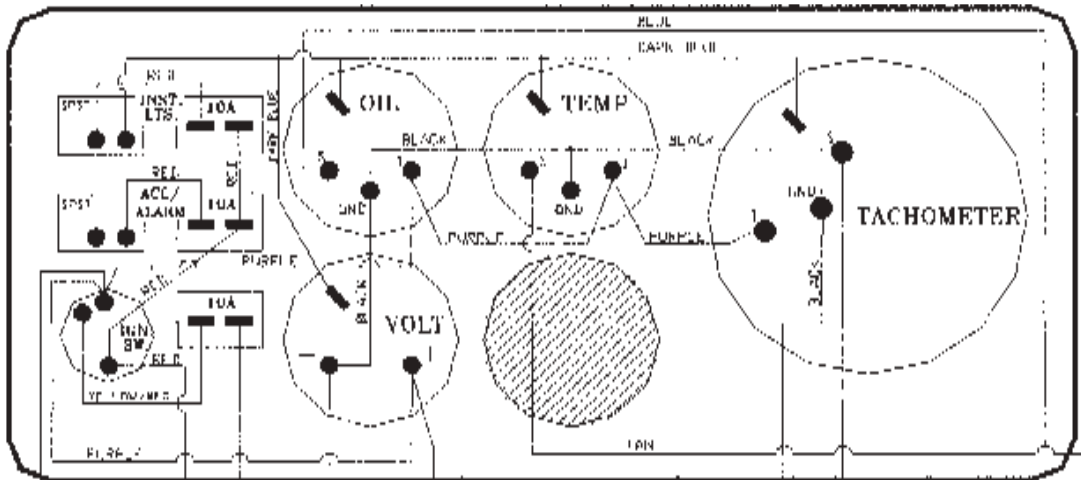

- NO.1 - 10 GA. BLACK
- NO.2 - 16 GA. GREY
- NO.3 - 14 GA. YELLOW/RED
- NO.4 - 16 GA. BROWN/WHITE

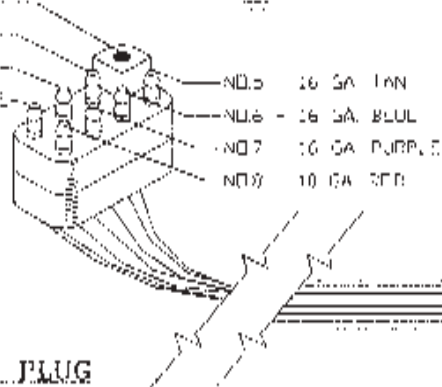

8X MOLDED MALE PLUG
7 PINS AND 1 SOCKET

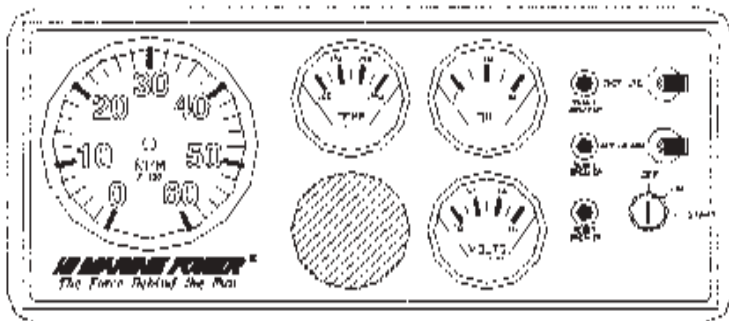

- 16 GA. TAN TEMPERATURE SENDER
- 16 GA. BLUE OIL SENDER
- 16 GA. PURPLE IGNITION
- 10 GA. RED BATTERY POSITIVE
- 10 GA. BLACK GROUND
- 16 GA. GREY TACHOMETER SENDER
- 14 GA. YELLOW/RED STARTER SOLENOID
- 16 GA. BROWN/WHITE ACCESSORY

PARTS LISTED ON PAGE 20

INITIAL TIMING JUMPER WIRING DIAGRAM

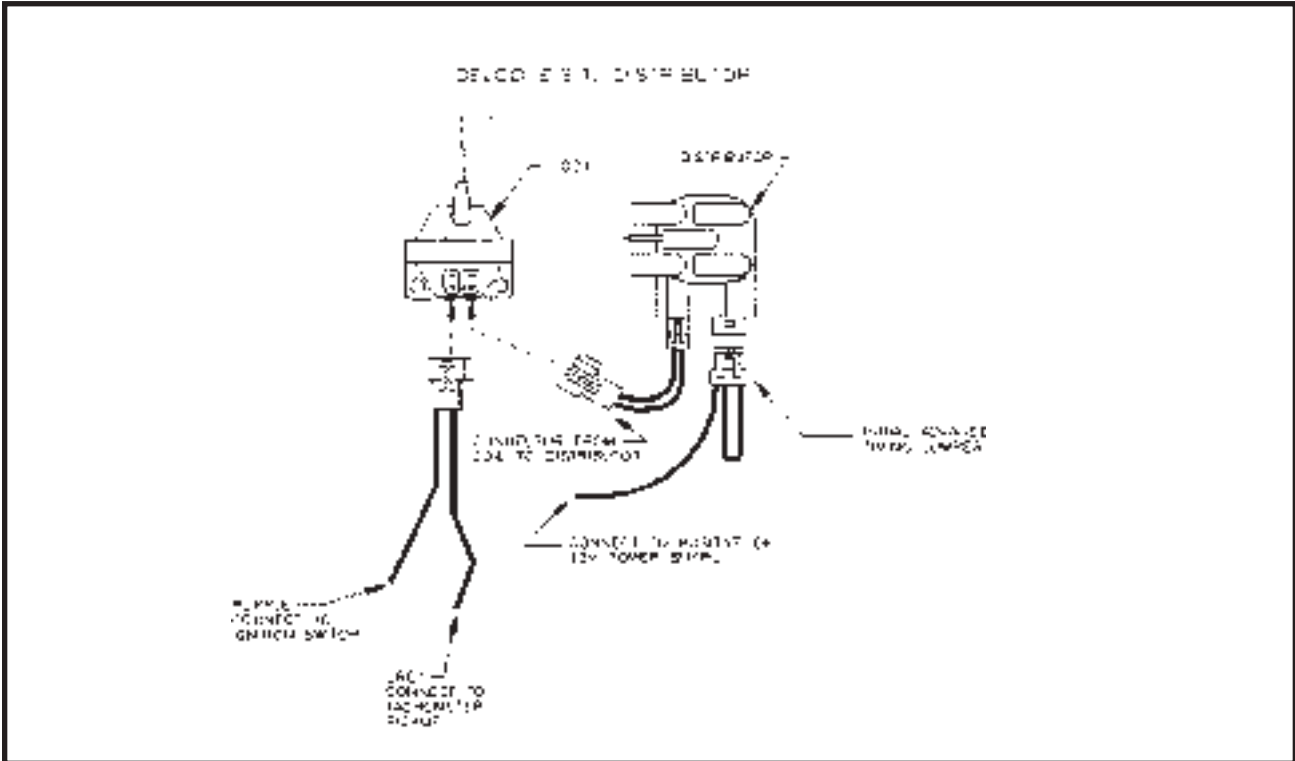

SHIFT ASSIST WIRING DIAGRAM

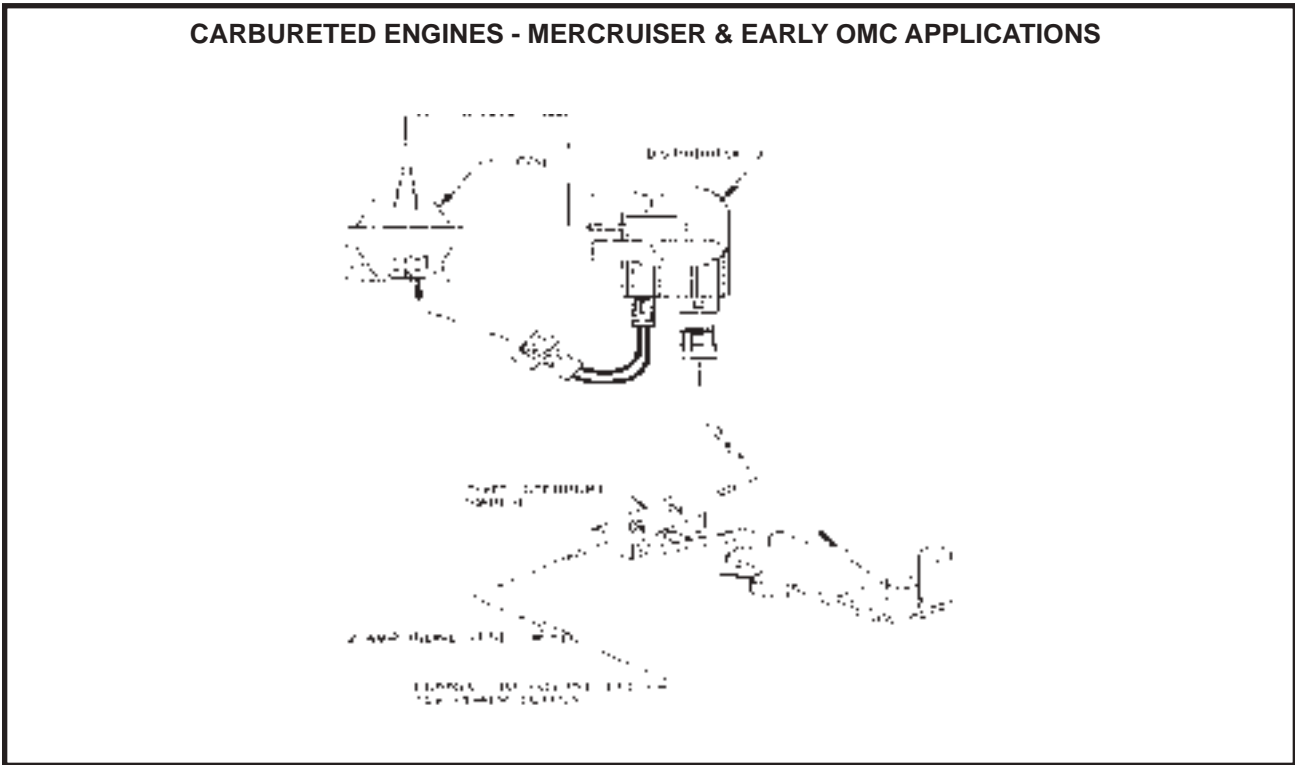

OMC SHIFT INTERRUPT DIAGRAM

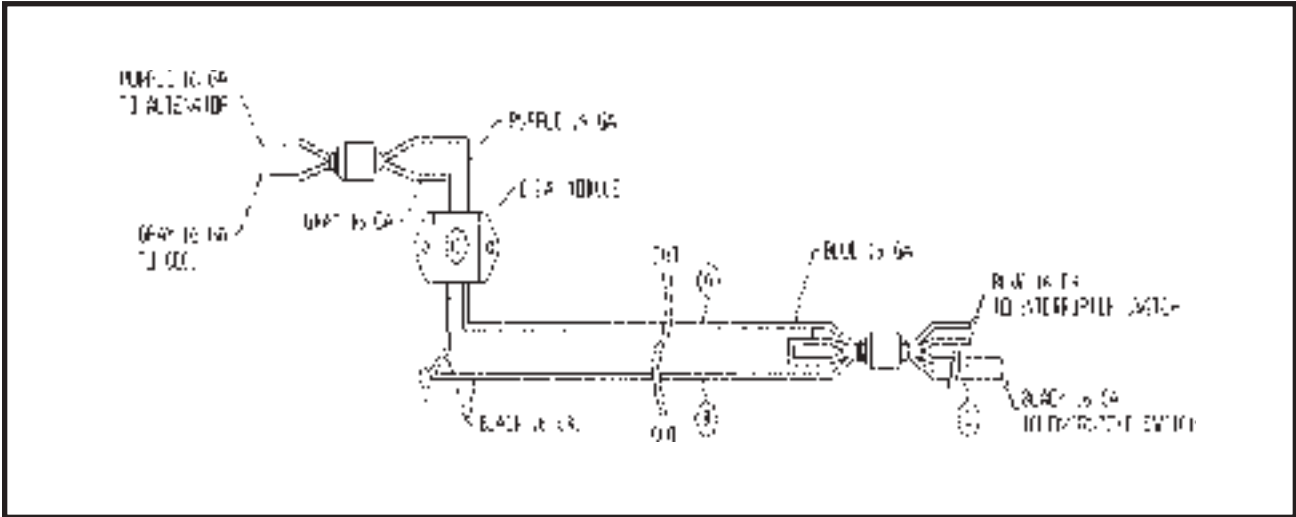

Installation Instructions:

1. Cut the blue 16 gauge wire (A) and connect to 12V positive supply when ignition switch is in the "ON" position with 2 amp in-line fuse.
2. Cut the black 16 gauge wire (B) and connect the shift interrupt wire on the engine. (Refer to Shift Cutout Wiring Diagram.)
3. Cut the black 16 gauge wire (C). The overstroke switch and the E.S.A. module are no longer used.



MARINE POWER MANIFOLDS & RISERS GROUP



0992-000
RISER: MP 3" IRON
0992-040
RISER: MP 4" IRON
0994-003
RISER: MP 3" ALUM
0994-004
RISER: MP 4" ALUM
0992-005
RISER: MP 4"
POLISHED ALUM



0992-300G5
GASKET: RISER MP
RAW WATER



0992-301G5
GASKET: RISER MP
FRESH WATER



0500-001
PLATE: BLOCK-OFF MP
(1 Required for FW)



0994-000
MANIFOLD: EXH MP
IRON 350 / 5.7
0994-538
MANIFOLD: EXH MP
ALUM 350 / 5.7
0994-537
MANIFOLD: EXH MP
POLISHED ALUM

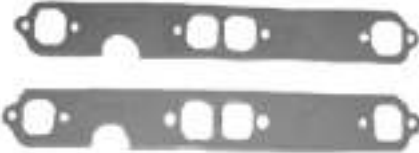

0994-600
GASKET: EXHAUST MANIFOLD 350/5.7V

BOLTS / WASHERS:
*B000-652 BOLT: MANIFOLD 3/8" X 3-1/4" NC STL
*BS00-616 BOLT: RISER RW 3/8" X 1" NC SS
*BS00-620 BOLT: RISER FW 3/8" X 1-1/4" NC SS
*WSL0-006 WASHER: LOCK 3/8" SS

FITTINGS:
0000-800H7 FITTING: BRASS STRAIGHT 3/4"
0000-815H7 FITTING: BRASS 90D 3/4"
0000-888 PLUG: 3/4" STEEL

MERC STYLE MANIFOLDS & RISERS GROUP



0992-400
RISER: MERC 4" IRON
0992-104
RISER: MERC 4" ALUM
0992-041
RISER: MERC 4"
CERAMIC



0992-310N4
GASKET: RISER
MERC SB/BB RW



0501-001N4
GASKET: RISER
BLOCK-OFF
SB/BB FW



0994-100
MANIFOLD: EXH MERC IRON
0994-538
MANIFOLD: EXH MERC ALUM



0992-660
SPACER: MERC 6"



0992-115
RISER: MERC C-R
15D



0992-635
SPACER: MERC 3"

BOLTS / WASHERS:
*B000-676 BOLT: MANIFOLD 3/8" X 4-3/4"
*B000-696 BOLT: RISER 3/8" X 6" NC STEEL
*W0L0-006 WASHER: LOCK 3/8" STEEL

FITTINGS:
0000-800H7 FITTING: BRASS STRAIGHT 3/4"
0000-815H7 FITTING: BRASS 90D 3/4"
0000-888 PLUG: 3/4" STEEL

MARINE POWER 2000 ALUMINUM MANIFOLDS & RISERS GROUP



0992-200P5
RISER: C-R MP 2000 FW
ALUM SB/BB
0992-210P5
RISER: C-R MP 2000 RW
ALUM SB/BB



0992-205P5
GASKET: RISER C-R
MP2000 RW/FW



0992-110P5
O-RING: RISER
MP2000
(2 REQUIRED)



0994-200P5
MANIFOLD: EXH 5.7 MP2000 FW
0994-210P5
MANIFOLD: EXH 5.7
MP 2000 RW



0992-215P5
HOSE: BYPASS
MP2000 RW



***SS38-200**
STUD: MANIFOLD MP2K 3/8" X 2"
***NSLO-006**
NUT: 3/8" LOCK NC SS

VOLVO STYLE (VR1) MANIFOLDS & RISERS GROUP



0999-773
RISER: VOLVO C-R RW
VR1 350 / 5.7
0999-776
RISER: VOLVO C-R FW



0999-774
GASKET: RISER
VOLVO VR1



0506-774
PLATE: BLOCK-OFF
VOLVO VR1



0999-772
MANIFOLD: EXHAUST
VOLVO VR1 350 / 5.7

| BOLTS / WASHERS: | | FITTINGS: | |
|-------------------------|-------------------------------------|------------------|-------------------------|
| *B000-680 | BOLT: MANIFOLD 3/8" X 5" NC STEEL | 0000-800H7 | FITTING: BRASS STR 3/4" |
| *BSC0-540 | BOLT: RISER 5/16" X 2-1/2" CAD | 0000-815H7 | FITTING: BRASS 90D 3/4" |
| *B000-584 | BOLT: RISER 5/16" X 5-1/4" NC STEEL | 0000-888 | PLUG: 3/4" STEEL |
| *W0L0-005 | WASHER: LOCK 5/16" STEEL | 0000-895 | PLUG: 1/2" BRASS |

VOLVO STYLE (VR2) MANIFOLDS & RISERS GROUP



0999-777
RISER: VOLVO C-R VR2
350 / 5.7



0999-778
GASKET: RISER
VOLVO VR2



0999-779
PLATE:
BLOCK-OFF
VOLVO VR2



0999-775
MANIFOLD: EXHAUST
VOLVO VR2
350 / 5.7

| BOLTS / WASHERS: | | FITTINGS: | |
|-------------------------|---------------------------------------|------------------|-------------------------|
| *B000-650 | BOLT: MANIFOLD 3/8" X 4-1/4" NC STEEL | 0000-815H7 | FITTING: BRASS STR 3/4" |
| *B000-750 | BOLT: RISER 3/8" X 7-1/2" NC STEEL | 0000-800H7 | FITTING: BRASS 90D 3/4" |
| *W0L0-006 | WASHER: LOCK 3/8" STEEL | 0000-888 | PLUG: 3/4" STEEL |

ROCHESTER CARBURETOR



0702-280
 CARBURETOR: ROCHESTER
 QUADRAJET
0702-100G4
 KIT: CARB REBUILD ROCH



0430-000
 FUEL LINE: MECH FUEL PUMP TO
 CARB 350



0430-054F9
 FUEL LINE: SEPARATOR TO
 PUMP 350 REAR STBD



0700-002
 GASKET: CARB
 ROCHESTER



0950-100
 COVER: WEATHER
***SS00-464**
 STUD: WEATHER COVER ROCH
 WITH / WING NUT



0430-053F9
 FUEL LINE: SEPARATOR TO PUMP
 350 REAR PORT



0699-001
 WEDGE PLATE: ROCHESTER
 14 DEGREES



0307-010
 THERMOCHOKE KIT: 350 / 5.7V



0430-051
 FUEL LINE: SEPARATOR TO PUMP
 350 FRONT PORT



0951-200G2
 FLAME ARRESTOR: CARB
 181/V6/5.7

ELECTRIC FUEL PUMP & BRACKETS



0303-016F1
 PUMP: ELECTRIC FUEL
0303-018F4
 KIT: MOUNTING ELECTRIC
 FUEL PUMP



0730-278N2
 BRACKET: FUEL PUMP
 LOW PRESSURE



0730-282N2
 BRACKET: FUEL/WATER
 SEPARATOR

FUEL/WATER



0307-016
 PUMP: FUEL 350
 MECHANICAL



0432-048
 BASE: FUEL/WATER
 SEPARATOR FILTER



0432-049
 FILTER: FUEL/WATER
 SEPARATOR

HOLLEY CARBURETORS



0701-416
CARBURETOR: 5.7 HOLLEY
UNIVERSAL
(REQUIRES 0000-855 FUEL INLET FITTING)
0701-420
KIT: CARB REBUILD
FOR 80551 & R-75009-2AZ
HOLLEY 4160 600CFM



0701-416N3
CARBURETOR: 5.7 HOLLEY
OEM STYLE
0701-420
KIT: CARB REBUILD
FOR 80551 & R-75009-2AZ
HOLLEY 4160 600CFM



0416-003P12
FUEL LINE: CARB - PUMP
UNIVERSAL CARB



0416-101N3
FUEL LINE: CARB - PUMP
OEM CARB



0430-004
FUEL LINE: FUEL PUMP - SEP FRONT
MOUNT - UNIVERSAL & OEM CARB

INTAKE MANIFOLDS



0017-275N11
MANIFOLD: INTAKE 5.7
WITHOUT BRASS FW
0017-276N11
MANIFOLD: INTAKE 5.7
WITH BRASS RW



0017-277P1
MANIFOLD: INTAKE 5.7
CAST IRON

GASKETS & WEDGE PLATE

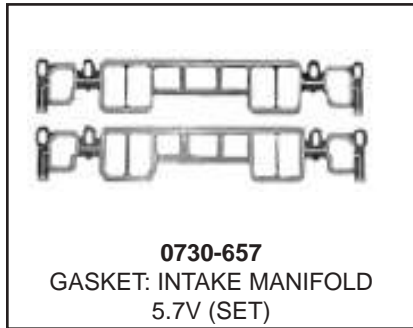

ELECTRIC FUEL PUMP



MISCELLANEOUS

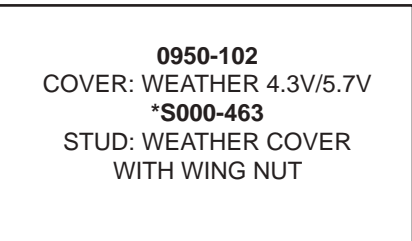

BRACKETS

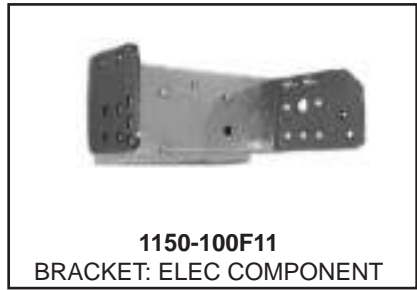

MISCELLANEOUS

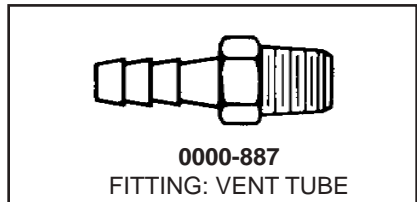

MISCELLANEOUS



0000-00108
CLIP: CONTROL CABLE
SINGLE



0000-001
CLAMP: CONTROL CABLE
CLIP



0000-002
CLIP: CONTROL CABLE
DUAL



0000-003
PIN: CONTROL CABLE
EYE



0000-004
EYE: CONTROL CABLE



0000-006
BALL JOINT: CONTROL
CABLE



0701-003N2
VALVE: PCV HOLLEY
CARB SB

FUEL PUMP KITS

0430-017
KIT: ELECTRIC FUEL PUMP HOLLEY 4160 5.7V
Designed to Fit Holley Carburetor 4160 Model 80551
Includes: Electric Fuel Pump, Fuel Pump Mounting Kit, Brackets,
Fuel/Water Separator Base & Filter, Fuel Lines, Fittings, Bolts, Etc.

0430-022
KIT: ELECTRIC FUEL PUMP HOLLEY UNIVERSAL
Designed to Fit Holley Carburetor Model 75009
Includes: Electric Fuel Pump, Fuel Pump Mounting Kit, Brackets,
Fuel/Water Separator Base & Filter, Fuel Lines, Fittings, Bolts, Etc.



THROTTLE BODY

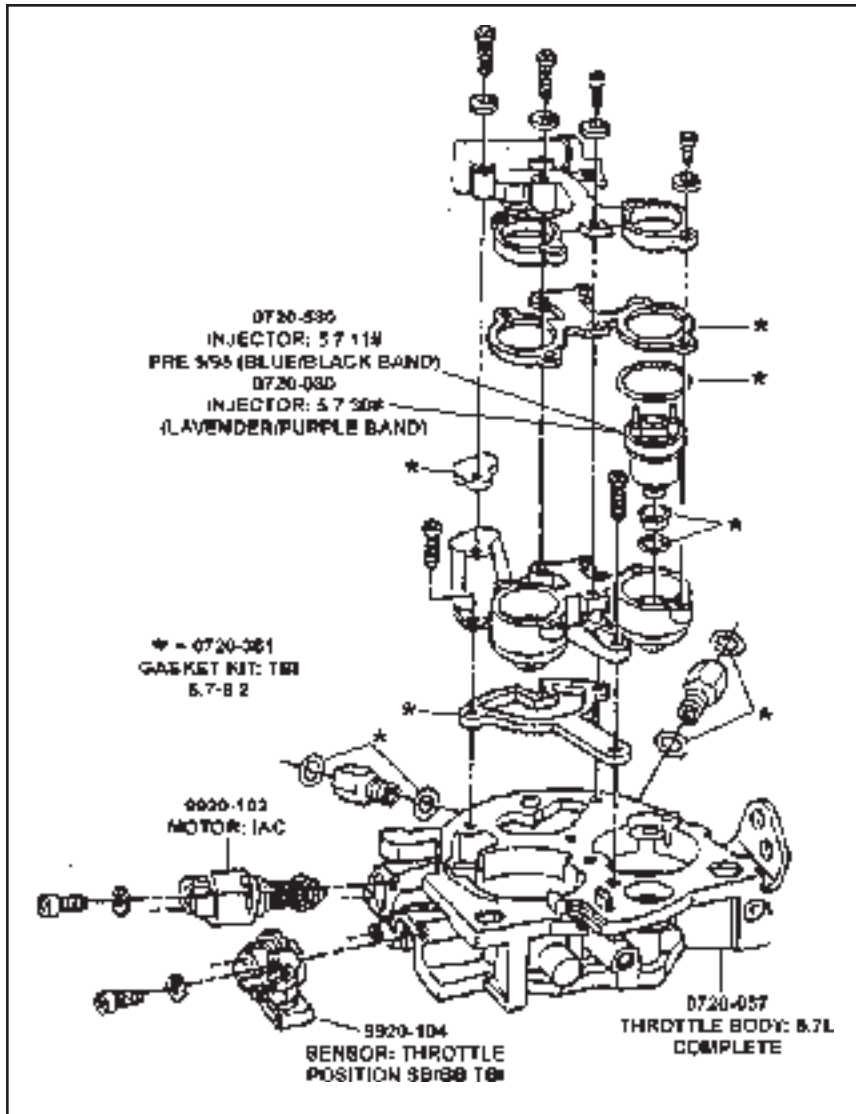

INTAKE



FUEL LINES



GASKETS

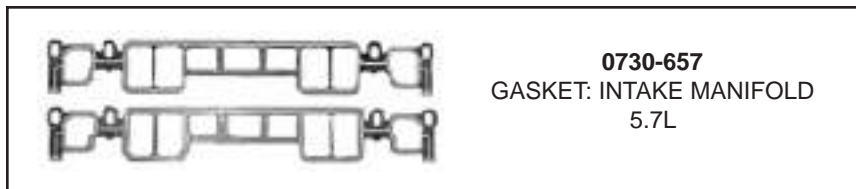

BRACKETS



0720-220
BRACKET: MAP SENSOR EFI



0720-279
BRACKET: THROTTLE 5.7L-7.4 TBI



0720-289N4
BRACKET: ECM TBI 5.7-7.4



0730-103N2
BRACKET: HI-PRESS PUMP
EFI



0730-278N2
BRACKET: LOW PRESSURE
FUEL PUMP



0730-282N2
BRACKET: FUEL/WATER
SEPARATOR-ALL MODELS



1150-100F11
BRACKET: ELEC
COMPONENT

HARNESSES



0806-824N5
HARNESSES: TBI 5.7



1140-334P8
HARNESSES: PRIMARY ENGINE
EFI >8/99

REFER TO PAGES 40 & 41 FOR WIRING HARNESS DIAGRAM

FUEL PUMPS



0303-016F1
PUMP: ELEC FUEL PUMP
7PSI



0730-016
PUMP: FUEL EFI 5.7-8.2

ELECTRICAL



0806-005
SENSOR: KNOCK 5.7
EFI/MSTS



0806-020F12
SENSOR: MAP ALL
EFI/MSTS (MEFI 1 &2)



0806-015
MODULE: KNOCK
5.7



0806-010F12
SENDER: TEMP
EFI/MSTS



0806-599
MODULE: ECM EFI #2
MEFI 1

Order This ECM To
Replace The Following ECM:
Model #: 16220371 or
Model #: 16189069
The #16189069 ECM has offset
hole pattern - it will require drilling
additional hole to fit replacement
ECM bolt pattern.



0806-596
MODULE: ECM EFI #3
MEFI 2

Order This ECM To
Replace The Following ECM:
Model #: 16210729



0806-600
MODULE: ECM >98 #4
MEFI 3 / MEFI 4

Order This ECM To
Replace The Following ECM:
Model #: 16237009

NOTE:
BEFORE ORDERING ECM MODULE, THE PROGRAM NUMBERS THAT
ARE RECORDED ON THE BACK OF THE ECM WILL BE REQUIRED TO
CORRECTLY PROGRAM REPLACEMENT MODULE.

MISCELLANEOUS



0432-048
BASE: FILTER FUEL/WATER
SEPARATOR



0432-049
FILTER: FUEL/WATER SEPA-
RATOR



0702-285
PLATE: ADAPTER TBI



0950-102
COVER: WEATHER VORTEC



0950-824
COVER: WEATHER EFI
NON-VORTEC



0720-000
FLAME ARRESTOR: 8" TBI

MISCELLANEOUS - Continued



0720-560
INJECTOR KIT: 5.7 11#
PRE 5/95 SER#15681 & BEFORE
BLUE/BLACK BAND



0720-080
INJECTOR KIT: 5.7 30#
AFTER SER#15682
LAVENDER/PURPLE BAND



0720-490
FILTER: FUEL IN-LINE EFI



0806-998
CODE MATE



0720-601
SEAL: TBI O-RING FUEL FEED
LARGE



0720-602
SEAL: TBI-O-RING FUEL RETURN
SMALL



0720-900
BOLT: TBI MOUNTING
(3 REQUIRED)



0730-957
BOLT: INTAKE MANIFOLD
(8 REQUIRED)



0080-650
GROMMET: HI-PRESS PUMP

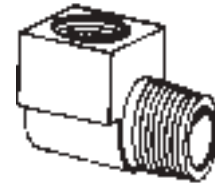

0000-882
FITTING: FUEL PUMP OUT
V6/V8

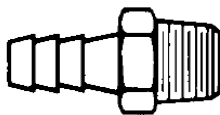

0000-887
FITTING: VENT HOSE



0720-806
FITTING: EFI FUEL PUMP
VAPOR 90D

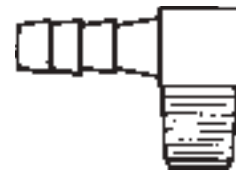

0720-851
FITTING: 1/4" NPT X 3/8" HOSE
BRASS 90D



0720-889
FITTING: 1/4" NPT X 1/4" NPT
F/M EL



0000-893
PLUG: PIPE 1/4" HEX HEAD

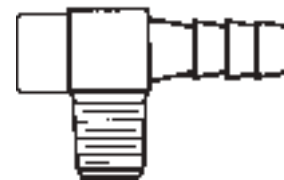

0720-455
FITTING: EFI RETURN "T"

PFI THROTTLE BODY

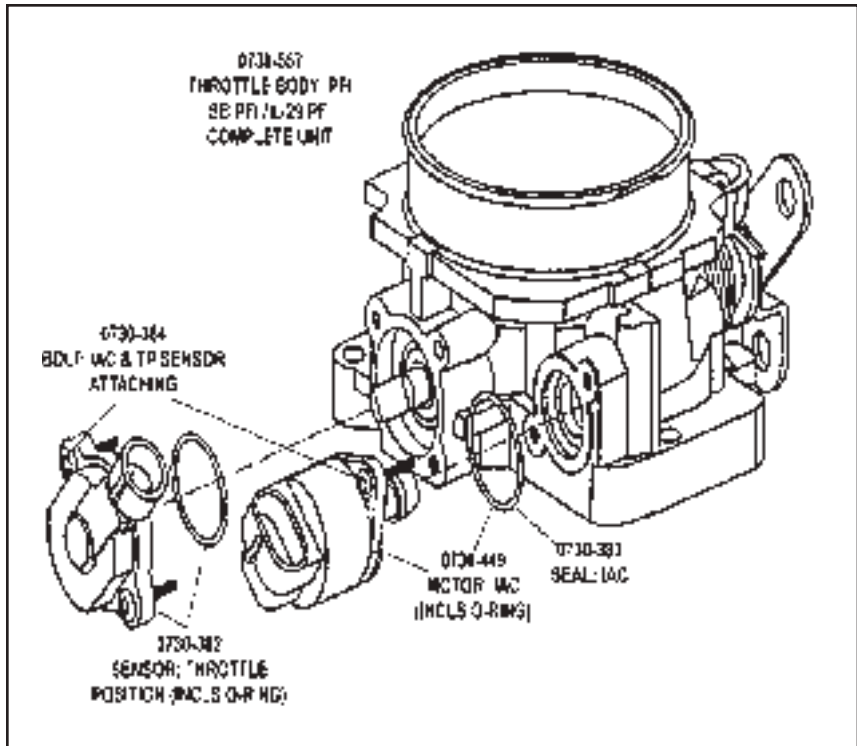

FUEL LINES



INTAKE



GASKETS

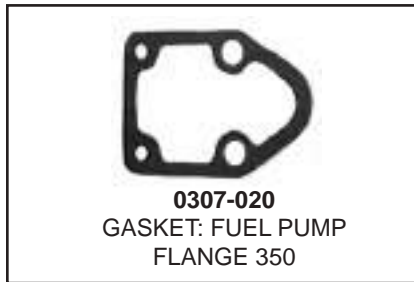

BRACKETS



HARNESSES

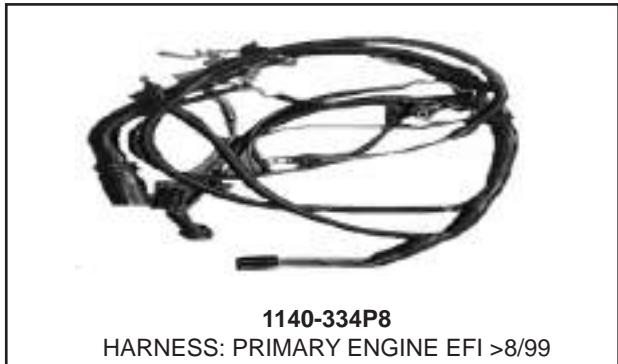

REFER TO PAGES 40 & 41 FOR WIRING HARNESS DIAGRAM

FUEL PUMPS

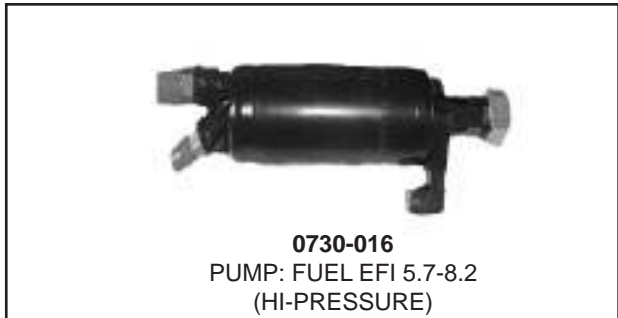
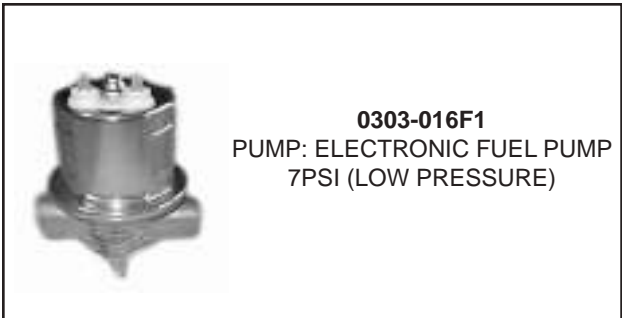

ELECTRICAL



0806-005
SENSOR: KNOCK 5.7 EFI/MSTS



0806-057
SENSOR: MAP 5.7 PFI



0806-010F12
SENDER: TEMP EFI/MSTS



0806-599
MODULE: ECM EFI #2
MEFI 1

Order This ECM To
Replace The Following ECM:
Model #: 16220371 or
Model #: 16189069
The #16189069 ECM has offset
hole pattern - it will require drilling
additional hole to fit replacement
ECM bolt pattern.



0806-596
MODULE: ECM EFI #3
MEFI 2

Order This ECM To
Replace The Following ECM:
Model #: 16210729



0806-600
MODULE: ECM >98 #4
MEFI 3 / MEFI 4

Order This ECM To
Replace The Following ECM:
Model #: 16237009

NOTE:
BEFORE ORDERING ECM MODULE, THE PROGRAM NUMBERS THAT
ARE RECORDED ON THE BACK OF THE ECM WILL BE REQUIRED TO
CORRECTLY PROGRAM REPLACEMENT MODULE.

HOSES



0700-125
HOSE: FUEL/VENT 1/8"
(Per Ft)



0730-427
HOSE: 5.7 PFI PRESSURE
REGULATOR ASSM



HHTO-010
HOSE: HEATER 5/8"
(Per Ft)



0730-457
HOSE: CRANKCASE VENT
5.7 PFI

MISCELLANEOUS



FITTINGS - PLUGS - BOLTS - ETC

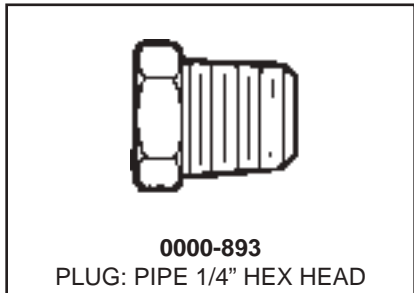
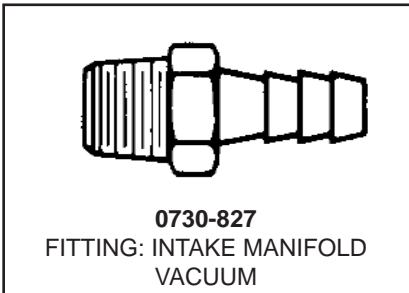
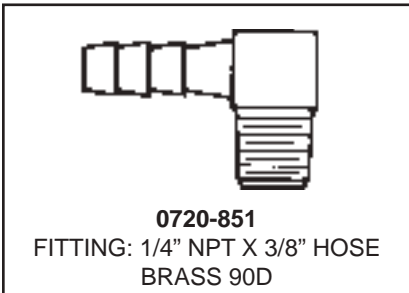
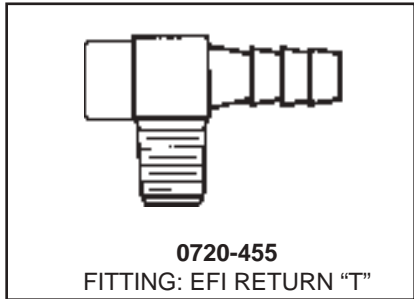
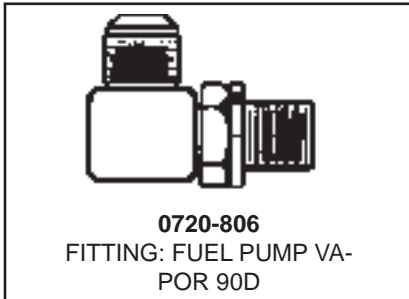
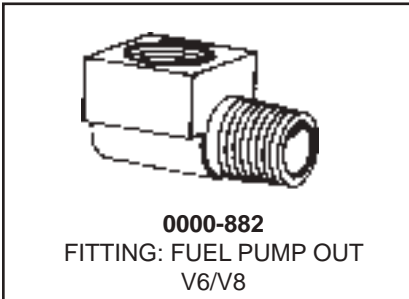
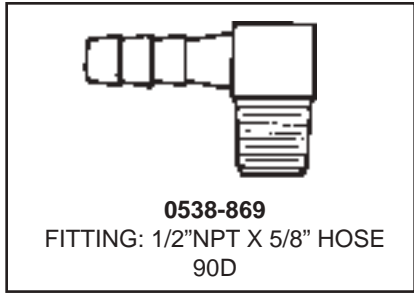
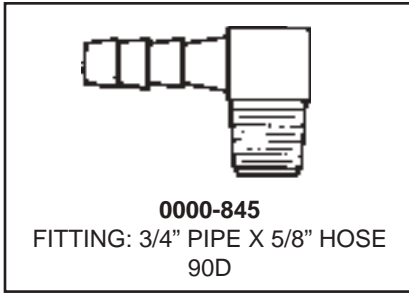
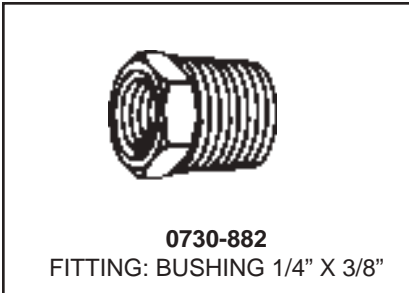

FITTINGS - PLUGS - BOLTS - ETC

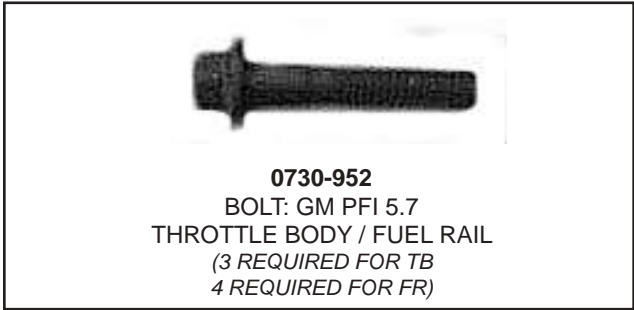

///MARINEPOWER™
The Force Behind The Fun.™

EFI PRIMARY WIRING HARNESS

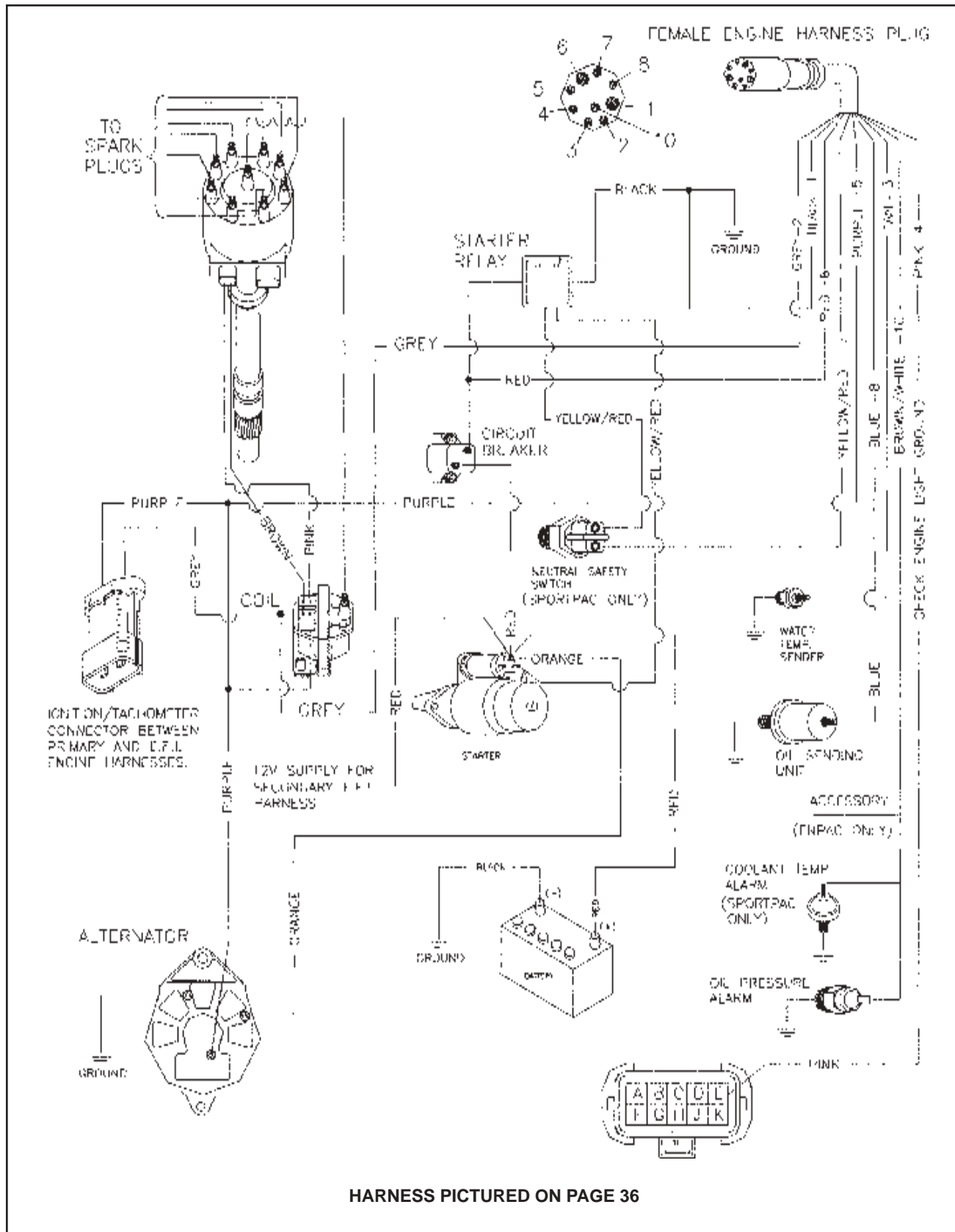

EFI SECONDARY WIRING HARNESS

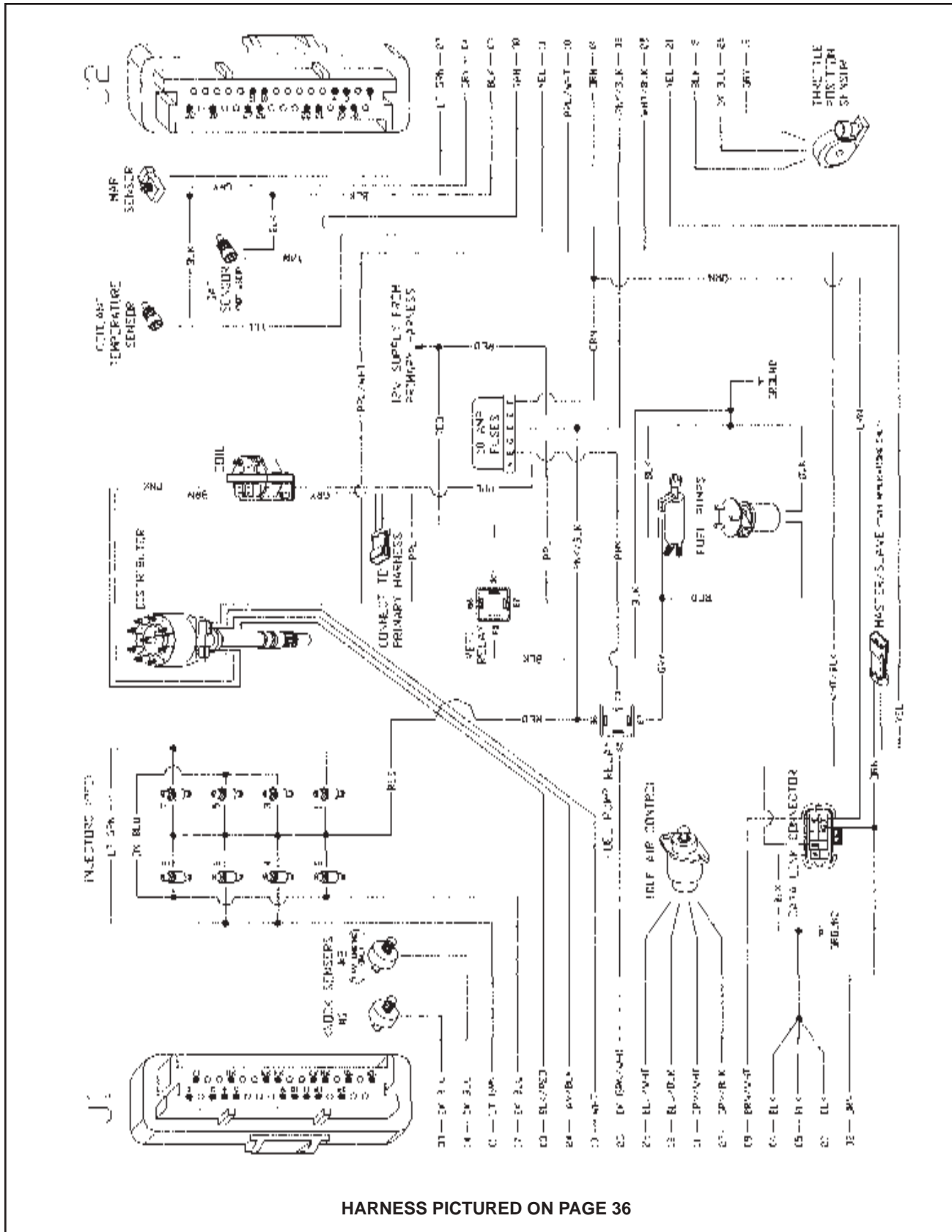

SHIFT INTERRUPT DIAGRAM

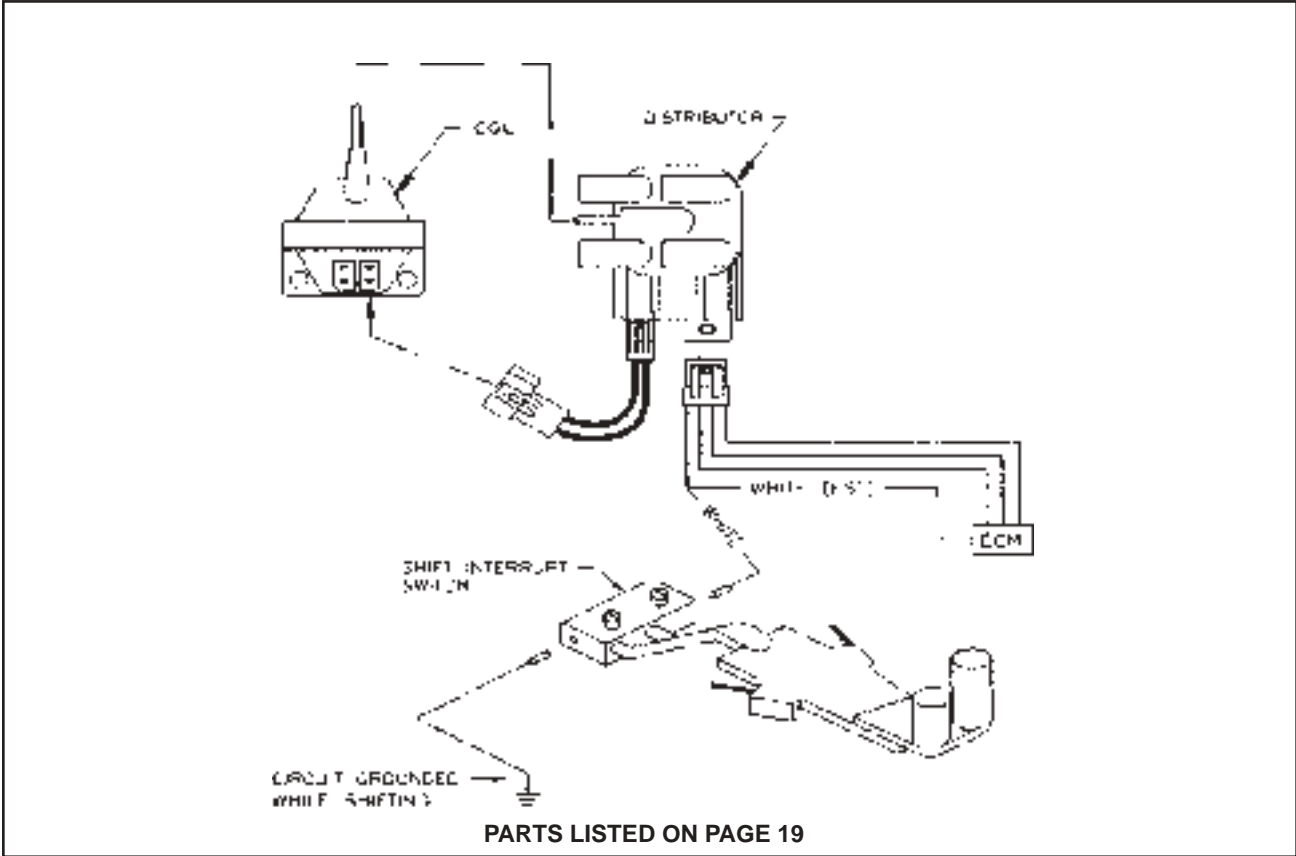

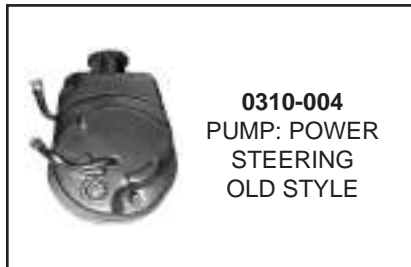

POWER STEERING DIAGRAM

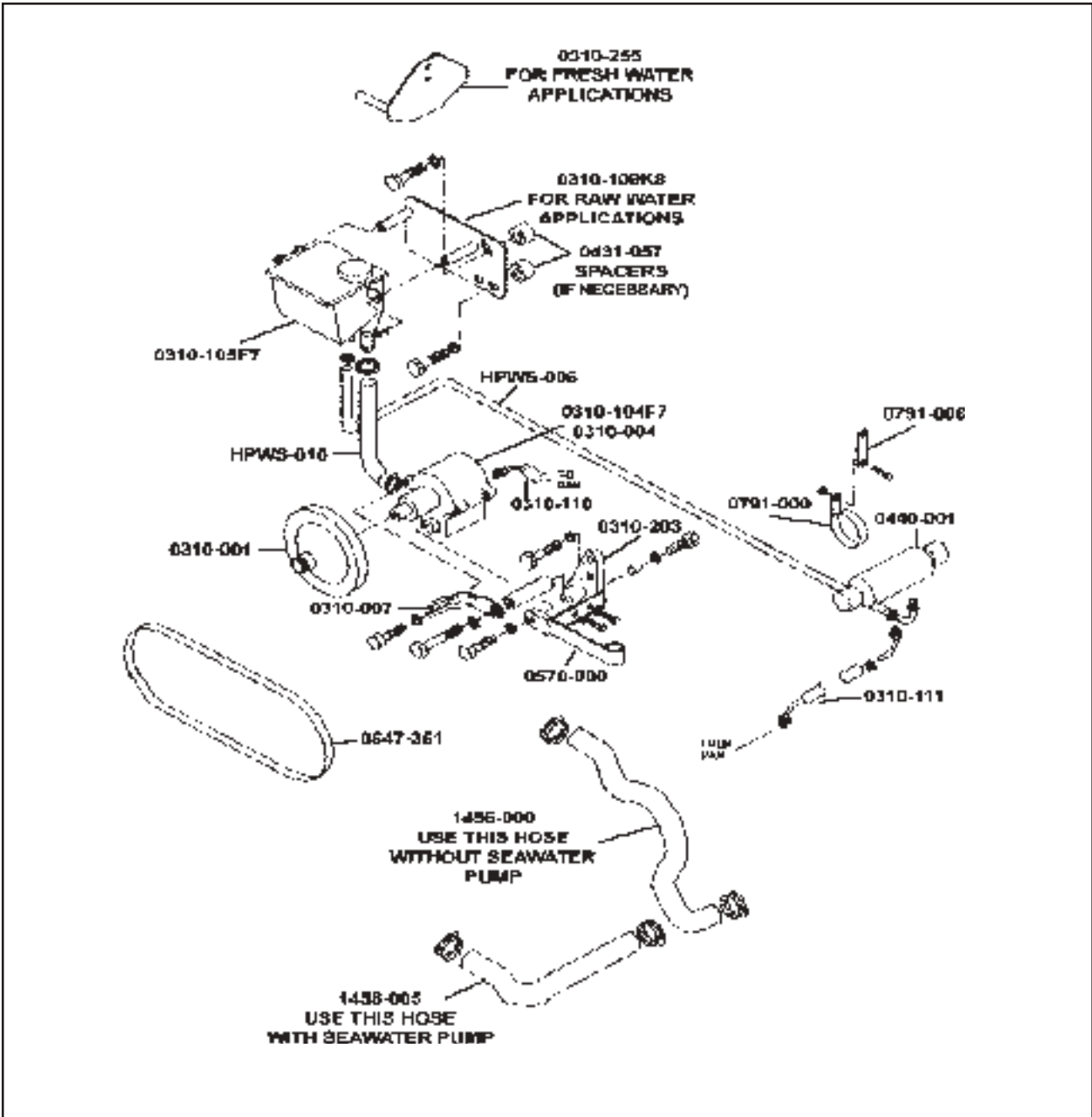

**#0310-350
KIT: POWER STEERING RAW WATER 5.7
#0311-350
KIT: POWER STEERING FRESH WATER 5.7**

**NOTE: MARINE POWER POWER STEERING KIT WILL NOT RETROFIT
ON MERCUISER APPLICATIONS WITH FRESH WATER COOLING**

ENGINE MOUNTS



GEAR MOUNTS



**NOTE: THE GEAR MOUNTS LISTED ARE MOUNTS CURRENTLY IN USE.
PLEASE CALL FOR PRICING AND AVAILABILITY ON PREVIOUSLY USED MOUNTS.**

MISCELLANEOUS



TRANSMISSIONS

VELVET DRIVE DIRECT DRIVE



6017-004
GEAR: 71C 1:1
6018-002
GEAR: 72C 1:1

VELVET DRIVE 5000C SERIES



6020-001
GEAR: 5000C 1:1
6020-002
GEAR: 5000C 1.25:1
6020-003
GEAR: 5000C 1.5:1
6020-004
GEAR: 5000C 2.0:1
6020-005
GEAR: 5000C 2.5:1
6020-006
GEAR: 5000C 2.8:1

HURTH DIRECT DRIVE



6450-100
GEAR: 450D 1:1

VELVET DRIVE 72C SERIES



6018-004
GEAR: 72C 1.5:1
6018-106
GEAR: 72C 1.88:1
6018-210
GEAR: 72C 2.1:1
6018-010
GEAR: 72C 2.5:1
6018-012
GEAR: 72C 2.9:1

HURTH



6450-125
GEAR: 450A 1.25:1
6450-150
GEAR: 450A 1.5:1
6450-200
GEAR: 450A 2.0:1

VELVET DRIVE 72C V-DRIVE SERIES



6005-012
GEAR: 72C V-DRIVE 1.2:1
GEAR DRIVEN
6005-013
GEAR: 72C V-DRIVE 1.2:1
CHAIN DRIVEN
6005-010
GEAR: 72C V-DRIVE 1.5:1
CHAIN DRIVEN
6005-011
GEAR: 72C V-DRIVE 1.5:1
GEAR DRIVEN
6005-002
GEAR: 72C V-DRIVE 1.9:1
GEAR DRIVEN
6005-003
GEAR: 72C V-DRIVE 1.9:1
CHAIN DRIVEN
6005-004
GEAR: 72C V-DRIVE 2.5:1
CHAIN DRIVEN
6005-005
GEAR: 72C V-DRIVE 2.5:1
GEAR DRIVEN

HURTH V-DRIVE



6635-130
GEAR: 630V 1.3:1
6635-150
GEAR: 630V 1.6:1
6635-210
GEAR: 630V 2.0:1
6635-250
GEAR: 630V 2.5:1

VELVET DRIVE 5000V V-DRIVE SERIES



6002-002
GEAR: 5000V 1.25:1
6002-003
GEAR: 5000V 1.5:1
6002-004
GEAR: 5000V 2.0:1
6022-005
GEAR: 5000V 2.5:1

NOTE:
SOME TRANSMISSIONS LISTED MAY NOT BE AN IN-STOCK ITEM. LEAD TIMES MAY APPLY TO CERTAIN TRANSMISSIONS. CALL FOR AVAILABILITY.

GEAR LINES, COOLER, SWITCHES & FITTING



1256-037F8
GEAR LINE: 37" SPORTPAC
1256-042F8
GEAR LINE: 42" SPORTPAC
1250-003E3
GEAR LINE: 45" SPORTPAC



0440-549G3
COOLER: DUAL 5 X 9 GEAR



0000-899
FITTING: OIL / GEAR
COOLER



6640-005
SWITCH: NEUTRAL SAFETY



6450-204
SWITCH: GEAR ALARM
HI-TEMP OIL

SHIFT BRACKETS



1194-630
BRACKET: SHIFT HURTH 630A



1194-500J12
BRACKET: SHIFT BW5000



1194-000
BRACKET: SHIFT GEAR BW
71C/72C

/// MARINEPOWER™
The Force Behind The Fun.™

MARINE POWER 5.7 VORTEC PARTS BOOK ALPHABETICAL LISTING

| PART NUMBER | DESCRIPTION | PAGE NUMBER(S) |
|-------------|--|----------------|
| 0105-000 | ADAPTER: CONE BERKLEY STYLE | 5 |
| 0007-042 | ADAPTER: OIL BYPASS | 2, 8 |
| 1210-000E7 | ALTERNATOR: 51 AMP | 18 |
| 0007-120 | ARM KIT: ROCKER W/ARM, BALL, NUT | 4 |
| 0007-250 | BAFFLE: OIL PAN 350/5.7V | 2 |
| 0007-004 | BALANCER: HARMONIC 350 | 2 |
| 0017-004 | BALANCER: HARMONIC 5.7V | 2 |
| 0000-006 | BALL JOINT: CONTROL CABLE | 30 |
| 0900-100 | BASE: DUAL OIL | 8 |
| 0432-048 | BASE: FUEL/WATER SEPARATOR FILTER | 27, 29, 33, 38 |
| 0900-001 | BASE: SINGLE OIL | 8 |
| 0505-009 | BASE: T-STAT HOUSING FWS REAR MT SB | 9 |
| 0017-090 | BEARING: CAMSHAFT #1 350/5.7V | 2 |
| 0017-091 | BEARING: CAMSHAFT #2, #5 350/5.7V | 2 |
| 0017-092 | BEARING: CAMSHAFT #3, #4 350/5.7V | 2 |
| 0007-038 | BEARING: CONNECTING ROD 181/350/5.7V | 2 |
| 0017-189 | BEARING: CRANKSHAFT #1, 2, 3, 4 5.7V 96> | 2 |
| 0009-440 | BEARING: CRANKSHAFT #1, 2, 3, 4 SB 91-95 | 2 |
| 0017-191 | BEARING: CRANKSHAFT #5 5.7V 96> | 2 |
| 0009-009 | BEARING: CRANKSHAFT #5 SB 91-95 | 2 |
| 0563-009 | BEARING: SEAWATER PUMP JOHNSON F5B/F6B | 13 |
| 0102-538 | BELLHOUSING: CAL JET 14" TOP MT | 5 |
| 0100-000 | BELLHOUSING: INBOARD GAS | 5 |
| 0545-350 | BELT: ALTERNATOR SB | 18 |
| 0547-351 | BELT: POWER STEERING SB | 43 |
| 0053-043 | BOLT: CAMSHAFT RETAINER 350/5.7V/BB | 2 |
| 0025-266 | BOLT: CAMSHAFT SPROCKET | 2 |
| 0007-066 | BOLT: CONNECTING ROD 350/5.7V | 2 |
| 0007-961 | BOLT: CRANK REAR OIL SEAL RETAINER | 2 |
| 0009-961 | BOLT: CRANK REAR OIL SEAL RETAINER | 2 |
| 0011-154 | BOLT: CRANKSHAFT BEARING CAP | 2 |
| 0007-027 | BOLT: CYLINDER HEAD LONG 350/5.7V | 4 |
| 0007-028 | BOLT: CYLINDER HEAD MEDIUM 350/5.7V | 4 |
| 0007-029 | BOLT: CYLINDER HEAD SHORT 350/5.7V | 4 |
| 0017-002 | BOLT: HARMONIC BALANCER | 2 |
| 0730-384 | BOLT: IAC & TP SENSOR ATTACHING | 35 |
| 0730-957 | BOLT: INTAKE MANIFOLD 5.7V | 34, 39 |
| 1110-903 | BOLT: LOOM SS SB | 19 |
| 0000-032 | BOLT: OIL FILTER ADAPTER | 2 |
| 0730-951 | BOLT: PFI FUEL PRESSURE REGULATOR | 39 |
| 0730-952 | BOLT: PFI THROTTLE BODY GM 5.7 | 39 |
| 0720-900 | BOLT: TBI MOUNTING | 34 |
| 0007-958 | BOLT: TIMING COVER 350 | 2 |
| 0017-958 | BOLT: TIMING COVER 5.7V | 2 |
| 0009-107 | BOLT: VALVE COVER 262/350/5.7V | 4 |
| 0509-101F4 | BOTTLE: RECOVERY | 10 |
| 1184-000 | BRACKET: ALTERNATOR SUPPORT SB | 18 |
| 0407-200 | BRACKET: DIPSTICK TUBE | 7 |
| 0901-538 | BRACKET: DUAL OIL BASE CAL JET | 8 |
| 0901-350 | BRACKET: DUAL OIL BASE SB / NW JET | 8 |

MARINE POWER 5.7 VORTEC PARTS BOOK ALPHABETICAL LISTING

| PART NUMBER | DESCRIPTION | PAGE NUMBER(S) |
|-------------|---------------------------------------|----------------|
| 0901-350 | BRACKET: DUAL OIL BASE SB / NW JET | 8 |
| 0720-289N4 | BRACKET: ECM TBI 5.7-7.4 | 32 |
| 1150-100F11 | BRACKET: ELEC COMPONENT | 29, 32 |
| 0730-284N5 | BRACKET: ELECT COMPONENT PFI 5.7 | 36 |
| 0730-282N2 | BRACKET: FUEL/WATER SEPARATOR | 27, 29, 32, 36 |
| 0506-115F6 | BRACKET: FW FRONT MOUNT LH SB | 10 |
| 0506-114F6 | BRACKET: FW FRONT MOUNT RH SB | 10 |
| 0505-014 | BRACKET: FW REAR MOUNT LH SB | 10 |
| 0505-015 | BRACKET: FW REAR MOUNT RH SB | 10 |
| 1440-001 | BRACKET: GEAR COOLER TWIST | 8 |
| 0730-103 | BRACKET: HI-PRESSURE PUMP | 36 |
| 0730-103N2 | BRACKET: HI-PRESSURE PUMP EFI | 32 |
| 0720-288 | BRACKET: INTAKE Z / ELEC COMPONENT | 29 |
| 0009-700F10 | BRACKET: LIFT FRONT SB | 14 |
| 0053-700F10 | BRACKET: LIFT REAR LONG | 14 |
| 0053-701F10 | BRACKET: LIFT REAR SHORT | 14 |
| 0053-702 | BRACKET: LIFT REAR TBI SB/BB | 14 |
| 0028-701 | BRACKET: LIFT SB VORTEC RW | 14 |
| 0730-278N2 | BRACKET: LOW PRESSURE FUEL PUMP | 27, 29, 32, 36 |
| 0720-220 | BRACKET: MAP SENSOR EFI | 32 |
| 9902-152 | BRACKET: MAP SENSOR SMALL | 36 |
| 0791-006 | BRACKET: OIL COOLER 6" | 8, 43 |
| 0730-284B | BRACKET: PFI RELAY GM | 36 |
| 0570-000 | BRACKET: POWER STEERING - SEAPUMP | 43 |
| 0310-007N3 | BRACKET: POWER STEERING / TENSION | 43 |
| 0310-203 | BRACKET: POWER STEERING PUMP MOUNTING | 43 |
| 0509-102 | BRACKET: RECOVERY BOTTLE MOUNTING | 10 |
| 0310-255 | BRACKET: RESERVOIR FRESH WATER | 43 |
| 0310-109K8 | BRACKET: RESERVOIR RAW WATER | 43 |
| 0573-000 | BRACKET: SEAWATER PUMP SB | 12 |
| 1194-500J12 | BRACKET: SHIFT BW 5000 GAS | 47 |
| 1194-000 | BRACKET: SHIFT BW 71/72C | 47 |
| 1194-630 | BRACKET: SHIFT HURTH 630A | 47 |
| 1185-000 | BRACKET: TENSION ARM SB/BB | 18 |
| 0720-279 | BRACKET: THROTTLE 5.7L-7.4L TBI | 32 |
| 0730-882 | BUSHING: 1/4" X 3/8" | 38 |
| 0000-847 | BUSHING: 3/4 X 1/4 | 14 |
| 0572-001 | BUSHING: SEAWATER PUMP | 12 |
| 0520-001 | BYPASS: OIL SB | 8 |
| 0566-004P8 | CAM: SEAWATER PUMP FULL JABSCO | 12 |
| 0563-002 | CAM: SEAWATER PUMP JOHNSON F5B | 13 |
| 0562-003 | CAM: SEAWATER PUMP JOHNSON F6B | 13 |
| 0007-089 | CAMSHAFT: 350 FLAT TAPPET NR 91-95 | 2 |
| 0008-089 | CAMSHAFT: 350 FLAT TAPPET OR 91-95 | 2 |
| 0017-089 | CAMSHAFT: 5.7V ROLLER NR 96> | 2 |
| 0805-001E5 | CAP: DISTRIBUTOR V8 | 18 |
| 0011-102 | CAP: OIL FILL <89 350 | 4 |
| 0009-102 | CAP: OIL FILL 90> 350/5.7V | 4 |
| 0505-002 | CAP: T-STAT HOUSING BASE FWS REAR MT | 9 |
| 0007-378 | CAP: VALVE SPRING 350 91-95 | 4 |
| 0017-378MK | CAP: VALVE SPRING 5.7V 96> | 4 |

MARINE POWER 5.7 VORTEC PARTS BOOK ALPHABETICAL LISTING

| PART NUMBER | DESCRIPTION | PAGE NUMBER(S) |
|-------------|---|----------------|
| 0017-378MK | CAP: VALVE SPRING 5.7V 96> | 4 |
| 0701-416N3 | CARBURETOR: HOLLEY 5.7 OEM STYLE | 28 |
| 0701-416 | CARBURETOR: HOLLEY 5.7 UNIVERSAL | 28 |
| 0702-280 | CARBURETOR: ROCHESTER QUADRAJET | 27 |
| 0007-084B | CHAIN: TIMING 350/5.7V (ROLLER CHAIN) | 2 |
| 1140-004 | CIRCUIT BREAKER: IGNITION | 19 |
| 0000-001 | CLAMP: CONTROL CABLE CLIP | 30 |
| 0007-312 | CLAMP: DIPSTICK TUBE ALUM PAN | 7 |
| 1005-000 | CLAMP: DIPSTICK TUBE RUBBER COATED 3/8" | 7 |
| 0303-042 | CLAMP: DISTRIBUTOR | 18 |
| 0791-000 | CLAMP: OIL COOLER 2" | 8 |
| 0790-000 | CLAMP: PREFORM SEAPUMP HOSE 1-1/2" | 9 |
| 0000-002 | CLIP: CONTROL CABLE DUAL | 30 |
| 0000-00108 | CLIP: CONTROL CABLE SINGLE | 30 |
| 1110-001 | CLIP: IGNITION WIRE | 19 |
| 0806-998 | CODE MATE | 34 |
| 0805-101H3 | COIL: HIGH PERFORMANCE | 18 |
| 0007-036 | CONNECTING ROD: 181/350/5.7V | 2 |
| 0440-549G3 | COOLER: DUAL 5 X 9 | 8, 11, 47 |
| 0440-001 | COOLER: ENGINE OIL 5" X 1-1/4" | 8, 11, 43 |
| 0017-999N6 | COUPLER: 14" VOLVO VR2 | 5 |
| 0025-990F7 | COUPLER: FLEXPLATE 12-3/4" | 5 |
| 0007-990F7 | COUPLER: FLEXPLATE 14" | 5 |
| 0151-000 | COVER: DUST 12-3/4" | 6 |
| 0151-538 | COVER: DUST CAL JET 14" | 6 |
| 0151-014 | COVER: DUST FORWARD ENTRY 14" | 6 |
| 0150-000 | COVER: DUST REAR ENTRY | 6 |
| 0566-003P8 | COVER: SEAWATER PUMP JABSCO | 12 |
| 0563-003 | COVER: SEAWATER PUMP JOHNSON F5B/F6B | 13 |
| 0007-058 | COVER: TIMING 350 | 2 |
| 0017-058 | COVER: TIMING 5.7V | 2 |
| 0950-100 | COVER: WEATHER | 27 |
| 0950-824 | COVER: WEATHER EFI NON-VORTEC | 33 |
| 0950-102 | COVER: WEATHER VORTEC | 29, 33 |
| 0007-021 | CRANKSHAFT: 350 NR 91-95 | 2 |
| 0017-021 | CRANKSHAFT: 5.7V NR 96> | 2 |
| 0072-000 | DAMPER PLATE: SB 12-3/4" | 5 |
| 0071-000 | DAMPER PLATE: SB 14" | 5 |
| 0307-002 | DIPSTICK TUBE: 350 | 7 |
| 0307-002N5 | DIPSTICK TUBE: 5.7 | 7 |
| 0007-310 | DIPSTICK TUBE: ALUM PAN 350/5.7 | 7 |
| 0407-002 | DIPSTICK TUBE: PLASTISOL PAN SB/BB/6.5 | 7 |
| 0307-001 | DIPSTICK: 350/5.7 | 7 |
| 0307-001N5 | DIPSTICK: 5.7 | 7 |
| 0007-311 | DIPSTICK: ALUM 350/5.7 | 7 |
| 0805-000E5 | DISTRIBUTOR: ELECTRONIC 350/5.7 | 18 |
| 0807-000M5 | DISTRIBUTOR: ELECTRONIC BB | 18 |
| 0808-000P9 | DISTRIBUTOR: ELECTRONIC V8 RH | 18 |
| 7909-005 | DRIVE LINE: NW JET / CAL JET | 6 |
| 0000-004 | EYE: CONTROL CABLE | 30 |
| 0757-550 | FILTER: AIR GM PFI SB ROUND INLET | 38 |

MARINE POWER 5.7 VORTEC PARTS BOOK ALPHABETICAL LISTING

| PART NUMBER | DESCRIPTION | PAGE NUMBER(S) |
|-------------|---|----------------|
| 0757-550 | FILTER: AIR GM PFI SB ROUND INLET | 38 |
| 0720-490 | FILTER: FUEL IN-LINE EFI | 34 |
| 0432-049 | FILTER: FUEL/WATER SEPARATOR | 27, 29, 33, 38 |
| 0905-000 | FILTER: OIL ENPAC | 8 |
| 0904-000 | FILTER: OIL SPORTPAC | 8 |
| 0538-869 | FITTING: 1/2" NPT X 5/8" HOSE 90D | 38 |
| 0720-889 | FITTING: 1/4" NPT X 1/4" NPT F/M EL | 34 |
| 0720-851 | FITTING: 1/4" NPT X 3/8" HOSE BRASS 90D | 14, 34, 38 |
| 0000-845 | FITTING: 3/4" PIPE X 5/8" HOSE 90D | 14, 38 |
| 0400-801 | FITTING: BANJO METRIC | 7 |
| 0400-800 | FITTING: BANJO STANDARD | 7 |
| 0720-852 | FITTING: BRASS 1/4 X 3/8 STR | 14 |
| 0000-815H7 | FITTING: BRASS 90D 3/4 X 1 | 14 |
| 0000-800H7 | FITTING: BRASS STRAIGHT 3/4 X 1 | 14 |
| 0000-871 | FITTING: DUAL OIL BASE | 8 |
| 0720-455 | FITTING: EFI RETURN "T" | 34, 38 |
| 0000-882 | FITTING: FUEL PUMP OUT V6/V8 | 34, 38 |
| 0720-806 | FITTING: FUEL PUMP VAPOR 90D | 34, 38 |
| 0730-827 | FITTING: INTAKE MANIFOLD VACUUM | 38 |
| 0000-899 | FITTING: OIL/GEAR COOLER | 47 |
| 0000-887 | FITTING: VENT TUBE | 29, 34 |
| 0720-000 | FLAME ARRESTOR: 8" TBI | 33 |
| 0951-200G2 | FLAME ARRESTOR: CARB 181/V6/5.7 | 27, 29 |
| 0952-002N6 | FLAME ARRESTOR: CARB NW JET 2-1/2" TALL | 29 |
| 0007-142B | FLYWHEEL: 12-3/4" BOTTOM MOUNT | 5 |
| 0007-141 | FLYWHEEL: 14" BOTTOM MOUNT | 5 |
| 0007-143G1 | FLYWHEEL: 14" JET FLEXPLATE | 5 |
| 0007-140 | FLYWHEEL: 14" TOP MOUNT | 5 |
| 0730-349 | FUEL LINE: 3.0L - 8.2L | 31, 35 |
| 0730-359 | FUEL LINE: 5.7L MP BILLET RETURN | 31 |
| 0416-101N3 | FUEL LINE: CARB - PUMP OEM CARB | 28 |
| 0416-003P12 | FUEL LINE: CARB - PUMP UNIVERSAL CARB | 28 |
| 0430-002 | FUEL LINE: HI-PRESSURE PUMP TO FUEL RAIL | 35 |
| 0430-000 | FUEL LINE: MECH FUEL PUMP TO CARB 350 | 27 |
| 0720-404O7 | FUEL LINE: PUMP TO TBI UNIT | 31 |
| 0720-404O7 | FUEL LINE: PUMP TO TBI UNIT | 31 |
| 0730-361 | FUEL LINE: REGULATOR TO HI-PRESSURE PUMP | 35 |
| 0430-004 | FUEL LINE: SEPARATOR TO ELECT FUEL PUMP | 28, 31, 35 |
| 0430-051 | FUEL LINE: SEPARATOR TO PUMP 350 FRONT PORT | 27 |
| 0430-053F9 | FUEL LINE: SEPARATOR TO PUMP 350 REAR PORT | 27 |
| 0430-054F9 | FUEL LINE: SEPARATOR TO PUMP 350 REAR STBD | 27 |
| 0730-401 | FUEL RAIL: PFI 5.7 EDELBROCK | 38 |
| 0720-361 | GASKET KIT: TBI 5.7-8.2 | 31 |
| 0501-001N4 | GASKET: BLOCK-OFF MERC SB/BB FW | 11, 25 |
| 0705-004 | GASKET: CARB HOLLEY 1/8" | 29, 31 |
| 0700-002 | GASKET: CARB ROCHESTER | 27 |
| 0307-050 | GASKET: CIRC WATER PUMP SB | 2, 12 |
| 0025-610 | GASKET: CRANK REAR OIL SEAL SB | 2 |
| 0007-025 | GASKET: CYLINDER HEAD 350/5.7V | 4 |
| 0303-043 | GASKET: DISTRIBUTOR V6/V8 | 18 |
| 0307-020 | GASKET: FUEL PUMP FLANGE 350 | 35 |

MARINE POWER 5.7 VORTEC PARTS BOOK ALPHABETICAL LISTING

| PART NUMBER | DESCRIPTION | PAGE NUMBER(S) |
|-------------|--|----------------|
| 0307-020 | GASKET: FUEL PUMP FLANGE 350 | 35 |
| 0730-657 | GASKET: INTAKE MANIFOLD 5.7V SET | 29, 31, 35 |
| 0007-245A | GASKET: OIL PAN 350/5.7 | 8 |
| 0992-301G5 | GASKET: RISER C-R FW MP RISER | 11, 25 |
| 0992-205P5 | GASKET: RISER C-R MP 2000 | 11, 25 |
| 0992-300G5 | GASKET: RISER C-R V8 MP | 11, 25 |
| 0992-310N4 | GASKET: RISER MERC RW | 11, 25 |
| 0999-774 | GASKET: RISER VOLVO VR1 | 11, 26 |
| 0999-778 | GASKET: RISER VOLVO VR2 | 11, 26 |
| 0566-002P8 | GASKET: SEAWATER PUMP JABSCO | 12 |
| 0562-002 | GASKET: SEAWATER PUMP JOHNSON F5B/F6B | 13 |
| 0720-651 | GASKET: TBI 51MM BORE 5.7L-7.4L | 31 |
| 0730-650 | GASKET: THROTTLE BODY PFI | 35 |
| 0009-061 | GASKET: TIMING COVER 262/350 91-95 | 2 |
| 0303-009 | GASKET: T-STAT ENGINE V6/V8 | 11 |
| 0505-027 | GASKET: T-STAT FWS LOWER | 11 |
| 0505-007 | GASKET: T-STAT FWS UPPER | 11 |
| 0007-101B | GASKET: VALVE COVER 350/5.7V | 4 |
| 0945-015 | GAUGE: FUEL | 20 |
| 0945-476 | GAUGE: HOUR METER | 20 |
| 0945-005 | GAUGE: OIL PRESSURE | 20 |
| 0945-004 | GAUGE: TACHOMETER GAS | 20 |
| 0945-003 | GAUGE: VOLTMETER | 20 |
| 0945-002 | GAUGE: WATER TEMP | 20 |
| 0010-081 | GEAR KIT: CAMSHAFT/CRANKSHAFT 350/5.7V | 2 |
| 1256-037F8 | GEAR LINE: 37" SPORTPAC | 47 |
| 1256-042F8 | GEAR LINE: 42" SPORTPAC | 47 |
| 1250-003E3 | GEAR LINE: 45" SPORTPAC | 47 |
| 6450-125 | GEAR: HURTH 450A 1.25:1 | 46 |
| 6450-150 | GEAR: HURTH 450A 1.5:1 | 46 |
| 6450-200 | GEAR: HURTH 450A 2.0:1 | 46 |
| 6450-100 | GEAR: HURTH 450D 1:1 DIRECT DRIVE | 46 |
| 6635-130 | GEAR: HURTH 630V V-DRIVE 1.3:1 | 46 |
| 6635-150 | GEAR: HURTH 630V V-DRIVE 1.6:1 | 46 |
| 6635-210 | GEAR: HURTH 630V V-DRIVE 2.0:1 | 46 |
| 6635-250 | GEAR: HURTH 630V V-DRIVE 2.5:1 | 46 |
| 6020-002 | GEAR: VELVET DRIVE 5000 1.25:1 | 46 |
| 6020-003 | GEAR: VELVET DRIVE 5000 1.5:1 | 46 |
| 6020-001 | GEAR: VELVET DRIVE 5000 1:1 | 46 |
| 6020-004 | GEAR: VELVET DRIVE 5000 2.0:1 | 46 |
| 6020-005 | GEAR: VELVET DRIVE 5000 2.5:1 | 46 |
| 6020-006 | GEAR: VELVET DRIVE 5000 2.8:1 | 46 |
| 6002-002 | GEAR: VELVET DRIVE 5000 V-DRIVE 1.25:1 | 46 |
| 6002-003 | GEAR: VELVET DRIVE 5000 V-DRIVE 1.5:1 | 46 |
| 6002-004 | GEAR: VELVET DRIVE 5000 V-DRIVE 2.0:1 | 46 |
| 6022-005 | GEAR: VELVET DRIVE 5000 V-DRIVE 2.5:1 | 46 |
| 6017-004 | GEAR: VELVET DRIVE 71C 1:1 | 46 |
| 6018-004 | GEAR: VELVET DRIVE 72C 1.5:1 | 46 |
| 6018-106 | GEAR: VELVET DRIVE 72C 1.88:1 | 46 |
| 6018-002 | GEAR: VELVET DRIVE 72C 1:1 | 46 |
| 6018-210 | GEAR: VELVET DRIVE 72C 2.1:1 | 46 |

MARINE POWER 5.7 VORTEC PARTS BOOK ALPHABETICAL LISTING

| PART NUMBER | DESCRIPTION | PAGE NUMBER(S) |
|-------------|--|----------------|
| 6018-210 | GEAR: VELVET DRIVE 72C 2.1:1 | 46 |
| 6018-010 | GEAR: VELVET DRIVE 72C 2.5:1 | 46 |
| 6018-012 | GEAR: VELVET DRIVE 72C 2.9:1 | 46 |
| 6005-013 | GEAR: VELVET DRIVE 72C V-DRIVE 1.2:1 CHAIN | 46 |
| 6005-012 | GEAR: VELVET DRIVE 72C V-DRIVE 1.2:1 GEAR | 46 |
| 6005-010 | GEAR: VELVET DRIVE 72C V-DRIVE 1.5:1 CHAIN | 46 |
| 6005-011 | GEAR: VELVET DRIVE 72C V-DRIVE 1.5:1 GEAR | 46 |
| 6005-003 | GEAR: VELVET DRIVE 72C V-DRIVE 1.9:1 CHAIN | 46 |
| 6005-002 | GEAR: VELVET DRIVE 72C V-DRIVE 1.9:1 GEAR | 46 |
| 6005-004 | GEAR: VELVET DRIVE 72C V-DRIVE 2.5:1 CHAIN | 46 |
| 6005-005 | GEAR: VELVET DRIVE 72C V-DRIVE 2.5:1 GEAR | 46 |
| 0080-650 | GROMMET: HI-PRESSURE PUMP | 34 |
| 0007-119 | GUIDE: VALVE 350/5.7V | 4 |
| 0947-010 | HARNESS: 10 FT EXTENSION | 20 |
| 0947-016 | HARNESS: 16 FT EXTENSION | 20 |
| 0947-025 | HARNESS: 25 FT EXTENSION | 20 |
| 0947-003 | HARNESS: 3 FT EXTENSION | 20 |
| 0947-035 | HARNESS: 35 FT EXTENSION | 20 |
| 1140-240N7 | HARNESS: CARBURETED 3.0-8.2L | 20 |
| 0806-735N5 | HARNESS: PFI 5.7 MEFI3 | 36 |
| 1140-334P8 | HARNESS: PRIMARY ENGINE EFI >8/99 | 32, 36 |
| 0806-824N5 | HARNESS: TBI 5.7 | 32 |
| 0007-024 | HEAD: CYLINDER BARE 350 91-95 | 4 |
| 0017-024 | HEAD: CYLINDER BARE 5.7V 96> | 4 |
| 0017-024Z | HEAD: CYLINDER COMPLETE 5.7V 96> | 4 |
| HPWS-006 | HOSE: 3/8" | 43 |
| 0992-215P5 | HOSE: BYPASS MP 2000 RW | 26 |
| 1452-000F11 | HOSE: CIRC PUMP | 9 |
| 1455-003 | HOSE: CIRC PUMP TO TANK RM | 9 |
| 0730-457 | HOSE: CRANKCASE VENT PFI 5.7 | 37 |
| 0700-125 | HOSE: FUEL/VENT 1/8" | 37 |
| 1455-017G8 | HOSE: FW TANK TO MANIFOLD SB | 9 |
| HHT0-010 | HOSE: HEATER 5/8" | 37 |
| 1458-102P10 | HOSE: MANIFOLD TO T-STAT HOUSING MERC STYLE PORT | 9 |
| 1458-101P10 | HOSE: MANIFOLD TO T-STAT HOUSING MERC STYLE STAR | 9 |
| 0730-427 | HOSE: PFI PRESSURE REGULATOR ASSM 5.7 | 37 |
| HPWS-010 | HOSE: POWER STEERING 5/8" | 43 |
| 0310-110 | HOSE: POWER STEERING PRESSURE | 43 |
| 0310-111 | HOSE: POWER STEERING RETURN | 43 |
| 1456-000 | HOSE: RAW WATER HOUSING - COOLER | 9, 43 |
| 1458-004 | HOSE: RISER TO FW TANK SB | 9 |
| HWRP-016 | HOSE: SEAFLEX 1" | 9 |
| HWRP-020 | HOSE: SEAFLEX 1-1/4" | 9 |
| 1458-005 | HOSE: SEAWATER PUMP TO COOLER | 9, 43 |
| 1458-003 | HOSE: SEAWATER PUMP TO FW TANK | 9 |
| 1450-100 | HOSE: VENT TUBE | 29 |
| 0506-009F4 | HOUSING: T-STAT FRESH WATER | 9 |
| 0509-004N11 | HOUSING: T-STAT FWS | 9 |
| 0212-001 | HOUSING: T-STAT MERC STYLE RAW WATER | 10 |
| 0210-000 | HOUSING: T-STAT RAW WATER | 9 |
| 0563-020 | IMPELLER KIT: JOHNSON F5B SB | 12 |

MARINE POWER 5.7 VORTEC PARTS BOOK ALPHABETICAL LISTING

| PART NUMBER | DESCRIPTION | PAGE NUMBER(S) |
|-------------|--|----------------|
| 0563-020 | IMPELLER KIT: JOHNSON F5B SB | 12 |
| 0562-020 | IMPELLER KIT: JOHNSON F6B BB | 12 |
| 0563-001 | IMPELLER: SEAWATER PUMP F5B JOHNSON | 13 |
| 0562-001 | IMPELLER: SEAWATER PUMP F6B JOHNSON | 13 |
| 0566-001P8 | IMPELLER: SEAWATER PUMP JABSCO | 12 |
| 0720-560 | INJECTOR KIT: 5.7 11# PRE 5/95 (BLUE/BLACK BAND) | 31, 34 |
| 0720-080 | INJECTOR KIT: 5.7 30# TBI (LAVENDER/PURPLE BAND) | 31, 34 |
| 0730-501 | INJECTOR: FUEL PFI 5.7 MP | 38 |
| 0004-094 | KEY: CRANKSHAFT BALANCER | 2 |
| 0007-380 | KEY: VALVE STEM 350/5.7V/6.5 | 4 |
| 0701-420 | KIT: CARB REBUILD HOLLEY 4160 | 27 |
| 0102-100G4 | KIT: CARB REBUILD ROCHESTER QUADRAJET | 27 |
| 0430-017 | KIT: ELEC FUEL PUMP HOLLEY 4160 5.7V | 30 |
| 0430-022 | KIT: ELEC FUEL PUMP HOLLEY UNIVERSAL | 30 |
| 0506-006N5 | KIT: FRESH WATER TANK BYPASS SB | 9 |
| 0303-018F4 | KIT: MOUNTING ELECTRIC FUEL PUMP | 27, 29 |
| 0520-000 | KIT: OIL BYPASS | 8 |
| 0900-400 | KIT: OIL EXCHANGE | 8 |
| 0900-400 | KIT: OIL EXCHANGE | 8 |
| 0310-311 | KIT: POWER STEERING FRESH WATER 5.7 | 44 |
| 0310-310 | KIT: POWER STEERING RAW WATER 5.7 | 44 |
| 0007-097 | LIFTER: VALVE FLAT TAPPET 350 91-95 (SET 8) | 4 |
| 0017-097 | LIFTER: VALVE ROLLER 5.7V >96 (SET 8) | 4 |
| 0566-008P8 | LIPSEAL: SEAWATER PUMP JABSCO | 12 |
| 0563-008 | LIPSEAL: SEAWATER PUMP JOHNSON F5B/F6B | 13 |
| 0994-538 | MANIFOLD: EXHAUST MERC STYLE ALUMINUM | 25 |
| 0994-100 | MANIFOLD: EXHAUST MERC STYLE IRON | 25 |
| 0994-200P5 | MANIFOLD: EXHAUST MP 2000 FW 5.7 | 26 |
| 0994-210P5 | MANIFOLD: EXHAUST MP 2000 RW 5.7 | 26 |
| 0994-528 | MANIFOLD: EXHAUST MP ALUM 350/5.7 | 25 |
| 0994-000 | MANIFOLD: EXHAUST MP IRON 350/5.7 | 25 |
| 0994-537 | MANIFOLD: EXHAUST MP POLISHED ALUMINUM | 25 |
| 0999-772 | MANIFOLD: EXHAUST VOLVO VR1 | 26 |
| 0999-775 | MANIFOLD: EXHAUST VOLVO VR2 | 26 |
| 0017-277P1 | MANIFOLD: INTAKE 5.7 CAST IRON | 28 |
| 0730-257 | MANIFOLD: INTAKE 5.7 GM PFI | 35 |
| 0017-276N11 | MANIFOLD: INTAKE 5.7V WITH BRASS RW | 28, 31 |
| 0017-275N11 | MANIFOLD: INTAKE 5.7V WITHOUT BRASS FW | 28, 31 |
| 0807-006M5 | MODULE: DISTRIBUTOR | 18 |
| 0806-599 | MODULE: ECM EFI #2 | 33, 37 |
| 0806-596 | MODULE: ECM EFI #3 | 33, 37 |
| 0806-600 | MODULE: ECM EFI MEFI3 #4 >98 | 33, 37 |
| 0730-449 | MOTOR: IAC | 35 |
| 9920-102 | MOTOR: IAC | 31 |
| 0032-002 | MOUNT: ENGINE ENPAC | 45 |
| 0032-001 | MOUNT: ENGINE TRUNION MEDIUM | 45 |
| 0032-00116 | MOUNT: ENGINE TRUNION SHORT | 45 |
| 0032-001F12 | MOUNT: ENGINE TRUNION TALL | 45 |
| 0034-100 | MOUNT: GEAR BW 71/72C | 45 |
| 0034-215 | MOUNT: GEAR UNIVERSAL BW 5000C / HURTH PORT | 45 |
| 0034-210 | MOUNT: GEAR UNIVERSAL BW 5000C / HURTH STBD | 45 |

MARINE POWER 5.7 VORTEC PARTS BOOK ALPHABETICAL LISTING

| PART NUMBER | DESCRIPTION | PAGE NUMBER(S) |
|-------------|---|----------------|
| 0034-210 | MOUNT: GEAR UNIVERSAL BW 5000C / HURTH STBD | 45 |
| 1435-000 | MOUNT: ISOLATOR | 45 |
| *NSL0-006 | NUT: 3/8" SELF LOCK NC SS | 26 |
| 0060-067 | NUT: CONNECTING ROD 350/5.7V/BB | 2 |
| 0007-962 | NUT: CRANK REAR OIL SEAL RETAINER | 2 |
| 0021-985 | NUT: ROCKER ARM | 4 |
| 1460-001 | OIL DRAIN: EZ METRIC | 8 |
| 1460-000 | OIL DRAIN: EZ STANDARD | 8 |
| 1256-019 | OIL LINE: 19.5" 90-90 | 8 |
| 1250-002E3 | OIL LINE: 28" 90-90 | 8 |
| 1250-051F8 | OIL LINE: 51" 90-90 | 8 |
| 0007-241P10 | OIL PAN: ALUMINUM SHALLOW 350/5.7L | 7 |
| 0007-241 | OIL PAN: DOOLEY JET 350/5.7L | 7 |
| 0007-246 | OIL PAN: PLASTISOL 6QT 350/5.7L | 7 |
| 0520-002 | O-RING: BYPASS COVER | 8 |
| 0992-110P5 | O-RING: RISER MP 2000 | 26 |
| 0945-000 | PANEL: INSTRUMENT | 20 |
| 0007-090 | PIN: CAMSHAFT GEAR LOC | 2 |
| 0000-003 | PIN: CONTROL CABLE EYE | 30 |
| 0025-910 | PIN: CRANKSHAFT REAR OIL SEAL HOUSING | 2 |
| 0007-206 | PIN: CYLINDER HEAD LOC | 4 |
| 0032-00316 | PIN: ENGINE/GEAR 4.75" | 45 |
| 0032-004 | PIN: ENGINE/GEAR 6" | 45 |
| 0007-260 | PIN: OIL PUMP LOC | 2 |
| 0017-260 | PIN: OIL PUMP LOC | 2 |
| 0020-037 | PISTON: | 2 |
| 0009-037LK | PISTON: 4.3V/5.7V | 2 |
| 0102-537 | PLATE: ACCESS CALL JET BELLHOUSING | 5 |
| 0702-285 | PLATE: ADAPTER TBI | 33 |
| 0500-001 | PLATE: BLOCK-OFF SB/BB MP | 11, 25 |
| 0506-774 | PLATE: BLOCK-OFF VOLVO VR1 | 11, 26 |
| 0999-779 | PLATE: BLOCK-OFF VOLVO VR2 | 11, 26 |
| 0151-010 | PLATE: STARTER BELLHOUSING | 6 |
| 0009-208 | PLUG: CAMSHAFT REAR BEARING HOLE | 2 |
| 0025-815 | PLUG: CYLINDER HEAD CORE 181/350/5.7 | 4 |
| 0009-862 | PLUG: CYLINDER HEAD CORE SB 91-95 | 4 |
| 0000-893 | PLUG: PIPE 1/4" HEX HEAD | 34,39 |
| 0000-878 | PLUG: PIPE 3/8 | 14 |
| 0307-007 | PULLEY: CIRC PUMP 2 GROOVE 181/SB/BB | 14 |
| 0307-028 | PULLEY: CRANKSHAFT 2 GROOVE 350/5.7 | 14 |
| 0307-038 | PULLEY: CRANKSHAFT 3 GROOVE 350/5.7 | 14 |
| 1210-002 | PULLEY: DUAL ALTERNATOR | 14 |
| 0310-001 | PULLEY: POWER STEERING | 43 |
| 0017-071 | PUMP: CIRC WATER 350/5.7 | 12 |
| 0730-016 | PUMP: FUEL EFI 5.7-8.2 | 32, 36 |
| 0303-016F1 | PUMP: FUEL ELECTRONIC 7PSI | 27, 29, 32, 36 |
| 0307-016 | PUMP: FUEL MECHANICAL 350 | 27 |
| 0007-255 | PUMP: OIL 350/5.7V | 2 |
| 0017-257 | PUMP: OIL SB JET W/SCREEN | 2 |
| 0310-104F7 | PUMP: POWER STEERING | 43 |

MARINE POWER 5.7 VORTEC PARTS BOOK ALPHABETICAL LISTING

| PART NUMBER | DESCRIPTION | PAGE NUMBER(S) |
|-------------|---|----------------|
| 0310-004 | PUMP: POWER STEERING OLD STYLE | 43 |
| 0566-000P8 | PUMP: SEAWATER SB/BB JABSCO | 12 |
| 0730-510 | REGULATOR: FUEL PRESSURE SB PFI/BB | 38 |
| 6754-850N4 | RELAY: ELECTRIC FUEL PUMP | 19 |
| 1140-102F5 | RELAY: HARNESS 40 AMP | 19 |
| 1140-011N4 | RELAY: STARTER 70 AMP | 19 |
| 1140-006 | RELAY: STARTER OLD STYLE | 19 |
| 0310-105F7 | RESERVOIR: POWER STEERING | 43 |
| 0023-066 | RETAINER: CAMSHAFT 350/5.7V/BB | 2 |
| 0017-034 | RETAINER: CRANK REAR OIL SEAL 5.7V 96> | 2 |
| 0009-034 | RETAINER: CRANK REAR OIL SEAL SB 91-95 | 2 |
| 0007-259 | RETAINER: OIL PUMP DRIVE SHAFT | 2 |
| 0014-348 | RING SET: PISTON 181/350 DEEP | 2 |
| 0017-348 | RING SET: PISTON SB VORTEC 95> | 2 |
| 0992-115 | RISER: C-R MERC STYLE 15D | 25 |
| 0992-104 | RISER: C-R MERC STYLE 4" ALUMINUM | 25 |
| 0992-041 | RISER: C-R MERC STYLE 4" CERAMIC COATED | 25 |
| 0992-400 | RISER: C-R MERC STYLE 4" IRON | 25 |
| 0992-200P5 | RISER: C-R MP 2000 ALUM FW SB/BB | 26 |
| 0992-210P5 | RISER: C-R MP 2000 ALUM RW SB/BB | 26 |
| 0994-003 | RISER: C-R MP 3" ALUMINUM | 25 |
| 0992-000 | RISER: C-R MP 3" IRON | 25 |
| 0994-004 | RISER: C-R MP 4" ALUMINUM | 25 |
| 0992-040 | RISER: C-R MP 4" IRON | 25 |
| 0992-005 | RISER: C-R MP 4" POLISHED ALUMINUM | 25 |
| 0999-776 | RISER: C-R VOLVO VR1 FW 350/5.7 | 26 |
| 0999-773 | RISER: C-R VOLVO VR1 RW 350/5.7 | 26 |
| 0999-777 | RISER: C-R VOLVO VR2 | 26 |
| 0007-127 | ROD: VALVE PUSH 350 91-95 | 4 |
| 0017-127 | ROD: VALVE PUSH 5.7V 96> | 4 |
| 0007-379 | ROTATOR: VALVE 91> | 4 |
| 0805-002E5 | ROTOR: DISTRIBUTOR 350/5.7 | 18 |
| 0007-256 | SCREEN: OIL PUMP 350/5.7V | 2 |
| 0566-005P8 | SCREW: SEAWATER PUMP CAM JABSCO | 12 |
| 0563-011 | SCREW: SEAWATER PUMP COVER F5B/F6B | 13 |
| 0566-011P8 | SCREW: SEAWATER PUMP COVER JABSCO | 12 |
| 0563-012 | SCREW: SEAWATER PUMP JOHNSON F5B/F6B | 13 |
| 0009-033 | SEAL: CRANK REAR OIL NR 350 91-95 | 2 |
| 0017-033 | SEAL: CRANK REAR OIL NR 5.7V 96> | 2 |
| 0010-033 | SEAL: CRANK REAR OIL OR 350 91-95 | 2 |
| 0025-005 | SEAL: CRANKSHAFT FRONT OIL 181/262/350 | 2 |
| 0007-178 | SEAL: EXHAUST VALVE STEM OIL 350 91-95 | 4 |
| 0017-178 | SEAL: EXHAUST VALVE STEM OIL 5.7V 96> | 4 |
| 0730-383 | SEAL: IAC | 35 |
| 0566-006P8 | SEAL: SPACER JABSCO | 12 |
| 0720-601 | SEAL: TBI O-RING FUEL FEED LARGE | 34 |
| 0720-602 | SEAL: TBI O-RING FUEL RETURN SMALL | 34 |
| 0940-102 | SENDER: OIL DUAL | 19 |
| 0940-002 | SENDER: OIL SINGLE | 19 |
| 0806-010F12 | SENDER: TEMP EFI/MSTS | 33, 37 |
| 0940-101 | SENDER: WATER DUAL 1/2" | 19 |

MARINE POWER 5.7 VORTEC PARTS BOOK ALPHABETICAL LISTING

| PART NUMBER | DESCRIPTION | PAGE NUMBER(S) |
|-------------|---|----------------|
| 0940-101 | SENDER: WATER DUAL 1/2" | 19 |
| 0940-111 | SENDER: WATER DUAL 3/8" | 19 |
| 0940-001 | SENDER: WATER SINGLE 1/2" | 19 |
| 0940-011 | SENDER: WATER SINGLE 3/8" | 19 |
| 0806-005 | SENSOR: KNOCK 5.7 EFI/MSTS | 33, 37 |
| 0806-020F12 | SENSOR: MAP ALL EFI/MSTS (MEFI 1 & 2) | 33 |
| 0806-057 | SENSOR: MAP SMALL (MEFI3) | 37 |
| 0730-382 | SENSOR: THROTTLE POSITION | 35 |
| 9920-104 | SENSOR: THROTTLE POSITION SB/BB TBI | 31 |
| 0007-258 | SHAFT: OIL PUMP DRIVE | 2 |
| 0007-377 | SHIELD: VALVE STEM OIL 350/5.7V | 4 |
| 1188-001 | SPACER: ALTERNATOR | 18 |
| 0992-635 | SPACER: RISER MERC STYLE 3" | 25 |
| 0992-660 | SPACER: RISER MERC STYLE 6" | 25 |
| 0505-008 | SPACER: THERMOSTAT REAR MOUNT | 10 |
| 0007-015 | SPARK PLUG: 181/ALL VORTEC | 18 |
| 0003-015 | SPARK PLUG: 350 STD / ALL BB | 18 |
| 0007-176 | SPRING: VALVE 350 91-95 | 4 |
| 0017-176 | SPRING: VALVE 5.7V 96> | 4 |
| 0007-081B | SPROCKET: CAMSHAFT 350 91-95 | 2 |
| 0023-081 | SPROCKET: CAMSHAFT 5.7V 96> | 2 |
| 0172-000 | STARTER: BOTTOM MOUNT 12-3/4" NR | 5 |
| 0174-000 | STARTER: BOTTOM MOUNT 14" NR | 5 |
| 0170-000 | STARTER: TOP MOUNT 14" NR | 5 |
| 0171-000 | STARTER: TOP MOUNT 14" OR | 5 |
| 0009-301 | STUD: CRANK REAR OIL SEAL RETAINER | 2 |
| 0007-964 | STUD: CRANKSHAFT BEARING CAP | 2 |
| 0007-963 | STUD: CRANKSHAFT REAR OIL SEAL 350/5.7V | 2 |
| *SS38-200 | STUD: MANIFOLD MP 2000 3/8" X 2" | 26 |
| 0025-940 | STUD: ROCKER ARM BALL 350/5.7V | 4 |
| *S000-463 | STUD: WEATHER COVER HOLLEY | 29 |
| *SS00-464 | STUD: WEATHER COVER ROCHESTER | 27 |
| 6450-204 | SWITCH: GEAR ALARM HI-TEMP | 47 |
| 0303-017F3 | SWITCH: HOBBS OIL | 19 |
| 6640-005 | SWITCH: NEUTRAL SAFETY | 47 |
| 0940-202 | SWITCH: OIL PRESSURE 1/8" 7PSI | 19 |
| 0940-201 | SWITCH: WATER TEMP 3/8" | 19 |
| 0506-103F7 | TANK: FWS SB FRONT MOUNT | 10 |
| 0505-103 | TANK: FWS SB REAR MOUNT | 10 |
| 0000-850 | TEE: FRESH WATER | 11 |
| 0000-852 | TEE: HEATER ADAPTER 5/8" 90D | 11 |
| 0500-007F6 | THERMOSTAT: FW FRONT MOUNT V8 | 10 |
| 0500-007 | THERMOSTAT: FW REAR MOUNT V8 | 10 |
| 0212-007 | THERMOSTAT: RAW WATER MERC | 10 |
| 0210-002 | THERMOSTAT: RAW WATER V8 | 10 |
| 0720-057 | THROTTLE BODY: 5.7L | 31 |
| 0720-057 | THROTTLE BODY: 5.7L COMPLETE | 31 |
| 0730-557 | THROTTLE BODY: PFI SB / 7.4L L-29 | 35 |
| 9000-001 | TOOL: TIMING | 19 |
| 0441-103 | TUBE: COPPER INLET RW NW JET | 11 |
| 0007-100D | VALVE COVER: 350/5.7V | 4 |

MARINE POWER 5.7 VORTEC PARTS BOOK ALPHABETICAL LISTING

| PART NUMBER | DESCRIPTION | PAGE NUMBER(S) |
|--------------------|---------------------------------------|-----------------------|
| 0007-100D | VALVE COVER: 350/5.7V | 4 |
| 0007-175 | VALVE: EXHAUST 350 91-95 | 4 |
| 0017-175 | VALVE: EXHAUST 5.7V >96 | 4 |
| 0007-174 | VALVE: INTAKE 350 91-95 | 4 |
| 0017-174 | VALVE: INTAKE 5.7V >96 | 4 |
| 0730-057 | VALVE: PCV ASSM 5.7 PFI | 39 |
| 0701-003N2 | VALVE: PCV HOLLEY CARB SB | 30 |
| 0563-013 | WASHER: SEAWATER PUMP JOHNSON F5B/F6B | 13 |
| 0811-027 | WIRE LEAD SET: ELECTRIC FUEL PUMP | 19 |
| 0811-016 | WIRE LEAD: COIL TO DIST + FILTER | 19 |
| 0811-018 | WIRE LEAD: COIL TO DIST + FILTER | 19 |
| 0811-020F8 | WIRE LEAD: HOBBS OIL SWITCH | 19 |
| 0811-019 | WIRE LEAD: IGNITION SHIFT INTERRUPT | 19 |
| 1110-000BLK | WIRE SET: IGNITION HI-PERF V8 BLACK | 19 |
| 1110-000N2 | WIRE SET: IGNITION V8 BLACK | 19 |
| 1110-000E5 | WIRE SET: IGNITION V8 YELLOW | 19 |

MARINE POWER 5.7 VORTEC PARTS BOOK NUMERICAL LISTING

| PART NUMBER | DESCRIPTION | PAGE NUMBER(S) |
|-------------|---|----------------|
| *NSL0-006 | NUT: 3/8" SELF LOCK NC SS | 26 |
| *S000-463 | STUD: WEATHER COVER HOLLEY | 29 |
| *SS00-464 | STUD: WEATHER COVER ROCHESTER | 27 |
| *SS38-200 | STUD: MANIFOLD MP 2000 3/8" X 2" | 26 |
| 0000-001 | CLAMP: CONTROL CABLE CLIP | 30 |
| 0000-001O8 | CLIP: CONTROL CABLE SINGLE | 30 |
| 0000-002 | CLIP: CONTROL CABLE DUAL | 30 |
| 0000-003 | PIN: CONTROL CABLE EYE | 30 |
| 0000-004 | EYE: CONTROL CABLE | 30 |
| 0000-006 | BALL JOINT: CONTROL CABLE | 30 |
| 0000-032 | BOLT: OIL FILTER ADAPTER | 2 |
| 0000-800H7 | FITTING: BRASS STRAIGHT 3/4 X 1 | 14 |
| 0000-815H7 | FITTING: BRASS 90D 3/4 X 1 | 14 |
| 0000-845 | FITTING: 3/4" PIPE X 5/8" HOSE 90D | 14, 38 |
| 0000-847 | BUSHING: 3/4 X 1/4 | 14 |
| 0000-850 | TEE: FRESH WATER | 11 |
| 0000-852 | TEE: HEATER ADAPTER 5/8" 90D | 11 |
| 0000-871 | FITTING: DUAL OIL BASE | 8 |
| 0000-878 | PLUG: PIPE 3/8 | 14 |
| 0000-882 | FITTING: FUEL PUMP OUT V6/V8 | 34, 38 |
| 0000-887 | FITTING: VENT TUBE | 29, 34 |
| 0000-893 | PLUG: PIPE 1/4" HEX HEAD | 34,39 |
| 0000-899 | FITTING: OIL/GEAR COOLER | 47 |
| 0003-015 | SPARK PLUG: 350 STD / ALL BB | 18 |
| 0004-094 | KEY: CRANKSHAFT BALANCER | 2 |
| 0007-004 | BALANCER: HARMONIC 350 | 2 |
| 0007-015 | SPARK PLUG: 181/ALL VORTEC | 18 |
| 0007-021 | CRANKSHAFT: 350 NR 91-95 | 2 |
| 0007-024 | HEAD: CYLINDER BARE 350 91-95 | 4 |
| 0007-025 | GASKET: CYLINDER HEAD 350/5.7V | 4 |
| 0007-027 | BOLT: CYLINDER HEAD LONG 350/5.7V | 4 |
| 0007-028 | BOLT: CYLINDER HEAD MEDIUM 350/5.7V | 4 |
| 0007-029 | BOLT: CYLINDER HEAD SHORT 350/5.7V | 4 |
| 0007-036 | CONNECTING ROD: 181/350/5.7V | 2 |
| 0007-038 | BEARING: CONNECTING ROD 181/350/5.7V | 2 |
| 0007-042 | ADAPTER: OIL BYPASS | 2, 8 |
| 0007-058 | COVER: TIMING 350 | 2 |
| 0007-066 | BOLT: CONNECTING ROD 350/5.7V | 2 |
| 0007-081B | SPROCKET: CAMSHAFT 350 91-95 | 2 |
| 0007-084B | CHAIN: TIMING 350/5.7V (ROLLER CHAIN) | 2 |
| 0007-089 | CAMSHAFT: 350 FLAT TAPPET NR 91-95 | 2 |
| 0007-090 | PIN: CAMSHAFT GEAR LOC | 2 |
| 0007-097 | LIFTER: VALVE FLAT TAPPET 350 91-95 (SET 8) | 4 |
| 0007-100D | VALVE COVER: 350/5.7V | 4 |
| 0007-101B | GASKET: VALVE COVER 350/5.7V | 4 |
| 0007-119 | GUIDE: VALVE 350/5.7V | 4 |
| 0007-120 | ARM KIT: ROCKER W/ARM, BALL, NUT | 4 |
| 0007-127 | ROD: VALVE PUSH 350 91-95 | 4 |
| 0007-140 | FLYWHEEL: 14" TOP MOUNT | 5 |
| 0007-141 | FLYWHEEL: 14" BOTTOM MOUNT | 5 |

MARINE POWER 5.7 VORTEC PARTS BOOK NUMERICAL LISTING

| PART NUMBER | DESCRIPTION | PAGE NUMBER(S) |
|-------------|--|----------------|
| 0007-141 | FLYWHEEL: 14" BOTTOM MOUNT | 5 |
| 0007-142B | FLYWHEEL: 12-3/4" BOTTOM MOUNT | 5 |
| 0007-143G1 | FLYWHEEL: 14" JET FLEXPLATE | 5 |
| 0007-175 | VALVE: EXHAUST 350 91-95 | 4 |
| 0007-176 | SPRING: VALVE 350 91-95 | 4 |
| 0007-178 | SEAL: EXHAUST VALVE STEM OIL 350 91-95 | 4 |
| 0007-206 | PIN: CYLINDER HEAD LOC | 4 |
| 0007-241 | OIL PAN: DOOLEY JET 350/5.7L | 7 |
| 0007-241P10 | OIL PAN: ALUMINUM SHALLOW 350/5.7L | 7 |
| 0007-245A | GASKET: OIL PAN 350/5.7 | 8 |
| 0007-246 | OIL PAN: PLASTISOL 6QT 350/5.7L | 7 |
| 0007-250 | BAFFLE: OIL PAN 350/5.7V | 2 |
| 0007-255 | PUMP: OIL 350/5.7V | 2 |
| 0007-256 | SCREEN: OIL PUMP 350/5.7V | 2 |
| 0007-258 | SHAFT: OIL PUMP DRIVE | 2 |
| 0007-259 | RETAINER: OIL PUMP DRIVE SHAFT | 2 |
| 0007-260 | PIN: OIL PUMP LOC | 2 |
| 0007-310 | DIPSTICK TUBE: ALUM PAN 350/5.7 | 7 |
| 0007-311 | DIPSTICK: ALUM 350/5.7 | 7 |
| 0007-312 | CLAMP: DIPSTICK TUBE ALUM PAN | 7 |
| 0007-377 | SHIELD: VALVE STEM OIL 350/5.7V | 4 |
| 0007-378 | CAP: VALVE SPRING 350 91-95 | 4 |
| 0007-379 | ROTATOR: VALVE 91> | 4 |
| 0007-380 | KEY: VALVE STEM 350/5.7V/6.5 | 4 |
| 0007-958 | BOLT: TIMING COVER 350 | 2 |
| 0007-961 | BOLT: CRANK REAR OIL SEAL RETAINER | 2 |
| 0007-962 | NUT: CRANK REAR OIL SEAL RETAINER | 2 |
| 0007-963 | STUD: CRANKSHAFT REAR OIL SEAL 350/5.7V | 2 |
| 0007-964 | STUD: CRANKSHAFT BEARING CAP | 2 |
| 0007-990F7 | COUPLER: FLEXPLATE 14" | 5 |
| 0008-089 | CAMSHAFT: 350 FLAT TAPPET OR 91-95 | 2 |
| 0009-009 | BEARING: CRANKSHAFT #5 SB 91-95 | 2 |
| 0009-033 | SEAL: CRANK REAR OIL NR 350 91-95 | 2 |
| 0009-034 | RETAINER: CRANK REAR OIL SEAL SB 91-95 | 2 |
| 0009-037LK | PISTON: 4.3V/5.7V | 2 |
| 0009-061 | GASKET: TIMING COVER 262/350 91-95 | 2 |
| 0009-102 | CAP: OIL FILL 90> 350/5.7V | 4 |
| 0009-107 | BOLT: VALVE COVER 262/350/5.7V | 4 |
| 0009-208 | PLUG: CAMSHAFT REAR BEARING HOLE | 2 |
| 0009-301 | STUD: CRANK REAR OIL SEAL RETAINER | 2 |
| 0009-440 | BEARING: CRANKSHAFT #1, 2, 3, 4 SB 91-95 | 2 |
| 0009-700F10 | BRACKET: LIFT FRONT SB | 14 |
| 0009-862 | PLUG: CYLINDER HEAD CORE SB 91-95 | 4 |
| 0009-961 | BOLT: CRANK REAR OIL SEAL RETAINER | 2 |
| 0010-033 | SEAL: CRANK REAR OIL OR 350 91-95 | 2 |
| 0010-081 | GEAR KIT: CAMSHAFT/CRANKSHAFT 350/5.7V | 2 |
| 0011-102 | CAP: OIL FILL <89 350 | 4 |
| 0011-154 | BOLT: CRANKSHAFT BEARING CAP | 2 |
| 0014-348 | RING SET: PISTON 181/350 DEEP | 2 |

MARINE POWER 5.7 VORTEC PARTS BOOK NUMERICAL LISTING

| PART NUMBER | DESCRIPTION | PAGE NUMBER(S) |
|-------------|--|----------------|
| 0014-348 | RING SET: PISTON 181/350 DEEP | 2 |
| 0017-002 | BOLT: HARMONIC BALANCER | 2 |
| 0017-004 | BALANCER: HARMONIC 5.7V | 2 |
| 0017-021 | CRANKSHAFT: 5.7V NR 96> | 2 |
| 0017-024 | HEAD: CYLINDER BARE 5.7V 96> | 4 |
| 0017-024Z | HEAD: CYLINDER COMPLETE 5.7V 96> | 4 |
| 0017-033 | SEAL: CRANK REAR OIL NR 5.7V 96> | 2 |
| 0017-034 | RETAINER: CRANK REAR OIL SEAL 5.7V 96> | 2 |
| 0017-058 | COVER: TIMING 5.7V | 2 |
| 0017-071 | PUMP: CIRC WATER 350/5.7 | 12 |
| 0017-089 | CAMSHAFT: 5.7V ROLLER NR 96> | 2 |
| 0017-090 | BEARING: CAMSHAFT #1 350/5.7V | 2 |
| 0017-091 | BEARING: CAMSHAFT #2, #5 350/5.7V | 2 |
| 0017-092 | BEARING: CAMSHAFT #3, #4 350/5.7V | 2 |
| 0017-097 | LIFTER: VALVE ROLLER 5.7V >96 (SET 8) | 4 |
| 0017-127 | ROD: VALVE PUSH 5.7V 96> | 4 |
| 0017-174 | VALVE: INTAKE 5.7V >96 | 4 |
| 0017-175 | VALVE: EXHAUST 5.7V >96 | 4 |
| 0017-176 | SPRING: VALVE 5.7V 96> | 4 |
| 0017-178 | SEAL: EXHAUST VALVE STEM OIL 5.7V 96> | 4 |
| 0017-189 | BEARING: CRANKSHAFT #1, 2, 3, 4 5.7V 96> | 2 |
| 0017-191 | BEARING: CRANKSHAFT #5 5.7V 96> | 2 |
| 0017-257 | PUMP: OIL SB JET W/SCREEN | 2 |
| 0017-260 | PIN: OIL PUMP LOC | 2 |
| 0017-275N11 | MANIFOLD: INTAKE 5.7V WITHOUT BRASS FW | 28, 31 |
| 0017-276N11 | MANIFOLD: INTAKE 5.7V WITH BRASS RW | 28, 31 |
| 0017-277P1 | MANIFOLD: INTAKE 5.7 CAST IRON | 28 |
| 0017-348 | RING SET: PISTON SB VORTEC 95> | 2 |
| 0017-378MK | CAP: VALVE SPRING 5.7V 96> | 4 |
| 0017-958 | BOLT: TIMING COVER 5.7V | 2 |
| 0017-999N6 | COUPLER: 14" VOLVO VR2 | 5 |
| 0020-037 | PISTON: | 2 |
| 0021-985 | NUT: ROCKER ARM | 4 |
| 0023-066 | RETAINER: CAMSHAFT 350/5.7V/BB | 2 |
| 0023-081 | SPROCKET: CAMSHAFT 5.7V 96> | 2 |
| 0025-005 | SEAL: CRANKSHAFT FRONT OIL 181/262/350 | 2 |
| 0025-266 | BOLT: CAMSHAFT SPROCKET | 2 |
| 0025-610 | GASKET: CRANK REAR OIL SEAL SB | 2 |
| 0025-815 | PLUG: CYLINDER HEAD CORE 181/350/5.7 | 4 |
| 0025-910 | PIN: CRANKSHAFT REAR OIL SEAL HOUSING | 2 |
| 0025-940 | STUD: ROCKER ARM BALL 350/5.7V | 4 |
| 0025-990F7 | COUPLER: FLEXPLATE 12-3/4" | 5 |
| 0028-701 | BRACKET: LIFT SB VORTEC RW | 14 |
| 0032-001 | MOUNT: ENGINE TRUNION MEDIUM | 45 |
| 0032-001F12 | MOUNT: ENGINE TRUNION TALL | 45 |
| 0032-001I6 | MOUNT: ENGINE TRUNION SHORT | 45 |
| 0032-002 | MOUNT: ENGINE ENPAC | 45 |
| 0032-003I6 | PIN: ENGINE/GEAR 4.75" | 45 |
| 0032-004 | PIN: ENGINE/GEAR 6" | 45 |

MARINE POWER 5.7 VORTEC PARTS BOOK NUMERICAL LISTING

| PART NUMBER | DESCRIPTION | PAGE NUMBER(S) |
|-------------|---|----------------|
| 0032-002 | MOUNT: ENGINE ENPAC | 45 |
| 0032-003I6 | PIN: ENGINE/GEAR 4.75" | 45 |
| 0032-004 | PIN: ENGINE/GEAR 6" | 45 |
| 0034-100 | MOUNT: GEAR BW 71/72C | 45 |
| 0034-210 | MOUNT: GEAR UNIVERSAL BW 5000C / HURTH STBD | 45 |
| 0034-215 | MOUNT: GEAR UNIVERSAL BW 5000C / HURTH PORT | 45 |
| 0053-043 | BOLT: CAMSHAFT RETAINER 350/5.7V/BB | 2 |
| 0053-700F10 | BRACKET: LIFT REAR LONG | 14 |
| 0053-701F10 | BRACKET: LIFT REAR SHORT | 14 |
| 0053-702 | BRACKET: LIFT REAR TBI SB/BB | 14 |
| 0060-067 | NUT: CONNECTING ROD 350/5.7V/BB | 2 |
| 0071-000 | DAMPER PLATE: SB 14" | 5 |
| 0072-000 | DAMPER PLATE: SB 12-3/4" | 5 |
| 0080-650 | GROMMET: HI-PRESSURE PUMP | 34 |
| 0100-000 | BELLHOUSING: INBOARD GAS | 5 |
| 0102-100G4 | KIT: CARB REBUILD ROCHESTER QUADRAJET | 27 |
| 0102-537 | PLATE: ACCESS CALL JET BELLHOUSING | 5 |
| 0102-538 | BELLHOUSING: CAL JET 14" TOP MT | 5 |
| 0105-000 | ADAPTER: CONE BERKLEY STYLE | 5 |
| 0150-000 | COVER: DUST REAR ENTRY | 6 |
| 0151-000 | COVER: DUST 12-3/4" | 6 |
| 0151-010 | PLATE: STARTER BELLHOUSING | 6 |
| 0151-014 | COVER: DUST FORWARD ENTRY 14" | 6 |
| 0151-538 | COVER: DUST CAL JET 14" | 6 |
| 0170-000 | STARTER: TOP MOUNT 14" NR | 5 |
| 0171-000 | STARTER: TOP MOUNT 14" OR | 5 |
| 0172-000 | STARTER: BOTTOM MOUNT 12-3/4" NR | 5 |
| 0174-000 | STARTER: BOTTOM MOUNT 14" NR | 5 |
| 0210-000 | HOUSING: T-STAT RAW WATER | 9 |
| 0210-002 | THERMOSTAT: RAW WATER V8 | 10 |
| 0212-001 | HOUSING: T-STAT MERC STYLE RAW WATER | 10 |
| 0212-007 | THERMOSTAT: RAW WATER MERC | 10 |
| 0303-009 | GASKET: T-STAT ENGINE V6/V8 | 11 |
| 0303-016F1 | PUMP: FUEL ELECTRONIC 7PSI | 27, 29, 32, 36 |
| 0303-017F3 | SWITCH: HOBBS OIL | 19 |
| 0303-018F4 | KIT: MOUNTING ELECTRIC FUEL PUMP | 27, 29 |
| 0303-042 | CLAMP: DISTRIBUTOR | 18 |
| 0303-043 | GASKET: DISTRIBUTOR V6/V8 | 18 |
| 0307-001 | DIPSTICK: 350/5.7 | 7 |
| 0307-001N5 | DIPSTICK: 5.7 | 7 |
| 0307-002 | DIPSTICK TUBE: 350 | 7 |
| 0307-002N5 | DIPSTICK TUBE: 5.7 | 7 |
| 0307-007 | PULLEY: CIRC PUMP 2 GROOVE 181/SB/BB | 14 |
| 0307-016 | PUMP: FUEL MECHANICAL 350 | 27 |
| 0307-020 | GASKET: FUEL PUMP FLANGE 350 | 35 |
| 0307-028 | PULLEY: CRANKSHAFT 2 GROOVE 350/5.7 | 14 |
| 0307-038 | PULLEY: CRANKSHAFT 3 GROOVE 350/5.7 | 14 |
| 0307-050 | GASKET: CIRC WATER PUMP SB | 2, 12 |
| 0310-001 | PULLEY: POWER STEERING | 43 |
| 0310-004 | PUMP: POWER STEERING OLD STYLE | 43 |

MARINE POWER 5.7 VORTEC PARTS BOOK NUMERICAL LISTING

| PART NUMBER | DESCRIPTION | PAGE NUMBER(S) |
|-------------|---|----------------|
| 0310-004 | PUMP: POWER STEERING OLD STYLE | 43 |
| 0310-007N3 | BRACKET: POWER STEERING / TENSION | 43 |
| 0310-104F7 | PUMP: POWER STEERING | 43 |
| 0310-105F7 | RESERVOIR: POWER STEERING | 43 |
| 0310-109K8 | BRACKET: RESERVOIR RAW WATER | 43 |
| 0310-110 | HOSE: POWER STEERING PRESSURE | 43 |
| 0310-111 | HOSE: POWER STEERING RETURN | 43 |
| 0310-203 | BRACKET: POWER STEERING PUMP MOUNTING | 43 |
| 0310-255 | BRACKET: RESERVOIR FRESH WATER | 43 |
| 0310-310 | KIT: POWER STEERING RAW WATER 5.7 | 44 |
| 0310-311 | KIT: POWER STEERING FRESH WATER 5.7 | 44 |
| 0400-800 | FITTING: BANJO STANDARD | 7 |
| 0400-801 | FITTING: BANJO METRIC | 7 |
| 0407-002 | DIPSTICK TUBE: PLASTISOL PAN SB/BB/6.5 | 7 |
| 0407-200 | BRACKET: DIPSTICK TUBE | 7 |
| 0416-003P12 | FUEL LINE: CARB - PUMP UNIVERSAL CARB | 28 |
| 0416-101N3 | FUEL LINE: CARB - PUMP OEM CARB | 28 |
| 0430-000 | FUEL LINE: MECH FUEL PUMP TO CARB 350 | 27 |
| 0430-002 | FUEL LINE: HI-PRESSURE PUMP TO FUEL RAIL | 35 |
| 0430-004 | FUEL LINE: SEPARATOR TO ELECT FUEL PUMP | 28, 31, 35 |
| 0430-017 | KIT: ELEC FUEL PUMP HOLLEY 4160 5.7V | 30 |
| 0430-022 | KIT: ELEC FUEL PUMP HOLLEY UNIVERSAL | 30 |
| 0430-051 | FUEL LINE: SEPARATOR TO PUMP 350 FRONT PORT | 27 |
| 0430-053F9 | FUEL LINE: SEPARATOR TO PUMP 350 REAR PORT | 27 |
| 0430-054F9 | FUEL LINE: SEPARATOR TO PUMP 350 REAR STBD | 27 |
| 0432-048 | BASE: FUEL/WATER SEPARATOR FILTER | 27, 29, 33, 38 |
| 0432-049 | FILTER: FUEL/WATER SEPARATOR | 27, 29, 33, 38 |
| 0440-001 | COOLER: ENGINE OIL 5" X 1-1/4" | 8, 11, 43 |
| 0440-549G3 | COOLER: DUAL 5 X 9 | 8, 11, 47 |
| 0441-103 | TUBE: COPPER INLET RW NW JET | 11 |
| 0500-001 | PLATE: BLOCK-OFF SB/BB MP | 11, 25 |
| 0500-007 | THERMOSTAT: FW REAR MOUNT V8 | 10 |
| 0500-007F6 | THERMOSTAT: FW FRONT MOUNT V8 | 10 |
| 0501-001N4 | GASKET: BLOCK-OFF MERC SB/BB FW | 11, 25 |
| 0505-002 | CAP: T-STAT HOUSING BASE FWS REAR MT | 9 |
| 0505-007 | GASKET: T-STAT FWS UPPER | 11 |
| 0505-008 | SPACER: THERMOSTAT REAR MOUNT | 10 |
| 0505-009 | BASE: T-STAT HOUSING FWS REAR MT SB | 9 |
| 0505-014 | BRACKET: FW REAR MOUNT LH SB | 10 |
| 0505-015 | BRACKET: FW REAR MOUNT RH SB | 10 |
| 0505-027 | GASKET: T-STAT FWS LOWER | 11 |
| 0505-103 | TANK: FWS SB REAR MOUNT | 10 |
| 0506-006N5 | KIT: FRESH WATER TANK BYPASS SB | 9 |
| 0506-009F4 | HOUSING: T-STAT FRESH WATER | 9 |
| 0506-103F7 | TANK: FWS SB FRONT MOUNT | 10 |
| 0506-114F6 | BRACKET: FW FRONT MOUNT RH SB | 10 |
| 0506-115F6 | BRACKET: FW FRONT MOUNT LH SB | 10 |
| 0506-774 | PLATE: BLOCK-OFF VOLVO VR1 | 11, 26 |
| 0509-004N11 | HOUSING: T-STAT FWS | 9 |
| 0509-101F4 | BOTTLE: RECOVERY | 10 |

MARINE POWER 5.7 VORTEC PARTS BOOK NUMERICAL LISTING

| PART NUMBER | DESCRIPTION | PAGE NUMBER(S) |
|-------------|--|----------------|
| 0509-101F4 | BOTTLE: RECOVERY | 10 |
| 0509-102 | BRACKET: RECOVERY BOTTLE MOUNTING | 10 |
| 0520-000 | KIT: OIL BYPASS | 8 |
| 0520-001 | BYPASS: OIL SB | 8 |
| 0520-002 | O-RING: BYPASS COVER | 8 |
| 0538-869 | FITTING: 1/2" NPT X 5/8" HOSE 90D | 38 |
| 0545-350 | BELT: ALTERNATOR SB | 18 |
| 0547-351 | BELT: POWER STEERING SB | 43 |
| 0562-001 | IMPELLER: SEAWATER PUMP F6B JOHNSON | 13 |
| 0562-002 | GASKET: SEAWATER PUMP JOHNSON F5B/F6B | 13 |
| 0562-003 | CAM: SEAWATER PUMP JOHNSON F6B | 13 |
| 0562-020 | IMPELLER KIT: JOHNSON F6B BB | 12 |
| 0563-001 | IMPELLER: SEAWATER PUMP F5B JOHNSON | 13 |
| 0563-002 | CAM: SEAWATER PUMP JOHNSON F5B | 13 |
| 0563-003 | COVER: SEAWATER PUMP JOHNSON F5B/F6B | 13 |
| 0563-008 | LIPSEAL: SEAWATER PUMP JOHNSON F5B/F6B | 13 |
| 0563-009 | BEARING: SEAWATER PUMP JOHNSON F5B/F6B | 13 |
| 0563-011 | SCREW: SEAWATER PUMP COVER F5B/F6B | 13 |
| 0563-012 | SCREW: SEAWATER PUMP JOHNSON F5B/F6B | 13 |
| 0563-013 | WASHER: SEAWATER PUMP JOHNSON F5B/F6B | 13 |
| 0563-020 | IMPELLER KIT: JOHNSON F5B SB | 12 |
| 0566-000P8 | PUMP: SEAWATER SB/BB JABSCO | 12 |
| 0566-001P8 | IMPELLER: SEAWATER PUMP JABSCO | 12 |
| 0566-002P8 | GASKET: SEAWATER PUMP JABSCO | 12 |
| 0566-003P8 | COVER: SEAWATER PUMP JABSCO | 12 |
| 0566-004P8 | CAM: SEAWATER PUMP FULL JABSCO | 12 |
| 0566-005P8 | SCREW: SEAWATER PUMP CAM JABSCO | 12 |
| 0566-006P8 | SEAL: SPACER JABSCO | 12 |
| 0566-008P8 | LIPSEAL: SEAWATER PUMP JABSCO | 12 |
| 0566-011P8 | SCREW: SEAWATER PUMP COVER JABSCO | 12 |
| 0570-000 | BRACKET: POWER STEERING - SEAPUMP | 43 |
| 0572-001 | BUSHING: SEAWATER PUMP | 12 |
| 0573-000 | BRACKET: SEAWATER PUMP SB | 12 |
| 0700-002 | GASKET: CARB ROCHESTER | 27 |
| 0700-125 | HOSE: FUEL/VENT 1/8" | 37 |
| 0701-003N2 | VALVE: PCV HOLLEY CARB SB | 30 |
| 0701-416 | CARBURETOR: HOLLEY 5.7 UNIVERSAL | 28 |
| 0701-416N3 | CARBURETOR: HOLLEY 5.7 OEM STYLE | 28 |
| 0701-420 | KIT: CARB REBUILD HOLLEY 4160 | 27 |
| 0702-280 | CARBURETOR: ROCHESTER QUADRAJET | 27 |
| 0702-285 | PLATE: ADAPTER TBI | 33 |
| 0705-004 | GASKET: CARB HOLLEY 1/8" | 29, 31 |
| 0720-000 | FLAME ARRESTOR: 8" TBI | 33 |
| 0720-057 | THROTTLE BODY: 5.7L | 31 |
| 0720-057 | THROTTLE BODY: 5.7L COMPLETE | 31 |
| 0720-080 | INJECTOR KIT: 5.7 30# TBI (LAVENDER/PURPLE BAND) | 31, 34 |
| 0720-220 | BRACKET: MAP SENSOR EFI | 32 |
| 0720-279 | BRACKET: THROTTLE 5.7L-7.4L TBI | 32 |
| 0720-288 | BRACKET: INTAKE Z / ELEC COMPONENT | 29 |
| 0720-289N4 | BRACKET: ECM TBI 5.7-7.4 | 32 |

MARINE POWER 5.7 VORTEC PARTS BOOK NUMERICAL LISTING

| PART NUMBER | DESCRIPTION | PAGE NUMBER(S) |
|-------------|--|----------------|
| 0720-289N4 | BRACKET: ECM TBI 5.7-7.4 | 32 |
| 0720-361 | GASKET KIT: TBI 5.7-8.2 | 31 |
| 0720-404O7 | FUEL LINE: PUMP TO TBI UNIT | 31 |
| 0720-404O7 | FUEL LINE: PUMP TO TBI UNIT | 31 |
| 0720-455 | FITTING: EFI RETURN "T" | 34, 38 |
| 0720-490 | FILTER: FUEL IN-LINE EFI | 34 |
| 0720-560 | INJECTOR KIT: 5.7 11# PRE 5/95 (BLUE/BLACK BAND) | 31, 34 |
| 0720-601 | SEAL: TBI O-RING FUEL FEED LARGE | 34 |
| 0720-602 | SEAL: TBI O-RING FUEL RETURN SMALL | 34 |
| 0720-651 | GASKET: TBI 51MM BORE 5.7L-7.4L | 31 |
| 0720-806 | FITTING: FUEL PUMP VAPOR 90D | 34, 38 |
| 0720-851 | FITTING: 1/4" NPT X 3/8" HOSE BRASS 90D | 14, 34, 38 |
| 0720-852 | FITTING: BRASS 1/4 X 3/8 STR | 14 |
| 0720-889 | FITTING: 1/4" NPT X 1/4" NPT F/M EL | 34 |
| 0720-900 | BOLT: TBI MOUNTING | 34 |
| 0730-016 | PUMP: FUEL EFI 5.7-8.2 | 32, 36 |
| 0730-057 | VALVE: PCV ASSM 5.7 PFI | 39 |
| 0730-103 | BRACKET: HI-PRESSURE PUMP | 36 |
| 0730-103N2 | BRACKET: HI-PRESSURE PUMP EFI | 32 |
| 0730-257 | MANIFOLD: INTAKE 5.7 GM PFI | 35 |
| 0730-278N2 | BRACKET: LOW PRESSURE FUEL PUMP | 27, 29, 32, 36 |
| 0730-282N2 | BRACKET: FUEL/WATER SEPARATOR | 27, 29, 32, 36 |
| 0730-284B | BRACKET: PFI RELAY GM | 36 |
| 0730-284N5 | BRACKET: ELECT COMPONENT PFI 5.7 | 36 |
| 0730-349 | FUEL LINE: 3.0L - 8.2L | 31, 35 |
| 0730-359 | FUEL LINE: 5.7L MP BILLET RETURN | 31 |
| 0730-361 | FUEL LINE: REGULATOR TO HI-PRESSURE PUMP | 35 |
| 0730-382 | SENSOR: THROTTLE POSITION | 35 |
| 0730-383 | SEAL: IAC | 35 |
| 0730-384 | BOLT: IAC & TP SENSOR ATTACHING | 35 |
| 0730-401 | FUEL RAIL: PFI 5.7 EDELBROCK | 38 |
| 0730-427 | HOSE: PFI PRESSURE REGULATOR ASSM 5.7 | 37 |
| 0730-449 | MOTOR: IAC | 35 |
| 0730-457 | HOSE: CRANKCASE VENT PFI 5.7 | 37 |
| 0730-501 | INJECTOR: FUEL PFI 5.7 MP | 38 |
| 0730-510 | REGULATOR: FUEL PRESSURE SB PFI/BB | 38 |
| 0730-557 | THROTTLE BODY: PFI SB / 7.4L L-29 | 35 |
| 0730-650 | GASKET: THROTTLE BODY PFI | 35 |
| 0730-657 | GASKET: INTAKE MANIFOLD 5.7V SET | 29, 31, 35 |
| 0730-827 | FITTING: INTAKE MANIFOLD VACUUM | 38 |
| 0730-882 | BUSHING: 1/4" X 3/8" | 38 |
| 0730-951 | BOLT: PFI FUEL PRESSURE REGULATOR | 39 |
| 0730-952 | BOLT: PFI THROTTLE BODY GM 5.7 | 39 |
| 0730-957 | BOLT: INTAKE MANIFOLD 5.7V | 34, 39 |
| 0757-550 | FILTER: AIR GM PFI SB ROUND INLET | 38 |
| 0790-000 | CLAMP: PREFORM SEAPUMP HOSE 1-1/2" | 9 |
| 0791-000 | CLAMP: OIL COOLER 2" | 8 |
| 0791-006 | BRACKET: OIL COOLER 6" | 8, 43 |
| 0805-000E5 | DISTRIBUTOR: ELECTRONIC 350/5.7 | 18 |
| 0805-001E5 | CAP: DISTRIBUTOR V8 | 18 |

MARINE POWER 5.7 VORTEC PARTS BOOK NUMERICAL LISTING

| PART NUMBER | DESCRIPTION | PAGE NUMBER(S) |
|-------------|---------------------------------------|----------------|
| 0805-001E5 | CAP: DISTRIBUTOR V8 | 18 |
| 0805-002E5 | ROTOR: DISTRIBUTOR 350/5.7 | 18 |
| 0805-101H3 | COIL: HIGH PERFORMANCE | 18 |
| 0806-005 | SENSOR: KNOCK 5.7 EFI/MSTS | 33, 37 |
| 0806-010F12 | SENDER: TEMP EFI/MSTS | 33, 37 |
| 0806-020F12 | SENSOR: MAP ALL EFI/MSTS (MEFI 1 & 2) | 33 |
| 0806-057 | SENSOR: MAP SMALL (MEFI3) | 37 |
| 0806-596 | MODULE: ECM EFI #3 | 33, 37 |
| 0806-599 | MODULE: ECM EFI #2 | 33, 37 |
| 0806-600 | MODULE: ECM EFI MEFI3 #4 >98 | 33, 37 |
| 0806-735N5 | HARNESS: PFI 5.7 MEFI3 | 36 |
| 0806-824N5 | HARNESS: TBI 5.7 | 32 |
| 0806-998 | CODE MATE | 34 |
| 0807-000M5 | DISTRIBUTOR: ELECTRONIC BB | 18 |
| 0807-006M5 | MODULE: DISTRIBUTOR | 18 |
| 0808-000P9 | DISTRIBUTOR: ELECTRONIC V8 RH | 18 |
| 0811-016 | WIRE LEAD: COIL TO DIST + FILTER | 19 |
| 0811-018 | WIRE LEAD: COIL TO DIST + FILTER | 19 |
| 0811-019 | WIRE LEAD: IGNITION SHIFT INTERRUPT | 19 |
| 0811-020F8 | WIRE LEAD: HOBBS OIL SWITCH | 19 |
| 0811-027 | WIRE LEAD SET: ELECTRIC FUEL PUMP | 19 |
| 0900-001 | BASE: SINGLE OIL | 8 |
| 0900-100 | BASE: DUAL OIL | 8 |
| 0900-400 | KIT: OIL EXCHANGE | 8 |
| 0901-350 | BRACKET: DUAL OIL BASE SB / NW JET | 8 |
| 0901-538 | BRACKET: DUAL OIL BASE CAL JET | 8 |
| 0904-000 | FILTER: OIL SPORTPAC | 8 |
| 0905-000 | FILTER: OIL ENPAC | 8 |
| 0940-001 | SENDER: WATER SINGLE 1/2" | 19 |
| 0940-002 | SENDER: OIL SINGLE | 19 |
| 0940-011 | SENDER: WATER SINGLE 3/8" | 19 |
| 0940-101 | SENDER: WATER DUAL 1/2" | 19 |
| 0940-102 | SENDER: OIL DUAL | 19 |
| 0940-111 | SENDER: WATER DUAL 3/8" | 19 |
| 0940-201 | SWITCH: WATER TEMP 3/8" | 19 |
| 0940-202 | SWITCH: OIL PRESSURE 1/8" 7PSI | 19 |
| 0945-000 | PANEL: INSTRUMENT | 20 |
| 0945-002 | GAUGE: WATER TEMP | 20 |
| 0945-003 | GAUGE: VOLTMETER | 20 |
| 0945-004 | GAUGE: TACHOMETER GAS | 20 |
| 0945-005 | GAUGE: OIL PRESSURE | 20 |
| 0945-015 | GAUGE: FUEL | 20 |
| 0945-476 | GAUGE: HOUR METER | 20 |
| 0947-003 | HARNESS: 3 FT EXTENSION | 20 |
| 0947-010 | HARNESS: 10 FT EXTENSION | 20 |
| 0947-016 | HARNESS: 16 FT EXTENSION | 20 |
| 0947-025 | HARNESS: 25 FT EXTENSION | 20 |
| 0947-035 | HARNESS: 35 FT EXTENSION | 20 |
| 0950-100 | COVER: WEATHER | 27 |
| 0950-102 | COVER: WEATHER VORTEC | 29, 33 |

MARINE POWER 5.7 VORTEC PARTS BOOK NUMERICAL LISTING

| PART NUMBER | DESCRIPTION | PAGE NUMBER(S) |
|-------------|---|----------------|
| 0950-102 | COVER: WEATHER VORTEC | 29, 33 |
| 0950-824 | COVER: WEATHER EFI NON-VORTEC | 33 |
| 0951-200G2 | FLAME ARRESTOR: CARB 181/V6/5.7 | 27, 29 |
| 0952-002N6 | FLAME ARRESTOR: CARB NW JET 2-1/2" TALL | 29 |
| 0992-000 | RISER: C-R MP 3" IRON | 25 |
| 0992-005 | RISER: C-R MP 4" POLISHED ALUMINUM | 25 |
| 0992-040 | RISER: C-R MP 4" IRON | 25 |
| 0992-041 | RISER: C-R MERC STYLE 4" CERAMIC COATED | 25 |
| 0992-104 | RISER: C-R MERC STYLE 4" ALUMINUM | 25 |
| 0992-110P5 | O-RING: RISER MP 2000 | 26 |
| 0992-115 | RISER: C-R MERC STYLE 15D | 25 |
| 0992-200P5 | RISER: C-R MP 2000 ALUM FW SB/BB | 26 |
| 0992-205P5 | GASKET: RISER C-R MP 2000 | 11, 25 |
| 0992-210P5 | RISER: C-R MP 2000 ALUM RW SB/BB | 26 |
| 0992-215P5 | HOSE: BYPASS MP 2000 RW | 26 |
| 0992-300G5 | GASKET: RISER C-R V8 MP | 11, 25 |
| 0992-301G5 | GASKET: RISER C-R FW MP RISER | 11, 25 |
| 0992-310N4 | GASKET: RISER MERC RW | 11, 25 |
| 0992-400 | RISER: C-R MERC STYLE 4" IRON | 25 |
| 0992-635 | SPACER: RISER MERC STYLE 3" | 25 |
| 0992-660 | SPACER: RISER MERC STYLE 6" | 25 |
| 0994-000 | MANIFOLD: EXHAUST MP IRON 350/5.7 | 25 |
| 0994-003 | RISER: C-R MP 3" ALUMINUM | 25 |
| 0994-004 | RISER: C-R MP 4" ALUMINUM | 25 |
| 0994-100 | MANIFOLD: EXHAUST MERC STYLE IRON | 25 |
| 0994-200P5 | MANIFOLD: EXHAUST MP 2000 FW 5.7 | 26 |
| 0994-210P5 | MANIFOLD: EXHAUST MP 2000 RW 5.7 | 26 |
| 0994-528 | MANIFOLD: EXHAUST MP ALUM 350/5.7 | 25 |
| 0994-537 | MANIFOLD: EXHAUST MP POLISHED ALUMINUM | 25 |
| 0994-538 | MANIFOLD: EXHAUST MERC STYLE ALUMINUM | 25 |
| 0999-772 | MANIFOLD: EXHAUST VOLVO VR1 | 26 |
| 0999-773 | RISER: C-R VOLVO VR1 RW 350/5.7 | 26 |
| 0999-774 | GASKET: RISER VOLVO VR1 | 11, 26 |
| 0999-775 | MANIFOLD: EXHAUST VOLVO VR2 | 26 |
| 0999-776 | RISER: C-R VOLVO VR1 FW 350/5.7 | 26 |
| 0999-777 | RISER: C-R VOLVO VR2 | 26 |
| 0999-778 | GASKET: RISER VOLVO VR2 | 11, 26 |
| 0999-779 | PLATE: BLOCK-OFF VOLVO VR2 | 11, 26 |
| 1005-000 | CLAMP: DIPSTICK TUBE RUBBER COATED 3/8" | 7 |
| 1110-000BLK | WIRE SET: IGNITION HI-PERF V8 BLACK | 19 |
| 1110-000E5 | WIRE SET: IGNITION V8 YELLOW | 19 |
| 1110-000N2 | WIRE SET: IGNITION V8 BLACK | 19 |
| 1110-001 | CLIP: IGNITION WIRE | 19 |
| 1110-903 | BOLT: LOOM SS SB | 19 |
| 1140-004 | CIRCUIT BREAKER: IGNITION | 19 |
| 1140-006 | RELAY: STARTER OLD STYLE | 19 |
| 1140-011N4 | RELAY: STARTER 70 AMP | 19 |
| 1140-102F5 | RELAY: HARNESS 40 AMP | 19 |
| 1140-240N7 | HARNESS: CARBURETED 3.0-8.2L | 20 |

MARINE POWER 5.7 VORTEC PARTS BOOK NUMERICAL LISTING

| PART NUMBER | DESCRIPTION | PAGE NUMBER(S) |
|-------------|---|----------------|
| 1140-334P8 | HARNES: PRIMARY ENGINE EFI >8/99 | 32, 36 |
| 1150-100F11 | BRACKET: ELEC COMPONENT | 29, 32 |
| 1184-000 | BRACKET: ALTERNATOR SUPPORT SB | 18 |
| 1185-000 | BRACKET: TENSION ARM SB/BB | 18 |
| 1188-001 | SPACER: ALTERNATOR | 18 |
| 1194-000 | BRACKET: SHIFT BW 71/72C | 47 |
| 1194-500J12 | BRACKET: SHIFT BW 5000 GAS | 47 |
| 1194-630 | BRACKET: SHIFT HURTH 630A | 47 |
| 1210-000E7 | ALTERNATOR: 51 AMP | 18 |
| 1210-002 | PULLEY: DUAL ALTERNATOR | 14 |
| 1250-002E3 | OIL LINE: 28" 90-90 | 8 |
| 1250-003E3 | GEAR LINE: 45" SPORTPAC | 47 |
| 1250-051F8 | OIL LINE: 51" 90-90 | 8 |
| 1256-019 | OIL LINE: 19.5" 90-90 | 8 |
| 1256-037F8 | GEAR LINE: 37" SPORTPAC | 47 |
| 1256-042F8 | GEAR LINE: 42" SPORTPAC | 47 |
| 1435-000 | MOUNT: ISOLATOR | 45 |
| 1440-001 | BRACKET: GEAR COOLER TWIST | 8 |
| 1450-100 | HOSE: VENT TUBE | 29 |
| 1452-000F11 | HOSE: CIRC PUMP | 9 |
| 1455-003 | HOSE: CIRC PUMP TO TANK RM | 9 |
| 1455-017G8 | HOSE: FW TANK TO MANIFOLD SB | 9 |
| 1456-000 | HOSE: RAW WATER HOUSING - COOLER | 9, 43 |
| 1458-003 | HOSE: SEAWATER PUMP TO FW TANK | 9 |
| 1458-004 | HOSE: RISER TO FW TANK SB | 9 |
| 1458-005 | HOSE: SEAWATER PUMP TO COOLER | 9, 43 |
| 1458-101P10 | HOSE: MANIFOLD TO T-STAT HOUSING MERC STYLE STARBOARD | 9 |
| 1458-102P10 | HOSE: MANIFOLD TO T-STAT HOUSING MERC STYLE PORT | 9 |
| 1460-000 | OIL DRAIN: EZ STANDARD | 8 |
| 1460-001 | OIL DRAIN: EZ METRIC | 8 |
| 6002-002 | GEAR: VELVET DRIVE 5000 V-DRIVE 1.25:1 | 46 |
| 6002-003 | GEAR: VELVET DRIVE 5000 V-DRIVE 1.5:1 | 46 |
| 6002-004 | GEAR: VELVET DRIVE 5000 V-DRIVE 2.0:1 | 46 |
| 6005-002 | GEAR: VELVET DRIVE 72C V-DRIVE 1.9:1 GEAR | 46 |
| 6005-003 | GEAR: VELVET DRIVE 72C V-DRIVE 1.9:1 CHAIN | 46 |
| 6005-004 | GEAR: VELVET DRIVE 72C V-DRIVE 2.5:1 CHAIN | 46 |
| 6005-005 | GEAR: VELVET DRIVE 72C V-DRIVE 2.5:1 GEAR | 46 |
| 6005-010 | GEAR: VELVET DRIVE 72C V-DRIVE 1.5:1 CHAIN | 46 |
| 6005-011 | GEAR: VELVET DRIVE 72C V-DRIVE 1.5:1 GEAR | 46 |
| 6005-012 | GEAR: VELVET DRIVE 72C V-DRIVE 1.2:1 GEAR | 46 |
| 6005-013 | GEAR: VELVET DRIVE 72C V-DRIVE 1.2:1 CHAIN | 46 |
| 6017-004 | GEAR: VELVET DRIVE 71C 1:1 | 46 |
| 6018-002 | GEAR: VELVET DRIVE 72C 1:1 | 46 |
| 6018-004 | GEAR: VELVET DRIVE 72C 1.5:1 | 46 |
| 6018-010 | GEAR: VELVET DRIVE 72C 2.5:1 | 46 |
| 6018-012 | GEAR: VELVET DRIVE 72C 2.9:1 | 46 |
| 6018-106 | GEAR: VELVET DRIVE 72C 1.88:1 | 46 |
| 6018-210 | GEAR: VELVET DRIVE 72C 2.1:1 | 46 |
| 6020-001 | GEAR: VELVET DRIVE 5000 1:1 | 46 |

MARINE POWER 5.7 VORTEC PARTS BOOK NUMERICAL LISTING

| PART NUMBER | DESCRIPTION | PAGE NUMBER(S) |
|-------------|---------------------------------------|----------------|
| 6020-002 | GEAR: VELVET DRIVE 5000 1.25:1 | 46 |
| 6020-003 | GEAR: VELVET DRIVE 5000 1.5:1 | 46 |
| 6020-004 | GEAR: VELVET DRIVE 5000 2.0:1 | 46 |
| 6020-005 | GEAR: VELVET DRIVE 5000 2.5:1 | 46 |
| 6020-006 | GEAR: VELVET DRIVE 5000 2.8:1 | 46 |
| 6022-005 | GEAR: VELVET DRIVE 5000 V-DRIVE 2.5:1 | 46 |
| 6450-100 | GEAR: HURTH 450D 1:1 DIRECT DRIVE | 46 |
| 6450-125 | GEAR: HURTH 450A 1.25:1 | 46 |
| 6450-150 | GEAR: HURTH 450A 1.5:1 | 46 |
| 6450-200 | GEAR: HURTH 450A 2.0:1 | 46 |
| 6450-204 | SWITCH: GEAR ALARM HI-TEMP | 47 |
| 6635-130 | GEAR: HURTH 630V V-DRIVE 1.3:1 | 46 |
| 6635-150 | GEAR: HURTH 630V V-DRIVE 1.6:1 | 46 |
| 6635-210 | GEAR: HURTH 630V V-DRIVE 2.0:1 | 46 |
| 6635-250 | GEAR: HURTH 630V V-DRIVE 2.5:1 | 46 |
| 6640-005 | SWITCH: NEUTRAL SAFETY | 47 |
| 6754-850N4 | RELAY: ELECTRIC FUEL PUMP | 19 |
| 7909-005 | DRIVE LINE: NW JET / CAL JET | 6 |
| 9000-001 | TOOL: TIMING | 19 |
| 9902-152 | BRACKET: MAP SENSOR SMALL | 36 |
| 9920-102 | MOTOR: IAC | 31 |
| 9920-104 | SENSOR: THROTTLE POSITION SB/BB TBI | 31 |
| HHT0-010 | HOSE: HEATER 5/8" | 37 |
| HPWS-006 | HOSE: 3/8" | 43 |
| HPWS-010 | HOSE: POWER STEERING 5/8" | 43 |
| HWRP-016 | HOSE: SEAFLEX 1" | 9 |
| HWRP-020 | HOSE: SEAFLEX 1-1/4" | 9 |