

PATHFINDER 2200 TOURNAMENT EDITION

O W N E R ' S M A N U A L

Dear New Boat Owner,

Welcome to the Pathfinder Family!

Thank you for choosing a Pathfinder boat to transport you to your angling dreams. We believe the Pathfinder 2200 Tournament Edition is the best all-purpose boat on the market, and we're sure that you'll be completely satisfied with the unmatched performance, quality and fishability of your new boat.

We value your input, not just at the time of the sale, but throughout the entire boat ownership period, and we've taken steps to allow you to share that information. Over the next year or so, you will receive at least two questionnaires to fill out and return.

Be sure to visit our website www.pathfinderboats.com to find information on company events like our Owner's Tournaments and Corporate Calendar. You'll find a wealth of information on our Forum, where you can ask questions, get answers and join other Pathfinder owners to discuss all applications of your boat. We're proud to have you as a member of the Pathfinder family!

Tight lines and screaming drags!

D. Scott Deal



PATHFINDER
ANGLER DRIVEN

TABLE OF CONTENTS

Maintenance and Cleaning.....	3	Self Bailing Cockpit.....	13
Engine Stop Switch.....	4	Livewell System.....	13
Fuel / Water Separators.....	5	Livewells.....	14
Garboard Drain Plug.....	5	Forward Lockable Rod Lockers.....	14
Gauges.....	6	Wiring System/Breakers and Fuses.....	15
Switch Panel.....	6	Trim Tabs.....	16
2200 Tournament Boat Layout.....	7	Console Storage.....	17
Ditty Bag.....	7	Leaning Post.....	17
Aluminum Plate Locations.....	8	Saltwater Washdown.....	18
Trolling Motor.....	8	Battery Switch/Breaker Panel.....	18
Wiring System.....	9	Gauge Upgrades.....	20
Bilge System.....	10	Optional Power Pole.....	20
Jackplate.....	12	Power Pole Aluminum Plate Placements.....	20
Props.....	12	Warranty.....	21
Fuel System.....	12		

Maintenance

Pathfinder Boats advises owners that maintenance and repairs should be performed at an authorized Pathfinder dealer. The following information is general in nature and should not be considered a repair manual or guidelines set forth by Maverick Boat Company.

Cleaning

Each Pathfinder boat is constructed using the finest materials and components available. However, no material is immune to the ravages of the saltwater environment. After each use, your boat should be rinsed thoroughly with fresh water. A mild detergent may also be used to remove any dirt, silt or stains. A light coat of lubricant on metal railing, screws and electrical connections will help prevent electrolysis. The same holds true for your trailer.

2400 TRS SPECIFICATIONS

L.O.A.....	23' 11"
BEAM.....	8' 06"
DRAFT.....	12"
WEIGHT W/ ENGINE.....	2,950 LBS.
FUEL CAPACITY.....	56 GAL.
DEADRISE @ TRANSOM.....	15 DEG MAXIMUM
H.P.....	300
TRANSOM HEIGHT.....	25"
MAXIMUM CAPACITIES.....	11 PERSONS OR 2,950 LBS

ENGINE BREAK-IN PERIOD

Engine Break-In Period

New engines require a period of break-in to allow the surfaces of the moving parts to mate evenly. Different engines require different break-in periods and methods. For instructions on break in methods, refer to your Yamaha Engine Owner's Manual for the correct break-in procedures and times for your model engines

Engine Stop Switch

If activated, the spring loaded engine stop switch will automatically shut down the engine during emergency situations to prevent uncontrolled or unattended operation. Certain emergency conditions (e.g., turbulent water, wakes, unanticipated movement) may impair a person's ability to operate the craft safely. The switch, located on the helm, must have the safety lanyard attached at its base. This activates the protective shutdown circuitry.

Securely attach the other end of the lanyard to the operator of the boat. If the operator moves, falls or is at an unsafe distance from the steering wheel, tension on the lanyard will pull it from the switch. When the lanyard is removed, the engine stop switch is released and automatic engine shutdown occurs.



Engine stop switch (above)

Engine Stop Switch

⚠ DANGER

An engine stop switch system that is not used or does not function properly can cause death or serious injury. **DO NOT** operate the boat if the engine stop switch system does not function properly. Go to a Cobia Dealer to have this resolved immediately

The lanyard should be securely attached to the boat operator at all times that the engine is on.

FUEL-WATER SEPARATOR & DRAIN

Garboard Drain Plug

The garboard drain plug is the small metal plug located at the lowest point on the hull, at the bottom of the transom right above the keel. The drain has been designed so that it can be loosened by hand while the hull is out of the water for draining. This allows the plug to stay in contact with the surrounding frame so you'll never misplace or lose it. You can completely remove the insert by pulling back and continue turning in a counter clockwise motion. It is manufactured with a rubber seal in place to ensure you bilge is watertight. Always make sure before putting the boat in the water that this plug is hand tightened firmly. Excess water in the bilge may be an indication of a problem with this plug or the automatic bilge pump. Refer to page 10 of this Owner's Manual for information on your boats bilge system.



Fuel-Water Separator

Each Pathfinder 2200 Tournament Edition is equipped with a fuel water separator to ensure maximum performance and protect the outboard engine from contaminated gasoline. The fuel separator is a metal, cylindrical unit secured to the transom section of your starboard aft rigging box.

The fuel separator can be checked by removing it from the mounting bracket in the rigging locker and dumping it into an approved waste collection device. If there appears to be an excessive amount of water, the filter component should be changed. See your authorized Pathfinder dealer for replacement parts.



Fuel/Water Separator (above)

Maintenance Note

In addition, the fuel separator should be changed as part of routine maintenance at 20, 50 and 100 hours checks.

SWITCH AND

Switch Panel

The dual activation switches are set in a standard grid, these switches can be flipped either up or down to control different accessories. The accessories located directly above a switch are activated when the switch is in the "Up" position and the accessories located directly below the switch are activated when the switch is flipped into the "Down" position. For example, in the "Up" position the first switch in the top left corner will turn on the navigation lights, but if in the "Down" position it will turn on the anchor lights. The bilge switch is an on-demand switch to run your bilge pump and is used as a backup in case the float indicator in your bilge pump becomes clogged.



Switch Panel

Instrument Panel

The instrument panel on your Pathfinder 2200 Tournament Edition is composed of two Yamaha digital gauges and a series of dual activation switches. The switches come with accessory plug-ins for wiring additional electronics, pumps or electrical circuits.

The standard digital gauges include a Yamaha tachometer and a Yamaha speedometer. The tachometer has several built in features including an engine temperature monitor, oil level monitor and engine trim indicator. The speedometer includes a digital readout of the speed, an hour meter, trip meter and clock. For more information on the specifics of your Yamaha gauges, see your Yamaha owner's manual.



BOAT LAYOUT

2400 TRS Boat Layout

Your Pathfinder 2200 Tournament Edition is designed to create the maximum amount of storage capacity without affecting fishing ability. Livewells, gasketed and guttered storage compartments and lockers are built to protect your gear from the elements.

Become familiar with the boat layout and features to take advantage of their special qualities. All Pathfinder boats are designed by anglers, for anglers, to offer the best fishing features in the Bay Boat market. The Pathfinder's superior layout offers hands-free fishability with the most storage and casting room available.

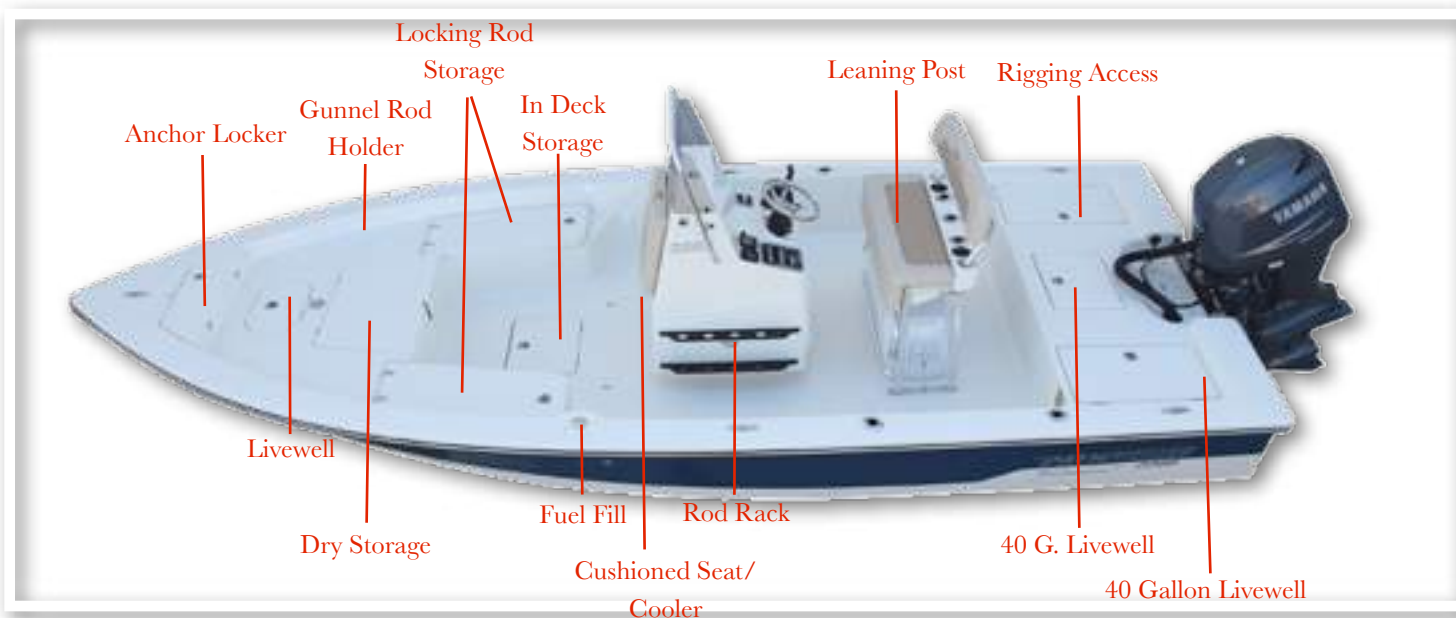

DITTY BAG

You should have received a cloth ditty bag with your new Pathfinder 2200 Tournament Edition. Inside the ditty bag are the following items:

- 1 Large Livewell Standpipe
- 1 Small Livewell Standpipe
- 1 1-1/2" Livewell Pacifier Plug
- 2 ignition keys and Emergency Kill Cord
- 1 Yamaha Engine Owner's Manual
- 1 Engine Start Cord
- 1 Garboard Drain Plug
- 1 Gas Fill Key
- 2 Glove Box Keys
- 1 Yamaha
- Various Product Manuals



Pathfinder 2400 TRS Ditty Bag

BACKING PLATES & TROLLING

Backing Plates

The diagram below shows all the screw-retention backing plates (trolling motor, T-Top, Leaning Post) originally placed in the deck of a Pathfinder 2200 Tournament Edition during the construction process.

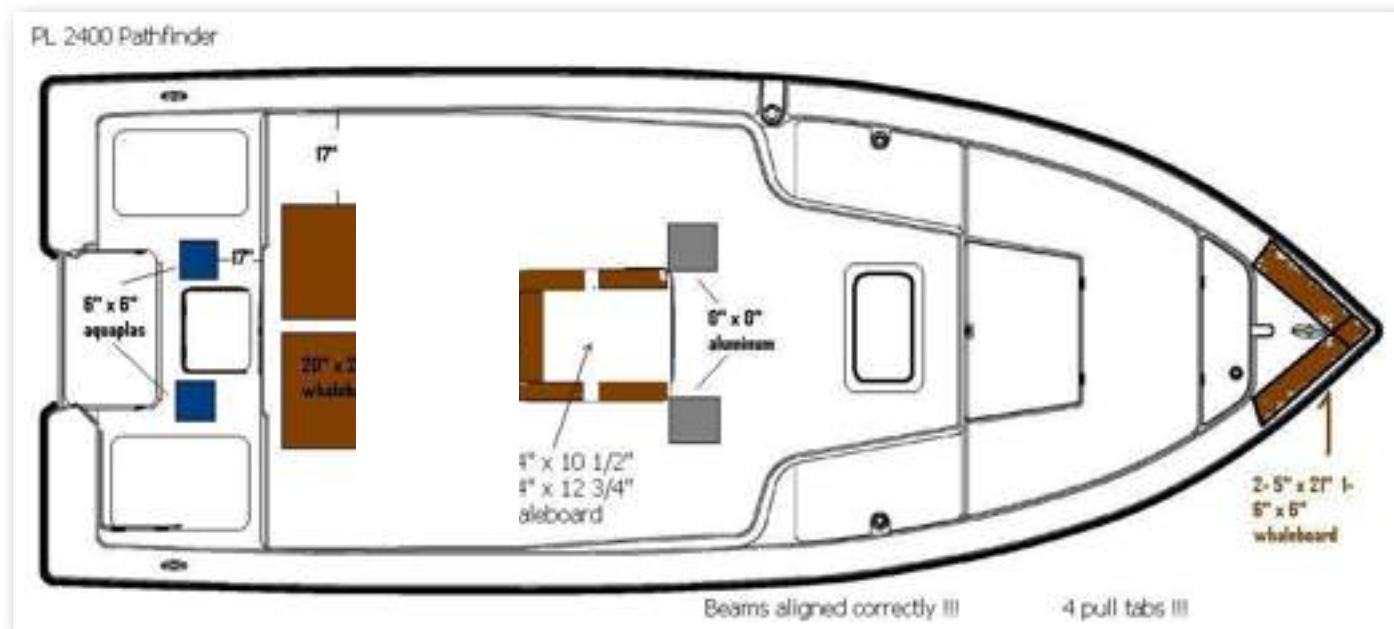

Trolling Motor/Wiring System

Your Pathfinder 2200 Tournament Edition comes standard with a 24V trolling motor wiring system. A trolling motor mounting plate was built into the bow of your Pathfinder during the manufacturing process. To attach a trolling motor, please go to your nearest Pathfinder dealer. All trolling motors should be attached by drilling through the mounting plate with a 13/64" drill bit and 1/4" tap and using 1/4" #20 machine screws. The plate is designed to accommodate the mounting patterns of all trolling motor brands on the market currently. See page 9 for optional trolling motor system with battery charger and wire routing.

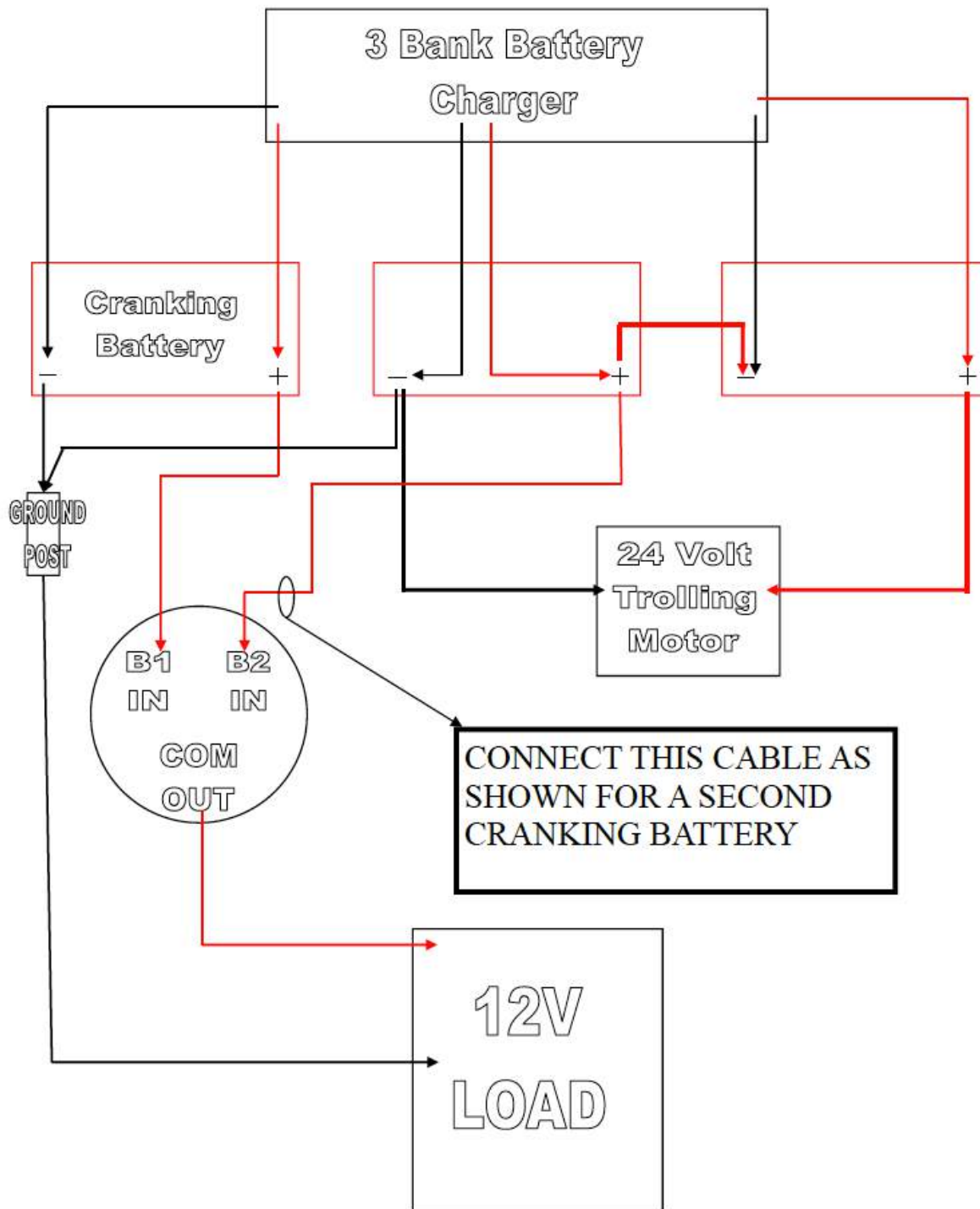

SYSTEMS

Ball Valves

Ball valves can be used to serve several purposes. They allow seawater to enter the boat, in the case of livewells, and they also act as a safeguard to stop water from entering in case of part failure, and function as an emergency shutoff. To tell which position a ball valve is in, open or closed, look at the valve and determine the direction of flow. When the ball valve handle is in the same position as the direction of flow, the valve is in the "OPEN" position. When the ball valve handle appears to cross the direction of flow, the valve is in the "CLOSED" position.

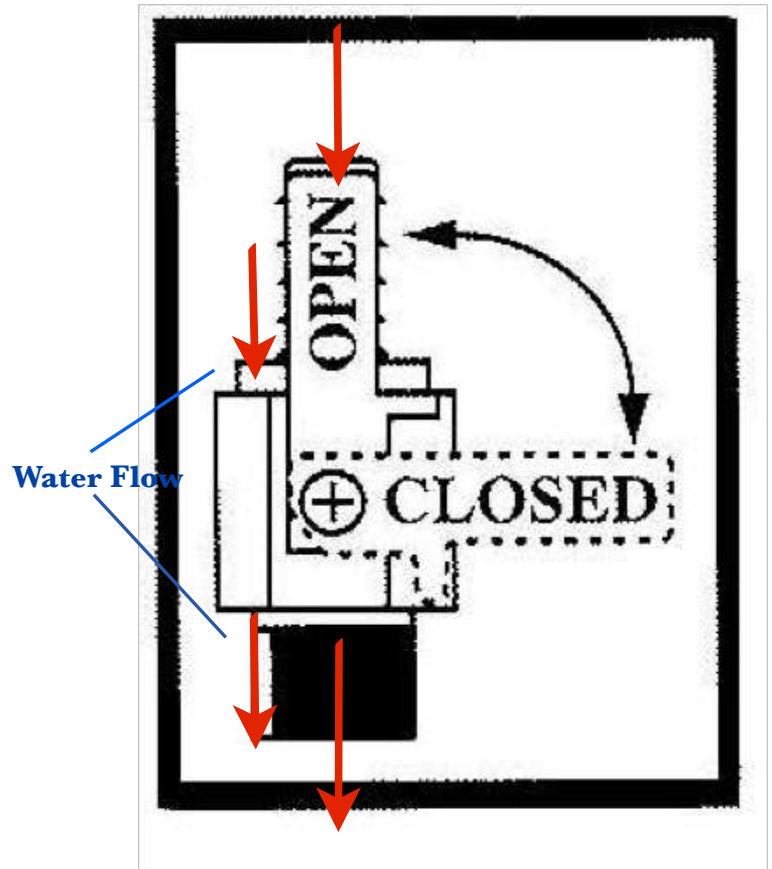

2200 Deckdrain System

The deckdrain system is equipped with 1 1/2" thru hull fittings through the aft port and starboard hull sides. These fittings have to be installed lower than the drains in the cockpit floor so that gravity will allow the cockpit to drain free of water. This puts these fittings very close to the water line of the hull. These drains are rigged with ball valves that can be opened and closed to control the flow of water. In the open position, these ball valves will allow water to flow freely from the cockpit, thus making the boat "self-bailing". When closed, no water will be allowed to travel to or from the cockpit.

2200 Livewell Pump Assembly

The livewell pump assembly is composed of a scoop strainer mounted to the bottom of the hull, a thru hull fitting, ball valve assembly, and the pump. As you can see, the ball valve assembly is in the "OPEN" position. This is the correct position for the operation of the livewell system.

*THE LIVEWELL PUMP
ASSEMBLY IN THE "OPEN"
POSITION*



BILGE

Bilge

The bilge of your Pathfinder 2200 Tournament Edition should always be checked after launch. A small amount of water in the bilge is normal for this area of the boat. Large amounts of water or any signs of fuel or oil require immediate attention. Never pump fuel or oil overboard while your boat is in the water.

Large quantities of water in the bilge may be an indication of a leak or that your bilge pump is jammed, broken or has blown a 5 amp fuse. First check that your bilge pump is running. Turn the switch on and listen for the bilge pump to turn on. If the bilge pump does not come on, check your fuse box to make sure the pump hasn't blown a fuse. If the fuse is damaged, replace it and turn the switch on again, listening for the bilge pump to come on.



The Bilge Pump is Mounted to ABS Plastic

If the fuse is in working order, make sure the pump is turned off, then unhook the bilge pump from its cradle by squeezing the blue tabs on the sides of the pump and lifting. The entire bilge pump and wiring should release from the cradle. Check the underside and impeller areas for miscellaneous items that might clog the pump.

Items such as monofilament, plastic, rocks and small clumps of debris can easily clog the impeller and prevent the bilge pump from operating correctly. Should you find a clog, remove the item and turn the pump switch to the "on" position. If the pump runs, turn the switch "off" and return the pump to its cradle.

If the fuse is working and the impeller is not clogged, the bilge pump is probably bad and needs to be replaced. See your local Pathfinder dealer for bilge pump replacement.

If the bilge pump is working and pumping water, but the water level in the bilge does not go down, you likely have a leak which requires immediate attention. Remove your boat from the water and see your local Pathfinder dealer to have the bilge area inspected for possible leaks.

Fuel leaks also require immediate attention. Be sure to check for fuel leaks frequently and repair any problems immediately. Any replacement of parts or repairs to the fuel system should be performed by a trained marine mechanic. See your authorized Pathfinder dealer for parts and repair.

Use bilge cleaner products to remove any obvious stains. Consult your authorized Pathfinder dealer for recommended types of bilge cleaners.

JACKPLATE & PROPS

Props

Prop selection on your Pathfinder 2200 Tournament Edition is determined by your local Pathfinder dealer but based on recommendations made by Pathfinder Boat Company and Yamaha Marine to give your boat the maximum overall performance. Different prop designs may improve performance or can be tailored to enhance specifics of boat and motor performance.

For instance, a prop with a smaller pitch will increase speed out of the hole (jumping onto plane) but will produce a decreased overall speed compared to a prop with a larger pitch. Four or five bladed props may increase overall speed or allow the boat to run shallower, and some props can decrease cavitation at high speeds. Your individual prop needs will determine the prop design and size that best fits your performance requirements.

Always inspect the engine and prop prior to launching your boat. Key prop issues include tangled fishing line or other types of debris, cracked blades or fluid leaking out of the seal. Look for fishing line tangled around the prop or lower unit seal. Consult your Yamaha Owner's Manual to address these issues.



JackPlates

A standard jackplate has been installed on your Pathfinder 2200 Tournament Edition to improve shallow water performance. A jackplate allows the motor to be trimmed straight up as opposed to the angled trimming of the stock engine trim motor, thus allowing more prop to remain in the water while running.

Jackplates have very specific applications and performance requirements. Before operating your boat, you should carefully review your jackplate owner's manual and your Yamaha engine manual.

***NOTE--The installation of a hydraulic jackplate greatly increases the amount of stress on the back of the boat. For this reason, we recommend all boats rigged with jackplates should also have a transom saver or other transom supporting device to minimize the stress on the entire transom area. Transom supporting devices can be purchased from your local Pathfinder dealer or boating and trailer supply stores.**

FUEL SYSTEM

FUEL SYSTEM

Your Pathfinder 2200 Tournament Edition comes with a 56-gallon aluminum fuel cell stationed midship between the stringers just below and in front of the console. The fuel fill receptacle is on the port gunwale forward of the console. There's also a recessed fuel overflow vent on the port side of the boat just below the fuel receptacle.

We regularly pressure test each fuel system when it is initially received at the factory and until it leaves the factory as a component on a new boat. Should you experience any fuel related problems or suspect problems with the fuel system, immediately take your boat to your local Pathfinder dealer.



DANGER

CAUTION—Do not smoke while filling the tank. Be sure to turn off the engines and all electrical equipment when fueling the boat to prevent accidental discharges of static electricity. Use only the recommended gasoline (see Yamaha's Owner's Manual). Do not use fuels with alcohol or alcohol related derivatives that can cause marine fuel system hoses to deteriorate.

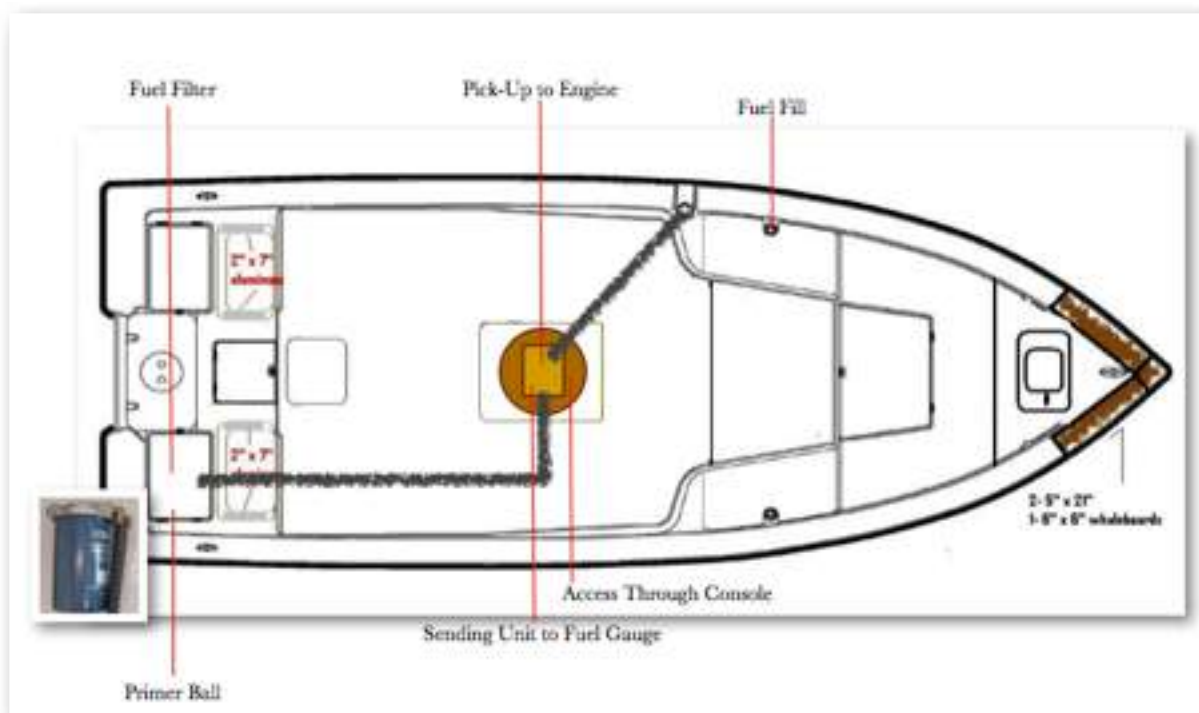

SELF-BAILING COCKPIT & LIVEWELL

Self Bailing Cockpit

The cockpit on your Pathfinder 2200 Tournament Edition is designed to be self-bailing, so that all water that comes into the cockpit can immediately flush out the back of the boat. This avoids holding standing water and allows the boat to drain at all times, including while docked.

Water drains out of the cockpit through the two aft cockpit drains located at each of the back corners of the cockpit. The drains run water via hoses out of the back of the transom--no water is drained into the bilge area.

The bilge is designed to drain any water entering the inside of the hull. Livewell and cockpit drains are closed systems that flush water out the drain scuppers in the stern. All hoses are sealed and double clamped during construction. Continuous or periodic running of the automatic bilge pump may be an indication of a hose leak or break in a seal and should be investigated by your local Pathfinder dealer immediately.



Livewell System

The new and improved livewell system on the 2200 Tournament Edition keeps bait alive longer than any other system on the market. It has a dual inflow system and a unique drain system that prevents dead zones and quickly expels any harmful chemicals (such as ammonia) from the water.

The livewell system takes water through our exclusive Sea Chest system. With this system, water enters the Sea Chest through a grate located at the bottom of the boat.

The boat is shipped with the shut-off valve turned to the "off" position (at a 90-degree angle). To start using your livewell, turn the shut-off valve counterclockwise so that it is in line with the pipe to open the system to water flow. This shut-off valve is also in place in case of the unlikely event of a leak while out on the water.

Your Pathfinder 2200 Tournament Edition comes with two standpipes and a pacifier-style drain plug to control water levels inside the livewell. The smaller standpipe is for use with crustaceans like shrimp and crabs that prefer a lower water level. The taller standpipe is for baitfish, and the drain plug is to hold water or seal the compartment. The standpipes should be placed in the hole located in the starboard aft section of the livewell. Make sure that the standpipe is firmly secured before covering the area with the plexiglass cover. Make sure that the bigger holes in the plexiglass cover are at the bottom before it is secured. Secure the cover by twisting the tabs located on both sides. On rare occasions, the livewell will not pump water even though the switch is turned on, the system is open and the livewell pump is running. If that occurs and there is not a clog in the filter, shift the throttle into reverse and back the boat several feet to purge a possible air pocket in the system. If there appears to be a clog in the drain, remove the grate and clear the top of the standpipe of any detritus.



Your boat might come with an optional recirculation system. This is a closed system that recycles the water already within the well. This system is also controlled by a switch on the switch panel and allows the boat operator to operate the livewell without an outside feed. This is ideal if you are transporting bait from different water extremes.

***--NOTE--Be sure to turn the shut-off valve to the 90-degree off position BEFORE unscrewing the filter cap (see photo above). Failure to do so will result in outside water entering the bilge area.**

FEATURES

Livewells

The Pathfinder 2200 Tournament Edition is a livebait friendly boat and comes with three standard livewells. With one 15-gallon livewell at the bow of the boat and two 40-gallon livewells at the stern (see diagram on page 7) this boat is capable of handling massive amounts of bait, or even keeping game fish alive for periods of time.



Stern Livewells (40-Gallons)

Locking Rod Storage

The Pathfinder 2200 Tournament Edition comes standard with both forward port and starboard lockable rod lockers. These lockers allow you to safely leave your rods in the boat if you ever have the occasion to leave them unattended. They also have large openings with gas shock assisted lids that open from the back allowing for quick and safe storage and retrieval of rods. Independent tubes forward protect brittle tips on rods up to 9 feet.



Port Lockable Rod Holder

WIRING

Wiring

A wiring diagram of your Pathfinder 2200 Tournament Edition has been included to help troubleshoot any electrical problems or add additional electronics or electrical connections. We recommend you use a trained marine electrician for all electrical issues.

Inside the console on the starboard side is the ground terminal and the breaker panel is located in the glove box. All the grounds lead to the ground terminal and then to the battery via a large diameter black wire.

Pathfinder Main Harness

To Console

Pin #	Function	Wire Color	AWG	
1.	Nav Lts (Instrumentation)	Grey	16	
2.	Nav Lts	Grey	16	
3.	Anc Lt (Console)	Grey/White	16	
4.	Anc Lt (T-TOP)	Grey/White	16	Pin C T-Top Recept
5.	Horn	Orange/White	16	
6.	Spreader Lt	Blue/Black	16	Pin A T-Top Recept
7.	Overhead Lts	Blue/Green	16	Pin B T-Top Recept
8.	PANEL GROUND	Black	16	Console Ground Bus

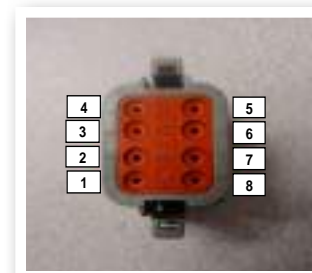

To Accessories

Pin #	Function	Main Harness Wire Color	AWG
1.	Bilge	Brown	
2.	L/W-1	Brown/White	14
3.	RECIRC-1	Red/White	14
4.	L/W-2	Brown/Yellow	14
5.	RELEASE WELL	Brown/Orange	14
6.	RECIRC-2	Red/Yellow	14
7.	BUBBLER	Red/Orange	14
8.	SALT WATER	Brown/Green	14
9.	FRESH WATER	Brown/Black	14
10.	LIVEWELL LTS	Blue/White	16
11.	COCKPIT LTS	Blue/Red	16
12.	COMPARTMENT LTS	Blue/Black	16

8 PIN Plug

Pin #	Function
1	ACC-1
2	ACC-2
3	ACC-3
4	ACC-4
5	ACC-5



Always use the recommended breaker/fuse amp sizes. Oversizing or using larger breakers/fuses than required can lead to electrical shorting and possible damage or destruction of the entire electrical system.

There are open slots on both the ground block and the breaker panel for additional electrical hook-ups. The accessory switches should be used for any additional hook-ups to protect the entire electrical system. All additional electrical hook-ups should be performed by a qualified marine electrician.

As a standard practice, we run pull cords forward and aft for any additional wiring needs. For your convenience and ease we have included a nylon rigging string that runs through the rigging tubes and terminates in the bow. The nylon string will allow you to easily run any additional wiring through the rigging tubes, thus protecting them from outside elements. We also run a string aft to the rigging box.

TRIM TABS

Trim Tabs

Trim tabs are a standard item on the Pathfinder 2200 Tournament Edition. We use external 9 X 12-inch Lenco electric trim tabs which can enhance the boat's performance. Because the tabs are electric, there is no hydraulic trim tab pump, thus eliminating the possibility for fluid leaks as with other trim tab manufacturers.

Trim tabs allow the boat operator to get the maximum performance from the boat and are also great for balancing weight in the boat and for lifting or lowering the hull to accommodate for different running situations.

Your port trim tab switch will greatly affect the port side of the boat, and the starboard switch will affect the starboard side, although they are operating tabs on the opposite sides. For instance, lowering the port trim tab creates stern lift on the port side, thus lowering the starboard bow. Raising the starboard trim tab lowers the stern on the starboard side and lifts the port bow. Use the tabs to adjust the attitude of the boat so that it sits evenly and to raise or lower the bow to control running performance.

Lightly tap the tabs with your fingers to allow the boat to adjust in response to the tabs without a dramatic change. Once the bow has been lowered or raised to the point that the ride has been adjusted for comfort and safety, tapping individual tabs can even improve the overall effects.

Pushing on the top of the switch (Down) will lower the trim tab and force the bow down, which is important for running through heavy seas or a stiff chop. In most instances, both tabs should be lowered for an even bow down ride.

Pushing the bottom of the switch (Up) will raise the tabs and lift the bow out of the water for better running performance. To achieve the best running performance with your Pathfinder 2200 Tournament Edition, use the engine trim in conjunction with your trim tabs to find the perfect amount of lift and a safe, comfortable ride.

In cases of severe weather or high winds, it is possible to use your trim tabs to lift the windward side of the boat to avoid spray blowing back onto the passengers. Do this in conjunction with lowering the bow to improve the overall ride.



Trim Tab

FEATURES

Forward Console Storage

The forward console cushion doubles as a removable door providing a huge access opening to the inside of the console and the back of the helm. Note the tackle drawer on the backside of the door designed to accommodate three flat tackle trays or other gear that you want to keep at the ready. To top it off, it's lockable.



The Leaning Post

The leaning post comes standard with the Pathfinder 2200 Tournament Edition and includes a folding footrest, four rodholders, two drink holders, cushions. A storage tray is located beneath the cushion.



BATTERY SWITCH/MAIN BREAKER

Battery Switch and Breaker Panel

The battery switch and main breaker panel is located in the aft starboard storage compartment. The top 50 amp breaker is the main power for the boat, which feeds the switch panel on the helm and it's associated accessories along with engine power. The 7 amp breaker below that is for the bilge and the remaining two 15 amp breakers are for adding additional accessories. Between each breaker and its label there is a small LED light which will be illuminated if that breaker and it's corresponding system is receiving power. When the battery switch is on the "off" position, only the light for the bilge should be on, as the bilge pump and float switch are wired directly to the batteries so that they remain operational at all times. (Refer to page 11 for bilge pump instructions). When the boat is not in use, it is recommended to leave the battery switch in the off, "0", position to ensure that the main battery is not drained over the long term by minor current flows.

Your Pathfinder is rigged at the factory so that the primary battery or "house battery" is tied to setting "1" on the battery switch. When the switch is in this position, your main breaker LED light should be illuminated. If that is not the case, determine if the breaker has been tripped by pressing in the right side of 50 amp switch labeled with the "I". This will close the circuit and should result in the LED coming on. In the event there is still no main power, this could be an indication of a dead battery, loose connection from this battery to the battery switch or the need for a new 50 amp breaker.

All Pathfinders are rigged standard with a 24 volt trolling motor wiring system. The battery switch allows for pulling from one of the trolling motor batteries or a secondary battery to supplement or totally replace the house battery. In the event that there is not enough power to crank the engine from battery "1", turning the battery switch to the "1 + 2" position will allow you to pull power from both batteries simultaneously. If this is required to start the engine, it is recommended to change the switch back to the "1" position once the engine is running so that the engine's alternator can recharge the primary battery.



Battery Switch, Shown in the "Off" Position

FEATURES

Salt Water Washdown

Salt-water washdown is an option on the 2200 Tournament Edition. The pump is located in the bilge forward of the livewell pump and is accessible through the splashwell hatch or the aft port hatch. To operate, hook a hose to the raw water receptacle in the aft section of the rod locker. Flip the switch labeled "Saltwater". The pump will pressurize the system with raw water. Once the system is pressurized, the pump will shut itself off with an internal pressure switch and will switch itself back on as you demand water. Be careful to only spray gelcoated fiberglass surfaces with saltwater and avoid all other areas. Always rinse your boat with freshwater as soon as you return to the dock or home if the boat is being trailered.



Raw Water Receptacle

OPTIONAL FEATURES

Command Link Gauges

Command Link gauges are an option for the 2200 Tournament Edition and are an upgrade from the standard digital gauges. Command Link gauges allow access to more information. Displays are user-selectable so you can choose the functions displayed on each gauge and what order. Speed data can be displayed from a pitot tube, Triducer, or NMEA protocol GPS unit



Stainless Boarding Ladder

The 2200 Tournament Edition comes with the option of the Swim/Dive Platform mounted in the stern of the boat. This platform provides for an easier and safer entry and exit from the boat. To operate the platform simply lift the metal ladder from the platform, extend the ladder to its full length, and let the ladder fall into the water



Boarding Ladder , Stowed

⚠ DANGER

No passenger should attempt to enter or exit the boat by the ladder or by any other means while the engine is on.

POWER POLE

Power Poles

Power Poles come as an option with the Pathfinder 2200 Tournament Edition and give the boat operator the ability to quickly and quietly stop the boat while in shallow water. Whether you want to enjoy a view, or if you've stumbled upon a group of tailing redfish the power pole will stop the boat quickly and easily. Please refer to the Power Pole owner's manual for operational and mechanical information. The 2400 TRS comes with 6" aluminum backing plates on the transom of the boat which are built into the boat at the factory and allow for the secure installation of a power pole. Refer to the diagram below for aluminum plate locations. If you want to install a Power Pole after your boat has left the factory, please take your boat to your nearest Pathfinder dealer.



Power Pole

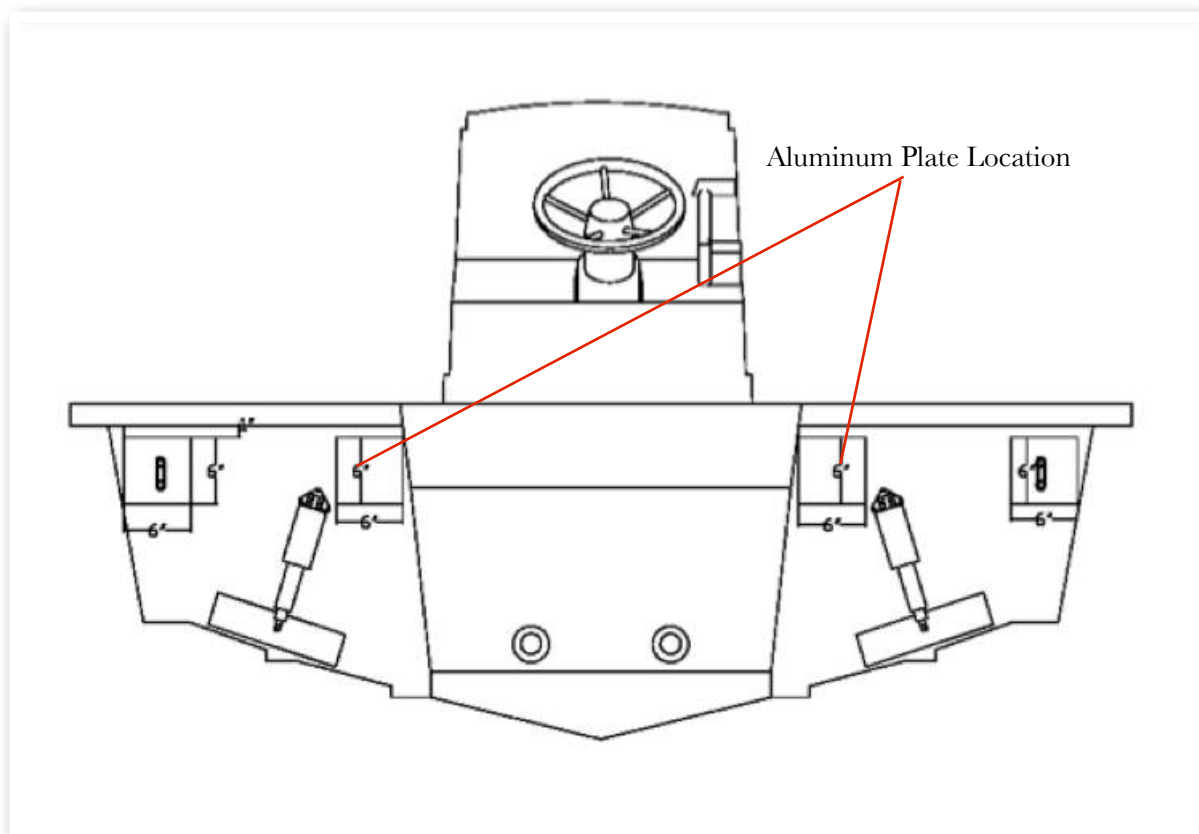

Warranty

Your relationship with your local Pathfinder dealer should never end with the delivery of your new boat. Your local Pathfinder dealership is where you will take your boat for service and repair, as well as to address any warranty issues. Pathfinder Boat Company is fortunate to have an outstanding dealer network selling and servicing our boats. Our dealers are knowledgeable in service and repairs for all our boat models and have extensive expertise troubleshooting a wide range of boat related issues.

All warranty claims and repair issues should be addressed to your local Pathfinder dealer. Through our dealer network, we should be able to address and fix repair issues and have you back on the water in a timely manner. A continued relationship with your local Pathfinder dealer will assure the best service and parts available and will create a direct link from the boat owner to the factory.

