



MONTEREY
BOATS

335 SPORT YACHT
OWNER'S MANUAL



Dear Valued Customer,

Welcome to the Monterey Life!

We would like to extend to you our "Thank You" for choosing a Monterey boat!

You have made an investment in our product and we are confident you will enjoy many years of boating pleasure. Your new boat has been built to the standards set forth by the United States Coast Guard and National Marine Manufacturers Association. We are proud to have you in our "Family!"

At this time, we need you to read your owner's manual and become familiar with all systems on your boat. Make certain that you and your dealer have filled out and mailed your warranty registration card back to us here at the factory. It is very important to us and it is also a U.S. Federal Regulation.

This manual is an important aid in the operation and maintenance of your boat. The information is intended as a guide and cannot cover every question you may have about your boat and boating in general. We encourage you to contact your dealership for any additional information you might need. If there is a question about your boat that can't be answered by your dealer, please contact our factory direct by calling the Monterey Boats Customer Service Department, (352) 529-9181 or online if you prefer at: www.info@montereyboats.com.

If you are new to boating, we recommend you participate in a boating class or group to gain more knowledge and confidence. Contact your dealer, local U.S. Coast Guard or U.S. Power Squadron Organizations for information in your area.

With proper care, routine service and preventive maintenance, your Monterey boat will not only reward you with enjoyment, but with reliability, dependability and one of the higher resale values in today's boating industry.

Enjoy your new boat and please respect our environment at all times. Always remember to practice safe boating procedures for your protection as well as those around you.

Sincerely,

The M.O.S.T. (Monterey Owners Support Team)

Please fill out the following information section and leave it in your Monterey owner's manual. This information will be important for you and Monterey service personnel to know, if you may need to call them for technical assistance or service.

BOAT	
MODEL:	HULL SERIAL #:
PURCHASE DATE:	DELIVERY DATE:
IGNITION KEYS #:	REGISTRATION #:
DOOR KEY #:	OTHER KEYS #:
ENGINES	
MAKE:	MODEL:
PORT SERIAL #:	STARBOARD SERIAL #:
OUTDRIVES	
MAKE:	MODEL:
PORT SERIAL #:	STARBOARD SERIAL #:
RATIO:	
GENERATOR	
MAKE:	MODEL:
SERIAL #:	KILOWATTS:
PROPELLERS	
MAKE:	BLADES:
DIAMETER/PITCH:	SHAFT:
AIR CONDITIONER	
MAKE:	MODEL:
SERIAL #:	BTU OUTPUT:
DEALER	MONTEREY
NAME:	PHONE:
DEALER/PHONE:	REPRESENTATIVE:
SALESMAN:	ADDRESS:
SERVICE MANAGER:	
ADDRESS:	MONTEREY E-MAIL:
	DEALER E-MAIL:

All information, illustrations, and specifications contained in this manual are based on the latest product information available at the time of publication. Monterey Boats reserves the right to make changes at anytime, without notice, in colors, materials, equipment, specifications, and models.

HULL LENGTH OVERALL	33' 10" / 10.3 m
WEIGHT DRY	13,200 lbs / 5988 kg
WEIGHT WITH WATER AND FUEL	14,840 lbs / 6731 kg
BEAM	10'-10" / 3.3 m
DEADRISE	17°
DRAFT WITH DRIVE UP	31" / .8 m
DRAFT WITH DRIVE DOWN	43" / 1.1 m
BRIDGE CLEARANCE WITH STANDARD OPTIONS & ARCH	10'2" / 3.1 m
FUEL CAPACITY	180 gal / 681.37 ltr
WATER TANK CAPACITY	42 gal / 159 ltr
WASTE TANK CAPACITY	28 gal / 106 ltr
MAXIMUM HORSEPOWER	640 hp / 239 kw
MAXIMUM NUMBER OF PERSONS	10
MAXIMUM PERSONS / GEAR WEIGHT	2205 lbs / 1000 kg

Note: Dry weight is the average weight of the base boat without options, fuel, water, waste, batteries or gear.

(For Export Only)

To be in compliance with European directives for recreational boats as published by the International Organization for Standardization (ISO) in effect at the time this boat was manufactured, we are providing the following information.

Manufacturer:

Name SEABRING MARINE INDUSTRIES, INC., d.b.a. Monterey Boats

Address 1579 SW 18th St.

Williston, FL Zip Code: 32696

Identification Numbers:

Hull Identification Number US-RGF

Port Engine Serial Number _____

Starboard Engine Serial Number _____

Intended Design Category:

Ocean (Cat A)

Inshore (Cat C)

Offshore (Cat B)

Sheltered Waters (Cat D)

Weight and Maximum Capacities:

Unladen Weight - Kilograms (Pounds) MLCC = 6441 kg (14,200 lbs)

Maximum Load - Weight- Kilograms (Pounds) MLDC = 8181 kg (18,036 lbs)

Number of People 11 PEOPLE

Maximum Rated Engine Horsepower - Kilowatts (Horsepower) 477 kw (640 hp)

Certifications:

Certifications & Components Covered See Declaration of conformity

Boat certified by IMCI (#0009) under certificate BMOHT025

All instructions given in this book are as seen from the stern looking toward the bow with starboard being to your right, and port to your left. The information and precautions listed in this manual are not all inclusive. It may be general in nature in some cases and detailed in others and is designed to provide you a basic understanding of your Monterey boat and some of the responsibilities that go along with owning/operating your boat.

The suppliers of some of the major components such as engines, pumps, and appliances, provide their own owner's manuals which have been included with your boat. You should read the information in this manual and the manuals of other suppliers completely and have a thorough understanding of all component systems and their proper operation before operating your boat.

REMEMBER - IT IS YOUR RESPONSIBILITY TO ENSURE THAT YOUR BOAT IS SAFE FOR YOU AND YOUR PASSENGERS. ALWAYS EXERCISE GOOD COMMON SENSE WHEN INSTALLING EQUIPMENT AND OPERATING THE BOAT.

Warranty and Warranty Registration Cards

The Monterey Limited Warranty Statement is included with your boat. It has been written to be clearly stated and easily understood. If you have any questions after reading the warranty, please contact the Monterey Boats Customer Service Department

Monterey, engine manufacturers, and the suppliers of major components maintain their own manufacturer's warranty and service facilities. It is important that you properly complete the warranty registration cards included with your boat and engines and mail them back to the manufacturer to register your ownership. This should be done within 15 days of the date of purchase and before the boat is put into service. A form for recording this information for your records is provided at the beginning of this manual. This information will be important for you and service personnel to know, if and when you may need service or technical information.

The boat warranty registration requires the **Hull Identification Number "HIN"** which is located on the starboard side of the transom, just below the rubrail. The engine and generator warranty registration requires the engine serial numbers.

Please refer to the engine and generator owner's manual for the location of the serial numbers.

IMPORTANT:

The terms and conditions of the Monterey Boats Limited Warranty are outlined in the warranty statement included in this manual. The manufacturer will automatically honor the warranty to the original purchaser for 15 days from the date of purchase. However, during that 15 day period, owners must comply with the steps outlined in the warranty statement to validate their warranty.

All boat manufacturers are required by the Federal Boat Safety Act of 1971 to notify first time owners in the event any defect is discovered "which creates a substantial risk of personal injury to the public." ***It is essential that we have your warranty registration card complete with your name and mailing address in our files so that we can comply with the law if it should become necessary.***

Your Monterey Boats Dealer will assist you in filling in the hull number and other data required on your Registration Card. Check to see that your card is complete and signed. Detach and mail. Your Warranty Registration Card will be added to our permanent files.

Transferring the Limited Structural Warranty

For a transfer fee, MONTEREY BOATS will offer to extend a Transferable Limited Structural Hull Warranty to subsequent owners of Monterey boats. Please refer to the Monterey Limited Warranty Statement for the terms and conditions of the Transferable Limited Structural Hull Warranty and the procedure to transfer the warranty.

Product Changes

Monterey is committed to the continuous improvement of our boats. As a result, some of the equipment described in this manual or pictured in the catalog may change or no longer be available. ***All information, illustrations, and specifications contained in this manual are based on the latest product information available at the time of publication. Monterey Boats reserves the right to make changes at any time, without notice, in colors, materials, equipment, specifications, and models.*** If

you have questions about the equipment on your Monterey, please contact the Monterey Boats Customer Service Department.

Service

All warranty repairs must be performed by an authorized Monterey Dealer. Should a problem develop that is related to faulty workmanship or

materials, as stated in the Limited Warranty, you should contact your Monterey dealer to arrange for the necessary repair. If you are not near your dealer or another authorized Monterey dealer or the dealer fails to remedy the cause of the problem, then contact Monterey within 15 days. ***It is the boat owner's responsibility to deliver the boat to the dealer for warranty service.***

MONTEREY BOATS LIFETIME LIMITED WARRANTY

MONTEREY BOATS warrants to the original retail purchaser of its product beginning with the 2017 models that it will repair or replace defects in materials and workmanship found to exist in its product during the applicable warranty periods defined below if purchased from an authorized MONTEREY BOATS dealer, subject to the exclusions, limitations, conditions and provisions noted below. All repairs and replacements under the following warranties will be performed by MONTEREY BOATS or an authorized MONTEREY BOATS dealer or representative selected by MONTEREY BOATS at its sole discretion.

LIFETIME LIMITED STRUCTURAL HULL AND DECK WARRANTY:

MONTEREY BOATS warrants to the original retail purchaser of its product that MONTEREY BOATS will repair or replace the fiberglass hull or deck of its product if it is found to be structurally defective in materials or workmanship for as long as the original retail purchaser owns the product. For purposes of this limited warranty: (1) a structural defect is defined as a defect that causes the hull or deck to be unsafe or unfit for use under normal operating conditions; (2) the fiberglass hull is defined as the single fiberglass molded shell and integral fiberglass structural components including stringers, transom and related structural components which are below the hull flange; and (3) the deck is defined as the single fiberglass molded shell and integral fiberglass structural components attached to the hull flange. This warranty is further subject to the exclusions, limitations, conditions and provisions noted below.

TEN-YEAR TRANSFERABLE LIMITED STRUCTURAL HULL AND DECK WARRANTY:

Beginning with the 2017 models, MONTEREY BOATS also offers a Ten-Year Transferable Limited Structural Hull and Deck Warranty. Under this warranty, MONTEREY BOATS will repair or replace the fiberglass hull or deck if it is found to be structurally defective in materials or workmanship within the first ten (10) years after the warranty commencement date. For purposes of this warranty: (1) a structural defect is defined as a defect that causes the hull or deck to be unsafe or unfit for use under normal operating conditions; (2) the fiberglass hull is defined as the single fiberglass molded shell and integral fiberglass structural components including stringers, transom and related structural components which are below the hull flange; and (3) the deck is defined as the single fiberglass molded shell and integral fiberglass structural components attached to the hull flange. This warranty may be transferred to subsequent purchasers (hereinafter "new owner") provided the new owner registers the transfer and pays the transfer fee in accordance with the requirements set forth below. This transfer will only apply to the balance of any warranty period left during the ten (10) year period commencing on the warranty commencement date.

1. The request for transfer must be made in writing by the new owner and sent within thirty (30) days of the date of his/her purchase of the boat to:

MONTEREY BOATS
1579 SW 18th Street
Williston, Florida 32696

2. The request must include: A copy of the bill of sale with the Hull ID number, the new owner's name and address and a Certified Check or Money Order for the correct transfer fee amount.

3. The transfer fee is \$300.00 for boats with hull lengths under 27', \$500.00 for boats with hull lengths from 27' but under 33', and \$700.00 for boats with hull lengths 33' and over.

In the event fiberglass hull or deck work is required, the new owner must return the boat to the original selling dealer or to a dealer authorized to service MONTEREY BOATS products. The cost of returning the boat to and from MONTEREY BOATS or an authorized MONTEREY BOATS dealer or representative will be the sole responsibility of the new owner. This warranty is further subject to the exclusions, limitations, conditions and provisions noted below.

FIVE-YEAR LIMITED HULL BLISTER WARRANTY:

MONTEREY BOATS warrants to the original retail purchaser of its product that MONTEREY BOATS will repair any osmotic blisters which occur on the underwater gelcoated surfaces of the hull as a result of defects in materials or workmanship within five (5) years from the warranty commencement date according to the following prorated schedule provided that the original factory gelcoat surface has not been altered in any way:

1. Up to two (2) years from the warranty commencement date, MONTEREY BOATS will pay 100% of the repair costs.
2. After two (2) years but up to three (3) years from the warranty commencement date, MONTEREY BOATS will pay 85% of the repair costs.
3. After three (3) years but up to four (4) years from the warranty commencement date, MONTEREY BOATS will pay 65% of the repair costs.
4. After four (4) years but up to five (5) years from the warranty commencement date, MONTEREY BOATS will pay 35% of the repair costs.
5. After five (5) years from the warranty commencement date, MONTEREY BOATS will pay 0% of the repair costs.

Alterations which will void this warranty include, without limitation, damage, accident repair, sanding, scraping, sandblasting, or improper surface preparation for application of a marine barrier coating or bottom paint. A marine barrier coating must be properly applied to the hull bottom if the boat is to be moored in water for periods of more than sixty (60) days in any ninety (90) day period and a marine barrier coating is also required if the boat is to be bottom painted. This warranty is further subject to the exclusions, limitations, conditions and provisions noted below.

THREE-YEAR EXTERIOR COSMETIC GELCOAT LIMITED WARRANTY:

MONTEREY BOATS warrants to the original retail purchaser of its product that MONTEREY BOATS will correct or repair any cracking or crazing of, and any air voids in, the exterior gelcoat surface of the boat as a result of defects in materials or workmanship within three (3) years from the warranty commencement date according to the following prorated schedule provided that the original factory gelcoat surface has not been altered in any way:

1. Up to one (1) year from the warranty commencement date, MONTEREY BOATS will pay 100% of the repair costs.
2. After one (1) year but up to two (2) years from the warranty commencement date, MONTEREY BOATS will pay 50% of the repair costs.

3. After two (2) years but up to three (3) years from the warranty commencement date, MONTEREY BOATS will pay 25% of the repair costs.

4. After three (3) years from the warranty commencement date, MONTEREY BOATS will pay 0% of the repair costs.

Alterations which will void this warranty include, without limitation, damage, accident repair, sanding, scraping, sandblasting, improper surface preparation for application of a marine barrier coating or paint, or if damage to the exterior gelcoat surface results from or is attributable to the addition of items not installed by MONTEREY BOATS. This warranty expressly excludes from coverage blushing of colored gelcoat below the waterline and is further subject to the exclusions, limitations, conditions and provisions noted below.

LIMITED WARRANTY FOR NON-STRUCTURAL PARTS AND COMPONENTS:

MONTEREY BOATS warrants to the original retail purchaser of its product that MONTEREY BOATS will repair or replace the following described non-structural parts and components for the reasons and during the periods indicated below measured from the warranty commencement date whether or not separately warranted by the part or component manufacturer:

1. Canvas: if it fades or dry rots within five (5) years or if it is found to be defective in materials or workmanship within two (2) years.
2. Upholstery: if it is found to be defective in materials or workmanship within three (3) years.
3. Generators: if it is found to be defective in materials or workmanship within five (5) years.
4. All other non-structural parts and components: if they are found to be defective in materials or workmanship within one (1) year.

WHAT IS NOT COVERED:

The limited warranties set forth above do not cover:

1. Engines, outdrives, air conditioners, and trim tabs;
2. Any boat that has been repaired or altered by persons other than MONTEREY BOATS or an authorized MONTEREY BOATS dealer or representative or modified in any way so as to affect its use and operation;
3. Any boat used for racing or for rental or commercial purposes or that has been subject to misuse, neglect, accident or structural modification;
4. Normal wear, tear, deterioration (including rust) of hardware, vinyl coverings, vinyl and fabric upholstery, plastic, stainless steel, other metal, wood, and trim tape;
5. Any defect caused by the failure of the owner to provide reasonable care and maintenance;
6. Installation of engines, generators, air conditioners, wake board towers, parts or other aftermarket accessories produced, installed or attached by anyone other than MONTEREY BOATS;
7. Loss of time, inconvenience, loss of the use of the boat or other matters not specifically covered hereunder;
8. Any boat purchased from an authorized MONTEREY BOATS dealer located in the United States or Canada that is registered and/or operated outside the United States or Canada; and

9. Any boat which has previously been repossessed from an authorized MONTEREY BOATS dealer. However, this exclusion shall not affect the Lifetime Limited Structural Hull and Deck Warranty set forth above.

GENERAL PROVISIONS:

ALL GENERAL, SPECIAL, INDIRECT, INCIDENTAL AND/OR CONSEQUENTIAL DAMAGES ARE EXCLUDED FROM THIS WARRANTY AND ARE TOTALLY DISCLAIMED BY MONTEREY BOATS. IT IS THE INTENT OF THE PARTIES THAT THE OWNER'S SOLE AND EXCLUSIVE REMEDY IS THE REPAIR OR REPLACEMENT OF THE PRODUCT OR ITS ALLEGEDLY DEFECTIVE COMPONENT PARTS AND THAT NO OTHER LEGAL OR EQUITABLE REMEDIES SHALL BE AVAILABLE TO SAID OWNER. SOME STATES DO NOT ALLOW THE EXCLUSION OF INCIDENTAL OR CONSEQUENTIAL DAMAGES SO THE INCLUSION OF INCIDENTAL OR CONSEQUENTIAL DAMAGES MAY NOT APPLY TO YOU. THIS IS A LIMITED WARRANTY. MONTEREY BOATS MAKES NO WARRANTY OTHER THAN CONTAINED HEREIN. TO THE EXTENT ALLOWED BY LAW ANY WARRANTIES OF **MERCHANTABILITY OR FITNESS FOR A PARTICULAR PURPOSE** ARISING IN STATE LAW ARE EXPRESSLY EXCLUDED. TO THE EXTENT ALLOWED BY LAW, ANY IMPLIED WARRANTY OF **MERCHANTABILITY** IS LIMITED TO THE DURATION OF THE LIMITED WARRANTY APPLICABLE TO THE PARTICULAR WARRANTED PART, COMPONENT, OR DEFECT. ALL OBLIGATIONS OF MONTEREY BOATS ARE SPECIFICALLY SET FORTH HEREIN. SOME STATES DO NOT ALLOW LIMITATIONS ON HOW LONG AN IMPLIED WARRANTY LASTS, SO THE ABOVE LIMITATION MAY NOT APPLY TO YOU. MONTEREY BOATS' OBLIGATION WITH RESPECT TO THIS WARRANTY IS LIMITED TO MAKING REPAIRS TO OR REPLACING THE DEFECTIVE PARTS AND NO CLAIM FOR BREACH OF WARRANTY SHALL BE CAUSE FOR CANCELLATION OR RESCISSION OF THE CONTRACT OR SALE FOR ANY BOAT MANUFACTURED BY MONTEREY BOATS.

This Lifetime Limited Warranty commences on the date of delivery to the original retail purchaser or when the boat has been operated for twenty-five (25) hours or on the first day of the twenty-fifth (25th) month from the date of shipment from MONTEREY BOATS to an authorized MONTEREY BOATS dealer, which ever occurs first.

MONTEREY BOATS will discharge its obligations under this Lifetime Limited Warranty as rapidly as possible, but cannot guarantee any specific completion date due to the different nature of claims which may be made and services which may be required. This Lifetime Limited Warranty gives you specific legal rights, and you may also have other rights which may vary from state to state. No person, including a MONTEREY BOATS dealer, is authorized to make any repairs or replacements under this Lifetime Limited Warranty without the prior written approval of MONTEREY BOATS. MONTEREY BOATS shall in no way be responsible for any repairs not PRE-AUTHORIZED by a MONTEREY BOATS Customer Service Manager or repairs performed by a repair shop not PRE-AUTHORIZED by a MONTEREY BOATS Customer Service Manager.

MONTEREY BOATS does not authorize any person to create or assume for it any other obligation or liability with respect to its products. The sales personnel or other employees of MONTEREY BOATS dealers are not authorized to make warranties concerning MONTEREY BOATS products. No brochure,

pamphlet or other written or pictorial presentation constitutes a warranty or representation as to any aspect of MONTEREY BOATS products.

MONTEREY BOATS shall have no obligation under this Lifetime Limited Warranty unless and until each of the following conditions are met:

1. The original retail purchaser of its product or the MONTEREY BOATS dealer either completes and returns the Warranty Registration to MONTEREY BOATS by mail or facsimile or the MONTEREY BOATS dealer registers the Warranty electronically "online" within fifteen (15) days from the date the product is delivered to the original retail purchaser;
2. Notice of each warranty claim is given to the MONTEREY BOATS dealer within a reasonable period of time after discovery of any claimed defect;
3. Notice of each warranty claim is made in writing to MONTEREY BOATS within the applicable time periods identified in the respective warranties as measured from the date of purchase by the original retail purchaser; and
4. All transportation charges incurred in transporting the boat for warranty work are paid for by the owner.

MONTEREY BOATS reserves the right to make changes at any time, without notice, in prices or to make changes in design, colors, specifications, equipment, options, materials, etc., and MONTEREY BOATS shall be under no obligation to equip or modify product built prior to such changes.

IMPORTANT: Proper registration of the Warranty with MONTEREY BOATS is important for purposes of recording customer information for notification and correction of product defects under the Federal Boat Safety Act.

MONTEREY BOATS is the registered tradename and trademark of SEABRING MARINE INDUSTRIES, INC., a Florida corporation, the warrantor herein.

SEABRING MARINE INDUSTRIES, INC.

d.b.a. MONTEREY BOATS

1579 SW 18th Street – Williston, Florida 32696- Phone (352) 528-2628 / Fax (352) 529-2628

Your Monterey owner's manual has been written to include a number of safety instructions to assure the safe operation and maintenance of your boat. These instructions are in the form of **DANGER**, **WARNING**, and **CAUTION** statements. The following definitions apply:

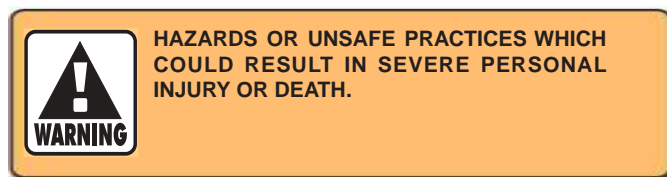
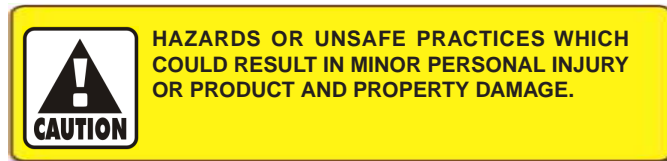

All instructions given in this book are as seen from the stern looking toward the bow, with starboard being to your right, and port to your left. A glossary of boating terms is included.

IMPORTANT NOTE: Your boat uses internal combustion engines and flammable fuel. Every precaution has been taken by Monterey to reduce the risks associated with possible injury and damage from fire or explosion, but your own precaution and good maintenance procedures are necessary in order to enjoy safe operation of your boat.

Registration and Numbering

Federal law requires that all undocumented vessels equipped with propulsion machinery be registered in the State of principal use. A certificate of number will be issued upon registering the boat. These numbers must be displayed on your boat. The owner/operator of a boat must carry a valid certificate of number whenever the boat is in use. When moved to a new State of principal use, the certificate is valid for 60 days.

In order to be valid, the numbers must be installed to the proper specifications. Check with your dealer or state boating authority for numbering requirements. The Coast Guard issues the certificate of number in Alaska; all others are issued by the state.

Insurance

In most States the boat owner is legally responsible for damages or injuries he or someone else operating the boat causes. Responsible boaters carry adequate liability and property damage insurance for their boat. You should also protect the boat against physical damage and theft. Some States have laws requiring minimum insurance coverage. Contact your dealer or state boating authority for information on the insurance requirements in your boating area.

Reporting Boating accidents

All boating accidents must be reported by the operator or owner of the boat to the proper marine law enforcement authority for the state in which the accident occurred. Immediate notification is required if a person dies or disappears as a result of a recreational boating accident.

If a person dies or there are injuries requiring more than first aid, a formal report must be filed within 48 hours.

A formal report must be made within 10 days for accidents involving more than \$500.00 damage or the complete loss of a boat.

A Boating Accident Report form is located near the back of this manual to assist you in reporting an accident. If you need additional information

regarding accident reporting, please call the Boating Safety Hotline, 800-368-5647.

Education

If you are not an experienced boater, we recommend that the boat operator and other people that normally accompany the operator, enroll in a boating safety course. Organizations such as the U.S. Power Squadrons, United States Coast Guard Auxiliary, State Boating Authorities and the American Red Cross offer excellent boating educational programs. These courses are worthwhile even for experienced boaters to sharpen your skills or bring you up to date on current rules and regulations. They can also help in providing local navigational information when moving to a new boating area. Contact your dealer, State Boating Authority or the Boating Safety Hotline, 800-368-5647 for further information on boating safety courses.

Required Equipment

U.S. Coast Guard regulations require certain equipment on each boat. The Coast Guard also sets minimum safety standards for vessels and associated equipment. To meet these standards some of the equipment must be Coast Guard approved. "Coast Guard Approved Equipment" has been determined to be in compliance with USCG specifications and regulations relating to performance, construction, or materials. The equipment requirements vary according to the length, type of boat, and the propulsion system. Some of the Coast Guard equipment is described in the Safety Equipment chapter of this manual. For a more detailed description, obtain "Federal Requirements And Safety Tips For Recreational Boats" by contacting the Boating Safety Hotline 800-368-5647 or your local marine dealer or retailer.

Some state and local agencies impose similar equipment requirements on waters that do not fall under Coast Guard jurisdiction. These agencies may also require additional equipment that is not required by the Coast Guard. Your dealer or local boating authority can provide you with additional information for the equipment requirements for your boating area.

Your Monterey boat is inspected at each step of the manufacturing process. Before leaving the factory, every Monterey boat undergoes a thorough check for systems operation, fit and finish. Your Monterey Dealer also performs a Pre-Delivery inspection prior to final delivery. When the new boat is delivered to you, the customer, a final check is performed during orientation. Both the Pre-Delivery and Final Delivery inspections are documented to ensure trouble free operation and returned to Monterey Boats.

At the time of new boat delivery, your Monterey Dealer will ask you to sign the completed Inspection Report at the same time as the Warranty Registrations for the boat and other accessory equipment. By signing these documents, you acknowledge that you have reviewed and understand all information.

WARRANTY REGISTRATION AND NEW BOAT CHECKLIST		 MONTEREY BOATS <small>3870 S.W. 18th Street Williston, FL 32696 Tel 904-529-8141 Fax 904-921-5207 www.montereyboats.com</small>
SUPER SPORT & CRUISER		
Boat Number (HPO): RGF _____	Boat Model: _____	
Selling Dealer: _____	Dealer Code: _____	
Engine Brand: _____	Engine Model: _____	
Engine Serial #1: _____	Drive Serial #1: _____	
Engine Serial #2: _____	Drive Serial #2: _____	
Date of Sale: _____	Warranty Start Date: _____	
Owner Name (Last, First): _____		
Address: _____		
City: _____	State: _____	Zip: _____
E-Mail Address: _____		(We respect your privacy and will use for internal purposes only.)
Phone: _____	2nd Phone: _____	
PLEASE, INSPECT AND CHECK OFF THE FOLLOWING OPERATIONS		
Indicate Status with the following Key: ? or 1 - OK, 2 - Needs Correction, 3- Completed, N/A - Not Applicable		
<p>BOAT</p> <p>_____ Boat gel coat, striping & graphics</p> <p>_____ Upholstery fit, clean and free of defects</p> <p>_____ Sundeck/Sun Island/lounger operation</p> <p>_____ Canvas fit, clean and free of defects</p> <p>_____ Cabin Doors, port, lights, hatches, cabinet & head doors, latches</p> <p>_____ All thru-hull fittings, ball valves, head drain, galley drain, anchor well drain, drain plug - full, wet bar drain are secure, no leaks</p> <p>_____ Windshield fit</p> <p>_____ Ladders</p> <p>EQUIPMENT</p> <p>_____ Running Lights (Navigation)</p> <p>_____ Cabin lights, cockpit lights</p> <p>_____ Toilet (Hood) operation & hoses</p> <p>_____ Stereo - Radio, CD, remote control</p> <p>_____ Bilge Pumps - Auto float switch</p> <p>_____ Air Conditioning/Heater - operation & components secure</p> <p>_____ Water pressure system (let pressure stand 15 minutes to see if pump goes on) & heater</p> <p>_____ Stove, coffee-maker, oven, refrigerator, ice maker</p> <p>_____ Generator - Operation & components secure</p> <p>_____ Bilge Blower(s)</p> <p>_____ Wipers</p> <p>_____ Shore power (AC)</p> <p>_____ Tables</p> <p>_____ Flaming Hose Clamps</p> <p>_____ Battery - Polarity, Voltage, Tight Connections</p> <p>_____ Battery Switch(es) - Operation</p> <p>ENGINE - BEFORE STARTING</p> <p>_____ Engine mounts - tight</p> <p>_____ Fuel system operation - no leaks</p> <p>_____ Engine compartment components not missing, disconnected, loose, kinked, pinched or could chafe</p> <p>_____ Hose clamps on engine & exhaust</p> <p>_____ Steering & shifters operation, components secure, steering wheel straight</p> <p>_____ Drains cooling system closed (Closed cooling coolant level)</p> <p>_____ Throttle control, operation & adjustment</p> <p>_____ Shifter control, operation & adjustment</p> <p>_____ Stern drive oil level at full mark</p> <p>_____ Camcoose & power steering oil levels at full mark</p> <p>_____ Stern drive trim operation</p> <p>_____ Prop Size: _____</p> <p>_____ Prop installed correctly with grease, nut(s), cotter pins</p> <p>_____ Prop rotation - Forward & Reverse</p> <p>_____ Neutral start switch, engine will not start in gear</p> <p>_____ Transom plate seal has no leaks - water, oil</p> <p>COMMENTS</p> <p>_____</p> <p>_____</p>	<p>ENGINE - AFTER STARTING (in water)</p> <p>_____ Oil pressure</p> <p>_____ Fuel line connectors - no leaks</p> <p>_____ Engine has no water or oil leaks</p> <p>_____ Idle speed per engine specs, in gear</p> <p>_____ Ignition timing check with timing light or scan tool</p> <p>_____ Gear Shift works properly - forward, neutral, reverse</p> <p>_____ Instruments read correctly</p> <p>_____ Exhaust system - no leaks</p> <p>SEA TRIAL</p> <p>_____ Boat performance</p> <p>_____ Port engine operation</p> <p>_____ Starboard engine operation</p> <p>_____ Steering - operation</p> <p>_____ Stern drive trim operation</p> <p>_____ Instruments rig after normal</p> <p>_____ Maximum R.P.M. _____</p> <p>Technical Check Performed by _____</p> <p>Technician _____ Date _____</p> <p>PRE-DELIVERY FINAL CHECK</p> <p>_____ All accessory equipment operates (Mech. & Elect.)</p> <p>_____ Carpets, curtains, cushions & canvas installed</p> <p>_____ All boat, engine and accessory items re-</p> <p>_____ Boat properly cleaned, interior and exterior</p> <p>_____ Trailer wiring, wheels, fenders & brakes</p> <p>OWNER ORIENTATION</p> <p>_____ Review & demonstrate Owner with operation of all features and options on boat</p> <p>_____ Sea Trial with Owner</p> <p>_____ Review of Owners Manual</p> <p>_____ Review of R/R policies</p> <p>_____ Review of Owner Responsibilities</p> <p>_____ Review of Service & Maintenance Procedures</p> <p>_____ Review of Care & Cleaning</p> <p>Owner Orientation Performed by _____</p> <p>Dealer Personnel _____ Date _____</p> <p>I have read and agree with the checklist. I have read and understood the Monterey Boats Lifetime Limited Warranty as it appears on the back of this form.</p> <p>Owner Signature _____ Date _____</p>	

WELCOME	3
BOAT INFORMATION	4
SPECIFICATIONS	5
CERTIFICATIONS & SPECIFICATIONS	6
INTRODUCTION AND IMPORTANT INFORMATION	7
MONTEREY BOATS LIMITED LIFETIME WARRANTY	9
SAFETY INFORMATION	14
OWNER'S / OPERATOR'S INFORMATION	15
NEW BOAT DELIVERY	16
TABLE OF CONTENTS	17

Chapter 1:

PROPULSION SYSTEM

1.1 General	21
1.2 Drive Systems	21
1.3 Engine Exhaust System.....	22
1.4 Engine Cooling System	22
1.5 Propellers	23
1.6 Performance Issues and Propellers.....	23
1.7 Engine and Helm Instrumentation	24

Chapter 2:

HELM CONTROL SYSTEMS

2.1 General	27
2.2 Engine Throttle and Shift Controls	27
2.3 Neutral Safety Switch	28
2.4 Outdrive Power Tilt and Trim.....	29
2.5 Steering System	29
2.6 Trim Tabs	30
2.7 Control Systems Maintenance	31

Chapter 3:

FUEL SYSTEM

3.1 General	33
3.2 Gasoline Engine Fuel Systems.....	34
3.3 Diesel Engine Fuel System.....	35
3.4 Generator Fuel System	35
3.5 Fueling Instructions.....	37
3.6 Fuel System Maintenance.....	38

Chapter 4:

ELECTRICAL SYSTEM

4.1 General	41
4.2 12-Volt System	41
4.3 120-Volt System	48
4.4 Generator	51
4.5 Bonding System.....	53
4.6 Electrical System Maintenance	53
4.7 AC Line Load Estimator	55

Chapter 5:

FRESH WATER SYSTEM

5.1 General	57
5.2 Fresh Water System Operation	57
5.3 Water Heater	58
5.4 Shore Water Connection	58
5.5 Shower Operation	59
5.6 Fresh Water System Maintenance	59

Chapter 6:

RAW WATER SYSTEM

6.1 General	61
6.2 Air Conditioning (Optional)	61
6.3 Raw Water System Maintenance	62

Chapter 7:

DRAINAGE SYSTEMS

7.1 General	63
7.2 Bilge Drainage	63
7.3 Cockpit and Deck Drains	64
7.4 Cabin Drains	64
7.5 Drainage System Maintenance	65

Chapter 8:

VENTILATION SYSTEM

8.1 Cabin Ventilation	67
8.2 Carbon Monoxide and Proper Ventilation	68
8.3 Engine Compartment Ventilation	69
8.4 Maintenance	70

Chapter 9:

EXTERIOR EQUIPMENT

9.1 Deck	71
9.2 Hull	74
9.3 Cockpit	75

Chapter 10:

INTERIOR EQUIPMENT

10.1 Head Compartment and Marine Toilet	83
10.2 Galley and Sink	85
10.3 Main Salon	87
10.4 Air Conditioner (Optional)	88
10.5 Master Stateroom	89
10.6 Mid Berth	90
10.7 Cabin Woodwork	91

Chapter 11:

SAFETY EQUIPMENT

11.1 General.....	93
11.2 Engine Alarms	93
11.3 Neutral Safety Switch	93
11.4 Required Safety Equipment.....	94
11.5 Automatic Fire Extinguishing System	95
11.6 Carbon Monoxide Monitoring System	97
11.7 First Aid	98
11.8 Additional Safety Equipment	98
11.9 Caution and Warning Labels.....	99

Chapter 12:

OPERATION

12.1 General.....	101
12.2 Rules of the Road	101
12.3 Pre-Cruise Check.....	104
12.4 Operating Your Boat	105
12.5 Docking, Anchoring and Mooring	106
12.6 Controls, Steering, or Propulsion System Failure:.....	108
12.7 Collision	108
12.8 Grounding, Towing and Rendering Assistance	108
12.9 Flooding or Capsizing	109
12.10 Fishing.....	109
12.11 Man Overboard	109
12.12 Trash Disposal.....	110
12.13 Transporting Your Boat.....	110

Chapter 13:

ROUTINE MAINTENANCE

13.1 Exterior Hull and Deck	111
13.2 Upholstery, Canvas and Enclosures	115
13.3 Cabin Interior	120
13.4 Bilge and Engine Compartment	120
13.5 Drainage System.....	121

Chapter 14:

SEASONAL MAINTENANCE

14.1 Lay-up and Storage	123
14.2 Winterizing.....	125
14.3 Recommissioning	127

Appendix A:

GENERAL MAINTENANCE SCHEDULE AND LOG	129
--	-----

Appendix B:

FLOAT PLAN.....	133
-----------------	-----

Appendix C:
Boating Accident Report136

Appendix D:
GLOSSARY OF TERMS139

Appendix E:
TROUBLESHOOTING GUIDE145

PROPULSION SYSTEM

1.1 General

The Monterey 335 Sport Yacht is designed to be powered with twin inboard/outboard gas or diesel engines and drive systems. Each manufacturer of the various inboard/outboard drive systems provides an owner's information manual with its product. It is important that you read the manual(s) very carefully and become familiar with the proper care and operation of the engine and drive system. A warranty registration card has been furnished with each new engine and can be located in the engine owner's manual. All information requested on this card should be filled out completely by the dealer and purchaser and then returned to the respective engine manufacturer as soon as possible.



CERTAIN MOVING PARTS ARE EXPOSED AND CAN PROVE DANGEROUS TO SOMEONE UNFAMILIAR WITH THE OPERATION AND FUNCTION OF THE EQUIPMENT. DO NOT ATTEMPT TO SERVICE ANY ENGINE OR DRIVE COMPONENT WITHOUT BEING TOTALLY FAMILIAR WITH THE SAFE AND PROPER SERVICE PROCEDURES.

1.2 Drive Systems

The inboard engines are mounted in the stern and coupled to transom mounted outdrives which do all shifting, steering, and propulsion functions. The outdrives are supplied by the engine manufacturer and have specific lubrication and maintenance requirements.

Proper engine alignment is very important. This was done by the factory when the engines were installed and should be checked once per season with Volvo engines and once every three years with Mercruiser engines thereafter. If you experience excessive vibrations or suspect that the engine is out of alignment, please contact your Monterey dealer.

Marine growth and galvanic corrosion is a concern if the boat is to be kept in the water. Marine growth occurs when components are left in the water for extended periods and can cause poor performance or permanent damage to the exposed



Typical Mercruiser Gas Engine



Typical Volvo Diesel Engines

components. The type of growth and how quickly it occurs is relative to the water conditions in your boating area. Water temperature, pollution, current, etc. can have an effect on marine growth. If the boat is to be left in saltwater, the hull and outdrive must be protected with antifouling paint. It is extremely important that the proper antifouling paint is used on each component. Contact your Monterey dealer for information on the proper paint to use in your area.

Galvanic corrosion is the corrosion process occurring when different metals are submerged in an electrolyte. Sea water is an electrolyte and submerged engine components must be properly protected. Outdrives are equipped with sacrificial anodes to prevent galvanic corrosion problems.

The anodes must be monitored and replaced as necessary.

On some outdrives, the standard anode may not provide an acceptable level of protection when a drive is used in fresh water and a magnesium anode must be used. A magnesium anode, when used for combined operation in both fresh and saltwater, or water with a low salt content, will deteriorate quicker and must therefore be replaced more often. For recommendations regarding corrosion protection for the engine or outdrive, please refer to the engine owner's manual.



SOME OUTDRIVES REQUIRE SPECIAL ANODES FOR FRESH WATER AND A DIFFERENT TYPE OF ANODE FOR SALTWATER TO PROTECT THE DRIVE FROM GALVANIC CORROSION. PLEASE CONTACT THE ENGINE MANUFACTURER OR YOUR MONTEREY DEALER FOR THE PROPER ANODE TO USE IN YOUR BOATING AREA.

MANY ANTI-FOULING PAINTS DESIGNED FOR BOAT HULLS CAN CAUSE SEVERE DAMAGE TO THE OUTDRIVE. DO NOT PAINT THE OUTDRIVE OR ALLOW THE OUTDRIVE TO COME IN CONTACT WITH ANTI-FOULING PAINTS DESIGNED FOR BOAT HULLS. CONTACT YOUR MONTEREY DEALER OR ENGINE MANUFACTURER FOR INFORMATION ON THE PROPER PAINTING PROCEDURES.

1.3 Engine Exhaust System

Inboard/outboard engines use the exhaust system to expel exhaust gases and cooling water. Engine exhaust exits the rear of the boat through the exhaust system. The system consists of engine exhaust manifolds, exhaust hoses and the outdrive.

A periodic inspection of the coolant hoses, exhaust hoses and related parts should be made to ensure that leaks, heat deterioration or damage has not resulted. Replace them as necessary. Refer to the engine owner's manual for more information on the exhaust system in your Monterey.



DO NOT INHALE EXHAUST FUMES! EXHAUST CONTAINS CARBON MONOXIDE THAT IS COLORLESS AND ODORLESS. CARBON MONOXIDE IS A DANGEROUS GAS THAT IS POTENTIALLY LETHAL.

1.4 Engine Cooling System

All marine engines use surface water as a cooling medium. The cooling water enters the system through a water intake in the outdrive and is expelled through the exhaust system. Water is pumped through the water inlets, circulated through the engine block or heat exchanger, and relinquished with the exhaust gases through the outdrive. The water pump uses a small impeller made of synthetic rubber. The impeller and water pump cannot run dry for more than a few seconds.



RUNNING THE ENGINE WITHOUT WATER FLOWING TO THE WATER PUMP CAN CAUSE SERIOUS DAMAGE TO THE WATER PUMP IMPELLER OR ENGINE. NEVER RUN THE MOTOR WITHOUT WATER FLOWING TO THE WATER PUMP.

Note: If the boat is used in salt or badly polluted water, engines without fresh water cooling should be flushed after each use. Refer to the engine owner's manual for the proper engine flushing procedure.

Fresh Water Cooling (Gas Engine Option)

Installation of a "Fresh Water" or "Closed" cooling system that is cooled by a heat exchanger and the seawater cooling system provides adequate engine cooling without exposing the internal engine cooling system to the harmful effects of surface water. This system is optional with gasoline engines and standard with diesel engines on the 335 Sport Yacht. The engine owner's manual provides additional information regarding service and maintenance of this equipment.



A RUPTURED COOLING OR EXHAUST HOSE CAN CAUSE SEVERE ENGINE DAMAGE OR ALLOW A LARGE AMOUNT OF WATER TO FLOW INTO THE BILGE. SHOULD AN ENGINE INTAKE, EXHAUST OR COOLING HOSE RUPTURE, TURN THE ENGINE OFF IMMEDIATELY. PROCEED UNDER TOW IF NECESSARY, TO A SERVICE FACILITY FOR APPROPRIATE REPAIRS. MAINTAIN A CLOSE VISUAL WATCH ON THE PROBLEM HOSE AND THE BILGE WATER LEVEL.

Neutra-Salt Engine Flushing System (Optional with Gas Engines)

Your boat could be equipped with the optional Neutra-Salt Engine Flushing System designed to provide you with an effective and simple solution

to flushing the seawater cooling system and combat internal corrosion of your engine. The system is designed with a solution reservoir for each engine that is connected to the raw water intake hose. A momentary rocker switch in the helm activates a solenoid valve near each reservoir. When activated, the system injects a concentrated solution into the seawater as it enters the engine. The solution effectively neutralizes the salinity of the seawater and applies a protective coating to the metal surfaces.

1. To operate, simply engage the "Flush" switch by pushing and holding the dash-mounted switch for 45 seconds while running the engine at idle speed, making sure the engine has an adequate supply of raw water.
2. Once the Flush switch is engaged, the Neutra-Salt concentrate solution will be injected into the cooling system, leaving a corrosion-inhibiting coating on all metal surfaces, thereby neutralizing the salinity of incoming seawater.
3. Before disengaging the Flush switch, you must turn off the engine. For best results, use the Neutra-Salt Engine Flushing System after every trip outing. You will typically get 10 to 15 flushes before a refill is needed.

Refer to the Neutra-Salt owner's manual for specific information on the system installed in your boat. It is important that you completely understand the system in theory and operation to achieve the best results. Contact your Monterey dealer to acquire solution for refills.

1.5 Propellers

The outdrive uses dual, counter rotating propellers that convert the engine's power into thrust. They come in a variety of styles, diameters and pitches. Pitch is the theoretical distance traveled by the propeller in each revolution.

The propellers that will best suit the needs of your 335 Sport Yacht will depend somewhat on your application and expected average load. Propeller sizes are identified by a number or code stamped on the prop. Always repair or replace a propeller immediately if it has been damaged. A damaged and therefore out of balance propeller can cause vibration that can be felt in the boat and could damage the outdrive gear assembly.



Neutra Salt Switches at Helm



Typical Stern Drive Propellers

Please refer to the outdrive owner's manual for specific information on propellers and the proper installation procedure.

1.6 Performance Issues and Propellers

It is extremely important that the boat is propped to run at or very near the recommended top RPM with an average load. If the top RPM is above or below the recommended range, the propellers must be changed to prevent loss of performance and possible engine damage.

Diesel and gas engines can be damaged and the warranty voided if the boat is not propped correctly. Always consult your Monterey or authorized engine service dealer when making changes to the propellers or if the boat does not run near the top recommended RPM.

Your boat was shipped with propellers that typically provide optimum performance for your boat. However there are factors that can affect performance and propeller requirements.

Note: Before changing propellers to correct boat performance problems, be sure other factors such as engine tuning, bottom and running gear growth, etc. are not the source of performance changes. Always be sure the load conditions are those normally experienced before changing propellers.

- The addition of heavy equipment like life rafts, personal water craft, additional coolers, etc., will cause additional load on the engines. Consequently, different propellers may be required.
- If the boat ran in the required RPM range when it was new and you have not added any additional gear or heavy equipment and have not damaged the propellers, there is a good chance the propellers are not the problem.
- Boats operated at high altitudes (above 2000 feet). Engines operated at high altitudes will not be able to develop as much horse power as they do at or near sea level. Consequently, different propellers may be required.

1.7 Engine and Helm Instrumentation

The helm station is equipped with a set of engine instruments and/or alarms. These instruments allow the pilot to monitor the engine operational conditions. Close observation of these instruments allows the pilot to operate the engines at the most efficient level and could save the engines from serious costly damage. The instrumentation is unique to the type of inboard/outboard motors installed on your Monterey. Some or all of the following gauges and instruments may be present.

Tachometer

The tachometer displays the speed of the engine in revolutions per minute (RPM). This speed is not the boat speed nor necessarily the speed of the propellers. The tachometer may not register zero with the key in the "OFF" position.



MAINTAINING MAXIMUM, OR CLOSE TO MAXIMUM RPM FOR EXTENDED PERIODS CAN REDUCE THE LIFE OF THE ENGINE. NEVER EXCEED THE MAXIMUM RECOMMENDED OPERATION RPM OF THE ENGINE.

Temperature Gauge

The temperature gauge indicates the temperature of the engine cooling system. A sudden increase in the temperature could signal a blocked cooling passage or a water pump malfunction



CONTINUED OPERATION OF AN OVERHEATED ENGINE CAN RESULT IN ENGINE SEIZURE. IF AN UNUSUALLY HIGH TEMPERATURE READING OCCURS, SHUT THE ENGINE OFF IMMEDIATELY. THEN INVESTIGATE AND CORRECT THE PROBLEM.

Oil Pressure Gauge

The oil pressure gauge monitors the engine lubrication system pressure. The oil pressure indicated when the engine is new is usually the reference for normal oil pressure for that engine. A drop in oil pressure is a possible indication of oil pump problems, a leak or fuel diluted oil.

Fuel Gauge

The fuel gauge indicates the amount of fuel in the fuel tank. This gauge is merely a relative indication of the available fuel supply and not a calibrated instrument.

Voltmeter

The voltmeter displays the voltage for the battery and the charging system. The normal voltage is 11 to 12.5 volts with the engines off, and 13 to 14.5 volts with the engine running.

Hour Meter

The hour meter keeps a record of the operating time for the engine. The hour meters are located in the in the tachometers or multi-meters on most installations.

Tilt/Trim Gauge



4 in 1 Multifunction Gauge

The tilt/trim gauge monitors the position of the outdrive. The upper range of the gauge indicates the tilt, which is used for trailering and shallow water operation. The lower range indicates the trim position. This is the range used to adjust the hull angle while operating your boat on plane. Please refer to Chapter 2 and the engine owner’s manual for more information on the operation of the outdrive power tilt and trim.

Trim Tab Indicator Gauges

Monitors the position of the trim tabs. The trim tabs should always be returned to the full up position whenever the boat is moored or before lifting the boat with a lift.

BI Data Gauge

The depth gauge indicates the depth of the water below the bottom of the boat, the boat speed, and water temperature.

Fuel Management (Optional)

Fuel management systems are optional and could be installed on your boat separately or as part of the engine monitoring system. The fuel management gauge is used to monitor the gallons per hour and also total gallons used. If you have a fuel management system installed on your boat, please refer to the engine or fuel management manual for information on that system.

Engine Alarm

Inboard engines are equipped with an audible alarm system mounted in the helm area that moni-

tors selected critical engine systems. The alarm will sound if one of these systems begins to fail. Refer to the engine owner’s manual for information on the alarms installed with your engine.

If an engine alarm sounds, immediately shut off the engine until the problem is found and corrected.

Volvo Penta EDC Display

The Volvo Penta electronic engine monitoring system is standard with Volvo diesel engines and optional on some Volvo gas engines. The system monitors all of your engine functions on one instrument at the touch of a button. Engine speed, coolant temperature, battery voltage, and boost pressure (diesel engines) can be monitored in analog or digital display in 8 different languages. In addition to monitoring basic engine information, you can switch modes to monitor current or average fuel consumption.

The display can also communicate with the navigation system in the boat to provide boat speed and miles per gallon from data received from the GPS or fish finder log. The type of navigation equipment you have installed in your boat will determine the functions available.

Refer to the Volvo engine and EDC display owner’s manuals for more information on the Volvo electronic engine monitoring system.

High Water Alarm

Your boat is equipped with an audible high water alarm system. The alarm will sound if water in the bilge rises high enough to activate the alarm switch.

The automatic switch for the alarm is mounted significantly higher than the automatic float switches for the bilge pumps. Therefore, immediate action should be taken to find and correct the problem if the alarm sounds. It could be that the automatic bilge pump system has failed or is being overcome by incoming water from a loose or broken hose, a loose thru-hull fitting, a defective or damaged outdrive component or damage to the hull.

Compass

The compass is on top of the console. To adjust the compass for your area, read the instructions on "Compass Compensation" given to you in the literature packet. The compass cannot be adjusted accurately at the factory because it must be compensated for the influence of the electrical equipment and electronics unique to your boat. Therefore, the compass should be adjusted by a professional after the electronics are installed and before operating the boat.

Instrument Maintenance

Electrical protection for the engine instruments and ignition circuitry is provided by circuit breakers located on the engines. The navigational electronics are protected by the electronics breaker in helm breaker panel. The ignition switch and instrument wire connectors should be sprayed periodically with a contact cleaner/lubricant. The ignition switch and all instruments, controls, etc. should be protected from the weather when not in use. Excessive exposure can lead to gauge and ignition switch difficulties.



Volvo EDC Display



Compass

HELM CONTROL SYSTEMS

2.1 General

The helm controls consist of three systems: the engine throttle and shift controls, the steering system, and the trim tab control switches. These systems provide the operator with the ability to control the direction and attitude of the boat from the helm station.

Each manufacturer of the control components provides an owner's manual with its product. It is important that you read the manuals and become familiar with the proper care and operation of the control systems.

2.2 Engine Throttle and Shift Controls

The shift and throttle controls on your boat may vary depending on the engines used. The following description is typical of most cable and electronic inboard/outboard remote controls. Refer to the engine or control manual for specific information on the controls installed on your Boat.

Cable Engine Controls

The cable engine throttle and shift control system consists of three major components: the control handle, the throttle cable, and the shift cable. The cables are all the push-pull type. Two cables are required for each engine and control. One connects the remote throttle control to the engine and the other connects the remote shift control to the outdrive shift linkage.

The helm on your Monterey is designed for a binnacle style control with a single lever for each engine that operates as a gear shift and a throttle. General operation will include a position for neutral (straight up and down), a forward position (the 1st detent forward of neutral), and a reverse position (the 1st detent aft of neutral). Advancing the control lever beyond the shift range advances the throttle in forward or reverse. Each control is equipped with a means of permitting the engine to be operated at a higher than idle RPM while in neutral for cold starting and warm-up purposes.

Electronic Engine Controls

Electronic engine controls are standard on diesel powered boats and optional with gasoline engines.



Volvo Engine Controls and Control Head

The shift and throttle control features may vary depending on the engines used. The following control description is typical of most electronic control installations.

The helm is designed for a binnacle style control with a single lever for each engine. The electronic control system consists of three major components: the electronic control head with integrated or separate keypad, the control processors and applicable harnesses. Some controls are completely electronic and there are no cables. Some control processors have electronically controlled servos that are connected to the engine and transmission control levers by cables.

Movement of the helm control arm sends a signal to the control processor, located in the engine

compartment that operates the engine throttle and transmission control lever. The controls have a single lever for each engine that operates as a gearshift and a throttle. General operation will include a position for neutral (straight up and down or slightly aft of vertical), a forward position (the 1st detent forward of neutral), and a reverse position (the 1st detent aft of neutral). Advancing the control lever beyond the shift range advances the throttle in forward or reverse. Each control is equipped with a means of permitting the engine to be operated at a higher than idle RPM while in neutral for cold starting and warm-up purposes. The control levers are equipped with adjustable control head detent and friction settings.

The control head key pad has integrated switches and indicator lights which allow the operator to control all aspects of the boat's propulsion system. The most common features activated or monitored by the keypad are:

- Starter lockout, which prevents the engine from being started in gear.
- Gear lockout, which allows the engine RPM to be advanced in neutral safely.
- Battery voltage warning indicator that warns the operator of high or low voltage supplied to the system (audible alarm)
- An engine synchronization feature that automatically keeps both engines at the same RPM. Refer to Engine Synchronizing in this section for more information regarding engine synchronization.

These features and others not mentioned require specific procedures to activate and operate them properly. Some of the procedures and features are unique to the engines, drive system and other options installed on your boat. It is essential that you read the owner's manual for the controls and be completely familiar with their operation before using your boat.



Volvo Electronic Engine Control

During most operations of a twin engine boat, it is advantageous for both engines to be operated at the same RPM. This reduces noise, and vibration, and can increase engine efficiency. Setting the throttles so that the engines are running the same RPM (synchronized) can be done by listening to the engine sounds, with the synchronizer feature built into some electronic engine controls or with an optional engine synchronizing gauge. Attempting to synchronize the engines solely by using the tachometer readings or control lever placement generally will not work. When the engines are in proper synchronization, the throttle levers may not necessarily be even. Please refer to the engine or control owner's manual for more information on the features for the controls installed on your boat.

2.3 Neutral Safety Switch

Every control system has a neutral safety switch. This device prohibits the engines from being started while the shift levers are in any position other than the neutral position. If the engine will not start, slight movement of the shift lever may be necessary to locate the neutral position and disengage the safety cutout switch. Control system adjustments may be required to correct this condition, should it persist. See your Monterey dealer for necessary control and cable adjustments.

The neutral safety switch should be tested periodically to ensure that it is operating properly. To test the neutral safety switch, make sure the outdrives are tilted down and move the shift levers to the forward position with the engines off.



ALWAYS RETURN THE ENGINE THROTTLE LEVER TO THE EXTREME LOW SPEED POSITION BEFORE SHIFTING. NEVER SHIFT THE UNIT WHILE ENGINE SPEED IS ABOVE IDLE RPM.

Make sure the throttle levers are set to the idle position. Activate the starter switch for each engine just long enough to briefly engage the starter. **Do not hold the starter switch in the start position long enough to start the engine.** The starter should not engage for either engine. Repeat this test with the shift levers in reverse and the engine throttles at idle. Again, the starter should not engage for either engine. If the starter for either engine engages with the shift controls in any position other than the neutral position, then the neutral safety switch is not functioning properly and you should contact your dealer and have the neutral safety switch repaired by a qualified technician before using your boat. If an engine starts in gear during this test, immediately move the shift levers to the neutral position and turn the engine off.



Steering Wheel Tilt Adjustment Lever



IN SOME SITUATIONS, IT MAY BE POSSIBLE TO ACCIDENTALLY START THE ENGINES IN GEAR WITH THE THROTTLES ABOVE IDLE IF THE NEUTRAL SAFETY SWITCHES ARE NOT OPERATING PROPERLY. THIS WOULD CAUSE THE BOAT TO ACCELERATE UNEXPECTEDLY IN FORWARD OR REVERSE AND COULD RESULT IN LOSS OF CONTROL, DAMAGE TO THE BOAT, OR INJURY TO PASSENGERS. ALWAYS TEST EACH NEUTRAL SAFETY SWITCH PERIODICALLY AND CORRECT ANY PROBLEMS BEFORE USING THE BOAT.



EXCESSIVE TRIM FOR THE OPERATING CONDITIONS, EITHER TRIM UP OR DOWN, CAN CAUSE BOAT INSTABILITY, PROPELLER CAVITATION, OR MAKE STEERING THE BOAT MORE DIFFICULT. IF THE BOAT BEGINS TO FEEL UNSTABLE OR IS HARD TO STEER, SLOW DOWN AND ADJUST THE TRIM ANGLE.

2.4 Outdrive Power Tilt and Trim

All inboard/outboard drive systems have a tilt and trim feature for the outdrive. This allows the operator to control the position of the outdrive from the helm. Moving the outdrive closer to the boat transom is called trimming "in" or "down." Moving the outdrive further away from the boat transom is called trimming "out" or "up." In most cases, the boat will run best with the drive unit adjusted so the hull will run at a 3 to 5 degree angle to the water.

The term "trim" generally refers to the adjustment of the outdrive within the first 20° range of travel. This is the range used while operating your boat on plane. The term "tilt" is generally used when referring to adjusting the outdrive further up for shallow water operation or trailering. For information on the proper use and maintenance of the power tilt and trim, please refer to the engine owner's manual.

2.5 Steering System

Your Monterey could be equipped with power assisted cable or hydraulic steering, depending on the engines selected.

Cable Power Assisted Steering

Cable power assisted steering is standard equipment on gasoline powered boats and some diesel powered boats. Turning the steering wheel moves the gears in the helm, pushing or pulling the cable assembly and turning the outdrives. An engine driven power hydraulic steering pump and cylinder assist the cable steering and reduces the effort required to turn the boat.

Refer to the engine and steering system manufacturer owner's manuals for specific information on the operation and maintenance for the steering system.

Hydraulic Power Assisted Steering

Some diesel powered boats are equipped with a power assisted, hydraulic steering system. Hydraulic power steering uses a hydraulic pump driven by one of the engines to provide the "POWER" for the power steering system. A manual hydraulic steering system consisting of a standard helm and hydraulic steering cylinder, supplies the "control" portion of the power steering system.

Under normal conditions, with engines running, a pressurized hydraulic oil supply is in a standby mode, ready to be directed to the steering cylinder as dictated by the steering wheel and power steering valve. Turning the steering wheel left or right causes the power system to go from 'standby' into 'operating' mode and pumps the fluid in the hydraulic hoses which activates the hydraulic cylinder, causing the outdrives to turn. A slight clicking sound may be heard as the wheel is turned. This sound is the opening and closing of valves in the helm unit and is normal. In the event of a power source failure, hydraulic oil is automatically pumped directly from the steering helm into the steering cylinder, providing the helmsman with manual backup steering.

An oil reservoir, engine hydraulic pump, and a reservoir at the helm allows easy system fill. It is important that the fluid level in the reservoirs is checked frequently and maintained at or near the maximum level. Both reservoirs use the same hydraulic fluid.

Refer to the engine and steering system manufacturer owner's manuals for specific information on the operation and maintenance for the steering system.

Helm and Outdrives

The steering wheel can be tilted to five different positions by activating the tilt lock lever located on the bottom side of the helm. When the lever is released, it automatically locks the steering wheel at or close to that angle.

Dual engine sterndrive boats have two outdrives. These are coupled together at the tiller arms or the drives themselves by a tie bar. Mercruiser drives are set parallel and Volvo drives are toed in 1/2" at the aft end of the cavitation plates to provide maximum stability on straight ahead runs and proper tracking through corners. Outdrive or steering system damage may require the outdrives to be realigned.

Please refer to the engine or steering system owner's manual or contact your dealer for information on the power steering system.

2.6 Trim Tabs

The trim tabs are mounted to the hull on the transom below the swim platform. Dual rocker switches in the helm are used to control the trim tabs. The switches are labeled and control bow



Transom Trim Tab Plane and Activator

up and down movements. They also control starboard and port up and down movements. Bow up and bow down will control the hull planing attitude, while port and starboard up and down provides control for the hull listing.

Before leaving the dock, make sure that the tabs are in the full "UP" position by holding the control in the bow up position for ten (10) seconds.

Always establish the intended heading and cruise speed before attempting to adjust the hull attitude with the trim tabs. After stabilizing speed and direction, move the trim tabs to achieve a level side to side running attitude being careful not to over trim.

After depressing a trim tab switch, always wait a few seconds for the change in the trim plane to take effect. Avoid depressing the switch while awaiting the trim plane reaction. By the time the effect is noticeable the trim tab plane will have moved too far and thus the boat will be in an overcompensated position.

When running at a speed that will result in the boat falling off plane, lowering the tabs slightly, bow down, will improve the running angle and operating efficiency. Positioning trim tabs too far in the down position can reduce operating efficiency and cause substantial steering and handling difficulties.

Be extremely careful when operating in a following sea. The effect of trim tabs is amplified under such conditions. Steering and handling difficulties can result from improper trim tab usage, particularly in a following sea. Always raise the tabs to the full bow up position in these conditions.

When running at high speeds be sure that the tabs are in the full "UP" position. Only enough trim plane action should be used to compensate for any listing. Trim tabs are extremely sensitive at high speeds. Adjust for this and be prepared to slow down if difficulties arise.

When running into a chop, a slight bow down attitude will improve the ride. Be careful not to over trim. Handling difficulties may result.



Typical Bennett Trim Tab Pump

2.7 Control Systems Maintenance

Control Maintenance

Periodic inspection of the control systems and all connections should be made. Signs of rust, corrosion, wear, or other deterioration should be serviced immediately. Generally, periodic lubrication of all moving parts and connections with a light waterproof grease is in order.

Lubrication should be performed as often as necessary to keep the system operating smoothly.

Control system adjustments may become necessary. If adjustment becomes necessary, see your Monterey dealer.



IMPROPERLY ADJUSTED ENGINE CONTROLS CAN CAUSE LOSS OF CONTROL AND SEVERE ENGINE OR OUTDRIVE DAMAGE. DO NOT ATTEMPT CONTROL SYSTEM ADJUSTMENTS UNLESS YOU ARE FAMILIAR WITH CONTROL SYSTEM SERVICING PROCEDURES.

Steering System Maintenance

A periodic inspection of all steering hoses, linkage and helm assemblies should be made. Signs of corrosion, cracking, loosening of fastenings, leaking fluid, excessive wear, or deterioration should be corrected immediately. The transom area in the engine compartment should be checked for leakage around the outdrives and for wires, hoses and cables that may be rubbing against the tie bar, steering cylinder or tiller arms.

You also should make sure that there are no wires or cables secured to the steering cable near the power steering cylinder. The cable is attached to the power steering cylinder control valve and must be free to move slightly to activate the valve. Hard or erratic steering is an indication that the steering cable is not moving freely.

Generally, periodic lubrication of all moving parts and connections with a light waterproof grease is in order. Failure to do so could lead to steering system failure that would result in loss of control.

The engine driven power steering system has specific fluid and maintenance requirements. The fluid level and belt tension should be checked frequently. The outdrives are equipped with grease fittings and must be lubricated periodically. Please refer to the engine owner's manual for maintenance information on the power steering system and lubricating the outdrive.

Trim Tab Maintenance

Marine growth can interfere with the proper operation of the trim tab planes and actuators. To reduce problems due to marine growth, always return the trim tabs to the full "UP" position after operating the boat and periodically inspect and clean marine growth from the actuators and planes.

The trim tab fluid should be checked often. Keep the fluid level between the marks on the trim tab pump reservoir.

If your boat will be left in saltwater for extended periods, it will be necessary to install anodes on the trim tab planes to prevent galvanic corrosion. Galvanic corrosion is the corrosion process occurring when different metals are submerged

in an electrolyte. Sea water is an electrolyte and submerged metal components must be properly protected. The anodes will need to be monitored and changed when they are 75% of their original size.

Refer to the trim tab owner's manual for additional maintenance information, fluid specifications and operating instructions.

FUEL SYSTEM

3.1 General

The fuel system used in Monterey boats is designed to meet or exceed the requirements of the U.S. Coast Guard and the Boating Industry Association in effect at the time of manufacture.

All fuel systems have been factory inspected and pressure tested in accordance with regulations in effect at the time of manufacture. This inspection assures that the system is air tight, leak proof and safe. It is the responsibility of the purchaser to maintain it in that condition. Make frequent inspections to assure that no deterioration or loosening of connections is resulting from vibration.

Fuel Tanks and Fuel Withdrawal Tubes

Your boat is equipped with two fuel tanks. The port fuel tank supplies the port engine and the starboard fuel tank supplies the starboard engine. The fuel withdrawal tubes are positioned in the fuel tanks to achieve optimum fuel usage, fuel line routing, etc. At certain speeds and hull trim angles, the fuel supply at the withdrawal tank location can increase or decrease accordingly. Be extremely careful when attempting to operate the boat when low on fuel. Though some fuel may be in the tank, the relative trim angle of the boat may cause the fuel to flow away from the withdrawal.

The generator is supplied fuel from either the port tank or the starboard tank. A selector valve on the forward engine room bulkhead allows the operator to select which tank the generator draws fuel from. The generator fuel system uses withdrawal tubes that are shorter than the main engine tube to prevent the generator from exhausting the reserve fuel in the selected tank.

Fuel withdrawal lines on gasoline fuel systems are equipped with anti-siphon valves where the lines attach to the fuel tank. These valves prevent gasoline from siphoning out of the fuel tank should a line rupture. Diesel fuel systems are not equipped with anti-siphon valves.



Typical Fuel Gauge Sender



IF A FUEL LINE SHOULD LEAK, ANTI-SIPHON VALVES PREVENT A SUBSTANTIAL AMOUNT OF FUEL FROM FLOWING INTO THE BILGE. SHOULD AN ANTI-SIPHON VALVE BECOME CLOGGED, CLEAN AND REINSTALL OR REPLACE. DO NOT REMOVE THE ANTI-SIPHON VALVES FROM THE SYSTEM. ANTI-SIPHON VALVES ARE REQUIRED, BY THE U.S. COAST GUARD, TO BE INSTALLED IN ALL BOATS EQUIPPED WITH GASOLINE ENGINES.

Fuel Gauges

The fuel gauges indicate the amount of fuel in the tanks. Due to the mechanical nature of the fuel senders, variations in readings during various speeds of operation may occur. This system is merely a relative indication of the available fuel supply and not a calibrated instrument.

There is a fuel gauge sender located in the top of each tank that is connected to a fuel gauge at the helm. The port tank fuel gauge sender is located below an access plate in cockpit sink cabinet. The access plate is below the refrigerator or ice maker if one of these options is installed. The fuel gauge sender for the starboard tank is below an access plate located in the cockpit lounge seat storage compartment.

Fuel Fills

The fuel fill deck plates are located on both sides of the transom and are marked "GAS" or "Diesel." The fuel fill is opened by turning it counter clockwise with a special key. Be sure to use the proper type and grade fuel. Refer to the engine owner's manual for additional information on the fuel requirements for your engines.

Note: Do not over tighten the fuel cap. If the cap is over tightened, the O-ring seal could be damaged allowing water to contaminate the fuel system.



Fuel Fills



DO NOT CONFUSE FUEL FILL DECK PLATES WITH THE WATER OR WASTE FILL DECK PLATES. THESE PLATES ARE ALSO LABELED ACCORDINGLY. IF GASOLINE OR DIESEL FUEL IS ACCIDENTALLY PUMPED INTO THE WATER OR WASTE TANK, DO NOT ATTEMPT TO PUMP IT OUT YOURSELF. WATER AND WASTE PUMPS ARE NOT DESIGNED TO PUMP FUEL AND A FIRE OR EXPLOSION COULD RESULT. CONTACT YOUR DEALER OR THE MONTEREY CUSTOMER SERVICE DEPARTMENT FOR ASSISTANCE IN HAVING THE FUEL PROFESSIONALLY REMOVED.

Fuel Vents

There are fuel vent fittings located on each side of the hull. While the tanks are being filled, the air displaced by the fuel escapes through the vents. When the tank is almost full, fuel will be ejected from the fuel vent. You should calculate the amount of fuel you need to avoid overfilling the tank and ejecting fuel from the vent or fuel fill.

After fueling, replace the fill caps, and wash the areas around the fuel fill plate and below the fuel vents. Residual fuel left on the hull sides can be dangerous and will yellow the gelcoat or damage the striping.

3.2 Gasoline Engine Fuel Systems

The gasoline fuel system on the 335 Sport Yacht has two fuel tanks, one tank for each engine. The port engine is always supplied fuel from the port tank and the starboard engine is always supplied fuel from the starboard tank. The generator can be supplied from either the port or starboard fuel tank and is controlled by a selector valve on the forward engine room bulkhead.



Typical Gas Engine Fuel Filter

Gasoline Fuel Filters

Each gasoline engine is equipped with a spin on, water separator type fuel filter located on the engine. The filter should be checked frequently and changed at least annually to assure an adequate supply of clean, dry fuel to the engine.

It is recommended that the filters are inspected after the first 25 hours of use and then serviced as needed. Always follow the engine or filter manufacturer's instructions when servicing or replacing the fuel filters.



BEFORE STARTING THE ENGINES, ALWAYS OPEN ALL HATCHES, WINDOWS, AND DOORS AND RUN THE BLOWER FOR AT LEAST FOUR (4) MINUTES TO COMPLETELY VENTILATE THE BOAT AFTER SERVICING THE FUEL SYSTEM.

3.3 Diesel Engine Fuel System

The diesel fuel system works much like the gas system. The main difference is the diesel system is not equipped with anti-siphon valves and there is always a fuel return line for each engine that returns unused fuel to the fuel tank.

The port engine is always supplied fuel from the port tank and the starboard engine supplied fuel from the starboard tank. Diesel engines circulate much more fuel than they consume and there is no selector valve for the return fuel lines. The return line for the port engine is connected to the port tank and the return line for the starboard engine is connected to the starboard tank.

Proper diesel engine operation requires a good supply of clean, dry diesel fuel. Improper marina fuel storage techniques, limited boat usage, etc. can cause the fuel to become contaminated. Periodically, it may be necessary to pump accumulating water and contaminated fuel from the bottom of the fuel tank. If the fuel system on your boat becomes contaminated, contact your dealer or the Monterey Customer Service Department for assistance.

Bacteria, commonly called algae, can grow in the accumulated water in diesel fuel tanks. This condition is most prevalent in warm climates. Periods of storage or limited use allow the bacteria to accumulate, making the situation worse. Periodically adding a high quality diesel fuel conditioner containing a biocide may be required to control bacteria in your boating area. Please contact your Monterey dealer or engine manufacturer for additional information regarding fuels and additives.

Diesel Fuel Filters

The diesel fuel filters are installed in the engine compartment near each engine. Check the filters for water before each use and replace the filter element as needed. Water is drained from the filters by placing a cup under the filter and draining through the petcock at the bottom of the filter until clean fuel flows. It is particularly important to monitor the condition of the fuel filters frequently because diesel engines circulate much more fuel than they consume.

A fuel shut-off valve is located on the fuel line near the filter. The valve should always be closed before servicing the fuel filter. Follow the filter or engine manufacturer's instructions for cleaning and replacing the filter elements.



Typical Diesel Fuel Filter



Typical Gasoline Generator

Note: Diesel fuel systems may need to be primed after servicing. Refer to the engine owner's manual for information on priming the fuel system.

3.4 Generator Fuel System

The generator fuel system is much like the primary engine fuel system. With diesel engines, there is a fuel supply and a fuel return line. With gasoline engines, there is a fuel supply line equipped with an anti-siphon valve. The generator can be supplied by either the port fuel tank or the starboard fuel tank. A valve on the forward engine compartment bulkhead allows the operator to select the fuel tank that supplies the generator. The selector valve automatically directs the return fuel to the same tank selected to supply fuel to the generator on diesel powered boats.

The fuel valve is labeled "PORT" and "STBD." The labels refer to the fuel tank the valve selects. To keep the boat properly balanced the fuel supply should be managed by switching tanks every six hours of generator operation.

The generator withdrawal tube is shorter than the main engine withdrawal tubes to prevent the generator from consuming the reserve fuel. Therefore, the generator will run out of fuel if the fuel level in either fuel tank drops below 1/4 of the tank.

A water separating fuel filter is located near the generator with diesel engines and on the generator near fuel pump with gas engines. Water is drained from the diesel fuel filter by placing a cup below the filter and draining through the petcock at the bottom of the filter until clean fuel flows. The diesel filter should be checked for water before each trip. The filter cartridge should be replaced on diesel or gas generators when the main engine fuel filter cartridges are changed. Diesel fuel systems have a shut-off valve that is located on the fuel line near the filter. The valve should always be closed before servicing the fuel filter.



Generator Fuel Crossover Valve



Typical Gasoline Generator Fuel Filter



IT IS EXTREMELY IMPORTANT THAT THE GENERATOR FUEL SELECTOR VALVE BE USED TO MANAGE THE FUEL DURING NORMAL GENERATOR OPERATION. IF THE TANKS ARE NOT SWITCHED EVERY SIX HOURS OF GENERATOR OPERATION, IT WILL CAUSE THE BOAT TO BECOME UNBALANCED AND LIST WHICH COULD AFFECT HANDLING AND THE SAFE OPERATION OF THE BOAT.

3.5 Fueling Instructions



FUEL IS VERY FLAMMABLE AND THE VAPORS CAN EXPLODE. BE CAREFUL WHEN FILLING THE FUEL TANKS. NO SMOKING. NEVER FILL THE TANKS WHILE THE ENGINES ARE RUNNING. FILL THE FUEL TANKS IN AN OPEN AREA. DO NOT FILL THE TANKS NEAR OPEN FLAMES.



TO PREVENT DAMAGE TO THE FUEL SYSTEM, USE ONLY A GOOD GRADE OF GASOLINE FOR GASOLINE ENGINES OR DIESEL FUEL FOR DIESEL ENGINES. DO NOT USE A FUEL THAT CONTAINS HARSH ADDITIVES OR IS AN ALCOHOL BLEND. ANY DAMAGE DONE TO THE FUEL SYSTEM THAT IS THE RESULT OF USE OF AN ALCOHOL BLEND, IS NOT COVERED BY THE MONTEREY WARRANTY. REFER TO THE ENGINE MANUFACTURER OWNER'S MANUAL REGARDING FUEL REQUIREMENTS FOR YOUR ENGINE.

To fill the fuel tanks at a marina, follow this procedure:

- Make sure the boat is securely moored.
- Make sure all switches are in the "OFF" position.
- Make sure all passengers leave the boat.
- Close all windows and hatches and make sure the blower is off to prevent fuel fumes from entering the cabin or engine compartment.



GASOLINE FUEL VAPORS THAT ACCUMULATE IN THE CABIN OR ENGINE COMPARTMENT WHILE FUELING CAN EXPLODE!! FUEL VAPORS ARE HEAVIER THAN AIR AND CAN ACCUMULATE IF THEY ARE CARRIED BY THE WIND INTO THE CABIN AND ENGINE COMPARTMENT THROUGH OPEN DOORS, WINDOWS, HATCHES OR VENTS. VAPORS CAN ALSO BE DRAWN INTO THE ENGINE COMPARTMENT BY THE BLOWERS. ALWAYS TURN THE BILGE BLOWERS OFF AND CLOSE CABIN WINDOWS, DOORS AND HATCHES BEFORE FUELING.

- Estimate how much fuel is needed and avoid overfilling the fuel tanks.

Note: When the fuel tank is full, fuel will come out through the fuel tank vent. The fuel tank vents are located on the side of the boat. Monitor the vents closely while fueling to prevent fuel from spilling into the water.

- A special key to open the fuel cap is supplied.
- Turn the key counter clockwise to open the cap.
- Remove the cap.
- Put the nozzle in the fuel opening and make sure it stays in contact with the fuel fill opening.



STATIC ELECTRICITY GENERATED BY FLOWING FUEL CAN CAUSE A FIRE OR EXPLOSION. TO PREVENT STATIC SPARKS WHEN FILLING THE TANK, MAKE SURE THE NOZZLE IS ALWAYS IN CONTACT WITH THE FUEL FILL OPENING.

SPILLED FUEL CAN CAUSE A FIRE OR AN EXPLOSION. MAKE SURE YOU DO NOT SPILL ANY FUEL. IF A SMALL AMOUNT OF FUEL IS SPILLED ON THE FIBERGLASS, USE A CLOTH TO REMOVE THE FUEL AND PROPERLY DISPOSE OF THE CONTAMINATED CLOTH. IF FUEL IS SPILLED ON THE WATER, EXERCISE EXTREME CAUTION. FUEL FLOATS ON THE SURFACE OF THE WATER AND CAN IGNITE. IF FUEL IS SPILLED INTO THE WATER, IMMEDIATELY EVACUATE THE AREA AND NOTIFY THE MARINA AND THE PROPER OFFICIALS.

- Fill the tank slightly less than the rated capacity to avoid spilling fuel out of the vent or the fuel fill and to allow for expansion.
- Remove the nozzle.
- Install the fuel cap.
- Open all hatches, windows and doors. **Run the blower for at least four minutes to completely ventilate the boat.**
- Check the fuel compartment and below the deck for fuel odors. If you smell fuel, do not start the engine.



GASOLINE FUEL VAPORS THAT ACCUMULATE IN THE CABIN OR ENGINE COMPARTMENT WHILE FUELING CAN EXPLODE!! TO REDUCE THE RISK OF A FIRE AND/OR EXPLOSION AFTER FILLING THE FUEL SYSTEM, ALWAYS RUN THE BLOWER FOR AT LEAST FOUR (4) MINUTES AND OPEN ALL HATCHES, WINDOWS, AND DOORS TO COMPLETELY VENTILATE THE BOAT BEFORE STARTING THE ENGINES.

3.6 Fuel System Maintenance

Periodically inspect all connections, clamps and hoses for leakage and damage or deterioration. Replace as necessary. Spray the valves, tank fuel gauge senders and ground connections with a metal protector.

Frequently inspect and lubricate the fuel fill cap O-ring seal with Teflon or silicone grease. The O-ring seal prevents water from entering the fuel system through the fuel fill cap and it should be replaced immediately if there is any sign of damage or deterioration.

Contaminated fuel may cause serious damage to your engines. The filters must be checked for water and other contamination frequently. Gasoline engine filters must be changed at least once each year and diesel engine filter elements must be changed at least twice a year or more frequently depending on the type of engines and the quality of the fuel. Please refer to the engine or fuel filter manufacturer's instructions for information on servicing and replacing the fuel filter elements.

Algae can grow in the accumulated water in diesel fuel tanks. This condition is most prevalent in warm climates. Periodically adding a high quality diesel fuel additive containing an algaecide may be required to control algae in your boating area. Since algae also can grow in accumulated water in the fuel filters, it is important to run the main engines and the generator for at least 30 minutes after the algaecide has been added so it will be circulated throughout the fuel system. This is even more important during periods of storage or if the boat is not used enough to require refueling at least once a month.

Severe algae in a diesel fuel system can be extremely difficult and expensive to clean. You should be diligent in monitoring the fuel system by checking the filters for water frequently and being alert for signs of algae in fuel that is drained from

the filters. Most algae appears as black, carpet-like fibers suspended in fuel and water drained from the filters. Severe cases of algae will produce a black jelly like substance that quickly clogs the filters and starves the engines for fuel.

Please contact your Monterey dealer or engine manufacturer for additional information regarding fuels and additives.

Note: Diesel engines circulate far more fuel than they consume. Therefore, it is extremely important that the fuel filters are checked for water and serviced frequently on boats equipped with diesel engines.

The age of gasoline can affect engine performance. Chemical changes occur as the gasoline ages that can cause deposits and varnish in the fuel system as well as reduce the octane rating of the fuel. Severely degraded fuel can damage the engine and boat fuel tank and lines. Therefore, if your boat is not being run enough to require at least one full tank of fresh fuel a month, a fuel stabilizer should be added to the gasoline to protect the fuel from degradation. Your dealer or the engine manufacturer can provide additional information on fuel degradation and fuel stabilizers recommended for your engine.

Avoid using fuels with alcohol additives. Gasoline that is an alcohol blend will absorb moisture from the air which can reach such concentrations that "phase separation" can occur whereby the water and alcohol mixture becomes heavy enough to settle out of the gasoline to the bottom of the tank. Since the fuel pick up tube is very near the bottom of the tank, phase separation can cause the engine to run very poorly or not at all. This condition is more severe with methyl alcohol and will worsen as the alcohol content increases. Water or a jelly like substance in the fuel filters is an indication of phase separation from the use of alcohol blended fuels.



LEAKING FUEL IS DANGEROUS AND CAN CAUSE A FIRE AND/OR EXPLOSION. AFTER THE FILTER ELEMENT HAS BEEN CHANGED, PRIME THE FUEL SYSTEM AND CHECK ALL FITTINGS FOR LEAKS BEFORE AND AFTER STARTING THE ENGINES.

DO NOT DRAIN ANY FUEL IN THE BILGE. THIS COULD LEAD TO A FIRE OR EXPLOSION. CHECK ALL FUEL LINE FITTINGS FOR LEAKS BEFORE AND AFTER STARTING THE ENGINES FOLLOWING ANY FUEL SYSTEM SERVICE.



TO REDUCE THE POSSIBILITY OF A FIRE OR EXPLOSION, MAKE SURE ALL ELECTRICAL SWITCHES ARE IN THE "OFF" POSITION BEFORE SERVICING THE FUEL SYSTEM.



AVOID SERIOUS INJURY OR DEATH FROM FIRE OR EXPLOSION RESULTING FROM LEAKING FUEL, INSPECT SYSTEM FOR LEAKS AT LEAST ONCE A YEAR. DO NOT DRAIN ANY FUEL INTO THE BILGE.



BEFORE STARTING THE ENGINES, ALWAYS OPEN ALL HATCHES, WINDOWS, AND DOORS AND RUN THE BLOWER FOR AT LEAST FOUR (4) MINUTES TO COMPLETELY VENTILATE THE BOAT AFTER SERVICING THE FUEL SYSTEM.

THIS PAGE WAS LEFT BLANK
INTENTIONALLY

ELECTRICAL SYSTEM

4.1 General

Your Monterey is equipped with 120-volt AC and 12-volt DC electrical systems. The AC system can draw current from one of two sources, either shore power outlets at dockside or the generator. The DC system draws current from on board batteries.

The 12-volt batteries in your boat are usually the lead-acid type. They will require similar maintenance as those found in automobiles.

4.2 12-Volt System

The 12-volt system is a standard marine system. There are four batteries, one for the starboard engine, one for the port engine, and two in parallel for the house, accessory circuits and the optional generator. The batteries themselves can be charged by the engines or by the battery charger when hooked to shore power or when operating the generator.

An automatic battery isolator/relay manages the charging current for the starboard engine and house batteries. Whenever the starboard engine is running, the isolator/relay automatically senses the condition of each battery bank and directs the available current to the batteries that require charging. The port engine battery is charged by the port engine. The system is equipped with a battery parallel feature that will connect both engine starting batteries in parallel for extra battery power while starting the engines. The battery parallel switch is activated by a momentary rocker switch located in the helm switch panel. When the switch is pressed and held for three seconds, a relay is engaged that connects both engine starting batteries. Once engaged, the relay remains activated for ten minutes and then automatically deactivates and the batteries are isolated.

Most 12-volt power is distributed to the 12-volt accessories through individual circuit breakers located in the 12-volt breaker panels in the cabin, at the helm and in the breaker panel near the battery switches in the engine compartment. Main breakers located in the engine compartment breaker panel protect the house, helm systems



Battery Selector Switches, Circuit Breakers and Charging Relay

and windlass from an overload. Other circuit breakers in the engine compartment panel protect the battery charger DC circuits, stereo and electronics memory, engine control memory, CO monitors, sump pump, amp and the automatic switches for the bilge pumps and high water alarm. Main breakers located on each engine protect the ignition, charging systems and gauges. Some 12-volt accessories are operated directly by a circuit breaker in the cabin breaker panel while others are operated by a switch fed by the panel breakers. Most of the 12-volt accessories on the deck and in the cockpit are operated by switches in the helm switch panel.

Battery Switches

Your boat is equipped with the latest in marine battery switching. Rather than having manually operated battery switches located somewhere in the cockpit, this boat has remotely operated electric battery switches mounted out of the way in the engine room. This method of switching is more convenient and more secure since they are controlled from the inside of a lockable cabin.

Upon commissioning of your new boat, take a moment to locate the bank of battery switches located on the forward bulkhead of the engine room. They are easy to identify by their distinc-

tive grey cases and the battery cables that run from under them. There are 4 large cases and one small case. The 4 large cases consist of 3 identical battery switches (port engine battery, starboard engine battery, and house battery) and one case marked "VSR Voltage Sensitive Relay Module." This is your parallel switch. It is controlled by the "Parallel" switch at the helm. The small grey case (also Marked VSR) is the voltage sensitive relay that keeps the house battery bank charged when only the engines are running.

Each battery switch in the engine compartment has a manual override that can activate or deactivate the switch if the relay fails. The manual override is a red knob on each battery switch/relay that can be rotated to select the "ON", "AUTO" or "OFF" position. The normal operating position for each switch is the "Auto" Position. However, to properly engage the automatic function of each switch, the red lever must first be placed in the "Off" position and then rotated into the "Auto" position. Once this has been done, the only time these levers would ever need to be operated again would be if there was damage to the boat in an emergency situation. The "Auto" position simply means that the battery switches are now under the control of the remote switches on your vessel's DC panel.

Each battery switch is controlled by a single momentary switch on your cabin DC breaker panel. Press the top of each remote switch to engage the battery switch. A red light will illuminate to indicate that the battery is now "on." To turn off, simply press the bottom of the momentary switch. The red light may not turn off immediately or will slowly fade out if there are no loads present on the system. This is normal as the capacitors in the system drain.

An automatic isolator/relay controls the charging of the starboard engine and house battery banks whenever the starboard engine is operating. The port engine battery is dedicated to starting and operating the port engine. It is charged by the port engine whenever the port engine is operating. The port and starboard engine batteries can be temporarily connected in parallel by the parallel switch in the helm to provide additional starting current for each engine. The engine and house batteries are also charged by the battery charger whenever it is operating.

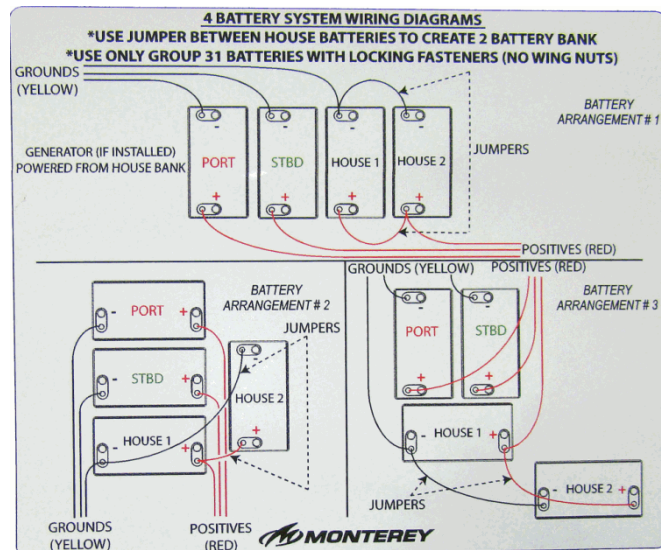

Battery System Wiring Diagrams

When in port or at anchor, the port and starboard engine switches should be off. Only the battery switch that activates the House battery should be on. This will keep both engine starting batteries in reserve for starting the engines. If the house battery bank becomes discharged to the point that the optional generator will not start, the starboard engine can be started to recharge the house battery bank enough to start the generator.

Note: Current is supplied to the high water alarm and automatic float switches for the bilge pumps when the batteries are connected and the battery switches are off.

The DC electrical system on your boat is designed for wet cell, gel cell or AGM marine batteries. The battery charger is equipped with a switch to select the type of batteries to be charged. The batteries will be damaged if the charger is not set properly. You should refer to the battery charger owner's manual to make sure the charger is set to the type of batteries in your boat and do not mix the size, type or brand of marine batteries.

The batteries in your boat were supplied by the dealer. Always consult your dealer before changing the type of batteries.

12-Volt Accessory Switch Panels

The main accessory switch panels and the engine start switch panel are located at the helm. The circuit breakers that protect the accessories and activate the engine starting circuits are located in a breaker panel below the helm switches and in the engine compartment breaker panel.

The following is a description of the accessories controlled by the main accessory switch panel:

Port Ignition Switch

The port ignition switch is a key activated switch, located near the helm below the steering wheel, which activates the port engine. The switch has off/on and momentary start positions. To start the engine, make sure the outdrive is down, the shift lever is in the neutral position and your hand is on the throttle lever in the idle position. Turn the ignition key to the start position. When the engine starts, release the key and the switch will automatically go to the run position. Stop the engine by turning the key to the off position. It is protected by a breaker located in the helm breaker panel and main breakers located on the engine.

Starboard Ignition Switch

The starboard ignition switch is a key activated switch, located near the helm below the steering wheel, which activates the starboard engine. The switch has off/on and momentary start positions. To start the engine, make sure the outdrive is down, the shift lever is in the neutral position and your hand is on the throttle lever in the idle position. Turn the ignition key to the start position. When the engine starts, release the key and the switch will automatically go to the run position. Stop the engine by turning the key to the off position. It is protected by a breaker located in the helm breaker panel and main breakers located on the engine.

The following is a description of the accessories controlled by the main accessory switch panel:

Engine Hatch

The engine hatch control is a momentary switch that controls the electric actuator for the engine hatch. Note that the House battery switch must be turned on for the hatch lifter to operate.

Engine Room Lights

Activates the 12-volt lights in the engine compartment.



Helm Switch Panel - Starboard Side



Helm Switch Panel - Port Side



Helm Switch Breaker Panel

Cockpit Lights

Activates the lights that illuminate the cockpit area and the cabin steps.

Panel Lights

Activates the lights that illuminate the engine gauges.

Nav/Anchor Lights

The switch is a three-position switch. The middle position is "OFF." Moving the switch in one direction will activate the navigation lights. Moving the switch in the opposite direction activates the anchor light.

Arch Light

Activates the light on the arch that illuminates the cockpit area and bridge deck.

Accessory

Reserved for additional 12-volt equipment.

Bow Thruster

Activates the control panel for the optional bow thruster. To activate the bow thruster, press the

switch once. The LED light in the switch flashes. Press the switch again, the steady LED light in the switch indicates the bow thruster control panel is activated and the bow thruster is operational.

Windlass Switch

This switch controls the optional windlass which is mounted to the deck directly above the rope locker. It is protected by a circuit breaker of the type and rating recommended by the windlass manufacturer that is located in the engine compartment breaker panel. There could also be optional foot activated switches on the deck next to the windlass.

Stbd Wiper

Activates the starboard windshield wiper.

Bilge Pump

Manually activates the aft bilge pump which is installed in the bilge near the transom, between the engines. The pump moves water out through the thru-hull fitting in the hull. To start the pump, place the switch in the "ON" position.

Emergency Pump

Manually activates the emergency bilge pump which is installed in the stern bilge below the step in the engine room. The pump moves water out through the thru-hull fitting in the hull. To start the pump, place the switch in the "ON" position.

Cabin Pump

Manually activates the cabin bilge pump which is installed in the forward bilge, below the aft berth sole in the cabin. The pump moves water out through the thru-hull fitting in the hull. To start the pump, place the switch in the "ON" position.

Note: The bilge pumps will start automatically when there is sufficient water in the bilge to activate the automatic float switch near each pump. The float switch for the emergency pump is located above the normal operating range of the aft bilge pump float switch. The automatic float switches are protected by breakers located in the engine compartment breaker panel and are always supplied current when the batteries are connected. Refer to the Drainage Systems chapter for more information on the bilge pump systems and high water alarms.

Blower

This switch supplies electrical current to the blowers that provide ventilation to the engine compartment.



GASOLINE VAPORS CAN EXPLODE. BEFORE STARTING THE ENGINES OR GENERATOR, OPERATE THE BLOWERS FOR FOUR (4) MINUTES. OPEN THE ENGINE COMPARTMENT ACCESS HATCH, INSPECT THE FUEL SYSTEM AND CHECK FOR THE ODOR OF GASOLINE VAPORS. ALWAYS OPERATE THE BLOWERS WHILE THE ENGINES ARE OPERATING BELOW CRUISE SPEED OR WHENEVER THE GENERATOR IS OPERATING. UNDER NO CIRCUMSTANCES SHOULD THIS PROCEDURE BE OVERLOOKED.

Parallel

The battery parallel switch is a momentary switch that provides additional starting power to the engine starters. When activated, both port and starboard engine batteries are momentarily used to crank the engines. When the switch is pressed and held for three seconds, a relay is engaged that connects both engine starting batteries. Once engaged, the relay remains activated for ten minutes and then automatically deactivates and the batteries are isolated.

Horn

Activates the boat horn.

Additional Accessory Switch Panels

Additional switch panels are located in various locations in the helm, cockpit and cabin. The following is a description of additional panels that may be on your Monterey and the accessories they control:

Trim Tab Switch

Located in the helm. This switch controls the trim tabs located on the transom of the boat. Please refer to the Helm Control Systems chapter for detailed information on the operation of the trim tab controls.

Stereo Control Pad

Located in the helm. Controls the stereo that is mounted in the cabin. Refer to the stereo owner's manual for details on operating the stereo control pad.

Holding Tank Macerator

The holding tank overboard discharge macerator switch panel is located in the head compartment

next to the holding tank monitor. It is a momentary switch that activates the level indicator lights and the macerator discharge system for the holding tank. Refer to the Marine Head System in the Interior Equipment chapter for additional information on the operation of the overboard macerator discharge system.

Engine Trim and Tilt Switches

Located in the helm. These switches are usually installed in the engine control handles or on the helm console. They control the trimming and tilting of the outdrives. Please refer to the Helm Control Systems chapter and the engine owner's manual for information regarding the proper use of the tilt and trim switches.

Automatic Fire Extinguisher Indicator Panel and Override Switch

The panel is equipped with lights that indicate the status of the automatic fire extinguishing system. The green light indicates the system is charged and ready. The red light indicates the system has discharged.

The system is completely automatic and will shut down the engines when it is activated. The panel is equipped with an override switch that enables the operator to restart the engines when he has determined it is safe to do so. This switch is necessary because diesel engines will consume fire extinguishing agent and must be shut down by the system when it is activated. The fire extinguishing agent will shut down gasoline engines which can be restarted once the fire extinguishing agent has dissipated from the engine compartment. Refer to the Automatic Fire Extinguishing System in the Safety Equipment chapter and the manufacturer's owner's manual for more information on the operation of the automatic fire extinguishing system.

Spot Light (Optional)

Located in the helm. Controls the spot light that is mounted on the deck. Refer to the spot light owner's manual for details on operating the control pad.

12-Volt Receptacles

Provides electrical current for portable 12-volt equipment.

DC Accessory Breaker Panels

Power is distributed to most of the 12-volt accessories through individual circuit breakers located in the DC breaker panels. There are three DC



Battery Switch Breaker Panel

breaker panels, the engine compartment breaker panel located in the engine compartment near the main battery switches, the main DC breaker panel located in the cabin on the AC/DC panel and the helm breaker panel at the helm station below the steering wheel. Main breakers located in the engine compartment breaker panel protect the system from an overload. Some 12-volt accessories are operated directly by the circuit breaker in the panel while others are operated by switches fed by the panel breakers.

A DC voltage meter is located in the cabin panel to monitor the voltage level in the House batteries. It will monitor the voltage of the batteries plus any electrical charges supplied when the engines or the battery charger are operating.

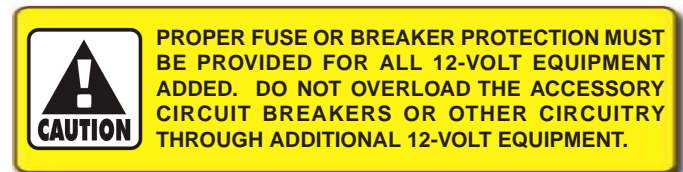

Engine Compartment Panel Breakers

The following is a description of the accessories controlled by the "push to reset" and main DC breakers in the engine compartment breaker panel located in the engine compartment near the battery switches on the forward engine compartment bulkhead.

Stereo Memory

Provides protection and power for the stereo and electronics memory. This "push to reset" breaker is always supplied current when the batteries are connected.

Amp

Provides protection and power for the stereo amplifier. This "push to reset" breaker is supplied current when the House battery selector switch is activated.

Cabin Pump

Provides protection and power for the automatic float switch on the forward bilge pump in the cabin bilge. This "push to reset" breaker is always supplied current when the batteries are connected. Another breaker in the helm breaker panel provides circuit protection for the manual switch.

Emergency Pump

Provides protection and power for the automatic float switch on the emergency bilge pump in the engine compartment bilge, below the step. This "push to reset" breaker is always supplied current when the batteries are connected. Another breaker in the helm breaker panel provides circuit protection for the manual switch.

Bilge Pump

Provides protection and power for the automatic float switch on the aft bilge pump. This "push to reset" breaker is always supplied current when the batteries are connected. Another breaker in the helm breaker panel provides circuit protection for the manual switch. This breaker also provides protection and power for the high water alarm.

Sump Pump

Provides protection and power for the automatic float switch in the shower sump pump. This "push to reset" breaker is always supplied current when the House battery switch is activated.

Carbon Monoxide Detector

Supplies 12-volt electrical current to the carbon monoxide detectors in the cabin. This is a "push to reset" breaker that is normally on, unless tripped by an overload, when the House battery switch is activated. It should be checked, and the power indicator on the carbon monoxide detectors should be lit whenever someone is occupying the cabin. If the breaker has tripped, it indicates that there is a problem with the carbon monoxide detector, the breaker, or the wiring from the breaker panel to the detector. Always determine the cause of the problem and correct it before resetting the breaker.

Accessory

Reserved for additional DC equipment.



Cabin DC Breaker Panel

Port Ignition

Provides protection and power for the computer memory for the port engine. This "push to reset" breaker is always supplied current when the batteries are connected.

Stbd Ignition

Provides protection and power for the computer memory for the starboard engine. This "push to reset" breaker is always supplied current when the batteries are connected.

Port Charge - Stbd Charge - Gen Charge

The wires that supply DC charging current to the batteries are protected by an internal fuse in the battery charger and three external "push to reset" breakers, one for each battery output wire. The external breakers protect the DC charging circuit from the batteries to the charger. The internal fuses in the charger protect the DC charging circuit from the charger to the batteries.

Helm and House Main Breakers

The primary circuits for the house DC panel, helm switch panel and the windlass are protected and powered by heavy duty circuit breakers. The breakers are supplied power whenever the House battery switch is on. These are heavy duty "push to reset" breakers that require a firm push to reset if they trip.

Windlass Main Breaker

The windlass breaker is located on the forward engine compartment bulkhead, next to the engine compartment breaker panel and main battery switches. If this heavy duty circuit breaker is tripped by an overload, a red lever will be exposed near the center of the breaker. Reset the breaker

by raising the lever until it locks in the horizontal position.

Engine Main Breakers

The primary circuits for the engines are protected by a heavy duty, "push to reset" breaker on each engine. They are supplied power whenever the engine battery switches are on. Refer to the engine owner's manual for information on the location and operation of the engine circuit breakers.

Cabin DC Breaker Panel

The cabin DC breaker panel is located on the starboard side of the cabin in a cabinet near the companionway. The following is a description of the accessories controlled by the breakers in the cabin DC breaker panel:

DC Volt Meter

Indicates the voltage available to the panel from the House Battery.

Water Gauge

Indicates the water level in the freshwater tank whenever the house battery is activated.

Main

Supplies the 12-volt current to the DC accessory breakers and protects the panel from an overload.

Cabin Lights

Supplies 12-volt electrical current to the cabin light switches.

Stereo

Supplies 12-volt electrical current to the stereo located in the cabinet above the dinette.

Water Pump

Supplies 12-volt electrical current directly to the fresh water pump pressure switch located on the pump. The pressure switch automatically controls the water pump when the system is activated and properly primed. It is protected by the circuit breaker in the panel and an automatically resetting breaker on the pump motor.

TV / DVD

Supplies 12-volt electrical current to the TV's and DVD players.

Head System

Supplies electrical current directly to the vacuum pump on the electric head system. A vacuum



Shore Power Inlets, Breakers,
TV/Phone and City Water Connection

switch on the pump automatically controls the pump and maintains proper vacuum in the system.

Macerator

Supplies electrical current to the holding tank monitor and the macerator pump.

Cabin Refrigerator

Supplies 12-volt electrical current directly to the refrigerator in the galley when AC current is not being used.

Cockpit Refrigerator

Supplies 12-volt electrical current directly to the optional cockpit refrigerator when AC current is not being used.

Acc

A "push to reset" breaker that is reserved for additional 12-volt equipment.

Head Fan

A "push to reset" breaker that supplies electrical current to the exhaust fan in the head compartment.

Blower 1

A "push to reset" breaker that supplies electrical current to the starboard bilge blower in the engine compartment.

Blower 2

A "push to reset" breaker that supplies electrical current to the port bilge blower in the engine compartment.

Generator Operation Panel

Located in the DC panel in the cabin. There are two switches. One switch activates the blowers and one switch controls the starting, running, and stopping of the optional generator.

Battery Switches

These switches remotely activate the relays that control the Starboard Engine, Port Engine and House/Generator battery switches. A red LED light in each switch glows when the battery switch it controls is on.

4.3 120-Volt System

Your boat is equipped with two 30 amp shore power cords and inlets located in the transom storage compartment, just forward of the swim platform. There is a main circuit breaker for each power cord located above the inlets and a main breaker for each circuit in the AC breaker panel located in the cabin. The AC system can be fed by either the shore power inlets or by the optional generator. It is wired totally separate from the 12-volt DC system and is equipped with an on board isolation system. If a generator is installed, selector switches in the AC panel are used to select the source of power desired. The AC main breakers must be switched to the "OFF" position before changing the selector switch.

All AC current is distributed to the AC accessories through individual circuit breakers located in the AC panel. The main breakers in the panel protect the system from an overload and the reverse polarity lights indicate any problems due to an improper shore power supply. All AC outlets in the cabin are protected by ground fault interrupts to protect against electrical shock. While moored dockside, 120-volt, 60 cycle, AC power should be utilized from dockside power, if available. A cord set is provided to supply power from the shore power outlet to the boat's 120-volt AC system.



TO REDUCE THE POSSIBILITY OF AN ELECTRICAL SHOCK, IT IS IMPORTANT THAT THE AC GROUND SYSTEM IS FUNCTIONING PROPERLY AND THAT A PROPER CONNECTION EXISTS BETWEEN THE SHORE POWER CORD, THE SHORE POWER INLET, THE BOAT BONDING SYSTEM AND THE OUTLET GROUND CIRCUITS. IF THERE IS ANY DOUBT ABOUT THE INTEGRITY OF THE GROUND CIRCUIT, A QUALIFIED MARINE ELECTRICIAN SHOULD BE CONTACTED IMMEDIATELY AND THE AC POWER SHOULD BE DISCONNECTED UNTIL THE NECESSARY REPAIRS ARE COMPLETED.

Recommended procedure for making a shore connection:

Turn the inlet and panel AC main breakers and all AC accessory breakers to the "OFF" position. If the dockside outlet includes a disconnect breaker, turn it to the "OFF" position also.

To avoid strain on the cables, make sure they have more slack than the mooring lines. Dress the cables so that they cannot be damaged by chafing between the boat and the dock. Make sure the cables do not come in contact with the water. Then connect the cables in the plug outlets, making sure the connection plug includes a three prong plug with a ground wire. Rotate the plugs clockwise to lock them in the inlets and tighten the lock rings on both the shore and the boat connector plugs.

Turn the shore disconnect and main inlet breakers to the "ON" position and check for proper polarity. If reverse polarity has been achieved, the red polarity indicators in the AC panel will light. If this should happen, make sure the AC main breakers on the panel and at the inlets are in the "OFF" position and turn the dock power breakers off. Notify a qualified electrician to check the wiring at the dock outlet. If the red polarity lights do not illuminate when power is supplied to the panel, the polarity is correct and the AC main breakers can be moved to the "ON" position.



ELECTRICAL SHOCKS FROM 120VOLT EQUIPMENT CAN CAUSE SEVERE INJURY OR DEATH. TO REDUCE THE RISK OF ELECTRICAL SHOCK IN WET WEATHER, AVOID MAKING CONTACT WITH THE SHORE CABLE OR MAKING A CONNECTION TO A LIVE SHORE OUTLET. NEVER SPRAY WATER ON ELECTRICAL CABLES WHILE WASHING DOWN DECKS.



REVERSE POLARITY WILL DAMAGE THE SYSTEM AND EXPOSE PASSENGERS TO ELECTROCUTION HAZARDS. THIS CONDITION COULD ALSO CAUSE A FIRE IN THE ELECTRICAL SYSTEM. DO NOT OPERATE THE AC ELECTRICAL SYSTEM FROM SHORE POWER WITH REVERSE POLARITY.



ELECTRIC SHOCK CAN CAUSE SEVERE INJURY OR EVEN DEATH. DO NOT ATTEMPT TO CORRECT THE WIRING YOURSELF. ALWAYS HAVE A QUALIFIED ELECTRICIAN CHECK WIRING

KEEP CHILDREN AWAY FROM ANY ELECTRICAL CABLES OR EQUIPMENT AND ALWAYS USE GROUNDED APPLIANCES ON BOARD YOUR BOAT.



UNDETECTED FAULTS IN THE AC ELECTRICAL SYSTEM COULD CAUSE THE WATER AROUND THE BOAT TO BECOME ENERGIZED. THIS COULD CAUSE A SEVERE SHOCK OR EVEN DEATH TO SOMEONE IN THE WATER NEAR THE BOAT. NEVER SWIM OR ALLOW SWIMMING AROUND THE BOAT WHEN THE AC SYSTEM IS ACTIVATED BY THE GENERATOR OR THE SHORE POWER CONNECTION.



AC Accessory Breaker Panel

Disconnecting procedure for the shore power connection:

Turn the main breakers on the AC panel and at the inlets to the "OFF" position. Turn the disconnect breakers on the dockside outlet to the "OFF" position.

Loosen the lock rings and rotate the plugs counterclockwise to disconnect the cables from the dockside outlets and replace the outlet caps. Disconnect the cables from the boat and replace the outlet caps. Store cables.

AC Accessory Breaker Panel

The AC panel is located in the mid cabin. The following is a description of the AC panel equipment and the breakers that protect the accessories:

AC MAIN # 1 and MAIN # 2 Selector Switches and Main Breakers

One shore cord supplies AC MAIN # 1 and one shore cord supplies AC MAIN # 2. Both main breakers protect the overall distribution network. These breakers are very sensitive. The resulting power surge, which occurs when connecting the dockside cords, may cause the main breakers to trip. To avoid this surge, always turn the main breakers to the "OFF" position prior to plugging or unplugging the shore power cord.

If your boat is equipped with the optional generator, these switches are used to select either shore power or the generator to supply 120-volt power to the AC breaker panel. When connected to dock-

side power, move the AC MAIN # 1 and AC MAIN # 2 selector switches to the SHORE POSITION and activate the SHORE POWER main breakers. When using the generator, move the AC MAIN # 1 and AC MAIN # 2 selector switches to the generator position and activate the GENERATOR main breakers. The main breakers must be in the "OFF" position before the selector switches can be moved to the GENERATOR or SHORE position.

Transfer Switch

A transfer switch is located on the main electrical panel in the cabin that is used to supply electrical current to AC SHORE MAIN #1 (which supplies current to the AC accessory breakers) and AC SHORE MAIN #2 (which supplies current to the breakers for the air conditioning units) from one shore power cord when only one dockside outlet is available.

You will not be able to operate all 120-volt AC accessories at one time and power management practices will need to be observed when operating on one 30 amp shore power cord and outlet. You should be aware of the load each accessory draws and make sure you don't overload the circuit. Overloading the circuit can damage accessories and cause serious damage to the AC electrical system.

The table at the end of this section will assist you in documenting the load AC accessories on your boat require and managing the electrical load on the circuit.

AC Volt Meters

Indicates the voltage supplied to the panel. There are two meters that monitor Shore Main # 1 or Shore Main # 2. You should always check the voltage for each circuit before activating the cabin AC accessories. If the meter indicates 120-volts AC, the AC accessories can be activated. If the meter indicates any voltage other than 120-volts, do not activate the AC panel breakers and contact the marina or a qualified marine electrician for assistance.

Reversed Polarity Lights

The red lights indicate reverse polarity current supplied to the panel for each circuit. This situation will cause the red light to remain lit. If reverse polarity is achieved, immediately turn off all cabin AC breakers and dockside outlet breakers. Disconnect the power cable from the dockside outlet and notify a qualified marine electrician to check the dockside wiring.

Reverse Polarity Light Test Switches

There is a momentary switch located next to the reverse polarity lights in the AC breaker panel. This switch is used to test the reverse polarity lights to ensure that they are functioning. The lights can be tested by depressing the switch whenever the AC system is activated. The reverse polarity lights should be tested each time the AC system is activated. If one or both of the lights does not activate when the switch is pressed, disconnect the shore power cable and notify a qualified electrician to check the light and the dockside wiring if necessary.

Shore 1 Breakers

Battery Charger

Supplies electrical current directly to the automatic battery charger. The battery charger charges and maintains the 12-volt batteries simultaneously when activated. It is fully automatic. See the battery charger manual for more information.

The charge to the engine batteries can be monitored by using the volt meters in the engine gauge cluster. To monitor the engine batteries, activate the charger and turn the engine battery switches on. Turn the ignition key switch for each engine to the "ON" position (**DO NOT START THE ENGINES**) and read the voltage on the volt meter for each engine. To monitor the House battery, activate the charger and turn the House battery switch on. Read the volt meter in the cabin DC breaker panel. If the batteries are in good condition and charging properly, the volt meters will

indicate between 12 and 14.5 volts. If the reading is below 12 volts, then the battery is not accepting a charge or the charger is not working properly. Always turn the ignition switches off immediately after the monitoring is complete. Refer to the battery charger manual for more information.

The wires that supply DC charging current to the batteries are protected by an internal fuse in the battery charger and 3 external breakers, one for each battery output wire, located in the engine compartment breaker panel near the battery switches. The external breakers protect the DC charging circuit from the batteries to the charger. The internal fuses in the charger protect the DC charging circuit from the charger to the batteries.

Water Heater

Supplies electrical current directly to the hot water heater circuit. A thermostat in the water heater control panel automatically controls the water temperature. Before operation, you must have water in the water heater. (See the water heater manual for details)

Cockpit Refrigerator / Ice maker (Optional)

Supplies AC electrical current directly to the optional ice maker or cockpit refrigerator when AC power is available. See the ice maker manual for more information.

Microwave

Supplies 120-volt AC electrical current to the cabin ground fault interrupter (G.F.I.) electrical outlet that activates the Microwave.

Refrigerator

Supplies 120-volt electrical current directly to the refrigerator when AC power is available and chosen over the 12-volt power supply. See the refrigerator manual for more information.

Stove

Supplies 120-volt AC electrical current to the stove in the galley.

Outlets

Supplies 120-volt AC electrical current to the cabin ground fault interrupter (G.F.I.) electrical outlets.

Note: All AC electrical outlets are provided with ground fault interrupts to protect against electric shock. These outlets should be tested periodically to ensure proper operation by pressing the test/reset buttons in the center of faceplate. G.F.I. outlets do not protect against short circuits and overloads. This is done by the outlet breakers on the AC panel.

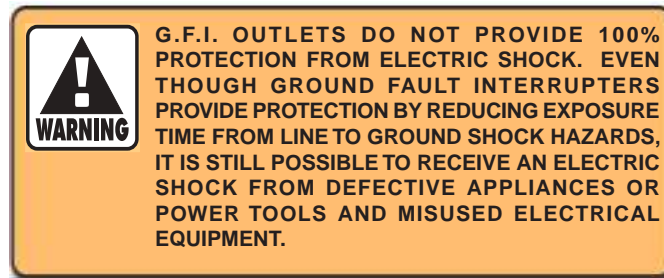

Accessory

Reserved for additional AC equipment.

Shore 2 Breakers

Air Conditioner (Optional)

The shore 2 main breaker supplies electrical current to the air conditioner control panel located in the cabin and the air conditioner raw water pump.

Note: After a certain amount of time without water flow, the air conditioning unit will automatically power down.

Additional AC Switch Panels and Breakers

Shore Power Inlet Breakers

Located in the transom storage compartment above the shore power inlet plugs. These breakers protect the AC system between the shore power inlet plugs and the main AC panel.

Inverter Switch

A special switch panel controls the inverter that supplies AC electrical current to the LCD screen for the TV. If your boat is equipped with the optional 15" screen, there will be two inverters, one for each TV screen. Inverters draw a substantial amount of current from the house batteries. It takes approximately 20 amps 12-volt DC current to provide 2 amps 120-volt AC current. Therefore, you should only use the Bat' save mode when shore or generator AC power is not available to maintain the house batteries with the battery charger while the inverter is activated.

The ON/OFF switch turns the TruePower Inverter to ON or to OFF. In the ON position, the Inverter / Fault LED light will illuminate green. The TruePower begins inverting and provides modified sine wave power. In this position the inverter will continue to supply AC power until the house batteries are depleted. The battery charger should be activated and maintaining the house battery whenever the inverter switch is in the ON position. In the OFF position the inverter draws no current from the battery.

Bat' Saver mode is the preferred setting, particularly when shore or generator AC power is not available to maintain the house Batteries. Bat' Saver mode allows the user to protect from draining down the entire power of the house batteries, and shuts the inverter off when the battery reaches a threshold of 11.7 volts allowing the other DC accessories to continue to operate normally and prevent excessive drain on the batteries. To use the Bat' Saver mode, turn the ON / OFF switch to the Bat' Saver mode.

The two indicator lights on the front panel of the inverter illustrate the operating status of the TruePower Inverter. When the inverter is on and supplying power normally the green light glows. The red "fault light" glows when there is a battery over voltage, low battery voltage, output overload or an over temperature condition in the inverter. Refer to the inverter operating manual for more information on the operation of the inverter.

4.4 Generator

The generator is activated by the house battery bank and is located in the engine compartment. The generator oil and coolant should be checked whenever you check the oil and coolant in the main engines.

There are two switches in the cabin DC panel that activate the generator. One switch activates the blowers and one switch controls the starting, running, and stopping of the optional generator. The generator can also be operated from a control panel on the generator. The circuit breakers that protect the generator AC and DC circuits are also on this panel. An owner operator's manual for the generator has been supplied with this manual. Please refer to it for details on the generator operation.

The generator engine uses a closed cooling system with a seawater-cooled heat exchanger. There is

an expansion tank for the engine coolant mounted near the generator. Make sure the fluid level in the expansion tank is kept between the maximum and minimum lines of the tank.

The seawater cooling system operates exactly like the cooling system on the main engines. It includes a strainer that prevents debris in the seawater from entering the cooling pump. The strainer is located near the generator. It is important to check and clean the strainer regularly to ensure the seawater system can circulate enough water to provide cooling for the closed cooling and exhaust systems on the generator. You should also check the exhaust port for water flow each time the generator is started. If there is no discharge within thirty seconds, shut down the generator and find and correct the problem.

Note: Generators consume DC electrical current and charge the house / generator battery just enough to compensate for the DC electrical current the engine requires to operate. Therefore, it is important to activate the battery charger to maintain the house and engine batteries whenever the generator is running.

Note: The generator may not be able to operate all 120-volt accessories at the same time. POWER MANAGEMENT PRACTICES may need to be observed depending on the AC power load.

Cleaning the Sea Strainers

- Turn off the engines and generator.
- Close the generator water intake valve.
- Open the top of the strainer and remove the screen.
- Thoroughly flush the screen and the inside of the strainer to remove foreign matter.
- Lubricate the seal.
- Reassemble the strainer making sure that all fasteners are tight.
- Open the intake valve.
- Start the generator and inspect the strainer for leaks.



Generator Control Panel, Blower Switch and Blower Circuit Breakers



Typical Diesel Generator and Onboard Control Panel with Circuit Breakers



Generator Sea Strainer

The generator fuel system is equipped with a water separating fuel filter and operates much like the fuel system for the main engines. Please refer to the Fuel System chapter for more information on generator fuel system.

You also should read the generator owner's manual for detailed information on the safe operation and maintenance of the generator.

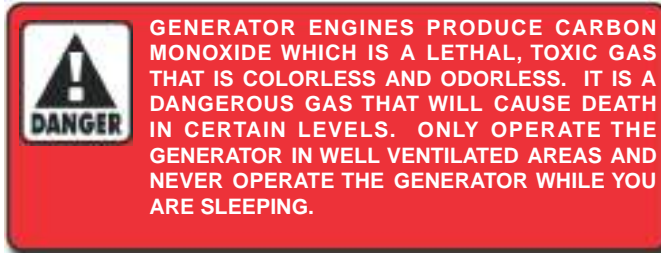

4.5 Bonding System

Your boat is equipped with a bonding system that interconnects all underwater metal hardware and thru-hull fittings to ensure that they are of the same electrical potential. Anodes are attached to the bonding system at the transom plates and outdrives. The anodes deteriorate before the other metals, thereby protecting the underwater metals from galvanic corrosion or stray electrical current. Since the zincs are sacrificial, it is important to monitor them and replace the zincs when they have deteriorated to 50 - 75% of their original size. The bonding system is connected to the DC ground and the earth ground wire for the AC electrical system. It provides a path to the safety earth ground in the event of a fault in the shore earth ground connection and when the boat is away from the dock.

4.6 Electrical System Maintenance

12-Volt AC Electrical System Maintenance

At least once a year, spray all exposed electrical components behind the helm and in the plugs, with a protector. Exterior light fixture bulbs should be removed and the metal contact areas coated with a non-water soluble lubricant like Teflon or silicone grease. The sockets should be sprayed with a protector. Care must be taken not to get any oil or grease on the glass portion of the bulbs as this will cause the bulb to overheat and burn out.



WHEN REPLACING LIGHT BULBS IN MARINE LIGHT FIXTURES, ALWAYS USE A BULB WITH THE SAME RATING AS THE ORIGINAL. USING A DIFFERENT BULB COULD CAUSE THE FIXTURE TO OVERHEAT AND MELT OR SHORT CIRCUIT.

Inspect all wiring for proper support, sound insulation, and tight terminals, paying particular attention to portable appliance cords and plugs.

Check all below deck wiring to be sure it is properly supported, that the insulation is sound, and that there are no loose or corroded terminals. Corroded terminals should be thoroughly cleaned with sandpaper or replaced, tightened securely and sprayed with a metal and electrical protector. Inspect all engine wiring.

Check the electrolyte level in the batteries regularly and add distilled water as necessary. If the batteries are frequently charged by the automatic battery charger, the electrolyte level will have to be checked more often. The correct fluid level in the cells is usually approximately 1/4 to 1/2 inch above the plates. If fluid is needed, fill to the proper level with distilled water. **Do not over fill!**

Note: Some batteries are sealed and do not require or allow the inspection of the electrolyte.

Keep the battery tops clean and dry. Dirt and water can conduct electricity from one post to the other causing the battery to discharge.

The battery posts should be kept free of corrosion. Remove the cables and clean the posts and cable clamps with a battery post cleaner or sandpaper as required. Coating the battery posts and cable clamps with Teflon or silicone grease will protect them and reduce corrosion.

Battery cables, both hot and ground, must be replaced when they show signs of corrosion or fraying. Deteriorated cables cause a considerable voltage loss when high currents are drawn, such as starting the engine.



A BATTERY CAN EXPLODE IF A FLAME OR SPARK IGNITES THE HYDROGEN GAS THE BATTERY EMITS WHILE BEING CHARGED. NEVER USE AN OPEN FLAME IN THE BATTERY STORAGE AREA. AVOID STRIKING SPARKS NEAR THE BATTERY.

AC Electrical System Maintenance

Periodically inspect all wiring for nicks, chafing, brittleness, improper support, etc. Examine each shore power cord closely for cracks in the insulation and corrosion in electrical connectors. Spraying receptacles and electrical connections with an electrical contact cleaner or a metal and electrical protector will reduce corrosion and improve electrical continuity.

Inspect all wiring for proper support, sound insulation, and tight terminals, paying particular attention to portable appliance cords and plugs.

The entire AC circuitry, especially the shore power cords, should be seasonally tested for proper continuity by an experienced electrician. This will detect any shorts, open wires, or ground faults. Ground fault interrupts should be tested periodically to ensure proper operation by pressing the test/reset buttons in the center of face plate. The polarity indicator system also should be inspected for proper operation.

Generator Maintenance

The engine maintenance required on the generator is similar in many ways to the main engines. The most important factors to the generator's longevity are proper ventilation and maintenance of the fuel system, ignition system, cooling system, lubrication system and the AC alternator.

Maintenance schedules and procedures are outlined in your generator owner's manual. They should be followed exactly.



CORROSION ALLOWED TO BUILD ON THE ELECTRICAL CONNECTORS CAN CAUSE A POOR CONNECTION RESULTING IN SHORTS, GROUND FAULTS OR POOR GROUND CONNECTIONS. ELECTRICAL CONNECTORS SHOULD BE CHECKED AT LEAST ANNUALLY AND CLEANED AS REQUIRED. DO NOT ALLOW CORROSION TO BUILD ON CONNECTIONS.

ELECTRIC SHOCK CAN CAUSE SEVERE INJURY OR EVEN DEATH. THE AC AND DC ELECTRICAL SYSTEMS ALWAYS SHOULD BE DISCONNECTED FROM THE POWER SOURCE BEFORE INSPECTING OR SERVICING THE SYSTEM. NEVER SERVICE ANY COMPONENT OF AN ELECTRICAL SYSTEM WHILE IT IS ENERGIZED.

4.7 AC Line Load Estimator

Depending on the AC power load your boat requires and the power available from the shore supply or the generator, you may not be able to operate all 120-volt AC accessories at one time. POWER MANAGEMENT PRACTICES may need to be observed particularly when only one 30 amp shore supply outlet is available or when supplying power from the optional generator. You should be aware of the load each accessory draws and make sure you don't overload the circuit.

The table in this section will assist you in documenting the load AC accessories on your boat

require and managing the electrical load on each circuit. An owner's manual for each AC accessory installed on your boat at the factory has been included with your boat. Additionally, you should make sure you have the manuals for accessories installed by your dealer or that you bring aboard. The specification section of the owner's manual will provide the wattage or amperage the accessory requires. Enter the load requirements in the table provided and use the information as a quick reference tool to calculate the electrical load. If only watts are given in the specifications, divide the watts by the voltage to determine the amps.

Appliances	Start-up Watts/Amps	Running Watts/Amps	Line 1 Amps	Line 2 Amps
Air Conditioner – 1				
Air Conditioner – 2				
Battery Charger				
Blender				
Cockpit Grill				
Coffee Maker				
Computer				
Crock Pot				
Curling Iron				
Electric Blanket				
Fan				
Freezer Plate				
Fry Pan				
Hair Dryer				
Ice Maker				
Iron				
Microwave				
Refrigerator				
Refrigerator - Wet Bar				
Space Heater				
Stove – Per Element				
Television - 1				
Television - 2				
Television - 3				
Toaster				
VCR/CD				
Water Heater				
		Line Totals		

THIS PAGE WAS LEFT BLANK
INTENTIONALLY

FRESH WATER SYSTEM

5.1 General

The fresh water system consists of a potable water tank, distribution lines and a distribution pump. The pump is equipped with an automatic pressure switch and is located on the water heater in the engine compartment. The water tank is located in the bilge below the aft berth in the cabin. The tank is filled through a labeled deck plate located in the cockpit step next to the wet bar. Shut off valves in the cold and hot water lines near the water heater enable the operator to turn the water off in the hot or cold lines if necessary.



DO NOT FILL SYSTEM WITH ANYTHING OTHER THAN WATER. SHOULD THE SYSTEM BECOME CONTAMINATED WITH FUEL OR OTHER TOXIC FLUIDS, COMPONENT REPLACEMENT MAY BE NECESSARY.



WATER AND WASTE PUMPS ARE NOT DESIGNED TO PUMP FUEL AND A FIRE OR EXPLOSION COULD RESULT. DO NOT CONFUSE FUEL FILL DECK PLATES WITH THE WATER OR WASTE FILL DECK PLATES. THESE PLATES ALSO ARE LABELED ACCORDINGLY. IF GASOLINE OR DIESEL FUEL IS ACCIDENTALLY PUMPED INTO THE WATER OR WASTE TANK, DO NOT ATTEMPT TO PUMP IT OUT YOURSELF. CONTACT YOUR DEALER OR THE MONTEREY BOATS CUSTOMER SERVICE DEPARTMENT FOR ASSISTANCE IN HAVING THE FUEL PROFESSIONALLY REMOVED AND COMPONENTS OF THE FRESH WATER SYSTEM REPLACED AS NECESSARY.



Fresh Water Fill



Fresh Water Pump, Water Heater and Waste System Vacuum Pump

5.2 Fresh Water System Operation

Fill the water supply tank slowly through the labeled deck plate. After filling the water tank, partially open all faucets. The Water Pump breaker on the cabin DC panel should be on. Allow the pump to run until all of the air is purged from the system and a steady stream of water is flowing from each outlet. Next, turn off the faucets one by one. As the pressure builds, the pump will automatically shut off.

When properly primed and activated the water system will operate much like the water system in a home. An automatic pressure sensor keeps the system pressurized. If the system has been re-

cently filled or has not been used for an extended period, air bubbles may accumulate at the pump and the system may have to be reprimed.

Whenever the boat is left unattended, the Water Pump breaker should be placed in the "OFF" position.



DO NOT ALLOW THE FRESH WATER PUMP TO RUN DRY. THE FRESH WATER PUMP WORKS ON DEMAND AND WILL NOT SHUT OFF AUTOMATICALLY WHEN THE TANK IS EMPTY. THIS CAN RESULT IN DAMAGE TO THE PUMP. ALWAYS TURN THE WATER PUMP BREAKER OFF WHEN THE FRESH WATER SYSTEM IS NOT IN USE.

5.3 Water Heater

The water heater is located in the engine compartment. It has a 120-volt element that is thermostatically controlled at the heater and activated by a circuit breaker located in the 120-volt panel. The water heater is also equipped with a heat exchanger that is plumbed to the water cooling system on one of the engines. The heat exchanger will heat the water in the hot water tank whenever that engine is operating.

Plumbing the heat exchanger to an engine is standard on Monterey boats. For highest efficiency, the engine heat exchanger is of the single wall type. The fresh water supply could become contaminated with engine coolant if the heat exchanger in the water heater fails and the engine is equipped with the optional fresh water cooling system.



Shore Water Connection

WARNING MOST ENGINE COOLANT IS TOXIC AND CAN CAUSE SERIOUS INJURY OR DEATH IF IT CONTAMINATES THE FRESH WATER SUPPLY AND SOMEONE DRINKS THE WATER. NEVER DRINK THE WATER FROM THE FRESH WATER SYSTEM FAUCETS WHEN THE ENGINE HEAT EXCHANGER IS ACTIVATED IN THE WATER HEATER.

A high pressure relief valve protects the system from excessive pressure. Always make sure all air is purged from the water heater and lines before activating the water heater breaker. Refer to the water heater owner's manual for additional information.

CAUTION DO NOT SUPPLY CURRENT TO AN EMPTY WATER HEATER. DAMAGE TO THE HEATER WILL RESULT. THE SYSTEM MUST BE FILLED AND PRIMED BEFORE USING THE WATER HEATER.

The second provides protection for the pressure pump when the shore water is connected.

To use shore water, connect a hose from the shore water faucet to the shore water fitting located in the transom storage compartment. Next, turn on the shore water. The pressure pump will not run and the water in the boat's water tank will not be used.

Note: The water tank will not be filled by connecting to shore water.

5.4 Shore Water Connection

The shore water connection allows the direct connection of the water system to a shore side water supply. This provides the system with a constant supply of fresh water and minimizes the pressure pump operation. A female inlet fitting is mounted in the stern equipment locker near the AC inlet plugs. A pressure reducer is installed in the system along with two check valves. One check valve keeps water from running out of the shore water inlet fitting when the pressure pump operates.

CAUTION DO NOT MODIFY OR CHANGE THE SHORE WATER INLET CONNECTOR WITH ANOTHER TYPE WITHOUT CONSULTING MONTEREY BOATS CUSTOMER SERVICE OR YOUR DEALER. THE USE OF THE WRONG TYPE OF INLET CONNECTOR CAN DAMAGE THE FRESH WATER SYSTEM.

CAUTION A SHORE WATER CONNECTION PROVIDES AN UNLIMITED SUPPLY OF WATER THAT COULD SINK THE BOAT. YOU SHOULD MONITOR THE SYSTEM FOR LEAKS WHEN IT IS CONNECTED AND ALWAYS TURN THE SHORE WATER SUPPLY VALVE OFF WHEN LEAVING THE BOAT UNATTENDED.

5.5 Shower Operation

There is a shower located in the head compartment and at the transom on the port side, near the transom door. Each shower has hot and cold water and a retractable shower head with an on/off valve.

Make sure the Water Pump breaker in the DC breaker panel is on, then turn the water on. Adjust the hot and cold water faucet until the desired temperature is obtained. Some minor variations in the water temperature may occur as the pressure pump cycles. To conserve water, use the valve on the shower head to turn the water on and off as you shower.

Shower water is drained from the head compartment by a sump pump system located below the aft berth in the cabin. An automatic float switch in the shower sump controls the pump. The pump is activated and protected by the shower sump pump circuit breaker in the engine compartment breaker panel. After showering, let the cold water flow for a period of time to flush the drainage system of soap residue. It is essential that the shower drain strainer is cleaned regularly and the sump is inspected periodically for accumulated debris that needs to be removed.

5.6 Fresh Water System Maintenance

Information and owner's manuals supplied with water system components is included with this manual. Refer to this information for additional operation and service data.

The following items should be done routinely to maintain your fresh water system:

- Periodically remove and clean the water strainer located near the intake side of the fresh water pump.
- Remove the filter screens from the faucet spouts and eliminate any accumulation of debris. A build up of debris can cause the pump to cycle excessively.
- Periodically remove the lid on the shower sump assembly located below the aft berth in the cabin. Clean debris from the sump and flush with clean water.



Head Compartment Shower



Transom Shower at Port Side of Swim Platform



Fresh Water Pump and Strainer

- Periodically spray the pumps and metal components with a metal protector.
- The batteries must be properly maintained and charged. Operating the pressure pump from a battery with a low charge could lead to pump failure.
- Add a commercially available potable water conditioner to the water tank to keep it fresh.
- Fill the water tank half full with freshwater, then pour the mixture into the water tank and top off the tank.
- Activate the system and allow the water to run for about one minute at each faucet. Let the treated water stand for 4-6 hours.
- Drain the system by pumping it dry and flush with several tank fulls of freshwater.
- The system should now be sanitized and can be filled with freshwater. If the chlorine smell is still strong, it should be flushed several more times with freshwater.

Note: The freshwater system must be properly winterized prior to winter lay-up. Refer to the section on winterizing for more information.

Sanitizing the Fresh Water Tank

The freshwater system should be sanitized if it has not been used for a long period or you are unsure of the quality of the water in the system.

The following steps can be used to sanitize the system:

- Activate the system, open all hot and cold faucets and pump out as much water as you can.
- Make a chlorine solution by mixing two ounces of household chlorine bleach in a gallon of water. This mixture will treat approximately fifteen gallons. If the water tank on your boat is larger or smaller than 15 gallons, then adjust the mixture accordingly. Always mix the chlorine with water in a separate container first and never add straight chlorine to the fresh water tank.

Note: The quality of the water in marine freshwater systems can be questionable. We recommend that you avoid using the water from the freshwater system for drinking and cooking. You should only use bottled water for these purposes.

RAW WATER SYSTEM

6.1 General

In the raw or sea water systems, all water pumps are supplied by hoses connected to ball valves and thru-hull fittings located in the in the bilge. Always make sure the ball valves are open before attempting to operate any component of the raw water system.

The air conditioner uses a 120-volt AC sea water supply pump. This is the only 120-volt AC pump in the system and it is automatically activated when the air conditioning or heating system is in use.

Priming the System

The intake for the air conditioner sea water pump is equipped with a scoop and ball valve. If the pump runs but will not prime after cleaning the strainer or at the time of launching, make sure the valve is open. If the pump still won't prime, it may be air locked. Make sure the valve is open and run the boat at or above 15 M.P.H. The water pressure from the scoop will force the trapped air through the pump and allow it to prime. If this procedure doesn't work, contact your Monterey or Marine Air dealer.

Closing the thru-hull ball valves before the boat is hauled from the water will help to eliminate air locks in raw water systems.

Note: It may be necessary to reprime the raw water system if the system is not used for an extended period and at the time of launching.

6.2 Air Conditioning (Optional)

The air conditioner is self-contained and sea water cooled. An AC centrifugal raw water pump supplies sea water that cools the condensing unit as it circulates through the system and is discharged overboard. The pump is located in the stern bilge below the step in the engine compartment. It is activated whenever AC current is available and the air conditioning system is operating.

Sea water is supplied to the pump from a thru hull fitting located in the hull near the pump. A sea strainer between the pump and thru hull fit-



Air Conditioning Pump



Air Conditioner Sea Strainer

ting protects the system from contaminants that could damage the pump or the air conditioning system. Make sure the sea water pump receives adequate sea water by periodically cleaning the sea strainer basket.

Cleaning the Sea Strainer

- Turn the air conditioner off at the control panel. Then turn the air conditioning breaker in the AC panel off.
- Close the water intake valve.
- Open the top of the strainer and remove the screen.

- Thoroughly flush the screen and the inside of the strainer to remove foreign matter.
- Lubricate the seal.
- Reassemble the strainer making sure that all fasteners are tight.
- Open the intake valve.
- Activate the air conditioner and inspect the strainer for leaks.
- If the system will not prime, follow the procedure for priming the system in this chapter.

You should refer to the air conditioner owner's manual for more information on the operation and maintenance of the air conditioner.

6.3 Raw Water System Maintenance

The following items should be done routinely to help maintain your raw water system:

- Check hoses, particularly the sea water supply lines, for signs of deterioration.
- Remove and clean the sea water strainer for the air conditioner as required.
- Spray pumps and thru-hull valves with a protective oil periodically.
- Operate all thru-hull valves at least once a month to keep them operating properly.

 **SHOULD A HOSE RUPTURE, TURN THE PUMP OFF IMMEDIATELY. ALWAYS CLOSE THE THRU-HULL VALVE WHEN PERFORMING MAINTENANCE ON A SEA WATER PUMP.**

THE RAW WATER SYSTEM MUST BE PROPERLY WINTERIZED PRIOR TO WINTER LAY-UP. SEE SECTION ON WINTERIZING.



Air Conditioner Sea Strainer Screen



Air Conditioner Sea Strainer



Air Conditioner Sea cock

DRAINAGE SYSTEMS

7.1 General

Most water is drained by gravity to overboard thru-hull fittings located in the hull sides above the waterline. You should check the drain system frequently to ensure it is free flowing and that the hoses on the thru-hull fittings are secure and not leaking.

7.2 Bilge Drainage

There are three bilge pumps, (forward, emergency, and aft) that are activated automatically by float switches located next to the pumps. The bilge pumps are activated both manually by switches in the helm station and automatically by float switches located next to the pumps. The automatic float switches are connected to the house battery. They are protected by "push to reset" circuit breakers in the engine compartment breaker panel and remain activated when the battery switches are in the "OFF" position and the batteries are connected. The manual switches are supplied current when the house battery switch is activated. They are protected by a breaker in the helm switch breaker panel.

All bilge pumps pump water out of thru-hulls located above the waterline in the starboard side of the hull. The aft bilge pump and automatic switch are located near the transom, between the engines, the emergency bilge pump and automatic switch are below the step in the engine compartment and the forward pump and automatic switch are located in the bilge below aft berth sole in the cabin.

The manual bilge pump switches should be activated briefly each time the boat is used. This will ensure that the pumps are operating properly and increase the service life of the pumps. The automatic switches should be manually activated periodically, by turning the test knob on the side of the switch, to verify operation. This is particularly important before operating the boat offshore.

The automatic float switch for emergency bilge pump is mounted above the normal operating range of the aft bilge pump automatic float switch. It activates an alarm if the bilge water level rises



Typical Bilge Pump and Automatic Float Switch



Automatic Float Switch for High Water Alarm and Emergency Bilge Pump Located Below the Engine Compartment Step.

above the normal operating range of the bilge pump automatic switches. The alarm switch is connected to the house battery and is protected by the emergency pump "push to reset" breaker located in the engine compartment breaker panel. It remains activated when the battery switches are in the "OFF" position and the batteries are connected.

When the boat is out of the water, the bilge can be drained by a thru-hull drain located in the hull near the transom. The plug should be removed whenever the boat is hauled out of the water and installed just prior to launching. It is important to check the drain plug regularly to make sure it is tight.



A LOOSE DRAIN PLUG WILL ALLOW SEAWATER TO ENTER THE BILGE AND COULD CAUSE THE BOAT TO SINK. IT IS VERY IMPORTANT TO CHECK THE DRAIN PLUG FREQUENTLY TO ENSURE IT IS PROPERLY TIGHTENED.

Note: See **Electrical Systems** for additional information on bilge pump operation.

Note: Any oil spilled in the bilge must be thoroughly removed and properly disposed of before operating the bilge pump. The discharge of oil from the bilge is illegal and subject to a fine.



THE FEDERAL WATER POLLUTION CONTROL ACT PROHIBITS THE DISCHARGE OF OIL OR OILY WASTE INTO OR UPON THE NAVIGABLE WATERS OF THE UNITED STATES OR THE WATERS OF THE CONTIGUOUS ZONE IF SUCH DISCHARGE CAUSES A FILM OR SHEEN UPON, OR A DISCOLORATION OF THE SURFACE OF THE WATER, OR CAUSES A SLUDGE OR EMULSION BENEATH THE SURFACE OF THE WATER. VIOLATORS ARE SUBJECT TO A PENALTY OF \$10,000.

7.3 Cockpit and Deck Drains

Cockpit and Engine Compartment

Water is drained from the cockpit through the transom door opening and the drain system for the engine compartment hatch. The engine compartment hatch is equipped with a gutter that drains the water to thru-hull fittings in the hull side. A flap built into the thru-hull fitting on side of the hull reduces the surge of sea water through the scupper and into the cockpit.

Water is channeled away from the engine compartment day hatch by a gutter system. The water then drains to the thru-hull fittings and then overboard.



Engine Compartment Hatch, Day Hatch and Cockpit Drain System

Wet Bar Sink Drains

The sink and optional ice maker are drained by gravity to a thru-hull fitting in the hull side. These drains should be flushed out periodically to keep them clean and free flowing.

Bridge Deck and Cockpit Storage Compartments

The storage boxes, located below the cockpit lounge seats, are drained by gravity to the cockpit deck. Water drains from the bridge deck to the stern cockpit and then overboard through the engine compartment hatch drain system.

Rope Locker Drains

The rope locker drains overboard through a fitting in the starboard hull side. It is important to inspect the drain frequently to remove any accumulated debris.

7.4 Cabin Drains

The galley sink, head sink, and refrigerator are drained by gravity to thru-hull fittings in the starboard hull side.

The shower and air conditioner condensation pan are drained by a sump pump system. An automatic float switch in the sump controls the pump. The sump pump is protected by the shower sump circuit breaker in the engine compartment breaker panel. The sump system is activated whenever the batteries are connected to ensure the shower and air conditioner will drain properly whenever they are used. After showering, let the cold water flow for a period of time to flush the drainage system of soap residue.

The sump system is located below the aft berth in the cabin and accessed by removing the mattress and opening the access hatch. The sump has a removable lid to allow the system to be inspected and serviced. It is essential that the sump system be inspected periodically and any accumulated debris removed. Manually activate the system to verify operation.

Optional Grey Water System

If your boat is equipped with this option, all sink drains and the head shower are drained by the shower sump system which pumps the waste water to the waste/grey water holding tank. The air conditioner condensation pan is connected to a separate sump pump system that pumps the accumulated condensation overboard thru a fitting in the hull side. Both sump systems are controlled by an automatic float switch in the sump and are protected by individual circuit breakers in the battery switch panel. They are activated whenever the house battery switch is on and are located in the bilge below the aft cabin sole.

The fluid level in the waste/grey water holding tank is monitored by the "Tank Watch Monitor" in the head compartment. When the holding tank is full, it must be pumped out by an approved waste dumping station. You should monitor the waste level carefully and not allow the tank to become full. The toilet will not flush when the tank is full and an overfilled holding tank will force waste into the vent filter. This will clog the filter, prevent the sinks from draining and could cause damage to the holding tank. It will also cause unpleasant odors in the cabin.

Note: The overboard macerator discharge pump option for the waste holding tank is not available with the grey water system.

7.5 Drainage System Maintenance

It is essential that the following items be done periodically to maintain proper drainage of your boat:

- Clean the cockpit and bridge deck drain rails with a hose to remove debris that can block water drainage.
- Clean the bilge pump strainers of debris and check the bilge for foreign material that can cause the automatic switches to malfunction.
- Frequently test the automatic bilge pump switches for proper operation. This is accomplished by turning the knob on the float switch until the pump is activated. You can also use a garden hose to raise the water level in the bilge until it is high enough to activate the pump.
- Flush all gravity drains with fresh water to keep them clean and free flowing.
- Flush the drain in the air conditioning condensation pan with fresh water periodically to remove mold and debris that can accumulate and block drainage to the sump system.
- Clean and inspect the shower and air conditioning drain sump system. Remove accumulated debris and flush with fresh water. Frequently test the automatic pump switch for proper operation.

Note: All drains and pumps must be properly winterized before winter lay-up.

Note: Never use harsh chemical drain cleaners in marine drain systems. Permanent damage to the hoses and fittings may result.

THIS PAGE WAS LEFT BLANK
INTENTIONALLY

VENTILATION SYSTEM

8.1 Cabin Ventilation

Ventilation to the cabin area is provided by three deck hatches. Additionally, there is a 12-volt exhaust blower in the head compartment that provides forced ventilation to that area whenever the blower is activated by the switch on the head compartment wall.

Deck Hatches

The deck hatches are supported in the open position by one or two adjustable hatch adjusters. They are secured in the closed position by one or two cam levers on the inside of the hatch. There is a sliding lock on each cam lever to prevent them from opening accidentally.

To open a hatch, release the lock and rotate the cam lever to the open position. Raise the hatch and secure it by tightening the cylinder on the hatch adjuster. To close the hatch, loosen the hatch adjuster and lower the hatch. Secure in the closed position with the cam levers and slide locks.

The cam levers can secure the hatch in two positions, the vent position or fully closed. The hatch is secured in the vent position by opening hatch slightly until the cam levers align with the notch in the hatch frame just above the fully closed, watertight position. With the cam levers secured in this position, the hatch will be open just enough to let air circulate into the cabin. Always secure the hatch in the water tight position when leaving the boat unattended or when running offshore.

When the hatch is open, a removable screen can be installed in the hatch trim ring to prevent insects from entering the cabin. The screen is secured in place by spring tension built into the screen. The screen must be removed to access the cam levers to open or close the hatch.

Port Windows

Opening port windows are located in V-berth, head compartment and main salon. Each window opens to provide ventilation into the cabin area and is equipped with a removable screen.

The windows are secured by adjustable cam le-



V-Berth Deck Hatch



Galley Hatch Fully Closed Screen Installed



Galley Deck Hatch Secured in Vent Position



Port Window

vers. The cam levers should be adjusted so they are tight enough to seal the windows in the closed position, but not so tight that the window becomes difficult to secure.

Always make sure the windows are closed and secured with the cam levers whenever the boat is underway. Sea spray could enter the cabin through an open window and damage upholstery, woodwork and cabin equipment.

8.2 Carbon Monoxide and Proper Ventilation



FAILURE TO PROPERLY VENTILATE THE BOAT WHILE THE ENGINES ARE RUNNING MAY PERMIT CARBON MONOXIDE TO ACCUMULATE WITHIN THE CABIN AND OPEN AREAS OF YOUR BOAT. CARBON MONOXIDE IS A COLORLESS AND ODORLESS GAS THAT IS LETHAL WHEN INHALED. CARE MUST BE TAKEN TO PROPERLY VENTILATE THE BOAT AND TO AVOID CARBON MONOXIDE FROM ACCUMULATING IN THE BOAT WHENEVER AN ENGINE IS RUNNING.

A by-product of combustion, carbon monoxide (CO) is invisible, tasteless, odorless, and is produced by all engines and gas heating and cooking appliances. The most common sources of CO on boats are gasoline engines, auxiliary generators and propane or butane stoves. These produce large amounts of CO and should never be operated while sleeping. The hazard also may be created by a boat nearby whose exhaust fumes are entering your boat. Boats also have a problem due to the "station wagon effect" where engine exhaust fumes are captured in the vacuum or low pressure area, usually the cockpit, bridge deck and cabin, that can be created by the forward speed of the boat.

Boats underway should close all aft facing hatches and doors. The forward facing deck hatches should be open whenever possible to help pressurize the living spaces of the boat. No sleeping in the cabin should be permitted while underway. Proper ventilation should be maintained on the bridge deck by opening windshield or forward clear connector vents, as far as possible to help pressurize the cockpit area. The canvas drop or aft curtain must be removed and the side curtains should be opened or removed to increase air flow and maintain proper ventilation whenever the engines are running. **Under no circumstances**

should the engines be operating with side curtains closed and the aft or drop curtain installed.

Extreme caution must be taken while at anchor or in a slip when an auxiliary power generator is operating. Wind still nights can easily allow exhaust fumes, containing high concentrations of CO, from the generator on your boat or from an adjacent boat's generator to enter the boat. The exhaust fumes may enter your boat through open hatches or windows.

A carbon monoxide detector has been installed in your cabin as standard equipment. While a CO detector enhances your protection from CO poisoning, it does not guarantee it will not occur. Do not use the carbon monoxide detector as a replacement for ordinary precautions or periodic inspections of equipment. Never rely on alarm systems to save your life, common sense is still prudent and necessary. Remember, the operator of the boat carries the ultimate responsibility to make sure the boat is properly ventilated and the passengers are not exposed to dangerous levels of carbon monoxide. You should always be alert to the symptoms and early warning signs of carbon monoxide poisoning. You also should read the "Carbon Monoxide Monitoring System" in the Safety Equipment chapter of this manual, and

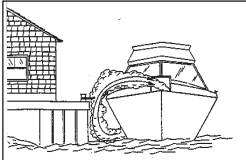
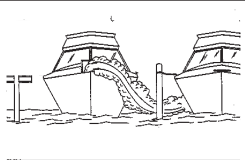
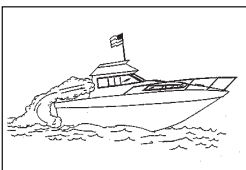
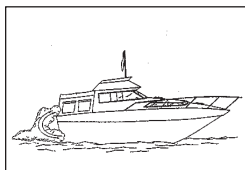
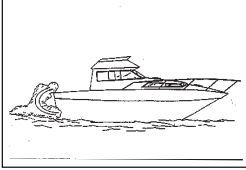
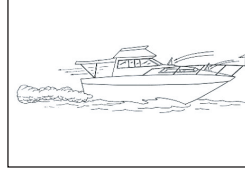
	
<p>Onboard Generator Exhaust - exhaust accumulates because of bulkhead.</p>	<p>Nearby Generator Exhaust - wind carries exhaust to the other boat</p>
	
<p>Back Drafting / Station Wagon Effect - at cruising speed with no forward ventilation</p>	<p>Back Drafting / Station Wagon Effect - at cruising speed with canvas closed</p>
	
<p>Slow Speed or Boat Stopped w/ engines running - CO can accumulate in cabin, cockpit & bridge</p>	<p>Desired Air Flow Through the Boat</p>

the owner's manual supplied by the CO detector manufacturer for operation instructions and additional information regarding the hazards and symptoms of carbon monoxide poisoning.



ACTIVATION OF THE CARBON MONOXIDE DETECTOR INDICATES THE PRESENCE OF CARBON MONOXIDE (CO) WHICH CAN BE FATAL. EVACUATE THE CABIN IMMEDIATELY. DO A HEAD COUNT TO CHECK THAT ALL PERSONS ARE ACCOUNTED FOR. DO NOT REENTER THE CABIN UNTIL IT HAS BEEN AIRED OUT AND THE PROBLEM FOUND AND CORRECTED.



PERIODICALLY TEST THE CARBON MONOXIDE ALARMS PER THE MANUFACTURER'S INSTRUCTIONS. PLEASE REFER TO THE CARBON MONOXIDE ALARM MANUAL OR CONTACT THE MANUFACTURER FOR MORE INFORMATION ON MAINTAINING AND CALIBRATING THE ALARM.



Engine Compartment Vents

8.3 Engine Compartment Ventilation

All Monterey inboard boats are equipped with an engine compartment ventilation system consisting of intake ducts and exhaust blowers. The ventilation system is designed to meet or exceed the requirements of the United States Coast Guard in effect at the time of manufacture and remove fuel vapors and excess heat from the engine room.

Free Air System

A flow of air into the engine compartment is provided by two vents located on either side of the deck. Exhaust ventilation designed into the vents provides a flow of air out of the engine compartment. The exhaust area of the vents have ducts that reach to the lower part of the engine compartment. This provides adequate air movement while operating at or near cruise speeds.

The vents are designed with special baffles that prevent sea water or spray from entering the engine compartment while providing adequate air movement for the engines.

Forced Ventilation

Electric blowers provide ventilation to the engine compartment prior to start up of the main engines or optional generator and while operating below cruise speed or running the generator. The blowers are activated by a switch at the helm or in the generator control panel. The blowers are located in the vent hoses on the port side of the engine

compartment. When activated, the blowers will remove bilge fumes through the bilge exhaust vents. Refer to the Electrical Systems chapter for more information on blower operation.

Inspect the blowers frequently to make sure they are operating properly. Always replace worn or defective components with new components of the same type. Refer to the Electrical Systems chapter for more information on blower operation.



GASOLINE VAPORS CAN EXPLODE. BEFORE STARTING THE ENGINES OR GENERATOR, OPERATE THE ENGINE COMPARTMENT BLOWER FOR FOUR (4) MINUTES, OPEN THE ENGINE ACCESS HATCH, INSPECT THE FUEL SYSTEM, AND CHECK THE ENGINES FOR THE ODOR OF GASOLINE VAPORS. ALWAYS OPERATE THE BLOWER WHILE THE ENGINES ARE AT IDLE OR WHEN OPERATING THE GENERATOR. UNDER NO CIRCUMSTANCES SHOULD THIS PROCEDURE BE OVERLOOKED.



ALWAYS RUN THE EXHAUST BLOWERS WHEN OPERATING THE BOAT BELOW CRUISE SPEEDS OR WHEN THE GENERATOR IS RUNNING TO ENSURE ADEQUATE VENTILATION AND COOLING OF THE ENGINE COMPARTMENT.



DO NOT OBSTRUCT OR MODIFY THE VENTILATION SYSTEM.

8.4 Maintenance

- Periodically lubricate all hinges and latch assemblies with a light oil.
- Periodically clean and coat gasket materials with silicone to help keep them pliable.
- The opening cabin deck hatches and the cabin door are made of acrylic plastic glass. Acrylic glass scratches easily. Never use a dry cloth or glass cleaning solutions on acrylic glass. Use a soft cloth and mild soap and water for routine cleaning. Solvents and products containing ammonia can permanently damage acrylic glass. Please refer to the Routine Maintenance chapter for more information on the proper maintenance for acrylic plastic glass.
- Periodic inspection and cleaning of the engine compartment ventilation ducts is necessary to ensure adequate air circulation. A buildup of leaves, twigs, or other debris can severely reduce ventilation. It also is important to be sure that the drains in the vent baffles are open to prevent excessive sea water from accumulating in the vents and overflowing into the engine compartment.
- The bilge blowers are permanently lubricated and require no maintenance. Blower operation can and should be tested by placing a hand over the exhaust vents. Do not rely on the sound of the blowers. A substantial amount of air should be exhausted by the blower. Frequently check the intake vents for obstructions, preferably before each cruise.

Note: Should blower noise become excessive, the source of the noise should be found and corrected before operating the boat.

EXTERIOR EQUIPMENT

9.1 Deck

Rails and Deck Hardware

The rail system and hardware fittings have been selected and installed to perform specific functions. Bow and hand rails are installed to provide a hand hold in certain areas of the boat. You should make sure you keep at least one hand on the hand holds as you move about the boat.

Your boat could be equipped with optional cleats that are retractable and flush with the deck when not in use. To use the cleats, pull up on the center of the cleat until it locks in the mooring position. Mooring lines should be secured to the cleats and not to rails or stanchions. Be sure a clear lead exists when running dock lines or anchor lines. A line inadvertently run around a stanchion or over the rail could cause damage.

Note: All fittings must be inspected periodically for loose fit or wear and damage. Any problems should be corrected immediately.



MONTEREY BOATS ARE NOT EQUIPPED WITH HARDWARE DESIGNED FOR TOWING PURPOSES. THE MOORING CLEATS ARE NOT TO BE USED FOR TOWING ANOTHER VESSEL OR HAVING THIS BOAT TOWED.



Roller Assembly, Spot Light and Bow Rail



Anchor Locker Hatch, Retractable Cleats, Spot Light, Windlass and Windlass Deck Switches

Stainless Steel Bow Roller

The bow roller assembly is mounted to the deck at the bow and allows the anchor to be operated and stored at the roller. A stainless plate on the hull below the roller helps to prevent damage from the anchor banging the hull as it is hauled into the roller assembly.

The roller is designed for a Danforth Style or Delta plow anchor. The anchor line is stored in the rope locker and routed out the rope locker hatch, through the roller and connected to the anchor chain. A cleat or chain binder is provided on the deck near the roller to secure the anchor. Always make sure the anchor is properly secured when it is in the stored position on the bow roller.

Anchor/Rope Locker

The anchor locker is in the bow of the boat and accessed through a hatch in the deck. The anchor line is always stored in the rope locker next to the anchor locker. If an anchor is stored in the anchor locker, it must be properly secured to prevent it from bouncing in the locker and causing damage to the hull or anchor locker.

The anchor locker is drained by thru-hull fittings in the hull side near the bottom of the locker. It is very important to check the drains frequently to make sure they are clean and free flowing.



A LOOSE ANCHOR IN THE ANCHOR LOCKER WILL BOUNCE AND CAN DAMAGE THE BOAT. THE ANCHOR MUST BE POSITIONED SO IT DOES NOT REST AGAINST THE HULL SIDES AND BE PROPERLY SECURED AT ALL TIMES WHEN IT IS STORED IN THE ANCHOR LOCKER. DAMAGE RESULTING FROM THE ANCHOR BOUNCING IN THE ANCHOR LOCKER IS NOT COVERED BY THE MONTEREY WARRANTY.



Windlass and Deck Switches

Periodically remove the anchor line from the rope locker, rinse it with fresh water and allow it to dry in the sun. Cleaning the anchor line regularly will reduce odors in the anchor locker and increase the life of the line.

The line should also be inspected for abrasions or signs of deterioration. Replace the line if it shows any sign of damage or deterioration. If your boat is equipped with the optional windlass, it is important to replace the anchor line with a new line of the type recommended or supplied by the windlass manufacturer.

Windlass (Optional)

The optional windlass is mounted to the deck near the rear of the anchor roller assembly above the rope locker. The anchor is stored on the roller assembly and is raised and lowered by the windlass. The anchor line is stored in the rope locker and routed out through the windlass to the anchor chain.

The anchor is lowered by releasing the anchor from the cleat or chain binder near the roller and operating a "DOWN" control at the helm, or the foot switch at the bow. The windlass control switch is activated and protected by a "push to reset" breaker in the helm switch breaker panel. The main circuit for the windlass is protected by a heavy duty circuit breaker in the engine compartment breaker panel.

After the anchor is set, the windlass must not be left to take the entire force from the anchor line. Boats lying to their anchor in a high swell or heavy weather conditions will snub on the line. This can cause slippage or apply excessive loads to the windlass. The line should be made fast to a bow cleat to relieve the load on the windlass.

The anchor is hauled in by releasing the line from the bow cleat and operating the "UP" control at the helm or the foot switch on the deck near the windlass. Once the anchor is retrieved, indepen-

dently secure the anchor to the cleat to prevent it from being accidentally released. This is especially important while the boat is under way.

The windlass manufacturer provides an owner's manual with its product. It is extremely important that you read the manual and become familiar with the proper care and operation of the windlass.



A WINDLASS MUST BE USED WITH CARE. IT IS EXTREMELY IMPORTANT THAT YOU READ THE OWNER'S MANUAL AND BECOME FAMILIAR WITH THE SAFETY INSTRUCTIONS AND PROPER OPERATION OF THE WINDLASS BEFORE USING IT WITH YOUR BOAT. ALWAYS ENSURE THAT LIMBS, FINGERS, HAIR AND CLOTHING ARE KEPT CLEAR OF THE WINDLASS AND ANCHOR LINE DURING OPERATION.



DO NOT USE A WINDLASS AS A SOLE MEANS OF SECURING AN ANCHOR IN THE BOW PULPIT. ALWAYS SECURE THE ANCHOR LINE TO A CLEAT OR CHAIN BINDER BEFORE OPERATING YOUR BOAT.

Windshield

Your boat is equipped with an anodized aluminum or optional stainless steel windshield with tinted glass, an opening center panel and windshield wipers. The front and side wing panels are tempered safety glass. The windshield wipers should only be used when the windshield is wet. The windshield glass can be scratched by activating the wipers when there is dried salt or dirt on the windshield.

The center windshield section opens to provide access to the bow deck area and ventilation to cockpit when the boat is at anchor or tied to a dock. The section is opened by releasing the locks on the inside of the windshield. A magnetic stop on the deck automatically secures the windshield section in the open position. Steps built into the cabin door provide access to the forward deck through the windshield. Make sure the cabin door is securely latched in the closed position before using the steps. The center windshield section should be closed and latched with both locks before cruising and never attempt to access the forward deck using the walk-thru windshield while the boat is underway.



Windshield



USE CAUTION WHEN OPENING WINDSHIELD WALK-THRU. THIS MAGNET IS VERY POWERFUL AND COULD CAUSE INJURY OR DAMAGE TO VESSEL

TO AVOID INJURY, WINDOW WALK-THRU MUST BE SECURED IN THE CLOSED POSITION WHEN VESSEL IS IN MOTION. USE BOTH WINDOW LOCKS. YOU SHOULD ALSO MAKE SURE THE CABIN DOOR IS SECURELY LATCHED IN THE OPEN POSITION BEFORE USING THE STEPS TO ACCESS THE WINDSHIELD WALK-THRU.



Sun Lounge Cushion, Deck Grab Rails and Deck Hatches

The standard welded aluminum windshield frame is anodized and the optional welded stainless steel frame is polished. Both are very durable and provide excellent resistance to the corrosive effects of saltwater, however the windshield must be maintained properly and certain precautions must be observed when mounting snaps or hardware to the windshield.

The windshield should be washed after each use with soap and water to keep it clean. Saltwater allowed to remain on the windshield frame will eventually begin to attack the aluminum or stainless steel and cause corrosion and/or rust stains, usually around fasteners and hardware mounted to the windshield. Snaps or any hardware mounted to the windshield must be properly sealed and isolated with caulk or a Teflon sealer to prevent salty moisture and galvanic corrosion from damaging the frame. Poor maintenance or improperly mounted hardware and snaps can void the warranty on the windshield.

Refer to the Routine Maintenance chapter for more information on the care and maintenance of anodized aluminum and stainless steel.

Sun Lounge Cushion

A removable sun lounge cushion is located on the deck. The cushion is secured to the deck by a special slide track on the forward end of the cushion and snaps on the rear. The cushion should be removed and stored in the cabin whenever the boat is not being used and installed before each cruise.

The cushion is installed by sliding the male slide track on the forward end of the cushion into the female slide track on the deck. Center the cushion and secure the rear with the snaps. Make sure the cushion is properly installed prior to leaving the dock or mooring. The cushion is large and somewhat awkward, making it difficult to install once the boat is underway. If it is not secured properly, the cushion could be caught by the wind and blown overboard or into the cockpit, causing damage to the boat or injury to passengers.

The sun lounge cushion and walk-thru windshield are intended to be used only when the boat is at the dock or at anchor. They should never be used while cruising.



PASSENGERS RIDING ON THE DECK WHILE CRUISING RESTRICT THE OPERATOR'S VISIBILITY AND COULD BE THROWN OVERBOARD BY WAVE ACTION OR AN UNEXPECTED MANEUVER FROM THE HELM. THIS IS A FREQUENT CAUSE OF ACCIDENTS. NEVER ALLOW PASSENGERS TO RIDE ON THE DECK WHILE THE BOAT IS CRUISING.

9.2 Hull Swim Platform

Your boat is equipped with an integral, fiberglass swim platform located in the stern of the boat. An optional teak inlay enhances the appearance of the boat and provides an excellent nonskid surface.

It is important to clean and oil the teak periodically with a commercial teak cleaner and oil, typically once or twice a year. Be careful to follow the manufacturer's directions exactly as some cleaners and oils may damage surrounding gelcoat, vinyl or aluminum. Use only a stiff brush, stainless wool, a "scotchbrite pad" or bronze wool for cleaning teak.

Never use steel wool on a boat as the bits of steel will get into the pores of the wood and gelcoat and cause rust stains.

Note: Avoid varnishing teak platforms. Varnish will not adhere well to teak and will make the surface very slippery when it is wet.

A telescoping boarding ladder is recessed into the swim platform under a special hatch. To use the ladder, make sure the engines are off and the steering wheel is turned straight ahead to move the props as far away from the ladder location as possible. Open the hatch in the middle of the swim platform. Rotate the ladder out of the recess to the down position. Pull the ladder out to the open position. The ladder must be retracted and folded into the recess before starting the engines.



MOVING PROPELLERS ARE DANGEROUS. THEY CAN CAUSE DEATH, LOSS OF LIMBS, OR OTHER SEVERE INJURY. DO NOT USE THE SWIM PLATFORM OR SWIM LADDER WHILE THE ENGINE(S) ARE RUNNING. STOP THE ENGINE(S) IF DIVERS OR SWIMMERS ARE ATTEMPTING TO BOARD. ALWAYS PROPERLY STORE THE LADDER BEFORE STARTING THE ENGINE(S).



Swim Platform and Ladder



Transom Storage Compartment and Cockpit Table Storage

Transom Storage Compartment and Shore Connectors

There is a compartment just forward of the swim platform, below the rear of the stern sun lounge. Another compartment on the starboard side of the transom provides protection for the shore connections for the 120-volt AC system, TV, telephone and shore water which are located in this compartment. A large cut out in the lower door frame on the compartment allows the door to be closed with the shore cords and hoses attached to the utilities at the dock. The door protects the inlet plugs from the elements and should be closed and latched at all times. It should only be open when making the connection to shore utilities.

The compartment below the sun lounge provides storage for the shore cords, water hose, and fenders. The hatch is equipped with special mounting brackets for the cockpit table and pedestal. It is drained by gravity to the engine hatch drain system. Gas charged springs on the storage compartment hatch help lift the hatch and support it when it is in the open position. A lift to release latch secures the hatch when it is closed and a LED light comes on when it is open.



DO NOT STORE FUEL OR FLAMMABLE LIQUIDS IN THE TRANSOM STORAGE COMPARTMENT. VENTILATION WAS NOT PROVIDED FOR EXPLOSIVE VAPORS.



Transom Shore Connector Locker

Trim Tabs

The trim actuators are mounted to the hull at the transom. The trim tabs are an important part of the control systems. Please refer to the Helm Control Systems chapter for detailed information on the trim tabs.



Unlatched



Latched

9.3 Cockpit

General

Some of the hatches and doors in the cockpit are secured with special flush mounted, twist lock latches with handles that store flush in the latch. Others are secured with push to close latches. Gas charged springs are used on some hatches that help raise the hatches and hold them in the open position.

The latch handles on the twist lock latches can be stored in the open or secured positions. There is a red dot in the handle that indicates that the latch is in the open position and the hatch is not secure. Always make sure the hatches are closed with the latches in the secured position before operating the boat above idle speed.



Transom Door in the Open Position
(door must be in the open position to open the engine hatch)



IN CERTAIN CONDITIONS, OPEN EXTERIOR DOORS AND HATCHES THAT ARE NOT SECURED PROPERLY CAN SLAM CLOSED UNEXPECTEDLY AND CAUSE INJURY TO PASSENGERS OR DAMAGE TO THE BOAT. MOST DOORS AND HATCHES ARE EQUIPPED WITH SPECIAL FASTENERS, HATCH LIFTERS, OR SNAPS AND/OR STRAPS, TO SECURE THEM IN THE OPEN POSITION. ALWAYS MAKE SURE THAT THESE HATCHES AND DOORS ARE PROPERLY SECURED WHENEVER THEY ARE IN THE OPEN POSITION.

Transom Door

A transom door is incorporated into the rear of the cockpit. The door is secured automatically in the open or closed position by a special magnetic latch system. The magnet releases and allows the door to be moved to the full open or closed position when enough force is exerted to overcome the magnet. When closing the transom door, make

sure it is completely closed and secured by the magnetic latch.

The transom door should be opened only when the boat is not in motion. The door must be secured in either the full open or full closed position. Never leave the transom door unsecured.

Note: Periodically inspect the transom door fittings for wear, damage, or loose fit. Any problems should be inspected and corrected immediately.



OPERATING THE BOAT UNDER POWER WITH THE TRANSOM DOOR OPEN MAY ALLOW PERSONS TO FALL OVERBOARD AND INTO BOAT PROPELLERS OR TO BE LOST IN OPEN WATER. ALWAYS CHECK TO MAKE SURE THE TRANSOM DOOR IS PROPERLY CLOSED AND SECURED BEFORE STARTING THE ENGINES AND NEVER OPERATE THE BOAT UNDER POWER WITH THE TRANSOM DOOR OPEN.



Engine Hatch and Actuator

Engine Access

Access to the engines is provided by a day hatch, located in the center of the cockpit, and by raising the cockpit deck and stern sun lounge above the engine room. The cockpit deck and sun lounge is hinged at the rear and raised by an electric hatch lifter activated by a switch in the helm switch panel. The electric actuator raises and lowers the front of the cockpit deck and sun lounge. The cockpit deck is designed to raise high enough to provide adequate access to service the components in the engine compartment.

The transom door must be secured by the magnetic latch in the open position before the engine hatch is lifted. There is a magnetic interlock switch built into the transom door that activates the circuit for engine hatch actuator and allows the engine hatch to be lifted when the transom door is in the open position. The interlock system is necessary to prevent the transom door and cockpit from being damaged by lifting the engine hatch with the transom door closed. Always make sure the transom door is secured in the full open position before attempting to lift the engine hatch.

Wet Bar

The wet bar is equipped with a sink, cutting board and sink basin divider, cup holders, an optional ice maker or refrigerator and a storage area. The counter top and sink cover are made of Karadon. A grab rail on the wet bar provides a hand hold when moving about the cockpit.



Wet Bar and Sink

The sink is plumbed to the fresh water system and is drained by gravity to a thru hull fitting in the hull side above the waterline. To use the sink, remove the Karadon lid and put it in a safe place. Rotate the faucet to the operating position and make sure the Water Pump breaker in the cabin breaker panel is on. The faucet works like faucets in your home when the fresh water system is activated. Always lower the faucet to the stored position and put the lid in place when the sink is not being used.

The ice maker or storage access doors are secured in the closed position with push to close latches that are flush to door. To open, pull the latch handle to release the latch. To close, push the

door until the latch catches. Periodically clean and lubricate the latches to protect them from corrosion and keep them operating properly.

Ice Maker or Cockpit Refrigerator (Optional)

An ice maker or refrigerator is supplied as optional equipment and is mounted below the sink in the wet bar. An access plate below the refrigerator or ice maker provides access to the port fuel gauge sender.

The ice maker operates on AC power only. A switch located just below the ice maker door turns the unit on or off. The ice maker door has a special latch to secure the door while under way. Make sure the door is properly secured whenever the boat is moving. The fresh water system supplies the water for the ice maker. Make sure the fresh water Pump is activated and there is water in the fresh water system before turning on the ice maker. Refer to the ice maker owner's manual for additional operating and maintenance instructions.

The optional dual voltage refrigerator will operate on 120-volt AC or 12-volt DC power. The refrigerator switches to 12-volt DC automatically when the AC power is disconnected and the Refrigerator breaker is activated on the cabin DC panel. When 120-volt AC current is provided by the Refrigerator circuit breaker on the 120-volt panel, the refrigerator automatically switches to AC power.

Care should be exercised while operating the refrigerator on 12-volt power without the engines running. It draws a substantial amount of current and can severely drain the house battery through extended use. The refrigerator door has a special latch to secure the door while under way. Make sure the door is properly secured whenever the boat is moving.

Refer to the refrigerator or ice maker owner's manual for additional operating and maintenance instructions.

Cockpit Lounge Seat

The cockpit lounge seat provides seating and the rear portion converts to a sun lounge. The rear portion of the seat raises with cockpit deck to provide access to the engine compartment. There is a cooler below the starboard lounge cushion that drains to the cockpit and drink holders located forward of the lounge. There is storage and access to the starboard fuel gauge sender on the fuel tank below the forward seat cushion and ad-



Dual Voltage Cockpit Refrigerator



Cockpit Lounge Seat in the Aft Position
**(the backrest should be in this position
whenever the engines are running)**

ditional storage below the forward sun lounge seat cushion above the engine compartment.

The backrest on the rear of the lounge seat has three positions. In the aft position, it is a backrest cushion for the lounge seat. In center position it converts the seat to a reverse facing sun lounge with backrest. In the forward position, it makes a full lay down sun lounge and enables the seat cushion to be opened to access the storage compartment.

The backrest is moved by lifting the center of the back rest and moving it toward the desired position. When the backrest reaches the next position it will drop slightly and lock.

For the safety of your passengers, always make sure the stern sun lounge back rest is in the full aft, lounge backrest position whenever the engines are running or the boat is underway. The backrest secures the cockpit and lounge seat area and prevents someone from accidentally falling overboard when it is in the aft position. Never allow someone to be on the reverse facing lounge seat with the backrest in the center or forward position when the engines are running.

A removable cockpit table mounts to a bracket on the starboard side of the cockpit lounge seat. The table and pedestal are stored in special mounting brackets built into the transom storage compartment hatch. A rotating latch secures the table in the mounting brackets and prevents it from sliding while the boat is underway.

To use the table, remove the table and pedestal from the storage compartment. Insert the pedestal base firmly in mounting bracket on the starboard side of the lounge seat and install the table on the pedestal. The table should only be used while at running at slow speeds, at the dock or at anchor. Always remove and properly stow the table and pedestal before cruising or running offshore. To prevent damage to the table or transom storage compartment, make sure to secure the table with the rotating latch when it is stored in the mounting brackets.



Cockpit Lounge Seat and Table



Cockpit Table and Pedestal Stored in Transom Storage Compartment

Bridge Deck Passenger Seat

The passenger seat is equipped with a flip up bolster to provide more room between the seat and the forward bulkhead. The bolster converts the seat to a leaning post style seat with a backrest and allows passengers to sit or stand. To convert the seat to a leaning post, lift the front of the seat cushion to raise the bolster and push it back above the seat cushion. Two arm rests on each seat provide a more comfortable cruising position and swing up into the backrest cushion to make it easier to enter and exit the helm area. A grab rail on the forward bulkhead provides a hand hold for passengers.

There is a storage compartment that drains to the bridge deck located below the seat. The compartment hatch is recessed and secured with a push to



Bridge Deck Passenger Seat in the Leaning Post Position

close latch. Additional storage compartments are located forward of the seat in the bulkhead.

Helm Seat

The helm seat is equipped with a flip up bolster to provide more room between the seat and the helm. The bolster converts the seat to a leaning post style seat with a backrest and allows the operator to sit or stand at the helm. To convert the seat to a leaning post, lift the front of the seat cushion to raise the bolster and push it back above the seat cushion.

Two arm rests on each seat provide a more comfortable driving position and swing up into the backrest cushion to make it easier to enter and exit the helm area.

There is a storage compartment that drains to the bridge deck located below the seat. The compartment hatch is recessed and secured with a push to close latch. If your boat is equipped with the optional cockpit air conditioner, it will be mounted in this compartment.

The intake for the optional cockpit air conditioner air handler is built into the compartment hatch below the helm seat. A digital air conditioner control panel is mounted in the starboard side of the cockpit next to the helm seat. The operation of the cockpit air conditioner is similar to the cabin air conditioner. Refer to the Raw Water Systems chapter, the Interior Equipment chapter and the air conditioner owner's manual for additional information on the operation of the air conditioning system.

Helm

The steering, engine controls, engine instruments and switches for exterior equipment and navigation lights are located on the helm station. The helm station is designed to provide good visibility, room for electronics and a more functional control station.

The steering helm and engine controls are located on the rear of the helm console. The helm switch panels are just forward of the helm and the engine ignition switches are located on separate panels below the steering wheel. The circuit breakers for the helm activated accessories are located in a panel below the steering wheel.

Molded-in electronics storage is located in the center of the helm, forward of the steering wheel.



Helm Seat



Optional Cockpit Air Conditioning Unit



Helm with Optional Electronics Package

Access to service the controls or to install or service electronics is provided through an opening access panel in the cabin.

A Raymarine BI Data that indicates depth, speed and water temperature is provided as standard equipment. Optional electronics packages that include a VHF radio, chart plotter, GPS and Radar may be installed with the Tri Data. Electronic Navigational equipment manufacturers provide detailed instruction manuals with their products. You should read them carefully and review the operation of the electronics with your dealer at the time of delivery.

Cabin Door

The sliding cabin door is made of acrylic plastic glass and slides on a top and bottom track. A lockable latch secures the door in the closed position. A special vinyl-covered latch near the bottom door track secures the door in the open position. Steps built into the cabin door provide access to the walk-thru windshield and the deck when the boat is at the dock or at anchor.

It is very important that the cabin door is secured properly in the open or closed position. The cabin door is heavy and if the door is not properly latched, it could slide when the boat rocks and pinch someone's fingers between the door and the bulkhead or damage the door. Additionally, the door must be closed and latched securely before using the steps to access the walk-thru windshield and deck.



Cabin Door with Built-In Steps Closed and Latched



Cabin Door Latched in the Open Position



TO AVOID SERIOUS INJURY, MAKE SURE THE CABIN DOOR IS SECURELY LATCHED IN THE CLOSED POSITION BEFORE USING THE STEPS TO ACCESS THE WINDSHIELD WALK-THRU. NEVER USE THE STEPS WITH THE DOOR PARTIALLY OPEN OR WHEN THE DOOR IS NOT SECURELY LATCHED. IF THE LATCH MALFUNCTIONS AND WILL NOT SECURE THE DOOR PROPERLY, STOP USING THE STEPS UNTIL THE LATCH IS REPAIRED OR REPLACED.

of the door preventing the open door from sliding as the boat rocks.

When closing the door, make sure you push the door against the door jam with enough pressure to allow the latch to secure the door. When the door is open, it must be properly secured with the latch near the bottom door track and to the port side of the companionway. To latch the door in the open position, open the door completely, then rotate the latch to lay on the track in front

The door is made of fiberglass. The fiberglass gelcoat can be chipped if the vinyl-covered latch that secures it in the open position is not in good condition. It should be changed whenever it shows signs of deterioration from the exposure to elements. Please refer to the Routine Maintenance chapter for information on the proper care and maintenance of fiberglass gelcoat.



NEVER LEAVE THE CABIN DOOR UNLATCHED. THE CABIN DOOR IS HEAVY AND SLIDES EASILY. IF THE DOOR IS LEFT UNLATCHED, IT COULD SLIDE UNEXPECTEDLY AS THE BOAT ROCKS, DAMAGING THE DOOR OR CAUSING AN INJURY TO A PASSENGER. ALWAYS MAKE SURE THE DOOR IS PROPERLY LATCHED IN THE OPEN OR CLOSED POSITION.

SECURE THE DOOR WHEN CRUISING. DO NOT SIT, STAND OR PLACE HEAVY OBJECTS ON THE DOOR.

KEEP CABIN DOOR CLOSED WHEN ENGINES OR GENERATOR ARE RUNNING.



Arch and Convertible Top

Convertible Top and Side Curtains

The canvas for Monterey boats is custom fit to each boat. The convertible top is designed with a relatively flat profile and a snug fit. The canvas is fit to the boat at the factory and the top must be installed properly in order for the clear connector and side curtains to fit.

The front and rear sections of the top are folded against the arch and covered with storage boots when the top is in the folded or down position. To open the rear top, remove the boot on the rear portion of the top and zip the top to the zipper on the rear of the arch. Open the top by pulling the main bow towards the rear of the boat until it stops. Remove the quick release pins on the deck hinges for the stanchions that are mounted on the arch and release the Velcro straps securing the stanchions to the main bows. Then attach the adjustable stanchions to the deck hinges. Secure each stanchion socket to the deck hinge with the quick release pins. Use your body weight on each rear corner of the top to pull down and stretch the fabric until the spring loaded button in the inner stanchion tube lines up with the hole in the outer stanchion tube and locks into place. The top canvas should be stretched tight when both stanchions are locked in the out position.

To open the front top, remove the boot on the front portion of the top and zip the top to the zipper on the front of the arch. Release the stanchions from the lower deck hinges and open the top it by pulling the main bow towards the front of the boat until it stops. Use your body weight on each side of the top bow to pull down and stretch the fabric until the stanchion socket will fit into the upper deck hinge on the forward side of the arch. Repeat on the other side and secure each stanchion socket to the deck hinge with the quick



Deck Hinge and Quick Release Pin

release pins. The top canvas should be stretched tight when both stanchions are secured in the upper deck hinge.

Attach the clear connector to the zipper at the front of the top and snap it to the top of the windshield frame beginning with the center snaps. If the top is adjusted properly, the clear connector will have to be stretched just enough to pull out the wrinkles and reach the snaps on the windshield. The front bow will continue to bear the main load of the top.

Once the clear connector is completely installed, the side curtains can be put on. Attach the forward side curtains to the zippers on the sides of the top and to the front connector. Snap the curtains to the windshield, deck and arch beginning with the forward snaps on the windshield. If the top is adjusted properly, the side curtains will have to be stretched slightly to pull out the wrinkles and reach the snaps. The main load for the top should remain on the bows and the arch.

If you have the optional drop curtain and rear enclosure, attach it to the zippers on the rear of the top and side curtains. Then snap the drop curtain to the arch and deck beginning with the forward snaps on the arch. A zippered door on the port side of the drop curtain provides access to the cockpit when the canvas is installed.

The side curtains and clear connector should be stored either rolled or flat, without folds or creases. Folding the curtains will make permanent creases that could cause the vinyl to crack.

Note: Cold weather can make the clear vinyl material on the curtains stiff and difficult to stretch to the snaps. This can be particularly difficult with new canvas that has been stored off the boat. Laying the curtains in the sun for 30 minutes during the heat of the day will make installing them much easier in cold weather.

Fiberglass Arch

A fiberglass arch is installed as standard equipment. It is designed to accommodate the canvas top, radio antennas, radar antennas and navigation lights. It is equipped with courtesy lights activated by a switch in the helm, speakers and grab rails.



Rear View of Fiberglass Arch

The warranty for the arch will be void if it is modified in any way or heavy accessories like life rafts are mounted to the arch. Additionally, if items like radar antennas spotlights and other accessories are mounted improperly or in the wrong location, the warranty could be void. If you intend to add equipment or make modifications to the arch, you should contact your dealer or Monterey Customer Service to make sure the equipment you would like to add or the intended modification will not void the warranty on the arch.

INTERIOR EQUIPMENT

10.1 Head Compartment and Marine Toilet

The head compartment is equipped with a sink and a hot and cold faucet that converts to a removable shower head. The shower head is equipped with a valve that allows the shower water to be turned on and off without affecting the temperature to conserve water while showering. The shower sump is always activated whenever the house battery switch is on.

A starboard seat over the toilet that is held open and closed with a gas spring is provided to make showering more comfortable. There also is a shower curtain that goes in front of the head door. Make sure the shower seat is down and the curtain is pulled across the head door before activating the shower.

There is storage above the vanity behind the mirror and under the sink. Ventilation is provided by an opening port window and exhaust blower ducts. There is also a 12-volt overhead light and a 120-volt G.F.I. duplex outlet. The light and exhaust blower are activated by switches near the sink.

Marine Head System

Your boat is equipped with a VacuFlush marine head system as standard equipment. VacuFlush systems use a small amount of water (one pint to one quart) and vacuum which is generated by the 12-volt vacuum pump to flush. The toilet is connected to the pressurized fresh water system. Using fresh water results in less odor in the head compartment.

To use the toilet, make sure the Head System and the Water Pump breakers on the cabin DC panel are on. Then add water to wet the bowl by depressing the foot activated flush lever slightly until the desired water level is reached. Flush the toilet by activating the flush lever all the way for approximately three seconds or until contents clear the bowl. A sharp popping noise is normal when the vacuum seal is broken and flushing action begins. It is also normal for a small amount of water to remain in the bowl after flushing.

The waste is transferred into the holding tank where it remains until it is pumped out by a



Head Sink and Retractable Shower Head



Sealand Head

waste dumping station or the overboard macerator discharge system. The waste moves through a one-inch opening in the toilet base. Incoming air fragments the waste as it passes through the base opening. This process eliminates the need for macerators or mechanical motors in the toilet base.

The vacuum generator is mounted on the holding tank and contains stored vacuum. System vacuum is monitored by a vacuum switch which is located on the vacuum generator tank. When the switch senses a drop in vacuum in the system, it automatically signals the pump to energize and bring the vacuum back to operating level. This

process is normally completed in less than two minutes.

It is normal for the stored vacuum to leak down slightly between flushes, causing the vacuum pump to run for a short period. The pump should not run more than once every three hours after the last flush for recharging the system. A holding tank fluid level monitor and macerator pump out switch is located near the sink. Please refer to the toilet manufacturer owner's manual for more information on the operation of the marine head system.

Holding Tank and Optional Macerator Discharge Pump

The holding tank and vacuum generator are located in the engine compartment. The macerator pump is located on the holding tank and discharges waste to a thru-hull fitting in the bilge, forward of the port engine.

When the tank is full, the tank monitor will show full and the vacuum pump will not run. The tank must either be pumped out by an approved waste dumping station through the waste deck fitting in the stern or be pumped overboard with the optional macerator discharge pump, when legal to do so.

To operate the macerator discharge pump, open the seacock at the overboard discharge thru-hull fitting located in the engine compartment. Make sure the green light in monitor panel is illuminated and activate the momentary macerator switch. Monitor the fluid level until the tank is emptied. Release the switch and close the discharge seacock when pumping is complete.

Note: The macerator discharge pump can only be run dry for a couple of seconds. Allowing the macerator pump to run after the holding tank is empty will cause damage to the pump.

Note: The overboard macerator discharge pump option for the waste holding tank is not available with the grey water system.



Holding Tank Monitor Panel



Holding Tank Overboard Discharge Thru-Hull Valve and Air Conditioner Sea Strainer



IN MANY AREAS IT IS ILLEGAL TO FLUSH HEAD WASTE DIRECTLY OVERBOARD. VIOLATION OF THESE POLLUTION LAWS CAN RESULT IN FINES OR IMPRISONMENT. ALWAYS KNOW THE LAW FOR THE AREAS IN WHICH YOU BOAT. NEVER DUMP HEAD OR HOLDING TANK WASTE OVERBOARD ILLEGALLY.

Maintenance

The head should be cleaned and inspected for leaks regularly. Monitor the cycle time of the vacuum pump. If it cycles more than once every two or three hours or runs longer than three minutes after a flush, there may be a leak in the system or the vacuum pump may require service.

Always make sure to leave enough water in the bowl to cover the flush valve and bowl seal. Periodically, lubricate the seal with Teflon grease. This will help keep the seal soft and pliable.

The holding tank should be pumped out and flushed as needed. Periodically add chemical to the head to help control odor and to chemically break down the waste. The macerator and vacuum pumps should be sprayed with a metal protector periodically to reduce corrosion. See the head manufacturer owner's manual for additional operating and maintenance information.

The vent hose for the holding tank is equipped with a charcoal filter to reduce odor from the holding tank. The filter should be changed once a year or if the holding tank has become overfilled, which will plug the filter and could cause damage to the waste system.

Note: The head system must be properly winterized before winter lay-up. See the manufacturer owner's manual for additional operating and maintenance information.

10.2 Galley and Sink

The galley is equipped with storage and a fresh water sink with hot and cold faucets. Water is supplied to the sink by a 12-volt pump located in the engine room. When activated by the Water Pump breaker in the cabin DC panel, the water system will operate much like the water system in a home. An automatic pressure sensor keeps the system pressurized. The sink drains overboard or to the optional grey water holding system through the cabin sink drain system. See the Fresh Water System chapter for more information on operating the fresh water system.

The sink counter tops are made of Karadon. Storage drawers, a built-in slide out waste basket and the refrigerator are located below the sink and counter top. A removable Karadon insert for the sink provides additional counter top space for the galley. Always make sure this insert is properly seated in the counter top recess before operating the boat.

A microwave oven, coffee maker and additional storage is built into the cabinets above the sink. Daylight and fresh air is provided to this area by an opening port window and an opening overhead hatch. Additional lighting is provided by 12-volt



Holding Tank, Vacuum Pump and Overboard Macerator Pump



Galley

lights recessed in the head liner above the galley.

Cabinet Door and Drawer Latches

The cabinet doors and drawers in the cabin are secured with dual action, push to lock latches. To open a drawer or cabinet door, push on the latch knob. The knob is spring loaded and will pop out one inch, providing a finger hold and releasing the dead bolt on the latch mechanism. A slight pull is required to release the friction latch and open the door. The cabinet doors and drawers will be held closed by the friction latches while at anchor or at the dock. To close and secure, make sure the door is completely closed and push the knob in. The knob will stay in and the locking mechanism will be activated.

The knobs should be pushed in to activate the positive lock dead bolts whenever the boat is underway.

Stove

The galley is equipped with a dual burner electric stove recessed into the counter top. To activate the stove, make sure the Stove breaker in the AC breaker panel is on and there is nothing but pots or pans on the stove, then activate the burners. A manual for the stove is included with your boat. It is extremely important that you read the manual and become familiar with the proper care and operation of the stove before attempting to use it.



Stove and Galley Sink with Removable Insert

After cooking, be sure the burners are turned off. Always be sure the burner is off and allowed to cool before placing anything on the stove.

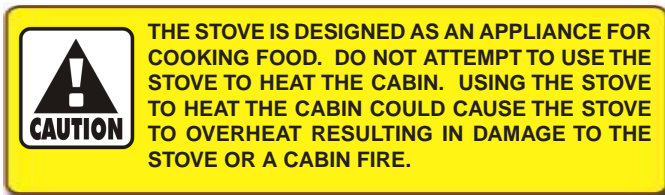

Refrigerator (AC - DC)

A dual voltage refrigerator is supplied as standard equipment and is mounted in the galley below the sink. This unit will operate on 120-volt AC or 12-volt DC power. The refrigerator switches to 12-volt DC automatically when the AC power is disconnected and the Refrigerator breaker is activated on the cabin DC panel. When 120-volt AC current is provided by the Refrigerator circuit breaker on the 120-volt panel, the refrigerator automatically switches to AC power.



Galley Refrigerator, Microwave, Drawers and Slide Out Waste Basket

Care should be exercised while operating the refrigerator on 12-volt power without the engines running. It draws a substantial amount of current and can severely drain the house battery through extended use. The refrigerator door has a special latch to secure the door while under way. Make sure the door is properly secured whenever the boat is moving. Refer to the refrigerator owner's manual for additional operating and maintenance instructions.

Microwave Oven

A microwave oven is provided as standard equipment. It operates on AC power and is protected by the Microwave breaker in the AC breaker panel.

Please refer to the microwave a owner's manual for detailed information on the microwave oven installed in your boat.

10.3 Main Salon

Lounge Seat and Dinette Table

The dinette is on the starboard side of the cabin. It is equipped with a table and a lounge seat that converts to a berth. A drink holder and tray for the entertainment center remote controls folds out of the center of the lounge backrest. There is also a 12-volt DC outlet, AC G.F.I. outlet and light switch in the fold out panel. Storage cabinets and lockers are located above the lounge.

The cabin AC/DC breaker panel is built into the cabinet at the rear of the lounge seat. A VCR, DVD, CD player, stereo, LED flashlight and storage is built into the cabinet below the breaker panels. The stereo is activated by the Stereo breaker in the DC electrical panel and the TV is activated by the inverter control panel.

The table is mounted on a portable pedestal assembly. To prevent damage to the table and cabin, the table and pedestal assembly must be properly stowed before each cruise. This is particularly important when the boat is run offshore or in heavy seas. To stow the table, remove it from the pedestal and place it in the dedicated table storage compartment below the V-berth. Remove the pedestal from the base and put them in the dedicated storage compartment with the pedestal secured by the special brackets in the floor of the compartment.

To convert the dinette to a berth, lift the lower edge of the side cushion on the base of the seat up to the berth position. Swing the leg assembly down to support the cushion. To return the berth to a lounge seat, lift the cushion and swing the leg assembly up until it locks in the storage clips on the bottom of the cushion. Then lower the cushion against the lounge seat base.

Daylight and fresh air is provided to this area by opening port windows and by overhead opening hatches. Additional lighting is provided by 12-volt lights on either end of the dinette.

Cabin Light Switches

Most of the cabin lights are controlled by switches on the cabin walls. Other lights have switches on the light fixture. Some of the lights are controlled by electronic dimmer switches. Pressing and holding the top of the switch will turn the lights on and make them brighter. Pressing and holding the bottom of the switches will dim the lights or turn them off.



Lounge Seat and Dinette Table



Dedicated Table Storage Below V-Berth



Typical Cabin Switch Panel and GFI Outlet

Carbon Monoxide Detector

A carbon monoxide (CO) detector is installed on the mid berth bulkhead. If excess carbon monoxide fumes are detected, an audible beeping will sound indicating the presence of the toxic gas.

A by-product of combustion, carbon monoxide is invisible, tasteless, odorless, and is produced by all engines, heating and cooking appliances. The most common sources of CO on boats are the engines, auxiliary generators and propane or butane stoves. These produce large amounts of CO and should never be operated while sleeping.

Please read the owner's manual supplied by the detector manufacturer for operation instructions and additional information regarding the hazards of carbon monoxide gas. Also read more about carbon monoxide, carbon monoxide detectors, and proper ventilation in the Ventilation Systems and Safety Equipment chapters in this manual. This is especially essential if your boat is equipped with the optional generator. If you did not receive a manual for your carbon monoxide detectors, please contact the Monterey Boats Customer Service Department.



CO Detector



ACTIVATION OF THE CARBON MONOXIDE DETECTOR INDICATES THE PRESENCE OF CARBON MONOXIDE (CO) WHICH CAN BE FATAL. EVACUATE THE CABIN IMMEDIATELY. DO A HEAD COUNT TO CHECK THAT ALL PERSONS ARE ACCOUNTED FOR. DO NOT REENTER THE CABIN UNTIL IT HAS BEEN AIRED OUT AND THE PROBLEM FOUND AND CORRECTED.



Air Conditioner Below V-Berth

10.4 Air Conditioner (Optional)

The air conditioning unit is the reverse cycle type and operates on AC power. It is equipped with reverse cycle heat and can be operated as a cooling or heating unit. There is one air conditioner with ducts for the main salon, head compartment, mid berth and the master stateroom. The main compressor and air handler is located below the berth in the master stateroom. It is protected by the Shore 2 breaker in the 120-volt AC breaker panel.

To operate, make sure the thru-hull valve for the air conditioner raw water supply pump, located in the engine compartment, is on. Turn the Shore 2 breaker in the AC breaker panel to the "ON" position. The air conditioning or heat then will be



Air Conditioner Control Panel

controlled by the electronic control panel in the master stateroom. When activated, water should continuously flow from the overboard thru-hull in the hull side.

The air conditioning system produces heat when it is operated in the reverse cycle mode. The ability of the unit to produce heat is affected by the temperature of the seawater. As the seawater temperature lowers, the air conditioner's ability to produce warm air decreases. When the seawater temperature drops below 40 - 45 degrees, the air conditioner will not be able to produce heat. You should not operate the air conditioner to produce heat when the water temperature is below 40 degrees.

The air conditioning unit creates condensation that drips into the pan at the base of the unit. A hose attached to the pan drains the water to the sump system. The sump system is activated whenever the house battery switch is on and must be activated when the air conditioner is operating. It is normal for some water to be in the pan whenever the air conditioner has been used. The condensation pan should be checked periodically to make sure it is draining properly.

The drain hoses, condensation pan and sump should be flushed clean if they become restricted by mold or debris. If the drain becomes plugged, the condensation pan will overflow into the V-berth storage compartment and could make the cabin floor wet.

You should always keep the cabin door closed when operating the air conditioner. If the cabin door is left open, it could cause the air conditioner unit to run continuously and not cycle enough to defrost the coils on the condenser. This could cause the coils to develop enough ice to reduce the unit's ability to cool the boat.

The intake line for the pump is equipped with a sea strainer that must be checked for debris frequently and cleaned as necessary. Refer to the Raw Water System chapter for information on the air conditioning pump and cleaning the sea strainer.

You also should refer to the air conditioner owner's manual for additional operating and maintenance instructions.



Master Stateroom

Note: Air conditioners use surface water as a cooling medium. The boat must be in the water and the raw water supply system must be properly activated prior to use. After a certain amount of time without water flow, the air conditioning unit will automatically power down. Always check for proper water flow out of the air conditioning pump discharge thru-hull when the air conditioner is operating.

10.5 Master Stateroom

The master stateroom is located in the bow area, forward of the main salon. The stateroom has a large berth set against the forward bulkhead with a fold out cushion at the rear that swings up to extend the berth. The cushion is also the backrest for the forward lounge seat. Storage for dunnage and the dinette table is located below the large hatch near the rear of the V-berth. The optional cabin air conditioning unit is located in a compartment below the small hatch near the front of the berth. A reading light, the air conditioner control panel and an LCD television are on the rear bulkhead. The inverter for the TV is located in the equipment locker behind an access panel in the mid cabin. A folding curtain just forward of the galley provides privacy.

To extend the V-berth for sleeping, lift the lower edge of the lounge seat backrest cushion at the rear of the berth up to the berth position. Swing the leg assembly down to support the cushion on the counter tops on each side of the seat cushion. To return the berth extension cushion to a lounge seat backrest, lift the cushion and swing the leg assembly up until it locks in the storage clips on the bottom of the cushion. Then lower the cushion against the rear of the V-berth.

A hanging locker is located on each side of the stateroom. A light in each locker is automatically activated when the door is opened and turned off when the door is closed.

Daylight and fresh air is provided to this area by an opening overhead hatch and two opening port windows. The hatch is equipped with a removable screen. Additional lighting is provided by two 12-volt lights near the forward bulkhead that are controlled by a wall switch near the TV and two lights with switches on the light fixtures mounted on rear bulkhead. Refer to the Ventilation System chapter for more information on operating the hatches and port windows.

10.6 Mid Berth

The mid berth is located aft of the cabin steps. It is equipped with a lounge seat that converts to a berth, 12-volt lighting and an opening port window. Access for the forward bilge pump and sump pump is provided by an access hatch in the sole. The fresh water tank is mounted in a compartment below the rear of the lounge seat.

A removable panel in the headliner provides access to service the helm wiring, electronics and rigging components. Another opening panel behind the starboard backrest cushion provides access to remote mounted electronics and stereo components, the inverter and other components or accessories mounted in this compartment. There is additional storage in a cabinet built into the port side bulkhead.

To convert the lounge seat to a berth, lift the front of the seat cushion slightly and slide it toward the front of the cabin until it stops. The rear lounge backrest cushion is also the filler cushion for the berth. To return the berth to a lounge seat, move the rear cushion to the backrest position and push the seat toward the rear of the cabin until it locks in the seat position.



Port Side Hanging Locker, LCD TV, Light Switch, Air Conditioner Control Panel and Light Fixture



Starboard Side Hanging Locker



Mid Berth

Daylight and fresh air is provided to this area by an opening port window. Additional lighting is provided by a 12-volt reading light controlled by a switch on the light fixture and overhead lights in the headliner activated by a switch on the starboard side.

10.7 Cabin Woodwork

Cabin Floors

The galley floor and steps are Lonseal vinyl with teak image and texture. It is important to avoid tracking sand and dirt on the cabin floor and steps. Sand and dirt acts like sand paper and will eventually sand off the finish in the traffic areas.

The wood floors and steps can be vacuumed and cleaned with a mixture of water and Murphy's Oil Soap. Wipe dry with a clean towel.

The carpeted areas are cleaned and maintained in the same fashion as the carpeting in your home.

Walls, Cabinets and Trim

The hardwood used for the wall trim moldings is finished with a high quality urethane varnish. The walls themselves and the cabinet doors are made of a laminated, simulated wood that requires no maintenance. The walls and molding can be routinely cleaned with a damp cloth. For heavy duty cleaning, use a mixture of water and Murphy's Oil Soap or white vinegar and water to clean the wood or laminate and wipe it dry with a clean towel. Apply a furniture polish to add luster and help to preserve the finish.



Equipment Locker and Remote Electronics, Inverter, Stereo Amplifier and Components



Mid Berth Bed



Cabin Steps, Simulated Wood Laminate and Wood Molding

THIS PAGE WAS LEFT BLANK
INTENTIONALLY

SAFETY EQUIPMENT

11.1 General

Your boat and inboard engines have been equipped with safety equipment designed to enhance the safe operation of the boat and to meet U.S. Coast Guard safety standards. The Coast Guard or state, county, and municipal law enforcement agencies require certain additional accessory safety equipment on each boat. This equipment varies according to length and type of boat and type of propulsion. The accessory equipment typically required by the Coast Guard is described in this chapter. Some local laws require additional equipment. It is important to obtain "Federal Requirements And Safety Tips for Recreational Boats," published by the Coast Guard, and copies of state and local laws, to make sure you have the required equipment for your boating area.

Your boat is equipped with engine alarms, an automatic fire extinguishing system and cabin monitoring equipment. These systems are designed to increase your boating safety by alerting you to potentially serious problems in the primary power systems, the engine compartment, and the cabin. Alarm systems are not intended to lessen or replace good maintenance and pre-cruise procedures.

This chapter also describes safety related equipment that could be installed on your boat. This equipment will vary depending on the type of engines and other options installed by you or your dealer.

11.2 Engine Alarms

Your boat is equipped with engine alarms that monitor water temperature and oil pressure. The alarms are equipped with a buzzer and/or a light located in the helm. The alarm will sound if the water temperature reaches 205 degrees F. or the oil pressure drops below 6 P.S.I.

If there is a problem with one of these systems, it will sound an alarm until the problem is found and resolved.



Throwable Device and Personal PFD

If the alarms sound:

- Immediately throttle the engines back to idle.
- Shift the transmissions to neutral.
- Monitor the engine gauges to determine the cause of the problem.
- If necessary, shut off the engines and investigate until the cause of the problem is found.

11.3 Neutral Safety Switch

Every control system has a neutral safety switch incorporated into it. This device prohibits the engines from being started while the shift lever is in any position other than the neutral position. If the engines will not start, slight movement of the shift levers may be necessary to locate the neutral position and disengage the safety cutout switch. Control or cable adjustments may be required to correct this condition should it persist. See your Monterey dealer for necessary control and cable adjustments. Please refer to the Helm Control Systems chapter for more information on the neutral safety switch.

11.4 Required Safety Equipment

Besides the equipment installed on your boat by Monterey, certain other equipment is required by the U.S. Coast Guard to help ensure passenger safety. Items like a sea anchor, working anchor, extra dock lines, flare pistol, life vests, a line permanently secured to your ring buoy, etc., could at some time save your passengers' lives, or save your boat from damage. Refer to the "Federal Requirements And Safety Tips For Recreational Boats" pamphlet for a more detailed description of the required equipment. You also can contact the U.S. Coast Guard Boating Safety Hotline, 800-368-5647, for information on boat safety courses and brochures listing the Federal equipment requirements. Also, check your local and state regulations.

The Coast Guard Auxiliary offers a "Courtesy Examination." This inspection will help ensure that your boat is equipped with all of the necessary safety equipment. The following is a list of the accessory equipment required on your boat by the U.S. Coast Guard:

Personal Flotation Devices (PFDs)

PFDs must be Coast Guard approved, in good and serviceable condition, and of appropriate size for the intended user. Wearable PFDs must be readily accessible, meaning you must be able to put them on in a reasonable amount of time in an emergency. Though not required, the Coast Guard emphasizes that PFDs should be worn at all times when the vessel is underway. Throwable devices must be immediately available for use. All Monterey boats must be equipped with at least one Type I, II or III PFD for each person on board, plus one throwable device (Type IV).

Please note that most state laws now require that children 13 years old and under must wear a PFD at all times.

Visual Distress Signals

All boats used on coastal waters, the Great Lakes, territorial seas, and those waters connected directly to them, must be equipped with Coast Guard approved visual distress signals. These signals are either Pyrotechnic or Non-Pyrotechnic devices.

Pyrotechnic Visual Distress Signals:

Pyrotechnic visual distress signals must be Coast Guard approved, in serviceable condition, and readily accessible. They are marked with a date showing the service life, which must not have expired. A minimum of three are required. Some

pyrotechnic signals meet both day and night use requirements. They should be stored in a cool, dry location. They include:

- Pyrotechnic red flares, hand held or aerial.
- Pyrotechnic orange smoke, hand-held or floating.
- Launchers for aerial red meteors or parachute flares.



PYROTECHNICS ARE UNIVERSALLY RECOGNIZED AS EXCELLENT DISTRESS SIGNALS. HOWEVER, THERE IS POTENTIAL FOR INJURY AND PROPERTY DAMAGE IF NOT PROPERLY HANDLED. THESE DEVICES PRODUCE A VERY HOT FLAME AND THE RESIDUE CAN CAUSE BURNS AND IGNITE FLAMMABLE MATERIAL. PISTOL LAUNCHED AND HAND-HELD PARACHUTE FLARES AND METEORS HAVE MANY CHARACTERISTICS OF A FIREARM AND MUST BE HANDLED WITH CAUTION. IN SOME STATES THEY ARE CONSIDERED A FIREARM AND PROHIBITED FROM USE. ALWAYS BE EXTREMELY CAREFUL AND FOLLOW THE MANUFACTURER'S INSTRUCTIONS EXACTLY WHEN USING PYROTECHNIC DISTRESS SIGNALS.

Non-Pyrotechnic Devices

Non-Pyrotechnic visual distress signals must be in serviceable condition, readily accessible, and certified by the manufacturer as complying with U.S. Coast Guard requirements. They include:

- **Orange Distress Flag (Day use only)**
The distress flag is a day signal only. It must be at least 3 x 3 feet with a black square and ball on an orange background. It is most distinctive when attached and waved from a paddle or boat hook.
- **Electric Distress Light (Night use only)**
The electric distress light is accepted for night use only and must automatically flash the international SOS distress signal. Under "Inland Navigation Rules," a high intensity white light flashing at regular intervals from 50-70 times per minute is considered a distress signal.

Sound Signaling Devices

The navigation rules require sound signals to be made under certain circumstances. Recreational vessels also are required to sound fog signals during periods of reduced visibility. Therefore, you must have some means of making an efficient sound signal.

Navigation Lights

Recreational boats are required to display navigation lights between sunset and sunrise and other periods of reduced visibility (fog, rain, haze, etc.) Navigation lights are intended to keep other vessels informed of your presence and course. Your boat is equipped with navigation lights required by the U.S. Coast Guard at the time of manufacture. It is up to you to make sure they are operational and turned on when required.

Fire Extinguishers

Boats over 26 feet are required to carry one or two fire extinguishers, depending on the type of fire extinguishers used. Coast Guard approved fire extinguishers are hand-portable, either B-I or B-II classification and have a specific marine type mounting bracket. It is recommended the extinguishers be mounted in a readily accessible position.



Fire extinguishers require regular inspections to ensure that:

- Seals & tamper indicators are not broken or missing.
- Pressure gauges or indicators read in the operable range.
- There is no obvious physical damage, corrosion, leakage or clogged nozzles.

Refer to the "Federal Requirements And Safety Tips For Recreational Boats" pamphlet or contact the U.S. Coast Guard Boating Safety Hotline, 1-800-368-5647, for information on the type and size fire extinguisher required for your boat.

Please refer to the information provided by the fire extinguisher manufacturer for instructions on the proper maintenance and use of your fire extinguisher.



INFORMATION FOR AGENT FE-241 AND FE-227 FIRE EXTINGUISHERS IS PROVIDED BY THE MANUFACTURER. IT IS ESSENTIAL THAT YOU READ THE INFORMATION CAREFULLY AND COMPLETELY UNDERSTAND THE SYSTEM, IN THEORY AND OPERATION, BEFORE USING YOUR BOAT.

Bilge and Fuel Fires

Fuel compartment and bilge fires are very dangerous because of the presence of gasoline or diesel fuel in the various components of the fuel system and the possibility for explosion. You must make the decision to fight the fire or abandon the boat. If the fire cannot be extinguished quickly or it is too intense to fight, abandoning the boat may be your only option.

If you find yourself in this situation, make sure all passengers have a life preserver on, go over the side and swim well upwind of the boat. This will keep you and your passengers well clear of any burning fuel that could be released and spread on the water as the boat burns or in the event of an explosion. When clear of the danger, check about and account for all those who were aboard with you. Give whatever assistance you can to anyone in need or in the water without a buoyant device. Keep everyone together in a group for morale and to aid rescue operations.



ALL TYPES OF FUEL CAN EXPLODE. IN THE EVENT OF A FUEL COMPARTMENT OR BILGE FIRE, YOU MUST MAKE THE DIFFICULT DECISION TO FIGHT THE FIRE OR ABANDON THE BOAT. YOU MUST CONSIDER YOUR SAFETY, THE SAFETY OF YOUR PASSENGERS, THE INTENSITY OF THE FIRE AND THE POSSIBILITY OF AN EXPLOSION IN YOUR DECISION.



IN THE EVENT OF A FIRE IN THE GENERATOR:

- TO KEEP THE FLAMES CONTAINED, DO NOT OPEN THE SOUND SHIELD.
- SHUT DOWN ENGINES, GENERATORS AND BLOWERS.
- CONTINUOUSLY DISCHARGE THE ENTIRE CONTENTS OF A PORTABLE FIRE EXTINGUISHER THROUGH THE FIRE PORT IN THE SOUND SHIELD IMMEDIATELY.

11.5 Automatic Fire Extinguishing System

The engine compartment is equipped with an automatic fire extinguishing system. The equipment has been chosen and located to provide sufficient volume and coverage of the entire engine compartment area. While the system ensures excellent bilge fire protection, it does not eliminate the U.S. Coast Guard requirement for hand held fire extinguishers. The automatic fire extinguishing system is automatically activated when the tem-

perature in the engine compartment reaches a specific temperature, usually around 165° F.

The boat is equipped with an indicator light at the helm. Under normal circumstances, whenever the ignition key is turned on, the green indicator light will glow. This indicates that the system is operating and ready for activation if necessary. If the indicator light does not glow when the ignition switch is turned on, either the system has discharged or there is a problem that should be corrected before using the boat.

The green light on the fire extinguisher/override control panel will go off, the red light will glow and an alarm will sound if activation should occur during the operation of the boat. You may also hear a rushing air sound as the extinguishing agent discharges.

There is an engine cut out circuit that automatically shuts down the engines and generator when the system is activated. A system override switch enables the operator to override the shutdown circuit and restart the engines. The cut out circuit is necessary because diesel engines will consume the fire extinguishing agent if they are allowed to run. If the engines continue to run, they should immediately be shut down manually, provided it is safe to do so. The fire extinguishing agent will shut down gasoline engines which can be restarted once the fire extinguishing agent has dissipated from the engine compartment.

When sufficient time has elapsed for the fire to be extinguished and a flashback is no longer possible, find and fix the problem, then the override switch can be moved to the "OVERRIDE" position and the engines can be restarted.



Automatic Fire Extinguishing System in the Engine Compartment



Override Switch and Fire Extinguisher Indicator Lights



DIESEL ENGINES WILL CONSUME EXTINGUISHING AGENT. IF THE SYSTEM DISCHARGES THE ENGINES DON'T SHUT DOWN AUTOMATICALLY, THEY MUST BE IMMEDIATELY SHUT DOWN MANUALLY. IF A DIESEL ENGINE IS ALLOWED TO RUN IN THIS SITUATION, IT WILL CONSUME THE EXTINGUISHING AGENT AND FLASH BACK COULD RESULT.



IF ACTIVATION SHOULD OCCUR, IMMEDIATELY SHUT DOWN ALL ENGINES. TURN OFF ALL ELECTRICAL SYSTEMS, POWERED VENTILATION AND EXTINGUISH ALL SMOKING MATERIALS. DO NOT OPEN THE ENGINE COMPARTMENT HATCH IMMEDIATELY!! THIS FEEDS OXYGEN TO THE FIRE AND FLASH BACK COULD RESULT. ALLOW THE EXTINGUISHING AGENT TO SOAK THE ENGINE COMPARTMENT FOR AT LEAST 15 MINUTES AND WAIT FOR HOT METALS OR FUELS TO COOL BEFORE CAUTIOUSLY INSPECTING FOR CAUSE OR DAMAGE. HAVE AN APPROVED PORTABLE FIRE EXTINGUISHER AT HAND AND READY FOR USE. DO NOT BREATHE FUMES OR VAPORS CAUSED BY THE FIRE!!



THE OWNER'S MANUAL PROVIDED BY THE FIRE EXTINGUISHING SYSTEM MANUFACTURER SHOULD BE INCLUDED WITH YOUR BOAT. IT IS ESSENTIAL THAT YOU READ THE INFORMATION CAREFULLY AND COMPLETELY UNDERSTAND THE SYSTEM IN THEORY AND OPERATION BEFORE USING YOUR BOAT. IF YOU DID NOT RECEIVE THE FIRE EXTINGUISHING SYSTEM OWNER'S MANUAL, PLEASE CONTACT YOUR DEALER OR THE MONTEREY CUSTOMER SERVICE DEPARTMENT.

11.6 Carbon Monoxide Monitoring System



CARBON MONOXIDE IS COLORLESS, ODORLESS AND DANGEROUS. ALL ENGINES, GENERATORS AND FUEL BURNING APPLIANCES EXHAUST CARBON MONOXIDE (CO). DIRECT AND PROLONGED EXPOSURE TO CO WILL CAUSE BRAIN DAMAGE OR DEATH. SIGNS OF EXPOSURE TO CO INCLUDE NAUSEA, DIZZINESS AND DROWSINESS.

The carbon monoxide (CO) detector is installed in the cabin as standard equipment and warns the occupants of dangerous accumulations of carbon monoxide gas. If excess carbon monoxide fumes are detected, the detector will sound an alarm indicating the presence of the toxic gas.

Should a very high level of carbon monoxide exist, the alarm will sound in a few minutes. However, if small quantities of CO are present or high levels are short-lived, the alarm will accumulate the information and determine when an alarm level has been reached. The carbon monoxide detector is automatically activated whenever the house battery switch is "ON". The power light on the carbon monoxide detector should be lit to indicate that the carbon monoxide detector is activated. **Always make sure the house battery switch is "ON" and the power light on the carbon monoxide detector is lit whenever the cabin is occupied.**

A by product of combustion, carbon monoxide (CO) is invisible, tasteless, odorless, and is produced by all engines, heating and cooking appliances. The most common sources of CO on boats are the engines, auxiliary generators and propane or butane stoves. These produce large amounts of CO and should never be operated while sleeping.

A slight buildup of carbon monoxide over several hours causes headache, nausea and other symptoms that are similar to food poisoning, motion sickness or flu. High concentrations can be fatal within minutes. Many cases of carbon monoxide poisoning indicate that while victims are aware they are not well, they become so disoriented they are unable to save themselves by either exiting the area or calling for help. Also, young children, elderly persons, and pets may be the first affected.

Drug or alcohol use increases the effect of CO exposure. Individuals with cardiac or respiratory conditions are very susceptible to the dangers of carbon monoxide. CO poisoning is especially dangerous during sleep when victims are unaware of any side effects. The following are symptoms which may signal exposure to CO: (1) Headache (2) Tightness of chest or hyperventilation (3) Flushed face (4) Nausea (5) Drowsiness (6) Fatigue or Weakness (7) Inattention or confusion (8) Lack of normal coordination.

Persons who have been exposed to carbon monoxide should be moved into fresh air immediately. Have the victim breath deeply and seek immediate medical attention. To learn more about CO poisoning, contact your local health authorities.

Low levels of carbon monoxide over an extended period of time can be just as lethal as high doses over a short period. Therefore, low levels of carbon monoxide can cause the alarm to sound before the occupants of the boat notice any symptoms of carbon monoxide poisoning. CO detectors are very reliable and rarely sound false alarms. If the alarm sounds, always assume the hazard is real and move persons who have been exposed to carbon monoxide into fresh air immediately. Never disable the CO detector because you think the alarm may be false. Always contact the detector manufacturer or your local fire department for assistance in finding and correcting the situation.

Remember, carbon monoxide detectors do not guarantee that CO poisoning will not occur. Do not use the CO detector as a replacement for ordinary precautions or periodic inspections of equipment. Never rely on alarm systems to save your life, common sense is still prudent and necessary.

Please read the owner's manual supplied by the CO detector manufacturer and included with this manual, for operation instructions and additional

information regarding the hazards of carbon monoxide gas. Refer to the Ventilation chapter for information on ventilating your boat properly while underway and other precautions while at anchor or in a slip. This is especially essential if your boat is equipped with the optional generator.

Many manufacturers of carbon monoxide detectors offer a testing and recertification program. We recommend that you contact the manufacturer of your carbon monoxide detector and have it tested and recertified periodically.



ACTUATION OF THE CARBON MONOXIDE DETECTOR INDICATES THE PRESENCE OF CARBON MONOXIDE (CO) WHICH CAN BE FATAL. EVACUATE THE CABIN IMMEDIATELY. DO A HEAD COUNT TO CHECK THAT ALL PERSONS ARE ACCOUNTED FOR. DO NOT REENTER THE CABIN UNTIL IT HAS BEEN AIRED OUT AND THE PROBLEM FOUND AND CORRECTED.

11.7 First Aid

It is the operator's responsibility to be familiar with the proper first-aid procedures and be able to care for minor injuries or illnesses of your passengers. In an emergency, you could be far from professional medical assistance. We



strongly recommend that you be prepared by receiving training in basic first aid and CPR. This can be done through classes given by the Red Cross or your local hospital.

Your boat also should be equipped with at least a simple marine first-aid kit and a first-aid manual. The marine first-aid kit should be designed for the marine environment and be well supplied. It should be accessible and each person on board should be aware of its location. As supplies are used, replace them promptly. Some common drugs and antiseptics may lose their strength or become unstable as they age. Ask a medical professional about the supplies you should carry and the safe shelf life of prescription drugs or other medical supplies that may be in your first-aid kit. Replace questionably old supplies whether they have been used or not.

In many emergency situations, the Coast Guard can provide assistance in obtaining medical advice

for treatment of serious injuries or illness. If you are within VHF range of a Coast Guard Station, make the initial contact on channel 16 and follow their instructions.

11.8 Additional Safety Equipment

Besides meeting the legal requirements, prudent boaters carry additional safety equipment. This is particularly important if you operate your boat offshore. You should consider the following items, depending on how you use your boat.

Satellite EPIRBs

EPIRBs (Emergency Position Indicating Radio Beacon) operate as part of a worldwide distress system. When activated, EPIRBs will send distress code homing beacons that allow Coast Guard aircraft to identify and find them quickly. The satellites that receive and relay EPIRB signals are operated by the National Oceanic and Atmospheric Administration (NOAA) in the United States. The EPIRB should be mounted and registered according to the instructions provided with the beacon, so that the beacon's unique distress code can be used to quickly identify the boat and owner.

Marine Radio

A marine radio is the most effective method of receiving information and requesting assistance. VHF marine radios are used near shore and single sideband radios are used for long range communication.

There are specific frequencies to use in an emergency. The VHF emergency channel is 16 in the United States. You should read the owners manual for your radio and know how to use it in an emergency or for normal operation. If you hear a distress call you should assist or monitor the situation until help is provided.

Additional Equipment to Consider:

VHF Radio	Life Raft
Spare Anchor	Fenders
Heaving Line	Mirror
First Aid Kit	Tool Kit
Flashlight & Batteries	Anchor light
Search	Sunburn Lotion
Boat Hook	Ring Buoy
Mooring Lines	Whistle or Horn
Binoculars	Portable Radio
Extra Clothing	Marine Hardware
Chart and Compass	Spare Keys
Food & Water	Spare Parts
Sunglasses	
Spare Propeller	

11.9 Caution and Warning Labels

The caution and warning labels shown are examples of the labels that could be on your boat. The actual labels and their location could vary on your boat.

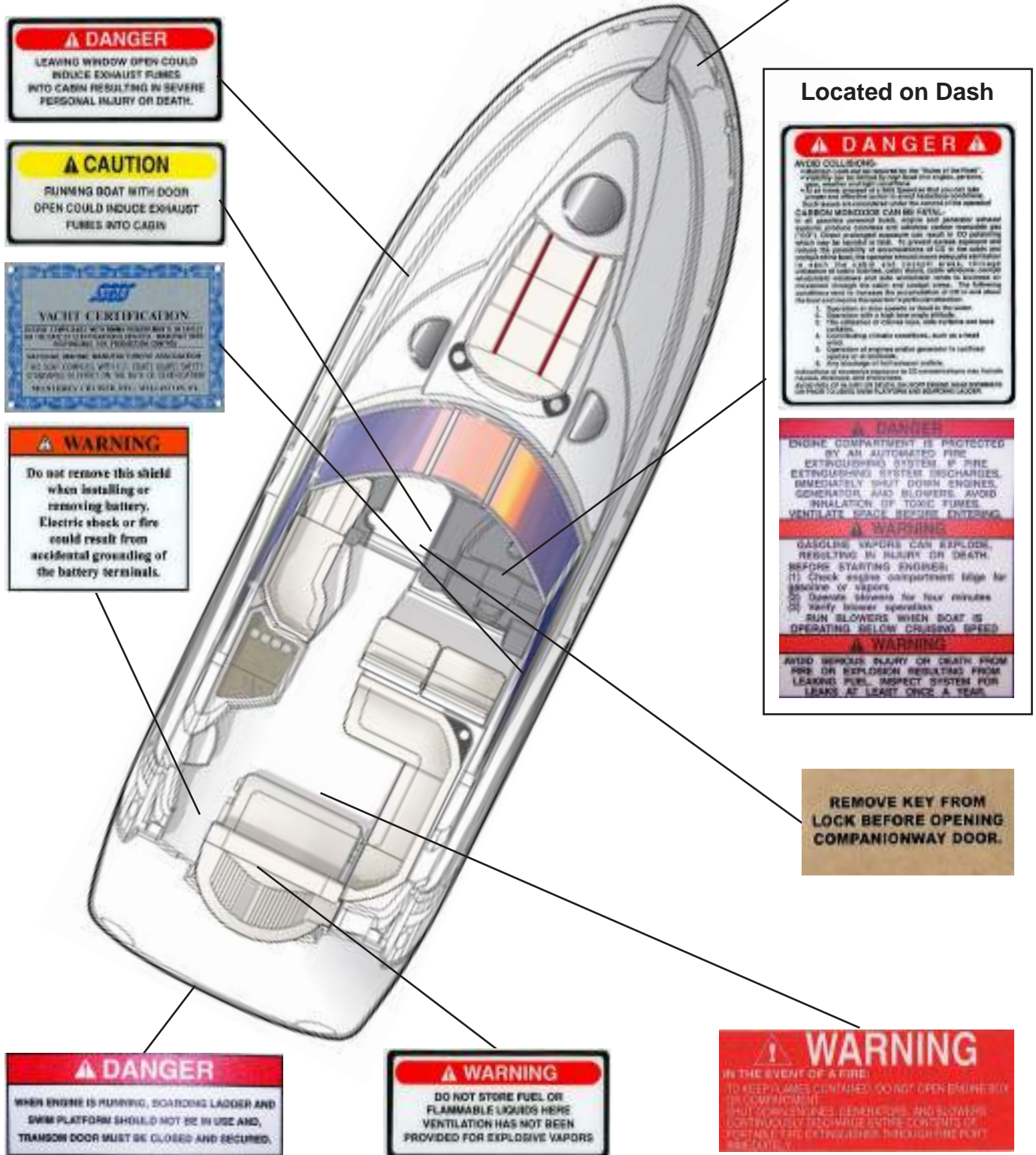

THIS PAGE WAS LEFT BLANK
INTENTIONALLY

OPERATION

12.1 General

Before you start the engines on your Monterey, you should have become familiar with the various component systems and their operation and have performed a "Precruise System Check." A thorough understanding of the component systems and their operation is essential to the proper operation of the boat. This manual and the associated manufacturers' information is provided to enhance your knowledge of your boat. Please read them carefully.

Your boat must have the necessary safety equipment on board and be in compliance with the U.S. Coast Guard, local and state safety regulations. There should be one Personal Flotation Device (PFD) for each person. Nonswimmers and small children should wear PFDs at all times. You should know and understand the "Rules of the Road" and have had an experienced operator brief you on the general operation of your new boat. At least one other person should be instructed on the proper operation of the boat in case the operator is suddenly incapacitated.

The operator is responsible for his safety and the safety of his passengers. When boarding or loading the boat, always step onto the boat, never jump. All passengers should be properly seated whenever the boat is operated above idle speed. Your passengers should not be allowed to sit on the seat backs, gunnels, bows, or transoms whenever the boat is underway. The passengers also should be seated to properly balance the load and must not obstruct the operator's view, particularly to the front.

Overloading and improper distribution of weight can cause the boat to become unstable and are significant causes of accidents. Know the weight capacity and horsepower rating of your boat. Do not overload or overpower your boat.

You should be aware of your limitations and the limitations of your boat in different situations or sea conditions. No boat is indestructible, no matter how well it is constructed. Any boat can be severely damaged if it is operated in a manner that exceeds its design limitations. If the ride is hard on you and your passengers, it is hard on

the boat as well. Always modify the boat speed in accordance with the sea conditions, boat traffic and weather conditions.

Remember, it is the operator's responsibility to use good common sense and sound judgment in loading and operating the boat.

12.2 Rules of the Road

As in driving an automobile, there are a few rules you must know for safe boating operation. The following information describes the basic navigation rules and action to be taken by vessels in crossing, meeting or overtaking situations while operating in inland waters. These are basic examples and not intended to teach all the rules of navigation. For further information consult the "Navigation Rules" or contact the Coast Guard, Coast Guard Auxiliary, Department of Natural Resources, or your local boat club. These organizations sponsor courses in boat handling, including rules of the road. We strongly recommend such courses. Books or videos on this subject also are available from your local library.

Note: Sailboats not under power, paddle boats, vessels unable to maneuver, vessels engaged in commercial fishing and other vessels without power have the right of way over motor powered boats. You must stay clear or pass to the stern of these vessels. Sailboats under power are considered motor boats.

Crossing Situations

When two motor boats are crossing, the boat on the right has the right of way. The boat with the right of way should maintain its course and speed. The other vessel should slow down and permit it to pass. The boats should sound the appropriate signals.

Meeting Head-On or Nearly-So Situations

When two motor boats are approaching each other head-on or nearly head-on, neither boat has the right of way. Both boats should reduce their speed and turn to the right so as to pass port side to port

side, providing enough clearance for safe passage. The boats should sound the appropriate signals.

Overtaking Situations

When one motor boat is overtaking another motor boat, the boat that is being passed has the right of way. The overtaking boat must make the adjustments necessary to provide clearance for a safe passage of the other vessel. The boats should sound the appropriate signals.

The General Prudential Rule

In obeying the Rules of the Road, due regard must be given to all dangers of navigation and collision, and to any special circumstances, including the limitations of the vessels, which may justify a departure from the rules that is necessary to avoid immediate danger or a collision.

Night Operation

Recreational boats are required to display navigation lights between sunset and sunrise and other periods of reduced visibility such as fog, rain, haze, etc. When operating your boat at night you should:

- Make sure your navigation lights are on and working properly. Navigation lights warn others of your position and course and the position and course of other vessels.
- All navigation rules apply. If the bow light of another vessel shows red, you should give way to that vessel, if it shows green, you have the right of way.
- Slow down and never operate at high speeds when operating at night, stay clear of all boats and use good common sense. Always be ready to slow down or steer clear of other vessels, even if you have the right-of-way.
- Avoid bright lights that can destroy night vision, making it difficult to see navigation lights and the lights of other boats. You and your passengers should keep a sharp lookout for hazards, other boats and navigational aids.

Navigation Aids

Aids to navigation are placed along coasts and navigable waters as guides to mark safe water and to assist mariners in determining their position in relation to land and hidden dangers. Each aid to navigation is used to provide specific information. You should be familiar with these and any other markers used in your boating area.

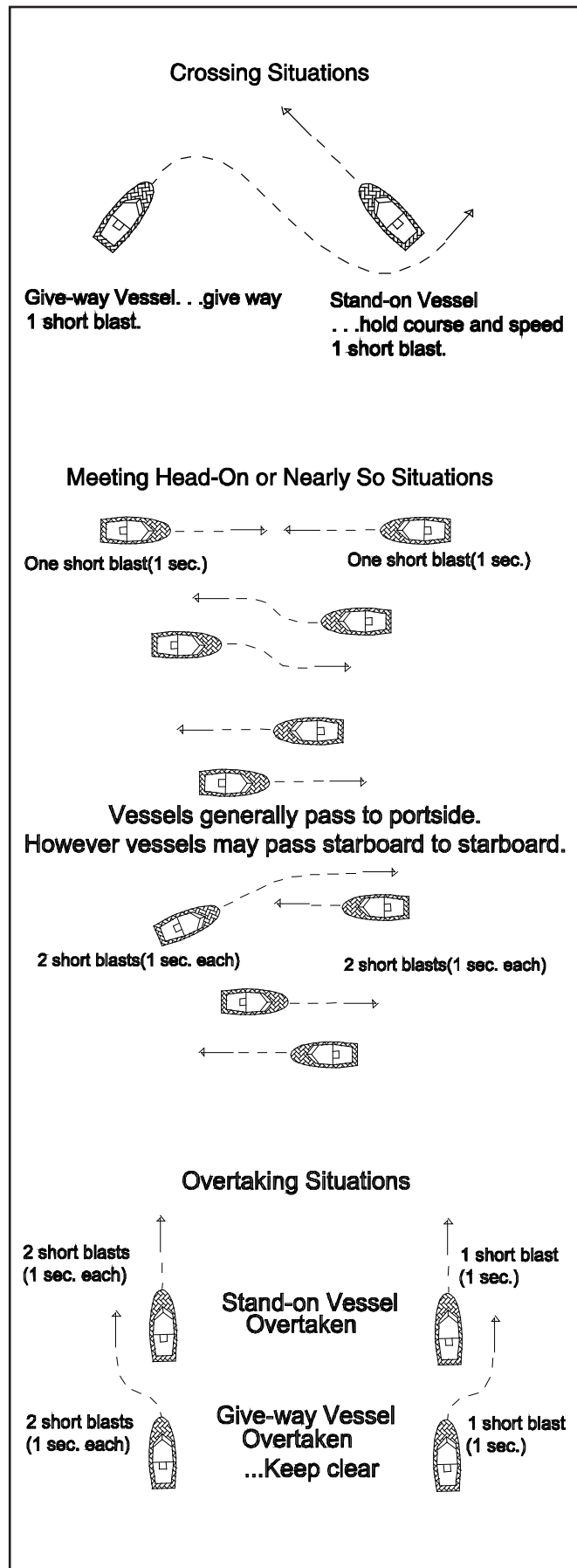

Navigational Aids Chart

REMEMBER THESE RULES

1. OVERTAKING - PASSING: Boat being passed has the right-of-way. KEEP CLEAR.
2. MEETING HEAD ON: Keep to the right.
3. CROSSING: Boat on right has the right-of-way. Slow down and permit boat to pass.

<p>← PORT</p> <p>Yield right-of-way to boats in your DANGER ZONE!</p> <p>STARBOARD →</p> <p>DANGER ZONE (Dead ahead to 2 points abaft your starboard beam)</p>	<p>STORM WARNINGS</p> <p>RED FLAG Small craft (winds to 33 knots)</p> <p>2 RED FLAGS Gale (winds up to 47 knots)</p> <p>SQUARE RED FLAG BLACK BOX (Storm)</p> <p>2 SQUARE RED FLAGS BLACK BOX (Hurricane)</p>																								
<p>WHISTLE SIGNALS</p> <p>ONE LONG BLAST: Warning signal (Coming out of slip)</p> <p>ONE SHORT BLAST: Pass on my port side</p> <p>TWO SHORT BLASTS: Pass on my starboard side</p> <p>THREE SHORT BLASTS: Engine(s) in reverse</p> <p>FOUR OR MORE BLASTS: Danger signal</p>	<p>BRIDGE SIGNALS</p> <table border="0"> <tr> <td>SOUND</td> <td>VISUAL</td> <td>DAY (Flag)</td> <td>NIGHT (Lights)</td> </tr> <tr> <td>VESSEL: Open</td> <td>— ●</td> <td>□</td> <td>○</td> </tr> <tr> <td>BRIDGE: OK</td> <td>— ●</td> <td>▽</td> <td>●</td> </tr> <tr> <td>No</td> <td>●●●●●</td> <td>Same</td> <td>or Same</td> </tr> <tr> <td>VESSEL: Replies:</td> <td>●●●●●</td> <td>No</td> <td>◀ ◻ ▶</td> </tr> <tr> <td>RADIO: VHF CH. 13</td> <td></td> <td></td> <td>◀ ● ▶</td> </tr> </table>	SOUND	VISUAL	DAY (Flag)	NIGHT (Lights)	VESSEL: Open	— ●	□	○	BRIDGE: OK	— ●	▽	●	No	●●●●●	Same	or Same	VESSEL: Replies:	●●●●●	No	◀ ◻ ▶	RADIO: VHF CH. 13			◀ ● ▶
SOUND	VISUAL	DAY (Flag)	NIGHT (Lights)																						
VESSEL: Open	— ●	□	○																						
BRIDGE: OK	— ●	▽	●																						
No	●●●●●	Same	or Same																						
VESSEL: Replies:	●●●●●	No	◀ ◻ ▶																						
RADIO: VHF CH. 13			◀ ● ▶																						

LATERAL AIDS AS SEEN ENTERING FROM SEAWARD

<p>PORT SIDE ODD NUMBERED AIDS</p> <p>GREEN LIGHT ONLY</p> <p>FLASHING: [diagram]</p> <p>OCCULTING: [diagram]</p> <p>QUICK FLASHING: [diagram]</p> <p>ISOPHASE: [diagram]</p> <p>LIGHTED BUOY: G "9" FI G 4sec</p> <p>CAN: G "7"</p> <p>DAYMARK: SG 1 G "1"</p>	<p>SAFE WATER MID-CHANNELS OR FAIRWAYS NO NUMBERS — MAY BE LETTERED</p> <p>WHITE LIGHT ONLY MORSE CODE</p> <p>Mo (A) [diagram] [diagram] [diagram]</p> <p>SPHERICAL: RW SP "G"</p> <p>MR: RW "A"</p> <p>LIGHTED AND OR SOUND: RW "N" Mo (A)</p> <p>PREFERRED CHANNEL NO NUMBERS — MAY BE LETTERED</p> <p>COMPOSITE GROUP FLASHING (2 + 1)</p> <p>GREEN LIGHT ONLY</p> <p>RED LIGHT ONLY</p> <p>PREFERRED CHANNEL TO STARBOARD TOPMOST BAND GREEN: GR "C" FI (2 + 1)</p> <p>PREFERRED CHANNEL TO PORT TOPMOST BAND RED: RG "B" FI (2 + 1)</p> <p>CAN: GR "C" L</p> <p>CAN: RG "B" N "W"</p> <p>DAYMARK: JG A GR "A"</p> <p>DAYMARK: JR B RG "B"</p>	<p>STARBOARD SIDE EVEN NUMBERED AIDS</p> <p>RED LIGHT ONLY</p> <p>FLASHING: [diagram]</p> <p>OCCULTING: [diagram]</p> <p>QUICK FLASHING: [diagram]</p> <p>ISOPHASE: [diagram]</p> <p>LIGHTED BUOY: R "8" FI R 4sec</p> <p>NUN: R "6"</p> <p>DAYMARK: TR 2 R "2"</p>
--	--	--

Note: Storms and wave action can cause buoys to move. You should not rely on buoys alone to determine your position.

12.3 Pre-Cruise Check

Before Starting the Engines:

- Check the weather forecast and sea conditions before leaving the dock. Decide if the planned cruise can be made safely.
- Be sure all required documents are on board.
- Be sure all necessary safety equipment is on board and operative. This should include items like the running lights, spotlight, life saving devices, etc. Please refer to the Safety Equipment chapter for additional information on safety equipment.
- Make sure you have signal kits and flare guns aboard, and they are current and in good operating condition.
- Be sure you have sufficient water and other provisions for the planned cruise.
- Leave a written message listing details of your planned cruise with a close friend ashore (Float Plan). The float plan should include a description of your boat, where you intend to cruise, and a schedule of when you expect to arrive in the cruising area, and when you expect to return. Keep the person informed of any changes in your plan to prevent false alarms. This information will tell authorities where to look and the type of boat to look for in the event you fail to arrive.
- Check the amount of fuel on board. Observe the "rule of thirds:" one third of the fuel for the trip out, one third to return and one third in reserve. An additional 15% may be consumed in rough seas.
- The engine fuel filters should be checked for leaks or corrosion.
- Turn the battery switches on.
- Check the bilge water level. Look for other signs of potential problems. Monitor for the scent of fuel fumes.

- Test the automatic and manual bilge pump switches to make sure the system is working properly.
- Turn on the bilge blower. Check the blower output and operate four (4) minutes before starting the engine. The blower also should be activated when operating below cruising speed and when operating the generator.
- Have a tool kit aboard. The kit should include the following basic tools:

Spark plug wrench	Hammer
Spark plug gap gauge	Electrician's tape
Screwdrivers	Offset screwdrivers
Lubricating oil	Pliers
Jackknife	Adjustable wrench
Basic 3/8" ratchet set	Vise grip pliers
Hex key set	Needle nose pliers
Wire crimping tool	Wire connector Set
End wrench set	Medium slip-joint pliers
Diagonal cutting pliers	DC electrical test light



THERE MUST BE AT LEAST ONE PERSONAL FLOTATION DEVICE ON BOARD FOR EVERY PERSON ON BOARD AND ONE THROW-OUT FLOTATION DEVICE. CHECK THE U.S. COAST GUARD STANDARDS FOR THE CORRECT TYPE OF DEVICE FOR YOUR BOAT.

- Have the following spare parts on board:

Extra light bulbs	Spark plugs
Fuses and	circuit breakers
Main 12-volt fuses	Assorted stainless screws
Assorted stainless bolts	Flashlight and batteries
Drain plugs	Engine oil
Transmission oil	Propellers
Propeller nuts	Fuel filters
Fuel hose and clamps	Wire ties
Engine cooling pump	Hydraulic oil
Impeller Kit	Assorted hose
Clamps	Rags
Steering fluid	Pump & alternator belts

- Make sure all fire extinguishers are in position and in good operating condition.

12.4 Operating Your Boat

After Starting the Engines:

- Check the engine gauges. Make sure they are reading normally.
- Visibly check the engines to be sure there are no apparent water, fuel or oil leaks.
- Check the operation of the engine cooling systems by monitoring the temperature gauges frequently until the engine temperature stabilizes at normal operating temperature.
- Check the steering and engine controls for proper operation.
- Make sure all lines, cables, anchors, etc. for securing a boat are on board and in good condition. All lines should be coiled, secured and off the decks when underway.
- Have a safe cruise and enjoy yourself.

Remember:

When you operate a boat, you accept the responsibility for the boat, for the safety of passengers and for others out enjoying the water.

- Alcohol and any drugs can severely reduce your reaction time and affect your better judgement.
- Alcohol severely reduces the ability to react to several different signals at once.
- Alcohol makes it difficult to correctly judge speed and distance, or track moving objects.
- Alcohol reduces night vision, and the ability to distinguish red from green.



YOU SHOULD NEVER OPERATE YOUR BOAT WHILE UNDER THE INFLUENCE OF ALCOHOL OR DRUGS.

- Make sure one other person on the boat is instructed in the operation of the boat.
- Make sure the boat is operated in compliance with all state and local laws governing the use of a boat.



DO NOT OPERATE THE BOAT UNLESS IT IS COMPLETELY ASSEMBLED. KEEP ALL FASTENERS TIGHT. KEEP ADJUSTMENTS ACCORDING TO SPECIFICATIONS.

- Always operate the blowers when operating the boat below cruising speed or when the generator is running to help cool the engine compartment and remove dangerous fumes.
- Avoid sea conditions that are beyond the skill and experience of you and your crew. Learn to understand weather patterns and indications for change. You should monitor NOAA weather broadcasts before leaving port and periodically while boating. If the weather deteriorates or a storm approaches, seek shelter in a safe harbor.
- Use caution during periods of reduced visibility due to weather or operation conditions. Reduce speed and designate a passenger to be a lookout for other boats, obstacles and navigational markers until you reach port or conditions improve.
- Your Monterey is a heavy boat that will produce a large wake at certain speeds. You are responsible for damage and injury caused by your boat's wake. Always observe no wake zones and be aware that your wake can endanger small vessels and their passengers. Always be courteous and slow down to reduce your wake when passing smaller boats.
- Before operating the boat for the first time, read the engine break-in procedures. The break-in procedures are found in the owner's manual for the engines. The manual is in the literature packet.
- As different types of engines are used to power the boat, have the dealer describe the operating procedures for your boat. For more instructions on "How To Operate The Boat," make sure you read the instructions given to you in the owner's manual for the engines you have selected.

Note: For more instructions on safety, equipment and boat handling, enroll in one of the several free boating courses offered. For information on the courses offered in your area, call the "Boating Course Hotline," 1-800-368-5647.

Note: If the running gear hits an underwater object, stop the engines. Inspect the propulsion system for damage. If the system is damaged, contact your dealer for a complete inspection and repair of the unit.

To stop the boat, follow this procedure:

- Allow the engines to drop to the idle speed.
- Make sure the shifting levers are in the neutral position.

Note: If the engines have been run at high speed for a long period of time, allow the engines to cool down by running the engines in the idle position for 3 to 5 minutes.

- Turn the ignition keys to the "OFF" position.
- Raise the trim tabs to the full up position.

After Operation:

- If operating in saltwater, wash the boat and all equipment with soap and water.
- Check the bilge area for debris and excess water.
- Fill the fuel tanks to near full to reduce condensation. Allow enough room in the tanks for the fuel to expand without being forced out through the vent.
- Turn off all electrical equipment except the automatic bilge pumps.
- If you are going to leave the boat for a long period of time, put the battery main switches in the "OFF" position and close all sea cocks.
- Make sure the boat is securely moored.

12.5 Docking, Anchoring and Mooring Docking and Dock Lines

Maneuvering the boat near the dock and securing the boat requires skill and techniques that are unique to the water and wind conditions and the layout of the dock. If possible, position a crew member at the bow and stern to man the lines and assist in docking operations. While maneuvering close to the dock, consideration must be giving to the wind and current. You should anticipate the effect these forces will have on the boat and use them to help put the boat where you want it. It is important to practice in open water using an imaginary dock enough to develop a sense for the way your boat handles in a variety of docking scenarios. You must be able to foresee the possibilities and have solutions in mind before problems occur.

Approaching a dock or backing into a slip in high winds or strong currents requires a considerable amount of skill. If you are new to boat handling, you should take lessons from an experienced pilot to learn how to maneuver your boat in tight quarters in less than ideal conditions. You should also practice away from the dock during windy conditions.

Dock lines are generally twisted or braided nylon. Nylon is strong and stretches to absorb shock. It also has a long life and is soft and easy on the hands. The line's size will vary with the size of the boat. Typically a 30 to 40 foot boat will use 5/8-inch line and a 20 to 30 foot boat will use 1/2-inch line. The number of lines and their configuration will vary depending on the dock, the range of the tide, and many other factors. Usually a combination of bow, stern and spring lines is used to secure the boat.

Maneuvering to the Dock

Approach the dock slowly at a 30 to 40 degree angle. Whenever possible, approach against the wind or current. Turn the outdrives straight & shift to neutral when you feel you have enough momentum to reach the dock. Use reverse on the engines while turning the steering wheel toward the dock to slow the boat and pull the stern toward the dock as the boat approaches. Straighten the outdrives and use the engines to stop the boat if it is still moving forward against the pilings. If you executed your approach properly, the boat will lightly touch the pilings at the same time the forward momentum is stopped. Have the dock lines ready and secure the boat as soon as it stops. Use fenders to protect the boat while



TO PREVENT DAMAGE TO THE BOAT, CLOSE ALL SEA COCKS BEFORE LEAVING THE BOAT.

it is docked. Keep the engines running until the lines are secured.

Backing into a Slip

Approach the slip with the stern against the wind or current and the outdrives straight ahead. Use the engines and turn the steering wheel to maneuver the boat into alignment with the slip. Reverse the engines and slowly back into the slip. Shift from reverse to neutral frequently to prevent the boat from gaining too much speed. Move the stern right and left by shifting the engines in and out of gear or turning the wheel. When nearly in the slip all the way, straighten the outdrives and shift to forward to stop. Keep the engines running until the lines are secured.

Securing Dock Lines

Securing a boat that is tied along side the dock typically requires a bow and stern line and two spring lines. The bow and stern lines are usually secured to the dock at a 40° angle aft of the stern cleat and forward of the bow cleat. The after bow spring line is secured to the dock at a 40° angle aft of the after bow spring cleat. The forward quarter spring line is secured to the dock at a 40° angle forward of the stern cleat or the stern spring cleat. The spring lines keep the boat square to the dock and reduce fore and aft movement while allowing the boat to move up and down with the tide.

Securing a boat in a slip is somewhat different. It typically requires two bow lines secured to pilings on each side of the bow, two stern lines secured to the dock and two spring lines that prevent the boat from hitting the dock. The bow lines are typically secured with enough slack to allow the boat to ride the tide. The stern lines are crossed. One line runs from the port aft boat cleat to the starboard dock cleat and the other line runs from the starboard aft boat cleat to the port cleat on the dock. The stern lines center the boat, control the forward motion, and allow the boat to ride the tide. Two forward quarter spring lines typically are secured to the stern cleats and to mid ship pilings or cleats. The spring lines keep the boat from backing into the dock while allowing it to ride the tide.

Leaving the Dock

Always start the engines and let them warm up for several minutes before releasing the lines. Boats steer from the stern and it is important that you achieve enough clearance at the stern to maneuver the boat as quickly as possible. Push the stern off and maneuver such that you get stern

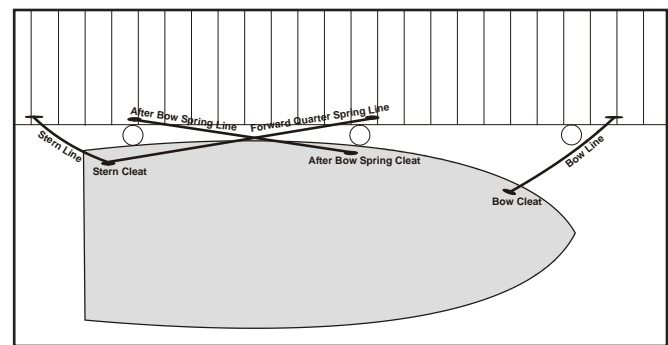

Securing The Boat Along Side A Dock (Typical)

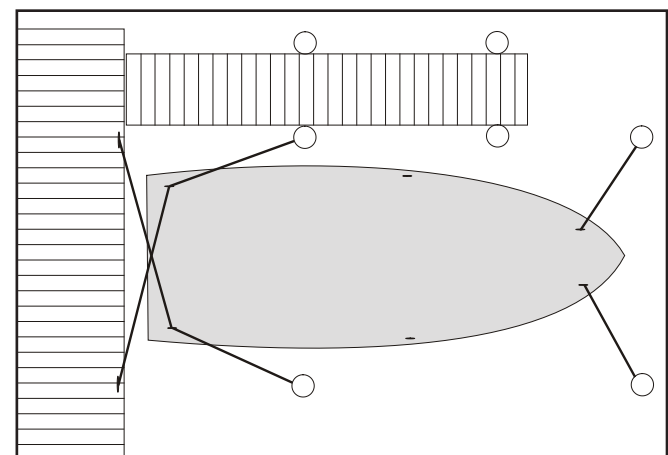

Securing The Boat In A Slip (Typical)

clearance quickly. Proceed slowly until well clear of the dock and other boats.

Mooring

Approach the mooring heading into the wind or current. Shift to neutral when you have just enough headway to reach the buoy. Position a crew member on the bow to retrieve the mooring with a boat hook and secure the line. Keep the engines running until the line is secured.

Leaving a Mooring

Start the engines and let them warm up for several minutes before releasing the mooring line. The boat will already be headed into the wind, so move it forward enough to loosen the line and untie it. Back the boat away from the mooring until you can see the buoy. Move the boat slowly away from the mooring.

Anchoring

Make sure the bitter end of the anchor line is attached to boat before dropping the anchor. Bring the bow into the wind or current and put the engine in neutral. When the vessel comes to a stop,

lower the anchor over the bow. Pay out anchor line so that it is at least 5 to 7 times the depth of the water and secure the line to a cleat. Use caution to avoid getting your feet or hands tangled in the line. Additional scope of 10 times the depth may be required for storm conditions. Check landmarks on shore to make sure the anchor is not dragging. If it is dragging, you will have to start all over. It is prudent to use two anchors if you are anchoring overnight or in rough weather.

Releasing the Anchor

Release the anchor by driving the boat slowly to the point where the anchor line becomes vertical. It should release when you pass that point. If the anchor doesn't release right away, stop the boat directly above the anchor and tie the line to the cleat as tight as possible. The up and down movement of the boat will usually loosen the anchor within a minute. Make sure you secure the anchor and properly stow the line before operating the boat.



NEVER ANCHOR THE BOAT BY THE STERN. THE STERN OF THE BOAT IS VULNERABLE TO SWAMPING FROM WAVE ACTION AND WIND AND CURRENT WILL PUT MORE STRESS ON THE ANCHOR WHEN IT IS ATTACHED TO THE STERN. ONLY ANCHOR THE BOAT BY THE BOW

12.6 Controls, Steering, or Propulsion System Failure:

If the propulsion, control or steering system fails while you are operating the boat, bring both throttles to idle and shift to neutral. Decide whether you need to put out the anchor to prevent the boat from drifting or to hold the bow into the seas. Investigate and correct the problem if you can. Turn the engines off before going into the engine compartment to make repairs. If you are unable to correct the problem, call for help.

If only one engine has failed, you can usually run home on the other engine. Be careful not to apply too much power to the engine that is running. When only one engine is used to power a twin engine boat, that engine is over propped and can be overloaded if too much throttle is applied. You should contact your dealer or the engine manufacturer for the maximum power settings when running on one engine.

12.7 Collision

If your boat is involved in a collision with another boat, dock, piling or a sandbar, your first priority is to check your passengers for injuries and administer first aid if necessary. Once your passengers situations are stabilized, thoroughly inspect the boat for damage. Check below decks for leaks and the control systems for proper operation. Plug all leaks or make the necessary repairs to the control systems before proceeding slowly and carefully to port. Request assistance if necessary. Haul the boat and make a thorough inspection of the hull and running gear for damage.

12.8 Grounding, Towing and Rendering Assistance

The law requires the owner or operator of a vessel to render assistance to any individual or vessel in distress, as long as his vessel is not endangered in the process.

If the boat should become disabled, or if another craft that is disabled requires assistance, great care must be taken. The stress applied to a boat during towing may become excessive. Excessive stress can damage the structure of the boat and create a safety hazard for those aboard.

Freeing a grounded vessel, or towing a boat that is disabled, requires specialized equipment and knowledge. Line failure and structural damage caused by improper towing have resulted in fatal injuries. Because of this, we strongly suggest that these activities be left to those who have the equipment and knowledge, e.g., the U.S. Coast Guard or a commercial towing company, to safely accomplish the towing task.



THE MOORING CLEATS ON MONTEREY BOATS ARE NOT DESIGNED OR INTENDED TO BE USED FOR TOWING PURPOSES. THESE CLEATS ARE SPECIFICALLY DESIGNED AS MOORING CLEATS FOR SECURING THE BOAT TO A DOCK, PIER, ETC. DO NOT USE THESE FITTINGS FOR TOWING OR ATTEMPTING TO FREE A GROUNDED VESSEL.



WHEN TOWING OPERATIONS ARE UNDERWAY, HAVE EVERYONE ABOARD BOTH VESSELS STAY CLEAR OF THE TOW LINE AND SURROUNDING AREA. A TOW LINE THAT SHOULD BREAK WHILE UNDER STRESS CAN BE VERY DANGEROUS, AND COULD CAUSE SERIOUS INJURY OR DEATH.



RUNNING AGROUND CAN CAUSE SERIOUS INJURY TO PASSENGERS AND DAMAGE TO A BOAT AND ITS UNDERWATER GEAR. IF YOUR BOAT SHOULD BECOME GROUNDED, DISTRIBUTE PERSONAL FLOTATION DEVICES AND INSPECT THE BOAT FOR POSSIBLE DAMAGE. THOROUGHLY INSPECT THE BILGE AREA FOR SIGNS OF LEAKAGE. AN EXPERIENCED SERVICE FACILITY SHOULD CHECK YOUR UNDERWATER GEAR AT THE FIRST OPPORTUNITY. DO NOT CONTINUE TO USE YOUR BOAT IF THE CONDITION OF THE UNDERWATER EQUIPMENT IS QUESTIONABLE.

12.9 Flooding or Capsizing

Boats can become unstable if they become flooded or completely swamped. You must always be aware of the position of the boat to the seas and the amount of water in the bilge. Water entering the boat through the transom door or over the stern gunnels can usually be corrected by turning the boat into the waves. If the bilge is flooding because of a hole in the hull or a defective hose, you may be able to plug it with rags, close the thru-hull valve or assist the pumps by bailing with buckets. Put a mayday call in to the Coast Guard or nearby boats and distribute life jackets as soon as you discover your boat is in trouble.

If the boat becomes swamped and capsizes, you and your passengers should stay with the boat as long as you can. It is much easier for the Coast Guard, aircraft, or other boats to spot, than people in the water. If your boat is equipped with an EPIRB, make sure it is activated. When activated, EPIRBs will send distress code homing beacons that allow Coast Guard aircraft to identify your boat and find you quickly.

12.10 Fishing

Fishing can be very exciting and distracting for the operator when the action gets intense. You must always be conscious of the fact that your primary responsibility is the safe operation of your boat and the safety of your passengers and other boats in the area.

You must always make sure the helm is properly manned and is never left unattended while trolling. If you are fishing in an area that is crowded with other fishing boats, it may be difficult to follow the rules of the road. This situation can become especially difficult when most boats are trolling. Being courteous and exercising good common

sense is essential. Avoid trying to assert your right of way and concentrate on staying clear and preventing tangled or cut lines and other unpleasant encounters with other boats. Also keep in mind that fishing line wrapped around a propeller shaft can damage the strut bearing.

12.11 Man Overboard

If someone falls overboard, you must be prepared to react quickly, particularly when you are offshore. The following procedures will help you in recovering a person that has fallen overboard.

- Immediately stop the boat and sound a man overboard alarm and have all passengers point to the person in the water.
- Circle around quickly and throw a cushion or life jacket to the person, if possible, and another to use as a marker.
- Keep the person on the driver side of the boat so you can keep him in sight at all times.
- Make sure to approach the person from the downwind side and maneuver the boat so the propellers are well clear of the person in the water.
- Turn off the engines when the person is alongside and use a ring buoy with a line attached, a paddle or boat hook to assist him to the boat. Make sure you don't hit him with the ring buoy or the boat.
- Pull the person to the boat and assist him on board.
- Check the person for injuries and administer first aid if necessary. If the injuries are serious, call for help. Refer to the Safety Equipment chapter for more information on first aid and requesting emergency medical assistance.



MOVING PROPELLERS ARE DANGEROUS. THEY CAN CAUSE DEATH, LOSS OF LIMBS, OR OTHER SEVERE INJURY. DO NOT USE THE SWIM PLATFORM OR SWIM LADDER WHILE THE ENGINE(S) ARE RUNNING. STOP THE ENGINE(S) IF DIVERS OR SWIMMERS ARE ATTEMPTING TO BOARD. ALWAYS PROPERLY STORE THE LADDER BEFORE STARTING THE ENGINE(S).

12.12 Trash Disposal

The discharge of plastic trash or trash mixed with plastic is illegal anywhere in the marine environment. U.S. Coast Guard regulations also restrict the dumping of other forms of garbage. Regional, State, and local restrictions on garbage discharges also may apply.

Responsible boaters store refuse in bags and dispose of it properly on shore. You should make sure your passengers are aware of the local waste laws and the trash management procedure on your boat. Refer to the placard mounted on your boat for more specific information regarding solid waste disposal.

12.13 Transporting Your Boat





Your Monterey is a large boat and should only be trailered by professionals that have the knowledge and equipment to move large boats without causing damage.

Please contact your dealer or the Monterey Boats Customer Service Department if you are planning to transport your boat and have any questions in regard to the proper equipment and support for the hull.



BOATS HAVE BEEN DAMAGED BY TRAILERS THAT DON'T PROPERLY SUPPORT THE HULL. ALWAYS MAKE SURE THE TRAILER BUNKS AND PADS ARE ADJUSTED SO THEY ARE NOT PUTTING EXCESSIVE PRESSURE ON THE LIFTING STRAKES AND ARE PROVIDING ENOUGH SUPPORT FOR THE HULL. HULL DAMAGE RESULTING FROM IMPROPER TRAILER SUPPORT IS NOT COVERED BY THE MONTEREY WARRANTY.

It is illegal for any vessel to dump plastic trash ANYWHERE in the ocean or navigable waters of the United States. Annex V of the MARPOL TREATY is an International Law for a cleaner, safer marine environment. Violation of these requirements is a Class D felony and may result in civil penalty up to a \$25,000 fine and imprisonment.

 U.S. Lakes, Rivers, Bays sounds and 3 miles from shore ILLEGAL TO DUMP Plastic & Garbage Paper Metal Rags Crockery Glass Dunnage Food	 3 to 12 miles ILLEGAL TO DUMP Plastic Dunnage, lining & packing materials that float, also if not ground to less than one inch Paper Crockery Rags Metal Glass Food	 12 to 25 miles ILLEGAL TO DUMP Plastic Dunnage, lining & packing materials that float	 Outside 25 miles ILLEGAL TO DUMP Plastic
---	---	--	---

Regional state and local regulations may further restrict the disposal of garbage. The discharge of all garbage into the Great Lakes or their connecting or tributary waters is prohibited.



ROUTINE MAINTENANCE

13.1 Exterior Hull and Deck

Hull Cleaning-Below The Water Line

Your Monterey hull is manufactured using state-of-the-art materials and processes. A layer of super tough, Ashland "AME" Resin with high density and superior adhesion properties provides an exceptionally effective barrier to osmotic blistering.

Osmosis is caused by a chemical reaction between water and substances in the hull laminate below the waterline. If water breaches the exterior gelcoat and barrier layer, it can react with the chemical components in the laminate creating acidic substances. These substances create pressure behind the gelcoat which causes blisters.



SANDBLASTING THE HULL BOTTOM WILL DAMAGE THE FIBERGLASS. USE A FIBERGLASS WAX REMOVER AND SAND TO SCUFF THE GELCOAT SURFACE. THE INSTRUCTIONS AND RECOMMENDATIONS OF THE BARRIER COATING AND ANTIFOULING PAINT MANUFACTURERS SHOULD BE FOLLOWED EXACTLY.



BARRIER COATINGS AND BOTTOM PAINT SHOULD BE APPLIED ONLY BY QUALIFIED MARINE PROFESSIONALS IN A BOATYARD OR DEALERSHIP THAT SPECIALIZES IN THEIR APPLICATION. USE ONLY STANDARD, HIGH QUALITY ANTIFOULING PAINTS AND BARRIER COATINGS FROM NAME BRAND MANUFACTURES SUCH AS INTERLUX AND PETTIT.

DO NOT ALLOW THE HULL ANTIFOULING PAINT TO CONTACT THE OUTDRIVE. MOST ANTIFOULING PAINTS DESIGNED FOR HULL BOTTOMS CONTAIN COPPER AND CAN CAUSE SEVERE GALVANIC CORROSION DAMAGE TO THE OUTDRIVE UNIT. USE ONLY ANTIFOULING PAINT DESIGNED FOR OUTDRIVES AND OUTBOARD MOTORS. ALWAYS LEAVE A ONE INCH BARRIER BETWEEN THE HULL BOTTOM PAINT AND OUTDRIVE.

Most bottom paints require some maintenance. Proper maintenance is especially important when the boat is in saltwater and not used for extended periods or after dry storage. If the hull bottom

has been painted with antifouling paint, contact your dealer for the recommended maintenance procedures.

Most bottom paints require some maintenance. Proper maintenance is especially important when the boat is in saltwater and not used for extended periods or after dry storage. If the hull bottom has been painted with antifouling paint, contact your dealer for the recommended maintenance procedures.

Sacrificial Anodes

Sacrificial anodes are installed on the inboard engines' freshwater cooling system, outdrives and on the transom. The transom anode is connected to the bonding system and protects the trim tab hinges, metal thru-hull fittings and other underwater hardware that is bonded. Additional anodes should be installed on the trim tab planes if the boat is to be left in the water, if not already installed.

The anodes are less noble than copper based alloys, aluminum and stainless steel. They will deteriorate first, protecting the more noble engine and underwater hardware against galvanic corrosion. Anodes should be checked monthly and changed when they are 75% of their original size. Additionally, anodes that are subjected to frequent wetting and drying require periodic scraping with sandpaper to remove scale and oxidation to maintain their effectiveness.

When replacing the anodes, make sure the contact surfaces are clean, shiny metal and free of paint and corrosion. Never paint over the anode. The bonding system should be inspected by a qualified marine electrician once a year to make sure all connections are sound and there is continuity throughout the system.

Boats stored in saltwater will normally need to have the anodes replaced every 6 months to one year. Anodes requiring replacement more frequently may indicate a stray current problem within the boat or at the slip or marina. Anodes that do not need to be replaced after one year may not be providing the proper protection. Loose or

low quality anodes could be the problem. There could also be a problem in the bonding system. Contact your dealer for the proper size and type of anodes to be used and the specific installation procedure.

Note: Your Volvo Penta or Mercruiser product has been shipped with Aluminum anodes. Aluminum is effective in both saltwater and in fresh water. If you will be boating in saltwater exclusively, we recommend switching the anodes to Zinc. If you will be boating in fresh water exclusively, we recommend switching the anodes to Magnesium. Using the recommended anode is more critical when stainless steel propellers are installed. Consult your dealer or the engine manufacturer for information on the proper anode for your boating area.

Fiberglass Gelcoat Surfaces

- Keep the gelcoat surface out of direct sunlight or covered when it is not in use.
- Wash gelcoat frequently (daily in salt or polluted environments) with mild detergent and plenty of fresh water. Remove any stains quickly. Gelcoat is microscopically porous, so long term staining may become permanent.
- Regularly (monthly in salt or polluted environments) wax gelcoat surfaces with marine grade wax recommended for fiberglass finishes. The washing and waxing of your boat will have the same beneficial effects as they have on an automobile finish. The wax will fill minute scratches and pores thus helping to prevent soiling and will extend the life of the gelcoat.

DON'TS

- Do not use plastic or other nonporous (non-breathable) materials to cover gelcoat surfaces. Trapped moisture from condensation can cause gelcoat damage. Shrink wrap storage covers must be properly ventilated, including hull sides.
- Do not use abrasives, bleaches, ammonia, acids or harsh detergents. See your dealer for special marine formulations. Harsh abrasive and chemical cleaners are not recommended because they can damage or dull the gelcoat, reducing its life and making it more susceptible to stains.

- NEVER apply wax or buffing compound to a gelcoat surface in direct sunlight.
- Do not attempt to remove stains and scratches. Chalking, stains, and minor scratches can be removed in most cases with careful rubbing and polishing with appropriate chemicals and is best done by a professional - see your dealer.

After the boat is exposed to the direct sunlight for a period of time, the color in the gelcoat tends to fade, dull or chalk. A heavier buffing is required to bring the gelcoat back to its original luster. For power cleaning use a light cleaner. To clean the boat by hand, use a heavier automotive cleaner. Before cleaning the surfaces, read the instructions given with the cleaner. After cleaning the surfaces, apply wax and polish all fiberglass surfaces except the nonskid areas.

If the fiberglass should become damaged and need repair, contact your dealer for an authorized repair person to make the repairs.

Stainless Steel Hardware

Marine grade stainless steel components such as hardware, cleats, eyes and rails offer superior corrosion resistance. When properly maintained, stainless steel will not rust or stain, even in harsh saltwater environments. However, if not maintained, stainless steel can rust, discolor or even corrode. The following guidelines will help keep stainless steel looking good for years to come.

DO'S

- Clean stainless steel frequently (daily in salt or polluted environments) with mild soap and plenty of water. Any cleaner safe for use on glass is usually safe for stainless.
- Remove rust spots (especially around welds) immediately with a brass, silver or chrome cleaner. Irreversible pitting will develop under rust allowed to remain on stainless for any period of time.
- Remove rust stains on gelcoat. See dealer for recommended product.
- Protect stainless with waxes or polishes suitable for marine use.

GEMPLUX MAINTENANCE INSTRUCTIONS

Job	Cleaning Agents	Method	Comments
Routine Cleaning	Soap and Water	Apply with a sponge or soft cloth. Dry area completely.	Once your stainless is free of discoloration and/or bleeding, spray GEMPLUX Passivation Solution directly onto stainless. Allow to cure for 30-60 seconds. Rinse with fresh water and dry the area. This solution will help re-passivate the stainless steel.
Stubborn stains, discoloration or bleeding	GEMPLUX Cleaning Wax	Apply with soft, dry cloth.	

DON'TS

- Do not use coarse abrasives like sandpaper or steel wool which may actually cause rusting.
- Do not use acids or bleaches which may etch the naturally occurring protective coating.
- Do not leave stainless steel in contact with iron, steel or other metals which cause contamination leading to rust or corrosion.

Gemlux Stainless Steel Hardware

Most of the stainless steel hardware on your boat is made of Gemlux, polished stainless steel. In order to ensure that your Gemlux stainless steel maintains its beautiful finish, it is critical that your care for it properly.



YOUR STAINLESS STEEL CAN BE DAMAGED BY EXPOSURE TO ACIDS AND OTHER CORROSIVE AGENTS FOUND IN MANY CLEANING PRODUCTS. A PARTIAL LIST OF ADDITIVES THAT MAY CAUSE STAINING AND A WEAKENING OF THE FINISH IS PROVIDED BELOW. USE OF THESE AND OTHER SIMILAR SOLUTIONS TO CLEAN YOUR BOAT CAN CAUSE YOUR STAINLESS STEEL TO BLEED AND WILL VOID YOUR WARRANTY.

Chlorsuphonic Acid	Sodium Hypochlorite
Ferrous Lodide	Sulphuric Acid
Hydrobromic Acid	Muriatic Acid
Iodine	On & Off Cleaner
Sodium Chlorite	Rust StainsAway
Sulphur Chloride	Ferrous Chloride
Bleach	Hydrochloric Acid
Comet	Hydrofluoric Acid
EZ-ON EZ-OFF Cleaner	Sodium Bifluoride
Ferric Chloride	Stannic Chloride
Fluorine	SnoBol
Hydrofluosilicic Acid	Soft Scrub
Silver Chloride	Marine Spray Nine

When using the boat in saltwater, the hardware should be washed with soap and water after each use. Frequent cleaning of your of your stainless steel with soap, water and Gemlux Cleaning Wax will help maintain the finish. Always rinse the metal thoroughly with clean water and dry completely. Clean soft cloths or pads should be used. The use of steel wool pads or other highly abrasive brushes or sponges are not recommended and will damage the surface.

Contamination of the surface by chemicals, dirt or other material hinders the passivation process and traps corrosive agents, thus reducing corrosion protection. If your stainless is exposed to such chemicals it should be re-passivated with Gemlux Passivation solution.

For purchase information on the Gemlux Cleaning Wax or Gemlux Passivation Solution, please contact Gemlux at: Phone: 888-436-5891 Fax: 904-269-5905 or on the web at www.gemlux.com.



UNDER NO CIRCUMSTANCES SHOULD ANY ABRASIVE MATERIALS SUCH AS SANDPAPER, BRONZE WOOL, OR STEEL WOOL BE USED ON STAINLESS STEEL. DAMAGE TO THE HARDWARE WILL RESULT.

Anodized Aluminum Surfaces

Anodized aluminum should be washed periodically with soap and water to keep it clean. If the boat is used in saltwater or polluted water, the aluminum should be washed with soap and water after each use. Saltwater allowed to remain on anodized aluminum will penetrate the anodized coating and attack the aluminum.



ONE DRAWBACK TO METAL PROTECTORS IS THAT THEY CAN MAKE THE METAL SLIPPERY. THEREFORE, METAL PROTECTORS SHOULD NOT BE USED ON TOWER LADDERS, STEERING WHEELS AND OTHER AREAS WHERE A GOOD GRIP AND SURE FOOTING IS IMPORTANT.

Stains can be removed from anodized aluminum with a metal polish or fine polishing compound. To minimize corrosion, use a caulking compound or Teflon based sealer to bed hardware and fasteners mounted to aluminum fabrications. If the anodized coating is badly scratched it can be touched up with paint. With proper care, anodized aluminum will provide many years of service.

Powder Coated Aluminum

Powder coated aluminum should be washed periodically with soap and water to keep it clean. If the boat is used in saltwater or polluted water, the aluminum should be washed with soap and water after each use. Saltwater allowed to remain on powder coated aluminum will penetrate the coating and attack the aluminum, usually around fasteners and hardware mounted to the aluminum.

Once a month check for damaged powder coating and corrosion around fasteners and hardware. Nicked or badly scratched powder coating can be sanded and touched up with enamel paint. Corrosion around fasteners will have to be sanded, then touched up with paint. The fasteners will require fiber washers and sealing with caulk or a Teflon based sealer to isolate the fastener from the aluminum and prevent damage to the paint or powder coating when the fastener is installed. Periodically applying automotive or boat wax to the powder coating will provide additional protection from the harsh effects of saltwater.

Always repair scratches, nicks and corroded areas in powder coating as soon as possible. Corrosion left unaddressed will lift the powder coating allowing moisture to travel between the power coating and the aluminum causing the corrosion to spread below the coating and damage the aluminum. If excessive chipping and peeling occurs, it could be an indication of an electrical fault in the boat or aluminum fabrication. You should contact a qualified marine electrician to inspect your boat immediately and correct the problem if you suspect that your boat may have a fault in the aluminum frame. You should also contact Monterey Boats Customer Service.

Note: Boats that are towed behind larger vessels require special attention to the aluminum hardware. The salt spray, salty steam, and chemicals in exhaust gases are particularly corrosive and will eventually penetrate and damage the surface of anodized or powder coated aluminum. It is imperative that the boat and the aluminum are cleaned thoroughly at the completion of each trip or at the end of each day on long cruises to reduce accelerated deterioration of the anodizing or powder coating and premature corrosion to the aluminum.

Chrome Hardware

Use a good chrome cleaner and polish on all chrome hardware.

Acrylic Plastic Glass

Acrylics and Plexiglas have properties that make them ideal for the marine environment. Components such as cabin doors and deck hatches need special care to prevent scratches and other damage. The following guidelines will help keep acrylics and Plexiglas looking good for years to come.

DO'S

- Wash your hatches, windshield connector, side curtains and other clear plastic pieces, as well as other acrylic components on your boat with a mild soap and plenty of lukewarm water.
- Use a clean, soft cloth, applying only light pressure.
- Rinse with clear water and dry by blotting with a damp cloth or chamois.
- Grease, oil or tar may be removed with a good grade of hexane, aliphatic naphtha or kerosene. These solvents may be obtained at a paint or hardware store and should be used in accordance with the manufacturer's recommendations.
- To maintain a high-luster finish on your acrylics, we recommend that after properly cleaning, apply Meguiar's™ Mirror Glaze #10 with a soft towel. Note: If slight scratches appear on acrylics, use Meguiar's™ Mirror Glaze #17

Note: Clear plastic (Isinglass) is subject to ultraviolet (sunlight) degradation over time. It may turn yellow-brown (a burnt appearance) and get brittle.

Two things that can accelerate this degradation are:

1. Direct contact with aluminum or stainless steel frames. Use "Standoffs."
2. In salt water areas, dried salt crystals on the plastic will amplify sunlight. Wash after each use and/or windy days.

DON'T'S

- Do not subject acrylic material to high temperatures when polishing.

- Do not use glass cleaning sprays, cleaners containing ammonia, scouring compounds, or solvents like acetone, alcohol, gasoline, benzene, carbon tetrachloride or lacquer thinner.
- Do not use masking tapes, duct tapes or packing tapes on your acrylic materials.
- Do not drill holes in your acrylic materials without proper drill bits (special bits are used in acrylic material to avoid damage).

13.2 Upholstery, Canvas and Enclosures **Marine Interior Vinyl Upholstery**

The vinyl upholstery used on the headliner and some cushions in the cabin should be cleaned periodically with soap and water. Any stain, spill or soiling should be cleaned up promptly to prevent the possibility of permanent staining. When cleaning, always rub gently. Avoid using products containing ammonia, powdered abrasive cleaners, steel wool, strong solvents, acetone and lacquer solvents or other harsh chemicals as they can cause permanent damage or shorten the life of vinyl. Never use steam heat, heat guns or hair dryers on vinyl.

Stronger cleaners, detergents and solvents may be effective in stain removal, but can cause either immediate damage or slow deterioration. Lotions, sun tan oil, waxes and polishes, etc., contain oils and dyes that can cause stiffening and staining of vinyl.

The following are typical stains and cleaning tips for marine vinyl:

- **For normal cleaning** – In general most common stains can be cleaned using warm, soapy water and clear water rinses. Moderate scrubbing with a medium bristle nylon brush will help to loosen soiling material from the depressions of embossed surfaces. For stubborn stains, use commercially available mild detergents in accordance with manufacturers instructions.

Full strength rubbing alcohol or mineral spirits may be tried cautiously as a last resort on very stubborn stains, if the above suggestions do not work. Indiscriminate use of any solvent or solvent containing cleaner can severely damage or discolor vinyl.

Certain stains may become permanently set unless they are removed immediately. The procedure for the removal of more severe staining agents are outlined below.

- **Ballpoint Ink, Permanent Marker** – Ink spots will stain vinyl permanently. Immediate wiping with rubbing alcohol in a well-ventilated area will remove much of the stain.
- **Oil based paint** – The use of turpentine in a well ventilated area will remove any fresh paint. Dried paint must be moistened carefully with a semisolid gel-type stripper so that the softened paint can be gently scraped away. Rinse with soap and water.

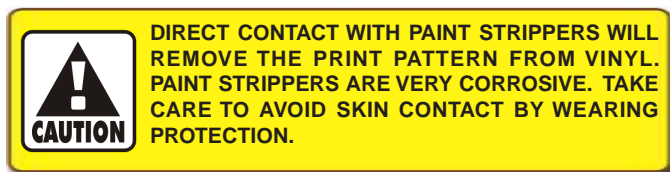

- **Latex paint** – Fresh paint can be wiped off with a damp cloth. Hot soapy water will normally remove dried latex.
- **Tar, Asphalt** – Remove immediately as prolonged contact will result in a permanent stain. Use a cloth lightly dampened with mineral spirits and rub the stain gently, working from the outer edge of the stain towards the center in order to prevent spreading. Rinse with soap and water.
- **Crayon, mustard, ketchup** – Sponge with mild soap and water. For stubborn stains that may have set, use a cloth soaked in diluted mild detergent with gentle rubbing. Any remaining stain should be washed with diluted bleach. Rinse repeatedly with clean water.
- **Chewing gum** – Scrape off as much as possible with a dull knife. Rubbing with an ice cube will assist and make it easier to remove when scraping. The remaining gum should then be removed in a well ventilated area using a cloth saturated with mineral spirits. Use light rubbing. Rinse thoroughly with clean water.

- **Lipstick, grease, oil, eye shadow, shoe polish** – Apply a small quantity of mineral spirits by means of a cloth with gentle rubbing. Take care not to spread the stain by smearing it beyond its original source. No time should be lost in removing shoe polish as it contains a dye that will cause permanent staining. Rinse thoroughly with water.
- **Candy, ice cream, coffee, tea, fruit stains, liquor, wine, suntan lotion, soft drinks** Use clear lukewarm water and a sponge repeatedly. Any loose material should be gently scraped with a dull knife. Any soiled area remaining after drying should be gently rubbed with a cloth spotted with a mild detergent solution. Rinse thoroughly with clean water.
- **Blood, leaf residue** - Sponge the area with a clean cloth soaked in cool water. If stubborn stains remain, use household ammonia and rinse repeatedly with a clean, wet cloth. Do not use hot water or soapsuds, as this will set the stain.
- **Bird excreta, nausea stains** - Sponge the area with soapy water containing diluted bleach until the stain is removed. Rinse thoroughly with water.
- **Urine Stains** – Sponge with soapy water containing a small amount of household ammonia. Rinse thoroughly with clean water.
- **Surface mildew** – Wash with diluted bleach using a soft nylon brush for stubborn growth. Rinse repeatedly with clean cold water.

The following are typical stains and cleaning tips for interior marine vinyl:

- **Dry soil, dust and dirt, dried on dirt** - Remove with a soft cloth. Wash with a soft cloth or nylon brush dampened with water.
- **Variations in surface gloss** - Wipe with a water dampened soft cloth and allow to air dry.
- **Stubborn dirt** - Wash with a soft cloth or soft nylon brush dampened with Ivory Soap® and water. Rinse with clean water.
- **Stubborn spots and stains** - Spray with Tannery Car Care Cleaner® and rub with a soft cloth. Rinse with clean water.

- **Liquid spills** - Wipe immediately with a clean absorbent cloth. Rinse with clean water.
- **Food grease and oily stains** - Spray immediately using either Fantastik Cleaner® or Tannery Car Care Cleaner®, wiping with a soft cloth. Take care not to extend the area of contamination beyond its original boundary. Rinse with clean water.

Additional Warnings for Vinyl Fabrics

- Detergents should not be used on a regular or repeated basis for normal cleaning.
- Powdered abrasives, cleaners containing abrasives, steel wool and industrial strength cleaners are not recommended for vinyl.
- Any lacquer solvent will cause immediate, irreparable damage to the vinyl.
- Wax should never be used on any vinyl upholstery, as it will cause premature embrittlement and cracking.
- Dilute chlorine bleach before using. Never use at full strength.
- If flammable solvents such as alcohol, turpentine or varsol are used for cleaning, then only small quantities should be employed in a well ventilated area. Exercise proper care by advising any personnel in the area and keep away from any ignition source. Always wear protective gloves.

Marine Interior Fabrics

Spot clean only with water based shampoo or foam upholstery cleaner. Pretest a small, inconspicuous area before proceeding. Do not over wet. Do not use solvents to spot clean. Pile fabrics may require brushing with a nonmetallic, stiff bristle brush to restore appearance.

Note: Water extraction or steam cleaning is not a recommended cleaning method. Cushion covers should not be removed and laundered.

To prevent overall soiling, frequent vacuuming or light brushing with a nonmetallic, stiff bristle brush to remove dust and grime is recommended. When cleaning a spill, blot immediately to remove spilled material. Clean spot or stains from the outside to the middle of the affected area to prevent circling.

Use a professional furniture cleaning service when an overall soiled condition has been reached.

Marine Exterior Vinyl Upholstery with PreFixx® Coating

Monterey Boats uses OMNOVA white, smoother and embossed pleated vinyl material with PreFixx top coating. All other accent embossed white and colored vinyl requires different care and maintenance.

PreFixx Cleaning Instructions

PreFixx is engineered so that upholstery can be cleaned again and again without showing signs of wear. With easy cleanability, proven stain and abrasion resistance, PreFixx protective finish can reduce maintenance costs and frequent reupholstery.

Durability

Creates a barrier that resists stains from penetrating to the surface of the vinyl for proven, long-lasting protection. With laboratory-tested stain resistance and improved wear properties, BoltaSoft® upholstery treated with PreFixx protective finish can retain a "like-new" appearance longer.

Easy Maintenance

Enables most common stains like dirt and smudges to wipe off easily. Many difficult stains like ball-point ink also can be cleaned with active solvents, such as nail polish remover, without damaging the PreFixx protective finish (when recommended cleaning instructions are followed).

Normal Care and Cleaning

Remove ordinary dirt and smudges with a mild soap and water solution and a clean, soft cloth or towel. Dry with a soft, lint-free cloth or towel.



THE USE OF VINYL "CONDITIONERS" OR "PROTECTANTS" IS NOT RECOMMENDED AND SHOULD BE AVOIDED ON VINYL UPHOLSTERY TREATED WITH PREFIXX PROTECTIVE FINISH.

Special Cleaning Problems

Although BoltaSoft upholstery treated with PreFixx protective finish is resistant to most common stains, the dyes and pigments in some staining agents have the ability to create a permanent stain if not treated properly. To clean difficult stains from upholstery treated with PreFixx protective finish, locate the staining agent in lists below and

CARPET STAIN REMOVAL INSTRUCTIONS

<p>Miscellaneous Stains</p> <p>Coffee, Tea, Coke, Dye, Fruit Juice, Ice Cream, Motor Oil, Clay, Grease, Blood, Catsup, Chocolate, Milk, Rust, Latex Paint, Water Colors, Berry Stains, Egg, Salad Dressing, Wine, Furniture Polish, Fish Formula, Mayonnaise or urine.</p>	<p>Removal Process</p> <p>Apply warm water and household detergent in minimal amounts to the stained area. Sponge or scrape until stain is removed and wash thoroughly with clean water.</p>
<p>Persistent Stains</p> <p>Chewing Gum, Crayon, Ink, Wax, Lipstick, Tar Polish or Oil Paint.</p>	<p>Removal Process</p> <p>Apply warm water and household detergent. Work well into the stained area, then flush with warm water.</p>

follow its recommended cleaning method. For best results, treat all stains immediately.

Cleaning Tip: To determine the method and type of cleaners, the source of the stain should be identified.

Staining Agents: Baby oil, ketchup, chocolate, motor oil, olive oil, grape juice, urine, blood, hair oil tonic, tea, coffee and betadine. Use Method 1.

Staining Agents: Eye shadow, crayon and grease. Use Method 1. If stains remain, use Method 2.

Staining Agents: Tobacco tar (nicotine) permanent felt tip marker, yellow mustard, lipstick, ballpoint pen and spray paint. Use Method 1. If stains remain, use Method 2. For stubborn stains still remaining, use Method 3.

The recommended cleaners used in Cleaning Methods 1, 2 and 3 are progressively more aggressive. Often, it is better to begin with the least aggressive cleaner and move the next strongest only if the stain remains. NEVER EXCEED a staining agent's recommended cleaner or cleaning method, however.

Method 1

Use one of the following cleaners with a soft cloth or damp sponge. Rinse area with fresh water, and then dry with a clean, lint-free cloth.

- Formula 409® All-Purpose Spray Cleaner
- Fantastik® Spray Cleaner

Method 2

Use a solvent-type cleaner, such as rubbing alcohol (isopropyl alcohol). Rinse cleaned area with fresh water, and then dry with a clean, lint-free cloth.

Method 3

Use a strong, active solvent cleaner diluted in water (70% water/30% solvent cleaner), such as nail polish remover (acetone/water). Clean with a soft cloth or damp sponge. Stain should be removed with less than six (6) rubs. If the stain persists after six rubs, the stain has set and probably cannot be removed. Rinse cleaned area with fresh water, and then dry with a clean, lint-free cloth.



SOME SOLVENTS ARE HIGHLY FLAMMABLE. EXERCISE PROPER CARE IN CLEANING AND NOTIFY PERSONNEL IN AREA OF DANGER. WEAR RUBBER GLOVES DURING ALL CLEANING ACTIVITIES. USE CAUTION IN CLEANING AROUND BUTTONS, STITCHING AND WOODEN OR DECORATIVE TRIM, SINCE THESE SOLVENTS COULD SERIOUSLY DAMAGE SUCH AREAS.

Exterior Carpet

Exterior carpet manufactured by Syntec® Industries is produced with a special blend of resilient fibers to withstand traffic and retain its beauty.

Carpets manufactured by Syntec are inherently stain-resistant. To keep your carpet at its best, we recommend regular vacuuming for general cleaning, soap and water for hard-to-remove spots and an approved cleaner for deep cleansing and to revitalize the carpet.

Stain Removal

If a spill does occur, it can easily be removed by following the stain removal chart. All stains should be removed as soon as possible, as this enhances the ability to remove the stain.

Note: Most stains should be removed easily from Olefin fibers. If the stain persists, the cleaning procedure should be repeated to ensure stain removal. Remember, the sooner the stain removal process begins, the easier the stain will be to remove. Under no circumstances should any solvent normally associated with the dry cleaning of apparel (perchloroethylene, carbon tetrachloride, etc,) be utilized, as permanent damage to the fiber will result.

Canvas and Side Curtains

Acrylic (Sunbrella) canvas should be rinsed frequently with clear, fresh water and cleaned periodically by using a mild soap and water. Scrub lightly and rinse thoroughly to remove the soap. Do not use detergents. The water should be cold or luke warm, never hot. Scrub with a soft brush and rinse thoroughly. Allow to air dry.

The top or accessories should never be folded or stored wet.

After several years, the acrylic canvas may lose some of its ability to shed water. If this occurs, wash the fabric and treat it with a commercially available water proofing designed for this purpose. Monterey recommends 303 High Tech Fabric Guard.

To apply waterproofing, wash the canvas and allow it to dry completely. Then apply a thin, even coat of waterproofing, allowing the first coat to air dry. Apply a second coat for increased protection.

Note: Some leakage at the seams is normal and unavoidable with acrylic enclosures.

Note: Some boats are equipped with acrylic (Sunbrella) canvas that is coated with a permanent water proofing called Sea Mark. Canvas treated with Sea Mark will not lose its ability to shed water and never needs to be retreated.

Side curtains and clear connectors can be cleaned with mild soap and water. They should not be al-

lowed to become badly soiled. Dirt, oil, mildew, and cleaning agents containing ammonia, will shorten the life of the vinyl that is used for clear curtains. After cleaning the curtains and allowing them to dry, apply a non-lemon furniture polish or an acrylic glass and clear plastic protector to extend the life of the curtains.

Vinyl curtains should be stored either rolled or flat, without folds or creases. Folding the curtains will make permanent creases that could cause the vinyl to crack.

Note: Do not use any polish containing lemon scents or lemon. The lemon juice will attack the vinyl and shorten its life.

Snaps should be lubricated periodically with Teflon or silicone grease. Zippers should be lubricated with silicone spray, paraffin or a product designed to lubricate zippers in marine canvas.

The bimini top, side curtains, clear connector, back drop and aft curtain must be removed when trailering. Canvas enclosures are not designed to withstand the extreme wind pressure encountered while trailering and will be damaged. Always remove and properly store the enclosure before trailering your boat.

Note: Your Monterey boat is basically an open vehicle. Therefore, in spite of well-designed and well-fitting canvas enclosures, your boat is not waterproof. We have made every effort to design these enclosures to conform with the boat, but a certain amount of leakage may occur, especially at the seam lines. After cleaning with soap and water, allow seams to thoroughly dry. A sealant can be applied on the seams to somewhat close the needle holes according to the manufacturer's instructions.



DO NOT OPERATE ENGINES, FUEL CONSUMING HEATERS OR BURNERS WITH THE CANVAS ENCLOSURES CLOSED. THE COCKPIT MUST BE OPEN FOR LEGAL VENTILATION AND TO PREVENT THE POSSIBLE ACCUMULATION OF CARBON MONOXIDE FUMES, WHICH COULD BE LETHAL.



CARBON MONOXIDE IS A LETHAL, TOXIC GAS THAT IS COLORLESS AND ODORLESS. IT IS A DANGEROUS GAS THAT WILL CAUSE DEATH IN CERTAIN LEVELS.



NEVER TRAILER YOUR BOAT WITH THE CANVAS ENCLOSURE (INCLUDING SIDE CURTAINS, AFT CURTAIN, WINDSHIELD CONNECTOR, BOW COVER AND COCKPIT COVER) UP. MONTEREY BOATS' CANVAS IS NOT DESIGNED TO WITHSTAND THE HIGH WIND LOADS OF TRAILERING. SEVERE WIND DAMAGE CAN OCCUR SUCH AS TORN MATERIAL, FASTENER PULL-OUT AND FRAME DISTORTION. DAMAGE CAUSED BY TRAILERING IS NOT COVERED UNDER THE LIMITED WARRANTY.

13.3 Cabin Interior

The cabin interior can be cleaned just like you would clean a home interior. The wood floors and steps can be vacuumed and cleaned with a mixture of water and Murphy's Oil Soap or white vinegar and water. Wipe the wood dry with a clean towel. To preserve the cherry and teak woodwork, use furniture polish with wax. To maintain the carpeting, use a vacuum cleaner.

Because air and sunlight are very good cleansers, periodically put cushions, sleeping bags, etc. on deck, in the sun and fresh air to dry and air out. If cushions or equipment get wet with saltwater, remove and use clean, fresh water to rinse off the salt crystals. Salt retains moisture and will cause damage. Dry thoroughly and reinstall.

Vinyl headliner material should be cleaned periodically as explained in the previous section. Avoid using products containing ammonia, bleach, or harsh chemicals as they can shorten the life of vinyl.

If you leave the boat for a long period of time, put all cushions on their sides, open all interior cabin and locker doors, and hang a commercially available mildew protector in the cabin.



ALWAYS READ THE LABEL CAREFULLY ON MILDEW PROTECTORS. REMOVE THE PROTECTOR AND ALLOW THE CABIN TO VENTILATE COMPLETELY BEFORE USING THE CABIN.

Karadon Surfaces

A mild liquid detergent and water or ammonia-based cleaners will remove most dirt and stains from Karadon. For heavy cleaning, oil, and grease, use Fantastik® spray cleaner. Rinse with a clean cloth moistened with fresh water. Wipe dry with a clean cloth.

In most cases, Karadon can be repaired if accidentally damaged. Minor damage, including scratches, general or chemical stains, scorches or burns, and minor impact marks, can be repaired with a light abrasive cleanser and a Scotch-Brite® pad. For heavier damage, light sanding and machine buffing may be necessary so contact your dealer or a professional.

- Avoid exposing Karadon to strong chemicals, such as paint removers, oven cleaners, etc. If contact occurs, quickly flush the surface with water.
- Remove nail polish with a non acetone-based polish remover and flush with water.
- Do not cut directly on Karadon counter tops.

13.4 Bilge and Engine Compartment

To keep the bilge clean and fresh, use a commercial bilge cleaner regularly. Follow the directions carefully. The engines and engine room should be kept clean and free of oil accumulation and debris. All exposed pumps and metal components, including the engines and drive gear, should be sprayed periodically with a protector to reduce the corrosive effects of the high humidity always present in these areas.

Maintenance intervals are outlined in the engine owner's manuals. Their recommendations should be followed exactly.

Periodically check the bilge pumps for proper operation and clean debris from the strainers and float switches. Inspect all hoses, clamps and thru-hulls for leaks and tightness on a regular basis and operate all thru-hull valves at least once a month to keep them operating properly.

A flow of air into the bilge is provided by vents located in the deck near the engine compartment. Periodic inspection and cleaning of the ventilation ducts is necessary to ensure adequate air circulation.

Engines

Proper engine maintenance is essential to the proper performance and reliability of your inboard engines. Maintenance schedules and procedures are outlined in your engine owner's manual. They should be followed exactly.

Proper engine operation requires a good supply of clean, dry fuel. Improper marina fuel storage techniques, limited boat usage, etc. can cause the fuel to become contaminated.

The age of fuel can affect engine performance. Chemical changes occur as the fuel ages that can cause deposits and reduce the cetane or octane rating of the fuel. Severely degraded fuel can damage the engine and boat fuel tank and lines. Therefore, if your boat is not being run enough to require at least one full tank of fresh fuel a month, a fuel additive should be added to protect it from degradation. Your dealer or the engine manufacturer can provide additional information on fuel degradation and fuel stabilizers recommended for your engine.

Generator (Optional)

The engine maintenance required on the generator is similar in many ways to the main engines. The engine incorporates a pressure-type lubrication system and a fresh water cooled engine block which is thermostatically controlled. The most important factors to the generator's longevity are proper ventilation and maintenance of the fuel system, ignition system, cooling system, lubrication system and the AC alternator.

Maintenance schedules and procedures are outlined in your generator owner's manual. They should be followed exactly.

Note: The generator charges the house batteries just enough to compensate for the DC electrical current the engine requires to operate. Therefore, it is important to activate the battery charger to maintain the house and engine batteries whenever the generator is running.

13.5 Drainage System

It is essential that the following items be done periodically to maintain proper drainage of your boat:

- Clean the cockpit drains with a hose to remove debris that can block water drainage.
- Frequently test the automatic bilge pump switches for proper operation. This is accomplished by lifting the float switch until the pump is activated. You can also use a garden hose to flood the bilge until the water level is high enough to activate the pump.
- Flush all gravity drains with fresh water to keep them clean and free flowing.
- Operate the thru-hull valves once a month and service as required.

Note: All drains and pumps must be properly winterized before winter lay-up.



NEVER USE HARSH CHEMICAL DRAIN CLEANERS IN MARINE DRAIN SYSTEMS. PERMANENT DAMAGE TO THE HOSES AND FITTINGS MAY RESULT.

THIS PAGE WAS LEFT BLANK
INTENTIONALLY

SEASONAL MAINTENANCE

14.1 Lay-up and Storage

Before Hauling:

- Pump out the head and holding tank. Flush the holding tank using clean water and a deodorizer. Pump out the cleaning solution.
- The fuel tanks should be left nearly full to reduce condensation that can accumulate in the tank. Allow enough room in the tank for the fuel to expand without leaking out the vents.
- The age of fuel can affect engine performance. Chemical changes occur as the fuel ages that can cause deposits and reduce the cetane or octane rating of the fuel. Severely degraded fuel can damage the engine and boat fuel tank and lines. Therefore, if your boat is not being run enough to require at least one full tank of fresh fuel a month, a fuel additive should be added to protect it from degradation. Operate the boat for at least 15 minutes after adding the additive to allow the treated fuel to reach the engine.

Your dealer or the engine manufacturer can provide additional information on fuel degradation and fuel additives recommended for your engine. For more recommendations for your specific area, check with your dealer.

- Drain water from the fresh water system.
- Consult the engine owner's manual for detailed information on preparing the engines for storage.

Lifting

It is essential that care be used when lifting your boat. Make sure the spreader bar at each sling is at least as long as the distance across the widest point of the boat that the sling will surround. Put the slings in position. Refer to the Slings Locations drawing in Appendix A for the correct position of the lifting slings. There are also sling tags on the side deck. The fore and aft slings should be tied together to prevent the slings from sliding on the hull.

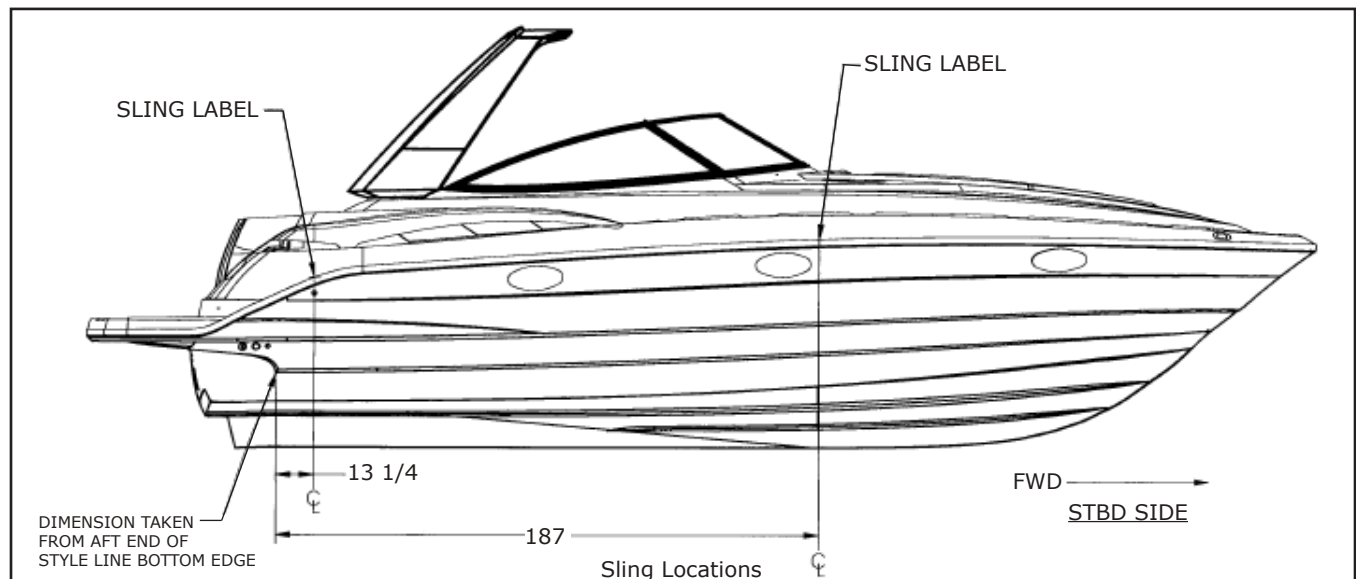

The bow should always be slightly higher than the stern while lifting the boat. This will allow the water to drain from the engine exhaust system and prevent water from surging over the risers and into the engine.



BOATS HAVE BEEN DAMAGED FROM IMPROPER LIFTING AND TRANSPORTING WITH FORK LIFTS. THE FORKS PLACE EXTREME PRESSURE POINTS ON THE HULL AND COULD CAUSE SERIOUS STRUCTURAL DAMAGE. YOUR BOAT IS TOO HEAVY FOR ANY FORK LIFT. NEVER ALLOW ANYONE TO LIFT THE BOAT WITH A FORK LIFT.



SEVERE GELCOAT CRAZING OR MORE SERIOUS HULL DAMAGE CAN OCCUR DURING HAULING AND LAUNCHING IF PRESSURE IS CREATED ON THE GUNWALES (SHEER) BY THE SLINGS. SPREADERS ARE NOT REQUIRED IF BELTS ARE NOT CREATING PRESSURE (CABLE DRUMS FURTHER APART THAN BEAM OF BOAT). FLAT, WIDE BELTING SLINGS AND SPREADERS LONG ENOUGH TO KEEP PRESSURE FROM THE GUNWALES ARE ESSENTIAL. DO NOT ALLOW ANYONE TO HAUL YOUR BOAT WHEN THE SPREADERS ON THE LIFT ARE NOT WIDE ENOUGH TO TAKE THE PRESSURE OFF THE GUNWALES.



IMPROPER LIFTING AND HANDLING WITH A FORK LIFT, CRANE OR TRAVEL LIFT CAN CAUSE SEVERE HULL AND DECK DAMAGE THAT WILL VOID THE MONTEREY WARRANTY.

Supporting The Boat For Storage

A well-made cradle or proper blocking is the best support for your boat during storage.



BOATS HAVE BEEN DAMAGED BY IMPROPER BLOCKING AND CRADLES THAT DON'T PROPERLY SUPPORT THE HULL. ALWAYS MAKE SURE THE BLOCKS, BUNKS AND PADS ARE ADJUSTED SO THEY ARE NOT PUTTING PRESSURE ON THE LIFTING STRAKES AND ARE PROVIDING ENOUGH SUPPORT FOR THE HULL. YOU SHOULD ALLOW ONLY EXPERIENCED PROFESSIONAL BOAT YARD PERSONNEL TO LIFT, BLOCK OR CRADLE YOUR BOAT. HULL DAMAGE RESULTING FROM IMPROPER CRADLE AND BLOCKING SUPPORT WILL VOID THE MONTEREY HULL WARRANTY.

When supporting the boat with blocking:

- Make sure the boat is blocked on a level surface and the bow is high enough so that water will drain from the bilge, cockpit and exhaust system.
- Make sure the keel is supported with large, solid wood blocks in at least three points.
- Use at least three heavy duty jacks on each side of the hull and make sure the boat is level from side to side. The jacks must be on a solid surface like packed gravel, concrete or pavement. All of the supports must be set up properly to prevent the boat from shifting while it is in storage.

When storing the boat on a cradle:

- Make sure the cradle is well supported and placed on a level surface with the bow high enough so that water will drain from the bilge, cockpit and exhaust system.
- The cradle must be in the proper fore and aft position to properly support the hull. When the cradle is designed properly and in the correct location, the bunks should match the bottom of the hull and should not be putting pressure on the lifting strakes.

Preparing The Boat For Storage

- Remove the bilge drain plug, if installed.
- Thoroughly wash the fiberglass exterior, especially the antifouling portion of the bottom. Remove as much marine growth as possible. Lightly wax the exterior fiberglass components.
- Remove all oxidation from the exterior hardware, and apply a light film of moisture displacing lubricant.
- Remove propellers and grease the propeller shafts using light waterproof grease.
- Remove the batteries and store in a cool place. Clean using clear, clean water. Be sure the batteries have sufficient water and clean terminals. Keep the batteries charged and safe from freezing throughout the storage period.

Note: Refer to the Electrical System chapter, for information on the maintenance of the AC and DC electrical systems.

- Coat all faucets and exposed electrical components in the cabin and cockpit with a protecting oil.
- Clean out, totally drain and completely dry the sinks and ice maker.
- Thoroughly clean the interior of the boat. Vacuum all carpets and dry clean drapes and upholstery.
- Remove cushions, open the ice maker and refrigerator doors and as many locker doors as possible. Leaving as many of these areas open as possible will improve the boat's ventilation during the storage period.

Note: It is recommended that a mildew preventer be hung in the boat's cabin before it is closed for storage.

- Clean the exterior upholstery with a good vinyl cleaner and dry thoroughly. Spray the weather covers and boat upholstery with a spray disinfectant. Enclosed areas such as the refrigerator, ice maker, shower basin, storage locker areas, etc. also should be sprayed with this disinfectant.

14.2 Winterizing Fresh Water System

The entire fresh water system must be completely drained. Disconnect all hoses, check valves, etc. and blow all the water from the system. Make sure the water heater and fresh water tank are completely drained. Use only very low air pressure when doing this to prevent possible system damage. Because of the check valve mechanism built in the pump, blowing the lines will not remove the water from the fresh water pump. Remove the inlet and outlet hoses on the pump. Turn the pump on and allow it to pump out any remaining water (about a cupful). A recommended alternative to the above-mentioned procedure is the use of commercially available non toxic, fresh water system antifreeze. After draining the potable water tank, lines and water heater, pour the antifreeze mixture into the fresh water tank, prime and operate the pump until the mixture flows from all fresh water faucets. Be sure to open all hot and cold water faucets, including the fresh water shower in the cockpit and the faucet in the wet bar. Make sure antifreeze has flowed through all of the fresh water drains and the ice maker supply line.

The shower drain water sump system must be properly winterized. Clean debris from the drain and sump and flush for several minutes with fresh clean water. After the system is clean, pump the drain sumps as dry as possible. Then pour a potable water antifreeze mixture into the shower drain until antifreeze has been pumped through the entire system and out of the thru-hull. Follow the same procedure for the optional grey water sump system. Pour the antifreeze for the grey water sump into the cabin sink drains until antifreeze has been pumped through the entire system and out of the thru-hull.

For additional information refer to the Fresh Water System chapter. Also, refer to the ice maker owner's manual for information on winterizing the ice maker.

Engine and Optional Generator Raw Water Systems

Drain all of the sea strainers, heat exchangers and raw water supply and discharge lines for the engine and generator raw water supply pumps. Make sure all seawater has drained from the exhaust system. Some, but not all, engine mufflers could have a drain plug that must be removed to properly drain the muffler. Once this is accomplished, pour a non toxic marine engine antifreeze mixture into a large pail and put the engine raw water intake lines into the solution. Run each engine one at a time until the antifreeze solution is visible at the transom exhaust port or the propeller exhaust hub, then shut the engine off.

Note: Properly winterize the engines and fuel system by following the engine manufacturer's winterizing procedures located in your engine owner's manuals or contact a Monterey dealer.

Refer to the Raw Water System chapter for additional information on the raw water system.

Marine Toilet

The marine toilet must be properly winterized by following the manufacturer's winterizing instructions in the marine toilet owner's manual. The fresh water supply will be winterized with the fresh water system. Drain the discharge hoses completely turning off the fresh water supply so the bowl stays dry and flushing the toilet several times. The head holding tank and macerator discharge pump must be pumped dry and three gallons of potable water antifreeze poured into

the tank through the deck waste pump out fitting. After the antifreeze has been added to the holding tank, open the overboard discharge valve and activate the macerator pump until the antifreeze solution is visible at the discharge thru-hull.

Note: Make sure you follow the marine toilet manufacturer's winterizing instructions exactly.

Air Conditioner

Disconnect and drain the seawater pump intake and discharge hoses. Remove all water from the sea strainer and thru-hull fitting. Allow all water to drain from the system. The air conditioner components must be properly winterized by following winterizing procedure in the manufacturer's owner's manual.

The drain sump system must be properly winterized. Clean debris from the drain and sump and flush for several minutes with fresh clean water. After the system is clean, pump the drain sump as dry as possible. Then pour a potable water antifreeze mixture into the air conditioning drain pan until antifreeze has been pumped through the entire system and out of the thru-hull. The air conditioning system and fresh water shower share the same sump system.

Note: The air conditioning, engine control system, head, and steering systems have specific lay up requirements. Please refer to their owner's manuals for recommended winterizing procedures.

Bilge

Coat all metal components, wire busses, and connector plugs in the bilge with a protecting oil. It is also important to protect all strainers, sea cocks and steering components. The bilge pumps and bilge pump lines must be completely free of water and dried out when the boat is laid up for the winter in climates where freezing occurs. Compartments in the bilge that will not drain completely should be pumped out and then sponged until completely free of water. Dry the hull bilge and self-bailing cockpit troughs. Water freezing in these areas could cause damage.

Special Notes Prior To Winter Storage

If the boat will be in outside storage, properly support a storage cover and secure it over the boat. It is best to have a frame built over the boat to support the canvas. It should be a few inches wider than the boat so the canvas will clear the rails and allow passage of air. If this cover is fastened too tightly there will be inadequate ventilation and this can lead to mildew, moisture accumulation, etc. It is essential to fasten the canvas down securely so that the wind cannot remove it or cause chafing of the hull superstructure. Do not store the boat in a damp storage enclosure. Excessive dampness can cause electrical problems, corrosion, and excessive mildew.

Whenever possible, do not use the enclosure curtains in place of the winter storage cover. The life of these curtains may be significantly shortened if exposed to harsh weather elements for long periods.

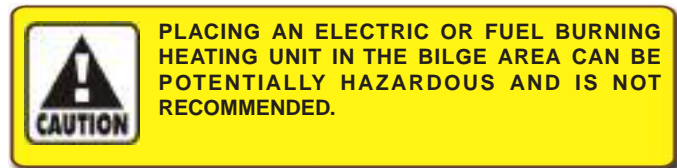

Proper storage is very important to prevent serious damage to the boat. If the boat is to be stored indoors, make sure the building has enough ventilation. It is very important that there is enough ventilation both inside the boat and around the boat.

Note: If the boat is to be stored indoors or outdoors, open all drawers, clothes lockers, cabinets, and doors a little. If possible, remove the upholstery, mattresses, clothing, and rugs. Then hang a commercially available mildew protector in the cabin.

14.3 Recommissioning



DO NOT OPERATE THE BOAT UNLESS IT IS COMPLETELY ASSEMBLED. KEEP ALL FASTENERS TIGHT. KEEP ADJUSTMENTS ACCORDING TO SPECIFICATIONS.

Note: It is important and recommended that the fitting out procedure for the marine gear be done by a qualified marine technician. Read the engine owner's manual for the recommended procedure.



MAKE SURE THE MUFFLER ON THE GENERATOR HAS NOT BEEN DAMAGED DURING WINTER STORAGE AND THAT THE DRAIN PLUGS ARE INSTALLED AND PROPERLY TIGHTENED. LOOSE OR MISSING DRAIN PLUGS AND DAMAGED OR LEAKING MUFFLERS OR EXHAUST HOSES WILL ALLOW CARBON MONOXIDE, ENGINE GASES, AND WATER INTO THE BILGE CREATING A POTENTIALLY HAZARDOUS CONDITION.

Note: Not all mufflers are equipped with drain plugs.

Reactivating The Boat After Storage:

- Apply a fresh coat of bottom paint on the hull and sterndrives.
- Inspect sterndrives and thru-hull fittings.
- Install the propellers. Refer to the sterndrive owner's manual for information on installing propellers.
- Install the drain plug in the hull.
- Charge and install the batteries.
- Check the engines for damage and follow the manufacturer's instructions for recommissioning.
- Check the engine mounting bolts to make sure they are tight.
- Perform all routine maintenance.
- Check all hose clamps for tightness.
- Pump the antifreeze from the fresh and raw water systems and flush several times with fresh water. Make sure all antifreeze is flushed from the water heater and it is filled with fresh water before it is activated.
- Check and lubricate the steering system.
- Clean and wash the boat.
- Install all upholstery, cushions and canvas.
- Check the fluid levels in the engines, generator and sterndrives.

After Launching:

- Carefully check the engines and all water systems for leaks. Operate each system one at a time checking for leaks and proper operation.
- Check the bilge pump automatic and manual switches.
- Prime the fuel system and start the engines.
- Carefully monitor the gauges and check for leakage and abnormal noises. Monitor the temperature gauges closely until they stabilize at normal operating temperature to ensure that the cooling pumps are operating properly.
- Operate the boat at slow speeds until the engine temperature stabilizes and all systems are operating normally.

THIS PAGE WAS LEFT BLANK
INTENTIONALLY

GENERAL MAINTENANCE SCHEDULE AND LOG

MAINTENANCE	Each Use	Weekly	Monthly	Each Season	Yearly	As Needed
Clean Hull Below the Waterline				X		
Bottom Paint Hull					X	X
Check Sacrificial Anodes			X			
Replace Sacrificial Anodes					X	X
Wash Boat, Canvas & Hardware	X		X			
Wax Exterior				X		
Clean & Protect Hardware				X		X
Polish & Protect Plastic Glass & Clear Connectors				X		
Clean Exterior Upholstery	X		X			X
Clean Cabin & Interior Upholstery						X
Service & Inspect Cabin Accessories				X		
Spray Metal Pumps and Components in Bilge with a Protector				X		
Clean Bilge				X		X
Check Bilge, Engine Components and Water Systems for Leaks	X		X			
Inspect & Operate Thru-Hull Valves			X			
Inspect & Clean Seawater Strainers	X					X
Test bilge Pump and High Water Alarm Auto Switches	X					
Check Engine Alignment					X	
Inspect Steering & Control Systems	X					
Service Steering & Control Systems				X		X
Inspect Fuel System for Leaks	X					
Inspect & Service Fuel System				X		X
Lubricate Fuel Fill O-Rings						X
Inspect Fire Extinguishers			X			
Inspect & Protect Electrical Components & Battery Connections				X		
Check Battery Electrolyte Service Batteries			X			
Test and Inspect AC Electrical System & Shore Power Cord				X		
Check Blower Operation & Safety Equipment	X					
Check Neutral Safety Switches	X					

FLOAT PLAN

Monterey Boats recommends filling out a float plan each time you use your boat for an offshore day trip or a long cruise. Leave this information with a responsible person ashore, like a close friend or relative that you know well.

1. Name of person reporting and telephone number.

2. Description of boat.

Type _____ Color _____ Trim _____

Registration No. _____ Length _____

Name _____ Make _____ Other Info _____

3. Engine type _____ H.P. _____

No. of Engines _____ Fuel Capacity _____

4. Survival equipment: (Check as appropriate)

<input type="checkbox"/> PFDS	<input type="checkbox"/> Flares	<input type="checkbox"/> Mirror
<input type="checkbox"/> Smoke Signals	<input type="checkbox"/> Flashlight	<input type="checkbox"/> Food
<input type="checkbox"/> Paddles	<input type="checkbox"/> Water	<input type="checkbox"/> Others
<input type="checkbox"/> Anchor	<input type="checkbox"/> Raft or Dinghy	<input type="checkbox"/> EPIRB

5. Radio Yes No Type _____

6. Automobile license _____

Type _____ Trailer License _____

Color _____ and make of auto _____

7. Persons aboard _____

Name _____ Age _____ Address & telephone No. _____

8. Do any of the persons aboard have a medical problem?

Yes No If yes, what? _____

9. Trip Expectations: Leave at _____

From _____ Going to _____

Expect to return by _____ (time)

and no later than _____

10. Any other pertinent info. _____

11. If not returned by _____ (time)

call the COAST GUARD, or (Local authority) _____

12. Telephone Numbers.

THIS PAGE WAS LEFT BLANK
INTENTIONALLY

DEPARTMENT OF TRANSPORTATION U.S. COAST GUARD CG-3865 (Rev. 9/95)		BOATING ACCIDENT REPORT		FORM APPROVED OMB NO. 2115-0010	
STATE ASSIGNED CASE NO. _____					
THE OPERATOR/OWNER OF A VESSEL USED FOR RECREATIONAL PURPOSES IS REQUIRED TO FILE A REPORT IN WRITING WHENEVER AN ACCIDENT RESULTS IN: LOSS OF LIFE OR DISAPPEARANCE FROM A VESSEL; AN INJURY WHICH REQUIRES MEDICAL TREATMENT BEYOND FIRST AID; OR PROPERTY DAMAGE IN EXCESS OF \$2000 OR COMPLETE LOSS OF THE VESSEL. REPORTS IN DEATH AND INJURY CASES MUST BE SUBMITTED WITHIN 48 HOURS. REPORTS IN OTHER CASES MUST BE SUBMITTED WITHIN 10 DAYS. REPORTS MUST BE SUBMITTED TO THE REPORTING AUTHORITY IN THE STATE WHERE THE ACCIDENT OCCURRED. THIS FORM IS PROVIDED TO ASSIST THE OPERATOR IN FILING THE REQUIRED WRITTEN REPORT.					
COMPLETE ALL BLOCKS (INDICATE THOSE NOT APPLICABLE BY "NA")					
ACCIDENT DATA					
DATE OF ACCIDENT	TIME	AM PM	NAME OF BODY OF WATER	LOCATION (GIVE LOCATION PRECISELY)	
NUMBER OF VESSELS INVOLVED	NEAREST CITY OR TOWN		COUNTY	STATE	ZIP CODE
WEATHER (CHECK ALL APPLICABLE) [] CLEAR [] RAIN [] CLOUDY [] SNOW [] FOG [] HAZY	WATER CONDITIONS [] CALM (WAVES LESS THAN 6") [] CHOPPY (WAVES 6" TO 2') [] ROUGH (WAVES 2' TO 6') [] VERY ROUGH (GREATER THAN 6') [] STRONG CURRENT		TEMPERATURE (ESTIMATE) AIR _____ °F WATER _____ °F	WIND [] NONE [] LIGHT (0-6 MPH) [] MODERATE (7-14 MPH) [] STRONG (15-25 MPH) [] STORM (OVER 25 MPH)	VISIBILITY DAY NIGHT [] GOOD [] [] FAIR [] [] POOR []
NAME OF OPERATOR			OPERATOR ADDRESS		
OPERATOR TELEPHONE NUMBER ()	DATE OF BIRTH MO DAY YR	OPERATOR'S EXPERIENCE [] NONE [] UNDER 100 HOURS [] > 100 HOURS		INSTRUCTION IN BOATING SAFETY [] STATE COURSE [] U.S. POWER SQUADRON [] USCG AUXILIARY [] AMERICAN RED CROSS [] NONE	
[] MALE [] FEMALE					
NAME OF OWNER			OWNER ADDRESS		
OWNER TELEPHONE NUMBER ()	NUMBER OF PEOPLE ON BOARD	NUMBER OF PEOPLE BEING TOWED	RENTED BOAT? [] YES [] NO		
BOAT NO. 1 (THIS VESSEL)					
BOAT REGISTRATION OR DOCUMENTATION NUMBER		STATE	HULL IDENTIFICATION NUMBER	BOAT NAME	
BOAT MANUFACTURER		LENGTH	MODEL	YEAR BUILT	
TYPE OF BOAT [] OPEN MOTORBOAT [] CABIN MOTORBOAT [] AUXILIARY SAIL [] SAIL (ONLY) [] ROWBOAT [] CANOE/KAYAK [] PERSONAL WATERCRAFT [] PONTOON BOAT [] HOUSEBOAT [] OTHER (SPECIFY)	HULL MATERIAL [] WOOD [] ALUMINUM [] STEEL [] FIBERGLASS [] RUBBER/VINYL/CANVAS [] RIGID HULL INFLATABLE [] OTHER (SPECIFY)	ENGINE [] OUTBOARD [] INBOARD [] INBOARD-STERNDRIVE (I/O) [] AIRBOAT	PROPULSION [] PROPELLER [] WATER JET [] AIR THRUST [] MANUAL [] SAIL	PERSONAL FLOTATION DEVICES (PFDS): WAS BOAT ADEQUATELY EQUIPPED WITH COAST GUARD APPROVED PFDS? [] YES [] NO WERE PFDS ACCESSIBLE? [] YES [] NO	
		FUEL [] GASOLINE [] DIESEL [] ELECTRIC	NUMBER OF ENGINES TOTAL HORSEPOWER	FIRE EXTINGUISHERS ON BOARD? [] YES [] NO USED? [] YES [] NO	
OPERATION AT TIME OF ACCIDENT (CHECK ALL APPLICABLE) [] CRUISING [] CHANGING DIRECTION [] CHANGING SPEED [] DRIFTING [] TOWING [] BEING TOWED [] ROWING/PADDLING [] SAILING [] LAUNCHING [] DOCKING/UNDocking [] AT ANCHOR [] TIED TO DOCK/MOORED [] OTHER (SPECIFY)		ACTIVITY AT TIME OF ACCIDENT (CHECK ANY IF APPLICABLE) [] FISHING [] TOURNAMENT [] HUNTING [] SWIMMING/DIVING [] MAKING REPAIRS [] WATERSKIING/TUBING/ETC. [] RACING [] WHITEWATER SPORTS [] FUELING [] STARTING ENGINE [] NON-RECREATIONAL [] OTHER (SPECIFY)	TYPE OF ACCIDENT [] GROUNDING [] CAPSIZING [] FLOODING/SWAMPING [] SINKING [] FIRE OR EXPLOSION (FUEL) [] FIRE OR EXPLOSION (OTHER) [] SKIER MISHAP [] COLLISION WITH VESSEL [] COLLISION WITH FIXED OBJECT [] COLLISION WITH FLOATING OBJ. [] FALLS OVERBOARD [] FALLS IN BOAT [] STRUCK BY BOAT [] STRUCK BY MOTOR/PROPELLER [] STRUCK SUBMERGED OBJECT [] OTHER (SPECIFY)		WHAT CONTRIBUTED TO ACCIDENT? (CHECK ALL APPLICABLE) [] WEATHER [] EXCESSIVE SPEED [] IMPROPER LOOKOUT [] RESTRICTED VISION [] OVERLOADING [] IMPROPER LOADING [] HAZARDOUS WATERS [] ALCOHOL USE [] DRUG USE [] HULL FAILURE [] MACHINERY FAILURE [] EQUIPMENT FAILURE [] OPERATOR INEXPERIENCE [] OPERATOR INATTENTION [] CONGESTED WATERS [] PASSENGER/SKIER BEHAVIOR [] DAM/LOCK [] OTHER (SPECIFY)
ESTIMATED SPEED [] NONE [] UNDER 10 MPH [] 10 - 20 MPH [] 21 - 40 MPH [] OVER 40 MPH		[] HIT AND RUN			

Boating Accident Report

**MONTEREY
BOATS**

DECEASED (IF MORE THAN 2 FATALITIES, ATTACH ADDITIONAL FORMS)			
NAME OF VICTIM		ADDRESS OF VICTIM	
DATE OF BIRTH		DEATH CAUSED BY	
<input type="checkbox"/> MALE	<input type="checkbox"/> FEMALE	<input type="checkbox"/> DROWNING	<input type="checkbox"/> OTHER
		<input type="checkbox"/> DISAPPEARANCE	
NAME OF VICTIM		ADDRESS OF VICTIM	
DATE OF BIRTH		DEATH CAUSED BY	
<input type="checkbox"/> MALE	<input type="checkbox"/> FEMALE	<input type="checkbox"/> DROWNING	<input type="checkbox"/> OTHER
		<input type="checkbox"/> DISAPPEARANCE	
INJURED (IF MORE THAN 2 INJURIES, ATTACH ADDITIONAL FORMS)			
NAME OF VICTIM		ADDRESS OF VICTIM	
DATE OF BIRTH		MEDICAL TREATMENT BEYOND FIRST AID?	
		<input type="checkbox"/> YES <input type="checkbox"/> NO	
		DESCRIBE INJURY	
WAS PFD WORN?		PRIOR TO ACCIDENT?	
<input type="checkbox"/> YES <input type="checkbox"/> NO		<input type="checkbox"/> YES <input type="checkbox"/> NO	
WAS IT INFLATABLE?		AS A RESULT OF ACCIDENT?	
<input type="checkbox"/> YES <input type="checkbox"/> NO		<input type="checkbox"/> YES <input type="checkbox"/> NO	
NAME OF VICTIM		ADDRESS OF VICTIM	
DATE OF BIRTH		MEDICAL TREATMENT BEYOND FIRST AID?	
		<input type="checkbox"/> YES <input type="checkbox"/> NO	
		DESCRIBE INJURY	
WAS PFD WORN?		PRIOR TO ACCIDENT?	
<input type="checkbox"/> YES <input type="checkbox"/> NO		<input type="checkbox"/> YES <input type="checkbox"/> NO	
WAS IT INFLATABLE?		AS A RESULT OF ACCIDENT?	
<input type="checkbox"/> YES <input type="checkbox"/> NO		<input type="checkbox"/> YES <input type="checkbox"/> NO	
OTHER PEOPLE ABOARD THIS BOAT (IF MORE THAN 2 PEOPLE, ATTACH ADDITIONAL FORMS)			
NAME		ADDRESS	
DATE OF BIRTH		WAS PFD WORN?	
		<input type="checkbox"/> YES <input type="checkbox"/> NO	
		PRIOR TO ACCIDENT?	
		<input type="checkbox"/> YES <input type="checkbox"/> NO	
		WAS IT INFLATABLE?	
		<input type="checkbox"/> YES <input type="checkbox"/> NO	
NAME		ADDRESS	
DATE OF BIRTH		WAS PFD WORN?	
		<input type="checkbox"/> YES <input type="checkbox"/> NO	
		PRIOR TO ACCIDENT?	
		<input type="checkbox"/> YES <input type="checkbox"/> NO	
		WAS IT INFLATABLE?	
		<input type="checkbox"/> YES <input type="checkbox"/> NO	
BOAT NO. 2 (IF MORE THAN 2 VESSELS, ATTACH ADDITIONAL IDENTIFYING INFORMATION)			
NAME OF OPERATOR		OPERATOR ADDRESS	
OPERATOR TELEPHONE NUMBER ()		BOAT REGISTRATION OR DOCUMENTATION NUMBER	
		STATE	
NAME OF OWNER		OWNER ADDRESS	
OWNER TELEPHONE NUMBER ()			
PROPERTY DAMAGE			
ESTIMATED AMOUNT: THIS BOAT AND CONTENTS:		OTHER BOAT(S) AND CONTENTS:	
\$		\$	
		OTHER PROPERTY:	
		\$	
DESCRIBE PROPERTY DAMAGED			
WITNESSES NOT ON THIS VESSEL			
NAME		ADDRESS	TELEPHONE NUMBER ()
NAME		ADDRESS	TELEPHONE NUMBER ()
PERSON COMPLETING REPORT			
NAME		ADDRESS	TELEPHONE NUMBER ()
SIGNATURE		QUALIFICATION	DATE SUBMITTED
		<input type="checkbox"/> OPERATOR <input type="checkbox"/> OWNER	
		<input type="checkbox"/> INVESTIGATOR <input type="checkbox"/> OTHER	
FOR AGENCY USE ONLY			
CAUSES BASED ON (CHECK ONE): <input type="checkbox"/> THIS REPORT <input type="checkbox"/> INVESTIGATION <input type="checkbox"/> INVESTIGATION AND THIS REPORT <input type="checkbox"/> OTHER			
NAME OF REVIEWING OFFICE		DATE RECEIVED	
		RECREATIONAL <input type="checkbox"/> NON-REPORTABLE <input type="checkbox"/>	
		COMMERCIAL <input type="checkbox"/>	
PRIMARY CAUSE		SECONDARY CAUSE	

Call the Coast Guard Infoline 1-800-368-5647 for information on **Federal Requirements for Recreational Boats**



ACCIDENT DESCRIPTION

DESCRIBE WHAT HAPPENED (SEQUENCE OF EVENTS. INCLUDE FAILURE OF EQUIPMENT. INCLUDE A DIAGRAM IF NEEDED. CONTINUE ON ADDITIONAL SHEETS IF NECESSARY. INCLUDE ANY INFORMATION REGARDING THE INVOLVEMENT OF ALCOHOL AN/OR DRUGS IN CAUSING OR CONTRIBUTING TO THE ACCIDENT. INCLUDE ANY DESCRIPTIVE INFORMATION ABOUT THE USE OF PFD'S.)

An agency may not conduct or sponsor and a person is not required to respond to an information collection, unless it displays a currently valid OMB Control Number. The Coast Guard estimates that the average burden for this report form is 30 minutes. You may submit any comments concerning the accuracy of this burden estimate or any suggestions for reducing the burden to: Commandant (G-OPB-1), U.S. Coast Guard, Washington, DC 20593-0001 or Office of Management and Budget, Paperwork Reduction Project (2115-0010), Washington, DC 20503.

THIS PAGE WAS LEFT BLANK
INTENTIONALLY

GLOSSARY OF TERMS

Aft: In, near, or toward the stern of a boat.

Aground: A boat stuck on the bottom.

Amidships: In or toward the part of a boat midway between the bow and stern.

Anchor: A specially shaped heavy metal device designed to dig efficiently into the bottom under a body of water and hold a boat in place.

Anchorage: An area specifically designated by governmental authorities in which boats may anchor.

Ashore: On shore.

Astern: Behind the boat, to move backwards.

Athwartship: At right angles to the center line of the boat.

Barnacles: Small, hard-shelled marine animals which are found in salt water attached to pilings, docks and bottoms of boats.

Beam: The breadth of a boat usually measured at its widest part.

Bearing: The direction of an object from the boat, either relative to the boat's direction or to compass degrees.

Berth: A bunk or a bed on a boat.

Bilge: The bottom of the boat below the flooring.

Bilge Pump: A pump that removes water that collects in the bilge.

Boarding: Entering or climbing into a boat.

Boarding Ladder: Set of steps temporarily fitted over the side of a boat to assist persons coming aboard.

Boat Hook: Short shaft of wood or metal with a hook fitting at one end shaped to aid in extending one's reach from the side of the boat.

Bow: The front end of a boat's hull.

Bow Line: A line that leads forward from the bow of the boat.

Bow Rail: Knee high rails of solid tubing to aid in preventing people from falling overboard.

Bridge: The area from which a boat is steered and controlled.

Bridge Deck: A deck forward and usually above the cockpit deck.

Broach: When the boat is sideways to the seas and in danger of capsizing; a very dangerous situation that should be avoided.

Bulkhead: Vertical partition or wall separating compartments of a boat.

Cabin: Enclosed superstructure above the main deck level.

Capsize: When a boat lays on its side or turns over.

Chock: A deck fitting, usually of metal, with inward curving arms through which mooring or anchor lines are passed so as to lead them in the proper direction both on board and off the boat.

Cleat: A deck fitting, usually of metal with projecting arms used for securing anchor and mooring lines.

Closed Cooling System: A separate supply of fresh water that is used to cool the engine and circulates only within the engine.

Coaming: A vertical piece around the edges of cockpit, hatches, etc. to stop water on deck from running below.

Cockpit: An open space, usually in the aft deck, outside of the cabin.

Companionway: Opening in the deck of a boat to provide access below.

Compartment: The interior of a boat divided off by bulkheads.

Cradle: A framework designed to support a boat as she is hauled out or stored.

Cutlass Bearing: A rubber bearing in the strut that supports the propeller shaft.

Deck: The floor-like platform of a boat that covers the hull.

Displacement: The volume of water displaced by the hull. The displacement weight is the weight of this volume of water.

Draft: The depth of water a boat needs to float.

Dry Rot: A fungus attack on wood areas.

Dry-dock: A dock that can be pumped dry during boat construction or repair.

Electrical Ground: A connection between an electrical connector and the earth.

Engine Beds: Sturdy structural members running fore and aft on which the inboard engines are mounted.

EPIRB: Emergency Position Indicating Radio Beacon. Operates as a part of a worldwide satellite distress system.

Even Keel: When a boat floats properly as designed.

Fathom: A measure of depth. One Fathom = 6 feet.

Fender: A soft object of rubber or plastic used to protect the topsides from scarring and rubbing against a dock or another vessel.

Fend off: To push or hold the boat off from the dock or another boat.

Flying Bridge: A control station above the level of the deck or cabin.

Flukes: The broad portions of an anchor which dig into the ground.

Fore: Applies to the forward portions of a boat near the bow.

Foundering: When a boat fills with water and sinks.

Freeboard: The height from the waterline to the lowest part of the deck.

Galley: The kitchen of a boat.

Grab Rail: Hand hold fittings mounted on cabin tops or sides for personal safety when moving around the boat, both on deck and below.

Ground Tackle: A general term including anchors, lines, and other gear used in anchoring.

Grounds: A boat touches the bottom.

Gunwale: The upper edge of a boat's side.

Hand Rail: Rail mounted on the boat, for grabbing with your hand, to steady you while walking about the boat.

Harbor: An anchorage which provides reasonably good protection for a boat, with shelter from wind and sea.

Hatch: An opening in the deck with a door or lid to allow for access down into a compartment of a boat.

Head: A toilet on a boat.

Heat Exchanger: Used to transfer the heat that is picked up by the closed cooling system to the raw cooling water.

Helm: The steering and control area of a boat.

Hull: The part of the boat from the deck down.

Inboard: A boat with the engine mounted within the hull of the boat. Also refers to the center of the boat away from the sides.

Inboard/outboard: Also stern drive or I/O. A boat with an inboard engine attached to an outboard drive unit.

Keel: A plate or timber plate running lengthwise along the center of the bottom of a boat.

Knot: Unit of speed indicating nautical miles per hour. 1 knot = 1 nautical mile per hour (1.15 miles per hour). A nautical mile is equal to one minute of latitude: 6076 feet. Knots times 1.15 equals miles per hour. Miles per hour times .87 equals knots.

Lay-up: To decommission a boat for the winter (usually in northern climates).

Leeward: The direction toward which the wind is blowing.

Length On The Waterline (l.w.l.): A length measurement of a boat at the waterline from the stern to where the hull breaks the water near the bow.

Limber Hole: A passage cut into the lower edges of floors and frames next to the keel to allow bilge water to flow to the lowest point of the hull where it can be pumped overboard.

Line: The term used to describe a rope when it is on a boat.

Lists: A boat that inclines to port or starboard while afloat.

L.O.A.: Boat length overall.

Locker: A closet, chest or box aboard a boat.

Loran: An electronic navigational instrument which monitors the boat's position using signals emitted from pairs of transmitting stations.

Lunch hook: A small light weight anchor typically used instead of the working anchor. Normally used in calm waters with the boat attended.

Midships: The center of the boat.

Marina: A protected facility primarily for recreational small craft.

Marine Ways or Railways: Inclined planes at the water's edge onto which boats are hauled.

Moored: A boat secured with cables, lines or anchors.

Mooring: An anchor permanently embedded in the bottom of a harbor that is used to secure a boat.

Nautical Mile: A unit of measure equal to one minute of latitude. (6076 feet)

Nun Buoy: A red or red-striped buoy of conical shape.

Outboard: A boat designed for an engine to be mounted on the transom. Also a term that refers to objects away from the center line or beyond the hull sides of a boat.

Pad Eye: A deck fitting consisting of a metal eye permanently secured to the boat.

Pier: A structure which projects out from the shoreline.

Pile or Piling: A long column driven into the bottom to which a boat can be tied.

Pitching: The fore and aft rocking motion of a boat as the bow rises and falls.

Pitch: The measure of the angle of a propeller blade. Refers to the theoretical distance the boat travels with each revolution of the propeller.

P.F.D: Personal Flotation Device.

Port: The left side of the boat when facing the bow.

Porthole (port): The opening in the side of a boat to allow the admittance of light and air.

Propeller: A device having two or more blades that is attached to the engine and used for propelling a boat.

Propeller Shaft: Shaft which runs from the back of the engine gear box, aft, through the stuffing box, shaft log, struts, and onto which the propeller is attached.

Pyrotechnic Distress Signals: Distress signals that resemble the brilliant display of flares or fireworks.

Raw Water Cooled: Refers to an engine cooling system that draws seawater in through a hull fitting or engine drive unit, circulates the water in the engine, and then discharges it overboard.

Reduction Gear: Often combined with the reverse gear so that the propeller turns at a slower rate than the engine.

Reverse Gear: Changes the direction of rotation of the propeller to provide thrust in the opposite direction for stopping the boat or giving it sternway.

Roll: A boat's sideways rotational motion in rough water.

Rope Locker: A locker, usually located in the bow of a boat, used for stowing the anchor line or chain.

Rubrail: Railing (often rubber or hard plastic) that runs along the boat's sheer to protect the hull when coming alongside docks, piers, or other boats.

Rudder: A moveable flat surface that is attached vertically at or near the stern for steering.

Sea anchor: An anchor that does not touch the bottom. Provides drag to hold the bow in the most favorable position in heavy seas.

Scupper: An opening in the hull side or transom of the boat through which water on deck or in the cockpit is drained overboard.

Sea cock: Safety valves installed just inside the thru-hull fittings and ahead of the piping or hose running from the fittings.

Shaft Log: Pipe through which the propeller shaft passes.

Sheer: The uppermost edge of the hull.

Sling: A strap which will hold the boat securely while being lifted, lowered, or carried.

Slip: A boat's berth between two pilings or piers.

Sole: The deck of a cockpit or interior cabin.

Spring Line: A line that leads from the bow aft or from the stern forward to prevent the boat from moving ahead or astern.

Starboard: The right side of a boat when facing the bow.

Steerageway: Sufficient speed to keep the boat responding to the rudder or drive unit.

Stem: The vertical portion of the hull at the bow.

Stern: The rear end of a boat.

Stow: To pack away neatly.

Stringer: Longitudinal members fastened inside the hull for additional structural strength.

Strut: Mounted to the hull which supports the propeller shaft in place.

Strut Bearing: See "cutlass bearing."

Stuffing Box: Prevents water from entering at the point where the propeller shaft passes through the shaft log.

Superstructure: Something built above the main deck level.

Swamps: When a boat fills with water from over the side.

Swimming Ladder: Much the same as the boarding ladder except that it extends down into the water.

Taffrail: Rail around the rear of the cockpit.

Thru-hull: A fitting used to pass fluids (usually water) through the hull surface, either above or below the waterline.

Topsides: The side skin of a boat between the waterline or chine and deck.

Transom: A flat stern at right angles to the keel.

Travel Lift: A machine used at boat yards to hoist boats out of and back into the water.

Trim: Refers to the boat's angle or the way it is balanced.

Trough: The area of water between the crests of waves and parallel to them.

Twin-Screw Craft: A boat with two propellers on two separate shafts.

Underway: When a boat moves through the water.

Wake: Disrupted water that a boat leaves astern as a result of its motion.

Wash: The flow of water that results from the action of the propeller or propellers.

Waterline: The plane of a boat where the surface of the water touches the hull when it is afloat on even keel.

Watertight Bulkhead: Bulkheads secured so tightly so as not to let water pass.

Wharf: A structure generally parallel to the shore.

Working Anchor: An anchor carried on a boat for most normal uses. Refers to the anchor used in typical anchoring situations.

Windlass: A winch used to raise and lower the anchor.

Windward: Toward the direction from which the wind is coming.

Yacht Basin: A protected facility primarily for recreational small craft.

Yaw: When a boat runs off her course to either side.

THIS PAGE WAS LEFT BLANK
INTENTIONALLY

TROUBLESHOOTING
GUIDE

PROBLEM	CAUSE AND SOLUTION
CONTROL SYSTEMS	
<p>Stern drive power steering over steers or does not respond properly.</p>	<ul style="list-style-type: none"> • The steering cable housing is bound near the transom. Free the cable and make sure no cables or wire harnesses are attached to it. • The steering cable is kinked, corroded or worn. Replace cable. • The power steering sensor valve is corroded or sticking. Service sensor valve. • The outdrive steering spindle is binding. Grease outdrive.
<p>Stern drive power steering is slow and jerks while turning the wheel.</p>	<ul style="list-style-type: none"> • The power steering pump belt on the engine is loose. Tighten or replace the belt. • The power steering pump is low on fluid. Fill the pump and check for leaks. • The outdrive steering spindle is binding. Grease outdrive.
<p>An engine will not start with the shift control lever in neutral.</p>	<ul style="list-style-type: none"> • The control cable is out of adjustment & not activating the neutral safety cut out switch. • The shift control lever is not in the neutral detent. Try moving the shift lever slightly. • There is a loose wire on the neutral safety switch. Inspect wires and repair loose connections. • The starter, ignition switch or neutral safety switch is bad. Replace the defective switch.
<p>The throttle lever is hard to move.</p>	<ul style="list-style-type: none"> • The cable is worn or corroded. Replace cable • The fuel injector linkage is corroded and stiff. Lubricate the linkage. • The throttle control in the helm control is corroded and binding. Lubricate the control. • The throttle control linkage in the helm is binding against something. Check and adjust or repair binding component.
<p>The shift lever is hard to move.</p>	<ul style="list-style-type: none"> • The cable worn or corroded. Replace cable • The outdrive linkage is corroded and stiff. Lubricate the linkage. • The cable is routed incorrectly and has tight bends or is kinked. Reroute or replace the cable. • The shift control in the helm control is corroded and binding. Lubricate the control. • The shift control linkage in the helm is binding against something. Check and adjust or repair binding component. • The engine idle is too high. Adjust engine idle.

PROBLEM	CAUSE AND SOLUTION
PERFORMANCE PROBLEMS	

Boat is sluggish and has lost speed & RPM.

- The outdrive may need to have marine growth cleaned from hull and running gear.
- A Propeller may be damaged & need repair.
- Weeds or line around the propellers. Clean propellers.
- Boat is overloaded. Reduce load.
- Check for excessive water in the bilge. Pump out bilge, then find & correct the problem.
- One of the throttle adjustments has changed and the engine is not getting full throttle. Adjust the throttle cable.
- One or both of the engines is not producing adequate power. Have engines checked by a qualified technician.

The boat vibrates at cruising speeds.

- Propeller may be damaged & need repair.
- A propeller shaft is bent. Repair or replace damaged components.
- An outdrive is fouled by marine growth or rope. Clean running gear.
- The outdrives are not trimmed properly. Trim outdrives.
- The engines are not at the same RPM. Synchronize throttles.

ENGINE PROBLEMS

An engine is running too hot.

- The raw water supply line to the pump is kinked. Replace hose.
- The engine raw water pump belt is loose or worn. Tighten or replace the belt. (Mercruiser Engines)
- The engine raw water pump impeller is worn or damaged. Repair the pump.
- The engine thermostat is faulty and needs to be replaced.
- The freshwater cooling heat exchanger is clogged and needs to be cleaned.
- The exhaust manifolds or riser water ports are clogged and need to be cleaned or the manifold or riser replaced.

An engine alternator is not charging properly.

- The engine alternator belt is loose or worn. Tighten or replace the belt.
- The alternator is not charging and must be replaced.
- The isolator in the charging system is not working properly. Replace the isolator.
- A battery is defective and not accepting a charge.

PROBLEM	CAUSE AND SOLUTION
ENGINE PROBLEMS	
<p>An engine suddenly will not operate at or above cruise RPM.</p>	<ul style="list-style-type: none"> • The engine emergency system has been activated. The on board computer has sensed a problem and has limited the RPM to protect the engine. Find and correct the problem. • The tachometer is bad and needs to be replaced. • A throttle control cable is loose and out of adjustment. Check and secure control cable.
<p>An engine is loosing RPM. The boat is not overloaded and the hull bottom and running gear are clean and in good condition.</p>	<ul style="list-style-type: none"> • The fuel filter could be dirty. Inspect and replace the fuel filter. • The electronic engine control system on the engine is malfunctioning. Repair the engine control system.
<p>Both engines suddenly shut down and won't restart.</p>	<ul style="list-style-type: none"> • The automatic fire extinguisher in the engine compartment has activated and the engines were shut down by the extinguishing agent. Check the monitor panel for a red light or no green light. If the red light is lit or the green light is out, wait 15 minutes, if safe to do so, to ensure a possible fire is out. Then inspect the engine compartment. Correct any problems found and then ventilate the engine compartment and start the engines.
<p>The engine runs too cold.</p>	<ul style="list-style-type: none"> • The thermostat is faulty. Replace thermostat. • The temperature gauge is not reading properly. Replace the temperature gauge or sender.
<p>The engine starter will not operate.</p>	<ul style="list-style-type: none"> • The battery selector switch is off. Turn on switch. • The shift control is not fully engaged in neutral. Move shifter from forward to neutral and try again. • The fuse or circuit breaker for the starting circuit is blown. Reset the breaker or replace the fuse. Repair circuit if necessary • The battery is weak or low. Charge or replace battery. • Corroded or loose battery connections. Tighten, clean and protect connections.

PROBLEM	CAUSE AND SOLUTION
ACCESSORY PROBLEMS	

The air conditioner runs for a short time & then cuts out.

- The air conditioner pump sea strainer is clogged. Clean the strainer.
- The raw water supply thru-hull valve is closed. Open the valve.
- The raw water system is air-bound. Make sure the thru hull valve is open and run the boat above 15 m.p.h. The speed scoop on the thru hull fitting will force the air lock out of the system.
- The air conditioner raw water pump is not pumping and needs to be repaired or replaced.

The carbon monoxide detector sounds the alarm when the engines are running.

- The canvas curtains are up and none of the forward facing vents are open, allowing carbon monoxide to accumulate in the cockpit and cabin. Open the deck hatch, windshield vents and side curtains to provide proper ventilation.
- The carbon monoxide detector is defective and needs to be calibrated by the manufacturer or replaced. Have the boat checked by a professional before condemning the CO monitor.

The fresh water pump runs, but will not pump water.

- The water tank is empty. Fill the tank.
- The in-line strainer for the pump is clogged. Clean the strainer.
- The intake hose is damaged and sucking air. Replace or repair the hose.
- The pump is defective. Repair or replace the pump.

The freshwater pump breaker is on, but the pump fails to run.

- There is a loose or corroded wiring connection. Find and repair the bad connection
- The fuse or circuit breaker supplying current to the pump is blown or defective. Reset or repair fuse or breaker.
- The thermal breaker on the pump is tripped. Repair or replace pump.
- The pressure switch on the pump has failed. Replace the pressure switch.
- The pump is defective. Repair or replace the pump.

The fresh water pump fails to turn off after all outlets are closed.

- There is a leak in a pressure line or outlet. Repair the leak.
- There is an air leak in the intake line. Repair the air leak.
- The pressure switch is defective. Replace the pressure switch.
- The voltage to the pump is low. Check for corroded or loose wiring connections or low battery.
- The strainer is clogged. Clean strainer.
- The pump is defective. Repair or replace the pump.

PROBLEM	CAUSE AND SOLUTION
---------	--------------------

ACCESSORY PROBLEMS	
--------------------	--

Reduction in water flow from the bilge pump.

- Impeller screen plugged with debris. Clean screen at the base of the pump.
- The discharge hose is pinched or clogged. Check discharge hose and clean or repair.
- Discharge hose is sagging below the pump and creating an airlock. Reroute hose so it runs uphill from the pump to the thru-hull fitting.
- Low voltage to the pump. Check the battery and wire connections.

The automatic float switch on the bilge pump raises but does not activate the pump.

- The circuit breaker near the battery switch has blown. Reset the circuit breaker.
- The battery is dead. Charge or replace the battery.
- The pump impeller is jammed by debris. Clean pump impeller housing.
- The wire connections in the bilge have corroded. Replace connectors and secure above the bilge waterline.
- The automatic switch is defective. Replace the switch.
- The pump is defective. Replace pump.

The bilge pump will not run when the manual switch is activated.

- The circuit breaker supplying the switch has tripped. Replace or reset the circuit breaker.
- The battery switch is off. Turn on the battery switch and bilge pump breaker.
- The pump impeller is jammed by debris. Clean pump impeller housing.
- The wire connections in the bilge have corroded. Replace connectors and secure above the bilge waterline.
- The switch is defective. Replace the switch.
- The pump is defective. Replace pump.

The refrigerator compressor runs frequently and the house battery life seems shorter than it should be whenever the refrigerator is operating on DC power.

- The thermostat in the refrigerator is set too cold. Check the temperature in the refrigerator and set the thermostat to a warmer setting if possible.
- The door gasket is dirty or moldy and not sealing properly. Clean or replace the door seal.
- The battery is weak and not providing the proper voltage to the refrigerator compressor. Replace the battery.
- The refrigerator is defective. Replace the refrigerator.

PROBLEM	CAUSE AND SOLUTION
---------	--------------------

ACCESSORY PROBLEMS	
--------------------	--

Head will not flush.

- Electric head breaker is not activated. Turn on breaker.
- There is a vacuum leak at the flush valve or the waste hose. Repair the leak.
- The holding tank is full and the sensor in the holding tank has deactivated the vacuum pump. Pump out the holding tank.

Head vacuum pump runs more frequently than it should.

- There is a slight vacuum leak in the system. Find and repair the leak.

Holding tank will not empty.

- Overboard discharge valve in the engine compartment is closed. Open discharge valve.
- Holding tank vent is clogged. Replace charcoal vent filter.
- There is a vacuum leak in the hose from the holding tank to the deck pump out fitting. Tighten loose fittings or replace damaged hoses.

Excessive odor from marine head.

- Back pressure in the holding tank. Pump out holding tank or replace the vent filter.
- Waste is in the discharge hose. Flush enough to move waste to the holding tank, particularly at the end of each day.
- No deodorizer in the holding tank. Add deodorizer to the holding tank each time it is pumped out.
- The waste in the tank is over two weeks old. Pump the holding if it has contained waste for two weeks or more.

The generator will not start.

- The generator battery switch is off. Turn on the generator battery switch.
- Generator battery is not charged. Charge or replace battery.
- The generator fuel supply valve is off. Turn on fuel supply valve.
- The fuel level is too low in the fuel tank that supplies the generator. Fill the fuel tanks.

Note: The fuel pick up tube for the generator is shorter than the main engine pick up. Therefore, the generator will run out of fuel before the boat engine. This is to prevent the generator from consuming reserve fuel.

The generator runs for a short time and shuts down.

- There is a problem with the generator and the emergency shut down system has activated to shut down the generator. Find and correct the problem, then restart the generator.
- The fuel level is too low in the fuel tank that supplies the generator. Fill the fuel tanks.
- The generator is overloaded. Manage AC accessory use to reduce excess amperage draw.





MONTEREY BOATS

1579 S.W. 18TH STREET
WILLISTON, FL 32696
PHONE: 352-529-9181 FAX: 352-529-9173

WWW.MONTEREYBOATS.COM