



MERIDIANTM
YACHTS

411SB SEDAN OWNER'S MANUAL

<https://www.boat-manuals.com/>

Date of Purchase: _____

Port Engine Serial Number: _____

Starboard Engine Serial Number: _____

Hull Identification Number: _____

Hull Identification Number

- The Hull Identification Number (HIN) is located on the starboard aft corner of the hull.
- Record the HIN (and the engine serial numbers) in the space provided above.
- Please refer to the HIN for any correspondence or orders.

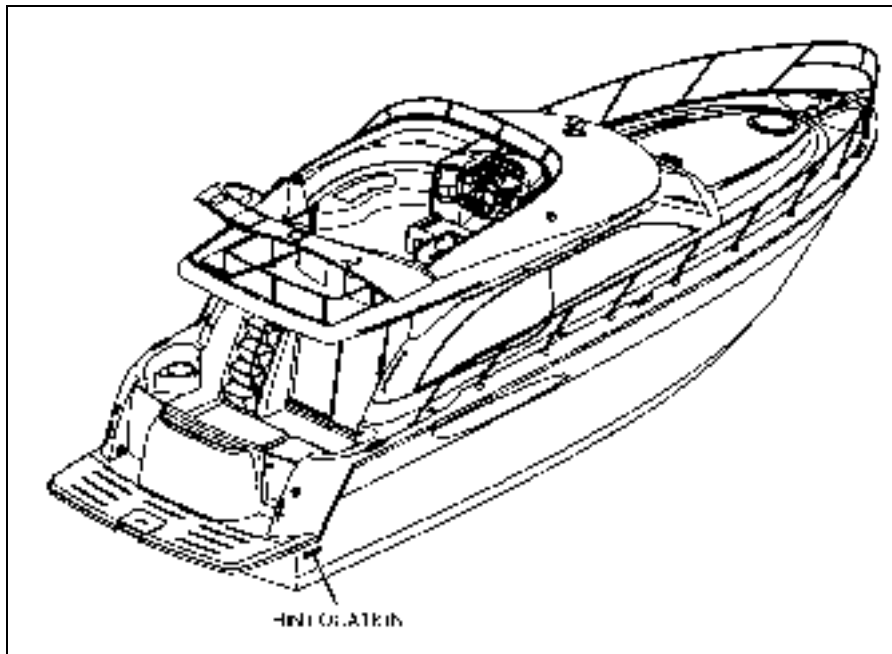

© 2007 Meridian Technical Publications. All rights reserved.

No part of this publication may be reproduced, stored in any retrieval system, or transmitted in any form by any means, electronic, mechanical, photocopying, recording or otherwise, without prior written permission of Meridian.

Printed in the United States of America.

General Notes

The material in this document is for information only and is subject to change without notice. While reasonable efforts have been made in the preparation of this document to assure its accuracy, Meridian assumes no liability resulting from errors or omissions in this document, or from the use of information contained herein.

Due to our commitment to product improvement, Meridian reserves the right to make changes in the product design, specifications, and equipment at any time without notice or obligation. Illustrations and/or photos may show optional equipment.

All Meridian products meet or exceed USCG (United States Coast Guard) and/or NMMA (National Marine Manufacturer's Association) construction standards. Manufactured with 1,1,1 Trichloroethane, a substance which harms public health and environment during the manufacturing process by destroying ozone in the upper atmosphere.

Proprietary Rights

This document discloses subject matter in which Meridian has proprietary rights. The information and design disclosed herein were originated by and are the property of Meridian. Neither receipt nor possession thereof confers or transfers any right to reproduce, copy, alter or disclose the document or any part thereof, any information contained therein, or to construct boats or any item from it, except by written permission from or written agreement with Meridian. This document is to be returned upon request to Meridian.

CONTENTS

Chapter 1: Welcome Aboard!

Dimensions & Tank Capacities	1
Dealer Service	1
Warranty Information	1
Boating Experience	2
Qualified Maintenance	2
Structural Limitations	2
Engine & Accessory Guidelines & Literature	3
<i>Propellers</i>	3
Safety Standards	4
Special Care for Moored Yachts	5
<i>Sacrificial Anodes (Zincs)</i>	5
Yacht Lifting	6
Carbon Monoxide (CO)	7
<i>CO Facts</i>	7
<i>Factors that Increase the Effects of CO Poisoning</i>	7
<i>Where & How CO Can Accumulate</i>	8
<i>How to Protect Yourself & Others From CO</i>	8
<i>CO Checklists</i>	9
<i>CO Monitors</i>	10
<i>More Information</i>	10

Chapter 2: Locations

Exterior Views	11
<i>Hull Views</i>	11
<i>Forward & Port Side Deck View</i>	12
<i>Aft & Starboard Side Deck View</i>	13
<i>Command Bridge Helm Station</i>	14
<i>Lower Helm Station (If Equipped)</i>	15
Component Locations	16

Chapter 3: Propulsion & Related Systems

Engines	38
Engine Cooling System	38
Exhaust System	39
Bilge Blower Systems	40
Fuel System	41
<i>Fuel Fills & Vents</i>	43
<i>Anti-siphon Valves (Gas Engines Only)</i>	43
<i>Gas Engine Fuel Filters</i>	43
<i>Electronic Fuel Shut-off Valves (Diesel Engines Only)</i>	43
<i>Fuel Filter/Water Separators (Diesel Engines Only)</i>	44
<i>Fuel Transfer Pump (If Equipped) (Diesel Engines Only)</i>	44
Oil Change System (If Equipped) (Diesel Engines Only)	45
Fire Suppression System (If Equipped)	45
Shaft-Transmission Alignment	46
<i>Shaft Log Packless Sealing System</i>	46

Chapter 4: Controls & Gauges

Steering	47
<i>Hydraulic Steering System</i>	47
Rudder Stuffing Gland	47
Autopilot (If Equipped)	48
Shift/Throttle Controls	48
<i>Engine Synchronization (If Equipped)</i>	48
Trim Tabs	49
Dual Thruster System	49
Gauges	50
<i>Cleaning the Gauges</i>	50
<i>Gauge Fogging</i>	50
<i>Radio Transmission Interference</i>	50
<i>Twin Engine Readings</i>	50
<i>Fuel Gauges</i>	50

Chapter 5: Navigation & Communication Equipment

Compass	51
Depth Finder	51
VHF Radio	51
Radar (If Equipped)	52
Global Positioning System (GPS) (If Equipped)	52

Chapter 6: Plumbing

Bilge Pumps	53
<i>Bilge Pump Testing</i>	54
<i>Autofloat Switches</i>	54
Seawater Systems	55
<i>Seacocks</i>	55
<i>Seawater Strainers</i>	55
<i>Seawater Washdown (If Equipped)</i>	56
Freshwater System	57
<i>Transom Shower</i>	58
<i>City Water Inlet</i>	58
<i>Freshwater System Winterization</i>	59
<i>Water Heater</i>	60
<i>Winterizing the Water Heater</i>	61
<i>Preparing the Water Heater for Use After Yacht Storage</i>	62
Drain Systems	63
<i>Deck Drains</i>	63
<i>Gray Water Drain System</i>	63
<i>Sump Pump Drain System</i>	63
<i>Sump Box Cleaning</i>	63
<i>Sump System Winterization</i>	63
Marine Heads & Holding Tank	64
<i>Vacuum Flush Head System</i>	64
<i>Macerator (If Equipped)</i>	65

Chapter 7: Deck Equipment

- Cleats 66
- Windlass 66
- Radar Wing 67
- Canvas & Vinyl Tops & Enclosures 67
 - Canvas Care* 68
 - Clear Vinyl Care* 69

Chapter 8: Appliances & Entertainment Systems

- Refrigerator 70
- Electric Stove 70
- Coffeemaker 70
- Audio & Visual Equipment 71
 - Dockside Television & Telephone Inlet* 71

Chapter 9: Lights

- Care & Maintenance 72
- Interior & Exterior Lights 72
- Navigation Lights 72
- Spotlight 72

Chapter 10: Air Conditioning & Heating

- Air Conditioner (If Equipped) 73
- Heat Exchanger Cabin Heat (If Equipped) 75
- Electric Heaters (If Equipped) 75

Chapter 11: Electrical Systems

- 12-Volt DC System 77
 - Batteries* 77
 - Battery Switches* 77
 - Emergency Battery Parallel Switch* 78
 - Fuses & Circuit Breakers* 79
 - 12-Volt DC Accessory Outlet(s)* 79
 - Alternators* 79
 - Battery Charger or Inverter/Battery Charger (If Equipped)* 80
- 110-Volt AC System 81
 - Shore Power* 82
 - Connecting to Shore Power* 83
 - Shore Power Cable Hoist (If Equipped)* 83
 - Parallel Switch (If Equipped with Dual Shore Power)* 84
 - Inverter Power (If Equipped)* 84
 - Generator* 85
- Electrical Routings 87
 - 12-Volt DC Deck Electrical Harnesses* 87
 - 12-Volt DC Hull Electrical Harnesses* 88
 - 12-Volt DC Command Bridge Electrical Harnesses* 89
 - 12-Volt DC Radar Wing Electrical Harness* 89
 - Batteries* 90
 - 110-Volt AC Electrical Harnesses* 91

Important Records 92

Float Plan 93

Hazard Boxes & Symbols





The hazard boxes and symbols shown below are used throughout this supplement to call attention to potentially dangerous situations which could lead to either personal injury or product damage. Read *all* warnings carefully and follow *all* safety instructions.

 **DANGER!**
This box alerts you to immediate hazards which *WILL* cause severe personal injury or death if the warning is ignored.

 **WARNING!**
This box alerts you to hazards or unsafe practices which *COULD* result in severe personal injury or death if the warning is ignored.

 **CAUTION**
This box alerts you to hazards or unsafe practices which *COULD* result in minor personal injury or cause product or property damage if the warning is ignored.

NOTICE
This box calls attention to installation, operation or maintenance information, which is important to proper operation but is not hazard related.

 FIRE HAZARD!	 EXPLOSION HAZARD!	 NO OPEN FLAME!	 ELECTRICAL HAZARD!	 HOT HAZARD!
---	--	---	--	--

 FALLING HAZARD!	 ROTATING PROPELLER HAZARD!	 RUN BILGE BLOWERS FOR 4 MINUTES!
--	---	--

CO POISONING HAZARD!

Chapter 1: Welcome Aboard!

- This *Owner's Manual* provides specific information about your yacht that is **not** covered in the *Cruiser & Yacht Owner's Manual Supplement*.
- The *Cruiser & Yacht Owner's Manual Supplement* contains general information about safe operating practices, general boating regulations, and general maintenance techniques. Information that is more specific to your particular yacht is found in this *Owner's Manual*.
- **Before** using your yacht, study this *Owner's Manual*, the *Cruiser & Yacht Owner's Manual Supplement*, and **all** engine and accessory literature carefully. If similar instructions are found in more than one manual, **always** refer to the specific manufacturer's manual (such as the engine manual) for the most complete and accurate information.
- Keep this *Owner's Manual* and the *Cruiser & Yacht Owner's Manual Supplement* on your yacht in a secure, yet readily available place.

Dimensions & Tank Capacities

Overall Length	Length Rigged	Bridge Clearance	Beam	Draft (Hull)	Draft (Maximum)	Fuel Capacity	Freshwater Capacity	Holding Tank Capacity
46' 0"	47' 2"	16' 11"	14' 2"	2' 7"	3' 11"	400 Gallons	150 Gallons	50 Gallons

Dealer Service

- Your dealer is your key to service.
- Ask your dealer to explain **all** systems **before** taking delivery of your yacht.
- Contact your dealer if you have any questions or problems with your new yacht.
- If your dealer cannot help, call our customer service hotline: 360-403-2198 or send us a FAX: 360-403-1158.
- Buy replacement parts from any authorized Meridian dealer.
- You can access on-line parts catalogs, links to vendor websites, and other helpful features by logging on to www.meridiancustomercare.com.

Warranty Information

- Meridian offers a Limited Warranty on each new Meridian purchased through an authorized Meridian dealer.
- A copy of the Limited Warranty was included in your owner's packet.
- If you did not get a copy of the Limited Warranty, please contact your Meridian dealer or call 360-403-2198 for a copy.

Boating Experience

WARNING!

CONTROL HAZARD!

An experienced operator *MUST* be in control of your yacht at *ALL* times. Do *NOT* operate your yacht while under the influence of alcohol or drugs.

If this is your first yacht or if you are changing to a type of yacht you are not familiar with, for your own comfort and safety, get handling and operating experience *before* assuming command of your yacht.

Take one of the boating safety classes offered by the U.S. Power Squadrons or the U.S. Coast Guard Auxiliary. For more course information, including dates and locations of upcoming classes, contact the organizations directly:

- U.S. Power Squadrons: 1-888-FOR-USPS (1-888-367-8777) or on the Internet at: <http://www.usps.org>
- In Canada, for the CPS courses call 1-888-CPS-BOAT.
- U.S. Coast Guard Auxiliary: 1-800-368-5647 or on the Internet at: <http://www.cgaux.org>

Outside the United States, your Meridian dealer, national sailing federation, or local boat club can advise you of local sea schools or competent instructors.

Qualified Maintenance

WARNING!

To maintain the safety of your yacht, allow *ONLY* trained personnel to work on, or change, in any way, the:

- **Steering system**
- **Propulsion system**
- **Engine control system**
- **Fuel system**
- **Environmental control system**
- **Electrical system**
- **Navigation system**

- Failure to maintain your yacht's systems (listed in the warning above) as designed could violate the laws in your jurisdiction and could expose you and other people to the danger of bodily injury or accidental death.
- Follow the instructions in this *Owner's Manual*, the *Cruiser & Yacht Owner's Manual Supplement*, the engine owner's manual, and *all* accessory literature.

Structural Limitations

The swim platform and command bridge are designed to be lightweight for proper yacht balance. The load limit for the swim platform is 30 pounds per square foot, evenly distributed. For the load limit of the command bridge, see the bridge capacity plate located at the top of the command bridge stairs.

Engine & Accessory Guidelines & Literature

NOTICE

BEFORE starting or working on your engine(s), read the engine manual.

NOTICE

BEFORE using the accessories on your yacht, read the accessory manuals.

NOTICE

BEFORE storing your yacht, refer to your engine and accessory manuals for storage/winterization instructions.

NOTICE

Certain modifications to your yacht **WILL** result in cancellation of your warranty protection. **ALWAYS** check with your dealer **BEFORE** making any modifications to your yacht.

- Your yacht's engines and accessories were selected to provide optimum performance and service.
- Installing different engines or adding accessories may affect your yacht's running trim.
- If you choose to install different engines or add accessories that may affect your yacht's running trim, have a trained marine technician do a safety inspection and handling test **before** using your yacht again.
- The engines and accessories on your yacht have their own manuals. Read these manuals **before** using the engines and accessories.

Unless noted otherwise, **all** engine and accessory literature referred to in this *Owner's Manual* is included in your owner's packet.

While the topics listed below may be included in this *Owner's Manual* and in the *Cruiser & Yacht Owner's Manual Supplement*, **always** refer to the engine manual first for specific information on these important subjects:

- Engine Break-in Procedure
- Engine Starting and Stopping
- Gear Shifting
- Fuel and Oil Recommendations
- Engine Maintenance
- Engine Storage/Winterization

Propellers



CAUTION

ENGINE DAMAGE HAZARD!

The factory standard propellers may not be the best for your particular yacht and load conditions. Refer to the engine manual for engine RPM ratings. The engines should reach, but **NOT** exceed the full rated RPM when full-throttle is applied.

Immediately contact your local Meridian dealer if:

- The engines cannot reach the full rated RPM when full-throttle is applied, or;
- The engines exceed the full rated RPM when full-throttle is applied.

- Keep the propellers in good repair and at the correct pitch for your particular situation.
- A slightly bent or nicked propeller will adversely affect the performance of your yacht.

Safety Standards



⚠ DANGER!



FALLING and ROTATING PROPELLER HAZARD!

- ***NEVER*** allow anyone to ride on parts of your yacht ***NOT*** designed for such use.
- Sitting on seat backs, lounging on the forward deck, bow riding, gun-wale riding or occupying the transom platform while underway is especially hazardous and ***WILL*** cause personal injury or death.

⚠ DANGER!

FALLING, ROTATING PROPELLER and CARBON MONOXIDE POISONING HAZARD!

- ***NEVER*** allow anyone to occupy, or hang from, the back deck or swim platform while the engines are running.
- Teak surfing, dragging, or water skiing within 20 feet of a moving watercraft can be fatal.

⚠ DANGER!

PERSONAL SAFETY HAZARD!

- ***ALWAYS*** secure the anchor and other loose objects ***BEFORE*** getting underway.
- The anchor and other items that are ***NOT*** properly secured can come loose when your yacht is moving and cause personal injury or death.

⚠ WARNING!

A wide variety of components used on this vessel contain or emit chemicals known to the State of California to cause cancer and birth defects and other reproductive harm.

Examples Include:

- Engine and generator exhaust
- Engine and generator fuel, and other liquids such as coolants and oil, especially used motor oil
- Cooking fuels
- Cleaners, paints, and substances used for vessel repair
- Waste materials that result from wear of vessel components
- Lead from battery terminals and from other sources such as ballast or fishing sinkers

To Avoid Harm:

- Keep away from engine, generator, and cooking fuel exhaust fumes.
- Wash exposed skin thoroughly with soap and water after handling the substances above.

- Your yacht's mechanical and electrical systems were designed to meet safety standards in effect at the time it was built.
- Some of these standards were mandated by law, and all of them were designed to insure your safety and the safety of other people, vessels and property.

Read this *Owner's Manual*, the *Cruiser & Yacht Owner's Manual Supplement*, and ***all*** accessory instructions for important safety standards and hazard information.

Special Care for Moored Yachts

- Whether moored in saltwater or freshwater, your yacht will collect marine growth on its hull bottom.
- This will detract from your yacht's beauty, greatly affect its performance, and may damage the gel coat.
- There are two ways to slow marine growth:
 1. Periodically haul your yacht out of the water and scrub the hull bottom with a bristle brush and a solution of soap and water.
 2. Occasionally reapply the anti-fouling paint on your hull bottom. How often your hull needs new anti-fouling paint depends on many factors. Ask your selling dealer or local marina for advice.

Sacrificial Anodes (Zincs)

NOTICE

- **Do *NOT* paint between the zinc and the metal surface it contacts and do *NOT* paint over the zincs.**
- **If the zincs are not bonded correctly, they will *NOT* provide protection.**

Your yacht features sacrificial anodes (zincs) to protect underwater metal parts from excessive deterioration. Check the zincs regularly and replace them if they have deteriorated more than 70%.

There are many factors that affect the rate at which the zincs deteriorate, including:

- Water temperature
- Salinity
- Water pollution
- Stray electrical current

Stray electrical current from your yacht, another boat, or the dock may cause complete deterioration of the zincs in just a few weeks. If there is rapid zinc deterioration, measure the electrolytic corrosion around your yacht with a corrosion test meter.



NEW SACRIFICIAL ANODE

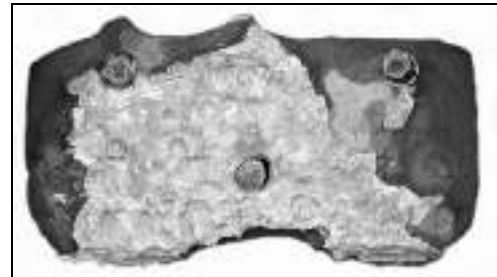

DETERIORATED SACRIFICIAL ANODE

Yacht Lifting



WARNING!

PERSONAL INJURY and/or PRODUCT or PROPERTY DAMAGE HAZARD!

- Lifting slings can slip on the hull, which could cause serious injury or death.
- Reduce the risk of sling slippage by **ALWAYS** securing the lifting slings together **BEFORE** lifting.



WARNING!

PERSONAL INJURY and/or PRODUCT or PROPERTY DAMAGE HAZARD!

NEVER lift your yacht using the cleats.



WARNING!

PERSONAL INJURY and/or PRODUCT or PROPERTY DAMAGE HAZARD!

- Water in the bilge can shift and change the balance of the load.
- If water is present in the bilge, pump the water out of the bilge areas **BEFORE** lifting your yacht.



CAUTION

PRODUCT or PROPERTY DAMAGE HAZARD!

- When lifting any boat, **ALWAYS** use a spreader bar.
- The spreader bar **MUST** be equal to the width of the boat at each lifting point.

- **Always** follow the lift equipment's instructions and requirements.
- When lifting your yacht, **always** position the lifting slings at the port and starboard lifting sling label positions, as shown in the illustration.

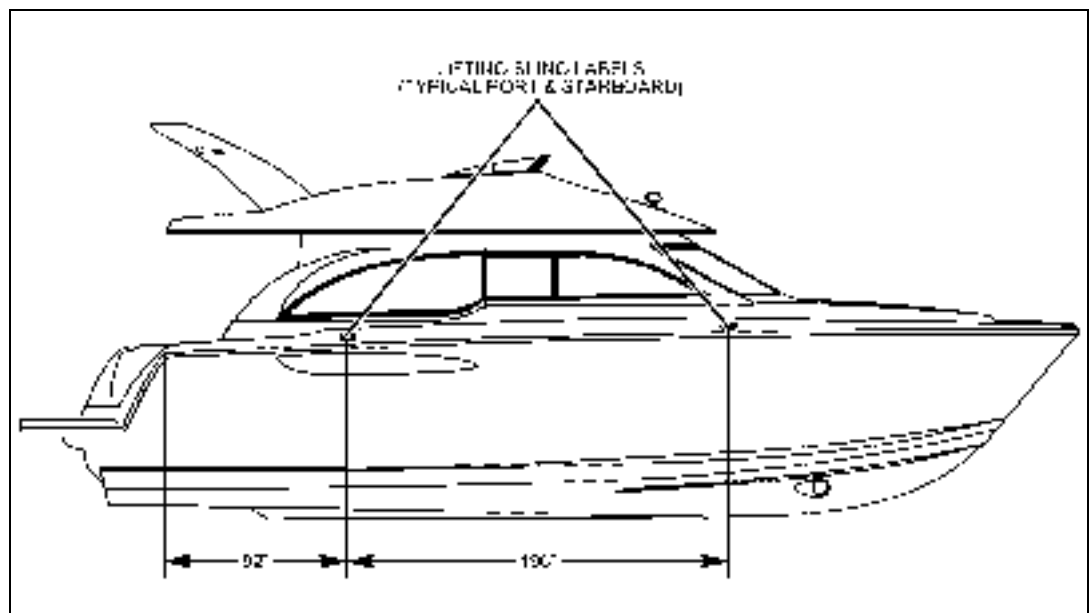

Carbon Monoxide (CO)

⚠ **DANGER!**



- Carbon monoxide gas (CO) is colorless, odorless, tasteless, and extremely dangerous.
- *ALL* engines, generators, and fuel burning appliances produce CO as exhaust.
- Prolonged exposure to low concentrations or very quick exposure to high concentrations *WILL* cause *BRAIN DAMAGE* or *DEATH*.
- Teak surfing, dragging, or water skiing within 20 feet of a moving watercraft can be fatal.

CO Facts

- CO poisoning causes a significant number of boating deaths each year.
- Called the "silent killer", CO is an extremely toxic, colorless, odorless and tasteless gas.
- CO can harm or even kill you inside or outside your yacht.
- CO can affect you whether you're underway, moored, or anchored.
- CO symptoms are similar to seasickness or alcohol intoxication.
- CO can make you sick in seconds. In high enough concentrations, even a few breaths can be fatal.
- Breathing CO blocks the ability of your blood to carry oxygen.
- The effects are cumulative. Even low levels of exposure can result in injury or death.

Factors that Increase the Effects of CO Poisoning

- Age
- Smokers or people exposed to high concentrations of cigarette smoke
- Consumption of alcohol
- Lung disorders
- Heart problems
- Pregnancy

Where & How CO Can Accumulate

Stationary conditions that increase CO accumulations include:

- A.** Using engine, generator, or other fuel burning device when yacht is moored in a confined space.

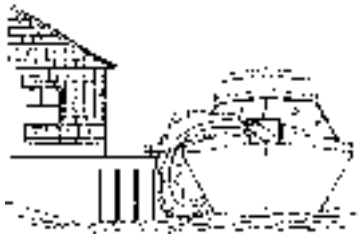

- B.** Mooring too close to another boat that is using its engine, generator, or other fuel burning device.



To correct stationary situations A and/or B:

- **Close all** windows, portlights and hatches.
- If possible, move your yacht away from source of CO.

Running conditions that increase CO accumulations include:

- C.** Running yacht with trim angle of bow too high.

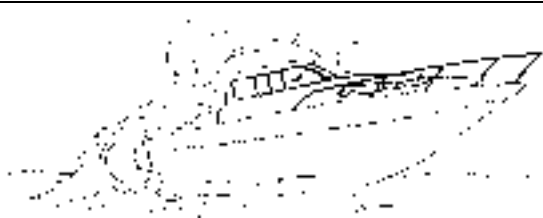

- D.** Running yacht without through ventilation (station wagon effect).

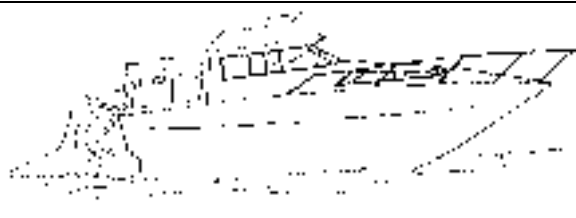

To correct running situations C and/or D:

- Trim bow down.
- **Open** windows and canvas.
- When possible, run yacht so that prevailing winds help dissipate exhaust.

How to Protect Yourself & Others From CO

- Know where and how CO may accumulate in and around your yacht (see above).
- **Always** maintain fresh air circulation throughout your yacht.
- Know where your engine and generator exhaust outlets are located and keep everyone away from these areas.
- **Never** sit on, or hang onto, the back deck or swim platform while the engines or generator are running.
- **Never** enter the areas under swim platforms where exhaust outlets are located.
- Although CO can be present without the smell of exhaust fumes, if exhaust fumes are detected on your yacht, take **immediate** action to dissipate these fumes.
- Treat symptoms of seasickness as possible CO poisoning. Get the person into fresh air **immediately**. Seek medical attention—unless you're sure it's not CO.
- Maintain the CO monitors inside your yacht. **NEVER** ignore any alarm. Replace monitors as recommended by the monitor manufacturer.
- Follow the checklists provided on the next page.
- Get a Vessel Safety Check.

For information about free VESSEL SAFETY CHECKS, visit www.vesselsafetycheck.org or contact your local U.S. Coast Guard Auxiliary or United States Power Squadrons®.

- U.S. Coast Guard Auxiliary: 1-800-368-5647 or on the Internet at: <http://www.cgaux.org>
- U.S. Power Squadrons: 1-888-FOR-USPS (1-888-367-8777) or on the Internet at: <http://www.usps.org>

CO Checklists

Trip Checklist

- Educate *all* passengers about the symptoms of CO poisoning and where CO may accumulate.
- When docked, or rafted with another boat, be aware of exhaust emissions from the other boats.
- Make sure you know where the exhaust outlets are located on your yacht.
- Confirm that water flows from the exhaust outlets when the engines and generator are started.
- Listen for any change in exhaust sound, which could mean an exhaust component failure.
- Test the operation of each CO monitor by pressing the test button.

Monthly Checklist

- Make sure *all* exhaust clamps are in place and secure.
- Look for exhaust leaking from exhaust system components. Signs include rust and/or black streaking, water leaks, or corroded or cracked fittings.
- Inspect rubber exhaust hoses for burned, cracked, or deteriorated sections. *All* rubber hoses should be pliable and free of kinks.

Annual Checklist

Have a Trained Marine Technician:

- Replace exhaust hoses if cracking, charring, or deterioration is found.
- Ensure that your engines and generators are properly tuned, and well maintained.
- Inspect each water pump impeller and the water pump housing. Replace if worn. Make sure cooling systems are in working condition.
- Inspect *all* metallic exhaust components for cracking, rusting, leaking, or loosening. Make sure they check the cylinder head gasket, exhaust manifold, water injection elbow, and the threaded adapter nipple between the manifold and the elbow.
- Clean, inspect, and confirm proper operation of the generator cooling water anti-siphon valve (if equipped).

CO Monitors

 **DANGER!**



CARBON MONOXIDE POISONING HAZARD!

- The house battery switch *MUST* be in the *On* position for the CO monitors to work.
- If your yacht will be unattended for an extended period of time, turn *Off* the house battery switch or the CO monitors *WILL* drain the house battery.
- **IMMEDIATELY** turn the house battery switch back *On* when you reboard your yacht.

- **NEVER** disconnect the CO monitors.
- Read the manufacturer's instructions for your CO monitors. **If you did not get the manufacturer's instructions, call (800) 383-0269 and they will be mailed to you.**

More Information

For more information about preventing carbon monoxide poisoning on recreational boats and other boating safety tips, contact:

United States Coast Guard Office of Boating Safety (G-OPB-3) 2100 Second Street SW Washington, DC 20593 www.uscgboating.org 1-800-368-5647	National Marine Manufacturers Association (NMMA) 200 East Randolph Drive Suite 5100 Chicago, IL 60601-9301 www.nmma.org 312-946-6200	American Boat & Yacht Council, Inc. (ABYC) 613 Third Street Suite 10 Annapolis, MD 21403 www.abycinc.org 410-990-4460
--	--	--

For information about free VESSEL SAFETY CHECKS, visit www.vesselsafetycheck.org or contact your local U.S. Coast Guard Auxiliary or United States Power Squadrons®.

- U.S. Coast Guard Auxiliary: 1-800-368-5647 or on the Internet at: <http://www.cgaux.org>
- U.S. Power Squadrons: 1-888-FOR-USPS (1-888-367-8777) or on the Internet at: <http://www.usps.org>

Chapter 2: Locations

Exterior Views

Hull Views

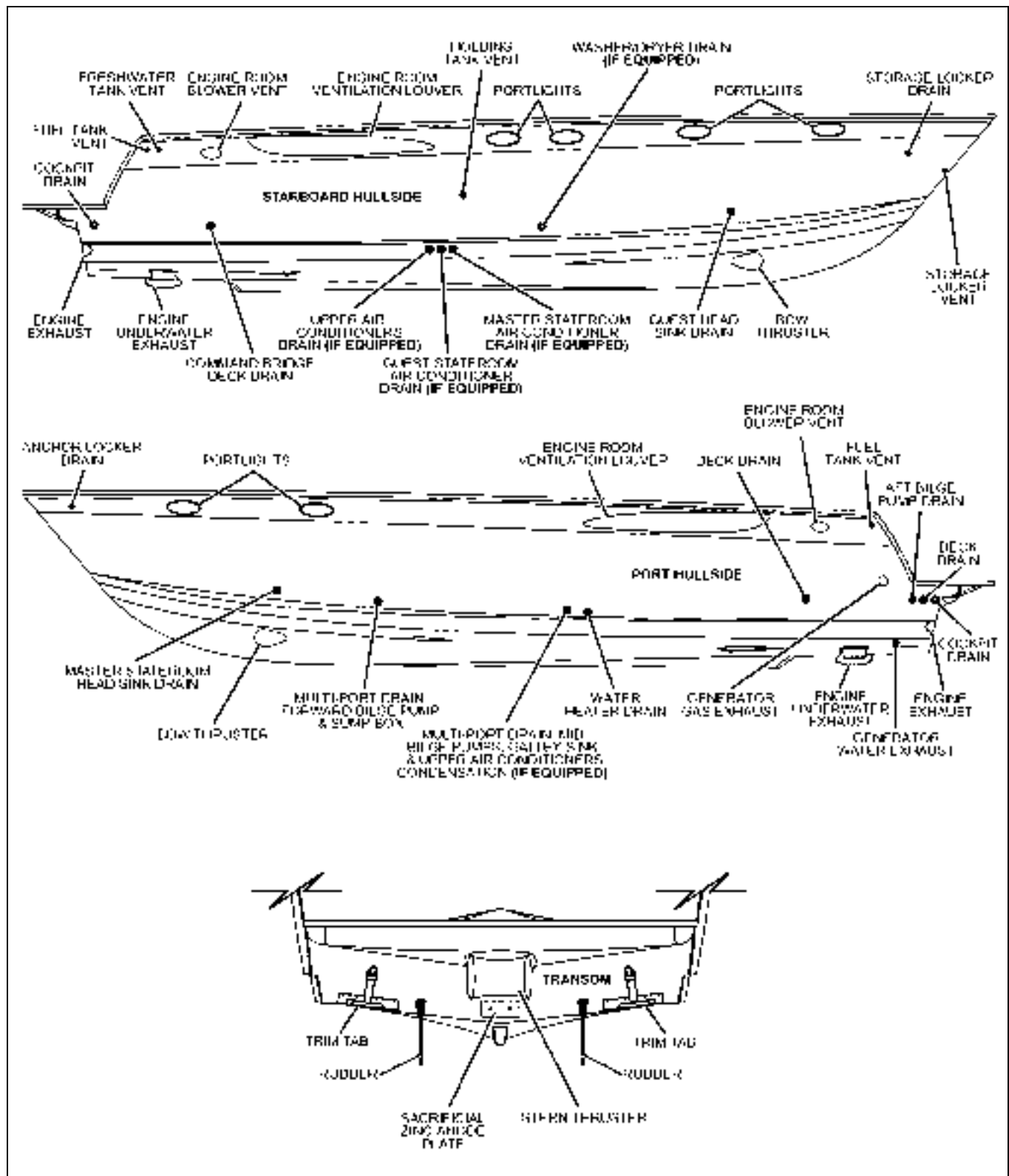

Aft & Starboard Side Deck View

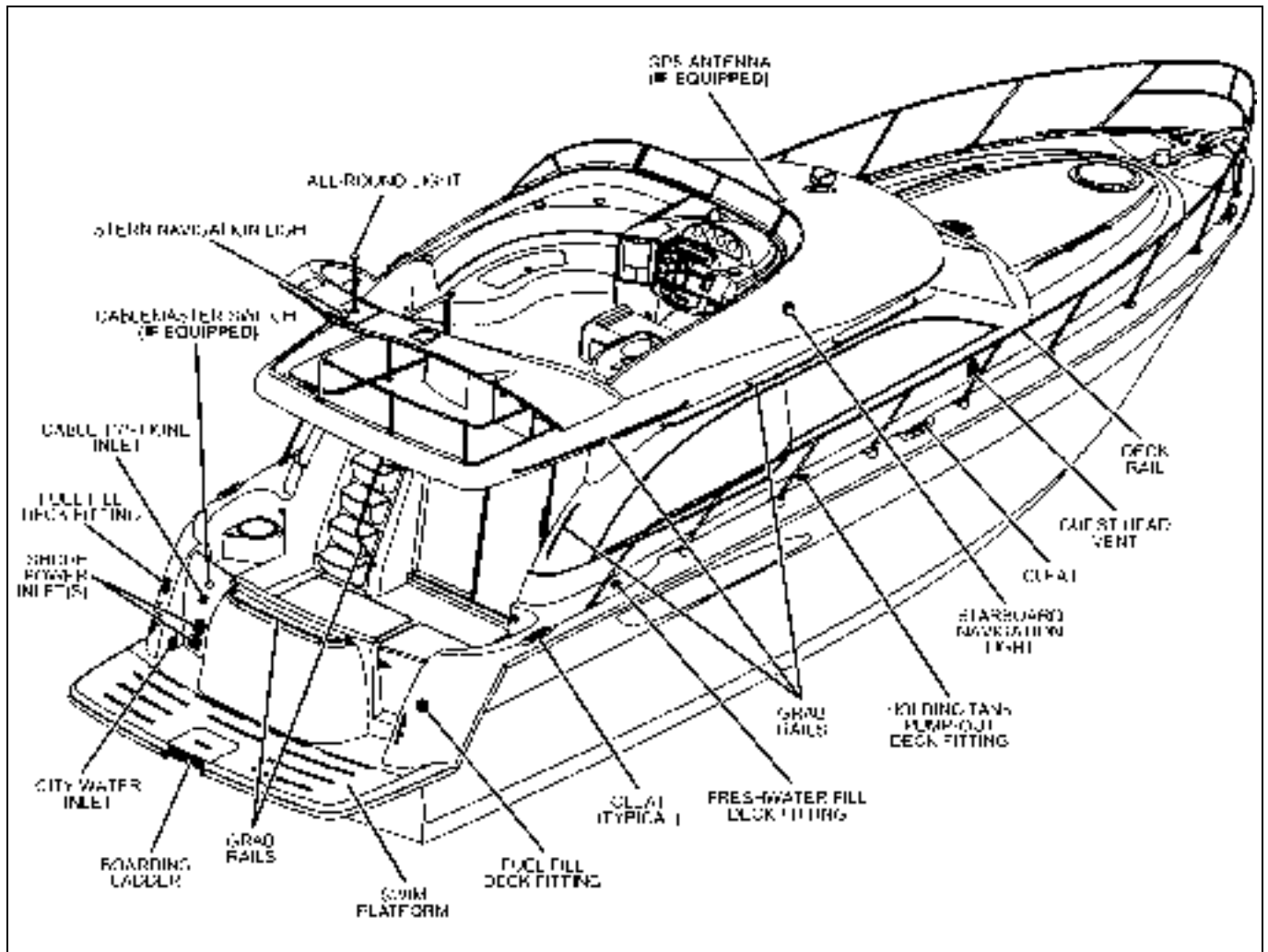

Command Bridge Helm Station

NOTE: TYPICAL HELM LAYOUTS SHOWN. ACTUAL LAYOUTS MAY VARY DEPENDING ON ENGINE & ACCESSORY OPTIONS.

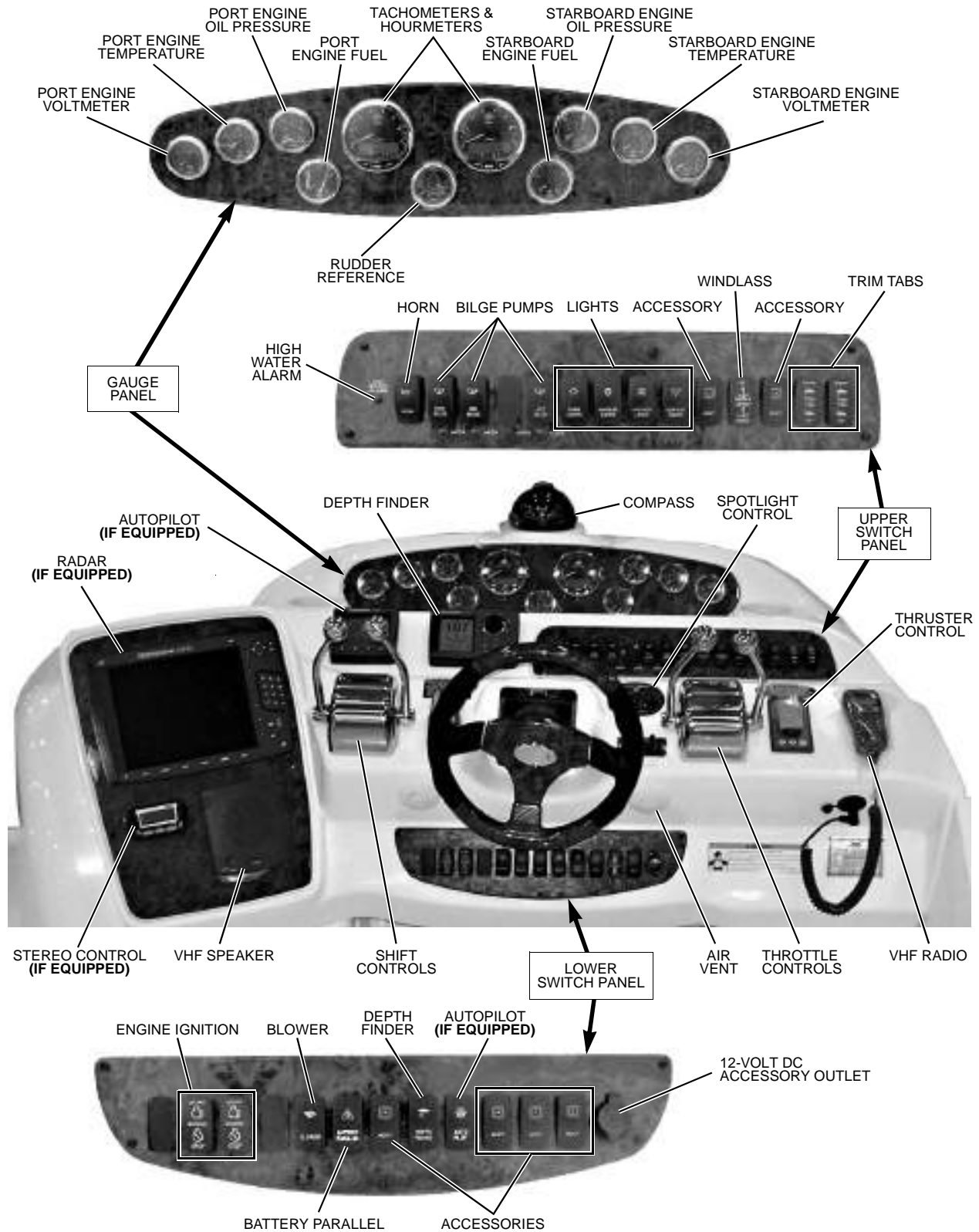

Lower Helm Station (If Equipped)

NOTE: TYPICAL HELM LAYOUTS SHOWN. ACTUAL LAYOUTS MAY VARY DEPENDING ON ENGINE & ACCESSORY OPTIONS.

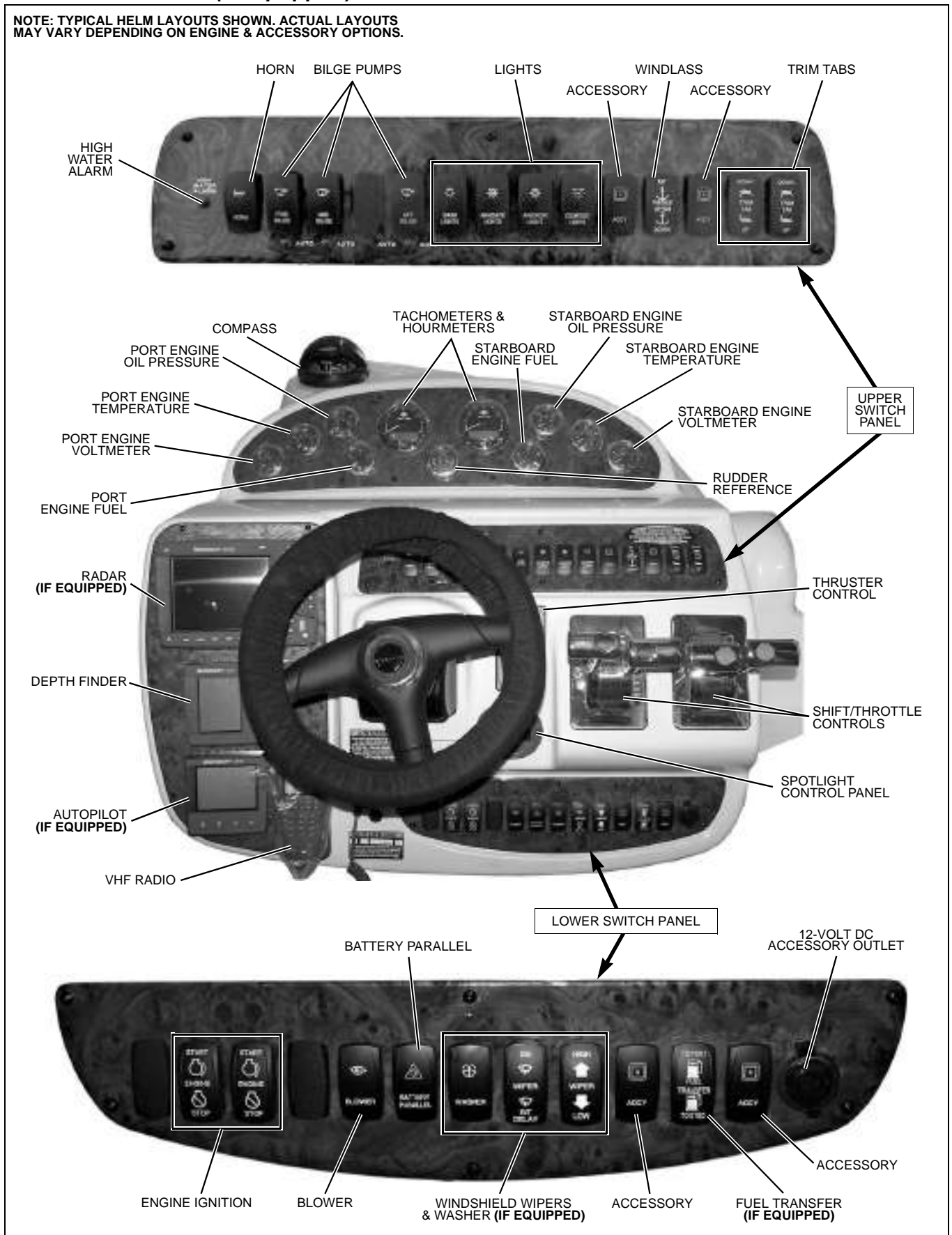

Component Locations

12-Volt DC Accessory Outlets:

- One is located on the ignition switch panel at the command bridge helm.



- One is located on the ignition switch panel at the lower helm (if equipped).

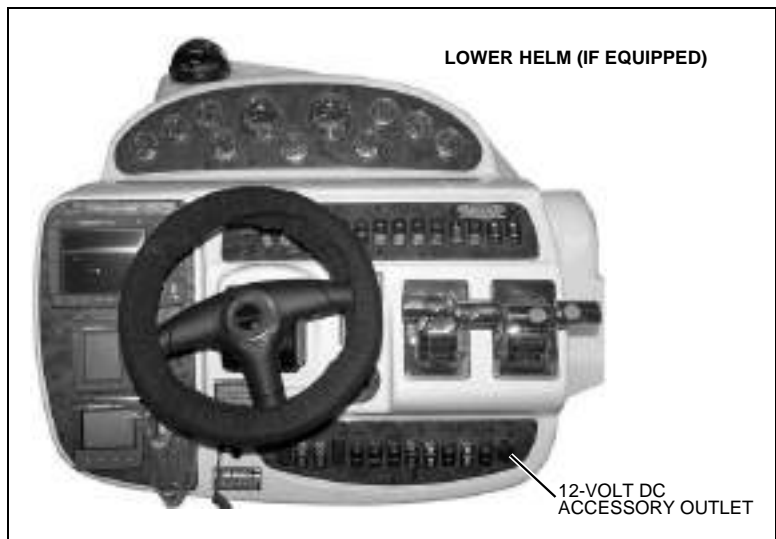

- One is located on the forward end of the TV cabinet (if equipped) on the port side of the master stateroom.

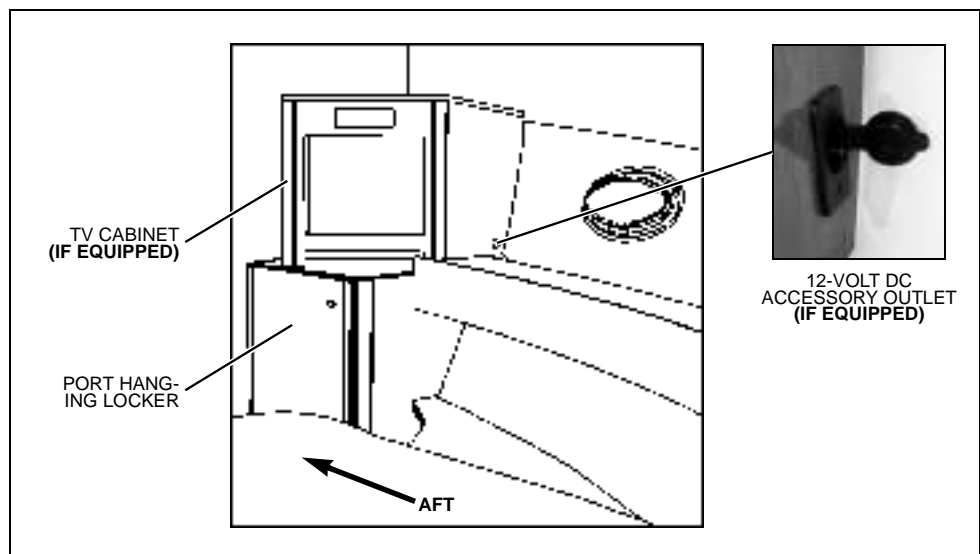

- One is located inside the TV cabinet (if equipped) on the starboard side of the guest stateroom.

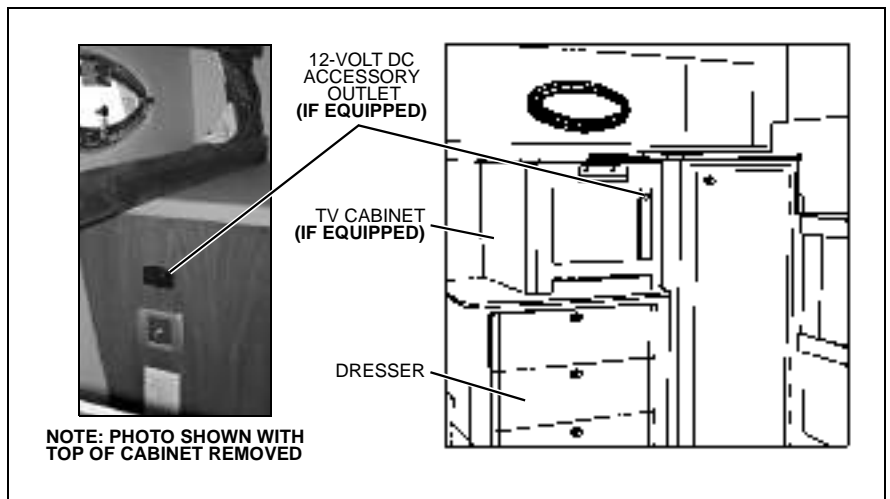

12-Volt DC Circuit Breakers:

- The 12-volt DC push-to-reset circuit breakers are located in the starboard wall hatch at the command bridge helm.
- The 12-volt DC main distribution panel is located inside the electrical cabinet in the starboard aft corner of the salon.
- The 12-volt DC main circuit breaker switches and standby-load push-to-reset circuit breakers are located on the battery management panel.
- The 12-volt DC windshield washer and wiper circuit breakers are located on the starboard wall at the lower helm (if equipped).

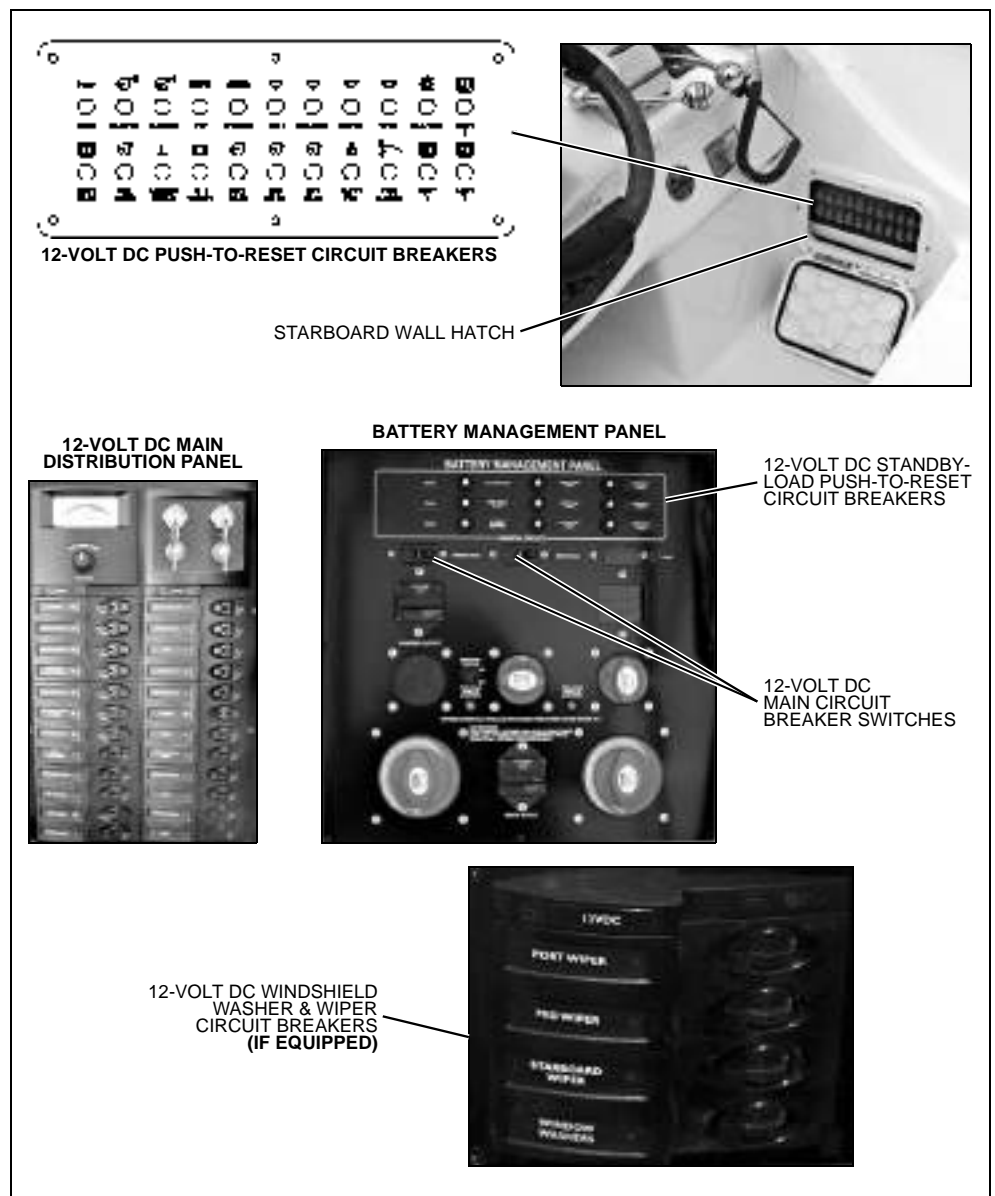

110-Volt AC & 12-Volt DC Master Panels:

Located inside the electrical cabinet in the starboard aft corner of the salon.

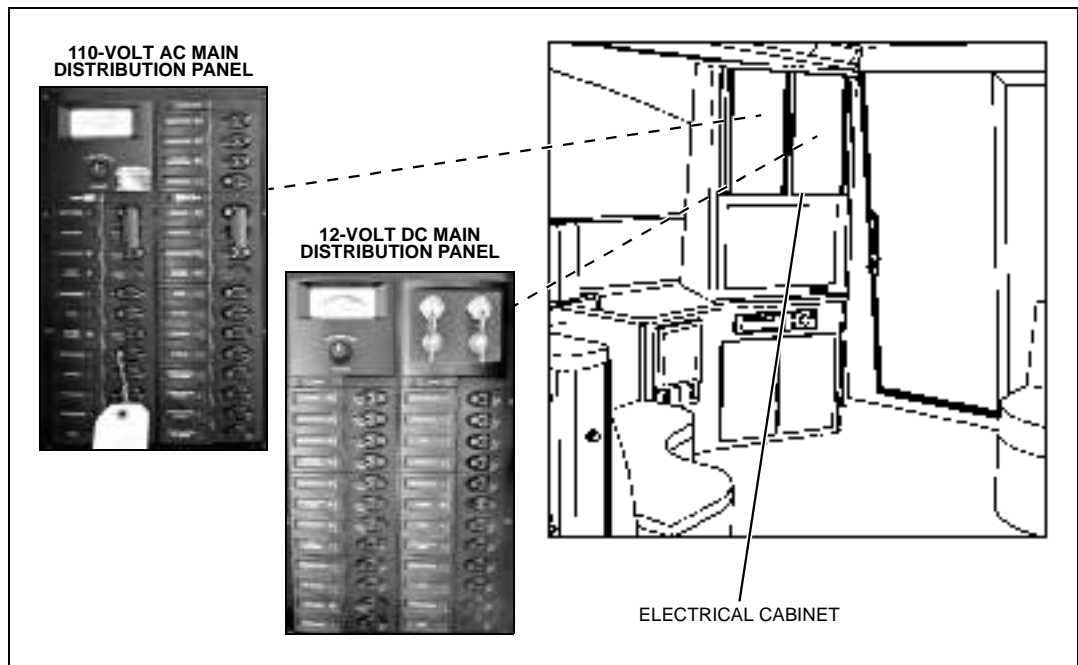

Air Conditioner Seawater Intake Seacock (If Equipped):

- Located forward of the starboard engine in the engine room.
- Access the engine room by lifting the command bridge stairs.

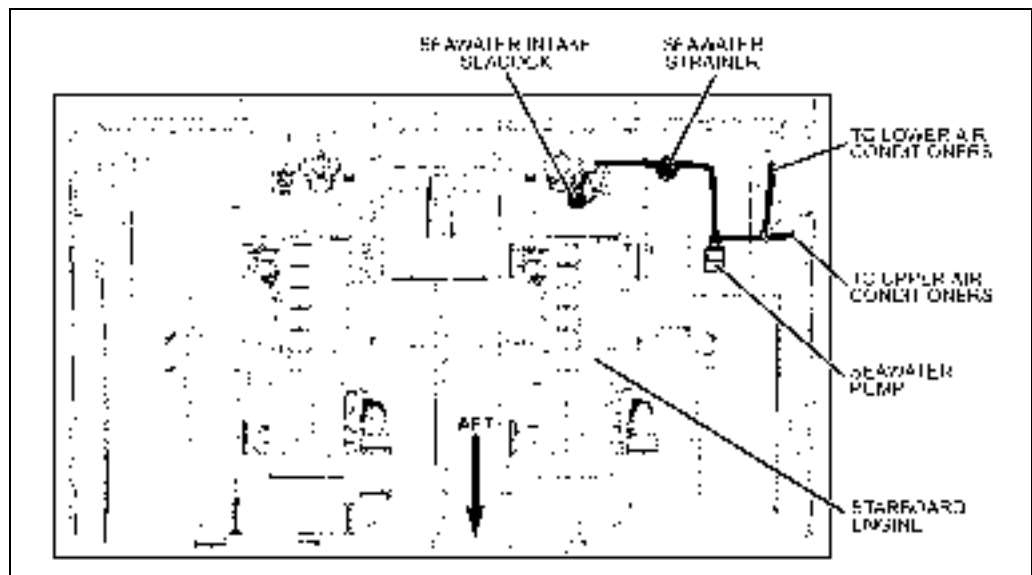

Air Conditioners (If Equipped) (4 total):

- Two are located behind the command bridge dash.
- Access through the hatch forward of the port lounge seat.

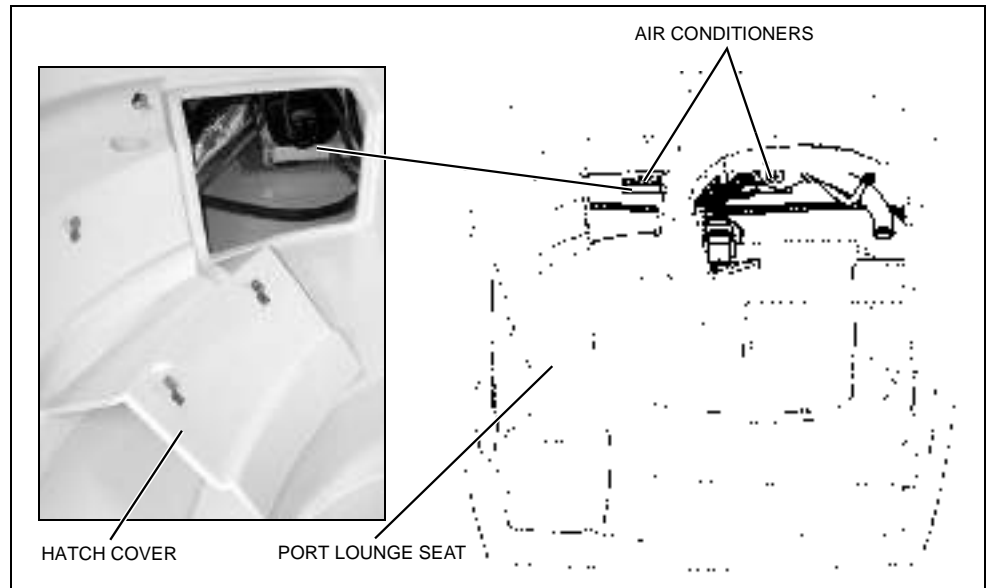

- One is located under the guest stateroom entry step.
- Access by lifting the top of the step.

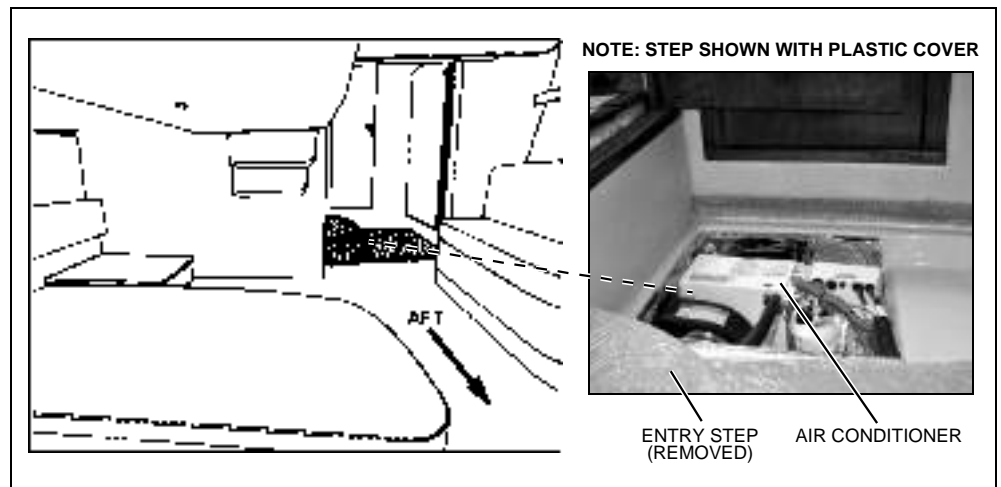

- One is located under the bunk storage hatch in the master stateroom.

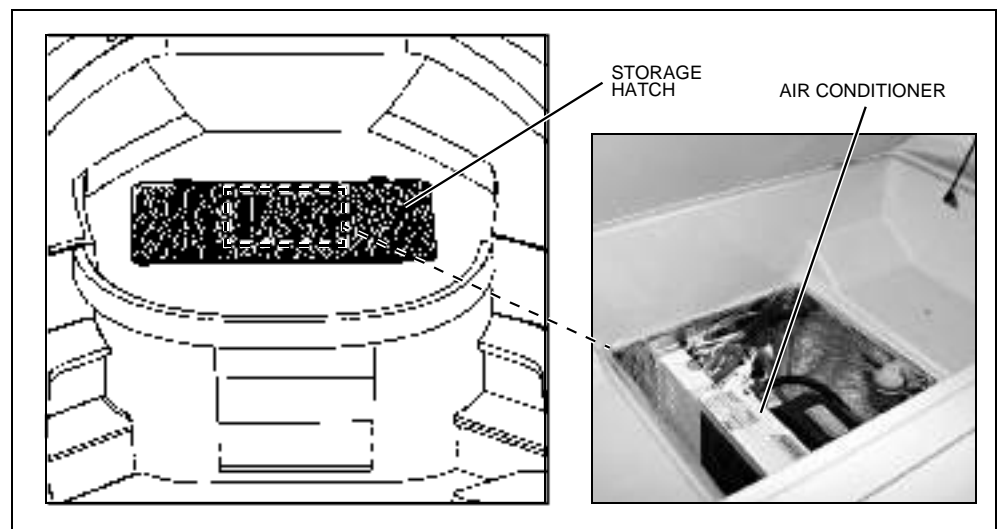

Batteries:

- All batteries except the bow thruster battery are located on the port side of the lazarette.
- The bow thruster battery is located forward of the water heater on the port side of the engine room.

NOTE: The house battery box contains two batteries.

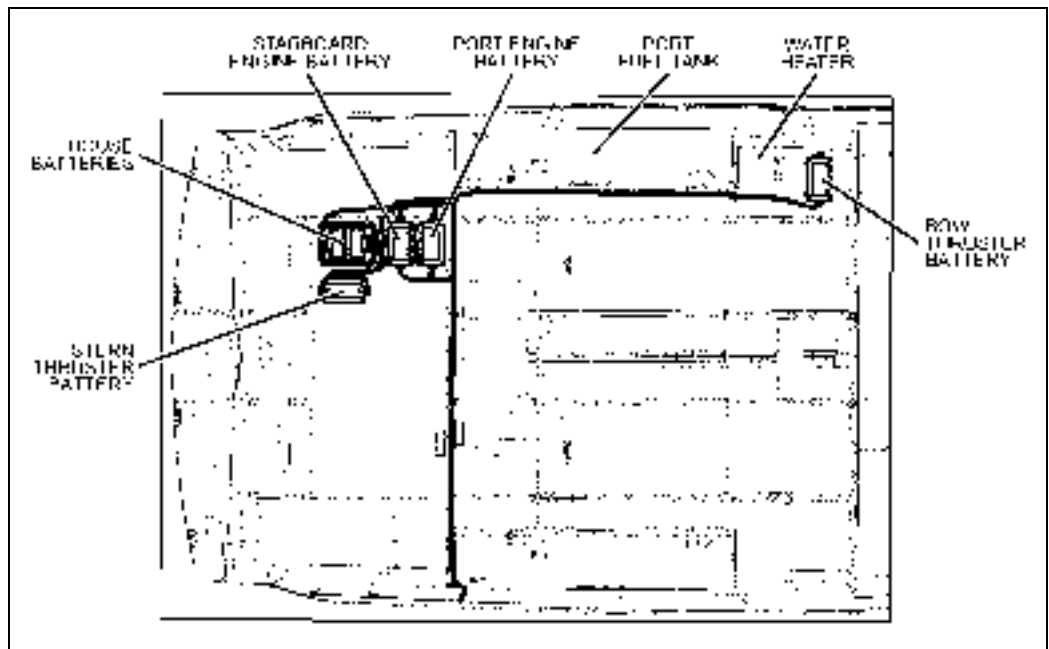

Battery Chargers: Located on the starboard aft wall of the engine room.

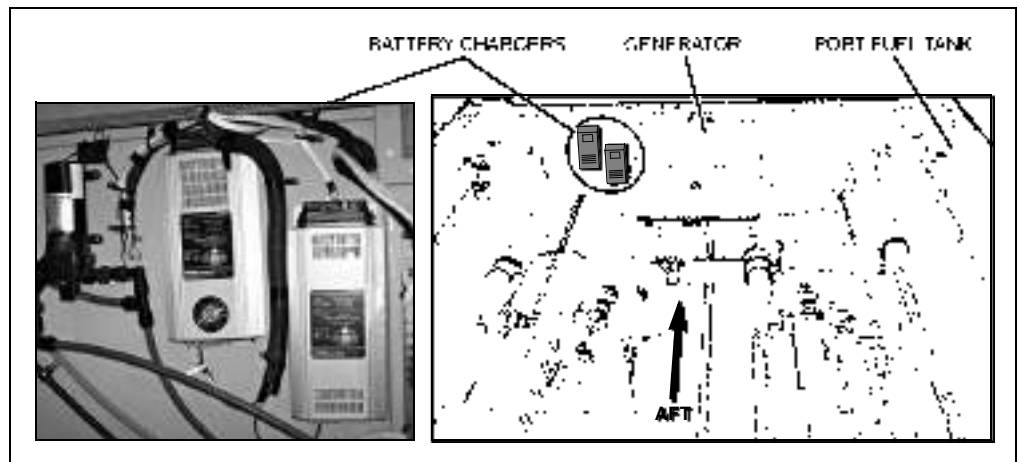

Battery Management Panel (Battery Switches):

- Located under the command bridge stairs.
- Access by lifting the command bridge stairs.

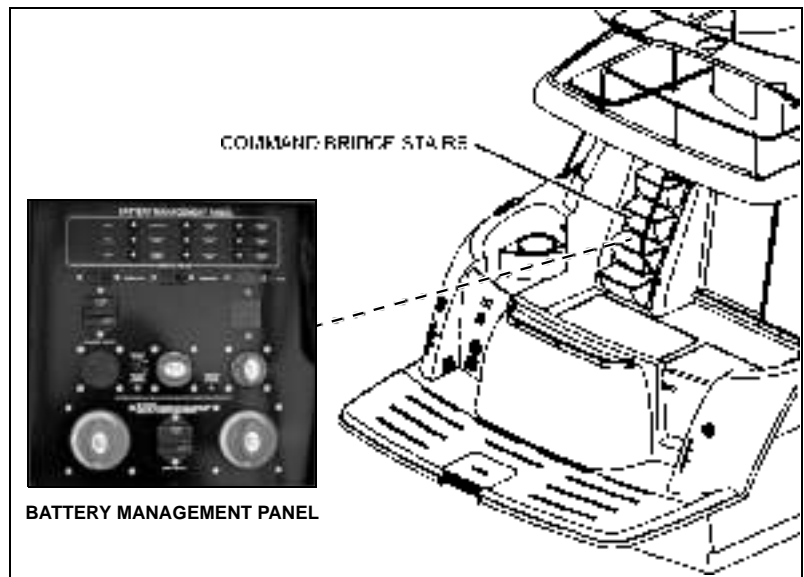

Bilge Pumps (4 total):

- One is located in the aft bilge area of the lazarette.

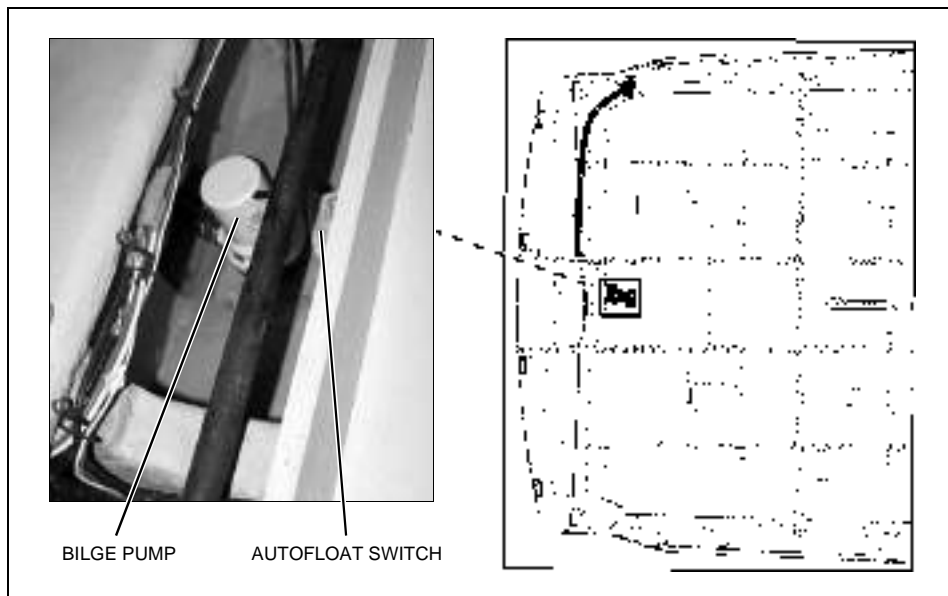

- Two are located in the forward bilge area of the engine room.

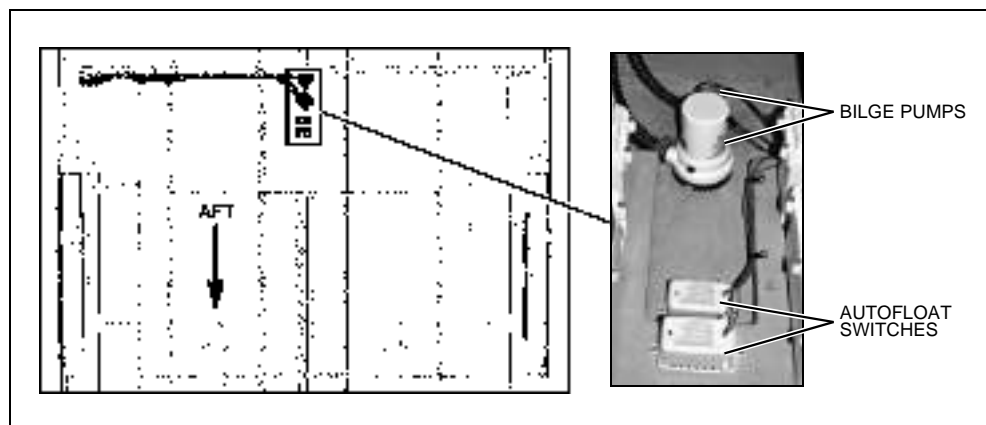

- One is located under the bottom step in the hallway.
- Access by lifting the top of the step.

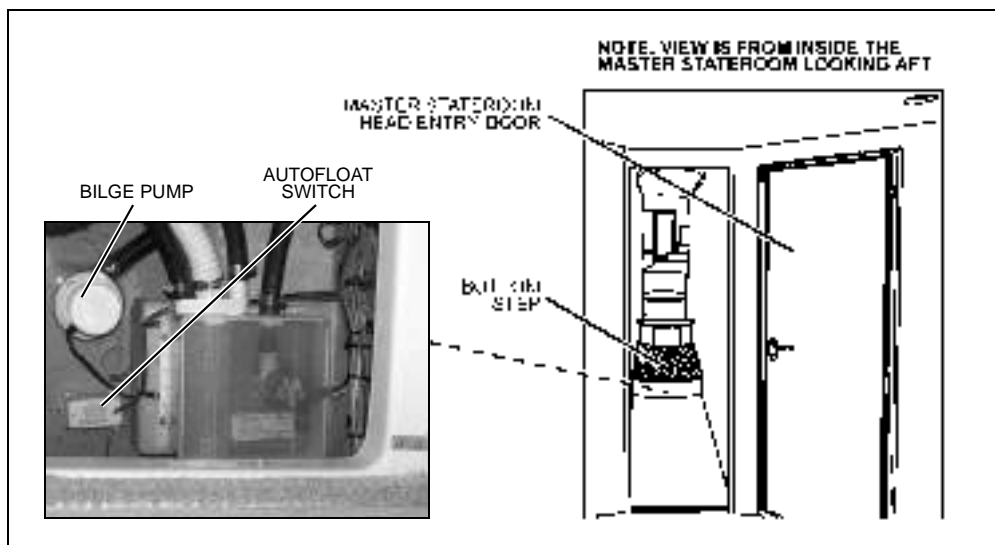

City Water Inlet: Located just above the swim platform on the port aft corner of the deck.

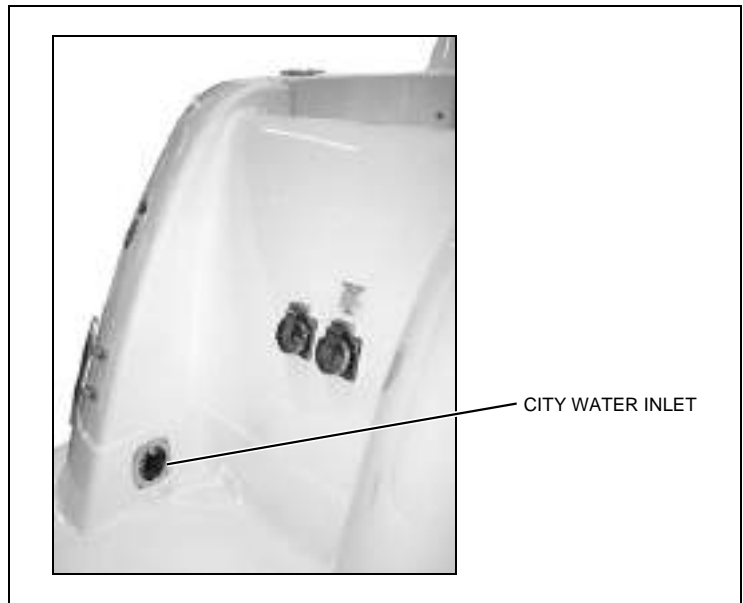

CO Monitors (3 total):

- One is located above the nightstand on the forward wall of the guest stateroom.

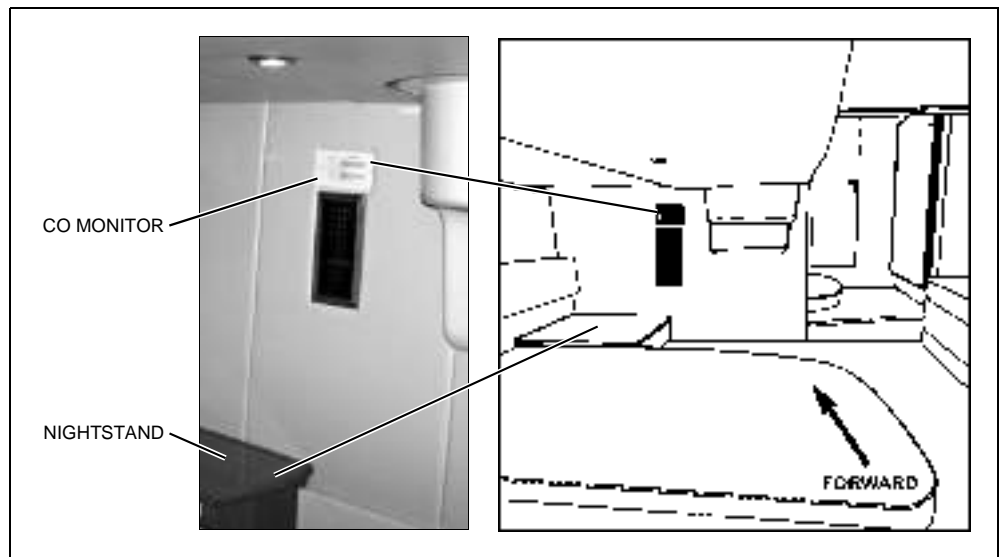

- One is located on the ceiling pad above the forward dinette seat.

NOTE: If equipped with lower helm, this CO monitor is located on the ceiling pad above the lower helm dash.

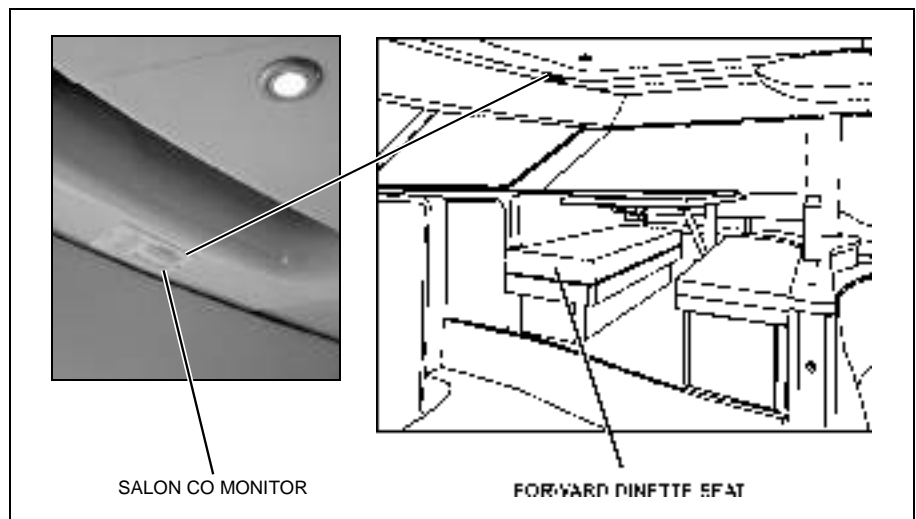

- One is located above the hanging locker in the starboard aft corner of the master stateroom.

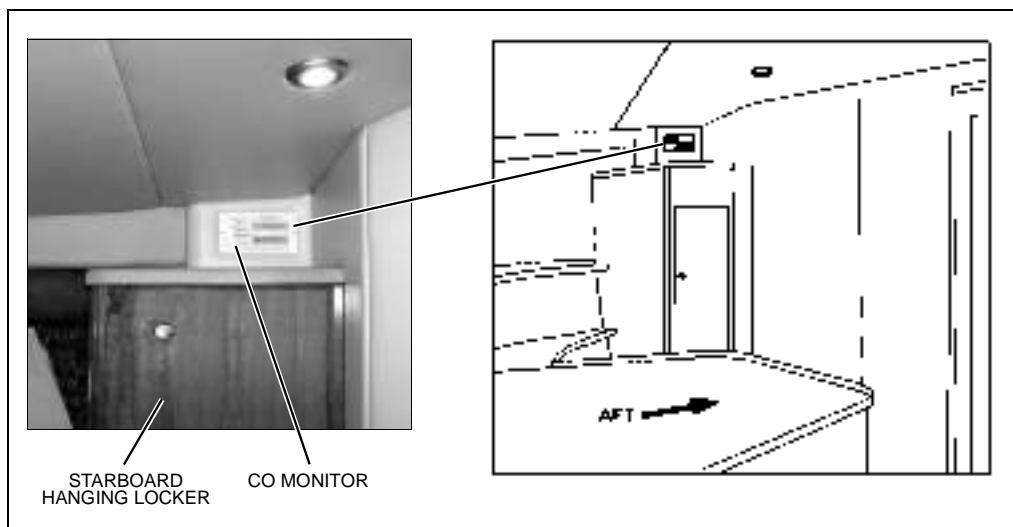

Depth Finder Transducer: Located in the forward bilge area of the engine room.

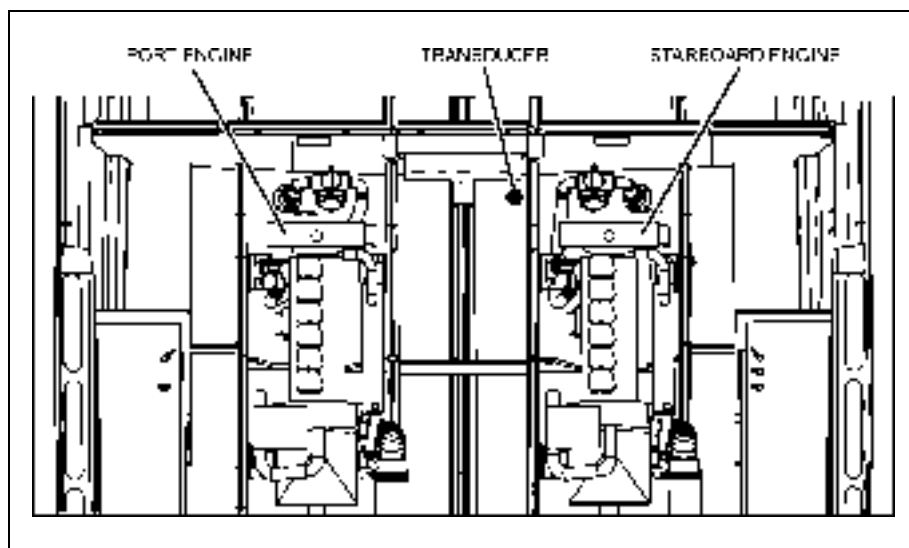

Engine Cooling System Seawater Intake Seacocks: Located forward of each engine in the engine room.

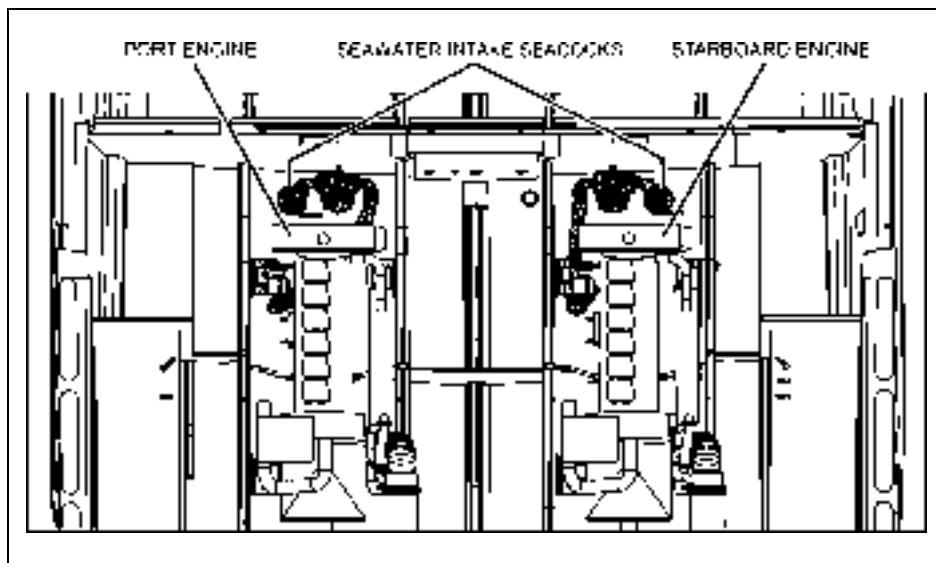

Engine Room:

- Access by lifting the command bridge stairs.
- There is additional access through the large floor hatch in the salon.

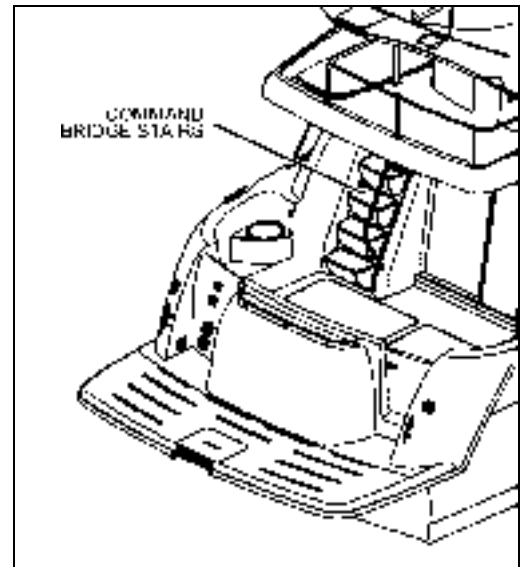

Freshwater Fill Deck Fitting: Located on the starboard aft deck trail.

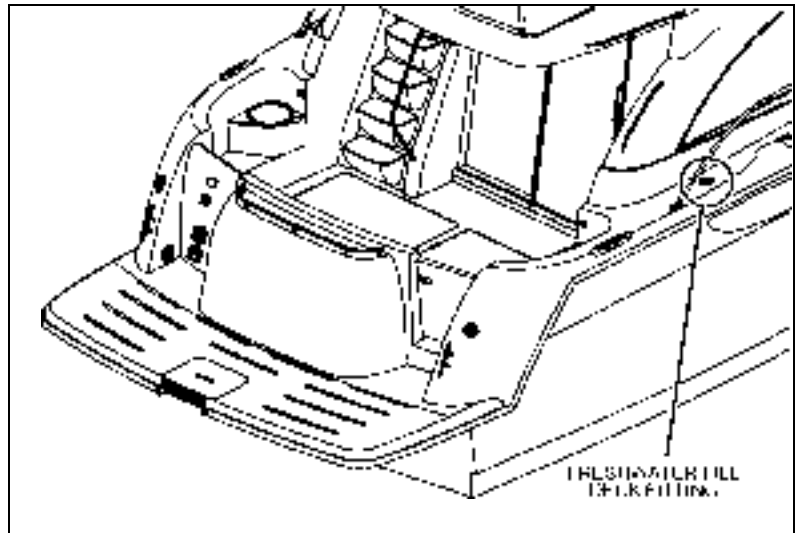

Freshwater Pump:
Located on the starboard aft wall of the engine room.

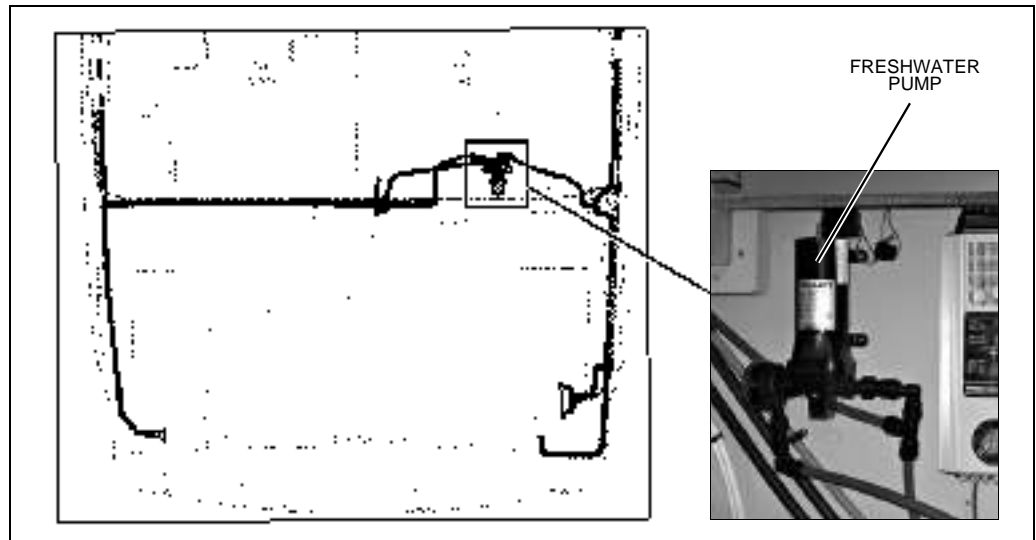

Freshwater Pump Switch: Located on the 12-volt DC main distribution panel inside the electrical cabinet in the starboard aft corner of the salon.

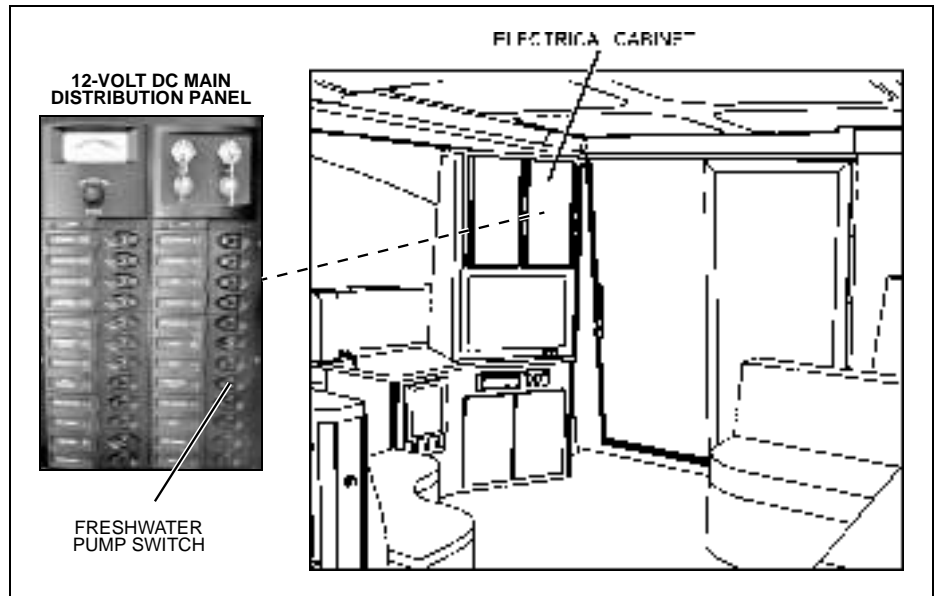

Freshwater Tank: Located in the forward center area of the lazarette.

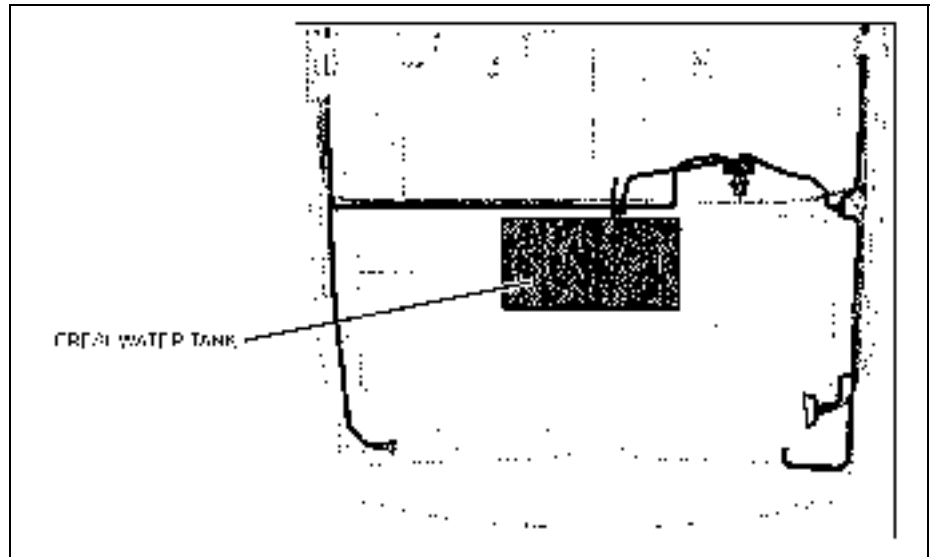

Freshwater Washdown Faucets (2 total):

- One is located inside the storage locker on the starboard side of the forward deck.

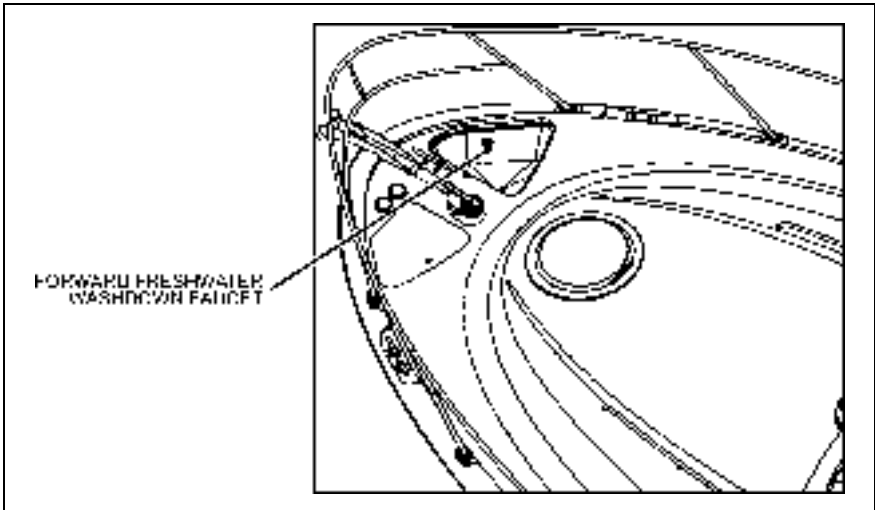

- One is located inside the starboard transom hatch in the cockpit.

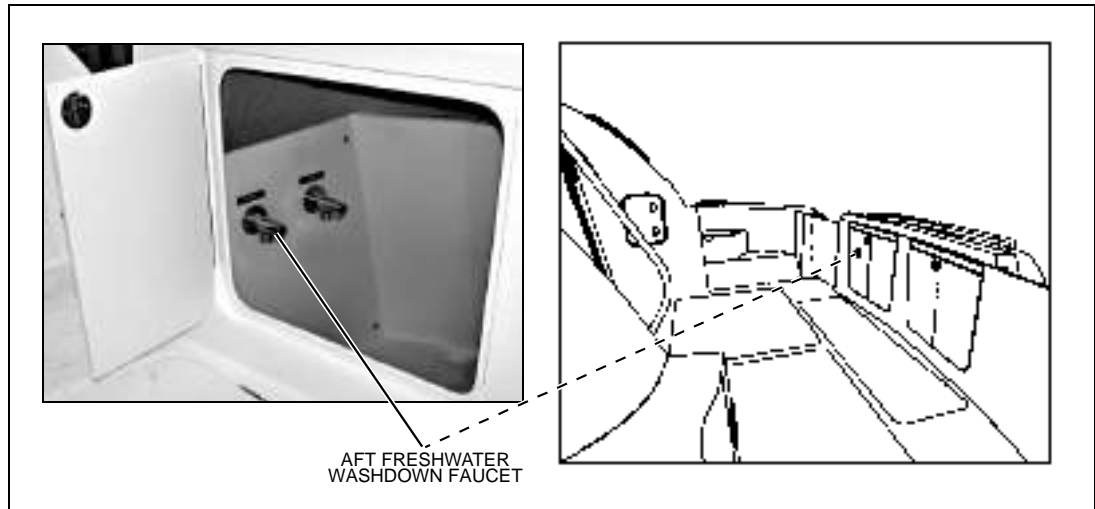

Fuel Fill Deck Fittings: Located on the port and starboard aft corners of the deck.

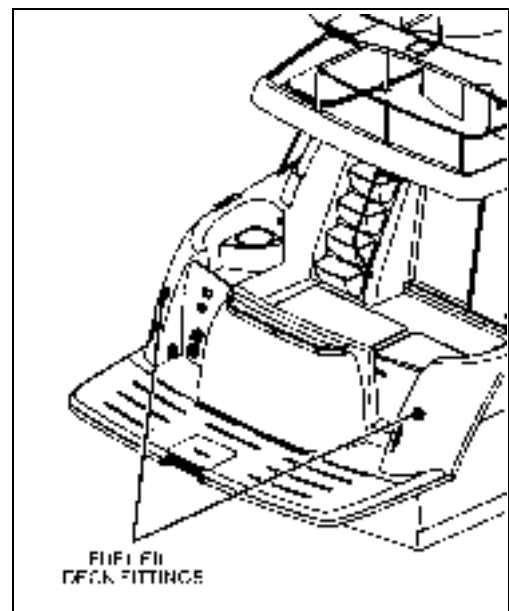

Fuel Tanks: Located on each side of the engine room.

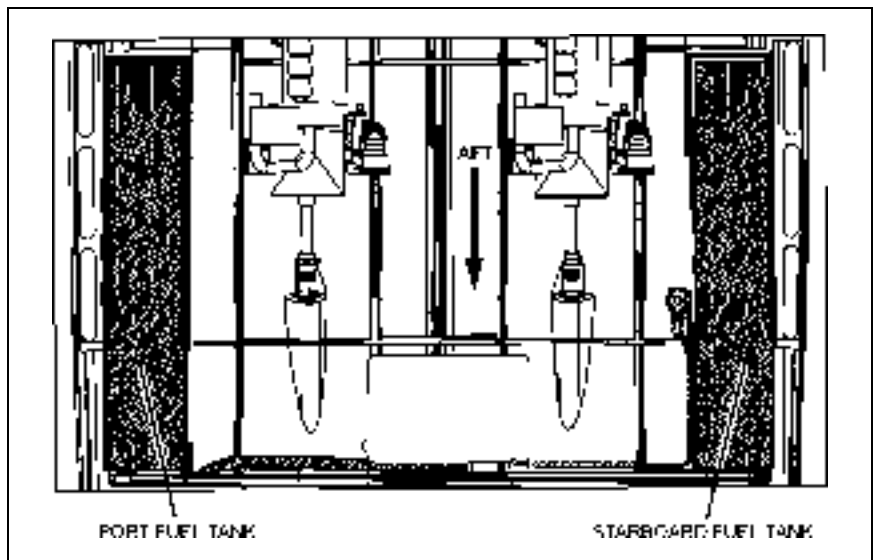

Fuel Transfer Pump (If Equipped): Located on the ceiling between the engines in the engine room.

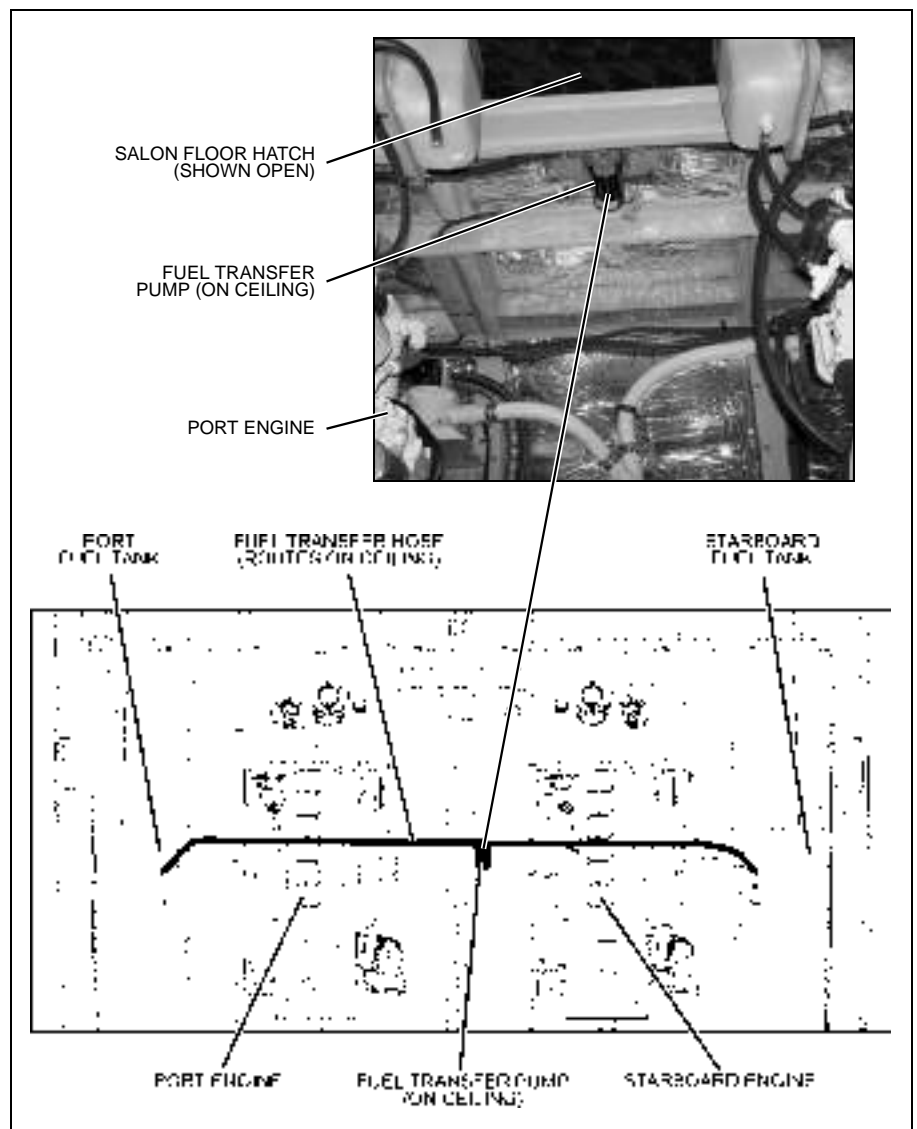

Generator: Located at the center aft end of the engine room.

Generator Seawater Intake Seacock: Located aft of the starboard engine in the engine room.

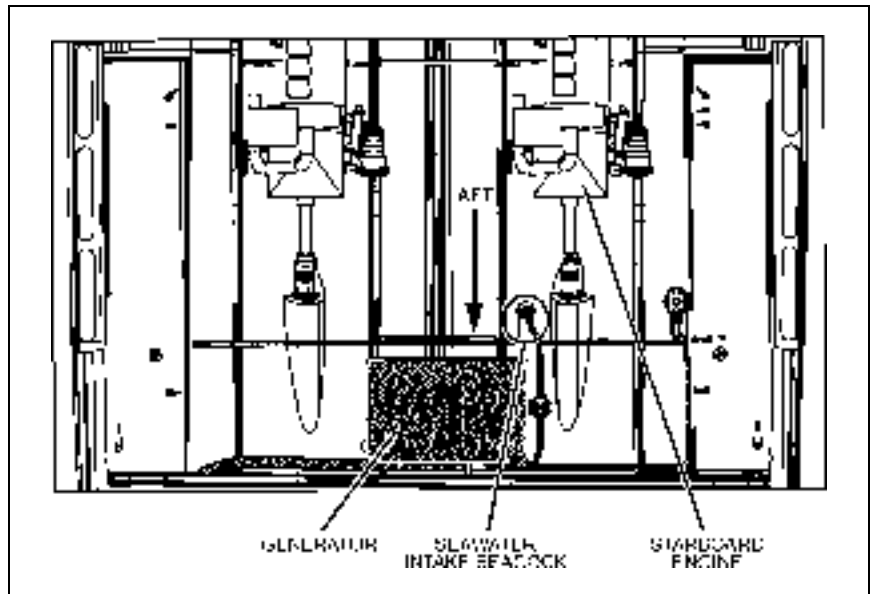

Heat Exchange Fan Switch (If Equipped): Located on the starboard side of the sink cabinets in the galley.

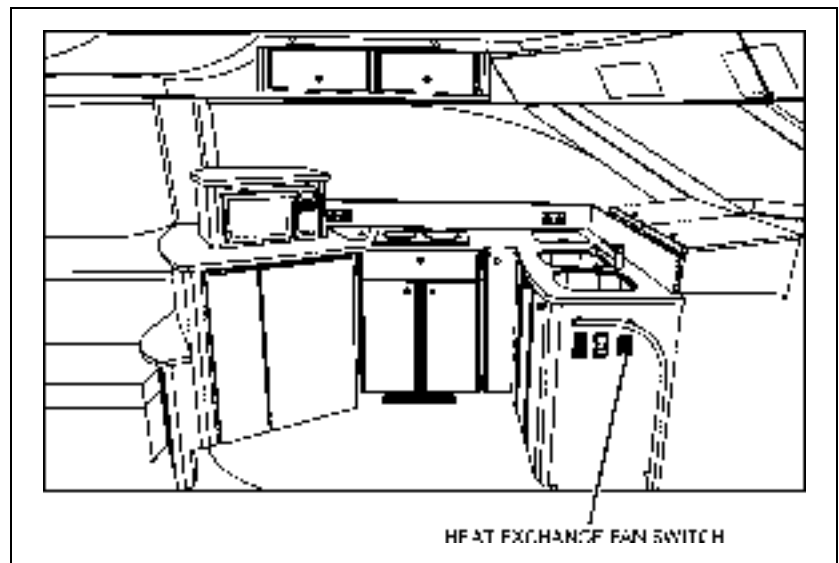

Heat Exchange Shut-off Valves (If Equipped): Located on the inboard side of the starboard fuel tank in the engine room.

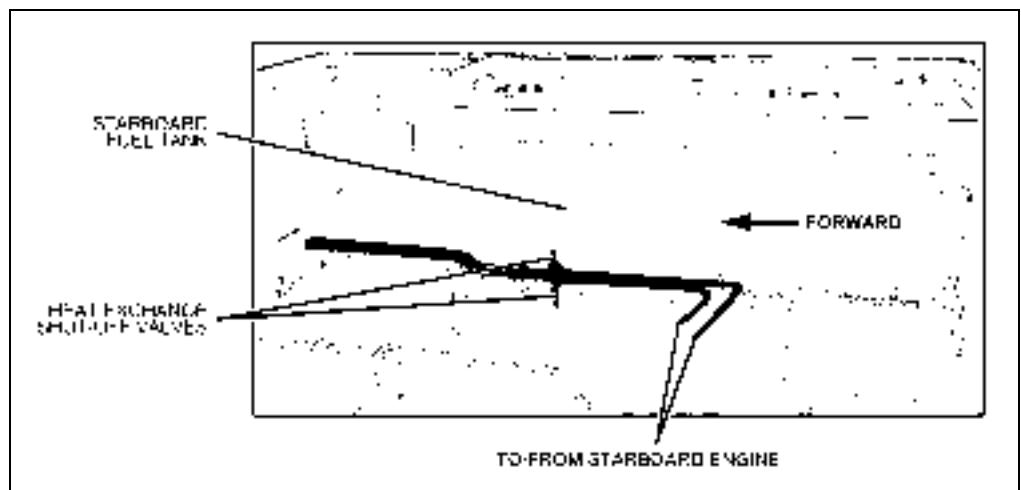

Holding Tank:

- Located under the guest stateroom floor.
- Access the tank fittings through the forward and aft floor hatches.

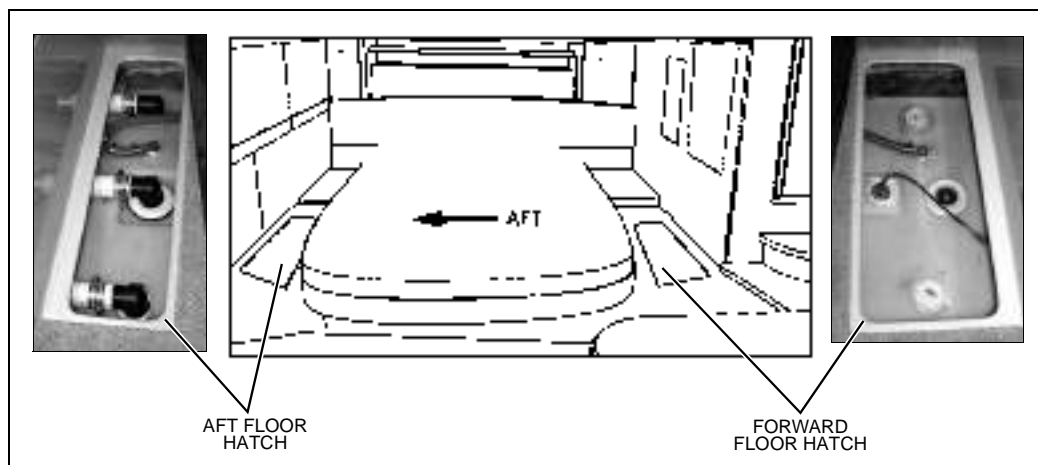

Holding Tank Monitor:

Located in the electrical cabinet in the starboard aft corner of the salon.

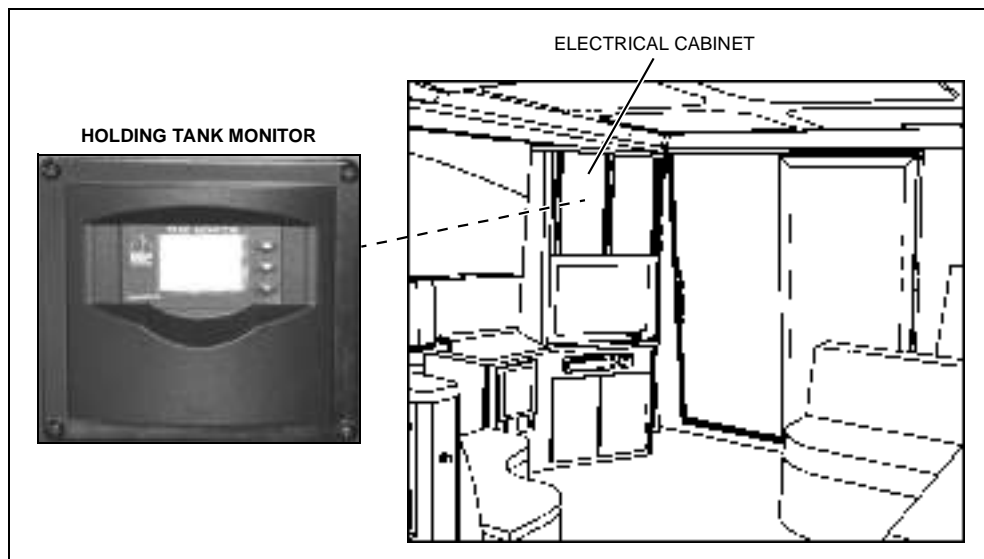

Holding Tank Pump-out Deck Fitting (marked WASTE): Located amidship on the starboard deck trail.

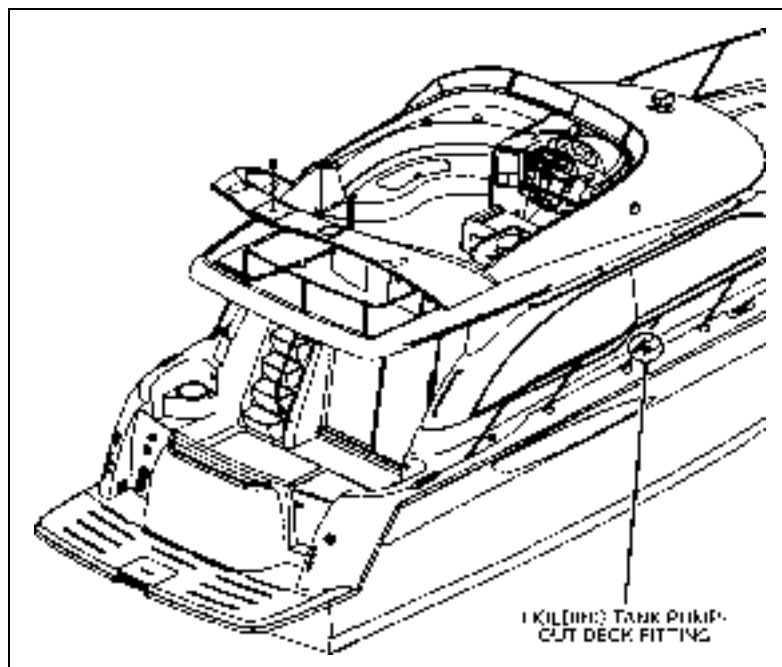

Hydraulic Steering Fluid Reservoir: Located on the steering wheel column at the command bridge helm and lower helm (if equipped).

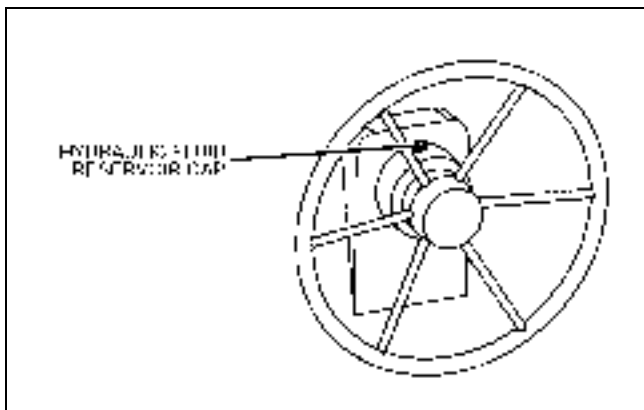

Inverter (If Equipped): Located on the forward starboard wall of the lazarette.

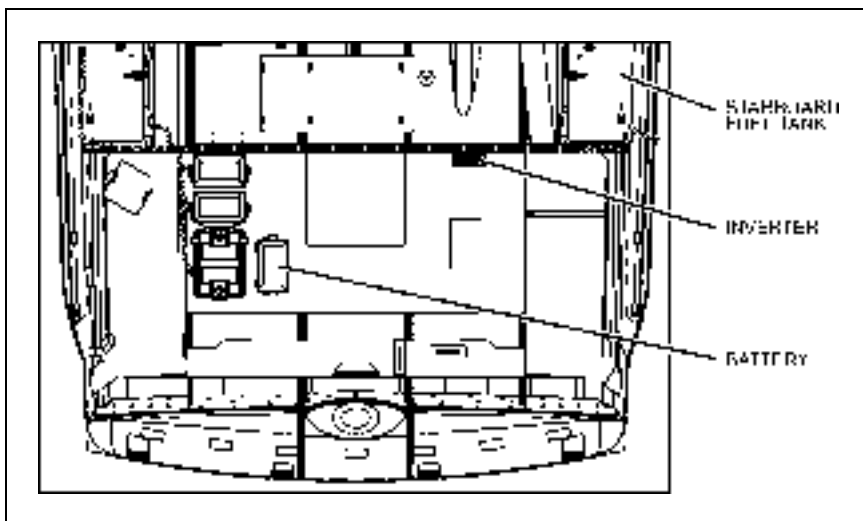

Lazarette: Access the lazarette through the cockpit floor hatches.

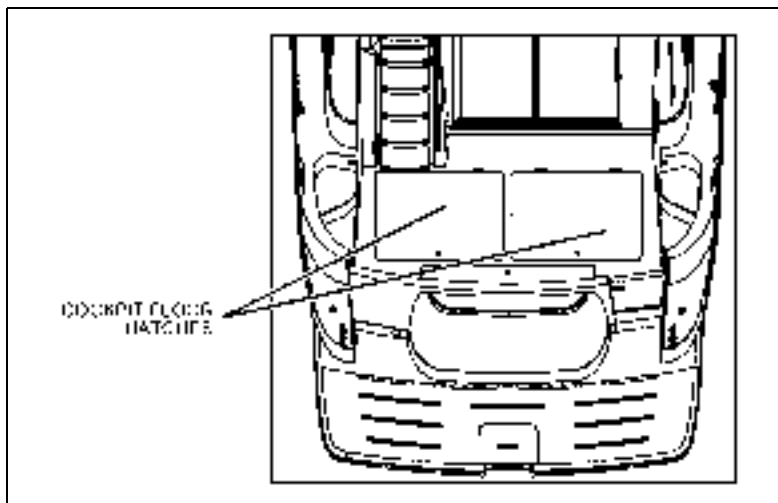

Macerator Switches (If Equipped): Located inside the electrical cabinet in the starboard aft corner of the salon.

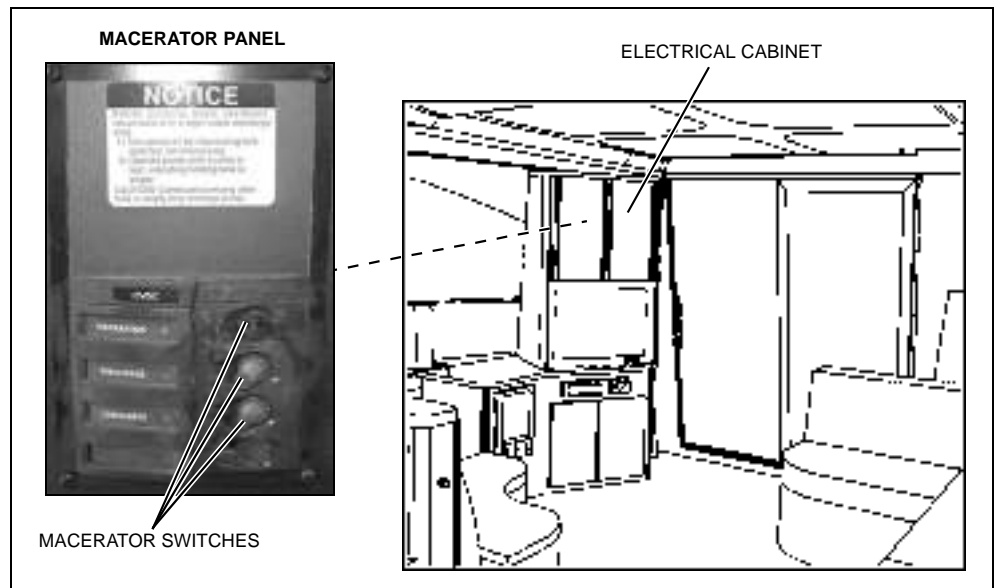

Macerator Underwater Discharge Seacock (If Equipped): Located forward of the port engine in the engine room.

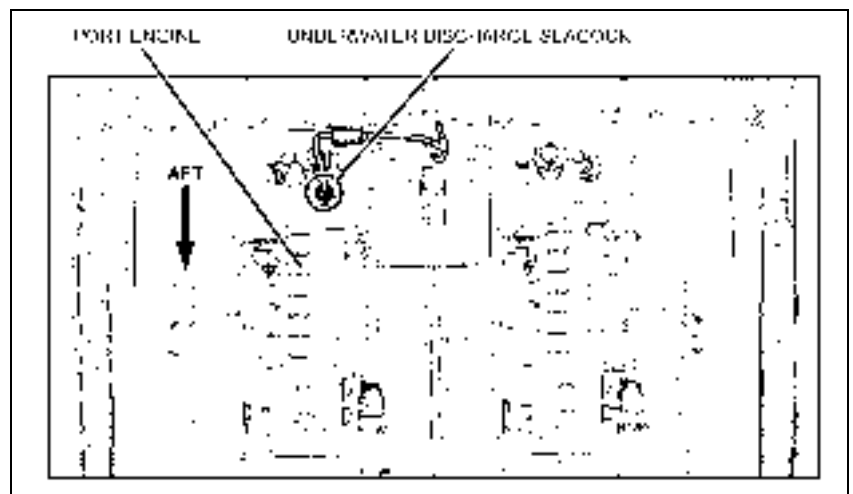

Marine Head Vacuum Flush Pumps (2 total): Located in the forward bilge area of the engine room.

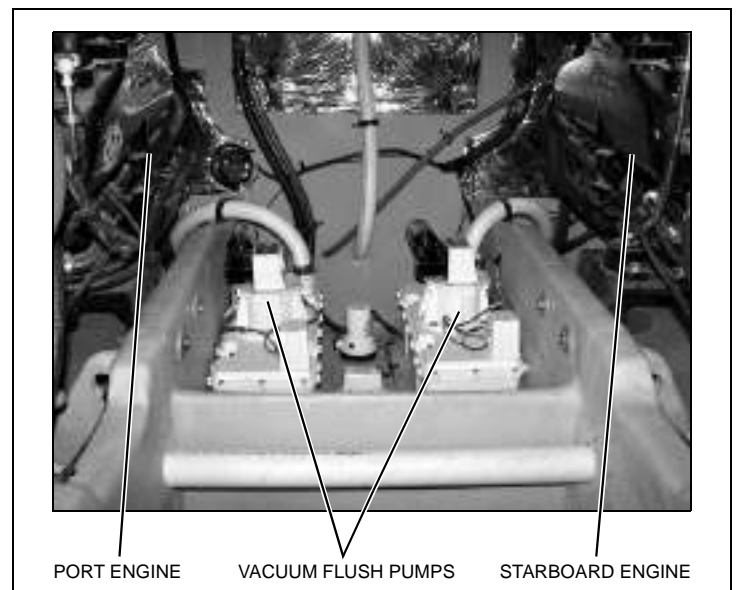

Oil Change System Shut-off Valves (3 total):

- The engine oil change shut-off valves are located along the inboard side of each engine.
- The generator oil change shut-off valve is located on the port side of the generator.

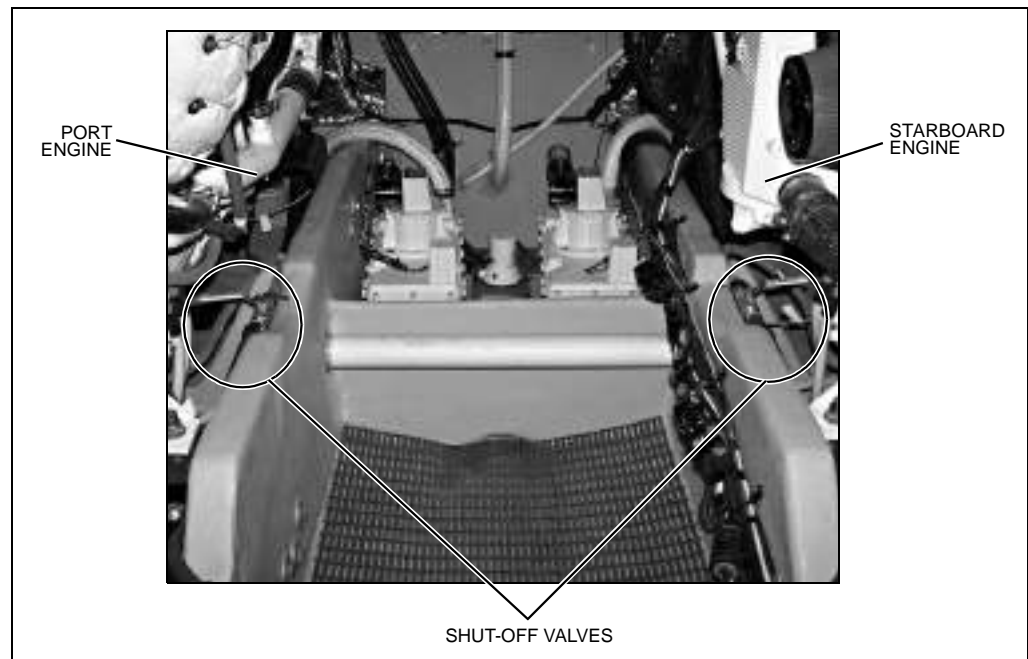

Seawater Washdown Faucets (If Equipped) (2 total):

- One is located in the storage locker on the starboard side of the forward deck.

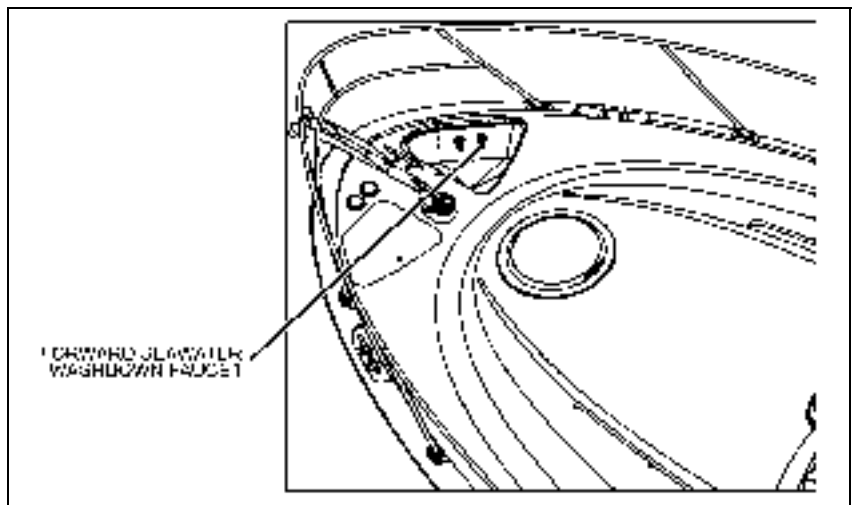

- One is located in the starboard transom hatch in the cockpit.

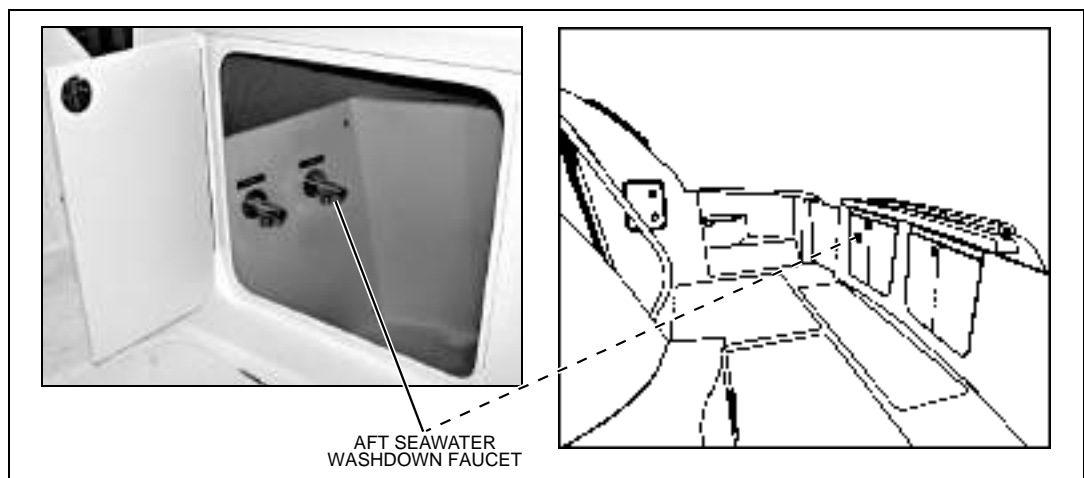

Seawater Washdown Intake Seacock (If Equipped):

- Located under the bottom step in the hallway.
- Access by lifting the top of the step.

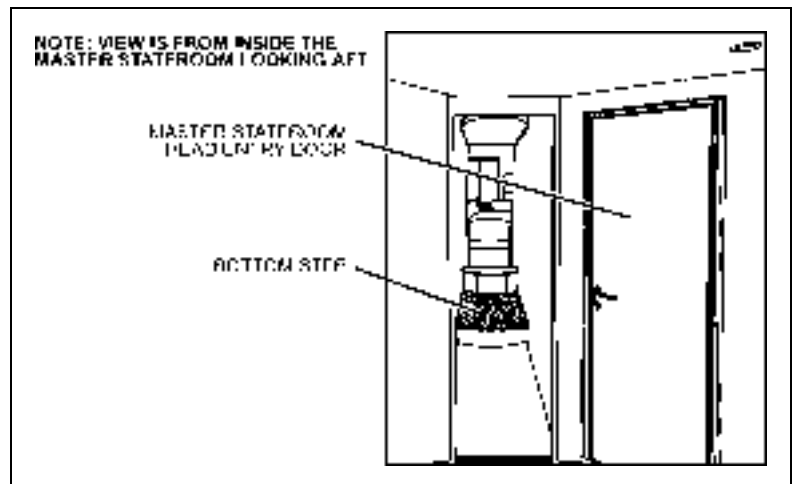

Seawater Washdown Pump Switch (If Equipped): Located on the 12-volt DC main distribution panel inside the electrical cabinet in the starboard aft corner of the salon.

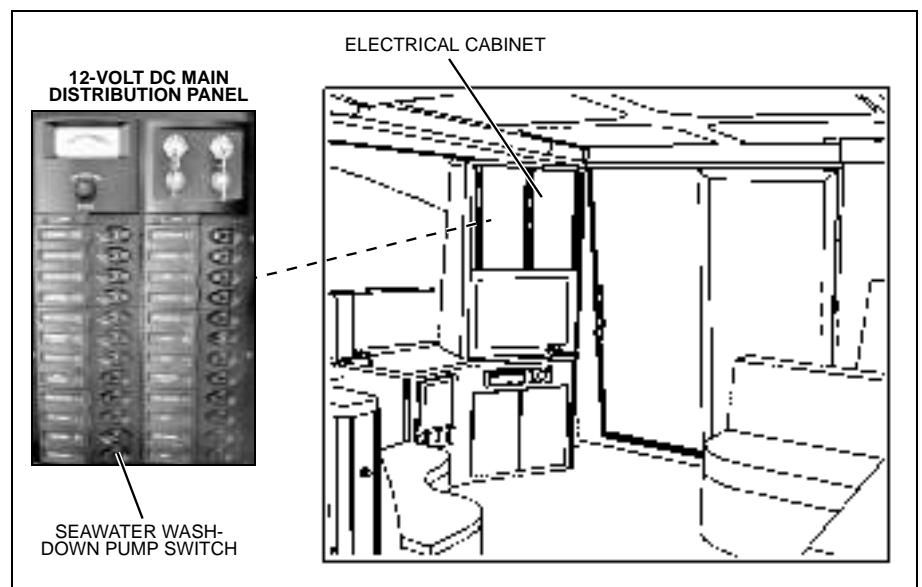

Spotlight: Located on the forward area of the command bridge.

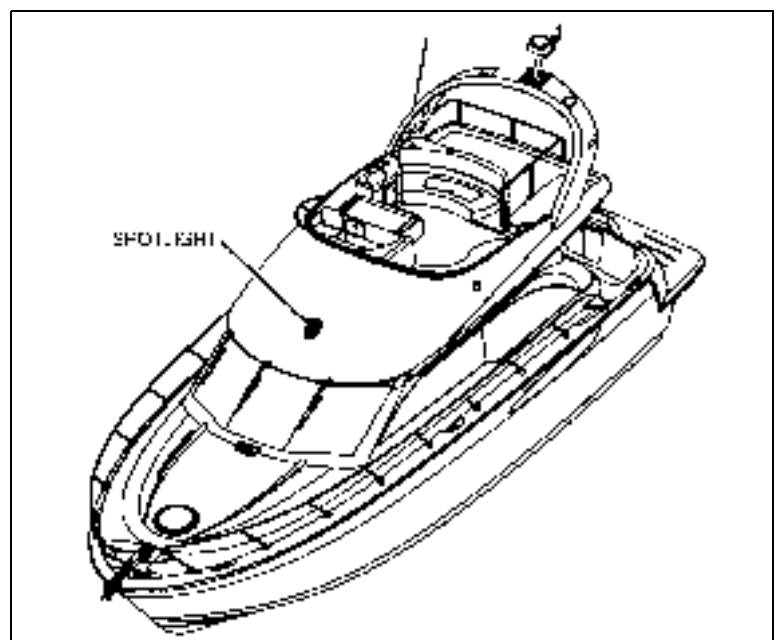

Spotlight Control Panel:
 Located at the upper helm and lower helm (if equipped).

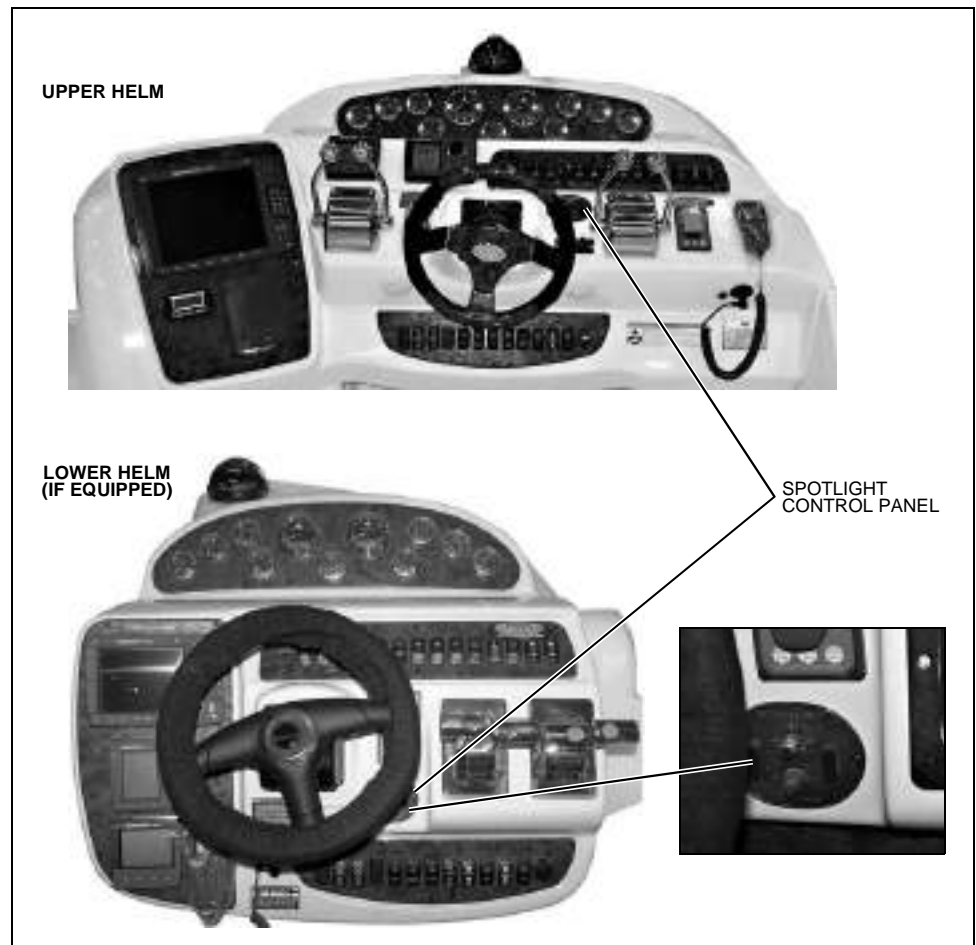

Sump Pump & Box:

- Located under the bottom step in the hallway.
- Access by lifting the top of the step.

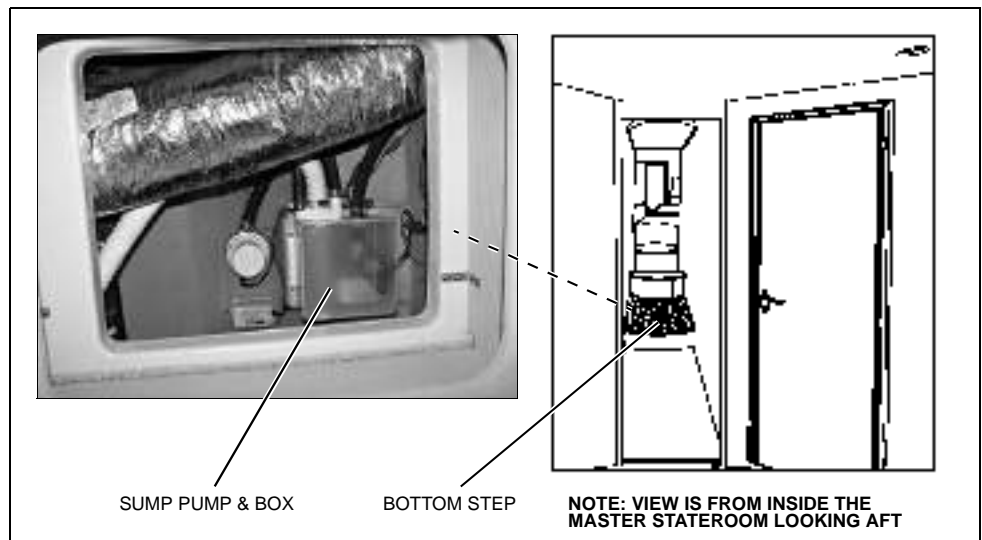

Thruster Oil Reservoirs (2 total):

- The bow thruster oil reservoir is located under the bunk storage hatch in the master stateroom.

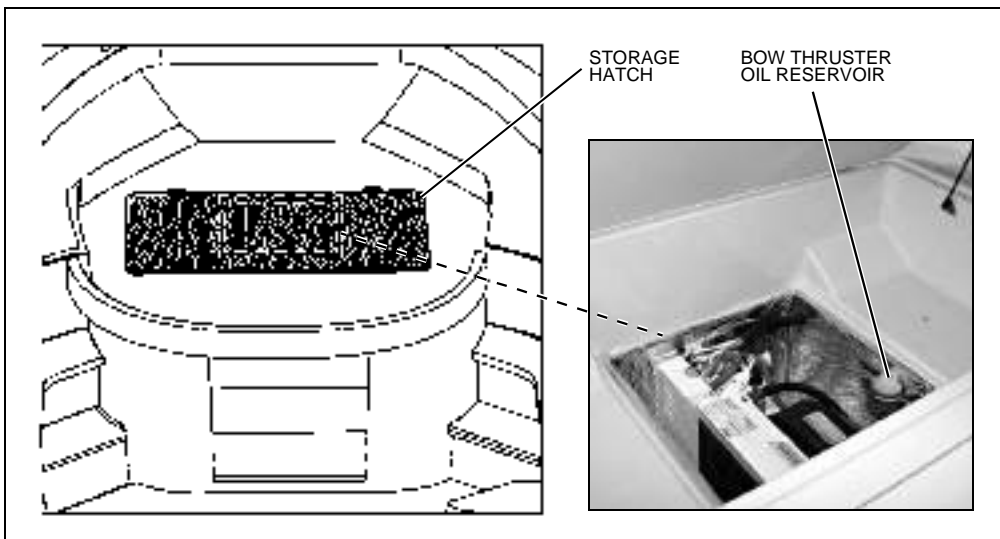

- The stern thruster oil reservoir is located above the stern thruster in the lazarette.

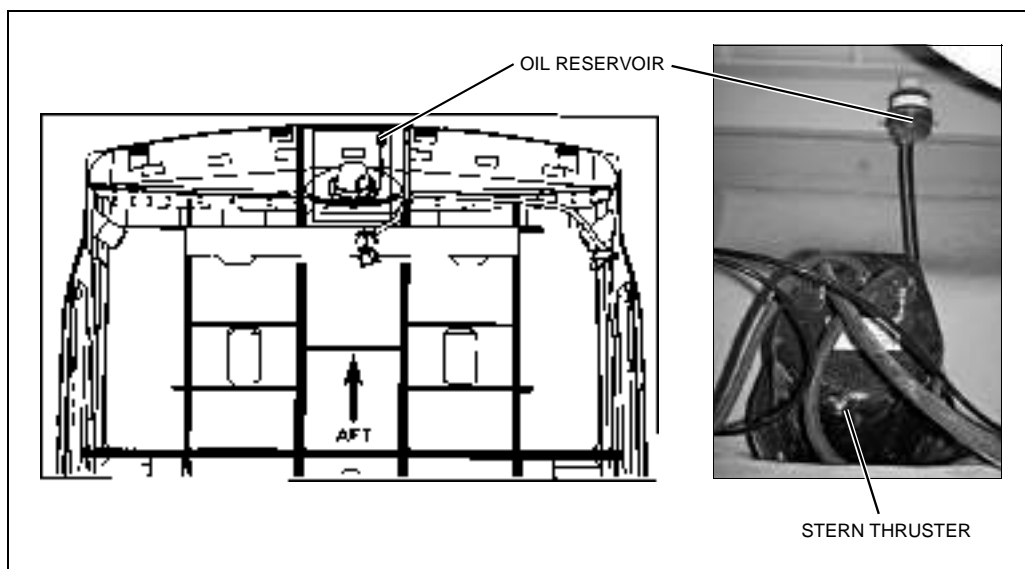

Transom Shower: Located just aft of the transom door.

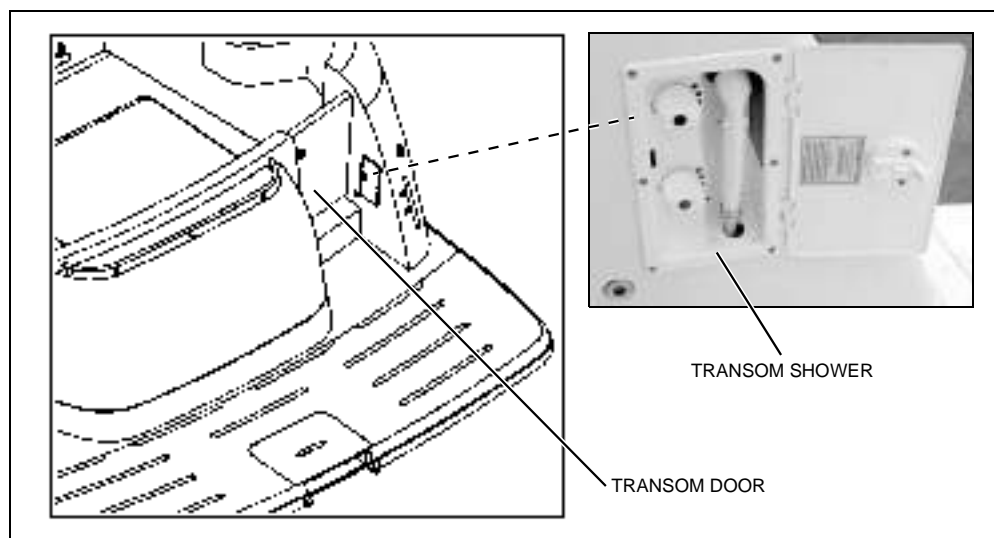

Trim Tab Hydraulic Fluid Reservoir and Pump: Located next to the stern thruster on a shelf above the center bilge area in the lazarette.

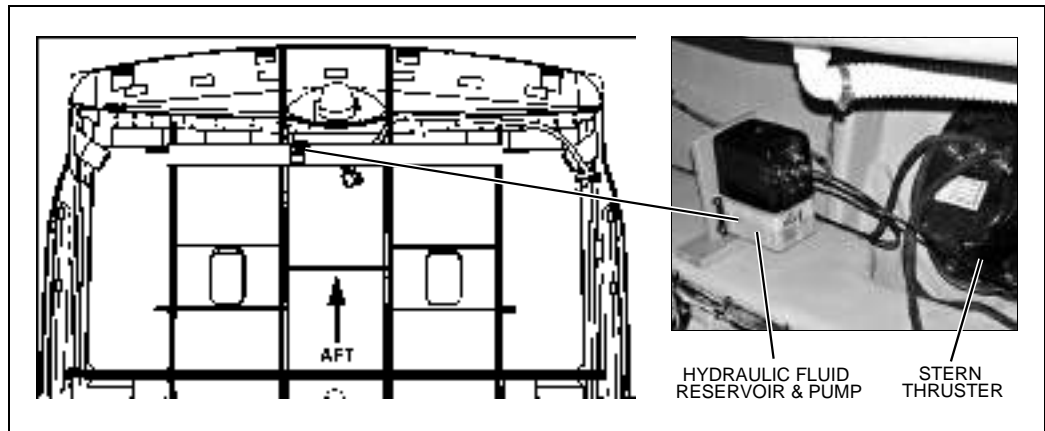

Wall Vacuum Unit (If Equipped): Located under the floor hatch in the hallway.

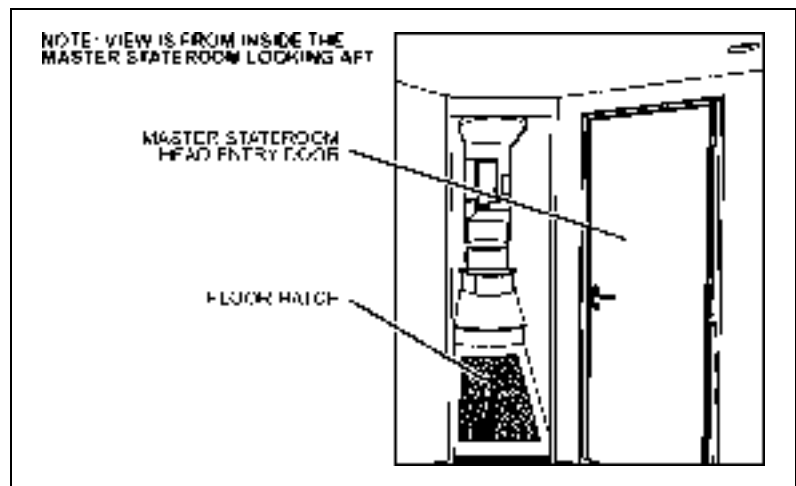

Water Heater: Located forward of the port fuel tank in the engine room.

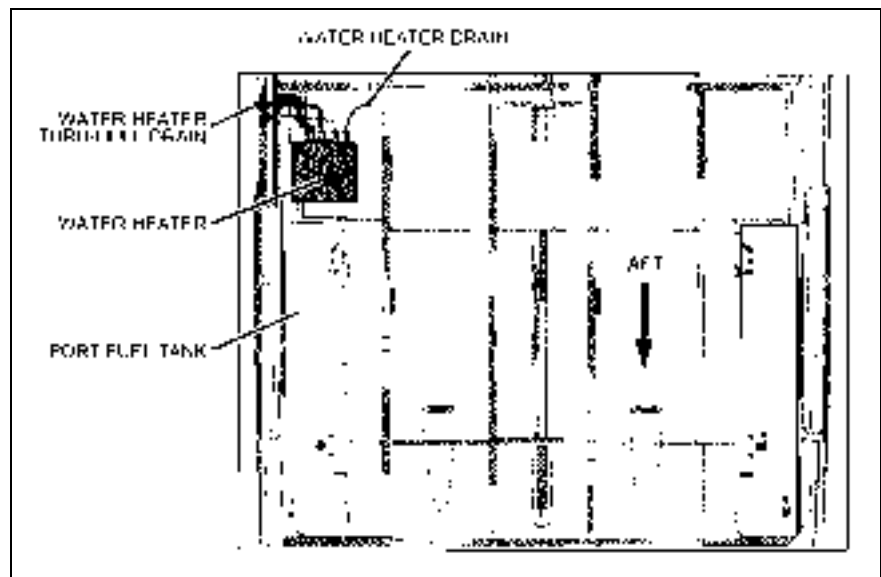

Windshield Washer Fluid Reservoir (If Equipped): Located on the forward wall of the engine room.

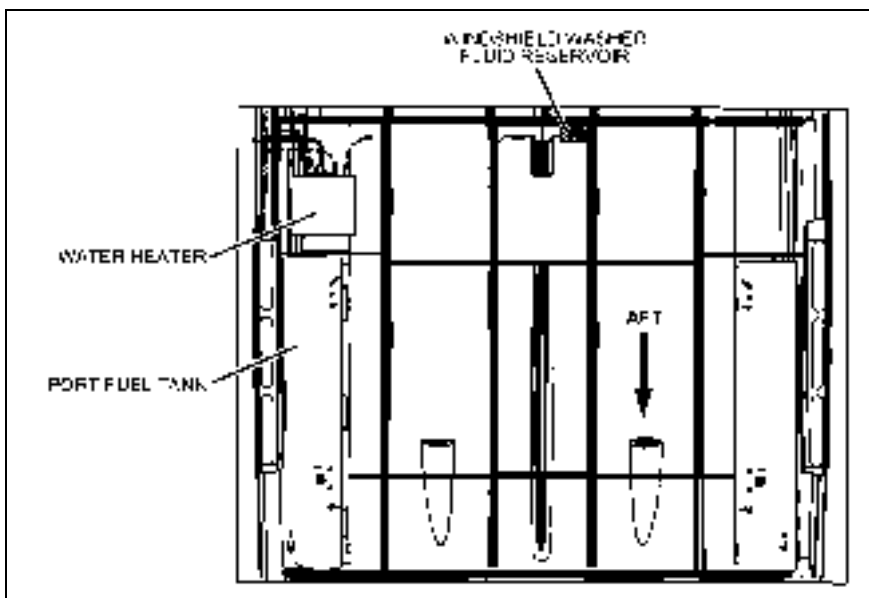

Chapter 3: Propulsion & Related Systems

Engines

NOTICE

Read the engine manual *BEFORE* starting or working on your engines.

While the topics listed below may be included in this *Owner's Manual* and in the *Cruiser & Yacht Owner's Manual Supplement*, *always* refer to the engine manual first for specific information on these important subjects:

- Engine Break-in Procedure
- Engine Starting and Stopping
- Gear Shifting
- Fuel and Oil Recommendations
- Engine Maintenance
- Engine Storage/Winterization

Engine Cooling System



WARNING!

FLOODING and SWAMPING HAZARD!

- *Close* the seacock(s) when leaving your yacht unattended for any length of time.
- If a seacock is left open, a hose failure could flood the bilge, swamp the batteries and the engines, and even sink your yacht.



CAUTION

SYSTEM DAMAGE HAZARD!

- *Open* the engine cooling system seacocks *BEFORE* starting the engines.
- **Keep** the engine cooling system seacocks *Open* while the engines are running.

Refer to the engine operation manual for cooling system details.

- *Open* the seawater intake seacock for each engine *before* starting the engines.
- Keep the seacocks *Open* while the engines are running.
- Check the cooling system's seawater strainers for leaks and debris *every time* you use your yacht.
- See the *Seawater Systems* section in *Chapter 6* of this *Owner's Manual* for instructions about cleaning the seawater strainers.

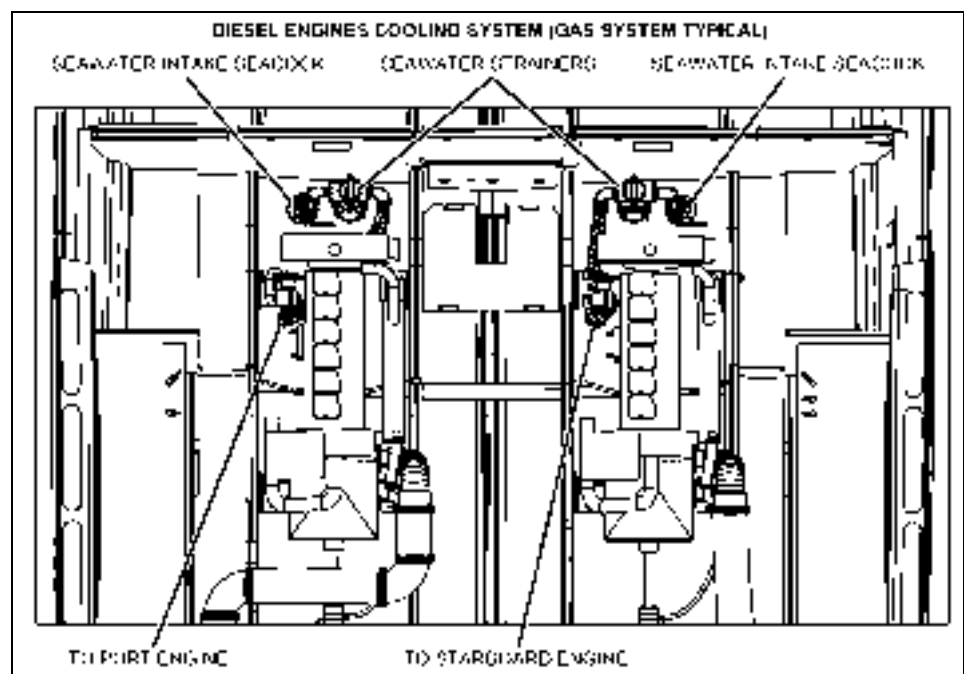

Exhaust System

⚠ **DANGER!**

CARBON MONOXIDE POISONING HAZARD!



Leaking engine and/or generator exhaust is a source of dangerous carbon monoxide gas (CO).

- Check **ALL** exhaust systems **BEFORE** each trip.
- Look for leaks in the exhaust systems of the engines and the generator.
- Look for discoloration, water leaks, carbon or stains around **ALL** joints.
- Make sure **ALL** of the exhaust clamps are in place and secured.

- Make sure the ventilation systems work and are **NOT** obstructed or restricted.
- To reduce the chance of CO entering the living spaces, fill any gaps around engine room plumbing, cableways, exhaust systems, doors, hatches, and access panels.
- Read the *Carbon Monoxide (CO)* section in *Chapter 1* of this *Owner's Manual*.

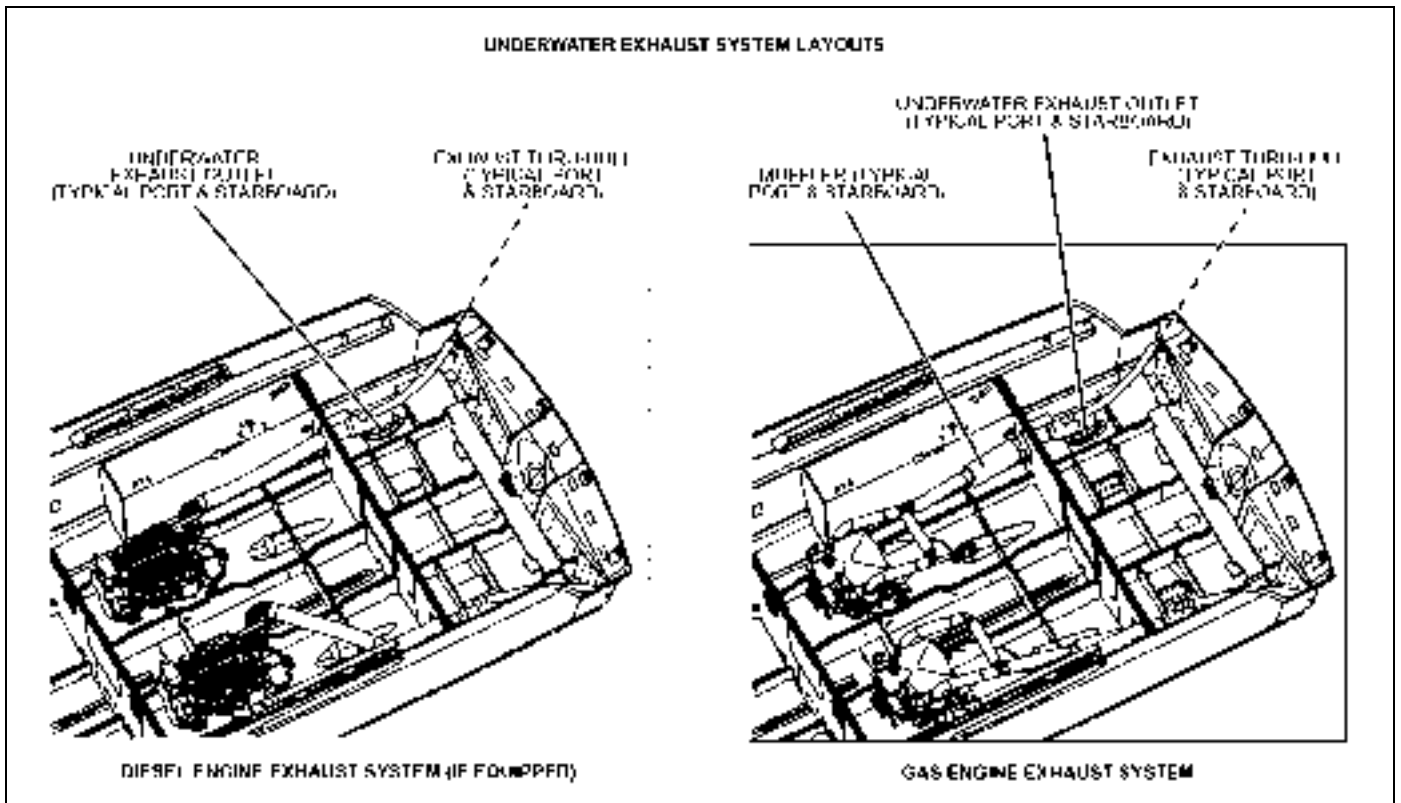

- *Always* consider the sea conditions *before* anchoring or shutting *Off* the engines.
- The exhaust system is designed to keep seawater out of the engines in most sea conditions.
- However, do *not* anchor the stern to sea or shut the engines *Off* if high seas might flood the exhaust system.

Bilge Blower Systems

⚠ WARNING!

FIRE and EXPLOSION HAZARD!

Fuel vapors can explode! **BEFORE** starting the engines:

1. Check the bilge areas for fuel vapors or leaking fuel. If you see leaking fuel or smell fuel vapors:
 - a. Do **NOT** start the engines or generator, do **NOT** turn *On* any electrical devices, put out **ALL** cigarettes, cigars, and other sources of flame or ignition.
 - b. Get everyone off your yacht.
 - c. Get trained help to find and fix the problem.
2. Run the bilge blowers for at least four minutes *Before* engine starting, generator starting, electrical system maintenance, or turning on electrical devices.
 - If you smell fuel vapors and the engines and/or generator are already running;
 - a. Shut *Off* the engines and/or generator, and turn *Off* **ALL** electrical devices.
 - b. Put out **ALL** cigarettes, cigars, and other sources of flame or ignition.
 - c. Get trained help to find and fix the problem.
 - **NEVER** obstruct or change the bilge blower system.



- The bilge blowers remove explosive fumes from the engine room and lazarette bilge areas.
- Fresh air is drawn into these areas through the vents.

To make sure the bilge areas are properly ventilated:

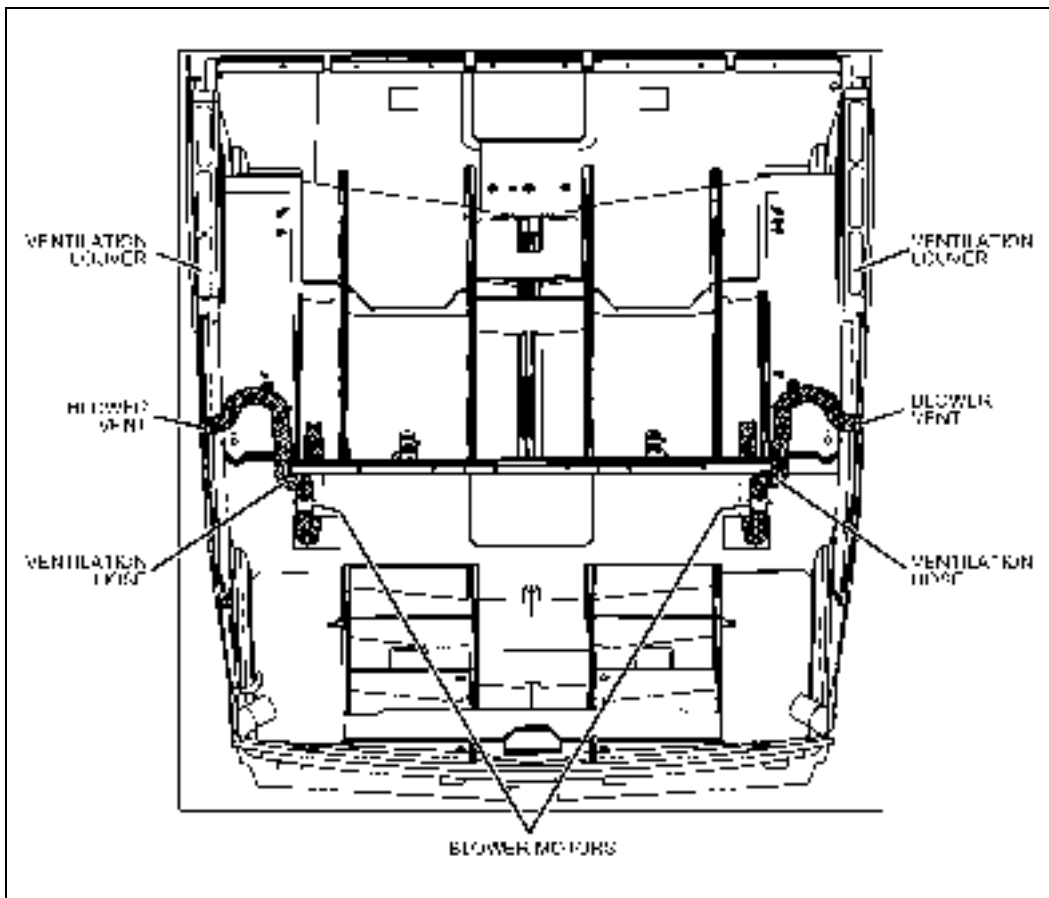
- **Always** run the bilge blowers for at least four minutes *before* starting the engines or the generator.
- Use the "sniff test" to check the bilge areas for fuel vapors *before* starting the engines or the generator.
- Continue to run the blowers until your yacht has reached cruising speed.
- **Always** run the blowers when operating your yacht below cruising speed.



Fuel System

 WARNING!	
<i>FIRE, EXPLOSION and OPEN FLAME HAZARD!</i>	
	
<ul style="list-style-type: none"> • It is very important that the fuel system be inspected thoroughly the first time it is filled and at each subsequent filling. • Read the fueling instructions in the engine operation manual and the <i>Cruiser & Yacht Owner's Manual Supplement</i>. 	

 CAUTION	
Avoid the storage or handling of gear near the fuel lines, fittings and tank.	

 CAUTION	
<i>SYSTEM DAMAGE HAZARD!</i>	
Use of any methanol, gasohol, or alcohol based fuel additive <i>WILL</i> damage the fuel system.	

NOTICE	
<ul style="list-style-type: none"> • On diesel engine models, air in the diesel supply system can stop an engine or severely restrict performance. • If you suspect air in the fuel lines, refer to your engine operation manual for detailed instructions on how to bleed the system. 	

NOTICE	
Carefully read the fuel section of both the <i>Cruiser & Yacht Owner's Manual Supplement</i> and the engine operation manual, paying special attention to the subject of <i>fuel recommendations</i> .	

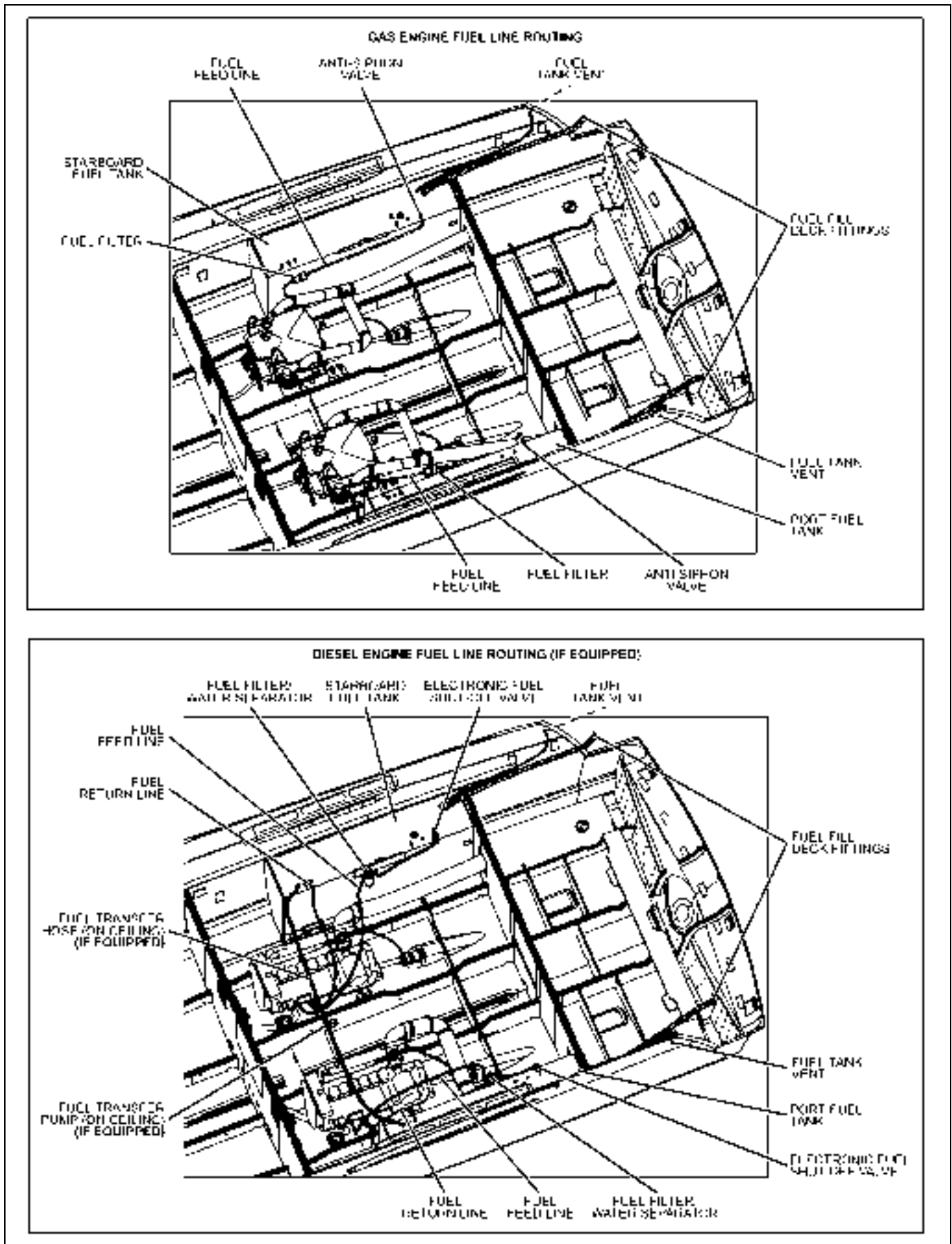

Fuel Fills & Vents

- Depending on engine type, the fuel fill deck fittings are marked either GAS or DIESEL.
- If you have problems filling either fuel tank, see if the fuel fill hose or fuel tank vent hose is kinked or collapsed.
- If there are no visible signs of a problem, contact your local dealer.

Anti-siphon Valves (Gas Engines Only)

NOTICE

- **If an engine running problem is diagnosed as fuel starvation, check the anti-siphon valve.**
- **If the valve is stuck or clogged, *ONLY* change or replace it while the engine is *Off*.**
- ***NEVER* run either engine with its anti-siphon valve removed, except in an emergency.**

- The anti-siphon valves are vital fuel system parts.
- If a fuel line ruptures, this valve prevents the siphoning of fuel from the tank.
- The valves are located on the fuel tanks, where the fuel feed lines attach to the tanks.
- These valves are spring loaded and are opened by fuel pump vacuum.

Gas Engine Fuel Filters

- The fuel pickup tube located inside each fuel tank is equipped with a fine mesh screen filter.
- Also, when supplied by the engine manufacturer, a fuel filter is installed on each engine.
- Periodically replace the fuel filters to make sure they remain clean and free of debris.
- Talk to your selling dealer or local marina about fuel additives that help prevent fungus or other buildup in your fuel tanks.

Electronic Fuel Shut-off Valves (Diesel Engines Only)

- Your diesel engines are equipped with electronic fuel shut-off valves.
- When you start your engines, the electronic fuel shut-off valves open to allow fuel to the engines.
- When you turn off the engines, the electronic fuel shut-off valves close, stopping the fuel from going to the engines.
- If one of the electronic fuel shut-off valves malfunction, it has a manual override.
- Turn the manual override clockwise to open the electronic fuel shut-off valve.

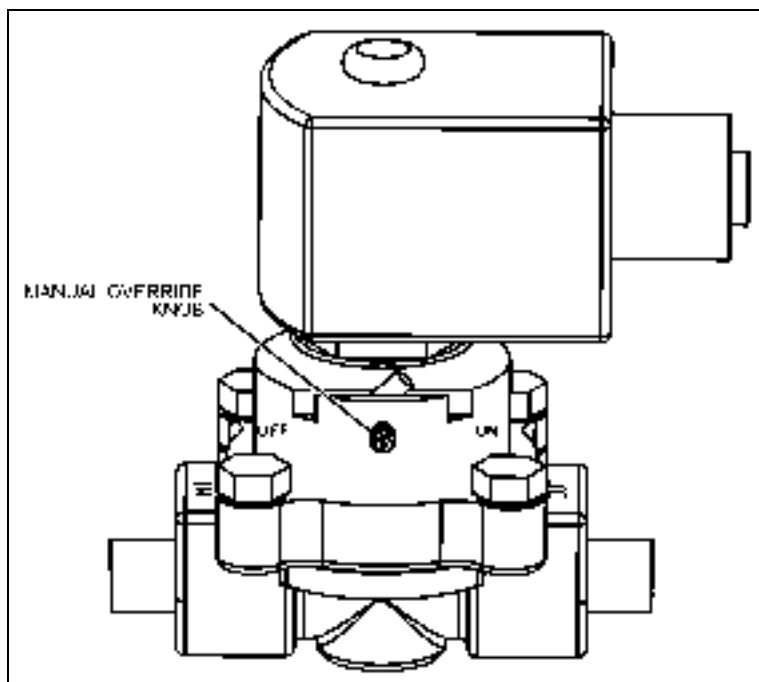

Fuel Filter/Water Separators (Diesel Engines Only)

NOTICE

Refer to the fuel filter/water separator manual for important service instructions.

Fuel Transfer Pump (If Equipped) (Diesel Engines Only)



CAUTION

ENVIRONMENTAL HAZARD!

- **NEVER** transfer fuel into a full (or nearly full) fuel tank.
- Fuel transferred into a full tank may spill overboard through the tank venting system.

The fuel transfer pump allows you to move fuel from one tank to another. Reasons for using the fuel transfer pump:

- To move fuel into an empty tank.
 - To balance the fuel levels between each tank.
1. The house battery switch must be turned **On** for the fuel transfer pump to run.
 2. **Before** transferring fuel, check the fuel gauges to make sure that fuel is not about to be transferred into a full (or nearly full) tank. For accuracy, check the fuel gauges when your yacht is **not** underway.
 3. After checking the fuel levels, hold the fuel transfer switch **On** to the side you want to pump fuel to.
NOTE: This switch must be **held On** throughout the entire fuel transfer process.
- If the fuel transfer pump does not run when you follow the steps above, check the pump's breaker on the 12-volt DC push-to-reset circuit breaker panel (for the location of this panel, see the *Component Locations* section in *Chapter 2* of this *Owner's Manual*).
 - If the pump is running, but you are having problems transferring fuel, see if the fuel transfer hose or fuel tank vent hose is kinked or collapsed. If there are no visible signs of a problem, contact your local dealer.
4. When the desired amount of fuel has been transferred, release the switch.

COMMAND BRIDGE HELM VIEW



LOWER HELM VIEW (IF EQUIPPED)

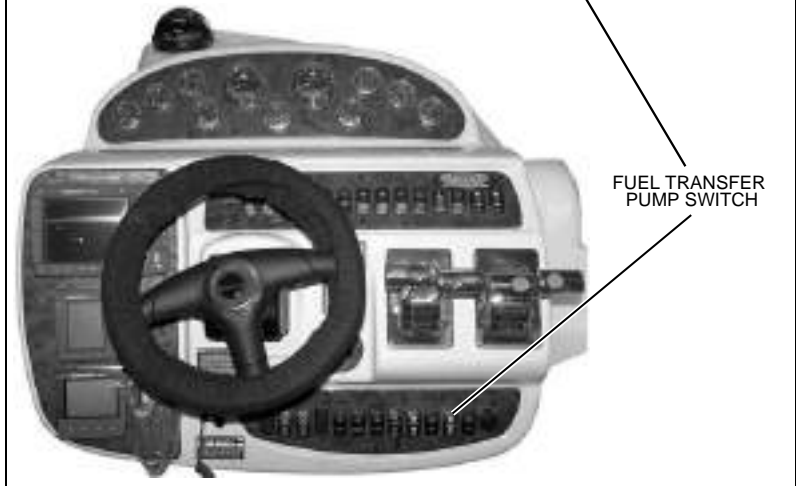

FUEL TRANSFER PUMP SWITCH

Oil Change System (If Equipped) (Diesel Engines Only)

- The oil change system makes it easier to drain and refill the engine and generator oil.
- Read the oil change system instructions for information on the use of this system.

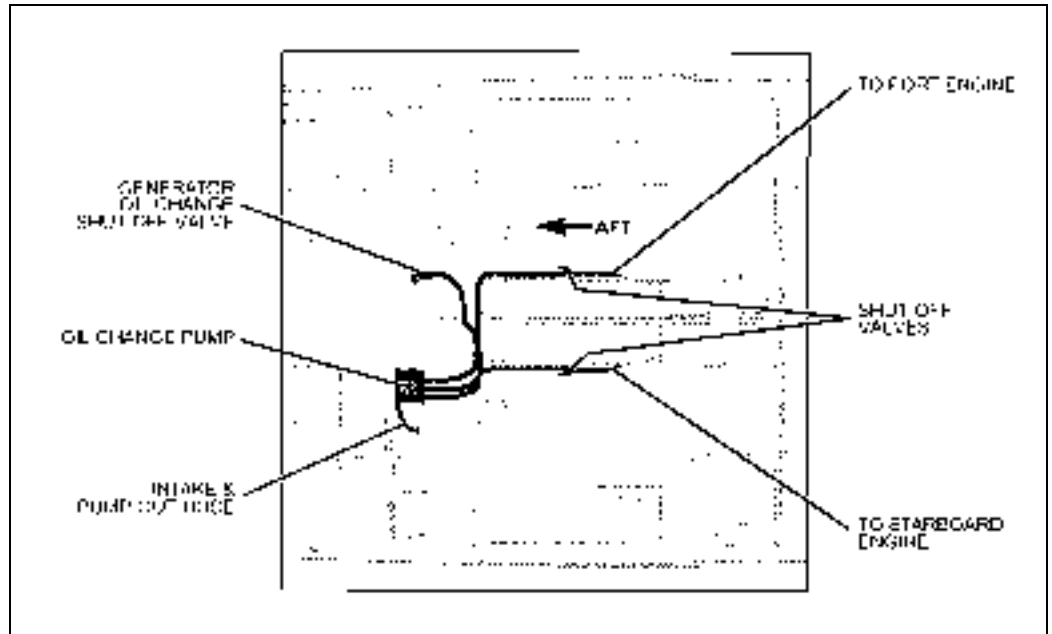

Fire Suppression System (If Equipped)

- The fire suppression system is designed to put out engine room fires.
- **Before** using your yacht for the first time, read the fire suppression system's instruction and maintenance manual and follow **all** warnings.
- The system will discharge automatically whenever direct heat from a fire is detected in the engine room.
- The system can **only** be discharged **once**.
- After the system is discharged it **must** be refilled and refurbished **before** it can be used again.

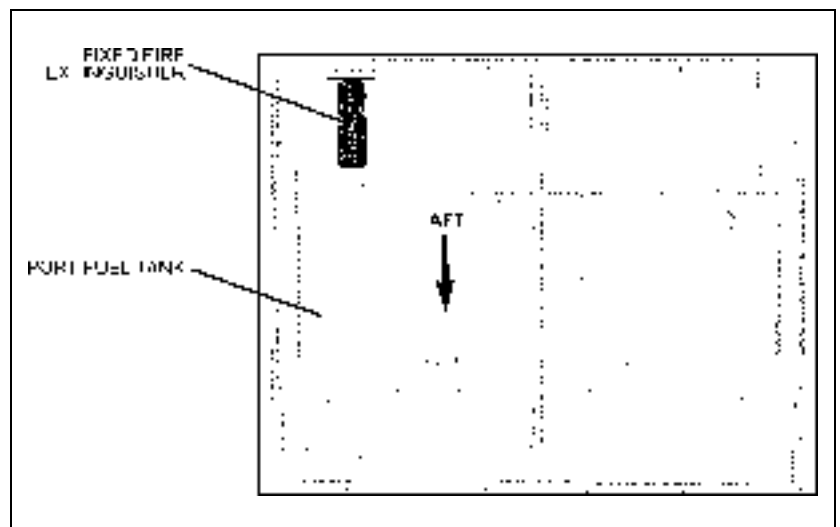

Shaft-Transmission Alignment



CAUTION

SYSTEM DAMAGE HAZARD!

- If you suspect a shaft-transmission alignment problem, have a trained mechanic inspect the alignment as soon as possible.
- Continued use may lead to premature engine, transmission, shaft, shaft seal and/or hull damage!

Alignment between the engine transmission output shaft and the propeller is critical. The alignment was done at the factory and was rechecked by the dealer after your yacht had been in the water for 48 hours.

- Have a marine mechanic inspect the alignment after the first 30 hours of operation. From then on, have the alignment rechecked after every 60 hours of operation. At any time, if unusual noise or vibration is noticed, have the alignment inspected *immediately*.
- Shaft-transmission alignment should be done by a marine mechanic since it requires moving the engine and prop shaft.
- To insure proper alignment after a haul out or dry storage, wait 48 hours after launching *before* final alignment adjustments by a marine mechanic are made.

Shaft Log Packless Sealing System

Read the PSS Shaft Seal Installation Instructions for maintenance and inspection details.

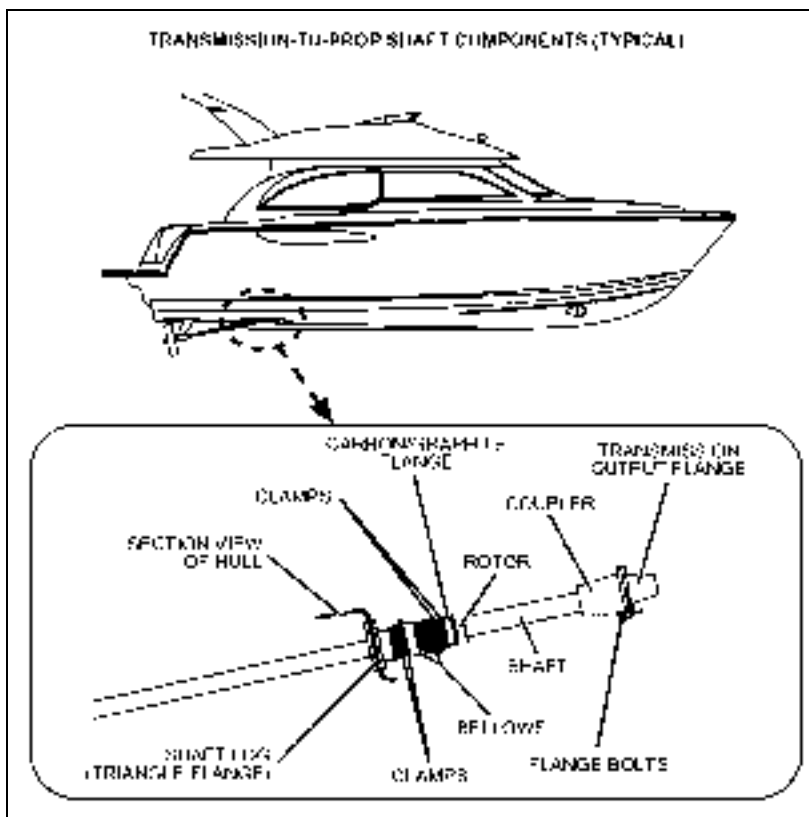

Chapter 4: Controls & Gauges

Steering

Hydraulic Steering System

- Your yacht features a hydraulic steering system.
- Check the fluid level in the hydraulic steering reservoir at each helm *every time* you use your yacht.
- Yacht steering is *not* self-centering.

Rudder Stuffing Gland

- The rudder stuffing gland is part of the assembly where the rudders emerge from the bottom of your yacht.
- The rudder stuffing gland should *not* leak any water.
- If a leak develops, it can usually be stopped by tightening the stuffing gland nuts *slightly*.
- Do *not* over tighten the stuffing gland nuts.
- If stuffing gland leakage becomes excessive, packing replacement can be done as follows:
 1. Remove your yacht from the water.
 2. Loosen the stuffing gland nuts and back the stuffing gland from the sleeve.
 3. Remove the old packing.
 4. Wrap new packing around the shaft.
 5. Cut the rings with a razor blade at an angle approximately 30 degrees to the long axis of the shaft.
 6. Stagger the ends of each ring around the shaft and insure that the rings are at the bottom in the sleeve.
 7. Tighten the stuffing gland nuts until resistance is felt.

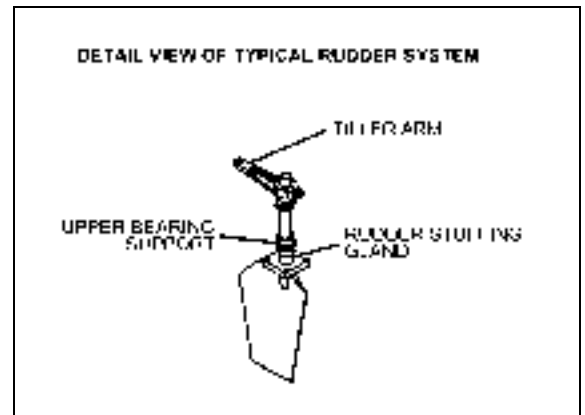

Autopilot (If Equipped)

 WARNING!
<ul style="list-style-type: none"> • NEVER leave the helm while the autopilot system is <i>On</i>! • An experienced operator MUST monitor the autopilot system at ALL times and keep a visual lookout for other marine traffic and other hazards.

NOTICE
<p>The autopilot system is ONLY an aid to navigation. It's accuracy can be affected by:</p> <ul style="list-style-type: none"> • Equipment failure or defects • Environmental conditions • Improper handling or use

- **Before** using the autopilot system, read the autopilot instruction manual(s).
- The autopilot will aid you in maintaining the chosen course of your yacht.
- To turn this system **On**, the bridge main breaker on the battery management panel **must** be switched **On**, the dash autopilot switch **must** be switched **On**, then power up the autopilot.

Shift/Throttle Controls

 WARNING!
<p>LOSS OF CONTROL HAZARD!</p> <p>Improper maintenance of shift/throttle hardware may cause a sudden loss of control!</p>

- Your yacht will have either mechanical or electronic shift/throttle controls. The operation of these two types of controls varies. Make sure you know which type of controls your yacht has.
- Read **all** of the information about the shift/throttle controls in the shift/throttle controls' manual, the engine operation manual, and the *Cruiser & Yacht Owner's Manual Supplement*.

Engine Synchronization (If Equipped)

Follow the instructions in the synchronization section of the shift/throttle controls' manual.

Trim Tabs

- Read the trim tabs' owner's manual *before* using the trim tabs.
- The trim tabs are controlled by two rocker switches at the helm.
- Check and refill the trim tab hydraulic fluid reservoir as directed in the trim tabs' owner's manual. For the location of the fluid reservoir, see the *Component Locations* section in *Chapter 2* of this *Owner's Manual*.

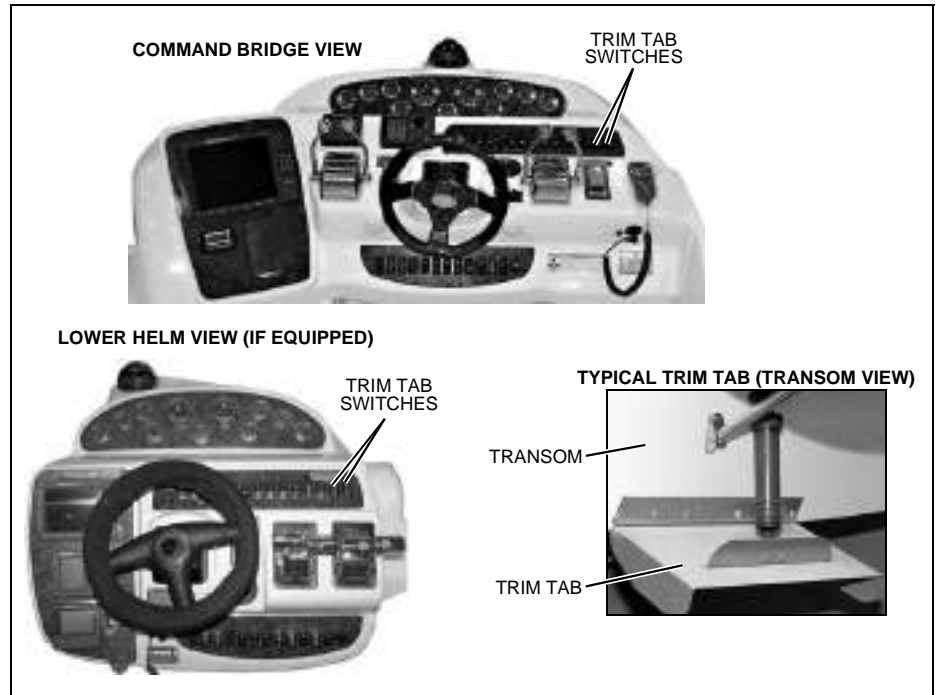

Dual Thruster System

- This system features bow and stern thrusters that can help you maneuver your yacht during docking.
- The thrusters can be controlled from either helm.
- Read the thruster's user manual *before* using the thruster system for the first time.
- Follow *all* user precautions carefully.

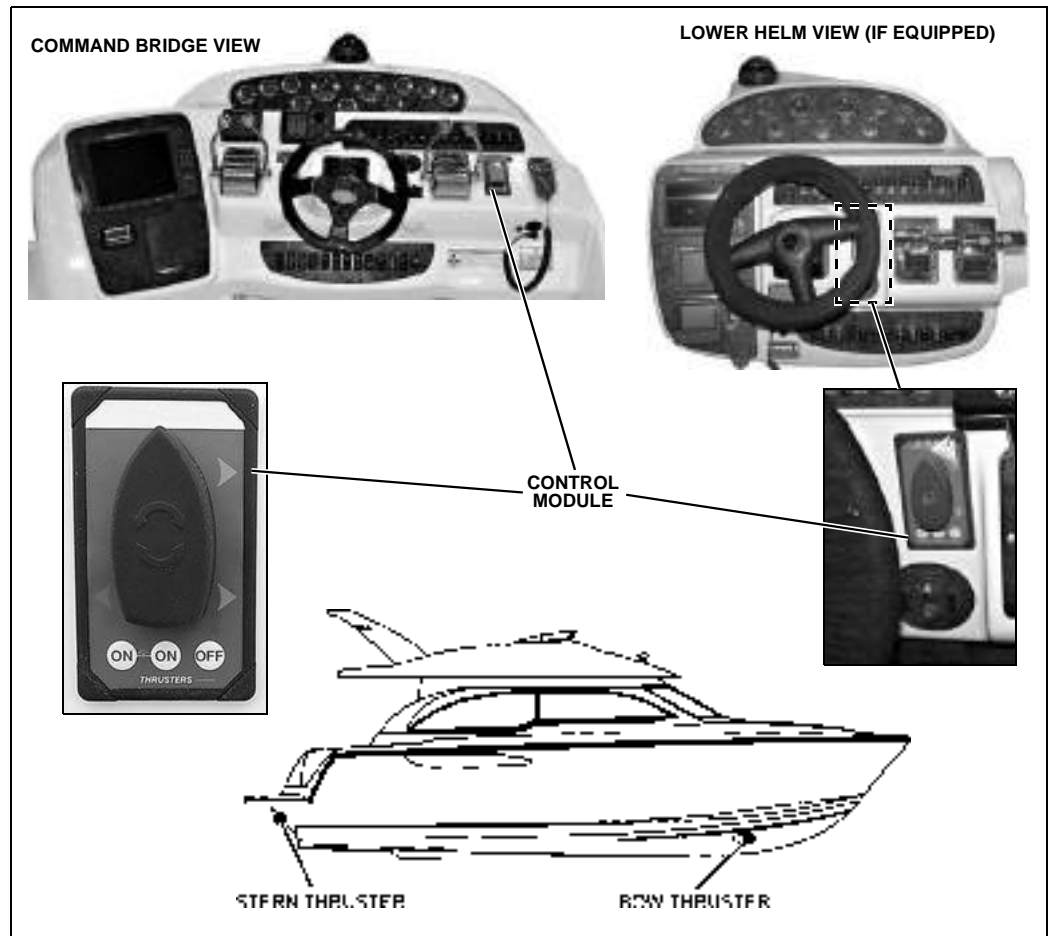

Gauges

Cleaning the Gauges

 CAUTION
<i>PRODUCT or PROPERTY DAMAGE HAZARD!</i>
<ul style="list-style-type: none">• Use ONLY mild soap and water to clean the gauge lenses and bezels.• Use of other cleaners, including common window cleaning solutions, may cause the lenses to crack.• Lenses cracked in this manner will NOT be covered by our warranty.

Gauge Fogging

- Moisture may occasionally find its way into the gauges causing lens fogging.
- Turning **On** the gauge lights will help dry the lenses.
- Fogging will not harm the gauges.

Radio Transmission Interference

VHF or other radio transmissions may cause brief erratic readings on the tachometers. This will not damage these gauges or affect their accuracy when the radio is not transmitting.

Twin Engine Readings

It is normal for tachometers and other gauges to have slightly different readings between engines.

Fuel Gauges

It is normal for the pointers on your fuel gauges to bounce as fuel sloshes back and forth in the fuel tanks.

Chapter 5: Navigation & Communication Equipment

Read the manuals for *all* navigation & communication equipment *before* using these systems.

Compass

NOTICE

- **Compass accuracy can be affected by many factors.**
- **Have a trained technician calibrate your compass.**
- **Make sure the technician gives you a deviation card which shows the corrections to apply in navigational calculations.**
- **Keep a copy of the deviation card at each helm.**

Depth Finder



WARNING!

- **Do *NOT* use the depth finder as a navigational aid to prevent collision, grounding, yacht damage or personal injury.**
- **When your yacht is moving, submerged objects will *NOT* be seen until they are already under your yacht.**
- **Bottom depths may change too quickly to allow time for your yacht to react.**
- **If you suspect shallow water or submerged objects, run your yacht at very slow speeds.**

VHF Radio

- Your yacht may include a VHF (Very High Frequency) radio.
- As permitted by the FCC (Federal Communications Commission), the VHF radio can be used to access weather reports, summon assistance, or contact other vessels.
- Contact the FCC for licensing, rules and laws concerning VHF radio usage.

Radar (If Equipped)



WARNING!

- Radar is meant to help the navigator, **NOT** replace him/her.
- The operator is responsible for keeping a visual look-out for possible collision situations.
- No single navigation aid (including this radar) should be relied upon as the only method for navigating your yacht.

NOTICE

The radar system is **ONLY** an aid to navigation. It's accuracy can be affected by:

- Equipment failure or defects
- Environmental conditions
- Improper handling or use

- The marine radar system gives you a complete and accurate 360° radar view of other vessels, buoys, and landfall surrounding your vessel.
- **Before** using the radar system, read the radar instruction manual(s).
- To turn this system **On**, the bridge main breaker on the battery management panel **must** be switched **On**, then power up the radar/GPS chart plotter.

Global Positioning System (GPS) (If Equipped)



WARNING!

- The GPS system should **NOT** be relied upon as the **ONLY** aid to navigation.
- An experienced operator **MUST** monitor the GPS system at **ALL** times and keep a look-out for other marine traffic and possible collision situations.

NOTICE

The GPS system is **only** an aid to navigation. It's accuracy can be affected by:

- Equipment failure or defects
- Environmental conditions
- Improper handling or use

- GPS receivers provide reliable and accurate position data, anywhere in the world.
- **Before** using the GPS system, read the GPS instruction manual(s).
- To turn this system **On**, the bridge main breaker on the battery management panel **must** be switched **On**, then power up the GPS chart plotter.

Chapter 6: Plumbing

Bilge Pumps

NOTICE

Discharge of oil, oil waste or fuel into navigable waters is prohibited by law. Violators are subject to legal action by the local authorities.

- Your yacht has several bilge pumps for pumping water out of the bilge.
- The autofloat switches, mounted next to the bilge pumps, will turn **On** the bilge pumps if bilge water rises above a preset level.
- You can also turn **On** the bilge pumps using the switches at the helm.
- The bilge pumps are wired directly to the batteries. Unless the batteries are dead, the bilge pump system should work even when your yacht is unattended.

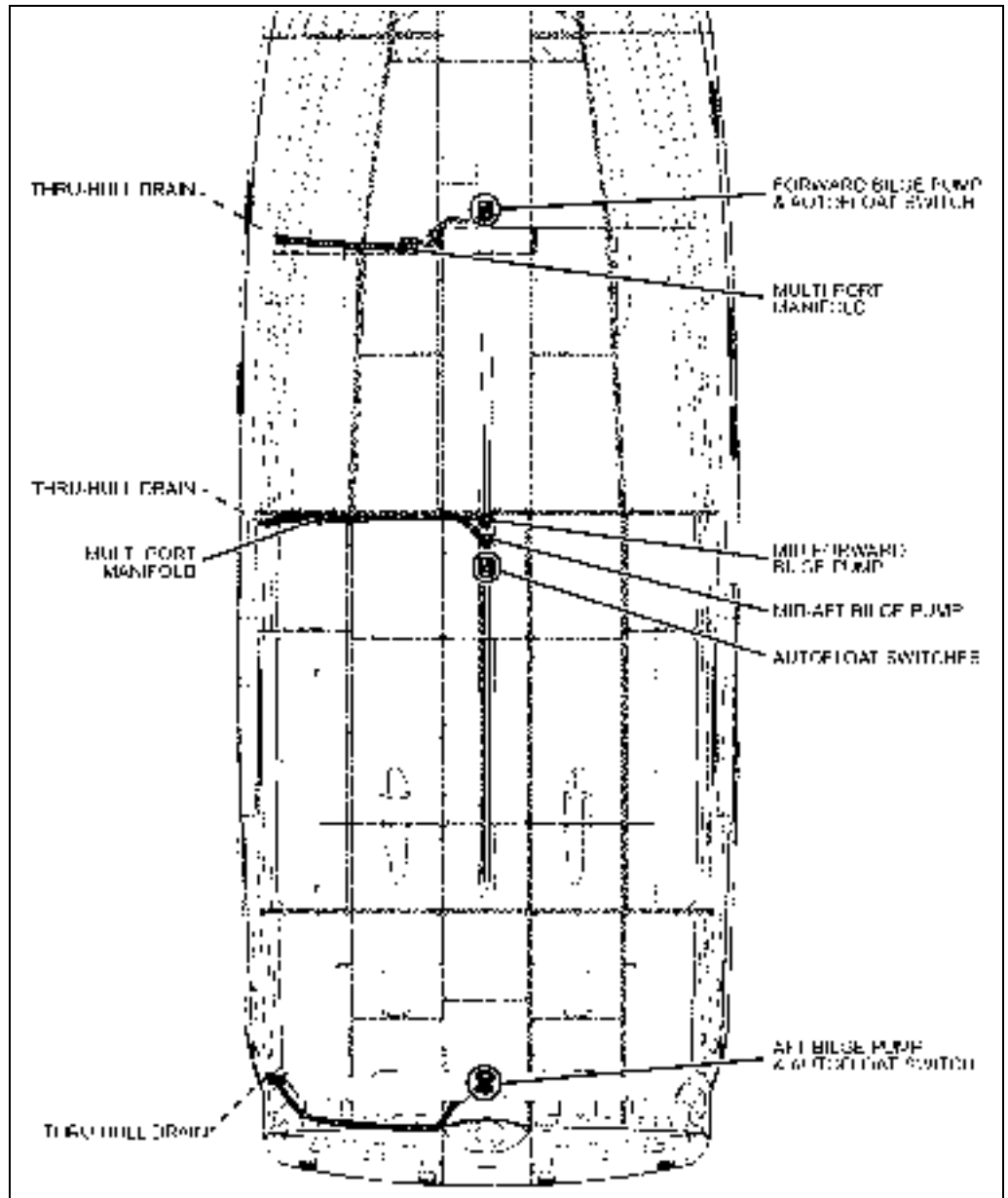

Bilge Pump Testing

- The bilge pumps are vital to the safety of your yacht.
 - Test the bilge pumps often to make sure they are working properly.
1. One at a time, turn **On** the bilge pump switches at the helm.
 2. Make sure that water in the bilge is pumped overboard.

If there is water in the bilge and a pump motor is running, but **not** pumping, inspect the discharge hose for a kink or collapsed area.

If the discharge hose looks okay, check the bilge pump and strainer for clogging debris.

Checking the bilge pump and strainer for clogging debris:

1. With your thumb and forefinger, squeeze the holding tabs on each side of the strainer.
2. Lift out the bilge pump.
3. Check the pump and strainer and clear any debris.

Reinstalling the bilge pump:

1. Align the tabs on the strainer with the slots on the pump.
2. Press down firmly until the tabs click into place.
3. Make sure the bilge pump is locked into place.

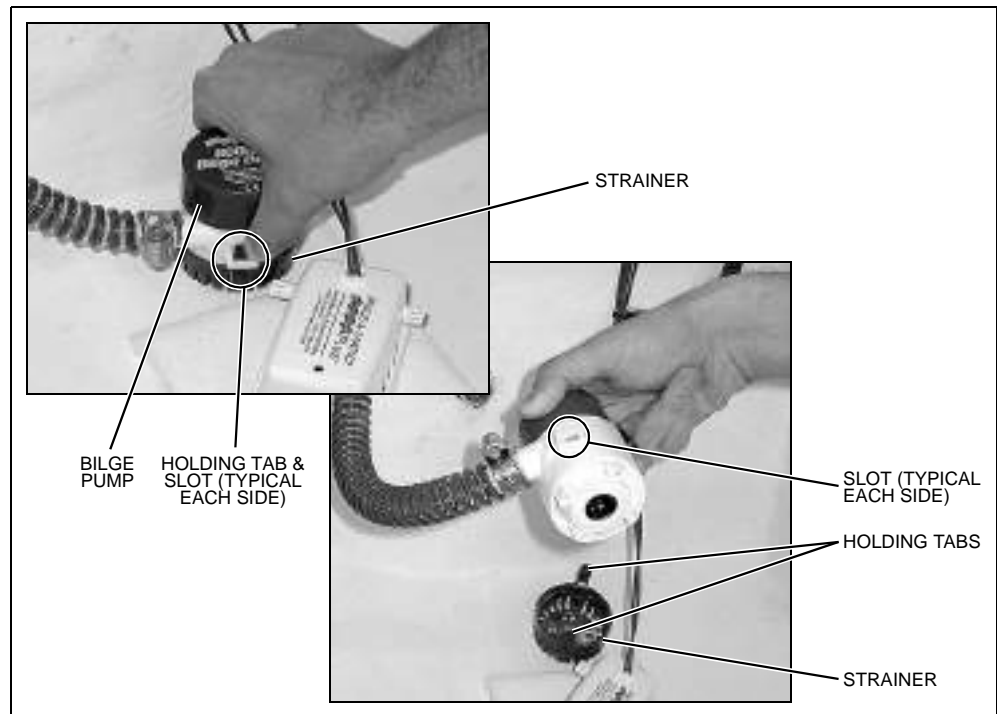

Autofloat Switches

- Each automatic bilge pump features an autofloat switch.
- The autofloat switch turns the pump **On** when water rises above a preset level.
- Each autofloat switch is normally located next to the bilge pump it controls.
- The autofloat switches should be tested often.

Autofloat switch testing:

1. Twist either of the white plastic knobs one quarter turn to lift the float and turn **On** the bilge pump.
- If the pump does not turn **On**, check the push-to-reset circuit breaker.
 - If the circuit breaker is good, but the switch still does not work, it may mean the switch is bad, or the battery is dead.

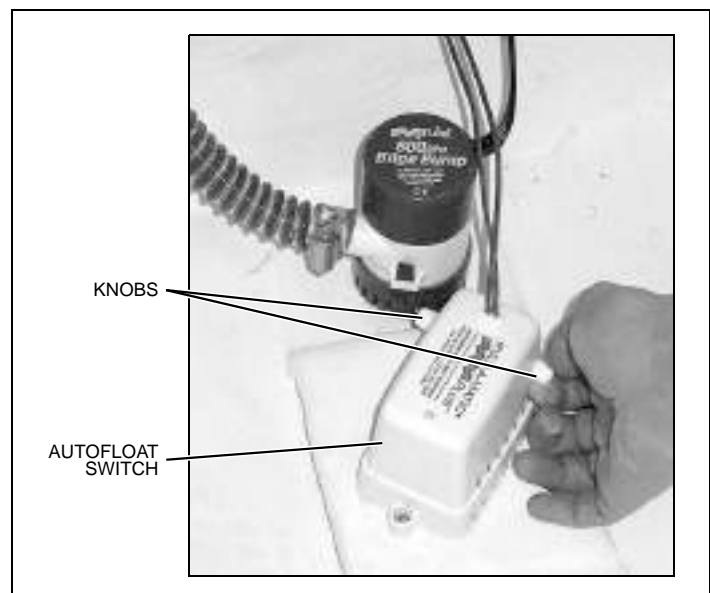

Seawater Systems

Seacocks



WARNING!

FLOODING and SWAMPING HAZARD!

- *Close* the seacock(s) when leaving your yacht unattended for any length of time.
- If a seacock is left open, a hose failure could flood the bilge, swamp the batteries and the engines, and even sink your yacht.



CAUTION

SYSTEM DAMAGE HAZARD!

- **BEFORE** using any system that has a seacock, make sure that the system's seacock is *Open*.
- Inspect and lubricate all seacocks annually.

Thru-hull inlet or outlet fittings near or below the waterline feature seacock valves. You can close a seacock to stop water entry:

- If the hose connected to the seacock fails, or;
- To work on equipment served by the seacock.

Seacocks are used on your yacht in seawater intake or liquid-discharge systems including, but not limited to:

- Engines
- Generator
- Air conditioner (if equipped)
- Marine head

Before using any system with a seacock, make sure the seacock is *Open* and stays *Open* until the system is shut *Off*.

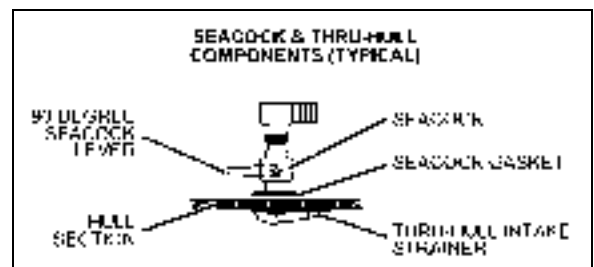

Seawater Strainers



CAUTION

FLOODING HAZARD!

- **BEFORE** taking apart a seawater strainer for cleaning or other work, *Close* the seacock that sends seawater to that strainer.
- Failure to close the seacock before taking apart the seawater strainer may allow large amounts of water to flood the bilge, which could swamp the batteries and the engines, and even sink your yacht.
- Keep the seacock *Closed* until the seawater strainer is completely reassembled.

SYSTEM DAMAGE HAZARD!

- After putting the seawater strainer back together, make sure that the seacock valve is *Open* **BEFORE** using the component/system.

- Seawater strainers are used to filter incoming seawater in *some* seawater intake systems. NOTE: Not all seawater intake systems have seawater strainers.
- If equipped, the seawater strainer is located near the seawater intake system's seacock.
- Check the strainers for leaks and/or debris *every time* you use your yacht.
- Refer to the seawater strainer instruction sheet for cleaning and maintenance information.

Seawater Washdown (If Equipped)

! WARNING!

FLOODING and SWAMPING HAZARD!

- **NEVER** leave your yacht unattended while the seawater washdown system is running.
- Any leak or break in this system may allow large amounts of water to flood the bilge, which could swamp the batteries and the engines, and even sink your yacht.
- **Close** the intake seacock when leaving your yacht unattended for any length of time.

! CAUTION

SYSTEM DAMAGE HAZARD!

BEFORE turning *On* the seawater washdown system, make sure the intake seacock is *Open*.

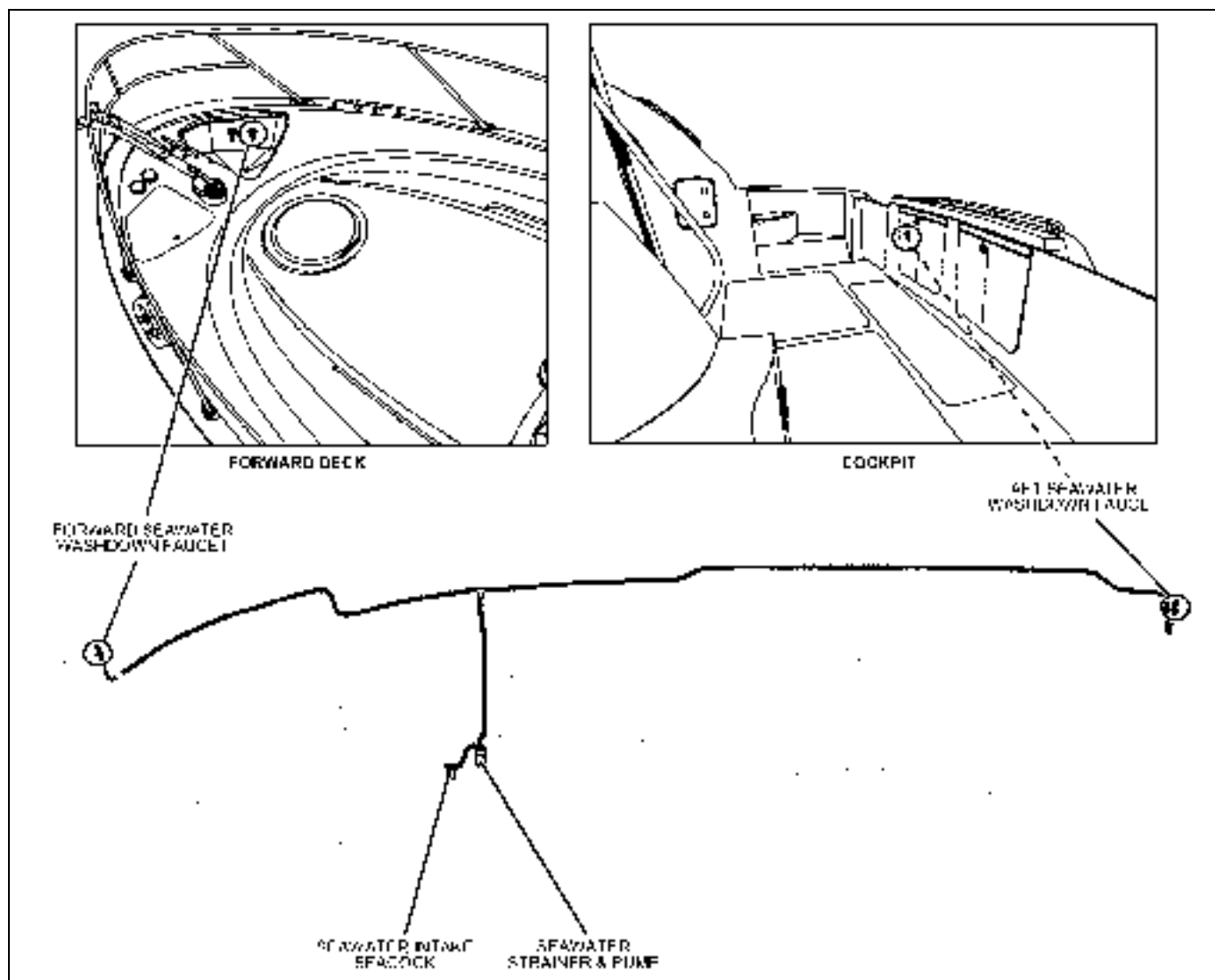

- **Always** make sure the seawater intake seacock is **Open before** turning the seawater washdown system **On**.
- Turn **On** the seawater washdown pump switch to pressurize this system. For the location of the seawater washdown pump switch, see the *Component Locations* section in *Chapter 2* of this *Owner's Manual*.

Freshwater System



WARNING!

- **ONLY** use safe drinking (potable) water in your yacht's freshwater system.
- **ONLY** use FDA approved "drinking water safe" hoses when filling the freshwater tank or connecting to city water.
- **NEVER** use a common garden hose for drinking water.

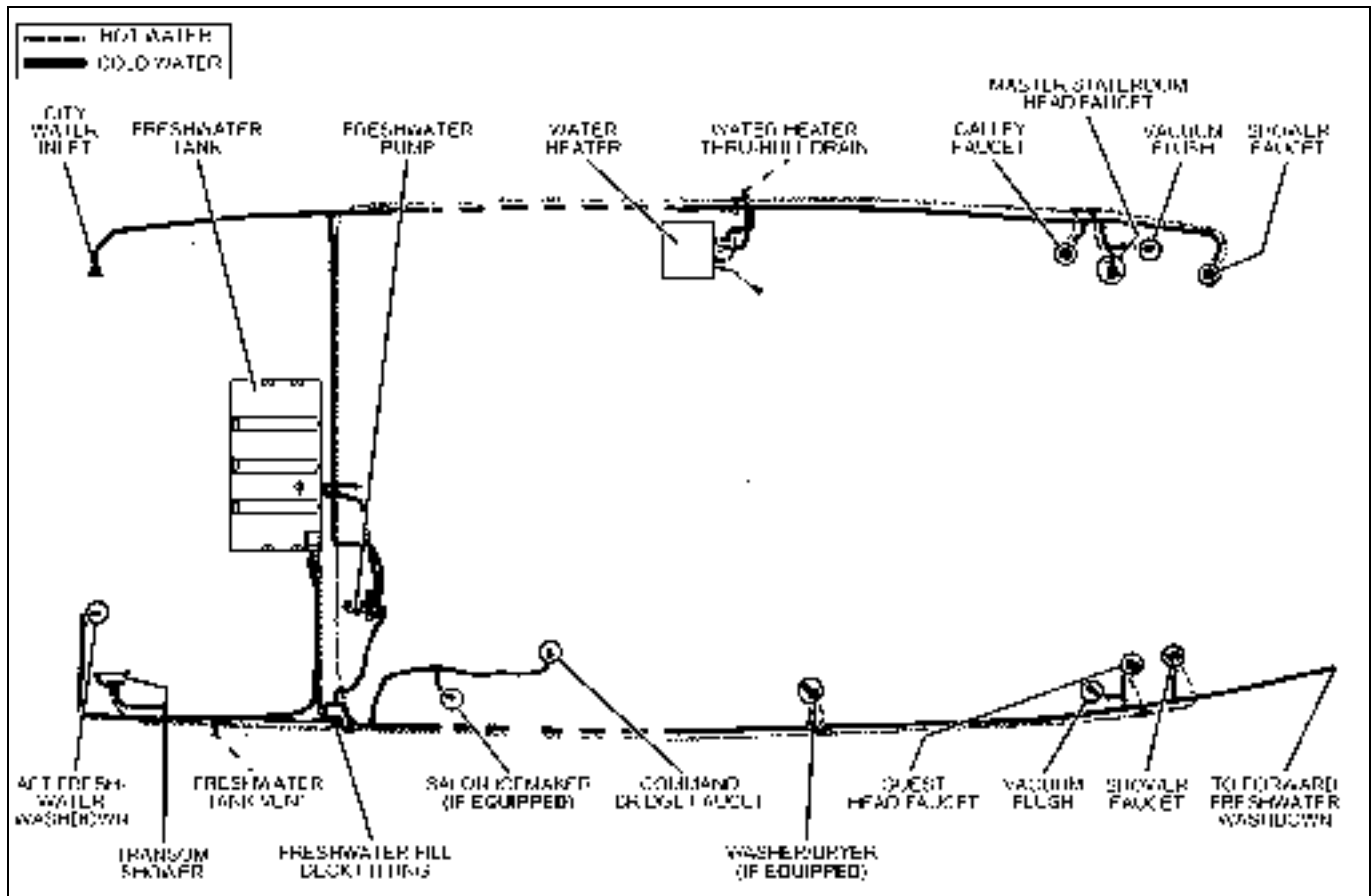

- Read the *Freshwater System* section in the *Cruiser & Yacht Owner's Manual Supplement*.
- Your yacht is equipped with a pressure type (demand) freshwater (potable) system.
- Pressurize the freshwater system by either:
 - a. turning **On** the freshwater pump switch (the battery switch must also be **On**) or;
 - b. connecting to city water.
- For the locations of the freshwater pump switch and the city water inlet, see the *Component Locations* section in *Chapter 2* of this *Owner's Manual*.
- **Always** turn **Off** the city water supply on the dock before leaving your yacht unattended.
- Turn **Off** the freshwater pump switch when your yacht is not in use or when the freshwater tank is empty.
- Inspect and clean the freshwater filter often (located on the freshwater pump).
- If your yacht is to be left unattended for a long period of time, pump the freshwater tank dry to prevent stored water from becoming stagnant and distasteful.
- If the freshwater system needs to be disinfected, ask your dealer about the treatments available.

Transom Shower

- Read the manufacturer's instructions *before* using the transom shower for the first time.
- To use the transom shower, your yacht *must* be connected to city water, or the freshwater pump switch *must* be turned *On*.

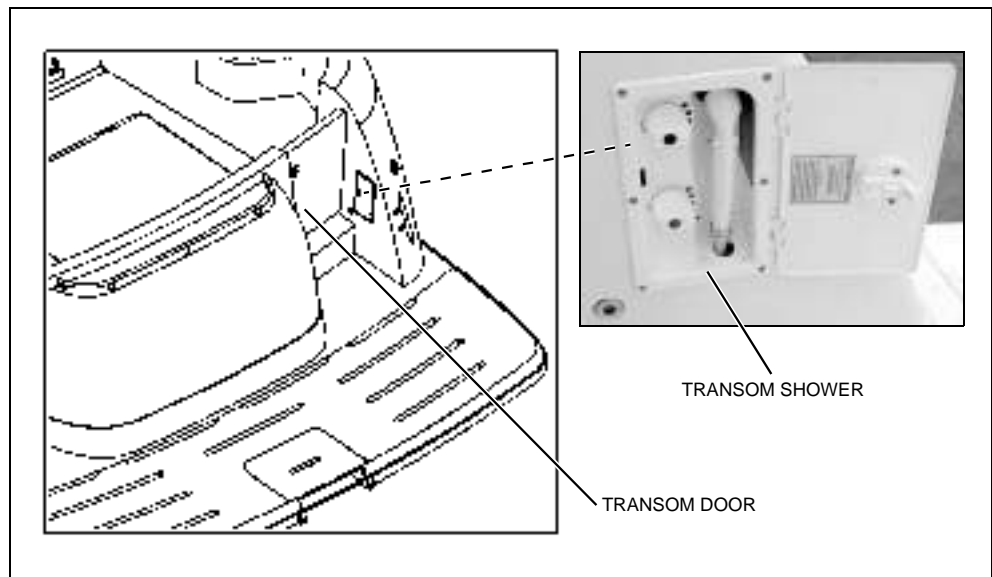

City Water Inlet

⚠ WARNING!

FLOODING and SWAMPING HAZARD!

- ***ALWAYS*** turn *Off* the city water supply on the dock before leaving your yacht unattended.
- Any leak or break in this system may allow large amounts of water to flood the bilge, which could swamp the batteries and the engines, and even sink your yacht.

- Read the *City Water Hookup* portion of the *Freshwater System* section in the *Cruiser & Yacht Owner's Manual Supplement*.
- Turn *Off* the freshwater pump's 12-volt DC breaker *before* pressurizing the freshwater system with a city water supply.

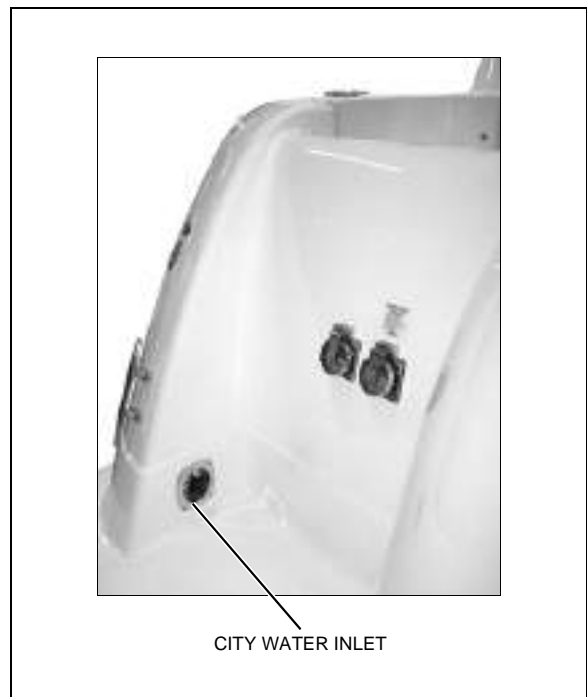

Freshwater System Winterization

1. Turn **Off** the water heater breaker on the 110-volt AC master panel.
2. Turn **On** the freshwater pump switch.
3. **Open all** of the faucets and showers and let the freshwater system drain completely.
4. Turn **Off** the freshwater pump switch.

All remaining water **must** be removed from the water lines. There are two ways to remove the remaining water from the lines:

- Compressed Air
- Gravity Draining

Compressed Air

CAUTION

FRESHWATER SYSTEM DAMAGE HAZARD!

- A faucet **MUST** be **Open** when compressed air is blown through the freshwater system.
- **NEVER** blow compressed air through the water system when **ALL** of the faucets are **Closed**.

You **must** have an air compressor with an air hose and an air nozzle.

1. Remove the water lines from the tee fitting on the outlet side of the freshwater pump (opposite side from filter).
2. Beginning with the port side, **Open** the faucet that is furthest away from the freshwater pump.
3. Place the air nozzle against the end of the just removed port side water line and blow air through the system.
4. When the water stops coming out of the faucet, stop the air and **Close** the faucet.
5. One at a time, repeat this process on **all** of the port side faucets and showers.
6. Repeat steps 2 through 5 on the starboard side water line.

Gravity Draining

1. **Open all** faucets and showers.
2. Remove the drain plug from the tee fitting on the freshwater tank.
3. When the water has stopped draining from the freshwater tank and the water lines, replace the drain plug.

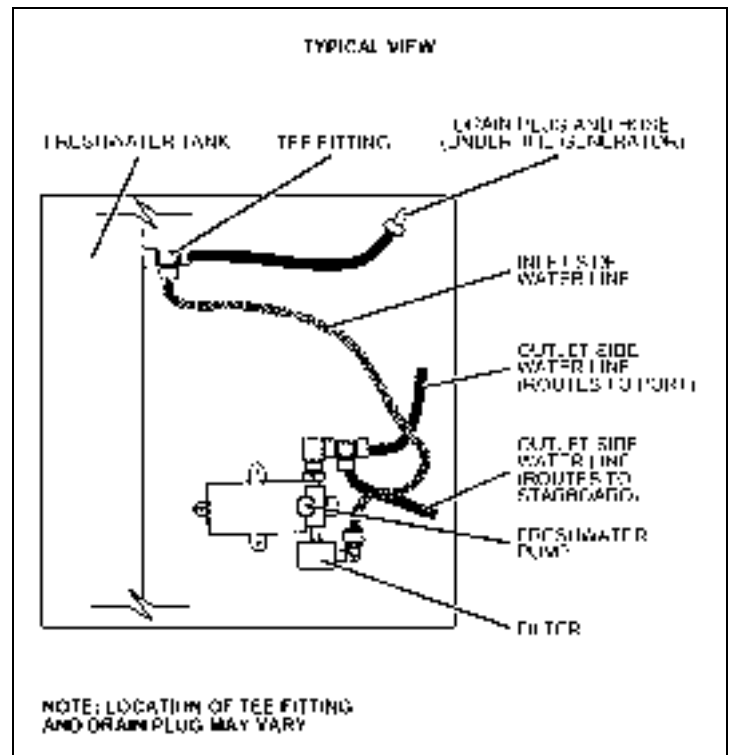

Water Heater

⚠ WARNING!

⚠ SCALDING HAZARD!
Water heated by the water heater can be hot enough to scald the skin.

⚠ CAUTION

WATER HEATER DAMAGE HAZARD!

- Do **NOT** turn *On* the water heater electrical circuit on the 110-volt AC master panel until the water heater tank is **COMPLETELY** filled with water.
- The tank is full if water flows from the tap when the hot water is turned *On* in the galley.
- Even brief water heater operation with a dry tank **WILL** damage the heating elements.
- Warranty replacements will **NOT** be made on elements damaged in this manner.
- Turn the power *Off* and drain the water heater when the chance of freezing exists (see winterizing instructions below).

NOTICE

If 110-volt AC power is being provided by shore power or generator power, but the water heater is not working:

- Make sure the water heater circuit breaker on the 110-volt AC master panel is switched *On*.
- If the circuit breaker is *On*, but the water heater is still not working, ask your dealer how to check the push-to-reset circuit breaker located on the water heater.

- Read the water heater instruction manual and heed the warnings above.
- The water heater is connected to the 110-volt AC power system.
- To heat the water, turn *On* the water heater breaker on the 110-volt AC master panel.

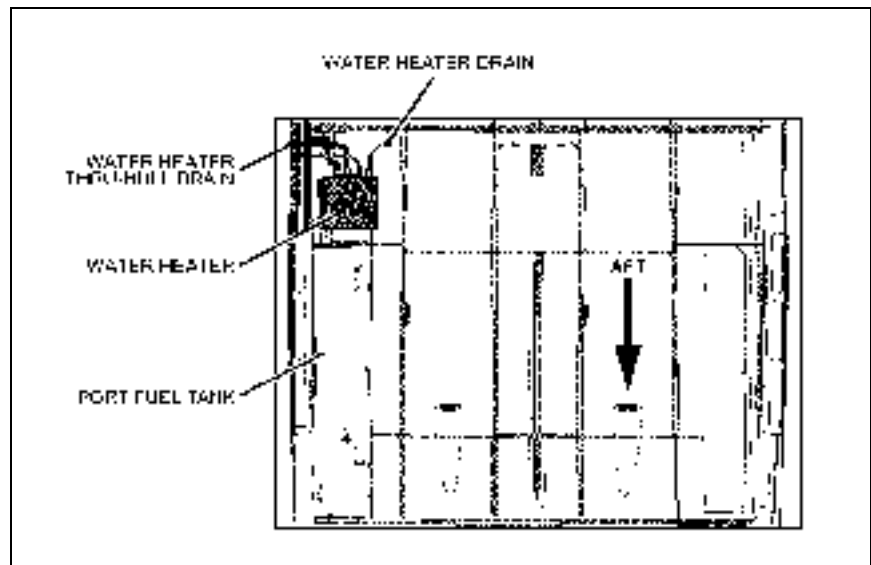

Winterizing the Water Heater



CAUTION

WATER HEATER DAMAGE HAZARD!

- **NEVER** turn *On* the water heater breaker on the 110-volt AC master panel while the water heater tank is empty.
- Even brief water heater operation with a dry tank **WILL** damage the heating elements.
- Warranty replacements will **NOT** be made on elements damaged in this manner.
- To prevent damage to the water heater after winterizing, always label the breaker switch on the 110-volt AC master panel as 'winterized'.

NOTICE

The freshwater system **MUST** be drained **BEFORE** winterizing the water heater (see the *Freshwater System Winterization Instructions* earlier in this section).

1. Turn *Off* the water heater breaker.
 2. Disconnect the hose (A) attached to the pressure relief valve (B).
 3. If there is any water in this hose, drain it into the bilge or into a bucket.
 4. *Open* the pressure relief valve (B).
 5. *Open* the drain valve (C).
 6. Attach a tag to the water heater breaker to indicate that the tank is empty.
- **NOTE:** Your yacht came with a tag attached to the water heater breaker. It is suggested that you keep this tag and re-use it when winterizing.
 - Leave the pressure relief and drain valves *Open* until you fit out your yacht after storage.

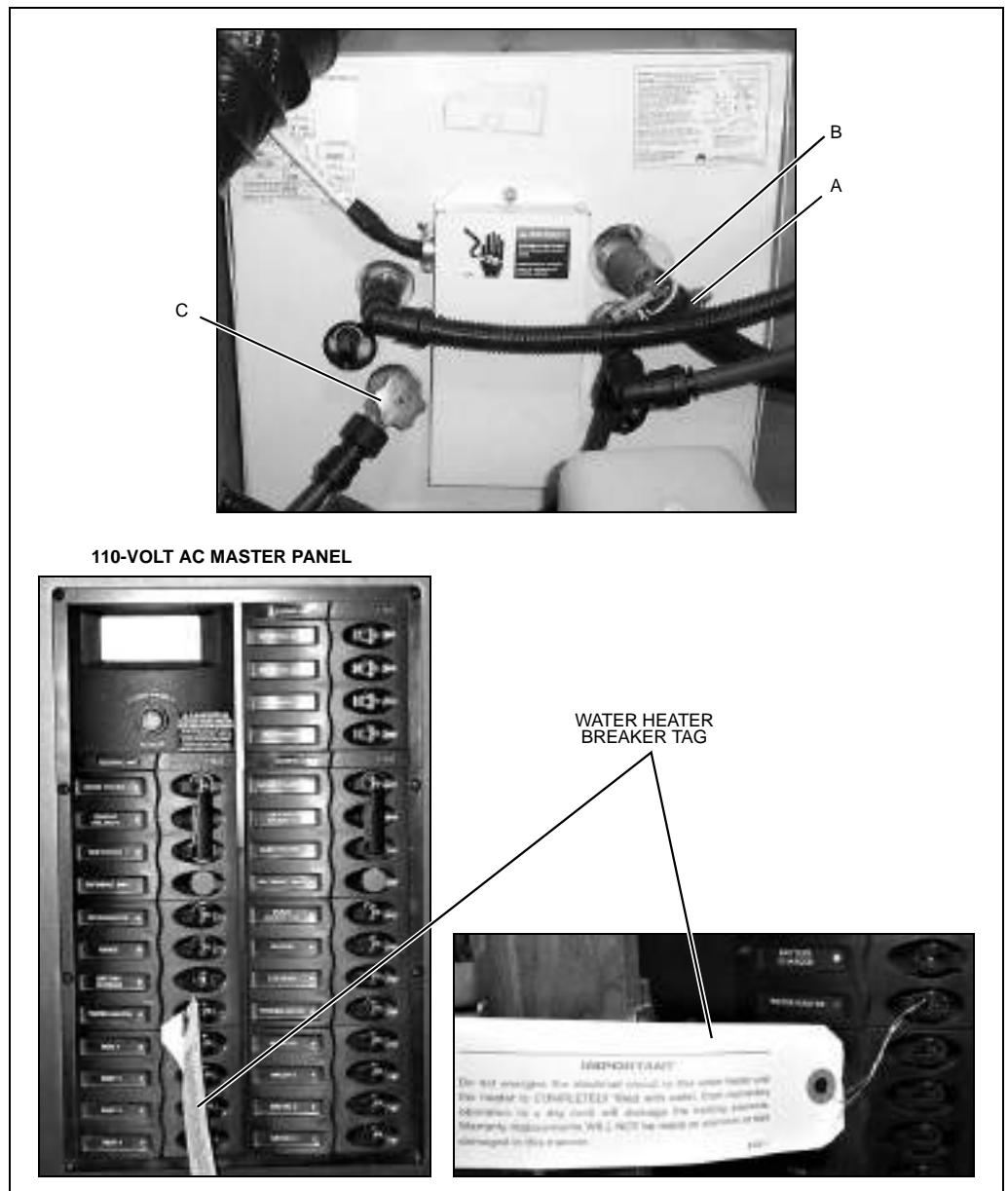

Preparing the Water Heater for Use After Yacht Storage



CAUTION

WATER HEATER DAMAGE HAZARD!

- Fill the water heater tank *BEFORE* turning *On* the water heater breaker on the 110-volt AC master panel.
- *NEVER* turn *On* the water heater breaker on the 110-volt AC master panel while the water heater tank is empty.
- To test if the tank is full, turn *On* a hot water faucet. If water flows from the tap, the water heater tank is full.
- Even brief water heater operation with a dry tank *WILL* damage the heating elements.
- Warranty replacements will *NOT* be made on elements damaged in this manner.

When you are ready to resume use of your yacht after it has been in storage, prepare the water heater for use as follows:

1. **Close** the drain valve (C).
2. **Close** the pressure relief valve (B).
3. Connect the hose (A) to the pressure relief valve (B).
4. Fill the water heater tank with freshwater.
5. Remove the 'winterized' tag on the water heater breaker on the 110-volt AC master panel **after** the water heater tank is **completely** filled with freshwater.
6. Turn **On** the water heater breaker.

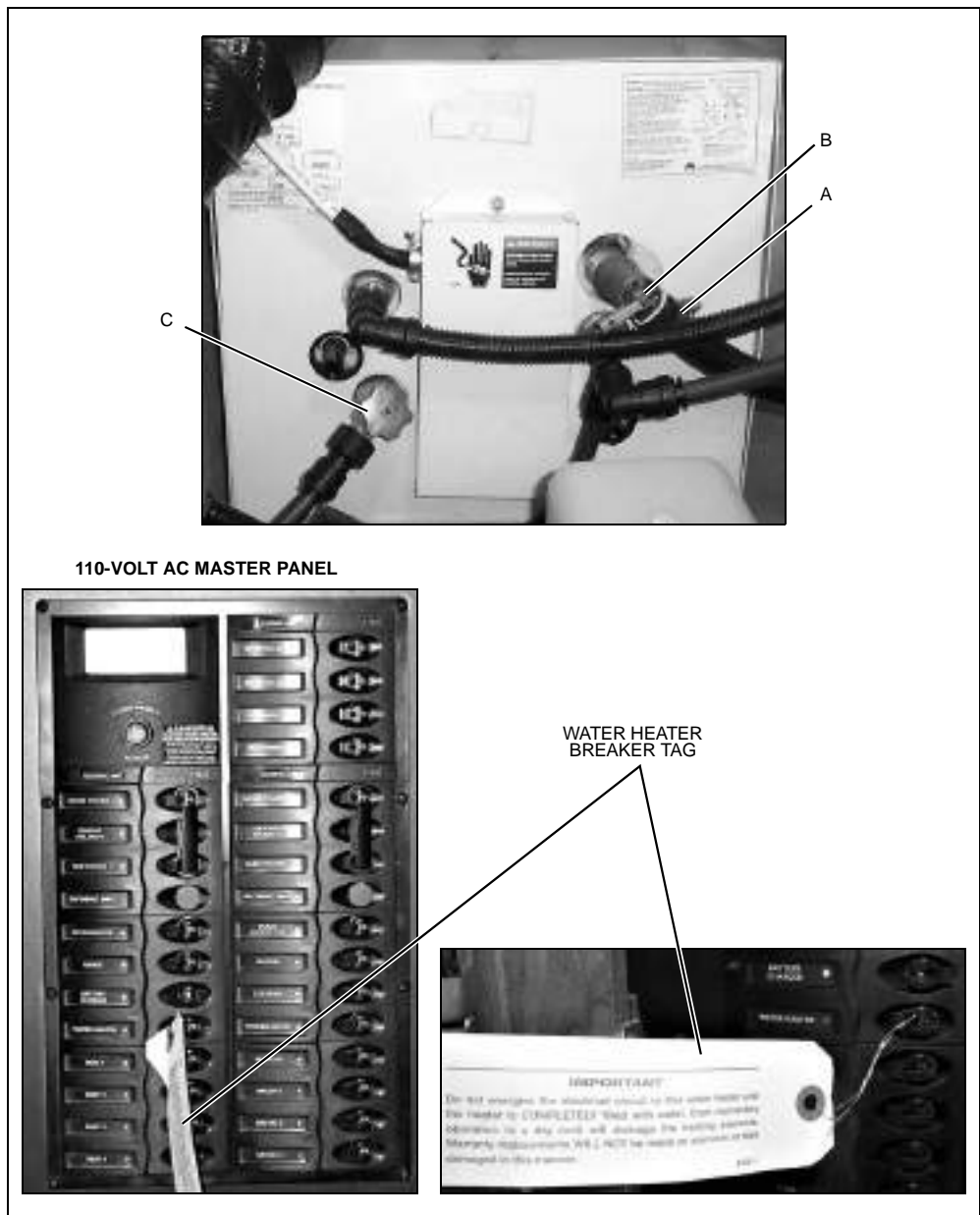

Drain Systems

Deck Drains

- Water on the deck is drained overboard through the deck drains.
- Keep the deck drains free of debris.

Gray Water Drain System

- The galley sink, head sinks, and command bridge sink are above the waterline and are gravity drained overboard.
- Gray water below the waterline drains into the sump pump box (see below).

Sump Pump Drain System

- The stateroom air conditioners (if equipped) and the showers drain into the sump pump box.
- The sump pump box has an autofloat switch.
- When the drain water rises to a preset level, the autofloat switch turns *On* the sump pump, and the drain water is pumped overboard.

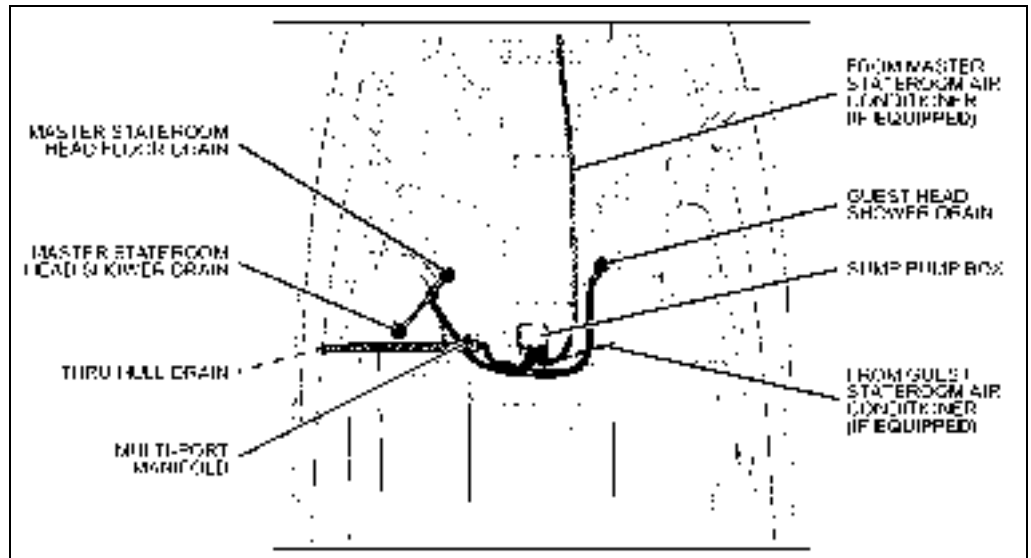

Sump Box Cleaning

Periodically clean the sump box, filter, and pump as follows:

1. Remove the cover screws (A) and the cover (B).
2. Remove any debris from the box and the filter.
3. Clean the sump pump as outlined in the *Bilge Pumps* section of this chapter.

Sump System Winterization

Drain the sump pump system in the winter months when not in use.

1. Disconnect and drain *all* lines to the unit.
2. Remove the screws from the mounting feet (C).
3. Turn the box upside down to remove the rest of the water.
4. Reinstall the screws in the mounting feet and reconnect the system.

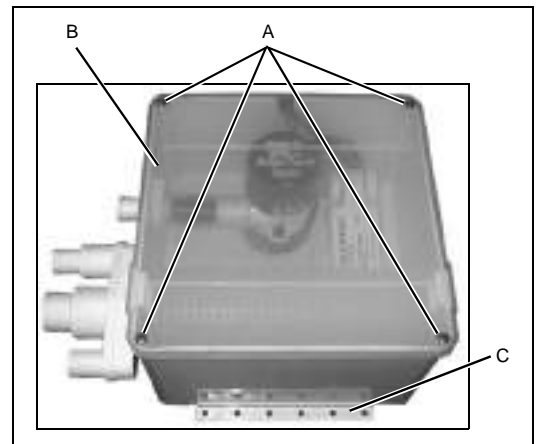

Marine Heads & Holding Tank

NOTICE

Check with local authorities about the legal use of marine head systems.

Vacuum Flush Head System

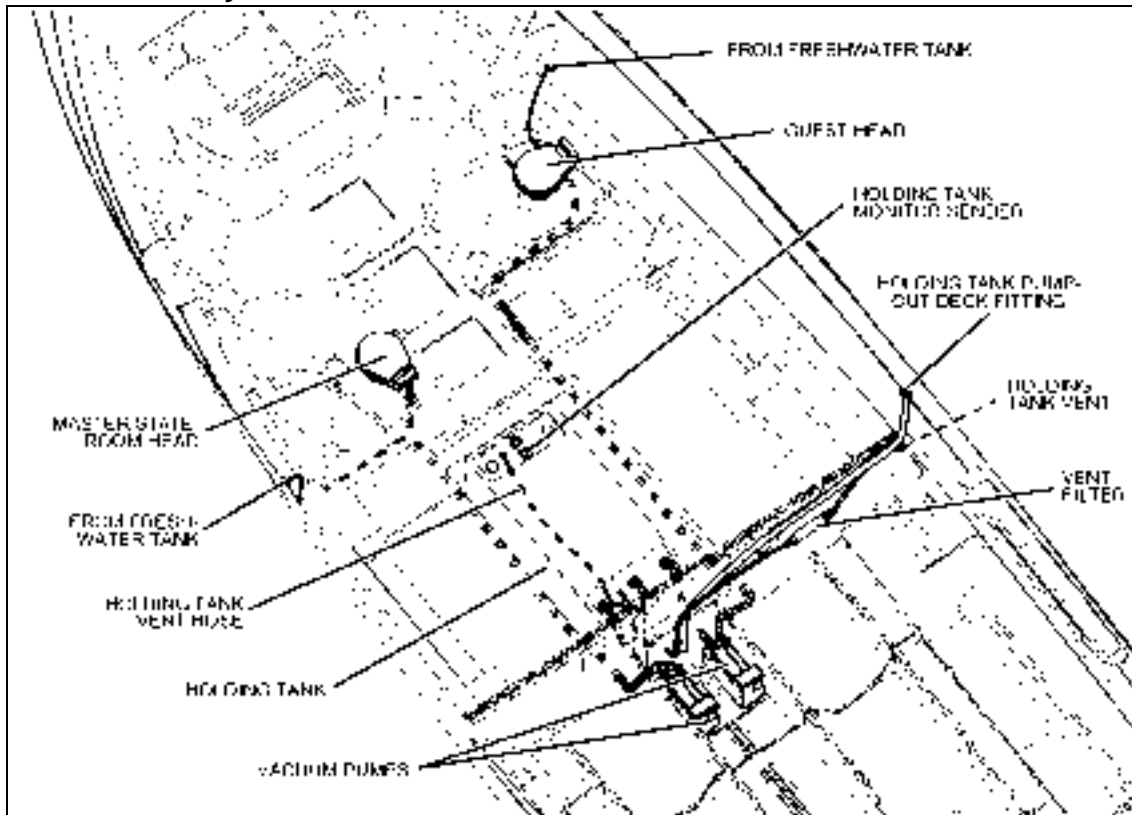

- Read the vacuum flush head's operation and maintenance manual.
- The vacuum flush head system uses freshwater from the freshwater tank and a vacuum pump to flush waste from the toilet into the holding tank.
- The holding tank is plumbed to a fitting on the deck for dockside pump-out.
- To check the content level of the holding tank, look at the monitoring gauge. For the location of the holding tank monitoring gauge, see the *Component Locations* section in *Chapter 2* of this *Owner's Manual*.
- Empty the holding tank at every opportunity.

Winterizing the System

Read the marine head's operation and maintenance manual for winterizing instructions.

Macerator (If Equipped)

To use the macerator to pump waste directly overboard (where laws permit):

1. ***Open*** the underwater discharge valve.
 2. Press both macerator switches at the same time to run the pump.
 3. Stop running the macerator as soon as the holding tank is empty.
 4. ***Close*** the underwater discharge valve when you are done pumping.
- For the locations of the underwater discharge valve and the macerator switches, see the *Component Locations* section in *Chapter 2* of this *Owner's Manual*.

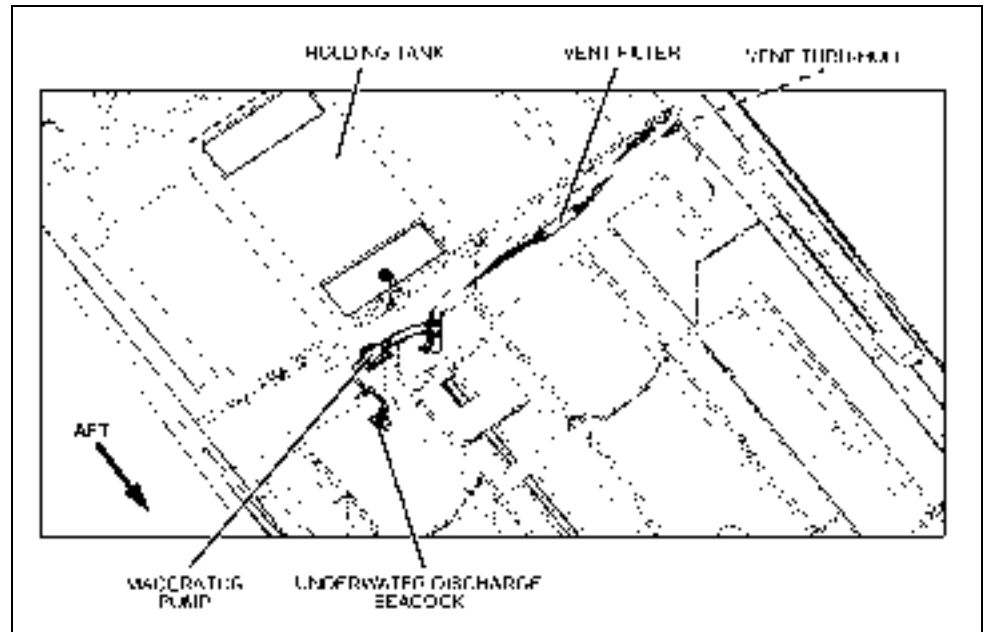

Chapter 7: Deck Equipment

Cleats

 WARNING!
<p><i>PERSONAL INJURY and/or PRODUCT or PROPERTY DAMAGE HAZARD!</i></p> <p><i>NEVER</i> lift your yacht using the cleats.</p>

Carefully read the section on towing in the *Cruiser & Yacht Owner's Manual Supplement* before towing anything behind your yacht or having your yacht towed by another vessel.

Windlass

 DANGER!
<p><i>PERSONAL SAFETY & PRODUCT DAMAGE HAZARD!</i></p> <p>An unsecured anchor could accidentally release while your yacht is moving, damaging your yacht and causing serious injury or death.</p> <p>After retrieving the anchor:</p> <ul style="list-style-type: none"> • Secure the anchor with an anchor safety strap, or a chain stopper. • Switch <i>OFF</i> the windlass circuit breaker to prevent accidental operation.

 CAUTION
<p><i>PRODUCT DAMAGE HAZARD!</i></p> <p>Do <i>NOT</i> rely on the windlass alone to hold your yacht at anchor. After setting the anchor, tie the rode off to a cleat or equivalent strong point.</p> <p>Do <i>NOT</i> pull your yacht to the anchor using the windlass, or continue running the windlass if it has stalled or is overloaded.</p>

- Read and follow the manufacturer's instruction manual *before* using the anchor windlass for the first time.
- The windlass can be controlled from a switch at the helm or from the deck foot switches.
- Make sure that the windlass circuit breaker is turned ***On before*** using the anchor windlass.
- To raise the anchor, use engine power (*not* the windlass) to move your yacht to, and directly above, the anchor.
- Dislodge the anchor from the bottom by pulling it straight up with the windlass.
- ***Before*** getting underway, make sure the anchor is secured and the windlass circuit breaker is turned ***Off***.

Radar Wing



CAUTION

PRODUCT DAMAGE HAZARD!

- When installing accessories on the radar wing, the maximum hole size diameter is 3/4 of an inch (0.75").
- Larger hole sizes will affect the structural integrity of the radar wing.

Canvas & Vinyl Tops & Enclosures



CAUTION

PRODUCT or PROPERTY DAMAGE HAZARD!

Take down and securely stow *ALL* canvas & vinyl *BEFORE* your yacht is transported by road.

NOTICE

BEFORE cleaning and/or stowing your canvas or vinyl, read the sections later in this chapter, *Canvas Care* and *Clear Vinyl Care*.

NOTICE

Two people are needed for most of the tasks listed in this section.

1. Insert the ball ends of the main bow (A) into the deck hinge sockets and snap the securing pins into place.
 2. Pull the secondary bow (B) forward and insert the ball ends of the forward braces (C) into the deck hinge sockets and snap the securing pins into place.
 3. Insert the ball ends of the aft braces (D) into the deck hinges on the radar wing and snap the securing pins into place.
- The jaw slides should *not* need to be adjusted.
 - If you decide to adjust the jaw slide positions, get the correct measurements from your selling dealer.
 - To release the ball end from the socket, pull the securing pin.

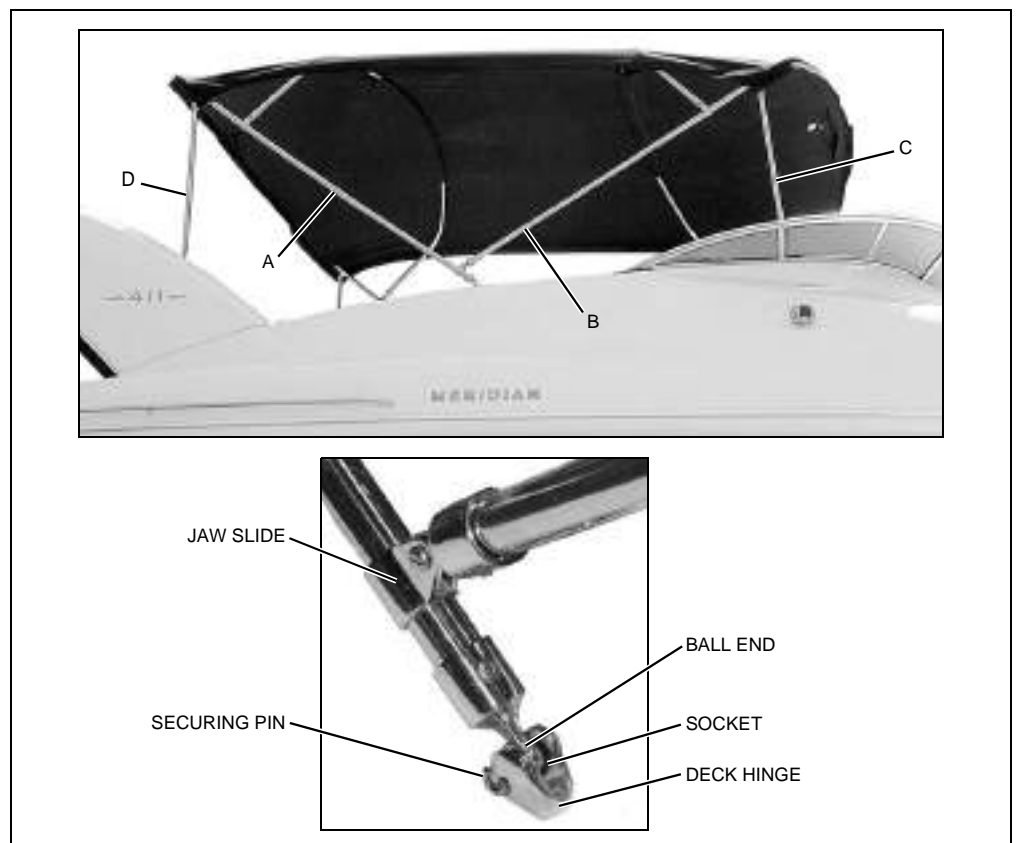

Canvas Care (see also 'Clear Vinyl Care' on next page)

- After each use, especially in saltwater, rinse the canvas with cold freshwater.
- Before stowing, let the canvas air-dry completely.
- The canvas can be rolled or folded for stowage.

Cleaning the Canvas

 CAUTION
<p>NEVER use detergents when washing the canvas. Detergents can destroy the water repellency, and mildew/UV resistant finish of your canvas.</p>

Regularly clean the canvas to prevent dirt, pollen, and etc. from embedding in the fabric. Generally, it is easiest to wash the canvas while it is installed on your yacht.

1. Use a soft-bristled brush to remove all dust and loose dirt.
2. Hose down the canvas with freshwater.
3. Gently wash the canvas with a solution of lukewarm water (no more than 100° F) and non-detergent mild soap, such as Ivory Snow®, Dreft®, or Woolite®.
4. Rinse thoroughly to remove the soap.
5. Before stowing, let the canvas air-dry completely.

Stubborn Stains

 CAUTION
<ul style="list-style-type: none"> • Soaking in bleach solutions may remove the waterproof finish of the fabric and may also decrease the life of the polyester thread used in the canvas. • If necessary, a water repellent treatment should be reapplied to your canvas. Ask your dealer about the treatments available for your yacht's canvas.

Some stubborn stains may resist normal washing and you can try the following methods. However, these methods may remove the waterproof finish of the fabric and may also decrease the life of the polyester thread used in the canvas. Reapply a water repellent treatment as necessary.

Method 1

1. Add 1/8 cup (1 oz.) of **non-chlorine** bleach to one gallon of water and mix thoroughly.
2. Thoroughly wet the canvas and then gently scrub the stained area with the weak bleach solution.
3. Rinse with cold water to remove all of the solution.

Method 2

1. Add 1/2 cup (4 oz.) of **non-chlorine** bleach and 1/2 cup (4 oz.) Ivory Snow®, Dreft®, or Woolite® to one gallon of water and mix thoroughly.
2. Soak the canvas in this solution for about 20 minutes.
3. Rinse with cold water to remove all of the solution.

Clear Vinyl Care



CAUTION

- **NEVER** store the clear vinyl pieces wet, as this will cause a milky film to develop.
- **NEVER** fold or crease the clear vinyl pieces as cracking will occur.
- Clear vinyl is **NOT** intended for use when your yacht is in storage or being moored.
- Clear vinyl does **NOT** hold up well against ultraviolet rays.
- Under direct sunlight conditions, do **NOT** let the clear vinyl touch the framework. The framework radiates heat and can burn the clear vinyl.

- After each use, especially in saltwater, rinse the clear vinyl with cold freshwater.
- **Before** stowing, the clear vinyl must be completely dry. Air-drying is best, but you can also carefully dry the vinyl with a chamois or soft cotton cloth.
- The clear vinyl can be rolled or laid out flat for stowage.
- **Never** fold or crease the clear vinyl parts as cracking **will** occur.

Cleaning Clear Vinyl

Regularly clean the clear vinyl to prevent dirt, pollen, and etc. from marring the surface. Generally, it is easiest to clean the clear vinyl while it is installed on your yacht.

1. Hose down the clear vinyl with freshwater.
 2. Using a soft cotton cloth (**paper towels are abrasive and should never be used on clear vinyl**), gently wash the clear vinyl with soap and water.
 3. Rinse thoroughly to remove the soap.
 4. **Before** stowing, the clear vinyl must be completely dry. Air-drying is best, but you can also carefully dry the vinyl with a chamois or soft cotton cloth.
- Ask your dealer about products available to keep the clear vinyl polished and looking new.

NEVER FOLD OR CREASE CLEAR VINYL!
FOLDING OR OTHERWISE CREASING
CLEAR VINYL WILL CAUSE DAMAGE
SUCH AS CRACKING TO OCCUR



AFTER CLEAR VINYL PARTS
HAVE COMPLETELY AIR DRIED
THEY CAN BE ROLLED OR SIMPLY
LAID FLAT FOR STOWAGE

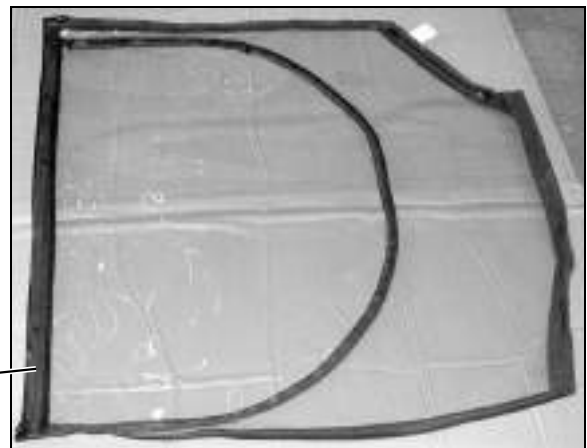

Chapter 8: Appliances & Entertainment Systems

NOTICE

Always keep an approved ABC-type fire extinguisher in galley area.

All appliances and entertainment systems installed on your yacht come with their own manuals. These manuals contain detailed instructions and important safeguards. Read these manuals *before* using your yacht's appliances and entertainment systems.



- Make sure the 110-volt AC breaker is turned *On* for the appliance or entertainment system you wish to use.

Refrigerator

The refrigerator runs on 12-volt DC power *unless* 110-volt AC power is being supplied by shore power or generator power *and* the refrigerator's circuit breaker on the 110-volt AC master panel is *On*.

Electric Stove

 **WARNING!**







BURN/SCALDING and/or FIRE HAZARD!

- Read the stove's instruction manual *BEFORE* using.
- *ALWAYS* keep an approved ABC-type fire extinguisher in galley area.

- Do *NOT* use the stove while underway.
- Any non-cooking devices on or near your stove during use are potential fire hazards!
- Do *NOT* touch burners, grates or nearby surfaces as they may be hot even when they are dark in color. Areas near burners and grates may become hot enough to cause burns.
- During and after use, do *NOT* touch or let clothing or other flammable material come in contact with heated units or areas near the units (burner tops, main frame sides and back, sea rails and pot holders) until they have had sufficient time to cool.

Coffeemaker

 **WARNING!**

BURN/SCALDING HAZARD!

- Read the coffeemaker's instruction manual *BEFORE* using.
- Do *NOT* use the coffeemaker while underway.
- Water heated by the coffeemaker can be hot enough to scald the skin.

Audio & Visual Equipment

NOTICE

AM radio reception may be impaired anytime the engine is running.

Dockside Television & Telephone Inlet

Plug a dockside source into the TV/telephone inlet if you want to watch cable TV or use a telephone.

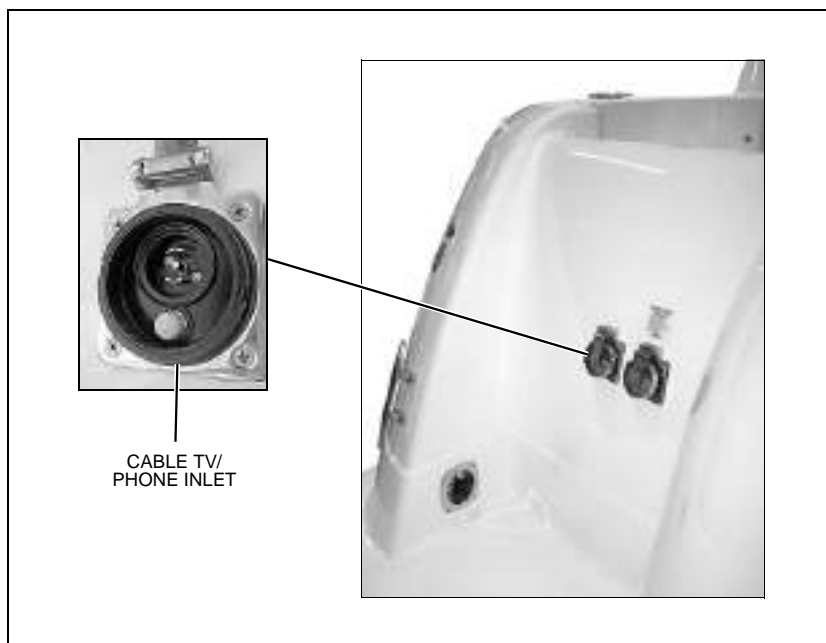

Chapter 9: Lights

Care & Maintenance

All of the lights installed on your yacht are of top quality, but you should be aware that failure may periodically occur for a variety of reasons:

1. There may be a blown fuse - *replace the fuse.*
2. The bulb may be burned out - *carry spare replacement bulbs, making sure the wattage is correct.*
3. A wire may be damaged or may have come loose - *repair as required.*
4. The bulb base may be corroded - *clean the base and coat it with non-conductive electrical lubricant.*

Interior & Exterior Lights

 CAUTION
<ul style="list-style-type: none"> • Be conservative in the use of battery power. • Prolonged use of cabin interior lights (overnight) <i>WILL</i> result in a drained battery.

- The lights are powered by your yacht's 12-volt DC system.
- The battery switch must be in the *On* position for the lights to work.

Navigation Lights

 CAUTION
<p>Avoid the storage of gear where it would block navigation lights from view.</p>

NOTICE
<p>Running lights are legally required to show vessel direction and right-of-way at night.</p>

Spotlight

Read the spotlight's operating instructions *before* using the spotlight.

Chapter 10: Air Conditioning & Heating

Air Conditioner (If Equipped)

⚠ DANGER!

CARBON MONOXIDE POISONING HAZARD!



- Dangerous carbon monoxide gas (CO) can be brought into your yacht through the air conditioning system.
- Read the *Carbon Monoxide (CO)* section in *Chapter 1* of this *Owner's Manual*.

⚠ CAUTION

SYSTEM DAMAGE HAZARD!

The air conditioning system's seawater intake seacock **MUST** be *Opened BEFORE* turning *On* the air conditioner and **MUST** stay *Open* during use.

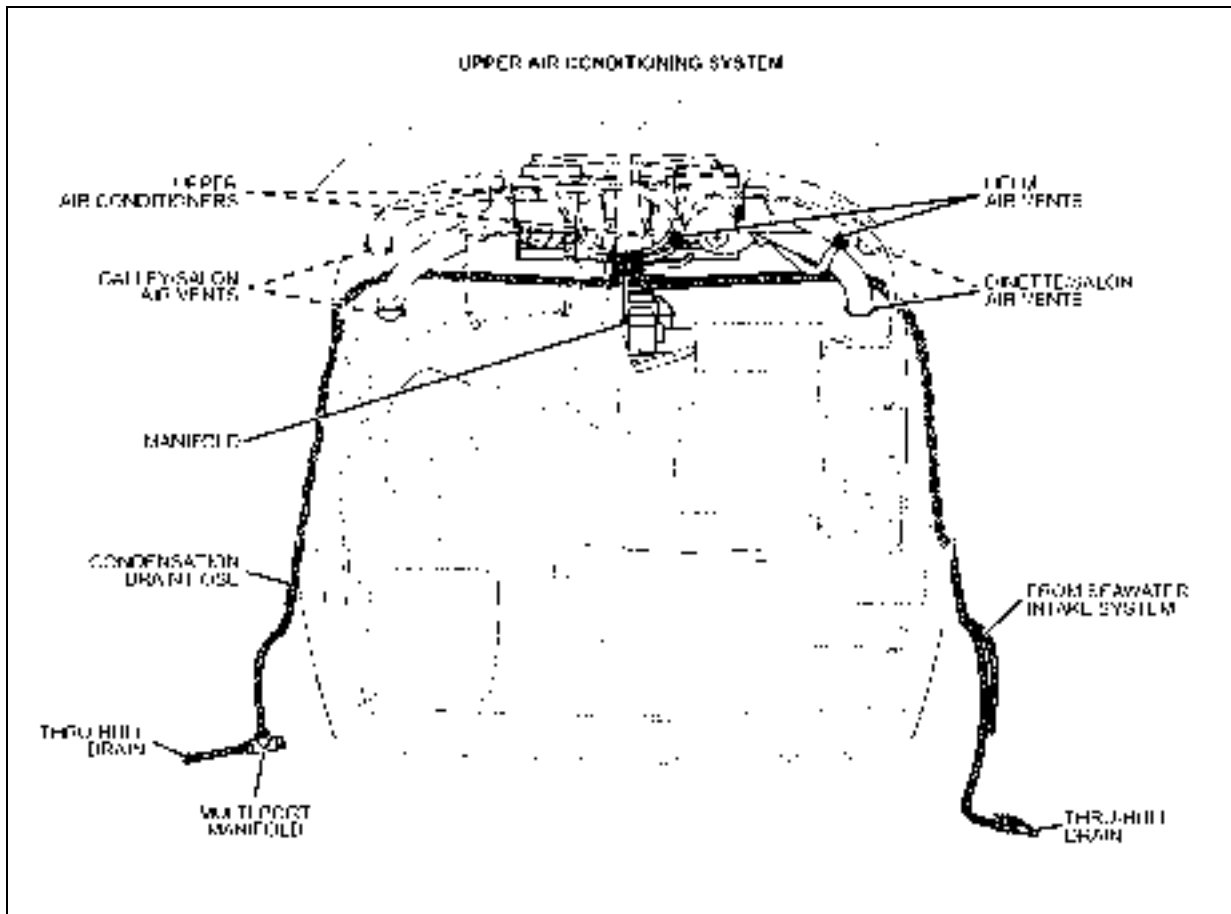

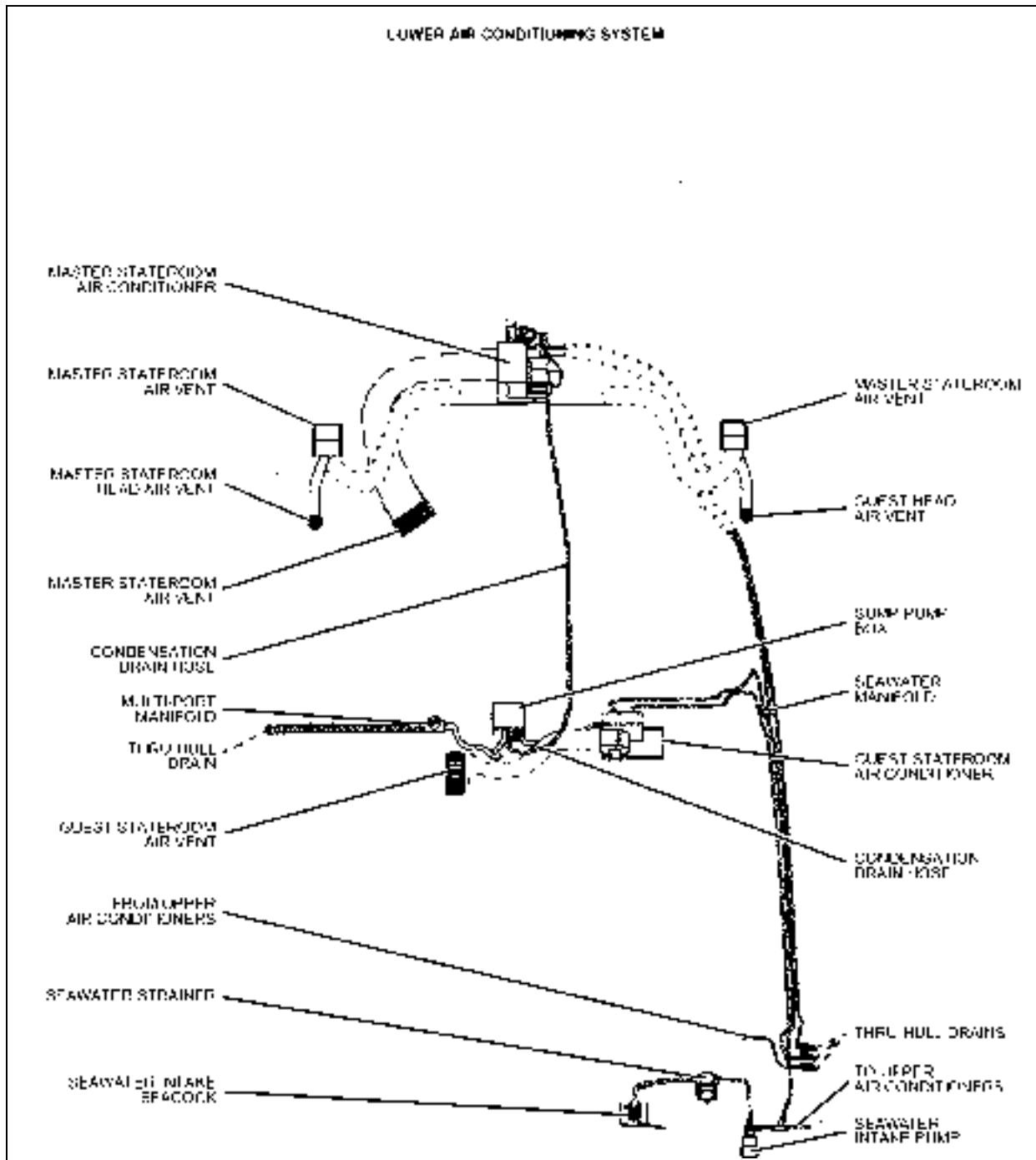

- Read the air conditioner manual *before* using the air conditioning system.
- **Before** using the air conditioning system, make sure the breakers on the 110-volt AC master panel are turned **On** and that the system's seawater intake seacock is **Open**.
- The seacock **must** remain **Open** while the air conditioner is in use.
- Check the seawater strainer for debris **before** each use of the air conditioning system.
- If the strainer needs to be cleaned out, follow the directions in the *Seawater Systems* section in *Chapter 6* of this *Owner's Manual*.

Heat Exchanger Cabin Heat (If Equipped)

Your yacht may feature a heat exchanger cabin heater. This heater runs directly off the starboard engine. **Before** using the heat exchanger cabin heater:

1. Read the manufacturer's instruction manual.
 2. Make sure the circulation loop shut-off valves are **Open**.
 3. Turn **On** the circuit breaker for the heater fan.
- If the heat exchanger circulation loop is **Open** and the starboard engine is running, the heater will radiate heat even if the heater fan is turned **Off**.
 - **All** circulation to the heater can be shut **Off** by **Closing** the circulation loop shut-off valves.

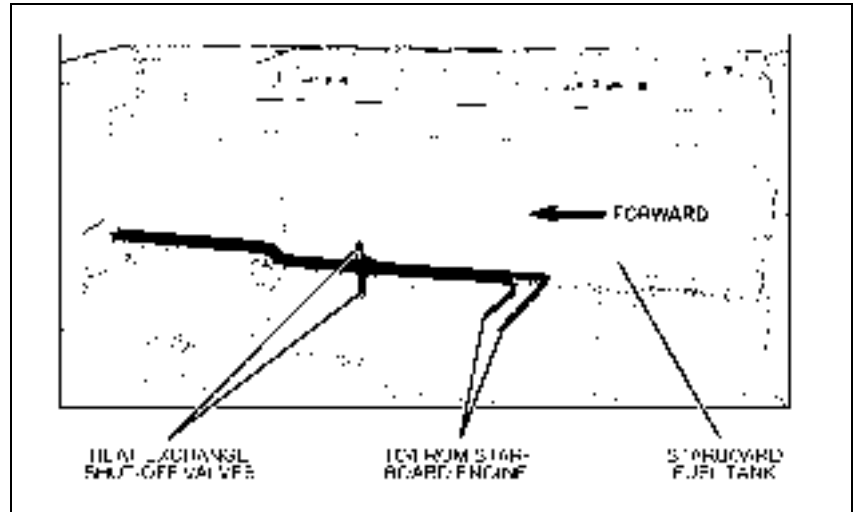





Electric Heaters (If Equipped)

Your yacht may feature electric cabin heaters. Operating instructions for this system can be found in the manufacturer's instruction manual.

- **Before** using the electric heaters, make sure the breakers on the 110-volt AC master panel are turned **On**.





Chapter 11: Electrical Systems

DANGER!



EXTREME FIRE, SHOCK and EXPLOSION HAZARD!

- **NEVER** install non-ignition protected switches or other arcing devices in the fuel compartments.
- **NEVER** substitute automotive parts for marine parts. Marine electrical, ignition, and fuel system parts were designed and manufactured to comply with rules and laws that minimize the risks of fire and explosion.
- **NEVER** change the electrical systems or relevant drawings.
- Allow **ONLY** trained marine electricians to install batteries and/or do electrical system work.
- Make sure that all battery switches are turned *Off BEFORE* working in the engine spaces.



WARNING!





FIRE and EXPLOSION HAZARD!

Fuel vapors can explode! **BEFORE** turning on electrical devices or working on the electrical system:

1. Check the bilge areas for fuel vapors or leaking fuel. If you see leaking fuel or smell fuel vapors:
 - a. Do **NOT** start the engines or generator, do **NOT** turn *On* any electrical devices, put out **ALL** cigarettes, cigars, and other sources of flame or ignition.
 - b. Get everyone off your yacht.
 - c. Get trained help to find and fix the problem.
2. Run the bilge blowers for at least four minutes **BEFORE** engine starting, electrical system maintenance, or turning on electrical devices.

CAUTION

SHOCK and ELECTRICAL SYSTEM DAMAGE HAZARD!

When the engines are running, **NEVER** turn *Off* the main battery switches or disconnect the battery cables. Doing either could cause damage to your yacht's engines and/or electrical system components.

NOTICE

Electrical connections are prone to corrosion. To reduce corrosion-caused electrical problems:

- Keep **ALL** electrical connections clean.
- Apply a spray-on protectant that is designed to protect connections from corrosion.

12-Volt DC System

Batteries

- The batteries supply electricity for lights, 12-volt accessories, engine starting and generator starting.
- The *Electrical* section in *Chapter 8* of the *Cruiser & Yacht Owner's Manual Supplement* provides battery care and maintenance instructions.

Battery Switches

⚠ CAUTION

⚡ SHOCK and ELECTRICAL SYSTEM DAMAGE HAZARD!

When the engines are running, **NEVER** turn *Off* the main battery switches or disconnect the battery cables. Doing either could cause damage to your yacht's engines and/or electrical system components.

NOTICE

Make sure your selling dealer fully explains how to use the battery switches.

- A separate battery switch is provided for each battery (or battery bank). The battery switches are located on the battery management panel. (For the location of the battery management panel, see the *Component Locations* section in *Chapter 2* of this *Owner's Manual*).
- Standby-loads, such as the automatic bilge pumps and the stereo memory, are not affected by the battery switches since they are wired directly to the batteries.
- Turn the battery switches to the *Off* position whenever your yacht will be unoccupied for long periods of time.

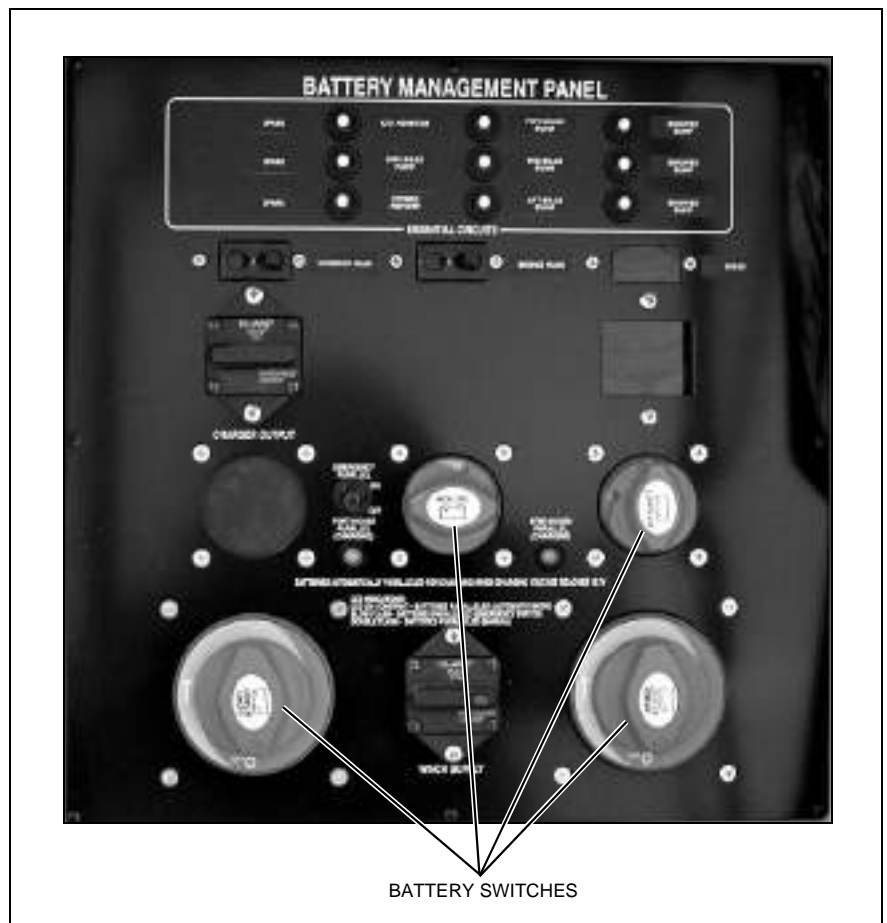

Emergency Battery Parallel Switch

- If an engine will not start because of a dead battery, the battery parallel switch allows you to use the other batteries for engine starting.
- A battery parallel switch is provided on the battery management panel and at each helm (see photos on right).
- Emergency parallel switch instructions are provided on the *VSR Charging Module Information Sheet*.

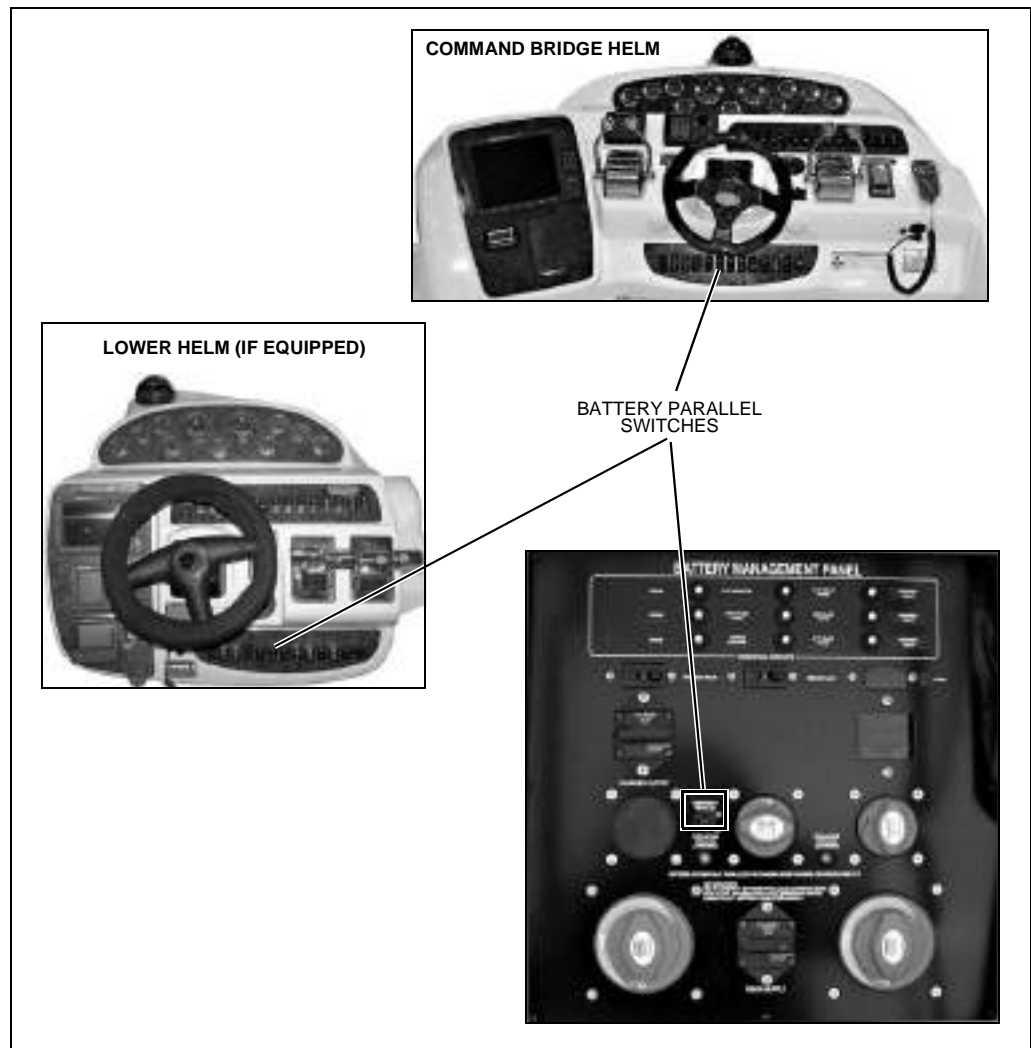

Fuses & Circuit Breakers

The fuses and circuit breakers for the engines and main accessory power are on the following panels:

- 12-volt DC main distribution panel.
- 12-volt DC push-to-reset circuit breaker panel.
- Battery management panel.

For the locations of these panels, see the *Component Locations* section in *Chapter 2* of this *Owner's Manual*.

NOTE: Some equipment may have secondary fuse protection at the unit, behind the battery management panel, or at the batteries.

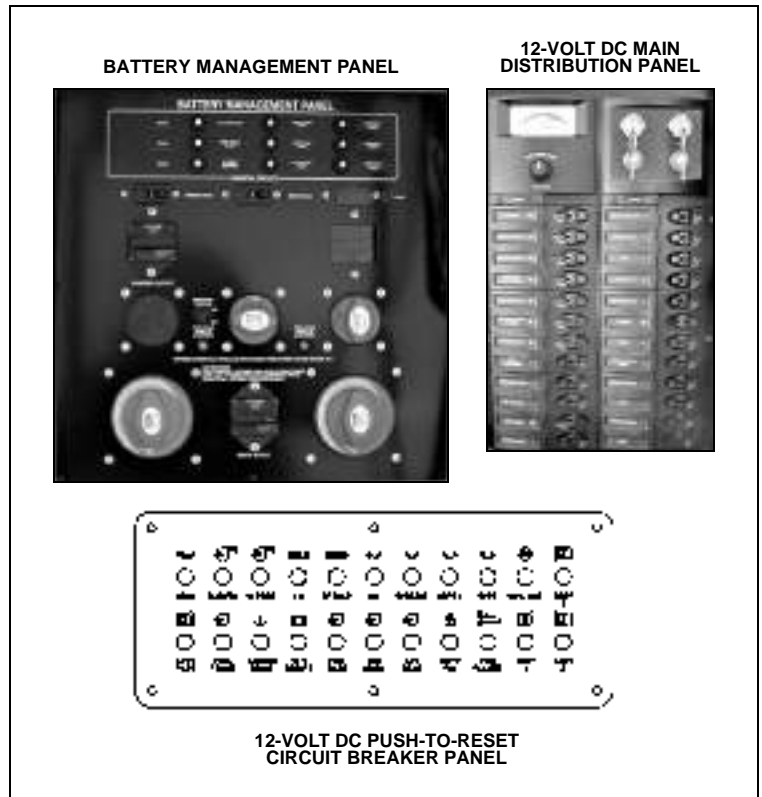

12-Volt DC Accessory Outlet(s)



CAUTION

Do NOT use the 12-volt DC accessory outlet with a cigarette or cigar lighter. High temperatures may melt the outlet.

- The outlet(s) can be used with any 12-volt device which draws 15-amps or less.
- The 12-volt DC accessory outlet(s) are protected by a 15-amp breaker on the 12-volt DC main distribution panel, except for the command bridge 12-volt DC outlet breaker which is on the 12-volt DC push-to-reset circuit breaker panel at the command bridge helm.
- For the locations of the 12-volt DC accessory outlets, see the *Component Locations* section in *Chapter 2* of this *Owner's Manual*.

Alternators

The engine alternators will keep the batteries properly charged when running at cruising speeds.

Battery Charger or Inverter/Battery Charger (If Equipped)**CAUTION****ENGINE and ELECTRICAL SYSTEM DAMAGE HAZARD!****NEVER** run your yacht's engines and the battery charger at the same time.**CAUTION**

- The battery charging systems (alternator and battery charger or inverter/battery charger) installed on your yacht are designed to charge conventional lead-acid batteries.
- **BEFORE** installing gel-cell or other new technology batteries, consult with the battery manufacturer about charging system requirements.

- **Before** using the battery charger or inverter/charger, read **all** instructions and warnings: (1) on the *VSR Charging Module Information Sheet*, (2) on the battery charger or inverter/charger, (3) on the batteries and (4) in the battery charger manual.
- The battery switches can be in any position during charging.
- The battery charger will automatically charge your yacht's batteries when 110-volt AC power is being provided by shore power or generator power, **and** the battery charger circuit breaker on the 110-volt AC master panel is **On**.
- For the inverter/charger (if equipped) to charge the batteries, the inverter **must** be turned **On** and the inverter battery switch must be turned **On**.
- You may use DC powered electrical systems, such as the lights and stereo, when the battery charger or inverter/charger is charging, but there will be a corresponding drop in charger performance.

110-Volt AC System



WARNING!

FIRE and ELECTRICAL SYSTEM DAMAGE HAZARD!

If equipped with a generator, using both shore power and generator power at the same time **WILL** cause major electrical system damage and could start a fire!

- The power source lockouts on the 110-volt AC master panel prevent the use of shore power and generator power at the same time.
- **NEVER** bypass the power source lockouts.



CAUTION

WATER HEATER DAMAGE HAZARD!

- Do **NOT** turn *On* the water heater circuit breaker on the 110-volt AC master panel until the water heater tank is **COMPLETELY** filled with water.
- The tank is full if water flows from the tap when the hot water is turned *On* in the galley.
- Even brief water heater operation with a dry tank **WILL** damage the heating elements.
- Warranty replacements will **NOT** be made on elements damaged in this manner.

NOTICE

- Whether using shore power or generator power, using several 110-volt AC accessories at the same time can result in an overloaded circuit.
- You may have to turn *Off* one or more accessories to use another accessory.

- To gain a basic understanding of your yacht's 110-volt AC system, read the handbook *A Boater's Guide To AC Electrical Systems*. If this handbook is not in your owner's packet, call 360-403-2198 and the handbook will be mailed to you.
- The 110-volt AC system can be energized by shore power, generator power, or inverter power (if equipped).
- The individual breakers on the 110-volt AC master panel **must** be turned *On* to supply power to the accessories you wish to use.
- The 110-volt AC master panel may contain circuit breakers for accessories that are not available for your yacht.

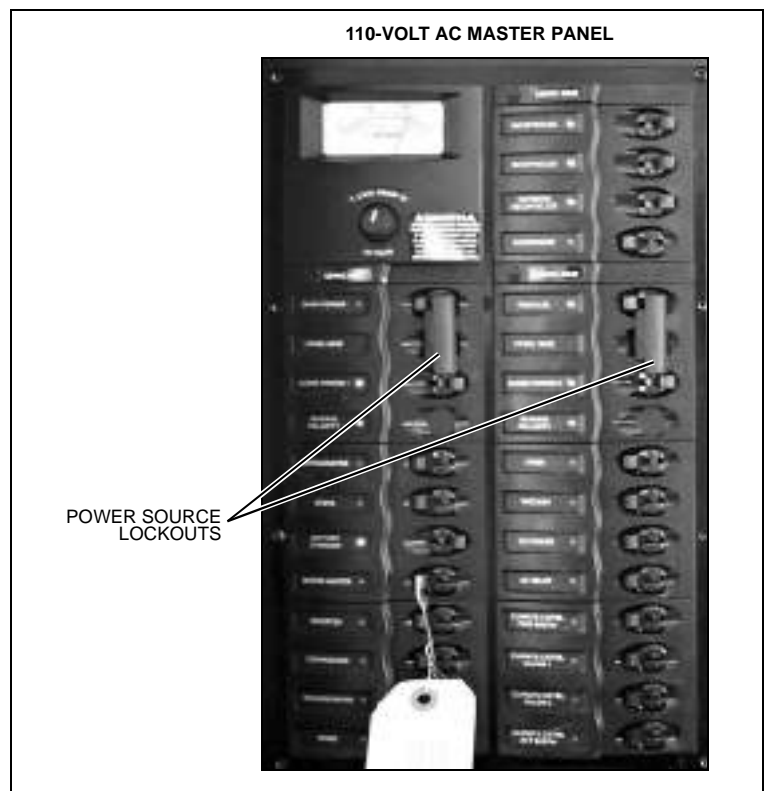



Shore Power

DANGER!



FIRE, EXPLOSION and SHOCK HAZARD!

- Use **ONLY** compatible shore power connectors and **NEVER** alter the connectors.
- Turn **Off ALL** breakers and switches on the 110-volt AC master panel **BEFORE** plugging in or unplugging the shore power cord.
- To prevent shock or injury from dropping a "hot" cord into the water:
 - a. **ALWAYS** plug the shore power cord into the yacht inlet first, and then into the dockside outlet.
 - b. When unplugging from shore power, **ALWAYS** unplug the shore power cord from the dockside outlet first.
- **NEVER** leave the shore power cord plugged into the dockside outlet **ONLY**.
- **ONLY** use shore power cords approved for marine use. **NEVER** use ordinary indoor or outdoor extension cords.

WARNING!



SHOCK and ELECTRICAL SYSTEM DAMAGE HAZARD!

- Monitor the polarity indicator lights **EVERY TIME** you connect to shore power.
- If a reversed polarity light turns on when you are connecting to shore power, do **NOT** turn on the main breaker switches.
- Instead, **IMMEDIATELY** unplug the shore power cord (**ALWAYS** from the dockside outlet first) and alert marina management.

WARNING!

SHOCK and ELECTRICAL SYSTEM DAMAGE HAZARD!

- **BEFORE** each use, check the shore power cord(s) for defects or damage.
- **NEVER** use damaged or faulty cords since the danger of fire and electrical shock exists.
- Do **NOT** pinch shore power cords in doors or hatches, or coil the shore power cord too tightly, since these situations can generate enough heat to result in a fire.
- If a shore power cord is dropped into the water, **COMPLETELY** dry the blades and contact slots **BEFORE** using.



CAUTION



ELECTRICAL SYSTEM DAMAGE HAZARD!

- **NEVER** connect to dockside power outside of North America unless you have purchased the international electrical conversion option.
- Using several 110-volt AC accessories at the same time can result in an overloaded circuit. You may have to turn **Off** one or more accessories to use another accessory.
- Use double insulated or three-wire protected electrical appliances whenever possible.

- Your yacht is equipped with two (2) 110-volt/30-amp shore power inlets or one (1) 220-volt/50-amp shore power inlet.
- The 110-volt/30-amp shore power inlets provide 110-volt/30-amp power to each shore power master breaker. The 220-volt/50-amp shore power inlet provides 110-volt/50-amp power to each shore power master breaker.
- Dual shore power inlets are labeled LINE 1 and LINE 2, which corresponds to the SHORE POWER 1 and SHORE POWER 2 master breakers on the 110-volt AC master panel.
- LINE 1 and LINE 2 are independent of each other except when the parallel switch is used.

Connecting to Shore Power

WARNING!

SHOCK and ELECTRICAL SYSTEM DAMAGE HAZARD!

- Monitor the polarity indicator lights *EVERY TIME* you connect to shore power.
- If a reversed polarity light turns on when you are connecting to shore power, do *NOT* turn on the main breaker switches.
- Instead, *IMMEDIATELY* unplug the shore power cord (*ALWAYS* from the dockside outlet first) and alert marina management.

1. Review all hazard information at the beginning of this section, *Shore Power*.
2. Turn *Off* all breakers and switches on the 110-volt AC master panel.
3. Attach the shore power cord(s) to the yacht inlet(s) first, then to the dockside outlet(s).
4. Switch the SHORE POWER 1 and/or SHORE POWER 2 master breakers *On*.
5. As needed, turn *On* the individual component breakers on the 110-volt AC master panel.

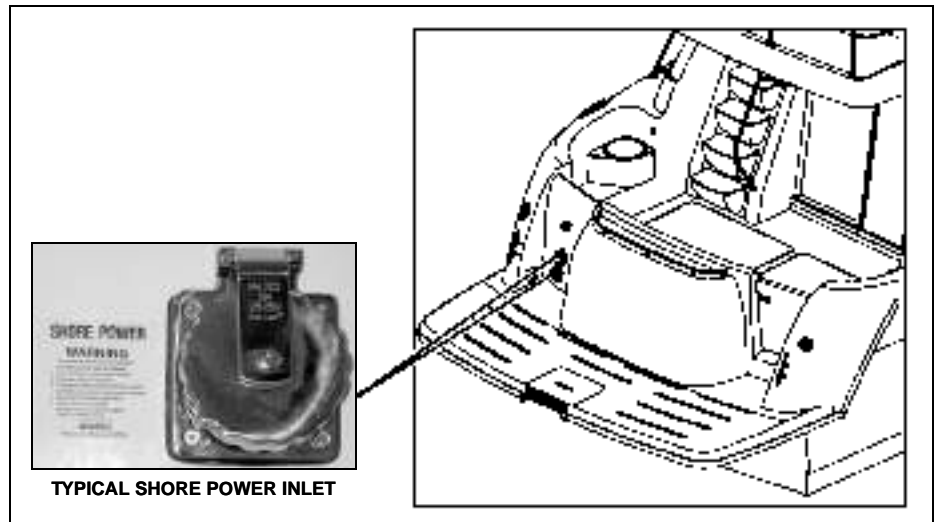

Shore Power Cable Hoist (If Equipped)

- The shore power cable hoist allows you to easily feed out and reel in the shore power cable.
- *Before* using the shore power cable hoist, read the cable hoist manual.

Parallel Switch (If Equipped with Dual Shore Power)

NOTICE

- **When using the parallel switch do *NOT* exceed 30 total amps.**
- **The amperage of each component breaker is shown on the breaker itself.**
- **The voltage on each line can be read on the voltmeter on the 110-volt AC master panel.**

When only one dockside outlet is available, you can use the parallel switch to provide power to both lines.

1. Connect to shore power as described in the *Connecting to Shore Power* section on the previous page.
2. Switch the parallel switch (transfers power from line 1 to line 2) ***On*** instead of the “SHORE POWER 2” master breaker.
3. Turn ***On*** the individual component breakers as required.

Inverter Power (If Equipped)

- The inverter allows the batteries to supply 110-volt AC power to some accessories when your yacht is ***not*** connected to shore power.
- Primary control is from the inverter remote control panel, and controls are also on the inverter itself.
- ***Before*** using the inverter, read ***all*** instructions and cautionary markings: (1) on the inverter, (2) on the batteries, and (3) in the inverter manual.
- Energize the 110-volt AC system under inverter power by switching ***On*** the inverter master breaker, and pressing the ***On/Off*** switch on the inverter remote control panel (or on the inverter itself).
- The inverter provides power ***only*** to the accessories on the 110-volt AC master panel.

Generator



DANGER!



CARBON MONOXIDE POISONING HAZARD!

- Generators are a source of dangerous carbon monoxide gas (CO). Check the generator exhaust system for leaks *BEFORE* each use.
- Read the *Carbon Monoxide (CO)* section in *Chapter 1* of this *Owner's Manual*.



WARNING!

FIRE and EXPLOSION HAZARD!

Fuel vapors can explode! *BEFORE* starting the generator:

1. Check the bilge areas for fuel vapors or leaking fuel. If you see leaking fuel or smell fuel vapors:
 - a. Do *NOT* start the generator or the engines, do *NOT* turn *On* any electrical devices, and put out *ALL* cigarettes, cigars, and other sources of flame or ignition.
 - b. Get everyone off your yacht.
 - c. Get trained help to find and fix the problem.
2. Run the bilge blowers for at least four minutes *BEFORE* generator or engine starting, electrical system work, or turning on electrical devices.
 - If you smell fuel vapors and the generator is already running:
 - a. Shut *Off* the generator and turn *Off ALL* electrical devices.
 - b. Put out *ALL* cigarettes, cigars, and other sources of flame or ignition.
 - c. Get trained help to find and fix the problem.

CAUTION

SYSTEM DAMAGE HAZARD!

- *ALWAYS* make sure the generator's seawater intake seacock is *Open BEFORE* starting, and during running of the generator.
- *NEVER* run the generator starter for more than 30 seconds. If the generator does not start, wait at least 30 seconds *BEFORE* trying again.
- After the generator starts, let the generator stabilize *BEFORE* turning *On* the component breakers on the 110-volt AC master panel.

- When your yacht is *not* connected to shore power, the generator can supply 110-volt/60-hertz power.
- **Before** using the generator, read the generator operation manual for pre-start checks and break-in procedures.
- Refer to the generator manual for starting/stopping instructions.

Important generator notes:

- Polarity has been established in the installation of the generator. Therefore the polarity lights will *not* function when using the generator.
- Fuel to run the generator is supplied from the starboard fuel tank.
- Periodically replace the filter on the generator to make sure it remains clean and free of debris.
- Diesel generators also have a fuel filter/water separator. Service instructions are provided on the fuel filter/water separator.
- The coolant mixture installed at the factory consists of equal parts of water and antifreeze (Ethylene Glycol).
- Check the generator's seawater strainer for leaks and/or debris *before* each use.

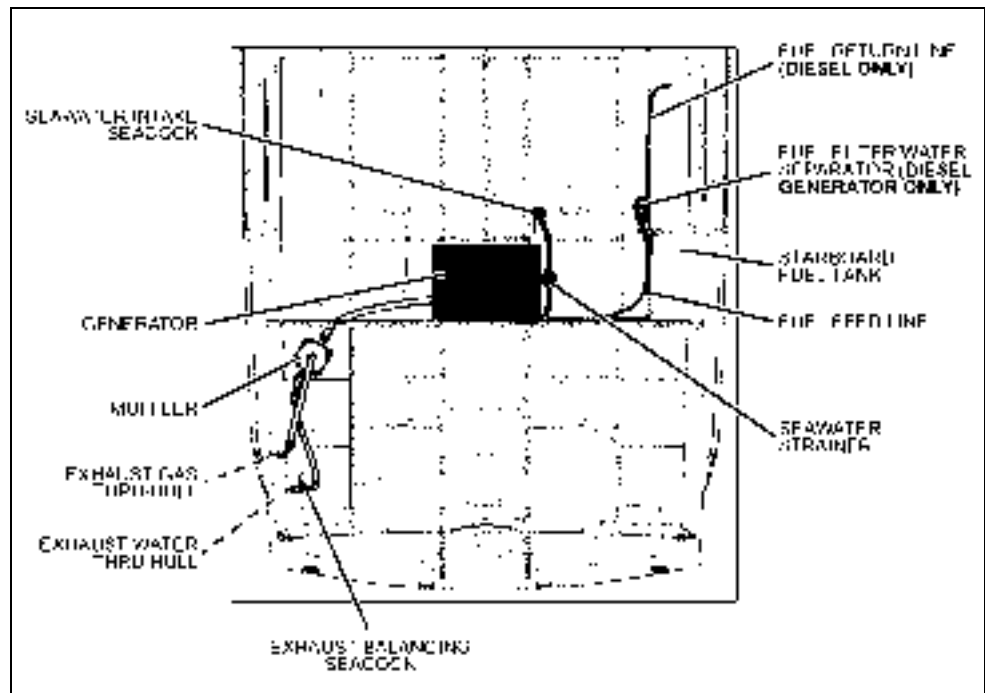

Combo-sep Generator Mufflers

- The combo-sep muffler has two exhaust hoses. The hose equipped with a seacock discharges the exhaust water while the other hose discharges the exhaust gas.
- The seacock's purpose is to balance the flow of the exhaust gas and water (see **Balancing the Combo-sep Exhaust** below).

Balancing the Combo-sep Exhaust

For proper system operation follow the steps below to balance the flow of the exhaust gas and water in this two hose system:

1. Fully open the water drain exhaust's seacock.
2. Start the generator and make sure it is running and stabilized at its normal power and load setting.
3. Observe the flow of water from the water drain thru-hull fitting. The bubbling at the exit point is exhaust gas mixed with the water.
4. Close the seacock in small increments until the bubbles at the exit point disappear. NOTE: After each small adjustment of the seacock, wait at least 30 seconds to one minute before checking for bubbles.
5. Now observe the upper gas exhaust thru-hull. Although the exhaust from the upper thru-hull will never be completely dry, it should be free of any large water droplets.

Electrical Routings

12-Volt DC Deck Electrical Harnesses

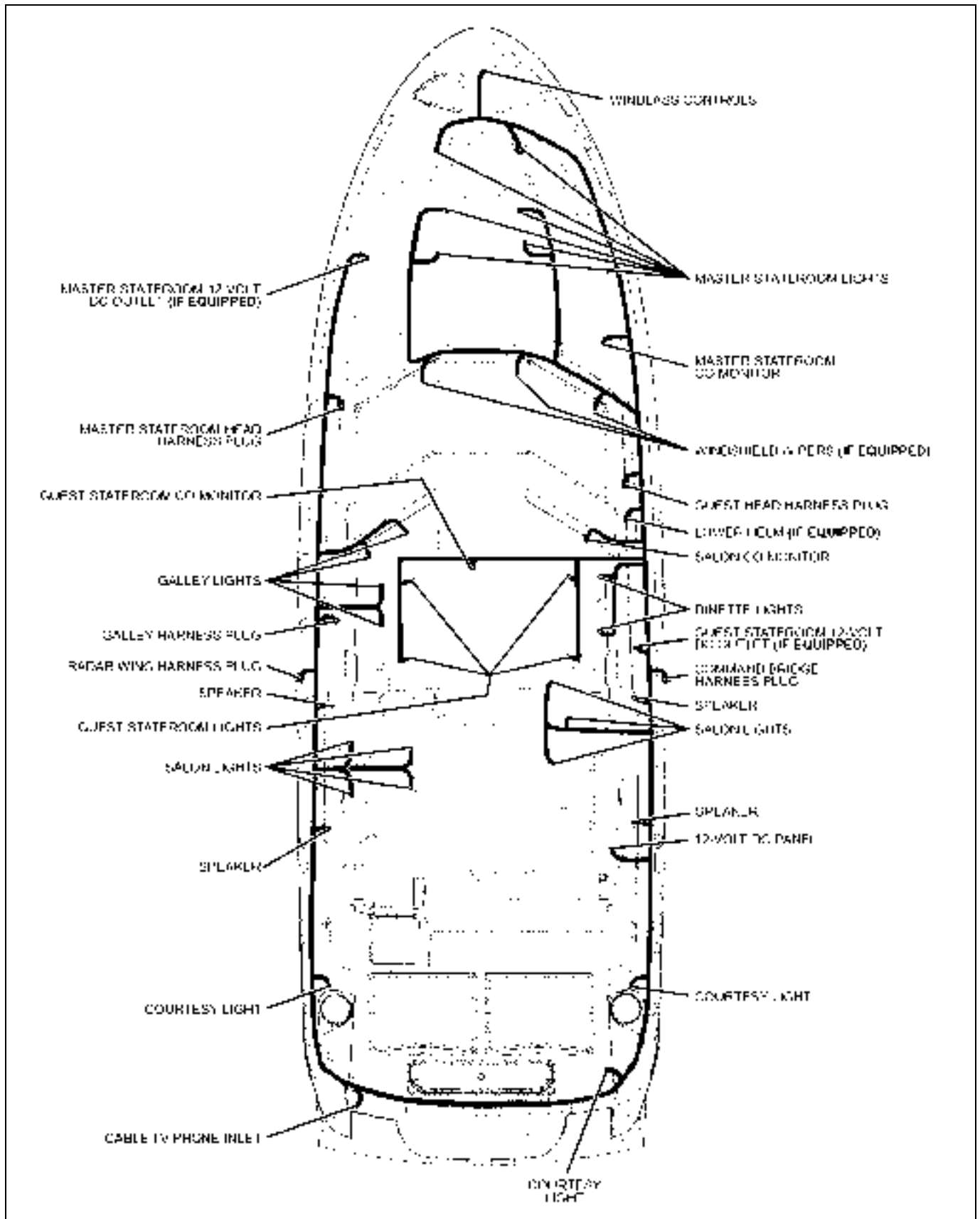

12-Volt DC Hull Electrical Harnesses

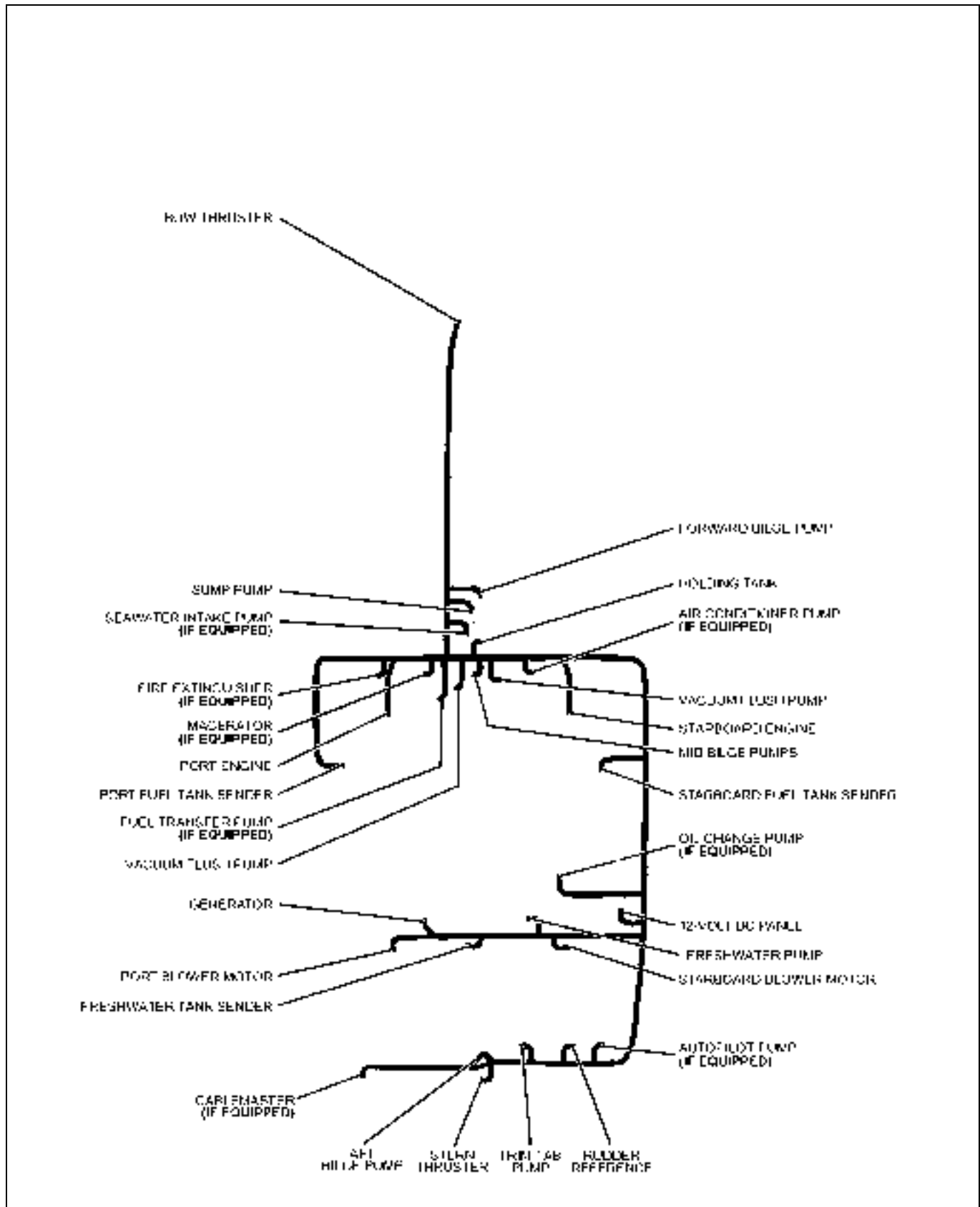

12-Volt DC Command Bridge Electrical Harnesses

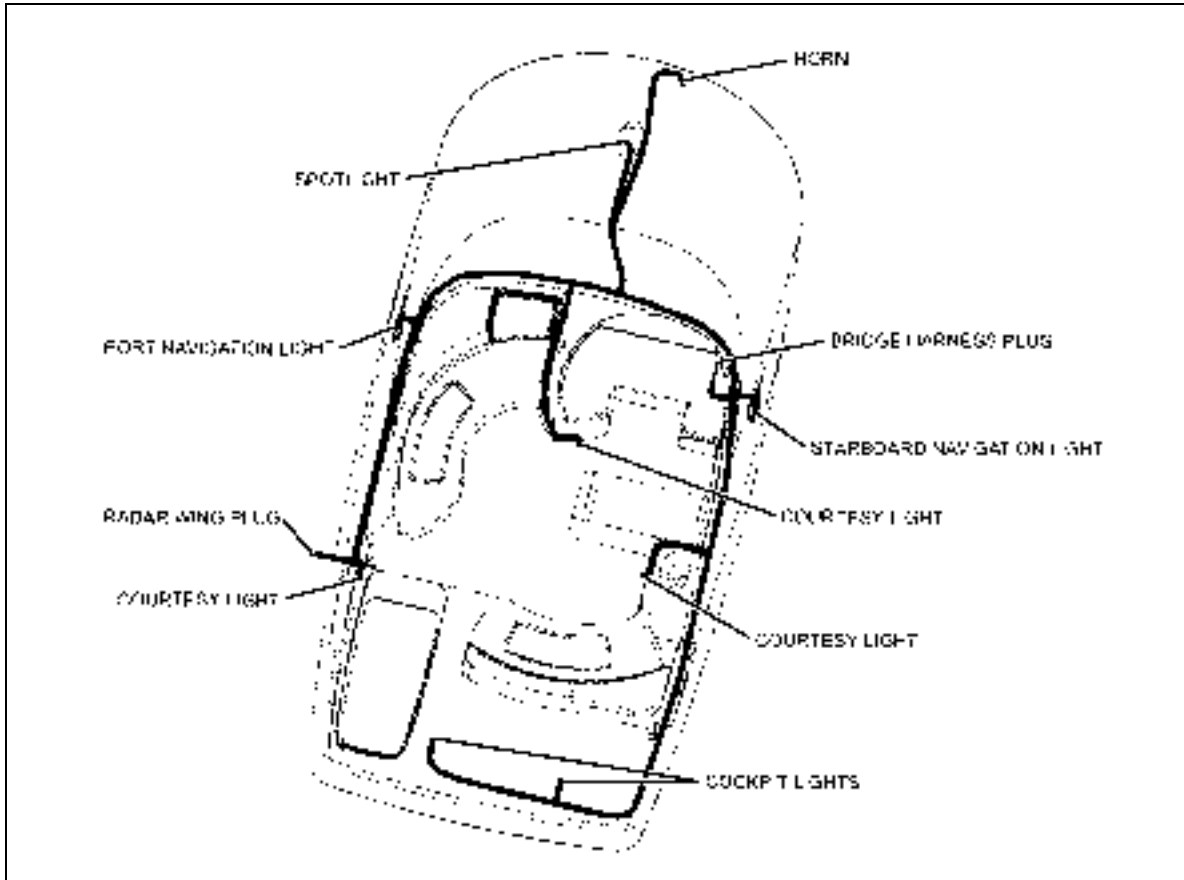

12-Volt DC Radar Wing Electrical Harness

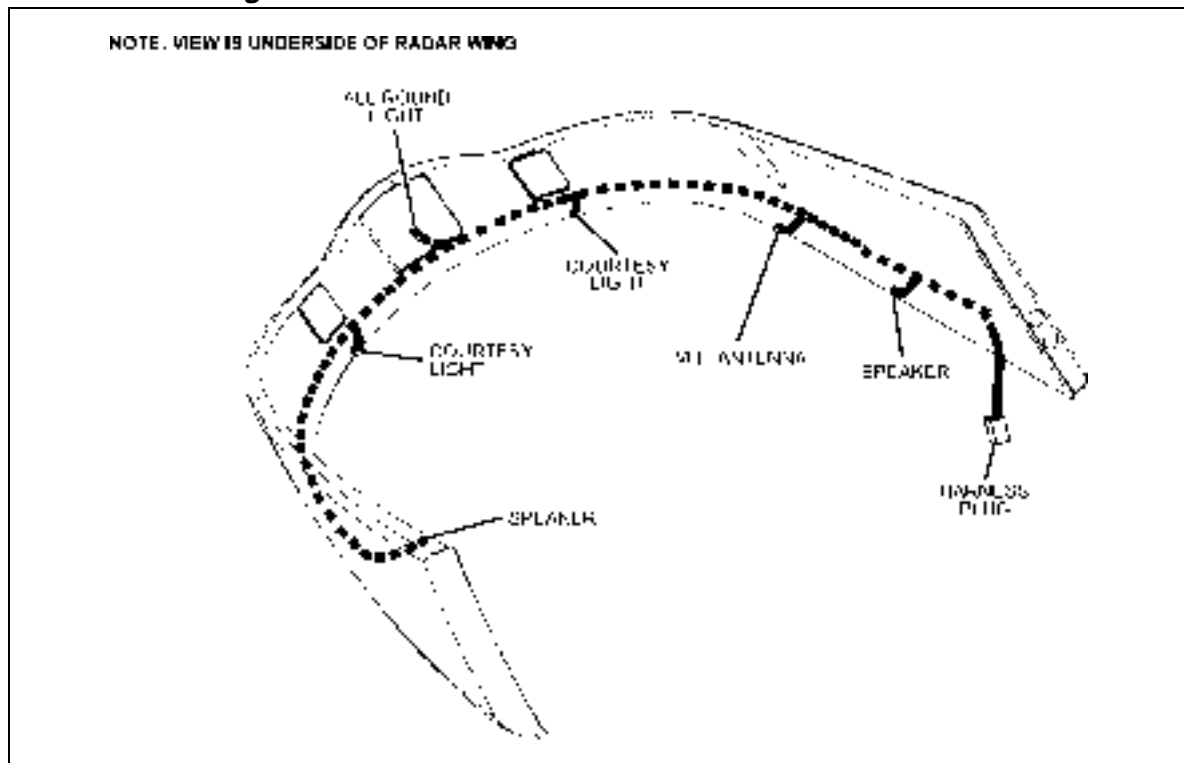

Batteries

NOTES
POSITIVE BATTERY CABLES ARE RED
NEGATIVE BATTERY CABLES ARE YELLOW

NOTE
THERE ARE TWO BATTERIES IN THE HOUSE BATTERY BOX.

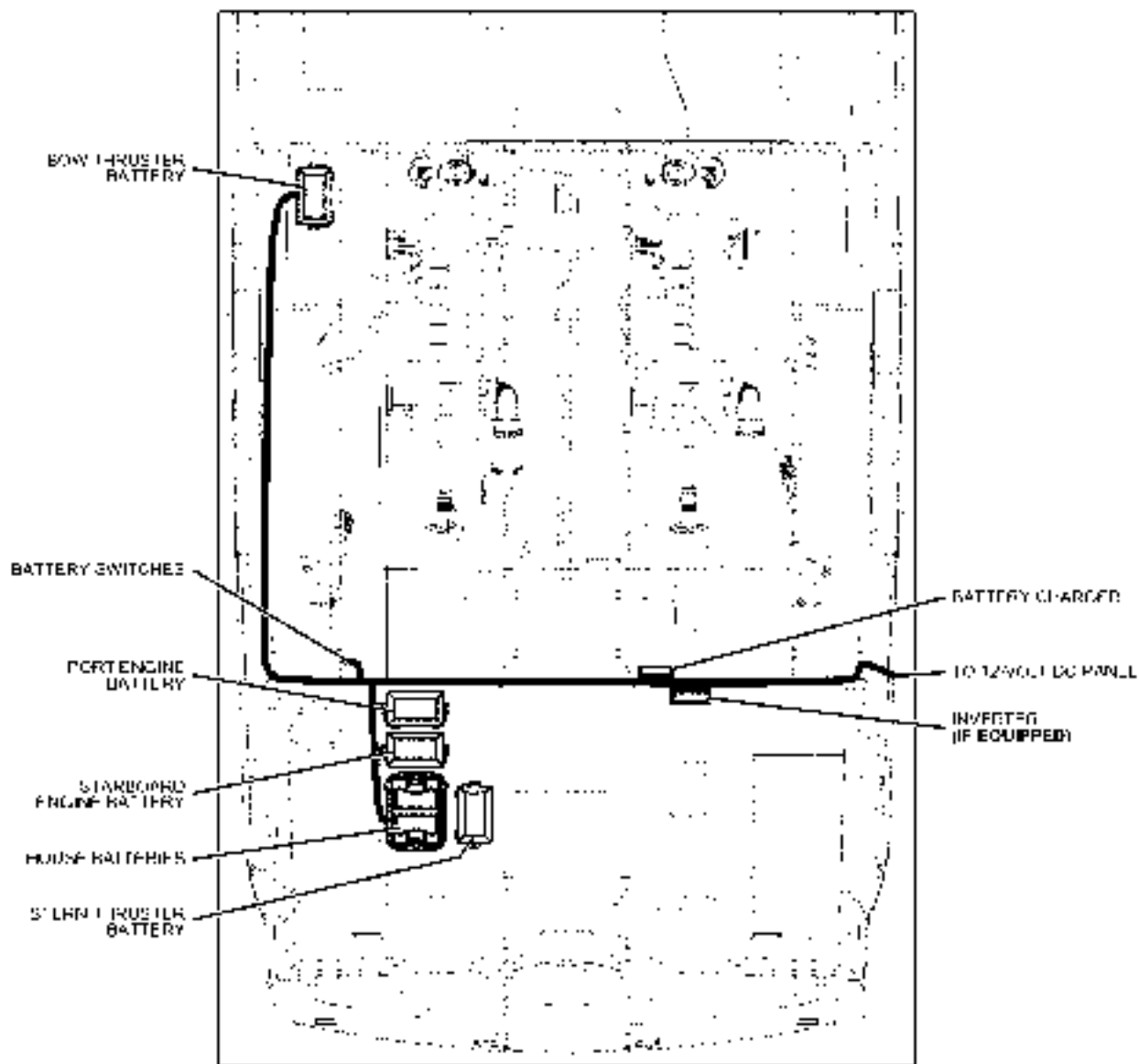

110-Volt AC Electrical Harnesses

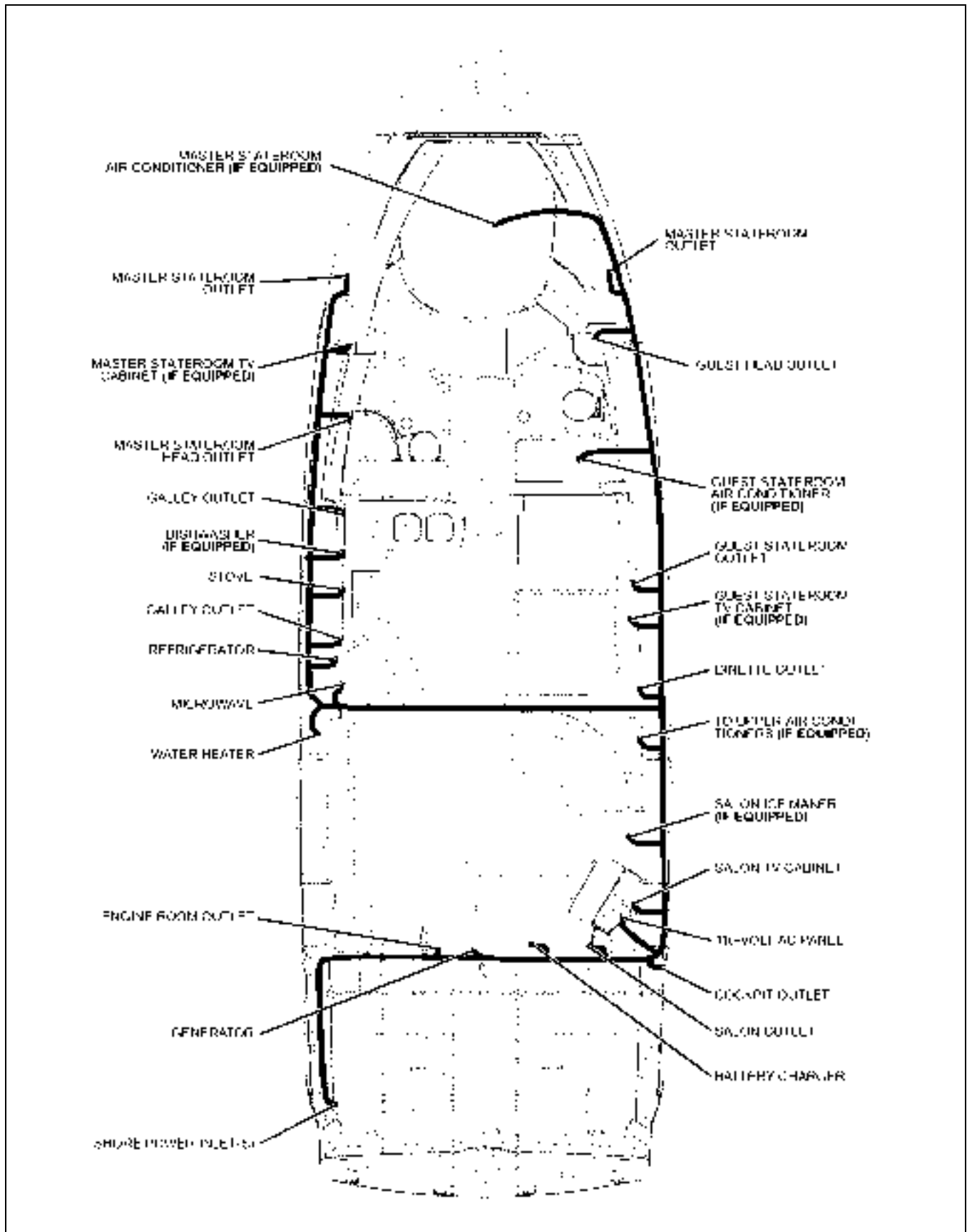

Important Records

Selling Dealer

Name Of Dealership

Address

Phone/FAX/E-mail

Sales Manager

Service Manager

Engines

Manufacturer

Model Name/Number

Port Engine Serial Number

Starboard Engine Serial Number

Oil Type/SAE

Quarts per Engine

Filter Type

Propellers

Manufacturer

Pitch

Model Number

Generator

Manufacturer

Model Name/Number

Serial Number

Oil Type/SAE

Quarts

Filter Type

Fuel System

Fuel Capacity

Filter Type

Plumbing

Freshwater Tank Capacity

Waste Holding Tank Capacity

Key Numbers

Cabin

Ignition

Other

Other

Electronics

Manufacturer

Model Name/Number

Serial Number

Manufacturer

Model Name/Number

Serial Number

Manufacturer

Model Name/Number

Serial Number

Manufacturer

Model Name/Number

Serial Number

Manufacturer

Model Name/Number

Serial Number

Manufacturer

Model Name/Number

Serial Number

Float Plan

Before leaving on each cruise, fill out a copy of this float plan (or similar) and leave it with a *reliable* person whom you can depend on to contact the Coast Guard or other rescue organization, if you do not return as scheduled.

Description of Yacht

Registration/Documentation Number		
Length	Make	Type
Hull Color		Trim Color
Fuel Capacity	Engine Type	Number of Engines
Distinguishing Features		
Distinguishing Features		

Full Name		
Age	Health	Phone Number
Full Name		
Age	Health	Phone Number
Full Name		
Age	Health	Phone Number

Operator of Yacht

Full Name		
Male or Female	Age	Health
Address		
Address		
Phone/FAX/E-mail		
Operator's Experience		

Full Name		
Age	Health	Phone Number
Full Name		
Age	Health	Phone Number
Full Name		
Age	Health	Phone Number

Persons Onboard

Full Name		
Age	Health	Phone Number
Full Name		
Age	Health	Phone Number

Full Name		
Age	Health	Phone Number
Full Name		
Age	Health	Phone Number
Full Name		
Age	Health	Phone Number

Survival Equipment

Number of PFDs	Flares (Yes/No)	Mirror (Yes/No)
Smoke Signals (Yes/No)	Flashlight (Yes/No)	Food (Yes/No)
Water (Yes/No)	Anchor (Yes/No)	Raft/Dinghy (Yes/No)
Paddles (Yes/No)	EPIRB (Yes/No)	Other
Other	Other	Other
Marine Radio (Yes/No)	Type	Frequencies

Stopover 4

Arrive No Later Than: Date

Arrive No Later Than: Time

Stopover 5

Arrive No Later Than: Date

Arrive No Later Than: Time

Stopover 6

Arrive No Later Than: Date

Arrive No Later Than: Time

Vehicle Description

Make	Model
Color	License Number
Where is the Vehicle Parked?	

Stopover 7

Arrive No Later Than: Date

Arrive No Later Than: Time

Stopover 8

Arrive No Later Than: Date

Arrive No Later Than: Time

Trip Expectations

Departing From

Departure Date

Departure Time

Stopover 1

Arrive No Later Than: Date

Arrive No Later Than: Time

Stopover 2

Arrive No Later Than: Date

Arrive No Later Than: Time

Stopover 3

Arrive No Later Than: Date

Arrive No Later Than: Time

Stopover 9

Arrive No Later Than: Date

Arrive No Later Than: Time

Stopover 10

Arrive No Later Than: Date

Arrive No Later Than: Time

Final Destination Port (If Different Than Home Port)

Arrive No Later Than: Date

Arrive No Later Than: Time

If not returned by the date and time listed above, call the Coast Guard or other local authority.

Coast Guard Phone Number

Local Authority Phone Number

MERIDIAN™
YACHTS

A subsidiary of the Brunswick Boat Group
www.meridian-yachts.com | part # 1895468