

OPERATION & MAINTENANCE MANUAL

MERCURY OUTBOARD

6 • 8 • 9.9
9.9 SAILPOWER

©1988, Brunswick Corporation

90-17890991 588

READ THIS MANUAL THOROUGHLY

If you don't understand any portion, contact your dealer for a demonstration of actual starting and operating procedures.

NOTICE

Throughout this publication, and on your outboard, **DANGER**, **WARNINGS** and **CAUTIONS**, accompanied by the international **HAZARD** Symbol , may be used to alert the installer/user to special instructions concerning a particular service or operation that may be hazardous if performed incorrectly or carelessly. **OBSERVE THEM CAREFULLY.**

These "Safety Alerts" alone cannot eliminate the hazards that they signal. Strict compliance to these special instructions while performing the service, plus "common sense" operation, are major accident prevention measures.



DANGER

DANGER - Immediate hazards which **WILL** result in severe personal injury or death.



WARNING

WARNING - Hazards or unsafe practices which **COULD** result in severe personal injury or death.



CAUTION

CAUTION - Hazards or unsafe practices which could result in minor personal injury or product or property damage.

IMPORTANT - Indicates information or instructions that are necessary for proper operation and/or maintenance.



WARNING

The operator (driver) is responsible for the correct and safe operation of the boat, the equipment aboard and the safety of all occupants aboard. We strongly recommend that the operator read this Operation

and Maintenance Manual and thoroughly understand the operational instructions for the outboard and all related accessories before the boat is used.



WARNING

The following advantages and disadvantages of an **EMERGENCY STOP SWITCH** (lanyard type) should be considered before electing to use, or not to use, such a switch.

ADVANTAGES: The purpose of an **EMERGENCY STOP SWITCH** is to stop the engine when the operator leaves his control station, either accidentally by falling into the boat, or by falling or being ejected overboard. This is most likely in certain types of boats such as low sided bass boats, high performance boats and light sensitive handling, fishing boats operated by hand-tiller. It is also likely as a result of poor operating practices such as sitting on the back of the seat at planing speeds, standing at planing speeds, operating at high speeds in shallow or obstacle infested waters, drinking and driving, or daring, high speed boat maneuvers.

DISADVANTAGES: Inadvertent activation of the switch is also a possibility. This could cause any or all of the following potentially hazardous situations:

- Loss of balance and falling forward of unstable boat passengers - a particular concern in bow rider type boats.
- Loss of power and directional control in heavy seas, strong current or high winds.
- Loss of control when docking.

As we cannot possibly know of and advise the boating public of ALL conceivable boat/motor types and/or poor operating practices, the final decision of whether to use an EMERGENCY STOP SWITCH rests with you, the owner/driver.

We strongly recommend that other occupants be instructed on proper starting and operating procedures should they be required to operate the outboard and boat in an emergency.



WARNING

A SECURITY LINE that is long enough to allow the outboard to disengage from the transom but too short to permit the outboard to submerge and stop running could cause the outboard to rebound into the boat and injure the occupants.

- An effective SECURITY LINE should be of a working strength approximately five (5) times the weight of the outboard motor.
- The SECURITY LINE should be SHORT enough and affixed in a manner to prevent the outboard from rising up and disengaging from the transom - OR -
- The SECURITY LINE should be LONG enough and affixed in a manner to permit the outboard to submerge behind the boat and thus stop running.



WARNING

It is difficult for a person standing or floating in the water to move clear if they see a powerboat heading toward them, even at slow speed. Shift the unit to neutral and shut off engine when your boat is near people in the water.

SERIOUS INJURY IS LIKELY IF A PERSON IN THE WATER IS STRUCK BY A MOVING BOAT, GEAR HOUSING, PROPELLER, OR ACCESSORY RIGIDLY ATTACHED TO YOUR BOAT OR OUTBOARD.



WARNING

The use of accessories not manufactured or sold by Mercury Marine is not recommended for use with your outboard. If your outboard or outboard operating system is equipped with an accessory not manufactured by Mercury Marine, be sure to read the Operation and Maintenance Manual for that accessory before operation. If you haven't been supplied with such a manual, contact your dealer or the manufacturer of the accessory to secure the applicable manual.



WARNING

USE CARE when transporting fuel container, whether in a boat or car. **DO NOT** fill fuel container to maximum capacity. Gasoline will expand considerably as it warms up and can build up pressure in the fuel container. This can cause fuel leakage and a potential fire hazard.

TABLE OF CONTENTS

Specifications	5
Motor Installation	7
Propellers	13
Conditions Affecting Operation	14
Fuel Recommendations	14
Motor Controls	17
Operation Models With Tiller Handle	17
Remote Control Components	21
Operation Electric Start Models with Remote Control	21
Emergency Operation	25
Cowl Removal and Installation	25
Lubrication Guide	27
Gear Housing Lubrication	27
Inspection and Maintenance	29
Flushing Motor Cooling System	29
Ignition Maintenance	30
Cleaning Fuel Filters	31
Fuel Reserve (6.6 Gallon Polyethylene Tank Only)	31
Carburetor Adjustment	33
Trailering Boat/Motor	34
Removing Motor From Boat	34

The description and specifications contained herein were in effect at the time this guide was approved for printing. Mercury Marine, whose policy is one of continuous improvement, reserves the right to discontinue models at any time, to change specifications, designs, methods or procedures without notice and without incurring obligation.

Mercury Marine, Fond du Lac, Wisconsin, U.S.A.

Litho in U.S.A.

©1988, Brunswick Corporation

The following are registered trademarks of Brunswick Corporation: Auto-stend, Jet-Prop, Maxiner, Merc, MerCathode, MerCruiser, Mercury, Mercury Marine, Quicksilver, Ride-Guide, and Thruster

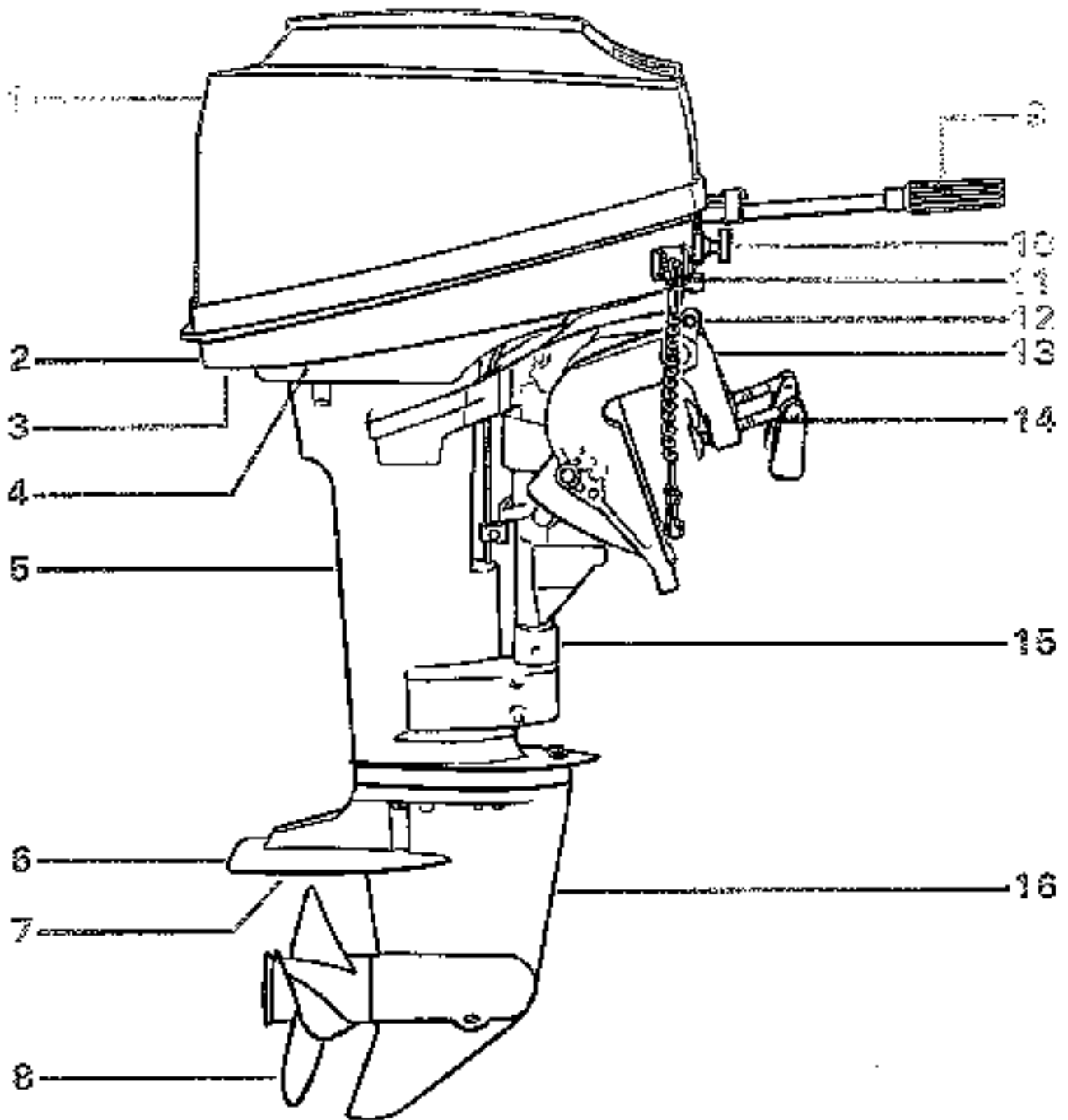

Side View (Starboard)

- | | |
|---------------------------|---|
| 1. Top Cowl | 9. Control Handle Assembly |
| 2. Cowl Latch | 10. Primer/Fast Idle Knob |
| 3. "Tell-Tale" Outlet | 11. Emergency Stop Switch (Tiller Handle Model) |
| 4. Bottom Cowl | 12. Safety Clip |
| 5. Drive Shaft Housing | 13. Clamp Bracket (2) |
| 6. Anti-Ventilation Plate | 14. Clamp Screw (2) |
| 7. Anodic Plate | 15. Swivel Bracket |
| 8. Propeller | 16. Gear Housing Assembly |

SPECIFICATIONS

Horsepower	9.9	8	6
Propshaft Kilowatts	9.9	8	6
Full Throttle RPM Range	7.4	5.9	4.5
Idle Speed	5000-6000	4500-5500	4000-5000
Engines with Idle Speed Screw	700-750 RPM (in Gear)		
Engines without Idle Speed Screw	600-700 RPM (in Gear)		
Piston Displacement	12.8 Cu. In. (209cc)		
Bore	2.125 (54mm)		
Stroke	1.800 (45.7mm)		
Recommended Spark Plug	Champion L82YC		
Spark Plug Gap	0.040" (1.0mm)		
Spark Advance	36° BTDC @ WOT		
Recommended Gasoline	Automotive Leaded or Unleaded (Lead Free) Gasoline		
Recommended Oil	Quicksilver 2-Cycle Outboard Oil		
Gasoline/Oil Ratio	50:1 (Including Break-In)		
Fuel Tank Capacity:			
- U.S. Gallons	6		3
- Imperial Gallons	5		2.5
- Liters	22.7		11.4
Battery Rating - Electric Start Models	Minimum Reserve Capacity Rating of 35 Minutes and Cold Cranking Amperage of 180 Amperes		
Standard Propeller	3 Blade Aluminum *(9" Dia. x 9" Pitch)		
Gear Ratio	2.08:1		
Transom Height	Short Shaft - 15" (38cm) Long Shaft - 20" (51cm)		

*Measured at the propshaft in accordance with ICOMIA 2B.

** (9-3/4" Dia. x 6-1/2" Pitch) supplied with 9.9 SAILPOWER

IMPORTANT: Fasteners (screws and nuts) used in the manufacture of your outboard motor are METRIC. (A few exceptions are: propeller shaft nut, flywheel nut and spark plugs, which are 13/16", and tilt tube nuts, which are 1-1/4".)

COMBINATION TOOL

A "Combination Tool" is provided with the outboard motor (stored in the "Owner's Literature Packet").

This handy tool incorporates a 21mm (13/16") hex socket (fits spark plugs and propeller nut) and a 10mm hex socket (fits 10mm fasteners, such as the rewind starter mounting bolts). The tool handle

also incorporates a standard tip (straight) screwdriver blade.

SPARE STARTER ROPE

A spare starter rope also is supplied with the motor (stored in the "Owner's Literature Packet"). The rope may be used for a replacement in the rewind starter assembly or as an emergency starter rope, in event that the rewind starter is inoperable.

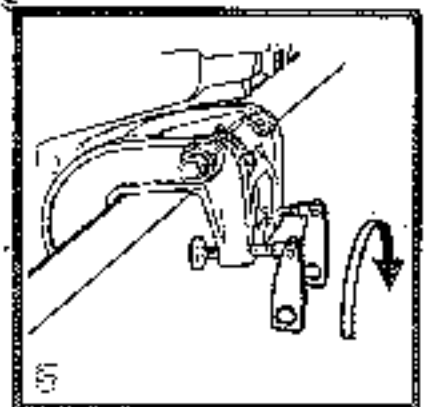
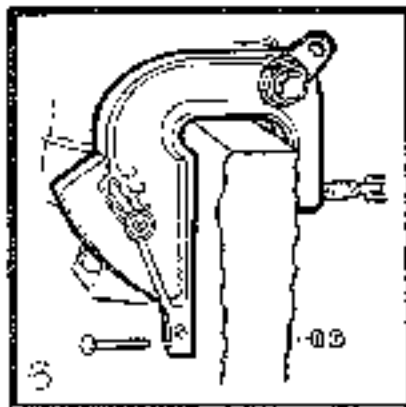
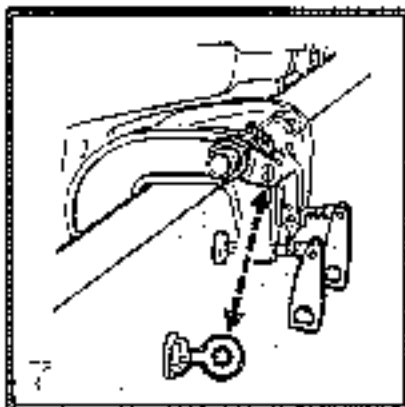
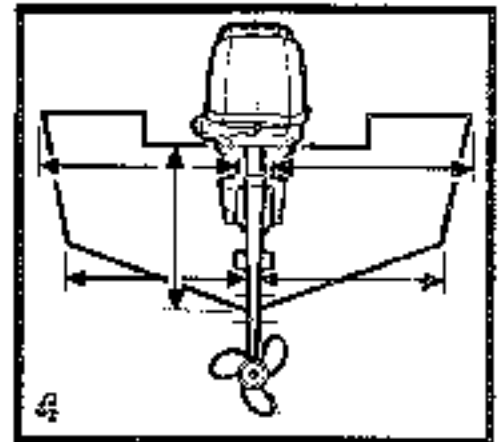
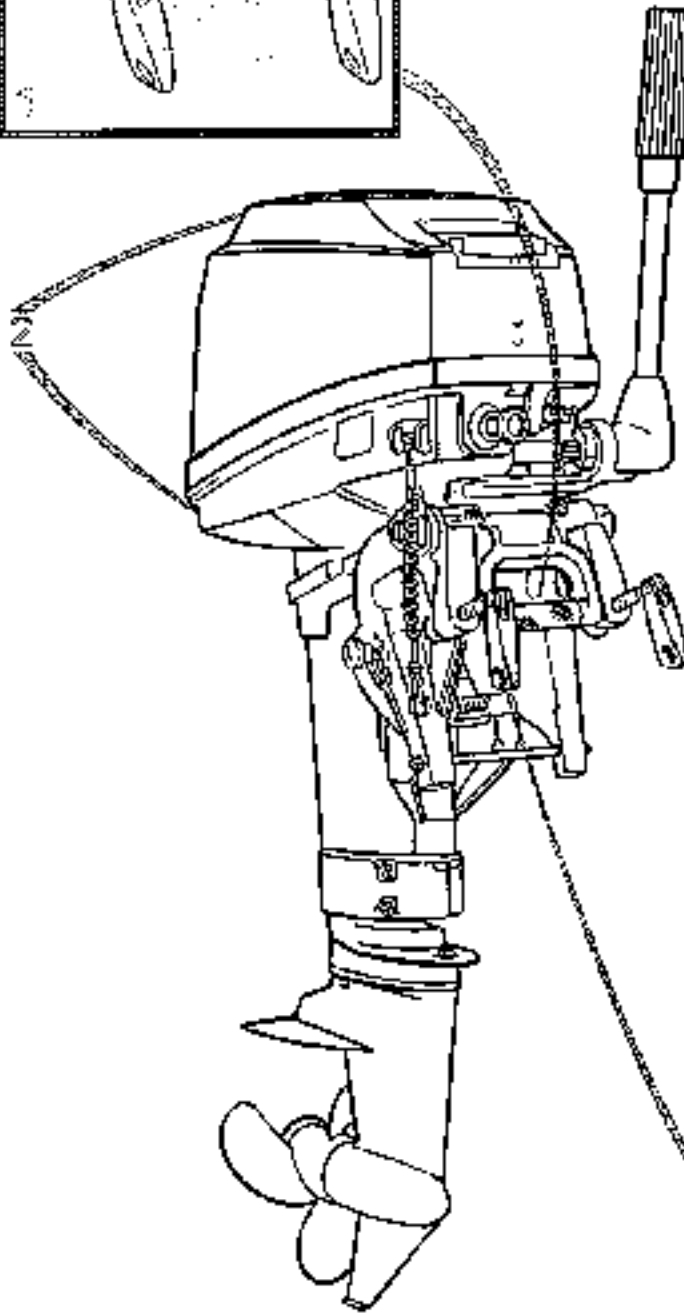
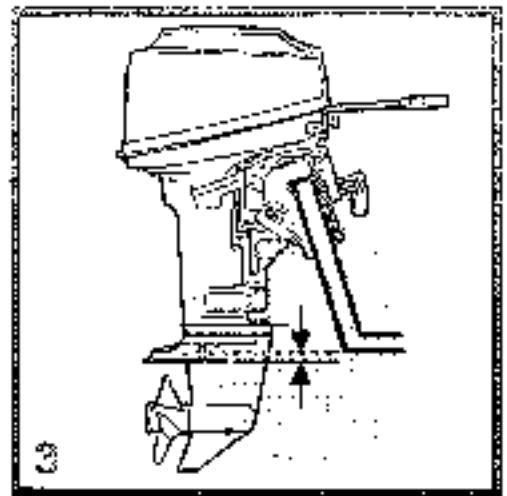
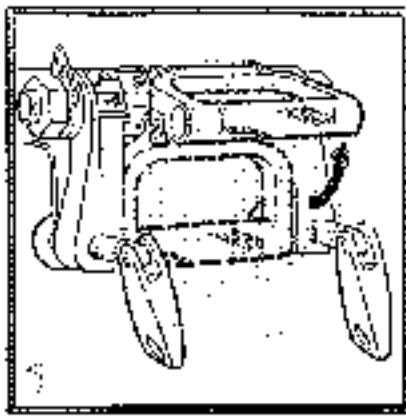

MOTOR INSTALLATION



WARNING

DO NOT OVERPOWER - Most boats are rated and certified for the maximum horsepower capabilities of the boat. Refer to the boat "Certification Plate" for the maximum horsepower limit. If in doubt, contact your dealer.

LIFT HANDLE

IMPORTANT: Motor **MUST BE** in **NEUTRAL** (which locks the reverse hooks over the tilt lock pin) before lifting or carrying the motor with the lift handle.

1 The lift handle is located at the front of the motor between the clamp brackets.

2 "Finger grip wells" are located at the back of both top and bottom cowls.

TRANSOM HEIGHT

3 Proper transom height is important for best boating performance. The gear housing anti-ventilation plate should be parallel to the boat bottom and at least 1" (25mm) below boat bottom.

MOUNTING MOTOR ON TRANSOM



WARNING

Before operating, motor(s) **MUST BE SECURED** to boat transom with two (hardware supplied) bolts and clamp screws tightened securely as shown. Installation must be water tight and clamp screws and mounting bolts

checked occasionally for tightness on the transom. Failure to fasten motor to transom with mounting bolts and clamp screws, may result in damage to boat and/or loss of motor and possible injury to occupants of boat.

Centerline

4 Center motor on boat transom.

Securing Motor

5 Tighten clamp screws securely.

6 Drill through transom and bolt motor clamp brackets to transom with bolts, nuts and washers provided.

7 Refer to Security Line Statement, Page 2

IMPORTANT: Periodically check clamp screws and transom mounting bolts to ensure that motor is secure on transom.

TILTING MOTOR

IMPORTANT: The motor must be shifted into **FORWARD** gear before the motor is tilted. To tilt the motor, grasp the rear of the top cowl and pull the motor forward.

The tilt angle of an outboard motor refers to how far out from the transom surface the lower unit is tilted. The tilt angle of the lower unit has a distinct effect on the planing angle of the boat, and can significantly alter top speed and handling.

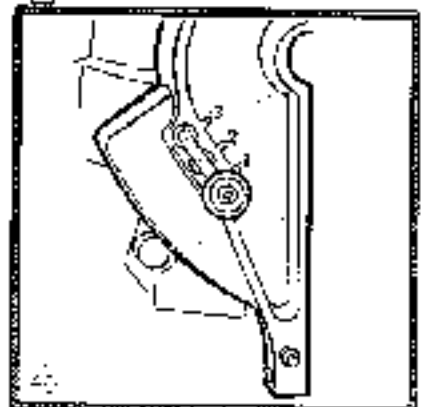
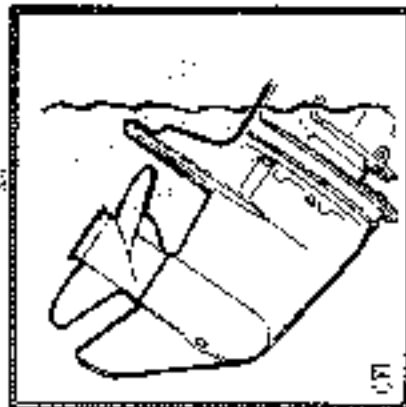
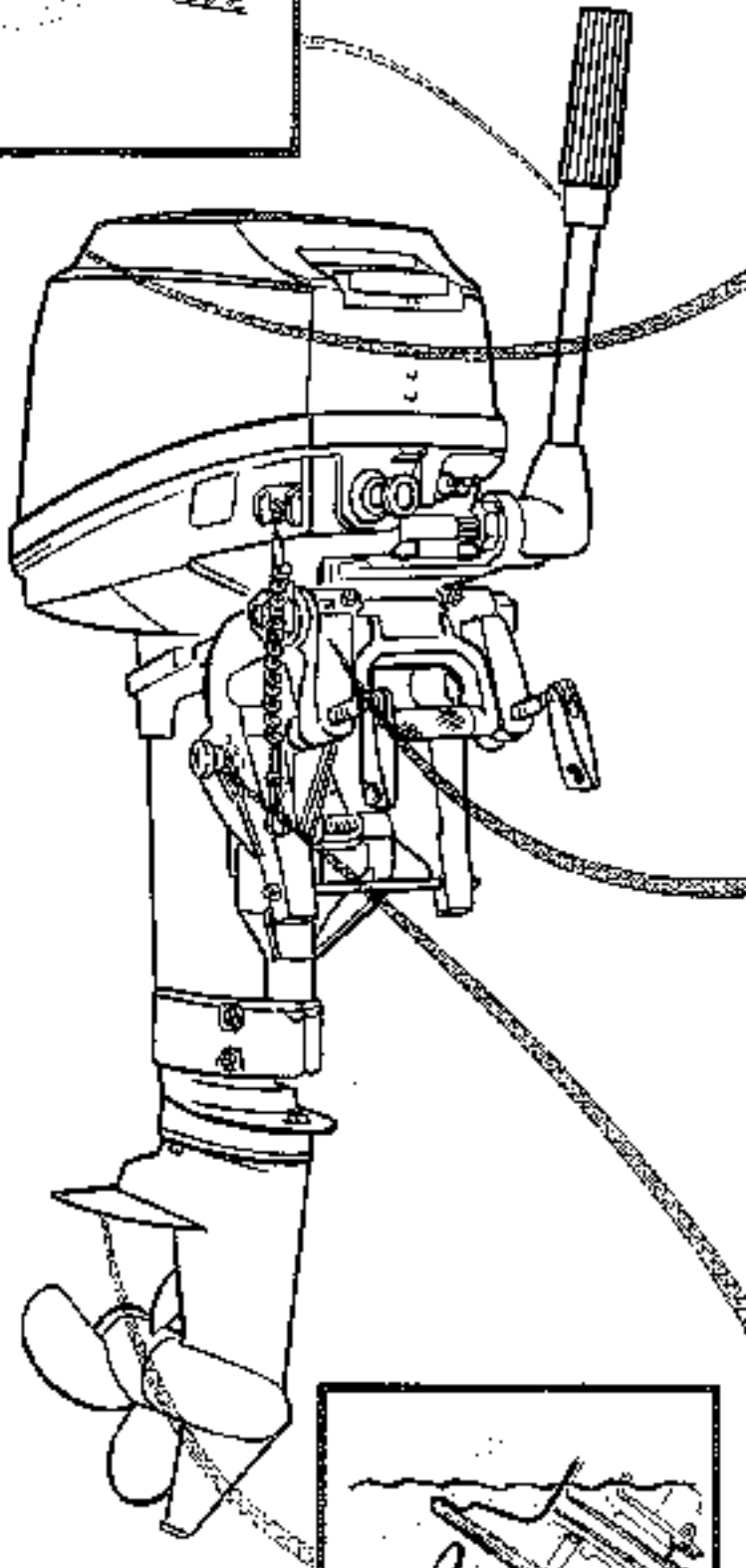
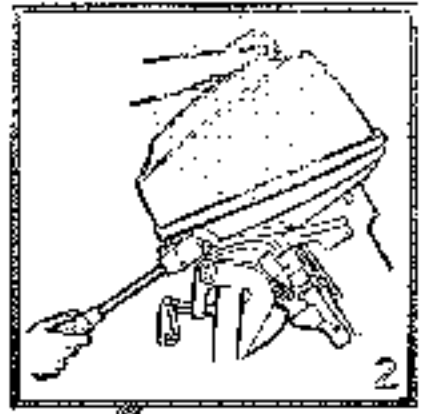
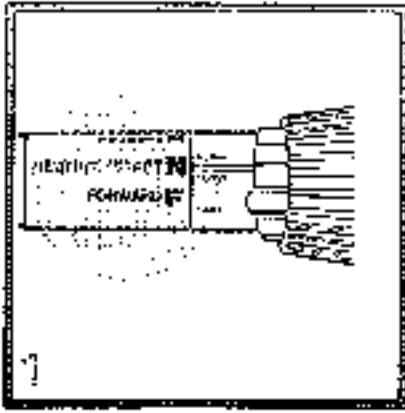

MOTOR INSTALLATION

(Continued)

Automatic Tilt

Your motor is equipped with Automatic Tilt for quick and easy adjustment of tilt angle. The operator should become familiar with the operation of the automatic tilt before using the motor. Automatic tilt provides:

- Three preset bottom tilt positions
- Three shallow water troll positions
- One high tilt position

IMPORTANT: Motor must be in **FORWARD** gear in order to change motor tilt position.

Basic Operation

- 1 Shift motor into **FORWARD** gear
- 2 Grasp rear of top cowl and tilt motor forward
- 3 The decal on right (starboard) clamp bracket indicates the various tilt angle positions and two **RELEASE AND RETURN** positions. The arrow mark indicates the current motor position.

Tilt Angle Adjustment

4 The first three tilt angle positions are **PRESET BOTTOM TRIM POSITIONS** and are numbered beside the trim angle knob. Place the tilt angle knob at the tilt angle position of your choice. This sets the

PRESET BOTTOM TRIM POSITION to which the motor will return each time it is manually tilted from the **RELEASE AND RETURN** position.

Shallow Water Troll Operation

5 For your convenience, the motor can be manually tilted at slow speed in **FORWARD** to any higher tilt angle position. Tip the motor toward you and it will click each time it moves into the next tilt position. To return to the **PRESET BOTTOM TRIM POSITION**, simply continue to tilt the motor until it reaches the first **RELEASE AND RETURN** position. The motor can then be lowered to the **PRESET BOTTOM TRIM POSITION**.



CAUTION

Follow these precautions when operating in the three higher trim shallow water positions:

- **DO NOT** operate motor above fast idle (1500 rpm).
- **BE SURE** rear edge of anti-ventilation plate remains submerged. This assures that the cooling water inlet is below water level.
- **DO NOT** move forward in the boat while the motor is running (even in **NEUTRAL**). Moving to the front of the boat may raise the water inlet above the water level and lead to motor damage caused by overheating.

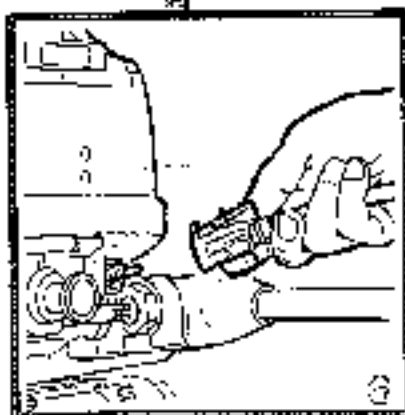
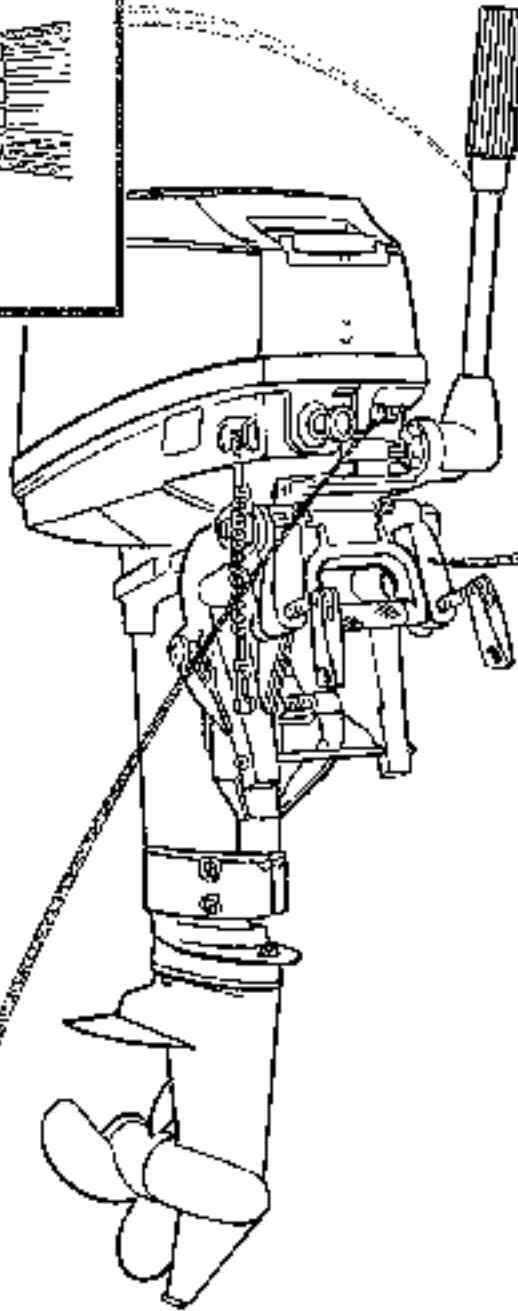
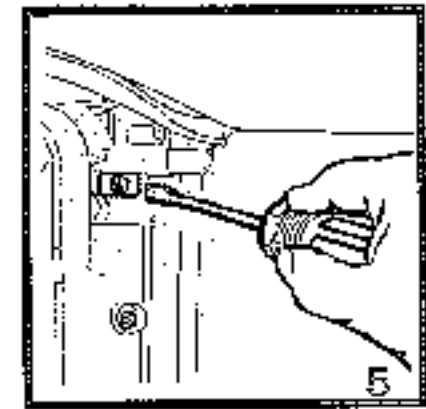
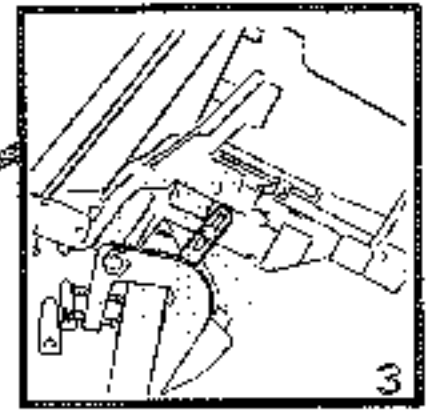
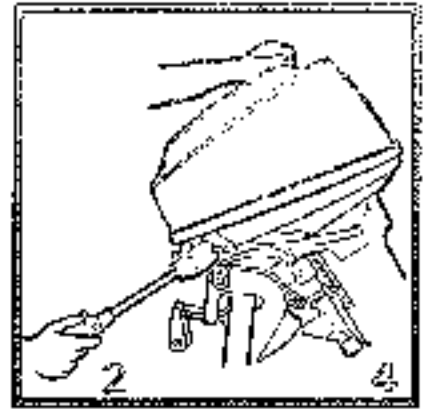
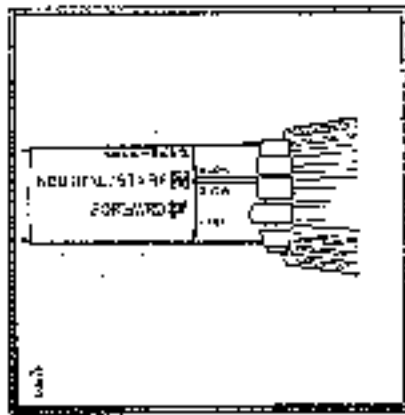

MOTOR INSTALLATION

(Continued)

Full Tilt Up Position

The motor can be conveniently locked in a full tilt up position in the following manner.

IMPORTANT: Motor must be in **FORWARD** gear in order to tilt up/out manually.



CAUTION

Engine must not be run in full tilt lock position, as water pickup in lower unit will be out of the water, and water pump and/or engine would be damaged.

DO NOT use tilt lever when **TRAILERING** boat/motor (or during **HIGH SPEED** and/or **ROUGH WATER** operation of a boat that is powered by a larger, main power motor). Refer to **TRAILERING BOAT/MOTOR**.

1 Shift motor into **FORWARD** gear.

IMPORTANT: To tilt motor, lift the motor using the "finger grip wells" located at the back of both top and bottom cowls.

2 Grasp motor "finger grip well" at back of top cowl and tilt motor to the high tilt position.

3 The spring loaded tilt lever will engage automatically and lock the motor in fully tilted position.

4 To disengage from the full tilt up position, tilt the motor up and forward as far as it will go. This disengages the spring loaded tilt lever and allows the motor to be lowered to normal operating position.

CO-PILOT ADJUSTMENT

5 Proper co pilot adjustment will keep motor on a fixed course (during **NORMAL** operation) while allowing easy manual steering control.

Turn adjusting screw clockwise to increase friction or counterclockwise to decrease friction.

BATTERY AND ELECTRICAL ACCESSORIES

Manual start alternator models are equipped with a 60 watt alternator.



CAUTION

Connect red battery cable to positive (+) battery terminal, and black battery cable to negative (-) battery terminal. Reversed connections will damage charging system.

IMPORTANT: Secure battery in a favorable position in the boat.

Any accessories, such as horns, lights, etc., should be properly fused and installed with connections attached directly to battery terminals.

MOUNTING FUEL TANK AND CONNECTING FUEL LINES

Secure fuel tank in a convenient location.

Arrange fuel line so that it does not become twisted, kinked, pinched, or stretched.

6 Connect fuel line to motor.

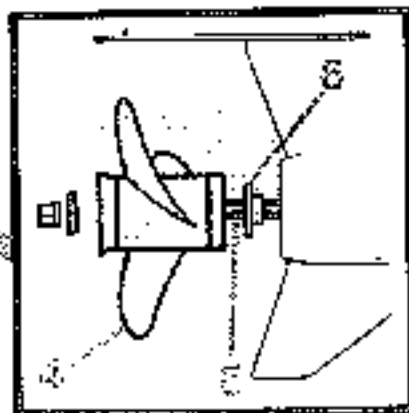
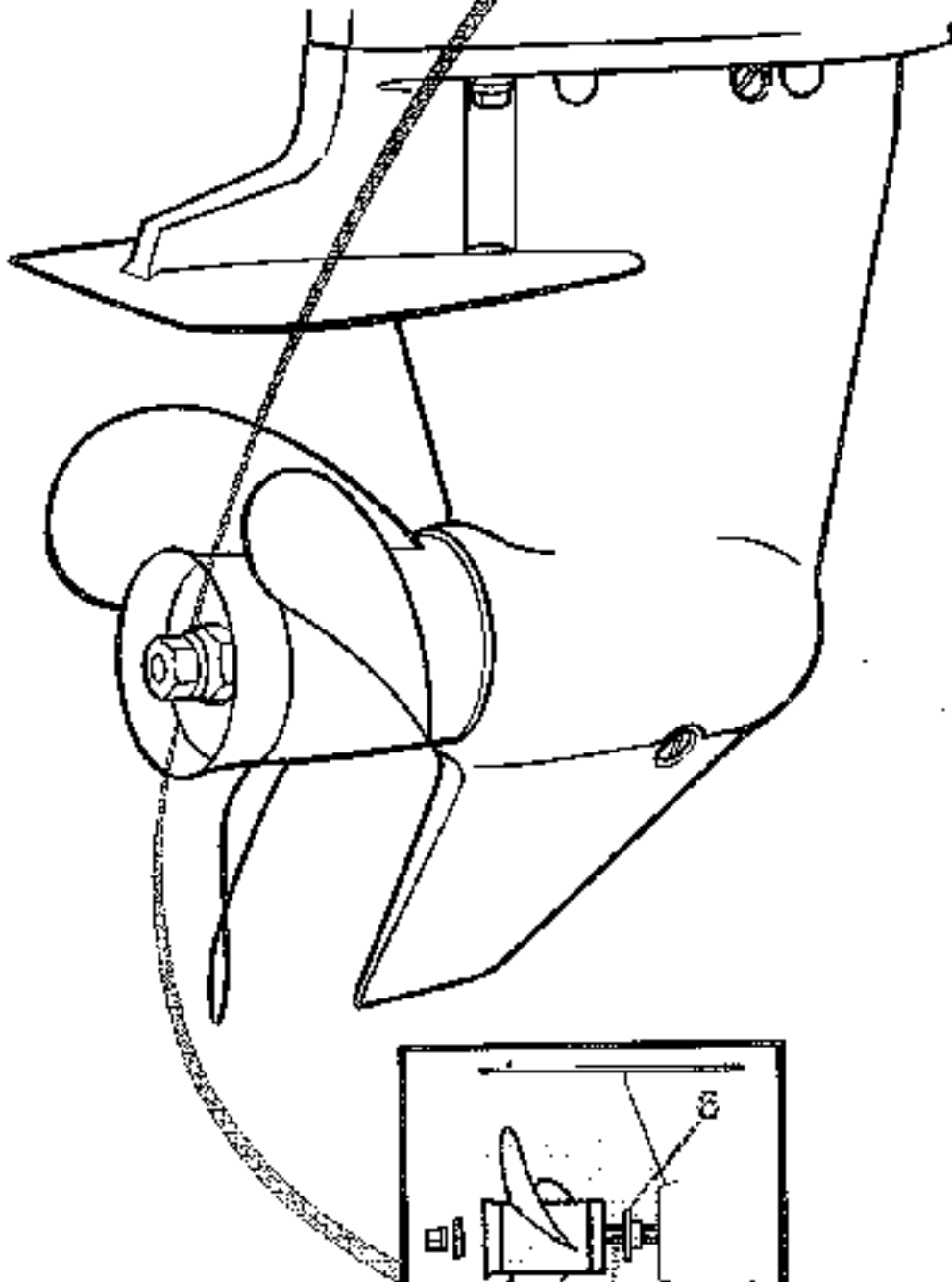
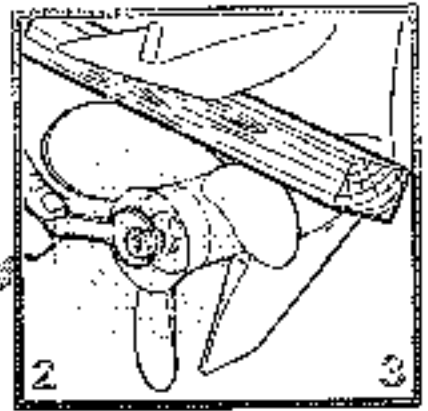
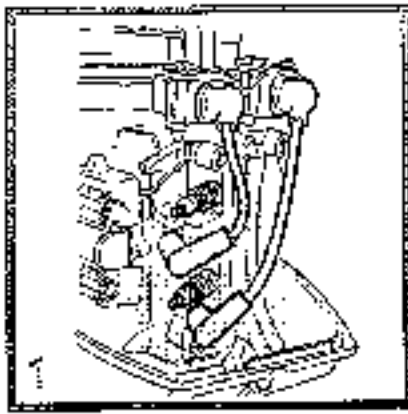

PROPELLERS

PROPELLER SELECTION

The propeller supplied with your motor provides the best overall performance under average operating conditions.

Alternative propellers are available for specific boating requirements. Consult your Authorized Dealer for recommendations.

PROPELLER REMOVAL



WARNING

Before attempting to remove or install propeller, remove spark plug leads from spark plugs to prevent engine from starting accidentally.

1 Remove top cowl (see COWL REMOVAL AND INSTALLATION) and disconnect spark plug leads.

2 Place wood block between propeller blade and anti-ventilation plate to prevent rotation.

3 Turn propeller shaft nut counterclockwise to remove nut (use a 15mm wrench.)

Remove propeller shaft nut and rear thrust hub from propeller shaft.

4 Slide propeller and splined thrust hub off propeller shaft.

PROPELLER REPAIR

Some damaged propellers can be repaired. Consult your Dealer.

PROPELLER INSTALLATION

IMPORTANT: Periodically check propeller nut for tightness during boating season.

5 Apply a liberal coat of one of the following Quicksilver lubricants to the propeller shaft: Special Lubricant 101, 2-4-C Marine Lubricant.

IMPORTANT: The cupped washer attached to the thrust hub prevents backward installation of the hub. The cupped washer **MUST REMAIN IN PLACE.**

6 Slide splined thrust hub onto propeller shaft with thrust hub "shoulder" toward gear housing.

Slide propeller onto propeller shaft and install rear thrust hub and propeller shaft nut.

Place a wood block between propeller blade and anti-ventilation plate to prevent rotation.

Turn propeller shaft nut clockwise. Using a 15mm wrench, **TIGHTEN NUT SECURELY.**

Reconnect spark plug leads and install top cowl.

CONDITIONS AFFECTING OPERATION

WEIGHT DISTRIBUTION

Positioning of weight (passengers and gear) inside the boat has the following effects:

A. Shifting weight to rear (stern).

- Generally increases speed and engine RPM.
- At extremes, can cause boat to porpoise.
- Causes bow to bounce in choppy water.
- Increases danger of the following-wave splashing into boat when coming off plane.

B. Shifting weight to front (bow).

- Improves ease of planing off.
- Improves rough water ride.
- At extremes, can cause boat to veer back and forth (bow steer).

BOTTOM OF BOAT

To maintain maximum speed the following conditions of the boat bottom should be observed:

A. Clean, free of barnacles and marine growth.

B. Free of distortion, nearly flat where it contacts the water.

C. Straight and smooth, fore and aft.

FUEL RECOMMENDATIONS

Any leaded or unleaded (lead-free) gasoline, that will satisfactorily operate an automobile engine is suitable for use in these model outboard motors.

However, gasolines containing alcohol, either methyl alcohol (methanol) or ethyl (ethanol) may cause increased:

- Corrosion of metal parts.
- Deterioration of elastomer and plastic parts.
- Fuel permeation through flexible fuel lines.
- Wear and damage of internal engine parts.
- Starting and operating difficulties.

Some of these adverse effects are due to the tendency of gasolines containing alcohol to absorb moisture from the air, resulting in a phase of water and alcohol separating from the gasoline in the fuel tank.

The adverse effects of alcohol are more severe with methyl alcohol (methanol) and are worse with increasing alcohol content.



WARNING

FIRE AND EXPLOSION HAZARD: Fuel leakage from any part of the fuel system can be a fire and explosion hazard which can cause serious bodily injury or death. Careful periodic inspection of the entire fuel system is mandatory, particularly after storage. All fuel components including fuel tanks, whether plastic, metal or fiberglass, fuel lines, primer bulbs, fittings, fuel filters and carburetors should be inspected for leakage, softening, hardening, swelling or corrosion. Any sign of leakage or deterioration necessitates replacement before further engine operation.

Because of the possible adverse effects of alcohol in gasoline, it is recommended that only alcohol-free gasoline be used where possible. If only alcohol-containing fuel is available, or if the presence of alcohol is unknown, then increased inspection frequency for leaks and abnormalities is required.

FUEL RECOMMENDATIONS (Continued)



WARNING

USE CARE when transporting fuel container, whether in a boat or car. **DO NOT** fill fuel container to maximum capacity. Gasoline will expand considerably as it warms up and can build up pressure in the fuel container. This can cause fuel leakage and a potential fire hazard.

OIL RECOMMENDATIONS



CAUTION

The use of other than recommended gasoline and Quicksilver 2-Cycle Outboard Oil or an acceptable BIA TC-W oil may cause piston scoring, bearing failure or both. **DO NOT**, under any circumstances, use multi-grade or other highly detergent automobile oils or oils which contain metallic additives.

Mix recommended gasoline with Quicksilver 2 Cycle Outboard Oil in ratio shown in the following chart. In an emergency, if this is not available, substitute a high quality 2-cycle oil that is intended for outboard use and meets BIA rating TC-W, shown on oil container. Use the oil manufacturer's recommended gasoline-oil mixture as shown on the label (**NOT TO EXCEED 50:1 RATIO**).

MIXING INSTRUCTIONS



WARNING

Observe fire prevention rules, particularly **NO SMOKING**. Mix fuel outdoors or in well ventilated location.



CAUTION

Follow break-in procedure carefully.

- Mix gasoline and oil at normal 50:1 ratio mixture.
- Operate new motor at varied throttle settings for the first hour (one hour).

IMPORTANT: Avoid both wide-open throttle operation and prolonged idling during first hour.

- After first hour (one hour) of operation, motor is ready for normal operation and may be run at any speed.



CAUTION

DO NOT EXCEED the full throttle RPM range. See **SPECIFICATIONS** for RPM range.

NORMAL 50:1 FUEL MIXTURE

Type of Oil	U.S. Measure	Imperial Measure	Metric Measure
Quicksilver 2 Cycle Outboard Oil	16 U.S. oz. to each 6 gallons of gasoline	15 Imp. oz. to each 5 Imp. gallons of gasoline	400cc to each 20 liters of gasoline
Other Acceptable BIA TC-W Oils	Use at Manufacturer's Recommendations. DO NOT EXCEED 50:1		

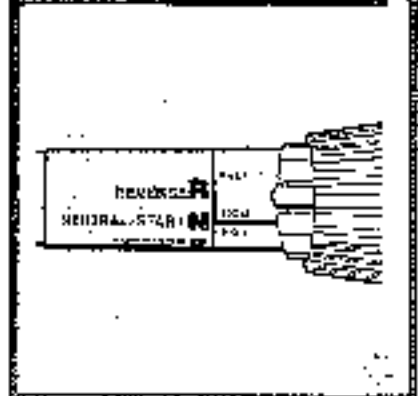
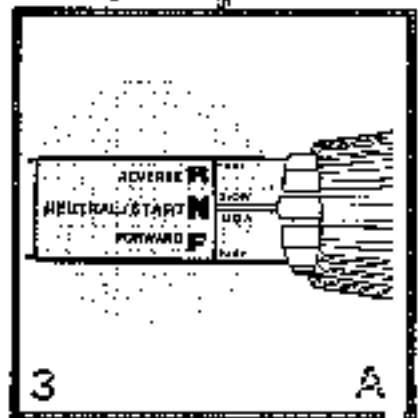
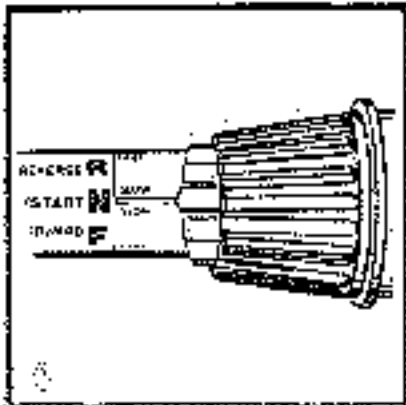
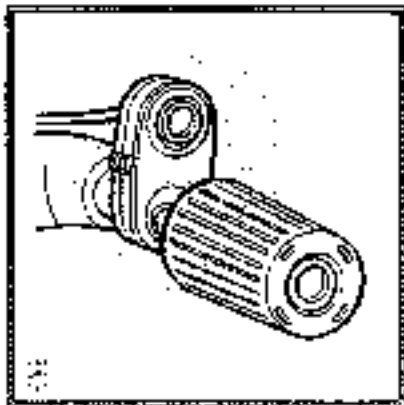
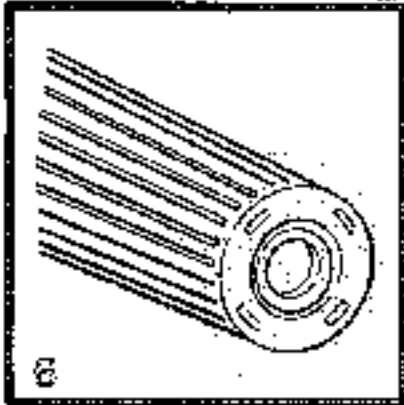
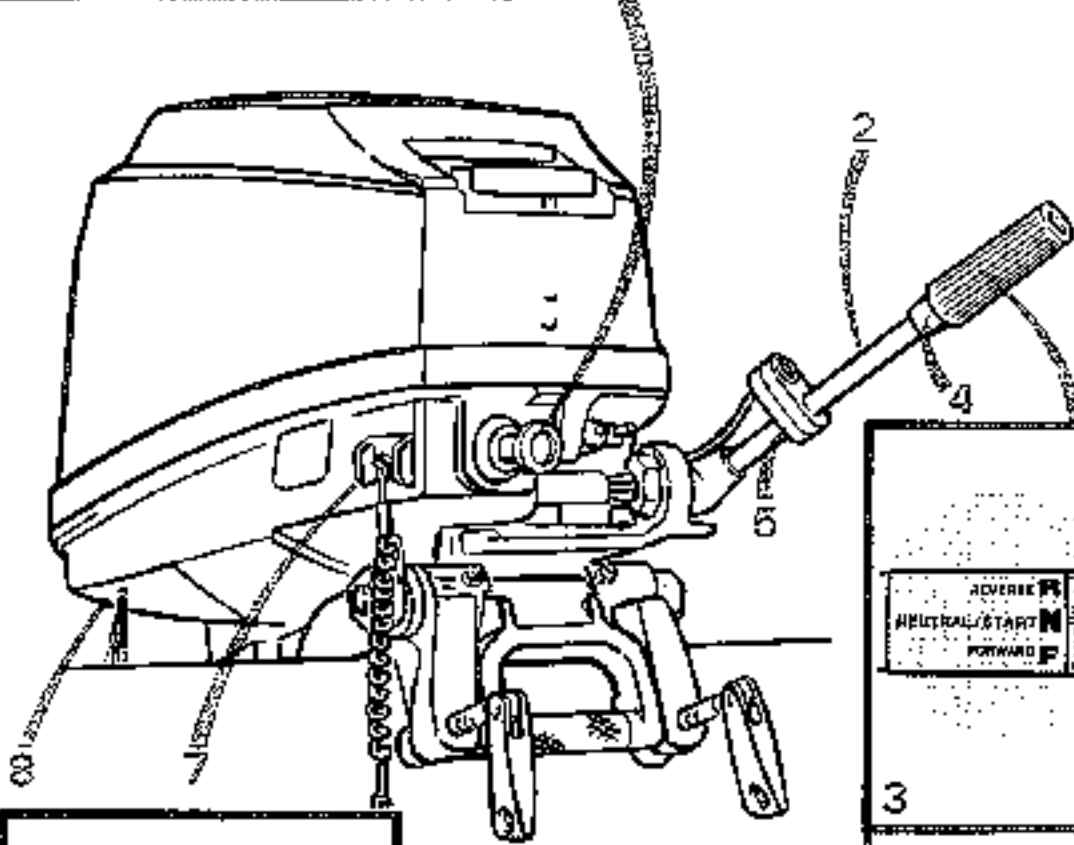
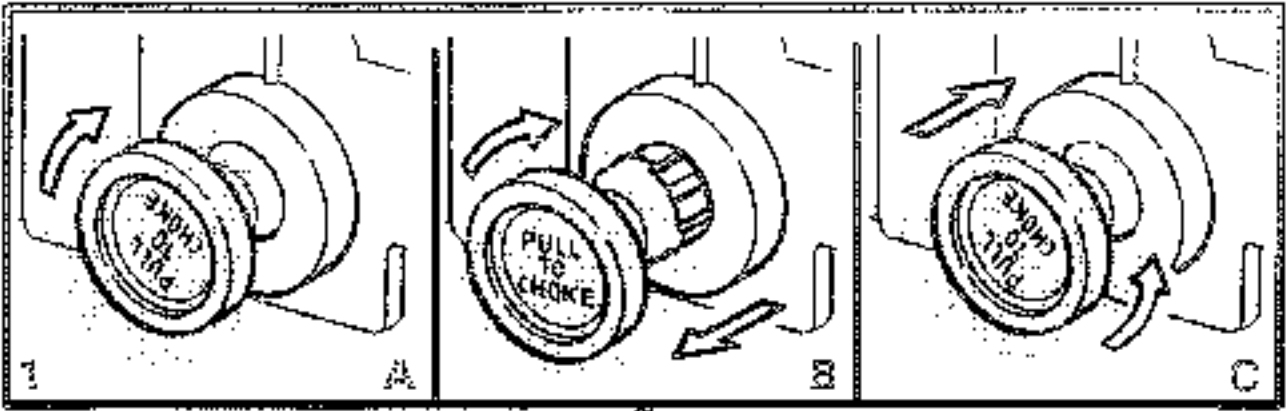

MOTOR CONTROLS

1 PRIMER/FAST IDLE KNOB

A ROTATE KNOB - Clockwise (to stop) when starting engine or to increase idle speed.

B PULL KNOB COMPLETELY OUT - (After rotating fully clockwise) to inject fuel into manifold for fast, easy starting when engine is cold.

C PUSH KNOB COMPLETELY IN - After engine starts. As engine warms up, rotate knob counterclockwise to return to normal idle speed.

2 TILLER HANDLE - Provides a means to steer boat, shift gears, and control engine speed on manually operated motors.

3 SHIFT POSITIONS

A NEUTRAL - Felt by detent in twist grip. The decal aligns with arrow on handle.

B FORWARD - Rotate twist grip counterclockwise. The decal indicates boat direction.

C REVERSE - Rotate twist grip clockwise. The decal indicates boat direction.

4 THROTTLE FRICTION KNOB - Adjusts twist grip friction to hold throttle at desired boat speed. Turn knob in either direction to increase friction.

5 TILLER HANDLE MOUNTED ELECTRIC START BUTTON - Used to start engine.

6 STOP BUTTON - Used to stop motor.

7 EMERGENCY STOP SWITCH - Refer to page 2 for explanation. The lanyard, when used with the emergency stop switch and connected to the driver, will stop the engine if the driver no longer has access to the tiller handle.

8 WATER PUMP OPERATION (No Thermostat)

Normal water pump operation is indicated by a steady, "Tell-Tale" stream of water issuing from a small hole at rear of bottom cowl while the motor is running and remain steady during the entire operation of the engine.

Water Pump Operation (Thermostat)

IMPORTANT: On models which are equipped with a thermostat (OPTIONAL ACCESSORY) in the cooling system, a "Tell-Tale" stream may not be visible until the engine reaches normal operating temperature and the thermostat opens (5 to 45 seconds, depending upon engine RPM and water temperature). The "Tell-Tale" may become intermittent while running as the thermostat opens and closes.

Operation with a defective water pump or obstruction in the cooling system will cause overheating and severe damage. Refer motor to Authorized Service facilities.

NOTICE: If your outboard will be operated primarily in cold water areas [normal water temperature **BELOW 50° F (10° C)**] and/or areas where extreme day-to-day air temperature variations of more than **30° F (17° C)** are common, we recommend installation of a thermostat (OPTIONAL ACCESSORY) in the engine cooling system.

A thermostat controlled cooling system maintains a constant, higher engine operating temperature, thus providing smoother engine operation, particularly at slower operating speeds. See an Authorized Servicing Dealer for this accessory.

OPERATION MODELS WITH TILLER HANDLE

BEFORE STARTING



CAUTION

This motor is water cooled. **DO NOT** operate motor out-of-water. Serious damage to motor could result from overheating.

DO NOT attempt to shift motor into **REVERSE** gear **WHEN ENGINE IS NOT RUNNING**. Damage to the shift mechanism could result.

OPERATOR and **PASSENGERS** **SHOULD BE SEATED** **WHENEVER ATTEMPTING** to **START** the **MOTOR**.

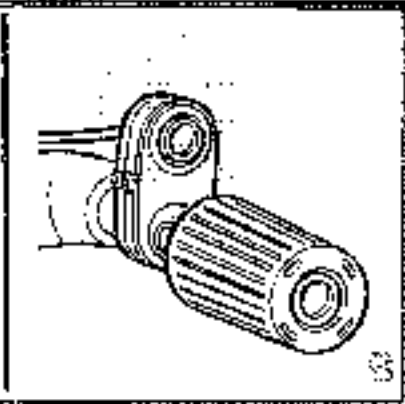
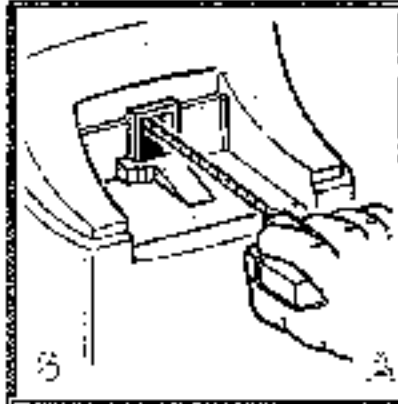
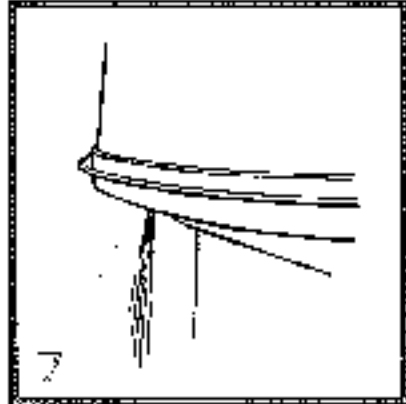
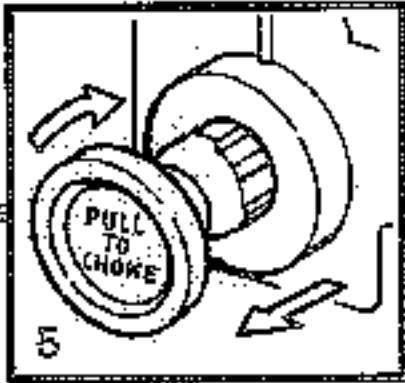
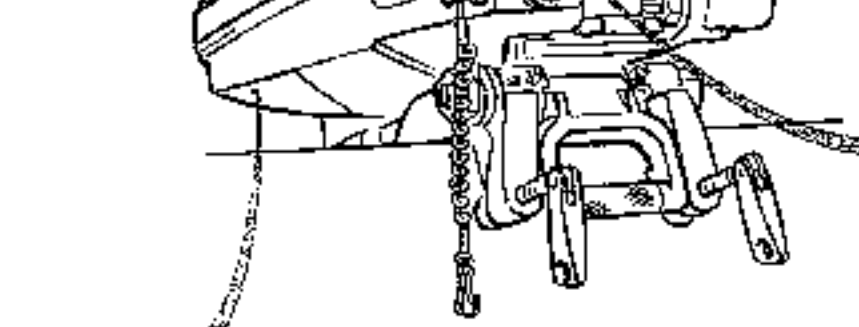
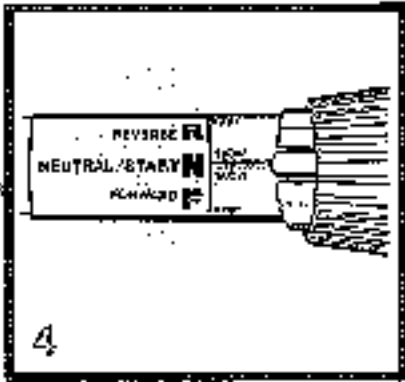
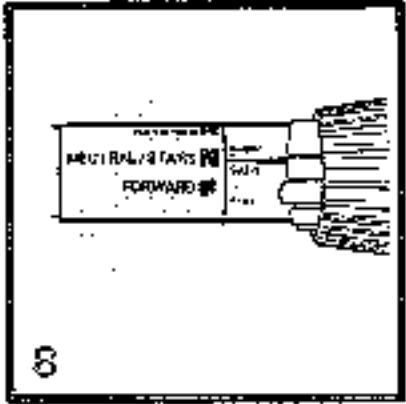
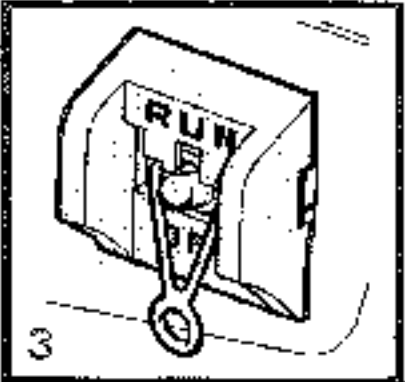
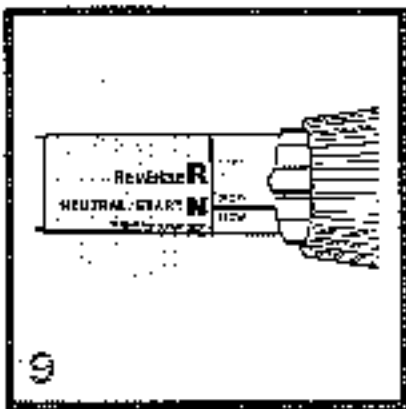
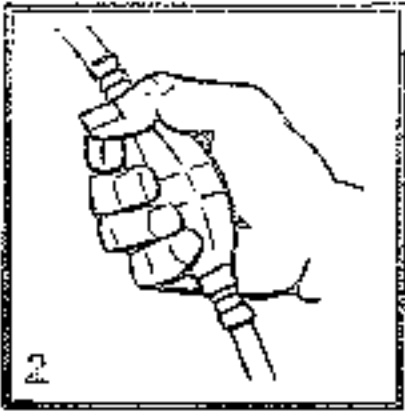
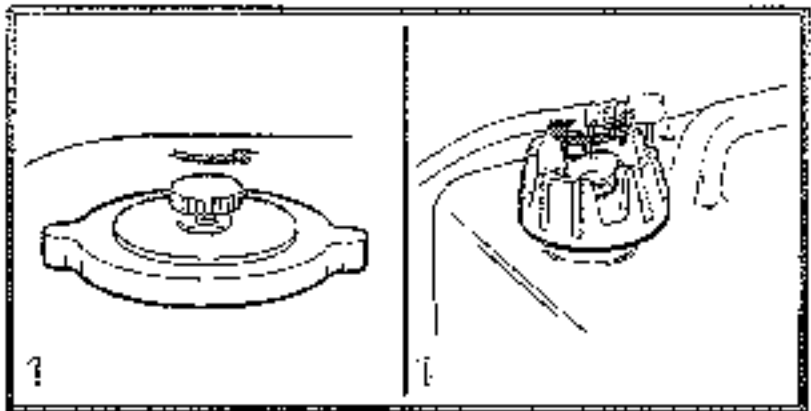

OPERATION (Continued)

MODELS WITH TILLER HANDLE

Before attempting to start motor, **MAKE CERTAIN** that motor is shifted into **NEUTRAL** and that area around boat is clear (to get underway).

Check fuel tank for sufficient fuel and that tank is secure in boat.

- 1 Open air vent on fuel tank cap.
- 2 Squeeze fuel primer bulb until it is firm.
- 3 Check that emergency stop switch is in **RUN** position.

STARTING

IMPORTANT: Manual starting motors are equipped with a rewind starter "lock-out" mechanism -- motor **MUST BE** in **NEUTRAL**, or twist grip in **SLOW** position, in order to start motor.

ELECTRIC starting motors are equipped with a starter "cut-out" switch -- the control handle twist grip or the remote control handle **MUST BE** in **NEUTRAL** position in order to start the engine.

- 4 Twist grip to **NEUTRAL (N)** position.
- 5 Rotate Primer/Fast Idle Knob clockwise (to stop) and pull completely out when starting cold engine. When restarting warm engine, rotate knob to full clockwise position. Do not pull out knob.
- 6A On manual start models, pull Starter Rope Handle slowly until engaged, then vigorously. Allow rope to rewind slowly. Repeat until motor starts.
- 6B On electric start models, press **STARTER BUTTON** - as soon as motor starts, release button.



CAUTION

DO NOT operate starter motor for longer than 30 seconds or starter motor may be damaged. Allow at least 2 minutes between starting attempts.

AFTER STARTING

- 7 **WATER PUMP OPERATION** (No Thermostat)
Normal water pump operation is indicated

by a steady, "Tell-Tale" stream of water issuing from a small hole at rear of bottom cowl while the motor is running and remain steady during the entire operation of the engine.

Water Pump Operation (Thermostat)
IMPORTANT: On models which are equipped with a thermostat (**OPTIONAL ACCESSORY**) in the cooling system, a "Tell-Tale" stream may not be visible until the engine reaches normal operating temperature and the thermostat opens (6 to 45 seconds, depending upon engine RPM and water temperature). The "Tell-Tale" may become intermittent while running as the thermostat opens and closes.

Operation with a defective water pump or obstruction in the cooling system will cause overheating and severe damage. Refer motor to Authorized Service facilities.

SHIFTING GEARS



CAUTION

Primer/Fast Idle Knob must be rotated completely counterclockwise **BEFORE** shifting. Shift gears with a firm, quick motion to avoid "gear chatter".

8 **FORWARD GEAR** - engaged by counterclockwise rotation of twist grip. Continued rotation increases speed.



CAUTION

Exercise extreme care when operating in **REVERSE GEAR**. **DO NOT** operate motor at high speeds in **REVERSE**.

9 **REVERSE GEAR** - engaged by clockwise rotation of twist grip. Continued rotation increases speed.

STOPPING

10 Press Stop Button at end of twist grip and hold until motor stops.

IMPORTANT: In an emergency the motor can be stopped at any speed, in or out of gear. For normal stopping, idle motor and shift to **NEUTRAL** before pressing **STOP BUTTON**.

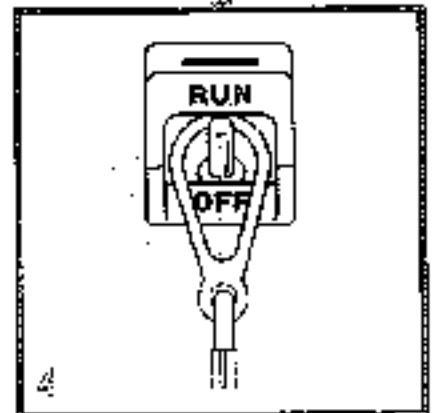
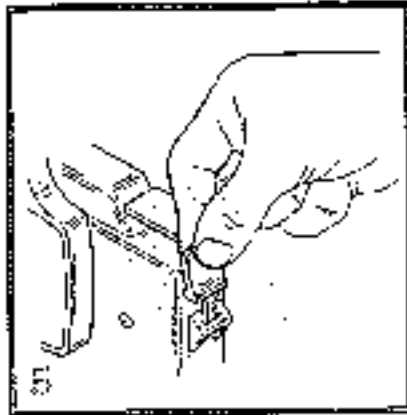
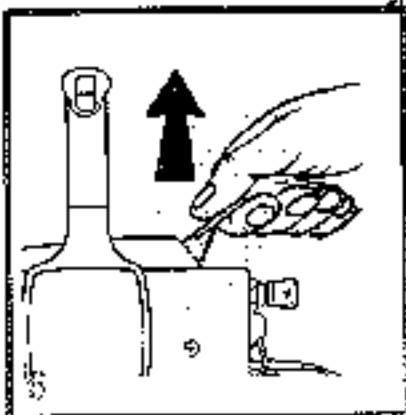
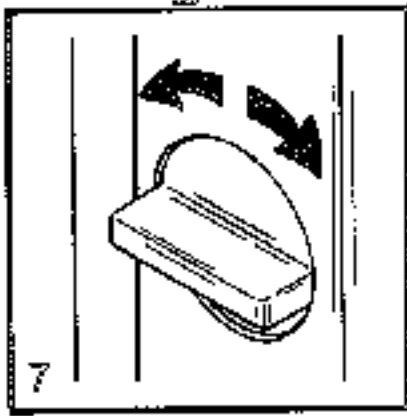
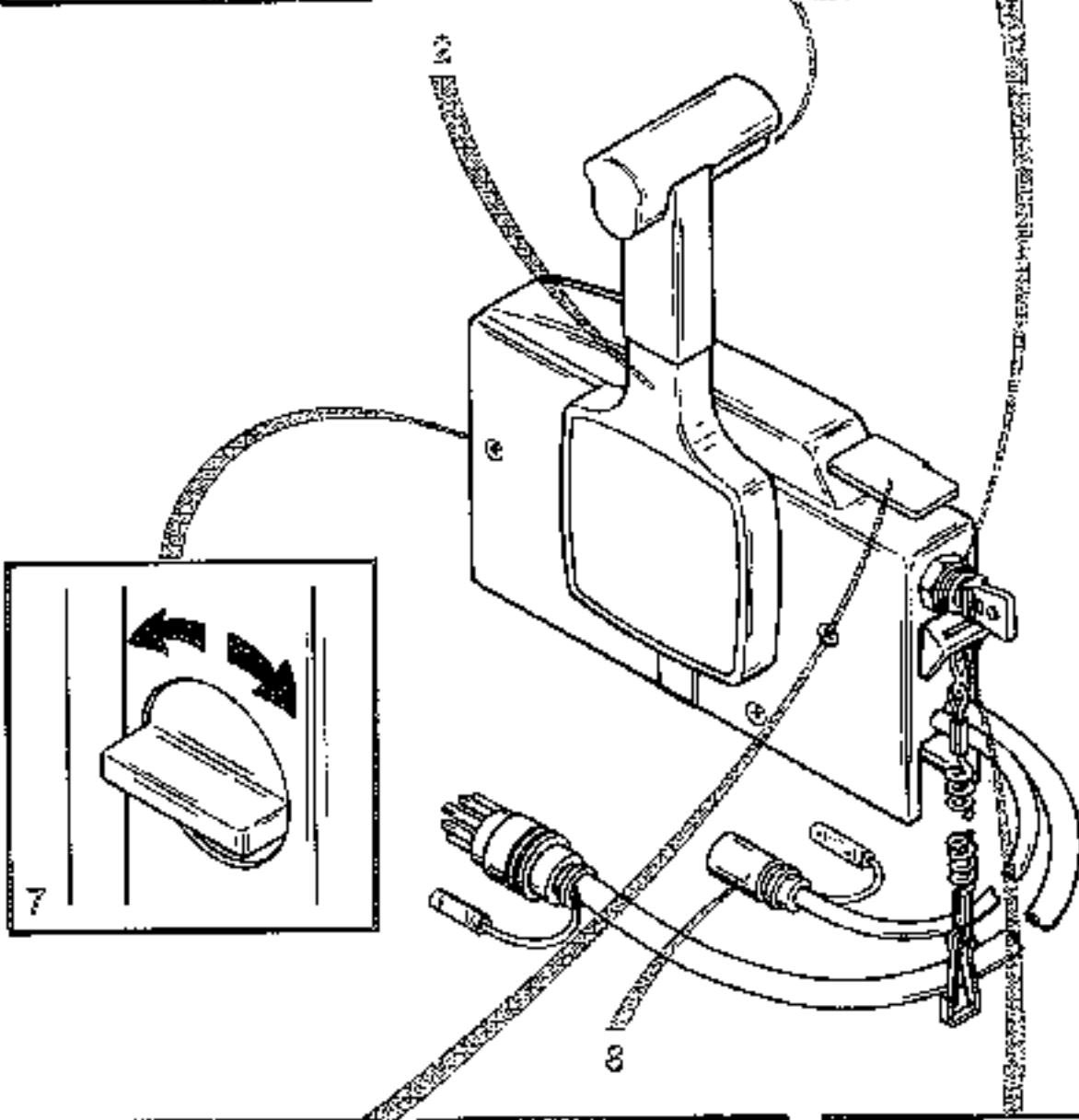
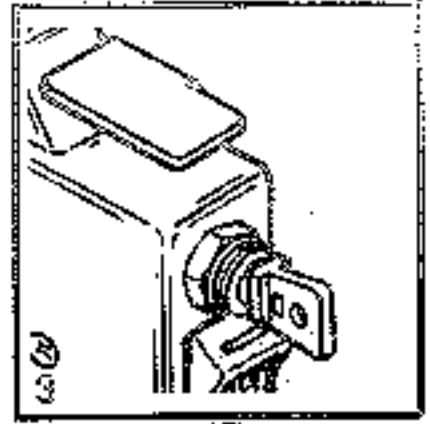
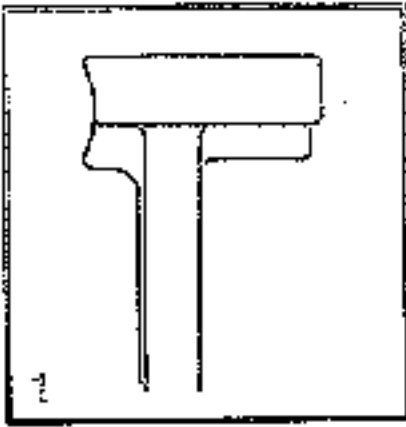

REMOTE CONTROL COMPONENTS

1 Neutral Lock Bar - prevents accidental shift and throttle engagement. Bar must be squeezed before control handle can be moved, from NEUTRAL.

2 Control Handle - controls forward, reverse motion and motor speed.

3 Ignition/Choke Switch - turns engine OFF and ON, actuates electric starter motor, and actuates carburetor choke.

4 Emergency Stop Switch - Refer to page 2 for explanation. The lanyard cord/clip, when used with the emergency stop switch **MUST BE** connected to boat driver. Should driver be unable to reach steering wheel or remote control, the lanyard cord/clip will be pulled from emergency stop switch and the engine will shut OFF. This emergency stop switch **SHOULD NOT BE USED** as normal engine shut-off.

IMPORTANT: The Emergency Stop Switch can be repositioned to RUN with or without stop clip and tether so that engine can be restarted.

5 Engine can be restarted with or without lanyard cord/clip installed by simply pushing switch up to run position. If necessary push switch down with key to reinstall clip.

6 FAST IDLE LEVER - Allows engine throttle advancement, without shifting gears, to assist engine starting.

7 THROTTLE FRICTION Adjustment Knob - Adjusts control handle friction so that motor speed can be set and drive does not have to hold handle. Turn knob clockwise to increase friction. **DO NOT** thread knob all the way out.

8 Tachometer Receptacle - Wiring harness connector for tachometer.

OPERATION ELECTRIC START MODELS WITH REMOTE CONTROL



CAUTION

OPERATOR and PASSENGERS SHOULD BE SEATED WHENEVER ATTEMPTING to START the MOTOR.

Before attempting to start motor, MAKE CERTAIN that motor is shifted

into NEUTRAL and that area around boat is clear (to get underway).

IMPORTANT: Remote control is equipped with a starter "out-out" switch -- remote control handle **MUST BE in NEUTRAL position in order to operate the starter.**

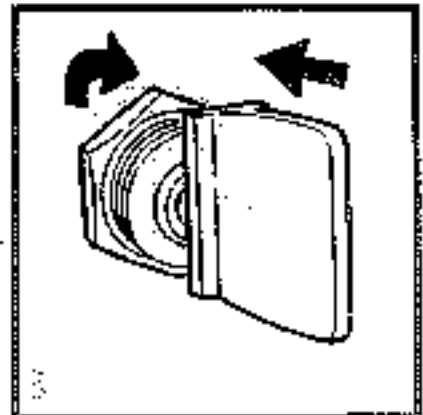
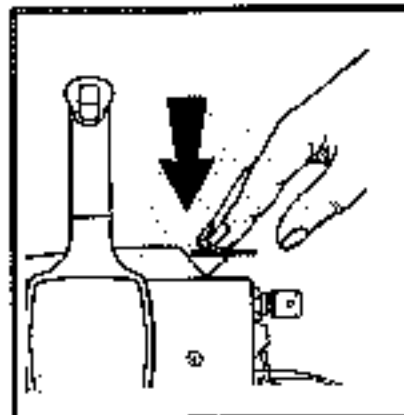
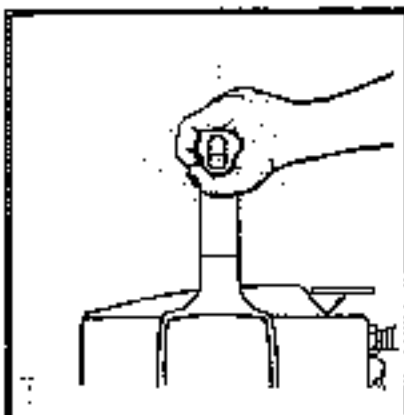
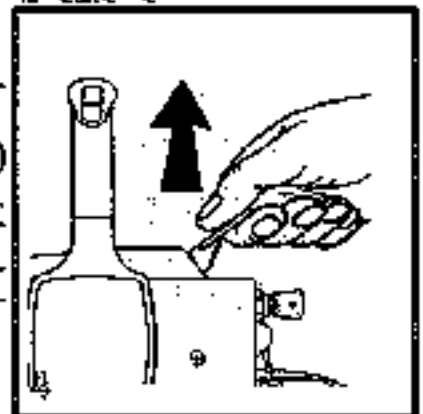
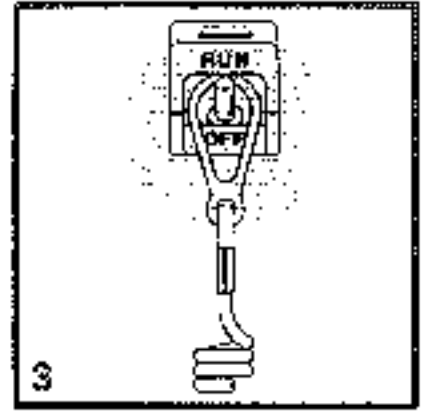
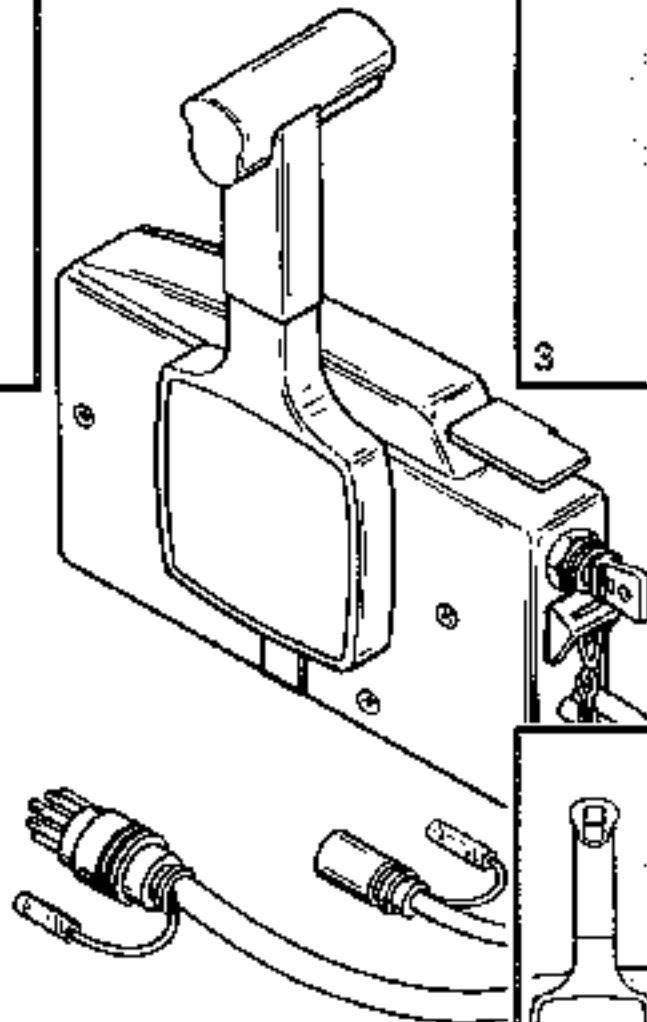
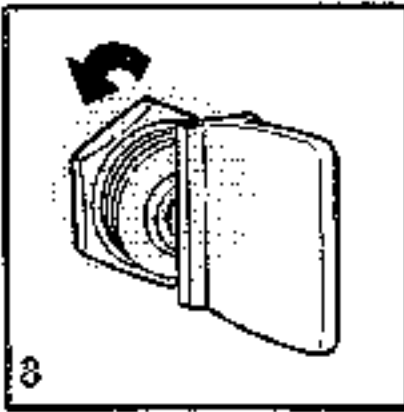
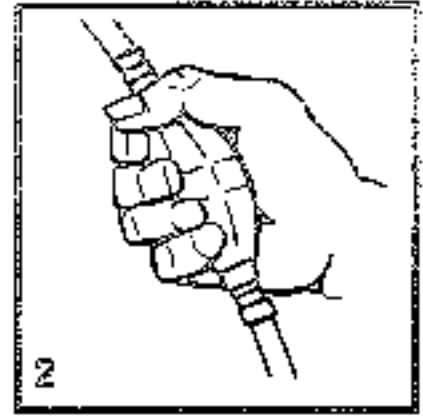
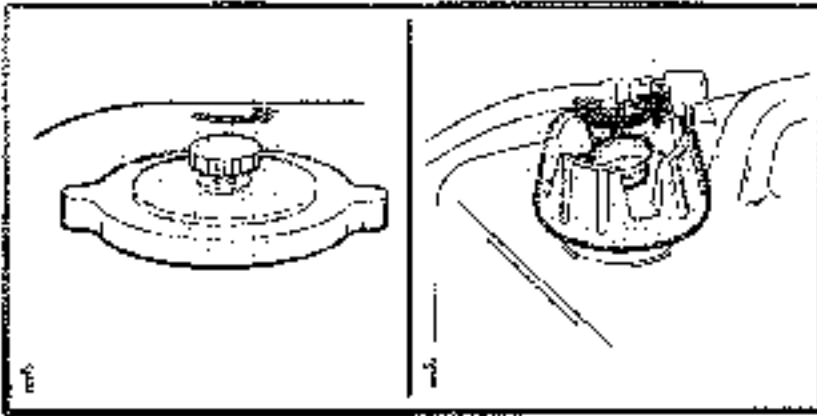

OPERATION (Continued)

ELECTRIC START MODELS WITH REMOTE CONTROL

BEFORE STARTING

Check fuel tank for sufficient fuel and that tank is secure in boat.

- 1 Open air vent on fuel tank cap.
- 2 Squeeze fuel primer bulb until it is firm.
- 3 Place control handle in NEUTRAL. Check that emergency stop switch is in RUN position.



CAUTION

DO NOT operate starter motor for longer than 30 seconds or starter motor may be damaged. Allow at least 2 minutes between starting attempts.

IMPORTANT: Starter circuit is protected by 5FE 20 AMP fuse a port side of engine. If starter fails to operate, check for blown fuse. **BEFORE** replacing fuse locate and correct cause for overload.

STARTING COLD MOTOR

- 4 Lift up on Fast Idle Lever.

IMPORTANT: With Fast Idle Lever in up position, control handle **CANNOT** be moved into FORWARD or REVERSE GEAR.

- 5 Turn key clockwise past RUN position to START and actuate choke by pressing in on key.

As soon as motor starts, allow key to return to RUN position and release choke. If motor falters, push in on key to actuate choke again.

- 6 After warm-up, return Fast Idle Lever to full down position.

STARTING WARM MOTOR

Turn key clockwise past RUN position to START.

As soon as motor starts, allow key to return to RUN position. If motor falters, push in on key to actuate choke.

NOTE: If motor fails to start, follow STARTING COLD MOTOR Procedure.

Water Pump Operation (No Thermostat)

Normal water pump operation is indicated by a steady "Tell-Tale" stream of water issuing from a small hole at rear of bottom cowl while the motor is running and remain steady during the entire operation of the engine.

Water Pump Operation (Thermostat)

IMPORTANT: On models which are equipped with a thermostat (OPTIONAL ACCESSORY) in the cooling system, a "Tell-Tale" stream may not be visible until the engine reaches normal operating temperature and the thermostat opens (5 to 45 seconds, depending upon engine RPM and water temperature). The "Tell-Tale" may become intermittent while running as the thermostat opens and closes.

Operation with a defective water pump or obstruction in the cooling system will cause overheating and severe damage. Refer motor to Authorized Service facilities.

THROTTLE/SHIFTING GEARS

- 7 Squeezing Neutral Lock Bar and pushing control handle forward engages the FORWARD GEAR. Pushing handle further forward increases motor speed.



CAUTION

Exercise extreme care when operating in REVERSE GEAR. DO NOT operate motor at high speeds in REVERSE.

Squeezing Neutral Lock Bar and pulling back on control handle engages REVERSE GEAR.

STOPPING

- 8 Shift to NEUTRAL and turn key counter-clockwise to OFF position.

IMPORTANT: In an emergency the motor can be stopped at any speed, in or out of gear. For normal operation, idle motor and shift to NEUTRAL before turning key OFF.

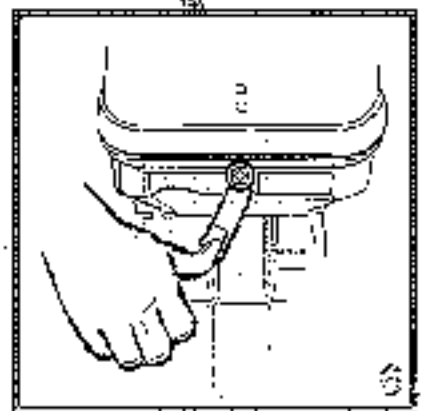
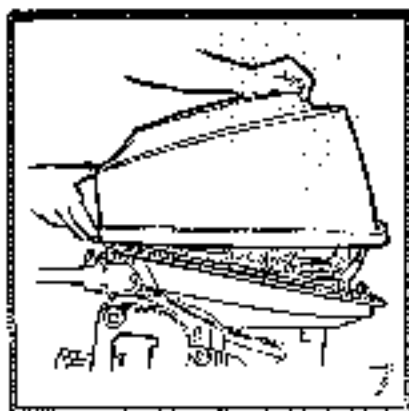
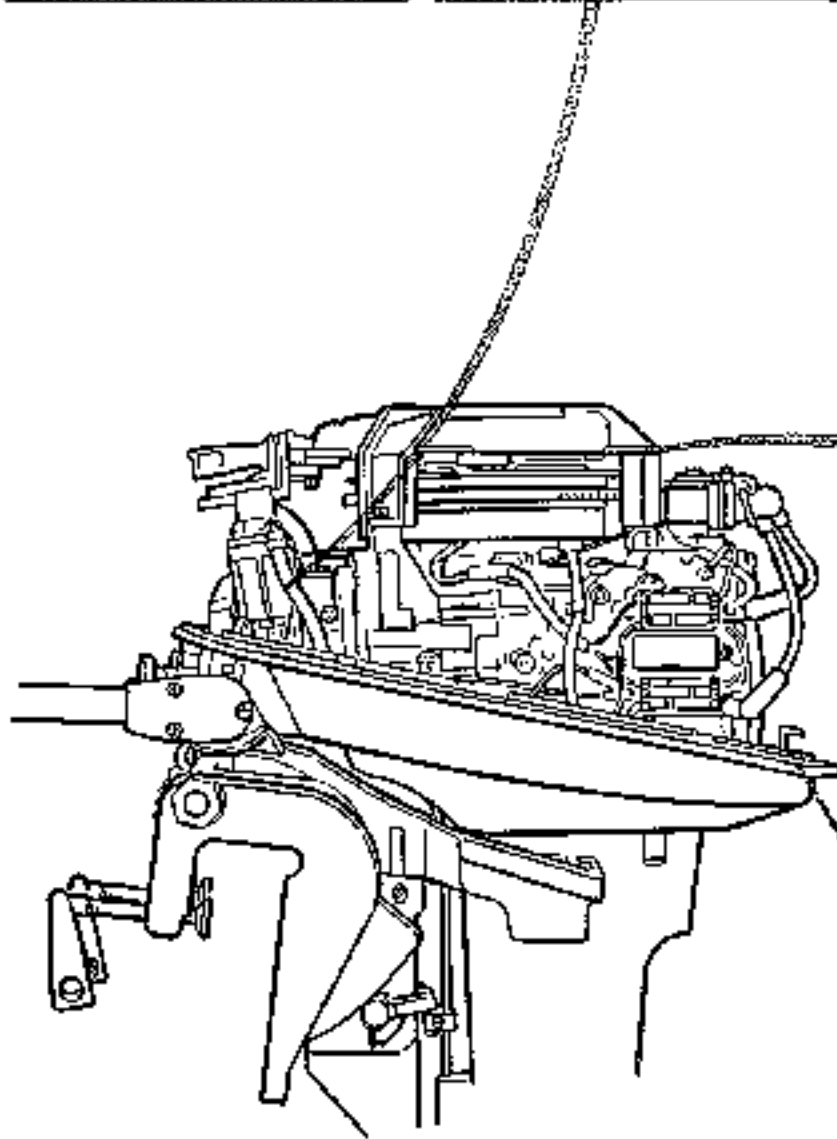
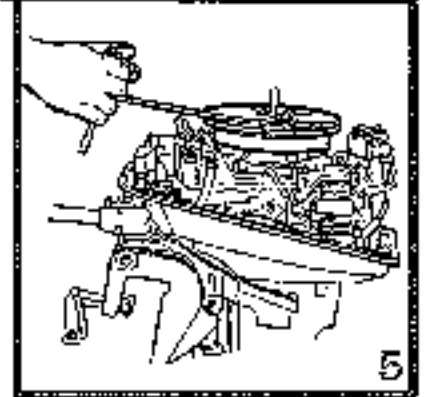
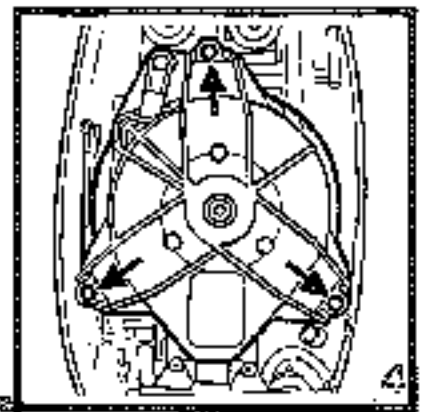
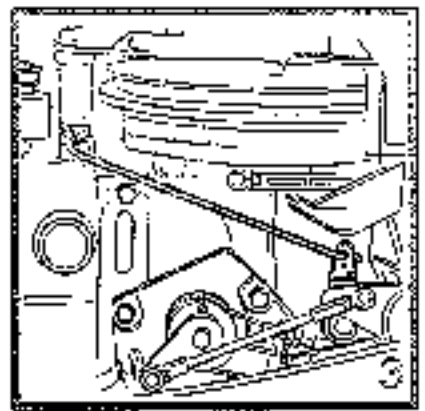
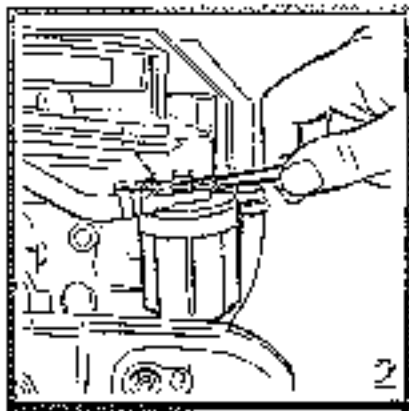
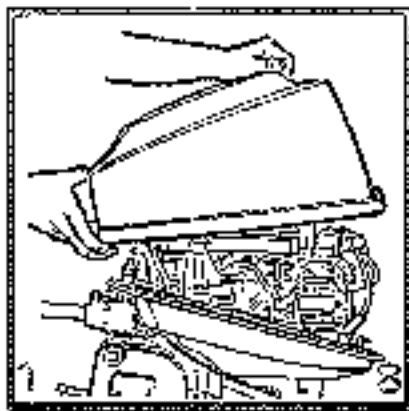

EMERGENCY OPERATION

STARTING ELECTRIC START MODELS

If desired (or in an emergency) motor can be operated without a battery (either disconnected or removed).



CAUTION

Battery leads to motor must be taped off (insulated). Electrical wiring harness on Electric Start Remote Control Models MUST REMAIN CONNECTED in order to stop motor with key.

Start motor with rewind starter as described in OPERATION - MANUAL START MODELS.

MANUAL START MODELS

If rewind starter becomes inoperative, the motor can be cranked (utilizing spare starter rope supplied) in the following manner.

1 Remove top cowl (refer to COWL REMOVAL AND INSTALLATION).

2 Remove fuel filter from starter housing (use "Combination Tool"). DO NOT turn or cock filter, pull filter straight down.

3 Remove manual start interlock linkage from the right (starboard) side of the rewind starter assembly

4 Remove 3 bolts which secure rewind starter assembly to engine. Lift rewind starter from engine

5 Tie knot in end of spare rope. Hook rope knot in flywheel notch and wind rope CLOCKWISE around flywheel at least 2 turns.



CAUTION

Make sure outboard is shifted into "Neutral" before attempting to start engine.

Observe preliminary motor starting steps as outlined in OPERATION procedures and pull rope to start motor. Repeat, if motor has not started.



CAUTION

DO NOT reinstall rewind starter or top cowl with motor running.

COWL REMOVAL AND INSTALLATION



CAUTION

DO NOT ATTEMPT TO REMOVE OR INSTALL COWL WHILE MOTOR IS RUNNING.

REMOVAL

STOP MOTOR

6 Push down to disengage cowl latch at rear of motor.

7 Lift up on rear of cowl and tilt forward to disengage cowl hook at front of motor.

8 Lift cowl off.

INSTALLATION

Position cowl over motor.

Lift up on rear of cowl and tilt it forward slightly to engage front hook.

Lower cowl into position and engage rear latch

Push latch up to secure cowl.

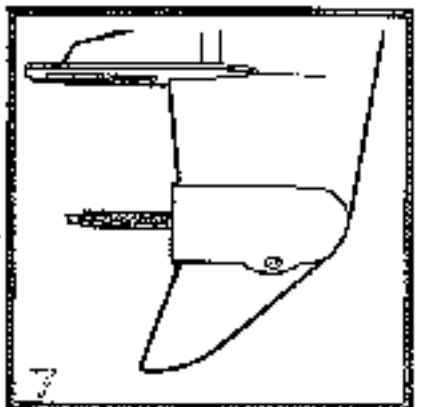
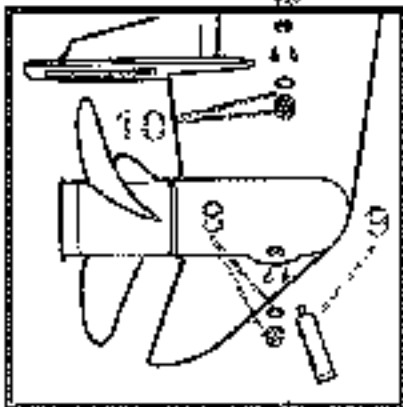
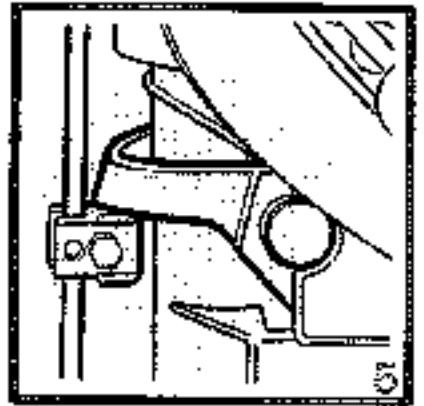
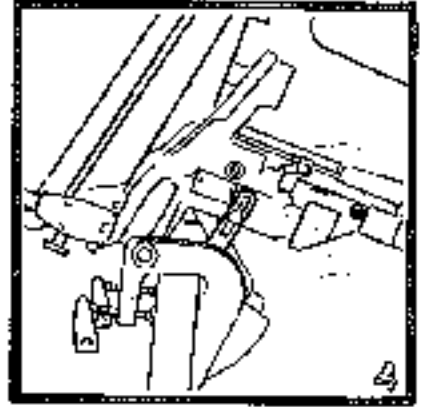
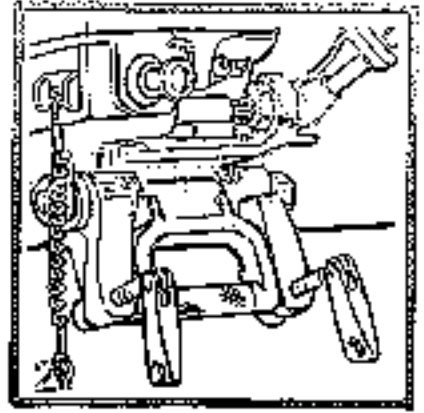
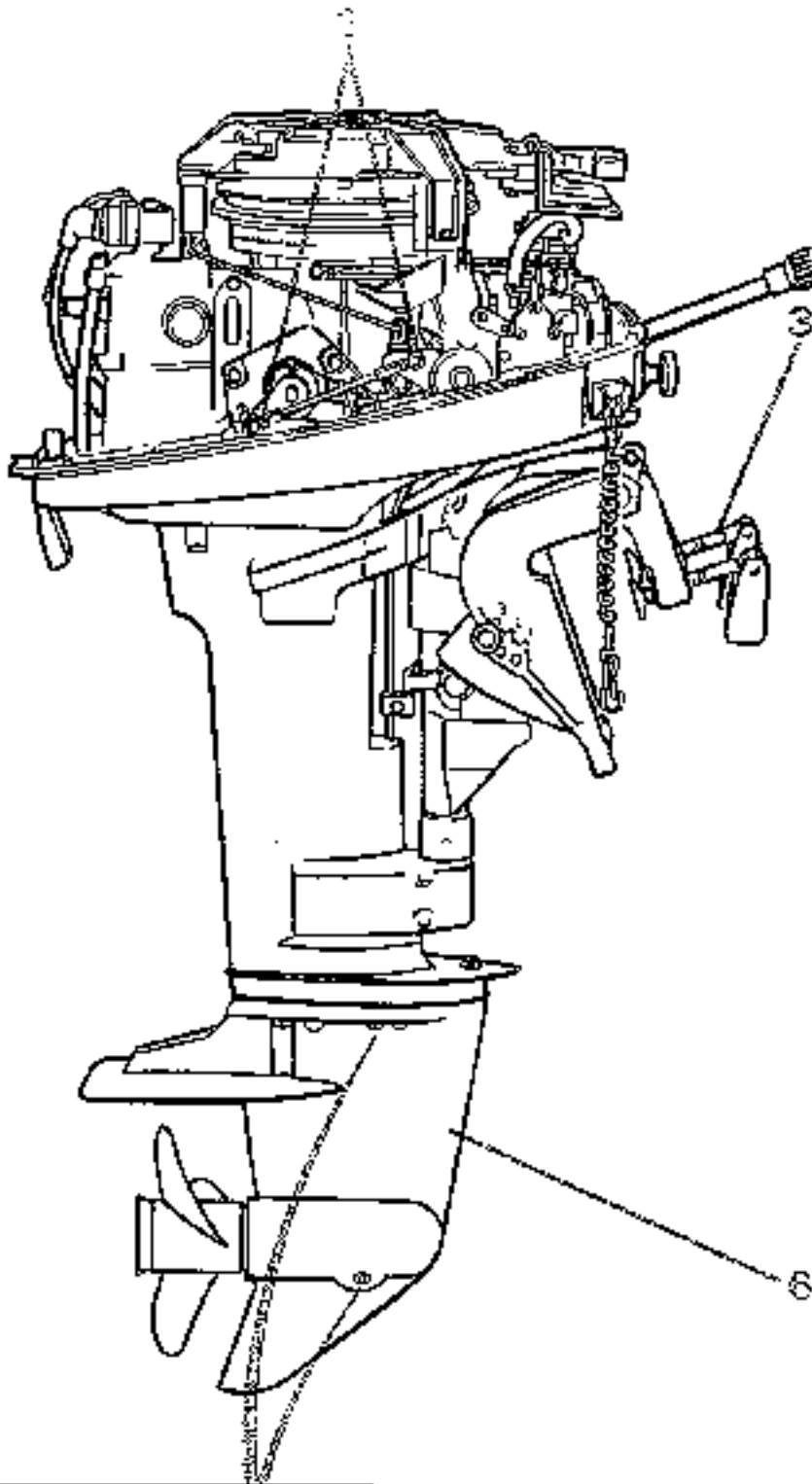

LUBRICATION GUIDE

ITEM	DESCRIPTION	TYPE OF LUBRICANT	FRESH WATER FREQUENCY	SALT WATER FREQUENCY
1	Throttle/Shift Linkage (All Pivot Points)	A	Every 60 days	Every 30 days
2	Tilt Tube/Control Handle Pivot	A	Every 60 days	Every 30 days
3	Clamp Screws	A	Every 60 days	Every 30 days
4	Swivel Bracket/ Swivel Pin	A	Every 60 days	Every 30 days
5	Reverse Lock Lever	A	Every 60 days	Every 30 days
6	Gear Housing	B	After 1st 10 days, then every 30 days	After 1st 10 days, then every 30 days
7	Propeller Shaft	A	Once a season	Every 60 days

Type of Lubricants

A = Quicksilver 2-4-C Marine Lubricant

B = Quicksilver Gear Lube

GEAR HOUSING LUBRICATION



CAUTION

Have gear housing checked by your local service dealer if any of the following are found:

Water drains from filler hole.

Metal particles are present on magnetic fill plug.

NOTE: Presence of a small amount of fine metal particles (resembling powder) indicates normal wear.

Lubricant appears milky brown

Large amounts of lubricant must be added to fill gear housing.

Lubricate gear housing as follows:

IMPORTANT: DO NOT use automotive lubricant in gear housing. Use only Quicksilver Gear Lube.

8 Remove fill plug and washer.

9 Insert lubricant tube into filler hole.

IMPORTANT: NEVER add lubricant to gear housing without first removing vent screw.

10 Remove vent screw and washer.

Add lubricant to gear housing until excess flows from vent hole.

Replace vent screw and washer.

Remove lubricant tube and install fill plug and washer.

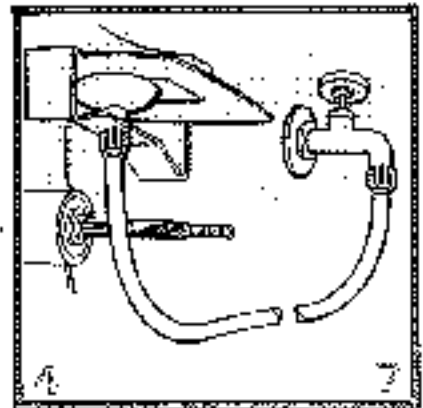
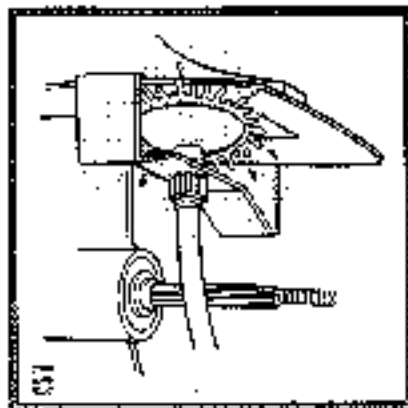
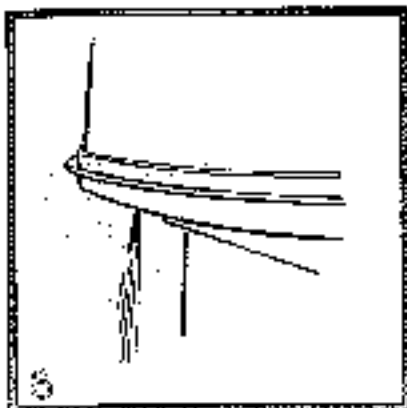
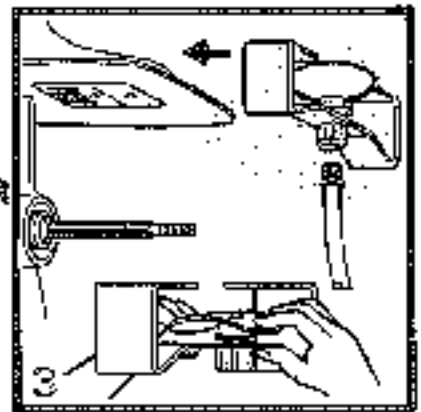
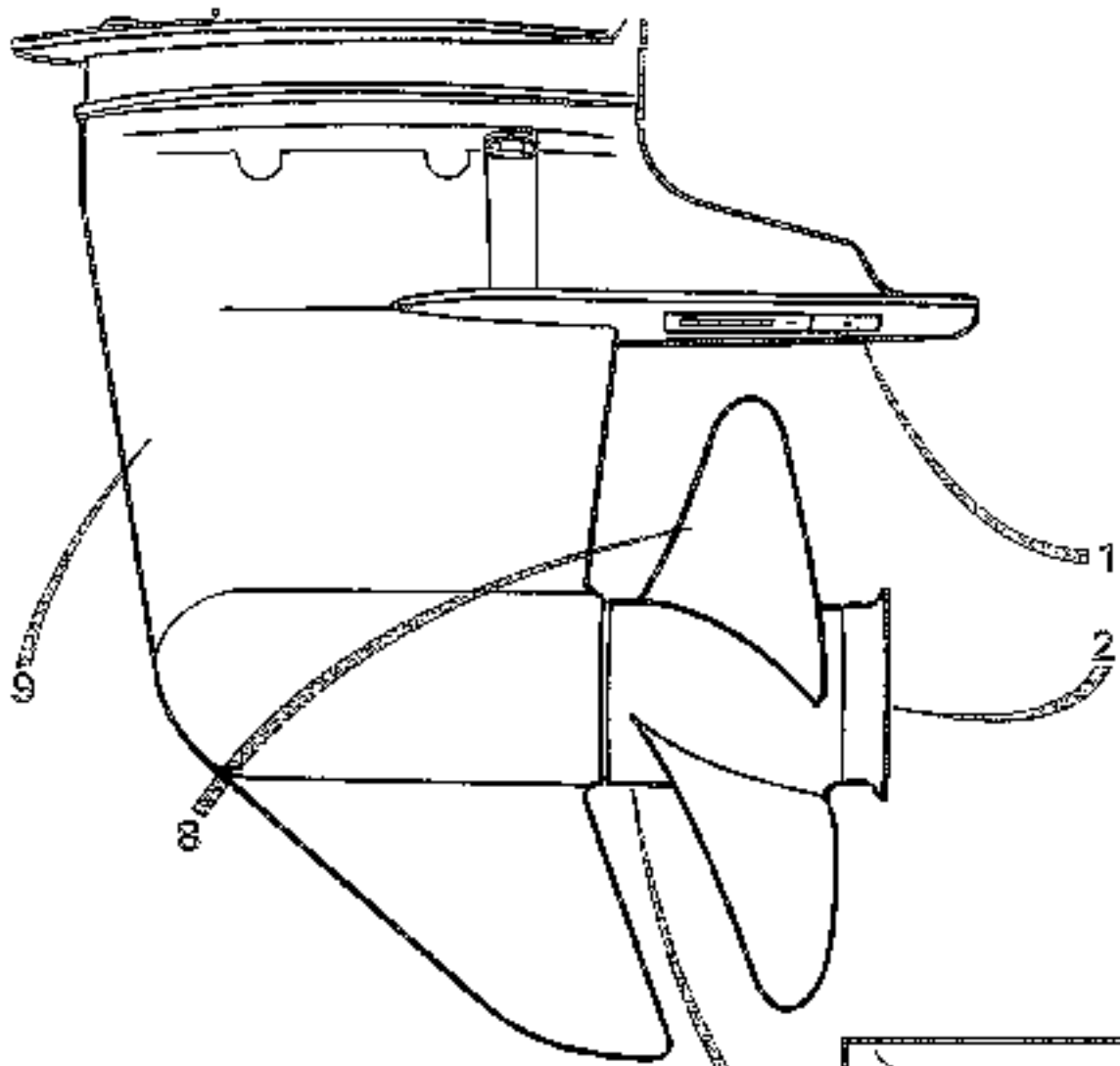

INSPECTION AND MAINTENANCE

Inspect motor often, and at regular intervals, to help maintain its top operating performance, and correct potential problems before they occur. The entire motor should be checked carefully, including all accessible engine parts.

Check for loose, damaged or missing parts. Tighten or replace as required.

Lubricate and check gear housing oil level per LUBRICATION GUIDE.

Service spark plugs. Check plug leads and electrical leads for damage.

Inspect fuel lines for damage. Service fuel filters.

Remove and inspect propeller. If badly nicked, bent or cracked, refer to Authorized Service Facilities (Refer to PROPELLER - INSTALLATION.)

Repair nicks and corrosion damage on finish. Use Quicksilver spray paints - see your Dealer.

1 Inspect anodic plate. Replace if 50% of anodic plate has been eroded away.

IMPORTANT: The anodic plate is made of a special alloy to protect motor housings from galvanic corrosion. **DO NOT** paint or place protective coating on the anodic plate.

FLUSHING MOTOR COOLING SYSTEM



CAUTION

When flushing, remove the propeller.

To prevent silt and/or salt buildup in cooling system, flush with fresh water periodically.

2 Remove propeller. Refer to PROPELLER REMOVAL.

3 Install Quicksilver Flushing Attachment (or equivalent) over water intake gear housing.

4 Connect hose between flushing attachment and water tap.

5 With motor in normal operating position, open water tap and adjust flow so that some water leaks from around flushing attachment.

6 Check that water is running from "Tell-Tale". Shift motor to NEUTRAL and start.

With motor running at Idle speed, continue flushing until water becomes clear (3 to 5 minutes for salt water units).

7 Stop motor, turn-off water and remove flushing attachment.

IMPORTANT: Keep motor in upright position until all water has drained out. Water left trapped in motor could cause engine damage.

8 Install propeller. Refer to PROPELLER INSTALLATION.

9 Clean motor surfaces and wipe with Quicksilver Corrosion and Rust Preventive Type II to protect finish.

IGNITION MAINTENANCE



CAUTION

DO NOT touch or disconnect any ignition system parts while engine is running, as high voltage is present.

If electrical/ignition system is not operating, **DO NOT** attempt to repair, but refer to your authorized service facility.

SPARK PLUGS

Periodic inspection, cleaning and/or replacement of spark plugs will enhance motor performance. Always replace spark plugs with type specified in SPECIFICATIONS.

Replace spark plugs as follows:

Remove cowl. (Refer to COWL REMOVAL AND INSTALLATION.)

1 Disconnect spark plug leads and use "Combination Tool" supplied, or 13/16" wrench, to remove spark plugs.

2 Check that gaskets are in place and install new plugs.

Thread spark plugs in by hand until finger-tight. Use "Tool" or wrench to tighten an additional 1/4 turn. **DO NOT OVERTIGHTEN.**

3 Reconnect spark plug leads to correct plugs.

Inspect spark plug leads for damage - replace as necessary.

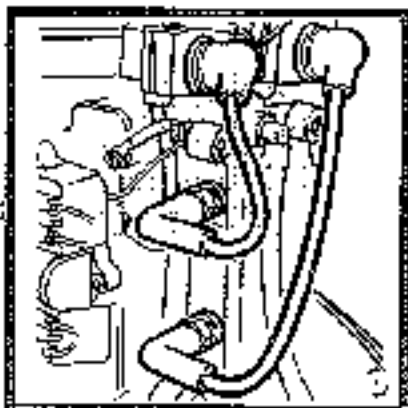
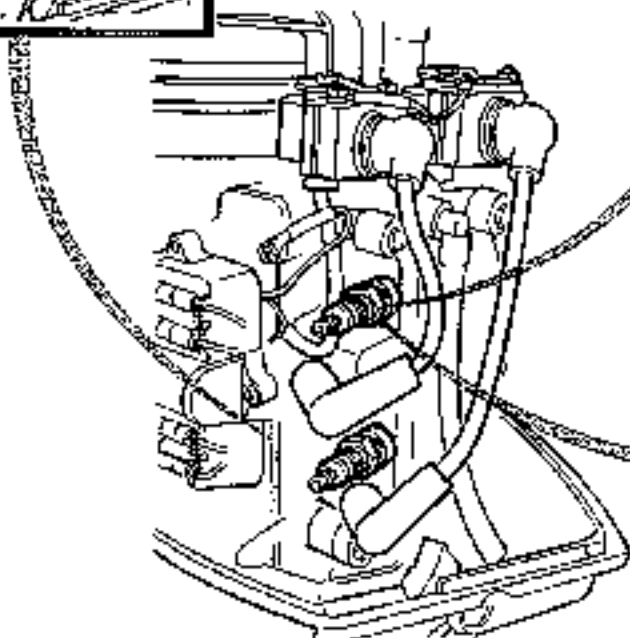
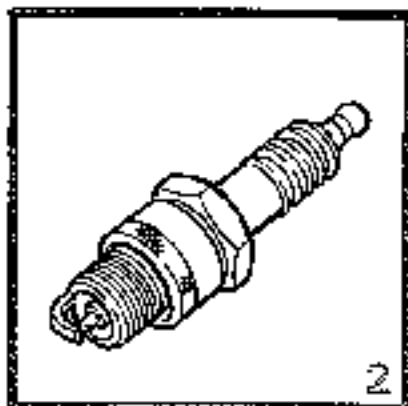

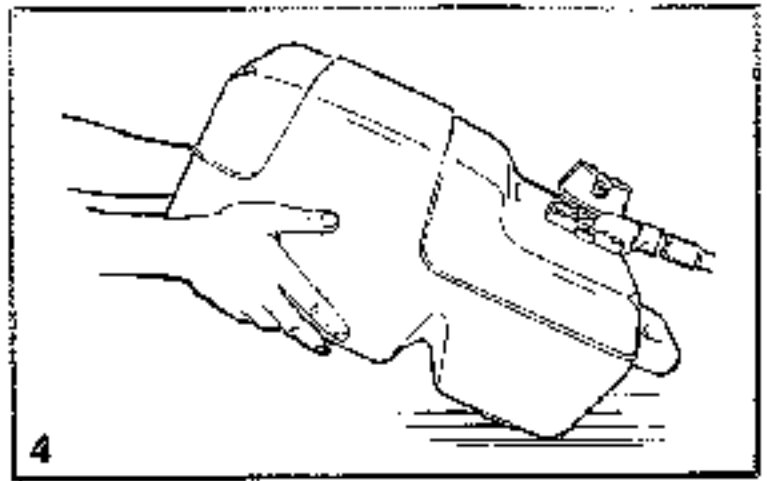
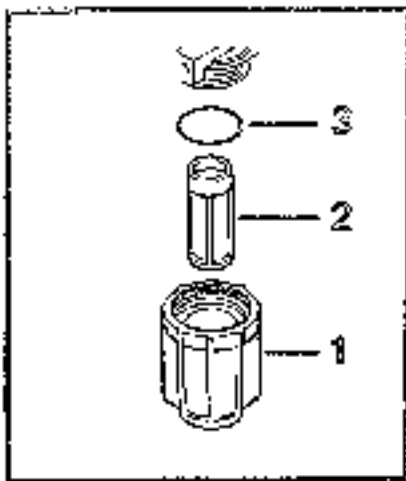

CLEANING FUEL FILTERS



WARNING

Be careful when cleaning fuel filter elements; gasoline is extremely flammable and highly explosive under certain conditions. Always stop the engine and **DO NOT** smoke or allow open flames in the area while cleaning fuel filter elements.

FUEL TANK PICKUP FILTER

Disconnect fuel line from tank.

Loosen and remove fuel pickup tube.

Clean filter by rinsing in clean gasoline.

Reinstall on fuel tank.

SIGHT BOWL FUEL FILTER

1 Unscrew sight bowl from filter cover. **DO NOT** allow cover to twist or turn.

2 Pull filter from cover. Rinse sight bowl and filter in clean gasoline.

3 Check that rubber seal ring is properly positioned in bowl.

Push filter into cover and hand tighten sight bowl onto cover.

Prime fuel system and check for fuel leaks

FUEL RESERVE (6.6 Gallon Polyethylene Tank Only)

The 6.6 gallon polyethylene tank incorporates a fuel reserve of approximately 1 gallon.

4 To utilize fuel reserve, tip tank toward fuel pickup and allow reserve fuel to flow into fuel pickup chamber.

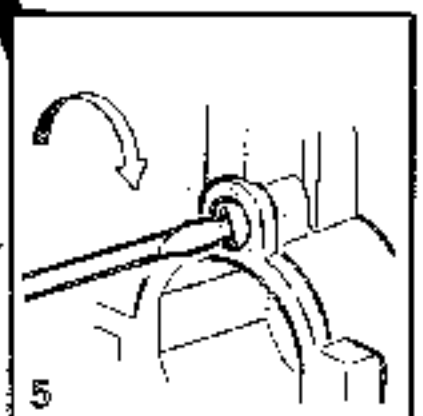
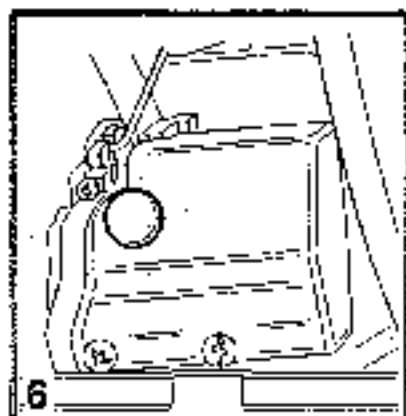
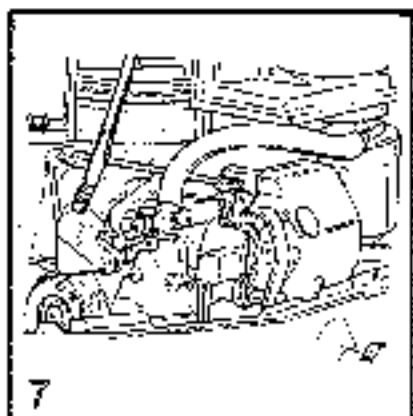
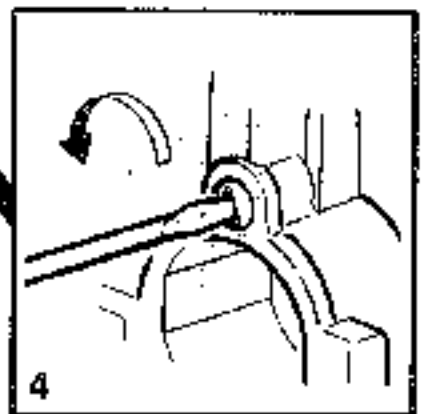
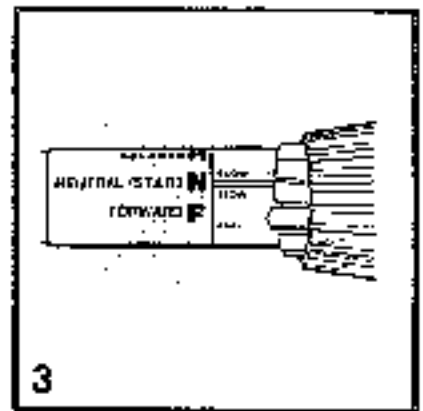
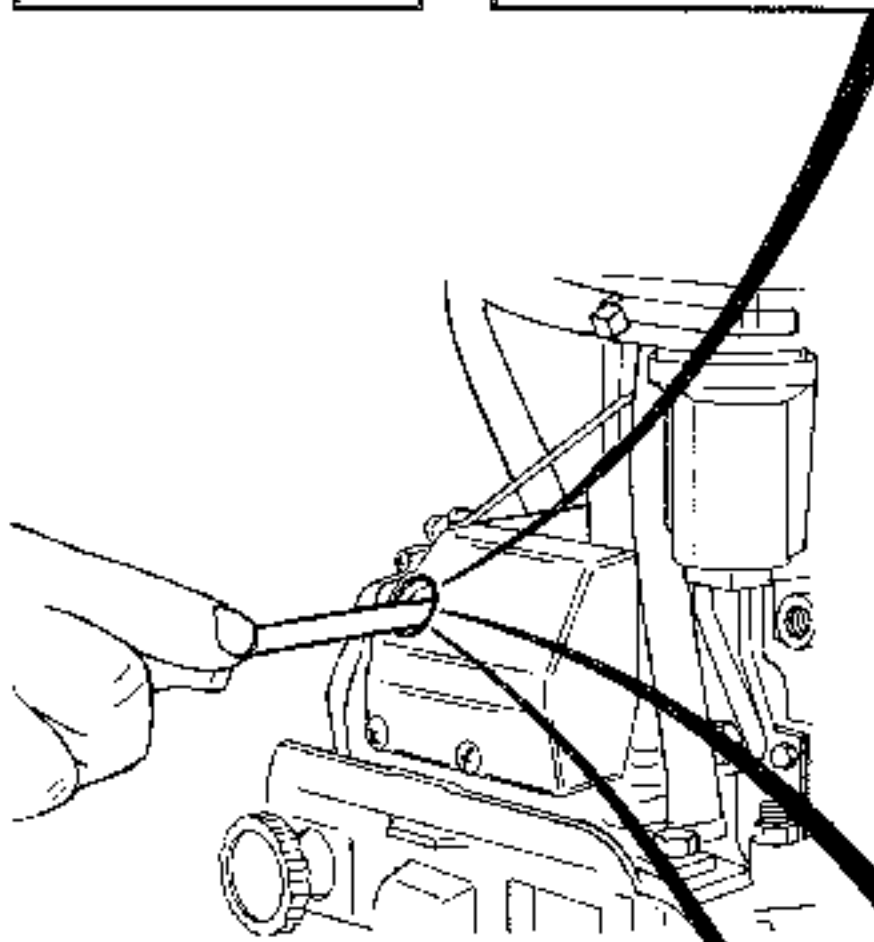
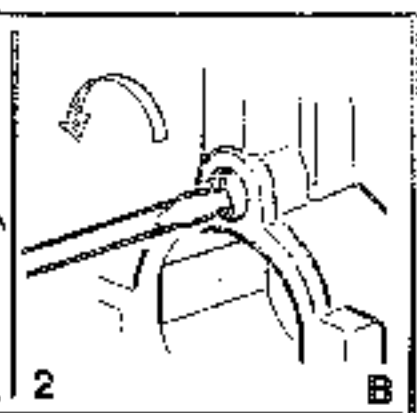
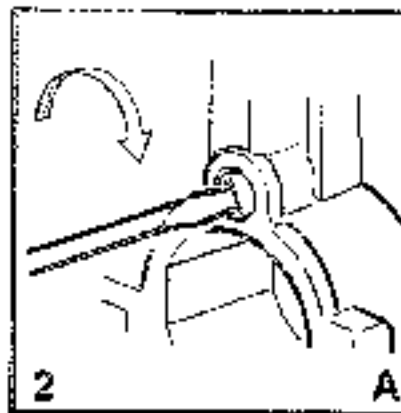
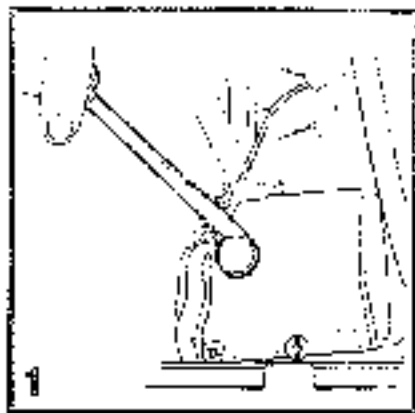

CARBURETOR ADJUSTMENTS

The carburetor has been calibrated and pre-set at factory to provide best performance under normal conditions. However, extreme changes in weather and/or elevation may necessitate further carburetor adjustments.

IMPORTANT: To maintain peak engine performance when operating at **HIGHER ELEVATIONS**, it will be necessary to install a **LEANER** fixed high speed jet. (See your authorized service facility).

LOW SPEED MIXTURE

1 Remove access plug from carburetor air intake cover.

2 Pre-set low speed mixture screw as follows:

A Lightly tighten screw - turn clockwise.

B Back out screw 1-1/2 turns counterclockwise.

Start engine - Allow to run at IDLE for several minutes.

3 With engine at IDLE, shift to FORWARD GEAR.

4 Turn screw counterclockwise until engine starts to "load-up" or fire unevenly (TOO RICH).

5 Slowly turn screw clockwise until engine fires evenly and RPM increases

Continue turning clockwise until RPM decreases and engine misfires (TOO LEAN)

Set low speed mixture screw at point midway between TOO RICH and TOO LEAN. When in doubt, set slightly RICH rather than TOO LEAN.

6 Install access plug into opening in carburetor air intake cover.

IDLE SPEED

7 Engine Equipped with an Adjustable Idle Speed Screw - With engine running at IDLE in FORWARD GEAR, make sure Primer/Fast Idle Knob is pushed completely in and rotated fully counterclockwise to stop. Adjust idle speed screw to obtain recommended Idle Speed. (See SPECIFICATIONS.)

Engines Not Equipped with an Adjustable Idle Speed Screw - Carburetors of engines not equipped with an adjustable idle speed screw have been calibrated to run at the recommended idle speed (see SPECIFICATIONS).

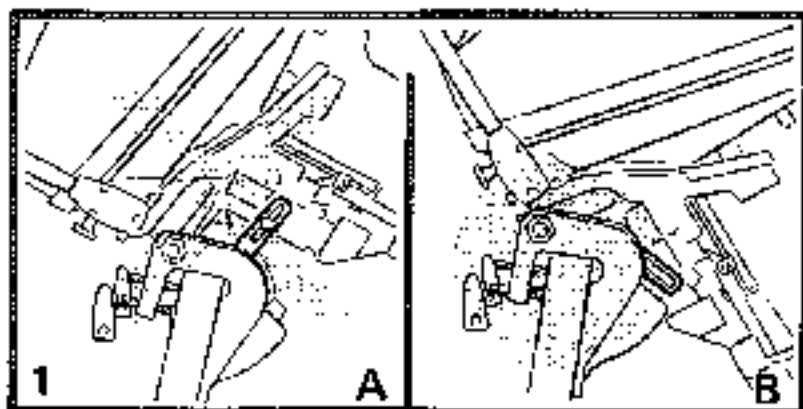

TRAILERING BOAT/MOTOR

When trailering or transporting the boat/motor, it is recommended that motor remain in normal operating position, with steering friction co-pilot tightened enough to hold forward direction and the gear shift placed in neutral to prevent engine from bouncing.



CAUTION

1A DO NOT use full tilt up position when trailering boat and motor. The motor **CANNOT** be locked in the full tilt up position. The lower unit could be severely damaged if it bounced and dropped to the **PRESET TILT** position without adequate road clearance.

1B If adequate road clearance presents a problem, either remove the motor from the transom and store securely, or tilt the motor up to any of the six tilt positions and place gear shift in **NEUTRAL** gear to prevent engine from bouncing.

REMOVING MOTOR BOAT

When removing, keep motor in an upright position, resting on its skog, until all water has drained from gear housing. If motor is placed on its side while water remains trapped in the gear housing, some water may enter the cylinders through the exhaust ports and cause internal damage.