

If the outboard motor's serial number plate contains the CE mark in the lower left-hand corner, the following statement applies:

This outboard motor manufactured by Mercury Marine, Fond du Lac, Wisconsin, USA or Marine Power Europe Inc. Park Industriel, de Petit-Rechain, Belgium complies with the requirements of the following directives and standards, as amended:

Recreational Craft Directive: 94/25/EC; std. ISO 8665,
ISO 11547

Machinery Directive: 98/37/EC,
EMC Directive: 89/336/EC; std. EN50081-1,
SAE J551 (CISPR Pub. 12),
EN 50082-1, IEC 61000 PT4-2,
IEC 61000 PT4-3



Patrick C. Mackey

President, Mercury Marine, Fond du Lac, WI USA

European Regulations Contact:
Product Environmental Engineering Department, Mercury Marine,
Fond du Lac, WI USA

Thank You

For your purchase of one of the finest outboards available. You have made a sound investment in boating pleasure. Your outboard has been manufactured by Mercury Marine, a world leader in marine technology and outboard manufacturing since 1939. These years of experience have been committed to the goal of producing the finest quality products. This led to Mercury Marine's reputation for strict quality control, excellence, durability, lasting performance and being the best at providing after-the-sale support.

Please read this manual carefully before operating your outboard. This manual has been prepared to assist you in the operation, safe use and care of your outboard.

All of us at Mercury Marine took pride in building your outboard and wish you many years of happy and safe boating.

Again, thank you for your confidence in Mercury Marine.

Warranty Message

The product you have purchased comes with a **limited warranty** from Mercury Marine, the terms of the warranty are set forth in the *Warranty Information* Section of this manual. The warranty statement contains a description of what is covered, what is not covered, the duration of coverage, how to best obtain warranty coverage, **important disclaimers and limitations of damages**, and other related information. Please review this important information.

TABLE OF CONTENTS

Warranty Information

Transfer of Warranty	5
Warranty Registration	
United States and Canada	6
Outside United States and Canada	7
Outboard Limited Warranty	8
3 Year Limited Warranty against Corrosion	10
Warranty Coverage and Exclusions	12

General Information

Boater's Responsibilities	14
Before Operating Your Outboard	15
Recording Serial Number	15
Boat Horsepower Capacity	16
Outboard Remote Control (If Equipped)	17
Remote Steering Notice	17
Lanyard Stop Switch	18
Stopping The Boat In an Emergency	20
Protecting People In The Water	21
Wave and Wake Jumping	22
Exhaust Emissions	23
Selecting Accessories For Your Outboard	25
Safe Boating Suggestions	25
Specifications	28

Installation

Installing Outboard On The Transom	29
Fastening Security Line	30
Battery Installation – Electric Start Models	31
Battery Connections	31

TABLE OF CONTENTS

Transporting

Carrying Your Outboard	32
Trailerling Your Boat	32
Transporting Your Outboard When Removed From Boat	33
Transporting Portable Fuel Tanks	33

Fuel & Oil

Gasoline Recommendations	34
Oil Recommendations	35
Mixing Fuel and Oil	35
Filling Fuel Tank	36

Features & Controls

Tiller Handle Models	37
Tilting Outboard To Full Up Position	41
Lowering Outboard Down To Run Position	41
Shallow Water Operation	42
Setting The Operating Angle Of Your Outboard	43

TABLE OF CONTENTS

Operation

Pre-Starting Check List	44
How the Jet Drive Operates	45
Stopping the Boat in an Emergency	46
Steering Your Boat	47
Operating in Shallow Water	48
Water Intake Blockage	48
Clearing a Jammed Impeller	49
Mooring Your Boat	49
Operating in Freezing Temperature	49
Operating at High Elevations	50
Operating in Salt Water or Polluted Water	50
Pre-Starting Instructions	51
Engine Break-In Procedure	51
Starting The Engine	52
Gear Shifting	55
Stopping The Engine	55
Emergency Starting	56

Maintenance

Outboard Care	58
Selecting Replacement Parts For Your Outboard	58
Inspection and Maintenance Schedule	60
Top Cowl Removal And Installation	62
Battery Inspection	62
Fuel System	63
Exterior Care	64
Steering Link Rod Fasteners	65
Fuse Replacement (Electric Start Remote Control Model)	66
Worn (Dull) Impeller	67
Impeller Clearance Adjustment	68
Impeller Removal and Installation	69
Shift Link Rod Adjustment	72
Lubrication Points	73
Spark Plug Inspection and Replacement	76
Carburetor Adjustments	77
Submerged Outboard	78

TABLE OF CONTENTS

Storage

Storage Preparation 79

Troubleshooting

Troubleshooting 82

Owner Service Assistance

Local Repair Service 84
 Service Away From Home 84
 Parts and Accessories Inquiries 84
 Service Assistance 85
 Mercury Marine Service Offices 86

Maintenance Log

Maintenance Log 87

The description and specifications contained herein were in effect at the time this manual was approved for printing. Mercury Marine, whose policy is one of continued improvement, reserves the right to discontinue models at any time, to change specifications, designs, methods, or procedures without notice and without incurring obligation.

Mercury Marine, Fond du Lac, Wisconsin U.S.A. Litho in U.S.A.

© 2003, Mercury Marine

The following are registered trademarks of Brunswick Corporation: AutoBlend, Force, Jet-Prop, Mariner, Merc, MerCathode, MerCruiser, Mercury, Mercury Marine, Quicksilver, RideGuide and Thruster.

WARRANTY INFORMATION

oq2

Transfer Of Warranty

The limited warranty is transferable to a subsequent purchaser, but only for the remainder of the unused portion of the limited warranty. This will not apply to products used for commercial applications.

DIRECT SALE BY OWNER

The second owner can be registered as the new owner and retain the unused portion of the limited warranty by sending the former owner's plastic Owner Warranty Registration Card and a copy of the bill of sale to show proof of ownership. In the United States and Canada, mail to:

Mercury Marine

W6250 W. Pioneer Road

P.O. Box 1939

Fond du Lac, WI 54936-1939

Attn: Warranty Registration Department

A new Owner Warranty Registration Card will be issued with the new owner's name and address. Registration records will be changed on the factory computer registration file.

There is no charge for this service.

For products purchased outside the United States and Canada, contact the distributor in your country, or the Mercury Marine Service Office closest to you.

WARRANTY INFORMATION

ou1

Warranty Registration

UNITED STATES AND CANADA

1. It is important that your selling dealer fills out the Warranty Registration Card completely and mails it to the factory immediately upon sale of the new product.
2. It identifies name and address of the original purchaser, product model and serial number(s), date of sale, type of use and selling dealer's code, name and address. The dealer also certifies that you are the original purchaser and user of the product.
3. Upon receipt of the Warranty Registration Card at the factory, you will be issued a plastic Owner Warranty Registration Card which is your only valid registration identification. It must be presented to the servicing dealer should warranty service be required. Warranty claims will not be accepted without presentation of this card.
4. A temporary Owner Warranty Registration Card will be presented to you when you purchase the product. It is valid only for 30 days from date of sale while your plastic Owner Warranty Registration Card is being processed. Should your product need service during this period, present the temporary registration card to the dealer. He will attach it to your warranty claim form.
5. Because of your selling dealer's continuing personal interest in your satisfaction, the product should be returned to him for warranty service.
6. If your plastic card is not received within 30 days from date of new product sale, please contact your selling dealer.
7. The product warranty is not effective until the product is registered at the factory.

NOTE: Registration lists must be maintained by factory and dealer on marine products sold in the United States, should notification under the Federal Boat Safety Act be required.

WARRANTY INFORMATION

ou2

Warranty Registration

OUTSIDE THE UNITED STATES AND CANADA

1. It is important that your selling dealer fills out the Warranty Registration Card completely and mails it to the distributor or Marine Power Service Center responsible for administering the warranty registration/claim program for your area.
2. The Warranty Registration Card identifies your name and address, product model and serial number(s), date of sale, type of use and the selling distributor's/dealer's code number, name and address. The distributor/dealer also certifies that you are the original purchaser and user of the product.
3. A copy of the Warranty Registration Card, designated as the "Purchaser's Copy", MUST be given to you immediately after the card has been completely filled out by the selling distributor/dealer. This card represents your factory registration identification, and should be retained by you for future use when required. Should you ever require warranty service on this product, your dealer may ask you for the Warranty Registration Card to verify date of purchase and to use the information on the card to prepare the warranty claim form(s).
4. In some countries, the Marine Power Service Center will issue you a permanent (plastic) Warranty Registration Card within 30 days after receiving the "Factory Copy" of the Warranty Registration Card from your distributor/dealer. If you receive a plastic Warranty Registration Card, you may discard the "Purchaser's Copy" that you received from the distributor/dealer when you purchased the product. Ask your distributor/dealer if this plastic card program applies to you.
5. For further information concerning the Warranty Registration Card and its relationship to Warranty Claim processing, refer to the "International Warranty".

IMPORTANT: Registration lists must be maintained by the factory and dealer in some countries by law. It is our desire to have ALL products registered at the factory should it ever be necessary to contact you. Make sure your dealer/distributor fills out the warranty registration card immediately and sends the factory copy to the Marine Power International Service Center for your area.

WARRANTY INFORMATION

ou40

Mercury Marine Two Years Limited Warranty(Europe)

WHAT IS COVERED

Mercury Marine warrant each new Mercury Outboard, Mariner Outboard, Jet Products, Thruster Electric Trolling Motors, Mercruiser Inboard or Sterndrive engine products to be free in material and workmanship during the period described below.

DURATION OF COVERAGE

This Limited Warranty provides coverage for two (2) years from the date the product is first sold to a recreational use retail purchaser, or the date on which the product is first put into service, whichever occurs first. Commercial users of these products receive warranty coverage of two (2) years from the date of first retail sale, or the accumulation of 500 hours of operation, whichever occurs first. Commercial use is defined as any work or employment related use of the product, or any use of the product which generates income, for any part of the warranty period, even if the product is only occasionally used for such purposes. The repair or replacement of parts, or the performance of service under this warranty, does not extend the life of this warranty beyond its original expiration date. Unexpired warranty coverage can be transferred to one recreational use to a subsequent recreational use customer upon proper re-registration of the product.

CONDITIONS THAT MUST BE MET IN ORDER TO OBTAIN WARRANTY COVERAGE

Warranty coverage is available only to retail customers that purchase from a Dealer authorized by Mercury Marine to distribute the product in the country in which the sale occurred, and then only after the Mercury Marine specified pre-delivery inspection process is completed and documented. Warranty coverage becomes available upon proper registration of the product by the authorized dealer. Inaccurate warranty registration information regarding recreational use, or subsequent change of use from recreational to commercial (unless properly re-registered) may void the warranty at the sole discretion of Mercury Marine. Routine maintenance outlined in the Operation and Maintenance Manual must be timely performed in order to maintain warranty coverage. If this maintenance is performed by the retail customer Mercury Marine reserves the right to make future warranty coverage contingent on proof of proper maintenance.

WHAT MERCURY WILL DO

Mercury's sole and exclusive obligation under this warranty is limited to, at our option, repairing a defective part, replacing such part or parts with new or Mercury Marine certified re-manufactured parts, or refunding the purchase price of the Mercury product. Mercury reserves the right to improve or modify products from time to time without assuming an obligation to modify products previously manufactured.

WARRANTY INFORMATION

Mercury Marine Two Years Limited Warranty(Europe)

HOW TO OBTAIN WARRANTY COVERAGE

The customer must provide Mercury with a reasonable opportunity to repair, and reasonable access to the product for warranty service. Warranty claims shall be made by delivering the product for inspection to a Mercury dealer authorized to service the product. If purchaser cannot deliver the product to such a dealer, written notice must be given to Mercury. We will then arrange for the inspection and any covered repair. Purchaser in that case shall pay for all related transportation charges and/or travel time. If the service provided is not covered by this warranty, purchaser shall pay for all related labor and material, and any other expenses associated with that service. Purchaser shall not, unless requested by Mercury, ship the product or parts of the product directly to Mercury. The warranty registration card is the only valid registration identification and must be presented to the dealer at the time warranty service is requested in order to obtain coverage.

WARRANTY INFORMATION

Mercury Marine Two Years Limited Warranty(Europe)

ou24a

WHAT IS NOT COVERED

This limited warranty does not cover routine maintenance items, tune ups, adjustments, normal wear and tear, damage caused by abuse, abnormal use, use of a propeller or gear ratio that does not allow the engine to run in its recommended wide-open-throttle RPM range (see the Operation and Maintenance Manual), operation of the product in a manner inconsistent with the recommended operation/duty cycle section of the Operation and Maintenance Manual, neglect, accident, submersion, improper installation (proper installation specifications and techniques are set forth in the installation instructions for the product), improper service, use of an accessory or part not manufactured or sold by us, jet pump impellers and liners, operation with fuels, oils or lubricants which are not suitable for use with the product (see the Operation and Maintenance Manual), alteration or removal of parts, or water entering the engine through the fuel intake, air intake or exhaust system. Use of the product for racing or other competitive activity, or operating with a racing type lower unit, at any point, even by a prior owner of the product, voids the warranty.

Expenses related to haul-out, launch, towing, storage, telephone, rental, inconvenience, slip fees, insurance coverage, loan payments, loss of time, loss of income, or any other type of incidental or consequential damages are not covered by this warranty. Also, expenses associated with the removal and/or replacement of boat partitions or material caused by boat design for access to the product are not covered by this warranty.

WARRANTY INFORMATION

Mercury Marine Two Years Limited Warranty(Europe)

No individual or entity, including Mercury Marine authorized dealers, has been given authority by Mercury Marine to make any affirmation, representation or warranty regarding the product, other than those contained in this limited warranty, and if made, shall not be enforceable against Mercury Marine.

For additional information regarding events and circumstances covered by this warranty, and those that are not, see the Warranty Coverage section of the Operation and Maintenance Manual, incorporated by reference into this warranty.

DISCLAIMERS AND LIMITATIONS:

THE IMPLIED WARRANTIES OF MERCHANTABILITY AND FITNESS FOR A PARTICULAR PURPOSE ARE EX-PRESSLY DISCLAIMED. TO THE EXTENT THAT THEY CANNOT BE DISCLAIMED, THE IMPLIED WARRANTIES ARE LIMITED IN DURATION TO THE LIFE OF THE EXPRESS WARRANTY. INCIDENTAL AND CONSEQUENTIAL DAMAGES ARE EXCLUDED FROM COVERAGE UNDER THIS WARRANTY. SOME STATES/COUNTRIES DO NOT ALLOW FOR THE DISCLAIMERS, LIMITATIONS AND EXCLUSIONS IDENTIFIED ABOVE, AS A RESULT, THEY MAY NOT APPLY TO YOU. THIS WARRANTY GIVES YOU SPECIFIC LEGAL RIGHTS, AND YOU MAY ALSO HAVE OTHER LEGAL RIGHTS WHICH VARY FROM STATE TO STATE AND COUNTRY TO COUNTRY.

WARRANTY INFORMATION

Mercury Marine ONE Year Limited

Warranty(Confederation of Independent States, Middle–East, Africa)

WHAT IS COVERED

Mercury Marine warrant each new Mercury outboard, Mariner outboard, Jet Products, Thruster Electric Trolling Motors, Mercruiser Inboard or Sterndrive engine products to be free in material and workmanship during the period described below.

DURATION OF COVERAGE

This Limited Warranty provides coverage for one (1) year from the date the product is first sold to a recreational use retail purchaser, or the date on which the product is first put into service, whichever occurs first. Commercial users of these products receive warranty coverage of one (1) years from the date of first retail sale, or the accumulation of 500 hours of operation, whichever occurs first. Commercial use is defined as any work or employment related use of the product, or any use of the product which generates income, for any part of the warranty period, even if the product is only occasionally used for such purposes. The repair or replacement of parts, or the performance of service under this warranty, does not extend the life of this warranty beyond its original expiration date. Unexpired warranty coverage can be transferred to a subsequent purchaser upon proper re–registration of the product.

CONDITIONS THAT MUST BE MET IN ORDER TO OBTAIN WARRANTY COVERAGE

Warranty coverage is available only to retail customers that purchase from a Dealer authorized by Mercury Marine to distribute the product in the country in which the sale occurred, and then only after the Mercury Marine specified pre–delivery inspection process is completed and documented. Warranty coverage becomes available upon proper registration of the product by the authorized dealer. Inaccurate warranty registration information regarding recreational use, or subsequent change of use from recreational to commercial (unless properly re–registered) may void the warranty at the sole discretion of Mercury Marine. Routine maintenance outlined in the Operation and Maintenance Manual must be timely performed in order to maintain warranty coverage. If this maintenance is performed by the retail customer Mercury Marine reserves the right to make future warranty coverage contingent on proof of proper maintenance.

WARRANTY INFORMATION

Mercury Marine ONE Year Limited

Warranty(Confederation of Independent States, Middle–East, Africa)

WHAT MERCURY WILL DO

Mercury's sole and exclusive obligation under this warranty is limited to, at our option, repairing a defective part, replacing such part or parts with new or Mercury Marine certified re-manufactured parts, or refunding the purchase price of the Mercury product. Mercury reserves the right to improve or modify products from time to time without assuming an obligation to modify products previously manufactured.

HOW TO OBTAIN WARRANTY COVERAGE

The customer must provide Mercury with a reasonable opportunity to repair, and reasonable access to the product for warranty service. Warranty claims shall be made by delivering the product for inspection to a Mercury dealer authorized to service the product. If purchaser cannot deliver the product to such a dealer, written notice must be given to Mercury. We will then arrange for the inspection and any covered repair. Purchaser in that case shall pay for all related transportation charges and/or travel time. If the service provided is not covered by this warranty, purchaser shall pay for all related labor and material, and any other expenses associated with that service. Purchaser shall not, unless requested by Mercury, ship the product or parts of the product directly to Mercury. The warranty registration card is the only valid registration identification and must be presented to the dealer at the time warranty service is requested in order to obtain coverage.

WARRANTY INFORMATION

Mercury Marine ONE Year Limited

Warranty(Confederation of Independent States, Middle–East, Africa)

WHAT IS NOT COVERED

This limited warranty does not cover routine maintenance items, tune ups, adjustments, normal wear and tear, damage caused by abuse, abnormal use, use of a propeller or gear ratio that does not allow the engine to run in its recommended wide–open–throttle RPM range (see the Operation and Maintenance Manual), operation of the product in a manner inconsistent with the recommended operation/duty cycle section of the Operation and Maintenance Manual, neglect, accident, submersion, improper installation (proper installation specifications and techniques are set forth in the installation instructions for the product), improper service, use of an accessory or part not manufactured or sold by us, jet pump impellers and liners, operation with fuels, oils or lubricants which are not suitable for use with the product (see the Operation and Maintenance Manual), alteration or removal of parts, or water entering the engine through the fuel intake, air intake or exhaust system. Use of the product for racing or other competitive activity, or operating with a racing type lower unit, at any point, even by a prior owner of the product, voids the warranty.

Expenses related to haul–out, launch, towing, storage, telephone, rental, inconvenience, slip fees, insurance coverage, loan payments, loss of time, loss of income, or any other type of incidental or consequential damages are not covered by this warranty. Also, expenses associated with the removal and/or replacement of boat partitions or material caused by boat design for access to the product are not covered by this warranty.

WARRANTY INFORMATION

Mercury Marine ONE Year Limited

Warranty(Confederation of Independent States, Middle–East, Africa)

No individual or entity, including Mercury Marine authorized dealers, has been given authority by Mercury Marine to make any affirmation, representation or warranty regarding the product, other than those contained in this limited warranty, and if made, shall not be enforceable against Mercury Marine.

For additional information regarding events and circumstances covered by this warranty, and those that are not, see the Warranty Coverage section of the Operation and Maintenance Manual, incorporated by reference into this warranty.

DISCLAIMERS AND LIMITATIONS:

THE IMPLIED WARRANTIES OF MERCHANTABILITY AND FITNESS FOR A PARTICULAR PURPOSE ARE EXPRESSLY DISCLAIMED. TO THE EXTENT THAT THEY CANNOT BE DISCLAIMED, THE IMPLIED WARRANTIES ARE LIMITED IN DURATION TO THE LIFE OF THE EXPRESS WARRANTY. INCIDENTAL AND CONSEQUENTIAL DAMAGES ARE EXCLUDED FROM COVERAGE UNDER THIS WARRANTY. SOME STATES/COUNTRIES DO NOT ALLOW FOR THE DISCLAIMERS, LIMITATIONS AND EXCLUSIONS IDENTIFIED ABOVE, AS A RESULT, THEY MAY NOT APPLY TO YOU. THIS WARRANTY GIVES YOU SPECIFIC LEGAL RIGHTS, AND YOU MAY ALSO HAVE OTHER LEGAL RIGHTS WHICH VARY FROM STATE TO STATE AND COUNTRY TO COUNTRY.

WARRANTY INFORMATION

ou51

3 Year Limited Warranty Against Corrosion Failure

WHAT IS COVERED

Mercury Marine warrants each new Mercury outboard, Mariner outboard, Mercury Racing, Jet Products, Thruster Electric Motor, Mercury Racing, Tracker by Mercury Marine Outboard, Mercruiser Inboard or sterndrive engine (Product) rendered inoperative as a direct result of corrosion for the period of time described below.

DURATION OF COVERAGE

This limited corrosion warranty provides coverage for three (3) years from the date the product is first sold, or the date on which the product is first put into service, whichever occurs first. The repair or replacement of parts, or the performance of service under this warranty does not extend the life of this warranty beyond its original expiration date. Unexpired warranty coverage can be transferred to subsequent (noncommercial use) purchaser upon proper re-registration of the product.

CONDITIONS THAT MUST BE MET IN ORDER TO OBTAIN WARRANTY COVERAGE

Warranty coverage is available only to retail customers that purchase from a Dealer authorized by Mercury Marine to distribute the product in the country in which the sale occurred, and then only after the Mercury Marine specified pre-delivery inspection process is completed and documented. Warranty coverage becomes available upon proper registration of the product by the authorized dealer. Corrosion prevention devices specified in the Operation and Maintenance Manual must be in use on the boat, and routine maintenance outlined in the Operation and Maintenance Manual must be timely performed (including without limitation the replacement of sacrificial anodes, use of specified lubricants, and touch-up of nicks and scratches) in order to maintain warranty coverage. If this maintenance is performed by the retail customer Mercury Marine reserves the right to make future warranty coverage contingent on proof of proper maintenance.

WHAT MERCURY WILL DO

Mercury's sole and exclusive obligation under this warranty is limited to, at our option, repairing a corroded part, replacing such part or parts with new or Mercury Marine certified re-manufactured parts, or refunding the purchase price of the Mercury product. Mercury reserves the right to improve or modify products from time to time without assuming an obligation to modify products previously manufactured.

WARRANTY INFORMATION

3 Year Limited Warranty Against Corrosion Failure

HOW TO OBTAIN WARRANTY COVERAGE

The customer must provide Mercury with a reasonable opportunity to repair, and reasonable access to the product for warranty service. Warranty claims shall be made by delivering the product for inspection to a Mercury dealer authorized to service the product. If purchaser cannot deliver the product to such a dealer, written notice must be given to Mercury. We will then arrange for the inspection and any covered repair. Purchaser in that case shall pay for all related transportation charges and/or travel time. If the service provided is not covered by this warranty, purchaser shall pay for all related labor and material, and any other expenses associated with that service. Purchaser shall not, unless requested by Mercury, ship the product or parts of the product directly to Mercury. The warranty registration card is the only valid registration identification and must be presented to the dealer at the time warranty service is requested in order to obtain coverage.

WARRANTY INFORMATION

3 Year Limited Warranty Against Corrosion Failure

WHAT IS NOT COVERED

This limited warranty does not cover electrical system corrosion; corrosion resulting from damage, corrosion which causes purely cosmetic damage, abuse or improper service; corrosion to accessories, instruments, steering systems; corrosion to factory installed jet drive unit; damage due to marine growth; product sold with less than a one year limited Product warranty; replacement parts (parts purchased by customer); products used in a commercial application. Commercial use is defined as any work or employment related use of the product, or any use of the product which generates income, for any part of the warranty period, even if the product is only occasionally used for such purposes.

Corrosion damage caused by stray electrical currents (on-shore power connections, nearby boats, submerged metal) is not covered by this corrosion warranty and should be protected against by the use of a corrosion protection system, such as the Mercury Precision Parts or Quicksilver MerCathode system and/or Galvanic Isolator. Corrosion damage caused by improper application of copper base anti-fouling paints is also not covered by this limited warranty. If anti-foul-ing protection is required, Tri-Butyl-Tin-Adipate (TBTA) base anti-fouling paints are recommended on Outboard and MerCruiser boating applications. In areas where TBTA base paints are prohibited by law, copper base paints can be used on the hull and transom. Do not apply paint to the outboard or MerCruiser product. In addition, care must be taken to avoid an electrical interconnection between the warranted product and the paint. Refer to the Operation and Maintenance Manual for additional details.

For additional information regarding events and circumstances covered by this warranty, and those that are not, see the Warranty Coverage section of the Operation and Maintenance Manual, incorporated by reference into this warranty.

DISCLAIMERS AND LIMITATIONS:

THE IMPLIED WARRANTIES OF MERCHANTABILITY AND FITNESS FOR A PARTICULAR PURPOSE ARE EXPRESSLY DISCLAIMED. TO THE EXTENT THAT THEY CANNOT BE DISCLAIMED, THE IMPLIED WARRANTIES ARE LIMITED IN DURATION TO THE LIFE OF THE EXPRESS WARRANTY. INCIDENTAL AND CONSEQUENTIAL DAMAGES ARE EXCLUDED FROM COVERAGE UNDER THIS WARRANTY. SOME STATES/COUNTRIES DO NOT ALLOW FOR THE DISCLAIMERS, LIMITATIONS AND EXCLUSIONS IDENTIFIED ABOVE, AS A RESULT, THEY MAY NOT APPLY TO YOU. THIS WARRANTY GIVES YOU SPECIFIC LEGAL RIGHTS, AND YOU MAY ALSO HAVE OTHER LEGAL RIGHTS WHICH VARY FROM STATE TO STATE AND COUNTRY TO COUNTRY.

WARRANTY INFORMATION

op5

Warranty Coverage and Exclusions

The purpose of this section is to help eliminate some of the more common misunderstandings regarding warranty coverage. The following information explains some of the types of services that are not covered by warranty. The provisions set forth following have been incorporated by reference into the Three Year Limited Warranty Against Corrosion Failure, the International Limited Outboard Warranty, and the United States and Canada Limited Outboard Warranty.

Keep in mind that warranty covers repairs that are needed within the warranty period because of defects in material and workmanship. Installation errors, accidents, normal wear, and a variety of other causes that affect the product are not covered.

Warranty is limited to defects in material or workmanship, but only when the consumer sale is made in the country to which distribution is authorized by us.

Should you have any questions concerning warranty coverage, contact your authorized dealer. They will be pleased to answer any questions that you may have.

GENERAL EXCLUSIONS FROM WARRANTY

1. Minor adjustments and tune-ups, including checking, cleaning or adjusting spark plugs, ignition components, carburetor settings, filters, belts, controls, and checking lubrication made in connection with normal services.
2. Factory Installed Jet Drive units – Specific parts excluded from the warranty are: The jet drive impeller and jet drive liner damaged by impact or wear, and water damaged drive shaft bearings as a result of improper maintenance.
3. Damage caused by neglect, lack of maintenance, accident, abnormal operation or improper installation or service.
4. Haul-out, launch, towing charges, removal and/or replacement of boat partitions or material because of boat design for necessary access to the product, all related transportation charges and/or travel time, etc. Reasonable access must be provided to the product for warranty service. Customer must deliver product to an authorized dealer.
5. Additional service work requested by customer other than that necessary to satisfy the warranty obligation.
6. Labor performed by other than an authorized dealer may be covered only under following circumstances: When performed on emergency basis (providing there are no authorized dealers in the area who can perform the work required or have no facilities to haul out, etc., and prior factory approval has been given to have the work performed at this facility).
7. All incidental and/or consequential damages (storage charges, telephone or rental charges of any type, inconvenience or loss of time or income) are the owner's responsibility.

WARRANTY INFORMATION

op6

Warranty Coverage and Exclusions

8. Use of other than Mercury Precision or Quicksilver parts when making warranty repairs.
9. Oils, lubricants or fluids changed as a matter of normal maintenance is customer's responsibility unless loss or contamination of same is caused by product failure that would be eligible for warranty consideration.
10. Participating in or preparing for racing or other competitive activity or operating with a racing type lower unit.
11. Engine noise does not necessarily indicate a serious engine problem. If diagnosis indicates a serious internal engine condition which could result in a failure, condition responsible for noise should be corrected under the warranty.
12. Lower unit and/or propeller damage caused by striking a submerged object is considered a marine hazard.
13. Water entering engine through the fuel intake, air intake or exhaust system. or submersion.
14. Failure of any parts caused by lack of cooling water, which results from starting motor out of water, foreign material blocking inlet holes, motor being mounted too high or trimmed too far out.
15. Use of fuels and lubricants which are not suitable for use with or on the product. Refer to the Maintenance Section.
16. Our limited warranty does not apply to any damage to our products caused by the installation or use of parts and accessories which are not manufactured or sold by us. Failures which are not related to the use of those parts or accessories are covered under warranty if they otherwise meet the terms of the limited warranty for that product.

GENERAL INFORMATION

oba2

Boater's Responsibilities

The operator (driver) is responsible for the correct and safe operation of the boat and safety of its occupants and general public. It is strongly recommended that each operator (driver) read and understand this entire manual before operating the outboard.

Be sure at least one additional person on board is instructed in the basics of starting and operating the outboard and boat handling in case the driver is unable to operate the boat.

This manual as well as safety labels posted on the outboard use the following safety alerts to draw your attention to special safety instructions that should be followed.

DANGER

DANGER – Immediate hazards which **WILL** result in severe personal injury or death.

WARNING

WARNING – Hazards or unsafe practices which **COULD** result in severe personal injury or death.

CAUTION

CAUTION – Hazards or unsafe practices which could result in minor injury or product or property damage.

GENERAL INFORMATION

obb2

Before Operating Your Outboard

Read this manual carefully. Learn the difference in handling characteristics between a jet drive boat and a propeller driven boat including:

- *Steering at low speeds* - unlike propeller driven boats, the jet drive boat tends to lose steering control as less water is drawn in and expelled. Increase speed slightly to regain steering.
- *Maneuverability* - the jet drive is highly maneuverable at higher speeds, more so, than propeller driven boats. Use caution when turning to prevent spin-outs.
- *In neutral* - the impeller continues to rotate. Although the approximate balancing of forward and reverse thrust will minimize boat movement, the boat may tend to creep slowly forward or backward. This is normal for a direct-drive jet-driven boat. The operator should be aware of this and use caution whenever the engine is running.

If you have any questions, contact your dealer.

Safety and operating information that is practiced along with using good common sense can help prevent personal injury and product damage.

ob19

Recording Serial Number

It is important to record this number for future reference. The serial number is located on the outboard as shown.

- a - Serial Number
- b - Model Year
- c - Model Designation
- d - Year Manufactured
- e - Certified Europe Insignia (as Applicable)

gob30

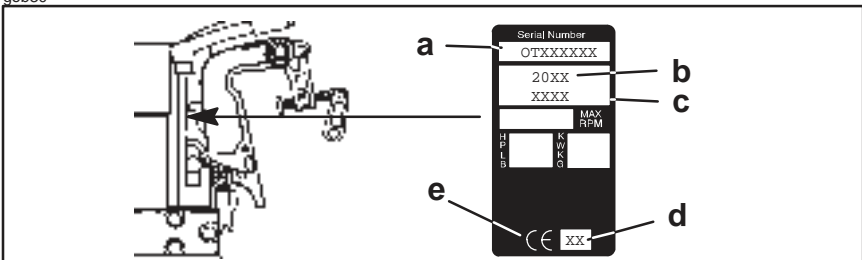

ob

GENERAL INFORMATION

gob1

1	U.S. COAST GUARD CAPACITY	
	MAXIMUM HORSEPOWER	XXX
	MAXIMUM PERSON CAPACITY (POUNDS)	XXX
	MAXIMUM WEIGHT CAPACITY	XXX

obc1

Boat Horsepower Capacity

- 1 Do not overpower or overload your boat. Most boats will carry a required capacity plate indicating the maximum acceptable power and load as determined by the manufacturer following certain federal guidelines. If in doubt, contact your dealer or the boat manufacturer.

WARNING

Using an outboard that exceeds the maximum horsepower limit of a boat can: 1. cause loss of boat control 2. place too much weight at the transom altering the designed flotation characteristics of the boat or 3. cause the boat to break apart particularly around the transom area. Overpowering a boat can result in serious injury, death or boat damage.

GENERAL INFORMATION

gob31

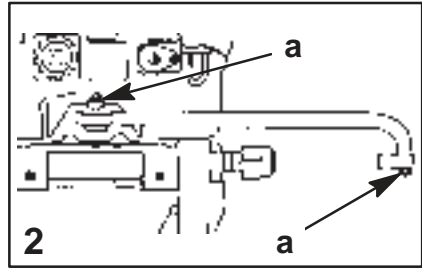
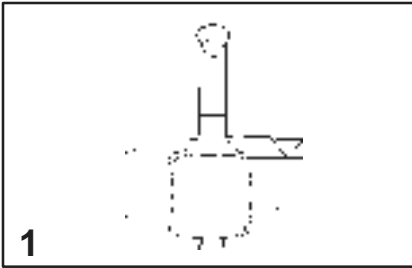

obe2

Outboard Remote Control (If Equipped)

- 1 The remote control connected to your outboard must be equipped with a “start-in-neutral” only protection device. This prevents the engine from starting when the shift is actuated in any position other than neutral.

⚠ WARNING

Avoid serious injury or death from a sudden unexpected acceleration when starting your engine. The design of this outboard requires that the remote control used with it must have a built in “start-in-neutral” only protection device.

obf1

Remote Steering Notice

- 2 The steering link rod that connects the steering cable to the engine must be fastened utilizing self-locking nuts (a). These self-locking nuts must never be replaced with common nuts (non locking) as they will work loose and vibrate off, freeing the link rod to disengage.

⚠ WARNING

Disengagement of a steering link rod can result in the boat taking a full, sudden, sharp turn. This potentially violent action can cause occupants to be thrown overboard exposing them to serious injury or death.

GENERAL INFORMATION

gob8

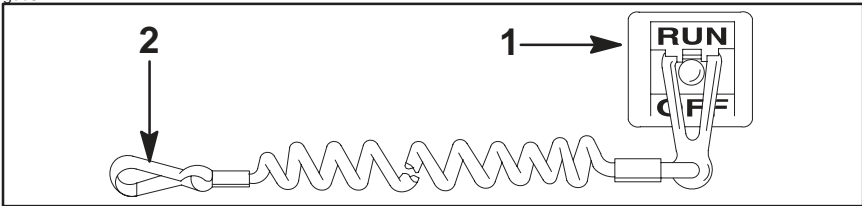

obg8

Lanyard Stop Switch

- 1 The purpose of a lanyard stop switch is to turn off the engine when the operator moves far enough away from the operator's position (as in accidental ejection from the operator's position) to activate the switch. Tiller handle outboards and some remote control units are equipped with a lanyard stop switch. A lanyard stop switch can be installed as an accessory – generally on the dashboard or side adjacent to the operator's position.
- 2 The lanyard is a cord usually between 4 and 5 feet (1220 and 1524 mm) in length when stretched out with an element on one end made to be inserted into the switch and a snap on the other end for attaching to the operator. The lanyard is coiled to make its at-rest condition as short as possible so as to minimize the likelihood of lanyard entanglement with nearby objects. It is made as long as it is in its stretched condition to minimize the likelihood of accidental activation should the operator choose to move around in an area close to the normal operator's position. If it is desired to have a shorter lanyard, wrap the lanyard around the operator's wrist or leg, or tie a knot in the lanyard.

(continued on next page)

GENERAL INFORMATION

Lanyard Stop Switch (Continued)

Read the following Safety Information before proceeding.

Important Safety Information: The purpose of a lanyard stop switch is to stop the engine when the operator moves far enough away from the operator's position to activate the switch. This would occur if the operator accidentally falls overboard or moves within the boat a sufficient distance from the operator's position. Accidental ejections and falls overboard are more likely to occur in certain types of boats such as low sided inflatables or bass boats, high-performance boats and light, sensitive-handling fishing boats operated by hand-tiller. Accidental ejections and falls overboard are also likely to occur as a result of poor operating practices such as sitting on the back of the seat or gunwale at planing speeds, standing at planing speeds, sitting on elevated fishing boat decks, operating at planing speeds in shallow or obstacle-infested waters, releasing your grip on a steering wheel or tiller handle that is pulling in one direction, drinking alcohol or consuming drugs, or daring, high-speed boat maneuvers.

While activation of the lanyard stop switch will stop the engine immediately, a boat will continue to coast for some distance depending upon the velocity and degree of any turn at shut-down. However, the boat will not complete a full circle. While the boat is coasting, it can cause injury to anyone in the boat's path as seriously as the boat would when under power.

We strongly recommend that other occupants be instructed on proper starting and operating procedures should they be required to operate the engine in an emergency (e.g. if the operator is accidentally ejected).

WARNING

Should the operator fall out of the boat, the possibility of serious injury or death from being run over by the boat can be greatly reduced by stopping the engine immediately. Always properly connect both ends of the stop switch lanyard – to the stop switch and the operator.

(continued on next page)

GENERAL INFORMATION

Lanyard Stop Switch (Continued)

Accidental or unintended activation of the switch during normal operation is also a possibility. This could cause any, or all, of the following potentially hazardous situations:

1. Occupants could be thrown forward due to unexpected loss of forward motion – a particular concern for passengers in the front of the boat who could be ejected over the bow and possibly struck by the hull.
2. Loss of power and directional control in heavy seas, strong current or high winds.
3. Loss of control when docking.

WARNING

Avoid serious injury or death from deceleration forces resulting from accidental or unintended stop switch activation. The boat operator should never leave the operator's station without first disconnecting the stop switch lanyard from the operator.

obo1

Stopping The Boat In An Emergency

Your jet powered boat has emergency stopping capability unique to this form of propulsion.

In an emergency, putting the remote control handle into reverse and applying reverse throttle can rapidly slow down your boat and reduce the stopping distance. Keep in mind, however, that such a maneuver may cause occupants in the boat to be thrown forward or even out of the boat.

WARNING

Using the emergency stopping capability of your jet drive will slow down your boat in an emergency. However keep in mind, sudden stopping may cause the occupants in the boat to be thrown forward or even out of the boat. This action may result in serious injury or death.

ob

GENERAL INFORMATION

gob3

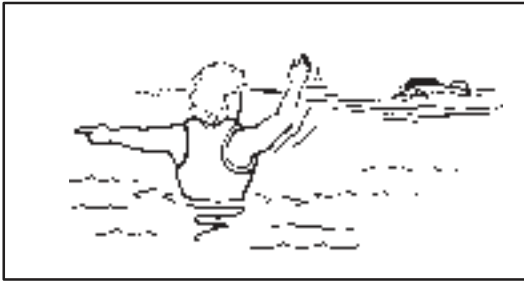

obh3

Protecting People In The Water

WHILE YOU ARE CRUISING

It is very difficult for a person standing or floating in the water to take quick action to avoid a boat heading in their direction even at slow speed.

Always slow down and exercise extreme caution any time you are boating in an area where there might be people in the water.

Avoid shallow water or where any loose material such as sand, shells, seaweed, grass, tree branches, etc. can be sucked in and expelled from the the pump as a high speed projectile.

obp1

WHILE BOAT IS STATIONARY

Stop the engine immediately whenever anyone in the water is near your boat. The jet drive is always drawing water through the water intake when the engine is running. Stay away from the water intake located under the jet drive and never insert an object into the water intake or water outlet nozzle when the engine is running.

WARNING

Avoid injury resulting from contacting the rotating impeller or having your hair, clothing or loose objects drawn into the water intake and wrapping around the impeller shaft. Stay away from the water intake and never insert an object into the water intake or water outlet nozzle when the engine is running.

ob

GENERAL INFORMATION

gob4

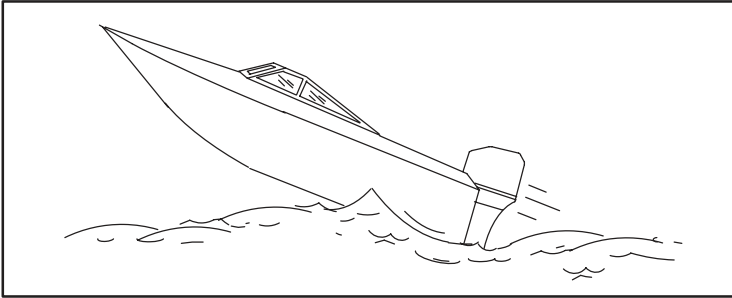

obu1

Wave And Wake Jumping

Operating recreational boats over waves and wakes is a natural part of boating. However, when this activity is done with sufficient speed to force the boat hull partially or completely out of the water, certain hazards arise, particularly when the boat re-enters the water.

The primary concern is the boat changing direction while in the midst of the jump. In such case the landing may cause the boat to veer violently in a new direction. Such a sharp change in direction can cause occupants to be thrown out of their seats, or out of the boat.

There is another less common hazardous result from allowing your boat to launch off a wave or wake. If the bow of your boat pitches down far enough while airborne, upon water contact it may penetrate under the water surface and “submarine” for an instant. This will bring the boat to a nearly instantaneous stop and can send the occupants flying forward. The boat may also steer sharply to one side.

WARNING

Avoid serious injury or death from being thrown within or out of a boat when it lands after jumping a wave or wake. Avoid wave or wake jumping whenever possible. Instruct all occupants that if a wake or wave jump occurs, get low and hang on to any boat hand hold.

GENERAL INFORMATION

gob4

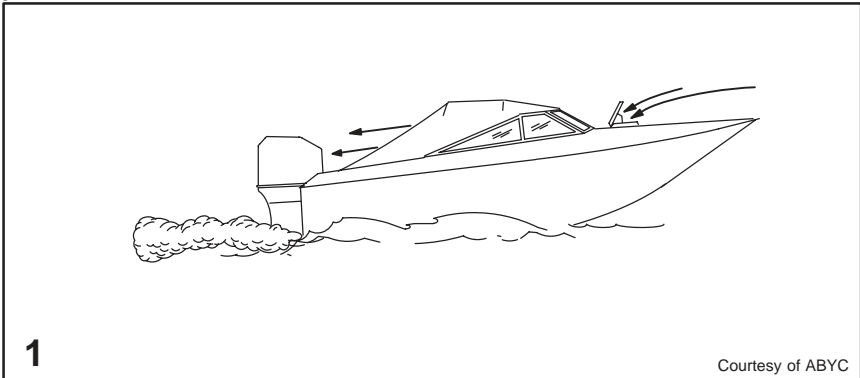

obi2

Exhaust Emissions

BE ALERT TO CARBON MONOXIDE POISONING

Carbon monoxide is present in the exhaust fumes of all internal combustion engines including the outboards, stern drives and inboard engines that propel boats, as well as the generators that power various boat accessories. Carbon monoxide is a deadly gas that is odorless, colorless and tasteless.

Early symptoms of carbon monoxide poisoning which should not be confused with seasickness or intoxication, include headache, dizziness, drowsiness, and nausea.

⚠ WARNING

Avoid the combination of a running engine and poor ventilation. Prolonged exposure to carbon monoxide in sufficient concentration can lead to unconsciousness, brain damage, or death.

GOOD VENTILATION

Ventilate passenger area, open side curtains, or forward hatches to remove fumes.

1 Example of desired air flow through the boat.

GENERAL INFORMATION

gob39

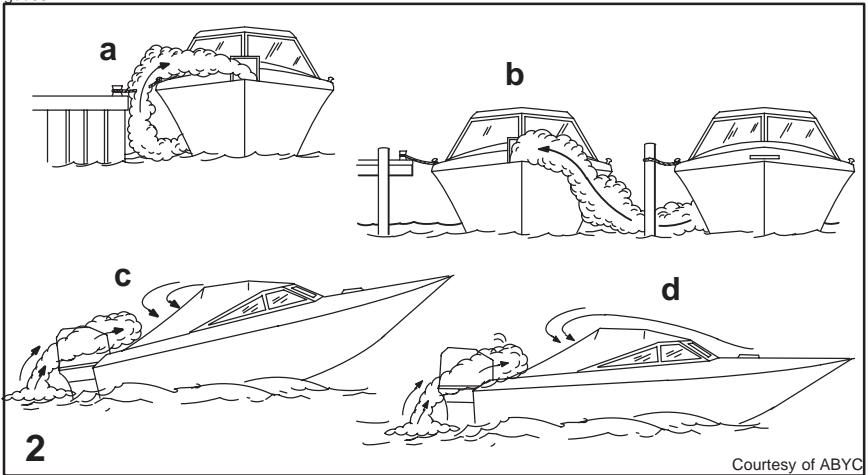

Courtesy of ABYC

obi3

Exhaust Emissions (Continued)

POOR VENTILATION

Under certain running and/or wind conditions, permanently enclosed or canvas enclosed cabins or cockpits with insufficient ventilation may draw in carbon monoxide. Install one or more carbon monoxide detectors in your boat.

Although the occurrence is rare, on a very calm day, swimmers and passengers in an unclosed area of a stationary boat that contains or is near a running engine may be exposed to a hazardous level of carbon monoxide.

2 Examples of Poor Ventilation:

While boat is stationary

- a. Running the engine when the boat is moored in a confined space.
- b. Mooring close to another boat that has its engine running.

While boat is moving

- c. Running the boat with the trim angle of the bow too high.
- d. Running the boat with no forward hatches open (station wagon effect).

GENERAL INFORMATION

Selecting Accessories For Your Outboard

Genuine Mercury Precision or Quicksilver Accessories have been specifically designed and tested for your outboard. These accessories are available from Mercury Marine dealers.

Some accessories not manufactured or sold by Mercury Marine are not designed to be safely used with your outboard or outboard operating system. Acquire and read the installation, operation, and maintenance manuals for all your selected accessories.

WARNING

Check with your dealer before installation of accessories. The misuse of acceptable accessories or the use of unacceptable accessories can result in serious injury, death, or product failure.

Safe Boating Suggestions

In order to safely enjoy the waterways, familiarize yourself with local and other government boating regulations and restrictions, and consider the following suggestions.

Use flotation devices. Have an approved personal flotation device of suitable size for each person aboard (it is the law) and have it readily accessible.

Do not overload your boat. Most boats are rated and certified for maximum load (weight) capacities (refer to your boat capacity plate). If in doubt, contact your dealer or the boats manufacturer.

Perform safety checks and required maintenance. Follow a regular schedule and ensure that all repairs are properly made.

(continued on next page)

GENERAL INFORMATION

Safe Boating Suggestions (Continued)

Know and obey all nautical rules and laws of the waterways. Boat operators should complete a boating safety course. Courses are offered in the U.S.A. by (1) The U.S. Coast Guard Auxiliary, (2) The Power Squadron, (3) The Red Cross and (4) your state boating law enforcement agency. Inquiries may be made to the Boating Hot-line, 1-800-368-5647 or the Boat U.S. Foundation information number 1-800-336-BOAT.

Make sure everyone in the boat is properly seated. Don't allow anyone to sit or ride on any part of the boat that was not intended for such use. This includes backs of seats, gunwales, transom, bow, decks, raised fishing seats, any rotating fishing seat; anywhere that sudden unexpected acceleration, sudden stopping, unexpected loss of boat control or sudden boat movement could cause a person to be thrown overboard or into the boat.

Never be under the influence of alcohol or drugs while boating (it is the law). They impair your judgment and greatly reduce your ability to react quickly.

Prepare other boat operators. Instruct at least one person on board in the basics of starting and operating the jet drive and boat handling in case the driver becomes disabled or falls overboard.

Passenger boarding. Stop the engine whenever passengers are boarding, unloading or are near the back (stern) of the boat. Just shifting the outboard into neutral is not sufficient.

Be alert. The operator of the boat is responsible by law to "maintain a proper lookout by sight (and hearing)." The operator must have an unobstructed view particularly to the front. No passengers, load, or fishing seats should block the operators view when operating the boat above idle speed.

Avoid shallow water conditions. Never operate your jet drive in very shallow water or where there is a noticeable amount of floating debris or weeds. Always be in at least 2 to 3 feet of water. Any loose material such as sand, shells, seaweed, grass, tree branches or etc. can be sucked up by the pump and may not only block the water flow and cause lost of steering control but can be expelled from the rear of the pump as a high-speed projectile.

(continued on next page)

GENERAL INFORMATION

Safe Boating Suggestions (Continued)

Watch for boat creeping in neutral. When the jet drive is in neutral, the drive impeller continues to rotate. Although the approximate balancing of forward and reverse thrust will minimize boat movement, the boat may tend to creep slowly forward or backward. This is normal for a direct-drive jet-driven boat. The operator should be aware of this and use caution whenever the engine is running.

Never drive your boat directly behind a water skier in case the skier falls. As an example, your boat traveling at 25 miles per hour (40 km/hr) in 5 seconds will overtake a fallen skier who was 200 feet (61m) in front of you.

Watch fallen skiers. When using your boat for water skiing or similar activities, always keep a fallen or down skier on the operator's side of the boat while returning to attend the skier. The operator should always have the down skier in sight and never back up to the skier or anyone in the water.

Report accidents. Boat operators are required by law to file a Boating Accident Report with their state boating law enforcement agency when their boat is involved in certain boating accidents. A boating accident must be reported if (1) there is loss of life or probable loss of life, (2) there is personal injury requiring medical treatment beyond first aid, (3) there is damage to boats or other property where the damage value exceeds \$500.00 or (4) there is complete loss of the boat. Seek further assistance from local law enforcement.

GENERAL INFORMATION

obm13

Specifications

Models	20
Jet Power	20
Engine Horsepower	25
Full Throttle RPM Range	5000-6000 RPM
Idle Speed in Forward Gear	750 ± 50 RPM
Number of Cylinders	2
Piston Displacement	24.4 cu. in. (400cc)
Cylinder Bore	2.560 in. (65mm)
Piston Stroke	2.360 in. (60mm)
Recommended Spark Plug	NGK BP8H-N-10*
Spark Plug Gap	.040 in. (1.0mm)
Recommended Gasoline	Refer to Fuel Section
Recommended Oil	Refer to Fuel Section
Battery Rating	465 Marine Cranking Amps (MCA) or 350 Cold Cranking Amps (CCA)

*Use NGK BPZ8H-N-10 spark plug where radio frequency interference (RFI) suppression is required.

INSTALLATION

goc18

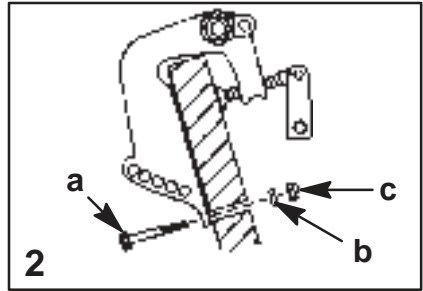

ocj1

Installing Outboard On The Transom

NOTE: Determine the recommended mounting height of your outboard by following instructions in the outboard jet installation supplement (provided with the outboard).

- 1** Place outboard on center line of transom. Tighten transom clamp handles.
- 2** To prevent loss of outboard overboard, fasten outboard by drilling two 5/16 in. (7.9 mm) holes through the transom using transom clamp holes as a template. Fasten with two bolts (a), flat washers (b) and locknuts (c). Use a marine waterproofing sealer in holes and around bolts to make the installation water tight.

INSTALLATION

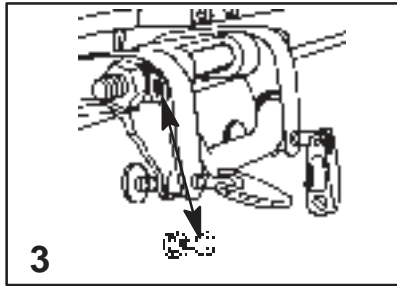

Fastening Security Line

- 3** The primary purpose for installing a security line is to prevent loss of the outboard if the outboard becomes detached from the boat transom.

An effective security line should be of a working strength of at least five times the weight of the outboard.

The security line should be attached between the boat and outboard following one of these steps.

Step 1. The length of the security line should be short enough and affixed in a manner to prevent the outboard from rising up and disengaging off the boat transom.

Step 2. The length of the security line should be long enough and affixed in a manner to permit a detached outboard to submerge completely behind the boat and stop running but not too short that could allow the outboard to continue running and propel itself back into the boat.

WARNING

If the length of security line being used is long enough to allow the outboard to disengage off the boat transom but is too short to not allow the outboard to submerge behind the boat and stop running, the outboard could continue running and propel itself back into the boat with the propeller rotating under power. This exposes the occupants to serious injury or death.

INSTALLATION

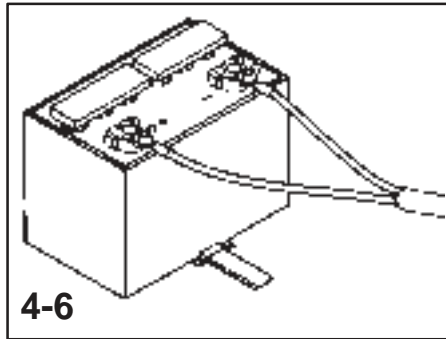

ock1

Battery Installation – Electric Start Models

MOUNTING BATTERY

- 4** Follow battery manufacturer's instructions carefully. Mount battery in the boat so it is secured against movement, preferably in a battery box. Make sure battery is equipped with a nonconductive shield to prevent accidental shorting of battery terminals.

ocg1

Battery Connections

CONNECTING OUTBOARD BATTERY CABLES

- 5** First, connect the red battery cable to the (+) positive battery terminal and then connect the black battery cable to the (–) negative battery terminal.

DISCONNECTING OUTBOARD BATTERY CABLES

- 6** First, disconnect the black battery cable from the (–) negative terminal and then disconnect the red battery cable from the (+) positive terminal.

TRANSPORTING

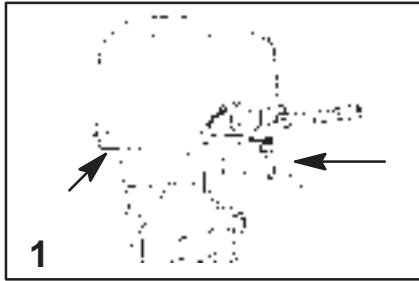

Carrying Your Outboard

- 1 Your outboard has a carrying handle located in front and a rear hand grip in the bottom cowl.

Trailing Your Boat

Your boat should be trailered with the outboard tilted down (normal operating position).

IMPORTANT: The tilt lock and shallow water drive feature (tiller handle models) on the outboard are not intended to support the outboard in the tilted position when trailering your boat.

If additional ground clearance is required, the outboard should be tilted up using an outboard support bar. Additional clearance may be needed for railroad crossings, driveways, and trailer bouncing.

TRANSPORTING

god19

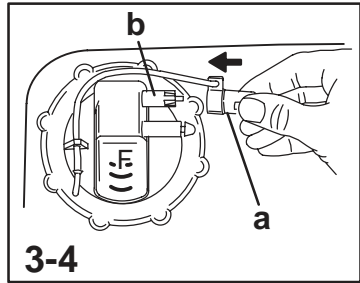
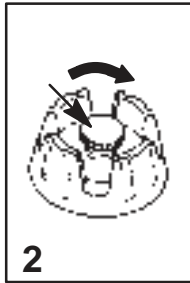

odb2

Transporting Your Outboard When Removed From Boat

- 1 With the outboard still in the water, disconnect the fuel line from the outboard and run engine until it stops, draining carburetor. Remove outboard from the boat and hold upright until all cooling water is drained out. Lay the outboard down horizontally on it's (tiller handle) side. Place a protective pad under the outboard.

odh1

Transporting Portable Fuel Tanks

MANUAL VENTING TYPE FUEL TANK

- 2 Close fuel tank air vent when transporting tank. This will prevent escape of fuel or vapors from tank.

AUTO-VENTING TYPE FUEL TANK

- 3 Disconnect the remote fuel line from tank. This will close the air vent and prevent escape of fuel or vapors from tank.
- 4 Install tether cap (a) over the fuel line connector stem (b). This will protect the connector stem from being accidentally pushed-in, thus, allowing fuel or vapor to escape.

WARNING

Avoid serious injury or death from a gasoline fire or explosion. Follow portable fuel tank transporting instructions. Transport the fuel tank in a well ventilated area away from open flame or sparks.

FUEL & OIL

oeb6

Gasoline Recommendations

UNITED STATES AND CANADA

Use a major brand of automotive unleaded gasoline with a minimum posted octane rating of 87. Mid-grade automotive gasolines that contain fuel injector cleaner are preferred for added internal engine cleanliness. Leaded gasoline is not recommended.

INTERNATIONAL

Use a major brand of automotive unleaded gasoline with a minimum posted octane rating of 90RON. Automotive gasolines that contain fuel injector cleaner are preferred for added internal engine cleanliness. Leaded gasoline is acceptable in areas where unleaded gasoline is not available.

ALCOHOL IN GASOLINE

We do not recommend the use of gasoline which contains alcohol because of the possible adverse effect the alcohol may have on the fuel system. In general, if only gasoline containing alcohol is available, it must not contain more than 10% ethanol or 5% methanol, and the addition of a Water Separating Fuel Filter is recommended.

If gasoline containing alcohol is used or if you suspect the presence of alcohol in your gasoline, increase your inspection of the fuel system, visually checking for fuel leaks or abnormalities.

Gasoline containing alcohol may cause the following problems to your outboard and fuel system:

- Corrosion of metal parts.
- Deterioration of elastomers and plastic parts.
- Wear and damage of internal engine parts.
- Starting and operating difficulties.
- Vapor lock or fuel starvation.

Some of these adverse effects are due to the tendency of gasoline containing alcohol to absorb moisture from the air, resulting in a phase of water and alcohol which separates from the gasoline in the fuel tank.

The adverse effects of alcohol are more severe with methanol and are worse with increasing content of alcohol.

FUEL & OIL

oec13

Oil Recommendation

Mercury or Quicksilver Premium TC-W3 2-cycle oil is recommended for your engine. For added protection and lubrication, Mercury or Quicksilver Premium Plus TC-W3 2-cycle oil is recommended. If Mercury or Quicksilver outboard oil is not available, substitute another brand of 2-cycle outboard oil that is NMMA Certified TC-W3. Severe engine damage may result from use of an inferior oil.

oeg8

Mixing Fuel And Oil

Use a 25:1 (4%) gasoline/oil mixture in the first tank of fuel.

After the break-in fuel mixture is used up, use a 50:1 (2%) gasoline/oil mixture. Follow the table below for mixing ratios.

oeh1

GASOLINE/OIL MIXING RATIO CHART

Gas/Oil Ratio	1 Gallon Gas (3.8 Liters)	3 Gallons Gas (11.5 Liters)	6 Gallons Gas (23 Liters)
25:1 (4%)	5 fl. oz. (148 ml) Oil	16 fl. oz. (473 ml) Oil	32 fl. oz. (946 ml) Oil
50:1 (2%)	3 fl. oz. (89 ml) Oil	8 fl. oz. (237 ml) Oil	16 fl. oz. (473 ml) Oil

FUEL & OIL

Filling Fuel Tank

WARNING

Avoid serious injury or death from a gasoline fire or explosion. Always stop the engine and DO NOT smoke or allow open flames or sparks in the area while filling fuel tanks.

Fill fuel tanks outdoors away from heat, sparks, and open flames.

Always stop engine before refilling tanks.

Do not completely fill the fuel tanks. Leave approximately 10% of the tank volume unfilled. Fuel will expand in volume as its temperature rises and can leak under pressure if the tank is completely filled.

FILLING FUEL TANKS PERMANENTLY INSTALLED

Slowly pour the correct amount of oil along with the gasoline as the tank is being filled.

FILLING PORTABLE FUEL TANKS

Remove portable fuel tanks from boat to refill them.

Pour the full amount of oil along with approximately one gallon of gasoline into the fuel tank. Mix thoroughly, then pour the remainder of gasoline into the tank.

PORTABLE FUEL TANK PLACEMENT IN THE BOAT

Place the fuel tank in the boat so that the tank vent will stay higher than the fuel level in the tank under normal boat operating conditions.

FEATURES & CONTROLS

gog79

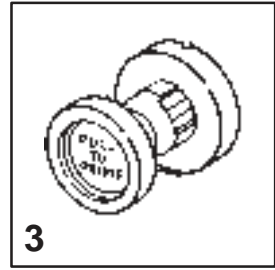
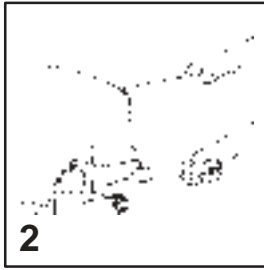
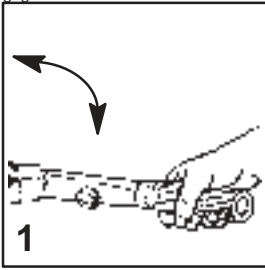

ogd8

Tiller Handle Models

- 1 Tiller handle – Handle can be tilted 100° for convenient handling during transportation and storage.
- 2 Starter Rope – Pulling the starter rope cranks the engine over for starting.
- 3 Primer/Idle Speed Knob – Pulling the knob out supplies a small amount of fuel to the engine for cold starting. Rotate knob to adjust idle speed after engine warms up.

FEATURES & CONTROLS

gog80

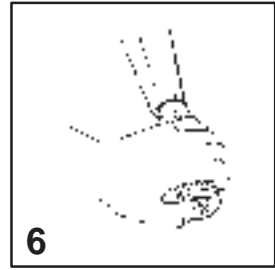
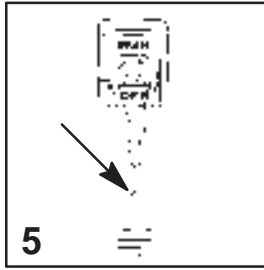
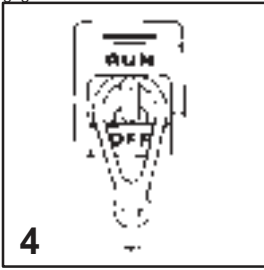

ogd12

Tiller Handle Models

- 4** Lanyard Stop Switch – Read the Lanyard Stop Switch safety explanation and Warning in the General Information Section.
- 5** Lanyard – Read the Lanyard Stop Switch safety explanation and Warning in the General Information Section.
- 6** Engine Stop Switch – Push in to stop engine.

FEATURES & CONTROLS

gog81

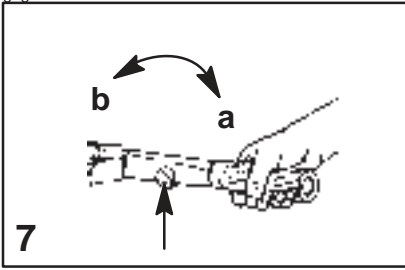

ogd10

Tiller Handle Models

7 Throttle Grip Friction Knob – Turn friction knob to set and maintain the throttle at desired speed. Turn knob towards (a) to tighten friction and move knob towards (b) to loosen friction.

8 Side Handle Gear Shift – Controls gear shift.

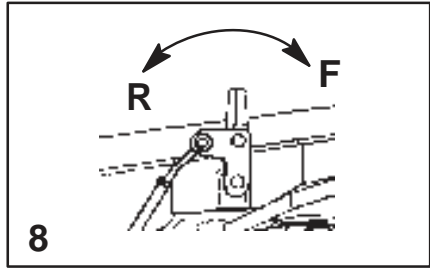

FEATURES & CONTROLS

gog28

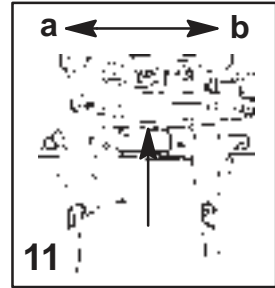
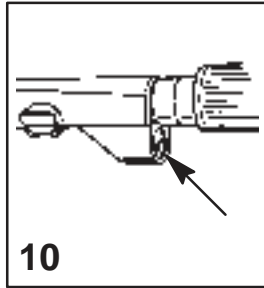
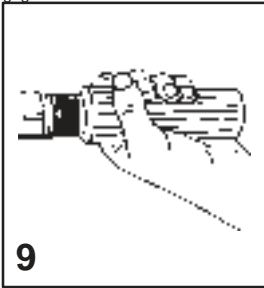

ogd11

Tiller Handle Models

- 9** Throttle Grip – Controls engine speed. Move to the start (slow speed) position for starting the engine.

NOTE: The outboard is equipped with a rewind starter “lock-out” mechanism. The throttle grip will have to be in the start (slow speed) position in order to start engine.

- 10** Electric Start Button (Electric Start Models) – Press button to start engine.
- 11** Steering Friction Adjustment – Adjust this lever to achieve the desired steering friction (drag) on the tiller handle. Move lever towards (a) to tighten friction and move lever towards (b) to loosen friction.

WARNING

Avoid possible serious injury or death from loss of boat control. Maintain sufficient steering friction to prevent the outboard from steering into a full turn if the tiller handle is released.

FEATURES & CONTROLS

gog82

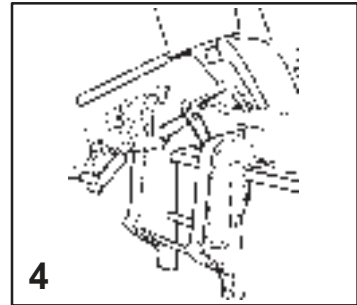
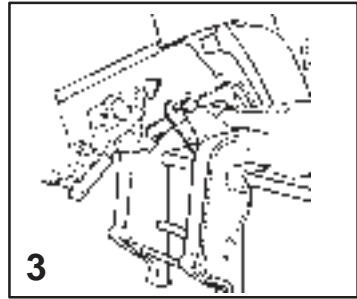

ogf4

Tilting Outboard To Full Up Position

- 1** Stop the engine. Shift the outboard into forward gear position.
- 2** Take hold of the top cowl grip and raise outboard to the full up position.
- 3** Move the tilt lock to the lock position.

Lowering Outboard Down To Run Position

- 4** Lift outboard and release tilt lock lever. Lower outboard.

FEATURES & CONTROLS

gog83

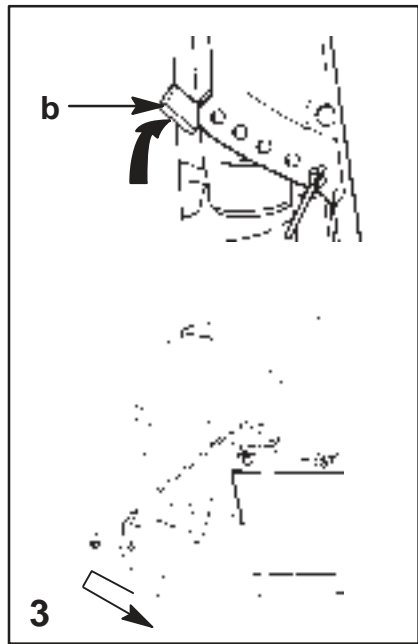
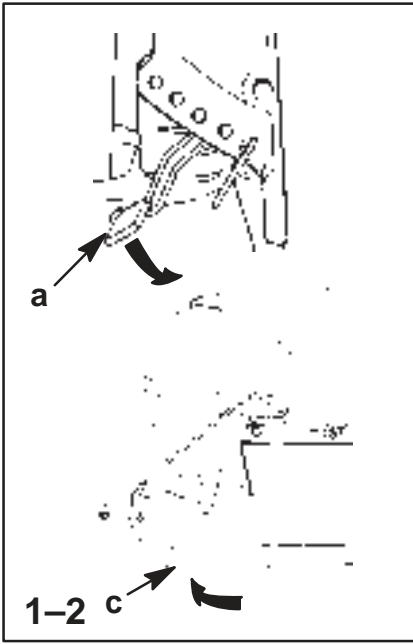

ogm1

Shallow Water Operation – Tiller Handle Models

Tiller handle model outboards are equipped with a shallow water tilt feature that allows you to tilt the outboard to a higher tilt angle to prevent hitting bottom.

ENGAGING SHALLOW WATER DRIVE

- 1 Reduce engine speed to idle. Shift the outboard into forward gear position.
- 2 Push down the shallow water drive lever (a). Tilt outboard up to the shallow water drive position. Be sure the cooling water intake (c) is submerged.

IMPORTANT: While in shallow water drive position, do not operate the outboard in reverse. Operate the outboard at slow speed and keep the cooling water intake submerged.

- 3 To release down to run position, lift up the shallow water drive lever (b). Tilt up the outboard to disengage the shallow water drive lock and lower it down.

FEATURES & CONTROLS

gog84

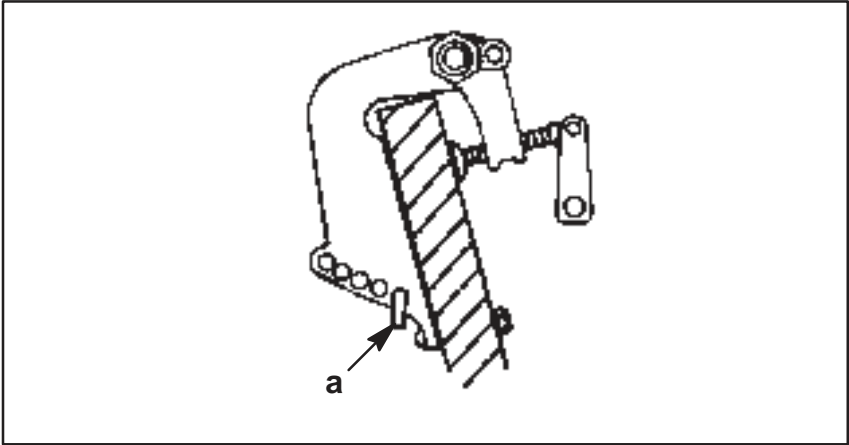

ogg3

Setting The Operating Angle Of Your Outboard

The vertical operating angle of your outboard is adjusted by changing the position of the tilt pin (a) in the five adjustment holes provided. Proper adjustment allows the boat to run stable, achieve optimum performance.

The tilt pin should be adjusted so the outboard is positioned to run perpendicular to the water when the boat is running at full speed. This allows the boat to be driven parallel to the water.

Arrange passengers and load in the boat so the weight is distributed evenly.

OPERATION

ofa4

Pre-Starting Check List

- Operator knows safe navigation, boating, and operating procedures.
- An approved personal flotation device of suitable size for each person aboard and readily accessible (it is the law).
- A ring type life buoy or buoyant cushion designed to be thrown to a person in the water.
- Know your boats maximum load capacity. Look at the boat capacity plate.
- Fuel supply OK.
- Oil supply (oil injection) OK.
- Make sure the boat drain plug is installed.
- Arrange passengers and load in the boat so the weight is distributed evenly and everyone is seated in a proper seat.
- Tell someone where you are going and when you expect to return.
- It is illegal to operate a boat while under the influence of alcohol or drugs.
- Know the waters and area you will be boating; tides, currents, sand bars, rocks, and other hazards.
- Make inspection checks listed in the Inspection and Maintenance Schedule. Refer to Maintenance Section.
- Check steering for free operation.
- Check for debris around the rudder and reverse gate which may jam or hinder operation.
- Before launching, examine the jet drive water intake for obstructions which may prevent pumping of water.
- Make sure the drive shaft bearing on the jet drive is lubricated.

OPERATION

gof86

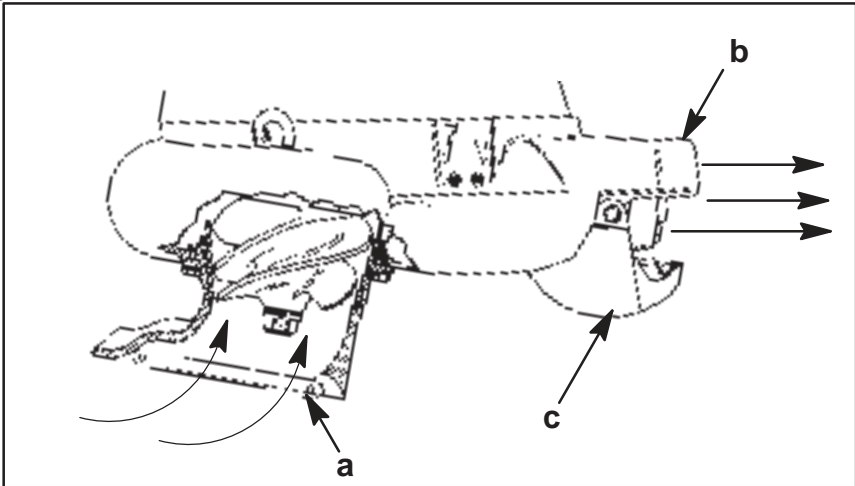

onm1

How The Jet Drive Operates

A jet-driven boat has substantially different handling characteristics compared to a propeller-driven boat. It is suggested that you adjust yourself to these characteristics by experimentation in open water at both high and low speeds.

The drive shaft driven impeller draws water up through the water intake (a) and then redirects it at a high pressure through the water outlet nozzle (b) to create forward thrust. To obtain reverse, the reverse gate (c) is swung over the outlet nozzle to direct the water in the opposite direction for reverse operation.

When the jet drive is in neutral, the impeller continues to rotate. However, the reverse gate is positioned so that some of the forward thrust is diverted to create reverse thrust. This approximate balancing of forward and reverse thrust will minimize any boat movement. However, because the impeller is always rotating and creating thrust when the engine is running, the boat may tend to creep slowly forward or backward. This is normal for a direct-drive, jet-driven boat. The operator should be aware of this and use caution whenever the engine is running.

(continued on next page)

OPERATION

How The Jet Drive Operates (Continued)

The jet drive is always drawing water into the housing when the engine is running. DO NOT operate the jet drive with the grate removed from the water intake. Keep your hands, feet, hair, loose clothing, life jackets, etc. away from the water intake. Never insert an object into the water intake or water outlet nozzle when the engine is running.

WARNING

Avoid injury resulting from contacting the rotating impeller or having your hair, clothing, or loose objects drawn into the water intake and wrapping around the impeller. Stay away from the water intake and never insert an object into the water intake or water outlet nozzle when the engine is running.

ofz1

Stopping The Boat In An Emergency

Your jet powered boat has emergency stopping capability unique to this form of propulsion.

In an emergency, shifting the jet drive into reverse and applying reverse throttle can rapidly slow down your boat and reduce the stopping distance. Keep in mind, however, that such a maneuver may cause occupants in the boat to be thrown forward or even out of the boat.

WARNING

Using the emergency stopping capability of your jet drive will slow down your boat in an emergency. However, keep in mind, sudden stopping may cause the occupants in the boat to be thrown forward or even out of the boat. This action may result in serious injury or death.

OPERATION

on1

Steering Your Boat

The jet drive is dependent on water jet thrust for steering the boat. The jet drive has a steerable outlet nozzle that directs this water jet thrust to the right or left. If the water jet thrust should ever stop, (water blockage, the engine stops, or, etc.) will cause the boat to slow to a stop. However, while slowing there will be a reduced ability to steer the boat.

While steering your outboard, you will find quick response to the helm, but due to the relatively flat-bottom hulls and lack of a gear case in the water, your boat will tend to skid on the turns. You must start your turns early and use sufficient power to maintain steering control.

WARNING

Avoid serious injury or death. Do not attempt to steer your boat into a tight turn; at too high a speed, your boat could “spin out” or even roll over, resulting in occupants being thrown within the boat or out of the boat.

WARNING

Avoid injury, death or property damage resulting from collision due to loss of directional control. Directional control is derived from the water jet thrust. Thus, caution should be exercised when maneuvering at higher speeds in areas where debris (weeds, logs, gravel, etc.) could be picked up into the jet drive. This can cut off or reduce the water jet thrust, thereby directly affecting boat directional control. Boat directional control can also be substantially reduced or lost altogether by a sudden loss of power such as running out of gas, quickly backing off throttle, turning off ignition switch, or activating lanyard stop switch. Remember your ability to take evasive action is dependent on sufficient water jet thrust to control your boat.

OPERATION

onk1

Operating In Shallow Water

The life of the impeller and water intake can be greatly increased by avoiding the intake of sand and gravel. The intake suction, acting on the bottom, will act like a dredge when the water intake comes within 2 to 3 inches of the bottom. It is better to stop the engine and drift up to shore when landing, and to shove off with an oar when leaving. You can idle through areas of water less than 1-foot deep, but there should be more than 1-foot of water under the boat when increasing speed to reach full plane.

Once the boat is on plane, the boat speed will prevent sucking in gravel and other debris off the bottom. The sucking is still acting, but the water intake passes over the bottom too quickly to allow debris to be lifted into the water intake.

While boating through shallow water areas, decide a course of travel that avoids sharp rocks and other underwater obstacles that could damage the boat. Running your boat through these areas on full plane may be helpful because the boat will be riding higher in the water. If the boat gets stuck on the bottom, immediately stop the engine and move the boat to deeper water.

onj1

Water Intake Blockage

It is possible to lose power caused by suction holding flat stones, weeds, leaves, plastic, paper, or other debris against the water intake and restricting water flow. If you shut off the engine and wait a few seconds, the debris may fall off and full power will be restored. If, however, the debris trapped in the water intake grate, the engine will have to be shut off and the blockage will have to be pried out.

WARNING

Avoid injury resulting from contacting the rotating impeller. Always shut off the engine before attempting to remove a blockage from the water intake.

of

OPERATION

ona1

Clearing A Jammed Impeller

It is possible, for a stone or other debris inside the jet housing to lodge between the impeller and wall, especially after the engine has been stopped. This will lock the drive shaft and will prevent the engine from being able to crank over for starting. In this case follow these steps for freeing the jam.

Turn the ignition key or lanyard stop switch to the OFF position and remove all the spark plug leads to prevent the engine from accidentally starting. Remove the flywheel or rewind cover and rotate the engine flywheel counterclockwise. If this doesn't free the jammed impeller, it will be necessary to remove the six screws and water intake housing.

WARNING

If the flywheel is rotated to free a jammed impeller, there is the possibility that the engine will crank over and start. To prevent this type of accidental engine starting and possible serious injury, always turn the ignition key or lanyard stop switch to the OFF position and remove all spark plug leads from the spark plugs.

oni1

Mooring Your Boat

When your boat is pulled onto a beach or tied to a dock where the up and down wave action may cause the water intake housing to dig into sand or other debris, be sure to tilt the jet drive out of water. Failure to do this may cause the water intake housing to fill with sand or other debris and could prevent the outboard from cranking over for starting.

onf3

Operating In Freezing Temperatures

If there is a chance of ice forming on the water, the jet drive should be removed and drained completely of water. If ice should form at the water level inside the outboard drive shaft housing, it will block water flow to the engine causing possible damage. Do not start the engine until the ice is clear.

OPERATION

Operating At High Elevations

Operating your outboard at an elevation higher than 2500 ft. (750 m) above sea level may require a carburetor jet change. Consult your dealer. This will reduce the normal performance loss experienced as a result of reduced oxygen in the air causing an overly rich fuel mixture.

IMPORTANT: To prevent serious damage to the engine caused by a lean fuel mixture, DO NOT operate your outboard (if the carburetor jets were changed for high elevation) at a lower elevation unless the jets are changed again to correspond to the new elevation.

Operating In Salt Water Or Polluted Water

If you keep your boat moored in the water, always tilt the outboard so the water intake is completely out of water (except in freezing temperature) when not in use.

Wash down the outboard exterior and flush out the exhaust outlet of the jet drive with fresh water after each use. Each month, spray Quicksilver or Mercury Precision Corrosion Guard on external metal surfaces.

OPERATION

gof87

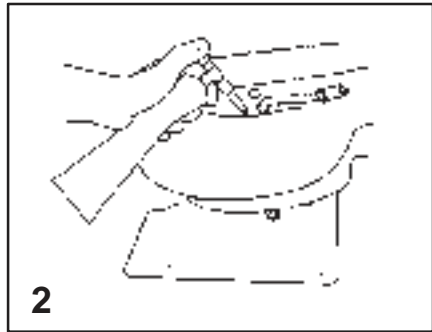
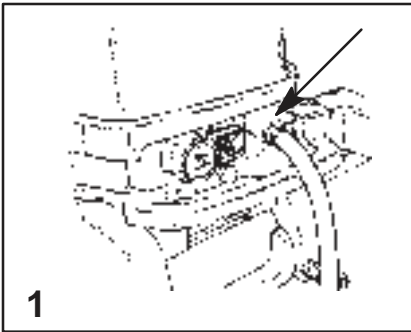

ofc3

Pre-Starting Instructions

- 1 Connect the remote fuel line to the outboard. Make sure connector is snapped into place.
- 2 Make sure the drive shaft bearing on the jet drive is lubricated. Refer to Maintenance Section.

CAUTION

Never start or run your outboard (even momentarily) without the water intake in the water to prevent damage to the water pump (running dry) or overheating of the engine.

ofd1

Engine Break-in Procedure

CAUTION

Severe damage to the engine can result by not complying with the Engine Break-in Procedure.

ENGINE BREAK-IN FUEL MIXTURE

Use a 25:1 (4%) gasoline/oil mixture in the first tank of fuel.

ENGINE BREAK-IN PROCEDURE

Vary the throttle setting during the first hour of operation. During the first hour of operation, avoid remaining at a constant speed for more than two minutes and avoid sustained wide open throttle.

OPERATION

gof108

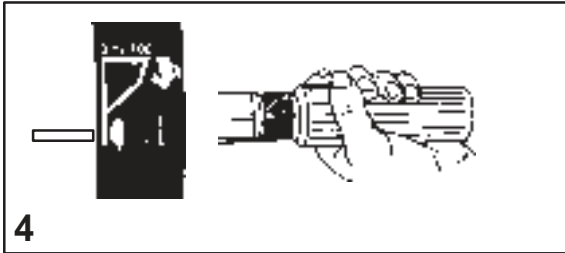
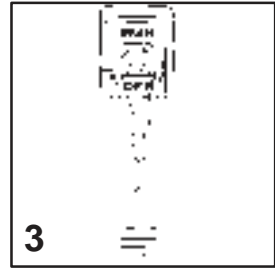
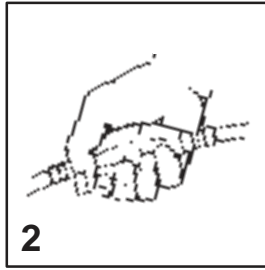
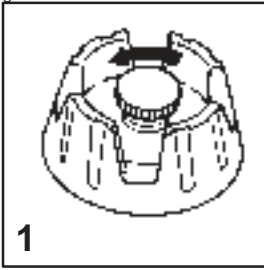

off6

Starting The Engine – Tiller Handle Models

Before starting, read the Pre-Starting Check List, Special Operating Instructions, Pre-Starting Instructions, and Engine Break-in Procedure on the first three pages in the Operation Section.

- 1 Open fuel tank vent on manual venting type tanks.
- 2 Squeeze the fuel line primer bulb several times until it feels firm.
- 3 Set the lanyard stop switch to RUN position.
- 4 Set the throttle grip to start position.

IMPORTANT: Electric starting outboards must not be run or started (either manually or electrically), without having the outboard battery cables connected to a battery, as damage to the charging system could result.

OPERATION

gof89

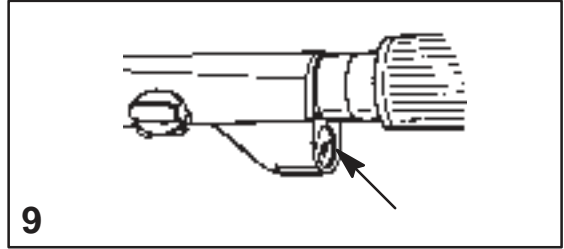
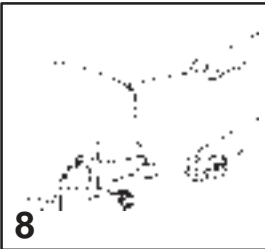
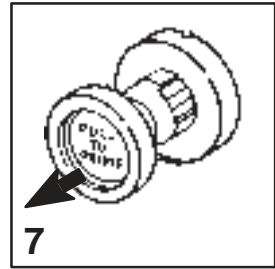
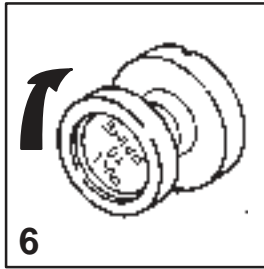
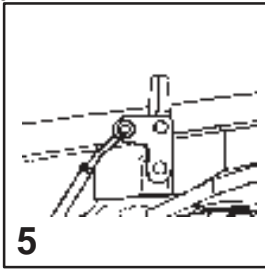

off1

Starting The Engine – Tiller Handle Models

- 5** Side Handle Gear Shift Models – Set the gear shift to NEUTRAL position.
- 6** Turn Primer/idle speed knob full clockwise (direction of arrow) to increase engine idle speed for starting.
- 7** When engine is cold, pull out and push in the primer/idle speed knob one to three times to prime the engine. Leave the knob in the pulled-out position when starting.
- 8** Manual Starting Models – Pull the starter rope slowly until you feel the starter engage, then pull rapidly to crank the engine. Allow rope to return slowly. Repeat until engine starts.
- 9** Electric Starting Models – Push starter button and crank the engine. Release button when engine starts. Do not operate starter motor continuously for longer than ten seconds at a time. If engine fails to start, wait 30 seconds and try again.

OPERATION

gof31

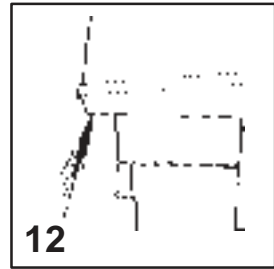
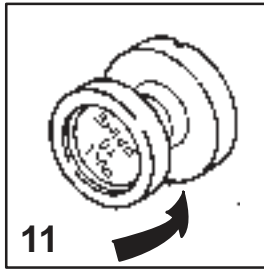
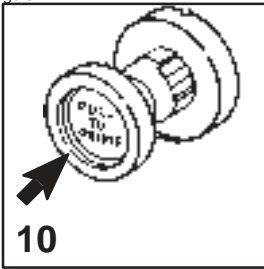

off17

Starting The Engine – Tiller Handle Models

10 Push in the primer/idle speed knob after engine starts. If engine begins to stall, re-prime until engine is running smoothly.

NOTE: Starting Flooded Engine – push in the primer/idle speed knob and turn full clockwise. Continue to crank the engine for starting.

11 Turn the primer/idle speed knob counterclockwise (direction of arrow) to obtain desired idle speed as engine warms up.

12 Check for water flowing out of the water pump indicator hole. For models equipped with a thermostat, the amount of water flow can vary, from droplets to a full spray, due to the thermostat operation. It may take several minutes for the engine to warm up enough for water to start spraying out of the indicator hole.

IMPORTANT: If no water is coming out of the water pump indicator hole, stop engine and check cooling water intake for obstruction. No obstruction may indicate a water pump failure or blockage in the cooling system. These conditions will cause the engine to overheat. Have the outboard checked by your dealer. Operating the engine while overheated may cause serious engine damage.

OPERATION

gof90

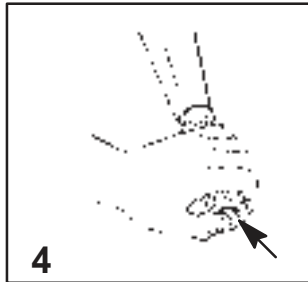
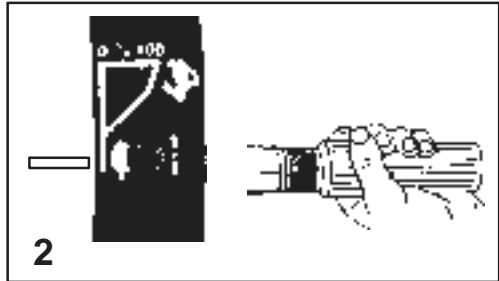
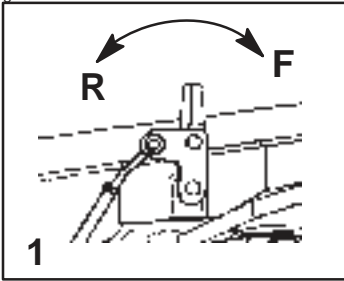

ofj6

Gear Shifting

- 1 Your outboard has three gear shift positions to provide operation: Forward (F), Neutral (out of gear), and Reverse (R)

NOTE: In neutral, the impeller continues to rotate. Although the approximate balancing of forward and reverse thrust will minimize boat movement, the boat may tend to creep slowly forward or backward. This is normal for a direct-drive jet-driven boat. The operator should be aware of this and use caution whenever the engine is running.

- 2 Align throttle grip pointer with slow speed shift position before shifting outboard into gear.
- 3 After shifting outboard into gear, advance the throttle to increase speed.

ofn1

Stopping The Engine

- 4 Reduce engine speed and shift outboard to neutral position. Push in the engine stop button or move the lanyard stop switch to the OFF position.

OPERATION

gof91

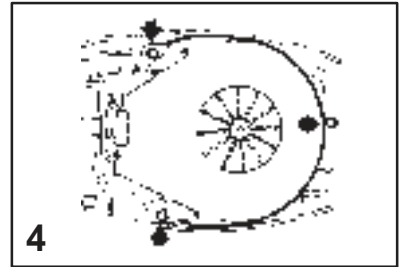
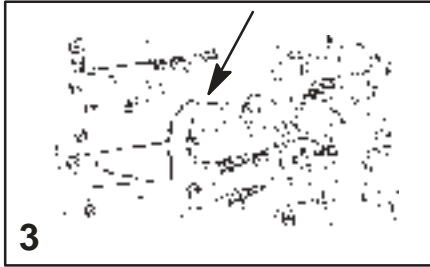
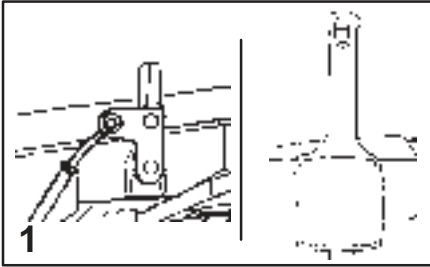

ofp4

Emergency Starting

If the starter rope should break or the rewind starter fails, use the spare starter rope (provided) and follow this procedure.

- 1 Shift outboard to neutral position.

⚠ WARNING

When using emergency starter rope to start engine, the start at idle speed protection is inoperative. Make sure to have the engine speed set at slow and the outboard gear shift positioned in neutral to prevent outboard from starting in gear. Sudden unexpected acceleration could result in serious injury or death.

- 2 Pry the fuel filter out of its mount.
- 3 Disconnect linkage from rewind starter assembly.
- 4 Remove three bolts and rewind starter assembly.

OPERATION

gof34

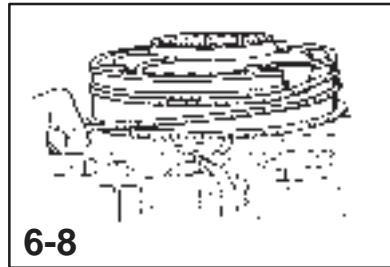
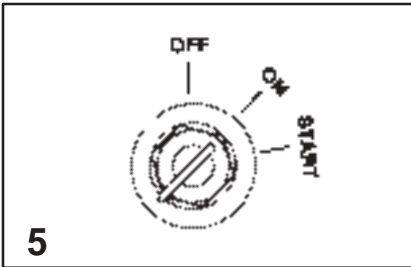

ofp5

Emergency Starting (Continued)

- 5 Electric Start Remote Control Models – Turn the ignition key to ON position.
- 6 Tie one end of the spare starter rope around screwdriver tool (provided) and tie a knot in other end.

⚠ WARNING

To prevent getting an electrical shock, DO NOT touch any ignition component, wiring, or spark plug wire when starting or running the engine.

⚠ WARNING

The exposed moving flywheel can cause serious injury. Keep your hands, hair, clothing, tools, and other objects away from engine when starting or running the engine.

Do not attempt to reinstall the rewind starter assembly or top cowl when engine is running.

- 7 Place the starter rope knot into the flywheel notch and wind the rope clockwise around the flywheel.
- 8 Pull the starter rope to start the engine.

MAINTENANCE

oha4

Outboard Care

To keep your outboard in the best operating condition, it is important that your outboard receive the periodic inspections and maintenance listed in the Inspection and Maintenance Schedule. We urge you to keep it maintained properly to ensure the safety of you and your passengers and retain its dependability.

WARNING

Neglected inspection and maintenance service of your outboard or attempting to perform maintenance or repair on your outboard if you are not familiar with the correct service and safety procedures could cause personal injury, death, or product failure.

Record maintenance performed in Maintenance Log at the back of this book. Save all maintenance work orders and receipts.

Selecting Replacement Parts For Your Outboard

We recommend using original Mercury Precision or Quicksilver replacement parts and Genuine Lubricants.

WARNING

Using a replacement part that is inferior to the original part could result in personal injury, death, or product failure.

MAINTENANCE

oti1

EPA Emissions Regulations

All new outboards manufactured by Mercury Marine are certified to the United States Environmental Protection Agency as conforming to the requirements of the regulations for the control of air pollution from new outboard motors. This certification is contingent on certain adjustments being set to factory standards. For this reason, the factory procedure for servicing the product must be strictly followed and, wherever practicable, returned to the original intent of the design. **Maintenance, replacement, or repair of the emission control devices and systems may be performed by any marine SI engine repair establishment or individual.**

oti8

EMISSION CERTIFICATION LABEL

An emission certification label, showing emission levels and engine specifications directly related to emissions, is placed on the engine at time of manufacture.

		EMISSION CONTROL INFORMATION	
This engine conforms to <input type="text"/> model year EPA regulations for Marine SI engines. Refer to Owner's Manual for required maintenance.			
a	IDLE SPEED: <input type="text"/>	f	FAMILY: <input type="text"/>
b	<input type="text"/> hp <input type="text"/> cc	g	FEL: <input type="text"/> g kW h
c	TIMING (IN DEGREES): <input type="text"/>		
d	Standard spark plug: <input type="text"/>	<input type="text"/>	
	Suppressor spark plug: <input type="text"/>		
	GAP: <input type="text"/>		
e	Valve Clearance (Cold) mm	Intake <input type="text"/>	Exhaust <input type="text"/>

a - Idle Speed

b - Engine Horsepower

c - Timing Specification

d - Recommended Spark Plug & Gap

e - Valve Clearance (if Applicable)

f - Family Number

g - Maximum Emission Output for the Engine Family

h - Piston Displacement

i - Date of Manufacture

oti7

OWNER RESPONSIBILITY

The owner/operator is required to have engine maintenance performed to maintain emission levels within prescribed certification standards.

The owner/operator is not to modify the engine in any manner that would alter the horsepower or allow emissions levels to exceed their predetermined factory specifications.

MAINTENANCE

Inspection And Maintenance Schedule

BEFORE EACH USE

1. Check that lanyard stop switch stops the engine.
2. Visually inspect the fuel system for deterioration or leaks.
3. Check outboard for tightness on transom.
4. Check steering system for binding or loose components.
5. Remote Control models – Visually check steering link rod fasteners for proper tightness.
6. Make sure the drive shaft bearing on the jet drive is lubricated. (page 73)

AFTER EACH USE AND AFTER EVERY 10 HOURS OF OPERATION

1. Lubricate the drive shaft bearing on the jet drive. (page 73)

AFTER EACH USE

1. If operating in salt water, wash off all salt deposits and flush out the exhaust outlet of the jet drive with fresh water.

EVERY 100 HOURS OF USE OR ONCE YEARLY, WHICHEVER OCCURS FIRST

1. Lubricate all lubrication points. Lubricate more frequently when used in salt water. (page 73)
2. Inspect and clean spark plugs. (page 76)
3. Check fuel line filter for contaminants. (pages 63 and 64)
4. Check carburetor adjustments, if required. (page 77)

(continued on next page)

MAINTENANCE

Inspection And Maintenance Schedule (Continued)

EVERY 100 HOURS OF USE OR ONCE YEARLY, WHICHEVER OCCURS FIRST

5. Lubricate splines on the drive shaft.*
6. Electric start models – Inspect battery. (page 62)
7. Remote control models – Check control cable adjustments. *
8. Remove engine deposits with Quicksilver or Mercury Precision Power Tune Engine Cleaner.
9. Clean fuel tank pick up filter.
10. Salt water use - remove and grease the jet drive mounting hardware, and reassemble.
11. Check tightness of bolts, nuts, and other fasteners.

EVERY 300 HOURS OF USE OR THREE YEARS

1. Replace water pump impeller (more often if overheating occurs or reduced water pressure is noted).*

BEFORE PERIODS OF STORAGE

1. Refer to Storage procedure. (page 79)

* *These items should be serviced by an authorized dealer.*

MAINTENANCE

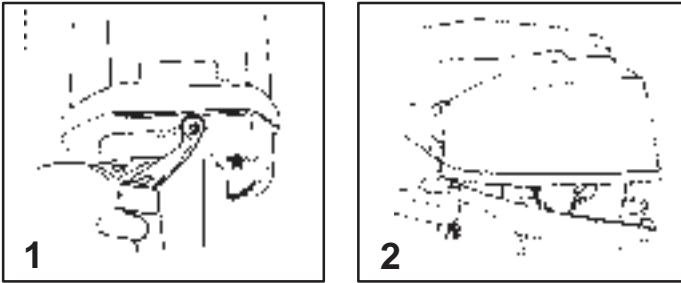

Top Cowl Removal And Installation

REMOVAL

- 1 Unlock the rear latch by pushing lever down.
- 2 Lift rear of cowl and disengage front hook.

INSTALLATION

Engage the front hook and push cowl back over the cowl seal.
Push cowl down and move the rear latch lever up to lock.

Battery Inspection

The battery should be inspected at periodic intervals to ensure proper engine starting capability.

IMPORTANT: Read the safety and maintenance instructions which accompany your battery.

1. Turn off the engine before servicing the battery.
2. Add water as necessary to keep the battery full.
3. Make sure the battery is secure against movement.
4. Battery cable terminals should be clean, tight, and correctly installed. Positive to positive and negative to negative.
5. Make sure the battery is equipped with a nonconductive shield to prevent accidental shorting of battery terminals.

MAINTENANCE

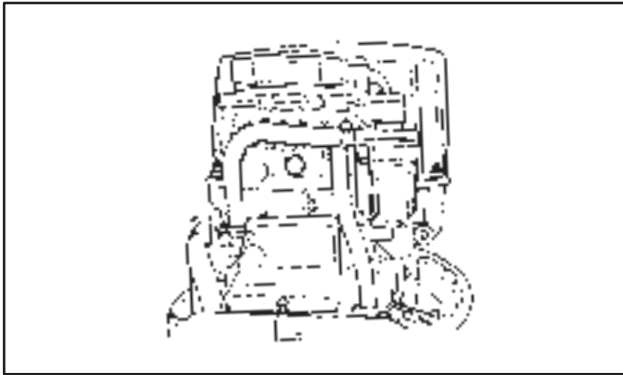

Fuel System

⚠ WARNING

Avoid serious injury, or death from gasoline fire, or explosion. Carefully follow all fuel system service instructions. Always stop the engine, and DO NOT smoke or allow open flames, or sparks in the area while servicing any part of the fuel system.

Before servicing any part of the fuel system, stop engine and disconnect the battery. Drain the fuel system completely. Use an approved container to collect and store fuel. Wipe up any spillage immediately. Material used to contain spillage must be disposed of in an approved receptacle. Any fuel system service must be performed in a well ventilated area. Inspect any completed service work for signs of fuel leakage.

FUEL LINE INSPECTION

Visually inspect the fuel line and primer bulb for cracks, swelling, leaks, hardness or other signs of deterioration or damage. If any of these conditions, are found, the fuel line or primer bulb must be replaced.

MAINTENANCE

goh127

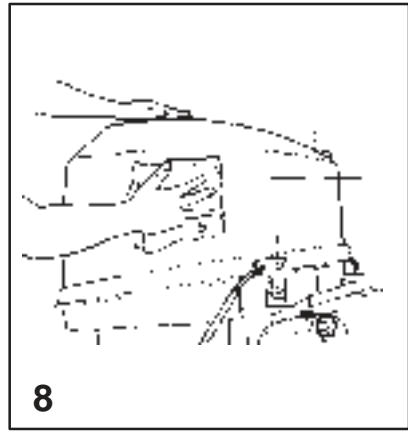
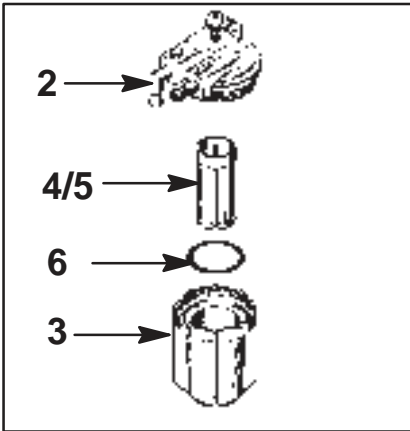

ohz1

ENGINE FUEL FILTER

Inspect the sight bowl for water accumulation and inspect the filter element for sediment. Clean filter as follows.

REMOVAL

- 1 Read Fuel System servicing information and Warning on the previous page.
- 2 Hold onto the cover to prevent it from turning.
- 3 Turn off the sight bowl.
- 4 Pull out the filter element and wash it with cleaning solvent.

INSTALLATION

- 5 Push the filter element (with open end toward cover) into cover.
- 6 Place the O-ring seal into the sight bowl and screw the sight bowl hand tight into the cover.
- 7 Visually inspect for fuel leakage around the sight bowl by squeezing the primer bulb until firm, forcing fuel into the sight bowl.

otg1

Exterior Care

- 8 Your outboard is protected with a durable baked enamel finish. Clean and wax often using marine cleaners and waxes.

MAINTENANCE

goh46

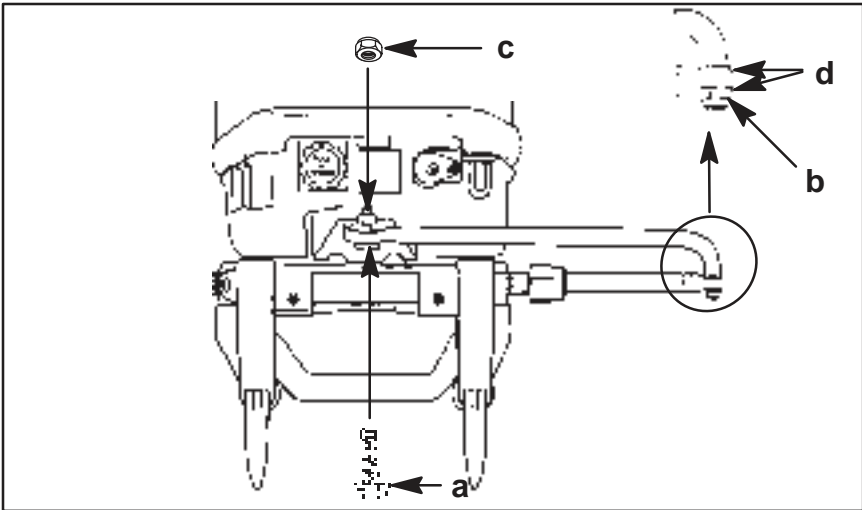

ohi1

Steering Link Rod Fasteners

IMPORTANT: The steering link rod that connects the steering cable to the engine must be fastened using special washer head bolt (“a” – Part Number 10-14000) and self locking nylon insert locknuts (“b” & “c” – Part Number 11-34863). These locknuts must never be replaced with common nuts (non locking) as they will work loose and vibrate off, freeing the link rod to disengage.

⚠ WARNING

Disengagement of a steering link rod can result in the boat taking a full, sudden, sharp turn. This potentially violent action can cause occupants to be thrown overboard exposing them to serious injury or death.

Assemble steering link rod to steering cable with two flat washers (d) and nylon insert locknut (“b” – Part Number 11-34863). Tighten locknut (b) until it seats, then back nut off 1/4 turn.

Assemble steering link rod to engine with special washer head bolt (“a” – Part Number 10-14000) and self locking nylon insert locknut (“c” – Part Number 11-34863). First torque bolt (a) to 20 lb. ft. (27 N-m), then torque locknut (c) to 20 lb. ft. (27 N-m).

MAINTENANCE

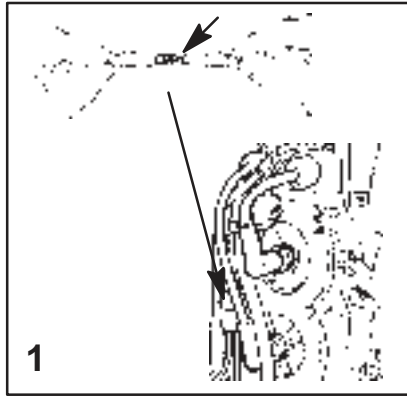

oma1

Fuse Replacement – Electric Start Remote Control Models

IMPORTANT: Always carry spare SFE 20 AMP fuses.

The electric starting circuit is protected from overload by a SFE 20 AMP fuse. If the fuse is blown, the electric starter motor will not operate. Try to locate and correct the cause of the overload. If the cause is not found, the fuse may blow again. Replace the fuse with a fuse of the same rating.

- 1 Replace with a new SFE 20 AMP fuse.

MAINTENANCE

goh128

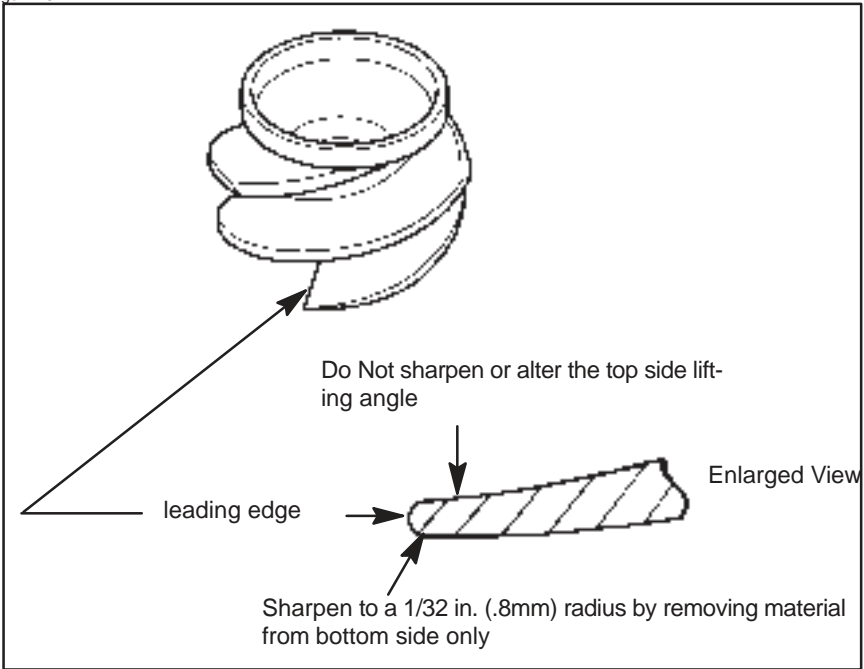

omm1

Worn (Dull) Impeller

The intake of gravel through the pump can round off and wear the leading edges on the impeller. Some conditions you may experience from a worn impeller are (1) a noticeable performance loss, especially on acceleration, (2) difficulty getting the boat on plane, or (3) an increase in engine RPM at wide open throttle. Check the impeller blades occasionally for damage. Use a flat file to resharpen the leading edges as shown.

MAINTENANCE

goh129

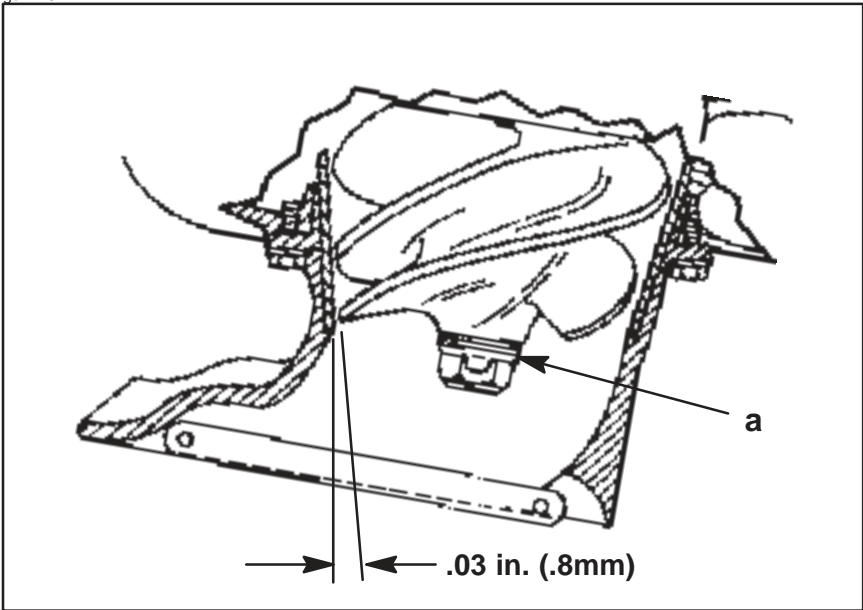

omn1

Impeller Clearance Adjustment

The impeller should be adjusted so there is approximately .03 in. (.8mm) clearance between the impeller edge and liner. Operating your jet drive in waters that contain sand and gravel can cause wear to the impeller blades, and the clearance will start to exceed .03 in. (.8mm). As the blades wear, shims (a) located in the stack outside of the impeller can be transferred behind the impeller. This will move the impeller further down into the tapered liner to reduce the clearance.

Check the impeller clearance by sliding a feeler gauge through the intake grate and measure the clearance between the impeller edge and liner. If adjustment is required, refer to Impeller Removal and Installation in this Maintenance Section.

MAINTENANCE

goh130

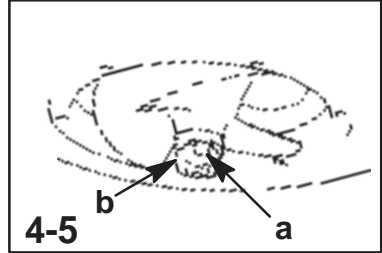
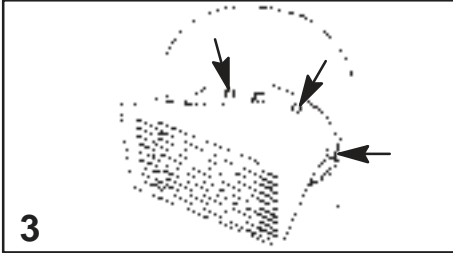
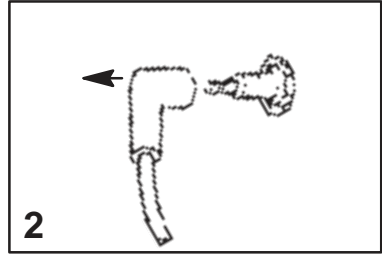
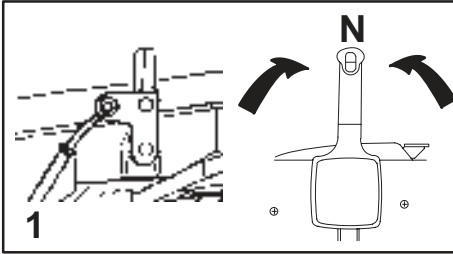

omo1

Impeller Removal And Installation

⚠ WARNING

If the drive shaft is rotated while the engine is in gear, there is the possibility that the engine will crank over and start. To prevent this type of accidental engine starting and possible serious injury caused from being struck by a rotating impeller, always shift outboard to neutral position and remove spark plug leads when you are servicing the propeller.

REMOVAL

- 1 Shift outboard to neutral (N) position.
- 2 Remove spark plug leads to prevent engine from starting.
- 3 Remove the water intake housing that is fastened with six screws.
- 4 Straighten the bent tabs (a) on the impeller nut retainer and remove the impeller nut (b).
- 5 Pull impeller straight off the shaft. If the impeller is tight, use a hammer and block of wood to rotate the impeller (clockwise) on the shaft until the keyway is directly above the flat on the shaft. This will free the jammed key and allow removal.

MAINTENANCE

goh131

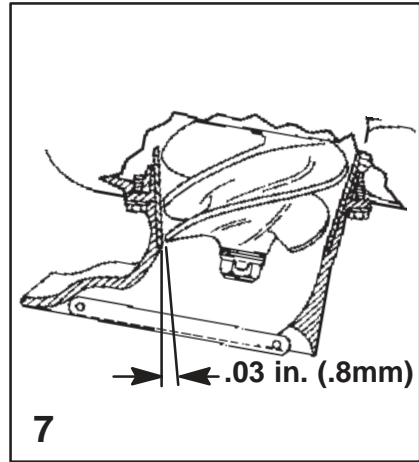
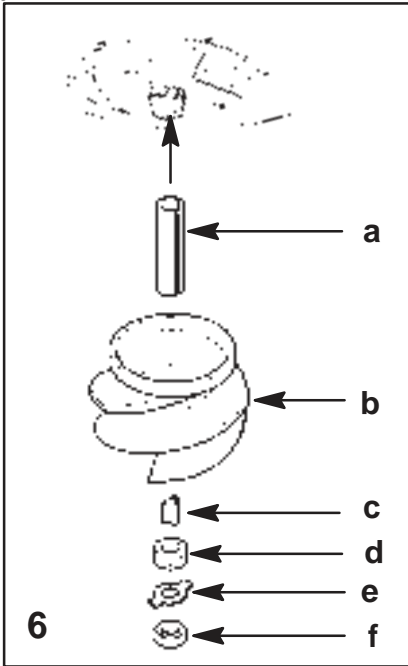

omo2

Impeller Removal And Installation

INSTALLATION

- 6** Grease the drive shaft, shear key, and impeller bore. Place the plastic sleeve (a) inside the impeller (b) and install impeller, shear key (c), shims (d) nut retainer (e), and impeller nut (f). Turn the nut tight on the shaft to remove any play between the impeller and shaft. If the tabs on the retainer do not line up with the flats on the nut, remove the nut and turn the retainer over and re-tighten the nut again.
- 7** Temporarily reinstall the water intake housing in order to check for impeller clearance. The clearance between the impeller and liner should be .030 in. (.8 mm). Shim washers can be transferred to either side of the impeller to raise or lower the impeller to the correct clearance setting. The water intake housing can be shifted side ways a small amount in order to center the casing liner.

MAINTENANCE

goh132

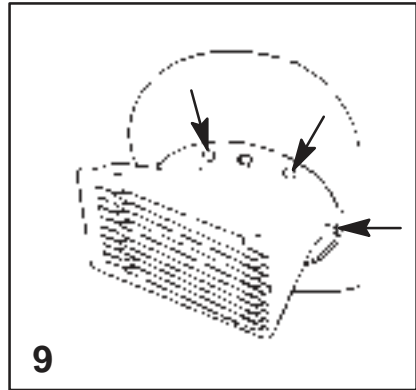
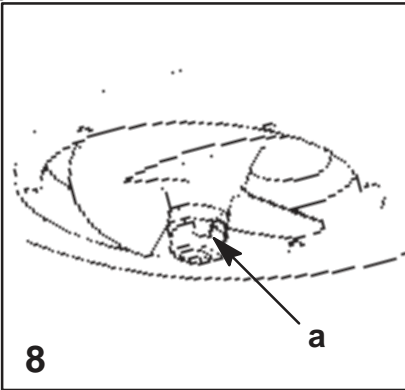

omo3

Impeller Removal And Installation

INSTALLATION (CONTINUED)

- 8** After setting the impeller height, tighten the impeller nut snug with a wrench. Secure impeller nut by bending tabs (a) against the flats on the impeller nut.

NOTE: If the outboard is used in salt water, apply Quicksilver or Mercury Precision Anti-Corrosion Grease around the entire mounting flange on the water intake housing and also to the threads on the six mounting bolts.

- 9** Reinstall the water intake housing with six bolts. Check clearance around the impeller to make sure the water intake housing is centered and not rubbing against the liner. Torque mounting bolts to 120 lbs. in. (13 N·M).

MAINTENANCE

goh155

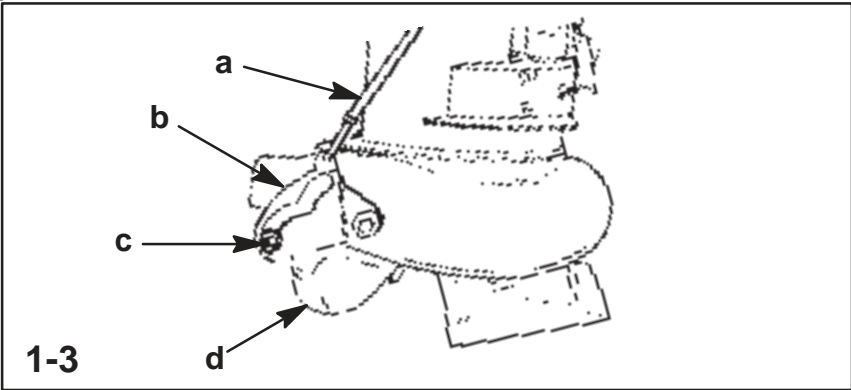

omp1

Shift Link Rod Adjustment

⚠ WARNING

The shift link rod must be adjusted to lock the reverse gate against unexpected engagement (caused by water pressure hitting the gate) while operating the boat in forward. Activation of the reverse gate will cause sudden unexpected stopping of the boat. Sudden stopping may cause occupants to be thrown within the boat or even out of the boat. This action may result in serious injury or death.

CHECKING SHIFT LINK ROD ADJUSTMENT

- 1 Check the shift link rod (a) adjustment in forward shift position. The correct adjustment will position the shift cam (b) far enough on the roller (c) in order to lock the the reverse gate (d) into forward position. You should not be able to forcibly push up the reverse gate toward neutral. Pull on the reverse gate by hand to verify this.

ADJUSTING SHIFT LINK ROD

- 2 Place the shift handle into full forward shift position.
- 3 Adjust the length of the shift link rod (a) so that roller (c) is at the full end of travel (bottom) in the shift cam (c) when the shift handle is in full forward.

MAINTENANCE

goh133

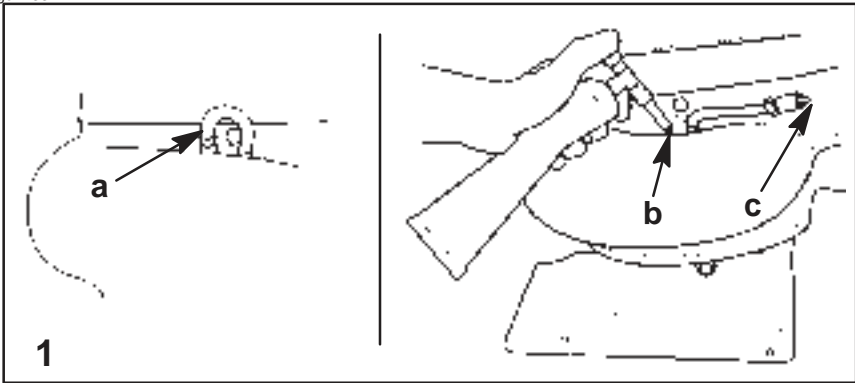

oho33

Lubrication Points

1 Lubricating the drive shaft bearing.

Recommended Lubrication - Use Quicksilver or Mercury Precision Lubricants 2-4-C w/Teflon, or Lubriplate 630-AA Grease.

IMPORTANT: It is important that you do not use a general-all-purpose grease for this bearing. The lubricant we recommend is a water resistant grease of the proper consistency for this application. If you use a substitute grease, be sure that it is water resistant and of the same consistency.

Frequency of lubrication - We recommend lubricating the drive shaft bearing after each day's use and after every 10 hours of operation. After every 30 hours of operation, pump in extra grease to purge out any moisture.

Lubricating Procedure - Pull vent hose (a) off the grease fitting. Pump in grease (b) through the grease fitting (using the grease gun provided) until excess grease starts to exit the vent hose(c).

Reconnect the vent hose (a) onto the grease fitting after greasing.

After 30 hours of operation, pump in extra grease to purge out any moisture. Visually inspecting the purged grease at this time will give you an indication of conditions inside the bearing housing. A gradual increase in moisture content, indicates seal wear. If the grease begins to turn dark, dirty gray, the drive shaft bearing and seals should be inspected and replaced if necessary. Some discoloration of the grease is normal during the break-in period on a new set of seals.

MAINTENANCE

goh134

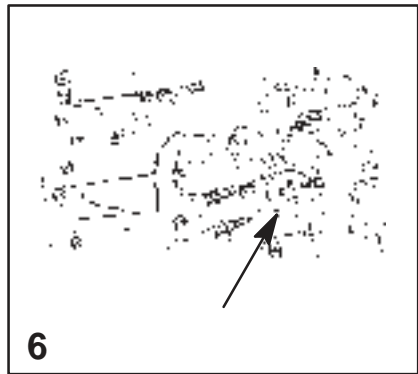
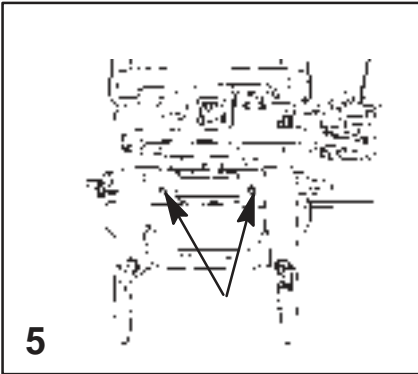
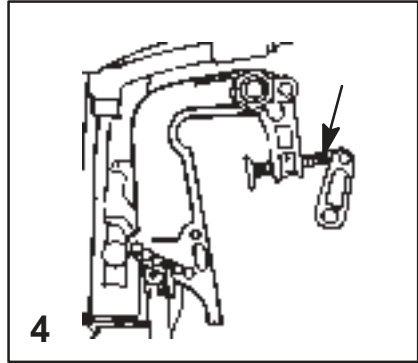
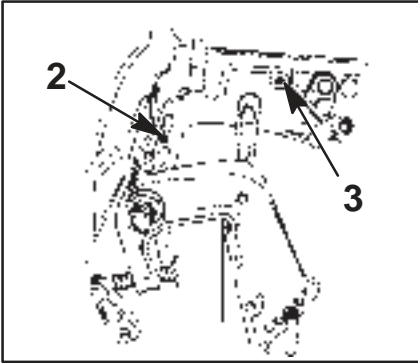

oho34

Lubrication Points

Lubricate Points 2 thru 7 with Quicksilver or Mercury Precision Lubricants 2-4-C Marine Lubricant with Teflon or Special Lubricate 101.

- 2** Steering Friction Adjustment Shaft (Tiller Handle Models) – Lubricate fitting.
- 3** Swivel Bracket – Lubricate fitting.
- 4** Transom Clamp Screws – Lubricate threads.
- 5** Tilt Tube – Lubricate fittings.
- 6** Lubricate the throttle and shaft cables, moving components and pivot locations.

(continued on next page)

MAINTENANCE

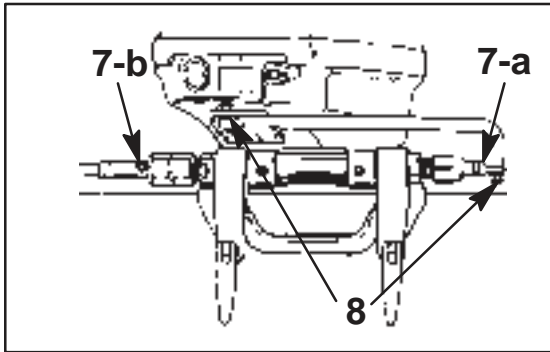

Lubrication Points (Continued)

⚠ WARNING

The end of the steering cable must be fully retracted into the outboard tilt tube before adding lubricant. Adding lubricant to steering cable when fully extended could cause steering cable to become hydraulically locked. An hydraulically locked steering cable will cause loss of steering control, possibly resulting in serious injury or death.

- 7** Steering Cable Grease Fitting (If Equipped) – Rotate steering wheel to fully retract the steering cable end (a) into the outboard tilt tube. Lubricate through fitting (b).

Lubricate points 8 With Light Weight Oil

- 8** Steering Link Rod Pivot Points – Lubricate points.

MAINTENANCE

goh14

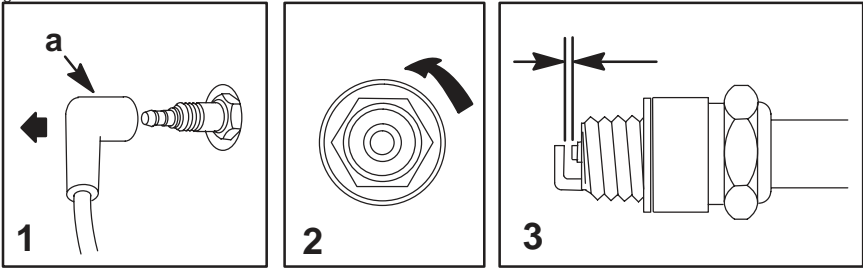

ohm16

Spark Plug Inspection and Replacement

⚠ WARNING

Avoid serious injury or death from fire or explosion caused by damaged spark plug boots (a). Damaged spark plug boots can emit sparks. Sparks can ignite fuel vapors under the engine cowl. To avoid damaging spark plug boots, do not use any sharp object or metal tool such as pliers, screwdriver, etc. to remove spark plug boots.

- 1** Remove the spark plug boots (a) by twisting the rubber boots slightly and pull off.
- 2** Remove the spark plugs to inspect. Replace spark plug if electrode is worn or the insulator is rough, cracked, broken, blistered or fouled.
- 3** Set the spark plug gap. See Specification Chart in General Information Section.
- 4** Before installing spark plugs, clean away dirt on the spark plug seats. Install plugs finger tight, and tighten 1/4 turn or torque to 20 lb. ft. (27 N·m).

MAINTENANCE

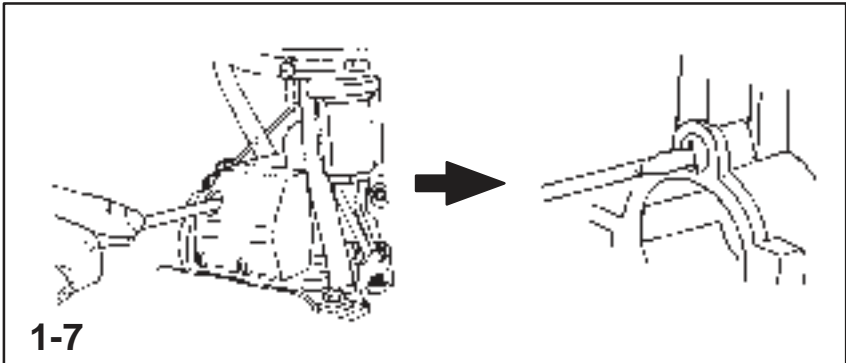

Carburetor Adjustments

SLOW SPEED MIXTURE ADJUSTMENT

- 1** Remove access plug from cover.
- 2** Before starting engine, turn the slow speed mixture screw in until it is lightly seated then back it out 1-1/2 turns.
- 3** With the boat tied securely to dock, start engine and allow it to warm up.
- 4** Shift the outboard to forward gear and reduce engine speed to idle.
- 5** Turn the slow speed mixture screw slowly in until the engine starts to misfire or stall due to a lean mixture. Note the position of the screw slot.
- 6** Turn the slow speed mixture screw slowly out until the engine starts to "load up" or fire unevenly due to a rich mixture.
- 7** Set the slow speed mixture screw midway between the rich and lean setting. When in doubt, set the mixture slightly rich rather than too lean.

MAINTENANCE

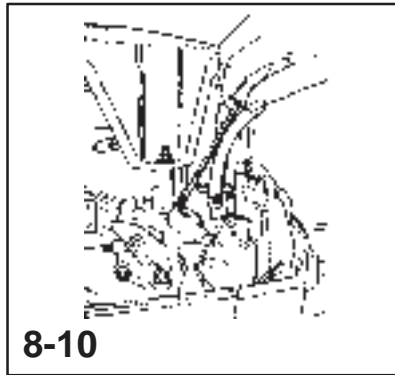

ENGINE IDLE SPEED ADJUSTMENT

- 8** With boat tied securely to dock, start engine and allow it to warm up.
- 9** Shift outboard to forward gear and reduce engine speed to idle. Make sure the Primer/Fast Idle Knob is pushed all the way in and turned to the slowest idle speed.
- 10** Adjust the idle speed screw to obtain the recommended engine idle speed. (Refer to Specification Chart in General Information Section.)

HIGH SPEED MIXTURE ADJUSTMENT

The carburetor is equipped with a standard size high speed fixed jet that is replaceable for operation at higher elevations.

Submerged Outboard

A submerged outboard will require service within a few hours by an authorized dealer once the outboard is recovered from the water. This immediate attention by a servicing dealer is necessary once the engine is exposed to the atmosphere to minimize internal corrosion damage to the engine.

STORAGE

oia2

Storage Preparation

The major consideration in preparing your outboard for storage is to protect it from rust, corrosion, and damage caused by freezing of trapped water.

The following storage procedures should be followed to prepare your outboard for out of season storage or prolonged storage (two months or longer).

⚠ CAUTION

Never start or run your outboard (even momentarily) without water circulating through all the cooling water intake holes in the gear case to prevent damage to the water pump (running dry) or overheating of the engine.

oib3

FUEL SYSTEM

IMPORTANT: Gasoline containing alcohol (ethanol or methanol) can cause a formation of acid during storage and can damage the fuel system. If the gasoline being used contains alcohol, It is advisable to drain as much of the remaining gasoline as possible from the fuel tank, remote fuel line, and engine fuel system.

Fill the fuel system (tank, hoses, fuel pump, and carburetor) with treated (stabilized) fuel to help prevent formation of varnish and gum. Proceed with following instructions.

1. Portable Fuel Tank – Pour the required amount of gasoline stabilizer (follow instructions on container) into fuel tank. Tip fuel tank back and forth to mix stabilizer with the fuel.
2. Permanently Installed Fuel Tank – Pour the required amount of gasoline stabilizer (follow instructions on container) into a separate container and mix with approximately one quart (one liter) of gasoline. Pour this mixture into fuel tank.
3. Place the outboard in water. Run the engine for ten minutes to allow treated fuel to reach the carburetor.

STORAGE

oic4

PROTECTING EXTERNAL OUTBOARD COMPONENTS

4. Lubricate all outboard components listed in the Inspection and Maintenance Schedule.
5. Touch up any paint nicks. See your dealer for touch-up paint.
6. Spray Quicksilver or Mercury Precision Lubricants Corrosion Guard on external metal surfaces (except corrosion control anodes).

oid3

PROTECTING INTERNAL ENGINE COMPONENTS

NOTE: Before performing Steps 7 and 8, make sure the fuel system has been prepared for storage. Refer to Fuel System on previous page.

7. Place the outboard in water. Start the engine and let it run in neutral to warm up.
8. With engine running at fast idle, stop the fuel flow by disconnecting the remote fuel line. When engine begins to stall, quickly spray Quicksilver or Mercury Precision Lubricants Storage Seal into carburetor until engine stops from lack of fuel.
9. Remove the spark plugs and inject a five second spray of storage seal around the inside of each cylinder.
10. Rotate the flywheel manually several times to distribute the storage seal in the cylinders. Reinstall spark plugs.

oih1

JET DRIVE

11. Pump extra grease into the jet drive bearing to purge out moisture.

STORAGE

POSITIONING OUTBOARD FOR STORAGE

Store outboard in an upright (vertical) position to allow water to drain out of outboard.

BATTERY STORAGE

1. Follow the battery manufacturers instructions for storage and recharging.
2. Remove the battery from the boat and check water level. Recharge if necessary.
3. Store the battery in a cool, dry place.
4. Periodically check the water level and recharge the battery during storage.

TROUBLESHOOTING

1 – STARTER MOTOR WILL NOT CRANK THE ENGINE (ELECTRIC START MODELS)

POSSIBLE CAUSES

- Remote control models – Blown 20 Amp fuse in the starting circuit. Refer to Maintenance Section
- Outboard is not shifted to neutral position.
- Weak battery or battery connections are loose or corroded.
- Ignition key switch failure.
- Wiring or electrical connection faulty.
- Starter motor or starter solenoid failure.

2 – ENGINE WILL NOT START

POSSIBLE CAUSES

- Lanyard stop switch not in RUN position.
- Incorrect starting procedure. Refer to Operating Section.
- Old or contaminated gasoline.
- Engine flooded. Refer to Operating Section.
- Fuel is not reaching the engine.
 - a. Fuel tank is empty.
 - b. Fuel tank vent not open or restricted.
 - c. Fuel line is disconnected or kinked.
 - d. Primer bulb not squeezed.
 - e. Primer bulb check valve is faulty.
 - f. Fuel filter is obstructed. Refer to Maintenance Section.
 - g. Fuel pump failure.
 - h. Fuel tank filter obstructed.
- Ignition system component failure
- Spark plugs fouled or defective. Refer to Maintenance Section.

TROUBLESHOOTING

3 – ENGINE RUNS ERRATICALLY

POSSIBLE CAUSES

- Spark plugs fouled or defective. Refer to Maintenance Section.
- Incorrect setup and adjustments.
- Fuel is being restricted to the engine.
 - a. Engine Fuel filter is obstructed. Refer to Maintenance Section.
 - b. Fuel tank filter obstructed.
 - c. Stuck anti-siphon valve located on permanently built in type fuel tanks.
 - d. Fuel line is kinked or pinched.
- Fuel pump failure.
- Ignition system component failure.

4 – ENGINE OVER-SPEED (EXCESSIVE RPM)

POSSIBLE CAUSES

- Outboard mounted too high on the transom.
- Worn jet pump impeller or liner.
- Incorrect jet pump impeller clearance adjustment.
- Tilting the outboard out beyond a vertical position.
- Cavitation of the impeller due to rough water or obstruction in the boat hull.

5 – BATTERY WILL NOT HOLD CHARGE

POSSIBLE CAUSES

- Battery connections are loose or corroded.
- Low electrolyte level in battery.
- Worn out or inefficient battery.
- Excessive use of electrical accessories.
- Defective rectifier, alternator, or voltage regulator.

OWNER SERVICE ASSISTANCE

or6

Local Repair Service

Always return your outboard to your local authorized dealer should the need for service arise. Only he has the factory-trained mechanics, knowledge, special tools and equipment and the genuine parts and accessories to properly service your engine should the need occur. He knows your engine best.

or2

Service Away From Home

If you are away from your local dealer and the need arises for service, contact the nearest authorized dealer. Refer to the Yellow Pages of the telephone directory. If, for any reason, you cannot obtain service, contact the nearest Mercury Marine Service Office.

or7

Parts And Accessories Inquiries

All inquiries concerning genuine replacement parts and accessories should be directed to your local authorized dealer. The dealer has the necessary information to order parts and accessories for you. When inquiring on parts and accessories, the dealer requires the model and serial number to order the correct parts.

OWNER SERVICE ASSISTANCE

or4

Service Assistance

Your satisfaction with your outboard product is very important to your dealer and to us. If you ever have a problem, question or concern about your outboard product, contact your dealer or any Authorized Mercury Marine Dealership. If additional assistance is required, take these steps.

1. *Talk with the dealership's sales manager or service manager. If this has already been done, then contact the owner of the dealership.*

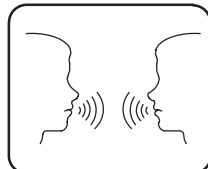

2. *Should you have a question, concern or problem that cannot be resolved by your dealership, please contact Mercury Marine Service Office for assistance. Mercury Marine will work with you and your dealership to resolve all problems.*

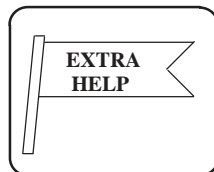

The following information will be needed by the service office:

- Your name and address
- Daytime telephone number
- Model and serial number of your outboard
- The name and address of your dealership
- Nature of problem

Mercury Marine Service Offices are listed on the next page.

OWNER SERVICE ASSISTANCE

or⁵

Mercury Marine Service Offices

For assistance, call, fax, or write. *Please include your daytime telephone number with mail and fax correspondence.*

 Telephone	 Fax	 Mail
United States		
(920) 929-5040	(920) 929-5893	Mercury Marine W6250 W. Pioneer Road P.O. Box 1939 Fond du Lac, WI 54936-1939
Canada		
(905) 567-6372	(905) 567-8515	Mercury Marine Ltd. 2395 Meadowpine Blvd. Mississauga, Ontario Canada L5N 7W6
Australia, Pacific		
(61) (3) 9791-5822	(61) (3) 9793-5880	Mercury Marine Australia 132-140 Frankston Road Dandenong, Victoria 3164 Australia
Europe, Middle East, Africa		
(32) (87) 32 • 32 • 11	(32) (87) 31 • 19 • 65	Marine Power - Europe, Inc. Parc Industriel de Petit-Rechain B-4800 Verviers Belgium
Mexico, Central America, South America, Caribbean		
(305) 385-9585	(305) 385-5507	Mercury Marine - Latin America & Caribbean 9010 S.W. 137th Ave. Suite 226 Miami, FL 33186 U.S.A.
Japan		
81-53-423-2500	81-53-423-2510	Mercury Marine - Japan 283-1 Anshin-cho Hamamatsu, Shizuoka, 435-0005 Japan
Asia, Singapore		
5466160	5467789	Mercury Marine Singapore 72 Loyang Way Singapore 508762

