



OWNER'S MANUAL
090-3099 A



WARNING

A wide variety of components used on this vessel contain or emit chemicals known to the State of California to cause cancer and birth defects and other reproductive harm.

EXAMPLES INCLUDE:

- Engine and generator exhaust
- Engine and generator fuel, and other liquids such as coolants and oil, especially used motor oil
- Cooking fuels
- Cleaners, paints, and substances used for vessel repair
- Waste materials that result from wear of vessel components
- Lead from battery terminals and from other sources such as ballast or fishing sinkers

TO AVOID HARM:

- Keep away from engine, generator, and cooking fuel exhaust fumes
- Wash areas thoroughly with soap and water after handling the substances above

GM2203301

Boating Safety Checklist

MUST HAVE ITEMS

As Required By Regulation

Personal Flotation Devices (Life Jackets)

- Type I, II, III, or V for each person onboard (Wearable)
- One Type IV (Throwable)
Not Required on Non-Powered Boats under 16'

Fire Extinguishers

Choose One	Boats w/out Fixed System		Boats w/ Fixed System
<input type="checkbox"/>	Boats <26'	1 Size B1	-OR- Fixed System
<input type="checkbox"/>	Boats 26' - <40'	2 Size B1*	-OR- Fixed System + 1 Size B1
<input type="checkbox"/>	Boats 40' - 65'	3 Size B1*	-OR- Fixed system + 2 Size B1*

* One Size B1 may be substituted for Two Size B1 Extinguishers

Visual Distress Signals (VDS)

- Choose One
- Combination Day/Night VDS (Flares or Flare Gun)
 - Daytime VDS (Flags, Smoke Signal) AND Nighttime VDS (Automated SOS Light)

Sound Signals

- Horn or Whistle
- Bell (Not required for vessels under 12m)

Ventilation (Boats with Gasoline Systems)

- Natural Ventilation
- Powered Ventilation

Backfire Flame Control

- Backfire Flame Arrestor (Gasoline Engines except outboards)

- The above represents minimum USCG Safety Requirements on-board vessels.
- Other Requirements may be necessary to comply with state laws.

- This is not intended to be an all-inclusive list but rather a baseline of items to make your boating adventure safe and fun.
- For Vessels over 65' refer to 33CFR 25.20-23 or ABYC A-4.



Boating Safety Checklist

Recommended Items

Items in Red May be Required in Some States

Boats on Inland Waters Everything on Required List PLUS:

- | | |
|--|--|
| <input type="checkbox"/> First Aid Kit | <input type="checkbox"/> Boating Safety Education/
Certificate |
| <input type="checkbox"/> Anchor with Sufficient Line | <input type="checkbox"/> Watersports Flag
(Skier Down/Driver Down Flag) |
| <input type="checkbox"/> Bailing Device | |
| <input type="checkbox"/> Sun Protection | |
| <input type="checkbox"/> Alternate Propulsion (Paddles, Oar) | |

Boats on Nearshore Waters Everything Above PLUS:

- | | |
|---|---|
| <input type="checkbox"/> Extra Food & Water | <input type="checkbox"/> GPS/Chartplotter |
| <input type="checkbox"/> Float Plan | <input type="checkbox"/> Depth Finder |
| <input type="checkbox"/> Compass | <input type="checkbox"/> Charts |
| <input type="checkbox"/> VHF Radio | <input type="checkbox"/> Spare Tool Kit |

Boats on Offshore Waters Everything Above PLUS:

- | | |
|---|---|
| <input type="checkbox"/> EPIRB | <input type="checkbox"/> Man-Overboard Recovery Gear |
| <input type="checkbox"/> Life Raft | <input type="checkbox"/> AIS |
| <input type="checkbox"/> Searchlight | <input type="checkbox"/> Sea Drogue |
| <input type="checkbox"/> List of CPR Instruction | <input type="checkbox"/> Safety Knife |
| <input type="checkbox"/> Radar | <input type="checkbox"/> Weather Information System |
| <input type="checkbox"/> Radar Reflector | <input type="checkbox"/> Radio Direction Finder |
| <input type="checkbox"/> Shore Landing Craft (Tender) | <input type="checkbox"/> Long Range Communications Gear |

Boats on River Waters Everything on Required List Plus:

- | | |
|------------------------------------|---------------------------------|
| <input type="checkbox"/> Throw Bag | <input type="checkbox"/> Helmet |
|------------------------------------|---------------------------------|

Miscellaneous Items Other Items That May be Recommended:

- | | |
|---|--|
| <input type="checkbox"/> Heaving Line | <input type="checkbox"/> Strobe Light |
| <input type="checkbox"/> Spare Keys | <input type="checkbox"/> Carbon Monoxide Detector |
| <input type="checkbox"/> Boat Hook/Pole | <input type="checkbox"/> Extra Clothing |
| <input type="checkbox"/> Spare Propeller | <input type="checkbox"/> Marine Hardware |
| <input type="checkbox"/> Extra Engine Oil | <input type="checkbox"/> Masks & Fins (For Clearing Props) |
| <input type="checkbox"/> Handheld Lead-line | <input type="checkbox"/> Storm Sails |

Scan here to download
the AYC Boating Safety
Checklist App
ayc.org/mobileapps





Table of Contents

INTRODUCTION	9
BOATING SAFETY & INFORMATION	10
A - 1 SAFETY MESSAGES	10
A - 2 CAPACITY & WARNING LABEL LOCATIONS.....	12
A - 3 ADDITIONAL LABELS & STICKERS.....	17
A - 4 GENERAL	17
A - 5 COMPONENT SYSTEMS	17
A - 6 SAFETY EQUIPMENT	17
A. Required Safety Equipment	18
B. Personal Flotation Devices (PFDs).....	18
C. PFD Types	18
D. PFD Pointers	19
E. Fire Extinguisher	19
F. Visual Distress Signal Devices	20
G. Sound Signaling Devices	20
H. Navigation Lights.....	20
I. Additional Recommended Equipment	21
A - 7 PASSENGER SAFETY	21
A - 8 RULES OF THE ROAD	21
A - 9 LIGHTNING.....	21
A - 10 DRUGS AND ALCOHOL.....	22
A - 11 CARBON MONOXIDE.....	22
A. Properties and Characteristics of Carbon Monoxide.....	22
B. What Makes Carbon Monoxide	23
C. How a Person is Affected by Carbon Monoxide.....	23
D. Effects of Carbon Monoxide	23
E. Symptoms.....	23
F. Treatment (Evaluate, Ventilate, Evacuate, Investigate, Take Corrective Action).....	23
G. Inspection.....	24
H. Operation	24
I. Boathouses, Sea Walls and Confined Spaces	24
J. The Effect of Boats Moored Along Side.....	24
K. Backdrafting (Station Wagon Effect).....	25
L. Accumulation of Exhaust Gases - Swim Platform.....	26
M. Dangerous Activity - "Teak Surfing"/"Dragging"	26
N. Ventilation of Accommodation (Occupied) Spaces	26
O. Running of Engine(s) in Idle	26
P. Altitude and Sea Conditions	26
Q. Portable Generator Sets.....	26
R. Maintenance - Engine Performance	26
S. Maintenance - External Conditions.....	27
T. Maintenance - Exhaust System Integrity	27
U. Maintenance - Ventilation Systems	27
V. Maintenance - Bulkhead and Deck Integrity	28
W. Maintenance - Liquid Drains.....	28
A - 12 SAFE BOATING PRACTICES.....	28
A. Drugs and Alcohol.....	28
B. Safe Operation.....	28
C. Passenger Safety.....	28
D. Jet Nozzle & Intakes Grates.....	29
E. First Aid.....	29
F. Operation By Minors	29

	G. Voluntary Inspections	29
	H. Safe Boating Courses	29
A - 13	WATER SPORTS	29
	A. Water Sport Guidelines	30
	B. Water Skiing/Wakeboarding/Kneeboarding	30
A - 14	HYPOTHERMIA	32
A - 15	BASIC SEAMANSHIP	32
	A. Boating Regulations.....	32
	B. Rules of Seamanship	32
	1. Right-of-way	32
	2. Meeting Head-on.....	33
	3. Crossing Situations	33
	4. Overtaking.....	33
	5. The General Prudential Rule	33
	6. Night Running and Navigation Lights.....	34
	7. Whistle Signal	34
	C. Navigational Aids	34
	1. International Association of Lighthouse Authorities System B (IALA-B)	35
	2. Lateral Markers	35
	3. Safe Water Markers	35
	4. The Uniform State Waterway Marking System	35
	5. A Special Sign.....	36
	6. Noise.....	36
	D. Owner's Logs and Records	36
	E. Navigational Aids Chart.....	36
A - 16	ANCHORING	36
A - 17	GROUNDING & TOWING	37
A - 18	HAZARDOUS CONDITIONS.....	38
	A. Storms	38
	B. Fog	38
	C. Running Aground.....	39
	D. Warning Markers.....	39
A - 19	REACTING TO EMERGENCIES.....	39
	A. Flooding	39
	B. Capsizing and Man Overboard.....	39
	1. Capsizing.....	39
	2. Man Overboard	39
	C. Collision	40
	D. Fire	40
	E. Medical Emergency.....	41
	F. Propulsion Failure	41
	G. Control Failure.....	41
	H. Steering Failure.....	41
	I. Additional Underway Information.....	41
A - 20	BOATING EDUCATION	41
	A. Boating Courses.....	41
	B. Recommended Reading	41
	C. Charts and Maps.....	42
	D. Laws and Regulations	42
	E. Contacts.....	42
A - 21	BOAT OWNER REGISTRATION	43
A - 22	ACCIDENT REPORTING	43
A - 23	DISCHARGE OF OIL	43
A - 24	DISPOSAL OF PLASTICS & OTHER GARBAGE	43



A - 25	MARPOL TREATY	44
BOAT SYSTEMS		45
B - 1	CONTROL SYSTEM	45
	A. Neutral Safety Switch.....	45
	B. Emergency Engine Shut Off Switch.....	45
	C. Control Systems Maintenance.....	46
B - 2	STEERING	46
	A. General	46
	B. Tilt Steering	47
	C. Steering System Maintenance	47
	1. Inspection.....	47
	2. Steering Systems Maintenance	47
	3. Winter Storage	48
B - 3	PROPULSION SYSTEM	48
	A. Engine(s).....	48
	B. Engine Exhaust	48
	C. Jet Nozzle(s)	49
B - 4	INSTRUMENTATION	49
	A. Speedometer - Analog & Digital Readings	50
	B. Tachometer - Analog & Digital Readings.....	51
	C. Hour Meter	51
	D. Fuel Gauge	51
	E. Information Display	52
	1. Compass.....	52
	2. Water Temperature	52
	3. Message Code	52
	F. Four Position Ignition Switch	53
	G. Instrument Maintenance	53
B - 5	ELECTRICAL SYSTEM	53
	A. Single Engine - Dual Battery System	55
	1. Installation.....	55
	2. Battery Switch Operation.....	55
	B. Twin Engine - Single Battery System.....	56
	1. Installation.....	56
	2. Battery Switch Operation.....	56
	C. Low/Hi Battery Voltage	57
	D. 12-Volt Electrical Equipment	57
	1. Helm Equipment	57
	2. Installation of Additional 12-Volt Equipment.....	60
	3. Interior 12-Volt Electrical Equipment	60
	E. 12-Volt Electrical Systems Shutdown Procedure	61
	F. Electrical Systems Maintenance.....	61
	1. Battery Maintenance	61
	2. Electrical Wiring Maintenance.....	61
	G. Stray Current Corrosion	62
	1. General.....	62
	2. Galvanic Corrosion.....	62
	3. Corrosion Prevention.....	62
B - 6	FUEL SYSTEM (GASOLINE)	63
	A. Fuel System	63
	B. System Testing	63
	C. Fuel Fills.....	64

D.	Fuel Vents.....	65
E.	Fuel Gauge	65
F.	Fuel Sender	65
G.	Fuel Filter	66
H.	Use and Maintenance	66
I.	Fuel Standards.....	66
1.	Problems With Alcohol in Gasoline.....	66
2.	Recommendations	66
J.	Fueling Instructions	67
B - 7	VENTILATION AND DRAINAGE SYSTEMS	68
A.	Engine Compartment Ventilation.....	68
1.	Natural Ventilation System	68
2.	Forced Air Ventilation	68
3.	Engine Ventilation System Maintenance.....	68
B.	Hull Drainage Systems.....	68
1.	Transom Drain.....	68
2.	Bilge Pump.....	68
3.	Liner Drains.....	69
4.	Bilge Compartment Drainage	69
B - 8	FRESH WATER SYSTEMS	69
A.	Head Sink	71
B.	Aft Shower	71
C.	Disinfecting the Fresh Water System	72
D.	System Maintenance.....	73
1.	Clean Vents and Screens.....	73
2.	Winterizing the Water System	73
B - 9	WASTE SYSTEMS.....	73
A.	Enclosed Head	73
B.	Porta-Potti	74
C.	Porta-Potti w/Pumpout	75
B - 10	BALLAST SYSTEM.....	76
A.	Ballast System Operations - Filling.....	76
B.	Ballast System Operations - Emptying	77
C.	Ballast System Maintenance	78
D.	Winterizing the Ballast System	78
BOAT EQUIPMENT		79
C - 1	DECK HARDWARE	79
A.	Grab Handles	79
B.	Cleats.....	79
C.	Transom Ski Tow Ring	80
D.	Maintenance	80
C - 2	WINDSHIELD.....	80
C - 3	AFT SWIM PLATFORM AND LADDER.....	81
C - 4	WAKEBOARD TOWER.....	82
C - 5	GLOVE BOX	83
C - 6	STEREO.....	83
C - 7	ANCHOR STORAGE	83
C - 8	COCKPIT STORAGE	84
C - 9	COCKPIT TABLES.....	85
C - 10	SEATING.....	85
A.	Bow Seating.....	85
B.	Bucket Seats.....	86



C. Stern Cockpit Seating.....	88
D. Swim Platform Lounge Seating	88
E. Sun Pad	88
F. Motorhood - Engine Compartment Access.....	89
OPERATION	90
D - 1 PRE-CRUISE INSPECTION.....	90
A. Before Starting the Engine	90
B. After Starting the Engine	91
D - 2 FUELING.....	91
A. Recommendations	91
B. Preliminary Guidelines	91
C. Pumping Fuel.....	91
D. After Fueling.....	92
D - 3 LOADING OF PASSENGERS & GEAR.....	92
D - 4 STARTING PROCEDURES	93
A. Preliminary Checks	93
B. Before Starting	93
C. Starting.....	94
D - 5 CONTROL OPERATIONS.....	95
A. Maneuvering of the Separate Shift & Throttle Control.....	95
B. Shifting and Control Speed - Separate Shift & Throttle Control.....	96
C. Stopping Engine.....	97
D. Maneuvering of the Side-Mount Control	97
E. Shifting and Control Speed - Side-Mount Control	98
F. Stopping Engine.....	98
D - 6 DIGITAL SPEED CONTROLS.....	98
A. General	99
B. Cruise Mode.....	99
1. Cruise Mode Limitations.....	99
2. Setting the Cruise Mode.....	99
3. Temporarily Deactivating the Cruise Mode.....	100
4. Cancelling the Cruise Mode	100
C. Ski Mode.....	100
1. Ski Mode Limitations	100
2. Setting the Ski Mode.....	100
3. Temporarily Deactivating the Ski Mode	101
4. Cancelling the Ski Mode.....	102
D. ECO Mode	102
1. Setting the ECO Mode	102
2. Cancelling the ECO Mode.....	102
E. Docking Mode	102
1. Setting the Docking Mode	102
2. Cancelling the Docking Mode.....	102
D - 7 STEERING OPERATIONS.....	103
D - 8 MANEUVERING.....	103
A. Leaving the Dock	103
B. Stopping.....	103
D - 9 PRACTICE MANEUVERS.....	104
A. Where to Practice Exercises	104
B. Practice Exercises.....	104
1. Turning.....	104
2. Stopping Distances	104

3. Reverse	104
4. Avoiding an Obstacle	104
5. Docking.....	105
6. Ski Mode and Cruise Mode.....	105
C. Important Factors to Remember.....	105
D - 10 ACCELERATION.....	105
D - 11 GENERAL OPERATING RECOMMENDATIONS	106
A. Rough Water or Poor Visibility Operation	106
B. Night Operation.....	106
C. Crossing Waves.....	106
D. Stopping/Docking.....	106
E. Beaching.....	106
D - 12 RETURNING TO SHORE.....	107
A. Docking.....	107
B. Mooring.....	107
CARE AND MAINTENANCE.....	109
E - 1 FIBERGLASS CARE & MAINTENANCE	109
A. General Maintenance	109
B. Weathering Effects on Gel Coat	109
C. Stains.....	110
E - 2 FIBERGLASS REPAIRS	110
A. Scratches	111
B. Gouges & Cracks.....	111
C. Osmotic Blistering	111
E - 3 EQUIPMENT INSTALLATION.....	112
E - 4 ANTI-FOULING PAINT	112
E - 5 HULL SUPPORT	112
E - 6 STAR BOARD	113
E - 7 LAMINATED FIBERGLASS.....	113
E - 8 ACRYLIC PLASTIC - (PLEXIGLASS).....	114
E - 9 SWIM PLATFORM MAT	114
E - 10 UPHOLSTERY CARE	114
A. Cleaning Vinyl	114
B. Exterior Carpets	116
1. Cleaning and Maintenance.....	116
2. Stain Removal Testing	117
3. Stain Removal Procedures.....	117
E - 11 REPLACEMENT UPHOLSTERY	117
E - 12 WEATHER COVERS	118
A. Bimini Top	119
B. Forward Cover	119
C. Cockpit Cover	119
D. Trailering Cover.....	120
E. Trailering with a Weather Cover.....	120
F. Winter Storage.....	120
G. Use of Weather Covers and Carbon Monoxide	120
H. Weather Cover Maintenance	120
E - 13 SPECIAL PROCEDURES	121
A. Jet Pump Water Intake and Impeller Cleaning.....	121
B. Towing the Boat in Water	122
C. Submerged Boat and Water-Flooded Engine	122
E - 14 WINTERIZATION	123



A.	Prior to Lifting for Winter Lay-up	123
B.	After Lifting	123
C.	Prior to Winter Storage.....	124
E - 15	GENERAL MAINTENANCE SCHEDULE	125-127
TRAILER INFORMATION		128
F - 1	GENERAL TRAILER INFORMATION	128
A.	Regulations	128
B.	Load Carrying Capacity.....	128
C.	Hitches.....	129
F - 2	TRAILER COMPONENTS.....	129
A.	Bunk Supports	129
B.	Tongue.....	130
C.	Swivel Jack	130
D.	Surge Brakes & Coupling Assembly.....	131
E.	Winch.....	132
F.	Tires & Wheels.....	133
G.	Spare Tire Carrier	133
H.	Lights	133
I.	Tie-downs	133
F - 3	OPERATION	135
A.	Hitching Trailers	135
B.	Backing Up with Surge Brakes	137
F - 4	TRAILERING	138
A.	Checklist	138
B.	Tactics	139
F - 5	MAINTENANCE	139
A.	Care of Exterior Finish.....	139
B.	Bunks.....	139
C.	Swivel Jack	140
D.	Brake Actuator & Coupling Assembly	140
E.	Winch.....	140
F.	Lights	140
G.	Tie-downs	140
H.	Wheels.....	140
I.	Brakes.....	140
J.	Bearings.....	141
F - 6	AXLE INSPECTION & REPAIRS.....	142
A.	Removal of Hub	142
B.	Bearing/Seal Inspection and Replacement.....	142
C.	Hub Reinstallation	142
F - 7	SUPPLEMENTAL TRAILER INFORMATION	143
A.	Information Contained on Sidewall of the Tire	143
B.	Sample Tire Registration	144
C.	Inflating Your Tires	144
D.	Load Carrying Capacity.....	145
E.	Reporting Safety Defects	146
F.	Glossary of Tire Terminology	146
WARRANTY AND SERVICE.....		147
G - 1	SCARAB WARRANTY POLICY	147
G - 2	DECK/HULL STRUCTURE WARRANTY	147

G - 3	WARRANTY REGISTRATION	147
G - 4	TRANSFER OF WARRANTY	147
G - 5	PRE-OWNED UNIT REGISTRATION	147
G - 6	INSURANCE COVERAGE	148
G - 7	SERIAL NUMBER RECORD.....	148
G - 8	PRE-DELIVERY SERVICE.....	148
G - 9	REPLACEMENT PARTS.....	148
G - 10	OWNER'S RESPONSIBILITIES	148
G - 11	CONSTRUCTION STANDARDS.....	149
G - 12	SCARAB APPAREL	149
	NAME/ADDRESS CHANGE FORM	151
	WARRANTY REGISTRATION TRANSFER REQUEST	153
NAUTICAL GLOSSARY.....		155
FLOAT PLAN		162
FUEL LOG.....		163
SERVICE LOG		166
SERVICE INFORMATION		169





Congratulations on your new Scarab® jet boat purchase and welcome to our boating family!

We want your boating experience to be the most enjoyable possible. The more you know about your new jet boat, the more you'll enjoy the time you spend aboard. That's why we prepared this manual. It's your guide for safe operation as well as understanding your jet boat. Be sure to read the contents thoroughly. This boat may exceed the performance of other boats you may have driven in the past. Take time to familiarize yourself with your new boat.

When appropriate, please utilize the information pertinent to your specific boat model, systems and equipment. It has been written for the beginning boater but experienced boaters will find helpful information as well. This manual will acquaint you with the use and maintenance of your new Scarab jet boat. This manual also provides special information critical to the safety of the passengers, and longevity of the equipment. The information on the following pages lists the graphics used to increase the visibility of these important messages. Also included in your owner's packet is additional information such as component manufacturer's literature. This information should be read along with your Scarab jet boat owner's manual before operating your boat. Review all information completely before using your new jet boat. **Please refer to our website for further updated information and possible revisions to this manual.**

Scarab continually strives to improve its products. Unit specifications, including standard and optional equipment are constantly being modified. **Equipment availability is also subject to change without notice. The most current and accurate information available at the time of publication is included in this manual. Some variation in material, equipment, description, location, and details can result.**

The information in this manual focuses upon the jet boats and equipment designed and manufactured by Scarab. When appropriate, please utilize the information pertinent to your specific jet boat model. Equipment such as engines, and other accessories are manufactured by others. **The information provided in this manual is intended to be used in conjunction with the information provided by the manufacturers of this equipment.** All information available at the time of manufacture has been included with your owner's packet. In many cases, replacement of manufacturer's literature may be obtained via their respective websites.

Read this entire manual carefully before operating your new boat. Many instructions may require direct performance of the activity to fully understand the correct method. If you choose to read this manual at home, remember to take it to the boat with you.

Your Scarab dealer knows your boat best and is committed to your complete satisfaction. Return to the dealer for service or other assistance. If you find it necessary to contact Scarab directly, please refer to the contact information listed below. Be sure to include the boat model, hull identification number, your daytime telephone number, and specifics of the information desired.

This manual has been specifically developed for the Scarab jet boat models. Please record the model and hull identification number information below.

Model

Hull Identification Number

This manual should be considered part of the boat. Should you sell the boat, pass this manual on to the new owner. Take special care of this manual. Certain information in this manual may not be available in a replacement manual. An electronic version of this manual may be viewed on our website at www.scarabboats.com.

Thank you for joining the Scarab family. We appreciate your purchase and welcome the opportunity to demonstrate our commitment to you.

Scarab Customer Service Department

925 Frisbie Street

Cadillac, Michigan 49601

231 775-1343 (Phone)

231 779-2345 (Fax)

E-mail Address: boating@scarabboats.com

©Rec Boat Holdings, LLC 2016 All Rights Reserved.

NOTICE

This manual has been compiled to help you operate your boat with safety and pleasure. It contains the details of the boat, the equipment supplied or fitted, its systems, and information on its operation and maintenance. Please read it carefully and familiarize yourself with the boat before using it.

If this is your first boat, or if you are changing to a type of boat you are not familiar with, for your own comfort and safety, please ensure that you obtain handling and operating experience before “assuming command” of the boat. Your dealer or national sailing federation or yacht club will be pleased to advise you of local sea schools and competent instructors.

PLEASE KEEP THIS MANUAL IN A SECURE PLACE, AND HAND IT OVER TO THE NEW OWNER WHEN YOU SELL THE BOAT.

A - 1 SAFETY MESSAGES

The popularity of boating and other water sports has grown tremendously in the past few years. Because of this, safety is an important issue for everyone who shares our waterways.

Remember that along with the freedom and exhilaration of boating comes the responsibility that you have for the safety of your passengers and the other boaters who share the water with you. Throughout this manual, specific precautions and symbols identify safety related information. Be sure to pay close attention to them.

NOTICE

Boxes that are gray require your special attention. Notice boxes include helpful boating practices and law reminders.



This symbol means “pay attention!” Here is important information for your safety. If you don’t follow these instructions, you can damage your boat, hurt yourself or someone else or, even worse, have a fatal accident.



This symbol and signal word indicate a potentially hazardous situation. If you ignore this safety message, property damage or minor or moderate personal injury MAY or CAN result.



This symbol and signal word indicate a potential hazard. If you ignore this safety message, serious injury or death CAN result.



This symbol and signal word indicates an immediate hazard. If you ignore this safety message, serious personal injury or death WILL result.

The precautions in this manual can not and do not cover every boating situation. If a specific method or procedure is not recommended, you must make sure that what you do is safe for you and others. Always use common sense when boating! Remember to make sure that every boating excursion is a safe and happy experience.

IMPORTANT HEALTH AND SAFETY INFORMATION ABOUT YOUR NEW BOAT

WARNING

A wide variety of components used on this vessel contain or emit chemicals known to the State of California to cause cancer and birth defects and other reproductive harm.

EXAMPLES INCLUDE:

- Engine and generator exhaust
- Engine and generator fuel, and other liquids such as coolants and oil, especially used motor oil
- Cooking fuels
- Cleaners, paints, and substances used for vessel repair
- Waste materials that result from wear of vessel components
- Lead from battery terminals and from other sources such as ballast or fishing sinkers

TO AVOID HARM:

- Keep away from engine, generator, and cooking fuel exhaust fumes
- Wash areas thoroughly with soap and water after handling the substances above

GM2203301





We'd also like to remind you to be kind to our environment while you're boating. Don't throw garbage and other refuse overboard. Do your best to keep harmful compounds like gasoline, oil and antifreeze out of the water. Please see the notifications below:

DISCHARGE OF OIL PROHIBITED

THE FEDERAL WATER POLLUTION CONTROL ACT PROHIBITS THE DISCHARGE OF OIL OR OILY WASTE INTO OR UPON THE NAVIGABLE WATERS OF THE UNITED STATES, OR THE WATERS OF THE CONTIGUOUS ZONE, OR WHICH MAY EFFECT NATURAL RESOURCES BELONGING TO, APPERTAINING TO, OR UNDER THE EXCLUSIVE MANAGEMENT AUTHORITY OF THE UNITED STATES, IF SUCH DISCHARGE CAUSES A FILM OR DISCOLORATION OF THE SURFACE OF THE WATER OR CAUSES A SLUDGE OR EMULSION BENEATH THE SURFACE OF THE WATER. VIOLATORS ARE SUBJECT TO SUBSTANTIAL CIVIL PENALTIES AND/OR CRIMINAL SANCTIONS INCLUDING FINES AND IMPRISONMENT.

Oil Discharge Plate - (Specific Models Only - Location Not Shown)

It is illegal for any vessel to dump plastic trash anywhere in the ocean or navigable waters of the United States. Annex V of the MARPOL TREATY is an international law for a cleaner, safer marine environment. Violation of these requirements may result in civil penalty up to \$25,000, fine and imprisonment.

 <p>U.S. Lakes, Rivers, Bays, Sounds and 3 miles from shore ILLEGAL TO DUMP Plastic & Garbage</p> <p>Paper Metal Rags Crockery Glass Dunnage Food</p>	 <p>3 to 12 miles ILLEGAL TO DUMP Plastic</p> <p>Dunnage, lining & packing materials that float, also if not ground to less than one inch:</p> <p>Paper Crockery Rags Metal Glass Food</p>	 <p>12 to 25 miles ILLEGAL TO DUMP Plastic</p> <p>Dunnage, lining & packing materials that float</p>	 <p>Outside 25 miles ILLEGAL TO DUMP Plastic</p>
--	---	--	---

State and local regulations may further restrict the disposal of garbage.

Trash Overboard Decal - (Specific Models Only - Location Not Shown)

A - 2 CAPACITY & WARNING LABEL LOCATIONS

The NMMA capacity label and various warning labels are placed at different locations on each model for your safety. Additional warnings for fuel leakage, blower operation, and other important information will be located at the helm. Many of these stickers and labels are not required by the U.S. Coast Guard but are important to ensure the safe operation of your boat. Should a warning label become worn or somehow removed, a replacement label may be obtained by contacting Scarab customer service. In addition, the Hull Identification Number plate is permanently attached below the deck-hull joint on the starboard aft corner. Please see the following diagrams for the specific wording of the warning label and its location. **Note: Labels and locations may vary depending on model of the boat.**



*Do Not Sit Here Warning Label
(Certain Models Only)*

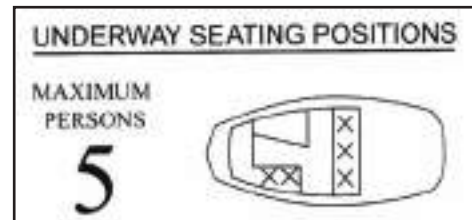

*Person Capacity &
Underway Seating Position Label
(Representative View - Models Will Vary)*



⚠ WARNING

Do not use reverse function to slow down or to stop boat above idle speed. Loss of control, ejection or injury can occur. Reverse is for low speed maneuvering only. Shift only while engine is idling or off.

Reverse Function Warning Label

U.S. COAST GUARD SAMPLE

MAXIMUM CAPACITIES

8 PERSONS OR 1325 LBS

1400 LBS, PERSONS, GEAR

THIS BOAT COMPLIES WITH U.S. COAST GUARD SAFETY STANDARDS IN EFFECT ON THE DATE OF CERTIFICATION

MANUFACTURER: SCARAB

MODEL: SB SERIES CADILLAC, MI 49601

MEETS US EPA EMIS. STANDARDS USING CERTIFIED COMPONENTS

*Capacity Label
(Models May Vary)*



⚠ WARNING

GASOLINE VAPORS CAN EXPLODE RESULTING IN INJURY OR DEATH. BEFORE STARTING ENGINE-CHECK ENGINE BILGE COMPARTMENT FOR GASOLINE OR VAPORS. OPERATE BLOWER FOR FOUR MINUTES AND VERIFY BLOWER OPERATION. RUN BLOWER WHEN VESSEL IS OPERATING BELOW CRUISING SPEED.

Helm Blower Warning

UNDERWAY SEATING POSITIONS

MAXIMUM PERSONS

8

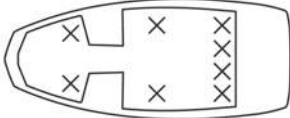

*Person Capacity & Underway Seating Position Label
(Representative View - Models Will Vary)*

⚠ WARNING

TO REDUCE THE RISK OF SEVERE INJURY OR DEATH:

WEAR A COAST GUARD APPROVED PERSONAL FLOTATION DEVICE (PFD)

KNOW LOCAL BOATING LAWS. Recommended minimum operation age is 16 years old. Know the operator age, training requirements, and applicable laws for your boating location.

PROPERLY ATTACH ENGINE SHUT-OFF LANYARD TO YOUR PFD.

BE SURE SHIFT CONTROL IS IN NEUTRAL BEFORE STARTING ENGINE(S)
Check throttle / shifter and steering operation before starting engine(s)

DO NOT PULL THROTTLE LEVERS BACK TO IDLE WHEN TRYING TO STEER- Apply throttle to steer boat. Steering is lost when engine(s) is off.

OPERATE WITHIN YOUR LIMITS AND AVOID AGGRESSIVE MANEUVERS to reduce the risk of loss of control, ejection and collision. Do not jump wakes or waves.

DO NOT APPLY THROTTLE WHEN ANYONE IS AT REAR OF BOAT - turn engine(s) off while boarding from the water, using the platform or when swimmers are behind the boat. Water and/or debris exiting the jet nozzle can cause severe injury including severe internal injuries if water is forced into body cavities. (rectum or vagina) Keep a safe distance from all other water users.

KEEP AWAY FROM INTAKE GRATES when engine(s) is running. Keep people, clothing and hair away from jet nozzles and intake grates when engine(s) are running to avoid entanglement or drowning.

READ AND FOLLOW OWNERS MANUAL

Jet Boat Warning Label



⚠ WARNING

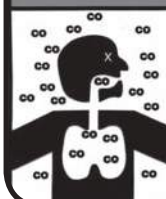

Carbon monoxide (CO) can cause brain damage or death.

Engine and generator exhaust contains odorless and colorless carbon monoxide gas.

Signs of carbon monoxide poisoning include nausea, headache, dizziness, drowsiness, and lack of consciousness.

Get fresh air if anyone shows signs of carbon monoxide poisoning.

See Owner's Manual for information regarding carbon monoxide poisoning.

CO-Helm Warning Label



Ski Tow Warning Label

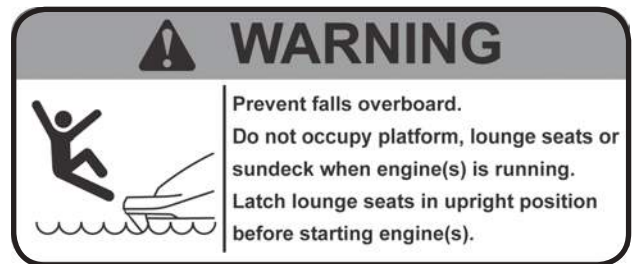

Platform Lounging Seats & Sun Lounge Warning Label



Jet Nozzle Warning Label



Leaking Fuel/Contents Under Pressure Warning Label

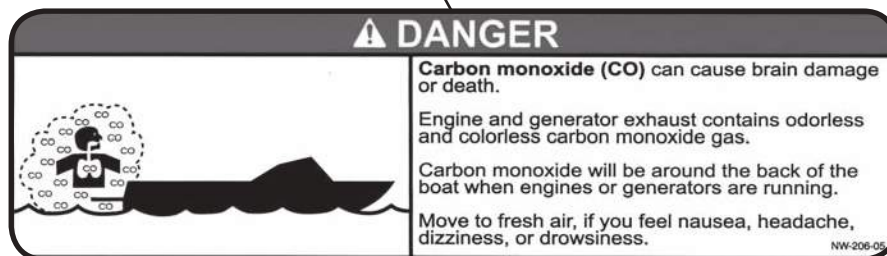



CO Swim Platform and Lounging Area Warning Label

A - 3 ADDITIONAL LABELS & STICKERS

NOTICE

The below label locations are not shown. These labels may or may not pertain to your specific model. Scarab has included them to familiarize the boat owner/operator with additional safety information.

CANADIAN COMPLIANCE NOTICE AVIS DE CONFORMITÉ CANADIEN	
MAXIMUM RECOMMENDED SAFE LIMITS LIMITES MAXIMALES DE SÉCURITÉ RECOMMANDÉES	
	7 525 kg 1157 lbs/lb
	+ 544 kg 1200 lbs/lb
<small>THE RECOMMENDED MAXIMUM SAFE LIMITS MAY HAVE TO BE REDUCED IN ADVERSE SEA AND WEATHER CONDITIONS. LES LIMITES MAXIMALES DE SÉCURITÉ RECOMMANDÉES PEUVENT DEVOIR ÊTRE RÉDUITES DANS LES CONDITIONS DE MER ET DES CONDITIONS MÉTÉOROLOGIQUES DIFFICILES.</small>	
SCARAB (PSB) CADILLAC, MI, USA MODEL / MODÈLE: ME	
<small>THE MANUFACTURER DECLARES THAT THIS VESSEL COMPLIES WITH THE CONSTRUCTION REQUIREMENTS OF THE SMALL VESSEL REGULATIONS AS THEY READ ON THE DAY ON WHICH THE CONSTRUCTION OF THE VESSEL WAS STARTED OR ON THE DAY ON WHICH THE VESSEL WAS IMPORTED. LE FABRICANT ATTESTE QUE CE PRODUIT EST CONFORME AUX EXIGENCES DE CONSTRUCTION DU RÉGLEMENT SUR LES PETITS BÂTIMENTS EN VIGUEUR À LA DATE DU DÉBUT DE SA CONSTRUCTION OU DE SON IMPORTATION.</small>	
SAMPLE	

Canadian Compliance Notice - Capacity



NMMA Certified Sticker

CANADIAN COMPLIANCE NOTICE AVIS DE CONFORMITÉ CANADIEN	
SCARAB (PSB) CADILLAC, MI, USA MODEL / MODÈLE:	
<small>THE MANUFACTURER DECLARES THAT THIS VESSEL COMPLIES WITH THE PLEASURE CRAFT CONSTRUCTION REQUIREMENTS OF THE SMALL VESSEL REGULATIONS, AS THEY READ ON THE DAY ON WHICH THE CONSTRUCTION OF THE VESSEL WAS STARTED OR ON THE DAY ON WHICH IT THE VESSEL WAS IMPORTED. LE FABRICANT ATTESTE QUE CE BÂTIMENT EST CONFORME AUX EXIGENCES DE CONSTRUCTION DES EMBARCATIONS DE PLAISANCE DU RÉGLEMENT SUR LES PETITS BÂTIMENTS, EN VIGUEUR À LA DATE DU DÉBUT DE SA CONSTRUCTION OU À LA DATE DE SON IMPORTATION.</small>	
SAMPLE	

Canadian Compliance Notice

A - 4 GENERAL

Before starting the boat, become familiar with all of the various systems and related operations. Be sure all necessary safety equipment is on-board. Know the "Rules of the Road". Have an experienced operator brief you on the general operation of your new boat. Perform a "pre-cruise systems check". This manual is a part of your boat's equipment. Always keep it on board.

A - 5 COMPONENT SYSTEMS

Before you can really enjoy your boat, a thorough understanding of its systems and their operation is essential. This manual and the associated manufacturers information are included in the owner's packet. This information is provided to enhance your knowledge of the boat. Read this information carefully.

After becoming familiar with the boat and its systems, reread this manual and other material provided in the owner's packet. Maintenance and service tips are included to help keep the boat in like-new condition.

A - 6 SAFETY EQUIPMENT

As the owner/operator of the boat, you are responsible for assuring that all required safety equipment is aboard. You should also consider supplying additional equipment as needed for your safety and that of your passengers. Check state and local regulations and visit the US Coast Guard's Office of Boating Safety website at www.uscgboating.org for information about required safety equipment. You may also want to visit the United Power Squadron website at www.usps.org. Remember that these laws are for your protection and are minimum requirements

Besides the equipment installed on the boat by Scarab, certain other equipment is required for passenger safety. Items like a sea anchor, working

anchor, extra dock lines, flare pistol, a line permanently secured to your ring buoy, etc. could at some time save your passengers lives, or save your boat from damage.

The Coast Guard Auxiliary offers a "Courtesy Examination." This inspection will confirm the boat is equipped with all of the necessary safety equipment.

A. Required Safety Equipment

One of the most important pieces of required safety equipment is a life jacket or personal flotation device (PFD). Personal Flotation Devices (life jackets) must fit the persons wearing them. Minimum requirements include the following:

- Personal Flotation Devices
- Visual Distress Signal
- Bell or Whistle
- Fire Extinguisher
- Navigation Lights

NOTICE

As the owner/operator of the boat, you are responsible for assuring that all required safety equipment is aboard and meets the boating regulations as prescribed by both federal and local authorities in your area.

B. Personal Flotation Devices (PFDs)

Federal regulations require that you have at least one Coast Guard approved personal flotation device (PFD) for each person in a recreational boat. You should not use your boat unless all PFDs are in serviceable condition, readily accessible, legibly marked with the Coast Guard approval number, of an appropriate size (within the weight range and chest size marked on the PFD) for each person aboard.

A PFD provides buoyancy to help keep your head above the water and to help you remain in a satisfactory position while in the water. Body weight and age should be considered when selecting a PFD. The buoyancy provided by the PFD should support your weight in water.

The size of the PFD must be appropriate for the wearer. Body weight or chest size are common methods used to size PFDs. It is your responsibility to ensure that you have the proper number and types

of PFDs on board and that your passengers know where and how to use them.

C. PFD Types

Five types of PFDs have been approved by the US Coast Guard. The PFDs are described as follows:

PFD Type 1, Wearable (Figure A1) has the greatest required buoyancy. Its design allows for turning most unconscious persons in the water from face down position to a vertical or slightly backward, face-up position. It can greatly increase the chances of survival. Type 1 is most effective for all waters, especially offshore when rescue may be delayed. It is also the most effective in rough waters.



Figure A1: Type I, Wearable

PFD Type II, Wearable (Figure A2) turns its wearer in the same way as Type I, but not as effectively. The Type II does not turn as many persons under the same conditions as a Type I. You may prefer to use this PFD where there is a probability of quick rescue such as in areas where other people are commonly involved in water activities.



Figure A2: Type II, Wearable

PFD Type III, Wearable (Figure A3) allows the wearer to place themselves in a vertical or slightly backward position. It does not turn the wearer. It maintains the wearer in a vertical or slightly backward position and has no tendency to turn the wearer face down. It has the same buoyancy as a Type II PFD and may be appropriate in areas where other people are commonly involved in water activities.



Figure A3: Type III, Wearable

PFD Type IV, Throwable (Figure A4) is required in addition to the PFDs previously discussed. The most common Type IV PFD is a buoyant cushion or ring buoy. It is designed to be thrown to a person in the water, grasped and held by the user until he or she is rescued. A Type IV PFD should always be in serviceable condition and immediately available for use. Grasping this PFD may be difficult if the rescue is delayed or if the user is overcome by hypothermia (loss of body heat).

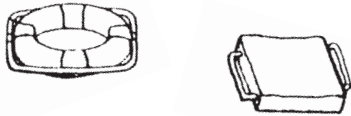

Figure A4: Type IV, Throwable

PFD Type V, Wearable (Figure A5) when inflated, it provides buoyancy equivalent to Type I, II, or III PFDs. When it is deflated, however, it may not support some people.



Figure A5: Type V, Wearable

D. PFD Pointers

The purpose of a PFD is to help save your life. If you want it to support you when you are in the water, it needs to fit, float, and be in good condition.

1. Try the PFD on and adjust it until it fits comfortably in and out of the water. Mark your PFD if you are the only wearer.
2. To make sure the PFD works, wear it in the water. This will show you how it works and give you confidence when you use it.

3. Teach children how to put a PFD on and allow them to try it in the water. That way, they know what the PFD is for and how it works. They will feel more comfortable with it if they suddenly find themselves in the water.
4. If the PFD is wet, allow it to dry thoroughly before storing it. Do not dry it in front of a radiator or heater. Store it in a well ventilated area.
5. Keep PFDs away from sharp objects which can tear the fabric or puncture the flotation pads.
6. For their own safety and the safety of others, all non-swimmers, poor swimmers, and small children should wear PFDs at all times, whether the boat is stationary or moving.
7. Check the PFD frequently to make sure that it is not torn, that flotation pads have no leaks, and that all seams and joints are securely sewn.
8. If a PFD contains kapok, the kapok fibers may become waterlogged and lose their buoyancy after the vinyl inserts are punctured. If the kapok becomes hard or if it is soaked with water, replace it. It may not work when you need it.

E. Fire Extinguisher

As the owner/operator of the boat, you are responsible for supplying a fire extinguisher approved by the US Coast Guard.

Hand-held portable extinguisher(s) should be mounted in a readily accessible location(s) away from the engine compartment. All persons aboard should know the location(s) and proper operation of the fire extinguisher(s).



FIRE

In case of fire do not open the engine compartment. Shut down engine(s), generator(s), and blower(s). Discharge entire contents of fixed fire suppression system, if equipped. If using a portable CO2 fire extinguisher, continuously discharge entire contents at the base of the fire.

NOTICE

Do not test fire extinguishers by squirting small amounts of the extinguishing compound. The fire extinguisher might not work when you really need it.

Scarab jet boat models are considered to be Class 1 powerboats (16 to less than 26 feet). Since they have permanently-installed fuel tanks, they are required to carry one (1) B-I type hand-held portable fire extinguisher. If the boat is equipped with a fixed fire extinguishing system in the engine compartment, one (1) B-I type hand-held portable fire extinguisher is still required.

Boats that are Class 2 powerboats (26 to less than 40 feet) are required to carry two (2) B-I type approved hand-held portable fire extinguishers or one (1) B-II type approved hand portable fire extinguisher. When a fixed fire extinguishing system is installed in machinery space(s), at least one (1) B-I type approved hand portable fire extinguisher is required.

An automatic fire extinguisher system may be available on certain boat models. The type of extinguishing agent used may vary. The equipment utilized has been so chosen, and located, to provide sufficient volume and coverage of the entire engine compartment. While the system ensures excellent overall bilge fire protection, **it does not eliminate the USCG requirement for hand-held fire extinguishers.** Refer to the extinguisher manufacturer's literature included in the owner's packet.

F. Visual Distress Signal Devices

Visual distress signal devices approved by the US Coast Guard are required on all recreational boats operating on coastal waters and to boats owned in the United States when they are operating on the high seas. Coastal waters include territorial seas and those waters directly connected to the Great Lakes and the territorial seas up to a point where the waters are less than two miles (3.2km) wide. Visual distress signal equipment may be of the pyrotechnic or non-pyrotechnic type. Regulations prohibit display of visual distress signals on the water under any circumstances except when assistance is required to prevent immediate or potential danger to persons on board a vessel.

The equipment must be approved by the US Coast Guard, be in serviceable condition, and be stowed in a readily accessible location. Equipment having

a date for serviceable life must be within the specified usage date shown. Careful selection and proper stowage of visual distress equipment is very important if young children are aboard.

DAY USE ONLY	NIGHT USE ONLY	DAY AND NIGHT USE
Three orange smoke signals (one hand held and two floating) or one orange flag with black square and disk.	One S-O-S electric distress light.	Three flares of the hand held, meteor or parachute type.

Distress Signal Table

The minimum visual distress signals required in coastal waters for a Class 1 or Class 2 powerboat is the following:

One orange flag with black square and disc (daytime); and an S-O-S electric light (nighttime); or three orange smoke signals, hand-held or floating (daytime); or three red flares of hand-held, meteor, or parachute type (daytime/nighttime).

NOTICE

No single signaling device is appropriate for all purposes. Consider keeping various types of equipment on board.

G. Sound Signaling Devices

Class 1 and Class 2 powerboats are required to carry a hand, mouth or power operated horn or whistle. It must produce a blast of two-second duration and audible at a distance of at least one-half (1/2) mile.

The following are standard whistle signals:

- One Prolonged Blast = Warning Signal
- One Short Blast = Pass on my Port Side
- Two Short Blasts = Pass on my Starboard Side
- Three Short Blasts = Engines in Reverse
- Five or More Blasts = Danger Signal

H. Navigation Lights

Navigation lights are intended to keep other vessels informed of your presence and course. If you are out on the water between sunset and sunrise, you are required to display appropriate navigation lights.

I. Additional Recommended Equipment

Scarab recommends that you acquire additional equipment for safe, enjoyable cruising. This list, while not all-inclusive, suggests items you should consider acquiring.

Basic Gear

Flashlight	Spare batteries	Tow line
Oar, paddle	Mooring lines	Compass
Dock fenders	Distress signals	First aid kit
Boat hook	VHF radio	EPIRB*
Sunscreen	Extra warm clothing	Charts
Second anchor & line		
Dewatering device (pump or bailer)		
Emergency supply of drinking water and food		
<u>*Emergency Position Indicating Radio Beacon</u>		

Tools

Spark plug wrench	Hammer
Screwdriver	Jackknife
Pliers	Electrical tape
Duct tape	Adjustable wrench
Lubricating oil	

Spare Parts

Extra bulbs	Extra fuses
Extra drain plug	Spark plugs
Spare wire	

Gear For Extended Cruises

Foul weather gear	Parallel rulers	Dividers
Global Positioning System navigation equipment		

A - 7 PASSENGER SAFETY

You are responsible for the safety of your passengers as well as for their behavior while aboard. Make sure:

1. Each passenger is properly instructed in Personal Flotation Device (PFD) use and keeps one within reach in case of emergency. All non-swimmers and children should wear a PFD at all times when underway.
2. Passengers do not sit on gunwales, open decks, elevated pedestal seats or on seat backs when the boat is underway. This could cause them to be thrown overboard during a sudden maneuver.
3. At least one other person knows how to operate the boat in case of an emergency.

A - 8 "RULES OF THE ROAD"

As a responsible boater, you must comply with the "Rules of the Road," the marine traffic laws enforced by the US Coast Guard. Navigating a boat is much the same as driving an automobile. Operating either one responsibly means complying with a set of rules intended to prevent accidents. As in driving an automobile, there are a few rules that must be known if safe boating operation is to be maintained. Just as you assume other drivers know what they are doing, other boaters assume you know what you are doing. Information regarding navigational rules and the "Rules of the Road" are discussed in further detail in A-15 of the this section.

The Coast Guard, Coast Guard Auxiliary, Department of Natural Resources or your local boat club sponsor courses in boat handling, including "rules of the road". Such courses are strongly recommended. Books on this subject are also available from local libraries.

A - 9 LIGHTNING

When boating, it is important to be aware of the weather around you. When the weather changes for the worse, DO NOT jeopardize your safety by trying to "ride out the storm". If possible, return to safe harbor and dock your vessel immediately.

If caught in a storm, seek shelter inside the cabin and wait for the storm to pass. With open bow models, suntops and campers will provide some protection, but should not be relied on if you are able to return to shore. Exercise care when high winds are present!



DO NOT swim or dangle legs or arms into the water during a lightning storm. Stay out of the water!

Lightning will seek a ground when it strikes. Avoid contact with metal parts such as bow rails, control handle, or windshield.



NOTICE: Scarab boats are not equipped with a lightning protection system.

A - 10 DRUGS AND ALCOHOL

Please keep in mind that along with the fun of boating comes responsibility. As the owner or operator of a pleasure boat, you are obligated (morally and legally) to use good judgement while underway in providing for the safety and well-being of your passengers and other boaters around you.

A common and flagrant violation of good judgement and the law by boaters involves the use of alcohol or drugs. Each year, about half of all accidents involving fatalities involve the use of alcohol or drugs.

It is a federal offense to operate a boat while intoxicated. Criminal penalties may include the termination of operating privileges for up to one year. Many states have passed similar laws.

Alcohol or drugs have an inhibiting effect on the judgement and reaction time of the boat operator and his/her passengers. Heed the advice of experts and statisticians: DO NOT drink or use drugs when operating a boat. NEVER allow an obviously intoxicated person to take the helm.

Have fun in your Scarab® jet boat but also, have the good sense to be mentally alert and physically capable of operating the boat in a safe manner.

A - 11 CARBON MONOXIDE



CARBON MONOXIDE!

Carbon monoxide (CO) can be harmful or fatal if inhaled. Brain damage or death can result from prolonged exposure to carbon monoxide. Keep exhaust outlets clear of blockage. Provide adequate ventilation. Open hatches, doors, windows and vents to insure adequate ventilation. Close engine compartment doors and hatches when engine or generator is running. Avoid operating the boat for extended periods of time at idle speed, and be sensitive to weather conditions that may prevent CO from dissipating into the air. Do not stand or swim near engine or generator exhausts when engines are running.



Before operation, make all passengers aware of the dangers of CO poisoning, its symptoms, possible places of accumulation and treatment.

Carbon monoxide accumulation is affected by many variables (e.g., boat geometry, hatch, window and door opening, ventilation openings, proximity to other structures, swim platforms, canvas enclosures, location of exhaust outlets, vessel attitude, wind direction, vessel speed, boat systems maintenance, etc.) The technical information included in this section is to inform the boat owner of possible cause and effects of carbon monoxide exposure. This information has been reprinted with permission from the American Boat and Yacht Council's (ABYC) technical information report: "[Educational Information About Carbon Monoxide](#)". This information pertains to all gasoline-powered boats manufactured by Scarab.

NOTICE

The boat owner should be aware that other factors may contribute to carbon monoxide accumulation. The most common ones are listed in this section. If a person is exhibiting carbon monoxide-type symptoms (Refer to B-2E Symptoms), be sure to take the necessary precautions as prescribed later in this section.

NOTICE

Boats fueled by diesel have limited carbon monoxide present in the exhaust in comparison to gasoline engine exhaust. However, the boat owner should still be aware of the causes and effects of carbon monoxide which may occur in different boating situations.

A. Properties and Characteristics of Carbon Monoxide

1. Carbon monoxide is a colorless, odorless and tasteless gas. It is commonly referred to as CO.
2. Its weight is about the same as air so it cannot be expected to rise or fall like some other gases, but will distribute itself throughout the space.

NOTICE

DO NOT rely on the use of smell or sight of other gases to detect CO, because it diffuses in the air much more rapidly than easily detectable vapors (i.e., visible and aromatic vapors).

B. What Makes Carbon Monoxide

Any time a material containing carbon burns such as gasoline, natural gas, oil, propane, coal, or wood, CO is produced.

Common sources of carbon monoxide are:

1. Internal combustion engines such as:
 - a. Propulsion engines
 - b. Generators
2. Open flame devices such as:
 - a. Cooking ranges
 - b. Central heating plants
 - c. Space heaters
 - d. Water heaters
 - e. Fireplaces
 - f. Charcoal grills

C. How a Person is Affected by Carbon Monoxide

Carbon monoxide is absorbed by the lungs and reacts with blood hemoglobin to form carboxyhemoglobin, which reduces the oxygen carrying capacity of the blood. The result is a lack of oxygen for the tissues with the subsequent tissue death and, **if exposure is prolonged, death of the individual.**

D. Effects of Carbon Monoxide

Carbon monoxide in high concentrations can be fatal in a matter of minutes. Lower concentrations must not be ignored because the effects of exposure to CO are cumulative and can be just as lethal.

Certain health related problems and age will increase the effects of CO. People who smoke or are exposed to high concentrations of cigarette smoke, consume alcohol or have lung disorders or heart problems, are particularly susceptible to an increase in the effects from CO; however, all occupants' health should be considered. Physical exertion accelerates the rate at which the blood absorbs CO.

E. Symptoms

One or more of the following symptoms can signal the adverse effect of CO accumulation:

1. Watering and itchy eyes
2. Flushed appearance
3. Throbbing temples
4. Inattentiveness
5. Inability to think coherently
6. Loss of physical coordination
7. Ringing in the ears
8. Tightness across the chest
9. Headache
10. Drowsiness
11. Incoherence
12. Slurred speech
13. Nausea
14. Dizziness
15. Fatigue
16. Vomiting
17. Collapse
18. Convulsions

NOTICE

The order of the above list is generally the sequence of appearance of symptoms. However, the order of appearance may change for different people.

NOTICE

The symptoms of carbon monoxide poisoning may easily be mistaken for seasickness or alcohol intake.

F. Treatment (Evaluate, Ventilate, Evacuate, Investigate, Take Corrective Action)

1. Evaluate the situation and ventilate the area if possible.
2. Evacuate the area and move affected person(s) to a fresh air environment.
3. Observe the victim(s).
4. Administer oxygen if available.
5. Contact medical help. If the victim is not breathing, perform rescue breathing or approved cardiopulmonary resuscitation (CPR), as appropriate, until medical help arrives and takes over.

- Investigate source of CO and take corrective action.

NOTICE

Prompt action can make the difference between life and death.

G. Inspection

Look and listen for leaks in the exhaust systems of both the generator (if applicable) and propulsion engine(s). Look for discoloration around joints in the system (water leaks, carbon, stains, etc.).

- Make sure all exhaust clamps are in place and secured.
- Make sure ventilation systems work and are not obstructed or restricted.
- Make sure gaps around the engine room plumbing and cableways and exhaust system doors, hatches, and access panels are minimized to reduce the opportunity for CO to enter the accommodation space(s).

H. Operation

Cold Start vs. Warm Start: CO production is greater while the combustion chamber surfaces and gas passages are cold versus when they are warm. A boat operator should:

- Pay attention to ventilating the boat.
- Orient the boat so it will allow the maximum dissipation of CO.
- Minimize the time spent on getting underway.
- In order to minimize CO buildup, do not warm up or run propulsion engine(s) for extended periods while the vessel is stationary.

WARNING

The following are examples of possible situations where carbon monoxide can accumulate within your boat while docked, anchored, or underway. Become familiar with these examples and their precautions to prevent dangerous accidents or death.

I. Boathouses, Sea Walls and Confined Spaces

A boat operator should be aware that dangerous concentrations of CO can accumulate when a boat, generator or other engine operated device is operated while the boat is moored in a confined area such as:

- Boathouses,
- Proximity to sea walls, or
- Proximity to other boats.

Keep engine room hatches and doors closed when operating engines, including the generator (if applicable).

Pay attention to prevailing conditions and provide for ventilation to induce fresh air and minimize exhaust re-entry. Orient the boat for maximum dissipation of the exhaust. **DO NOT** run the boat or boat equipment for extended periods under these conditions. See Figure A6.



Figure A6: Minimize Exhaust Re-entropy

Be aware that cockpit and deck drains can be a source of CO ingress into boats, especially boats with cockpit or decks enclosed with canvas or permanent boat structures.

J. The Effect of Boats Moored Along Side

A boat operator should be aware that carbon monoxide is emitted from any boat's exhaust. The operation, mooring, and anchoring in an area containing other boats may be in an atmosphere containing CO not of the operator's making. An operator likewise needs to be aware of the effect of their boat on other boats in the area. Of prime concern is the operation of an auxiliary generator where boats are moored along side each other. Be aware of the effect your exhaust may have on other boats and be aware that the operation of other boats' equipment may affect the carbon monoxide concentration on your boat. See Figure A7.



Figure A7: The effect of boats moored along side

K. Backdrafting (Station Wagon Effect)

Backdrafting or the “station wagon effect” is caused by air movement over or around a boat creating a low pressure area or suction area around the stern that can increase CO level on the boat. Backdrafting can be affected by relative wind direction, boat speed, and boat trim angle. See Figure A8 Backdrafting – Airflows Over Boat and Behind Transom”.



Figure B8: Backdrafting - Air flows over boat and behind transom

Under certain speed and operating conditions, the low pressure area may form in other regions and permit carbon monoxide to enter the hull through openings that are not on the back of the boat. Boat factors which may affect CO concentration:

1. Intentional or unintentional excessive trim angle causing high bow angle. See Figure A9.
2. Excessive or unequally distributed weight.



Figure A9: Inefficient trim angles

3. Canvas configurations – Under various conditions, adding or removing canvas may raise or lower CO levels. See Figures A8, A9 & A11.

⚠ DANGER

EXHAUST FUMES!

Hull exhaust from your boat can cause excessive accumulation of poisonous carbon monoxide gas within cockpit areas when using protective weather coverings (while underway or while stationary). Provide adequate ventilation when the canvas top, side curtains and/or back (aft) curtains are in their closed protective positions.

4. Opening and closing ports, hatches, doors, and windows may raise or lower CO levels on board a boat. When airflow is moving forward inside the boat, CO may be entering the boat. See Figures A10 and A11.



Figure A10: Desired air flow through the boat



Figure A11: The effect of canvas configurations

5. Operating a boat at slow speeds with a following wind should be avoided. Consider changing direction, adjusting speed, or both. See Figure A12.



Figure A12: Operating at Slow Speed with Following Wind

6. Be aware that cockpit and deck drains can be a source of CO ingress into boats, especially boats with cockpit or decks enclosed with canvas or permanent boat structures.

L. Accumulation of Exhaust Gases - Swim Platform

When the propulsion engine(s) or generator is running, CO is produced and may remain in the vicinity of the exhaust outlet (including underwater exhaust outlets).

1. Do not occupy aft lounging area(s) or swim platform.
2. Do not swim under or around swim platform.
3. Do not swim in the vicinity of the exhaust outlet. Refer to Figure A13.

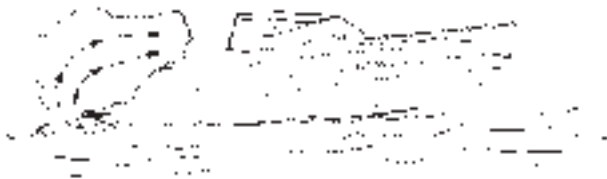

Figure A13: Exhaust Gas Accumulation at Swim Platform

M. Dangerous Activity - "Teak Surfing"/"Dragging"

Do not sit on, occupy or hang on any stern appendages (e.g., swim platforms, boarding ladders, etc.) while underway. Do not body surf, commonly known as "teak surfing" or "dragging", etc., in the wake of the boat. Do not tow persons in close proximity to the stern of the boat. See Figure A14. This activity can also increase the possibility of injury due to contact with water or debris exiting the jet nozzle.



Figure A14: Exhaust Gas Accumulation - Dangerous Activity

N. Ventilation of Accommodation (Occupied) Spaces

Accommodation spaces need to be ventilated to introduce fresh air into the spaces. Ventilation methods

(e.g., windows, hatches, doors, and blowers) used to accomplish this may, under certain conditions, bring hazardous levels of CO into the occupied spaces. Care should be taken to be aware of all prevailing conditions when using these ventilating methods.

O. Running of Engine(s) in Idle

Engines running in idle exhaust carbon monoxide that can accumulate near the hull of the boat. Do not stand or swim near the engine exhaust or jet nozzle(s) when engine(s) are idling or generator is running.

P. Altitude and Sea Conditions

Operation at altitudes greater than 5,000 feet contributes to inefficient engine performance and may require adjustments to the ignition systems, fuel systems or the impeller.

1. Failure to make adjustments to ignition systems and/or fuel systems for altitude conditions may cause an increase in CO production.
2. Heavy sea or out of trim conditions tend to load engines resulting in reduced performance and thereby increasing their CO production.

Q. Portable Generator Sets



Never use a portable generator on a boat.

Gasoline-powered portable generators are available in the marine market place and are not an option available through Scarab. Portable generators will produce CO. These sets discharge their exhaust products in locations which can lead to an increase in the accumulation of carbon monoxide in the accommodation occupied space. **Do not use gasoline-powered portable generators on Scarab jet boats.**

R. Maintenance - Engine Performance

Efficient engine performance is vital to minimizing CO production. The following items are those considered to have the greatest effect on increased CO production:

1. Fuel Systems - Fuel that is contaminated, stale or incorrect octane number



2. Carburetors/Injectors

- a. Dirty or clogged flame arrester
- b. Malfunctioning automatic choke plate or faulty adjustment of manual choke plate
- c. Worn float needle valve and seat
- d. High float level
- e. Incorrect idle mixture adjustment
- f. Dirty or worn injectors

3. Ignition System

- a. Fouled or worn spark plug.
- b. Worn points or incorrect gap on points
- c. Shorted or opened circuit high tension spark plug cables
- d. Incorrect ignition timing.

4. General

- a. Worn piston rings and valves
- b. Engine temperature - Cold running engines increase CO production. Engine cooling water system design and selection of thermostat(s) are primary considerations affecting engine operating temperature. Generally, an engine produces less CO if it operates at a relatively high temperature within manufacturer's specifications.
- c. Exhaust Back-Pressure - Certain alterations to the exhaust system may increase engine exhaust back pressure and CO production.
- d. Restricted engine room or compartment ventilation

S. Maintenance - External Conditions

External conditions that contribute to inefficient engine performance can include:

1. Fouled hull bottom
2. Damaged and fouled jet nozzle(s)

T. Maintenance - Exhaust System Integrity

Gas tight integrity of exhaust systems must be maintained to insure that leakage of CO within the boat does not occur. Disassembly may be required to carry out a thorough inspection. Repair or replace components as indicated. Inspect the following:

1. Gaskets at cylinder head connection
2. Casting and pipe fittings in the dry section
3. All joints
4. Hoses
5. Clamps
6. Mufflers and their drain plugs
7. Thru-hull fittings
8. Hangers and other supports

U. Maintenance - Ventilation Systems

Boats are equipped with ventilation systems to eliminate gasoline vapors. Blowers and fans may also be provided for ventilation and to mitigate the migration of CO into occupied compartments. Attention should be paid to the following:

1. Keeping ventilation intakes clear of debris
2. Replacing damaged hardware
3. Maintaining the integrity of the duct material and its connections
4. Ensuring that position of duct intakes are not obstructed or restricted, collapsed, kinked, or crushed
5. Eliminating sags in ducts that can form a water trap
6. Checking hangers and other supports
7. Ensuring blower/fan is operational
8. Ensuring that airflow is present at discharge
9. Inspecting wiring to equipment

V. Maintenance - Bulkhead and Deck Integrity

1. Seal all visible openings (e.g., cracks, crevices, holes, including openings around wiring and piping runs) in bulkheads and decks that separate machinery compartments from occupied compartments. These openings can permit migration of CO vapors.
2. Check gaskets and sealing surfaces on hatches, doors, and access panels.

W. Maintenance - Liquid Drains

Sink, shower and condensate drains can be a source of CO ingress. Ensure that water traps are present and contain fluid. These traps may be in the form of a double loop in the drain line or prefabricated p-traps. Any drain that terminates below the waterline is, by virtue of its design, sealed against CO intrusion. Some drains that are below the waterline when boat is underway will be above the waterline when the boat is at rest. The location of drains, relative to the waterline, can be affected by the dynamics of boat motion (i.e., underway or at rest).

A - 12 SAFE BOATING PRACTICES

NOTICE

***YOU** are responsible for your own safety, the safety of your passengers, and the safety of fellow boaters.*

A. Drugs and Alcohol

WARNING

Alcohol consumption and boating do not mix! Operating under the influence endangers the lives of your passengers and other boaters. Federal laws prohibit operating a boat under the influence of alcohol or drugs.

Do not use drugs or drink alcohol while operating a boat. Like driving a car, driving a boat requires sober, attentive care. Operating a boat while intoxicated or under the influence of drugs is not only dangerous, but it is also a Federal offense carrying a significant penalty. These laws are vigorously enforced. The use of drugs and alcohol, singly or in combination, decreases reaction time, impedes judgement, impairs vision, and inhibits your ability to operate a boat.

B. Safe Operation

Safe operation means that you do not misuse your boat nor do you allow your passengers to do so. Safe operation means using good judgement at all times. It includes, without limitation, the following actions:

- Observe all safety signs and warnings both inside the boat and in the immediate boating area.
- Become familiar with and adhere to the "Rules of the Road".
- Maintain boat speed at or below the legal limits. Avoid excessive speed or speeds not appropriate for operating conditions.
- Be sure at least one other passenger is familiar with the operation and the safety aspects of the boat in case of an emergency, and knows how to use and locate all safety equipment.
- Load the boat within the limits listed on the capacity plate. Balance loads bow and stern and port to starboard. Passengers are to sit only on seats, not seat backs, gunwales, engine cover, or any other unsafe locations.
- Do not use the boat in bad weather or sea conditions beyond the skill or experience of the operator or the comfortable capability of the boat or passengers.
- Make sure the passengers and gear do not obstruct the operator's view or impede his ability to move.
- Do not exceed the maximum engine power rating stated on the certification plate located inside the boat.

C. Passenger Safety

Before getting underway, show all passengers where emergency and safety equipment is stowed, and explain how to use it. Everyone aboard should wear rubber-soled shoes which resist slipping on wet surfaces. While underway, passengers should remain seated inside the deck rails and gates. Do not allow passengers to drag their feet or hands in the water. Always use hand holds and other safety hardware to prevent falls. All non swimmers, poor swimmers and small children should wear PFDs at all times.



D. Jet Nozzle & Intake Grates



WARNING

AVOID SEVERE INJURY OR DEATH

Do not swim near boat, board from rear or use swim platform if engine (s) is running.

Water and/or debris exiting the jet nozzle can cause severe injury including internal injuries if water is forced into body cavities. (rectum or vagina)

Keep people, clothing and hair away from intake grates to avoid entanglement or drowning.

Jet Nozzle Warning Label

NOTICE

Although the boat requires only 30 cm (1 ft) of water to float, the engine should be started with at least 90 cm (3 ft) of water below the hull. If the depth of water is less than 90cm (3 ft) and the engines are running, the impeller is turning and debris can be drawn from the bottom and damage the propulsion system.



WARNING

Shut off motor when near swimmers. Severe injury or death will result from contact with water and/or debris from the jet nozzle. Possible entanglement or drowning will occur should there be contact with intake grates.



WARNING

When pulling skiers do not turn on the engine(s) until you are at least a boat length away from the person in the water. When approaching a downed skier, turn off the engine(s) at least one boat length away before reaching the skier in the water.

E. First Aid

As a boater, you should be familiar with the basic first aid procedures that may be needed while you are out far from help. Fish hook accidents or minor cuts and abrasions may be the most serious mishaps on board a boat but you should also learn the proper procedures and be ready to deal with the truly serious problems like mouth-to-mouth resuscitation, excessive bleeding, hypothermia, and burns. First aid literature

and courses are available through most Red Cross chapters.

F. Operation By Minors

Minors should always be supervised by an adult whenever operating a boat. Many states have laws regarding the minimum age and licensing requirements of minors. Be sure to check local laws or contact the state boating authorities for information.

G. Voluntary Inspections

State boating officials in many states or the US Coast Guard Auxiliaries offer courtesy inspections to check out your craft. They will check for compliance with safety standards and required safety equipment. You may voluntarily consent to one of these inspections, and you are allowed to make corrections without prosecution. Check with the appropriate state agency or the Coast Guard Auxiliary for details.

H. Safe Boating Courses

The local US Coast Guard Auxiliary and the US Power Squadrons offer comprehensive safe boating classes several times a year. You may contact the Boat U.S. website at www.boatus.com/courseline for a course scheduled in your area. Also contact the US Coast Guard Auxiliary or Power Squadron Flotilla for the time and place of their next scheduled class.

A - 13 WATER SPORTS



WARNING

PERSONAL INJURY

Scarab jet boats are not designed for and should not be used for pulling parasails, kites, gliders or any device which can become airborne. Use boat only for appropriate water sports. (See Section A - 2 for actual warning label).

Water skiing, wakeboarding, kneeboarding, or riding a towed, inflatable apparatus are some of the more popular water sports. Taking part in any water sport requires increased safety awareness by the participant and the boat operator. If you have never pulled someone behind your boat before, it is a good idea to spend some hours as an observer, working with and learning from an experienced driver. It is also important to be aware of the skill and experience of the

person being pulled. Always have a second person on board to observe the person in the water so the driver can concentrate on operating the boat.

A. Water Sport Guidelines

Everyone participating in a water sport should observe these guidelines:

1. Allow only capable swimmers to take part in any water sport.
2. Always wear a personal flotation device (PFD) approved by the US Coast Guard. Wearing a properly designed PFD helps a stunned or unconscious person stay afloat.
3. Be considerate of others with whom you share the water.
4. Give immediate attention to a person who has fallen. He or she is vulnerable in the water alone and may not be seen by other boaters.
5. Approach a person in the water from the lee side (opposite the direction of the wind). **Turn off the motor at least a boat length from the person.**
6. Turn engine off and anchor before swimming.
7. Always participate in water sports in safe areas. Stay away from other boats, beaches, restricted areas, swimmers and heavily traveled waterways.
8. Swim only in areas designated as safe for swimming. These are usually marked with a swim area buoy (see Figure A15). Do not swim alone or at night.



Figure A15: Swim Area Buoy

WARNING

AVOID SEVERE INJURY OR DEATH

Contact with water and/or debris from the jet nozzle causing serious injury or death will occur. Shut engine off and remove ignition key when anyone is swimming nearby.

9. Do not allow anyone near the jet nozzle, water and/or debris from the jet nozzle causing serious injury or death will occur. Stay at least 150 feet away from areas marked by diver down float. See Figure A16.



Figure A16: Diver Down Float

10. Do not drive the boat directly behind a water skier. At 25 miles per hour, the boat will overtake a fallen skier who was 200 feet in front in about 5 seconds.

B. Water Skiing/Wakeboarding/Kneeboarding

The popular sport of water skiing has brought a special set of safety precautions to observe in boating. The following guides help prevent accidents while water skiing.

1. Water ski only in safe areas, away from other boats and swimmers, out of channels, and in water free of underwater obstructions.
2. Allow no one who can not swim to water ski. Skiers must wear a USCG approved flotation device. A Type III water-ski vest is an approved and practical PFD.
3. Have a second person aboard to observe the skier and inform the driver about the skier's hand signals (Figure A17). The driver must give full attention to operating the boat and the waters ahead.
4. Give immediate attention to a fallen skier. Be careful not to swamp the boat while taking the skier on board.

5. Always participate in water sports in safe areas. Stay away from other boats, beaches, swimmers, and heavily traveled waterways.
6. Be considerate of others with whom you share the water.
7. Give immediate attention to a person who has fallen. He or she is vulnerable in the water alone and may not be seen by other boaters.
8. Approach a person in the water from the lee side (opposite the direction of the wind). Stop the motor at least a boat length from the person.
9. Turn off engine and anchor your boat before swimming.

⚠ WARNING

AVOID SEVERE INJURY OR DEATH

Water and/or debris from the jet nozzle causing serious injury or death will occur. Switch engine off before skiers enter the water and before taking skiers aboard. Do not leave engine running in neutral. Accidentally engaging shift can seriously injure skier.

10. Do not water ski between sunset and sunrise. It is illegal in most states.

For more information about waterskiing, wakeboarding, and/or kneeboarding, please visit the American Water Ski Association, at their website: www.usawaterski.org

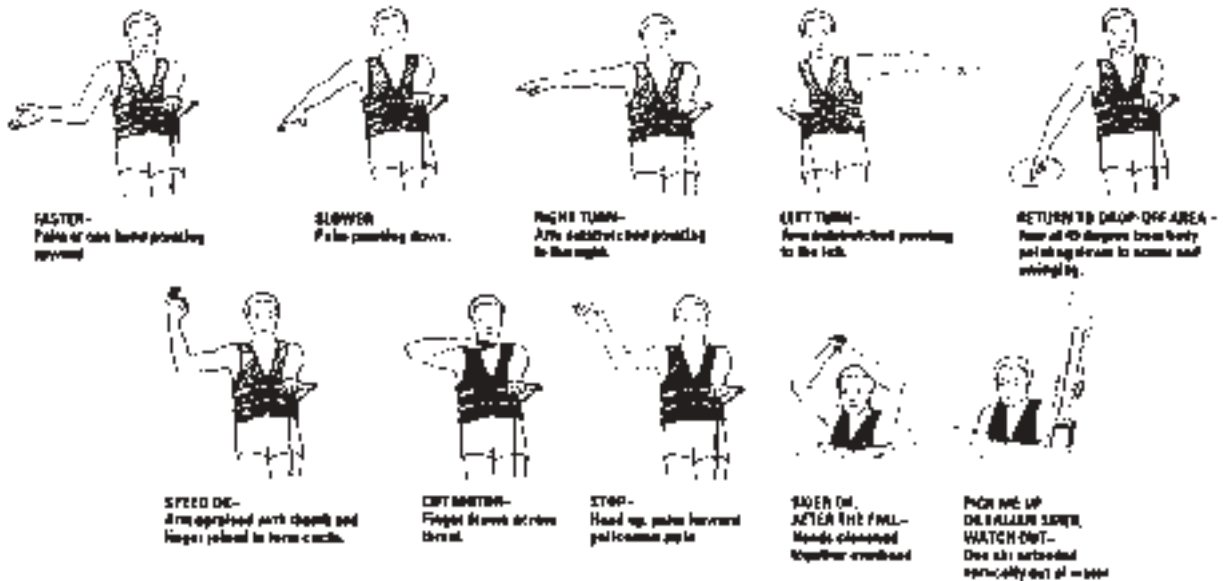

Figure A17: Skier's Hand Signals

A - 14 HYPOTHERMIA

Hypothermia is a significant cause of deaths in boating accidents and should be taken very seriously. It occurs when the body is unable to generate enough heat to overcome the body's loss of heat to the environment such as water. Should a man overboard situation occur immediate action is necessary. Typically, when an individual has been overcome by hypothermia, loss of consciousness will take place and drowning will then occur. The colder the water the quicker hypothermia can set in.

PFDs can increase survival time because of the insulation they provide. When operating in cold water (below 40°F (4.4°C) consideration should be given to using a coat or jacket style PFD as they cover more of the body than the vest style PFDs. Additional note: Certain types of pfd's allow for turning most unconscious persons in the water from face down position to a vertical or slightly backward, face-up position. These types may increase the chances for survival.

Points to remember should you find yourself in the water:

1. Conservation of body heat is vital! While afloat in the water, do not attempt to swim unless it is to reach a nearby boat, fellow survivor, or a floating object on which you can lean or climb. Unnecessary swimming increases the rate of body heat loss. In cold water, drown-proof method that require putting your head in the water are not recommended. Keep your head above the water. This will greatly lessen heat loss and increase your survival time.
2. Keep a positive attitude about your survival and rescue. This will improve your chances of extending your survival time until rescued. Your will to live does make a difference!
3. If there is more than one person in the water, huddling is recommended while waiting to be rescued. This action tends to reduce the rate of heat loss and thus increase the survival time.
4. Always wear your PFD. It won't help you fight off the effects of hypothermia if you don't have it on when you go into the water.

A - 15 BASIC SEAMANSHIP

Basic rules of seamanship, general information about navigational aids, and sources for additional reading and boater education are presented in this portion of your owner's manual.

A. Boating Regulations

The US Coast Guard is the authority of the waterways. State boating regulations are enforced by local authorities. Your boat is subject to the marine traffic laws known as "Rules of the Road," which are enforced by the US Coast Guard. You are subject to marine traffic laws and "Rules of the Road" for both federal and state waterways; you must stop if signaled to do so by enforcement officers, and permit them to board if asked. The "Navigational Rules, International-Inland Rules of the Road" can be obtained from the US Coast Guard website at www.uscgboating.org.

Many pamphlets prepared by the US Coast Guard are available. They explain signal lights, buoys, safety, international and inland regulations and other information which goes beyond the scope of this manual. "Aids to Navigation" (US Coast Guard pamphlet #123) explains the significance of various lights and buoys. Because of proposed alterations to buoys and markers, contact the US Coast Guard or visit their website to stay informed of changes. Other pamphlets, including the "Boating Safety Training Manual" and "Federal Requirements For Recreational Boats," are also available from the US Coast Guard.

NOTICE

The spoken word "MAYDAY" is the international signal for distress. "MAYDAY" should NEVER be used unless there is grave or imminent danger, and you are in need of immediate assistance.

B. Rules of Seamanship

1. Right-of-way

In general, boats with less maneuverability have right-of-way over a more agile craft. You must stay out of the way of the following vessels:

A vessel not under command or aground.	These vessels have no maneuverability.
A vessel restricted in its maneuverability.	These vessels are performing work which limits their maneuverability such as surveying, dredging, laying pipe or cable, servicing navigational markers among others.
A vessel engaged in fishing.	These include boats fishing with lines, trawl or nets; but not trolling lines.
Sailboats	Sailboats have the right-of-way over power boats; however, if a sailboat is using a propeller to move forward, it is considered a power boat even if its sails are up.

2. Meeting Head-on

When two boats meet head-on neither boat has right-of-way. Both boats should decrease speed and pass port to port. However, if both boats are on the left side of a channel, each vessel should sound two short horn blasts and pass to starboard to starboard. See Figure A18.

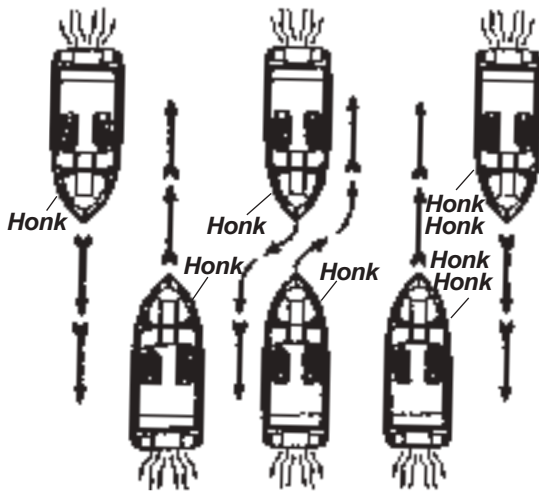

Figure A18: Meeting Head-On

3. Crossing Situations

In a crossing situation, the boat on the right from the 12-4 o'clock position has the right-of-way. It must hold course and speed. The boat without the right-of-way must keep clear and pass to the stern. See Figure A19.

Stand-on (Privileged) vessel holds course and speed

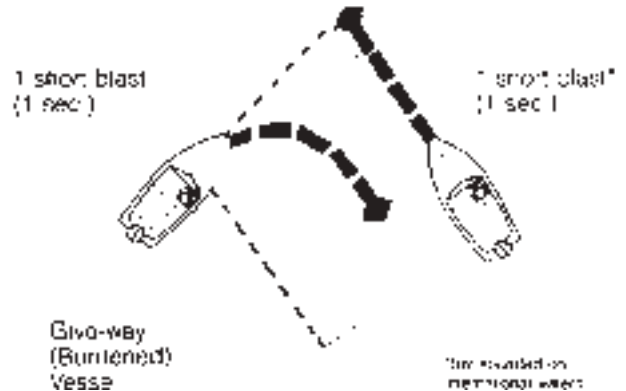

Figure A19: Crossing Situation

4. Overtaking

The boat overtaking the one ahead must yield the right-of-way to the boat being passed. The overtaking boat must make necessary adjustments to keep out of its path. The boat being passed should hold its course and speed. See Figure A20.



Inland Rules	Stand-on (Privileged) Vessel Being Overtaken	Inland Rules
"I want to pass you on your port side."		"I want to pass you on your starboard side."
2 short blasts (1 sec.)		1 short blast (1 sec.)
"Proceed"		"Proceed"
2 short blasts (1 sec.)		1 short blast (1 sec.)
International Rules		International Rules
"I am altering my course to port."		"I am altering my course to starboard."
2 short blasts (1 sec.)		1 short blast (1 sec.)
International Rules in Narrow Channels		International Rules in Narrow Channels
"I intend to pass you on your port side."		"I intend to pass you on your starboard side."
2 prolonged blasts (4-6 sec.) 2 short blasts (1 sec.)		2 prolonged blasts (4-6 sec.) 1 short blast (1 sec.)
"Proceed."		"Proceed."
1 prolonged, 1 short 1 prolonged, 1 short		1 prolonged, 1 short 1 prolonged, 1 short blast
	Give-way (Burdened) Vessel Overtaking	

Figure S20: Overtaking

5. The General Prudential Rule

The general prudential rule regarding right-of-way is that if a collision appears unavoidable, neither boat has right-of-way. As prescribed in the "Rules of the Road", both boats must act to avoid collision.

6. Night Running and Navigation Lights

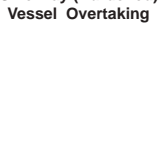
Boats operating between sunset and sunrise (hours vary by state), or in conditions of reduced visibility, must use navigational lights. Nighttime operation, especially during bad weather or fog, can be dangerous. All “Rules of the Road” apply at night, but it is best to slow down and stay clear of all boats regardless of who has right-of-way.

Although night activities are limited, cruising at night can be very pleasurable. It can also be dangerous if you don’t pay close attention to water levels and obstacles. Be especially careful of shallow waters and watch for submerged debris, rocks and other obstacles in the water. Your navigation lights are intended only to prevent collision, not to improve your night vision. You may choose to use a spotlight instead.

NOTICE

It is illegal to use your spotlight as a headlight. Use it only temporarily to check the position of your boat and the surrounding area.

To see more easily at night, avoid bright lights when possible. Also, it is helpful to have a passenger keep watch for other boats, water hazards, and navigational aids.

Your boat has one white (stern) and one combination bow light which includes a red (port) and a green (starboard) light. These lights are removable. To use these lights, line up the two-prong plug in the pole with the receptacle in the base. Plug the light in, and lock or tighten into place. When not in use, stow the lights inside your boat for safekeeping. These light can be turned on or off at the helm.

Check lights for proper operation before heading out at night. You should also learn to identify the running light combinations for other vessels. We recommend that you participate in a boating safety course to further learn about navigation lights and safe boating practices.

To determine the size, speed and direction of other vessels at night, you should use running lights. A green light indicates the starboard side, and the red light indicates the port side. Generally, if you see a green light, you have the right-of-way; if you see a red light, give way to the other vessel. See Figure A21.

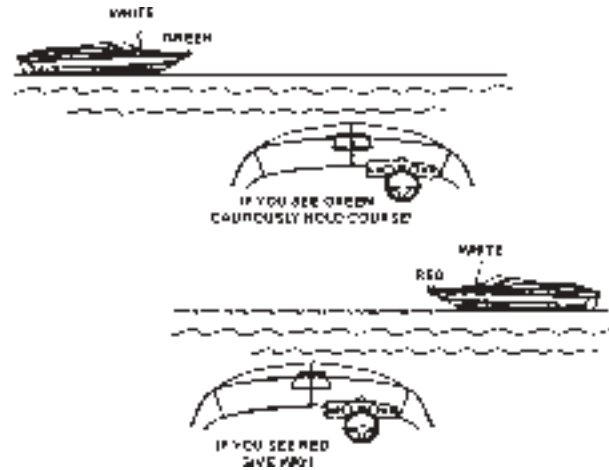

Figure A21: Night Running

The anchor lights and navigation lights are controlled by a switch at the helm. The anchor light switch allows you to turn on just the stern (white) light when anchored or moored. While underway, use the navigation light switch to turn on the stern (white) and combination bow light. Lights are off when switches are in the OFF position.

7. Whistle Signal

Out on the water, whistle signals are commonly used. Although using a whistle signal is not necessary every time a boat is nearby, operators must signal their intentions when necessary to avoid potentially confusing or hazardous situations. Use whistle blasts early enough to be noticed and understood by other boaters.

It is customary for the privileged boat to signal first and the yielding boat to return the same signal to acknowledge she understands and will comply. Use the danger signal (five or more short and rapid blasts) if intent is not clear. A short blast is one or two seconds long. A long blast is 4 to 6 seconds long. The Navigational Aids Chart at the end of this manual lists the meanings of the various whistle signals.

C. Navigational Aids

Aids to navigation (ATONS) help you to travel safely on the water. They help you get from one place to another and are most helpful if you have a nautical chart. A navigational aids chart is at the end of this manual (inside back cover).

⚠ DANGER

NEVER tie your vessel to an ATON. It is illegal because it blocks the ATON from view of other boaters. Decreased visibility can contribute to a serious accident which may result in property damage, personal injury, or death.

There are two ATON systems. The system used on federal waters is known as the International Association of Lighthouse Authorities System B (IALA-B). The US Coast Guard maintains this system. The second system is the Uniform State Waterway Marking System (USWMS). This system is maintained by state authorities.

1. International Association of Lighthouse Authorities System B (IALA-B)

IALA-B uses four types of ATONS. This section discusses the two most common markers: lateral markers and safe water markers. Other federal markers include special markers and isolated danger markers. The Navigational Aids Chart at the end of this manual shows these aids.

2. Lateral Markers

Lateral markers indicate the sides of navigable channels. They consist of lighted can or nun buoys and daymarks. Each has a number and is either red or green. The numbers on the green markers are odd. Red markers have even numbers.

Buoys are red or green floating ATONS. If lighted, they have either red or green lights. Unlighted green buoys, called cans, look like cylinders. Unlighted red nun buoys have a cone shaped top with their points cut off. Do not pass too close to a buoy. You may foul the jet nozzle in its chain.

NOTICE

Buoys are anchored floating objects and may not always be in exactly the same position.

Daymarks are red or green boards with numbers. They are on posts or groups of pilings tied together and called dolphins. Daymarks and their supports are daybeacons. Daybeacons may or may not have lights. If a red or green daybeacon has a light, it is the same color as the marker-red or green. Red daymarks are triangular and have even numbers. Green daymarks are square and have odd numbers.

Red Right Returning is a basic rule to assist you in using lateral markers. When you are returning from seaward, keep red markers on the starboard (right) side when you pass them. Keep green markers to the port side.

Returning from seaward is very clear if you have been on the ocean. You are returning to port. By agreement, going upstream on a navigational river is returning from seaward. The outlet ends of the Great Lakes are also the seaward ends. Traveling from a large body of water to a smaller one is considered returning from seaward.

3. Safe Water Markers

Safe water markers have vertical red and white stripes and mark the center of navigable channels and fairways. Safe water markers included both lighted and unlighted buoys and daymarks. If a marker is lighted, the light is white and flashes the letter "A" in Morse Code.

Preferred Channel markers have horizontal red and green bands. If lighted, the color of the light is the same as the top of the band. They show the preferred channel for you to use at a junction point. Be sure to notice the color of the top of the band, and treat it as any other marker you would of that color. If the band is red and you are returning from seaward, keep the marker to the right.

Most lights on markers flash on and off. Others such as lights on aids with no lateral significance are fixed. They stay on all night. ATON lights flash in regular patterns. For example, they may flash every three seconds, or in groups such as two flashes and a pause. There are a number of flashing patterns, which help you identify the light at night. To identify a light, note its color and pattern or timing of flashes, and compare it to your chart to find its location.

4. The Uniform State Waterway Marking System

This section discusses three kinds of markers in this system: Regulatory, Informational, and Lateral.

Regulatory markers in this system are either signs or buoys. Signs are square with orange borders. Regulatory buoys are white and shaped like cylinders. They have horizontal orange bands near their tops and just above the water's surface. An orange circle on a marker means a controlled area. A message such as "No Wake, Idle Speed, No Skiing, or 5 M.P.H." may



appear on a marker. An orange diamond means danger. If a diamond has an orange cross inside it, do not enter the area. The reason you should stay out, such as “Swim Area” may be printed in black on the marker.

Informational Markers are white signs with orange borders. They give information such as direction, distance, and location.

Lateral markers in the USWMS system are either numbered red or black buoys. Black buoys may have green reflectors or lights. They are the equivalent of green buoys in the IALA-B system. Red buoys may have red reflectors or lights. They are the same as red buoys in the IALA-B system. Red or black buoys are usually found in pairs – pass between them.

5. A Special Sign

In Florida, you may see a special sign: “Caution, Manatee Area”. When you see this sign, slow down to idle speed. Manatees, an endangered species, are passive, large, slow-moving mammals. Many manatees are seriously injured or killed each year due to accidental collisions with boats.

6. Noise

Always be aware of local laws on noise limits. Noise means engine noise, radio noise or even yelling by people on your boat. Good seamanship demands that you operate your boat quietly so as not to infringe on the rights of others. Do not use thru-hull exhaust unless you are well offshore.

D. Owner’s Logs and Records

At the end of this owner’s manual are several forms which you will find very helpful.

The **Float Plan** provides a record of your destination, departure and return times, boat description, passenger list, and other information about the trip you have planned. At the bottom of the form is space for listing emergency telephone numbers in case your return is delayed past the expected time. It also has space for indicating information about the person filing this report. Leave the completed form ashore with a responsible person. We recommend you make several copies of this form each boating season to assure an ample supply.

The **Fuel Log** is a handy way to record information covering engine hours, fuel consumption, miles traveled, as well as RPM (revolutions per minute),

average MPH (miles per hour) and GPH (gallons per hour).

The **Service/Maintenance Log** provides a record of maintenance work completed, the date of completion, and the engine hour reading. This log also helps you identify the frequency of routine maintenance work, such as engine oil changes. If you should decide to sell your boat, it demonstrates to perspective buyers that you have done a good job taking care of it.

The **Service Information Sheet** allows you to record all the pertinent information regarding your Scarab jet boat. This sheet will be extremely helpful when ordering additional/optional parts for your boat or when having service work done.

E. Navigational Aids Chart

The illustrated Navigational Aids Charts contains information concerning whistle signals, storm warnings, bridge signals, and buoy descriptions. See the inside back cover of this manual.

A - 16 ANCHORING

The weight of the anchor and diameter of anchor line should be governed by the size and weight of your boat. Keep anchor secure while underway to prevent damage or injury due to sudden shifting in the boat’s attitude.

Use two or more anchors if anchoring overnight or for extended periods. If not using two anchors, make certain there is sufficient clearance for your boat to swing in a full circle to prevent damage in case of shifting winds.

Make certain you have enough anchor line (or scope) for the depth of water. Your anchor line should be 6 to 7 times the depth of water anchored in. For example, if you are in 20 feet of water, use 120 to 140 feet of anchor line.



*Secure anchor line to bow eye or deck cleat.
Never tie anchor line to a rail, rail fitting or other hardware not designed to support this stress.*



To drop anchor (if equipped):

Approach your selected anchoring site from downwind and come to a dead stop over the spot where you want to drop anchor. Lower the anchor manually or by using the windlass if applicable.

Maneuver the boat slowly backwards until length of anchor line is 6 or 7 times the depth of the water.

Fasten the anchor line around the bow eye or deck cleat. Anchor flukes should dig in and catch. Watch for anchor drag by checking shoreline landmarks at the time the anchor is dropped and one-half hour later. If the boat has drifted away from these reference marks, the anchor is dragging and must be reset.

To weigh anchor:

Start the engine running before pulling in anchor.

Slowly maneuver the boat forward to reduce tension on the line and make retrieval of the anchor line easier.

Raise the anchor manually or by using the windlass if applicable. Make sure the anchor safety strap is attached to anchor chain nearest the anchor or anchor shackle or anchor eye depending upon how the anchor is rigged. Properly stow anchor and anchor line.

 **WARNING**

Always be sure to raise and secure the anchor prior to operating your boat. Failure to raise and secure anchor before getting underway could result in severe injury or damage to boat from rebounding anchor.

 **WARNING**

Always utilize the anchor safety strap provided with the windlass/bow roller combination. The chain stop prevents the anchor from accidentally releasing while the boat is moving thus preventing damage to the boat or possible injury or death to individual(s) aboard the boat.

If the anchor becomes stuck, attach the vertical line to the mooring cleat. Wave action on the bow may lift flukes from the bottom and free the anchor. If the anchor is still stuck, feed out a few feet of line and attach it to the bow cleat. Maneuver the boat around the

anchor, keeping the line firm. Determine the angle that will work to pull the anchor free.

Anchors are available in different shapes, sizes and weights to fit different boats, uses, and conditions. Your Scarab dealer can tell you which anchor will work best for your boat.

A - 17 GROUNDING AND TOWING

 **WARNING**

If the boat should become disabled, or if assisting another craft that is disabled, great care must be taken. The stress applied to a boat during towing may become excessive. Excessive stress can damage the structure of the boat and create a safety hazard for those aboard.

Scarab jet boats are not designed nor intended to be used as a towing vessel. The mooring cleats are not designed or intended to be used for towing purposes. These cleats are specifically designed as mooring cleats for securing the boat to a dock, pier, etc. DO NOT use these fittings for towing or attempting to free a grounded vessel.

Freeing a grounded vessel or towing a boat that is disabled requires specialized equipment and knowledge. Line failure and structural damage caused by improper towing have resulted in fatal injuries. Because of this, Scarab strongly suggests that these activities be left to those who have the equipment and knowledge such as the US Coast Guard or Sea Tow® to safely accomplish the towing task.

 **CAUTION**

Running aground can cause serious damage to a boat and associated underwater gear. If the boat should become grounded, distribute personal flotation devices and inspect the boat for possible damage. Thoroughly inspect the bilge area for signs of leakage. An experienced service facility should check the hull and underwater gear at the first opportunity. DO NOT continue to use the boat if the condition of the hull or underwater equipment is questionable.

If towing or being towed is absolutely necessary, special precautions should be taken. Use the strongest

lines available, and attach them to the bow eyes or stern eyes only. Have all passengers slip on life jackets and take a seat in a protected area of the boat.

 **WARNING**

Lines can snap or other hardware can be loosened or broken while towing. Under certain conditions, this can cause severe injury or fatality.

The maximum recommended towing speed is 24 km/h (15 MPH).

When towing your boat in water, pinch the exhaust manifold water outlet hose on the engine(s) with a large hose pincher. This will prevent the exhaust system from filling which may lead to water being injected into the engine. Without the engine running there isn't any exhaust pressure to carry the water out the exhaust outlet.

NOTICE

Failure to pinch the exhaust manifold water outlet hose may result in damage to the engine. If your boat must be towed in water and you do not have a hose pincher, be sure to stay well below the maximum towing speed of 24 km/h (15 MPH).

NOTICE

When finished towing the boat, the hose pincher must be removed before operating the boat. Failure to do so will result engine damage.

A - 18 HAZARDOUS CONDITIONS

A. Storms

Storms sometimes appear without advance notice. Although weather information from meteorological observation and reporting stations is available, weather bureaus are known to have failures in their predictions or information gathering equipment. There is no substitute for a strong understanding of what action to take when the weather takes a turn for the worse. Many marinas fly weather signals. You should learn to recognize these signals and monitor your local weather forecasts before leaving port.

The present and forecasted weather conditions are of primary consideration, but a threat of possible storms

should always be a concern. Observance of the following information will help in your safety afloat if storms do occur:

- Keep a watch on the horizon for approaching storm indicators.
- Turn radio ON. Dial in local weather station and monitor forecast. If your boat has a VHF radio, check the weather channels.
- The best possible situation is to return to a safe port if time allows.
- Close and secure all portals and hatches. Stow all loose gear below deck and tie down any gear required to remain on deck.
- Reduce speed as the seas build. Make sure all passengers are wearing their PFDs.
- If you lose power, keep the boat headed into the waves by rigging a sea anchor off the bow. If there is no sea anchor on board, use a canvas bucket or any object that will offer resistance.
- Radar reflectors (if installed on your boat) should be 18 inches diagonally and placed 12 feet above the waterline.

B. Fog

Fog is a result of either warm surface or cold surface conditions. You can judge the likelihood of fog formation by periodically measuring the air temperature and dew point temperature. If the spread (difference) between these two temperatures is small, you likely will incur a fog situation. Remember the following guidelines:

- Turn on running lights.
- As fog sets in, take bearings and mark your position on the chart while continuing to log your course and speed.
- Make sure all persons aboard are wearing their PFDs.
- If your boat has depth finding equipment, take sounding and match them with soundings on your charts.
- Station a person forward on the boat as a lookout.
- Reduce your speed. From time to time, stop engine and listen for fog signals.
- Sound the proper horn or fog bell at proper intervals to warn other boaters.
- If there is any doubt in continuing boat movement, anchor. Listen for other fog signals while continuing to sound the proper fog horn or bell for a boat at anchor.

C. Running Aground



To prevent boat damage, DO NOT use deck hardware or water ski pylon for towing. Use a commercial towing service.

Operating in shallow water can present a number of hazards. Sand bars in narrow inlets are constantly shifting, making it difficult to mark them with buoys. Sometimes sand bars are indicated by waves as they form into breakers when passing over sand bars. In coastal areas, tides can change water levels by as much as 30 feet. Check with local marinas or Coast Guard stations for tide tables and current charts. If your boat runs aground, first check persons aboard for injury. Then check for damage to the boat. If the underwater propulsion unit strikes a submerged hazard, check the boat and underwater propulsion unit for damage. If the engine vibrates excessively after striking an underwater obstruction, it may indicate damage. If vibration is noticeable, call for a tow as previously mentioned. If you feel you can safely return to port do so slowly to prevent further engine damage. Watch the temperature gauge to make sure you do not overheat the engine.

If the boat is not taking on any water, it may be possible to rock the boat by shifting the weight of the passengers and gear while reversing the engine.

If you ground your boat on a sand bar, shut down the engine and seek help from another boater or radio for help. See your dealer as soon as possible, as sand ingested in the engine cooling system can cause major engine damage.

D. Warning Markers

It is a good idea to find out about hazardous areas and how they are marked by asking your local authorities.

- Boaters must also recognize the flag designs which indicate that scuba divers are present and keep well clear of the area.
- Watch for swimmers. Swimming areas may not be marked. Steer clear from the area and always remain alert.
- Distress flags indicate a fellow boater is in need of assistance.

- Navigation markers serve as a means of identifying navigable routes and indicate water hazards. Boaters should become familiar with navigation markers and stay within marked boundaries and clear of hazards.

A - 19 REACTING TO EMERGENCIES

Be prepared to deal with emergencies before they happen. Try to formulate a plan for each type of emergency in advance so that decisions can be made quickly and without hesitation. Precious moments lost can mean the difference between losing and saving a life.

A. Flooding

If your boat starts taking on water, activate the bilge pump immediately. Make sure all passengers are wearing their PFDs. Open the engine compartment, look for the cause of the flooding. Check all hoses, through hull fittings, seacocks and strainers. If flooding occurs as a result of collision or grounding damage, call for assistance and head for shore if possible.

B. Capsizing and Man Overboard

By far, the largest number of boating fatalities involve capsizing and falling overboard accidents. By being prepared ahead of time with an appropriate plan of action, you can greatly lower your chances and your passengers' chances of becoming seriously injured.

1. Capsizing

Wear PFDs or have them readily available at all times. If your boat capsizes, and others were on board, locate them and guide them to the safety of the hull. Even if the boat floats in an upside-down position, stay with it. The boat hull is much easier for rescuers to spot than a human head sticking out of the water. DO NOT attempt to swim ashore, it may be further than it looks.

2. Man Overboard

Think through and follow these procedures if someone in your boat falls overboard.

- Remember, every second counts, you must act fast.

- Move throttles to idle position immediately and yell “MAN OVERBOARD.”
 - Throw some floating object overboard immediately. Keep your required Type IV PFD accessible at all times for such an emergency.
 - Keep the person in the water in sight at all times. Have a passenger do nothing but watch the person. Do not go into the water to help the victim. One person in the water is enough trouble.
 - Circle around quickly, approaching into the wind and waves. When the person is alongside, put the engine in neutral and throw them a Type IV PFD with a line attached or extend a paddle or boat hook within his/her reach.
1. Make sure all persons aboard are wearing their PFDs.
 2. If the fire is small, attempt to put it out with your fire extinguisher. If the fire is in the engine compartment, turn off the bilge blower. Do not open the engine compartment. This feeds oxygen to the fire and may cause it to flare up.
 3. If the fire gets out of control, execute a distress signal and call for help if equipped with a ship-to-shore radio.
 4. All persons aboard should jump overboard and swim a safe distance away from the flames.

C. Collision

If a serious collision occurs, you should first check the condition of all passengers aboard, then inspect your boat to determine the extent of damage.

1. Make sure all persons aboard are wearing their PFDs.
2. If you need help and your boat has a ship-to-shore radio, first contact the U. S. Coast Guard (VHF Channel 16) or other rescue authorities immediately.
3. Prepare to assist the other vessel unless your passengers and/or boat are in danger.
4. If the bow of the other boat penetrated your boat's hull, prepare to block the opening once the boats are separated.
5. Shore up the hole with a spare PFD or bunk cushion from your boat.
6. While blocking the hole, trim the boat so that the hole is out of the water.

D. Fire

Most fires are caused by electrical problems or careless fueling practices. A fire on board your boat is a serious emergency. You must work quickly to implement safety procedures. If a fire occurs, immediately stop the engine.

IMPORTANT: All persons aboard should know the location and proper operation of the fire extinguishers.

Guidelines

- Use only approved marine cooking and heating systems.
- Open flames demand constant attention.
- Keep flammable materials in approved containers in a overboard vented locker sealed from the interior of the boat.
- Ensure ventilation systems are unobstructed.
- Remove mooring covers before starting engine.
- Check the bilge for fuel leaks.
- Extinguish smoking materials carefully.
- Use special care with flame or high temperatures around urethane foam.
- Check cleaning products for flammability.
- Ventilate when cleaning or painting.
- Disconnect electrical system from its power source before performing maintenance.
- Replace breaker or fuse with same amperage device.
- Electrical appliances must be within rated amperage of boat circuits. Observe the boat carefully while the electrical system is being energized.
- Allow only a qualified marine electrician to service the boats electrical system.



E. Medical Emergency

Accidents while boating can and may happen. Be prepared to handle these emergencies when they happen. Keeping a first aid kit and dry blankets on board can assist during these situations. It is also a good idea to contact your local Red Cross for information and training on first aid and CPR.

F. Propulsion Failure

Before you call for help regarding an engine or jet pump failure, it is a good idea to eliminate the possibility of simple problems. Turn off the engine and check to see that (1) there is fuel in the tank; (2) the jet pump water intakes are not clogged; (3) no hoses are leaking; (4) there is oil in the engine.

Once you have checked out the possibilities listed above and find they are not the problem, call for help giving your position and a detailed description of your boat.

G. Control Failure

In the unlikely event of a shift/throttle failure, shut down the engine immediately. Carefully check the control connections in the engine compartment to see if they are secure. If not, try to locate the attaching hardware and reassemble. If that is not possible, try to use whatever is available such as paper clips, hair clips, tape, etc., to secure the connections. If a temporary repair is made, return to port at the slowest steerable speed and be prepared to take emergency action should the temporary repair fail also. Have your dealer make repairs before using the boat again.

H. Steering Failure

If a problem with the steering occurs, shut down the engine immediately. Check the steering connections. If unable to troubleshoot, do not operate the boat and call for assistance. See your Scarab dealer for service/repair.

I. Additional Underway Information

- Always be aware of local laws on noise limits. Noise means engine noise, radio noise or even yelling by people on your boat. Good seamanship demands that you operate your boat quietly so as not to infringe on the rights of others. Don't use thru-transom exhaust unless you are well off shore.

- You are responsible for any damage or injury caused by your boat's wake. Observe no wake speed zone warnings. Operate your boat with regard for the safety of other boats and people in your boating area.
- Keep your engine well tuned to decrease exhaust hydrocarbon emissions that pollute the air and water.

A - 20 BOATING EDUCATION

A. Boating Courses

Boating education classes are offered throughout the country. The United States Coast Guard Auxiliary offers free courses on different topics usually during the off-season. The most popular course is the "Boating Skills & Seamanship Course," and information can be obtained by visiting their website at: www.boatus.com/courseline.

The United States Power Squadron also offers free courses ranging from basic seamanship to celestial navigation. For information, contact your local Power Squadron, or write: USPS, P.O. Box 30423, Raleigh, NC 27622 or visit their website at: www.usps.org.

The World Wide Web contains many websites devoted to boating and boating safety. One such site is www.discoverboating.com which contains many informative articles and website links for both the new boater as well as the experienced boater alike.

The Canadian Power and Sail Squadron offers seamanship courses. Information may be obtained by visiting their website at www.cps-ecp.ca/.

B. Recommended Reading

We recommend that you read the boating literature published by your state boating agency and the US Coast Guard. Also, check the local library or bookstore for additional information on boating.

A good source of information is the US Coast Guard's home study book called "The Skipper's Course". This book may be purchased through Superintendent of Documents, US Government Printing Office, Washington, DC 20402, Stock # 050-012-00159-6.



Other suggested reading includes the following:

Damford, Don. Anchoring. (ISBN 0-915160-64-1). Seven Seas.

United States Coast Guard Auxiliary. Boating Skills and Seamanship. LC74-164688.(illus.). (ISBN 0-930028-00-7). US Coast Guard.

Bottomley, Tom. Boatman's Handbook, (illus.). 316 p. (ISBN 0-688-03925-1, Hearst Marine Book). Morrow.

Whiting, John and Bottomley, Tom. Chapman's Log and Owner's Manual. 192 p.(ISBN 0-686-96737-2). Hearst Marine Book.

Chapman, Charles F. and Maloney, E.S. Chapman's Piloting, Seamanship and Small Boat Handling. (illus.). 62 p. (ISBN 0-87851-814-2, Pub. by Hearst Bks.); deluxe ed. (ISBN 0-87851-815-0). Morrow.

National Fire Protection Association. Fire Protection Standard for Pleasure and Commercial Motor Craft. (ISBN 0-317-07388-5, NFPA 302). National Fire Protection Association.

Brotherton, Miner. Twelve-Volt Bible. (ISBN 0-915160-81-1). Seven Seas.

C. Charts and Maps

US nautical charts are sold throughout the country at Governmental Printing Office stores and other agents. Chart catalogs are available by visiting the National Oceanic and Atmospheric Administration website at <http://nauticalcharts.noaa.gov/mcd/ccatalogs.htm#state>.

In addition, many federal agencies publish recreational maps, including the US Army Corp of Engineers, the Forest Service, the National Park Service, and the Tennessee Valley Authority.

Addresses of all state boating law administration offices are found in the "Boating Basics, A Guide to Responsible Boating", included in your owner's packet. Additional copies may be purchased by contacting the publisher.

D. Laws and Regulations

The US Coast Guard is the authority of the waterways; they are there to help the boating public. State boating regulations are enforced by local authorities.

You are subject to marine traffic laws and "Rules of the Road" for both federal and state waterways; you must stop if signaled to do so by enforcement officers, and permit to be boarded if asked.

There are many pamphlets, prepared by the US Coast Guard, available to you. These pamphlets explain "Rules of the Road," signal lights, buoys, safety, international and inland regulations and other information which goes beyond the scope of this manual. For more information contact your local US Coast Guard Unit or visit the US Power Squadron website at www.usps.org.

E. Contacts

There are many good boating publications that have information about your area and what other boats are doing, such as clubs and other activities. Educational programs are sponsored by publications and organizations such as the US Power Squadron, US Coast Guard Auxiliary and the American Red Cross. See your dealer about special courses available in the area. For detailed information contact:

American Red Cross
Local address (see local telephone directory)
website: www.redcross.org

Boat U.S. Foundation for Boating Safety
website: www.boatus.com/courseline

US Coast Guard Office of Boating Safety
website: www.uscgboating.org

Skippers Course
GPO Superintendent of Documents
Washington, DC 20012
202 512-1800
202 512-2250 (fax)

United States Coast Guard Auxiliary
Local Flotilla or contact appropriate Coast Guard
District Headquarters
website: www.cgaux.org

United States Coast Guard Headquarters
2100 2nd St., SW
Washington, D.C. 20593-0001
202 267-1060
website: www.uscgboating.org

United States Power Squadron
 P.O. Box 30423
 Raleigh, NC 27617
 website: www.usps.org

A - 21 BOAT OWNER REGISTRATION

Federal and state laws require that every boat equipped with propulsion machinery of any type must be registered in the primary state of usage. Registration numbers and validation stickers must be displayed on the boat according to regulations. In most states, this means registration with the designated state agency. In a few jurisdictions, the Coast Guard retains registration authority. Your dealer will either supply registration forms or tell you where they may be obtained. The registration agency will issue you a certificate that must be carried on board when the boat is in use. Some states require additional registration when an out of state boat is used within their boundaries.

Your boat has a hull identification number (HIN) on the starboard hull at the transom. Figure A22 shows a typical identification number. Use this hull identification number for registration and to identify your boat for warranty service.

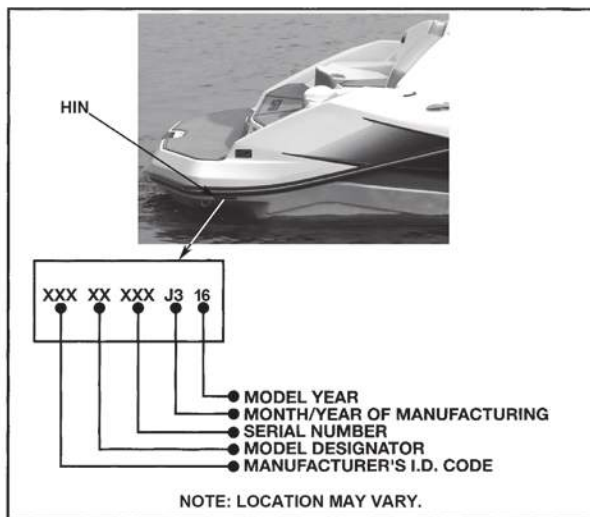

Figure A22: HIN

In most states, the boat owner is legally responsible for damages or injuries he or she causes, even if someone else is operating the boat at the time of the accident. Common sense dictates that you carry adequate personal liability and property damage insurance on your boat, just as you would on an automobile. You should also protect your investment by insuring your boat against physical damage or theft.

A - 22 ACCIDENT REPORTING

The operator of the boat is responsible for filing a report with the appropriate authorities. In general, reports are necessary for accidents involving loss of life, injury, or damage over \$500. In the case of accidents with reportable injuries or death, a formal report is required within 48 hours. If only property damage is involved, a report must be made within ten days. The 1971 Boating Safety Act may impose a \$1,000 civil fine for people who fail to submit a boating accident report. Ask your insurance agent for more information. The Department of Homeland Security, US Coast Guard's Recreational Boating Accident Report has been included at the end of this manual to assist you should you need to refer to it. You may also access it online at https://www.uscg.mil/forms/cg/CG_3865.pdf.

If you see a distress signal, you must assume it is a real emergency and render assistance immediately. The master or person in charge of a boat is obligated by law to provide assistance to any individual in danger at sea. However, you should not put your boat or crew in a dangerous situation which exceeds your capabilities or those of your boat. The 1971 Boating Safety Act grants protection to a Good Samaritan boater offering good faith assistance, and absolves a boater from any civil liability arising from assistance given.

A - 23 DISCHARGE OF OIL

The Federal Water Pollution Control Act prohibits the discharge of oil waste into or upon the navigable waters of the United States or the waters of the contiguous zone if such discharge causes a film or sheen upon or a discoloration of the surface of the water or causes a sludge or emulsion beneath the surface of the water. Violators are subject to a penalty of \$5,000.

A - 24 DISPOSAL OF PLASTICS & OTHER GARBAGE

Plastic refuse dumped in the water can kill fish and marine wildlife and can foul jet boat intake grates and cooling water intakes. Other forms of waterborne garbage can litter our beaches and make people sick. US Coast Guard and most state regulations prohibit the dumping of plastic refuse or other garbage mixed with plastic into the water anywhere, and restrict the dumping of other forms of garbage within specified distances from shore.

A - 25 MARPOL TREATY

Boats 26 feet or longer must display a sign stating the disposal regulations of the Federal Water Pollution Control Act. The US Coast Guard has issued these regulations to implement Annex V of the International Convention for the Prevention of Pollution from Ships, 1973, commonly known as Annex V of the MARPOL (Marine Pollution) Treaty 73/78. They apply to all US boats wherever they operate (except waters under the exclusive jurisdiction of a State) and foreign boats operating in US waters out to and including the Exclusive Economic Zone (200 miles). It is important to know these regulations and adhere to them.

The regulations require US recreational boaters, if your boat is 26 feet or more in length, to affix one or more USCG Trash Dumping Restrictions placards to your boat. The placard warns against the discharge of plastic and other forms of garbage within the navigable waters of the United States and specify discharge restrictions beyond the territorial sea. (The territorial sea generally ends three nautical miles from the seashore.) In addition, the placard must contain the warning that a person who violates these requirements is liable to civil (\$25,000) and criminal (imprisonment) penalties. The placard also must note that State and local regulations may further restrict the disposal of garbage.

Operators shall display one or more placards in a prominent location and in sufficient numbers so they can be observed and read by crew and passengers. These locations might include embarkation points, food service areas, galleys, garbage handling spaces and common deck spaces frequented by crew and passengers. We recommend that these placards may be purchased from local marinas, boat dealerships and marine equipment suppliers. A special placard is available for boats operating on the Great Lakes.

NOTICE

NOTE: Some states and localities have legal limits on speed, noise and trailer specifications. It is your responsibility to be aware of these laws and limits and to insure that your boat (and trailer) comply. Consult with your local Marine Patrol or local Coast Guard office.

NOTICE

IMPORTANT: It is illegal to discharge waste from your marine sanitary device (toilet) into the water in most areas. It is your responsibility to be aware of and adhere to all local laws concerning waste discharge. Consult with the Coast Guard, local marina or your dealer for additional information.



B - 1 CONTROL SYSTEM

Control systems permit the remote operation of the engine's throttle and shift mechanisms. Certain models include separate shift and throttle levers with shift cables. Other Scarab models with either a single engine or twin engine utilize an electronic shift/throttle control body and "fly-by-wire" technology. Either style of control allows you to select forward or reverse gear and regulate engine speed. Always ensure shifting is done at low engine speed.

A "start-in-neutral-only" feature which prevents starting in gear is included. Refer to B-1A Neutral Safety Switch in this section. Also, the shift lever and side mount control have a neutral lock release to prevent accidental shifting. It must be depressed to permit shifting from neutral to forward or reverse. See Figures B1 and B2.

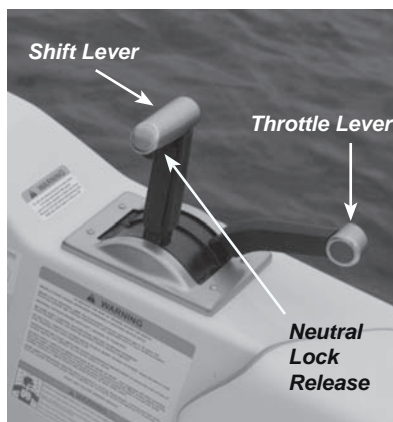

Figure B1: Throttle and Shift Lever Controls



Figure B2: Side-Mount Control



Figure B3: Helm Station
(Representation only - Models May Vary)

NOTICE

Allow the engine(s) to warm up before engaging the shift control. Monitor all instruments while engine is idling during warm up.

A. Neutral Safety Switch

Every control system has a neutral safety switch incorporated into it. This device prohibits the engine from being started while the shift lever is in any position other than the neutral position. If the engine will not start, slight movement of the shift lever may be necessary to locate the neutral position and disengage the safety cutout switch. Control or cable adjustments are required to correct this condition should it persist. See your Scarab dealer for necessary control and cable adjustments.

B. Emergency Engine Shut Off Switch

This safety device automatically stops the engine if the lanyard is attached to the operator and the operator falls from his helm station. Refer to the manufacturer's literature for additional information about using this switch.

The emergency engine shut off switch (Figure B4) incorporates a shut off (interrupter) switch, switch clip, lanyard, and lanyard clip. The lanyard clip **must** be securely attached to the operator's PFD, clothing, arm, or leg. Be sure to attach the lanyard to a place where it is free of obstructions and to something that will move with the operator if he or she leaves the helm station. If the engine shuts down because this switch was activated, the clip **must** be reinstalled on the interrupter switch before the engine can be restarted.

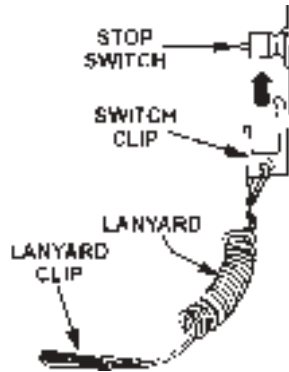

Figure B4: Emergency Engine Shut Off Switch

WARNING

Keep emergency engine shut off switch lanyard free from obstructions that could interfere with its operation. Do not modify or remove emergency stop switch or bypass its safety features. The proper use of the emergency stop switch will prevent a runaway boat situation which can cause severe personal injury or death. Remove the ignition key from the ignition switch when stopped to prevent accidental starting.

The emergency shut off switch can only be effective when in good working condition. Observe the following:

1. Lanyard must always be free of entanglements that could hinder its operation.
2. Once a month, check the switch for proper operation. With engine running, pull lanyard. If the engine does not stop, see your Scarab Dealer.
3. Once a month, inspect both the clip and lanyard for cuts, breaks or wear. Replace worn or damaged parts.

In an emergency situation, any occupant of the boat can restart the engine. Just press in and hold the emergency stop switch button, then follow normal starting procedures. When the button is released, the engine will stop.

WARNING

Avoid knocking or pulling the clip or lanyard from the emergency engine shut off switch during regular boating operation. Should the engine be shut off, boat directional control is not available and a possible collision could occur. Occupants may be thrown forward or possible engine damage may occur by the sudden loss of engine power.

C. Control System Maintenance

Periodic inspections of the controls, cables, and all connections should be made. Signs of looseness, rust, corrosion, wear, cable jacket cracks or other deterioration require immediate system servicing. Replace all damaged components.

Generally, periodic lubrication of all moving parts and connections with a light, waterproof grease is in order. Cables can be lubricated by positioning them to their fullest extension and applying light grease to the inner cable near the jacket. Working the cables back and forth will distribute the grease in the inner cable. Reapply the grease if necessary.

Lubrication should be performed as often as necessary to keep the system operating smoothly. Special tools may be available from the cable manufacturer to ease the lubrication process.

Cable and control adjustments may become necessary. Adjustment screws in the control, on the cables and in the linkage are provided. See your Scarab dealer for necessary control and cable adjustments.

NOTICE

Due to highly technical nature of the control system, especially the electronic shifter, it is highly recommended that you consult your Scarab dealer and have a qualified service technician make the necessary adjustments.

B - 2 STEERING

A. General

Scarab jet boats are equipped with a very responsive steering system. The steering assembly is mounted under the dash behind the steering wheel with a one-piece cable running through the boat into the

engine compartment. At the transom, the cable turns and is connected to the engine.

B. Tilt Steering

If equipped with tilt steering, depress the release lever (adjusting tab) with your thumb to tilt the steering wheel. Be sure to hold the top of the wheel to assist in positioning. Release the lever once the steering wheel is in the position desired. See Figures B5 and B6. Refer to the steering manufacturer's literature, included in the owner's packet, for additional information.

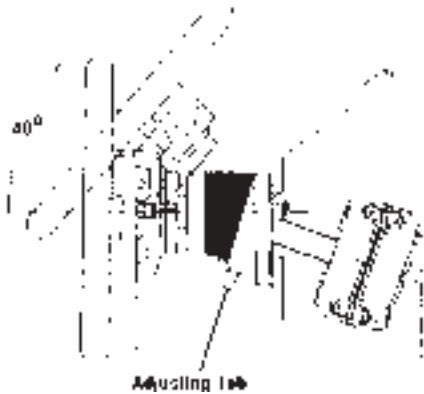

Figure B5: Tilt Steering



Figure B6: Tilt Steering Wheel (Adjusting Tab)

WARNING

The tilt mechanism should not be adjusted when the boat is moving. Sudden boat movement may cause loss of control resulting in an accident and/or injury.

WARNING

The tilt mechanism is spring loaded. Due to the variation in steering wheel offerings, the wheel may spring up rapidly when depressing the release lever. ALWAYS KEEP ONE HAND ON THE WHEEL DURING TILT ADJUSTMENT OR INJURY MAY OCCUR.

NOTICE

DO NOT interfere with or restrict steering cable movement through the last 90° of bend at the engine. DO NOT use cable retainers, clamps or tie straps. Using one or all of these could restrict the cable movement near the engine. DO NOT tie wiring harnesses or other control cables to the steering cable. Make sure the deck coaming pads and bulkheads allow for steering cable movement in all positions of trim.

CAUTION

After the first two hours of running time, check the entire steering system for loose bolts, nuts and fasteners which could adversely affect steering control.

NOTICE

When storing equipment in the engine compartment, be sure to avoid contact with the steering cable. Cables may become kinked or damaged and may increase steering effort.

C. Steering System Maintenance

1. Inspection

A periodic inspection of all steering cables, linkage and helm assemblies should be made. Signs of corrosion, cracking, loosening of fastenings, excessive wear, or deterioration should be immediately corrected. Failure to do so could lead to steering system failure and corresponding loss of control.

NOTICE

Check all bolts, nuts and fasteners for tightness.

2. Steering System Maintenance

The helm and cable assembly should be so adjusted that the steering wheel is centered with the jet

nozzle(s) in the straight ahead position. There should be an equal number of turns to port and starboard from the straight ahead position. If adjustment becomes necessary, see your Scarab dealer.

Check all metal parts at the cable output end for corrosion. Remove any old grease from the cable ram and motor swivel connections using a mild solvent such as WD-40. Spray the cleaned areas with a moisture-displacing lubricant and apply a light coat of good quality marine grease. Do this with the ram fully extended.

3. Winter Storage

If the boat is placed in winter storage or used infrequently, clean the cable ram as instructed earlier. Cycle the steering several times when applying lubricant. If at any time the steering system becomes stiff, has an excessive amount of free play or shows any change in its operating characteristics, contact your Scarab dealer to have the system inspected.

B - 3 PROPULSION SYSTEM

A. Engine(s)



DO NOT attempt to service any engine without being totally familiar with the safe and proper service procedures. Do not attempt to maintain or adjust an engine while it is running. Certain moving parts are exposed and failing to shut off the engine can result in serious injury or death.

Scarab does not manufacture engines. Because of the technical nature of the engines, all manufacturers of these items require that warranty and service problems be taken directly to an authorized dealer for resolution. The Scarab dealer from whom you purchased your boat will handle all warranty and service matters with the engine manufacturer for you.

In compliance with the Federal Boat Safety Act of 1971, all engine manufacturers require their products to be registered. A registration card is furnished with each new engine. When selling a Scarab boat, the dealer, along with the purchaser, should complete the information requested on these cards and return them

to the respective engine manufacturers. Engine registration cards are provided with the engine and will usually be found with the owner's information packet.

Each manufacturer of the various marine power components provides an owners information manual with their product. This publication is included with this manual. It is important that you read the manual(s) carefully and become completely familiar with proper care and operation of the engine. Be sure to read the section on winterization. Replacement costs associated with frozen engine components are quite substantial.

NOTICE

Consult the engine owners manual for all information regarding the engine to include type of fuel, oil and coolant to be used.

NOTICE

Starting the engine or riding the boat in shallower water may damage the impeller or other jet pump components.

NOTICE

Never use propulsion system as a supporting point to board the boat.

Also review the other sections in this manual, especially Fuel System and Control System.

B. Engine Exhaust

The carbon monoxide in exhaust fumes can be hazardous. It is important for you and your passengers to be aware of the potential safety hazard created by exhaust fumes. Familiarize yourself with the symptoms of individuals overcome by carbon monoxide, and most importantly, ways you can protect yourself and your guests.

⚠ WARNING

DO NOT inhale exhaust fumes! Exhaust contains carbon monoxide which is colorless and odorless. Carbon monoxide is a dangerous gas that is potentially lethal.

Persons overcome by carbon monoxide may exhibit the following symptoms:

- a. *Watering and itchy eyes*
- b. *Flushed appearance*
- c. *Throbbing temples*
- d. *Inattentiveness*
- e. *Inability to think coherently*
- f. *Ringing in the ears*
- g. *Tightness across the chest*
- h. *Headache*
- i. *Drowsiness*
- j. *Incoherence*
- k. *Nausea*
- l. *Dizziness*
- m. *Fatigue*
- n. *Vomiting*
- o. *Collapse*
- p. *Convulsions*

IF YOU THINK EXHAUST FUMES ARE ENTERING YOUR BOAT, DETERMINE THE CAUSE AND HAVE IT CORRECTED IMMEDIATELY!

The following suggestions can help prevent exhaust fumes from entering the boat:

1. DO NOT allow the boat to remain stationary with the engine running for an extended period of time. Do not stand or swim near the exhaust output or jet nozzle(s) when the engine is idling.
2. Use extreme caution while operating the engine in confined areas such as enclosed slips or congested piers. Operation under such conditions could easily lead to exhaust gasses (carbon monoxide) entering even though you may have all the hatches, windows, doors and portholes closed.
3. Persons sleeping can be easily overcome by carbon monoxide because they are unaware of its presence. Sleeping while the engine is running is not recommended. If persons are sleeping aboard while underway, those awake should monitor for carbon monoxide accumulation in the cabin; especially the sleeping areas.

⚠ WARNING

NEVER operate the propulsion engine while everyone onboard is sleeping. Fatal carbon monoxide poisoning can occur.

For additional information, refer to Section A-11 Carbon Monoxide.

C. Jet Nozzle(s)

A jet boat moves over the water by a jet of water forced through the jet nozzle(s). Unlike a boat that uses a propeller, a jet boat draws the water from under the boat through an intake grate(s) into a pump(s) inside the boat. The water is then forced through a nozzle(s) at the stern of the boat. The boat's jet thrust can cause injury. Always accelerate slowly, and decelerate in a controlled fashion.

In shallow water, proceed with caution and at very low speeds. Grounding or abrupt stops may result in injury to you, your passengers or others. The jet pump may pick up debris and throw it rearward causing a risk of injuring people or damaging the jet pump or other property.

Avoid personal injury! Do not allow anyone near the jet pump or intake grate, even when the engine is off.

⚠ WARNING**AVOID SEVERE INJURY OR DEATH**

Do not swim near boat, board from rear or use swim platform if engine (s) is running.

Water and/or debris exiting the jet nozzle can cause severe injury including internal injuries if water is forced into body cavities. (rectum or vagina)

Keep people, clothing and hair away from intake grates to avoid entanglement or drowning.

B - 4 INSTRUMENTATION

The helm on Scarab models are equipped with a multi-function, center style information gauge. See Figures B7, B8 & B9. This center gauge allows the boat operator the ability to monitor several key pieces of information such as fuel level, fuel consumption, tachometer(s), GPS speed, hour meter, compass, low oil pressure, volt,

overheat and check engine in real time. Close observation of these readings could save the engine from damage, or possibly help prevent another type of mishap which could spoil your outing. See an authorized Scarab dealer for unit settings.



Figure B7: Information Center Gauges - Single Engine



Figure B8: Information Center Gauges - Twin Engines

Notice: The following descriptions and images depict single engine Information Center gauge features. The Information Center gauge for twin engines follows the same concept as well as having the same features.

At start-up, all LCD segments and indicator lights will turn on for 3 seconds each time the information center is activated. (Note: The emergency engine shut-off switch must be engaged.) This allows the driver to observe that they are all working properly.

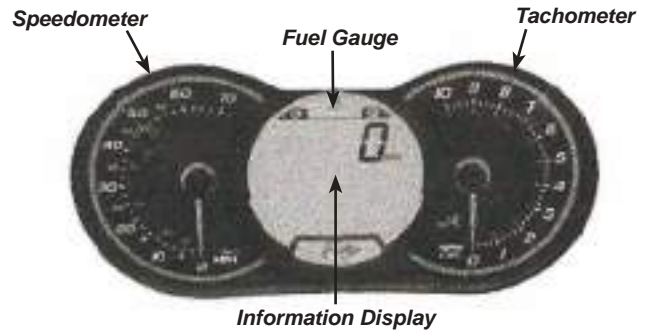

Figure B9: Information Center Gauge - Single Engine

NOTICE

Gauge is illuminated whenever the navigation lights are used.

WARNING

Do not adjust the display while riding. You could lose control.

A. Speedometer - Analog & Digital Readings

Speedometer indicates the speed of the boat in miles per hour (MPH) or kilometers per hour (km/h). The speed is indicated by the analog gauge and or by the GPS indicator when the mode switch is set to GPS speed. The speedometer is designed to be used like an automobile speedometer. See Figures B9 & B10. This automotive helm design helps give the driver a familiar feel.



Figure B10: Speedometer

NOTICE

Speedometers are not precision instruments. The indications are relative and should never be used for navigational purposes or similar critical situations.

CAUTION

DO NOT rely on the speedometer when trying to achieve a "NO WAKE" condition in a harbor or other enclosed waterway. ALWAYS reduce throttle! Speedometers are not effective at measuring low operational speeds. You are responsible for damage caused by the wake of your boat.

B. Tachometer - Analog & Digital Readings

Tachometer indicates the revolutions per minute (RPM) of the engine. Multiply by 1000 to obtain the actual revolutions. This speed is not the boat speed. The tachometer may not register zero with the ignition key in the OFF position. See Figures B9 & B11.

NOTICE

Never exceed the maximum recommended operating RPM of your engine. Maintaining maximum, or close to maximum RPM for extended periods can reduce the life of the engine.

Some engines are equipped with devices that limit engine RPM in accordance with the oil pressure, or engine temperature. Refer to the engine manual included in the owner's packet for additional information.

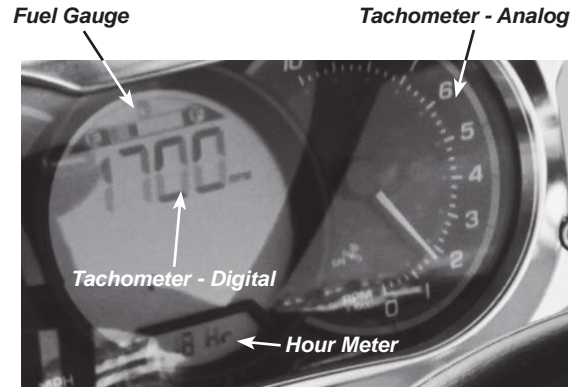

Figure B11: Fuel Gauge, Tachometers & Hour Meter

C. Hour Meter

The hour meter provides a numeric record of elapsed engine operating time. It displays the time in hours of the boat's usage. See Figure B11. This information is important in determining scheduled maintenance intervals, ship's log data, cruise information, etc.

The hour meter is connected to the ignition switch. Be sure the ignition switch is in the OFF position when the engine is not operating or the hour meter (when in the RUN/ON position) will record additional time.

D. Fuel Gauge

The fuel gauge (bar gauge) continuously displays the level of fuel that is present in the fuel tank. The fuel gauge will operate when the ignition switch supplying power to the fuel gauge is in the RUN/ON position.

Due to the mechanical nature of the fuel sender, variations in readings during various speeds of operation may occur. This system is merely a relative indication of the available fuel supply and not a calibrated instrument. Refer to Section B-6I - Fuel Sender for additional information.

NOTICE

Use only clean fuel of the type and grade recommended by the engine manufacturer. The use of incorrect or contaminated fuel can cause engine malfunction and serious damage. Refer to Section B-6 Fuel Systems for additional information.

E. Information Display

The following information is found in the information display of the Information Display gauge. See Figure B9.

1. Compass - displays the cardinal points to indicate the orientation of the boat. The compass can provide general directional information when operating offshore, in unfamiliar waters, or in adverse weather conditions.



Use the compass as a guide only. Not to be used for navigation purposes.

2. Water Temperature - Displays the water temperature of the water surface in degrees Celsius (°C) or Fahrenheit (°F).

3. Message Code - Displays a message code whenever one of the following circumstances occurs. The following abbreviations between parenthesis are the codes displayed.

(H-TEMP) - Engine or exhaust system overheating. Turn off engine as soon as possible. Check oil and coolant levels and refill if necessary. Refer to engine owner's manual maintenance procedures. If engine still overheats, contact your engine certified mechanic or Scarab dealer for repairs.

NOTICE

If the monitoring beeper continuously sounds, stop engine as soon as possible. Operation of an overheated engine can result in engine seizure.

(OIL) - Low or high oil pressure in the engine's lubrication system. A significant drop in oil pressure is a possible indication of an oil pump or other leakage problem. Check oil level as soon as possible. Please see your engine owner's manual for specific engine information. If lamp remains ON contact an authorized Scarab dealer.

NOTICE

Never run engine out of oil. Serious engine damage will occur. Operation of an engine with abnormally low oil pressure can lead to engine damage and possible seizure. Have the engine serviced immediately upon a reduced oil pressure indication.

(12 V LOW) - Low battery voltage. Before the battery becomes too discharged to start the engines, the low/high battery voltage indicator light will come on.

When the indicator light is ON, you should discontinue all use of electrical accessories immediately and start the engine in order to recharge the battery.

(12 V HI) - High battery voltage. See an authorized Scarab dealer.

(FUEL-LOW) - Low fuel level. Fill up fuel tank as soon as possible.

(MAINT) - Maintenance reminder.

NOTICE

When the boat is due for a maintenance inspection, the message MAINT will blink. After servicing, your authorized Scarab dealer will clear it.

(CHK ENG) - Check engine. Note: If a fault occurs, this system generates numbered fault codes (P-XXXX) that are displayed through the information center. In case of a failure, you may call your authorized Scarab dealer and he would be able to assist you to obtain the code descriptions to help troubleshooting.

(SENSOR) - Sensor failure (boat electronic equipment). See an authorized Scarab dealer.

Additional Information - A beeper will sound and indicator light will blink depending on the fault occurring to catch the driver attention when necessary. Note: Except for low liquid levels, which can be corrected by refilling, it is recommended that an authorized Scarab dealer is contacted when other messages occur.



Indicator Lights - NOTE: Refer to MESSAGE CODE above for additional information regarding messages.



Low Oil Pressure (OIL)



Check Engine (CHK ENG)



Engine or Exhaust System Overheating (H-TEMP)



Low Fuel Level (FUEL-LOW)



Low/High Battery Voltage (12 V LOW/HI)



Maintenance Reminder (MAINT)

F. Four Position Ignition Switch

Most models use an ignition switch(es) with four positions: OFF, ON/RUN, ACCESSORIES, and START. The START position is spring loaded and the key should be held in this position until the engine starts but for no more than 5 seconds at a time. If engine fails to start after 5 seconds release the key. Wait 15 seconds and then try again. Once engine starts, the key will return to the RUN position once released.

WARNING

DO NOT hold in START position for more than 5 seconds. Holding the key in the START position longer than 5 seconds will quickly drain the start battery and thus be unable to start the motor. Damage to the starter motors is also possible.

WARNING

While engine is running, never turn the ignition key to the START position. Damage to the starter may occur.

Always turn the key to the OFF position when the engine(s) is not running. This will prevent discharging of the battery(s). The ACCESSORIES position allows the operator to run the stereo without activating the other ship's systems.

Should the boat be left unattended, be sure to remove the key from the ignition to avoid possible unauthorized use or theft.

G. Instrument Maintenance

Electrical protection for instruments and ignition circuitry is provided by either by fuses or circuit breakers depending on the model. On those models utilizing fuses they are located in the fuse block which is located in the helm console storage. The circuit breakers are located on the battery switch panel. The battery switch panel is typically located inside the port stern seat storage compartment. Lift or remove the port stern seat cushion to access the battery switch panel.

Periodically, spray the ignition switch with a contact cleaner. The ignition switch and all instruments, controls, etc. should be protected from the weather when not in use. Scarab offers appropriate weather covers for each model. Excessive exposure can lead to gauge and ignition switch difficulties.

CAUTION

DO NOT use a product such as WD-40 as a contact cleaner. Be sure to read the label before using any product.

Electronic gauges are affected by static electricity that builds-up on the glass face. Periodic washing on the gauge face with a dampened soft cloth and mild dish detergent will help eliminate the static electricity problem and improve gauge accuracy. Note: Do not saturate gauges with water.

B - 5 ELECTRICAL SYSTEM

All electrical equipment on the Scarab jet boat models operates on 12-Volt DC. Certain Scarab models come equipped with a single battery system. The battery is located typically in the port engine compartment storage. Note: Location may vary depending on the model and optional equipment installed.

WARNING

Fire or Explosion Hazard!

Electrical system parts are designed and manufactured to comply with the US Coast Guard requirements to minimize risks of fire or explosion. **Never substitute automotive parts for marine parts.** Automotive parts do not provide the necessary ignition spark protection.

WARNING

DO NOT tamper with any electrical connection, panel or harness, or attempt installation of any electrical equipment unless thoroughly familiar with the systems and experienced in making such installations.

On certain Scarab models, the 12 Volt DC outlet and helm switch circuitry are protected by a fuse panel located inside the helm console storage. See Figure B12. Access to the fuse panel may be gained by raising the starboard helm console storage lid. Figure B13 depicts the fuse block along with the fuse schedule. Both the function and fuse rating are also identified on the fuse panel. The fuses are a “blade-type” fuses and labeled for amperage. Note: Fuse panels may vary by model.

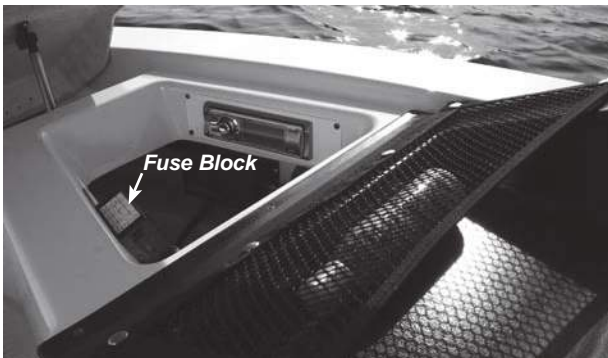
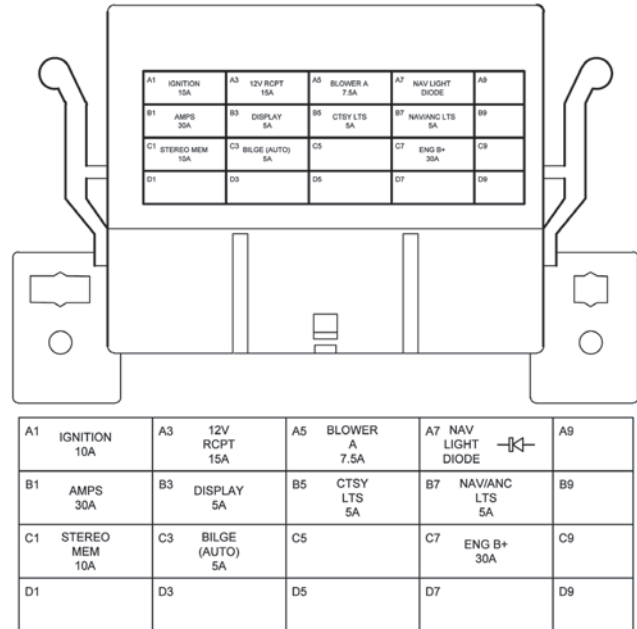

Figure B12: Fuse Block - Under Helm Console

WARNING

To avoid electrical problems, equipment damage or electrical fires, use only replacement fuses that are of equal rating to the originals.



**Figure B13: Fuse Block with Fuse Schedule
(Applicable Models Only)**

A battery switch is provided on certain Scarab models. The battery switch is typically located inside the port stern seat storage compartment. See Figure B14.



**Figure B14: Battery Switch Panel Location
(Location May Vary Depending on Model)**

The single battery, provides power to both the ship’s systems (BOAT POWER) and engine. On models equipped with dual batteries both engines are powered from the port battery. The starboard battery powers the ship’s systems. Circuit breakers are installed on the battery switch panel to protect various system component circuitry. The “BOAT POWER”

breaker protects the DC electrical component circuitry with the exceptions of bilge pump, stereo memory, stereo amplifier, accessories, fresh water pump and ballast pump where applicable. The circuit breakers are labeled for amperage and use. See Figures B15 & B16.

WARNING

To avoid electrical problems, equipment damage or electrical fires, use only circuit breakers that are of equal rating to the originals.

NOTICE

Listed on the battery switch panel are circuit breakers protecting different components. A particular label does not necessarily mean your boat is equipped with this component if either the component is optional or not available to that particular model. Please see your Scarab dealer for details.

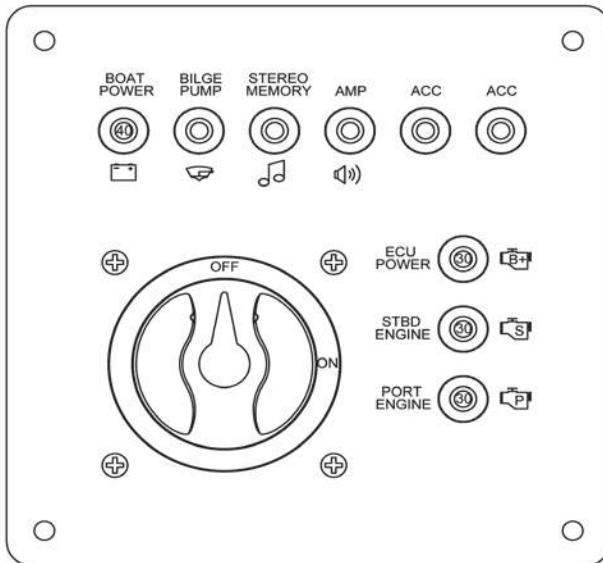

Figure B15: Battery Switch Panel - Single Engine
(Battery Switch Panel May Vary Depending on Model)

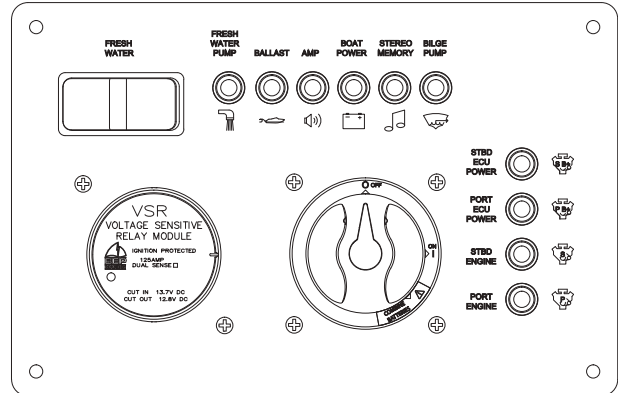

Figure B16: Battery Switch Panel - Twin Engine
(Battery Switch Panel May Vary Depending on Model)

A. Single Engine - Single Battery System

On certain models, a single battery is provided as standard equipment (12-Volt DC). When installing the battery, proceed as follows:

1. Installation

- a. Connect the red (positive) cable running from the battery switch to the positive (+) battery terminal.
- b. Connect the black or yellow (negative) battery cable running from the engine block to the negative (-) battery terminal.

CAUTION

When disconnecting the cables from the battery, make sure all switches are OFF and disconnect the black or yellow negative cable first to prevent spark.

NOTICE

DO NOT disconnect the battery while the engine is running.

2. Battery Switch Operation

Power to the engine and all 12-Volt electrical equipment is controlled at the battery switch panel. Separate circuit breakers are provided on the battery selector switch panel to protect the bilge pump, stereo memory, and stereo amplifier (if applicable) and accessories (if applicable). See Figure B15.

A description of the various positions for this battery switch (Figure B17) is as follows:

“OFF” - With the battery selector switch in the “OFF” position, all 12-Volt power to the boat is shut off completely except to the automatic bilge pump, stereo memory, and accessories (if applicable). Always turn the battery selector switch to the “OFF” position when the boat is removed from the water or when the boat is not going to be used for an extended period of time.



Figure B17: Battery Switch - Single Engine
(Representative View - Models May Vary)

NOTICE

DO NOT turn or “pass” the battery selector switch to the “OFF” position while the engine is running. Wiring damage could result.

“ON” (I) - When the battery switch is set to “ON”, current flows from the engine (start) battery to the engine start circuit and ship’s systems circuits.

B. Twin Engine - Dual Battery System

On certain models, dual batteries may be installed. When installing the batteries, proceed as follows:

1. Installation

- a. Connect each of the red (positive) battery cables leading from the battery selector switch to the positive (+) terminal on each of the two batteries.

NOTICE

Be sure the two red (positive) cables are installed on the positive (+) battery terminals.

- b. Connect each of the black or yellow (negative) battery cables leading to the respective engine blocks to the negative (-) battery terminal on each of the two batteries.

WARNING

When disconnecting the cables from the battery, make sure all switches are off and disconnect the black or yellow negative cable(s) first to prevent spark.

2. Battery Switch Operation

Power to the engine and all 12 volt electrical equipment is controlled at the battery switch panel. Separate circuit breakers are provided on the battery selector switch panel to protect the bilge pump, stereo memory, stereo amplifier, accessories, fresh water pump and ballast pump where applicable. See Figure B16.

The battery switch as described by the manufacturer Blue Sea® Systems, (See Figure B18) “makes it possible to switch two battery banks simultaneously with one single ON/OFF switch. It eliminates the confusion surrounding the traditional four-position selector surrounding the battery switch. The battery switch offers simple ON/OFF switching and the isolated engine start and ship’s systems (house) circuits reduces the chance of fully discharging both batteries. It also protects house electronics from engine starting sags and spikes as well as protecting engine electronics controls from stray house line noise.”



Figure B18: Battery Switch
(Representative View - Models May Vary)

A description of the various positions for this battery switch is as follows:

“OFF” - With the battery selector switch in the “OFF” position, all 12 volt power to the boat is shut off

completely except to the automatic bilge pump and stereo memory. A separate circuit breaker is provided on the battery switch panel for the automatic bilge pump. Always turn the battery selector switch to the "OFF" position when the boat is removed from the water.

NOTICE

DO NOT turn or "pass" the battery selector switch to the "OFF" position while the engine is running. Alternator and wiring damage could result.

"ON" (I) - When the battery switch is set to "ON", current flows from the engine (start) battery to the engine start circuit, and from the ship's systems (house) battery to the ship's systems circuits.

"COMBINE BATTERIES" - When the battery switch is set to "COMBINE BATTERIES", current flows from both ship's systems and engine batteries to ship's systems and engine circuits. The "COMBINE BATTERIES" function offers the ability to combine the two battery banks in the event of a low start battery.

NOTICE

The panel is equipped with a voltage sensitive relay (VSR) to allow charging of both batteries when the alternator is charging.

B. Low/High Battery Voltage

The information center gauge will display a low or high battery voltage code when this situation exists. The codes are as follows:

(12 V LOW) - Low battery voltage. Before the battery becomes too discharged to start the engine, the low/high battery voltage indicator light will come on. See Figure B19.

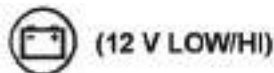

Figure B19: Low/Hi Battery Voltage Indicator Light

When the indicator light is ON, you should discontinue all use of electrical accessories immediately and start the engine in order to recharge the battery. Should the high battery voltage code (12 V HI) appear you should see an authorized Scarab dealer for resolution.

C. 12-Volt Electrical Equipment

1. Helm Equipment

Depending on the model, the ignition circuit is protected by circuit breaker (Boat Power) located on the battery switch panel or by the a fuse in the fuse panel. The helm switches use symbols for ease of identification. See Figures B20, B21 & B22. Many of the helm panel switches have a built-in LED which lights up when the switch is placed in the "ON" position. This feature helps the operator know whether or not a component has been activated, especially in low-light situations. **Note:** Helm and switch panels may vary by model along with the location of various switches.



Figure B20: Ignition Switch - Single Engine



Figure B21: Ignition Switches - Twin Engine



Figure B22: Helm Switches w/LED

⚠ WARNING

To avoid electrical problems, equipment damage or electrical fires, use only replacement fuses or breakers that are of equal rating to the originals.

To assist you, we have listed the descriptions of individual switches, receptacles and their uses:

Accessories - Additional 12-Volt equipment may be added to the boat by using the accessory switches (ACC) if equipped. Certain options or accessories may be wired to the battery switch.

NOTE: Rotax engines are equipped with a station charging system with limited charging ability. Select only low amperage or intermittent accessories.

12-Volt DC Receptacle - Permits the use of additional 12-Volt equipment such as a cell phone. Using the appropriate adaptor, the equipment draws power from either the engine start battery or ship's system battery if applicable. A 12-Volt DC receptacle is located inside the port helm glove box on certain models. See Figure B23.

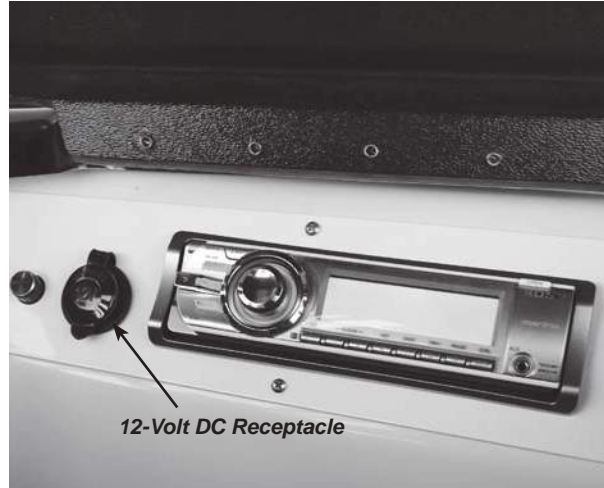

Figure B23: 12-Volt DC Receptacle
(Location May Vary Depending on Model)

Aft Bilge Pump - The BILGE switch (Figure B24) is used to manually activate the bilge pump in the engine compartment (after cleaning, storage, etc.). The bilge pump is used to remove water from the bilge (bottom of the hull) area of the boat by pumping that water overboard.

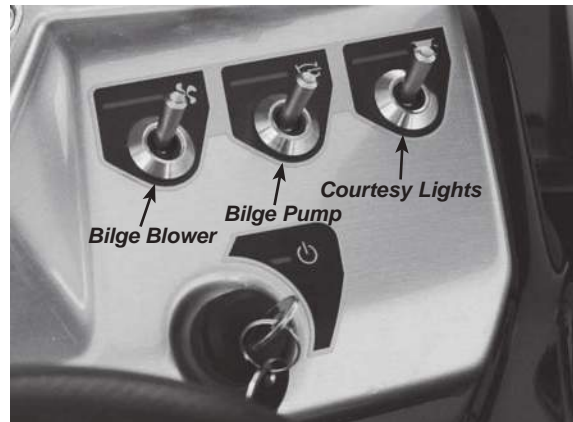

Figure B24: Starboard Helm Switches
Representation only - Models May Vary)

NOTICE

Do not operate for prolonged time if the bilge is dry. Battery drainage will occur and pump will be damaged.

NOTICE

Always turn pump OFF after water is evacuated or before operating the engine above idle. Bilge pump will then switch to automatic mode.

The aft bilge pump is equipped with an automatic bilge switch and will operate whenever bilge water rises to a level that will cause the float to move upward. This automatic bilge pump is active even if the battery selector switch is in the “OFF” position. The automatic bilge pump circuitry is connected directly to the battery. When leaving your boat unattended for an extended period, check the charge on the battery periodically. Also check the water level in the bilge and make sure the float switch is functional.

NOTICE

If boat is exposed to prolonged rain without a cover, battery will discharge and bilge pump will quit working. Boat may sink if in water.

If the automatic bilge pump must be disabled, disconnect the wiring plug near the bilge pump.

Blower - The BLOWER switch (Figure B24) is used to activate the bilge blower. Toggle the switch to the “ON” position, activates the electric bilge blowers, changing the air in the engine compartment that may contain gas vapors.

⚠ WARNING

Gasoline vapors can explode resulting in injury or death. Before starting the engine, check engine compartment bilge for gasoline or vapors. Operate blower for four minutes, and verify blower operation. ALWAYS run the blower when the vessel is operating below cruising speed.

Courtesy (Cockpit) Lights - The CTSY LTS switch is used to activate the courtesy lights.

Horn - To sound the horn, press the HORN switch.

Navigation & Anchor Lights - Toggle “UP” activates the bow lights, the all-around light and the instrument lights on the dash. Toggle “DOWN” to activate the all-around light. The center switch position is “OFF”. See Figure B25.

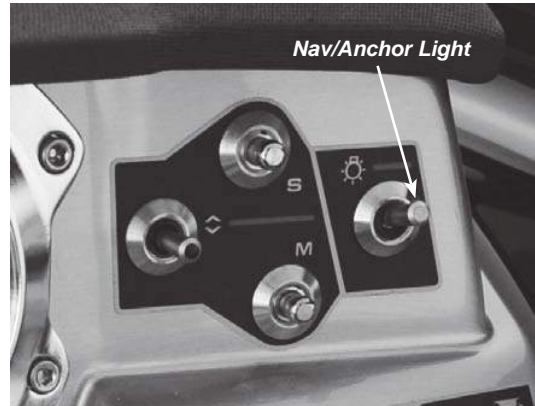

Figure B25: Navigation & Anchor Light Switch
(Location May Vary Depending on Model)

Digital Speed Control Switches - are located on the dash or on the starboard armrest depending on the model. See Figures B26 & B27. These switches may include the MODE, SET and ADJUST (Up/Down - Toggle) switch. These switches allow you to choose a type of mode you desire. These modes may include CRUISE, SKI, ECO & DOCKING (if equipped). A detailed explanations along with the instructions of how to program these various modes are found in the Operation section of the this manual.

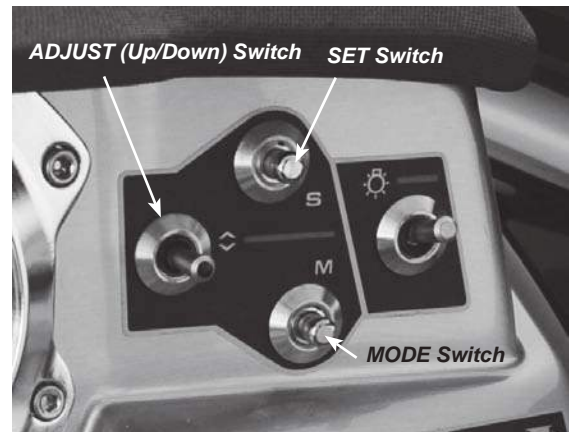

Figure B26: Digital Speed Control Switches
(Location May Vary Depending on Model)

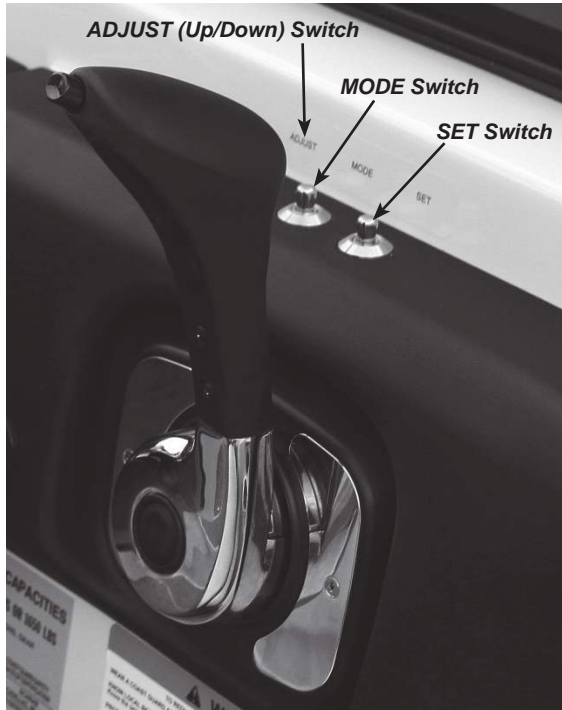

Figure B27: Digital Speed Control Switches - Armrest

2. Installation of Additional 12-Volt Equipment

Non-factory installed 12-Volt accessory equipment can be connected to the “ACC” switch(s) if installed on the dash.

NOTE: Rotax engines are equipped with a station charging system with limited charging ability. Select only low amperage or intermittent accessories.

CAUTION

Be sure to provide proper fuse or circuit breaker protection for all 12-volt equipment that is installed. DO NOT overload the accessory circuitry by installing too much additional 12-volt equipment.

3. Interior 12-Volt Electrical Equipment

Stereo - An AM/FM stereo with Bluetooth® connectivity is available on certain Scarab models. If equipped, the stereo may be mounted in the glove box of the port console. On other models, when equipped, the stereo is located under the helm console storage. An MP3/USB port is shown and is available on certain models only. See Figure B28. The speakers are installed typically in the side bulkheads. An available stereo remote may also be installed at the helm (Figure B29) and/or at the transom (Figure B30) for

convenience on applicable models. Please see your Scarab dealer regarding availability.

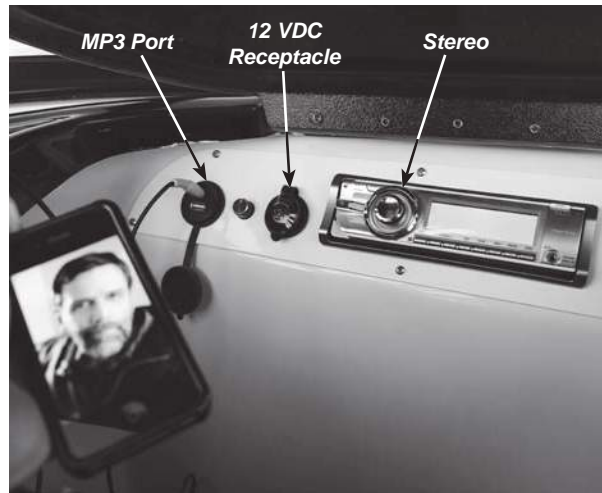

Figure B28: Stereo
(Certain Models Only - Location May Vary)



Figure B29: Helm Stereo Remote
(Certain Models Only - Location May Vary)



Figure B30: Transom Stereo Remote
(Certain Models Only - Location May Vary)

A premium sound system is available for certain models. Please see your dealer for details and availability. Con-

sult the manufacturer's literature, included in owner's information packet, regarding operation, care & maintenance of this system if installed.

D. 12-Volt Electrical System Shutdown Procedure

When leaving your boat unattended for an extended period of time it is advisable to shutdown the electrical system to reduce battery drainage and/or possible electrical draw.

To shutdown:

1. Turn ignition key to the "OFF" position and remove key.
2. Turn the battery switch to the "OFF" position.

E. Electrical System Maintenance

1. Battery Maintenance

Be sure to keep the batteries charged. Also, keep the batteries clean, especially the terminals and connection lugs. Be sure the batteries are fastened securely while in use.

Check the battery fluid level often, especially when a charger/converter is being used. Replenish a battery indicating a low charge. Determine the reason for the discharge. Lack of battery usage is as detrimental to battery longevity as is overuse. Alternating battery usage is important. Refer to the battery manufacturer's instructions included with your battery.

 **DANGER**

Batteries produce hydrogen and oxygen gases when being charged. These explosive gases escape through the vent/fill caps and may form an explosive atmosphere around the battery if the ventilation is poor. This gas may remain around the battery for several hours after charging. Sparks or flames can ignite the gas and cause an explosion.

 **WARNING**

Fire or Explosion Hazard!

Only qualified personnel should install batteries and perform electrical system maintenance. Do not expose batteries to open flame or sparks. Do not smoke near batteries.

 **WARNING**

Poison!

Sulfuric acid in batteries can cause severe burns. Avoid contact with skin, eyes, or clothing. Wear goggles, rubber gloves and protective apron when working with batteries. In case of skin contact, flush with water at least 15 minutes. If swallowed, drink large quantities of water or milk. Follow with Milk of Magnesia, beaten egg or vegetable oil. Get medical attention immediately.

 **WARNING**

Disconnect the battery before working on electrical or ignition system to prevent electrical shock and accidental ignition.

2. Electrical Wiring Maintenance

Periodically, inspect all wiring for nicks, chafing, brittleness, improper support, etc. Spraying the electrical connections with an electrical connection cleaner will reduce corrosion and improve electrical continuity.

 **WARNING**

DO NOT allow corrosion to build up on connections. This can cause equipment to operate improperly.

The American Boat and Yacht Council (ABYC) has published a standard for the color coding of boat wiring. Scarab voluntarily complies with these standards so a qualified service technician can install new equipment or troubleshoot the electrical system. The following table (Figure B31) summarizes the color code system:

Wire Color	Wire Designation
Red	Wires on positive (+) side of battery that go to starter. This wire is non-protected.
Yellow/Red Stripe	Wire from starter switch to starter solenoid.
Brown/Yellow	Power lead to bilge blower from a fuse or switch.
Dark Gray	Sensor wire from tachometer sender to tachometer.
Brown/Orange	Leads to bilge pump from switch.
Brown/Red	Leads to auto bilge pump.
Purple	Wire between ignition switch and coil. Wire from ignition switch through distribution panel to electrical instruments.
Orange	Accessories
Pink	Sensor wire from fuel tank level sender.
Yellow	Ground
Gray/Green	Bow light
Gray/Blue	Stern light

Note: Some of these colors can serve more than one type of circuit.
Figure B31 Wiring Color Codes

F. Stray Current Corrosion

1. General

Electrically induced underwater corrosion occasionally affects boats and their related components. This is referred to as “Stray Current Corrosion” and appears as surface pitting or deterioration. Stray current corrosion is the decomposition of chemical compounds by electric current. Keep all electrical connections as high as possible above the waterline. Stray current corrosion can be caused by the polarity of the dockside wiring system of the boat being reversed from the power source (reversed polarity) or surrounding boats, an improperly wired battery installation, other boats that are in close proximity that have electrical power leakages, or any other source close to the boat that has electrical power leakage into the water. Jet nozzle(s) are especially vulnerable to stray current corrosion.

Periodically inspect the jet nozzle components and thru-hull fittings to determine if stray current corrosion damage exists. If corrosion damage is found, determine and correct the cause of stray current to prevent

further damage. Consult an experienced marine electrician or contact your Scarab dealer for assistance.

The use of some shore power battery chargers while the boat is in the water and the battery is connected to the system can cause stray current corrosion. Have an experienced marine electrician review any battery charger installation to ensure a stray current corrosion problem will not develop. An improper battery connection is a common cause of stray current corrosion.

NOTICE

Use only UL Marine – ignition protected battery chargers. Consult your Scarab Dealer for recommendations.

Corrosion is usually more prevalent in polluted or salt water than in fresh water. It is also more likely to occur when dockage is in an area with steel piers, large metal boats, or where shore power is in use.

2. Galvanic Corrosion

Galvanic corrosion results from a potential electrical difference existing between dissimilar metals immersed in a conductive solution (e.g., salt or brackish water). If these metals touch or are otherwise electrically connected, this potential difference produces an electron flow between them. The attack on the more active metal is usually increased and the attack on the less active metal is decreased, as compared to when these metals are not touching.

3. Corrosion Prevention

Anti-corrosion (sacrificial) anodes are attached to certain parts of the jet nozzle components to reduce corrosion. The anode corrodes, rather than the part to which the anode is attached. Periodic inspection of the sacrificial anodes is necessary. Change each anode when 50% of its weight has corroded away.

Anodes are attached at the following locations:

- Ride shoe/cooling plate
- Pump housing
- Reverse gate support
- Steering nozzle
- Reverse gate.

Please refer to the section on “Sacrificial Anodes” in your engine manufacturer’s manual for additional information. The engine manual is included in the owner’s packet.

B - 6 FUEL SYSTEM (GASOLINE)

A. Fuel System

The equipment used by Scarab, as described by the manufacturer, is designed to provide maximum engine fuel flow. Overfill protection helps prevent the possibility of accidental fuel spills. The fuel system on the Scarab jet boats have automotive style refueling, to include automatic nozzle shut off and fuel nozzle retention. **Note:** The automatic shut off feature only exists when dispensing fuel with an auto shut off nozzle.

NOTICE

Gasoline fuel systems used in Scarab jet boats are designed to meet or exceed the requirements of the Environmental Protection Agency (EPA), US Coast Guard, California Air Resources Board (CARB), the National Marine Manufacturers Association, and the American Boat and Yacht Council in effect at the time of manufacture.

These models include an integrated fuel system which utilizes a pressurized system. See Figure B32. A pump pressurizes the system pushing the fuel to the engine.

When filling the fuel tank air in the tank is vented through the fuel fill vent. Once a predetermined level has been reached in the tank the fuel limit vent valve shuts off. Pressure quickly builds in the tank and the fuel fill inlet control closes. Fuel no longer can enter the tank. As the fuel level rises in the fill hose it shuts off the fuel flow from the fuel nozzle (just like when you fill your car's fuel tank).

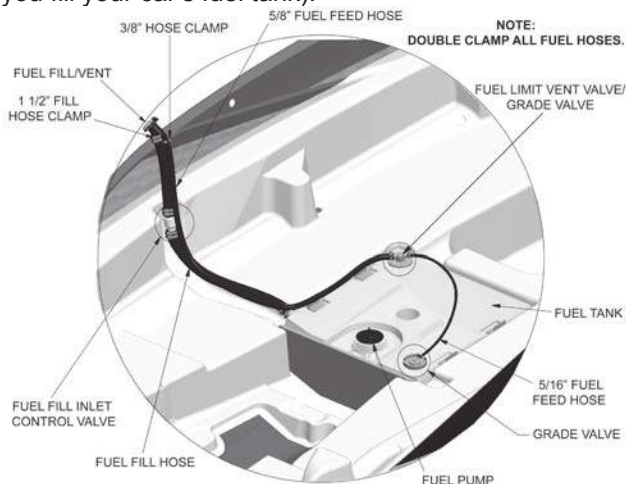

Figure B32: Pressurized Fuel System

WARNING

*Avoid overboard spills. Be alert. The fuel nozzle should automatically shut off when using an automatic shut off nozzle. Be ready in the event it does not or if you are using a different type of nozzle for dispensing fuel. **DO NOT TOP OFF.***

When the pressure reduces in the fuel tank the fuel fill inlet control valve opens and allows the remaining fuel in the fuel line to drain into the fuel tank.

It should also be noted that when the air temperature rises so does the pressure in the fuel tank. When this happens the pressure is released through one or both the grade valves depending upon the angle of the fuel in the tank.

The location of the tank is forward of the aft bilge compartment below the floor. Please visit our website at www.scarabboats.com for fuel tank capacities. See Figure B33.

NOTICE

An access plate or lid is provided in the cockpit floor for access to the fuel pump.

NOTICE

Use only clean fuel of the type and grade recommended by the engine manufacturer. Engine damage resulting from the use of a lower octane gasoline is considered misuse of the engine and will void the engine warranty. Refer to the section on gasoline requirements in the engine manual for information on octane specifications.

B. System Testing

All gasoline fuel systems have been factory inspected and pressure tested in accordance with regulations in effect at the time of manufacture. Additionally, each fuel tank must pass rigid tests and inspections performed by the fuel tank manufacturer.

Prior to taking delivery, it is important that a full inspection be made of the entire fuel system by the selling dealer. An entry on the Scarab Pre-Delivery Inspection Form portion of the online Warranty Registration will attest to the dealer's performance of this service.

C. Fuel Fills

Fuel deck fills are located either on the aft deck or side decks, and are clearly marked with a fuel symbol or are labeled "GAS". See Figure B33. The fuel deck fill is hinged to prevent loss. It is designed for nozzle retention, are automatically shut-off compatible and includes dual over pressure relief valves. The water-resistant gas cap prevents water from entering the fuel system.



Figure B33: Fuel Deck Fill

The "click-to-close" gas cap allows for ease of use. To open, push the catch/release mechanism (Figure B34) inward. Open fill slowly. Contents can be under pressure.

To close, simply shut the cap and press the cap until it "clicks" shut. Hearing the click ensures that the gas cap is completely closed. Be sure to utilize the proper type and grade of fuel as recommended by the engine manufacturer.

 **WARNING**

Avoid serious Injury spills, or death from fire or explosion from leaking fuel. Contents can be under pressure. Open slowly in well ventilated area. No smoking or open flames. Check for leaks at least once a year.



Figure B34: Fuel Deck Fill Catch/Release Mechanism

NOTICE

All connections, including the fuel deck fill, should be checked annually for leaks.

 **WARNING**

DO NOT confuse "GAS" deck fill with "WATER" or "WASTE" deck plates. Deck fill plates are labeled according to the intended use.

 **WARNING**

Spilled fuel is a fire hazard. DO NOT overfill or overflow the tank, or allow fuel spills into the hull or bilge. If spillage occurs, clean up immediately and dispose of soiled rags/towels in a proper container.

NOTICE

When fueling at a marina, DO NOT overfill. Fuel may spill into the water.

 **WARNING**

*Avoid overboard spills. Be alert. The fuel nozzle should automatically shut off when using an automatic shut off nozzle. Be ready in the event it does not or if you are using a different type of nozzle for dispensing fuel. **DO NOT TOP OFF.***

After fueling, insert the fill cap and tighten. Be sure to wash the areas around the fuel fill cap. Residual fuel left on the deck and hull sides can be dangerous and will yellow the fiberglass. It can also damage the tape stripes and logos. Care should be taken, when cleaning,

to prevent contaminating the fuel vent and deck fill. Cleaning with only mild soapy water is recommended.

D. Fuel Vents

On these models, the deck fill has an integrated vent is installed. See Figures B32. While the tank is being filled, the air displaced by the fuel escapes through the vent overboard.

E. Fuel Gauge

The fuel gauge indicates the amount of fuel in the tank. See Section B-4D - Fuel Gauge for additional information.

F. Fuel Sender

The fuel sender consists of a float which travels up and down a stationary tube. The float measures the level of the fuel in the tank and sends a signal to the fuel gauge. See Figure B35.

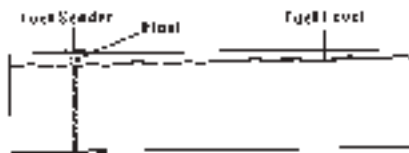

Figure B35: Fuel Sender Operation

Due to the mechanical nature of the fuel sender, variations in readings during various speeds of operation may occur. This system is merely a relative indication of the available fuel supply and not a calibrated instrument. With this type of sending unit a more accurate measurement of fuel level is obtained with the boat in a level position.

The gauge readings will also vary with the trim angle of the boat. When sitting at a dock and the boat is nearly level, the fuel gauge will register accurately. Refer to Figure B35. When boating, the trim angle of the boat changes and affects the gauge readings. Under these conditions, the fuel sender will register "full" for the first few hours of running time until the fuel level drops below the 3/4 or 1/2 mark. This is caused by the angle of the fuel in the tank as shown in Figure B36.

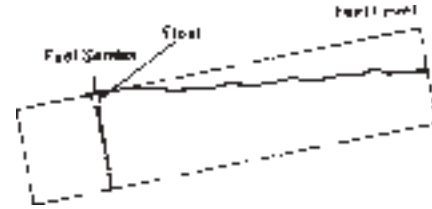

Figure B36: Effects of Trim Angle

It is very important to keep track of hours and fuel consumption to obtain an average gallon per hour consumption figure. Refer to the fuel log located at the back of this manual. This will help to prevent any problems with running out of fuel on the water.

Dealers are equipped with some general figures on consumption which can be used as a guide until specific information on your boat is determined. Because of boating conditions, speed, weight and other factors common to your situation, fuel consumption will vary between your boat and consumption figures developed by Scarab.

When the fuel gauge begins to register below the "Full" mark, the gauge readings will drop much faster until it reads "empty". When this occurs, the trim angle has affected the sender reading. When the gauge registers "empty", the sender has bottomed out and there may be 3 to 4 gallons of fuel in the tank. See Figure B37.

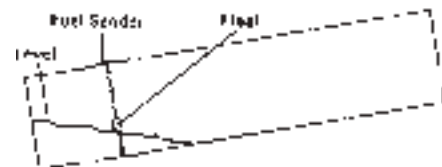

Figure B37: Trim Angle Effect with Low Fuel

CAUTION

The fuel withdrawals are positioned in the fuel tanks to achieve optimum fuel usage, and fuel line routing. At certain speeds and hull trim angles, the fuel supply at the withdrawal tank location can increase or decrease accordingly. Be extremely careful when attempting to operate the boat on a minimum amount of fuel. Though some fuel may be in the tank, the relative trim angle of the boat may cause the fuel to flow away from the withdrawal.

G. Fuel Filter

A fuel filter is installed on the fuel pump. The filter should be changed frequently to assure an adequate supply of fuel to the engine. Refer to the engine manual for additional information. The engine manual is included in the owner's information packet.

H. Use and Maintenance

WARNING

DO NOT let the odor of gasoline go unchecked. If the odor of gasoline is noted, DO NOT START ENGINE. If engine is running, SHUT OFF ENGINE, ELECTRICAL AND HEAT GENERATING EQUIPMENT. Investigate and correct the situation immediately! Have all passengers put on personal flotation devices and keep fire extinguishers at hand until the situation is resolved.

WARNING

Avoid serious injury or death from fire or explosion resulting from leaking fuel. Inspect systems for leaks at least once a year.

WARNING

To help guard against damage, avoid the storage or handling of gear near the fuel lines, fittings and tanks.

I. Fuel Standards

Be cautious when using gasoline that contains alcohol. The fuel system components on the plastic fuel tanks used by Scarab will withstand up to 10% alcohol content in the gasoline. Also refer to the section on gasoline requirements in your engine manual for additional information.

CAUTION

To conform to Federal Air Quality Standards, the petroleum industry reduced the amount of tetraethyl lead in gasoline. Alcohol is being blended with gasoline to help restore the octane rating lost when the lead was removed. While blending alcohol with gasoline increases the octane level of the fuel, it can also create certain safety and performance related problems for boaters.

1. Problems with Alcohol in Gasoline

Below is a list of problems which may be experienced when using blended gasoline.

- A. Premature deterioration of fuel system components may occur. Alcohol will attack rubber fuel hoses, fuel tanks, fuel filters, fuel pumps and rubber gaskets. This deterioration will lead to fuel system leakage.
- B. Phase separation of fuel will cause contamination. Water which accumulates in the tank through contamination or condensation will be absorbed by the alcohol. This water-heavy alcohol will settle at the bottom of the tank. This phase separation will lead to fuel tank corrosion. This may also result in a lean mixture to the carburetor and cause engine stalling or possible engine damage.

The use of alcohol additives in gasoline has become more widespread. Regulations on public notification of the existence of additives is currently controlled by the Environmental Protection Agency (EPA). Some states do require that gasoline pumps display information on additives (especially alcohol). If alcohol content is not posted, ask and avoid using fuel containing alcohol if possible.

2. Recommendations

Assume blended gasoline is being used and follow these recommendations below.

- A. Inspect fuel hoses often. A deteriorated hose containing alcohol blended gasoline will normally be soft and swollen. A deteriorating hose containing no fuel will normally be hard and brittle. In both cases the hose should be replaced.
- B. Ventilate the engine compartment before starting the engine. Operate the engine compartment blower for four (4) minutes. Then, prior to starting

the engine, check the bilge area for the scent of gasoline fumes; DO NOT start the engine if the odor of gasoline is detected.

- C. Frequently inspect the fuel system fittings. Inspect the fuel tank, pump and filter for signs of leaks or corrosion. Visually inspect for deteriorating metal fittings at the fuel hose connections.

⚠ WARNING

Avoid serious injury or death from fire or explosion resulting from leaking fuel. Inspect system for leaks at least once a year.

If areas are found within the fuel system that appear questionable, have a qualified marine technician inspect the system. A thorough fuel system examination should be made by an experienced marine technician at least once a year.

J. Fueling Instructions

1. Avoid fueling at night except in emergencies.
2. When moored at fueling pier:
 - a. Do not smoke, strike matches, or throw switches.
 - b. Stop all engines, motors, fans, and devices that could produce sparks.
 - c. Put out all lights.
3. Before starting to fuel:
 - a. Ensure that boat is moored securely.
 - b. Be sure the proper type and grade of fuel as recommended by your Engine Owners Manual is used.
 - c. Know the capacity of your fuel tank and how much fuel is currently in the tank before fueling. Determine how much additional fuel is required to avoid overflow.
4. During fueling: Keep the fill nozzle in contact with the fuel opening at all times to guard against possible static spark. See Figure B38.

⚠ WARNING

To prevent fuel back-flow, fill up tank slowly so the air can escape from the fuel tank.

⚠ WARNING

*Avoid overboard spills. When tank is almost full the sound from the fuel fill/vent will change. The pitch will become higher indicating the tank is close to being full. Stop pumping fuel into tank. **DO NOT TOP OFF.***



(Nozzle in contact with fuel opening. Grounding the fuel hose - proper)

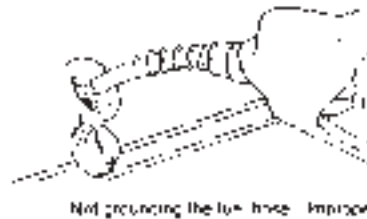

(Nozzle not in contact with fuel opening. Not grounding the fuel hose - Improper)

Figure B38: Grounding Fuel Hose

5. After fueling:
 - a. Replace all fill cap(s) securely.
 - b. Wipe up any spilled fuel.
 - c. Determine that there is no odor of gasoline in the engine compartment or below decks before starting machinery, turning on lights or lighting stove (if applicable). Operate the bilge blower system for at least four (4) minutes before engine start-up.
 - d. Be prepared to cast off moorings as soon as engine is started.

B - 7 VENTILATION & DRAINAGE SYSTEMS

A. Engine Compartment Ventilation

All Scarab jet boat models are equipped with engine compartment ventilation. This system is designed to meet or exceed the requirements (in effect at the time of manufacture) of the U.S. Coast Guard, the National Marine Manufacturers Association, and the American Boat and Yacht Council.

1. Natural Ventilation System

This system includes air intake and exhaust components. The air and exhaust ducts reach to the lower bilge area. This provides adequate air movement while underway and during bilge blower operation.

2. Forced Air Ventilation

All Scarab models are equipped with an electric bilge blower. The bilge blower provides the ventilation required prior to starting the engines and while at idle. See Section B-5C - 12 Volt Electrical Equipment for blower operation instructions.

WARNING

Gasoline vapors can explode resulting in injury or death. Before starting the engine, check the engine compartment bilge for gasoline or vapors, and operate blower for four (4) minutes, and verify blower operation. Run blower when vessel is operating below cruising speed. ALWAYS operate the bilge blower while the engines are at idle.

3. Engine Ventilation System Maintenance

Periodic inspection and cleaning of the ventilation ducts is necessary to ensure adequate air circulation. A buildup of leaves, twigs, or other debris can severely reduce ventilation. Be sure bilge water does not accumulate to a level that would obstruct the ventilation ducts.

Blower operation can be tested by placing a hand over the vents. DO NOT rely on the sound of the blower. Be sure a substantial amount of air is being exhausted by the bilge blower. Check the bilge blower system often, preferably before each cruise.

Should blower noise and vibration be excessive,

loosening the bilge blower mounting screws and then tightening evenly usually reduces noise considerably.

B. Hull Drainage Systems

1. Transom Drains

Transom drains with plugs are provided in the engine compartment to allow water drainage. When the boat is out of the water, the boat and trailer should be positioned so any bilge water accumulation during dry storage will flow towards the transom.

CAUTION

Be sure the drain plugs are securely in place prior to launching the boat. Upon shipment of the boat, the drain plugs are usually taped to the steering wheel.

2. Bilge Pump

A bilge pump is provided in the bottom of the hull to remove miscellaneous water accumulations that might occur during normal boating or weather conditions. The bilge pump is controlled by the bilge pump switch on the dash panel. See Section B-5C - 12-Volt Electrical Equipment for a detailed description of the bilge pump switch.

The bilge pump is typically equipped with an automatic switch. As the water level rises, the automatic float switch will activate the pump. When leaving the boat unattended for long periods of time or during excessive rain storms, it is a good idea to check on the boat for excessive water accumulation. Be sure both the bilge pump and automatic float switch are operating properly. The operating time of the bilge pump will be limited to the battery capacity.

NOTICE

While at rest, any bilge water accumulation may flow forward. Therefore, operate the bilge pump shortly after getting underway and while the boat is at a substantial running angle. DO NOT allow bilge water to accumulate. Damage to the engine or other components may result.

Periodically, clean the bilge pump strainers. DO NOT allow dirt and debris to clog the bilge pump intakes. Check operation of the bilge pump float switch often to ensure movement of the switch is not restricted by debris, portions of the hull, etc. Wipe up any oil accumulation in the bilge prior to activation of the bilge

pump. Pumping oil overboard will pollute the water, and is subject to fine.

Before winter storage, ensure the bilge area, bilge pump and associated hoses are thoroughly dry. Damage to the hull, bilge pump and other equipment could occur if water is allowed to freeze in the bilge.

3. Liner Drains

Fiberglass liners with liner drains are standard on most models. Fiberglass liners can be cleaned easily with water and a brush. See Figures B39 & B40. The water will drain into the bilge and be pumped overboard by the bilge pump.



Figure B39: Liner Drain



Figure B40: Fiberglass Liner

4. Bilge Compartment Drainage

Certain bulkhead areas of Scarab boats are sealed in accordance with U.S. Coast Guard regulations effective at the date of manufacture. Drainage is provided and water can be removed with the bilge pump.

B - 8 FRESH WATER SYSTEM

Certain Scarab models may be equipped with a fresh water supply system. If equipped, this system generally consists of a water supply tank, water distribution lines, transom shower, sink with faucet and a distribution pump.

The location of the water fill deck plate for the fresh water system is located on the starboard transom of the deck. The water fill deck plate is clearly marked "WATER". See Figure B41.

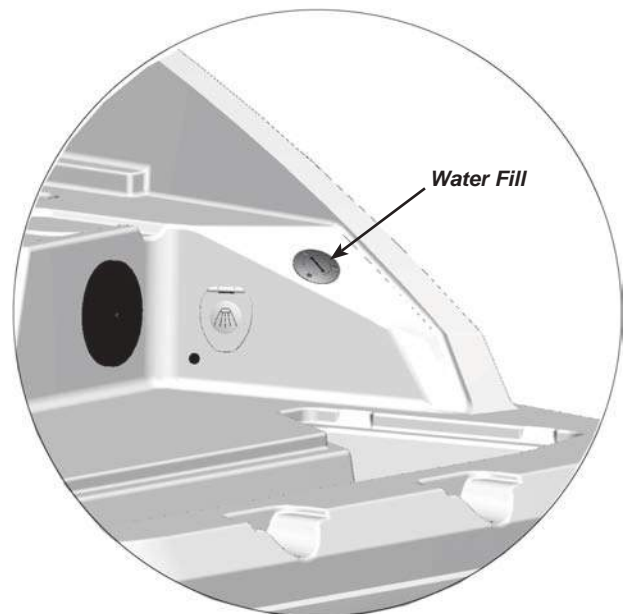

Figure B41: Water Fill - Starboard Transom

CAUTION

The water deck plate is appropriately labeled WATER. DO NOT fill the system with anything other than water. Should the system become contaminated with fuel or other toxic solution, complete system or component replacement may be necessary.

The fresh water tank which supplies water to the aft shower and sink is typically located inside the engine compartment on the starboard side. See Figure B42.

Locations may vary depending upon model and options installed.

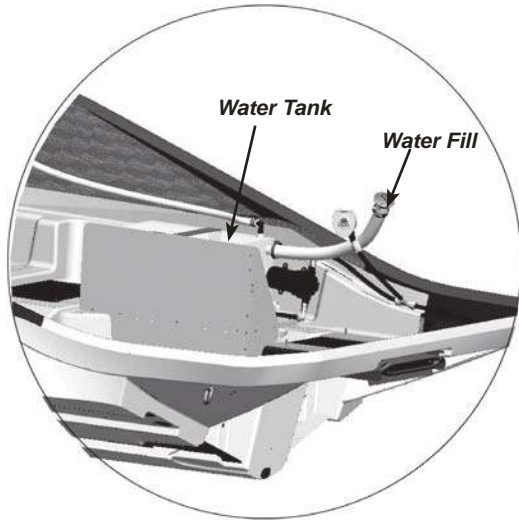

Figure B42: Fresh Water Tank Location (Starboard Aft Seat Storage)

The water tank is vented overboard. See Figure B43. Maintain a close visual watch on the vent while filling the water tank. Always fill the tank slowly. When the tank is almost full, water will spurt out of the vent.

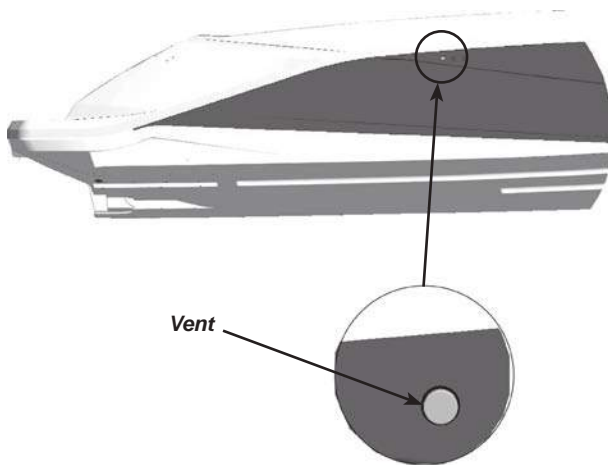

Figure B43: Fresh Water Vent Location

NOTICE

When filling the tank, never seal the hose to the deck plate. The tank would become pressurized and could rupture.

NOTICE

DO NOT overfill the water tank. Tank damage may result. Water capacity and tank location may vary due to other equipment that may be installed on the boat.

For information concerning fresh water tank capacities, please visit our website at www.scarabboats.com or contact your Scarab dealer.

The materials from which the components of the water system are made may give the water supply a peculiar taste, especially when new. This condition is normal and can be reduced somewhat through the use of a water filter. The taste should completely dissipate in time.

The fresh water switch is typically located on the battery switch panel. See Figure B44. After the tank has been filled, activate the “FRESH WATER” switch until water comes out of the aft shower or sink faucet. After all the air has been purged from the system and a steady flow of water is coming from the aft shower or faucet. Turn off the shower or faucet. The excess water from the sink will drain overboard.

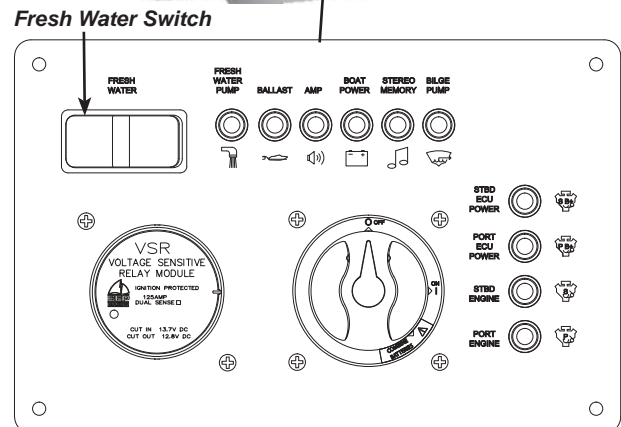
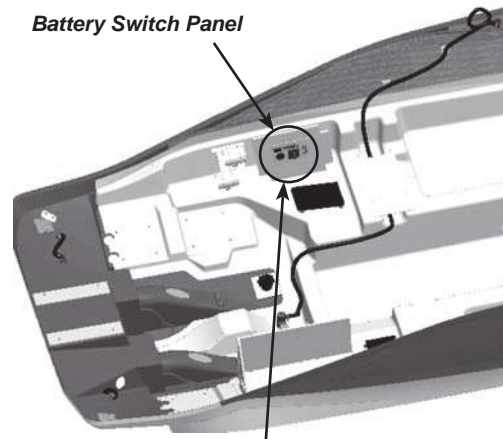

Figure B44: Fresh Water Switch on Battery Switch Panel

When properly primed and activated, the pressurized water system can be used in the same manner as the water system in a home. An automatic pressure sensor in the water pump keeps the system pressurized. Simply operate the faucet and water will be delivered with the “FRESH WATER” switch activated.

Turn the “FRESH WATER” switch “OFF” when not on use.

NOTICE

If the line is routed improperly, kinked or is dislocated, the water pump may not operate properly. Inspect and correct the hose routing (if necessary). If a problem still exists, contact your Scarab dealer for assistance.

NOTICE

DO NOT operate the pump with an empty tank. Damage to the water pump may result. Be sure the pump switch is off when not in use.

A. Head Sink

Certain Scarab models may be equipped with fresh water have a sink located in the head. If equipped, this sink and faucet provide pressurized water for washing hands as well as for drinking. The same fresh water pump is utilized by the head sink and aft shower (if equipped). See Figure B45.



Figure B45: Head Sink (Enclosed Head)
(Certain Models Only)

B. Aft Shower

The aft shower is available on certain Scarab models. The shower unit is located on the starboard side of the transom. The fresh water supply system can be used for showering or washdown purposes at the transom.

The switch to operate the fresh water system is found on the battery switch panel located inside the aft port seat storage and is marked “FRESH WATER”. See Figures B44 & B47.

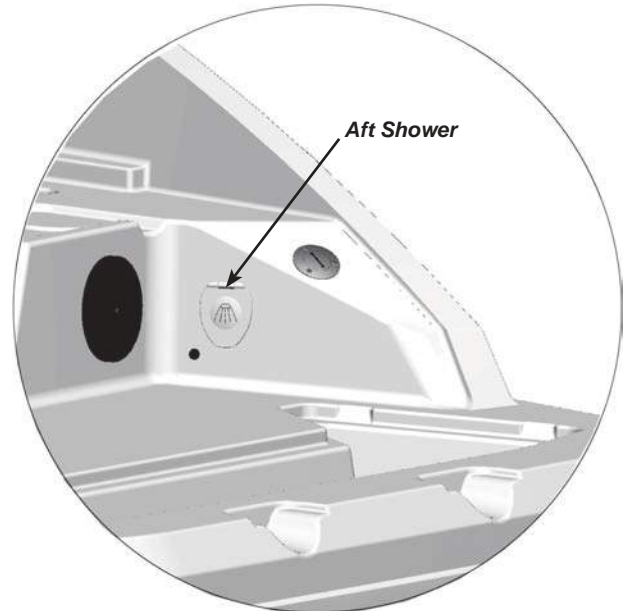

Figure B47: Aft (Transom) Shower

The fresh water pump supplies water to the transom shower. The pump is located in the starboard aft seat storage compartment mounted to the starboard transom as shown in Figure B48.

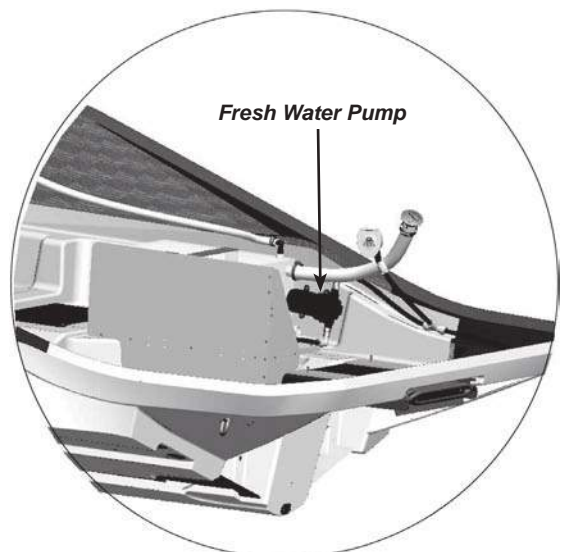

Figure B48 Fresh Water Pump Location
(Location may vary depending on model)

After the fresh water tank has been filled, operate the “FRESH WATER” switch (which activates the fresh water pump) until water comes out of the aft shower.



After all the air has been purged from the system and a steady flow of water is coming from the shower release the shower's trigger. Turn the "FRESH WATER" switch to "OFF" (which deactivates the pump) when no longer needed.

NOTICE
If the line is routed improperly, kinked or is dislocated, the water pump may not operate properly. Inspect and correct the hose routing (if necessary). If a problem still exists, contact your Scarab dealer for assistance.

NOTICE
DO NOT operate the pump with an empty tank. Damage to the water pump may result. Be sure the pump switch is off when not in use.

To operate the shower:

Place the "FRESH WATER" switch "ON", push the spray nozzle trigger to purge any air that may be in the system. When a steady flow of water is coming from the shower nozzle the air has been purged. Release the spray nozzle trigger when finished. As the pressure builds, the pump will automatically shut off at 35 psi.

When properly primed and activated, the pressurized water system can be used in the same manner as the water system in a home. An automatic pressure sensor in the water pump keeps the system pressurized. Simply operate the spray nozzle and water will be delivered. If the system has been recently filled, or has not been used for an extended period of time, air bubbles may accumulate at the pump. If this should happen, re-priming may be necessary. Turn the "Fresh Water" switch to "OFF" when not in use.

C. Disinfecting the Fresh Water System

CAUTION
The fresh (potable) water system should be disinfected prior to initial use.

The water system should be disinfected before first use and at the beginning of each season. The following information is a general guide to disinfecting the fresh water system.

A suggested method of disinfection is taken the American Boat & Yacht Council (ABYC H-23). Perform the following steps in the order indicated:

1. Flush entire system thoroughly by allowing potable water to flow through it;
2. Drain system completely;
3. Fill entire system with a chlorine solution having a strength of at least 100 parts per million, and allow to stand for one (1) hour. Shorter periods will require greater concentrations of chlorine solution. See Table I.
4. Drain chlorine solution from entire system.
5. Flush entire system thoroughly with potable water;
6. Fill system with potable water.

Table I shows how much disinfecting agent is required to make up various quantities of 100 parts per million chlorine solution.

Amount of chlorine compound required for 100 ppm solution

Solution (Gallons)	Chlorinated Lime 25% (ounces)	High Test Calcium Hypochlorite 70% (ounces)	Liquid Sodium Hypochlorite 1% (quarts)
5	0.3	0.1	0.2
10	0.6	0.2	0.4
15	0.9	0.3	0.6
20	1.2	0.4	0.8
30	1.8	0.6	1.2
50	3.0	1.0	2.0
100	6.0	2.0	4.0

Table 1 – Chlorine Concentrations

NOTE: This table contains information taken from the Handbook on Sanitation of Vessel Water Points, Public Health Service Publication No. 274 - Reprinted June 1963.

To remove excessive chlorine taste or odor which might remain in the system, prepare a solution of one quart vinegar to five gallons water and allow this solution to agitate in the tank for several days during boating. Then drain tank and refill with fresh water.

Note: Sinks (if applicable) are equipped with traps, and the water will drain slowly. If the system is not operating properly, have it checked by your authorized Scarab dealer.

D. System Maintenance

Be sure the battery(s) in the boat are properly charged. Operating the pressure pump from a battery with a low charge will result in pump cycling. This could lead to premature pump failure.

1. Clean Vents and Screens

Periodically, inspect the water tank vents and thru-hull vent fittings for any dirt, wax, etc. Carefully remove any obstruction with a pipe cleaner or similar device.

Be sure not to puncture any screens.

NOTICE

Failure to keep the water tank vent fitting clean will cause excessive pressure buildup within the tank during filling. This can cause water tank damage.

2. Winterizing the Water System

Winter lay-up service procedures should include a thorough draining of the water system. Disconnect all accessible fittings. Blow out all lines. Be sure the water tank, waste tank, pumps and lines are completely dry. Freezing water can cause severe damage to all water system components.

NOTICE

It may be necessary to disconnect the hose below the faucet to remove excess water in the lines to prevent freeze damage.

NOTICE

Always winterize the fresh water system prior to winterization of the hull drainage (bilge pump) system.

Draining the system as mentioned can be very tedious and an incomplete job can result in expensive repairs. The use of nontoxic antifreeze (such as RV antifreeze) designed for fresh water systems considerably reduces the work necessary and is a more positive means of winterizing the system. Follow the directions included with the antifreeze solution.

To winterize:

1. Turn on the water pump/faucet and drain the water tank. The water tanks on some models can be drained by removing the withdrawal hose from the tank and allowing water to drain into the bilge.

NOTICE

DO NOT run the water pump without water in the system. Pump damage can result. Be watchful and turn the pump off as soon as the tank becomes empty.

2. Add 1/2 gallon of RV non-toxic antifreeze to the water tank.
3. Turn ON the pump until undiluted antifreeze is seen.

DANGER

Use only nontoxic antifreeze solutions such as RV antifreeze. DO NOT use ethylene glycol solutions (the type that is used in engine coolant systems). These are toxic.

NOTICE

Be sure to wipe up any antifreeze that has been spilled on the fiberglass surfaces to prevent possible discoloration or damage to the gel coat.

Depending upon options and model, additional information by the equipment manufacturers may be included in the owner's packet. Also, refer to Section E for maintenance.

B - 9 WASTE SYSTEMS

A. Enclosed Head

On certain models, a fully enclosed fiberglass head is available and is built into the port console. See Figure B49. If equipped, these heads may offer such things as hard surface countertop, sink, toilet paper holder and porta-potti or porta-potti with pumpout. Note: Heads may vary by model. Refer to the manufacturer's literature included in the owner's packet regarding the use, care and maintenance of the porta-potti.



Figure B49: Enclosed Head
(Applicable Models Only)

B. Porta-Potti

A porta-potti or porta-potti with pumpout is available on certain Scarab models. A general guide on porta-potti use is included in this section. Note: Models may vary. Refer to the manufacturer's literature included in the owner's packet regarding the use, care and maintenance of the porta-potti if installed.

Porta-Potti Preparation:

Separate unit by sliding the locking lever to the left "unlocked" position and hold (Figure B50-A). Separate the units (Figure B50-B).



Figure B50 (A & B): Separate Porta-Potti

With the waste tank (lower section) sitting flat, open valve by pulling handle out (Figure B51-A). Add deodorant through the valve opening (Figure B51-B). Use Thetford Holding Tank Deodorant (sample included) in built-in storage compartment (Figure B51-C). Add water to cover tank bottom. Close valve and replace deodorant (Figure B51-D).



Figure B51 (A-D): Porta-Potti Preparation

Recombine the unit. Align hinge with front interlocking tabs. To secure unit, press downward – it should click into place.

Fill fresh water tank by removing the water fill cap and filling the tank with fresh water (Figure B52). **(NEVER add holding tank chemical to the fresh water tank assembly.)** Replace and tighten the cap securely.



Figure B52: Filling Fresh Water Tank

NOTICE

Before each use: With seat cover closed, open and close the holding tank valve (Figure B53-A & B) to vent any pressure that may have built up as a result of heat or altitude. This prevents upward splashing of bowl contents when toilet is flushed.

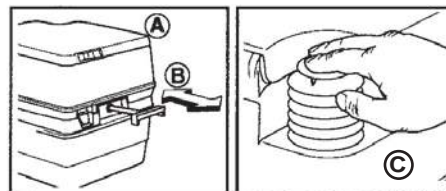

Figure B53 (A-C): Porta-Potti - Bellows Flush Operation

Bellows Flush Operation:

1. Pull out holding tank valve handle (Figure B53-B).
2. Push down on bellows to rinse the bowl. (Figure B53-C).
3. Push valve handle all the way in to insure an odor-tight seal.

Emptying of Portable Models:

1. Empty when waste holding tank level appears full. **DO NOT ALLOW THE TANK TO BECOME OVER-FILLED.**
2. Make sure waste valve handle is in the closed position.
3. Remove fresh water tank from waste holding tank (Figure B54-A & B).

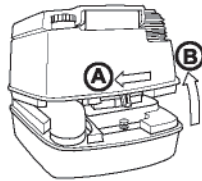

Figure B54 (A-B) Removing Fresh Water Tank

4. Remove waste holding tank from hold down brackets.
5. Carry the waste holding tank to any permanent toilet facility. Rotate the pour-out spout to the desired position. Remove the cap. Depress the air relief valve with your thumb while emptying (Figure B55).



Figure B55: Emptying Waste Holding Tank

6. Rinse waste holding tank and recharge as described under preparation portion of this section.
7. Reassemble unit and fasten to floor or deck.

C. Porta-Potti w/Pumpout

If equipped, the waste holding tank should be emptied when waste holding tank level gauge indicator on the porta-potti (models with pumpout only) has changed from green to red (Figure B56). **DO NOT ALLOW THE TANK TO BECOME OVERFILLED.**



Figure B56: Porta-Potti Level Gauge Indicator

With the head pumpout, the waste can be removed from the tank at a pumping station. A deck plate fitting labeled "WASTE" is provided for this purpose. See Figure B57. Most marina fueling facilities provide service for waste pump out. For waste holding capacities, please refer to the manufacturer's literature and/or our website.

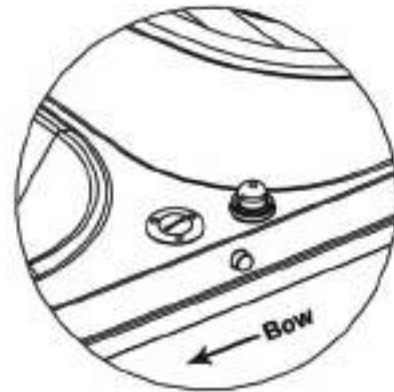

Figure B57: Pumpout Waste Deck Fitting

To pump out the holding tank:

1. Connect the dockside pump out connection to the WASTE plate located on the deck.

NOTICE

Usually the dockside pump out connection will screw into the waste deck plate or has a rubber sleeve that inserts into the plate and must be held in position during the pump out operation.

2. Have the pumping station operator activate the pumping equipment. The waste will be drawn from the holding tank and into the pumping stations disposal tank.
3. Remove the pump out connection from the deck plate. Add 1 gallon of clean water to the holding tank through the waste deck fitting using a dockside water hose.
4. Repeat steps 1 & 2 above to pump out the water used in step 3 to flush the holding tank.

5. Add waste holding tank treatment chemical, available from the dockside pumping station operator, to the head. Flush at least twice.

CAUTION

Be careful when handling and storing treatment chemicals. Not only are they toxic, but they will also stain and damage surrounding surface.

It will be necessary to remove the top holding tank of the portable head to fill with water. Refer to the manufacturer's literature included in the owner's packet regarding the use, care and maintenance of the porta-potti.

WARNING

The decomposition of waste produces methane, a colorless, odorless gas that is lighter than air, combustible, and extremely lethal. Always provide sufficient ventilation when effecting repairs to the waste system and allow no odor from the waste system to go unresolved.

B - 10 BALLAST SYSTEM

The ballast system is a factory installed option and is available on certain models only. In general it consists of portable water sacs, hoses, thru-hull fittings, seacock, ballast pump, controllers, port/starboard selector switch and switch panel. See Figures B58, B59, B60 and B61. Access to the seacock, pumps, hoses, water sacs and other components may be gained by either opening the ski locker lid or the engine compartment.

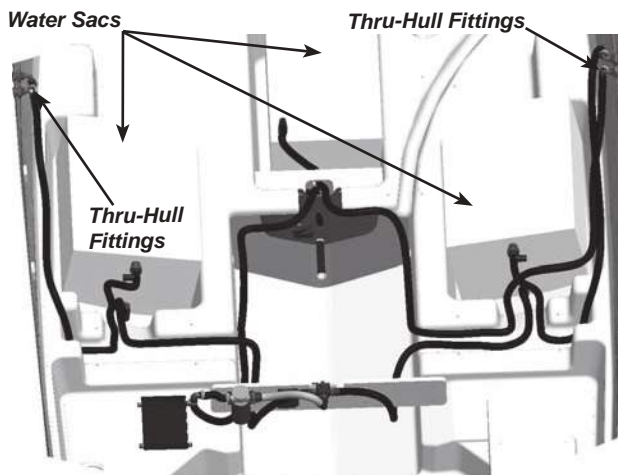

Figure B58: Ballast Water Sacs & Thru-Hull Fittings

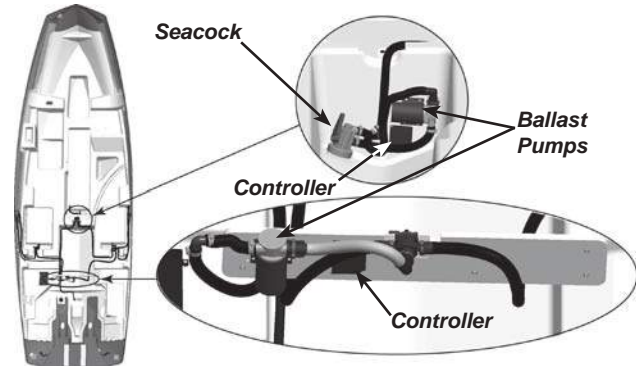

Figure B59: Pumps, Controllers & Seacock Location

Refer to the following ballast system operation and Section A-13 Water Sports of this manual for water sport safety guidelines.

A. Ballast System Operations - Filling

NOTICE

When filling the ballast system it is recommended to perform the operation in open waters away from the dock, shoreline, shallow water or other areas where sea grass, sand, rocks and other debris may be picked up by the pump. These items can damage pump system and other components. Failures related to ingested debris are not covered by the limited warranty.

1. Unstrap and unfold the water sacs prior to filling.
2. Open the seacock by placing the valve lever parallel with the valve. This permits the intake and pumps to draw water from the body of water your boating on. Note: When not using the ballast system you should close the seacock by placing the valve lever perpendicular to the valve.

NOTICE

The ballast system is not designed nor can it be filled by using a water hose. The water source is the body of water you are boating on.

CAUTION

Always make sure your seacock is open before attempting to fill the ballast system. This will protect the pumps from premature failure.

3. With the boat in the water and the seacock open, place the toggle switch to the FILL (up) position to fill the respective water sac(s) as indicated on the switch panel. See Figure B60.
4. A Port/Starboard Ballast Selector switch is located below the side-mount shifter. Using this switch allows you the ability to fill the port and/or starboard water sacs as to how you prefer. Place the selector switch to the desired position to fill the respective water sac(s). See Figure B61.



Figure B60: Ballast System Switch Panel



Figure B61: Port/Starboard Ballast Selector Switch

NOTICE

It is recommended to be below planning speed when filling ballast system. Higher speeds may effect the time it takes to fill the sacs.

5. When water is spilling overboard from the thru-hull fittings or when the desired ballast is achieved place the switch to the OFF (center position). By turning the switch to OFF position you help preserve the life of the ballast pumps.
6. Operate your boat. Note: Your boats maneuverability will be affected therefore be aware of how it handles with this extra ballast.

CAUTION

Be aware of "NO WAKE" areas such as in a harbor or other enclosed waterway. ALWAYS reduce throttle in these areas. Check your wake and not just your speedometer especially with running with extra ballast. You are responsible for damage caused by the wake of your boat.

B. Ballast System Operations - Emptying

1. To empty the water sacs, place the switch of the respective water sac(s) to the EMPTY (down) position. Water will then evacuate the system and pump the water overboard via the thru-hull fillings.
2. When the indicator light appears and/or when the pump noise changes water sacs are empty. Pumps are equipped with "run-dry" protection controllers which automatically turn off the pump when the sac(s) level gets low. The toggle switch light will flash one (1) blink. Always monitor sac(s) level and listen to pump tone to avoid damage.
3. Place the switch to the OFF (center position).

NOTICE

DO NOT run the ballast pump(s) without water in the system. Pump damage can result. Be watchful and turn the pump(s) OFF as soon as the water bladders become empty.

4. Close the seacock by placing the valve lever perpendicular to the valve.

Once the water has been evacuated, you can now dock your boat or safely load the boat on the trailer.

NOTICE

Should you not be operating your boat for an extended period of time and just leaving it moored, it is recommended that you empty the ballast system. This helps to ensure your boat is not under unwarranted stress or possible damage due to weather conditions.

⚠ WARNING

TRAILER OVERLOAD HAZARD

Avoid serious injury or death from an overloaded trailer. Never exceed the trailer carrying capacity. The boat's ballast system must be pumped out before loading the boat on the trailer. Never trailer boat with water in the ballast system.

NOTICE

INVASIVE AQUATIC SPECIES

Invasive Aquatic Species can be transported via ballast system water. Help protect our waters. Ensure to completely empty the ballast systems prior to towing boat. Failure to do so could lead to the spread of these invasive aquatic species. If found transporting such species could result in a very significant fine and/or punishment.

C. Ballast System Maintenance

Periodic inspections of all hoses, water sacs, fittings, and connections should be made. Signs of looseness, rust, corrosion, leaks, wear or other deterioration require immediate system servicing. Replace all damaged components. See your Scarab dealer for necessary servicing.

Refer to Table 2: Ballast System Blink Codes to help with troubleshooting should there be an issue with the unit/pump(s) of the ballast system. If these blinks (indicators) appear on your ballast system switch panel consult your Scarab dealer for remedy.

BLINK CODES FOR UNIT/PUMP PROBLEMS	
LOW AMPERAGE (EMPTY TANK/RUN DRY)	1 BLINK
HIGH CURRENT (BLOCKAGE)	2 BLINKS
OPEN/NO CURRENT (BAD MOTOR/CIRCUIT)	3 BLINKS
LOW VOLTAGE (LOW BATTERY)	4 BLINKS
AL UNIT FAILS INTERNAL TEST	5 BLINKS
TIME OUT	6 BLINKS

Table 2: Ballast System Blink Codes

D. Winterizing the Ballast System

Prior to winter storage, be sure that the system is purged of all water. Contact your Scarab dealer with any questions.

NOTICE

Failure to winterize the ballast system properly can result in costly damage to the ballast system due to freezing.

Steps for winterizing the ballast system is as follows:

1. Empty ballast sac(s) with the onboard pumps removing as much water as possible. Close seacock.
2. Disconnect the hose from the ballast sac(s) at the quick connect fitting on each sac.
3. Remove ballast sac(s) from the boat and empty any residual water left in sac(s).
4. With the ballast sac(s) disconnected and seacock open, run ballast pump in the empty position for 5-seconds. Close seacock.
5. Store ballast sac(s) empty and disconnected until the start of the next boat season.

NOTICE

Models may vary with regard to content based on standard and options availability.

C - 1 DECK HARDWARE

The hardware fittings have been selected and installed to perform specific functions for the Scarab models. Ensure that all equipment and hardware fittings are used properly and for their intended use only.

A. Grab Handles

Grab handles have been installed to provide security for passengers in the cockpit. See Figure C1. All those on board should be safely seated while underway. Refer to person capacity label at the helm. Limiting passenger movement while underway is recommended. Additional care must be taken when in rough seas or foul weather.



Figure C1: Passenger Grab Handle - Stern

WARNING

Prevent personal injury or possible man-overboard situations. Do not conduct maneuvers that could launch passengers or driver from their seats and/or overboard.

B. Cleats

The cleats that have been installed are specifically designed and are intended to be used as mooring cleats. Their purpose is for securing the vessel to a dock, pier, mooring, or anchor. Use of fenders is

highly recommended when mooring to a dock. Also be sure to tie off at both the bow and at the stern. Be certain that a clear lead exists when running dock lines or an anchor line. A line inadvertently threaded around a stanchion or around a grab handle could cause damage.

A pull-up style cleat is available for the Scarab models. If equipped, the pull-up cleat gives the boat a sleek style. When you desire to use the cleat, simply pull up on the cleat. When finished with the cleat, push in and the cleat will remain in its retracted position until the next time you desire to use it. See Figures C2 and C3.



Figure C2: Pull-Up Cleat - Extended



Figure C3: Pull-Up Cleat - Retracted

WARNING

Scarab boats are not equipped with any hardware designed for towing other craft. The mooring cleats that are installed on the boat are not to be used for towing another vessel or having the boat towed. Refer to the section on Section A-17 Grounding & Towing for additional precautions.

C. Transom Ski Tow

The stainless steel transom ski tow is mounted on the transom above the swim platform. Scarab recommends no more than two skiers be pulled behind the boat at any time. See Figure C4.

NOTICE

Refer to A-13 Water Sports of the Boating Safety & Information section of this manual often.



Figure C4: Transom Ski Tow

WARNING

When pulling a tube, skier or wakeboarder always have an observer, proceed with only as much speed as required, and follow the observer's instructions.

WARNING

Pulling a tube, skier or wakeboarder makes the boat handle differently and requires greater skill. Unless absolutely necessary, do not make tight, sharp turns. Keep a safe distance from docks, swimmers, other craft or objects. Be advised that serious injury can result if the tow rope becomes slack during a tight turn or when circling. The rope could become wrapped around the neck or limbs of a person.

WARNING

Do not use ski tow fitting or arch (if applicable) for lifting or parasailing. Fittings could pull out of deck resulting in serious injury or death.

WARNING

To prevent personal injury or damage to the boat, DO NOT tow more than two water skiers with the transom mounted ski tow ring.

NOTICE

Skier's weight, boating conditions, amount of gear, and operator's experience will affect the number of skiers which can be pulled.

D. Maintenance

The majority of the hardware installed is made of stainless steel. Regardless of the type of hardware used, periodic maintenance is necessary.

The manufacturer of the hardware recommends the following when washing your boat:

1. Rinse the hardware with fresh water after each exposure to saltwater.
2. Periodically wash the hardware with mild soap, warm water, and a sponge. Then dry it with a soft cloth.
3. Avoid cleaners, abrasives, waxes, and most of all, do not use steel wool.

NOTICE

All fittings must be periodically inspected for loosening, wear, and damage. Problems should be corrected immediately!

C - 2 WINDSHIELD

A windshield is available on most Scarab models. See Figure C5. The windshield consists of tempered safety glass and the windshield frame may consist of either a painted, powder coated or anodized aluminum (depending on the model). For easy accessibility to and from the bow, a walk-thru center windshield is standard. Stainless steel supports or braces are used in most of the windshield assemblies.



Figure C5: Windshield

CAUTION

We recommend you close and secure the walk-thru windshield while underway. Damage to the windshield could result otherwise.

WARNING

Secure windshield with windshield strap when in open position. Securing the walk-thru windshield will help prevent the windshield from accidentally slamming closed due to high wind and/or wake condition, thus reducing the chance of damage to windshield or injury.

Windshields made of tempered glass can be cleaned with automotive glass cleaners or dishwashing soap and water. Ensure that a clean cloth is used to prevent scratching the glass.

Aluminum can be cleaned with similar products or with nonabrasive cleaners such as Fantastik™.

NOTICE

Read the label before using any product. **DO NOT** use abrasive cleaners.

C - 3 AFT SWIM PLATFORM AND LADDER

An aft swim platform is found on the Scarab models. See Figure C6. The swim platform creates more space for water sport activities and has a skid-resistant surface. A swim platform mat may also be available.



Figure C6: Swim Platform w/Mat
(Representative View - Models May Vary)

WARNING

Do not sit on, occupy or hang on any stern appendages (e.g., swim platforms, boarding ladders, etc.) while underway. Do not body surf, commonly known as “teak surfing” or “dragging”, etc., in the wake of the boat. Do not tow persons in close proximity to the stern of the boat. See Figure A14. This activity can also increase the possibility of injury due to contact with water or debris exiting the jet nozzle.

The Scarab models have a stern ladder that is telescoping and located under the swim platform, at its center. The ladder allows for reboarding the boat from the water. A grab handle is built into the swim platform to make reboarding easier. See Figures C6 & C7.

To use the ladder follow the steps below:

- 1) Remove the retaining cords from the end of the ladder.
- 2) Extend the ladder straight out horizontally.
- 3) Once extended, allow the ladder to swing down into the water.



Figure C7: Stern Reboarding Ladder

To store the ladder follow the steps below:

- 1) Raise the ladder to the horizontal position.
- 2) Slide the ladder forward until fully retracted.
- 3) Place the retaining cords around the ends of the ladder.

⚠ WARNING

Keep hands and fingers away from ladder hinges to prevent injury.

⚠ WARNING

Never approach or use ladder when the motor is running. Engine should be OFF. Keep limbs away from jet or intake grate. Only one person at a time on the ladder. Never use the ladder for pulling, towing, diving or jumping, boarding a boat that is out of the water or any other purpose other than a ladder.

⚠ WARNING

To prevent personal injury, swim platform and transom entry area must not be occupied while engine is running and/or boat is underway.

NOTICE

Always secure the ladder before boating. Damage to the ladder may otherwise result.

C - 4 WAKEBOARD TOWER

Certain Scarab models have a wakeboard tower available. See Figures C8 & C9. The towers come with a variety of features which will sure to please the wakeboard enthusiasts. Please see your Scarab dealer for information regarding this available feature. If equipped, follow the manufacturer's instructions for use and maintenance. Refer to Section A-13 Water Sports of this manual for safety guidelines.



Figure C8: Wakeboard Tower



Figure C9: Wakeboard Tower Speaker

⚠ WARNING

Do not use ski tow fitting or wakeboard tower for lifting or parasailing. Fittings could pull out of deck resulting in serious injury or death.

WARNING

Misuse of tower can over stress tower or dangerously imbalance boat. Failure to follow these guidelines can result in injury or death. This tow tower is to be used for towing wake-board and ski devices only. Do not tow more than two persons at a time from this tower. Do not use tower for lifting, parasailing or towing other watercraft. Do not allow passengers to sit behind rope attachment point when tower is in use. Do not allow loose tow rope ends to dangle. Do not climb on, hang on, sit on, jump or dive off this tower. Check all tower fasteners for tightness before using tower.

C - 5 GLOVE BOX

A glove box is available on certain Scarab models and is built into the port console. See Figure C10. A spring lid stays holds the glove box door open. Note: When closing the glove box door be sure to break the spring lid stay with your finger otherwise damage to the stay and possibly the door may result.



Figure C10: Port Console Glove Box

C - 6 STEREO

Depending on the Scarab model, an AM/FM stereo with Bluetooth® connectivity may be available. If equipped, the stereo may be mounted inside the glove box or it may be under the helm storage. On models with changing room or enclosed head, the stereo is installed inside. This placement offers better protection as well as security. Note: The MP3/USB port is available on certain models only. See Figures C10 & C11. For stereo operating instructions, see the manufacturer's literature included in the owner's packet.



Figure C11: Stereo - Port Console Glove Box

The stereo may include a remote display at the helm depending on the model. An available stereo remote may be installed at the swim platform on certain models. The speakers are installed within the side bulkheads. See Figures C12 & C13. For additional information refer the manufacturer's literature included in the owner's packet.



Figure C12: Stereo - Under Helm Console



Figure C13: Speaker

C - 7 ANCHOR STORAGE

Built-in storage for an anchor under the center bow seat may be available on certain Scarab models. See Figure C14. To gain access the anchor simply remove the center bow cushion. The anchor storage compart-

ment has an overboard drain to remove any water that might otherwise accumulate. The compartment should be inspected after each use and kept clean of dirt and debris to prevent plugging of the drain hole. For information on anchors, refer to Section A-16 Anchoring.



Figure C14: Anchor Storage

A port helm console storage may be available. If equipped, access may be gained by lifting up and rotating the latch a 1/4 turn. Reverse the process to secure the storage door. This storage space makes a great place to store the removable cooler. See Figure C16.



Figure C16: Port Console Storage

C - 8 COCKPIT STORAGE

The port and starboard bow seat cushions are removable for storage access underneath. See Figure C15



Figure C15: Bow Storage

The port and starboard cockpit aft seats have storage compartments located under the respective cushions. Cushions are removable for easy access. See Figure C17.



Figure C17: Starboard Cockpit Seat Cushion Storage

NOTICE

Always use care when removing cushions. Store cushion properly to prevent damage to cushion or fiberglass. After accessing storage compartment ensure to replace and properly secure cushion to prevent possible loss overboard.

Cargo nets provide convenient storage for those essentials items one might need. Those essentials might include paperback books, tanning lotion, towel and sunglasses. See Figure C18.



Figure C18: Cargo Net Storage

Available on many of the Scarab models is a in-floor ski locker. The ski storage locker is located in the cockpit floor, between the driver and passenger seats. The locker allows for storage of skis, knee boards, tow ropes, personal flotation devices, etc. See Figure C19.



Figure C19: In-Floor Ski Locker

Under the sun pad additional storage space may be found. Gas-assist lifts hold the sun pad open to allow access to the engine compartment and storage. See Figure C20.



**Figure C20: Sun Pad Storage/Engine Compartment
(Certain Models Only)**

C - 9 COCKPIT TABLES

A table with mount is available for certain Scarab models. If equipped, the cockpit table provides a solid surface to enjoy refreshments or games. The table leg is angled and attaches to the seat base using the mount. This type of mounting provides for more leg room. Rotating the table top while lifting will ease the removal of the table from the leg. The angled table leg slides out from the mount for storage. See Figure C21.



Figure C21: Aft Cockpit Table - Oval

See Section E-7 - Laminated Fiberglass for care instructions.

C - 10 SEATING

A. Bow Seating

Bow seating is provided on the Scarab models. These cushions are removable to allow for access to storage areas below. See Figure C22.



Figure C22: Bow Seating

Bow fill-in cushions are available for most models. If equipped, the fill-in cushions help form a sundeck across the bow area. These cushions may be stored in the walk-thru storage or bow storage area

B. Bucket Seats

Certain Scarab models have adjustable bucket seat(s) as part of the seating configuration available. Also available on the bucket seat(s) is a flip-up bolster. By placing the bolster in the raised position (if equipped) the driver is able to sit higher in the seat. This is designed to give the driver and passenger greater flexibility, increased visibility and riding comfort. See Figures C23, C24 & C25.



Figure C24: Bucket Seat with Flip-Up Bolster (Down)

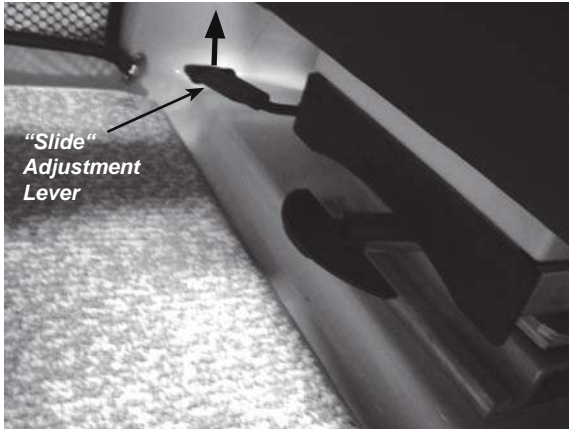

Figure C25: Bucket Seat with Flip-Up Bolster (Up)

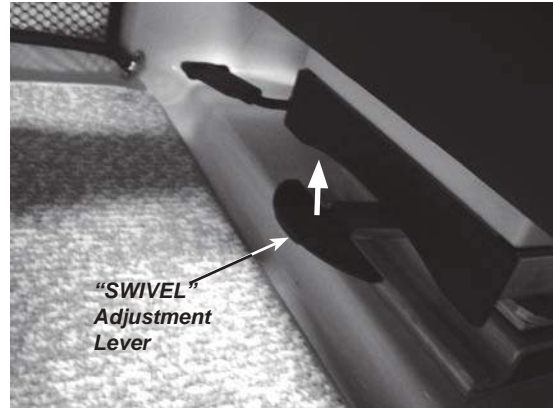

Figure C23 Helm Bucket Seat

To manually adjust the position of the bucket seat lift up on the “Slide” adjustment lever located under the seat. Slide the seat forward or aft to the desired position. Release the “Slide” lever and it locks the seat into position. The seat will adjust approximately five (5) inches. See Figures C26A & C26B.



**Figure C26A: Bucket Seat "Slide" Lever
(Certain Models Only)**



**Figure C27A: "Swivel" Lever - Release to Rotate
(Certain Models Only)**



**Figure C26B: Bucket Seat "Slide" Lever
(Certain Models Only)**

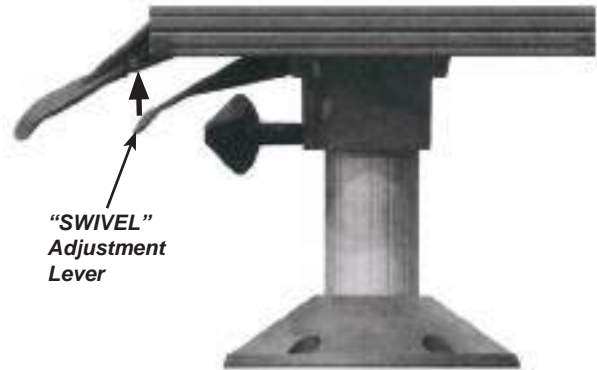

**Figure C27B: "Swivel" Lever - Release to Rotate
(Certain Models Only)**

The driver's side bucket seat and the port side bucket seat can swivel and face toward the stern of the boat. When pulling a water skier, this permits the spotter to be in the proper position to observe. Depending upon which model you have, the bucket seat(s) may be limited in the amount and direction of swivel possible.

To rotate the bucket seat to face inboard:

1. Tilt the steering wheel (if applicable) as far forward as possible.
2. Locate the "Slide" handle (See Figures C26A & C26B). Slide the seat either forward or rearward to clear the coaming/side pad or seat cushion. When at the desired position, release the handle and the slide will lock into position.
3. Locate the "Swivel" lever under the bucket seat. Lift upward on the lever to release the lock. This will allow you to rotate the seat. See Figures C27A & C27B).

4. Rotate the seat inboard (towards the center of the boat) until it faces as far aft as possible or desired. Once in position, release the lever. To lock, slightly rotate seat until handle clicks and hardware locks securely into position.

NOTICE

The bucket seats may or may not rotate completely 180°. The amount of bucket seat rotation may vary. The amount and direction of swivel available depends on the model you have and its placement in the boat.

NOTICE

When rotating the bucket seat, damage to seat, steering wheel (if applicable), and/or coaming pad may result if attempting to rotate in the wrong direction, over-rotating or failing to slide seat forward to clear coaming pad/side cushion. DO NOT USE FORCE to rotate the seat.

⚠ WARNING

After rotating, ensure seat is securely locked into position. Sudden acceleration with seat unlocked could cause loss of balance and possible injury.

⚠ WARNING

DO NOT sit on the backrest portion of any cockpit seat. The operator could lose control of boat or passengers could be thrown from boat. Also, the seat may be damaged from improper use.

C. Stern Cockpit Seating

U-shaped stern seating is available on certain models. Port and starboard stern cushions may be removed to access storage space below. The center stern backrest may be lowered to create an armrest for passengers occupying the center stern seat. This lowered position also makes for a walk-thru to the swim platform. See Figures C28 & C29.



Figure C28: Stern Cockpit Seating



Figure C29: Stern Cockpit Seating w/Armrest

D. Swim Platform Lounge Seating

Swim platform lounge seats make the swim platform the place to be when anchored. The port and starboard stern backrests may be hinged so they can be repositioned to create the backrest for the lounge seats. See Figure C30.



Figure C30: Swim Platform Lounge Seating

To reposition the backrests for swim platform lounge seating simply pivot the top of the backrest towards the bow. To return to the stern seating backrest position reverse the previous step. See Figure C31.



Figure C31: Adjustable Stern Backrest (Swim Platform Lounge Seating Position)

⚠ WARNING

Prevent falls overboard. Do not occupy swim platform or lounge seats while engine(s) is running.

E. Sun Pad

On certain Scarab models, a sun pad can be created at the stern of the boat creating multiple-piece cushion that runs the entire width (beam) of the boat at the

stern. The sun pad can be used for sunbathing and is great for observing activities at the swim platform. Again the port & starboard stern seat backrests with the specialized hinges are used along with the center stern backrest. See Figure C32.



Figure C32 Sun Pad

⚠ WARNING

Prevent falls overboard. Do not occupy swim platform or sun pad when engine is running and/or boat is moving. Stay inside cockpit (seated) while underway.

To create the sun pad:

- 1) Rotate the top of each backrest towards the bow to the Swim Platform Lounge Seating position (Figure C31).
- 2) Lift the backrest(s) straight up as far as it can go and rotate the backrest to the horizontal position.
- 3) Push backrest(s) aft until against the aft seat cushion(s).
- 4) Rotate the center stern seat backrest to the horizontal position in the same manner as describe in steps 1-3.

To reposition the backrest(s) for stern seating:

- 1) Lift the backrest(s) up and rotate towards the stern of the boat.
- 2) Lower the backrest(s) into its opening.
- 3) Reposition the backrest(s) to the vertical stern seat backrest position.

- 4) Reposition the center stern seat backrest to the vertical stern seat backrest position in the same manner as described in steps 1-3.

F. Motorhood - Engine Compartment Access

Access to the engine compartment is gained by raising the center stern seat/motorhood. The center stern seat/motorhood is hinged and utilizes gas-assist lifts or hydraulic supports to aid in raising the center stern seat. These gas-assist lifts also keep it in the raised position when maintaining the engine. While these gas-assist lifts ease the amount of force necessary to manually lift or lower the center stern seat cushion(s), a certain amount of effort is still necessary. See Figure C33.



Figure C33: Raised Center Stern Seat - Engine Compartment Access - Models May Vary

To raise the center stern seat/motorhood.

Release the latch and with both hands placed underneath the center seat cushion(s), lift upward to the raised position.

NOTICE

Never operate or trailer your boat with the center stern seat in the raised position. Doing so could result in damage to the center stern seat, hardware, and/or loss of cushions.

To close the center stern seat/motorhood:

With both hands placed on top of the center seat cushion(s), apply an even downward force to close.

NOTICE

Placing an uneven force on the center stern seat may make closing more difficult. Possible damage to one or more of the gas-assist supports could also result.

D - 1 PRE-CRUISE INSPECTION **WARNING**

This boat may exceed the performance of other boats you may have driven in the past. Take time to familiarize yourself with your new boat.

 **WARNING**

The pre-cruise inspection is very important before operating the boat. Bring all safety equipment required by local laws. Perform a pre-cruise inspection before each ride to detect potential problems during operation. The pre-cruise inspection can help you monitor wear and deterioration before they become a problem. Correct any problems that you discover to reduce the risk of a breakdown or accident. See an authorized Scarab dealer if necessary.

Note: Pre-cruise inspection should be conducted daily at the first start up.

A. Before Starting the Engine

1. Inspect the hull for damage. Clean as required. Excessive dirt or marine growth will effect your boat's performance and fuel efficiency.
 2. Inspect jet pump water intakes. Remove any blockages.
 3. If your boat has been out of the water, check to see that all bilge water has drained out. Install hull drain plugs.
 4. Check all deck hardware to include tower and bimini top (if applicable) for serviceability. Tighten fasteners as needed.
 5. Open engine compartment. Inspect for fuel odors and visible leaks in the fuel, oil, coolant, and exhaust systems. Visually inspect engine(s) for cracked hose, defective belts, or other signs of potential engine problems. If problem exists contact your Scarab dealer immediately. Do not start engine until issue is corrected. Check engine oil, coolant and battery water levels. Check battery electrolyte range.
 6. If your boat has been in the water, Check the bilge water level and bilge pump operation. Run the bilge pump until the flow of water stops.
 7. Operate the bilge blower for at least four (4) minutes before engine start-up. Check the blower output.
-  **WARNING**
- Gasoline vapors can explode resulting injury or death. Before starting the engine, check engine compartment bilge for gasoline or vapors. Operate blower for four minutes, and verify blower operation. ALWAYS run the blower when the vessel is operating below cruising speed.*
8. Check fuel level. Fuel tank(s) should be filled to slightly less than capacity. Allow for fuel expansion.
 9. Check the operation of the electrical system and navigation lights.
 10. Check operation of steering system, control lever and operation of horn.
 11. Be sure all necessary safety equipment is on board and in good working condition. Examples include personal flotation devices (PFDs), horn, fire extinguisher, visual distress signals, etc. Take along extra drinking water. A Boating Safety Checklist from the American Boat and Yacht Council (ABYC) has been included at the front of this manual to assist you with having the necessary safety items on board your boat.
 12. Check that other important equipment is on board. Examples include mooring lines, anchor and line, boat hook, tool kit, first aid kit, etc.
 13. Make sure passengers and crew know what to do in case of an emergency and how to operate safety equipment.
 14. Always keep accurate up-to-date charts of your boating area on board. Make sure navigational equipment is on board and functioning properly.
 15. Make sure all required documents are on board.

16. File a float/trip plan with a responsible party ashore. A copy of a float plan has been included at the back of this manual.
17. Keep an eye on the weather. Get a current weather report. Determine if the cruise planned can be made safely. Be aware of possible changing conditions by monitoring local weather broadcasts prior to departure. If the weather will not be favorable, postpone your trip. The captain or first mate should personally monitor strong winds and electrical storms.

B. After Starting the Engine

1. Check operation of engine ignition (starting and stopping).
2. Verify engine emergency shut-off switch operation. Be sure engine stops when the switch clip (attached to lanyard) is pulled from the switch.
3. Visibly check the engine to be sure there are no apparent water or oil leaks.
4. Check the instrument gauges. Make sure the oil pressure, engine temperature, battery, etc., are reading normally.

D - 2 FUELING

WARNING

Do not smoke; extinguish all open flames, STOP all engines and other devices that could cause sparks, including the bilge blower. Do not use electrical switches or accessories. Shut OFF all stoves that may produce a spark or flame. Close all openings into the cabin area of the boat.

A. Recommendations

WARNING

When fueling or having your boat fueled by an attendant, be sure the waste pump-out or fresh water fitting is not mistaken for the gas fill.

Although alcohol boosts the octane level of gasoline, it also attacks the rubber fuel distribution lines and even metal fuel system components. Alcohol will permeate most fuel hoses and other components such as fuel

pump, gaskets and seals, and can also contribute to fuel system contamination.

The hoses we use in our boats are alcohol-resistant as are the materials used by the engine manufacturers. If only fuel containing alcohol is available, or the presence of alcohol is unknown, you must perform more frequent inspections for leaks and abnormalities. Any sign of leakage or deterioration requires your immediate attention. Refer to the engine manufacturer's recommendations on fuel type and octane ratings.

B. Preliminary Guidelines

1. Safely secure your boat to the dock.
2. Close all hatches, windows, doors and compartments to prevent accumulation of fuel vapors.
3. Ensure that a fire extinguisher is readily available.
4. Do not store fuel in areas that are not adequately ventilated.
5. Use only fuel lubricants recommended by the engine manufacturer.

C. Pumping Fuel

WARNING

Follow engine manufacturer's recommendations for types of fuel and oil. Use of improper products can damage the engine and void the warranty.

1. Be sure to fuel in a well-lit area; gasoline spills are unnoticeable under poor lighting or in the dark.
2. Open the gas fill cover.
3. Insert the fuel supply nozzle, keeping it in contact with the fuel fill plate to guard against static produced sparks.
4. Stand away from the fuel tank gas fill/vent during fueling. Splash back may occur and can be an eye irritant and/or a fire hazard.
5. Avoid spillage. Wipe up any excess fuel immediately.
6. After pumping approximately 10 gallons of fuel into the fuel tank, inspect the engine and fuel tank

area for any signs of leakage. If no leaks or other problems are detected, resume fueling.

7. Allow space at the top of the tank for thermal expansion.
8. If fuel cannot be pumped in at a reasonable rate, check for fuel vent blockage or a kink in the line.

D. After Fueling

1. Close and secure the gas fill cover and wipe up any fuel spilled. Discard rags used in a safe place ashore.
2. Open the engine compartment and other compartments that were closed during fueling. Inspect these areas for the odor of fuel vapors and visible fuel leakage.

 **WARNING**

Investigate and correct any sign of fuel leakage or indication of vapors before starting engine. Do not run blower or operate any electrical switch until problem is corrected. Fire or explosion may result.

D - 3 LOADING OF PASSENGERS & GEAR

NOTE: All boats under 20 feet in length must have a capacity rating plate showing the recommended person capacity as well as the maximum capacity of the boat including persons and gear.

When loading your boat, remember to distribute the load evenly. Keep the load low and do not overload. The capacity label affixed to your boat states the maximum load capacity. The plate shows in pounds,

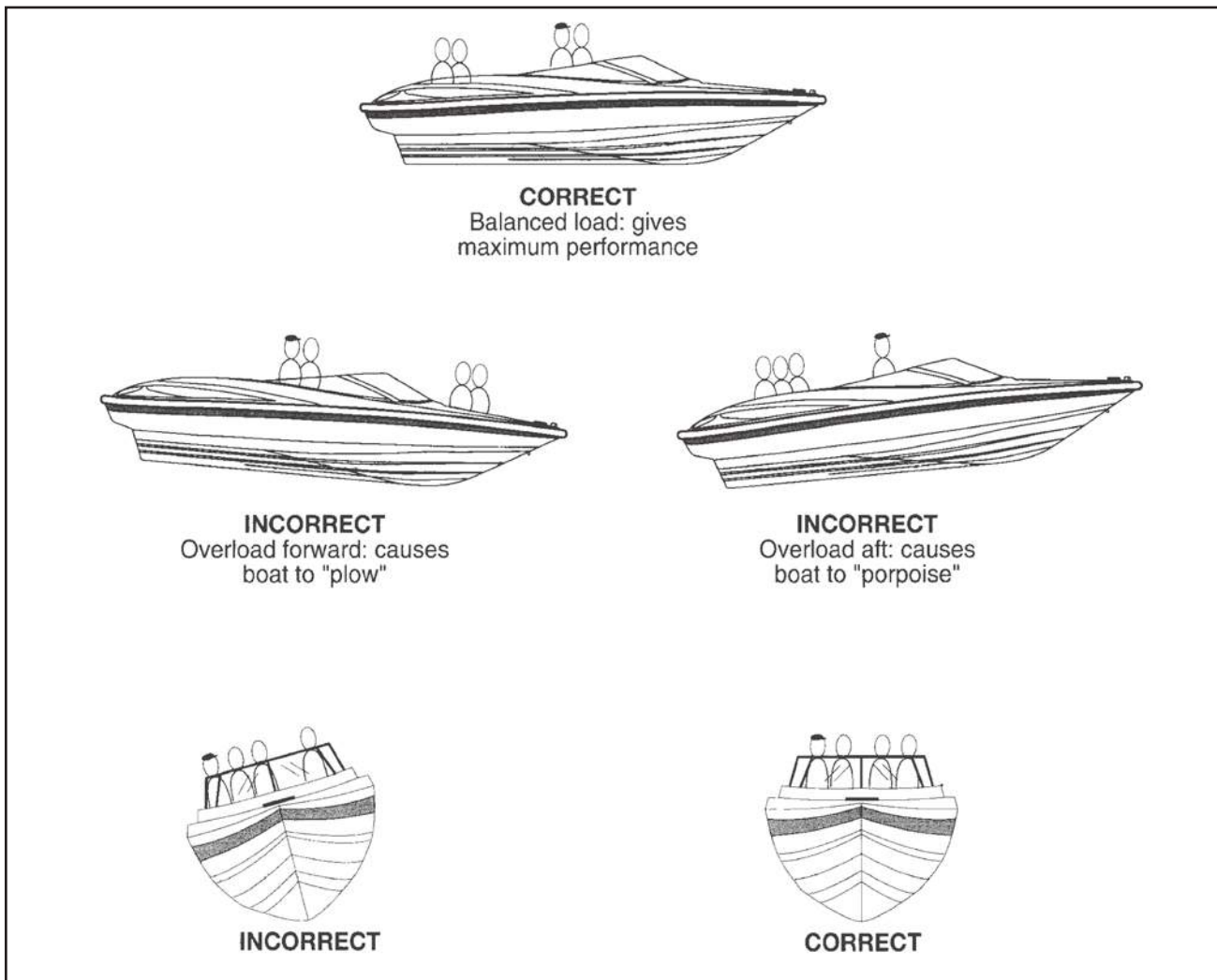

Figure D1: Loading Passengers and Gear



the amount of persons and gear that the boat will safely handle under normal conditions. US Coast Guard regulations establishes these load capacity ratings. Position passengers and gear so that the load is balanced. See the Person Capacity & Underway Seating Position label at the helm for passenger placement and Figure D1.

NOTICE

An unbalanced load will hinder the boat's ability to track in a straight line especially at low speed. Position passengers and gear so that the load is balanced.

When loading, always step into the boat, never board by jumping. Have someone on the dock pass your gear aboard. Secure all gear firmly so it doesn't move or interfere with operation of the boat. Passengers should board the boat one-at-a-time and be seated. Passengers should remain seated during loading of the boat to maintain an even trim.



WARNING

Passengers seated in the bow area should not obstruct the driver's vision.

On certain Scarab models, seating in the center bow seat is prohibited when underway due to a potential falling hazard. See the following warning. This warning label is also placed at the center bow seat location of the respective boat.



WARNING

Falling Hazard. Falling on the deck or overboard can cause injury or death. Do not sit here when boat is underway.

IMPORTANT: Passengers are prohibited from riding on the bow with feet hanging over the side or ride while sitting on the stern, gunwales or seat backs. The Coast Guard considers these acts to be negligent or grossly negligent operation. They are prohibited by law because falls from moving boats are a major cause of fatal recreational boating accidents.

IMPORTANT: The presence of the capacity label does not relieve the boat operator from the responsibility of using common sense or sound judgment. Turbulent waters and adverse weather conditions will reduce the maximum load capacity rating of the boat.

D - 4 STARTING PROCEDURES

Notice: Refer to your engine owner's manual. The operation and maintenance manual supplied with your engine provides pre-start, starting and cold-starting instructions. The following information is merely a guide and not intended to explain in detail all starting procedures and instructions. Refer to your engine owner's manual.

A. Preliminary Checks

1. Secure boat to the dock before attempting to start engine. The boat should be kept secure until the engine is running and warmed up.
2. Operate the bilge pump until the flow of water stops.
3. Check all electrical systems and navigation lights.
4. Make sure the throttle is in the neutral position.
5. Make sure passengers seated in the bow area do not obstruct the driver's vision.

B. Before Starting

1. Check the engine compartment for water, gas, and/or oil leaks of any kind. Keep the bilge in a clean condition to prevent blower and bilge pump damage, and fire hazards.
2. Check the fluid levels of the engine oil and coolant. Fill oil and or coolant as required by the indications on the dip stick or level indicator on the reservoir. Refer to your engine manual included in the owner's packet. Follow engine manufacturer's recommendations.

NOTICE

IMPORTANT: Lubrication requirements for catalyzed engines differ from the requirements for non-catalyzed engines. Some marine-grade lubricants contain high levels of phosphorus, which can damage the catalyst system. Although these high phosphorus lubricants may allow acceptable engine performance, exposure over time will damage the catalyst. Catalysts damaged by lubricants containing high levels of phosphorus may not be covered by the engine manufacturer's warranty.

3. Start and operate the bilge blower system for at least four (4) minutes before every start-up.

4. Make sure the jet pump water intakes are under the water.

C. Starting

 **WARNING**

Before starting the engine, the operator and passengers should always be properly seated. Do not allow swimmers and passengers to stay close to the propulsion system.

NOTICE

Starting the engine or riding the boat in shallow water may damage the impeller or other jet pump components.

 **DANGER**

To prevent excessive exposure and reduce the possibility of carbon monoxide accumulation in the cockpit the operator should be prepared to cast off quickly. See Section A-11 for information about the dangers of Carbon Monoxide.

1. If your boat is equipped with a battery switch, turn the battery switch to I (ON) position (positions may vary depending on which model you have).
2. The driver **must always** attach the emergency engine shut off lanyard(s) securely to his or her body. In the event that you move away from the helm area and beyond the length of the lanyard, the engine will be turned off.
3. Move the control handle to neutral detent (idle) position. The position of the control handle is typically in the center or straight up position of the control. See Figures D2 & D3. Notice as you push the shifter control to the neutral position you will feel the neutral detent engage thus indicating you are in neutral. Note: A “start-in-neutral-only” feature prevents starting the engine while in gear.

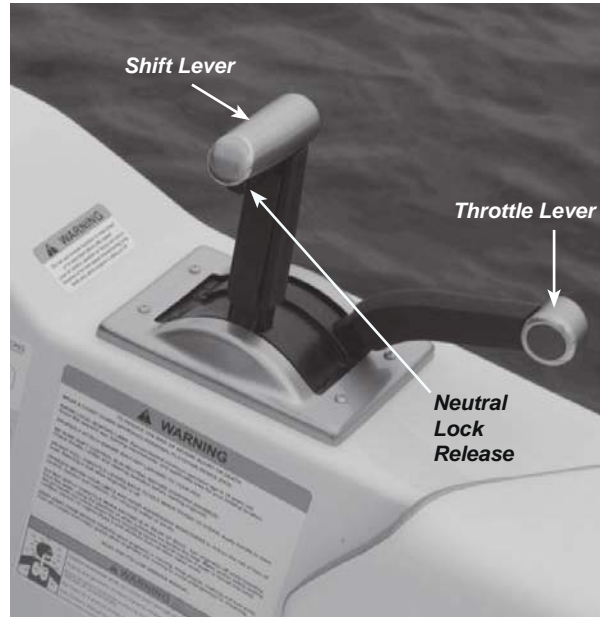

Figure D2: Separate Shift & Throttle Control
Note: Shift Lever in Neutral & Throttle Lever in Idle Position

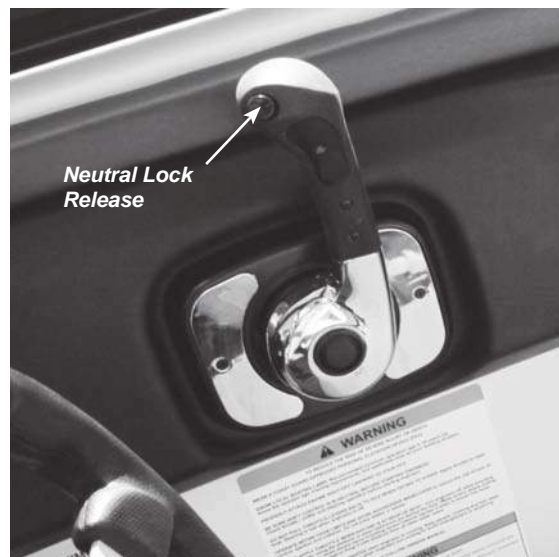

Figure D3: Throttle/Shift Control in Neutral/Idle Position

4. Turn the key switch to start and hold until engine starts, for no longer than 5 seconds. If engine does not start, let go momentarily, then try again. Note: You may need to jiggle the control lever a bit to ensure the neutral detent is engaged.

NOTICE

To avoid starter motor overheating, the cranking period should not exceed 5 - 10 seconds and a rest period of 30 seconds should be observed between cranking cycles to let the starter cool down and its mechanism disengage.

5. As soon as engine starts, release key and it will automatically turn to the ON/RUN position.
6. Check steering operation. Turn steering wheel full to port and starboard while observing jet nozzle(s) movement.
7. After starting the engine and before engaging the throttle/shifter, the operator must ensure the jet nozzle is in the "straight ahead" position.

Steps to center the jet nozzle ("straight ahead" position):

- a. Rotate the steering wheel all the way in one direction.
- b. Rotate the steering wheel all the way back in the opposite direction, counting the number of revolutions of the wheel as you do this.
- c. Lastly, rotate the wheel back again in the opposite direction half as many revolutions as it took to go completely in the other direction.

WARNING

Prevent possible man-overboard situations. Scarab jet boats are equipped with an extremely responsive steering and propulsion system. Ensure jet nozzle is in the "straight ahead" position before engaging throttle/shifter.

8. Check tachometer to monitor engine rpms.
9. Once engine has warmed up, check to see if high temperature warning message code is displayed. If not displayed the engine temperature is staying within optimum range. If warning message is displayed, stop engine immediately and inspect for cause of high reading.
10. With engine running, verify that no high or low voltage code is displayed. No message code indicates that the battery is in good condition.

11. Inspect for fuel odors and visible leaks in the fuel, oil, coolant, and exhaust systems.
12. Make sure boat is securely moored to the dock and engine is idling. Then move the throttle forward and then aft and back to neutral to check for proper operation of the shifting motion. Be careful. Leave the engine in gear for only a split-second.

D - 5 CONTROL OPERATIONS

NOTICE

The control information included in this section is general only. For specific operation of the controls on your boat, refer to the control manufacturer's literature and engine manufacturer's literature included in your owner's packet. Ensure you completely understand the operation of the controls before operating your boat. Also consult your dealer should any questions arise regarding the operation of the control unit.

A. Maneuvering of the Separate Shift & Throttle Control

Shifting and engine speed are controlled with the separate levers. See Figure D4.

- N** - When the shift handle is in neutral position, the impeller is turning. Reverse gate will be in the middle position, directing half of the thrust toward the front of the boat to minimize movement.
- F** - Gate positioned for forward movement (ahead).
- R** - Gate positioned for backward movement (astern).
- T** - Engine speed control.



Figure D4: Separate Shift & Throttle Control Operation

B. Shifting and Control Speed - Separate Shift & Throttle Control

1. Move shift lever to the neutral position and Place the throttle lever in the idle position. See Figure D5. Placing the shift lever in neutral detent position and throttle lever in the neutral position will engage neutral start switch and allow engine to start.

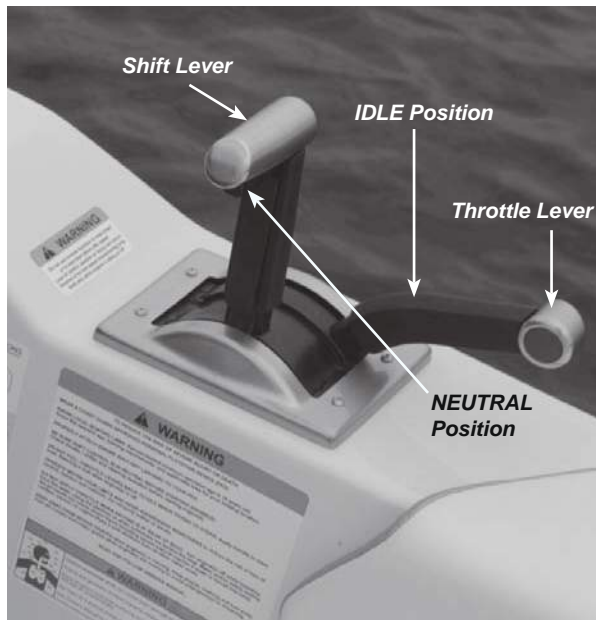

Figure D5: Separate Shift & Throttle Controls Neutral & Idle Positions

NOTICE

On models with separate shift and throttle controls, the throttle lever will not move from the idle position until the shift lever has been placed in either forward or reverse gear.

NOTICE

For additional information, refer to the section on “Starting and Operation” in the engine manufacturer’s manual.

CAUTION

DO NOT shift into FORWARD or REVERSE unless engine is running. Damage to the shift system could result from trying to shift without the engine running. Carefully check function of all control and engine systems before leaving the dock.

2. To go FORWARD - actuate the neutral lock release mechanism and move the shift lever forward. Once forward gear engagement is complete, push throttle lever forward until desired speed is achieved.
3. To go in REVERSE - actuate the neutral lock release mechanism and move the shift lever rearward. Once rearward gear engagement is complete, push throttle lever forward until desired speed is achieved. See the following reverse notifications.

WARNING

Always ensure the path behind the boat is clear of people and objects before going into reverse.

NOTICE

To obtain maximum efficiency and control from the reverse, increase engine speed to slightly above idle. Too much RPM will create water turbulence and reduce reverse efficiency.

The boat behaves differently when using reverse. At first outing, carefully practice this maneuver away from anything with which you might collide.

WARNING

Become fully familiar with the reverse operation during your first ride and before carrying passengers.

WARNING

DO NOT shift from forward to reverse when the boat is planing.

4. To go from FORWARD to REVERSE, or REVERSE to FORWARD; always pause at NEUTRAL and allow engine speed to return to idle.
5. After shifting is completed, slowly push the throttle lever forward until desired speed is achieved.

WARNING

Any time the boat is operated, be aware of changes in shift system operation. A sudden increase in shift effort of the shifter lever, or other abnormal operation, indicates a possible problem in the shift system. If this occurs, the following precautions must be taken:

- With engine running and boat securely tied to the dock, shift drive into forward and reverse to ensure there is gear engagement. Shifting in gear should be for a split-second only and then return to neutral.
- When docking the boat, all docking maneuvers must be performed at slow speed. Pay special attention to other boaters. Passengers should be informed of potential problems and precautions taken.

If you suspect there is a problem, see your certified engine dealer as soon as possible for proper diagnosis and required service or adjustment. Continued operation could result in damage to the shift mechanism and loss of control.

C. Stopping Engine

1. Move shift lever to the NEUTRAL position. Move throttle lever to the IDLE position.
2. Turn ignition key to the OFF position.

WARNING

Should the engine be shut off, boat directional control is not available. Never leave the key in the ignition and the cord connected to the engine cut-off switch when boat is not in operation to avoid unauthorized use by children or theft.

NOTICE

DO NOT stop engine at speeds above idle or "speed up" engine while turning off ignition. Engine damage could result.

Should the boat be left unattended, be sure to remove the key from the ignition to avoid possible unauthorized use or theft.

D. Maneuvering of the Side-Mount Control

Shifting and engine speed are controlled with the same lever (1). See Figure D6.

- N** - When the shift handle is in neutral position, the impeller is turning. Reverse gate will be in the middle position, directing half of the thrust toward the front of the boat to minimize movement.
- F** - Gate positioned for forward movement (ahead).
- R** - Gate positioned for backward movement (astern).
- T** - Engine speed control.

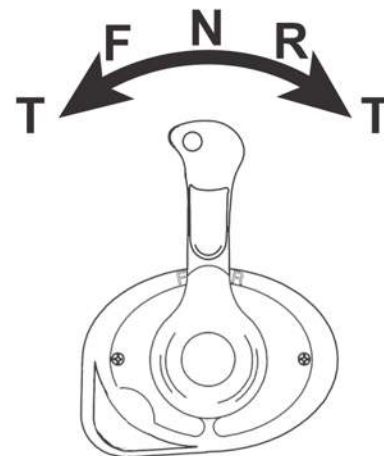

Figure D6: Side-Mount Control Operation

E. Shifting and Control Speed - Side-Mount Control

1. Move shift/throttle lever to the neutral idle position. Placing the shift/throttle lever in the neutral detent position will engage neutral start switch and allow engine to start.

NOTICE

For additional information, refer to the section on "Starting and Operation" in the engine manufacturer's manual.

CAUTION

DO NOT shift into FORWARD or REVERSE unless engine is running. Damage to the shift system could result from trying to shift without the engine running. Carefully check function of all control and engine systems before leaving the dock.

2. To go FORWARD - actuate the neutral lock release mechanism and move the shift/throttle lever forward. Once forward gear engagement is complete, push shift/throttle lever forward until desired speed is achieved.
3. To go in REVERSE - actuate the neutral lock release mechanism and move the shift/throttle lever rearward. Once rearward gear engagement is complete, pull shift/throttle lever rearward until desired speed is achieved. See the following reverse notifications.

WARNING

Always ensure the path behind the boat is clear of people and objects before going into reverse.

NOTICE

To obtain maximum efficiency and control from the reverse, increase engine speed to slightly above idle. Too much RPM will create water turbulence and reduce reverse efficiency.

The boat behaves differently when using reverse. At first outing, carefully practice this maneuver away from anything with which you might collide.

WARNING

Become fully familiar with the reverse operation during your first ride and before carrying passengers.

WARNING

DO NOT shift from forward to reverse when the boat is planing.

4. To go from FORWARD to REVERSE, or REVERSE to FORWARD; always pause at NEUTRAL and allow engine speed to return to idle.
5. After shifting is completed, slowly push shift/throttle lever forward/rearward until desired speed is achieved.

WARNING

Any time the boat is operated, be aware of changes in shift system operation. A sudden increase in shift effort of the shifter lever, or other abnormal operation, indicates a possible problem in the shift system. If this occurs, the following precautions must be taken:

- *With engine running and boat securely tied to the dock, shift drive into forward and reverse to ensure there is gear engagement. Shifting in gear should be for a split-second only and then return to neutral.*
- *When docking the boat, all docking maneuvers must be performed at slow speed. Pay special attention to other boaters. Passengers should be informed of potential problems and precautions taken.*

If you suspect there is a problem, see your certified engine dealer as soon as possible for proper diagnosis and required service or adjustment. Continued operation could result in damage to the shift mechanism and loss of control.

F. Stopping Engine

1. Move control handle to the NEUTRAL position.
2. Turn ignition key to the OFF position.

WARNING

Should the engine be shut off, boat directional control is not available. Never leave the key in the ignition and the cord connected to the engine cut-off switch when boat is not in operation to avoid unauthorized use by children or theft.

NOTICE

DO NOT stop engine at speeds above idle or "speed up" engine while turning off ignition. Engine damage could result.

Should the boat be left unattended, be sure to remove the key from the ignition to avoid possible unauthorized use or theft.

D - 6 DIGITAL SPEED CONTROLS

A. General

The following descriptions and images depict a single engine Digital Speed Controls features and switch locations. The Digital Speed Controls for twin engines follow the same procedures as well as having the same features. Switch locations do vary. Certain Digital Control features may be optional.

NOTE: These operating modes do not resume if engine was stopped

B. Cruise Mode

WARNING

It is not recommended to use the CRUISE mode when pulling a tube, skier or wakeboarder. Maintain your speed manually or use the SKI MODE.

CRUISE mode is a function of DSC (Digital Speed Control) system that allows to maintain a steady speed while riding the boat. It will prevent the boat from going above a set speed limit. This is useful when cruising for long distances or operating in limited speed zones.

NOTICE

The boat speed may vary slightly depending on the weather or water conditions such as the wind or waves.

The CRUISE mode is designed to be used for prolonged drives on open waters.

WARNING

Improper use of the CRUISE mode can lead the boat to a loss of control.

1. Cruise Mode Limitations

The CRUISE mode is not an automatic pilot, it will not drive the boat. The CRUISE mode does not anticipate for obstacles, other users, objects, etc, and will not steer or stop the boat.

2. Setting the Cruise Mode

NOTE: To use the CRUISE mode, the boat speed must be above approximately 10 km/h (6MPH).

To activate the CRUISE mode:

- a. Using the throttle/shifter lever or throttle lever, bring the boat at the speed you want to maintain.
- b. Press MODE button repeatedly until CRUISE mode is displayed. See Figures D7, D8 & D9.

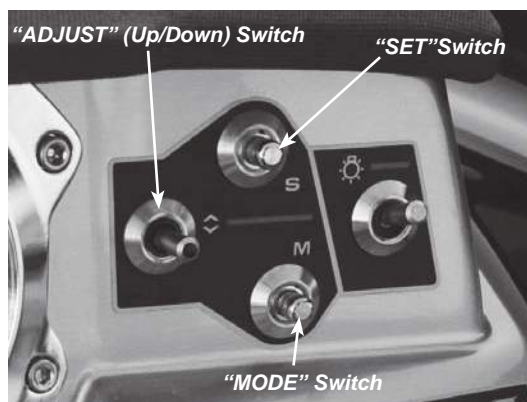

Figure D7: Digital Speed Control Switch

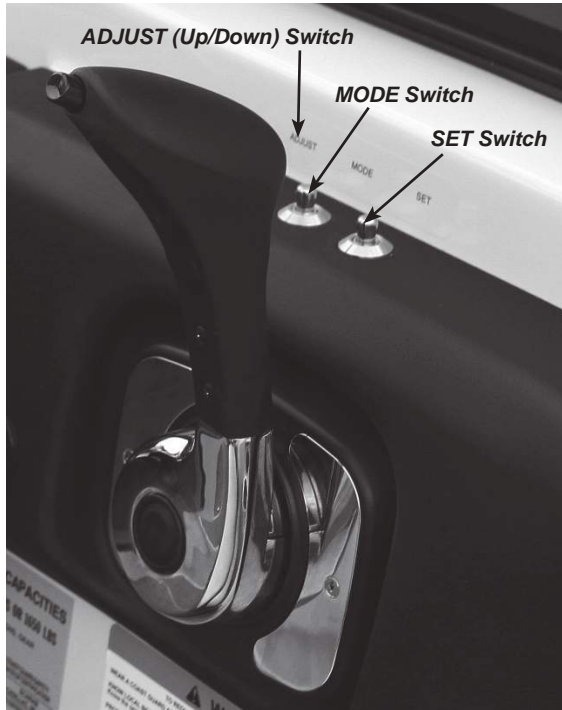

Figure D8: Digital Speed Control Switches - Armrest



Figure D9: CRUISE MODE Displayed

- c. Press the SET button once, the following message will be displayed "HOLD SET TO ACTIVATE OR MODE TO EXIT".
- d. Hold the SET button until CRUISE mode reappears. At this time, the CRUISE light blinks and you hear one short beep.
- e. Slightly move throttle/Shifter lever or throttle lever forward until CRUISE light turns ON and activates the CRUISE mode.

3. Temporarily Deactivating the Cruise Mode

- a. To deactivate the CRUISE mode temporarily, move the throttle/shifter lever or throttle lever backward.
- b. To reactivate the CRUISE mode, push throttle/shifter lever or throttle lever forward or until the light turns ON again.

4. Cancelling the Cruise Mode

To cancel the CRUISE mode, move the throttle/shifter lever or throttle & shift levers to NEUTRAL/IDLE position(s) and press the MODE button twice. Two short beeps will be heard.

C. Ski Mode

Ski Mode allows the driver to adjust launch intensity and set target speeds for different rider skill levels and tow sports while maintaining a constant speed.

The Ski Mode offers five acceleration curves with the slowest at RAMP 1 increasing to setting RAMP 5. For each RAMP, a predetermined speed range is available.

<u>RAMP</u>	<u>APPROXIMATE SPEED</u>
1	6 MPH to 22 MPH (10 km/h to 35 km/h)
2	9 MPH to 28 MPH (15 km/h to 45 km/h)
3	12 MPH to 34 MPH (20 km/h to 55 km/h)
4	19 MPH to 40 MPH (30 km/h to 65 km/h)
5	25 MPH to 42 MPH (40 km/h to 67 km/h)

1. Ski Mode Limitations

The Ski Mode is not an automatic pilot, it will not drive the boat. Always leave your hand on the throttle and keep an eye on the water ahead. Pull back throttle to neutral to stop the boat (the Ski Mode immediately disengages - setting boat control on manual).

2. Setting the Ski Mode

- a. To activate the SKI MODE (if equipped), press MODE button until SKI MODE is displayed. See Figure D10.



Figure D10: SKI MODE Displayed

- b. Press the SET button once to enter SKI MODE. The RAMP indication will be displayed. See Figure D11.



Figure D11: RAMP Displayed (Ski Model)

- c. Using the ADJUST (Up and Down) switch, select the appropriate RAMP.
- d. Press SET button to accept the selection.
- e. Now determine the target speed using ADJUST (Up and Down) switch. See Figure D12.



Figure D12: TARGET SPEED Displayed (Ski Mode)

- f. Press SET button to confirm the speed. The indication SKI MODE will be displayed with the determined speed. See Figure D13.



Figure D13: SKI MODE Displayed (w/Target Speed)

- g. Press the SET button again to activate the launch sequence. At this time, the SKI MODE light blinks.

NOTE: In the launch sequence mode, the first 95% of throttle/shifter lever travel is used to position the boat and stretch the cord without engaging the SKI MODE.

- h. When everybody is ready (operator, watcher and skier, tube rider or wakeboarder), push the throttle/shifter lever or throttle lever to full throttle position. The SKI MODE will be activated and the light turns ON.

3. Temporarily Deactivating the Ski Mode

- a. To deactivate the SKI MODE temporarily, move the throttle/shifter lever to the NEUTRAL position or move the throttle lever to IDLE and shift lever to NEUTRAL and press the MODE button to return to step 7 of SETTING THE SKI MODE. All of the throttle/shifter lever or the shift lever and throttle lever travel can be used without restriction. The SKI MODE light will blink again and a beep will be heard every 3 seconds.
- b. To reactivate the SKI MODE, place the throttle/shifter lever to NEUTRAL position move the throttle lever to IDLE and shift lever to NEUTRAL and press the SET button to return to step 8 of SETTING THE SKI MODE.

4. Cancelling the Ski Mode

To cancel the SKI MODE, move the throttle/shifter lever to NEUTRAL position or move the throttle lever to IDLE and shift lever to NEUTRAL and press the MODE button twice.

D. ECO Mode

The ECO mode optimizes fuel efficiency by limiting engine torque.

1. Setting the ECO Mode

- a. To engage the fuel economy mode, press MODE button repeatedly until ECO MODE is displayed. See Figure D14.



Figure D14: ECO MODE Displayed

- b. Press the SET button once, the following message will be displayed ECO MODE - PRESS SET to activate or MODE to exit.
- c. Press and hold the SET button until ECO MODE reappears. To confirm the ECO mode, the symbol ECO is displayed on the LH of the smiling fuel tank. See Figure D15.

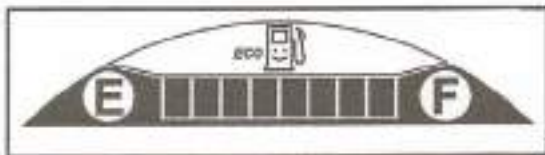

Figure D15: ECO MODE Confirmed Displayed

2. Cancelling the ECO Mode

To cancel the fuel economy mode, move throttle/shifter lever in NEUTRAL position or move the throttle lever to IDLE and shifter lever to NEUTRAL Press the MODE button.

E. Docking Mode

The docking mode limits engine power for increased maneuverability while docking.

1. Setting the Docking Mode

- a. To select this mode, reduce throttle speed to idle.
- b. Press the MODE button repeatedly until DOCKING is displayed in the information center. See Figure D16.



Figure D16: DOCKING MODE displayed

- c. Press the SET button once, the following message will be displayed: PRESS AND HOLD SET BUTTON.
- d. Press and hold the SET button until DOCKING reappears.
- e. The docking mode is now activated and the information center returns to main display.

2. Cancelling the Docking Mode

- a. To cancel this mode, press the MODE button repeatedly until DOCKING is displayed in the information center.
- b. Press the SET button once, the following message will be displayed PRESS AND HOLD SET BUTTON.
- c. Press the MODE button once. The DOCKING mode will turn OFF right after the throttle/shifter lever is placed in NEUTRAL position or when the throttle lever is moved to IDLE and shifter lever is moved to NEUTRAL position.

NOTE: This mode is cancelled automatically when engine(s) are turned off.

D - 7 STEERING OPERATION

Turning the steering pivots the jet pump nozzle(s) which controls the boat direction. Turning the steering wheel clockwise will turn the boat to the right and inversely. Above idle speed, throttle must be applied to turn the boat.

WARNING

Throttle must be applied and steering turned to change the direction of the boat at speed. Steering efficiency will differ depending on the number of passengers, load and water conditions.

Hint: Before beginning your cruise it is a good idea to know where your jet nozzle(s) is at. To position your jet nozzle in straight forward position (centered) rotate your steering wheel to the full left turn or right turn position. Once at full left or right turn position count how many complete revolutions it takes to turn the steering wheel to get to the opposite full turn position. Then turn your steering wheel back half the amount of revolutions and your jet nozzle should be centered.

A jet propelled boat needs some throttle applied in order to turn. Practice in a safe area applying the throttle and turning away from an imaginary object. This is a good collision avoidance practice

D - 8 MANEUVERING

WARNING

Boat steering is not self-centering. Steering is effected by wave and current action and the speed of the hull through the water. Constant attention to steering is required for safe operation.

When all your pre-departure checks have been completed and the engine has warmed up, you will be ready to leave the dock. Take into account the amount of wind, tide current, and other forces that may affect your maneuvering as you leave the dock. Idle speeds work best when maneuvering to and from the dock. Do not forget to release the mooring lines.

A. Leaving the Dock

You are ready to leave the dock after the engine has warmed up. Check the center instrument gauge. Ver-

ity there are no message codes displayed (after the 3-second initialization) before casting off. If a message code is displayed be sure to remedy the cause prior to leaving the dock. Check for fuel, oil, and exhaust leaks. Correct the cause of any abnormal condition before getting underway.

WARNING

Make sure passengers sitting in the bow area do not obstruct the operator's vision when casting off or while underway.

After making sure your boat is ready, check wind, tide, current and other forces that will affect the way you maneuver your boat away from the dock. Throw mooring lines off to your boat. Shift your boat's engine into forward or reverse depending on whether you want to move the bow or the stern away from the dock first. Run your engine at a slow speed as you move away from the dock. If you move the bow out first, watch that the stern of the boat does not swing into the dock or a piling.

Once away from the dock, devote some time to learning how to maneuver. Practice docking using an imaginary dock. Practice stopping and reversing.

NOTICE

To obtain maximum efficiency and control from the reverse, increase engine speed to slightly above idle. Too much RPM will create water turbulence and reduce reverse efficiency.

NOTICE

A boat will not respond to steering in reverse nearly as well as it does when going forward, so do not expect to accomplish tight turning maneuvers when backing up.

B. Stopping

Boats have no brakes. Stopping is accomplished by backing down on the throttle. Practice stopping maneuvers and learn early how your boat reacts. From forward motion, pull the throttle back towards NEUTRAL. Depending on your speed, the distance the boat travels until it comes to a complete stop will vary. The ability to measure the distance **will only be acquired through experience.**

Once the boat has slowed and motor is idling, place the shift in REVERSE. Gradually increasing reverse power with the throttle.

 **WARNING**

Do not use reverse function to slow down or to stop boat above idle speed. Loss of control, ejection or injury can occur. Reverse is for low speed maneuvering only. Shift only while engine is idling.

Remember that all boats steer by the stern (the feeling is much like steering your automobile in reverse). This means that the stern of your boat will swing in the direction opposite to your turn. For example, when you turn the helm wheel to the left, the stern of your boat will swing in the direction opposite to your turn. This is especially important to keep in mind when docking, operating in close quarters with other boats, or when approaching a swimmer or downed skier in the water.

Always look behind you and to both sides of the boat before slowing down. Tell your passengers your intentions to allow them time to make adjustments to their balance or positions.

Slowly pull back on throttles, glance back and see if a large following wave is approaching the transom. If so give the engines a little throttle as the wave arrives to keep wave from rolling over the transom.

D - 9 PRACTICE MANEUVERS

It is always a good idea to practice and get familiar with all controls, functions and handling characteristics of your boat before venturing on the water.

Always secure the tether cord to the engine shut-off switch and the clip to your PFD or a wrist strap.

A. Where to Practice Exercises

Find a suitable area to practice the exercises. Ensure the area meet the following requirements:

- No traffic
- No obstacles
- No swimmers
- No current
- Ample space to maneuver
- Water depth is adequate.

B. Practice Exercises

Practice alone the following exercises.

1. Turning

Practice turning in circles in both directions at slow speed. When comfortable with the exercise, increase difficulty by making some figure 8s. When this is mastered, repeat the above exercises but at increased speed.

2. Stopping Distances

Practice stopping the boat in a straight line at different speeds. Remember, water drag is the main factor which reduces the boat speed and thus the stopping distance.

NOTICE

The boat speed, load, current and wind also play an important role in affecting stopping distances.

 **WARNING**

Do not use the reverse to stop.

3. Reverse

Practice reverse operation to learn how the boat operates in reverse and reacts with steering inputs.

NOTICE

Always perform this exercise at slow speeds.

4 Avoiding an Obstacle

Practice to avoid an obstacle (choose a virtual point on the water) by steering boat and maintaining throttle.

Repeat exercise, but this time release throttle while turning.

NOTICE

With this exercise, you will learn that you need throttle to steer the boat in a different direction.

Collision Avoidance - Techniques to Remember:

- Do not decrease throttle when trying to steer away from objects. You need throttle to steer.
- Always keep a constant lookout for other water users, other craft or objects, especially when turning. Be alert for conditions that may limit your visibility or block your vision of others.
- Respect the rights of others and always keep a safe distance from all other craft, people and objects.
- Do not wake or wave jump, ride the surf line or attempt to spray or splash others with your boat. You may misjudge the ability of the boat or your own driving skills and strike a boat or person.
- This boat has the capability of turning more sharply than other boats. However, unless in an emergency, do not negotiate sharp, high speed turns. Such maneuvers make it hard for others to avoid you or understand where you are going. Also, you and/or your passenger(s) could be ejected from the boat.
- This boat has no brake. Stopping distance will vary depending on initial speed, load, wind, and water conditions. Practice stopping and docking in a safe, traffic free area to have an idea of how long it will take to stop the boat under various conditions.
- Maintaining or increasing speed may be necessary to avoid a collision

5. Docking

If your boat has the Docking Mode, it is also important to understand its operations and get familiar with it prior to using it on a ride with other people.

Practice docking using the throttle and shift lever along with the steering to become familiar with the response of the boat and develop good control skills.

6. Ski Mode and Cruise Mode

If your boat has the Ski Mode or Cruise mode, it is also important to understand their operation and to become familiar with these features prior to using them on a ride with other people. See Section D-6 - Digital Speed Controls.

WARNING

These operating modes are not an automatic pilot and are not meant as a replacement for an experienced operator.

C. Important Factors to Remember

In addition, always remember that the following conditions have a direct impact on how your boat will behave and respond to different inputs:

- Load change
- Currents
- Wind
- Water conditions.

Make sure to be alert to these conditions, and adapt accordingly. If possible, practice further in these conditions. For delicate maneuvers, the best advice is always to reduce your speed to a minimum.

D - 10 ACCELERATION

NOTICE **ENGINE BREAK-IN PERIOD** **Operating During Break-In**

Carefully follow the instructions on engine break-in located in the engine manual. Failure to do so may reduce the engine's life and/or performance.

A break-in period of 10 hours is required before continuous operation at full throttle.

To achieve a good break-in, throttle lever should not be advanced more than 3/4 opening, however, brief acceleration and speed variations contribute to a good break-in.

NOTICE

Continued wide open throttle runs and prolonged cruising without speed variations should be avoided. This can cause engine damage during the break-in period.

⚠ WARNING

Before accelerating to bring your boat on plane, be sure that the area in front of your boat is clear. The bow will rise out of the water momentarily before you plane and may temporarily obstruct your vision.

If you have never had your boat on plane before, choose a calm day for your first on plane experience. Never boat beyond your ability and experience. Before bringing your boat “on plane”, check the entire area to make sure you have a clear, safe path. As you throttle up to accelerate, your boat will increase its angle of trim, causing the bow to ride high. From a maximum angle, the boat will level out to its planing attitude with continued acceleration. This maximum angle is known as the “hump”. Because visibility, handling, and performance are reduced, it is advisable to get “over the hump” as soon as possible.

A few seconds at full throttle should get the boat over the hump and into its planing attitude.

After getting over the hump, accelerate until reaching a comfortable plane, then throttle down to cruising speed. This also will provide for better fuel efficiency.

D - 11 GENERAL OPERATING RECOMMENDATIONS

A. Rough Water or Poor Visibility Operation

Avoid operation in these conditions. If you must do so, proceed with caution and prudence using minimum speed. Turn on navigation lights if necessary.

B. Night Operation

Between sunset and sunrise, use the navigation lights and reduce speed.

⚠ WARNING

Navigation lights should always be used between sunset and sunrise. Ensure the bow and stern lights are installed.

C. Crossing Waves

Reduce speed when crossing waves. Always be prepared to steer and balance as necessary. When crossing wakes, always keep a safe distance from boat ahead.

⚠ WARNING

When crossing wakes, slow down. Operator and passenger(s) can brace themselves by posting. Do not jump waves or wakes.

D. Stopping/Docking

The boat is slowed by water drag. The stopping distance will vary depending on weight, speed, water surface condition, presence and direction of wind and current. The operator should become familiar with the stopping distance under different conditions.

Reduce speed to idle. Shift to neutral, reverse or forward as required when approaching a dock then shut off the engine just before coming alongside.

⚠ WARNING

Directional control is reduced when throttle is decreased and lost when engine is off.

Turn the ignition switch to OFF to stop the engine.

E. Beaching

NOTICE

It is not recommended to run the boat onto the beach.

Come slowly to the beach and shut off the engine using the ignition key when water depth is 90 cm (3 ft) under the hull, then pull the boat to the beach. Ensure that all accessories are OFF.

⚠ WARNING

In shallow water, shells, sand, pebbles or other objects could be drawn up by the jet pump and thrown rearward.



D - 12 RETURNING TO SHORE

A. Docking

Always approach the dock slowly. Think before acting. If you are wondering whether your boat will fit in a space against a dock, remember that pilings are often (but not always) spaced 10 feet apart.

Remember that it is easier to control a boat in reverse because a boat steers from the stern. When backing into a slip, back so that bow swings into the wind if possible. You will have more control.

If possible, come in against the wind or current, whichever is stronger. Approach the dock at a 30-45° angle. As the boat nears the dock, slowly swing parallel to it. Tie the bow line first; then the stern. If wind or current is moving toward the dock, move parallel to the dock further out. Let the wind or current push you in. Tie the stern first, then the bow.

Use extreme caution if wind or current is from your stern. Back in towards the dock slowly at a slight angle with engine in slow reverse. Gently swing parallel. Tie stern first, then the bow.

If the weather looks bad, use spring-lines from the bow and stern to dock amidships of the boat. Tie up on the downwind side of the dock. If the wind is changeable, place fenders over the side between the boat and the dock.

B. Mooring

After you have positioned your boat next to the dock, you must secure it with mooring lines to keep it in position. Mooring lines must be long enough to secure your boat in any docking situation. For example, the length of the lines for a 16-foot runabout should be at least 15 feet. An eye splice at the end of each line works well with bow or stern cleats.

The mooring lines you will use most often are the bow line, the stern line, and spring lines as shown on Figure D17 (see following page). Each line has a specific purpose. The bow line and the stern line secure your boat's bow and stern. The two spring lines keep your boat from moving forward or backward when you are moored alongside a dock.

If you are mooring your boat for a short time, bow and stern lines may be the only lines you will need. If you are mooring your boat for a longer time or the currents are swift, you should use spring lines. The stern spring line leads from the boat's stern cleat forward to the piling or cleat on the dock. The bow spring line leads from the bow cleat aft to the dock.

If you are mooring your boat in a slip, bow and spring lines, port and starboard, will keep your boat in position.

NOTE: If tides are a consideration, be sure to leave slack in the lines to make up for the rise and fall of the water while your boat is docked.

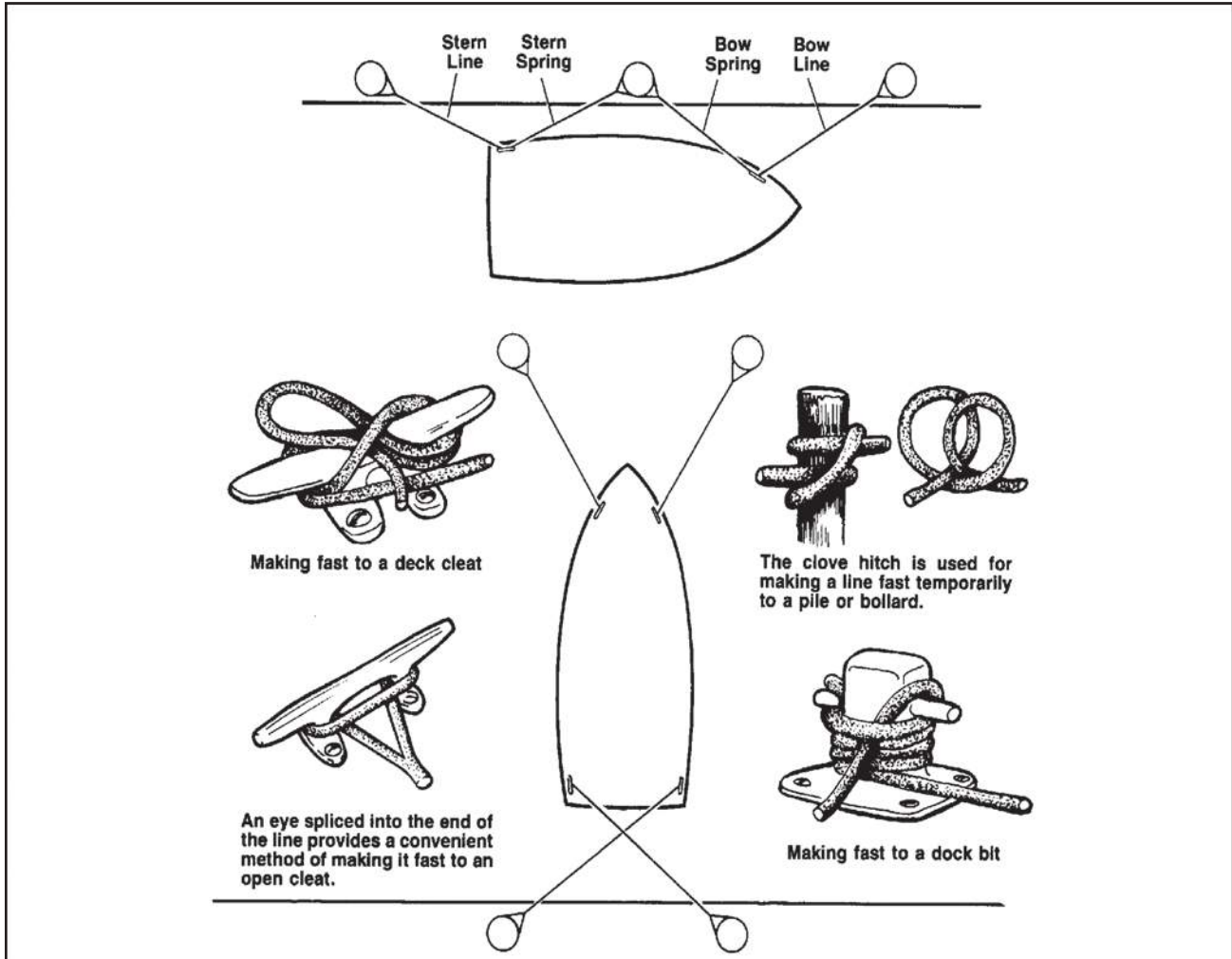

Figure D17: Mooring Lines



E - 1 FIBERGLASS CARE & MAINTENANCE

Fiberglass is affected by weathering processes and requires maintenance on a periodic basis to help maintain the beauty and shine. The effects upon the gel coat will be dependent upon boating conditions, storage, type of use, and the care given to the boat during the boating season.

Scarab utilizes fade-fighting gel coat in the exterior finish. It is specially formulated to resist fading and yellowing, and retain more of its original gloss than lesser grade gel coats. However, it is still important to maintain the gel coat to protect the finish.

A. General Maintenance

For freshwater use, the boat should be washed once or twice a month. When using in a salt water environment, considerably more care will be necessary. Be careful when selecting a cleaning agent. Hand dishwashing detergents are usually gentle and are recommended for cleaning gel coat. Cleaning products such as Ivory® or Dawn® hand dishwashing liquid can be safely used. Always read the label before using any product.

NOTICE

DO NOT use acetone, paint thinner, solvents, or strong alkaline based detergents, nor cleaners with a "gritty" and abrasive texture. Avoid products which contain sodium phosphate. Common examples of these types of household cleaning agents are: Tide™, Oxydol™, Janitor-in-a-Drum™, Formula 409™, Clorox™, etc. Always read the label before using an agent.

There are several products available which are specifically designed to clean fiberglass exterior finishes. Many companies like Johnson & Johnson®, Turtle Wax®, etc. manufacture cleaning fluids mild enough to clean without stripping the wax.

NOTICE

Treading on a soiled fiberglass surface can severely scratch and mar the finish. Keep the fiberglass as clean as possible.

When cleaning nonskid areas, DO NOT attempt to use a wire brush or sandpaper because this will remove the non-skid gel.

Apply wax once or twice a year to maintain gel coat lustre. Read the label before using any product. Make sure product is formulated for gel coat surfaces. Also, consult a Scarab dealer for their recommendations.

NOTICE

Do not use carnuba-based waxes. This type of wax yellows over time and makes the fiberglass appear yellow.

DANGER

Waxing decks, cockpit floors or other areas on which one walks is not recommended. Waxing will produce a very slippery surface, especially when wet. Wax may also buildup in the nonskid surfaces. Be sure all persons wear deck shoes while aboard the boat. Footing will be improved and feet will be protected from accidental cuts and bruises.

A darkening or discoloration of the non-skid surfaces can sometimes occur as a result of wax buildup. Exposure to the sun and elements can turn the wax darker, or occasionally can cause it to become flaky or powdery. To remove, use fine rubbing compound and a low RPM buffer (1200 to 2000 RPM). Apply light pressure and keep the buffer moving at all times to prevent heat build up. Read the directions before using any equipment.

B. Weathering Effects on Gel Coat

Weathering occurs from direct sunlight, water, chemicals, and dust. Some of the terms below describe the changes that can occur to the gel coat surface.

Chalking is a result of the gel coat's top surface being broken down into an extremely fine powder. When this happens, the color whitens. The chalk is present on the surface only.

Fading is the uniform change in color. This happens when the actual pigments have changed color, especially from excessive chalking, or when the gel coat has either been stained or bleached by something.

Yellowing is gel coat which has a yellow cast and streaking usually deals with a stain or contact with another surface.



Gloss refers to the shine of the surface. This can change from sanding action, chalk, residues, or exposure.

Blistering refers to a condition in which the unprotected gel coat surface below the waterline has absorbed water and formed bubbles. See Section E-2 for additional information.

Follow the instructions below for boats that have weathered and chalked.

1. Wash.
2. Wax. If this does not work, then use a fine rubbing compound. If this does not work use 400 or 600 wet or dry sandpaper, followed by fine rubbing compound and wax.

When using wax or fine rubbing compounds, make sure to read the label and follow the directions. Some helpful tips are as follows:

1. Avoid working in direct sunlight. This dries out the wax or compound, and can stain the surface.
2. Use clean pads or cloths to apply a thin coating of wax or rubbing compound to a small area such as three feet by three feet. Remove any excess, and then rub the area with a buffing pad, or power buffer. Apply pressure only as necessary to restore the surface finish. Applying too much pressure or buffing in one place too long can permanently damage the surface.
3. After applying compound, always follow with waxing.

NOTICE

If using a power buffer, use a low RPM buffer with light pressure. Keep the pad wet and the buffer moving at all times to prevent heat build up.

NOTICE

When sanding, DO NOT use a power or belt sander. Gouges, uneven areas, or other damage could occur. For best results, block sand the gel coat.

C. Stains

Stains can appear anywhere on the exterior of the boat and may be a result of contact with tar, plant sap, leaves, rust from metal fittings, and other materials. Surface stains may be removed with hand dishwashing soap, mild cleansers, or some household detergents. DO NOT use chlorine or ammonia products. These products can affect the color of gel coat. Commercial car washes use strong cleaners and should be avoided.

To remove stains, refer to the procedures below.

1. Wash area with hand dishwashing soap.
2. Begin with a small area such as three feet by three feet and apply a mild cleanser.
3. Rinse with clean water.
4. Follow with compound and waxing as outlined in procedure above.

If the stain is not removed by the hand dishwashing soap or mild cleanser, then the next procedure is to use either denatured or rubbing alcohol. If this does not work, consult your Scarab dealer for professional assistance.

NOTICE

DO NOT use acetone, ketone, or other solvents to remove stains. These chemicals are flammable and may damage the gel coat.

E - 2 FIBERGLASS REPAIRS

Fiberglass is one of the most durable, strong, and forgiving construction materials afloat. It is resilient and normal repairs can be made without affecting the strength or structural integrity of the boat.

WARNING

Striking docks, other boats, or submerged objects could create a very hazardous situation or severely damage the fiberglass. In the event an object is struck below or near the waterline, proceed directly and cautiously to the nearest service facility and remove the boat from the water. Closely inspect the hull for damage. If the outer fiberglass laminate was penetrated, repairs must be made prior to relaunch.



Occasionally, blisters, crazing, scratches, or damage to the fiberglass can occur. Repairs may be necessary to correct the problem.

A. Scratches

Scratches occur during normal use. Below is a step by step procedure to repair scratches.

1. Clean area with soap and water.
2. Apply a fine rubbing compound and buff.
3. Wax. If this does not work, clean the area and sand lightly with 400 to 600 wet or dry sandpaper and follow with rubbing compound and wax.

B. Gouges & Cracks

Stress cracks and crazing are the appearance of hairline cracks in the gel coat surface. When present, these problems usually occur in the gel coat finish or the outer "skin coat" fiberglass laminate. The appearance of these cracks does not pose a threat to the structural integrity of the boat. In most cases, they are cosmetic and can be treated. Cosmetic surface damage can be repaired as follows:

1. Sand the surrounding area with medium or fine grit sandpaper. Clean all marine growth, dirt, anti-fouling paint, etc. from the immediate area. DO NOT excessively scratch or gouge the surrounding area.
2. Use a hard, pointed tool to open the gel crack. Take care not to damage the surrounding gel coat.
3. Sand the crack or gouge so the edges are smooth and will allow proper "feathering" of the area.
4. Clean the area thoroughly. Make sure the area is dry before proceeding.

NOTICE

Be sure the structure and the ambient temperature are above 60 degrees F (15 degrees C) and the relative humidity below 70% immediately before, during, and after the repair.

5. If the nick or gouge is deep and penetrates through the gel coat, fill the area with fiberglass patching paste. Follow the directions on the can when mixing the paste with the catalyst.

6. After the gouge is filled and has dried, sand the patched area. Begin by using medium-fine grade sandpaper. Progressively use finer grade sandpaper until the surface is very smooth. If necessary, add filler and then sand the surface again.

7. Apply two or three light coats of matching fiberglass gel coat to the repaired area. Enough gel coat should be used so that the entire area is covered.

The gel coat must be catalyzed using up to 2% MEK Peroxide which can be purchased at a supplier handling fiberglass reinforced products. Contact your Scarab dealer for assistance.

8. After ample drying time, sand the area using very fine wet/dry sandpaper. If the appearance of the area is still not satisfactory, repeat steps 2 through 8 as necessary.
9. If above the waterline, polish the area using a fiberglass rubbing compound and then wax. If the repaired area is below the waterline, the area should be primed and painted in accordance with the anti-fouling paint manufacturer's instructions.

Gel coat, like paint, will change colors with time and exposure to sunlight (ultraviolet). For this reason, "matching" gel coat obtained from Scarab may not match the gel color of a boat that has been exposed. However, this is the closest match commercially available. A fiberglass/gel coat technician can tint the gel to be used in the repair to provide a closer color match.

More severe fiberglass damage, especially when structural, requires the expertise of an experienced fiberglass repair technician. See your Scarab dealer for assistance.

NOTICE

Improper repair techniques can lead to further fiberglass component damage.

C. Osmotic Blistering

Osmotic blistering or "boat pox" is an unfortunate but not uncommon occurrence in fiberglass boats. Fiberglass is water retardant, not waterproof. When a boat is left in the water for a period of time, the fiberglass will absorb water. It is a natural process that can not be eliminated in production methods or material selection and usage. However, there are ways to control and possibly prevent blisters. If you do encounter blisters, be assured that the blisters are



merely cosmetic. They do not indicate a defect in the boat structure or lamination. Scarab, along with most boat manufacturers, regard gel blisters as a standard maintenance item.

The repair procedure for gel coat blisters is similar to the procedures outlined in the previous section on cracks and gouges. There is an exception however, in that the hull must dry out for several days or possibly weeks before repairs can proceed.

To determine if the hull has dried sufficiently, tape one square foot of household plastic wrap securely to the hull bottom. Make sure all edges are sealed and let it stand for twenty-four hours. If condensation has accumulated under the plastic, the hull is still "wet" and must be allowed to dry longer before repairing.

When the repair is completed, an application of an epoxy barrier coat should be considered. This will help prevent the possibility of reoccurrence of blisters. Your Scarab dealer or local ship store will have information on barrier coat products.

E - 3 EQUIPMENT INSTALLATION

Many boats are used for specific purposes or under conditions which require the addition of special equipment to the hull or deck. Special care must be taken during the installation of any equipment to a fiberglass component. A polysulfide or butyl based sealant should be used to seal installations below the water line. Silicone "marine" seal or similar bedding compound should be used elsewhere.

NOTICE

DO NOT install any item onto or through the hull without adequately sealing the hull area penetrated by the installed item or related fasteners. Improper installations could cause leakage or allow water absorption and thus cause serious hull damage.

Always pre-drill fastening holes with a proper size bit. Pre-drilling will help prevent the fiberglass from splintering and thus causing unsightly damage. Also, countersink holes to prevent the gel coat from chipping.

Any equipment which will be subjected to cyclic loading or significant force should be through-bolted to a fiberglass component. A butt block or backing plate should be used to strengthen any area onto which an item will be mounted.

E - 4 ANTI-FOULING PAINT

Scarab recommends anti-fouling or bottom paint for boats which will be kept in the water for extended periods of time. Anti-fouling paint reacts with water to retard the growth of algae, barnacles and other marine growth on the hull. In addition to marine growth, it offers protection against excessive water pollution.

Anti-fouling paint begins reaction upon contact with water. After a season's use or sooner under certain conditions, the anti-fouling paint may appear to be dissolving. This is due to the paint's chemical emission that in turn retards marine growth. When this occurs, refinishing is in order.

Scarab recommends reapplication of the anti-fouling paint seasonally. The effectiveness of the paint will be drastically reduced if used longer. Though Scarab has found the use of anti-fouling paints provide good marine growth protection in most water, other paints may be more effective in certain water conditions. See a Scarab dealer for recommendations on anti-fouling paint use in your area.

NOTICE

During surface preparation, the hull should be sanded only enough to remove any foreign matter, and loose paint. DO NOT sand deeply into the gel coat, fiberglass cosmetic problems could later result. After sanding, the surface should be wiped with a rag treated with a cleaner recommended by the anti-fouling paint manufacturer. The surface must be clean and slightly rough to ensure proper paint adhesion.

Prior to application of the anti-fouling paint, the boat owner may consider coating the hull bottom with an epoxy coating. Scarab recommends this procedure as a preventive and effective means of controlling osmotic blistering. Most major anti-fouling paint manufacturers also supply a line of epoxy undercoatings. Consult your Scarab dealer for recommendations on epoxy undercoatings.

E - 5 HULL SUPPORT

Proper support of the hull while it is out of the water is imperative. Due to the design complexities, Scarab does not recommend trailers or storage cradles be homemade. The boat is a valuable piece of equipment. DO NOT risk permanent damage to the hull structure in an attempt to save the cost of an ad-

equate support. Improper support can lead to serious and permanent hull deformation.

CAUTION

Failure to adequately support the hull may result in permanent hull structure damage and will invalidate the hull structure warranty.

NOTICE

When attempting to raise the hull, never allow one end of the boat to rise first, while letting the opposite rest momentarily on the underwater gear. Serious damage to these components could result. DO NOT place lifting straps on underwater gear. Be sure the strap is against the hull surface only.

A trailer, or storage cradle designed for a larger or smaller boat will not provide proper support for the hull. This could lead to hull deformation and thus serious performance deficiencies.

Scarab® trailers are available for most models. Refer to Section F - Trailers for additional information.

E - 6 STAR BOARD

Star board is a high density polyethylene (plastic) and is very durable and fade resistant. Star board requires little maintenance, and is being used in place of wood in certain areas of the boat. The ski locker lid is one example of where star board is used.

To clean star board, use a solvent-free, nonabrasive cleaner such as dishwashing soap or Fantastic™. Read the label before using any cleaning product.

NOTICE

Star board will stain when exposed to certain oils or chemicals. Always wipe up any spills immediately.

E - 7 LAMINATED FIBERGLASS

The decks and cockpit flooring are made up of laminated fiberglass. Cleaning can be done using mild dishwashing soap and soft nylon brush. Rinse thoroughly with clean water after scrubbing with the brush. See Figure E1.



Figure E1: Cockpit Floor

A removable cockpit table is available on certain Scarab models. The table also consists of a laminated fiberglass material. It can be cleaned with mild dishwashing soap and water. Always read the label before using any cleaning product.

NOTICE

DO NOT use abrasive cleaners or solvents on cockpit table. DO NOT use Soft Scrub™ soap or similar cleaning products; they will scratch the surface and remove the shine.

NOTICE

DO NOT use cockpit table as a cutting board. The knife will leave gouges/marks in the surface of the table.

E - 8 ACRYLIC PLASTIC - (Plexiglass)

Acrylic plastic may be utilized in such things as storage doors and walk-thru doors.

To clean acrylic plastic:

1. Rinse with plenty of water to wash off as much dirt as possible.
2. Using your bare hand, along with plenty of water, feel and remove any dried-on dirt or mud.
3. Wash using a soft, grit-free cloth or sponge and mild, nonabrasive soap or detergent.
4. Rinse thoroughly with water.
5. Blot dry using a clean, damp chamois.

NOTICE

Never use a dry cloth, duster, glass cleaning solutions or citrus cleaner on acrylic plastic.

NOTICE

Do not use solvents such as acetone, silicone spray, benzene, carbon tetrachloride, fire extinguisher fluid, dry cleaning fluid, lacquer thinner or ammonia. These solutions damage the acrylic surface.

You can use fine automotive acrylic rubbing and polishing compounds to remove fine scratches on acrylic. Always read the label before using any product.

E - 9 SWIM PLATFORM MAT

Available for the swim platform is a mat available. See Figure E2. This mat is bonded to the fiberglass swim platform using adhesive and is typically installed by Scarab. This mat provides a comfortable surface for enjoying those watersport activities.



Figure E2: Swim Platform Mat

Swim platform care instructions:

1. If possible keep covered while in storage or not in use.
2. Spills: Scoop or scrape up as much of spill as possible and follow by blotting the remaining spot with a dry clean cloth. Paper towel can be substituted when cloth is not available.
3. Non-Oil Based Stained: Make a detergent solution by adding a ¼ inch teaspoon liquid dish detergent to 1 cup warm water. Apply solution to the affected area and blot - (DO NOT SCRUB) with a dry clean cloth, repeat process until stain stops transferring to the cloth. If stain still appears, apply solution to area let stand 2-5 minutes and rinse with clean water.
4. Oil Based Stains: Apply Naphtha or mineral spirits to effected area and follow the instructions on the solvent container. - Always work the stain from the outside toward the center - (DO NOT SCRUB).
5. If Stain Still Appears: Surface can be restored by lightly sanding area with 24-36 grit sandpaper. (Sanded area may appear slightly lighter but it will blend over time).

E - 10 UPHOLSTERY CARE

A. Cleaning Vinyl

NOTICE

Vinyl upholstery should be cleaned and maintained in accordance with the manufacturer's recommendations and instructions.



The vinyl material used on the exterior upholstery should be cleaned regularly with warm water and a mild dish soap or Vinyl Finish Vinyl Cleaner® using a soft clean cloth, then rinse with a soft clean cloth. For dirt buildup, spray Vinyl Finish Vinyl Cleaner®, let soak for approximately ten (10) minutes, then gently scrub with a soft bristle brush. Be sure to thoroughly rinse the vinyl after washing with mild dish soap or Vinyl Finish Vinyl Cleaner® to remove all residue. Towel dry the vinyl. Periodic spraying of the seats with Lysol Spray Disinfectant™ will help retard mildew.

To further protect the vinyl from early degradation, use 303 Aerospace Vinyl Protectant®. Spray on, then wipe dry. 303 Aerospace Vinyl Protectant® should be applied every 3-5 weeks when boat is in use. Regular cleaning with mild soap and water or Vinyl Finish Cleaner will not remove the 303.

NOTICE

DO NOT apply vinyl protectants such as ArmorAll®. The manufacturer does not recommend this product because it removes the oils present in vinyl that keeps vinyl soft.

A recommended “Cleaning Kit” includes:

- Ivory Dishwashing Liquid™ and water
- Clean, white towels
- Soft bristle brush
- Denatured Alcohol
- Hemisphere Ink Remover®
(for ordering information call 800-247-9901)
- Vinyl Finish Vinyl Cleaner® -
(everyday cleaning & care, call 800-247-9901)
- 303 Aerospace Vinyl Protectant® -
(for ordering information call 800-247-9901)
- Tough Duty Cleaner™ - (to locate the nearest distributor, call 800-537-8990)
- Ammonia and hydrogen peroxide

To remove stains, follow the general guidelines listed below and/or refer to the Step-by Step Cleaning Instructions table:

General Stain Removal Guidelines

1. Basic Stains/Grease/Pencil/Dirt:

Ivory (mild) Dishwashing Soap™ and water, applied with a medium-soft brush or Vinyl Finish Vinyl Cleaner® using a soft clean cloth, then rinse with a soft clean cloth.

2. Tough Stains/Adhesive/Teak Oil/Rust:

Tough Duty Cleaner™; rinse with soap and water or spray with Vinyl Finish Vinyl Cleaner®, let soak for approximately ten (10) minutes, then gently scrub with a soft bristle brush. Thoroughly rinse vinyl and dry.

NOTICE

To prevent possible damage to the vinyl, rinse with soap and water after applying the Tough Duty Cleaner™ or Vinyl Finish Vinyl Cleaner®. Then rinse and dry.

3. Ink:

Denatured alcohol or Hemisphere Ink Remover®.

4. Mildew Stains:

To kill bacteria creating the mildew, vigorously brush the stained area with a 4-to-1 mixture of water and ammonia; rinse thoroughly with water and dry.

5. Tough Mildew Stains:

Apply a mixture of one (1) teaspoon ammonia, one-fourth (1/4) cup of hydrogen peroxide, and three-fourths (3/4) cup of distilled water; rinse with water and dry.

Step-by-step cleaning instructions

Type of stain	STEPS: 1,	2,	3
General Care	A	B	
Dirt Build-up	A	B	
Ballpoint ink*	E	B	A
Chewing gum	D	A	
Coffee, tea, chocolate	B		
Grease	D	B	
Household soil	A	B	
Ketchup	A	B	
Latex paint	A	B	
Lipstick	A	B	
Mildew or wet leaves*	C	B	A
Motor oil	B		
Oil-based paint	D	B	
Permanent marker*	E	B	C
Spray paint	B		
Suntan lotion*	A	B	
Tar / Asphalt	D	B	
Yellow mustard	A	B	C

Legend

- A. Medium-soft brush, warm soapy water
Rinse / Dry
- B. Vinyl Finish Vinyl Cleaner®
Rinse / Dry
- C. One (1) tablespoon of ammonia; one-fourth (1/4) cup of water
Rinse / Dry
- D. Wipe or scrape off excess (chill gum with ice before hand)
- E. Hemisphere Ink Remover
Rinse / Dry

All cleaning methods must be followed by a thorough rinse with clean warm water.

Certain household cleaners, powdered abrasives, steel wool and industrial cleaners can cause damage and discoloration and are not recommended. Dry cleaning fluids and lacquer solvents should not be used as they will remove the printed pattern and gloss. Waxes should be used with caution as many contain dyes or solvents that can permanently damage the protective coating.

*Suntan lotion, tree pollen, wet leaves and some other products can contain dyes that stain permanently. Care should be exercised and boat covers should be utilized.

Step-By-Step Vinyl Cleaning Instructions Table

Do's

- Vinyl Finish Vinyl Cleaner
- Dish Soap (Dawn, Ivory)
- 303 Aerospace Vinyl Protectant

Don'ts

- Formula 409
- Fantastik
- Simple Green
- Armorall
- Murphy's Oil Soap,
- Son-of-a-Gun
- Bleach / Baking Soda
- Turtle Wax
- Tar Remover

NOTICE

Failure to care for your vinyl properly, or use of improper cleaners may void your warranty and damage your vinyl.

NOTICE

When docking or mooring your boat be aware of your surroundings i.e. trees with pollen, wet leaves, berries etc. These and other items can contain dyes that stain permanently. Utilize weather covers whenever possibly to protect vinyl from potential stains.

NOTICE

ALWAYS CLEAN STAINS IMMEDIATELY!
DO NOT use Formula 409™ Fantastik™, Simple Green™, Armorall™, Murphy's Oil Soap™, Son-of-a-Gun™, Bleach / Baking Soda, Turtle Wax™ or Tar Remover on vinyl. Do not use kerosine, gasoline or acetone as they will remove the protective marine topcoat.

NOTICE

All cleaning methods must be followed by a thorough rinse with water and drying.

Additional cleaning information is provided by the manufacturer and is included with this manual.

Scarab offers a variety of optional weather covers for protection of the boat and associated equipment. Continued exposure can damage the upholstery and seating. The seating can become thoroughly saturated with water if not adequately protected. Refer to Section E -12 - Weather Covers for more information.

NOTICE

The appearance and longevity of the exterior upholstery will be affected by water saturation. Protect these items appropriately.

B. Exterior Carpets

The removable exterior grade carpeting is available and if installed may be periodically washed with mild laundry soaps or carpet shampoo, dried and reinstalled. It is 100% UV stabilized Olefin™ polypropylene fiber with rubber backing. See Figure E3.

NOTICE

Prior to using any mild laundry soaps or carpet shampoo, always conduct a color-fast test on a small inconspicuous portion of carpet before applying to entire carpet.

NOTICE

DO NOT dry carpeting in an automatic dryer.

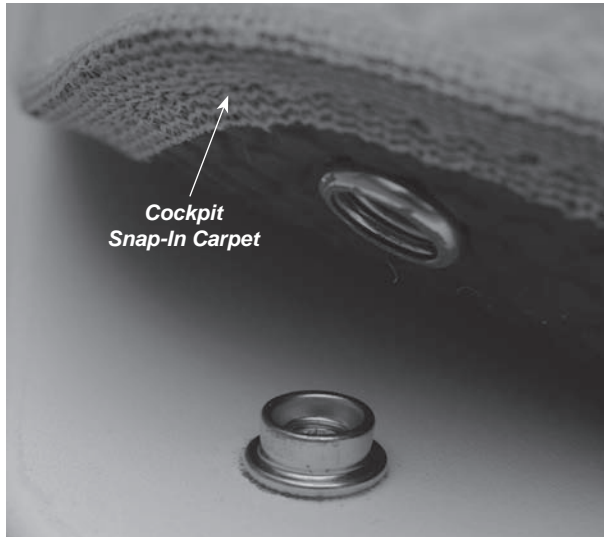

Figure E3: Cockpit Snap-in Carpet

1. Cleaning and Maintenance

The following information should be useful in helping you keep your carpet looking well maintained.

Carpet made with Olefin™ fiber possesses built-in stain and soil release for easy, less costly maintenance. Regular vacuuming and occasional shampooing will help it stay attractive and serviceable.

2. Stain Removal Testing

Even the most stubborn stains can be removed from Olefin fiber following the procedures outlined. Stains were selected as being representative of spills commonly occurring on carpets. Stains were pressed into the carpet to simulate foot pressure following a spill. Stains were applied to a two-inch square section and allowed to penetrate. Removal was performed after two weeks. Carpets were tested for stain removal by an independent laboratory. Stain removal was effective for the all the stains selected. Results are shown in the table on the following page.

3. Stain Removal Procedures

Regular maintenance such as vacuuming, hosing or washing should be performed. Most stains and mildew are easily removed from carpet made with Olefin fiber using common household cleaners. Refer to Table I. Olefin™ fiber is so resistant to chemical

attack that Clorox™ bleach may be used to clean up any mildew that may result from excessive wetness.

Code for stain removal procedure (See Table 1):

“A” Apply warm water and household detergent in minimal amounts to stained area. Sponge or scrape until stain is removed. Rinse with clean water.

“B” Apply warm water and household detergent. Work well into stained area then flush with warm water.

Most stains should be easily removed however, if the stain persists, the cleaning procedure should be repeated to insure stain removal. Remember, the sooner the stain removal process begins, the easier the stain will be to remove.

NOTICE

Do not use dry cleaning solvents on carpet or vinyl. Permanent damage to the fiber will result.

E - 11 REPLACEMENT UPHOLSTERY

Should upholstery become severely soiled, torn, or in some manner damaged, replacement upholstery cushions are available. Larger upholstery items have separate component parts for easier serviceability. Depending upon the year and model of the boat, most upholstery parts can be obtained through your Scarab servicing dealer within a short period of time.

STAIN	REMOVAL PROCEDURE
Automotive Grease	A
Automotive Oil (New or Used)	A
Bacon Grease	A
Berry Stain	A
Blood	A
Butter	A
Catsup or Mustard	A
Chewing Gum	A (Repeat)
Chlorine Bleach (5%)	A
Chocolate (Melted)	A
Clay	A
Coffee or Tea	A
Cola	A
Crayon	B
Dye	A
Egg	A
Feces	A
Fish Formula	A
Fruit Juice	A
Furniture Polish	A
Gravy	A
Ice Cream	A
Ink (Permanent Black)	B
Ink (Scripto, Ballpoint)	B
Iron Rust	A
Lipstick	B
Mayonnaise	A
Milk	A
Latex Paint	A
Oil Base Paint	B
Polish	B
Rust	A
Salad Dressing	A
Shaving Cream or Lotion	A
Tar	B
Urine	A
Vomit	A
Water Colors	A
Wax	B
Wine	A

Table I: Stain Removal

E - 12 WEATHER COVERS

Weather covers for the cockpit areas are available on the Scarab models. Scarab covers are designed and intended to provide protection of the cockpit seating areas.

⚠ WARNING

Never use any form of open flame cooking device while under, in any area fully enclosed, or near any acrylic weather cover. This material is flammable.

Scarab utilizes acrylic-type material for all its covers. During the manufacture of the weather covers, the smallest possible needle and highest quality UV stabilized, bonded polyester thread is used in the stitching.

The weather cover is water repellent but not water proof. During a hard rain, you may notice a light mist permeating through a weather cover. This is normal. If the seams leak, they can be sprayed with Scotch-guard™ or similar water repellent or a seam sealing compound can be applied. Keep objects from contacting the inside of the cover. Leakage may occur at point of contact.

Weather covers must be installed taut or will be damaged by accumulation of rain water.

NOTICE

If boat is exposed to prolonged rain without a cover, battery will discharge and bilge pump will quit working. Boat may sink if in water.

After use, the top canvas should be rolled up into the boot (if supplied) and secured.

NOTICE

NEVER fold or store a wet weather cover. This can lead to mildew or shrinkage. Roll rather than fold the enclosure curtains. Sharp folds increase the chance of cracking the clear vinyl.

NOTICE

DO NOT use the weather covers for outdoor winter storage. The weight of the snow or heavy rain can cause severe damage to the material or top structure.



When snapping covers to the boat, apply direct downward pressure on the snap. When unsnapping, rotate the snap and cover upward at each snap location.

NOTICE

Remove snaps one at a time to prevent damage. DO NOT rip off or pull the weather cover as a whole; acrylic material may tear at snaps.

A. Bimini Top

A bimini top is available on most Scarab models. This style is a “freestanding” top and is supported only by the bow assembly. Note: This style of canvas when deployed permits most occupants the ability to stand and walk about the cockpit while the boat is at rest.

To install:

1. Unboot and attach the bimini main bow to the deck mounts (if not already done).
2. Extend the forward portion of the bimini and attach the forward brace rods to deck mounts. If straps are used instead of forward brace rods, attach straps to the strap eyes mounts on the deck.
3. Extend the rear portion of the bimini and attach the stern brace rods to the deck mounts (if applicable).
4. If applicable, attach the stern cross-brace to the stern portion of the main bow and then to the port stern brace rod.
5. If straps are used instead of forward brace rods, Adjust the forward straps and secondary bow couplers for tautness if necessary.
6. Snap forward windshield connector (clear visor) to windshield (if applicable). Starting at the walk-thru windshield may prove to be easiest. Windshield snaps can be adjusted to match snaps in canvas.
7. Zip forward windshield connector section to the bimini top.

To close and boot (mounted storage) the bimini, reverse the procedure described above. Brace rods, if applicable to your model, snap into storage clips for safe keeping while booted.

You may choose to run your Scarab with the bimini top either fully deployed or folded together (closed) and secured with the boot provided. Either way it is designed to remain mounted. No storage is provided for this top in your boat.

NOTICE

Use two people to remove the bimini top (winter storage). This will help minimize the risk of injury and help prevent damage to the upholstery, the bimini top, and/or the boat.

NOTICE

Aft/Main bimini canvas deployment should only be utilized at or below moderate cruising speed (approximately 0-40 mph). Avoid full throttle operation of boat while having canvas deployed. Scarab recommends booting the canvas before running at or close to maximum speed. In so doing you will help to maintain the life of the canvas and hardware. Also, the wind should be taken into consideration when determining operating speed with canvas deployed. The boat speed plus (+) wind speed should not be exceed 40 mph.

B. Forward Cover

The forward cover is available for the Scarab models and must be ordered with the cockpit cover. It is installed over the bow seating area and is snapped to the deck. An adjustable pole is provided to adjust the canvas for tautness and prevent the build up of water.

NOTICE

The front center snap of the forward cover should be centered on the center bow stud at the bow. The front center snap is located at the front of the forward cover at the center seam.

C. Cockpit Cover

The cockpit cover is used to cover the complete cockpit area and is intended as a short term storage cover. The cockpit cover is available on most Scarab models.

To install:

1. Snap the forward edge of the cockpit cover to the bottom edge of the windshield track. Snaps can be adjusted on the windshield track if necessary.

NOTICE

The front center snap of the cockpit cover should be centered on the center windshield snap on the windshield track. The front center snap is located at the front of the cockpit cover at the center seam.

2. Snap the cockpit cover sides to the deck.
3. Secure the rear corners and aft edge of the cockpit canvas.
4. Place the adjustable poles in position. The adjustable poles are provided to adjust the canvas for tautness and prevent puddling.

Before storing the cockpit cover, ensure the cover is dry. Once dry, we recommend folding the cover in half, lengthwise and then rolling the cover up.

D. Trailering Cover

Trailering covers may be available for certain models only and are intended for longer term storage. These covers spread over the entire boat. See Figure E4. If a trailering cover is used in areas with snow accumulation, be sure to support the canvas adequately and inspect frequently for snow loads or damage will occur. Refer to the section on Winter Storage for additional information. Check with your Scarab Dealer for availability.



Figure E4: Trailering Cover - Models May Vary

To install:

1. Spread trailering cover over entire boat.
2. Install adjustable poles in the rear cockpit and forward bow areas. Be sure the canvas is taut and no pockets (sags) exist.
3. Ensure the trailer cover extends below the gunneling.

4. Tighten the cover's ratchet straps to secure the cover to the boat.

E. Trailering with a Weather Cover

High winds encountered during trailering your boat can severely damage most weather covers with the exception of the trailer cover. If an extended trip at highway speeds is planned, the top and other weather covers should be in the down position or removed entirely. This will prevent damage and loss.

NOTICE

DO NOT tow your boat at highway speeds with weather covers in place (with the exception of the trailer cover). High winds encountered during trailering your boat can severely damage most weather covers. Damage to weather covers incurred as a result of trailering your boat is not covered under warranty.

F. Winter Storage

The boat must be properly protected during winter dry dock storage. A winter storage cover is advisable. Many marine dealers offer shrink-wrap enclosures for outdoor storage. See a Scarab dealer for information on the availability of winter storage covers or other alternatives for storage.

When storing outdoors, make sure the supporting framework keeps the weight of the snow and rain from accumulating on the storage cover. Proper ventilation must also be provided or dry rot and mildew will occur. See the section on General Maintenance for additional winter storage information.

G. Use of Weather Covers and Carbon Monoxide

When an engine is running, a natural vacuum may exist with the right wind and sea conditions to allow exhaust gases (which includes carbon monoxide) to seep into the boat. When canvas is utilized, this compounds the possibility of this occurring and inhibits natural ventilation. For more information, refer to Section A-11 - Carbon Monoxide in this manual. The carbon monoxide in exhaust fumes can be hazardous. It is important for you and your passengers to be aware of the potential safety hazard created by exhaust fumes. Familiarize yourself with the symptoms of individuals overcome by carbon monoxide, and most importantly, ways you can protect yourself and your guests. Figure E5 - Carbon Monoxide Canvas Warning Label.

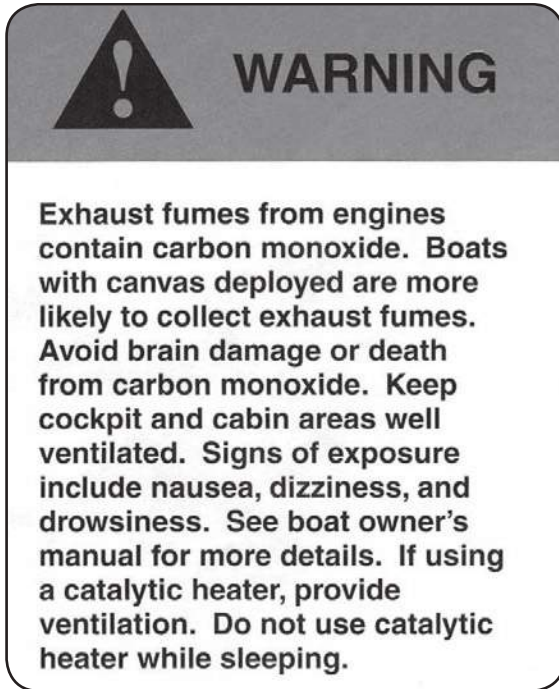

Figure E5: Carbon Monoxide Canvas Warning Label

H. Weather Cover Maintenance

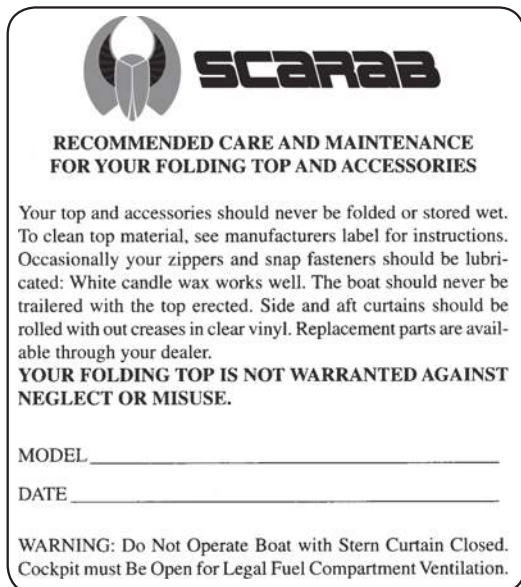

Figure E6: Canvas Care & Maintenance Tag

Moisture, dirt, chemicals from industrial fallout, heat, ultraviolet rays and in some cases, salt water are factors which affect the longevity of acrylic covers. See Figure E6.

1. Moisture can cause shrinkage and mildew. Allow the cover to dry thoroughly before disassembling tops. Keep it clean and well ventilated to prevent

mildew. Spraying the weather cover with Lysol Disinfectant™ or similar product will help prevent mildew.

2. Dirt creates a starting point for mildew when moisture is present. Clean the top with a sponge or soft scrub brush and mild detergent when the cover is installed. Make sure cover is taut to help prevent shrinkage.
3. Chemicals cause decay if allowed to accumulate for long periods of time. Keep the cover clean to prevent decay.
4. Heat can cause cracks in vinyl components and stiffening of fabric when enclosed in plastic or polyethylene. DO NOT store the weather cover in polyethylene under direct sunlight or high temperature situations.
5. Ultraviolet degradation may occur under prolonged exposure to direct sunlight. Store the top in the boot when not in use.
6. Salt water can corrode brass, aluminum, or stainless steel fittings and fasteners. Keep fittings clean, lubricated, and waxed to prevent corrosion.

Clear vinyl curtains and windows demand extra care to prevent scratching. DO NOT use cloth or chamois skin. Dirt or grit in the cloth will scratch the vinyl window. Using a hose, apply clean water to the clear vinyl and rinse off all salt, dirt, and/or grime.

NOTICE

DO NOT use hot water. DO NOT dry in an automatic dryer. DO NOT dry clean or steam press.

Leakage after cleaning may be the result of insufficient rinsing. Re-rinse. If leakage continues, apply a coat of silicone air drying water repellent, such as Scotchguard™. See your Scarab dealer for additional information on weather covers.

E - 13 SPECIAL PROCEDURES

A. Jet Pump Water Intake and Impeller Cleaning

Water is drawn up by the impeller through this opening. The grate minimizes entry of foreign objects into the propulsion system.

⚠ WARNING

Keep away from intake grate while engine is on. Items such as long hair, loose clothing or personal flotation device straps can become entangled in moving parts resulting in severe injury or drowning.

Weeds, shells or debris can get caught on the intake grate, drive shaft and/or impeller. A clogged water intake may cause troubles such as:

1. Cavitation: Engine speed is high but boat moves slowly due to reduced jet thrust; jet pump components may be damaged.
2. Overheating: Since the jet pump operation controls the flow of water to cool the exhaust system, a clogged intake will cause the engine to overheat and damage internal engine components.

The clogged area can be cleaned as follows:

In-water cleaning: Turn the ignition key to the OFF position and remove the key. Let the boat stop by itself. Wait a while to allow weeds or other debris to escape from grate. It may be necessary to repeat the procedure. In severe conditions if the above method does not work, the following can be performed:

1. With engine running, put shift lever in reverse position and vary throttle setting quickly several times.
2. Try accelerating again. Most of the time, debris will escape from the propulsion system.

Out of water cleaning: If the system is still clogged, shut off the engine by turning the ignition key to the OFF position and removing the key.

⚠ WARNING

Always remove the tether cord from the engine cut-off switch to prevent accidental engine starting before cleaning the jet pump area.

From underneath boat, manually clean water intake area. If the system is still clogged, refer to an authorized Scarab boat dealer for servicing.

NOTICE

Avoid operation in weeded areas. If unavoidable, vary speed. Weeds tend to entangle more at steady and slow speeds. Inspect water intake grate for damage. See an authorized Scarab boat dealer for repair as necessary.

B. Towing the Boat in Water

Special precautions should be taken when towing a Scarab jet boat in water.

Maximum recommended towing speed is 24 km/h (15 MPH).

When towing your boat in water, pinch the exhaust manifold water outlet hose on each engine with a large hose pincher. This will prevent the exhaust system from filling which may lead to water being injected into the engine. Without the engine running there isn't any exhaust pressure to carry the water out the exhaust outlet.

NOTICE

Failure to pinch the exhaust manifold water outlet hose may result in damage to the engine. If your boat must be towed in water and you do not have a hose pincher, be sure to stay well below the maximum towing speed of 24 km/h (15 MPH).

NOTICE

When finished towing the boat, the hose pincher must be removed before operating the boat. Failure to do so will result engine damage.

C. Submerged Boat and Water-Flooded Engine

To limit damages to the engine, perform the following procedure as soon as possible.

Drain bilge.

If it was submerged in salt water, spray bilge and all components with fresh water using a garden hose to stop the salt corrosive effect.



NOTICE

Never try to crank or start the engine. Water trapped in intake manifold would flow towards the engine and may cause severe damage to the engine.

Bring the boat to be serviced by an authorized Scarab boat dealer as soon as possible.

NOTICE

The longer the delay before you have the engine serviced, the greater the damage will be to the engine. Failure to have the engine properly serviced will cause severe engine damage.

E - 14 WINTERIZATION

NOTICE

Certain features described in this section may or may not apply to your particular model.

A. Prior to Lifting for Winter Lay-up

1. Have the fuel tank either full or completely empty. See the Engine Owner's manual for recommendations. Also, check with the dry dock operators for recommendations. If winter storing with a full fuel tank, gasoline winterizer such as Sta-bil® fuel conditioner, will reduce varnishing, condensation, etc.

NOTICE

If the fuel has been treated with winterizer, run engines for ten minutes to make sure the treated fuel is present in all lines and parts of the engines.

3. Before winterizing the engine, flush out the system according to the specific engine owner's manual. The engine flush out should be used to clean the engine of unwanted salt, mud, sludge, etc. which may have accumulated in the engine cooling system.
5. Winterize the engine and related propulsion components as recommended in the engine owner's manual. Portions of this winterization procedure may require that the boat be lifted. Winterization of engine and boat systems should be performed by qualified service personnel.

NOTICE

If the fuel has been treated with winterizer, run engines for ten minutes to make sure the treated fuel is present in all lines and parts of the engines.

2. Before winterizing the engine, flush out the system according to the specific engine owner's manual. The engine flush out should be used to clean the engine of unwanted salt, mud, sludge, etc. which may have accumulated in the engine cooling system.
3. Winterize the engine and related propulsion components as recommended in the engine owner's manual. Portions of this winterization procedure may require that the boat be lifted. Winterization of engine and boat systems should be performed by qualified service personnel.
Note: Repairs and replacement costs associated with frozen engine components are quite substantial.
4. If the boat is to be lifted or taken off a trailer, see Section E-5 - Hull Support in this manual for additional details.

B. After Lifting

1. Remove the drain plug.
2. Thoroughly wash the fiberglass exterior, especially the hull bottom. Remove as much marine growth as possible. Wax lightly.
3. Lower boat onto cradle properly or place boat on trailer (if applicable). Be sure boat is adequately supported. The boat should be raised slightly under the forward supports or trailer tongue to improve drainage to the transom drain.
4. Ensure that all water is removed from the bilge pump and bilge pump lines. Dry the hull bilge, self-bailing cockpit drain and related hoses. Water freezing in these areas could cause damage. See Section B-7B - Hull Drainage Systems.
5. Remove the batteries and store in a cool place. Clean the batteries using clear, clean water. Be sure the battery has sufficient water and clean terminals. Keep the batteries charged throughout the storage period. DO NOT store the batteries on a concrete floor or other damp or conductive surface.

6. Wash exterior fiberglass components, wax lightly.
7. Clean exterior upholstery with Vinyl Finish Vinyl Cleaner and/or hand dishwashing soap and water rinse, and dry thoroughly. Apply 303 Aerospace Vinyl Protectant.
8. Remove all oxidation from exterior hardware and apply a light film of moisture displacing lubricant.

C. Prior to Winter Storage

1. Remove as many cushions as possible. Remove storage lids or hatches. Open as many locker doors, as possible. Leave these areas open to improve ventilation.
2. Spray the weather covers and the boat upholstery with Lysol Spray Disinfectant™. Applicable storage locker areas should also be sprayed with Lysol Disinfectant™.
3. Place small dishes of rodent poison such as D-Con™ in a number of areas around the boat. Be sure dishes are placed near the head and the engines, as rodents will destroy upholstery, water intake and discharge hoses.
4. If the boat will be in outside storage, properly support a storage cover and secure it over the boat. DO NOT secure the cover tightly to the boat. This does not allow adequate ventilation and can lead to dry rot. DO NOT store the boat in a damp storage enclosure. Excessive dampness can cause electrical problems, corrosion and dry rot.

 **WARNING**

*Placing an electric or fuel burning heating unit in the bilge of the boat during cold weather could cause fire or explosion and is **not** recommended.*

5. DO NOT use the bimini top as a winter storage cover. The life of these covers may be significantly shortened if exposed to harsh weather elements for long periods.

NOTICE

Boats stored outside in areas with heavy snow accumulation are more susceptible to damage, and should be inspected regularly during the winter months.





E - 15 GENERAL MAINTENANCE SCHEDULE

SERVICE	AT LAUNCH AND FIRST OPERATION*	25 HOUR CHECK EACH SEASON*	BI-SEASONALLY OR EVERY 6 MONTHS OR EVERY 100 HOURS*	SEASONALLY OR EVERY 12 MONTHS OR EVERY 200 HOURS*
Engine and Instrumentation	Refer to Section B			
Engine Maintenance	As Recommended by the Engine Manufacturer - Refer to Engine Manual			
Inspect Exhaust System Hoses, Connections and Components. (Condition & Leaks)				
Exhaust System Flushing (Note: Daily Flushing in Salt or Brackish Water)	As Recommended by the Engine Manufacturer (Refer to Engine Manual)			
Inspect Cooling System Hoses, Connections and Coolant Level	As Recommended by the Engine Manufacturer (Refer to Engine Manual)			
Propulsion System	As Recommended by the Engine Manufacturer (Refer to Engine Manual)			
Check Jet Pump Water Inlets and Jet Nozzles	Before Every Use			
Sacrificial Anodes	As Recommended by the Engine Manufacturer (Refer to Engine Manual)			
Check All Thru-Hull Fittings				
Test Emergency Shut-Off Switch				
Gauge Cleaning				
Controls Systems	Refer to Section B			
Throttle and Shift Adjustment				
Neutral Safety Switch Test				
Cable and Control Lubrication				
Steering Systems	Refer to Section B			
Steering Cable and Connection Inspection				
Steering Nozzle Bushings				
Electrical Systems	Refer to Section B			
Inspect Battery Connections				
Check Battery Water				
Check Battery Switch Operation				
ECM Connectors - Visual Inspection without Disconnecting (Every 10 Hours in Salt Water Use.)				
12 Volt Equipment Operation & Wiring Inspection				

* Or as Required

■ – Shaded areas indicate the time frame when service/inspection should be conducted.



SERVICE	AT LAUNCH AND FIRST OPERATION	* 25 HOUR CHECK EACH SEASON*	BI-SEASONALLY OR EVERY 6 MONTHS OR EVERY 200 HOURS*	SEASONALLY OR EVERY 12 MONTHS OR EVERY 200 HOURS*
Ventilation and Drainage	Refer to Section B			
Engine Blower Operation	Before Every Use			
Blower Vent System Cleaning				
Bilge Pump Operation and Cleaning	Before Every Use			
Check Transom Drain Plug				
Interior Equipment	Refer to Section C			
Thru-Hull Fitting Inspection				
Clean Cooler	As Required			
Exterior Equipment	Refer to Section C			
Clean Windshield	As Required			
Check PFD's for Serviceability and Correct Number	As Required			
Check Charge of Fire Extinguishers	As Required			
Wakeboard Tower Fittings & Fasteners				
Upholstery	Refer to Section E			
Clean Upholstery				
Clean Carpet				
Spray Upholstery with Lysol				
Check Seat Hardware				
Weather Covers	Refer to Section E			
Wash Weather Covers with Lysol				
Fuel System	Refer to Section B			
Inspect for Condition & Leaks - Fuel Lines, Connections, Pressure Relief Valves (Every 10 Hours in Salt Water Use.)				
Fuel Sender Inspection				
Fuel Filter Inspection				
Fuel Tank Inspection				

* Or as Required

■ – Shaded areas indicate the time frame when service/inspection should be conducted.



SERVICE	AT LAUNCH AND FIRST OPERATION	* 25 HOUR CHECK EACH SEASON*	BI-SEASONALLY OR EVERY 6 MONTHS OR EVERY 200 HOURS*	SEASONALLY OR EVERY 12 MONTHS OR EVERY 200 HOURS*
Fresh Water System	Refer to Section B			
Inspect Fresh Water System				
Fresh Water Tank				
Drain and Flush Fresh Water System				
Waste System	Refer to Section B			
Porta Potti Maintenance	As Recommended by the Manufacturer			
Drain and Flush Waste System				
Fiberglass Components and Hull	Refer to Section E			
Check All Fastenings (securing rails, seats, etc.)				
Clean Fiberglass Thoroughly				
Wax Hull Sides and All Non-tread Areas				
Inspect Fiberglass Areas for Damage				
Perform Minor Touch-up Repairs				
Sand Hull and Re-apply Anti-fouling Paint				
Woodwork & Composite Maintenance	Refer to Section E			
Clean Star Board	As Needed			
Clean Cockpit Table	As Needed			
Clean Plexiglass Components	As Needed			
Trailers	Refer to Section F			
Wax Trailer				
Lubricate Trailer Jack				
Lubricate Trailer Coupler				
Lubricate Trailer Winch				
Brake Operation	Before Every Use			
Brake Inspection				
Verify Trailer Light Operation (Turn, Brake, Running & Emergency)	Before Every Use			
Inspect Hubs/Disc Brakes				
Inspect Bearings & Seals				
Lubricate Bearings				
Springs, Hangers & Suspensions Parts				
Inspect Tightness of Wheel Lug Nuts				
Inspect Wheels				
Tire Pressure & Condition	Before Every Use			

* Or as Required

■ – Shaded areas indicate the time frame when service/inspection should be conducted.



F - 1 GENERAL TRAILER INFORMATION

NOTICE

Trailer models may vary. Please consult the trailer component manufacturer's information in your owner's packet for additional information.

The trailer must properly "match" the boat's weight and hull design. Scarab trailers are designed specifically for the Scarab models only. Please consult our website at www.scarabboats.com or your Scarab dealer for applicable trailer models. Scarab trailers meet or exceed the National Marine Manufacturers Association's trailer requirements.

Scarab manufactures bunk type trailers for the Scarab models only. The bunks are located specifically for Scarab boats and adequately support all parts of the boat. It is a "drive-on" type trailer which means winching the boat from the water is not normally necessary.

NOTICE

*If winching the boat onto the trailer, **be sure the bunks are wet to prevent damage to the boat or trailer.** DO NOT attempt to winch the boat forward when out of the water. Damage to the winch stand/assembly or tongue could occur.*

Scarab offers trailers with a painted finish or trailers with GatorHyde™ protective coating. The painted trailer is intended to be used in fresh water and the GatorHyde™ trailer in salt/brackish water.

NOTICE

Scarab does not recommend the usage of painted trailers for salt/brackish water conditions, as trailer life may be substantially reduced.

A. Regulations

Federal law requires that the trailer and tire registration information be compiled and recorded. The Scarab® boat registration includes trailer registration information. A tire registration form, included in the owner's packet, is to be filled out and returned to the tire manufacturer. Please see Section F-7 - "Supplemental Trailer Information" for additional information to assist you in completing the tire registration form.

NOTICE

Manufacturer's Tire Registry

Ensure to fill out your name and address on the tire registration form provided in your owners packet. Mail it to the tire manufacturer for the purposes of compliance with Federal defect notification regulations.

Laws covering such items as trailer brakes, lights, safety chains, etc., will vary from state to state. Please contact the motor vehicle department in your state for additional information.

B. Load Carrying Capacity

The certification label shows the maximum load-carrying capacity and is located on the port forward side of the trailer. The Gross Vehicle Weight Rating (GVWR) is the load-carrying capacity plus the weight of the trailer itself. DO NOT exceed the GVWR rating for the trailer.

NOTICE

When using or choosing a tow vehicle with the correct GVWR, you must consider not only the weight of the boat and trailer but also the weight of the fuel, water, equipment, etc. Refer to Table 1 below:

EQUIPMENT	WEIGHT (AVERAGE)
Battery	60 Lbs./Battery
Fuel	6.5 Lbs./Gal.
Water	8 Lbs./Gal.
Accessories	150 Lbs. (Approximate)

Table 1: Average Equipment Weight

If selecting a trailer from another manufacturer, check the load-carrying capacity. A trailer with a load-carrying capacity that is too low will be unsafe on the highway and could cause sudden failure of critical trailer components or abnormal tire wear. A trailer with too high of a load-carrying capacity that is sprung for heavy loads can damage a lighter boat.

NOTICE

DO NOT overload your trailer by placing camping gear or other heavy equipment in the boat. DO NOT exceed the GVWR rating. Damage to the hitch, coupler, or trailer may occur.

For trailers, the steps to determining correct load limit are:

- (1) Locate the statement “The weight of cargo should never exceed the XXX kg or XXX lbs.” on your vehicle’s placard. See Figure F1.
- (2) This figure equals the available amount of cargo and luggage load capacity.
- (3) Determine the combined weight of luggage and cargo being loaded on the vehicle. That weight may not safely exceed the available cargo and luggage load capacity.



TIRE AND LOADING INFORMATION

Total load should never exceed
kgs. or lbs.

TIRE	SIZE	COLD TIRE PRESSURE	SEE OWNER'S MANUAL FOR ADDITIONAL INFORMATION
FRONT			
REAR			
SPARE			

Figure F1: Tire Label

Improper weight distribution can place excessive strain on the towing vehicle and trailer. It can also cause the trailer to “fishtail” (sway side to side). Be sure gear and other items are distributed evenly in the boat.

C. Hitches

The load-carrying capacity of trailer hitches will vary between manufacturers and must equal or exceed the GVWR. Scarab trailers use surge brake systems and require a fixed hitch. Refer to Section F-2D Surge Brakes for more information.

Before hitching the trailer to the vehicle, make sure the proper size hitch ball is installed to match the coupler. The ball size is determined by the Gross

Vehicle Weight Rating or GVWR. The GVWR is printed either on the trailer plate or embossed on the tongue, coupler or actuator. For trailers with a GVWR of 7000 pounds or less a 2” ball is used. For trailers with a GVWR over 7000 pounds a 2 5/16” ball is used. This information may also be obtained on our website at www.scarabboats.com. Refer to Section F-3 Operation for additional information on hitches. Also, consult your Scarab dealer for his recommendation before purchasing a trailer hitch for your towing vehicle.

WARNING

*To help guard against a sudden failure while in use, **do not use a worn hitch ball.** Replace all worn or damaged parts.*

F - 2 TRAILER COMPONENTS

A. Bunk Supports

All bunk boards are made of pressure treated wood. This wood is rot resistant. All boards are covered with a high quality exterior grade carpet to protect the boat from damage during normal use.

Bunk supports run parallel to the keel and support the hull, extending beyond the transom. See Figure F2.

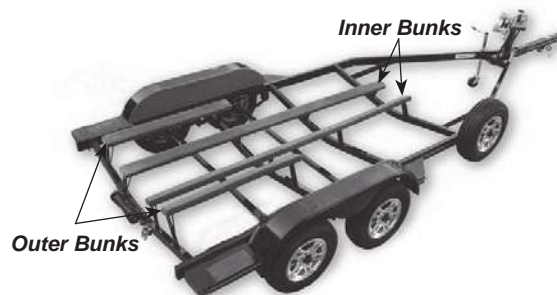

Figure F2: Trailer Bunks

Outer bunk supports provide stability for the boat. The inside bunks are the main weight bearing members. Keeping the tie-downs tightly fastened will prevent the boat from bouncing against the bunk supports.

NOTICE

Improper trailer setup can cause hull damage.

B. Tongue

Scarab trailers are designed with tongue weights between 7% and 11% of the total weight of the boat, fuel, gear and trailer. If the downward weight on the coupling ball does not fall within this range, coupler failure and towing instability may occur. If using another manufacturer's trailer, have the dealer check the tongue weight before trailering.

NOTICE

DO NOT use a bent or damaged tongue or coupler. Replacement parts may be ordered through a Scarab dealer.

On some models the trailer tongue is hinged. This allows for easier storage. The tongue is attached with clevis pin(s) with locking hair pin(s) or clevis pin keeper(s) to the trailer frame. Refer to Figure F3.

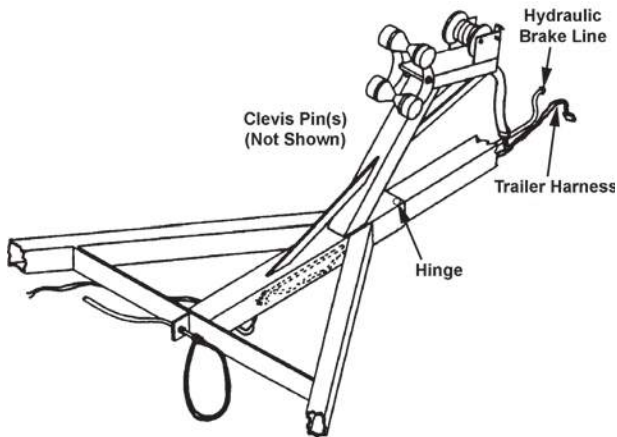

Figure F3: Trailer Tongue Assembly

To pivot the tongue on trailers models with exposed hinges:

1. Make sure the trailer jack is supporting the trailer load properly. Refer to Section F-2C on Swivel Jacks for additional information.
2. Disconnect the trailer from the tow vehicle.
3. Unplug the trailer's wire harness from the tow vehicle's trunk connector.
4. Remove the clevis pin keeper and clevis pin.

NOTICE

The tongue will exert some pressure on the clevis pins. It may be necessary to lift, push or wiggle the tongue to remove the clevis pins.

5. Pivot the tongue towards the trailer as far as it will go.

To reinstall, follow this procedure in reverse order.

1. Pivot the tongue until the clevis pin holes aligned.

NOTICE

When extending tongue ensure that the brake line and wire harness are not pinched. Failure to check could result in damage.

2. Insert clevis pin. **Always** be sure to insert clevis pin from the top and insert the clevis pin keeper.

NOTICE

The tongue will exert some pressure on the clevis pins. It may be necessary to lift, push or wiggle the tongue to insert the clevis pins.

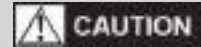

Make sure the trailer tongue is secure before hitching to the towing vehicle.

4. If towing the trailer, remember to plug the 5-wire tongue harness to the trunk connector wire harness of your tow vehicle.

C. Swivel Jack

The jack is designed to lift, lower and support the tongues of the trailers when not connected to the towing vehicle. Before unhitching the trailer, use the following guidelines when setting up the jack.

1. Pull on the locking pin release. See Figure F4.



Figure F4: Swivel Jack

2. Swivel jack to the vertical position.
3. Release the locking pin release and make sure the pin fully engages to lock the swivel jack in place.

CAUTION

Be sure dirt, sand, ice, etc., does not obstruct the proper seating of the lock pin.

4. When raising or lowering the jack, prevent the caster from rotating while cranking. Make sure the jack is planted on a firm and level surface before unhitching the trailer. Be sure to block the trailer's wheels should it be parked on an incline and removed from the tow vehicle.

WARNING

To prevent personal injury or damage to the boat and trailer, observe the following:

- *NEVER pull on the lock pin when any trailer weight is on the trailer jack.*
- *DO NOT move the trailer when resting on the swivel jack. Use towing vehicle to move the boat and trailer.*
- *Keep body and feet clear of trailer tongue when raising or lowering jack.*

Always remember to swivel jack to the horizontal position before towing the trailer. Damage to the caster and jack may result.

The swivel jack provided on the certain Scarab trailer can be removed from the trailer to allow for maintenance or repairs. Follow the manufacturer's recommendations provided in the owner's packet.

D. Surge Brakes & Coupling Assembly

Surge brakes are available on certain Scarab trailers. When equipped, surge brakes operate automatically when the tow vehicle's brakes are applied. When the tow vehicle slows down or stops, the forward momentum or "surge" of the trailer against the hitch ball applies pressure to a master cylinder in the trailer coupler. The master cylinder supplies hydraulic pressure through the hydraulic system which activates the trailer's disc brakes. See Figure F5. Please refer to the manufacturer's literature included in your owner's packet for further details regarding operation and maintenance.

To hitch the trailer to the tow vehicle, place the coupler latch in the open position to unlock the coupler. See Figure F5. Push down on the coupler latch to lock the trailer to the ball hitch. Push coupler latch lever back until the latch engages and is properly seated. The safety pin, provided with the trailer, or a padlock **must be inserted completely** in the forward coupler latch hole. See Figure F6. This helps ensure the coupler's latch remains in the locked position during towing of the trailer. Refer to Section F-3 Operation for additional information on couplers and hitching to the tow vehicle.

NOTICE

Anti-sway devices as used on recreational vehicles (RV's) are not applicable to surge brake systems and should not be used on Scarab trailers.

DO NOT use a trailer hitch with moving parts. The brakes could activate when traveling downhill. Always use a fixed hitch.

Release lever must be in open position to remove from or place on ball.

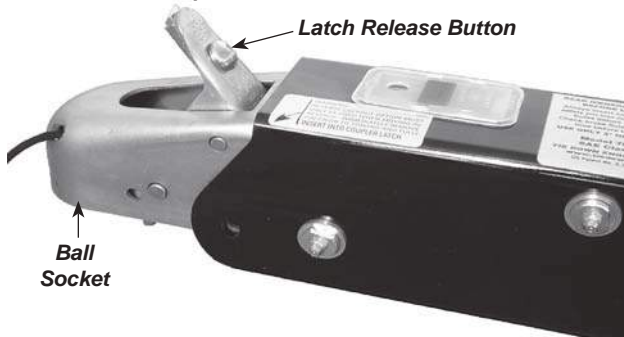

Figure F5: Brake Actuator & Coupling Assembly - Open

Release lever must be fully closed and pin inserted before towing.

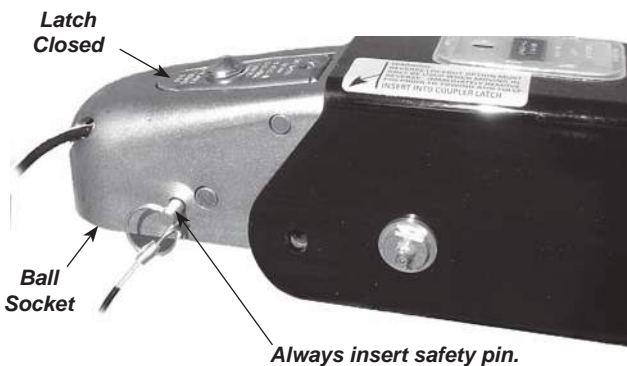

Figure F6: Brake Actuator & Coupling Assembly - Closed

The brake actuator and coupling assembly comes with a 5-wire plug for connecting to the tow vehicle's trailering harness. Figure F7 depicts the 5-wire plug, the color of the individual wires, and the designated circuit for each wire.

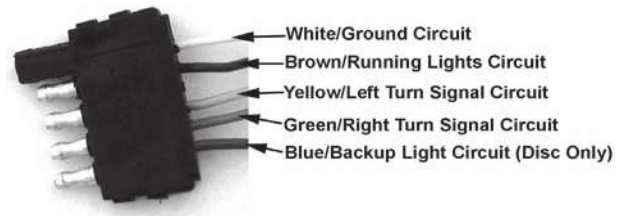

Figure F7: 5-Wire Plug Harness

For maintenance and other information, refer to the manufacturer's literature included with in the owner's packet.

E. Winch

Winch operating instructions are listed below.

To release the winch, place the ratchet in the REVERSE or NEUTRAL position. The winch handle may spin when pulling on the winch line.



To prevent personal injury, observe the following:

A spinning winch handle can cause injury. Be sure the area is clear.

DO NOT release the handle when the ratchet is disengaged. Be sure the ratchet is engaged or no load is on the winch before releasing the handle.



To prevent personal injury, ALWAYS inspect the winch line and hook before each use. NEVER use line that is worn or frayed. NEVER let anyone stand in or behind a boat while pulling with the winch.

To rewind the winch, ALWAYS engage the ratchet first. Turn the handle in the appropriate direction to rewind the line.

CAUTION

A clicking sound will be heard when the winch is properly engaged. If a clicking sound is not heard, DO NOT release the handle. Handle may spin backwards. Lower the load into a safe position before releasing the handle.

Refer to the manufacturer's literature, included in the owner's packet, for more information on winch operation.

F. Tires & Wheels

The tires installed on Scarab trailers meet the trailer load requirements for each model. Before trailering, make sure the tires are inflated according to the manufacturer's recommendation. Tire pressure information is noted on the tire and in the manufacturer's literature included in the owner's packet. Also refer to Section F-7 - "Supplemental Trailer Information" for additional information.

NOTICE

DO NOT use an air wrench or other power equipment to install lug nuts on aluminum (Mag) wheels. Damage to the wheel may result. Lug nuts should be torqued to 90-110 foot pounds.

Examine the tires frequently for snags, bulges, excessive tread wear, separations or cuts. Refer to the manufacturer's literature included in the owner's packet for more information.

NOTICE

The warranty of the tire is administered by the manufacturer of the tire. Contact the tire manufacturer regarding any warranty concerns relating to your tires.

G. Spare Tire Carrier

Spare tires are optional on all Scarab trailers. A spare tire carrier is bolted to the trailer frame and is available in painted or GatorHyde™ finish. A spare tire carrier and wheel can be ordered from your Scarab dealer. Refer to Figure F8.

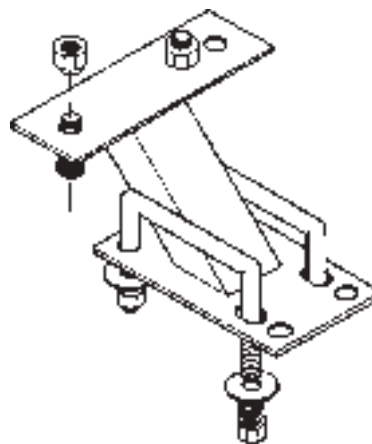

Figure F8: Spare Tire Carrier

H. Lights

Scarab trailers are equipped with taillights, brake lights, turning signals, and clearance lights. All lights are sealed to prevent moisture from entering. The taillight assemblies may be replaced. The LEDs of the taillight are also enclosed in a sealed housing which should not be opened. See Figure F9. Contact your Scarab dealer for assistance should replacement be necessary.



Figure F9: Tail Light - LED

Consult your dealer for state trailer regulations concerning lighting and other optional equipment.

I. Tie-downs

The boat should be secured to the trailer by tie-downs to prevent damage to the hull. The boat may shift or bounce against the bunks or hull supports if not secured. It may also slide or fall off the trailer while being towed.

There are two types of tie-downs being used:

1. **Bow Tie-downs:** A bow stop to hold the front of your boat in place is located on the winch stand. It should be positioned so that the winch line pulls straight and is parallel to the trailer frame. A separate tie-down should then be attached to hold the boat. See Figure F10.

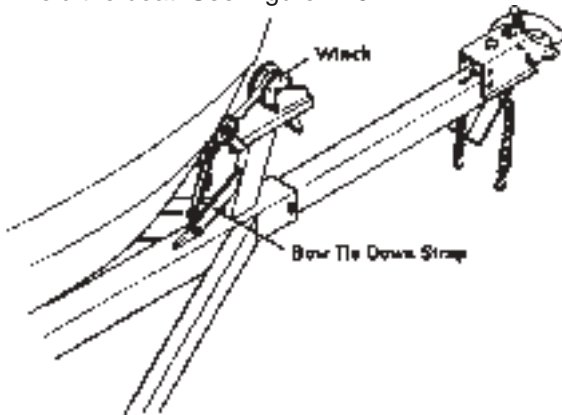

Figure F10: Bow Tie Down Strap

NOTICE

DO NOT rely on the winch cable (or line) alone to hold the bow of the boat against the bow stop. A bow tie-down is provided with the Scarab trailer.

2. **Rear Tie-downs:** It is very important that the transom is resting centered, securely on the bunk supports at the rear of the trailer. On some models rear tie-downs are attached to the trailer and used to secure the boat to the trailer. Tighten the tie-downs to prevent the boat from moving. See Figure F11.



Figure F11: Rear Tie Down Straps

The **bow tie-down** is a mechanical ratchet device. To allow the strap out, follow the procedures below:

1. Place two fingers on spring-loaded release, and pull release away from spindle/gear.
2. Open tie-down to a flat, 180° position.

NOTICE

Spring-loaded release should click into a notch on the handle. Both spring releases should clear the inner gear.

3. Pull strap out. The inner spindle/gear should move freely.

To ratchet strap or tighten down the strap on the boat:

1. Place two fingers on spring-loaded release, and pull release away from spindle/gear.
2. Bring both handles together. Both handles should ride on the inner gear.
3. Open (to approximately 110°) and close handles to ratchet. Leave in closed position to maintain pressure on strap.

The **rear tie-down straps** are also a mechanical ratchet devices. To allow the strap out, follow the procedures below:

1. Place two fingers on spring-loaded release and push release downward while pushing the handle forward towards the trailer. See Figure F12.



Figure F12: Rear Tie Down Strap - Release

2. With other hand, pull strap upward. The inner spindle/gear should move freely.

To ratchet strap or tighten down the strap on the boat:

1. Place hand on handle and lift upward and away from trailer until the spindle/gear locks and handle stops.

2. Return handle to start position and repeat step one. Continue until strap has been sufficiently tightened. See Figure F13.

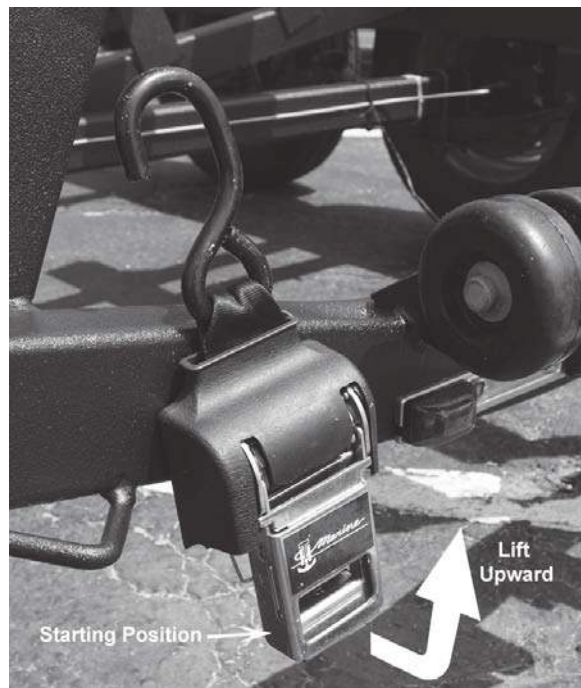

Figure F13: Rear Tie Down Strap - Tightening

F - 3 OPERATION

A. Hitching Trailer

Before towing, the trailer must be properly hitched to the tow vehicle.

WARNING

To ensure proper engagement of the actuator's coupler to the tow ball, **DO NOT** use a multi-piece ball, an incorrectly sized ball, or a worn/damaged ball. Please refer to the trailer's certification plate, coupler or actuator on the trailer for Gross Vehicle Weight Rating (GVWR) or visit our website at www.scarabboats.com. Trailers with a GVWR of 7000 pounds or below require a 2" tow ball and trailers above a GVWR of 7000 pounds require a 2 5/16" tow ball.

1. Position actuator ball socket above ball hitch.
Note that the actuator's emergency stop is not engaged. Refer to Figure F14. To manually release the emergency stop refer to Step 8 and Figure F15.

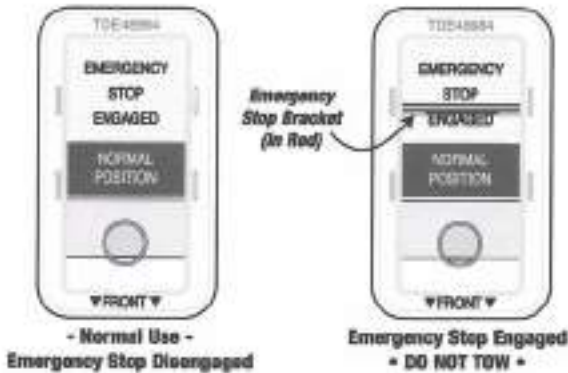

Figure F14: Emergency Break-Away System - Normal Use & Emergency Stop Indicator Positions

2. Open the coupler latch fully to allow the ball latch to rotate open. Note: You will have to remove the safety pin from the coupler latch hole to fully extend the coupler latch. The coupler latch will remain up to indicate that it is not yet attached to the ball. See Figures F5 & F6.
3. Lower trailer tongue until ball is seated or rests in ball socket. Ensure the ball latch is in the correct position to retain the hitch ball.
4. Close coupler latch by pushing latch down until latch engages properly.

The coupler latch should close and secure freely with finger pressure when ball is properly seated in the ball socket. **If the coupler latch does not close freely or does not engage properly, do not tow trailer. DO NOT** force the coupler latch into closed position, otherwise damage could result. Inspect actuator for bent parts or cause of improper operation.

NOTICE

Keep the coupler clean and lubricated to prevent damage to the coupler.

5. Make sure the actuator is secure. If unsure, extend the trailer tongue jack to the ground and lift (with the jack) the vehicle and trailer combination approximately 2" to 4". If the ball does not disengage and remains secured, the actuator is latched properly.

NOTICE

To prevent back injury, DO NOT physically lift the trailer tongue when loaded.

6. The safety pin, provided with the trailer, or a padlock **must be inserted completely** in the coupler latch hole. This ensures the coupler's locking latch remains in the locked position during towing of the trailer. Use of a padlock will help to deter theft.
7. Connect actuator break-away cable S-hook securely to one of the tow vehicle hitch's safety chain connection points. Do not connect S-hook to the safety cables or chains. The cable should hang clear of trailer tongue and be long enough to permit short radius turns without pulling the break-away cable. **DO NOT** loop the break-away cable around a bracket and loop it back onto itself.
8. If the break-away system is accidentally applied while unhitching, Press down the emergency stop release bracket with a screwdriver the E-stop bracket snaps back into the "NORMAL POSITION". See Figure F15.

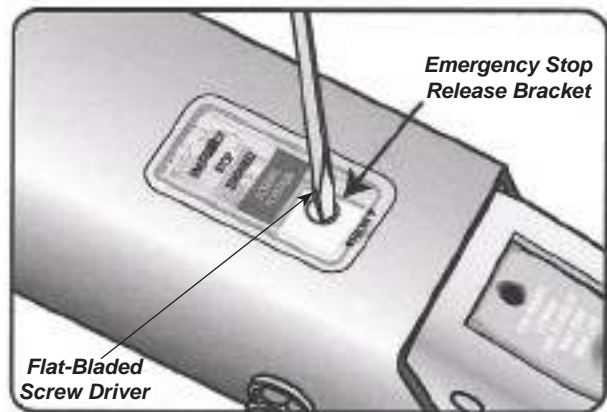

Figure F15: Emergency Break-Away System - Manual Release

WARNING

When resetting the break-away system keep hands and fingers clear as you reset the mechanism. Hydraulic pressure held in the system may cause the assembly to snap back suddenly.

CAUTION

The break-away system is not designed to operate if the trailer does not separate completely from the tow vehicle, or if the trailer tongue “submerges” and goes beneath the tow vehicle. **DO NOT** use break-away cable as a parking brake.

- Safety cables are provided and must be used. Cross the safety cables under the coupling and attach to the towing vehicle’s frame or bumper. See Figure F16. Always allow slack for turns. Regulations vary from state to state. Please check the local laws in your state.

WARNING

The trailer’s safety cable length **MUST** be set short enough so the actuator’s break-away cable is **NOT** pulled if the coupler separates from the tow vehicle’s hitch but remains connected by the safety cables. The break-away system should only be activated after **BOTH** the trailer’s coupler and safety cables have failed and allowed the trailer to completely separate from the tow vehicle. Provide just enough slack in the trailer safety cables to allow short radius turns. The cables should not drag on the ground. **Safety cables must be used.**

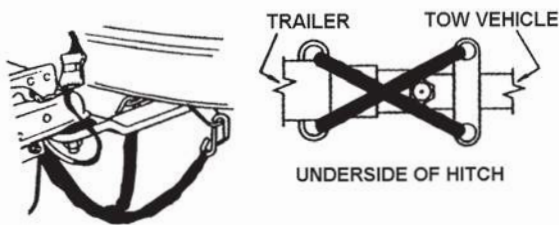

Figure F16: Crossing the Safety Cables

WARNING

To reduce the risk of break-away accidents, be sure coupler is seated and safety cables are crisscrossed before trailering.

- Retract jack fully and place in trailering/horizontal position.

- Check for proper tow vehicle-trailer hookup. The tow vehicle and trailer should be level with a positive tongue load. Scarab trailers are designed with tongue weights between 7% and 11% of the total weight of the boat, fuel, gear and trailer. The trailer should be close to level. If unsure of tongue load and trailer position, consult your Scarab dealer before proceeding.

WARNING

Be sure the tow vehicle and trailer are level and have a positive tongue load. This will allow the brake actuators to function properly on trailer models having such braking systems.

Be sure to read the manufacturer’s literature, included in the owner’s packet, before towing your Scarab boat and trailer.

B. Backing Up With Surge Brakes

Follow the steps listed above for hitching the trailer before backing up.

- Before backing up a slope or through soft ground, pull the trailer forward slightly to assure the actuator socket is in the fully forward position.
- Back the trailer up.

CAUTION

Avoid sharp turns. This could bend, create extreme stress or fracture either the actuator or trailer tongue.

NOTICE

Be sure to check for obstacles or persons behind the trailer before backing up. Also, adjust your mirrors for clear view of the area behind the trailer.

- If the trailer is to be uncoupled from the tow vehicle after backing, block all trailer wheels and pull forward slightly to take strain off the actuator. Uncouple the actuator by lifting the release handle and raise the trailer tongue with the jack.

For most trailering conditions, the brake actuator will allow you to back up normally using a 5-wire harness connector. However, if the coupler is not wired or if there is a failure the trailer can still be backed up by using the manual brake lockout.

To use your lockout, check that no force is being applied to the actuator. This is achieved by positioning the towing vehicle and the trailer on a flat service, or with the trailer downhill from the tow vehicle. Set the vehicle's parking brake.

Insert a 5/16" x 4" bolt or screwdriver into the reverse lockout position hole (upper hole on side of actuator). This will then block movement of the actuator. See Figure F17. Reverse lockout option must only be used when moving in reverse and when braking is not required. Immediately remove bolt or screwdriver prior to towing after backing up is completed.

NOTICE

The reverse lockout position hole and actuator hole may not be in alignment. You may have to block the trailer's wheels and pull the trailer forward enough so the holes are aligned and a bolt or screwdriver may be inserted completely into the reverse lockout position holes.



Figure F17: Reverse Manual Brake Lockout

WARNING

Never allow the bolt or screwdriver to remain in the reverse lockout position hole. After reverse maneuvering, always remove bolt or screwdriver from the reverse lockout position hole. Failure to remove bolt or screwdriver from reverse lockout position hole will prevent forward movement braking which can result in serious property damage, injury or death.

NOTICE

Trailer components may be different between models and may change during the model year. Be sure to read all manufacturer's literature supplied with your Scarab trailer.

F - 4 TRAILERING

A. Checklist

Before trailering, the trailer should be inspected for the following:

1. Check tires for proper inflation. Under-inflated tires heat up rapidly and may blowout or cause uncontrolled swaying.
2. Check lug nuts for proper tightness (90-110 ft-lbs).
3. Be sure the coupler is secured to the trailer hitch and safety cables are attached.
4. Be sure trailer taillights and turning signals are operational.
5. Check the brakes for proper operation prior to departure.
6. Check tie-downs and make sure boat is secured to the trailer.
7. Check the springs and under carriage for loose parts.
8. Before towing, close and secure all hatches, doors, and windows. Securely store all equipment and canvas. Installed tops, side curtains, and aft curtains can be damaged while towing.



9. Carry a spare tire for both the trailer and towing vehicle. On extended trips, carry spare wheel bearings, seals, and races. Be sure and carry the proper tools to complete the repairs.

 **WARNING**

To avoid bearing failure and possible wheel loss, keep wheel bearings properly lubricated. Inspect the wheel bearings periodically and check for damage.

10. Before trailering, inspect the bearings for wear and adequate lubrication. When traveling, check the wheel hubs during stops at gas stations, restaurants or other places. If the hub feels abnormally hot, the bearing should be inspected before continuing the trip.

B. Tactics

NOTICE

Be sure to check the towing vehicle manufacturer's literature for recommendations on towing.

1. Install outside rear view mirrors on both sides of the towing vehicle to improve vision. Check the rear view mirrors at frequent intervals to be sure trailer and boat are riding smoothly.
2. Allow at least one car and trailer length between vehicles for each 10 mph. **DO NOT** tailgate.
3. Use low gear (on manual transmissions) when traveling up steep hills or over sand, gravel, or dirt roads.
4. Use care if shifting to a lower gear while traveling downhill. This could activate the trailer's surge brakes for the duration of the downhill run and cause overheating. Extended overheating could result in complete loss of the trailer brakes.

To help prevent overheating, slow down while approaching the crest of a hill and maintain a slow, controlled downhill speed. Apply brakes in short intervals to allow time between braking for the brakes to cool off.

5. When rounding turns on highways or streets, **DO NOT** cut corners. Also, travel slowly over railroad tracks.

6. If the trailer begins to "fishtail" when accelerating, reduce speed until it ceases. If the trailer "fishtails" again during acceleration, stop to investigate the cause of the problem. Check for improper trailer load and uneven weight distribution inside the boat. Check the winch line and tie-downs. Also check the tires for proper inflation or damage. If necessary, redistribute the load before continuing.

For additional information on trailering, refer to the "Boating Basics" manual included in the owner's packet.

F - 5 MAINTENANCE

A. Care of Exterior Finish

When using the trailer, keep in mind the paint can scratch and become marred during normal use. In most cases, touch-up paint can be ordered. Please contact a Scarab dealer for assistance.

Some maintenance is required to maintain the finish and minimize rusting. The trailer should be washed and rinsed with clean water immediately after each use. Depending upon use, waxing is recommended twice a year. Use paste wax designed for enamel paint.

On trailers with GatorHyde™, rinse all exposed metal parts thoroughly with only clean water after use. The GatorHyde™ protective coating may be cleaned with mild dishwashing soap in a bucket of water along with a nylon boat brush. Rinse thoroughly with clean water.

To rejuvenate as well as UV protect worn and faded GatorHyde™ you may purchase a product called GatorGloss™. To place an order you can phone Elastomer Specialties, Inc. at 918-485-2835 or Fax 918-485-2856.

B. Bunks

The bunks should be replaced if they are cracked, warped, or evidence of dry-rot is found. The replacement boards should be treated lumber of the same length and width. Re-carpet bunks with high quality exterior grade carpet.



DO NOT burn damaged or broken bunks. Toxic fumes will be released. Dispose of bunks properly.

C. Swivel Jack

Keep the swivel jack clean of dirt, tar, and mud. Lubricate every six months. The swivel jack's inner ram should be lubricated with SAE 30 weight oil. The top cover may be removed to lubricate the gears with wheel bearing grease.

Replace all worn and damaged parts. ALWAYS use the manufacturer's replacement parts. Replacement parts may be ordered through your Scarab dealer.

For more information on maintenance, refer to the manufacturer's literature included in the owner's packet.

D. Brake Actuator & Coupling Assembly

When storing or parking your trailer, keep the brake actuator and coupling assembly (coupler) off the ground to prevent dirt buildup in the ball socket. Keep the coupler clean of dirt, tar, and mud. Lubricate the coupler with SAE 30 weight oil every six months or as often as necessary. Replace any worn or defective parts. If the coupler is damaged, contact your Scarab dealer for replacement parts. DO NOT use a damaged or bent coupler assembly.

For more information on maintenance, refer to the manufacturer's literature included in the owner's packet.

NOTICE

The trailer should be set up at a slight angle to allow for water to drain aft in the boat.

E. Winch

The winch should be kept clean of dirt, ice, paint, etc., and the spur gears should have a film of grease on them at all times. Apply several drops of SAE 30 weight oil to the ratchet pawl mechanism, bushings and pinion shaft threads twice per season.

Replace any worn or damaged parts. For more information on maintenance, refer to the manufacturer's literature included in the owner's packet.

F. Lights

Inspect wiring for cuts or bare wire which could cause electrical shorts. Repair or replace defective wiring. Replace cracked or damaged lights and always carry spare bulbs if applicable. Replacement parts may be ordered through a Scarab dealer.

G. Tie-downs

Replace frayed or damaged tie-downs. Periodically, lubricate the ratchet mechanism with a fine oil or silicone spray. Replacement parts may be ordered through a Scarab dealer.

H. Wheels

Some maintenance is required to maintain the finish of the rims. Chrome wheel rims may be cleaned with dishwashing soap and water. Also, there are cleaning products specifically for chrome that can be used. Cleaners may be obtained from Scarab dealers and your local auto parts stores. The aluminum wheel manufacturer recommends a product by Priority One® called Pro-Long Aluminum/Chrome Wheel Protectant™. Galvanized rims should be rinsed only with clean water immediately after each use.

NOTICE

ALWAYS read the manufacturer's instructions on the label before using any product.

I. Brakes

Keep the actuator clean of dirt, tar, and mud. The actuator and internal parts should be lubricated at all times with SAE 30 weight oil. The hitch ball may be lubricated with automotive grease or lubricant made for hitch balls.

Periodically inspect the brake system for leaks. Check all hoses for cuts or wear. Replace all defective hoses. The master cylinder should be filled within 1/2 inch from the top of the reservoir.

At the beginning of each year, inspect the brakes for excessive wear, have linings replaced if necessary.

If the brakes need bleeding, consult your Scarab dealer for assistance. If unavailable, a brake or auto repair facility can perform the repair.

Refer to the manufacturer's literature included in the owner's packet for additional information on the brake system.

J. Bearings

Wheel bearings and seals should be inspected at the same time as brakes. Have worn or defective parts replaced.

The Scarab trailer is equipped with Vortex hubs/spindles from Tie Down Engineering and the information which follows comes from the manufacturer's literature. The hubs are pre-grease and assembled at the factory and should not require any additional adjustments. See Figure F18.



Figure F18: Vortex Hub

Should the hub/bearings require additional lubrication for any reason, the Vortex lubrication system allows you to do so without removing the hub or having to re-adjust the bearings. New Lucas Oil Marine grease is pumped into the zerc fitting at the end of the spindle, travels to the rear bearing where the new grease pushes out the old grease through the rear bearing, center of hub, and then through the front bearing. See Figure F19.

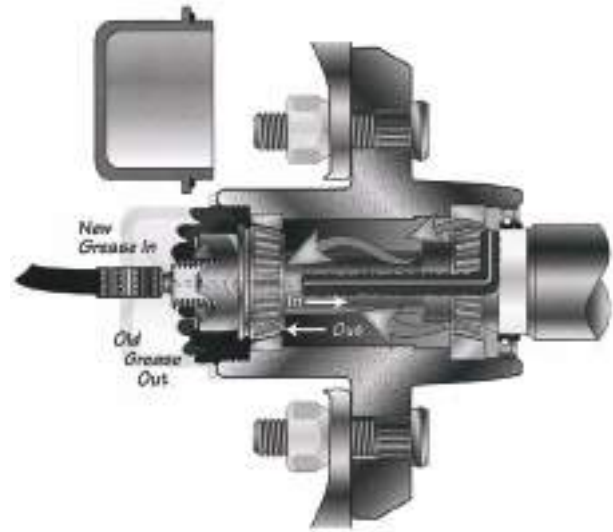

Figure F19: Vortex Lubrication System (Adding Grease)

To add or change Lucas Oil Marine grease in the Vortex hub follow these steps:

1. Remove the Vortex grease cap, unscrewing in a counterclockwise rotation.
2. Use a standard grease gun loaded with Lucas Oil marine grease to pump grease into the zerc fitting located on the end of the spindle.
3. Pump the Lucas Oil Marine grease into the zerc fitting while slowly rotating the wheel. Grease will flow out of the hub around the front bearing.
4. When the grease appears to be the new clean grease, remove the grease gun.
5. Replace the Vortex grease cap. Turn in a clockwise rotation until the o-ring on the cap is in contact with the hub surface. Turn an additional 1/4 turn to seal the Vortex cap to the hub. (This is similar to installing an oil filter in an automobile)

NOTICE

To maintain the factory warranty, Lucas Oil Marine grease must be used when adding or replacing grease in the vortex hub.

NOTICE

Most bearing failures are due to improper maintenance. Be sure to inspect bearings and seals as noted in Section F-6B and refer to the manufacturer's literature included with your trailer.

F - 6 AXLE INSPECTION & REPAIRS

As a general rule, repairs and maintenance should be performed by qualified servicing personnel. Our axle manufacturer recommends that a certified mechanic should be consulted on the following items:

1. Broken axle
2. Broken spring
3. Worn spring eye bushing parts
4. Sagging springs
5. Welding fatigue
6. Serious leakage of seal
7. Tire wear
8. Loose or worn suspension parts
9. All brake related adjustments, inspections and problems



Removing the Vortex Hub for inspection or maintenance should be done in a safe location away from moving vehicles.

A. Removal of Hub

The following instructions pertain only to trailers manufactured by Scarab. To remove the hub to inspect the bearings and seals, refer to Figure F20 and the following instructions:

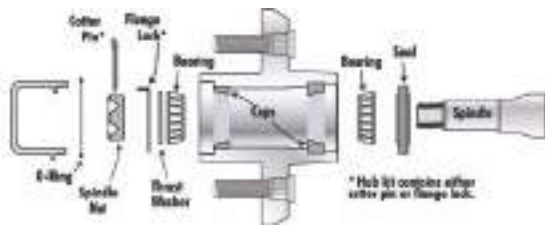

Figure F20: Axle Components

1. Elevate the trailer on level ground using the manufacturer's instructions. Always use jack stands or other solid supports. Do not rely on a jack to support the trailer. Block wheels to keep the trailer from rolling.

2. Remove the tire/wheel assembly.
3. Place a newspaper or cloth on the ground under the hub to keep any parts from falling onto a dirty surface.
4. Remove the Vortex grease cap by unscrewing in a counter clockwise rotation.
5. Remove the cotter pin, castle nut (in a counter-clockwise rotation) and washer.
6. Remove the hub from the spindle. If you have disc brakes, you will need to remove the brake caliper to remove the rotor. Follow separate instructions for disc brake rotor removal.
7. Be careful not to allow the bearing

B. Bearing/Seal Inspection and Replacement

When inspecting bearings or seals:

1. Inspect the grease seal for damage, tears, or cracks. If there is no damage or leakage is not occurring, the seal is in good condition.

If the seal is torn or cracked, then it should be replaced. The seal can be pried out of the hub with a screw driver. Be sure to replace the seal using the recommended replacement parts. Parts can be obtained from your Scarab dealer.

2. When inspecting the bearing, check for corrosion and wear. If any rust or wear exists on the bearing, then remove and replace with the manufacturer's recommended part.
3. If the bearings are in good condition, repacking the grease should be done at this time. Hand pack each bearing individually using a premium water-resistant wheel bearing grease.

NOTICE

To maintain the factory warranty, Lucas Oil Marine grease must be used when adding or replacing grease in the vortex hub.

C. Hub Reinstallation

1. To re-install, coat bearings with Lucas Oil Marine Grease before re-installing.

2. Install bearings and place hub on spindle in reverse order as listed in the Section F6-A - "Removal of Hub". Rotate the hub while applying approximately 50 ft-lbs. of torque to the spindle nut. This translates into a full hand pressure load with a 12" long wrench. This "seats" the bearings.
3. Loosen the spindle nut to remove the torque applied. **DO NOT ROTATE THE HUB.**
4. Tighten the spindle nut until snug, backing off only enough to line up the cotter pin with the hole in the spindle.
5. Bend the cotter pin into place.
6. Load hub with "Lucas Oil Marine" grease using the instructions for adding or changing grease Section F5-J - "Bearings" and/or manufacturer's Literature.
7. Replace the Vortex grease cap. Turn in a clockwise rotation until the o-ring on the cap comes in contact with the hub surface. Turn an additional 1/4 turn to seal the Vortex cap to the hub. (This is similar to installing an oil filter in an automobile).
8. Replace tire/wheel, torque lug nuts according to wheel manufacturer's instructions.
9. Test hub for proper end play by grabbing the tire and pulling the tire from side to side. Readjust if necessary.

**NOTICE:
IMPORTANT**

Re-check lug nuts after 25 miles of use.

Refer to Sections F-2F and the F-7 for additional information.

F - 7 SUPPLEMENTAL TRAILER INFORMATION

A. Information Contained on Sidewall of the Tire

Both U.S. and Canada Federal regulations require tire manufacturers to place standardized information on the sidewall of all tires. This information identifies and describes the characteristics of the tire. See Figure F21.

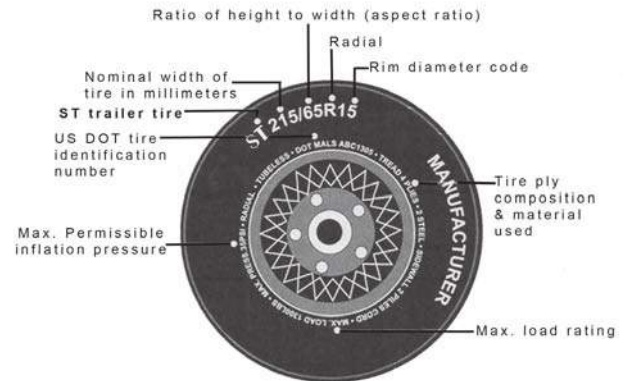

Figure F21: Axle Components

Maximum Permissible Inflation Pressure: Indicates the tire manufacturer's maximum permissible pressure and/or the pressure at which the maximum load can be carried by the tire. Refer to the Certification Label on the port forward half of the trailer for the correct tire pressure for your trailer.

U.S. DOT Tire Identification Number (TIN): This begins with the letters 'DOT' and indicates the tire meets all federal standards. The next two numbers or letters are the plant code designating where it was manufactured, the next two are the tire size code, and the last four numbers represent the week and year the tire was built. For example, the numbers 5110 mean the tire was built the 51st week of 2010. The numbers are identification codes used for traceability. This information is used to contact customers if a tire defect requires a recall.

ST: Indicates the tire is a special tire for trailers in highway service.

215: Indicates the nominal width of the tire in millimeters from sidewall edge to sidewall edge. In general, the larger the number, the wider the tire will be.
65: Indicates the aspect ratio which gives the tire's ratio of height to width.

R: Indicates a "radial" type tire.

15: Indicates the wheel or rim diameter in inches.

Tire Ply Composition and Materials Used: Indicates the number of plies or the number of rubber-coated fabric in the tire tread and sidewall. Tire manufacturers also must indicate the ply materials in the tire and the sidewall, which include steel nylon, polyester, and others.

Maximum Load Rating: Indicates the maximum load in kilograms and pounds that can be carried by the tire. Refer to the Certification Label on the port forward half of the trailer for the correct tire pressure for your trailer.

B. Sample Tire Registration

NOTICE:

Manufacturer's Tire Registry: Be sure to fill out the tire registration form provided with your owner's packet. Mail it to the tire manufacturer for the purpose of Federal Defect Notification Regulations. See Figure F22.

IMPORTANT

In case of a recall, we can reach you only if we have your name and address. You **MUST** send in this card to be on recall list. **Do it today.**

SHADED AREAS MUST BE FILLED IN BY SELLER

CUSTOMER'S NAME (PLEASE PRINT)	TIRE BRAND	TIRE IDENTIFICATION NUMBER															
		QTY	1	2	3	4	5	6	7	8	9	10	11	12	13		
CUSTOMER'S ADDRESS																	
CITY STATE ZIP CODE																	
NAME OF DEALER WHICH SOLD TIRE																	
DEALER'S ADDRESS																	
CITY STATE ZIP CODE																	
DEALER NON-SID #																	

Figure F22: Sample Tire Registration Form

C. Inflating Your Tires

Safe operation of your trailer requires that your tires are properly inflated. Remember that a tire can lose up to half of its air pressure without appearing flat. Before each trip, check your tires with a tire gauge, including the spare (if equipped). Inflate all tires to the inflation pressure recommended on the Tire Label and/or on the Certification Label located on the port side of the forward half of the trailer. See Figures F23 & F24. Failure to follow the tire pressure recommendations can cause uneven tread wear patterns and adversely affect the way your trailer handles.

TIRE AND LOADING INFORMATION

Total load should never exceed
kgs. or lbs.

TIRE	SIZE	COLD TIRE PRESSURE	SEE OWNER'S MANUAL FOR ADDITIONAL INFORMATION
FRONT			
REAR			
SPARE			

Figure F23: Tire Label

Labels located on the port side of the forward half of the trailer.

MANUFACTURED BY / FABRIQUE PAR: _____ DATE: _____

GVRW / PNBV KG (LB) TIRES / PNEU _____

GAWR(EACH AXLE) / PNBE (CHAQUE ESSIEU) KG (LB) LOAD CAPACITY _____

RIMS / JANTE _____ KPA(PSI / LPC) SINGLE DUAL

COLD INFL. PRESS. / PRESS. DE GONFL. A FROID _____

THIS VEHICLE CONFORMS TO ALL APPLICABLE U.S. FEDERAL MOTOR VEHICLE SAFETY STANDARDS IN EFFECT ON THE DATE OF MANUFACTURE SHOWN ABOVE.
THIS VEHICLE CONFORMS TO ALL APPLICABLE STANDARDS PRESCRIBED UNDER THE CANADIAN MOTOR VEHICLE SAFETY REGULATIONS IN EFFECT ON THE DATE OF MANUFACTURE. - CE VEHICULE EST CONFORME A TOUTES LES NORMES QUI LUI SONT APPLICABLES EN VERTU DU REGLEMENT SUR LA SECURITE DES VEHICULES AUTOMOBILES DU CANADA EN VIGUEUR A LA DATE DE SA FABRICATION.

V.I.N. / N.I.V. _____ TYPE / TYPE: TRAILER TRA / REM _____

Figure F24: Certification Label



When weather temperature changes occur, tire inflation pressures also change. A 10° F (6° C) temperature drop can cause a corresponding drop of 1 psi (7 kPa) in inflation pressure.

NOTICE:

Under-inflation is the most common cause of tire failures and may result in severe tire cracking, tread separation or “blowout”, with unexpected loss of vehicle control and increased risk of injury. Under-inflation increases sidewall flexing and rolling resistance, resulting in heat buildup and internal damage to the tire. It also may result in unnecessary tire stress, irregular wear, loss of vehicle control and accidents. A tire can lose up to half its air pressure and not appear flat!

To check the pressure in your tire(s):

- 1: Check your tire(s) when they are “cold”. The term cold does not relate to the outside temperature. Rather, a cold tire is one that has not been driven for at least three hours. When you drive, your tires get warmer, causing the air pressure to increase. Therefore, to get an accurate tire pressure reading, you must measure the tire pressure when the tires are cold or compensate for the extra pressure in warm tires.
- 2: Remove the cap from the valve on one tire, then firmly press the tire gauge onto the valve and measure the pressure with the tire gauge.
- 3: Add (or remove) enough air to reach the recommended air pressure indicated on your Certification Label and or Tire Label. See Figures F23-F25.

4: Replace the valve cap.

5: Repeat this procedure for each tire, including the spare.

Tire Care:

Periodically inspect the tire treads for uneven or excessive wear and remove objects such as stones, nails, or glass that may be wedged in the tire grooves. Check for holes or cuts that may permit air leakage from the tire and make necessary repairs. Also inspect the tire sidewalls for cracking, cuts, bulges, and other signs of damage or excessive wear. If internal damage to the tire is suspected, have the tire removed and inspected in case it needs to be repaired or replaced. For your safety, tires that are damaged or show signs of excessive wear should not be used because they are more likely to blow out or fail. Improper or inadequate trailer maintenance can cause tires to wear abnormally. Inspect your tires, including the spare frequently, and replace them if one or more show signs of damage or excessive wear.

**NOTICE:
AGE**

Tires degrade over time, even when they are not being used. It is recommended the tires generally be replaced after 6 years of normal service. Heat caused by hot climates or frequent high loading conditions can accelerate the aging process. You should replace the spare tire when you replace the other tires due to the aging of the spare tire.



TIRE AND LOADING INFORMATION

Total load should never exceed
1719 kgs or 3790 lbs.

ORIGINAL TIRE SIZE	COLD TIRE PRESSURE	SEE OWNER'S MANUAL FOR ADDITIONAL INFORMATION
FRONT ST215/75R14C	50 PSI	
REAR ST215/75R14C	50 PSI	
SPARE ST215/75R14C	50 PSI	

Figure F25: Sample Tire Label

D. Load Carrying Capacity

The certification label shows the maximum load-carrying capacity and is located on the port forward inside of the trailer. See Figure F24.

GVWR is the Gross Vehicle Weight Rating. It is the total combined weight of the trailer and its maximum load-carrying capacity. DO NOT exceed the GVWR rating for the trailer.

Total Load is the maximum load-carrying capacity of the trailer minus the weight of the trailer.



Locate the statement “Total load should never exceed XXX kg or XXX lbs.” on your trailer’s tire label located on the port forward side of your trailer.

This figure equals the available amount of the boat with all equipment, gear, fuel, water, and luggage load capacity.

Determine the combined weight of the boat with all equipment, gear, fuel, water, and luggage being loaded on the trailer. That weight may not safely exceed the tire labels total load.

Improper weight distribution can place excessive strain on the towing vehicle and trailer. It can also cause the trailer to “fishtail” (sway side to side). Be sure gear and luggage are distributed evenly in the boat.

E. Reporting Safety Defects

If you believe that your vehicle has a defect which could cause a crash or could cause injury or death, you should immediately inform the National Highway Traffic Safety Administration (NHTSA) in addition to notifying (INSERT NAME OF MANUFACTURER).

If NHTSA receives similar complaints, it may open an investigation, and if it finds that a safety defect exists in a group of vehicles, it may order a recall and remedy campaign. However, NHTSA cannot become involved in individual problems between you, your dealer, or (INSERT NAME OF MANUFACTURER).

To contact NHTSA, you may call the Vehicle Safety Hotline toll-free at 1-888-327-4236 (TTY: 1-800-424-9153); go to <http://nhtsa.safercar.gov>; or write to: Administrator, NHTSA, 1200 New Jersey Avenue SE, Washington, DC 20590. You can also obtain other information about motor vehicle safety from <http://www.safercar.gov>.

F. Glossary of Tire Terminology

Tire label: A label showing the tire sizes, recommended inflation pressure, and the maximum weight the trailer can carry.

Tire Identification Number (TIN): A number on the sidewall of each tire providing information about the tire brand, manufacturing plant, tire size, and date of manufacture. It is also referred as the DOT code.

Inflation pressure: A measure of the amount of air in a tire.

kPa: Kilopascal, a metric unit of air pressure.

PSI: Pounds per square inch, a standard unit of air pressure.

Cold tire pressure: The tire pressure when the trailer has been stationary and out of direct sunlight for an hour or more and prior to the trailer being pulled 1 mile (1.6 km)

Recommended inflation pressure: The cold inflation pressure found on the certification label or tire label located on the port forward side of the trailer.

Bead area of the tire: Area of the tire next to the rim.

Sidewall of the tire: Area between the bead area and the tread.

Tread area of the tire: Area of the perimeter of the tire that contacts the road when mounted on the trailer.

Rim: The metal support (wheel) for a tire upon which the tire beads are seated.





G - 1 SCARAB WARRANTY POLICY

The Scarab warranty provides the new Scarab purchaser with one of the most comprehensive corporate commitments in the marine industry today. The Warranty statement defines the warranty coverage on all units manufactured by Scarab. It thoroughly describes the warranty policies and those procedures to be followed to obtain warranty coverage. Review the Scarab limited warranty statements carefully.

All engines utilized in the Scarab® product are warranted by the engine manufacturer. Your Scarab dealer is authorized to repair your engines and will work closely with the engine manufacturer to resolve any problems you have.

G - 2 DECK/HULL STRUCTURE WARRANTY

Each unit manufactured by Scarab is encompassed by a separate warranty providing specific coverage on the deck/hull structure. The Scarab warranty statement thoroughly describes this coverage.

G - 3 WARRANTY REGISTRATION

A Scarab Warranty Registration is attached to the warranty statement. Your Scarab Dealer is responsible for completing and submitting the warranty registration at the time of purchase. The receipt of the warranty registration is the sole basis for establishing proof of ownership of the boat and corresponding warranty validation.

By signing the warranty registration you, the new owner, indicate an understanding of the terms and conditions of the Limited Warranty. The warranty registration should be properly completed by the dealer, signed by the new owner, and submitted to us via the Extranet within fifteen (15) days after the original purchase in order to validate the warranty. This is a dealership's responsibility. Be sure to keep a copy of the Owner's Registration for your records. All warranty registrations are performed on-line via the Extranet.

All boat manufacturers are required by The Federal Boat Safety Act of 1971 to notify first time owners in the event any defect is discovered "which creates a substantial risk of personal injury to the public." In order for us to notify you if necessary, be sure to verify the accuracy of the warranty registration upon receipt. You should receive your warranty registration at the time of delivery or within approximately 30 days from the day of your boat purchase. If you have not received your

warranty registration within this time frame please contact your Scarab selling dealer for resolution. If upon receipt of the warranty registration you discover a discrepancy, please notify Scarab at 231-775-1343. The information will be corrected and a new copy will be supplied to you.

Other equipment manufacturers also require that their products be registered with their respective company. Warranty registrations are provided in the owner's information packet.

G - 4 TRANSFER OF WARRANTY

Scarab' confidence in the product and our warranty commitments can extend after the original purchaser may choose to move on to a new boat. The remainder of the Scarab warranty coverage is transferable to the second owner of the boat for a fee. The warranty may be transferred only once. Registration of the second owner is required and the amount of the transfer fee is indicated on the warranty statement of the Warranty Registration. Transfer of the remainder of the warranty must occur within five (5) years of the original retail sale. The transfer fee must be paid within fifteen (15) days of purchase of the used boat by check, money order or cashier's check payable to Rec Boat Holdings, L.L.C. Proof of purchase date is required.

G - 5 PRE-OWNED UNIT REGISTRATION

Section G-4 Transfer of Warranty discusses the need to properly register the purchase of a pre-owned boat with Scarab in order to transfer applicable warranty coverage.

Purchasers of all Pre-Owned Scarab models, regardless of the decision to transfer warranty coverage, are encouraged to register ownership with Scarab. To register ownership of a "Pre-Owned Scarab boat," provide Scarab with your name, address, daytime phone number, e-mail address, purchase date, and hull serial number of the boat purchased. The hull serial number plate is permanently affixed to the starboard side of the transom. Registration of a Pre-Owned Scarab boat does not extend or in any way affect or modify the specific terms of the Limited Warranties. We provide this service to the purchasers of Pre-Owned Scarab® boats in the interest of better boating. Scarab welcomes every purchaser of a Scarab boat, new or used, to our family.



G - 6 INSURANCE COVERAGE

One of your responsibilities as a new boat owner is to acquire proper insurance protection. Insurance should include comprehensive and general liability coverage appropriate to your financial needs. Please contact your local agent for assistance on insurance coverage.

G - 7 SERIAL NUMBER RECORD

The manufacturer, model, and serial number of major components are recorded during the assembly of each Scarab boat. A copy of this form is included in the owner's packet. Using this form, you may want to have your dealer help you complete the service information form at the back of this manual. A copy of the serial number record should be made and kept by the dealer in his records. This can assist the dealer in processing warranty claims, or obtaining necessary information. The original copy of the serial number record should be kept in the owner packet. The service information form should remain in the owners manual for easy reference.

G - 8 PRE-DELIVERY SERVICE

Scarab makes every effort to deliver your boat in "turn key" condition to the dealer. The process of transporting and handling the boat necessitates certain inspections and adjustments prior to delivery to you. Also, various aspects of operation must be checked and adjusted immediately prior to final delivery and use.

The selling Scarab dealer must perform this thorough review of the boat and its numerous systems during the commissioning or "dealer pre-delivery service" of the craft.

A Scarab Pre-Delivery Inspection Form is part of the Warranty Registration. It lists the many items encompassed by the pre-delivery service previously described. The dealer is to check off the items as they are completed, and complete the form as indicated providing specific performance related information appropriately.

Your Scarab dealer will sign the Pre-Delivery Inspection Form of the Warranty Registration upon completion of the work. You will also be asked to sign the Pre-Delivery Inspection Form upon accepting delivery of the boat. You are to retain the two copies marked "Boat Owner". Your dealer is to retain the copy marked "Dealer copy" for his records. The manufacturer's copy

is submitted on-line via the Extranet to the Scarab Customer Service Department.

G - 9 REPLACEMENT PARTS

Scarab dealers have access to an electronic Scarab parts manual that details the components of each model and their appropriate part numbers. Many Scarab dealers inventory common replacement components. The parts catalog is also accessible on our website.

In addition, Scarab maintains specific records on the components used in the manufacture of each unit and makes a concerted effort to maintain components specifically to fill replacement part needs.

The Scarab dealer from whom you purchased your boat is in the best position to meet your needs. If the dealer does not have the needed item, the dealer has the capability, through direct contact with the Scarab Customer Service Department, to obtain it quickly. Scarab will only sell replacement parts to established Scarab dealers. If you relocate and cannot find a Scarab dealer close to you, contact the Scarab Customer Service Department for information on the nearest dealer in your area.

G - 10 OWNER'S RESPONSIBILITIES

1. Sign the warranty registration verifying your address, model and hull serial number. The dealer is responsible for on-line submission of the warranty registration.
2. Inspect the boat at the time of delivery to verify that all systems and components are operating safely and acceptably. Read all manuals and instructions.
3. Operate all equipment in compliance with the manufacturer's instructions.
4. Review the pre-delivery checklist for the boat and engine with your dealer when you take delivery.
5. Schedule your 20-hour boat and engine checkup with your dealer.
6. Know how to safely operate your boat and the rules of the road before you use your boat.



IMPORTANT: Make sure that your dealer checks the engine alignment during your boat's 20-hour checkup. The engine alignment check should be performed in accordance with recommended procedures as stated by the engine manufacturer in your engine owner's manual. Failure to do so could result in drive train damage, which is not covered under the warranty.

7. We recommend that you review your engine owners manual and warranty certificate for break-in advice, initial inspection and service requirements.
8. Perform or provide for the scheduled maintenance checks outlined in this manual and all related service guides and manuals.
9. You are responsible for any modifications made to the boat or its equipment that could affect the safe operation of the boat.

Along with boating, comes responsibility...responsibility for safety, boating laws, and the environment. Please think about the future of our waterways, oceans and marine life while you're out enjoying them and take all necessary measures to help protect what natural habitats we have left. Keeping our waterways and marine habitats free from debris, and showing consideration for the creatures who thrive in these environments are some ways you can help assure the pleasure of boating for years to come.

The operator is also responsible for complying with the following procedures and operational requirements:

- State registration
- Insurance
- Warranty registration
- Warranty terms and conditions
- Rules of the road
- Break-in procedure
- Proper maintenance of the boat and its systems
- Safety equipment
- Safety training of passengers and crews
- Knowledge of boat systems
- Seaworthiness/operational inspection
- Safe operating practices
- Avoiding use of drugs/alcohol
- Environmental regulations
- Accident reporting

G - 11 CONSTRUCTION STANDARDS

All Scarab boats meet or exceed the construction standards set by the US Coast Guard and the American Boat and Yacht Council (ABYC) concerning:

- Navigational lights
- Factory-installed fuel systems
- Engine and fuel tank compartment ventilation
- Flotation
- Steering systems
- Backfire flame arresters

We recommend that you see your dealer if you wish to modify factory-installed equipment or add new equipment. Your dealer is qualified to make such modifications or additions without placing the safety or design integrity of your boat at risk and without invalidating the warranty.

G - 12 SCARAB APPAREL

Show your colors! Scarab offers a complete line of sports clothing designed to complement your new boat. The apparel line is on display on our website at www.scarabboats.com.

This page is intentionally blank.



Please place in envelope and mail to:
Rec Boat Holdings, L.L.C.
Attn: Scarab Customer Service Department
925 Frisbie Street
Cadillac, MI 49601



NAME / ADDRESS CHANGE FORM

Name & Address:

Please print clearly.

Telephone & E-mail Address:

Hull Identification Number:

Boat Model:

Date of Purchase:

NOTE: For warranty transfer please use the Warranty Transfer Request Form also included in this manual.

Please place in envelope and mail to:
Rec Boat Holdings, L.L.C.
Attn: Scarab Customer Service Department
925 Frisbie Street
Cadillac, MI 49601



NAME / ADDRESS CHANGE FORM

Name & Address:

Please print clearly.

Telephone & E-mail Address:

Hull Identification Number:

Boat Model:

Date of Purchase:

NOTE: For warranty transfer please use the Warranty Transfer Request Form also included in this manual.

Please place in envelope and mail to:
Rec Boat Holdings, L.L.C.
Attn: Scarab Customer Service Department
925 Frisbie Street
Cadillac, MI 49601



NAME / ADDRESS CHANGE FORM

Name & Address:

Please print clearly.

Telephone & E-mail Address:

Hull Identification Number:

Boat Model:

Date of Purchase:

NOTE: For warranty transfer please use the Warranty Transfer Request Form also included in this manual.

This page is intentionally blank.





Rec Boat Holdings L.L.C., 925 Frisbie Street, Cadillac, MI 49601 Phone (231) 775-1343

WARRANTY REGISTRATION TRANSFER REQUEST

Original Owner Name & Address: _____

Original Date of Purchase: _____

Hull Identification Number: _____

Boat Model: _____

Selling Dealer: _____

Name and address of new purchaser: _____

Telephone & E-Mail Address: _____

Date of Purchase: _____

The warranty may be transferred only once. Registration of the second owner is required and the amount of the transfer fee* is indicated on the warranty statement of the Warranty Registration Card. Transfer of the remainder of the warranty must occur within five (5) years of the original retail sale. The transfer fee must be paid within fifteen (15) days of purchase of the used boat by check, money order or cashier's check payable to Rec Boat Holdings, L.L.C.

This warranty registration request if accepted, transfers the warranty coverage remaining on the boat to the new purchaser. Acceptance of this request does not create any additional warranties or obligation on Rec Boat Holdings, L.L.C.

Warranty Expiration Date: _____

Scarab Transfer Acceptance Date: _____

Scarab Authorized Signature: _____

Mail to: Rec Boat Holdings L.L.C.
925 Frisbie Street
Cadillac, MI 49601
Attn: Scarab Customer Service Department

***Subject to change without notice.**

This page is intentionally blank.





ABAFT - Toward the rear of a boat.

ABEAM - At right angles to the keel of the boat.

ABOARD - On the boat.

ABREAST - Side by side.

ADRIFT - Loose, not on moorings or towline.

AFT - Moving toward the stern, you are going aft.

AGROUND - Stuck fast to the bottom.

AHEAD - In a forward direction.

ALEE - Away from the direction of the wind; opposite of windward.

ALOFT - Above the deck.

AMIDSHIPS - 1. An object or area midway between the bow and stern. 2. An object or area midway between the port side and the starboard side of a vessel.

AMPERE - The standard unit used to measure the draw of an electrical current.

ANCHOR RODE OR ROPE - The line (chain) connecting a vessel to its anchor.

ANCHOR BALL - A black, circular, day signal hoisted to show that a vessel is anchored. Replaced at dusk by the anchor light.

ASTERN - Anywhere behind the boat, a reverse direction, opposite of ahead.

ATHWARTSHIPS - A line, or anything else, running perpendicular to the fore-and-aft center line of a boat.

BATTEN - A strip of wood or metal used to secure tarpaulin(s) in place over a hatch. To batten down means to secure for rough weather.

BEAM - 1. The widest distance across a boat from the outside skin on one side to the outside skin on the other. 2. A transverse structural member that stiffens and supports a portion of the deck.

BEAM WIND - A wind blowing against the side of the vessel, perpendicular to the long axis of the vessel.

BILGE - The lowest interior area of a hull, used to collect water that has entered.

BILGE PUMP - A pump intended for removal of spray, rainwater, and the normal accumulation of water due to seepage and spillage; not intended for damage control.

BINNACLE - The stand or support for a magnetic compass occasionally used to mean helm.

BITT - A heavy and firmly mounted piece of wood or metal used for securing lines.

BLOCK - A wooden or metal case enclosing one or more pulleys and having a hook, eye, or strap by which it may be attached.

BOLLARD - A single post (wood, metal, or concrete) on a dock, pier, or wharf used to secure a vessel's lines.

BONDING - The electrical connection of exposed metallic, non-current carrying components to a common point on the main engine block.

BOW - The front end of the boat.

BOW LINE - A docking line leading from the bow.

BREAKER - A single breaking, plunging or spilling wave.

BREAKER LINE - The outer limit of the surf. However, all breakers may not be in a line. They can occur outside the breaker line.

BRIDGE - The main vessel control station.

BROACH - The turning of a boat parallel to the waves, subjecting it to possible capsizing.

BULKHEADS - The interior walls of a boat.

BULWARK - The side of a vessel when carried above the level of the deck.

BUOY - An anchored float used for marking a position on the water, a hazard, or a shoal.

CAPSIZE - To turn over.



CAPSTAN - A machine that moves a cylindrical device on a shaft for the purpose of hauling up an anchor.

CAST OFF - To let go.

CATAMARAN - A twin-hulled boat, with the hulls being side-by-side.

CHINE - The intersection of a boat's bottom and side. If this intersection is rounded, it is a "soft" chine. If the intersection is squared off, it is a "hard" chine.

CHOCK - 1. A fitting or hole in a railing or deck through which a mooring or anchor line is routed.
2. A wedge used to secure an item in place.

CIRCUIT BREAKER - A device used to interrupt an electrical circuit when current flow exceeds a predetermined level.

CLEAT - A double-ended deck fitting to which lines are secured; usually anvil-shaped.

COAMINGS - Raised lips around cockpits or hatches used to keep water from entering

COCKPIT - An exposed deck area (usually aft) that is substantially lower than the adjacent deck.

COMBER - A wave on the point of breaking. A comber has a thin line of white water on its crest, known as "feathering."

COMPANIONWAY - The steps or ladder leading downward from a deck.

COMPARTMENTS - Rooms divided by bulkheads.

COUNTER - The overhang at the stern of a boat.

CRADLE - A framework, generally made of wood, used to support a boat when it is out of the water.

CREST - The top of a wave, breaker or swell.

CUDDY - A small sheltered cabin in a boat.

CURRENT - 1. The movement of water,
2. The flow of electrical charge.

DEAD AHEAD - Directly in front of the boat.

DEAD RECKONING - A plot of courses steered and distances traveled through the water.

DECK - A permanent covering over a compartment, hull or any part thereof.

DESIGNATOR - Model identifier or model name.

1. to mark or point out; indicate; show; specify.
2. to denote; indicate; signify.
3. to name; entitle; style.

DINGHY - A small, open boat used for ship to shore transportation.

DISPLACEMENT - The weight of water displaced by the hull of a vessel.

DISPLACEMENT HULL - A hull that "displaces" a volume of water equal to the weight of the boat. A hull designed to run in the water rather than on top of the water. When a displacement hull moves through the water, it pushes that water out of the way. Water will then flow around the hull and fill the "hole" the boat leaves astern.

DOCUMENTED VESSEL - Documented yachts have been specially registered with the U.S. Coast Guard. All documented yachts must have their name and home (hailing) port marked on some conspicuous place on the hull. Numbering is not required. Advantages include legal authority to fly the yacht ensign, privilege of recording bills of sale, and other instruments of title with federal officials, and preferred status for mortgages. Documentation does not exempt the unit from any State or Federal taxes. All safety and equipment regulations still apply.

DOLPHIN - A group of piles driven close together and bound with wire cables into a single structure.

DRAFT - 1. The depth of a boat from the actual water line to the bottom of the lowest part of the boat (e.g., the propeller tip or rudder). 2. The depth of water necessary to float a boat.

DROGUE - Any device streamed astern to check a vessel's speed, or to keep its stern up to the waves in a following sea.

DYE MARKER - A brightly colored chemical that spreads when released into water; normally used to attract attention.

EBB TIDE - A receding tide.



EVEN KEEL - To be floating evenly without listing to either side.

EXHAUST SYSTEM - The means by which the hot engine (or generator) exhaust gases are moved from the engine to an outboard port and then released into atmosphere.

EYE SPLICE - A permanent loop spliced in the end of a line.

FAST - Said of an object that is secured to another.

FATHOM - Six feet.

FENDER - A device (usually constructed of rubber or plastic) positioned so as to absorb the impact between vessels or dock.

FETCH - The unobstructed distance that the wind can blow over the water to create waves.

FLARE - 1. Outboard curve of the hull as it comes up the side from the waterline; the reverse of tumble home. 2. A pyrotechnic device used for emergency signaling.

FLAT - A small deck that is built below decks, specifically to support a piece of equipment.

FLEMISH - To coil down a line or rope on deck in a flat, circular, concentric arrangement.

FLOTSAM - Floating wreckage, trash or debris.

FLUKE - The palm of an anchor.

FOAM CREST - The top of the foaming water that speeds toward the beach after a wave has broken, commonly referred to as "white water."

FOLLOWING SEA - A sea (waves) moving in the same direction as a vessel.

FORE-AND-AFT - A line, or anything else, that runs parallel to the longitudinal center line of a boat.

FOREFOOT - The portion of a vessel's keel that curves upward to meet the stem.

FOREPEAK - A compartment in the bow of a boat.

FORWARD - Toward the bow.

FREEBOARD - The minimum vertical distance from the surface of the water to the gunwale.

FREQUENCY - The number of crests passing a fixed point at a given time.

FRONTS - Where opposing warm and cold air masses meet, generally producing a band of wet, stormy weather wherever they meet.

GALLEY - The kitchen area of a boat.

GALVANIC CORROSION - A potential electrical difference exists between dissimilar metals immersed in a conductive solution (e.g., salt water). If these metals touch or are otherwise electrically connected, this potential difference produces an electron flow between them. The attack on the less corrosion resistant metal is usually increased and the attack on the more resistant metal is decreased, as compared to when these metals are not touching.

GANGWAY - The area of a ship's side where people board and disembark.

GASKET - A strip of sealing material, usually rubber, set along the edge of a water or gas tight door, port, cover or hatch.

GELCOAT - The thin outer layer of pigmented plastic covering a fiberglass vessel.

GLAND - The movable part of a stuffing box, which when tightened, compresses the packing.

GROUND - Electrical term meaning the electrical potential of the earth's surface, which is zero.

GROUND SPEED - A vessel's speed made good over the earth's surface along a course or track.

GROUND TACKLE - The anchor, anchor rodes, and other fittings that are used to secure a vessel at anchor or dockside.

GUNWALE - 1. The line where the upper deck and the hull meet. 2. The upper edge of a boat's side.

HALYARD - A line used to hoist a flag or pennant.

HATCHES - Cover on hatchways.

HATCHWAYS - Access ways through decks.



HARDTOP - A permanent cover over the cabin or cockpit.

HAWSER - A heavy rope or cable used for mooring or towing.

HEAD - A toilet or lavatory area.

HEADING - The direction that a vessel is going with reference to true, magnetic, or compass north.

HEADWAY - The forward motion of a vessel through the water.

HEAVE TO - To bring a vessel up in a position where it will maintain little or no headway, usually with the bow into the wind.

HEAVY WEATHER - Stormy weather with high seas and strong winds.

HEEL - To tip to one side.

HELM - The wheel or tiller that manually controls the boat's steering system.

HELMSMAN - The individual steering the vessel.

HIGHS - A center of pressure surrounded by lower pressure on all sides. Caused by a mass of cooler, sinking, drier air. This raises the area ground level air pressure and provides clear skies.

HULL - The main body of a boat.

INBOARD - 1. From either the port or starboard side of a boat toward the fore-and-aft centerline of a boat. 2. The dock side of a moored boat.

INLAND RULES - Nautical "Rules-of-the-Road" that apply in U.S. lakes, rivers, and coastal waters.

INTERNATIONAL RULES - Nautical "Rules-of-the-Road" that are in effect by international agreement to the high seas.

ISOBARS - Lines of equal air pressure that connect all the local points on a weather map. These lines are usually closed and define high or low pressure air masses.

ISOTHERMS - Isotherms are lines that are similar to Isobars except that Isotherms connect all the points that are of equal temperature.

JETSAM - Refuse that sinks when discharged overboard.

KEDGE(S) - One or more anchors set out from a grounded vessel, usually astern, to 1) keep it from being driven further aground and 2) to aid in refloating.

KEEL - 1. The centerline of a boat hull bottom running fore and aft, 2. The backbone of a vessel.

KNOT - 1. A maritime unit of speed equal to one nautical mile per hour (6076 feet). 2. A term for hitches and bends.

LANYARD - A short line made fast to an object to secure it.

LATITUDE - The measure of angular distance in degrees, minutes, and seconds, north or south of the equator.

LAZARETTE - Storage compartment in the deck at the stern.

LEADLINE - A weighted line used to take depth measurements.

LEE - The direction opposite that of the wind.

LEEWARD - Away from the wind.

LIST - A vessel that inclines to port or starboard.

LORAN - Long Range Navigation. An electronic system whereby a navigator can determine position regardless of weather.

LONGITUDINAL - Running lengthwise.

LOWS - A region of low atmospheric pressure. Hurricanes are extremely concentrated low pressure systems.

LUBBER LINE - A mark or line on the compass parallel to the keel indicating forward.

MAST - A spar that is set upright to support lighting, rigging, or sails.



MODEL DESIGNATOR - Model identifier or model name.

MOORING - An arrangement for securing a boat to a mooring buoy or pier.

NAVIGATION LIGHTS - A set of red and green or white lights which must be shown by all vessels between dusk and dawn.

OVERHEAD - A ceiling or roof of a vessel.

OVERBOARD - Over the side of the boat.

OUTBOARD - 1. From the fore-and-aft centerline of a boat toward both the port and starboard sides. 2. The seaward side of a moored boat. 3. An engine that is mounted externally onto the transom of a boat.

PAINTER - A line to the bow of a small boat used for making fast.

PASSAGEWAY - A corridor or hallway aboard ship.

PENNANT - The line by which a boat is made fast to a mooring buoy; also pendant.

PERSONAL FLOTATION DEVICE (PFD) - A life preserver.

PIER - A loading platform that extends at an angle from the shore.

PILASTER - A rectangular structural support column that is an extension of the port and starboard aft cabin sides and which supports the hardtop and flybridge.

PILING - Support, or protection for wharves, piers, etc.

PITCH - 1. The vertical (up and down) motion of a bow in a seaway, about the athwartships axis. 2. The axial advance of a propeller during one complete revolution.

PITCHPOLING - A boat being thrown end-over-end.

PLACARD - A board or stiff card bearing a notice, advertisement, message, etc.

PLANING HULL - At slow speeds, a planing hull will displace water in the same manner as a displacement hull. As speed is increased, the hull provides a lifting effect up onto the surface of the water.

POINT - One of 32 points of the compass that is equal to 11-1/4 degrees.

PORT - 1. Looking forward, the left side of a boat, 2. A harbor, 3. An opening for light or ventilation or passage of material in the side of a boat.

PORT BEAM - The left-center of a boat.

PORT BOW - Facing the bow, the front left side.

PORT QUARTER - Looking forward, a vessel's left rear section.

QUARTER - The sides of a boat aft of amidships.

QUARTERING SEA - Sea coming on a boat's quarter.

RED-RIGHT-RETURNING - A term for helmsmen that buoys and day markers are on the right when returning from seaward.

REEF - A shallow underwater barrier.

REEVE - To pass a line through a block or other opening.

RIDGES - High pressure fingers extending out from a high.

RODE - The anchor line or chain.

RUNNING LIGHTS - Lights required to be shown on boats underway between sundown and sunup.

RUDDER - A vertical plate for steering a boat.

SALON - The main social cabin on a vessel, usually the largest area, occasionally referred to as the deckhouse.

SCREW - A propeller.

SCUPPER - A drain from the edge of a deck that discharges overboard.

SEACOCK - A positive action shut-off valve connected directly to the hull seawater intake and discharge piping.

SERIES - A group of waves which seem to travel together and at about the same speed.



SHACKLE - A "U" shaped connector with a pin or bolt across the open end.

SHAFT - The long, round member that connects the engine or transmission to the propeller.

SHAFT LOG - A fitting at the hull bottom where the shaft connecting an engine to its propeller penetrates the hull. A shaft log permits the shaft to rotate while simultaneously preventing water from entering the hull.

SHEER - The top of the hull's curvature at the deck line from the bow to the stern.

SHEER STRAKE - The upper edge of the hull, immediately below the deck.

SHEET BEND - A knot used to join tow ropes.

SHOAL - An area of shallow water.

SILENCER - A baffled chamber installed in an exhaust system to reduce the noise.

SOLE - Term for deck, cabin or cockpit floor.

SPAR - A general term for booms, masts, yards etc.

SPRING LINE - A pivot line used in docking, undocking, or to prevent the boat from moving forward or astern while made fast to a dock.

STARBOARD - Looking forward, the right side of a boat.

STARBOARD BEAM - The right-center of a boat.

STARBOARD BOW - When facing the bow, the front right side.

STARBOARD QUARTER - When looking forward, the right rear section of the boat.

STEERAGEWAY - The lowest speed at which a vessel can be controlled by the steering wheel.

STEM - The leading edge of a boat's hull.

STERN - The back of a boat.

STRINGER - A fore and aft continuous member used to provide a vessel longitudinal strength.

STRUT - A propeller shaft support that is below the hull.

SUMP - A pit or well into which water is drained.

SUPERSTRUCTURE - Deck houses and other structures extending above the deck.

THWART - A seat or brace running laterally across a boat.

THWARTSHIPS - At right angles to the centerline.

TILLER - A bar or handle for turning a boat's rudder, or motor.

TOPSIDE - To go up to the top deck.

TRANSOM - The stern cross-section of a square sterned boat

TRANSVERSE - Across the vessel; athwartships.

TRIM - Fore and aft balance of a boat.

TROUGH - 1. The valley that exists between waves. 2. A trough is the opposite of a ridge in that it is an elongated low-pressure area extending out from a low. A trough normally indicates unsettled weather.

TUMBLE HOME - The opposite of flare. The shape of the hull as it moves outboard going down from the gunwale to the waterline or chine.

UNDERWAY - Movement. Usually referring to a vessel proceeding forward.

V-BOTTOM - A hull with the bottom section in the shape of a "V."

V DRIVE - A drive system that has the output of the engine facing forward and coupled to a transmission. The prop shaft is then coupled to the transmission.

WAKE - Moving waves, track or path that a boat leaves behind it when moving across the water.



WATER LINE - The line of the water on the hull when the vessel is afloat.

WATCH - A 4 hour duty period while at sea.

WAVES - Waves are periodic disturbances of the sea's surface, caused by wind, seaquakes, and the gravitational pull of the moon and the sun.

WAVE GRADIENT - A wave's slope or angle from trough to crest with respect to the horizon.

WAVE HEIGHT - From the bottom of a wave's trough to the top of the crest.

WEATHER DECK - A deck with no overhead protection.

WET EXHAUST - This term refers to an exhaust system where the cooling seawater is mixed with the exhaust gases just after the riser. This mixture is then ejected through the drive or ports located in the transom or hull sides.

WHARF - A man-made structure bounding the edge of a dock and built along the shoreline.

WHIPPING - The act of wrapping the end of a piece of rope with small line, tape or plastic to prevent it from fraying.

WINDLASS - A device used to raise and lower the anchor.

WINDWARD - Toward the direction from which the wind is coming.

YAW - 1. To swing off course, as when due to the impact of a following or quartering sea. 2. Any motion about a vertical axis.





Float Plan

Copy this page and fill out before going boating. Leave the completed copy with a reliable person who can be depended upon to notify the Coast Guard, or other rescue organization, should you not return as scheduled. DO NOT file this plan with the Coast Guard.

Name _____ Telephone _____

Description of Boat _____ Type _____ Color _____ Trim _____

Registration Number _____

Length _____ Name _____ Make _____

Scarab® Hull Identification Number _____

Other Information _____

Persons Aboard: Name	Age	Address	Telephone

Engine Type _____ HP _____

Number of Engines _____ Fuel Capacity _____

Survival Equipment:

PFDs _____ Flares _____ Mirror _____

Smoke Signals _____ Flashlight _____ Food _____

Paddles _____ Water _____ Anchor _____

Raft or Dinghy _____ EPIRB _____ Sea Anchor _____

Navigation Equipment:

Compass _____ Loran _____ GPS _____ Radar _____

Radio: Yes _____ No _____ Type _____ Frequency _____

Phone: Yes _____ No _____ Phone Number _____

Destination _____ Estimated Time of Arrival _____

Expected to Return By _____

AutoType _____ License No. _____ Where _____

If not returned by _____ call the Coast Guard, or _____
Local Marine Authority

Coast Guard Telephone Number: _____

Local Marine Authority Telephone Number: _____



Service Information

DESCRIPTION	INFORMATION / DATA
BOAT MODEL	
HULL IDENTIFICATION NUMBER	
ENGINE MODEL	
ENGINE SERIAL NUMBER(S)	
OIL FILTER PART NUMBER	
BOAT COLOR	
COCKPIT UPHOLSTERY COLOR	
FUEL CAPACITY	
FUEL: ESTIMATED AVG. GALLONS/HOUR USAGE	
IGNITION KEY NUMBER(S)	
GLOVE BOX KEY NUMBER	
TRAILER MODEL	
TRAILER COLOR	
TRAILER SERIAL NUMBER	
TRAILER TIRE SIZE & MANUFACTURER	
SELLING DEALER	
ADDRESS	
CITY, STATE & ZIP CODE	
PHONE NUMBER	
MISCELLANEOUS	

This page is intentionally blank.





DEPARTMENT OF HOMELAND SECURITY
U.S. Coast Guard
RECREATIONAL BOATING ACCIDENT REPORT

OMB Control Number: 1625-0003
Expires: 12/31/2015

INSTRUCTIONS: Use "Report required because" section below to determine if a report is required for your accident. If required, please have each vessel owner or operator involved in the accident submit a report to their state reporting authority. Each boat operator/owner involved in an accident should submit a separate report. For each question below, please provide answers if applicable and if known; otherwise leave blank. *Privacy Act Notice: Authority- 48 U.S.C. 8102 and 33 CFR 173 & 174 authorize the collection of information on boating accidents. Purpose-The Coast Guard uses this information for statistical purposes, chiefly to inform the public, to measure the Program's efforts, and to regulate issues relating to boating safety. Routine Uses-The Coast Guard shares this information within the agency, and if state and federal law permit it, to the public.*

REPORT SUBMISSION

Report required because (select all that apply):

- At least one person in this accident died. If so, how many? _____
- At least one injured person in this accident *required or was in need of treatment beyond first aid*. If so, how many? _____
- At least one person in this accident disappeared and has not yet been recovered. If so, how many? _____
- All boat and other property damage (e.g., fishing/hunting gear) caused by this accident totaled (or likely totaled) \$2,000 or more:
 Approximate value of damage to your boat: \$ _____
 Approximate value of damage to your other property: \$ _____
- Your or another boat in this accident was (or likely was) a total loss

Report submitted by (select all that apply):

- Boat Operator (required if possible)
- Boat Owner (if operator unable, or same as operator)
- Other (describe): _____

To be submitted within:

48 hours (if injury, disappearance or death)
10 days (if boat/property damage only)

To be submitted to: (Local State Reporting Authority)

Phone:

You may submit any comments concerning the accuracy of the burden estimate or any suggestions for reducing the burden to: Commandant (CG-85X-31), U.S. Coast Guard, Washington, DC 20583-0001 or Office of Management and Budget, Paperwork Reduction Project (1625-0003), Washington, DC 20503. Questions relating to the collection of this data should be sent to the Coast Guard.

For State Agency Use Only

First Name	Last Name
Phone:	

First Name	Last Name	Phone	Primary Cause of Accident
------------	-----------	-------	---------------------------

ACCIDENT SUMMARY

<p>WHEN</p> <p>Date: _____ Time: _____ am <input type="checkbox"/> pm <input type="checkbox"/> (mm/dd/yyyy) (select one)</p>	<p>ACCIDENT DESCRIPTION: Briefly describe this accident (attach extra pages if necessary)</p>
<p>WHERE</p> <p>Body of Water Name _____</p> <p>Location (on water) description _____</p> <p>Nearest city/town _____</p> <p>County: _____ State: _____</p>	<p>DAMAGE TO YOUR BOAT: Briefly summarize any damage to your boat</p>
<p>YOUR BOAT - PEOPLE</p> <p># people on board (including operator): _____</p> <p># people being towed (e.g., on tubes, skis): _____</p> <p># people wearing lifejackets (on board or towed): _____</p>	<p>DAMAGE TO YOUR OTHER PROPERTY: (NOT BOAT) Briefly summarize any damage to your other property (not boat)</p>
<p>OTHER BOATS INVOLVED IN ACCIDENT</p> <p># of other boats involved: _____</p>	



For each question below, please provide answers IF APPLICABLE AND IF KNOWN, otherwise leave blank.																
YOUR BOAT																
BOAT IDENTIFICATION																
Your Boat Name:						Manufacturer:										
Model Name:						Model Year:										
Registration #:						Documentation #:										
Hull Identification # (-HIN)						Rented: <input type="checkbox"/> Yes <input type="checkbox"/> No										
SIZE ESTIMATES																
Length:		ft.		Depth from transom (stem) to keel (bottommost point):				ft.		in.		Beam width at widest point:		ft.		
HULL MATERIAL																
Type of Hull Material (select one)																
Fiberglass			Wood			Rubber/vinyl/canvas			Other (describe):							
Aluminum			Steel			Plastic										
BOAT TYPE																
Boat Type (select one)						Available Propulsion (select all that apply)										
Cabin motorboat		Inflatable		Canoe		Personal watercraft (PWC) (e.g., Wave Runner™, Jet Ski™, Sea-Doo™)			Propeller		Air thrust					
Open motorboat		Houseboat		Rowboat					Sail		Other (describe):					
Auxiliary sail		Sail (only)		Air boat		Other (describe)			Manual							
Pontoon boat		Kayak							Water jet							
ENGINE																
# Engines			Engine type and horsepower (select one)						Fuel type (select all that apply)							
Manufacturer			Outboard		Sterndrive (I/O)		Inboard		None		Gasoline		Diesel		Electric	
			Total horsepower: hp													
SAFETY MEASURES																
Organizations that have conducted a vessel safety check (VSC) on board your boat within the past year (including carriage of safety equipment, e.g., lifejackets, anchor and line, fire extinguishers):																
US Coast Guard Auxiliary: VSC Decal? <input type="checkbox"/> Yes <input type="checkbox"/> No						Federal Agency (Name)										
US Power Squadrons: VSC Decal? <input type="checkbox"/> Yes <input type="checkbox"/> No						State Agency (Name)										
						Other Agency (Name)										
# Life jackets on board:			# Fire extinguishers on board:			Type of fire extinguishers (e.g., ABC):										
			# Fire extinguishers used:			Amount of fire extinguishers used:										
ACCIDENT DETAILS – EXTERNAL CONDITIONS																
WEATHER																
Overall weather was (select one)				It was (select one)		Visibility was (select one)		Wind was (select one)								
Clear		Raining		Day		Good		0 mph (none)								
Cloudy		Snowing		Night		Fair		Over 0, up to 12 mph (light)								
Foggy		Hazy				Poor		Over 12, up to 25 mph (moderate)								
Other (describe):				Approximate air temperature:		°F		Over 25, up to 55 mph (strong)								
								Over 55 mph (stormy)								
WATER																
Overall water conditions (select one):						Other water conditions:										
Up to 6 in. waves (calm)						Approximate water temperature:			°F							
Over 6 in., up to 2 ft. waves (choppy)						Strong current?			Yes		No					
Over 2 ft., up to 6 ft. waves (rough)						Hazardous waters? (e.g., rapid tidal flow, currents)			Yes		No					
Over 6 ft. waves (very rough)						Congested waters?			Yes		No					



For each question below, please provide answers IF APPLICABLE AND IF KNOWN, otherwise leave blank.			
ACCIDENT DETAILS – ACTIVITIES AND OPERATIONS ON YOUR BOAT			
OPERATOR/PASSENGER ACTIVITIES			
Operator/passenger activities on your boat at time of accident:			
Activities were (select one)		Operator/Passenger activities (select all that apply)	
Recreational	Fishing	Tubing	Starting engine
Commercial	Hunting	Water Skiing	Making repairs
	White water activity (e.g., rafting)	Relaxing	Other (list):
BOAT OPERATIONS			
Your boat operations at time of accident (select all that apply)			
Cruising (underway under power)	Drifting	Racing	Towing another vessel
Changing direction	At anchor	Rowing/paddling	Launching
Changing speed	Being towed	Docking/undocking	Tied to dock/mooring
Sailing	Other (list)		
ACCIDENT DETAILS – CONTRIBUTING FACTORS ON YOUR BOAT			
CONTRIBUTING FACTORS			
Indicate factors on your boat which may have contributed to this accident (select all that apply)			
Alcohol use	Improper lookout	Dam/lock	Starting in gear
Drug use	Operator inattention	Force of wake/wave	Sharp turn
Excessive speed	Operator inexperience	Hazardous waters	Restricted vision (e.g., fog)
Improper anchoring	Language barrier	Heavy weather	Mission/inadequate aids to navigation (e.g., buoy, daymarker)
Improper loading	Navigation rules violation	Ignition of fuel or vapor	Inadequate on-board navigation lights
Overloading	Failure to vent	Hull failure	People on gunwale, bow or transom
Other (describe):			
ACCIDENT DETAILS – YOUR BOAT			
MACHINERY/EQUIPMENT FAILURE			
Failure of the following machinery/equipment on your boat contributed to this accident (select all that apply)			
Engine	Onboard lights	Shift	Sound equipment (e.g., horn, whistle)
Electrical system	Seats	Radio	Auxiliary equipment
Fuel system	Steering	Fire extinguisher	Other (list):
Sail/mast	Throttle	Ventilation	
Onboard navigation aids (e.g., GPS)			
ACCIDENT DETAILS – EVENTS ON YOUR BOAT			
ACCIDENT EVENTS			
Types of events occurring to/on your boat during accident (select all that apply)			
Collision with recreational boat	Flooding/swamping	Person fell overboard	
Collision with commercial boat (e.g., tug, barge)	Fire/explosion – fuel	Person fell on/within boat	
Collision with fixed object (e.g., dock, bridge)	Fire/explosion – non-fuel	Sudden medical condition	
Collision with submerged object (e.g., stump, cable)	Carbon monoxide exposure	Person struck by boat	
Collision with floating object (e.g., log, buoy)	Mishap of skier, tuber, wake boarder, etc.	Person struck by propeller or propulsion unit	
Capsizing	Person left boat voluntarily	Person electrocuted	
Grounding	Person ejected from boat (caused by collision or maneuver)		
Sinking	Other (describe)		



For each question below, please provide answers IF APPLICABLE AND IF KNOWN, otherwise leave blank.

ACCIDENT DETAILS – YOUR BOAT – INJURED PEOPLE RECEIVING OR IN NEED OF TREATMENT BEYOND FIRST AID

Report only injured people on, struck by, or being towed by your boat, receiving or in need of treatment beyond first aid. Do not report injured people on, struck by, or being towed by another boat or no boat (e.g., swimmers, people on a dock). If more than one injured person to report, attach additional copies of this page. If none, SKIP INJURED PEOPLE section.

INJURED PERSON

First Name	MI	Last Name
Street		
City	State	Zip
Phone	Date of Birth (mm/dd/yyyy)	Age

INJURY DETAILS

Injury caused when person (select all that apply)			Nature of most serious injury (select one)		
Struck the (e.g., boat, water):			Scrape/bruise		Dislocation
Was struck by a (e.g., boat, propeller):			Cut		Internal organ injury
Was exposed to carbon monoxide poisoning			Sprain/strain		Amputation
Received an electric shock			Concussion/brain injury		Burn
Other (describe):			Spinal cord injury		Other (describe):
Person was wearing lifejacket?	Yes	No	Broken/fractured bone		
Person received treatment beyond first aid?	Yes	No	Body part of most serious injury (e.g., head, trunk, leg):		
Person was admitted to a hospital?	Yes	No			

ACCIDENT DETAILS – YOUR BOAT – DEATHS/DISAPPEARANCES

Only report deaths/disappearances of people on, struck by, or being towed by your boat. If more than one death/disappearance to report, attach additional copies of this page. If none, SKIP DEATHS/DISAPPEARANCES section.

PERSON WHO DIED/DISAPPEARED

First Name	MI	Last Name
Street		
City	State	Zip
Phone	Date of Birth (mm/dd/yyyy)	Age

DETAILS OF DEATH/DISAPPEARANCE

Injury caused when person (select all that apply)			Nature of death/disappearance (select one)		
Struck the (e.g., boat, water):			Death – by drowning		
Was struck by a (e.g., boat, propeller):			Death – other likely cause (describe)		
Was exposed to carbon monoxide poisoning			Disappeared and not yet recovered		
Received an electric shock					
Other (describe):			Person was wearing lifejacket?	Yes	No



For each question below, please provide answers IF APPLICABLE AND IF KNOWN, otherwise leave blank.

ACCIDENT DETAILS – YOUR BOAT OPERATOR

OPERATOR INSTRUCTION		OPERATOR SAFETY MEASURES		
Boating safety instruction completed <i>(select all that apply)</i>		On board, prior to accident, was operator wearing:		
None		A lifejacket?	Yes	No
State course		An engine cut-off switch (Lanyard or wireless device) if equipped?	Yes	No
USCG Auxiliary course		On board, prior to accident, was operator using:		
US Power Squadrons course		Alcohol?	Yes	No
Internet <i>(name of sponsoring organization)</i>		Drugs?	Yes	No
Other <i>(describe)</i>		Operator arrested for Boating Under the Influence?	Yes	No
		Weather reports consulted prior to accident?	Yes	No

OPERATOR EXPERIENCE

Experience operating this type of boat *(select one)*

0 to 10 hours	Over 10, up to 100 hours	Over 100, up to 500 hours	Over 500 hours
---------------	--------------------------	---------------------------	----------------

ACCIDENT DETAILS – OTHER KEY PEOPLE

Only report other key people not already documented as injured, died, disappeared or operator/owner of your boat. If more than two other key people to report, attach additional copies of this page.

NAME/ADDRESS

This other key person was a(n) *(select all that apply)*

Other boat operator Other boat owner Owner of other damaged property Passenger on your boat Witness

First Name	MI	Last Name	
Street			
City	State	Zip	Phone
Other boat name <i>(if any)</i>		Other boat registration # <i>(if any)</i>	

NAME/ADDRESS

This other key person was a(n) *(select all that apply)*

Other boat operator Other boat owner Owner of other damaged property Passenger on your boat Witness

First Name	MI	Last Name	
Street			
City	State	Zip	Phone
Other boat name <i>(if any)</i>		Other boat registration # <i>(if any)</i>	



For each question below, please provide answers IF APPLICABLE AND IF KNOWN, otherwise leave blank.

YOUR BOAT OPERATOR

NAME/ADDRESS		
First Name	MI	Last Name
Street		
City	State	Zip

AGE/GENDER/PHONE					
Date of Birth <i>(mm/dd/yyyy)</i>	Age	Gender	Male	Female	Phone

YOUR BOAT OWNER

If same as your boat operator SKIP rest of YOUR BOAT OWNER section.

NAME/ADDRESS/PHONE			
First Name	MI	Last Name	
Street			
City	State	Zip	Phone

PERSON SUBMITTING THIS REPORT

If same as your boat operator OR owner, SKIP rest of PERSON SUBMITTING THIS REPORT section.

NAME/ADDRESS/PHONE/ROLE			
First Name	MI	Last Name	
Street			
City	State	Zip	Phone

I was a(n) *(select one)*

<input type="checkbox"/>	Other person on board this boat
<input type="checkbox"/>	Accident witness <i>not</i> on board this boat
<input type="checkbox"/>	Other <i>(describe):</i>

SIGNATURE OF PERSON SUBMITTING THIS REPORT

Your signature	Date <i>(mm/dd/yyyy)</i>
----------------	--------------------------



An Agency may not conduct or sponsor and a person is not required to respond to an information collection, unless it displays a currently valid OMB Control Number.

The Coast Guard estimates that the average burden for this report form is 30 minutes. You may submit any comments concerning the accuracy of this burden estimate or any suggestions for reducing the burden to: Commandant (CG-BSX-21), U.S. Coast Guard, Washington, DC 20593-0001 or Office of Management and Budget, Paperwork Reduction Project (1625-0003), Washington, DC 20503.







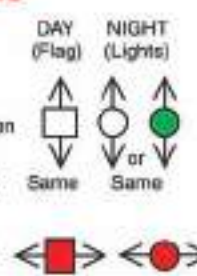



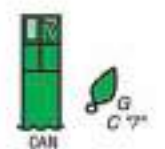

Navigational Aids Chart

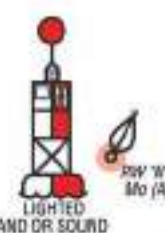
REMEMBER THESE RULES

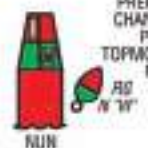
1. OVERTAKING - PASSING: Boat being passed has the right-of-way. **KEEP CLEAR.**
2. MEETING HEAD ON: Keep to the right.
3. CROSSING: Boat on right has the right-of-way. Slow down and permit boat to pass.

<p>← PORT</p> <p>Yield right-of-way to boats in your DANGER ZONE!</p>  <p>STARBOARD →</p> <p>DANGER ZONE (Dead ahead to 2 points abaft your starboard beam)</p>	<h3>STORM WARNINGS</h3>  <p>RED FLAG Small craft (winds to 33 knots)</p> <p>2 RED FLAGS Gale (winds up to 47 knots)</p> <p>SQUARE RED FLAG BLACK BOX (Storm)</p> <p>2 SQUARE RED FLAGS BLACK BOX (Hurricane)</p>
<h3>WHISTLE SIGNALS</h3> <p>ONE LONG BLAST: Warning signal (Coming out of slip)</p> <p>ONE SHORT BLAST: Pass on my port side</p> <p>TWO SHORT BLASTS: Pass on my starboard side</p> <p>THREE SHORT BLASTS: Engine(s) in reverse</p> <p>FIVE OR MORE BLASTS: Danger signal</p>	<h3>BRIDGE SIGNALS</h3> <p>SOUND</p> <p>VESSEL: Open — ●</p> <p>BRIDGE: OK — ●</p> <p>No ●●●●●</p> <p>VESSEL: Replies: ●●●●●</p> <p>RADIO: VHF CH. 13</p> <p>VISUAL</p> <p>VESSEL: Open</p> <p>BRIDGE: OK</p> <p>No</p> <p>DAY (Flag) NIGHT (Lights)</p> <p>Same or Same</p> 

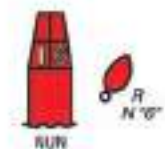
LATERAL AIDS AS SEEN ENTERING FROM SEAWARD

<h3>PORT SIDE ODD NUMBERED AIDS</h3> <p>GREEN LIGHT ONLY</p> <p>FLASHING: ■■■■■■</p> <p>OCULTING: ■■■■■■</p> <p>QUICK FLASHING: ■■■■■■</p> <p>ISOPHASE: ■■■■■■</p>  <p>LIGHTED BUOY G "9" Fl G 4sec</p>  <p>CAN G "7"</p>  <p>DAYMARK SG 1</p>	<h3>SAFE WATER MID-CHANNELS OR FAIRWAYS NO NUMBERS — MAY BE LETTERED</h3> <p>□ WHITE LIGHT ONLY MORSE CODE</p> <p>Mo (A) □ □ □ □</p>  <p>SPHERICAL RW "G" SP "G"</p>  <p>MIDI RW "A" "A"</p>  <p>LIGHTED AND OR SOUND RW "W" Mo (A)</p> <h3>PREFERRED CHANNEL</h3> <p>COMPOSITE GROUP FLASHING (2 + 1) □ □ □ □ □ □ □ □</p> <p>GREEN LIGHT ONLY RED LIGHT ONLY</p>  <p>GR "C" Fl (2 + 1)</p>  <p>RG "B" Fl (2 + 1)</p> <p>LIGHTED</p>  <p>PREFERRED CHANNEL TO STARBOARD TOPMOST BAND GREEN GR "C" 1" CAN</p>  <p>PREFERRED CHANNEL TO PORT TOPMOST BAND RED RG "B" "W" NUN</p>  <p>DAYMARK JG A GR "A"</p>  <p>DAYMARK JR B RG "B"</p>	<h3>STARBOARD SIDE EVEN NUMBERED AIDS</h3> <p>RED LIGHT ONLY</p> <p>FLASHING: ■■■■■■</p> <p>OCULTING: ■■■■■■</p> <p>QUICK FLASHING: ■■■■■■</p> <p>ISOPHASE: ■■■■■■</p>  <p>LIGHTED BUOY R "8" Fl R 4sec</p>  <p>NUN R "6"</p>  <p>DAYMARK TR 2 R "2"</p>
---	--	---



www.scarabboats.com