

MALIBU

2019 Owners Manual



Congratulations on your purchase of a new, high-performance recreational tow boat. Your Malibu Boats, LLC ("Malibu") boat has been constructed to meet and/or exceed all U.S. Coast Guard (USCG) and National Marine Manufacturers Association (NMMA) requirements applicable at the time of its manufacture. However, it is still your responsibility as the boat owner to ensure the boat is operated in a safe manner and is properly maintained.

Before operating this vessel, please take the time to get acquainted with the vessel and its various features and controls. We recommend that you carefully read and familiarize yourself with this Owner's Manual and all on-product safety labels prior to operating your new watercraft.

Prior to operating the boat for the first time, you must carefully read and familiarize yourself with this Owner's Manual and all on-product safety labels. You must also agree to comply with Federal, State and Local Boating Regulations.

This manual contains important information on Boating Safety, Boating Rules, Proper Operation and Maintenance of your boat. This manual provides a guideline for proper operation and maintenance of your boat, and you should consider it a permanent part of your vessel. In the event that this boat is sold, this manual should be included along with the boat to ensure that it will provide the same important information to the next owner.

Images and information utilized in this manual were the most up-to-date available at press time. Because of Malibu's commitment to continuous improvement, actual boats and components may vary from those illustrated. Malibu does not guarantee the availability of what is shown herein.

Congratulations!







ABOUT THIS OWNER'S MANUAL

The recommended practices and warnings in this manual represent sound advice for recreational boating and identify common risks encountered by boaters engaging in towed watersport activities. Read and understand the contents of this manual. Ask questions of a boating professional if anything in this manual does not make sense to you. The manual does not cover all instances of risk or danger, so please use common sense and good judgment when boating. If you follow the advice provided in this manual you will significantly reduce risk to yourself, your passengers, towed participants, and other boaters.

This manual is not intended to be a substitute for taking a course on boating safety nor is it a substitute for boating experience. It is recommended that if you are unfamiliar with the use and operation of a boat you seek advice and training from a qualified individual or organization. Check with your local marine law enforcement agency or dealer for more information about boating safety classes in your area.

The precautions listed in this manual and on the boat are not all-inclusive. If a procedure or method is not specifically recommended, YOU must be satisfied that it is safe for you and your passengers, and that the boat will not be damaged or made unsafe as a result of your decision. Remember – always use caution and common sense when operating and maintaining your boat!

ABOUT YOUR NEW BOAT

Malibu is proud to provide you with the most exciting, cutting-edge technology available in the towing-boat industry. The boat you have purchased represents the state of the art at the time of manufacture. As you may expect from the industry's leader since 1982, Malibu expands and innovates continually. As a result, updated product or specifications may be introduced during any given model year. Malibu reserves the right to introduce new product or changes to existing model lines without notification or incurring responsibility to make the same changes to boats in the market completed prior to the date of change.

This Owner's Manual has been compiled to address as many potential issues and questions as may arise in addition to explaining how to operate the boat and its systems correctly and safely as possible to ensure long-term and enjoyable use. However, Malibu cannot anticipate every potential situation that can arise, affecting the care and protection of your boat, nor every circumstance that could arise in the operation or care of the boat when not in use. Malibu strongly recommends reading any and all additional information provided by component manufacturers' and supplied with the boat at time of purchase. Also check out websites for Malibu and its component manufacturers periodically to stay abreast of any changes, updates, service bulletins and general information. Malibu will use these various methods of communication, from this Owner's Manual and including, but not limited to, direct mail contact and website updates, to make every reasonable effort to apprise you of the information you will need to continue long-term and highly satisfactory use of your boat.





Table of Contents

SAFETY

Embracing Safety	4
Signal Words and Symbols Used in This Manual	4
Basic Safety Rules	4
Pre-Operation Check List—Before Leaving the Dock	4
Precautions While Underway	5
Safety While Maintaining the Vessel	7
Owner Responsibility and Boating Education	8
Important Safety Information	8
Responsibilities of Boat Owner and Operators	8
Registration	9
Insurance	9
Boating Safety Education Opportunities	9
Operation by Minors and Licensing	10
Navigation Lights	10
Emergency Safety Stop Switch	10
Personal Flotation Devices	11
Fire Extinguisher	12
Horn or Whistle	12
Bilge Pump(s)	12
Visual Distress Signals	12
Recommended Safety Equipment	12
General Boating Safety Topics	13
Safe Speed	13
Passenger Safety	13
Carbon Monoxide Safety	13
Proper Loading	15
Weighting Your Boat During Watersport Activities	15
Visibility of the Operator	16
Boating Under the Influence	16
Product Misuse	17
Reporting Accidents	17
Rendering Assistance	17
Hazardous Conditions	17
Environmental Concerns	18
On Product Warning Labels	19
Warning Labels and Locations	19
Wakesetter Label Locations	20
Response TXi Label Locations	22
Basic Rules of the Road	23
Boating Regulations	23
Encountering Another Vessel	23
Privileged Vessel	23

Burdened Vessel	23
Crossing	23
Meeting Head-On	24
Overtaking	24
The General Prudential Rule	24
Other Rules of the Road	24
Aids to Navigation	24
Night Running	26
Watersports Safety	28
Hand Signals	28
Towed Person Safety Responsibilities	29
Additional Precautions for Towed Skier/Rider	29
Tow Line Guidelines	31
Fallen Skier or Rider	31
Develop Water Sense	31
Emergency Procedures	33
Explosion and Fire	33
Swamping and Flooding	34
Capsizing	34
Staying Afloat	34
Collisions	34
Grounding	34
Person Overboard	34
Drowning	35
Medical Emergency	35
Operation Failure	35
Towing	35

QUICK REFERENCE GUIDE

Response TXi	38
20VTX	40
21MLX	42
21VLX	44
22LSV	46
23LSV	48
25LSV	50
22MXZ	52
24MXZ	54
M235	56
Recommended Seating	58

DASHES & VIDEO SCREENS

Wakesetter Command Center	62
Engine Starting Code	62

Text/Phone Alert	62
System Overview.....	62
Save Preset Button.....	63
Four Corner Buttons	63
Depth Screen.....	63
Ballast Screen	63
Wake View.....	64
Speed Control.....	64
Surf Gate Control.....	64
Power Wedge Control	65
Preset Screen.....	66
Media Screen	66
Stereo Screen.....	67
Controls Screen.....	68
Advanced Lighting Controls.....	68
Settings Screen	69
Maps Screen	72
TXi Standard Gauges and Screen.....	75
Gauges.....	75
Keypad	75
Center Screen	75
Cruise Screen.....	75
Engine Screen.....	76
Depth Screen.....	76
Alerts.....	76
Lights Menu	76
Controls Menu	76
Settings Menu.....	76
Video Screens (Optional Malibu Open Edition)	77
Engine Start Code	77
Gauge View and Speed Control	78
Night Mode	78
Speed Control Operation.....	78
Stereo Screen.....	78
Media Screen	79
PDF Viewer and Video Player	79
Rear Camera	80
Controls Screen.....	80
Settings Screen	80
Maps Screen	82
3-in-1 Event Screen	84
Care and Maintenance	84
Navigation Features	84
GPS Information	85
Zero Off GPS Speed Control.....	85
Three Event Information	85
Slalom Settings.....	85
Buzzer Volume	85

Timing Recap	86
Slalom Wait Time.....	86
Jump Settings.....	86
Buzzer Volume	86
Timing Recap	86
Jump Switch	86
Jump Switch Timeout	86
Trick Settings	86
Buzzer Volume	87
River Mode & Offset	87
Course Manager.....	87
Auto Detect.....	87
Pull Type.....	88
Plus (+) Factor.....	88
Troubleshooting Guide	88
Basic Electrical Components	89
Circuit Breakers.....	89
Fuse Box	89
Electrical Harnesses and Wiring.....	89
Batteries	89
Connecting/Disconnecting Batteries.....	91
Battery Maintenance.....	92
Battery Charger	92
Engine Sensors	92
Other Electrical Components	93
12-Volt Receptacle	83
Port Rear Breaker Board.....	93
Surf Band.....	93
Alarms.....	93
 MALIBU MONSOON ENGINES, TRANSMISSIONS & V-DRIVES	
Malibu Monsoon Engines, Transmissions & V-Drives	98
Safety	98
General Information.....	99
California Emissions Information	100
General Emissions Information	101
Star Label	101
Additional Information, Including Warranty	102
Malibu Fuel System	102
Fuel Information.....	104
When the Boat Is Not in Operation (Fuel)	104
Electrical System	105
Alarms.....	105
Cooling System	105
Exhaust System.....	107
Break-In Period—All Boats.....	108
Vapor Lock.....	110

Transmissions & V-Drives	110
Transmissions.....	110
V-Drives	110

HOW IT WORKS

Safety First	114
Fire Extinguishing Equipment.....	114
Emergency Engine Stop Switch	115
Lighting	115
Tie-Ups	117
Anchor Locker.....	118
Horn.....	118
Mirror	118
Ladder	118
Fuel Fill.....	118

Interior Performance	119
Steering Wheel.....	119
Shifter/Throttle.....	120
Electronic Throttle Control (ETC)	121
Pylon(s)	121
Sports Dash.....	121
Rear and/or Dock Camera.....	122

Interior Luxury	122
Stereo Components.....	122
Seating	122
Heated and/or Powered Driver's Seat.....	124
Armrests	124
Glove Box.....	124
Storage Compartments	125
Removable Cooler.....	125
Cup Holders.....	126
Removable Trash Receptacle	126
Carpets and Mats	126
Cockpit Table	126
Grab Handles	127
Heater.....	127

Tower, Canvas & Accessories	128
G3.5 Tower	128
GX Tower.....	129

Tower Accessories	130
Tower Lights	130
Bimini Top.....	130
G-Force Icon 8 Tower Speakers or G-Force Rev 8 Speakers with Horn.....	130
G3.5 PTM Clamping Spinner Board Racks or Ski Rack.....	130
G3.5 Tower Mirror.....	130

On and Under the Water	131
Blower System.....	131
Bilge System.....	132
Ballast System.....	134
Power Wedge III.....	135
Surf Gate.....	136
Underwater Gear (Rudder, Fins, Strut, Propeller, Paddlewheel, Raw-Water Intake/Sea Strainer and Bow Thruster).....	136
Shower.....	138
Swim Board and Ladders.....	139
Flush Kit.....	139
Salt Water Series.....	140
 TRAILERS	
Reporting Safety Defects.....	144
Legal Requirements for Towing.....	144
Basic Safety Rules.....	144
 Connections to the Tow Vehicle	144
Preparation.....	144
Trailer Hitch.....	146
Safety Cables.....	146
Breakaway Cable.....	147
Weight Distribution.....	147
 How to Connect to the Tow Vehicle	147
Attaching to the Tow Vehicle.....	147
To Open the Coupler.....	148
To Close the Coupler.....	148
Hitching Up.....	148
 Connecting to the Boat	148
Trailer Winch.....	148
Tie-Downs.....	149
 Trailer Components and How They Function	150
Trailer Jack.....	150
Lights.....	150
Axles.....	151
Wheels and Hubs.....	151
Lug Nuts.....	151
Tires.....	152
Brakes.....	152
Optional Storage Compartment.....	154
 Towing Advice	155
Prior to Towing.....	155
Pre-Tow Check List.....	155
Underway.....	155

Launching and Re-Loading the Boat from the Trailer	156
When the Trailer Is Not in Use	156

GET READY

Get Ready	158
Malibu Fuel System.....	158
Operations	161
Final Checks Before Starting.....	161
Starting and Operation.....	162
Starting the Engine–Wakesetters.....	162
To Turn Off–Wakesetters.....	162
Starting the Engine–Response.....	163
To Turn Off–Response.....	163
Break-In Period–All Boats.....	164
Smart Operations.....	164
Stopping.....	165
High Speed Maneuvers.....	165
Special Conditions.....	165
Towing and Interaction.....	165
Anchoring.....	166
Docking and Tie-Up.....	166

CARE & MAINTENANCE

On-Going Care	170
General Cleaning.....	170
Canvas.....	170
Upholstery.....	172
Approved Cleaners for Malibu Upholstery.....	173
Carpets and Mats.....	175
Swim Board.....	175
Hull and Deck Finishes.....	175
Stainless Steel, Chrome and Aluminum Components.....	175
Salt Water Series Care and Maintenance.....	176
Routine Maintenance	176
Before Starting the Engine.....	177
After Starting the Engine.....	177
After the Outing.....	177
After 10 Hours on the Hourmeter.....	177
After 75 Hours or Annually.....	177
Storage and Winterization.....	177
Routine Salt Water/Brackish Water Protection.....	177
Before Starting the Engine	178
Check Coolant Level.....	178
Inspect the Sea Strainer.....	179
Check the Battery Holders and the Connections.....	179
Check for Odors.....	180

After Starting the Engine	181
Check for Odors, Particularly From Exhaust Emissions.....	181
Be Certain that the Battery Registers as Fully Charged and That There Is Sufficient Fuel for the Outing	181
After the Outing	181
Give the Engine Compartment a General Inspection	181
Check the Other Components	182
Note How Much Fuel and Battery Charge Were Used	182
Give the Boat a Good General Cleaning as Outlined in the On-Going Care Information that Precedes This Section.....	182
Salt Water/Brackish Water Extra Attention	182
Flushing the Engine.....	184
After 10 Hours on the Hourmeter	184
Have the Oil Changed by Your Authorized Malibu Dealer	184
Check the Safety Equipment.....	185
After 75 Hours or Annually (whichever comes first)	185
Engine Mounts.....	185
Exhaust Flap.....	185
Steering System	185
Shift and Throttle System	186
Battery	186
Pumps	186
Coolant System	186
Oil System	187
Transmission/V-Drive System.....	188
Fuel System.....	189
Hydraulic Steering System	189
Check the Safety Equipment	189
Power Wedge Manual Extension and Retraction	189
Salt Water Boats.....	190
Storage and Winterization	191
Hull Gel Coat	191
Extended Non-Use	191
Lifting the Boat.....	191
Winterizing Boats Equipped with Optional Flush Kit.....	192
For Extended Storage Winterization.....	193
WARRANTY	
Malibu Boats, LLC Limited Warranty	196
Warranty Transfer	206
California and U.S. EPA Emission Control Warranty Statement.....	207
Troubleshooting the Boat	209
Troubleshooting the Trailer	211
Service Log	212
Index	214

SAFETY





EMBRACING SAFETY

Signal Words and Symbols

Used In This Manual

Throughout this manual specific precautions and symbols identify safety-related information. You will find **DANGER**, **CAUTION**, **WARNING**, **NOTICE** and **SAFETY INSTRUCTIONS** symbols which require special attention. Please read them carefully and follow these precautions as indicated! They will explain how to avoid hazards that may endanger you, your passengers, towed participants, and other boaters. **PLEASE REVIEW ALL SAFETY INFORMATION.**



DANGER indicates a hazardous situation which, if not avoided, will result in death or serious injury.



WARNING indicates a hazardous situation which, if not avoided, could result in death or serious injury.



CAUTION indicates a hazardous situation which, if not avoided, could result in minor or moderate injury.

NOTICE

NOTICE is used to address practices not related to physical injury.

SAFETY INSTRUCTIONS

Safety instructions (or equivalent) signs indicate specific safety-related instructions or procedures.

Basic Safety Rules

Make sure you understand all of the operating instructions prior to attempting to operate this boat. Boating-related accidents are generally caused by the operator's failure to follow basic safety rules or written precautions. Most accidents can be avoided if the operator is completely familiar with the boat and its operation, follows recommended practices, and is able to recognize and avoid potentially hazardous situations.

Past accident data shows that most **fatalities** involve actions which cause falls or ejections overboard, mishaps with towed persons, propeller strikes, collisions, and carbon monoxide exposure. Past accident data shows that most **injuries** are associated with collisions, mishaps with towed persons, falls or ejections overboard, being struck by the propeller, and fires and explosions. These incidents are mostly caused by operator inattention, operator inexperience, reckless operation, alcohol/drug use, excessive speed, passenger or towed person behavior, and violation of navigation rules.

Failure to observe the safety recommendations contained in this manual may result in severe personal injury or death to you or to others. Use caution and common sense when operating your boat. Don't take unnecessary chances! Basic safety rules are outlined in this section of the manual.

Pre-operation Check List- Before Leaving the Dock



Failure to follow these precautions may result in severe injury or death to you and/or others.

The operator shall:

- Check that weather conditions are safe for boating. It is the driver's responsibility to determine if weather or other factors have created an unsafe boating environment. Boaters must continuously be aware of weather conditions. Sudden storms, wind, water conditions, lightning, etc., can unexpectedly put boaters in grave danger. Always check the local weather report before going boating.
- Check that drain plugs are securely in place.
- Check bilge pump, horn, lights, blower and other equipment to verify they are operating properly.
- Verify that the emergency cutoff switch lanyard is in proper operating condition and is properly affixed to the driver.
- Check the operation of the steering system. Verify that the steering is operational before launching the boat. If the boat is already in the water, verify proper steering wheel operation at low speed. Turn the steering wheel full stop in both directions and

verify proper rudder movement. Ensure that there is no binding or stiffness in the steering wheel rotation. Binding and stiffness is an indication that the steering needs repair. Failure of the steering cable will result in loss of control of the boat.

- Ensure that the load of persons, ballast, and equipment is within the limits stated on the USCG Maximum Capacities Plate and is properly distributed based on instructions in this manual.
- Check that all safety equipment and life jackets, personal flotation devices (PFDs), and throwable cushions are in good condition and suitable for your boat and passenger load.
- Inform all passengers where safety equipment is located and how to use it.
- Have at least one other passenger who is capable of operating the boat safely in case of an emergency.



WARNING

GASOLINE VAPORS CAN EXPLODE. BEFORE STARTING ENGINE, OPERATE BLOWER

FOR FOUR (4) MINUTES AND CHECK ENGINE COMPARTMENT BILGE FOR GASOLINE VAPORS.

- It is very important to open the engine cover and check the

engine compartment and bilge for liquid gasoline and gasoline vapors prior to each use of your boat and after refueling. Failure to do so may result in fire or explosion as well as serious injury or death to you and/or others.

- If you see liquid gasoline in the engine compartments/bilge or smell gasoline vapors, **DO NOT** attempt to start the engine. Liquid gasoline in the bilge is an extreme fire and explosion hazard which may cause injury or death. Find and fix the source of the leakage, remove the liquid gasoline from the bilge. Then ventilate the engine compartment/bilge and run the blower to remove all gasoline vapors before starting the engine.
- If gasoline vapors persist after running the blower, **DO NOT** attempt to start the engine. Likely, there is a gasoline leak that is creating the excessive vapor.
- Always operate blower below cruising speed and after stopping the boat.

Precautions While Underway



DANGER

Failure to follow these precautions will result in serious injury or death.



The operator shall:

- Check that the area behind the boat is all clear before starting the engine to **AVOID PROPELLER INJURY** to persons in the water behind the boat or on the swim platform.
- Turn off the engine prior to anyone occupying the swim platform or being in the water behind the boat to **AVOID PROPELLER INJURY**. Being in neutral gear is insufficient; the propeller may still be turning, or engine may be inadvertently shifted into gear.
- Not back the boat toward persons in the water behind the boat to **AVOID PROPELLER INJURY**.
- Not allow people to be on or near the swim platform or in the water near the swim platform while the engine is running because **CARBON MONOXIDE** will exist around the back of the boat when the engine is running. Engine exhaust contains carbon monoxide, which is a deadly, odorless, colorless gas.
- Not operate the engine in a confined space or while tethered

to another vessel as **CARBON MONOXIDE** will be around the boats.

- Not go under the boat cover with the engine running or shortly after the engine has been running because **CARBON MONOXIDE** may remain under the cover. Remove cover to ventilate the area.



Failure to follow these precautions may result in severe injury or death to you and/or others.

The operator shall:

- Follow safe operating practices, the “Rules of the Road,” and the Watersports Responsibility Code.
- Not operate a boat if under the influence of alcohol or other drugs.



- Attach the emergency cutoff switch lanyard to the boat operator when operating the boat.
- Maintain a proper course and safe speed at all times to avoid collisions.
- Maintain a lookout for other boats, swimmers and obstructions in the water.
- Operate slowly in congested areas such as marinas and mooring areas.
- Keep a safe distance from other boats, swimmers, personal watercraft, docks, and fixed objects.
- Look before you turn/maneuver the boat so as to avoid potential collisions with oncoming or overtaking vessels.
- Be aware that this boat is a high-performance boat and is capable of quick, tight turns and changes in direction. Familiarize yourself with the handling characteristics of the boat. It is the operator's responsibility to operate the boat in a manner that ensures the safety of all passengers. Abrupt maneuvers may result in the ejection of unsecured, unseated, or improperly positioned passengers. Verbally warn passengers before making quick, tight turns so they may have time to grasp a handrail, hand-hold, or portion of the boat.
- Be aware that your boat will handle differently depending on loading and on-board weight distribution.
- Ensure that all passengers are properly and securely seated in appropriate seating locations to avoid falling or falling overboard.
- Instruct and ensure that passengers remain properly seated at all times while the boat is in motion above idle speed.
- Not allow passengers to sit on the transom, seat backs, engine cover or sides of the boat while the engine is running and the boat is in motion to avoid falling overboard.
- Not allow passengers to sit in a position that obstructs the operator's view.
- **NEVER** leave children unattended and in the boat without adult supervision.
- Have children riding in the bow of the boat be accompanied by an adult in the bow and ensure that all remain seated when the boat is in motion.
- Not let passengers occupy seats which may be in the path of the tow line.
- Slow down when crossing waves or wakes in order to minimize the impact on passengers and the boat. Crossing waves or wakes at an angle (such as 45 degrees) rather than perpendicularly will reduce the severity of the impact. Avoid rough water, large waves and large wakes from other boats when at high speed. Jumping waves/wakes or slamming the bow will cause large vertical impacts which may cause injury to occupants or cause ejections.
- For safe towing (water skiing, tubing, wakeboarding, wake surfing, knee boarding, etc.) be experienced and have an observer [an observer or "spotter" is required by law in most states]. A rear view mirror is helpful if you are allowed to tow without an observer in your state.
- Avoid letting tow lines or mooring lines wrap around anyone's body parts/limbs. Doing so could allow body parts/limbs to become entangled in the line and could cause significant injury, such as amputations.
- Keep track of tow lines and dock lines so that they do not become entangled in the propeller. A tow line will wrap quickly around a spinning propeller and is capable of immobilizing the boat and dragging a person entangled in the tow line underwater or causing amputations. Shut off the engine if a tow line has potential for wrapping in the propeller.
- The tower is designed to pull a single individual. Please consult the remainder of this manual and/or warning labels on the tower for details. **DO NOT** climb, sit on, stand on or jump/dive off of the tower. Tow line may loop on inverted tricks. **DO NOT** sit behind the pulling point of the tower.
- **NEVER** allow any type of spark or open flame on board. It may result in fire or explosion.
- Avoid grounding the boat: Be familiar with local conditions and water depth. If you are uncertain, then proceed slowly with caution. Sudden groundings from planing speeds may cause rapid decelerations and cause occupants to impact the boat and/or to be ejected from the boat. Boat damage may also occur.
- Always watch for low obstacles such as tree limbs, bridges or power lines, especially in boats with tow towers.
- Seek shelter from open water if there is threat of lightning or severe weather.
- **NEVER** dive from the boat without being absolutely sure of the depth of the water. Severe injury or death may occur from striking the bottom or submerged objects. Striking the bottom or a submerged object while diving head first can cause paralysis, head injury or death.
- Provide assistance to other boaters in distress while ensuring the safety of your own passengers.
- When you leave the boat, take the keys with you. This will keep untrained and unauthorized persons from operating the boat. *(This will not be applicable on some keyless ignition systems.)*

Safety While Maintaining the Vessel➤



Failure to follow these precautions may result in severe injury or death to you and/or others.

The operator shall:

- Visually inspect the engine compartment and ventilate after refueling.
- Inspect fuel system regularly. Examine fuel tanks, hoses and

fittings for leaks or corrosion at least annually because leaking fuel is a fire and explosion hazard.

- Never remove or modify components of the fuel system in any way except for maintenance by qualified personnel. Tampering with fuel components may cause a hazardous condition which could lead to a fire or explosion.
- Never override or modify the engine neutral starting safety switch in any way. Your boat engine should not start in gear. If it does, do not use the boat until this safety feature is fixed by an authorized dealer.
- Be aware that batteries generate small amounts of dangerous hydrogen gas when charging. This gas is highly explosive. Keep all sparks, flames and smoking well away from the area. Failure to follow instructions when charging a battery may cause an explosion of the battery or the atmosphere near the battery, which could result in death or serious injury.
- Keep the engine off whenever the engine box/cover/hatch is

open. The engine box/cover/hatch serves as a machinery guard. Clothing or body parts can get caught in moving parts, causing death or serious injury. Keep away from moving parts.

- Not replace your boat's marine parts with automotive parts or parts that were not designed for your boat.
- Be aware that battery electrolyte fluid is dangerous. It contains sulfuric acid, which is poisonous, corrosive and caustic. If electrolyte fluid is spilled or placed on any part of the human body, immediately flush the area with large amounts of clean water and immediately seek medical attention.
- Check the tightness of the tower bolts **BEFORE** each use. If a tower collapses it may result in injury to boat occupants or towed persons.
- Not modify the tow bar. The tow pylon/bar is not designed for vertical extensions. Any modifications to the tow pylon/bar or its mountings may result in damage to the boat and injury to the user.
- Only lift the boat from approved lift points, which are identified in later parts of this owner's manual.

OWNER RESPONSIBILITY AND BOATING EDUCATION

Important Safety Information

Your safety, the safety of your passengers, and the safety of other boaters is dependent on how you operate and maintain your boat. As operator or owner of this boat, you are responsible for the safety of those with and around you while boating.

Responsibilities of Boat Owner and Operators

It is the owner's responsibility to ensure that the operator of the boat has been properly instructed in the lawful and safe operation of this vessel. Therefore, before operating the boat, thoroughly read this owner/operator manual. Be sure you understand each item before operating it. Improper operation or trailering of the boat could lead to severe personal injury or death. Improper operation or trailering of the boat may also damage the boat.

The operator and the boat owner assume all risks for themselves, their guests and anyone in proximity to their boat and ensure that all passengers understand the risks and responsibilities associated with boating.

This manual is not intended to provide complete training on all aspects of boat operation. We strongly recommend that all operators of this boat seek additional training on boat handling and safety. Have all operators become familiar with the handling characteristics,

and proper steering and control system usage before attempting high-speed operation.

At the time of delivery, the owner/operator is responsible for:

- Understanding the warranty terms and conditions of your boat, your engine, and your trailer.
- Obtaining insurance.
- Examining the boat to ensure the proper operation of all systems. Before operating the boat, the owner/operator is responsible for:
- Registering the boat as required in the jurisdiction where the boat is being operated.
- Providing the proper (USCG) safety equipment, and checking local, state and federal agencies as to laws and regulations (USCG carriage requirements).
- Carefully reading and understanding safety information and proper operating procedures within this manual.
- Obtaining other boating education if you lack operational experience.
- Familiarizing yourself with the navigable waters where you intend to operate the boat.
- Following the proper break-in procedure for the engine.

Registration

Federal Law requires that all motorboats be registered and that all motorcraft not documented by the U.S. Coast Guard display registration numbers. In nearly all states, this means registration with the designated state agency. In a few jurisdictions, the Coast Guard retains registration authority. Your dealer will either supply registration forms or tell you where they may be obtained. The agency will supply you with a certificate which must be carried with you when the boat is in operation. International laws may vary as to required registration.

Insurance

The boat owner may be legally responsible for damages or injuries caused by both himself and the operator (if different than the owner). Common sense dictates that you carry adequate personal liability and property damage insurance on your boat, just as you would on your automobile. Many states have laws detailing minimum insurance needs. Your insurance agent or your dealer may be able to supply you with more information. You should also protect your boat from physical damage or theft.

Boating Safety Education Opportunities

It is recommended that the boat owner/operator obtain boater safety education. If you have never owned a boat before, you can get an excellent introduction to boat handling from organizations such as the U.S. Coast Guard, American Red Cross, United States Coast Guard Auxiliary, or your local boating authority. Even if you are a veteran boater, these courses will help sharpen your boating skills as well as bring you up to date on current rules and regulations. See your local boating agency or dealer for information on classes in your area.

Some states require youths, 16 years of age and younger, to complete a boating safety course before operating any watercraft. Many others require operators under the age of 18 to be licensed in small boat operation.

Boat smart from the start: Take a boating safety course and get a free vessel safety check annually for your boat. For more information, contact: United States Coast Guard Auxiliary, www.cgaux.org; United States Power Squadrons, 1-888-FOR-USPS, www.usps.org.

The following is a list of some other agencies and organizations that offer Water Safety, First Aid and CPR courses or information.



To find boating safety courses in your area, call your state's local boating agency or the USCG boating safety course line at 1-800-336-2628 (1-800-245-2628 in Virginia).

- USCG Office of Boating (www.uscgboating.org)
- American Red Cross (www.redcross.org)
- U.S. Coast Guard Auxiliary (www.cgaux.org)
- U.S. Power Squadrons (www.usps.org)
- State Boating Offices
- Canadian Power and Sail Squadrons (www.cps-ecp.ca)
- Boat Owners Association of the United States (www.boatus.com)
- National Safe Boating Council (www.safeboatingcouncil.org)
- Water Sports Industry Association (www.wsia.net)
- European or international organizations

Operation by Minors and Licensing

If your boat will be operated by a minor, remember to have an adult present at all times. Many states have laws regarding minimum age and licensing requirements for minors.

Some states require boat training courses, certification, or licensing for minors and/or adults. Contact state and local authorities for requirements that apply in your area.

Your boat and equipment must be in compliance with federal, state and local safety equipment regulations. USCG regulations require certain safety equipment be present on your boat during operation. For a detailed description, obtain "Federal Requirements for Recreational Boats" published by the U.S. Coast Guard and available online at:

<http://www.uscgboating.org/images/420.PDF>

In addition to the USCG regulations, other local and/or international law enforcement agencies may have similar requirements. You should check with your local marine law enforcement agency regarding any such requirements before boating.

Equipment requirements for coastal and inland waters differ. Check with local authorities and/or the USCG for further information about coastal water requirements.

The Federal Boat Safety Act of 1971 (FBSA/71) and the National Recreation Boating Safety Program have established minimum safety standards for boats and associated equipment, specified by the USCG. In addition, the American Boat and Yacht Council (ABYC) and the National Marine Manufacturers Association (NMMA) work with boat builders to develop voluntary standards that exceed the USCG requirements. The included safety equipment on your boat meets or exceeds the standards of the USCG, ABYC and the NMMA.

Some required safety equipment, such as life jackets (PFDs), are not included with your boat. Your dealer can help you choose the appropriate equipment.

NOTICE

Many states' equipment requirements go beyond USCG requirements.

Contact your state boating office for further information.

Navigation Lights

Your boat is equipped with navigational lights. Recreational boats are required to display navigational lights between sunset and sunrise and other periods of reduced visibility (fog, rain, haze, etc.). Navigation lights are provided to keep other boats informed of your presence and course. It is up to you to make sure they are operational, displayed correctly, and turned on when required.



Emergency Safety Stop Switch

Your boat is equipped with an Emergency Safety Lanyard (cutoff switch). We recommend that the lanyard be secured to the operator and the lock plate attached to the emergency cutoff switch prior to starting the engine and anytime the engine is operating. The Emergency Safety Lanyard is designed to turn off the engine whenever the operator moves far enough away from the helm to activate the switch. The purpose is to stop the engine, propeller, and boat in the event the operator leaves the helm location, falls overboard, or is ejected from the boat. If the engine is stopped it will prevent the boat from becoming a run-away, unmanned boat, which may cause injury or death to boat occupants who have fallen overboard or been ejected, or to other nearby people. If the engine stops it will minimize the subsequent opportunity for propeller contact with the operator or other persons in the water. If the engine and boat stop it will afford opportunity for the operator or other persons who have fallen overboard to safely re-board the boat.



It is recommended that you use the Emergency Safety Lanyard system as failure to do so can cause death or serious injury. DO NOT operate the boat if the Emergency Safety Lanyard system does not function properly.

- Attach the Emergency Safety Lanyard to a secure place on your clothing, your arm or your leg while operating.
- **DO NOT** attach the lanyard to clothing that could tear loose.
- **DO NOT** route the lanyard where it could become entangled, preventing it from functioning.
- Avoid accidentally pulling the lanyard during normal operation.
- Loss of engine power means loss of most steering control.
- Without engine power, the boat will decelerate rapidly. This could cause people in the boat to be thrown forward or ejected overboard if they are not properly seated in the boat.

There are practical limitations to what the Emergency Safety

Lanyard can do. It can take several seconds for the engine and propeller to stop turning. The boat can continue to coast for several hundred feet depending on the boat speed at the time the switch is activated. While the boat is coasting, it can cause injury to anyone in its path. Accidental loss of power can be hazardous particularly when docking or in heavy seas, strong current, or high winds.

While at the dock or when the boat is not moving, periodically disconnect/pull the Emergency Safety Lanyard out of the switch while the engine is running to test for proper operation. The engine should shut off when the lanyard is disconnected/pulled from the switch. You should not be able to restart the engine until the lanyard is back in place.

Personal Flotation Devices

Federal law requires that you have at least one wearable Personal Flotation Device (PFD) of the proper size (Type I, II, III or V), for each person on board or being towed, and at least one throwable PFD (Type IV) in the boat. PFDs must be Coast Guard approved, in good and serviceable condition and the appropriate size for the user. To meet requirements, each lifesaving device must have a current, legible USCG approval stamp permanently affixed. At the beginning of each season, inspect life jackets (PFDs) for damage and test for proper flotation. Refer to the life jacket (PFD) manufacturer's information.

REMEMBER- The best PFD is the one that is worn – that is, the one that can save your life. PFDs are intended to save lives; it is highly recommended that you and your passengers wear them while in the boat. Learn how to use them and adjust as necessary for comfort. It is especially important that children and non-swimmers wear a life jacket (PFD) at all times. Make certain all passengers know where life jackets are located, how to put on and properly adjust their life jackets (PFDs), and that life jackets are readily accessible at all times.

Your dealer can help you select appropriate life jackets (PFDs) and throwable lifesaving devices for your area. Some PFDs are specially made for use while water skiing or wakeboarding and are not U.S.C.G.-approved. Please check local law with respect to their use. Some states require children to wear a PFD at all times. There are four types of wearable PFDs (Type I, II, III or V) and one throwable type of PFD (Type IV) used for throwing in emergency situations. Examples of these USCG approved PFDs are shown:



Type I



Type II



Type III



Type IV



Type V

Type I PFD – Offshore Life Jacket: This PFD is designed for extended survival in rough, open water. It usually will turn an unconscious person face up and has over 22 pounds of buoyancy. This is the best PFD to keep you afloat in remote regions where rescue may be slow in coming.

Type II PFD – Near Shore Buoyant Vest:

This “classic” PFD comes in several sizes for adults and children and is for calm inland water where there is chance of fast rescue. It is less bulky and less expensive than a Type I, and many will turn an unconscious person face up in the water.

Type III PFD - Flotation Aid:

These life jackets are generally considered the most comfortable, with styles for different boating activities and sports. They are for use in calm water where there is good chance of fast rescue since they will generally not turn an unconscious person face up. Flotation aids come in many sizes and styles.

Type IV– Throwable Device:

These are designed to be thrown to a person in the water. Throwable devices include boat cushions, ring buoys, and horseshoe buoys. They are not designed to be worn and must be supplemented by wearable PFD. It is important to keep these devices immediately available for emergencies.

Type V PFD - Special Use Device:

Special use PFDs include work vests, deck suits, and hybrids for restricted use. Hybrid vests contain some internal buoyancy and are inflatable to provide additional flotation. These PFDs may be used instead of a Type I, II, or III PFD with non-towed participants if used in accordance with the approval conditions on the label and if worn when the boat is underway. Some Type V PFDs provide increased protection against hypothermia.

NOTICE

A Type V PFD must be worn to be counted toward the minimum carriage requirements.

NOTICE

Special life jackets are available for skiing and other water sports. These non-Coast Guard approved life jackets do not count as PFDs.

Fire Extinguisher

A portable fire extinguisher is required if your boat has an inboard engine, or when fuel is stored in closed stowage compartments.

Approved fire extinguishers are classified by a letter symbol, either B-I or B-II with the B designating that the material will extinguish flammable liquids such as gasoline, oil, etc. B-I extinguishers are required for boats less than 26 feet in length. Check periodically to ensure that the extinguisher is in working condition and fully charged. Check local, state and federal agencies as to laws and regulations.



Horn or Whistle

All boats over 16 feet (4.8 meters) in length must be equipped with an operable horn or whistle. Test the operation of the horn periodically, so as to make sure it will sound when you actually need to alert someone or another boat. The following are standard signals when using a whistle or a horn:

- **One prolonged blast:** Warning.
- **One short blast:** Pass on my port (left) side.
- **Two short blasts:** Pass on my starboard (right) side.
- **Three short blasts:** My engines are in reverse.
- **Five or more blasts:** *Danger!*

Bilge Pump(s)

Bilge pump(s) are installed in your boat to remove water that may accumulate in the bilge. Know the location of the pump(s), where they discharge, and where switches are located. Typically there are manual switch and/or an automatic switch position(s). On boats equipped with the Viper II system, the bilge pumps are controlled via the touch screen for manual operation. Periodically test the operation of bilge pumps by activating the manual switch and observing the water discharge. It is best to leave the bilge pump switches in

automatic mode, so as to not allow excess water to unknowingly accumulate in the bilge of your boat. If your bilge pump comes on too frequently or continuously, investigate the source of leaking water (check for hull damage, hose or piping leaks, missing drain plug, exhaust system or ballast system failures, etc.), and/or return to shore. Excess water in the bilge of your boat can cause loss of engine power, sinking, and/or capsizing.

Visual Distress Signals

All vessels used on coastal waters, the Great Lakes, territorial seas, and those waters connected directly to them up to a point where a body of water is greater than two miles wide, must be equipped with USCG approved visual distress signals. Your dealer or local authorities can help you select appropriate visual distress signals for your area.

If you are required to carry distress signals, you must have three USCG-approved pyrotechnic devices. Be sure they are in serviceable condition, not exceeding the expiration date and stored in a cool, dry location in a red or orange waterproof container.



Pyrotechnic signaling devices can cause fire and/or explosion, death, serious injury, and property damage if improperly handled. Follow the pyrotechnic manufacturer's directions.

Recommended Safety Equipment

As a precaution, a prudent boater will avoid potential problems on an outing by having additional equipment on board. Normally, this equipment is dependent on the size and type of the body of water and the length of the trip. Your dealer can assist you in acquiring this additional equipment.

We recommend the following equipment:

- First aid kit and manual
- Anchor with at least 75 feet (23 meters) of line
- Mooring lines and fenders
- Bailing device (bucket, hand pump)
- Combination paddle/boat hook
- Local charts and compass
- Day/night distress signals
- Waterproof flashlight and spare batteries
- Cellular phone
- Waterproof container for cell phone
- GPS Global Positioning System
- Binoculars
- Portable AM/FM radio with weather band

- A non-electric horn or whistle
- Extra engine oil
- Tool kit
- Spare propeller and mounting hardware
- Spare fuses
- Spare keys
- Sunglasses and sun block lotion

GENERAL BOATING SAFETY TOPICS

Safe Speed

Navigation rules state that a boat be operated at a safe speed at all times. Determination of a safe speed involves consideration of many factors, such as, but not limited to:

- Boating activity (tubing, water skiing, wakeboarding, wake surfing, etc.)
- Boat traffic congestion
- Water conditions
- Environmental conditions (shore line, docks, and depth of water)
- Weather
- Visibility

The boat should not be driven at a rate of speed faster than will allow it to be brought to a full stop within the operator's field of view given the environmental conditions at the time. Safe speed for the conditions and driver attention (lookout) are important factors in avoiding collisions which may cause injury or death. When in doubt it is prudent to slow down within adequate time and distance so as to be able to assess the conditions and paths of other boats.

It is important to know the Rules of the Road, although do not assume that all boaters also know the rules or that they will abide by them. Avoid collisions by constantly assessing the ever-changing situation and be sure to make appropriate speed and course changes early.

Passenger Safety

The operator of the boat is responsible for the safety of the passengers, all skiers/riders, as well as his/her own safety. Ensure that you and your passengers adhere to these safety recommendations:

- ✓ Any time you take your boat out, make sure that there is at least one other passenger aboard who is familiar with the operation of your boat.
- ✓ Ensure that all passengers are properly and securely seated in appropriate seating locations to avoid falling or falling overboard.
- ✓ While the engine is running, and while the boat is maneuvering, all occupants should be properly seated. **DO NOT** stand while the boat is moving.

- ✓ **DO NOT** sit on the engine box, seat backs, transom seating, sun pad, boarding platform or gunnels while the boat is underway. You could fall overboard and be hit by the propeller, or another boat.
- ✓ **DO NOT** allow objects, arms or legs, or any other body parts to hang over the bow or gunnels. Stay within the boat.
- ✓ Passengers should not sit in locations that obstruct the operator's visibility.
- ✓ Persons and gear should be stowed in a way that distributes weight appropriately and in a manner that trims the boat properly (pitch angle). Excessive weight at either the bow or the stern relative to one another can cause trim problems leading to reduced driver visibility, erratic steering, loss of control, or bow submergence and flooding/swamping.
- ✓ Passengers should be well aware of emergency equipment and instructed in its use.
- ✓ Passengers should assist with lookout duties and notify the operator of any approaching watercraft or potentially unsafe conditions to provide assistance with collision avoidance.

Carbon Monoxide Safety

Carbon Monoxide (CO) is a deadly, colorless and odorless gas produced by all engines and fuel-burning appliances. Even with the best boat design and construction, plus the utmost care in inspection, operation and maintenance, hazardous levels of carbon monoxide may be present in or near the boat under certain conditions. The boat owner, operator, as well as all boat occupants, must understand the dangers of carbon monoxide and must comply with all safety recommendations/requirements. For boats with cabins, always ventilate the boat interior and avoid boating situations which cause increased exposure.



Carbon monoxide (CO) can cause brain damage or death. Engine and generator exhaust contains odorless and colorless carbon monoxide gas.

Carbon monoxide will be around the back of the boat when engines or generators are running. Move to fresh air, if you feel nausea, headache, dizziness, or drowsiness.

- **DO NOT** allow people to be on or near the swim platform or in the water near the swim platform while the engine is running. Carbon monoxide will exist around the back of the boat when engines are running.
- **DO NOT** operate the engine in a confined space or while the boat is tethered to another vessel.
- **DO NOT** go under the boat cover while the engine is running or shortly after the engine has been running. Carbon monoxide may be trapped under the cover. It is important to remove the cover and/or ventilate the area before going under the boat cover.
- **DO NOT** “platform/teak” surf or platform drag. Carbon monoxide will exist in high concentrations in the vicinity of the swim platform near the water while the engine is running. The USCG has deemed platform dragging as a dangerous and hazardous activity which should be prohibited, as it can result in injury or death.
- In the event that someone exhibits the symptoms of carbon monoxide exposure (nausea, headache, dizziness, or drowsiness), have them breathe fresh air and, if necessary, immediately seek medical attention.

Hazardous boating situations involving carbon monoxide include:



Blockage of boat exhaust by obstruction.

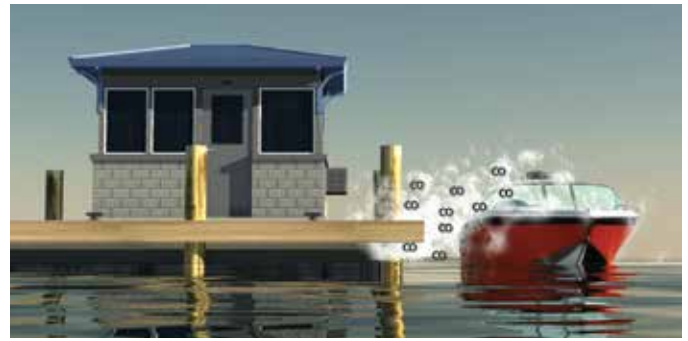

Exhaust traveling along obstruction.

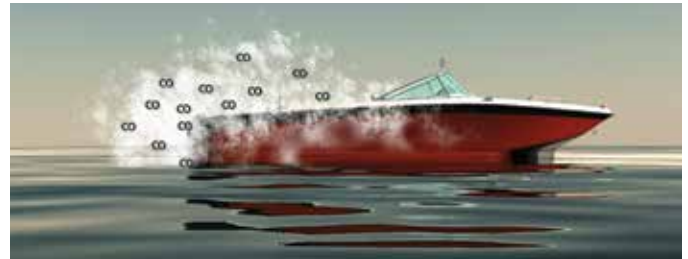

Operating at slow speed or while dead in the water.

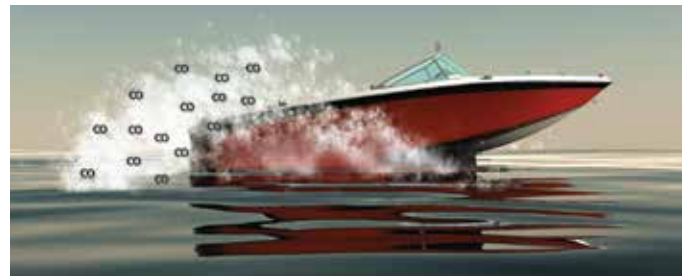

Operating with high bow angle.



Exhausts from other vessels in confined areas.

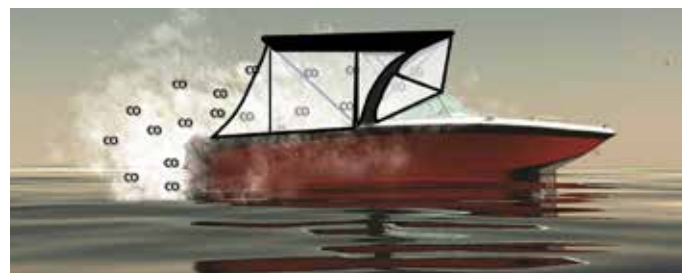

Operating with canvas tops and side curtains in place without ventilation.

For the most current information on carbon monoxide, you may call, write or visit online any of the following:

United States Coast Guard
Office of Boating Safety (CG-5422)
2100 Second Street SW STOP 7581,
Washington, DC 20593-7581
(www.uscgboating.org/safety/carbon_monoxide.aspx)

NMMA
231 S. LaSalle St., Suite 2050
Chicago, IL 60604
312-946-6200
www.nmma.org

American Boat & Yacht Council, Inc.
613 Third Street, Suite 10, Annapolis, MD 21403
410-956-4460 www.abycinc.org

Proper Loading →

 **WARNING** **DO NOT overload your boat. Overloading or uneven loading can cause loss of control, capsizing, or swamping, which may lead to death or serious injury. Adhere to the load capacity plate restrictions, and always account for persons, gear, and all non-factory-installed ballast or other equipment.**

Your boat is equipped with a maximum load capacity plate indicating the maximum acceptable load as determined by the manufacturer following certain Federal guidelines. In addition to following these weight guidelines, it is critical that you properly distribute this weight throughout the boat. If too much weight is placed in one area it can have serious impact on the boat's handling and control, which has the potential to lead to injury or death.

The load capacity plate is used by boat manufacturers participating in the National Marine Manufacturers Association certification program. Your manufacturer has submitted your model for inspection and compliance with their guidelines. The maximum number of persons allowed on the boat has been determined by the manufacturer and displayed on the capacity plate. (Additional information regarding weight distribution appears in the Get Ready section of this owner's manual.) This information on the capacity plate applies under normal conditions and special care must be used in any abnormal conditions. Check the capacity plate on your boat and abide by these limits.

The capacity plate has the following information permanently printed on it:

- The total weight of persons, gear and other items which the boat is capable of carrying under normal conditions. This weight must include any added ballast above and beyond boat manufacturer's factory-installed ballast system(s), such as the manufacturer's-approved, optional Plug 'n Play (which has been factored into the maximum capacity) or any other added, but unapproved ballast.

 **WARNING** **Any non-factory-installed ballast must be properly secured to prevent injury.**

 **WARNING** **Do not fill the bilge area with water. Excessive water in the bilge can cause changes in boat trim and reduce boat stability which may lead to submergence or capsizing.**

Weighting Your Boat During Watersport Activities →

Although water intrusion and waves spilling inside a boat is an obvious boating hazard, this hazard can be increased when weighting your boat for water sports such as wakeboarding or wakesurfing. As wakeboarding has evolved, ballast systems have been developed to add weight and increase the size of the wake. The simplest ballast system on the market is the water ballast type, such as the "FAT SAC." The quest for the largest wake has caused some boat operators to excessively overload their boats. It is not uncommon to see operators use aftermarket ballast systems and then put additional people and gear in their boat. Be advised that this practice can lead to overloading your boat which may lead to any of the following: changes in handling and performance; capsizing, flooding, and sinking; boat occupants going overboard. **DO NOT** overload your boat.

Always be aware of the load in your boat and do not load the boat in excess of the listed capacity. Each boat has a maximum capacity label displaying the maximum weight of people, gear and ballast that can be placed in the boat.

When loading your boat, give attention to the effect that the load distribution has on the boat's trim angle. Trim angle is the technical term for the up or down pitch angle of your boat (also known as the "bow up" or "bow down" angle). The fore and aft load distribution of weight, passenger, and gear can affect the running trim angle of the boat.

- Excessive weight placed in the stern of the boat can cause the inability to get on plane, high bow-up angles, and can lead to steering difficulties. High bow-up angles can be dangerous due

to the reduction in the operator's forward visibility which can lead to collisions and groundings. High bow-up angles cause longer transition times from displacement mode (slow velocity, 0 to 5 mph) to planing speeds (18 to 20 mph and above). During transition, it is important that the boat operator pays attention so that they are able to see forward and that the time in transition (or in the "hump" speed region) is minimized.

- Excessive weight placed in the bow of the boat can lead to very flat planing trim angles which may lead the boat to turn aggressively, unpredictably, and without steer input. The phenomenon of yaw instability is caused by heavy bow weights and running very flat (bow down or flat trim angles). This can occur with excessive weight in the bow compared to weight in the stern of the boat. Another ill effect of too much bow weight in comparison to stern weight is that with extremely heavy bow loads, the boat's bow may dive or submerge when coming off plane (decelerating rapidly, or encountering waves/wakes at slow speed). If the bow submerges, then water will enter and flood your boat.
- When encountering conditions which may lead to bow diving or bow submergence, it is recommended to accelerate the boat before the wave/wake in order to help raise the bow and get over the wave/wake.
- If the bow submerges, the recommended action is to reduce throttle to stop forward speed, get passengers to move aft, and turn on the bilge pump.

It is the boat operator's responsibility to tell passengers to move to other seats on the boat, so as to not overload the stern or bow of the boat, nor restrict the boat operator's forward visibility. (See Get Ready section of this owner's manual for additional information.) There is no single recommended seating or load distribution for all conditions. Experience with your boat will allow you to determine where to properly allow passengers and gear to be placed.



Excess and improper loading of bow area forward of windshield may cause water influx, operating instability,

and loss of control resulting in injury or death. Bow Capacity Limit - X persons or XXX lbs. person, gear and ballast. This is posted separately on your boat but still included in overall capacity. Use good judgment when weighting your boat for any towed water sports.

Visibility of the Operator

The operator of the boat is responsible, by law, to "maintain a proper lookout by sight and hearing." The operator must ensure that he/she has appropriate visibility for safe operation. No passengers or equipment should block the operator's view, including the view of



other boats, skier(s), rider(s), swimmer(s), or anyone or anything else in the water. Even momentary interference can result in the driver's inability to respond to a situation that requires avoidance of another vessel or submerged or partially-submerged object(s).

Look carefully before turning, especially when you are turning around to pick up a fallen skier/rider. Other boats in your vicinity may not necessarily be following the Rules of the Road. Be alert and keep a visual check for other boats in and around your intended path. Do not turn or maneuver your boat without first checking that it is clear to do so. Failure to look before turning can result in an encounter with another boat where neither boat has enough time to avoid a collision. This situation can develop very quickly if you fail to look first, and turn in front of another oncoming boat.



Obstructed visibility can cause death or serious injury. The operator must maintain clear visibility at all times while operating the boat. Arrange passengers and equipment appropriately or designate a passenger to assist when visibility is limited.

Boating Under the Influence



Operating the boat or boating under the influence of alcohol and/or drugs can cause serious injury or death. Alcohol and drugs slow your reaction time and impair your judgment. Do not operate a boat or allow passengers to boat while under the influence of alcohol and/or drugs.

Boating under the influence of alcohol or drugs can be deadly. Alcohol and/or drug use is the leading contributing factor to all recreational boating fatalities. Alcohol and drugs can increase your reaction time and impair your judgment. Combined with the sun, wind, waves, and noise of other watercraft, the effects of drugs and alcohol can be increased and can significantly increase your reaction time. As the owner/operator, you are responsible for the alcohol/drug use and onboard behavior of your passengers. Additionally, civil lawsuits in cases of property damage or injury/death to others can result in significantly higher verdicts when alcohol or drugs are allowed.



WARNING

Impaired operation may result in severe personal injury or death. Federal and state laws prohibit operating a boat under the influence of alcohol and other drugs. If the operator's blood alcohol content is above the legal limit, violators are subject to fines and may go to jail. Violators may also lose automobile driving privileges.

Product Misuse

Misuse of the product or use of it in a manner for which it was never intended can create dangerous situations. The boat operator and passengers are responsible for using the product safely and as intended. The driver must operate the boat in a manner that ensures the safety of all passengers. If you or your passengers are unsure about the proper use of the product, unsure about performing certain boating maneuvers or are unsure about a particular water activity, refer to this owner's manual or contact a knowledgeable source, such as your local dealer, the US Coast Guard, or your local boating authority.

Reporting Accidents

Boat operators may be required by law to file a Boating Accident report with their state boating law enforcement agency or local authority, the USCG, or their country's boating law enforcement agency when their boat is involved in certain boating accidents. A boating accident must be reported if there is a loss or probable loss of life or a personal injury requiring medical attention beyond first aid. In these situations, a formal report must generally be filed within 48 hours of the accident. Also a boating accident must be reported for accidents when damage exceeding \$500 is incurred, or there is a complete loss of the boat. In these situations, a formal report must generally be filed within 10 days. If any of these events occur, seek further assistance from local law enforcement personnel. Please note that the submittal of a report is the responsibility of the boat owner. This requirement is different than laws associated with the reporting of automobile accidents.

Rendering Assistance

If you see a distress signal or suspect a boat is in trouble, you must assume it is a real emergency and render assistance immediately. By law, the operator in charge of the craft is obligated to provide assistance to any individual in danger, presuming assistance can be safely provided. Failure to render assistance can result in a fine and/or imprisonment.

The 1971 Boating Safety Act grants protection to a "Good Samaritan" boater providing good faith assistance, and absolves a boater from any civil liability arising from such assistance.

Hazardous Conditions

Every waterway poses hazards that should be avoided. You will be best prepared to avoid these hazards if you are familiar with the waterway where you are boating. Whenever possible familiarize yourself with navigation charts, depth charts, and waterway maps before you go boating. The following information outlines some of the most common hazards which may be encountered:

Shallow Water Operation

Shallow water brings on obvious hazards such as sand bars, stumps, rocks, etc. Know the area in which you will be operating the boat. Grounding the vessel or striking submerged objects can result in serious injury or death and can cause severe damage to your watercraft. At high speed, this can cause rapid deceleration or stop your boat abruptly, which may cause occupants to impact the interior of the boat or be ejected. Stick to deeper water whenever possible, and if you must travel in shallow water, proceed at low speed and post a lookout.

Know the minimal depth your boat can safely travel.

Warning Markers

Learn to recognize the different buoys and day markers; they are used as the signposts of the waterways identifying navigable routes and water hazards. It is a good idea to ask local authorities about hazard areas and if they are marked. Stay within boundaries and clear of hazards.

Weeds

Weeds can generally be a threat to a boat's engine and other components on the boat. If weeds wrap around the propeller, they can create vibration in the engine. They also can restrict water intakes or clog the water filter, causing the engine to overheat. Learn to recognize the typical normal operating temperature range for your engine. If temperature rises high above normal, then check for blockage of the engine cooling water system.

NOTICE

Weeds can sometimes be removed by shifting to NEUTRAL, pausing for a moment, then shifting to REVERSE to unwind the weeds from the propeller.

Dam Spillways

The area around dam spillways is very hazardous and conditions can change rapidly. Keep clear of the spillways and areas below dams. Currents created by spillways can draw in objects, including your boat.

Restricted Areas

Before boating, check with Local, State, and Federal authorities to identify restricted areas. Because of the threat of terrorism, the U.S. Coast Guard has and will continue to implement strict limits on watercraft near U.S. Navy and Coast Guard ships and other potential targets.

Weather/Seas

Learn and understand weather patterns and signs of change. Bad weather can cause an uncomfortable and unsafe situation. If a storm approaches, seek a safe harbor. Check forecasts before getting underway and continue to monitor conditions while on the water.

Environmental Concerns →

As a boater, you already appreciate nature's beauty and the peace of the great outdoors. It is a boater's responsibility to protect the natural environment by keeping waterways clean.

Foreign Species

If you trailer your boat from lake to lake, you have the potential of unknowingly introducing a foreign aquatic species from one lake to the next. It is important to thoroughly clean the bottom of the boat below the water line, remove all weeds and algae, and drain the bilge, ballast, and livewells before launching the boat in a new body of water. Check local, state, country agencies as to laws and regulations.

Fuel/Oil Spillage

The spilling of fuel or oil into our waterways contaminates the environment and is dangerous to wildlife. **DO NOT EVER** discharge or dispose of fuel, oil or other chemicals into the water; it is prohibited and can result in fines. These are three common, accidental types of discharge:

- During initial fueling of a nearly empty tank
- Overfilling the fuel tanks
- Pumping contaminated bilge water



Fumes from rags can collect in the bilge and pose an extremely hazardous fire and explosion risk, which can result in injury or death. Never store rags used to wipe up fuel or solvent spills in the boat. Dispose of rags properly ashore.

Discharge/Disposal of Waste

Waste means all forms of garbage, plastics, recyclables, food, wood, detergents, sewerage and even fish parts in certain waters – in short, nearly everything. We recommend you bring back everything you take out with you for proper disposal ashore.

Excessive Noise

Noise means engine noise, radio noise, loud conversation, or even yelling. Many bodies of water have adopted noise limits. Noise can carry a considerable distance on water, especially at night. Be sure to follow regulations and be courteous.

Speed/ Wake/Wash

Be alert for **NO WAKE** zones. You are responsible for any damage or injury caused by your wake/wash. Prior to entering a **NO WAKE** zone, reduce throttle, come off plane to the slowest steerable speed. Use caution when operating around smaller crafts, in channels and marinas, and in congested areas.

Some states and boating areas have imposed speed limits for the operation of boats, including, but not limited to, no-wake zones. Check local, state, and federal agencies as to laws and regulations. The U.S. Coast Guard and local boating authorities are excellent sources for this information, which can include penalties for failure to observe the requirements.

Exhaust Emissions

Increased exhaust (hydrocarbon) emissions pollute our water and air. Keep your engine tuned and boat hull clean for peak performance. Consult your Malibu dealer for information.

Paints

If your boat is kept in water where marine growth is a problem, the use of anti-fouling paint may reduce the growth rate. Be aware of environmental regulations that may govern your paint choice. Contact your local boating authorities for information.

Cleaning Agents

Household cleaners should be used sparingly and not discharged into waterways. Never mix cleaners and be sure to use plenty of ventilation in enclosed areas while cleaning your boat. **DO NOT** use products which contain phosphates, chlorine, solvents, non-biodegradable or petroleum based products. Refer to the *Care and Maintenance* section in this manual for more information.

MARPOL Treaty

The USCG enforces the International Convention for the Prevention of Pollution from ships, commonly referred to as the

MARPOL Treaty (Marine Pollution). This treaty prohibits the overboard dumping of all ship-generated plastics, chemicals, garbage and oil.



ON PRODUCT WARNING LABELS

Warning Labels & Locations

Warning labels are placed at specific locations on your Malibu boat at the time of manufacture to alert you to potential hazards that may not be obvious. These labels also indicate how to avoid these hazards. Warning labels should never be removed and must remain legible. If you suspect a label is missing, or if a label becomes damaged or becomes unreadable (damaged, faded, or sun bleached), contact your dealer for replacement.

It is the responsibility of the boat owner and occupants of the boat to understand and comply with all warning labels and safety recommendations/requirements. The driver of the boat and the boat

owner are responsible for the proper operation of the boat and the safety of the occupants of the boat. Failure to adhere to and comply with the on-product warning labels and safety statements labeled as dangers, warnings, and cautions that appear in this manual can lead to serious injury, or death, as well as property damage. **READ AND ADHERE TO ALL WARNING PLATES AND LABELS** from bow to stern, including those that are installed inside the engine compartment, lockers, and underneath seating.

WALKTHRU DECALS

WARNING

Failure to follow these warnings could cause serious injury or death.



Only use this tow pylon for waterskiing, boarding, or recreational towables.

Do not use this tow pylon for parasailing, kite flying, pyramids, group pulls, barefootboating toons, pylon extensions or towing other boats.

Do not sit in the path of the tow line when it is in use.

882011.3-C

WARNING

Failure to follow these warnings while using the tow tower could cause serious injury or death.

Lock the tower in place and secure all hardware before and during use.

Do not tow more than 1 person or 500 pounds at one time from this tow tower.

Only use this tow tower for waterskiing, boarding, or recreational towables.

Do not use this tow tower for parasailing, kite flying, pyramids, group pulls, towing other boats, or tubes.

Do not climb on, sit on, stand on, jump off of or dive off of the tow tower.

882011.3-B

WARNING

Failure to follow these warnings could cause severe injury or death

<ul style="list-style-type: none"> • GASOLINE VAPORS CAN EXPLODE. BEFORE STARTING ENGINE: <ul style="list-style-type: none"> - OPERATE BLOWER for 4 minutes - CHECK THE ENGINE COMPARTMENT for gasoline vapors to light and smell. • OPERATE BLOWER to clear gasoline vapors from engine compartment when engine is at idle, while before starting speed and after stopping engines. • CARBON MONOXIDE (CO) CAN CAUSE BRAIN DAMAGE OR DEATH. <ul style="list-style-type: none"> - Engine exhaust contains carbon monoxide gas. - Signs of carbon monoxide poisoning include nausea, headache, dizziness, drowsiness and loss of consciousness. - MOVE TO FRESH AIR if anyone shows signs of carbon monoxide poisoning. - SEE OWNER'S MANUAL for additional information regarding carbon monoxide poisoning. 	<ul style="list-style-type: none"> • CHECK WEATHER FORECAST BEFORE DEPARTING DOCK and heed of weather advisories. • WEAR SAFETY LANYARD at all times while operating boat to prevent inadvertent boat operation. • NEVER OPERATE WHILE UNDER THE INFLUENCE of drugs or alcohol. • DO NOT OVERLOAD THE BOAT. ENSURE THAT WEIGHT IS PROPERLY AND EVENLY DISTRIBUTED bow and aft and on both sides of the boat to avoid poor handling, sudden loss of control, swaying and/or capsizing. • USCG APPROVED LIFE JACKETS SHALL BE ON BOARD FOR ALL PASSENGERS AND TORSEI PARTICIPANTS. • MAKE SURE THAT ALL PASSENGERS ARE PROPERLY SEATED WHILE UNDERWAY. To avoid passengers falling overboard or being ejected from the boat, do not allow passengers to sit on seat backs, gunwales or transom-deck edges while boat is moving. 	<ul style="list-style-type: none"> • REDUCE SPEED BEFORE ATTEMPTING SUDDEN OR SHARP TURNS, AND MAINTAIN SAFE SPEEDS for water conditions and environment of all times. Maneuverability at high speeds is limited, and sudden turns may cause loss of boat control. • KEEP PROPER LOOKOUT and SAFE DISTANCE for the conditions at all times to avoid collisions. • OBEY APPLICABLE NAVIGATION RULES AND BOATING LAWS. • USE CAUTION AND PROPER LIGHTING during nighttime boating and boating in adverse weather. • READ THE OWNER'S MANUAL AND COMPLETE THE BOATER'S PRE-OPERATION CHECKLIST prior to boat operation. 
------------------------------------------------------------------------------------------------------------------------------------------------------------------------------------------------------------------------------------------------------------------------------------------------------------------------------------------------------------------------------------------------------------------------------------------------------------------------------------------------------------------------------------------------------------------------------------------------------------------------------------------------------------------------------------------------------------------------------------------------------------------------------------------------------------------------------------------------------------------------------------------------------------------------------------------------------------------------------------------------------------------------------------------------------------	-------------------------------------------------------------------------------------------------------------------------------------------------------------------------------------------------------------------------------------------------------------------------------------------------------------------------------------------------------------------------------------------------------------------------------------------------------------------------------------------------------------------------------------------------------------------------------------------------------------------------------------------------------------------------------------------------------------------------------------------------------------------------------------------------------------------------------------------------------------------------------------------------------------------------------------------------------------------------------	-------------------------------------------------------------------------------------------------------------------------------------------------------------------------------------------------------------------------------------------------------------------------------------------------------------------------------------------------------------------------------------------------------------------------------------------------------------------------------------------------------------------------------------------------------------------------------------------------------------------------------------------------------------------------------------------------------------------------------------------------------------

882012.1

WALKTHRU DECALS (MODEL SPECIFIC)

MAXIMUM CAPACITIES

15 PERSONS OR 2115 LBS.

2115 POUND PERSON, GEAR

*THIS BOAT COMPLIES WITH U.S. COAST GUARD SAFETY REQUIREMENTS AS EFFECT IN THE STATE OF OREGON WITH THE EXCEPTION OF CERTAIN FUEL SYSTEM REQUIREMENTS ASSOCIATED WITH 15 PERSONS. THESE ARE AUTHORIZED BY U.S. COAST GUARD STATE OF OREGON COAST MARINE MAINTENANCE OF THE FUEL SYSTEM IN THIS BOAT SHOULD BE PERFORMED ONLY BY EXPERTS IN MALIBU MARINE TECHNOLOGY GROUP SERVICE, NOT OTHER COMPANIES!

MANUFACTURER: MALIBU BOATS, LLC

MODEL: WAKESETTER 23 LBP LOUDON, TN

*BOAT COMPLIANT WITH NMEA REQUIREMENTS BELOW IN CERTAIN AREAS. RESPONSIBLE FOR PREVENTION CONTROL.

NMEA NATIONAL MARINE ELECTRONIC ASSOCIATION

882013-C

WARNING

Failure to follow these warnings could cause serious injury or death.



Remain properly seated and hold on to available handrails while boat is moving to avoid falling overboard or being ejected from the boat. Do not sit on gunwales or deck edges.

Do not overload the boat. Occupants and gear must be evenly distributed on both sides of the boat to avoid poor handling, sudden loss of control, swaying and/or capsizing.

Refer to your specific model's Designated Occupant Positions depicted in the Owner's Manual.

Keep limbs and body clear of all low lines at all times to avoid entanglement and other types of injuries.

USCG approved life jackets should be on board for all passengers and all towed participants.

882013-B

FUEL CAP DECALS

WARNING

The use of E-15 fuel in this vessel is prohibited by law.

See Owners Manual for complete explanation.

8822951.3-F

WARNING

Contents can be under pressure

Avoid serious injury or death from fire or explosion

Open slowly in well-ventilated area, no smoking or open flames

8822951.3-H

WAKESETTER LABEL LOCATIONS

WINDSHIELD DECALS (MODEL SPECIFIC)

WARNING
 Failure to follow these warnings could cause serious injury or death

 <p>REMAIN PROPERLY SEATED AND HOLD ON TO AVAILABLE HANDRAILS while boat is moving to avoid falling overboard or being ejected from the boat. Do not sit on gunwales or deck edges.</p> <p>USCG APPROVED LIFE JACKETS should be on board for all passengers and on all towed participants.</p>	 <p>DO NOT EXCEED THE BOW CAPACITY of 3 persons or 500 pounds. Overloading the bow of the boat can cause loss of control, swamping and/or capsizing.</p> <p>DO NOT OBSTRUCT OPERATOR VISIBILITY. Operators must have a clear view in front of them to avoid collisions.</p>
----------------------------------------------------------------------------------------------------------------------------------------------------------------------------------------------------------------------------------------------------------------------------------------------------------------------------------------------------------------------------------------	----------------------------------------------------------------------------------------------------------------------------------------------------------------------------------------------------------------------------------------------------------------------------------------------------------------------------------------------------------------------------

5823951.3-A

ENGINE COMPARTMENT DECALS

WARNING

LEAKING FUEL IS A FIRE AND EXPLOSION HAZARD, INSPECT SYSTEM REGULARLY. EXAMINE FUEL TANKS FOR LEAKS OR CORROSION AT LEAST ANNUALLY

5823951.3-G

WARNING!

SERVICE OF THE ENGINE ON THIS BOAT REQUIRES SPECIAL TOOLS, TRAINING AND GENUINE REPLACEMENT PARTS WHICH ARE ONLY AVAILABLE FROM MALIBU BOATS COMPANY, THE FUEL SYSTEM SHOULD BE SERVICED ONLY BY A MALIBU TRAINED CERTIFIED TECHNICIAN. DO NOT ATTEMPT TO SERVICE THE SYSTEM YOURSELF.

5823951.3-A

WHERE EQUIPPED - (MODEL SPECIFIC)

EXEMPTION NOTICE

"THIS BOAT COMPLIES WITH U.S. COAST GUARD SAFETY STANDARDS IN EFFECT ON THE DATE OF CERTIFICATION WITH THE EXCEPTION OF CERTAIN FUEL SYSTEMS REQUIREMENTS ASSOCIATED WITH ITS FUEL INJECTED ENGINE AS AUTHORIZED BY U.S. COAST GUARD GRANT OF EXEMPTION (CGB-06-005). MAINTENANCE OF THE FUEL SYSTEM IN THIS BOAT SHOULD BE PERFORMED ONLY BY MALIBU TRAINED CERTIFIED TECHNICIANS USING IDENTICAL FUEL SYSTEM COMPONENTS."

FUEL CAP DECALS

WARNING

The use of E-15 fuel in this vessel is prohibited by law. See Owners Manual for complete explanation.

5823951.3-F

WARNING

Contents can be under pressure. Avoid serious injury or death from fire or explosion. Open slowly in well-ventilated area, no smoking or open flames.

5823951.3-H

DECK SEAT DECAL

WARNING

To avoid serious injury or death seat location not intended for use while boat is underway.

5823951.3-I



TRANSOM DECALS

WHERE EQUIPPED - (MODEL SPECIFIC)

NOTICE

ENSURE CAP IS TIGHT FOR PROPER COOLING SYSTEM PERFORMANCE

DANGER

	<p>CONTACT WITH A SPINNING PROPELLER WILL CAUSE SERIOUS INJURY OR DEATH. STAY CLEAR OF BOAT AND STAY OFF SWIM PLATFORM WHILE ENGINE IS RUNNING.</p>
	<p>CARBON MONOXIDE (CO) CAN CAUSE BRAIN DAMAGE OR DEATH. Engine exhaust contains odorless and colorless carbon monoxide gas. Carbon monoxide will be around the back of the boat when engines or generators are running. MOVE TO FRESH AIR. If you feel nausea, headache, dizziness, or drowsiness.</p>

5823951.3-D

RESPONSE TXi LABEL LOCATIONS

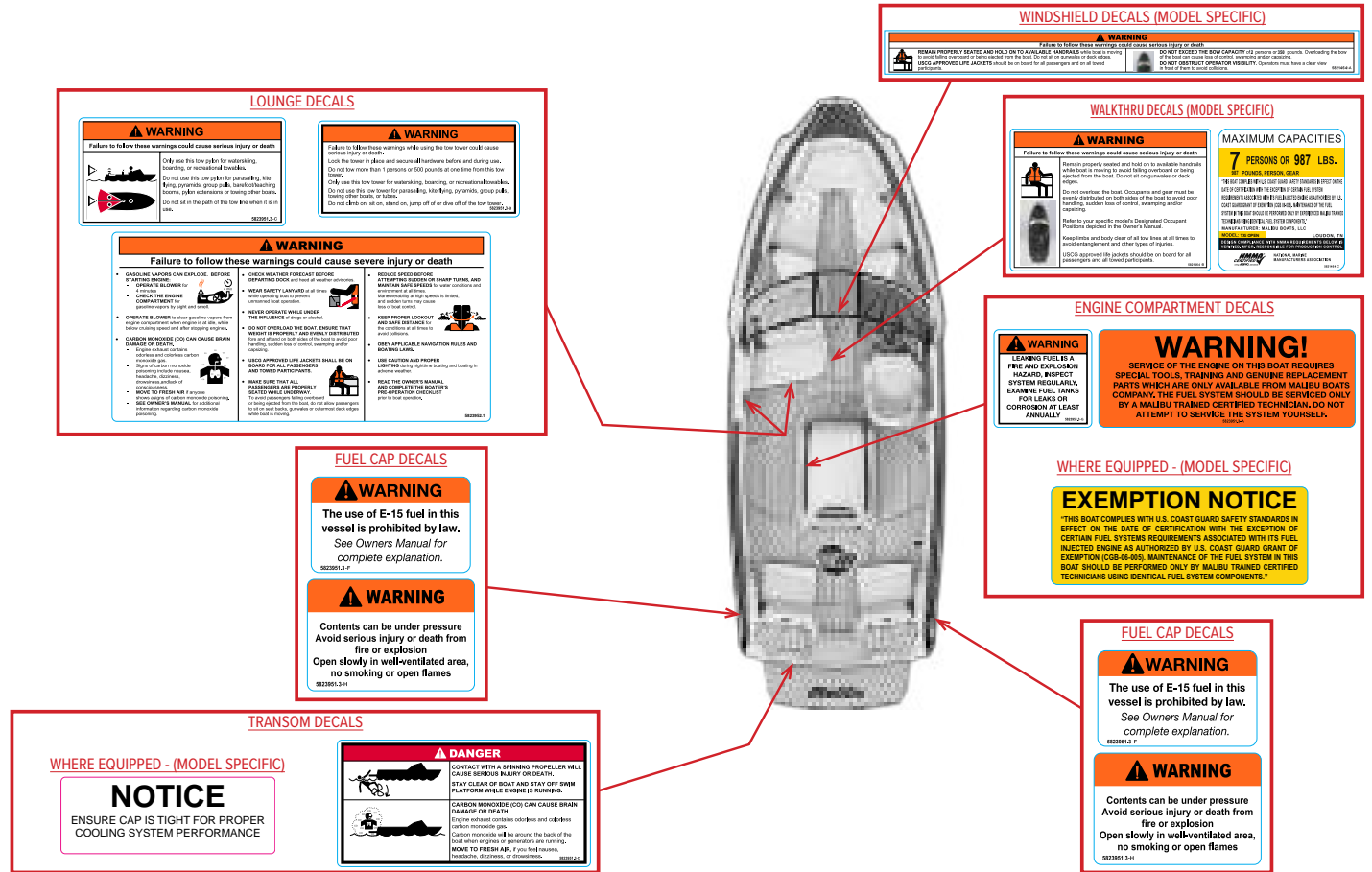

BASIC RULES OF THE ROAD

Boating Regulations

The U.S. Coast Guard (USCG) is the governing authority of the United States waterways and serves to help the boating public. State boating regulations are enforced by local authorities. Owners and users outside of the United States must be cognizant of that country's laws and regulations. You are subject to marine traffic laws and Rules of the Road for both federal and state waterways; you must stop if signaled to do so by enforcement officers, and permit them to board if asked.

Review and understand all local, state, federal, and country boating laws.

There are many USCG pamphlets available to you. These pamphlets go beyond the contents of this manual and explain Rules of the Road, signal lights, buoys, safety, international and inland regulations. An example is the Ultimate Watersports Handbook you should have received with your new boat, or which can be ordered by contacting WSIA, go to: www.WSIA.net. For more information, contact your local USCG Unit or visit <http://www.uscgboating.org>.

You should be aware of these rules and follow them whenever you encounter another vessel on the water. The rules presented in this manual outline only the most basic of the nautical Rules of the Road and have been provided as a convenience only. Consult your local U.S. Coast Guard Auxiliary (USCGA), Department of Motor Vehicles (DMV) or local maritime authority for a complete set of rules governing the waters in which you will be using your boat. If you plan to travel—even for a short trip—you would be well-served to contact the regional USCGA or DMV in the area where you will be boating.

The nautical Rules of the Road must be followed to prevent collisions between vessels. Like traffic laws for automobiles, the operator is legally required to follow the rules.



WARNING

Collisions between boats can cause death or serious injury. Keep a proper lookout, safe speed, and

follow the nautical Rules of the Road.

Encountering Another Vessel

Any time two vessels on the water meet one another, one vessel has the right-of-way. It is called the “stand-on” or “privileged vessel.” The vessel which does **NOT** have the right-of-way is called the “give-way” or “burdened vessel.” These rules determine which vessel has

the right-of-way, and accordingly, what each vessel should do.

Privileged Vessel

The privileged vessel has the right-of-way and has the duty to continue its course and speed, except to avoid an immediate collision. When you maintain your direction and speed, the other vessel will be able to determine how best to avoid you.

NOTICE

In general, boats with less maneuverability have right of way over more-agile crafts. You must stay clear of the vessel with right of way and pass to his stern.

Sailboats and boats paddled or rowed have the right of way over motor boats. Sailboats under power are considered motorboats. Small pleasure craft must yield to large commercial boats in narrow channels.

Burdened Vessel

The burdened vessel does not have the right-of-way and has the duty to take positive and timely action to stay out of the way of the privileged vessel. Normally, the burdened vessel should not cross in front of the privileged vessel. The burdened vessel should slow down or change directions and pass behind the other vessel. The burdened vessel operator should always move in such a way that the privileged vessel operator can see what you are doing in ample time to avoid a collision.

Crossing

In crossing situations, the boat to the right from the 12 o'clock to the 4 o'clock position has the right-of-way, and it must hold course and speed. The burdened boat passes behind the privileged boat. Boats going up and down a river have the privilege over boats

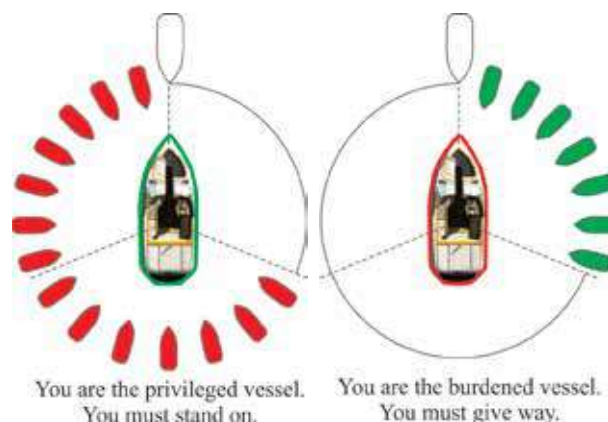

crossing the river. The illustration depicts a situation in which you are the boat in the center and you are the privileged vessel. You must hold course and speed. All vessels approaching your vessel from the directions depicted by the red vessels must yield to your boat.

Conversely, the illustration depicts a situation in which you are the boat in the center and you are the burdened vessel. You must give right-of-way to all vessels coming towards you from the directions shown in green.

Meeting Head-On

When meeting head-on, neither vessel has the right of way. Both boats should decrease speed, turn towards their right (starboard side) and pass on their left sides (port-to-port). However, if both boats are clearly on each other's right (starboard) side then, each vessel should sound two short blasts and pass on their right sides (starboard-to-starboard).

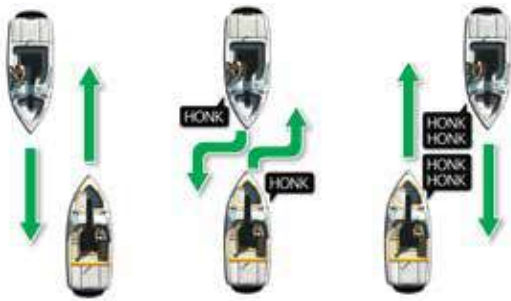

Overtaking

The boat that is overtaking one ahead of it is the burdened boat and must make any adjustments necessary to keep out of the way of the privileged boat, until the burdened boat is well ahead and clear of the vessel being overtaken.

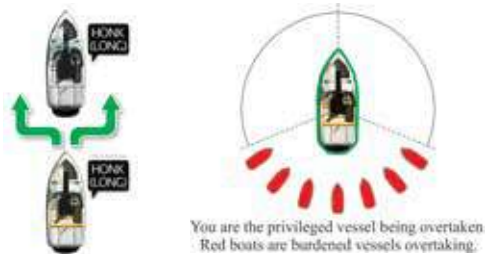

The General Prudential Rule

The General Prudential Rule regarding right of way, is that if a collision appears unavoidable, neither boat has right of way. As prescribed in the Rules of the Road, both boats must act to avoid collision.

Rule 2 in the International Rules says, "In construing and

complying with these Rules due regard shall be had to all dangers of navigation and collision and to any special circumstances, including the limitations of the vessels involved, which may make a departure from these Rules necessary to avoid immediate danger."

Other Rules of the Road

When navigating in narrow channels, you should keep to the right when it is safe and practical to do so. If the operator of a power-driven vessel is preparing to go around a bend that may obstruct the view of other water vessels, the operator should sound a prolonged blast on the whistle or horn—four to six seconds.

If another vessel is around the bend, it too should sound the whistle or horn. Even if no reply is heard, however, the vessel should still proceed around the bend with caution.

If you navigate these type of waters, you should carry a portable air horn, which are available from local marine supply stores.

Aids to Navigation

Learn to recognize the different buoys and day markers; they are the signposts of the waterways. The United States Aids to Navigation System (USATONS) is the primary marking system used on inland water, coastal waters and rivers in the United States. This system is maintained by the U.S. Coast Guard (USCG).



Spherical Safe Water Marker

There are two primary marking systems in use in the U.S.: the Uniform State Waterway Marking System (USWMS), used on inland waters and maintained by each state, and the Federal Waterway Marking System (FWMS), used on coastal waters and rivers and maintained by the USCG. In addition, the FWMS has two modified systems: the Western River Buoyage, and the Intracoastal Waterway Buoyage. Be sure to check with local authorities on the buoyage system in use in your boating region.

The type of hazard/warning buoys and markers depends on the area of jurisdiction. Check with local boating authorities.

USWMS System

In the USWMS Lateral System, well-defined channels are marked with red and black buoys, and the boat should pass between them.

The USWMS Cardinal System is used when there is no well-

defined channel or where an obstruction may be approached from more than one direction. With the cardinal system:

- Pass north or east of **BLACK-TOPPED WHITE** buoy.
- Pass south or west of **RED-TOPPED WHITE** buoy.
- **RED** and **WHITE VERTICALLY STRIPED** buoy indicates boat should pass outside of the buoy (away from shore).

FWMS System

The FWMS Lateral System is for use on navigable waters except Western Rivers and Intracoastal Waterways. The markings on these buoys are oriented from the perspective of being entered from seaward (the boater is going toward the port). This means that red buoys are passed on the starboard (right) side of the vessel when proceeding from open water into port, and green buoys to the port (left) side.

The right side (starboard) of the channel is marked with **RED**, even numbered buoys.

The left (port) side of the channel is marked with **GREEN**, odd numbered buoys.

The middle of the channel is marked with **RED** and **WHITE** vertically striped buoys; pass close to these buoys.

Obstructions, channel junctions, etc. are marked with **RED** and **GREEN** horizontally striped buoys.

A **RED** band at the top means the preferred channel is to the left of the buoy; a **GREEN** top band means the preferred channel is to the right of the buoy.

Day markers are colored and numbered the same as buoys. **RED**, triangular day markers with even numbers mark the starboard side of the channel. **GREEN**, square day markers with odd numbers mark the port side of the channel.

Lights, bells and horns are used on buoys for night or poor visibility conditions. Buoys with unique light flashing characteristics are identified on nautical charts with the specific flashing pattern.

Types of Buoys

There are several types and shapes of buoys. Buoys may be unlighted, lighted, with sound or may have both an audible and a visual signal. Lights, bells and horns are used on buoys for night or poor visibility conditions. Different shapes of buoys are shown following.

Buoys with unique light flashing characteristics are identified on nautical charts with the specific flashing pattern.

Mooring Buoys

The only buoys from which you are permitted to moor are mooring buoys. Mooring buoys are white with a blue horizontal stripe. Mooring to a navigation buoy, regulatory markers or lateral markers is illegal.



UNLIGHTED BELL BUOY



SPAR BUOY



NUN BUOY



LIGHTED BUOY

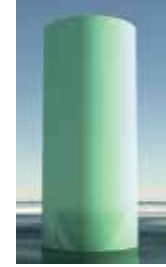

CAN BUOY



MOORING BUOY-(WHITE WITH BLUE BAND MAY SHOW WHITE REFLECTOR OR LIGHT)

Uniform State Regulatory Markers

Regulatory markers indicate dangerous or restricted controlled areas. These markers are used to indicate speed zones, areas set aside for particular use, general information and directions.

Regulatory markers are white with orange geometric shapes and also have orange bands near the top and at the water line of the buoy. You must obey regulatory markers.



CONTROLLED AREA



DANGER



BOATS KEEP OUT



INFORMATION

Uniform State Waterway Marking System (USWMS)



Diver's Flag

Used by recreational divers—indicates position. Stay far away from diver flags. Someone is underwater in the vicinity.



Alpha Flag

Worldwide vessels engaged in diving operations—does not indicate diver's position. Stay far away from diver flag. Someone is underwater in the vicinity.



Distress Flag

Indicates fellow boater is in need of assistance.

Warning Markers

It is a good idea to ask local authorities if there are hazardous areas and how they are marked. Boaters must also recognize the

flag designs, which indicate that skin divers are present and keep well clear of the area. Divers underwater cannot be seen. Stay well away from boats or floats displaying Diver Flags.

Watch for swimmers. Swimming areas may not be marked. Steer clear from the area and remain alert.



SKIN DIVER WARNING FLAG



SWIM AREA WARNING BUOY

Navigation markers serve as a means of identifying navigable routes, and indicate water hazards. Boaters should become familiar with navigation markers and stay within marked boundaries and clear of hazards.

Night Running

Boats operating between sunset and sunrise (hours vary by state) must use navigational lights. Nighttime operation, especially during bad weather or fog can be dangerous. All Rules of the Road apply at night, but it is best to slow down and stay clear of all boats, regardless of who has right of way. Protect your night vision by avoiding bright lights and have a passenger, if possible, help keep watch for other boats, water hazards and aids to navigation. It is best to proceed slowly at night, as there is always the possibility of unlit boats, floating objects, and fixed objects which will be very difficult to see in time to avoid if you are at planing speeds or above.

There are many light patterns on different types of boats and for boats performing various functions while underway or at anchor. For most applications on recreational boats the following navigation light patterns are applicable.

(NOTE: Information is included here that does not apply to Malibu boats. However, the information is included here to assist Malibu operators in being aware of the navigational lights that may appear on other vessels you may encounter.)

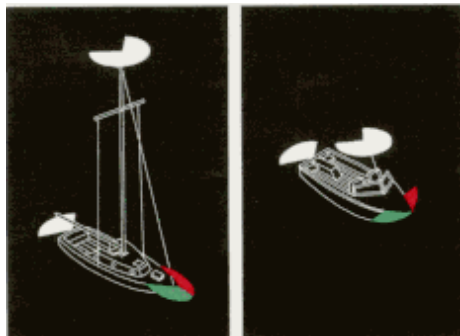

Figure 1

Motorboats less than 20 meters (65.62 feet) shall exhibit navigation lights as shown in Figure 1. (Note: Two masthead lights are optional for boats under 50 meters. Boats over 50 meters [164 feet] will display two masthead lights.)

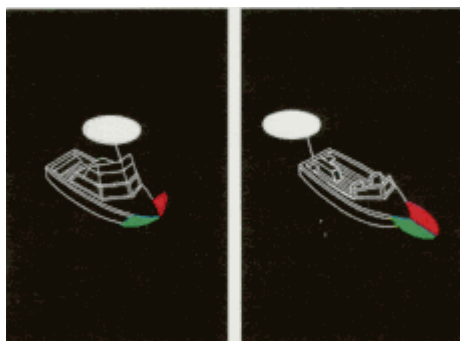

Figure 2

Motorboats of less than 12 meters (39 feet, 4 inches) in length, may show the lights in either Figure 1 or Figure 2. Boats of less than 7 meters (23 feet) whose maximum speed cannot exceed seven (7) knots may exhibit an all-around white light, and, if practicable, sidelights instead of the lights prescribed above, in international waters only.

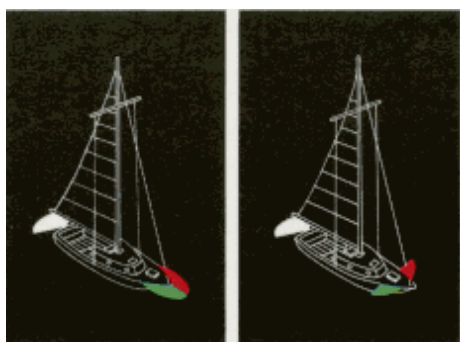

Figure 3

Sailboats and watercraft under oars: Sailboats less than 20 meters (65.62 feet) may exhibit the navigation lights shown in Figures 3 or 4.

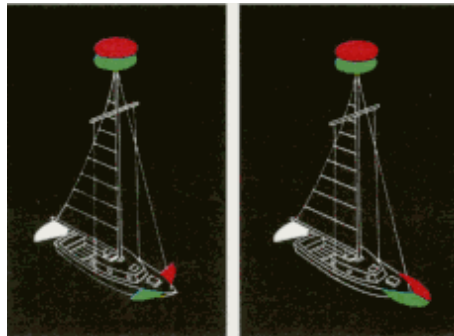

Figure 4



Figure 5

Another option for sailboats is to use a single combination lantern at the top of the mast as shown in Figure 5.

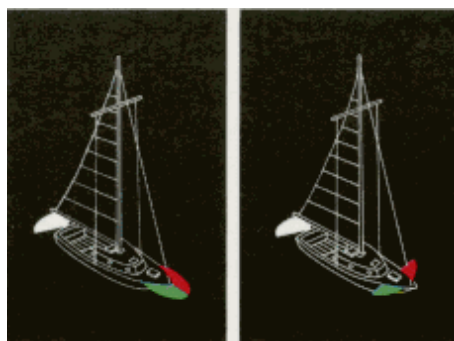

Figure 6

Sailboats less than 7 meters (22.96 feet) may carry an electric torch or lighted lantern showing a white light to be displayed in sufficient time to prevent collision (see Figure 6). If practicable the lights prescribed for sailboats less than 20 meters should be displayed. Watercraft under oars (such as a canoe) may display the lights prescribed for sailboats, but if not, must have ready at hand an electric torch or lighted lantern (flashlight) showing a white light to be displayed in sufficient time to prevent collision (see Figure 6).

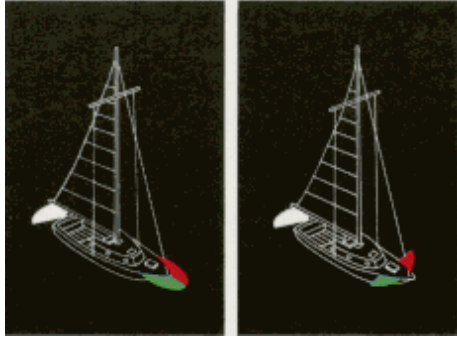

Figure 7

Anchored boats: Motorboats and sailboats at anchor must display anchor lights. An anchor light for a watercraft less than 50 meters (164 feet) in length is an all-around white light, visible for 2 miles exhibited where it can best be seen (see Figure 7).

Sailboats operating under machinery, or under sail and machinery, are considered power driven and must display the lights prescribed for a power-driven boat.

WATERSPORTS SAFETY

Skiers or riders are obligated to be aware of the same fundamental safety rules as boat operators. If you are new to water skiing, wakeboarding, wake surfing, and other towed watersports, seek certified training before starting. You will find it especially helpful to join a local ski club, World Wakeboard Association, and/or USA Water Ski, when possible.

Always remember that the majority of injuries occurring while water skiing/wakeboarding and other towed watersports are the result of impacts with other objects. Always look where you are going and be aware of what is going on around you.

When participating in towing watersports, be safe and courteous and follow these guidelines:

- Be considerate to fishermen and others who are sharing the same body of water.
- **DO NOT** perform watersports in congested areas.
- Stay away from navigation markers.
- Stay away from other boats and watersports participants.



Contact with a spinning propeller can cause injury and death. Do not enter or exit the water when the

engine is running (ON) and the propeller spinning. Do not get on the swim platform when the engine is running. Do not swim towards the back of the boat if the engine is on.



Failure to adhere to these warnings may result in severe injury or death to you and/or others.

- Every towed person must always wear a USCG-approved personal flotation device.
- Always have an experienced driver and a designated observer in the boat while being towed.

- Maintain a distance of at least 100 feet from all other objects, including other boats, piers, rafts, mooring and navigational buoys, pilings, abutments, or any other items.
- Never water ski, wakeboard or participate in other towed watersports in shallow water, close to shore, or in water where you do not know the depth or what is beneath the surface.
- Never put your arm, head, or any other part of your body through the handle-bridle of the tow line nor wrap the line around any part of the body at any time.
- **DO NOT** participate in watersports while under the influence of alcohol and/or drugs.
- **DO NOT** participate in watersports during inclement weather or on rough water.
- Never water ski, wakeboard or participate in other towed watersports directly in front of other boats who may run over you if you fall.
- Never water ski, wakeboard or participate in other towed watersports at night.
- Never jump from a boat that is moving at any speed.
- Make sure that everyone knows and uses approved towed watersports hand signals.

Hand Signals

Make sure that everyone knows and uses approved towed watersports hand signals, as shown.



Circle

Back to Dock

Cut Engine



Skier in Water



Skier OK



Speed OK



Stop



Speed Faster



Speed Slower



Turn Left



Turn Right

Towed Person Safety Responsibilities>

Most injuries and fatalities that occur on high-performance recreational tow boats occur to the persons being towed (water skiing, kneeboarding, wakeboarding, wake surfing, tubing, etc.). It is the responsibility of the boat operator to pay attention to a multitude of things while utilizing the boat for water tow sports. The towed person has little or no control over their path nor do they have much in the way of protection from impact with obstacles or other boats. Therefore, it is recommended that boat operators, observers, and towed persons communicate effectively and clearly as to their intentions and their surroundings. The main responsibilities for each participant are as follows:

Operators should:

- Assign a passenger to be a designated observer.
- Turn the engine off whenever a person is on the swim platform or in the water near the boat. This is especially important for the area near the back of the boat to avoid propeller injuries.
- Ensure that it is “all clear” behind the boat when starting the engine. Ask for verbal confirmation or hand signals that it is “all clear” behind the boat. Then, and only then, start the engine.
- Keep their main focus on maneuvering the boat safely while avoiding other boats, fixed objects, the shore, and shallow water.
- Use rear view mirrors to allow the driver to glance at the towed person, while still keeping their main attention on the path of the boat and the surroundings.

- Return safely to pick up towed persons or persons in the water. Keep the individual in view, approach slowly (preferably on the driver's side), and shut off the engine when close to an individual in the water. Do not back up or operate the boat in reverse to a person in the water.

Observers should:

- Confirm for the boat operator that it is “all clear” behind the boat prior to starting the engine.
- Watch the towed person.
- Be responsible for communication of the signals and status of the towed person to the boat driver.
- Notify the boat operator of status and changing conditions with the towed person, and inform the boat driver of the towed person's readiness to start, their desire to go faster or slower, or that they have fallen and are in need of retrieval.
- Deploy the fallen skier flag when the towed person falls, if needed. In some states, it is required to raise the “fallen skier” flag when the skier has fallen.
- Monitor the tow line to ensure that it does not become tangled, it does not become wrapped around anyone in the boat, and it does not become wrapped around the towed person. Also monitor the tow line so that it does not become tangled in the propeller. Notify the boat operator if any of these conditions are observed to avoid potential injury.
- Remind the boat operator to shut off the engine when persons are on the swim platform or in the water near the back of the boat.

Towed persons should:

- Wear a PFD.
- Not approach the back of the boat if the engine is running.
- Not become entangled in a tow line or wrap a tow line around any body part.
- Know signals to communicate with the observer and boat operator.

Additional Precautions for Towed Skier/Rider>

- Wear wet suits or protective shorts when engaging in high energy skiing/riding to prevent abrasions, hypothermia, and injuries to orifices (rectal and vaginal) from impact with the water surface.
- Inspect watersports equipment for wear, fraying, etc., before use. **DO NOT** use if they show signs of wear or fraying. Ropes or watersport equipment tow points may break during use, causing you to coast into obstacles or fall with the risk of being struck by another vessel.
- Inspect the boat tow points before use. If there is any evidence of corrosion or other damage, do not use until it has been inspected by your authorized Malibu Boat dealer.

- **NEVER** attach ski/wakeboard rope to anything but approved pylons and wakeboard towers. Make sure tow ropes are properly attached to the boat tow points.
- The skier/rider should verbally indicate that (s)he is safely clear of the boat prior to operator starting the boat engine or putting the boat into gear.
- Slowly take up slack in tow lines before accelerating to watersports speeds. Jerking the slack out of a tow line can cause high forces on the rope and towing equipment. This may cause the rope or equipment to break and the rope to snap back at occupants of your boat and at the towed person.
- Never put your arm, head or any other part of your body through the handle/bridle of the ski or wakeboarding line, nor wrap the line around any part of the body at any time. If you fall, the line will tighten and forcefully constrict around your body part and may result in amputation.
- **DO NOT** ski near swimming areas, beaches, personal watercraft, or other vessels/boats.
- Never attempt land or dock starts. These activities will increase your risk of injury or death.
- **DO NOT** jump from a boat that is moving at any speed, nor enter or exit the water when the engine is running.
- **DO NOT** "back up" to anyone in the water, they will be in danger of hitting the spinning propeller which can cause severe injury or death.
- **DO NOT** follow directly behind another boat or skier/rider without leaving an adequate safe distance in case that towed person falls into the water. You will need ample time and distance to maneuver your boat away from that person in the water and to avoid their tow boat which will be circling back to retrieve their downed person.
- **DO NOT** participate in towed watersports at night. It is illegal and other boats will not be able to see you, nor will they anticipate or expect your presence behind the towing boat. Furthermore, once you fall they will not see you swimming.
- **DO NOT** tow with multiple skier/riders with different length ropes.
- **DO NOT** ski in limited visibility conditions.
- Never climb, sit or stand on a wakeboard tower. The wakeboard tower is intended for towing only as noted. It is designed to pull a limited number of individual(s), and in some cases only one (1) individual. Please consult the remainder of this owner's manual and warning labels on the tower for details. The wakeboard tower approved for use on your boat should be used only for water skis, wakeboards or recreational towables, and not for parasailing, kite flying or towing other boats.
- Many states require the use of "skier down" flags. Check your local lake and state requirements. Having the observer raise a skier down



- flag when your towed watersport participant falls down or off the towed device will alert boats around you to the fact that someone is in the water nearby and that they should avoid the area.
- Many lakes have recommended tow patterns. Other boats may expect that you know the local customs and practices. It is common that the tow pattern is counter-clockwise around the lake, but there are exceptions. Check for local recommendations or requirements.
 - **NEVER** lift or trailer the boat with water in the bilge or in ballast tanks. Lift or trailer per manufacturer's instructions.
 - Around marina docks where electrical current is present (such as shore power connections) it is unsafe to swim as stray electrical currents may exist, which can cause you to drown.

Tow Line Guidelines

Tow lines come in different lengths and strengths for different activities. Make sure any line you are using is suited for skiing or riding and that it is in good condition.

- Never use a tow line that is frayed, knotted, unraveling or discolored from use or being left in the sun. If a line breaks while in use it can recoil at the skier/rider being towed or into the watercraft where it might strike passengers. Replace tow lines with any sign of damage.
- Never use a tow line with elastic or bungee material to pull skiers or riders.
- Tow line should be attached to the watercraft in an approved fashion with hardware designed for towing. Refer to your watercraft manual for instructions on proper tow line attachment.
- Always route tow lines away from the propeller, even when idling. Shut off the engine if your boat starts to cross a floating tow line.
- If a tow line should become entangled in a propeller, shut off engine, remove the key and put it in your pocket before retrieving the line.
- Tow lines should be neatly coiled and stowed in the boat when not in use.

Fallen Skier or Rider

Falling and injuries are common in water skiing and other towed watersports. Keep tow speeds in a comfortable range given the rules of the activity and the skill level of participants.

- Display a red or orange skier/rider down flag to alert other vessels that a skier/rider is down. In some states, it is required to raise the "fallen skier" flag when the skier has fallen.
- Turn the boat and slowly circle toward the person in the water to return the tow line handle or towed device to that person.
- Always keep the fallen skier/rider in view and preferably on the operator's side of the watercraft.
- Put the watercraft in neutral whenever you are near a fallen skier/rider.

- Shut off the engine when retrieving someone from the water or if the person in the water gets too close to the boat. Do not trust neutral gear with an idling engine. Someone may accidentally or prematurely shift the gear, or the linkages may be out of adjustment and the propeller may still be slowly spinning.

Develop WATER SENSE

The Watersports Responsibility Code and the Watersports Safety Code have been developed by WSIA and industry equipment manufacturers. These Codes are reproduced here for your reference.



Watersports Responsibility Code Familiarize yourself with and follow The Watersports Responsibility Code.

WATERSPORTS SAFETY CODE

Before you get in the water: Skiing or riding instruction is recommended before use. Instruction will teach general safety guidelines and proper skiing or riding techniques, which may reduce your risk of injury. For more information on skiing or riding schools, contact your dealer, Association, or local ski club.

- Know the federal, state and local laws that apply to your area.
- If you are not familiar with a waterway, ask someone who is knowledgeable to tell you about any hidden dangers or things to avoid.
- Whether you plan to be in a watercraft, or skiing/riding behind one it is important you are wearing a properly fitted life jacket (PFD) approved by your country's agency, USCG Type III, ISO, etc.
- Inspect all equipment prior to each use, check bindings, fins, tube, attachment, tow rope and flotation device. Do not use if damaged.

Watercraft Safety: A knowledgeable and responsible driver is the most important safety device on any watercraft.

- Never operate a watercraft, ski or ride under the influence of alcohol or drugs.
- Only use water ballast and people for additional weight.
- Never exceed the passenger or weight limitations of the watercraft.
- Never allow passengers to hang outside the watercraft or towed device or sit on the gunwales or anywhere outside of the normal seating area.
- Never allow water to overflow the bow or gunwales of the watercraft.



- Uneven weight distribution or additional weight may affect the handling of the watercraft.

Carbon Monoxide: The exhaust from the engine on a watercraft contains Carbon Monoxide (CO) which is a colorless, odorless and poisonous gas. Excessive exposure to CO can cause severe injury or death. Follow this advice to avoid injury.

- Never "Platform Drag" by holding onto the boarding platform or being dragged directly behind the watercraft. This is where CO will be.
- **DO NOT** sit on the watercraft transom or the boarding platform while the engine is running.
- Make sure the engine is properly tuned and running well. An improperly tuned engine produces excessive exhaust and CO.
- If you smell engine exhaust do not stay in that position.
- Go to the United States Coast Guard's website: (www.uscgboating.org) for more information on how to help protect yourself and others from the dangers of CO.

Tow Ropes: Tow ropes come in different lengths and strengths for different activities. Make sure any rope you are using is suited for that activity and that it is in good condition.

- Never use a rope that is frayed, knotted, unraveling or discolored from use or being left in the sun. If a rope breaks while in use it can recoil at the skier/rider being towed or into the watercraft where it might strike passengers. Replace tow ropes with any sign of damage.
- Never use a tow rope with elastic or bungee material to pull skiers or riders.
- Rope should be attached to the watercraft in an approved fashion with hardware designed for towing. Refer to your watercraft manual

for instructions on proper tow rope attachment.

- Always keep people and tow ropes away from the propeller, even when idling.
- If a tow rope should become entangled in a propeller, shut off the engine, remove the key and secure it in a safe location before retrieving the rope.
- Tow ropes should be neatly stowed in the boat when not in use.

Preparing to ski or ride: Always have a person other than the driver act as an observer to look out for the skier/rider.

- Be sure the driver is aware of the experience and ability of the skier/ rider.
- The driver, observer and skier/rider need to agree on hand signals before skiing or riding. Signals should include **READY, STOP, SPEED UP** and **SLOW DOWN**.
- Start the engine only after making sure that no one in the water is near the propeller.
- Turn the engine off when people are getting into or out of the watercraft, or in the water near the watercraft.
- Always make sure the tow rope is not wrapped around anyone's hands, arms, legs or other parts of the body.
- Start the watercraft and move slowly to remove slack until the tow rope is tight.
- When the skier/rider signals **READY** and there is no traffic ahead, take off in a straight line. Adjust the speed according to the signals given by the skier/rider.

Skiing or riding: The watercraft and skier/rider should always maintain a sufficient distance from obstacles so a skier/rider falling or coasting and/or watercraft will not encounter any obstacle.

- Do not use in shallow water or near shore, docks, pilings, swimmers, other watercraft, or any other obstacles.
- Use only on water.
- Never attempt land or dock starts. This will increase your risk of injury or death.
- Always wear a properly fitted life jacket (PFD) approved by your country's agency, USCG Type III, ISO, etc.
- The faster you ski or ride, the greater your risk of injury.
- Never make sharp turns that may cause a slingshot effect on the skier/rider's speed.
- The skier/rider should be towed at an appropriate speed for his or her ability level.

Faller skier or rider: Falling and injuries are common in skiing or riding.

- Circle a fallen skier/rider slowly to return the tow rope handle or pick up the fallen skier/rider.
- Turn off the engine when near a fallen skier/rider.
- Always keep the fallen skier/rider in view and on the driver's side of the watercraft.
- Display a red or orange skier-down flag to alert other vessels that a skier/rider is down if required by the state in which you are operating.

The Warnings and practices in the Watersports Safety Code represent common risks encountered by users. The code does not cover all instances of risk or danger. Please use common sense and good judgment.

EMERGENCY PROCEDURES

In an emergency situation, you may have to resort to measures which are not commonly practiced. Always assess the dangers of being in harm's way versus the protection of equipment. Keep a sound mind during an emergency and always use common sense.

Explosion and Fire

Many boat fires and explosions involve flammable liquids such as gas or oil, which are used in your boat's propulsion engine(s) and generator. Carefully follow all warning labels and safety precautions while handling flammable substances. Many fires in inboard boats start in the bilge area due to gasoline vapors. Gasoline vapors are heavier than air and collect in the bilge of boats.

Explosion

- If explosion is imminent, put on PFDs, grab distress signals and survival gear, and immediately abandon ship.

Fire

- Immediately turn off engines, generators, stoves and blowers.
- Extinguish smoking materials.
- A fixed fire suppression system, if equipped, has heat sensors that automatically flood the machinery space with a fire extinguishant.

Allow extinguishant to "soak" the compartment for at least 15 minutes to cool the hot metals or fuel before cautiously inspecting the fire area. Have portable fire extinguishers ready. **DO NOT** breathe fumes or vapors caused by the fire or extinguishant.

- If no fixed fire suppression system is installed and a fire is in the engine compartment, discharge portable fire extinguishers through the engine compartment access plate, if equipped. **DO NOT** open the engine hatch as this feeds oxygen to the fire.
- If you have access to the fire, direct the contents of the fire extinguishers at the base of flames, not at the top.
- Throw burning materials overboard if possible.
- Move anyone not needed for firefighting operations away from the flames.
- Signal for help.
- Put on PFDs (Personal Flotation Devices), grab distress signals and survival gear, and prepare to abandon ship.



Burn hazard from gasoline floating on water which is ignited can cause death or serious injury. Gasoline will float on top of water and can burn. If the boat is abandoned, swim upwind, far enough to avoid fuel that can spread over the surface of the water.

Swamping and Flooding

In the event that the vessel begins to take on water, turn on the bilge pump to evacuate water and slow its accumulation, and try to determine the source of the water. A collision with an underwater object can cause the hull to develop a leak. A loose fitting hose clamp on a piece of equipment can cause a leak. Try to repair the leak if possible. If a leak is threatening the safety of you and your passengers, call or signal for assistance.

- Turn on bilge pump(s).
- Access PFDs, pass them out to everyone, and put them on.
- Identify source of leak and try to stop the leak and flooding.
- **STAY WITH THE BOAT!** A boat will usually float even if there is major hull damage. Rescuers can spot a boat much easier than a head bobbing in the water.
- Signal or call for help.
- If others were on board, try to locate them, make sure that they are conscious and that they can swim.
- Immersion in water speeds the loss of body heat and can lead to hypothermia (the abnormal lowering of internal body temperature).

Capsizing

- If others were on board, try to locate them, make sure that they are conscious and they can swim.
- If possible, access life jackets (PFDs), pass them out to everyone, and put them on.
- **STAY WITH THE BOAT!** A boat will usually float even if there is major hull damage. Rescuers can spot a boat much easier than a head bobbing in the water.
- Signal or call for help.
- Immersion in water speeds the loss of body heat and can lead to hypothermia (the abnormal lowering of internal body temperature).

Staying Afloat

- Remain calm. Do not thrash about or try to remove clothing or footwear. This leads to exhaustion and increases the loss of air that may keep you afloat.
- Keep your life jacket (PFD) on.
- Keep your knees bent.
- Float on your back and paddle slowly to safety.

Collisions

- Immediately account for all passengers.
- Check for injuries.
- If any person is in the water make sure they have proper flotation devices.
- Assess the hull for damage.

- Activate the bilge pump(s) to reduce any flooding.
- Try to operate the boat to keep the damaged area above water.
- If necessary, call or signal for assistance.
- **STAY WITH THE BOAT!**

Grounding

In the event you run aground, assess the situation before proceeding. Your response to grounding will depend on how hard the boat hits bottom and whether the boat remains stranded, the extent of damage, and proximity to shore and help.

- If it is a simple touch, you may need only to inspect the hull.
- If you are aground, assess the situation before reacting. In some cases, throwing the boat into reverse can cause more damage.
- Check for leaks and immediately stop any water from entering the boat.
- Inspect the hull, steering system and propulsion system for damage.
- Maneuver the boat to safe water only if the hull and all operating systems are in satisfactory operating condition. Otherwise, call or signal for assistance.

Person Overboard

- Immediately react to a person who has fallen overboard by sounding an alarm.
- Keep the victim constantly in your sight.
- If another passenger is on board, assign them to look at and keep pointing at the person in the water. They are to do nothing else but stay focused on the person in the water and to point at them.
- Throw the person a life preserver even if they are wearing a PFD. It will serve as a marker in the water and will provide additional flotation.
- Immediately slow or stop the boat and safely circle toward the victim as soon as possible.
- Keep the victim on the helm side of the vessel so as to keep the victim constantly in your sight.
- When almost alongside, shut off the engine.
- Assist the person into the boat.

Drowning

- Swim to rescue a drowning victim only as a last resort.
- **Immediate resuscitation is critical!** It may be possible to revive a drowning victim who has been under water for some time and shows no sign of life. Start CPR immediately and get the victim to a hospital as quickly as possible.
- Keep the victim warm.
- Use care in handling. Spinal injury may exist if the victim fell overboard.
- Call and signal for help.

Medical Emergency

In an emergency, you may be far from professional medical assistance. Be prepared and know how to use your first aid kit. Be aware of any special medical conditions of your passengers.

Operation Failure

If you experience a propulsion, electrical, steering or control failure, immediately shut off the engine. If it is safe to do so and you are qualified, then try to determine the cause of the failure and repair. Otherwise, call or signal for assistance. Anchor the boat if drifting will put you and others in danger.



WARNING

Towing or being towed stresses the boats, hardware and lines. Failure of any part can seriously injure people or damage the boat.

Towing

A recreational boat towing another should be a last resort due to the potential for damaging one or both boats. The Coast Guard or a private salvage company is better equipped for this activity. A recreational boat may assist by standing by, and possibly by keeping the disabled boat's bow at a proper angle until help arrives. Only when conditions are ideal—that is, waters are calm, disabled boat is small, appropriate hardware is available, and one or both skippers know the correct technique—should a recreational boat tow another.

Towing Vessel

- Be sure your boat will not run aground too.

- Because you are maneuverable and the grounded boat is not, you should pass the towline to the grounded boat.
- Select an appropriately strong tow line. Use double-braided or braid-on-braid line. Never use three-strand twisted nylon; it has too much elasticity and can snap back dangerously.
- Select an appropriate attachment point. If available fasten the towline to the forward tow pylon of the towing boat. Otherwise fasten tow line to stern tow point. Fastening to the stern tow point will restrict maneuverability of the towing boat.
- If possible, use a bridle.
- Move slowly to prevent sudden strain on slack line.
- Proceed at slow speed.
- Avoid abrupt changes in throttle as that may cause the tow line to slacken and jerk tight. Sudden strain or jerking the line causes excessive tow line forces which may part the line. Keep slack out of the tow line, but if it occurs proceed slowly to again take up the strain on the line and avoid sudden jerks in the line.
- Be ready to cast loose or cut the line if the towing situation becomes hazardous.

Vessel Being Towed

- Attach the towline to the bow eye.
- If it is necessary to be towed after being freed, keep someone at the wheel to steer.

Both Vessels

- If you attach the towline to a fitting, be sure the fitting is fastened with a through bolt and is reinforced on the underside.
- Keep lines clear of propellers on both boats.
- Keep hands and feet clear of the other boat. Do not get caught, or pinched between the two boats as severe injury could occur.
- Never hold a towline after it is pulled taut.



QUICK REFERENCE GUIDE

Weight capacities shown reflect the best-available information at press time. Please check the weight capacity label affixed to the boat to determine actual allowable total additional weight, including ballast, that can be added to the boat.



Malibu

RASP

Response TXi

(Available also as Malibu Open Edition; open or closed bow)



Specifications

LENGTH	20'6"/6.25 m
BEAM	95"/2.41 m
DRAFT	22"/0.6 m
FUEL	40 gal/151 l
HULL TYPE.....	T-cut diamond
CAPACITY	7 people total (2 in bow), open bow
.....	5 people total, closed bow
.....	987 lbs., open bow; including people;
.....	705 lbs., closed bow; including people
.....	350 lbs., maximum in bow

1 - DOCKING LIGHTS
(TWO, PORT & STARBOARD, FORWARD HULL)

2 - STORAGE
(WHERE EQUIPPED—UNDER BOW SEATING)

3 - ZERO OFF GPS PUCK
(PORT BOW DECK ADJACENT TO SEATING)

4 - GLOVE BOX
(FORWARD OF OBSERVER SEAT ON PANEL)

5 - AUXILIARY AUDIO PORT
(INSIDE GLOVE BOX AS PART OF STEREO PACKAGE)

6 - USB AUDIO-ONLY PORT
(INSIDE GLOVE BOX)

7 - COMPOSITE RCA PORT
(INSIDE GLOVE BOX)

8 - AMP
(COMPONENT BOARD MOUNTED—OBSERVER SEAT AREA)

9 - STORAGE
(UNDER OBSERVER SEATING)

10 - BATTERIES
(UNDER OBSERVER SEAT)

11 - BATTERY SWITCH
(WHERE EQUIPPED—BENEATH OBSERVER SEAT—ON-OFF)

12 - BATTERY CHARGER
(WHERE EQUIPPED—BENEATH OBSERVER SEAT)

13 - CENTER DRAIN PLUG
(DECK, BETWEEN OBSERVER SEAT & HELM)

HEATER VENTS
(WHERE EQUIPPED—TWO OR THREE VENTS, INTERIOR MIDSHIP)

LIGHTS
(VARIOUS INTERIOR LOCATIONS)

14 - ENGINE COMPARTMENT
(CENTER DECK)

15 - AUTOMATIC FIRE EXTINGUISHER
(WHERE EQUIPPED—INSIDE ENGINE COMPARTMENT)

16 - FUEL FILL
(TWO, PORT & STARBOARD EXTERIOR)

17 - BACK-UP CAMERA
(WHERE EQUIPPED—STERN, ABOVE SWIM BOARD)

18 - ENGINE EXHAUST
(TWO, PORT & STARBOARD BENEATH SWIM BOARD)

19 - AFT DRAIN PLUG
(STERN, BELOW SWIM BOARD)

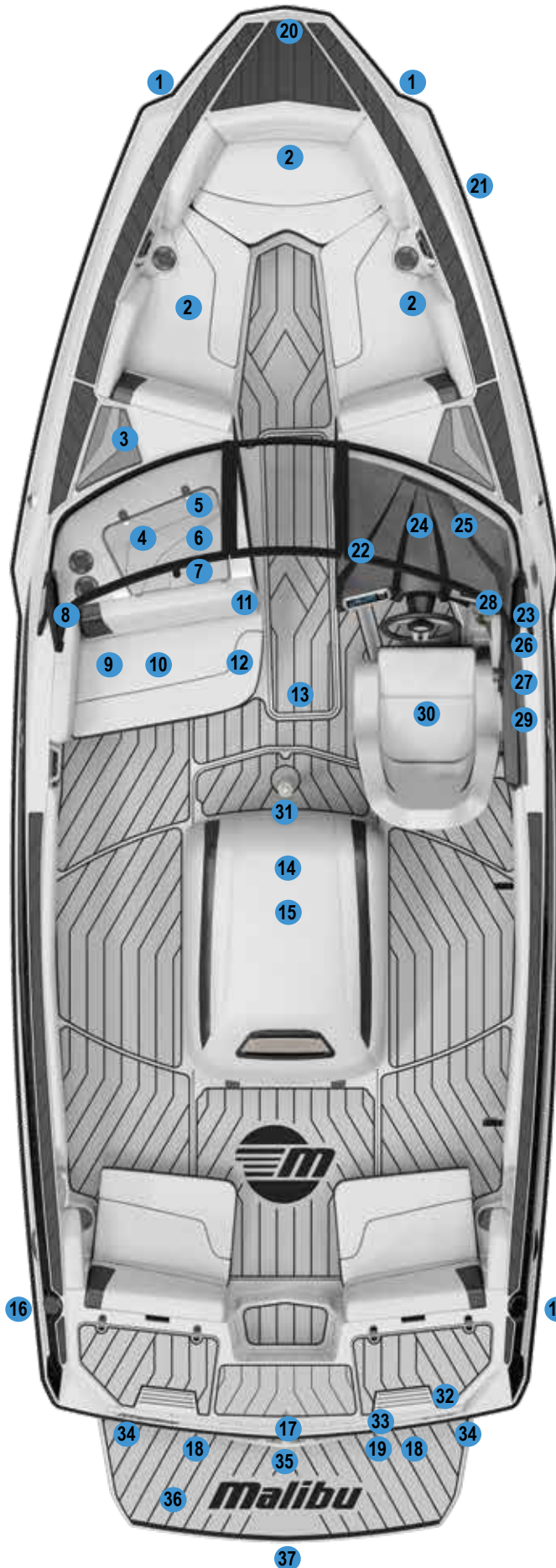

20 - BOW LIGHT
(WHERE EQUIPPED—STANDARD OR POP-UP, BOW POINT ON DECK)

21 - BILGE THRU-HULL OUTLETS
(STARBOARD SIDE OF HULL)

22 - ADJUSTABLE MIRROR
(MOUNTED TO WINDSHIELD)

23 - FIRE EXTINGUISHER INDICATOR
(WHERE EQUIPPED—UPPER PORT SIDE OF INSTRUMENT PANEL)

24 - FUSE PANEL POWER MODULE CONTROL
(BENEATH INSTRUMENT PANEL)

25 - HEATER UNIT
(BENEATH INSTRUMENT PANEL)

26 - SHIFT/THROTTLE CONTROL
(HELM SIDE PANEL)

27 - EMERGENCY SAFETY STOP SWITCH
(HELM SIDE PANEL)

28 - 12-VOLT CHARGER
(BREAKER PANEL)

29 - CIRCUIT BREAKER PANEL
(HELM SIDE PANEL, BELOW SHIFT-THROTTLE)

30 - HEATED SEAT
(WHERE EQUIPPED)

31 - SKI PYLON
(CENTER, FORWARD OF ENGINE COMPARTMENT)

32 - SHOWER
(WHERE EQUIPPED—STERN, ABOVE SWIM BOARD)

33 - STEREO REMOTE
(WHERE EQUIPPED—STERN, ABOVE SWIM BOARD)

34 - UNDERWATER LIGHTS
(WHERE EQUIPPED—TWO, BENEATH SWIM BOARD)

35 - AUTO SET WEDGE
(WHERE EQUIPPED—CENTER, UNDER SWIM BOARD)

36 - SWIM BOARD
(STERN)

37 - LADDER
(WHERE EQUIPPED—UNDER SWIM BOARD)

Specifications

LENGTH	20'6.10 m
BEAM	98"/2.50 m
DRAFT	27"/0.7 m
FUEL	38 gal/144 l
HULL TYPE.....	T-cut diamond
CAPACITY	11 people total (2 in bow) 1,588 lbs., including people 350 lbs., maximum in bow



Wakesetter 20VTX

STORAGE

(UNDER BOW SEATING EXCEPT WHEN OPTIONAL BOW TANK INSTALLED; UNDER OBSERVER SEAT; UNDER INTERIOR SEATING; UNDER DRIVER'S SEAT; WATERTIGHT BOX ON SHIFTER PANEL)

1 - ZERO OFF GPS PUCK

(PORT BOW DECK ADJACENT TO SEATING)

2 - BATTERY ON-OFF

(WHERE EQUIPPED—WALK-THRU SIDE PANEL)

3 - GLOVE BOX

(INCLUDES 12-VOLT CHARGER, USB AUDIO-ONLY PORT, AUX-AUDIO PORT, COMPOSITE VIDEO-YELLOW RCA PORT)

4 - CLEAT

(WHERE EQUIPPED)

5 - AMP

(COMPONENT BOARD MOUNTED—OBSERVER SEAT AREA)

6 - BATTERIES

(BENEATH BOW SEAT)

HEATER VENTS

(WHERE EQUIPPED—TWO OR THREE VENTS IN BOAT INTERIOR)

7 - CENTER DRAIN PLUG

(MAY BE UNDER OPTIONAL FLOORING)

8 - COCKPIT TABLE MOUNT

(INTERIOR SEATING KICK PANEL)

9 - G3.5 TOWER OR OPTION GX TOWER

(MAY ALSO INCLUDE TOWER ACCESSORIES SUCH AS G-FORCE WET SOUNDS SPEAKERS AND AMPS; TOW ATTACHMENT, CAMERA, LIGHTS, MIRROR, RACKS.)

10 - CLEAT

(WHERE EQUIPPED)

11 - FUEL FILL

(EXTERIOR PORT SIDE)

12 - ENGINE EXHAUST

(BENEATH SWIM BOARD, TWO, PORT AND STARBOARD SIDES)

13 - TRANSOM DRAIN PLUG

(BENEATH THE SWIM BOARD)

14 - STEREO REMOTE

(WHERE EQUIPPED—ON TRANSOM)

15 - TRANSOM TOW EYE

(CENTER TRANSOM)

16 - UNDER SWIM BOARD

UNDERWATER LIGHTS
LADDER
WEDGE PLATE
SURF GATE
POWER WEDGE
(WHERE EQUIPPED—ALL ARE LOCATED BENEATH THE SWIM BOARD)



17 - BOW CAMERA
(WHERE EQUIPPED—BOW)

18 - BOW LIGHT
(STANDARD OR POP-UP, WHERE EQUIPPED)

19 - DOCKING LIGHTS
(WHERE EQUIPPED—ALSO ON PORT SIDE)

20 - THRU-HULL OUTLETS
(BILGE & BALLAST; ADDITIONAL OUTLETS AFT PORT, STARBOARD AND TRANSOM)

21 - INVERTER PLUG-IN
(WHERE EQUIPPED—WALK-THRU SIDE PANEL)

22 - FUSE PANEL POWER MODULE CONTROL
(BENEATH INSTRUMENT PANEL)

23 - HEATER UNIT
(BENEATH INSTRUMENT PANEL)

24 - ADJUSTABLE MIRROR
(WHERE EQUIPPED—MOUNTED TO WINDSHIELD)

25 - EMERGENCY SAFETY STOP SWITCH
(ON SIDE PANEL)

26 - CLEAT
(WHERE EQUIPPED)

27 - SHIFT/THROTTLE CONTROL
(ON SIDE PANEL)

28 - CIRCUIT BREAKER PANEL
(BENEATH SHIFT/THROTTLE CONTROL)

29 - FIRE EXTINGUISHER INDICATOR
(WHERE EQUIPPED—ON SIDE PANEL)

30 - SUBWOOFER
(WHERE EQUIPPED—BENEATH INSTRUMENT PANEL)

31 - HEATED AND/OR POWER SEAT
(WHERE EQUIPPED)

32 - REMOVABLE COOLER
(WHERE EQUIPPED—BENEATH SEAT)

33 - SKI PYLON

34 - REMOVABLE TRASH CAN
(BENEATH SEAT)

35 - CLEAT
(WHERE EQUIPPED)

36 - FUEL FILL
(EXTERIOR STARBOARD SIDE)

37 - POP-UP SKI PYLON
(CENTER ADJACENT TO ENGINE COMPARTMENT)

38 - ENGINE COMPARTMENT
(V-DRIVE, LOCATED AFT)

39 - AUTOMATIC FIRE EXTINGUISHER
(WHERE EQUIPPED—ENGINE COMPARTMENT)

40 - FRESHWATER FLUSH KIT AND/OR SHOWER
(WHERE EQUIPPED—STARBOARD TRANSOM)

41 - BACK-UP CAMERA
(WHERE EQUIPPED—CENTER TRANSOM)

42 - SWIM BOARD

Wakesetter 21MLX



Specifications

LENGTH	21'6.40 m
BEAM	98"/2.50 m
DRAFT	27"/0.7 m
FUEL	48 gal/182 l
HULL TYPE.....	Wake Plus
CAPACITY	14 people total (3 in bow) 1,974 lbs., including people 500 lbs., maximum in bow

STORAGE

(UNDER BOW SEATING EXCEPT WHEN OPTIONAL BOW TANK INSTALLED; UNDER OBSERVER SEAT; UNDER INTERIOR SEATING; UNDER DRIVER'S SEAT; WATERTIGHT BOX ON SHIFTER PANEL)

1 - BATTERIES

(BENEATH BOW SEAT)

2 - ZERO OFF GPS PUCK

(PORT BOW DECK ADJACENT TO SEATING)

3 - AMP

(COMPONENT BOARD MOUNTED—OBSERVER SEAT AREA)

4 - BATTERY ON-OFF

(WHERE EQUIPPED—WALK-THRU SIDE PANEL)

5 - GLOVE BOX

(INCLUDES 12-VOLT CHARGER, USB AUDIO-ONLY PORT, AUX-AUDIO PORT, COMPOSITE VIDEO-YELLOW RCA PORT)

6 - CLEAT

(WHERE EQUIPPED)

7 - CENTER DRAIN PLUG

(MAY BE UNDER OPTIONAL FLOORING)

8 - G3.5 TOWER

(MAY ALSO INCLUDE TOWER ACCESSORIES SUCH AS G-FORCE WET SOUNDS SPEAKERS AND AMPS; TOW ATTACHMENT, CAMERA, LIGHTS, MIRROR, RACKS.)

9 - FUEL FILL

(EXTERIOR PORT SIDE)

10 - CLEAT

(WHERE EQUIPPED)

11 - ENGINE EXHAUST

(BENEATH SWIM BOARD, TWO, PORT AND STARBOARD SIDES)

12 - TRANSOM DRAIN PLUG

(BENEATH THE SWIM BOARD)

13 - STEREO REMOTE

(WHERE EQUIPPED—ON TRANSOM)

14 - TRANSOM TOW EYE

(CENTER TRANSOM)

15 - UNDER SWIM BOARD

UNDERWATER LIGHTS
LADDER
WEDGE PLATE
SURF GATE
POWER WEDGE
(WHERE EQUIPPED—ALL ARE LOCATED BENEATH THE SWIM BOARD)

16 - BOW LIGHT

(STANDARD OR POP-UP, WHERE EQUIPPED)

17 - THRU-HULL OUTLETS

(BILGE & BALLAST; ADDITIONAL OUTLETS AFT PORT, STARBOARD AND TRANSOM)

18 - INVERTER PLUG-IN

(WHERE EQUIPPED—WALK-THRU SIDE PANEL)

19 - FUSE PANEL POWER MODULE CONTROL

(BENEATH INSTRUMENT PANEL)

20 - ADJUSTABLE MIRROR

(WHERE EQUIPPED—MOUNTED TO WINDSHIELD)

21 - EMERGENCY SAFETY STOP SWITCH

(ON SIDE PANEL)

22 - CLEAT

(WHERE EQUIPPED)

23 - SHIFT/THROTTLE CONTROL

(ON SIDE PANEL)

24 - CIRCUIT BREAKER PANEL

(BENEATH SHIFT/THROTTLE CONTROL)

25 - SUBWOOFER

(WHERE EQUIPPED—BENEATH INSTRUMENT PANEL)

26 - HEATED AND/OR POWER SEAT

(WHERE EQUIPPED)

27 - REMOVABLE COOLER

(WHERE EQUIPPED—BENEATH SEAT)

28 - SKI PYLON

29 - REMOVABLE TRASH CAN

(BENEATH SEAT)

30 - FUEL FILL

(EXTERIOR STARBOARD SIDE)

31 - CLEAT

(WHERE EQUIPPED)

32 - POP-UP SKI PYLON

(CENTER ADJACENT TO ENGINE COMPARTMENT)

33 - ENGINE COMPARTMENT

(V-DRIVE, LOCATED AFT)

34 - SWIM BOARD

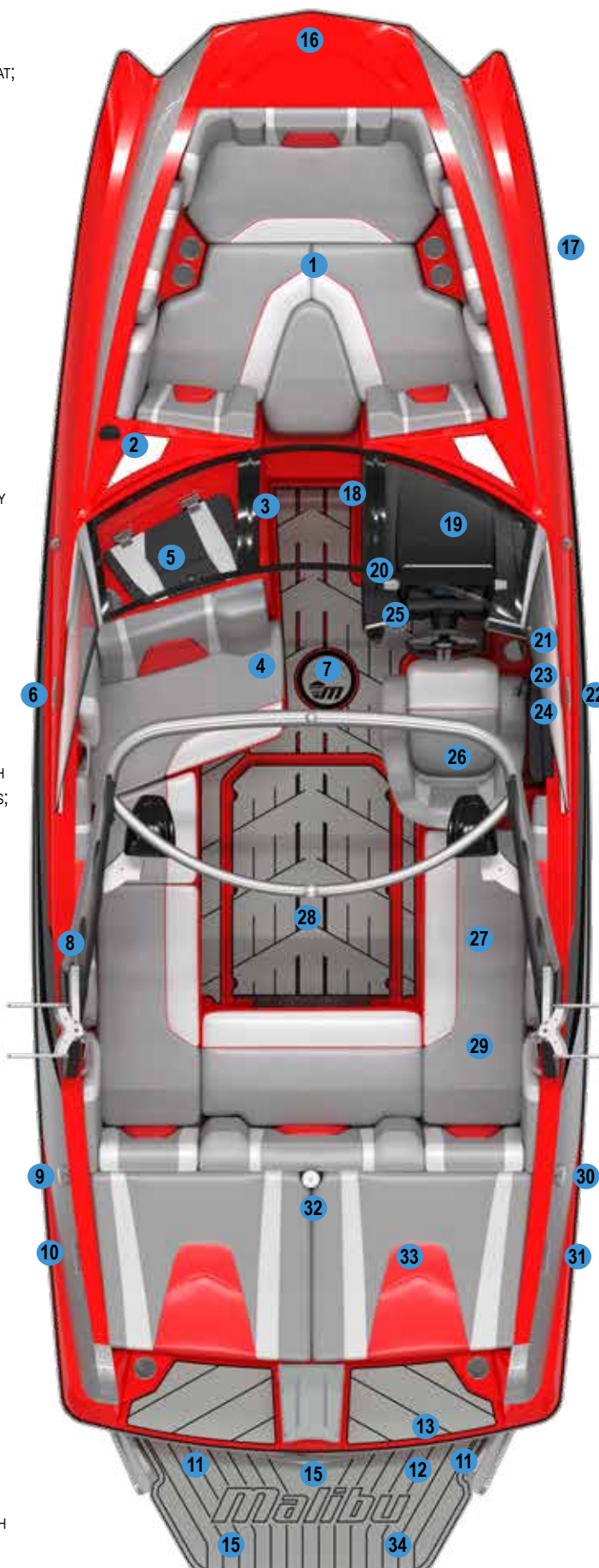

Wakesetter 21VLX



Specifications

LENGTH	21'6.40 m
BEAM	98"/2.49 m
DRAFT	27"/0.7 m
FUEL	48 gal/182 l
HULL TYPE.....	Wake Plus Diamond
CAPACITY	13 people total (3 in bow)
	1,833 lbs., including people
	500 lbs., maximum in bow

STORAGE

(UNDER BOW SEATING EXCEPT WHEN OPTIONAL BOW TANK INSTALLED; UNDER OBSERVER SEAT; UNDER INTERIOR SEATING; UNDER DRIVER'S SEAT; WATERTIGHT BOX ON SHIFTER PANEL)

1 - BATTERIES

(BENEATH BOW SEAT)

2 - ZERO OFF GPS PUCK

(PORT BOW DECK ADJACENT TO SEATING)

3 - AMP

(COMPONENT BOARD MOUNTED—OBSERVER SEAT AREA)

4 - GLOVE BOX

(INCLUDES 12-VOLT CHARGER, USB AUDIO-ONLY PORT, AUX-AUDIO PORT, COMPOSITE VIDEO-YELLOW RCA PORT)

5 - BATTERY ON-OFF

(WHERE EQUIPPED—OBSERVER SEAT SIDE PANEL—AFT WALK-THRU)

6 - CLEAT

(WHERE EQUIPPED)

7 - CENTER DRAIN PLUG

(MAY BE UNDER OPTIONAL FLOORING)

8 - G3.5 TOWER

(MAY ALSO INCLUDE TOWER ACCESSORIES SUCH AS G-FORCE WET SOUNDS SPEAKERS AND AMPS; TOW ATTACHMENT, CAMERA, LIGHTS, MIRROR, RACKS.)

9 - FUEL FILL

(EXTERIOR PORT SIDE)

10 - CLEAT

(WHERE EQUIPPED)

11 - ENGINE EXHAUST

(BENEATH SWIM BOARD, TWO, PORT AND STARBOARD SIDES)

12 - TRANSOM DRAIN PLUG

(BENEATH THE SWIM BOARD)

13 - STEREO REMOTE

(WHERE EQUIPPED—ON TRANSOM)

14 - TRANSOM TOW EYE

(CENTER TRANSOM)

15 - UNDER SWIM BOARD

UNDERWATER LIGHTS
LADDER
WEDGE PLATE
SURF GATE
POWER WEDGE
(WHERE EQUIPPED—ALL ARE LOCATED BENEATH THE SWIM BOARD)

16 - BOW LIGHT

(STANDARD OR POP-UP, WHERE EQUIPPED)

17 - THRU-HULL OUTLETS

(BILGE & BALLAST; ADDITIONAL OUTLETS AFT PORT, STARBOARD AND TRANSOM)

18 - INVERTER PLUG-IN

(WHERE EQUIPPED—WALK-THRU SIDE PANEL)

19 - FUSE PANEL POWER MODULE CONTROL

(BENEATH INSTRUMENT PANEL)

20 - ADJUSTABLE MIRROR

(WHERE EQUIPPED—MOUNTED TO WINDSHIELD)

21 - EMERGENCY SAFETY STOP SWITCH

(ON SIDE PANEL)

22 - CLEAT

(WHERE EQUIPPED)

23 - SHIFT/THROTTLE CONTROL

(ON SIDE PANEL)

24 - CIRCUIT BREAKER PANEL

(BENEATH SHIFT/THROTTLE CONTROL)

25 - SUBWOOFER

(WHERE EQUIPPED—BENEATH INSTRUMENT PANEL)

26 - HEATED AND/OR POWER SEAT

(WHERE EQUIPPED)

27 - REMOVABLE COOLER

(WHERE EQUIPPED—BENEATH SEAT)

28 - SKI PYLON

29 - REMOVABLE TRASH CAN

(BENEATH SEAT)

30 - FUEL FILL

(EXTERIOR STARBOARD SIDE)

31 - CLEAT

(WHERE EQUIPPED)

32 - POP-UP SKI PYLON

(CENTER ADJACENT TO ENGINE COMPARTMENT)

33 - ENGINE COMPARTMENT

(V-DRIVE, LOCATED AFT)

34 - SWIM BOARD

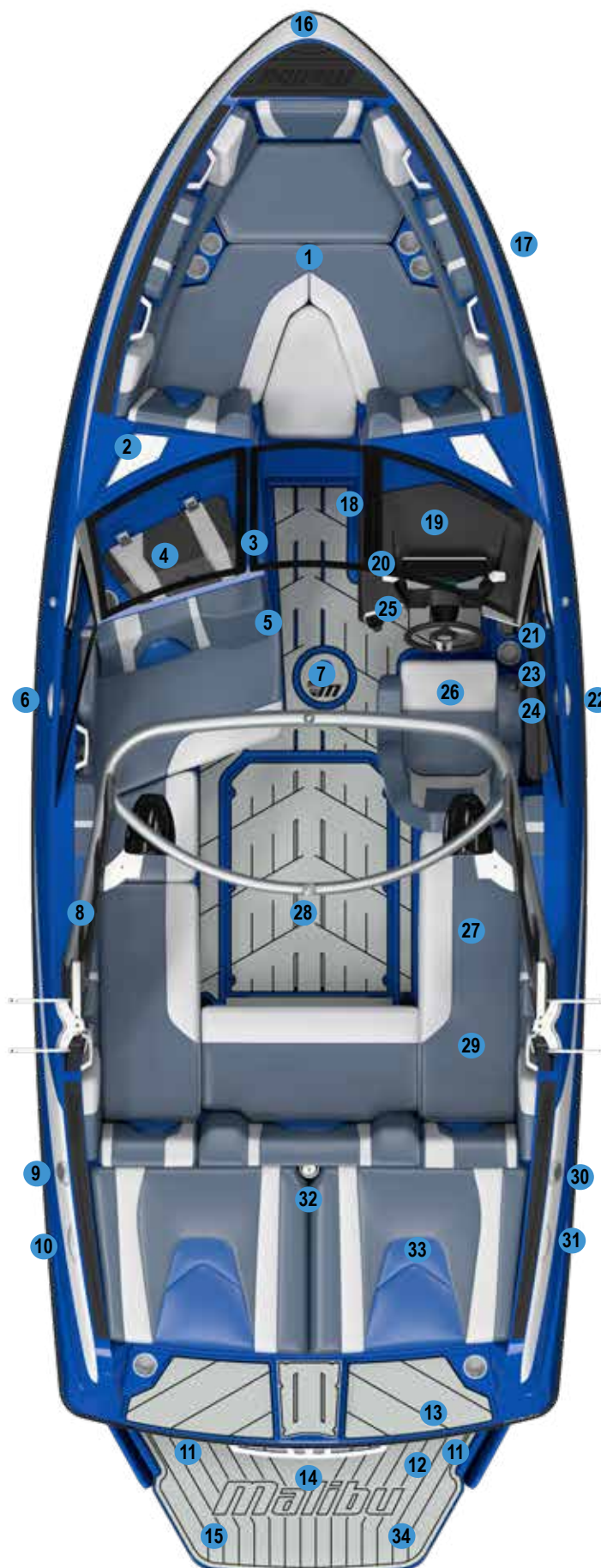

Wakesetter 22LSV

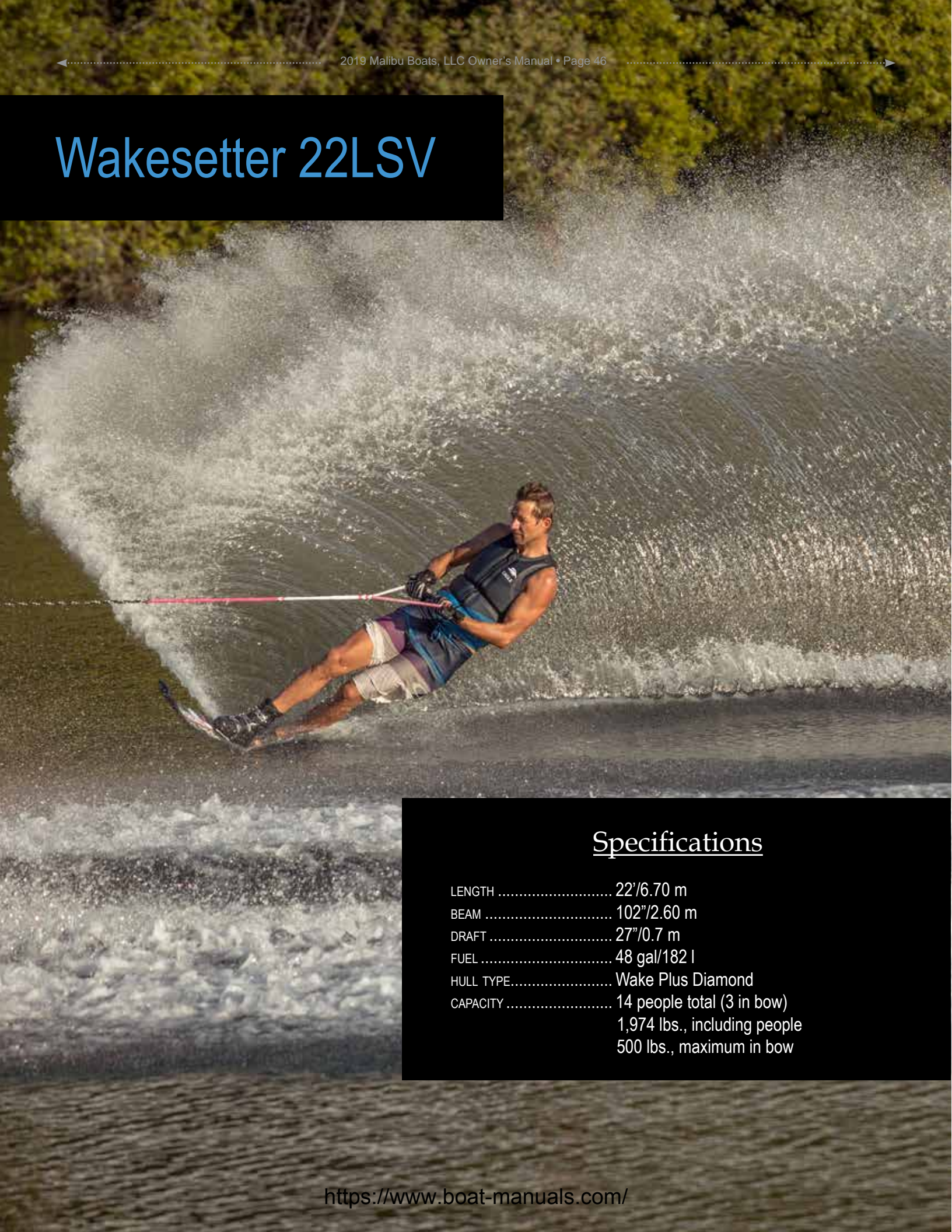

Specifications

LENGTH	22'/6.70 m
BEAM	102"/2.60 m
DRAFT	27"/0.7 m
FUEL	48 gal/182 l
HULL TYPE.....	Wake Plus Diamond
CAPACITY	14 people total (3 in bow)
	1,974 lbs., including people
	500 lbs., maximum in bow

STORAGE

(UNDER BOW SEATING EXCEPT WHEN OPTIONAL BOW TANK INSTALLED; UNDER OBSERVER SEAT; UNDER INTERIOR SEATING; UNDER DRIVER'S SEAT; WATERTIGHT BOX ON SHIFTER PANEL)

1 - BATTERIES

(BENEATH BOW SEAT)

2 - ZERO OFF GPS PUCK

(PORT BOW DECK ADJACENT TO SEATING)

3 - GLOVE BOX

(INCLUDES 12-VOLT CHARGER, USB AUDIO-ONLY PORT, AUX-AUDIO PORT, COMPOSITE VIDEO-YELLOW RCA PORT)

4 - BATTERY ON-OFF

(WHERE EQUIPPED—OBSERVER SEAT SIDE PANEL—AFT WALK-THRU)

5 - CLEAT

(WHERE EQUIPPED)

6 - AMP

(COMPONENT BOARD MOUNTED—OBSERVER SEAT AREA)

7 - CENTER DRAIN PLUG

(MAY BE UNDER OPTIONAL FLOORING)

8 - COCKPIT TABLE MOUNT

(INTERIOR SEATING KICK PANEL)

9 - G3.5 TOWER OR OPTION GX TOWER

(MAY ALSO INCLUDE TOWER ACCESSORIES SUCH AS G-FORCE WET SOUNDS SPEAKERS AND AMPS; TOW ATTACHMENT, CAMERA, LIGHTS, MIRROR, RACKS.)

10 - CLEAT

(WHERE EQUIPPED)

11 - FUEL FILL

(EXTERIOR PORT SIDE)

12 - ENGINE EXHAUST

(BENEATH SWIM BOARD, TWO, PORT AND STARBOARD SIDES)

13 - TRANSOM DRAIN PLUG

(BENEATH THE SWIM BOARD)

14 - STEREO REMOTE

(WHERE EQUIPPED—ON TRANSOM)

15 - TRANSOM TOW EYE

(CENTER TRANSOM)

16 - UNDER SWIM BOARD

UNDERWATER LIGHTS
LADDER
WEDGE PLATE
SURF GATE
POWER WEDGE
(WHERE EQUIPPED—ALL ARE LOCATED BENEATH THE SWIM BOARD)

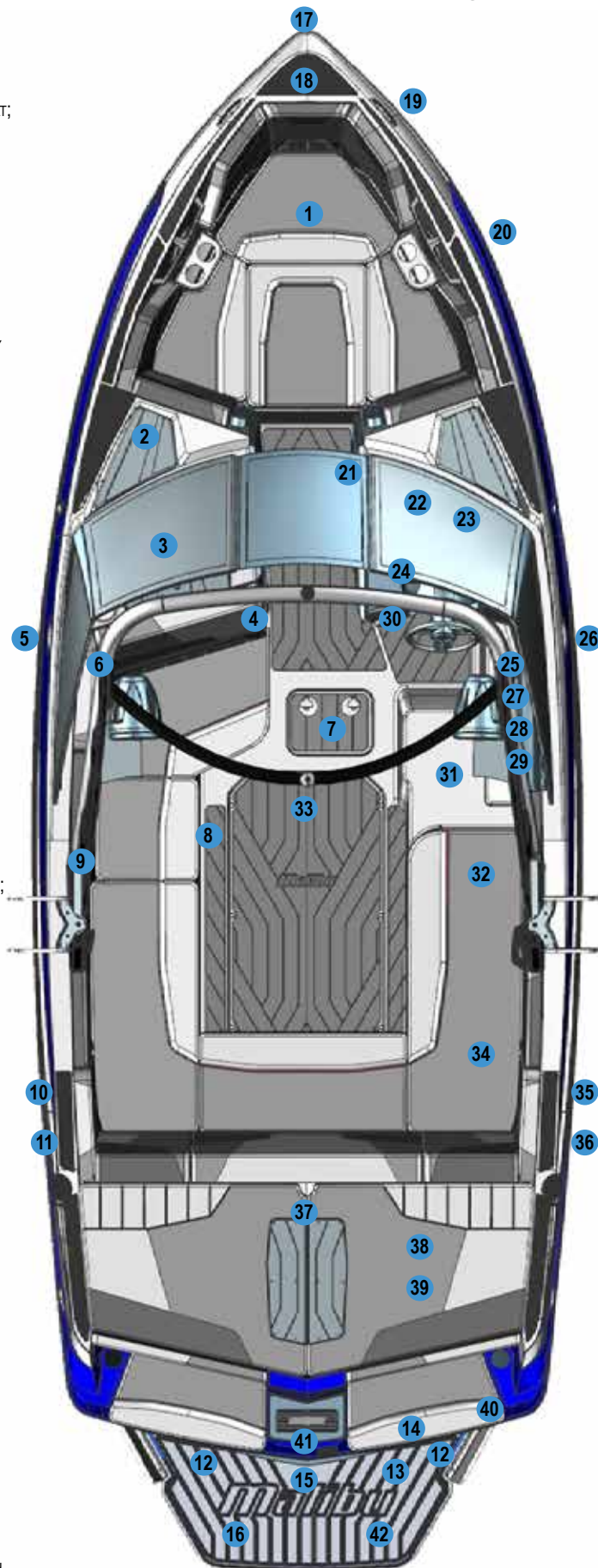

17 - BOW CAMERA
(WHERE EQUIPPED—BOW)

18 - BOW LIGHT
(STANDARD OR POP-UP, WHERE EQUIPPED)

19 - DOCKING LIGHTS
(WHERE EQUIPPED—ALSO ON PORT SIDE)

20 - THRU-HULL OUTLETS
(BILGE & BALLAST; ADDITIONAL OUTLETS AFT PORT, STARBOARD AND TRANSOM)

21 - INVERTER PLUG-IN
(WHERE EQUIPPED—WALK-THRU SIDE PANEL)

22 - FUSE PANEL POWER MODULE CONTROL
(BENEATH INSTRUMENT PANEL)

23 - HEATER UNIT
(BENEATH INSTRUMENT PANEL)

24 - ADJUSTABLE MIRROR
(WHERE EQUIPPED—MOUNTED TO WINDSHIELD)

25 - EMERGENCY SAFETY STOP SWITCH
(ON SIDE PANEL)

26 - CLEAT
(WHERE EQUIPPED)

27 - SHIFT/THROTTLE CONTROL
(ON SIDE PANEL)

28 - CIRCUIT BREAKER PANEL
(BENEATH SHIFT/THROTTLE CONTROL)

29 - FIRE EXTINGUISHER INDICATOR
(WHERE EQUIPPED—ON SIDE PANEL)

30 - SUBWOOFER
(WHERE EQUIPPED—BENEATH INSTRUMENT PANEL)

31 - HEATED AND/OR POWER SEAT
(WHERE EQUIPPED)

32 - REMOVABLE COOLER
(WHERE EQUIPPED—BENEATH SEAT)

33 - SKI PYLON

34 - REMOVABLE TRASH CAN
(BENEATH SEAT)

35 - CLEAT
(WHERE EQUIPPED)

36 - FUEL FILL
(EXTERIOR STARBOARD SIDE)

37 - POP-UP SKI PYLON
(CENTER ADJACENT TO ENGINE COMPARTMENT)

38 - ENGINE COMPARTMENT
(V-DRIVE, LOCATED AFT)

39 - AUTOMATIC FIRE EXTINGUISHER
(WHERE EQUIPPED—ENGINE COMPARTMENT)

40 - FRESHWATER FLUSH KIT AND/OR SHOWER
(WHERE EQUIPPED—STARBOARD TRANSOM)

41 - BACK-UP CAMERA
(WHERE EQUIPPED—CENTER TRANSOM)

42 - SWIM BOARD

Wakesetter 23LSV



Specifications

LENGTH	23'/7.01 m
BEAM	102"/2.60 m
DRAFT	27"/0.7 m
FUEL	67 gal/254 l
HULL TYPE.....	Wake Plus Diamond
CAPACITY	15 people total (3 in bow) 2,115 lbs., including people 500 lbs., maximum in bow

STORAGE

(UNDER BOW SEATING EXCEPT WHEN OPTIONAL BOW TANK INSTALLED; UNDER OBSERVER SEAT; UNDER INTERIOR SEATING; UNDER DRIVER'S SEAT; WATERTIGHT BOX ON SHIFTER PANEL)

1 - BATTERIES

(BENEATH BOW SEAT)

2 - ZERO OFF GPS PUCK

(PORT BOW DECK ADJACENT TO SEATING)

3 - GLOVE BOX

(INCLUDES 12-VOLT CHARGER, USB AUDIO-ONLY PORT, AUX-AUDIO PORT, COMPOSITE VIDEO-YELLOW RCA PORT)

4 - BATTERY ON-OFF

(WHERE EQUIPPED—OBSERVER SEAT SIDE PANEL—AFT WALK-THRU)

5 - CLEAT

(WHERE EQUIPPED)

6 - AMP

(COMPONENT BOARD MOUNTED—OBSERVER SEAT AREA)

7 - SECONDARY SUBWOOFER

(WHERE EQUIPPED—BENEATH OBSERVER SEAT)

8 - CENTER DRAIN PLUG

(MAY BE UNDER OPTIONAL FLOORING)

9 - COCKPIT TABLE MOUNT

(INTERIOR SEATING KICK PANEL)

10 - G3.5 TOWER OR OPTION GX TOWER

(MAY ALSO INCLUDE TOWER ACCESSORIES SUCH AS G-FORCE WET SOUNDS SPEAKERS AND AMPS; TOW ATTACHMENT, CAMERA, LIGHTS, MIRROR, RACKS.)

11 - FUEL FILL

(EXTERIOR PORT SIDE)

12 - CLEAT

(WHERE EQUIPPED)

13 - ENGINE EXHAUST

(BENEATH SWIM BOARD, TWO, PORT AND STARBOARD SIDES)

14 - TRANSOM DRAIN PLUG

(BENEATH THE SWIM BOARD)

15 - STEREO REMOTE

(WHERE EQUIPPED—ON TRANSOM)

16 - TRANSOM TOW EYE

(CENTER TRANSOM)

17 - UNDER SWIM BOARD

UNDERWATER LIGHTS
LADDER
WEDGE PLATE
SURF GATE
POWER WEDGE
(WHERE EQUIPPED—ALL ARE LOCATED BENEATH THE SWIM BOARD)

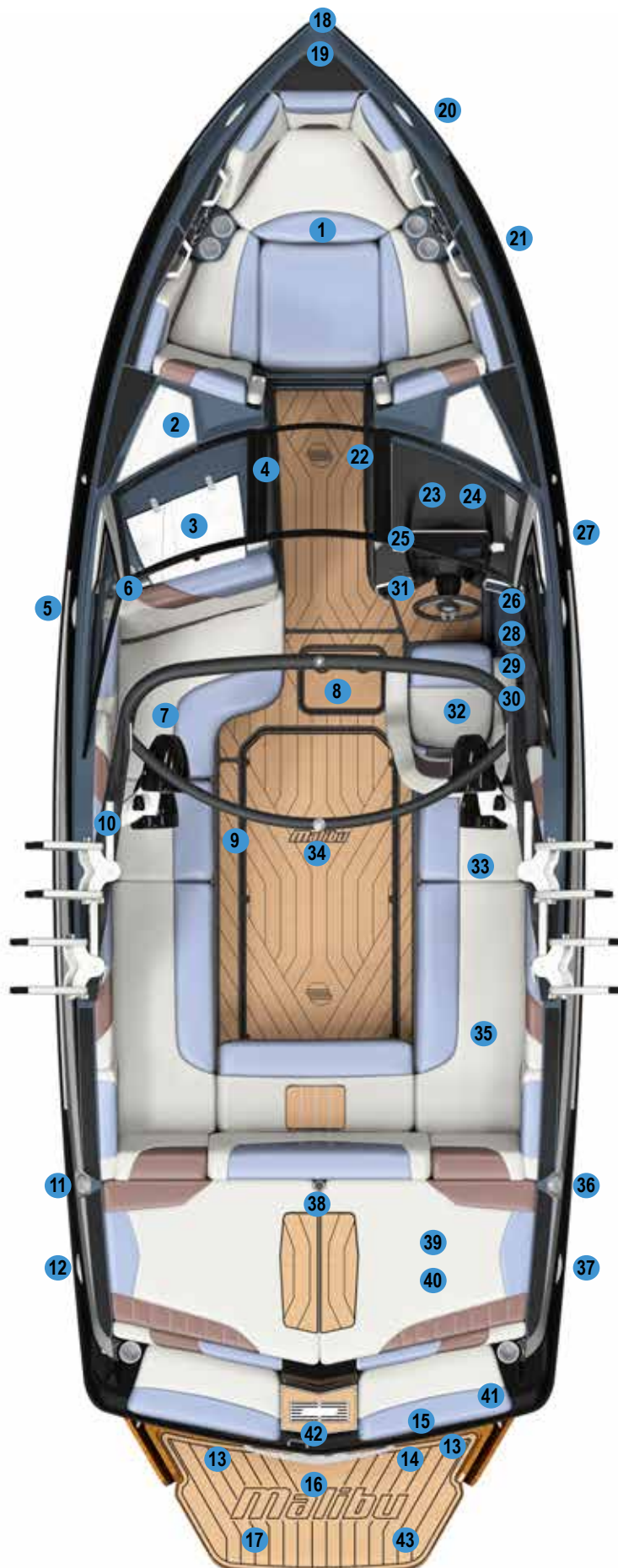

18 - BOW CAMERA
(WHERE EQUIPPED—BOW)

19 - BOW LIGHT
(STANDARD OR POP-UP, WHERE EQUIPPED)

20 - DOCKING LIGHTS
(WHERE EQUIPPED—ALSO ON PORT SIDE)

21 - THRU-HULL OUTLETS
(BILGE & BALLAST; ADDITIONAL OUTLETS AFT PORT, STARBOARD AND TRANSOM)

22 - INVERTER PLUG-IN
(WHERE EQUIPPED—WALK-THRU SIDE PANEL)

23 - FUSE PANEL POWER MODULE CONTROL
(BENEATH INSTRUMENT PANEL)

24 - HEATER UNIT
(BENEATH INSTRUMENT PANEL)

25 - ADJUSTABLE MIRROR
(WHERE EQUIPPED—MOUNTED TO WINDSHIELD)

26 - EMERGENCY SAFETY STOP SWITCH
(ON SIDE PANEL)

27 - CLEAT
(WHERE EQUIPPED)

28 - SHIFT/THROTTLE CONTROL
(ON SIDE PANEL)

29 - CIRCUIT BREAKER PANEL
(BENEATH SHIFT/THROTTLE CONTROL)

30 - FIRE EXTINGUISHER INDICATOR
(WHERE EQUIPPED—ON SIDE PANEL)

31 - SUBWOOFER
(WHERE EQUIPPED—BENEATH INSTRUMENT PANEL)

32 - HEATED AND/OR POWER SEAT
(WHERE EQUIPPED)

33 - REMOVABLE COOLER
(WHERE EQUIPPED—BENEATH SEAT)

34 - SKI PYLON

35 - REMOVABLE TRASH CAN
(BENEATH SEAT)

36 - FUEL FILL
(EXTERIOR STARBOARD SIDE)

37 - CLEAT
(WHERE EQUIPPED)

38 - POP-UP SKI PYLON
(CENTER ADJACENT TO ENGINE COMPARTMENT)

39 - ENGINE COMPARTMENT
(V-DRIVE, LOCATED AFT)

40 - AUTOMATIC FIRE EXTINGUISHER
(WHERE EQUIPPED—ENGINE COMPARTMENT)

41 - FRESHWATER FLUSH KIT AND/OR SHOWER
(WHERE EQUIPPED—STARBOARD TRANSOM)

42 - BACK-UP CAMERA
(WHERE EQUIPPED—CENTER TRANSOM)

43 - SWIM BOARD

Wakesetter 25LSV



Specifications

LENGTH	25'/7.62 m
BEAM	102"/2.60 m
DRAFT	32"/0.8 m
FUEL	77 gal/291 l
HULL TYPE.....	Wake Plus
CAPACITY	18 people total (3 in bow) 2,538 lbs., including people 500 lbs., maximum in bow

STORAGE

(UNDER BOW SEATING EXCEPT WHEN OPTIONAL BOW TANK INSTALLED; UNDER OBSERVER SEAT; UNDER INTERIOR SEATING; UNDER DRIVER'S SEAT; WATERTIGHT BOX ON SHIFTER PANEL)

1 - BATTERIES

(BENEATH BOW SEAT)

2 - ZERO OFF GPS PUCK

(PORT BOW DECK ADJACENT TO SEATING)

3 - GLOVE BOX

(INCLUDES 12-VOLT CHARGER, USB AUDIO-ONLY PORT, AUX-AUDIO PORT, COMPOSITE VIDEO-YELLOW RCA PORT)

4 - BATTERY ON-OFF

(WHERE EQUIPPED—OBSERVER SEAT SIDE PANEL—AFT WALK-THRU)

5 - CLEAT

(WHERE EQUIPPED)

6 - AMP

(COMPONENT BOARD MOUNTED—OBSERVER SEAT AREA)

7 - SECONDARY SUBWOOFER

(WHERE EQUIPPED—BENEATH OBSERVER SEAT)

8 - CENTER DRAIN PLUG

(MAY BE UNDER OPTIONAL FLOORING)

9 - COCKPIT TABLE MOUNT

(INTERIOR SEATING KICK PANEL)

10 - G3.5 TOWER OR OPTION GX TOWER

(MAY ALSO INCLUDE TOWER ACCESSORIES SUCH AS G-FORCE WET SOUNDS SPEAKERS AND AMPS; TOW ATTACHMENT, CAMERA, LIGHTS, MIRROR, RACKS.)

11 - FUEL FILL

(EXTERIOR PORT SIDE)

12 - CLEAT

(WHERE EQUIPPED)

13 - ENGINE EXHAUST

(BENEATH SWIM BOARD, TWO, PORT AND STARBOARD SIDES)

14 - TRANSOM DRAIN PLUG

(BENEATH THE SWIM BOARD)

15 - STEREO REMOTE

(WHERE EQUIPPED—ON TRANSOM)

16 - TRANSOM TOW EYE

(CENTER TRANSOM)

17 - UNDER SWIM BOARD

UNDERWATER LIGHTS
LADDER
WEDGE PLATE
SURF GATE
POWER WEDGE
(WHERE EQUIPPED—ALL ARE LOCATED BENEATH THE SWIM BOARD)

18 - BOW CAMERA
(WHERE EQUIPPED—BOW)

19 - BOW LIGHT
(STANDARD OR POP-UP, WHERE EQUIPPED)

20 - DOCKING LIGHTS
(WHERE EQUIPPED—ALSO ON PORT SIDE)

21 - THRU-HULL OUTLETS
(BILGE & BALLAST; ADDITIONAL OUTLETS AFT PORT, STARBOARD AND TRANSOM)

22 - INVERTER PLUG-IN
(WHERE EQUIPPED—WALK-THRU SIDE PANEL)

23 - FUSE PANEL POWER MODULE CONTROL
(BENEATH INSTRUMENT PANEL)

24 - HEATER UNIT
(BENEATH INSTRUMENT PANEL)

25 - ADJUSTABLE MIRROR
(WHERE EQUIPPED—MOUNTED TO WINDSHIELD)

26 - EMERGENCY SAFETY STOP SWITCH
(ON SIDE PANEL)

27 - CLEAT
(WHERE EQUIPPED)

28 - SHIFT/THROTTLE CONTROL
(ON SIDE PANEL)

29 - CIRCUIT BREAKER PANEL
(BENEATH SHIFT/THROTTLE CONTROL)

30 - FIRE EXTINGUISHER INDICATOR
(WHERE EQUIPPED—ON SIDE PANEL)

31 - SUBWOOFER
(WHERE EQUIPPED—BENEATH INSTRUMENT PANEL)

32 - HEATED AND/OR POWER SEAT
(WHERE EQUIPPED)

33 - REMOVABLE COOLER
(WHERE EQUIPPED—BENEATH SEAT)

34 - SKI PYLON

35 - REMOVABLE TRASH CAN
(BENEATH SEAT)

36 - FUEL FILL
(EXTERIOR STARBOARD SIDE)

37 - CLEAT
(WHERE EQUIPPED)

38 - POP-UP SKI PYLON
(CENTER ADJACENT TO ENGINE COMPARTMENT)

39 - ENGINE COMPARTMENT
(V-DRIVE, LOCATED AFT)

40 - AUTOMATIC FIRE EXTINGUISHER
(WHERE EQUIPPED—ENGINE COMPARTMENT)

41 - FRESHWATER FLUSH KIT AND/OR SHOWER
(WHERE EQUIPPED—STARBOARD TRANSOM)

42 - BACK-UP CAMERA
(WHERE EQUIPPED—CENTER TRANSOM)

43 - SWIM BOARD

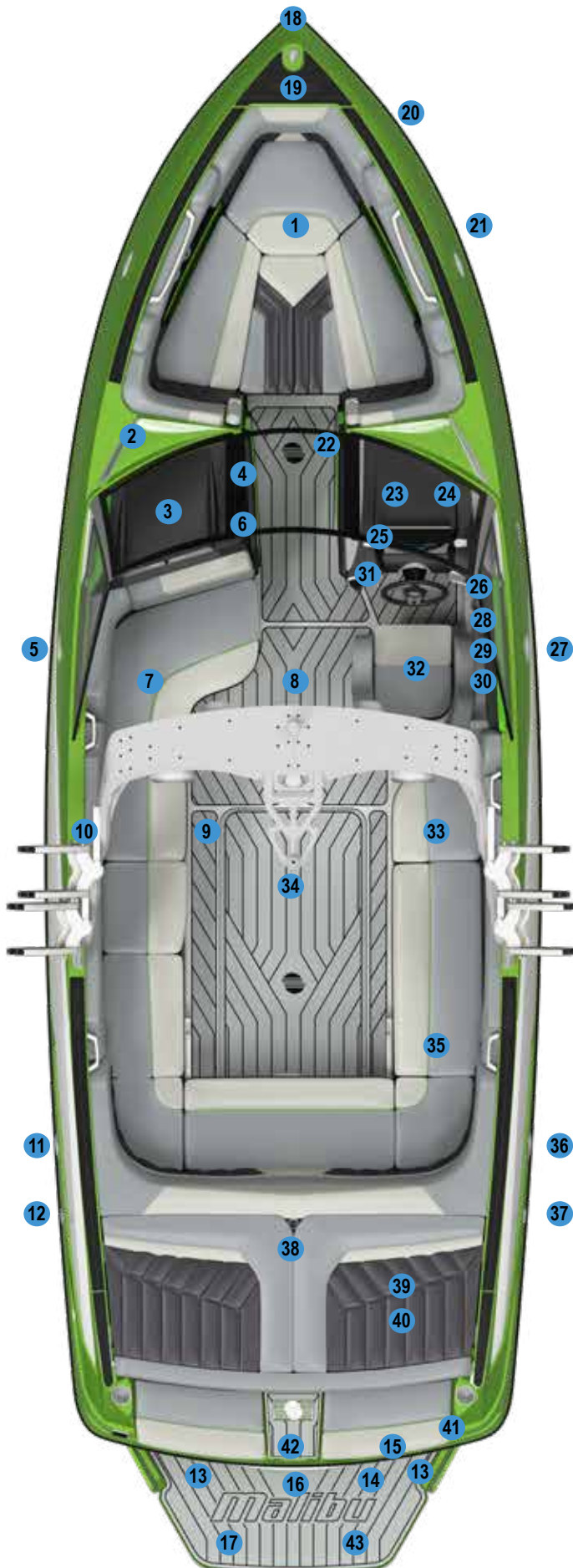

Wakesetter 22MXZ



Specifications

LENGTH	22'5"/6.83 m
BEAM	102"/2.60 m
DRAFT	27"/0.7 m
FUEL	48 gal/181 l
HULL TYPE.....	Wake Plus
CAPACITY	15 people total (4 in bow) 2,115 lbs., including people 600 lbs., maximum in bow

STORAGE

(UNDER BOW SEATING EXCEPT WHEN OPTIONAL BOW TANK INSTALLED; UNDER OBSERVER SEAT; UNDER INTERIOR SEATING; UNDER DRIVER'S SEAT; WATERTIGHT BOX ON SHIFTER PANEL)

1 - ZERO OFF GPS PUCK
(PORT BOW DECK ADJACENT TO SEATING)

2 - BATTERY ON-OFF
(WHERE EQUIPPED—OBSERVER SEAT SIDE PANEL—AFT WALK-THRU)

3 - GLOVE BOX
(INCLUDES 12-VOLT CHARGER, USB AUDIO-ONLY PORT, AUX-AUDIO PORT, COMPOSITE VIDEO-YELLOW RCA PORT)

4 - CLEAT
(WHERE EQUIPPED)

5 - AMP
(COMPONENT BOARD MOUNTED—OBSERVER SEAT AREA)

6 - BATTERIES
(BENEATH OBSERVER SEAT)

7 - CENTER DRAIN PLUG
(MAY BE UNDER OPTIONAL FLOORING)

8 - COCKPIT TABLE MOUNT
(INTERIOR SEATING KICK PANEL)

HEATER VENTS
(WHERE EQUIPPED—TWO OR THREE VENTS IN BOAT INTERIOR)

9 - G3.5 TOWER OR OPTION GX TOWER
(MAY ALSO INCLUDE TOWER ACCESSORIES SUCH AS G-FORCE WET SOUNDS SPEAKERS AND AMPS; TOW ATTACHMENT, CAMERA, LIGHTS, MIRROR, RACKS.)

10 - FUEL FILL
(EXTERIOR PORT SIDE)

11 - CLEAT
(WHERE EQUIPPED)

12 - ENGINE EXHAUST
(BENEATH SWIM BOARD, TWO, PORT AND STARBOARD SIDES)

13 - TRANSOM DRAIN PLUG
(BENEATH THE SWIM BOARD)

14 - STEREO REMOTE
(WHERE EQUIPPED—ON TRANSOM)

15 - TRANSOM TOW EYE
(CENTER TRANSOM)

16 - UNDER SWIM BOARD
UNDERWATER LIGHTS
LADDER
WEDGE PLATE
SURF GATE
POWER WEDGE
(WHERE EQUIPPED—ALL ARE LOCATED BENEATH THE SWIM BOARD)

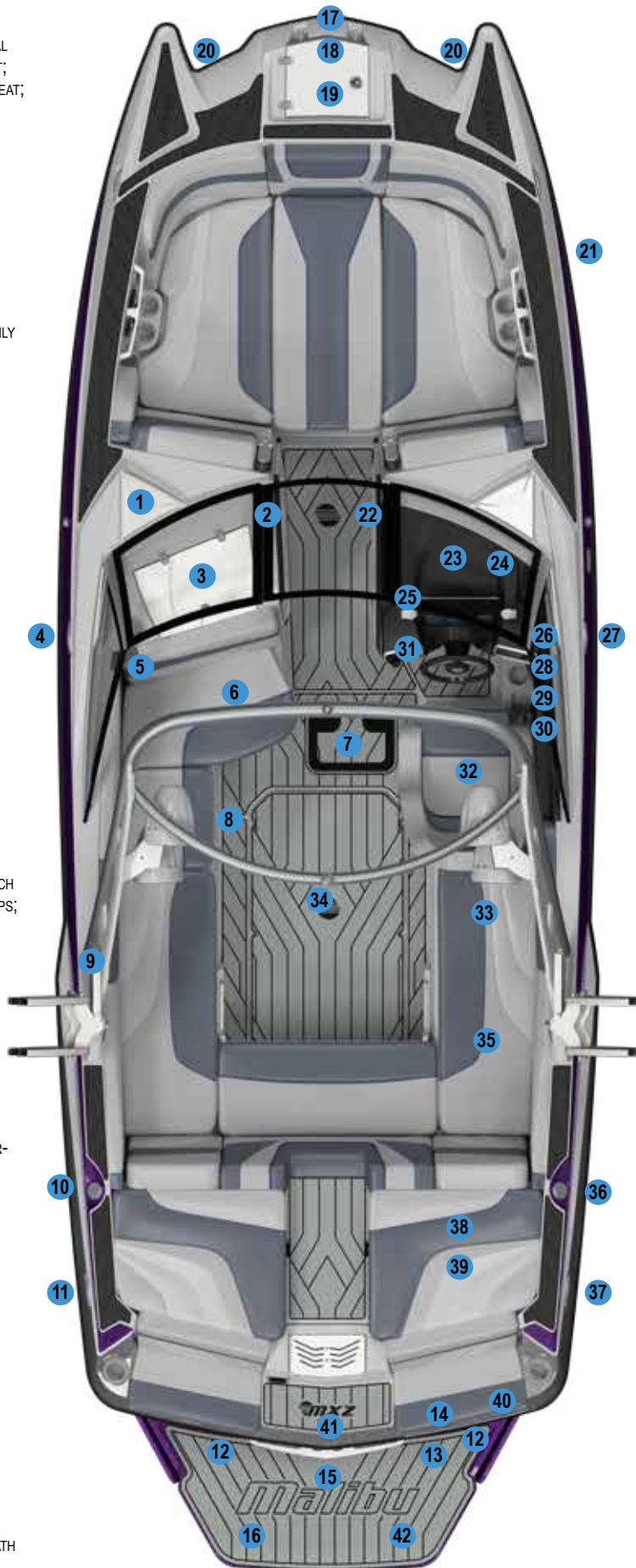

17 - BOW CAMERA
(WHERE EQUIPPED—BOW)

18 - BOW LIGHT
(STANDARD OR POP-UP, WHERE EQUIPPED)

19 - ANCHOR LOCKER
(CENTER, TOP DECK)

20 - DOCKING LIGHTS
(WHERE EQUIPPED—ALSO ON PORT SIDE)

21 - THRU-HULL OUTLETS
(BILGE & BALLAST; ADDITIONAL OUTLETS AFT PORT, STARBOARD AND TRANSOM)

22 - INVERTER PLUG-IN
(WHERE EQUIPPED—WALK-THRU SIDE PANEL)

23 - FUSE PANEL POWER MODULE CONTROL
(BENEATH INSTRUMENT PANEL)

24 - HEATER UNIT
(BENEATH INSTRUMENT PANEL)

25 - ADJUSTABLE MIRROR
(WHERE EQUIPPED—MOUNTED TO WINDSHIELD)

26 - EMERGENCY SAFETY STOP SWITCH
(ON SIDE PANEL)

27 - CLEAT
(WHERE EQUIPPED)

28 - SHIFT/THROTTLE CONTROL
(ON SIDE PANEL)

29 - CIRCUIT BREAKER PANEL
(BENEATH SHIFT/THROTTLE CONTROL)

30 - FIRE EXTINGUISHER INDICATOR
(WHERE EQUIPPED—ON SIDE PANEL)

31 - SUBWOOFER
(WHERE EQUIPPED—BENEATH INSTRUMENT PANEL)

32 - HEATED AND/OR POWER SEAT
(WHERE EQUIPPED)

33 - REMOVABLE COOLER
(WHERE EQUIPPED—BENEATH SEAT)

34 - SKI PYLON

35 - REMOVABLE TRASH CAN
(BENEATH SEAT)

36 - FUEL FILL
(EXTERIOR STARBOARD SIDE)

37 - CLEAT
(WHERE EQUIPPED)

38 - ENGINE COMPARTMENT
(V-DRIVE, LOCATED AFT)

39 - AUTOMATIC FIRE EXTINGUISHER
(WHERE EQUIPPED—ENGINE COMPARTMENT)

40 - FRESHWATER FLUSH KIT AND/OR SHOWER
(WHERE EQUIPPED—STARBOARD TRANSOM)

41 - BACK-UP CAMERA
(WHERE EQUIPPED—CENTER TRANSOM)

42 - SWIM BOARD

Wakesetter 24MXZ



Specifications

LENGTH	24'5" / 7.44 m
BEAM	102" / 2.60 m
DRAFT	32" / 0.8 m
FUEL	77 gal / 291 l
HULL TYPE.....	Wake Plus
CAPACITY	18 people total (4 in bow) 2,538 lbs., including people 600 lbs., maximum in bow

STORAGE

(UNDER BOW SEATING EXCEPT WHEN OPTIONAL BOW TANK INSTALLED; UNDER OBSERVER SEAT; UNDER INTERIOR SEATING; UNDER DRIVER'S SEAT; WATERTIGHT BOX ON SHIFTER PANEL)

1 - ZERO OFF GPS PUCK
(PORT BOW DECK ADJACENT TO SEATING)

2 - BATTERY ON-OFF
(WHERE EQUIPPED—OBSERVER SEAT SIDE PANEL—AFT WALK-THRU)

3 - GLOVE BOX
(INCLUDES 12-VOLT CHARGER, USB AUDIO-ONLY PORT, AUX-AUDIO PORT, COMPOSITE VIDEO-YELLOW RCA PORT)

4 - CLEAT
(WHERE EQUIPPED)

5 - AMP
(COMPONENT BOARD MOUNTED—OBSERVER SEAT AREA)

6 - BATTERIES
(BENEATH BOW SEAT)

7 - SECONDARY SUBWOOFER
(WHERE EQUIPPED—BENEATH OBSERVER SEAT)

8 - CENTER DRAIN PLUG
(MAY BE UNDER OPTIONAL FLOORING)

9 - COCKPIT TABLE MOUNT
(INTERIOR SEATING KICK PANEL)

HEATER VENTS
(WHERE EQUIPPED—TWO OR THREE VENTS IN BOAT INTERIOR)

10 - G3.5 TOWER OR OPTION GX TOWER
(MAY ALSO INCLUDE TOWER ACCESSORIES SUCH AS G-FORCE WET SOUNDS SPEAKERS AND AMPS; TOW ATTACHMENT, CAMERA, LIGHTS, MIRROR, RACKS.)

11 - FUEL FILL
(EXTERIOR PORT SIDE)

12 - CLEAT
(WHERE EQUIPPED)

13 - ENGINE EXHAUST
(BENEATH SWIM BOARD, TWO, PORT AND STARBOARD SIDES)

14 - TRANSOM DRAIN PLUG
(BENEATH THE SWIM BOARD)

15 - STEREO REMOTE
(WHERE EQUIPPED—ON TRANSOM)

16 - TRANSOM TOW EYE
(CENTER TRANSOM)

17 - UNDER SWIM BOARD
UNDERWATER LIGHTS
LADDER
WEDGE PLATE
SURF GATE
POWER WEDGE
(WHERE EQUIPPED—ALL ARE LOCATED BENEATH THE SWIM BOARD)

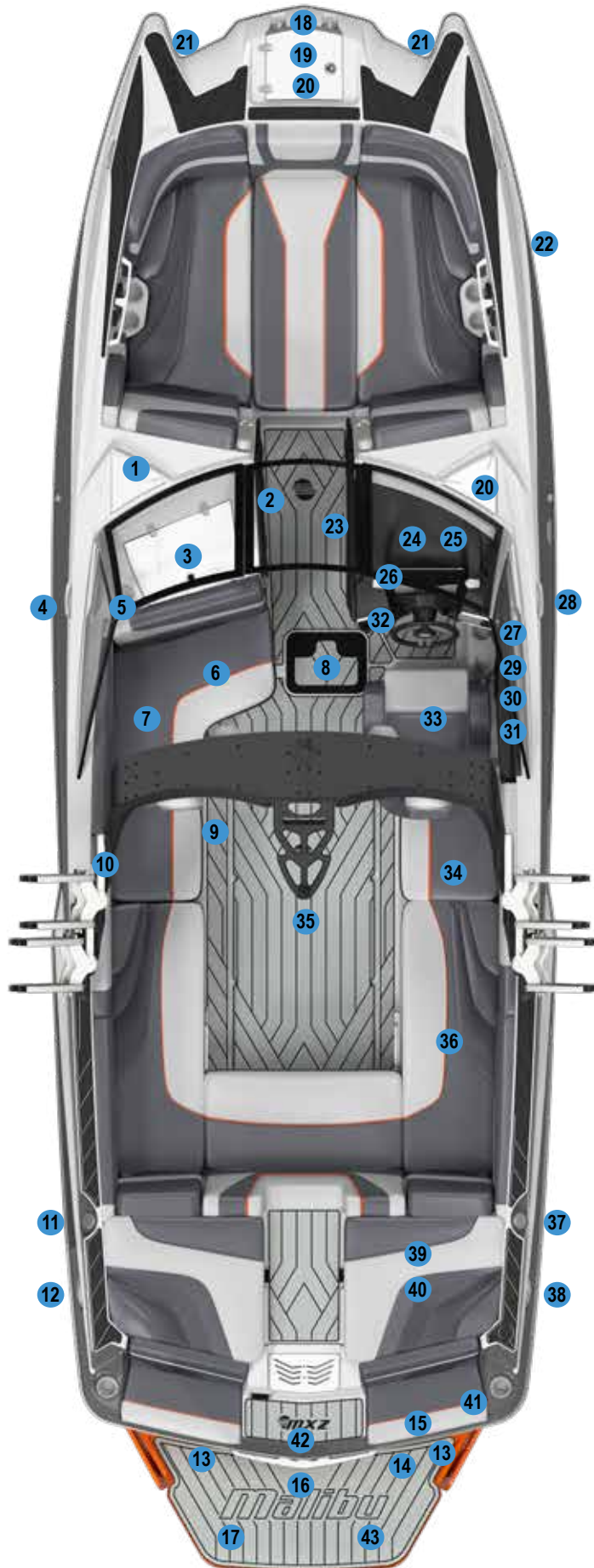

18 - BOW CAMERA
(WHERE EQUIPPED—BOW)

19 - BOW LIGHT
(STANDARD OR POP-UP, WHERE EQUIPPED)

20 - ANCHOR LOCKER
(CENTER, TOP DECK)

21 - DOCKING LIGHTS
(WHERE EQUIPPED—ALSO ON PORT SIDE)

22 - THRU-HULL OUTLETS
(BILGE & BALLAST; ADDITIONAL OUTLETS AFT PORT, STARBOARD AND TRANSOM)

23 - INVERTER PLUG-IN
(WHERE EQUIPPED—WALK-THRU SIDE PANEL)

24 - FUSE PANEL POWER MODULE CONTROL
(BENEATH INSTRUMENT PANEL)

25 - HEATER UNIT
(BENEATH INSTRUMENT PANEL)

26 - ADJUSTABLE MIRROR
(WHERE EQUIPPED—MOUNTED TO WINDSHIELD)

27 - EMERGENCY SAFETY STOP SWITCH
(ON SIDE PANEL)

28 - CLEAT
(WHERE EQUIPPED)

29 - SHIFT/THROTTLE CONTROL
(ON SIDE PANEL)

30 - CIRCUIT BREAKER PANEL
(BENEATH SHIFT/THROTTLE CONTROL)

31 - FIRE EXTINGUISHER INDICATOR
(WHERE EQUIPPED—ON SIDE PANEL)

32 - SUBWOOFER
(WHERE EQUIPPED—BENEATH INSTRUMENT PANEL)

33 - HEATED AND/OR POWER SEAT
(WHERE EQUIPPED)

34 - REMOVABLE COOLER
(WHERE EQUIPPED—BENEATH SEAT)

35 - SKI PYLON

36 - REMOVABLE TRASH CAN
(BENEATH SEAT)

37 - FUEL FILL
(EXTERIOR STARBOARD SIDE)

38 - CLEAT
(WHERE EQUIPPED)

39 - ENGINE COMPARTMENT
(V-DRIVE, LOCATED AFT)

40 - AUTOMATIC FIRE EXTINGUISHER
(WHERE EQUIPPED—ENGINE COMPARTMENT)

41 - FRESHWATER FLUSH KIT AND/OR SHOWER
(WHERE EQUIPPED—STARBOARD TRANSOM)

42 - BACK-UP CAMERA
(WHERE EQUIPPED—CENTER TRANSOM)

43 - SWIM BOARD

M235



Specifications

LENGTH	23'5"/7.14 m
BEAM	102"/2.60 m
DRAFT	32"/0.8 m
FUEL	78 gal/295 l
HULL TYPE.....	Wake Plus
CAPACITY	17 people total (4 in bow) 2,397 lbs., including people 600 lbs., maximum in bow

STORAGE

(UNDER BOW SEATING EXCEPT WHEN OPTIONAL BOW TANK INSTALLED; UNDER OBSERVER SEAT; UNDER INTERIOR SEATING; UNDER DRIVER'S SEAT; WATERTIGHT BOX ON SHIFTER PANEL)

1 - BATTERIES

(BENEATH BOW SEAT)

2 - ZERO OFF GPS PUCK

(PORT BOW DECK ADJACENT TO SEATING)

3 - GLOVE BOX

(INCLUDES 12-VOLT CHARGER, USB AUDIO-ONLY PORT, AUX-AUDIO PORT, COMPOSITE VIDEO-YELLOW RCA PORT)

4 - BATTERY ON-OFF

(WHERE EQUIPPED—OBSERVER SEAT SIDE PANEL—AFT WALK-THRU)

5 - CLEAT

(WHERE EQUIPPED)

6 - AMP

(COMPONENT BOARD MOUNTED—OBSERVER SEAT AREA)

7 - CENTER DRAIN PLUG

(MAY BE UNDER OPTIONAL FLOORING)

8 - COCKPIT TABLE MOUNT

(INTERIOR SEATING KICK PANEL)

9 - G3.5 TOWER OR OPTION GX TOWER

(MAY ALSO INCLUDE TOWER ACCESSORIES SUCH AS G-FORCE WET SOUNDS SPEAKERS AND AMPS; TOW ATTACHMENT, CAMERA, LIGHTS, MIRROR, RACKS.)

10 - FUEL FILL

(EXTERIOR PORT SIDE)

11 - CLEAT

(WHERE EQUIPPED)

12 - ENGINE EXHAUST

(BENEATH SWIM BOARD, TWO, PORT AND STARBOARD SIDES)

13 - TRANSOM DRAIN PLUG

(BENEATH THE SWIM BOARD)

14 - STEREO REMOTE

(WHERE EQUIPPED—ON TRANSOM)

15 - TRANSOM TOW EYE

(CENTER TRANSOM)

16 - UNDER SWIM BOARD

UNDERWATER LIGHTS
LADDER
WEDGE PLATE
SURF GATE
POWER WEDGE
(WHERE EQUIPPED—ALL ARE LOCATED BENEATH THE SWIM BOARD)

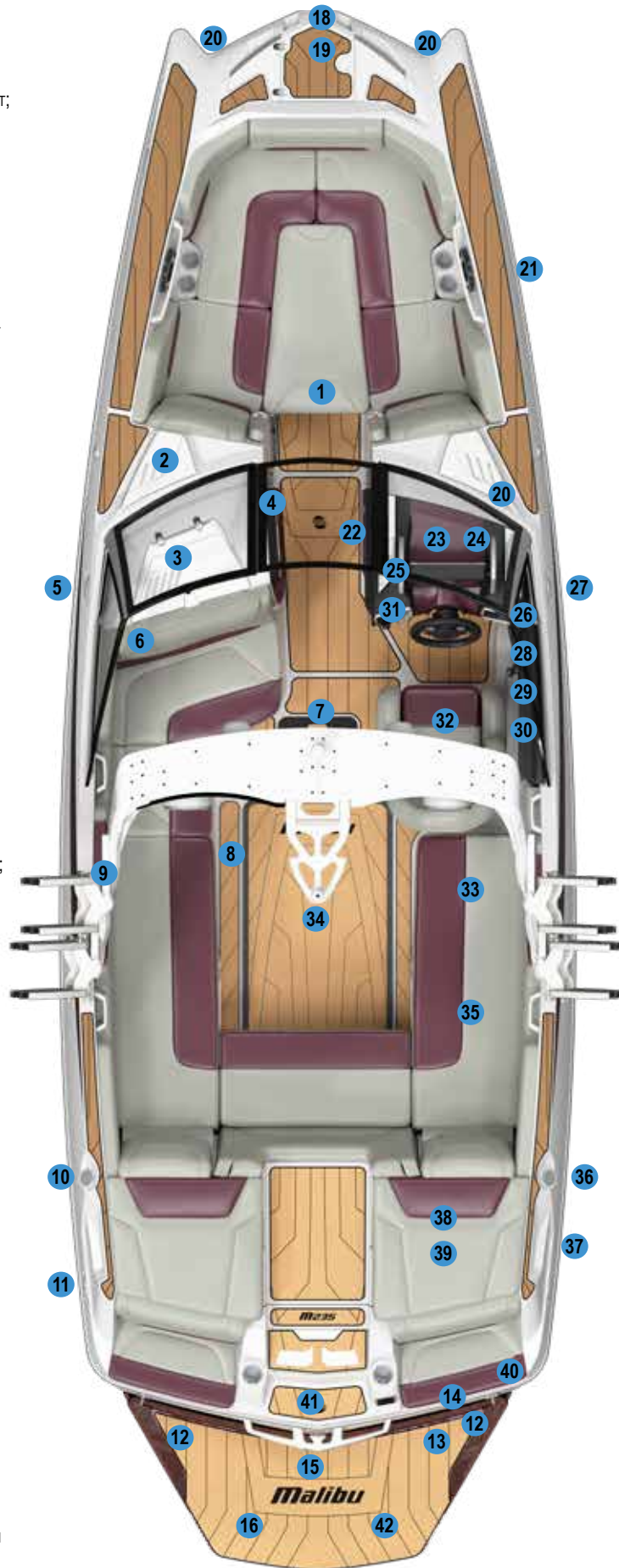

18 - BOW CAMERA
(WHERE EQUIPPED—BOW)

19 - BOW LIGHT
(STANDARD OR POP-UP, WHERE EQUIPPED)

20 - DOCKING LIGHTS
(WHERE EQUIPPED—ALSO ON PORT SIDE)

21 - THRU-HULL OUTLETS
(BILGE & BALLAST; ADDITIONAL OUTLETS AFT PORT, STARBOARD AND TRANSOM)

22 - INVERTER PLUG-IN
(WHERE EQUIPPED—WALK-THRU SIDE PANEL)

23 - FUSE PANEL POWER MODULE CONTROL
(BENEATH INSTRUMENT PANEL)

24 - HEATER UNIT
(BENEATH INSTRUMENT PANEL)

25 - ADJUSTABLE MIRROR
(WHERE EQUIPPED—MOUNTED TO WINDSHIELD)

26 - EMERGENCY SAFETY STOP SWITCH
(ON SIDE PANEL)

27 - CLEAT
(WHERE EQUIPPED)

28 - SHIFT/THROTTLE CONTROL
(ON SIDE PANEL)

29 - CIRCUIT BREAKER PANEL
(BENEATH SHIFT/THROTTLE CONTROL)

30 - FIRE EXTINGUISHER INDICATOR
(WHERE EQUIPPED—ON SIDE PANEL)

31 - SUBWOOFER
(WHERE EQUIPPED—BENEATH INSTRUMENT PANEL)

32 - HEATED AND/OR POWER SEAT
(WHERE EQUIPPED)

33 - REMOVABLE COOLER
(WHERE EQUIPPED—BENEATH SEAT)

34 - SKI PYLON

35 - REMOVABLE TRASH CAN
(BENEATH SEAT)

36 - FUEL FILL
(EXTERIOR STARBOARD SIDE)

37 - CLEAT
(WHERE EQUIPPED)

38 - ENGINE COMPARTMENT
(V-DRIVE, LOCATED AFT)

39 - AUTOMATIC FIRE EXTINGUISHER
(WHERE EQUIPPED—ENGINE COMPARTMENT)

40 - FRESHWATER FLUSH KIT AND/OR SHOWER
(WHERE EQUIPPED—STARBOARD TRANSOM)

41 - BACK-UP CAMERA
(WHERE EQUIPPED—CENTER TRANSOM)

42 - SWIM BOARD

Recommended Seating

The seating chart is provided to aid in safer boating. What is shown is the maximum capacity in terms of people on board. As more gear is added, the number of people must be reduced to avoid a situation in which the boat could potentially capsize.

In instances in which fewer than the maximum number of people are on-board, it is important to redistribute seating locations (and stowing of gear) to ensure that weight is evenly distributed. At no time should all passengers ride in the bow as it can cause a loss of stability and maneuverability. Never allow riders on the sun deck while the boat is in motion.

TXi

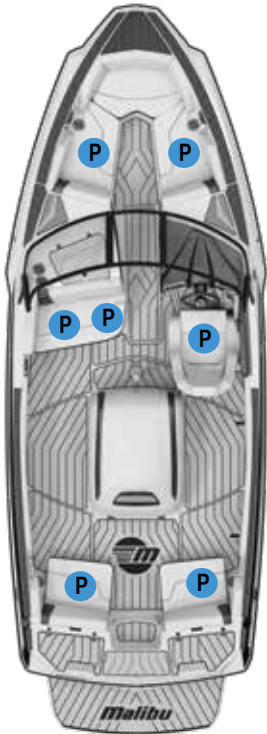

20VTX

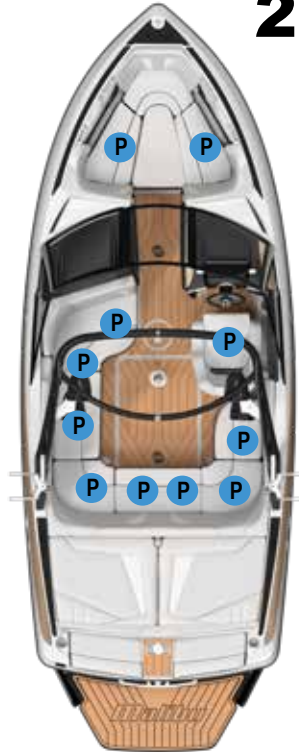

21MLX

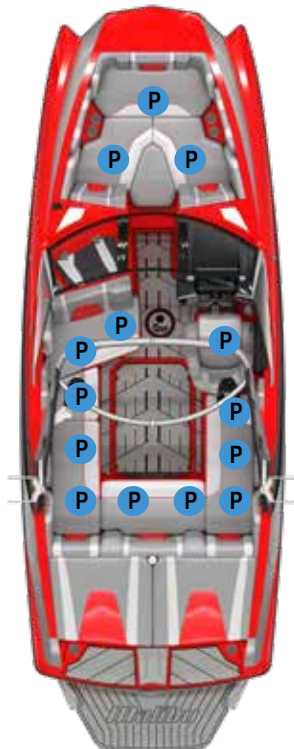

21VLX

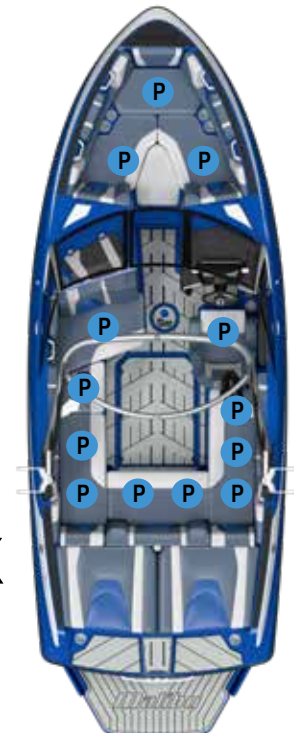



WARNING

DO NOT overload the boat. Overloading or uneven loading can cause loss of control, capsizing or swamping, which may lead to death or serious injury. Adhere to the load capacity plate restrictions and always account for persons, gear and all non-factory-installed ballast or other equipment.

22LSV

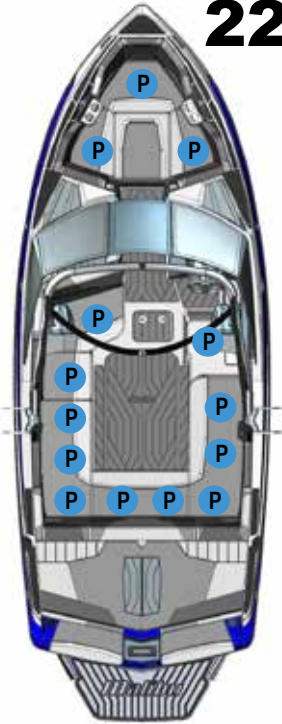

25LSV

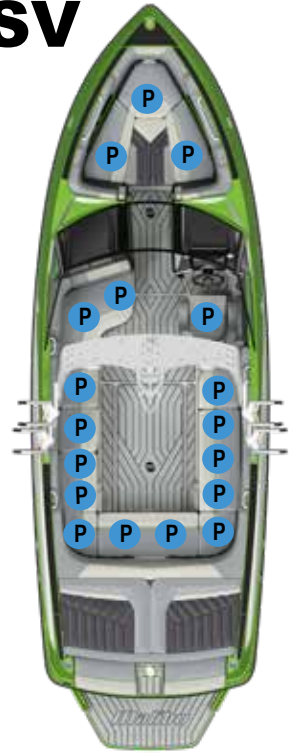

23LSV

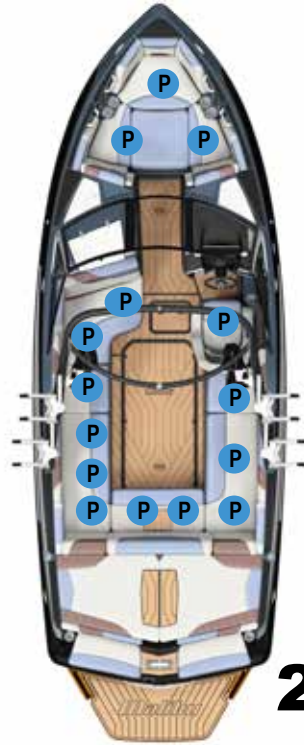

22MXZ

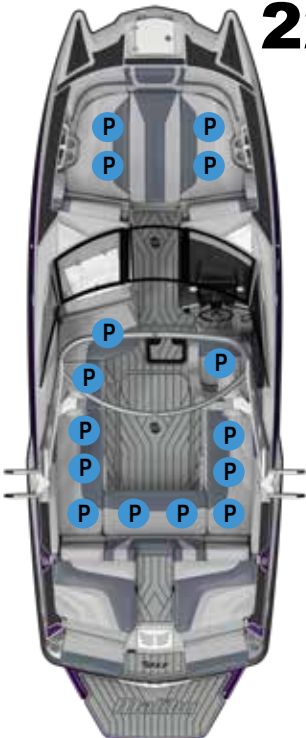

M235

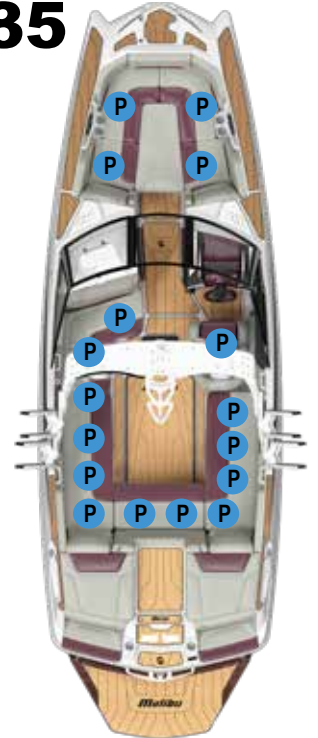

24MXZ

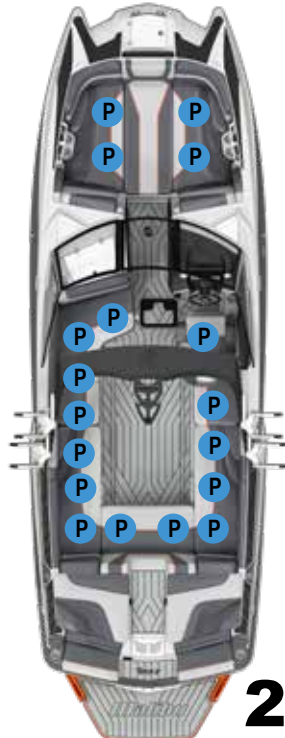



DASHES AND VIDEO SCREENS



Wakesetter Command Center

The Malibu dash features two video screens through which most of the functionality of the boat operation is controlled. On the lower left is standard storage or an optional Sport Dash (shown). It is explained in further detail in the *How It Works* section of this owner's manual.



Engine Start Code

The driver will be prompted to enter an ENGINE START CODE on the 7" display each time the power button is pressed ON or the ignition key is cycled.

To change the start code, touch CHANGE and enter the current code followed by the new code.

To disable the prompt, touch the DISABLE and enter the current code. To RE-ENABLE the start code prompt, go into the settings menu and select SHOW ENGINE CODE. From that menu, select SHOW.

NOTICE: Upon entry of the correct code, or ignition if code prompt is disabled, the blower will turn on for four (4) minutes in preparation for engine starting.



Text/Phone Alert

A pop-up alert signals a new incoming text message or phone call.



System Overview

The system architecture combines an industry leading 12.3" and a 7" LCD placing the most commonly used controls and information on the top surface. Critical information is always in view and the center of the 12.3" screen swaps out with a touch of a button.



- 1 - Current Water depth
- 2 - Engine Hours
- 3 - 8-Point Compass Heading
- 4 - Go Home Mode Button
- 5 - Night Mode Button
- 6 - Speed Input
- 7 - Engine Temperature Gauge
- 8 - Oil Pressure Gauge
- 9 - Viper II Clock/Blue Tooth/Audio Info
- 10 - Voltage Gauge
- 11 - Save Button
- 12 - Fuel Gauge
- 13 - Dock Mode Button

7.0" Malibu Touch Command (MTC) Display



Save Preset Button

Touch the SAVE button to save all the current boat settings and create a new preset.

Four Corner Buttons

The four corners of the display provide convenient access to depth, display brightness, docking throttle profile, and the GO HOME preset.

DEPTH: Water depth is displayed in the top left hand corner of the screen. A graphical view of depth is available by touching the DEPTH SCREEN button at the top of the display.

NIGHT: The NIGHT button toggles display brightness between NIGHT MODE and DAYTIME settings. These settings are adjusted in the BACKLIGHTING section of the SETTINGS menu.

DOCK: The DOCK mode button changes the throttle sensitivity to make docking more controlled. Normal throttle sensitivity returns by touching the DOCK button a second time.

GO HOME: The GO HOME button enables GO HOME MODE. This mode turns speed control off, drains all tanks, moves the SURF GATE to center, and moves the POWER WEDGE to the stow position once the boat is moving between 2 and 10 mph.

Depth Screen

The DEPTH SCREEN shows a graphical representation of depth, in addition to water and air temperature readings.

NOTICE: If the water depth is less than the set DEPTH height then a SHALLOW DEPTH ALARM will sound, and a notice will display. The DEPTH height is adjusted in the CALIBRATION section of the SETTINGS menu.



Ballast Screen

Touch the BALLAST SCREEN button to drain, fill, and view current ballast tank levels. Choose the perfect ballast combination to create a custom wake.

NOTICE: TANK INDICATORS always display the ACTUAL LEVEL in the tank whether resting, filling or draining. Optional ballast bags can ONLY be filled or drained by touching the FILL ALL or DRAIN ALL buttons.



Ballast Tank Operation

1. Touch the TANK INDICATOR to change the level. The indicator will turn white. More than one can be selected if they have the same DESTINATION LEVEL.
2. Touch one of the five DESTINATION LEVEL choices E, 1/4, 1/2, 3/4, or F. The TANK INDICATOR turns blur and continues to display the ACTUAL LEVEL, but now includes a spinning progress indicator and filling or draining status above it.
3. Once the DESTINATION LEVEL is reached, the pump and spinning indicator will stop.



Touch STOP, and then touch the corresponding TANK INDICATOR to stop any pump.

Touch STOP ALL to stop all pumps at once, from filling or draining.

Touch FILL ALL to fill all tanks at once. The filling process will stop when the tanks reach 100%.

Touch DRAIN ALL to drain all tanks at once. The draining process will stop once the tanks are completely empty.

NOTICE: Once the FILL ALL or DRAIN ALL process is initiated, the pumps WILL NOT STOP until the user stops them or the system has powered down.

Wake View

The WAKE VIEW screen provides a simplified wake control interface. Use the BOAT/WAKE VIEW BUTTON to switch between modes.



WAKE SIZE OPERATION

Touch DRAIN ALL to automatically empty all the tanks at once.

Touch the SECOND button to fill the rear tanks to 25%.

Touch the THIRD button to fill all the tanks to 25%.

Touch the FOURTH button to fill the rear tanks to 50% and the front tanks to 25%.

Touch the FIFTH button to fill all tanks to 50%.

Touch the SIXTH button to fill the rear tanks to 75% and the front tanks to 50%.

Touch the SEVENTH BUTTON to fill all the tanks to 75%.

Touch the EIGHTH button to fill the rear tanks to 100% and the front tanks to 75%.

Wake Shape Operation

The Wake Shape Control functions the same as the POWER WEDGE Control. See POWER WEDGE operation instructions in this section of the owner's manual.

Speed Control

Automatically maintain a consistent cruising rate with SPEED CONTROL. When turned on and engaged, the cruise control system will hold the speed of the boat once the ACTUAL SPEED has reached the desired SET SPEED.

Speed Control Operation

Turn SPEED CONTROL ON/OFF by touching the button to the left of the displayed ACTUAL SPEED.



1. With the engine running and in NEUTRAL, press the SPEED CONTROL button to turn the system ON. The button will turn green and ON will be displayed. SPEED READY will appear

above the THROTTLE BAR.

2. Choose a desired SET SPEED by touching the SPEED UP/DOWN buttons.
3. Advance the throttle position until the engine takes control and SPEED ENGAGED is displayed. A THROTTLE TARGET WINDOW will appear on the throttle bar until the engine disengages cruise.
4. Keep the orange THROTTLE MARKER inside the THROTTLE TARGET WINDOW.
5. Throttle position adjustment is needed if the orange marker moves outside of the target window. If left of the window, MORE THROTTLE is displayed until the marker is moved forward. If right, OVER SPEED MODE is displayed until the marker is back inside the window. The driver has control of the boat speed until the marker is back inside the window and the system is engaged.
6. Touch the SPEED UP/DOWN buttons to adjust the desired SET SPEED in 0.1 MPH increments once the SPEED CONTROL is engaged. Touch and hold the button for faster rate of change.
7. Returning the throttle position to NEUTRAL will disengage the system. SPEED CONTROL is still ON, but disengaged.
8. Turn OFF the system by touching the SPEED CONTROL button and returning the throttle position to NEUTRAL, which will disengage the engine. SPEED OFF will appear above the throttle bar.

Speed Input

Press the SPEED INPUT button in to the lower left of the display to access the SPEED INPUT SETTINGS. Select between the desired speed input sources of Paddle Wheel or Zero Off - GPS. Changes will not take place until throttle is put into IDLE position.



Surf Gate Control

Easily create a surf wake and switch it from side to side with the press of a button, without having to adjust the ballast.

NOTICE: When speed exceeds 13.6 mph, the SURF GATES will automatically move to the CENTER position until speed returns to less than 13.6 mph.

The SURF GATES must be calibrated before use to work properly. Follow the procedure in the SURF GATE section in the SETTINGS menu in this section of the Owner's Manual.



Surf Gate Operation

Touch LEFT, RIGHT, or CENTER button to position the side of the SURF GATE. The selected position changes to white and a progress meter appears until the position is achieved. The boat speed must be between 7.0 and 13.6 mph, with no active alarms to engage.

The selected position will be in READY MODE when the boat speed is out of range or an alarm is active. Both SURF GATES retract in the CENTER position. Normal SURF GATE system operation will resume after alarm conditions are resolved and notifications acknowledged. Refer to the following list of alarms.

To alert the driver and rider of SURF GATE position switch, the TOWER LIGHTS will flash and audible beeps will sound. These alerts can be disabled in the SURF GATE section of the SETTINGS menu explained later in this section of the owner's manual.

Surf Gate Alarms

Under certain operating conditions, SURF GATE alarm notices appear.

MAX CURRENT DRAW EXTENDING LEFT = Error with Left surf actuator.

MAX CURRENT DRAW RETRACTING LEFT = Error with Left surf actuator.

MAX CURRENT DRAW EXTENDING RIGHT = Error with Right surf actuator.

MAX CURRENT DRAW RETRACTING RIGHT = Error with Right surf actuator.

HIGH SPEED SURF GATE = Speed Exceeds 13.6 mph.

SURF GATE LEFT SWITCH = Gates limit switch is open after retraction.

The gate will extend back out then retract again. If the switch is still out a new alarm will appear "SURF GATE LEFT SWITCH SEE DEALER". The SURF GATES will be locked until the battery is reset.

SURF GATE RIGHT SWITCH = Gates limit switch is open after retraction.

The gate will extend back out then retract again. If the switch is still out a new alarm will appear "SURF GATE RIGHT SWITCH SEE DEALER". The SURF GATES will be locked until the battery is reset.

Power Wedge Control

Tune the ideal wake for surfing and wakeboarding with the POWER WEDGE.



The Power Wedge is not intended for use at speeds greater than 26 mph. An alarm will sound and a notice will be displayed if the Power Wedge is in a deployed position at speeds exceeding 26 mph. Boat speed must be below 26 mph to dismiss the alarm. Ensure all passengers are in the boat before changing the Power Wedge position. Stay clear of the Power Wedge while it is in motion. Extremities and clothing might become pinched or caught and cause serious injury!

Power Wedge Operation

The POWER WEDGE position adjustment is permitted ONLY when boat speed and POWER WEDGE position are within safe operational range. The POWER WEDGE is NOT intended for use at speeds greater than 26 mph. The POWER WEDGE will return to the STOWED position only at speeds of 1 to 10 mph.



Before riding, deploy the POWER WEDGE to a downward position by touching any one of the eight (8) position buttons on the POWER WEDGE Control. If the wedge is in the STOW position (all the way up) you can press any of the remaining buttons to deploy the wedge.

The remaining keys range from VERT, which is the most aggressive wedge setting, to LIFT. The selected button will turn white.

The size and shape of the wake can be adjusted when the boat has reached a speed of 10 to 26 mph. Select a new position on the POWER WEDGE control or make fine adjustments using the buttons on the bottom of the optional joystick.

Wedge Locator

The wedge locator widget will follow the POWER WEDGE during motion. The white will indicate the current selected wedge location, but may not reflect its actual physical position.

Auto Wedge

AUTO-WEDGE is the automatic active control of the POWER WEDGE. The system helps the boat get on plane and reduce drag

until down force is required. The POWER WEDGE will move to the selected position automatically once the desired speed is achieved. AUTO-WEDGE is turned ON/OFF in the POWER WEDGE section of the SETTINGS menu explained later in this section of the Owner's Manual.

The factory default setting is ON.

Preset Screen

In the Preset Screen easily create and manage personalized user experience preferences for that perfect ride.



Create New Preset

1. Touch NEW to start the step-by-step process of creating a preset.
2. Jump to any step in the process by touching BACK or NEXT, or by touching the progress bar dot. Cancel at any time by touching the EXIT button (red X).
3. Enter a preset NAME using the keyboard, then touch NEXT.
4. Select a preset PIC, then touch NEXT.
5. Select a SURF GATE position, then touch NEXT.
6. Select a SET SPEED for speed control using UP/DOWN, then touch NEXT.
7. Select BALLAST LEVELS for each tank, then touch NEXT.
8. Select a POWER WEDGE position, then touch NEXT.
9. Select an AUTO-VOLUME level, turn it OFF, or use the default level, then touch SAVE.



Copy a Preset

1. View the available presets in the list box. Use UP/DOWN to scroll the list.
2. Select a preset by touching it in the list box.
3. Touch COPY to create a copy of the selection. Rename or make changes using EDIT.

Edit a Preset

1. View the available presets in the list box. Use UP/DOWN to scroll the list.
2. Select a preset by touching it in the list box.
3. Touch EDIT to make changes using the same steps as CREATE NEW PRESET.

Delete a Preset

1. View the available presets in the list box. Use UP/DOWN to scroll the list.
2. Select a preset by touching it in the list box.
3. Touch DELETE to PERMANENTLY DELETE the selection from system memory.

Load a Preset

1. View the available presets in the list box. Use UP/DOWN to scroll the list.
2. Select a preset by touching it in the list box.
3. Touch LOAD to make this preset active in the SPEED CONTROL system.
4. The screen will transition to the BALLAST SCREEN and the loaded preset NAME will appear under the ballast controls.

CANCEL A PRESET

Turn the speed control system OFF to CANCEL a preset by touching SPEED CONTROL. The POWER WEDGE, SURF GATE and ballast will stay in the current position.

Media Screen

View a PDF document or video from an SD card. This feature functions ONLY when the engine is OFF.



PDF and Video Viewer

The PDF and VIDEO buttons will allow the user to view pdfs and play videos that have been stored on the SD card in the Malibu folder.



Rear Camera

The REAR CAMERA (where equipped) will be selectable when the BACKUP CAMERA option is turned ON, in the ACCESSORY OUTPUTS section of the SETTINGS menu.



Auto Reverse Screen

The AUTO REVERSE screen appears automatically when the throttle is in REVERSE, and it is turned ON in the ACCESSORY OUTPUTS section of the SETTINGS menu.

File Transfer

Manage files from USB input device to SD Card with FILE TRANSFER. Follow the on-screen directions to move, copy or delete files. USB 1 input is located on the dash board. The optional USB 2 (if installed) will be located in the storage compartment by the throttle. Please wait sufficient time for larger files to transfer.

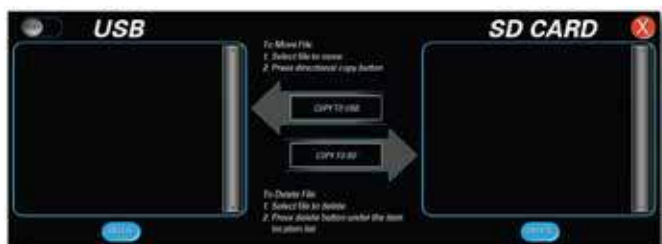

Stereo Screen

Touch the STEREO button for direct access to certain audio controls including AM/FM stereo channels, Bluetooth wireless, Satellite, USB and Auxiliary input ports.

1. FM Radio
2. Satellite Radio
3. Bluetooth
4. AM Radio
5. USB Input
6. Auxiliary Input
7. Weather
8. Main Volume



AM/FM Radio/Weather

Touch AM RADIO or FM RADIO for AM/FM stereo channels/weather band.

1. Source Select.
2. Stereo Menu.
3. Equalization Adjustment.
4. Seek Forward/Back.



Satellite Radio

Touch SATELLITE for satellite radio stations.



Viper II Bluetooth

Touch BLUE-TOOTH to play songs on your phone or mobile device with Bluetooth technology.



USB Input

Touch USB to access USB input ports.



Auxiliary Input

Touch AUXILIARY to access the auxiliary input port.



Equalization Adjustment

Touch EQ to adjust sound levels.



Acknowledgement Screen

The RGB lighting acknowledgement screen will appear when anchor and navigation lights are powered on.



Advance Lighting Controls

The M235 has optional RGB lighting. Where equipped, touch the RGB button to access the Advanced Lighting Controls screen. The system allows individual or simultaneous control of three separate lighting zones on the boat.

Controls Screen

Manage navigation and accent lighting, bilge pumps, blower, heater, and settings. If buttons for any equipment are not shown, touch SETTINGS and verify that the output is ACTIVE.



- Touch SWIM to toggle the SWIM PLATFORM LIGHTING ON/OFF.
- Touch INTERIOR to toggle the INTERIOR LIGHTING ON/OFF.
- Touch TOWER with consecutive button touches to toggle through the TOWER LIGHTING modes FRONT ON, REAR ON, BOTH ON, and ALL OFF.
- Touch ANC to toggle the ANCHOR LIGHT ON/OFF.
- Touch NAV to toggle the NAVIGATION LIGHTS ON/OFF.
- Touch DOCKING to toggle the DOCKING LIGHTS ON/OFF.
- Touch ALL OFF to turn ALL LIGHTS, BILGE PUMPS, BLOWER, and HEATER OFF.
- Touch BLOWER to toggle the blower ON/OFF.
- Touch AFT BILGE to toggle the aft bilge ON/OFF.
- Touch FWD BILGE to toggle FORWARD BILGE ON/OFF.
- Touch SEAT HEATER to toggle heated seat ON/OFF.
- Touch HEATER with consecutive button touches to toggle through the HEATER MODES HIGH, LOW and OFF.

On/Off Toggle

Touch the ON/OFF toggle switch to power up or shut off the system. When the system is powered off the control screen will be blank and the current settings will be saved.



On system power up you will receive a confirmation reminder: ATTENTION RGB lights are ON. Please turn them OFF while the boat is underway or at night.



MUSIC Mode

Touch the MUSIC icon button to have the lighting react to the music playing through the Viper II displays stereo system.



Backlighting Zones

The zone backlighting buttons, INTERIOR/CUPHOLDER/TOWER/ALL ZONES, allow each button to match the selected color and mode of that zone.



Solid Mode

Touch SOLID for continuous solid lighting. Touch the BRIGHTNESS and COLOR sliders to control the brightness and color of the lighting, or select a preset color with one of the BLUE/GREEN/RED/WHITE color select buttons.



Pulse Mode

Touch PULSE for a single color strobing effect. As with Solid Mode, touch the BRIGHTNESS and COLOR sliders. To control the brightness and color of the lighting, or select a preset color with one of the BLUE/GREEN/RED/WHITE color select buttons. The speed rate of the pulse can be increased or decreased with the SPEED slider.



Jump Mode

Touch JUMP to have the lighting cycle through multiple colors. Select between four or seven different colors with the 4 and 7 buttons. Touch the BRIGHTNESS sliders to control the brightness level of the lighting, and the SPEED slider for the rate of cycling.



Settings Screen

Touch the SETTINGS button on the CONTROLS PAGE to manage system settings, options, troubleshooting, and software updates here. View the available settings list with the SCROLL BAR on the right side of the screen and touch an item on list to view available SETTINGS CHOICES. Touch the RED X button to EXIT the setting screen. Changes will automatically be saved upon leaving the SETTINGS screen.



Touch MALIBU BLUETOOTH to enable PAIRING, and to edit the Bluetooth name of the boat. When pairing a device to the system, the default is "Viper11", but after pairing, the boat name changes to "Malibu Boat."



Touch SPEED/THROTTLE, then THROTTLE, to select the throttle sensitivity of STANDARD or AGGRESSIVE.



Touch ABOUT (UPDATE) to view the installed software version, and instructions on how to install software updates.



Touch SPEED/THROTTLE, then CALIBRATION, to calibrate the PADDLEWHEEL speed signal or adjust the displayed speed. You must use a portable GPS such as a smartphone app or navigation product to determine ACTUAL SPEED.



Touch BACKLIGHTING to adjust the BRIGHTNESS of the display screen. The NIGHT button (located in the bottom left corner of the 12 in display) is used to toggle between the DAY-TIME and NIGHT MODE settings.

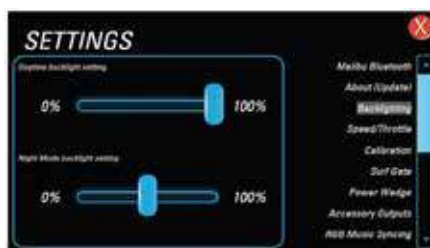

Touch CALIBRATION, then UNITS, to choose either ENGLISH or METRIC units.



Touch SPEED/THROTTLE, then SOURCE, to select the speed signal source from Zero Off or PADDLEWHEEL. The default is Zero Off. The boat must be at idle throttle when changing this setting.



Touch CALIBRATION, then TEMP, to adjust the DISPLAYED air temperature to match an ACTUAL temperature reading.



Touch CALIBRATION, then DEPTH, to adjust the height at which the SHALLOW DEPTH ALARM will sound.



Touch CALIBRATION, then TIME ZONE, to turn ON/OFF Daylight Savings Time and select time zone location.



Touch RGB MUSIC SYNCING to adjust the SAMPLE RATE and GAIN of the time-synced music.



Touch SURF GATE to CALIBRATE, SERVICE, or toggle the audible and visual indicators for SURF GATE switching ON/OFF.

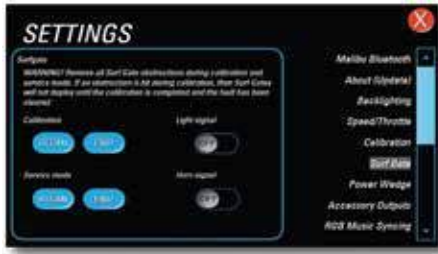

Touch LIGHTING OUTPUTS to ENABLE/DISABLE on-screen touch control buttons for lighting systems on the boat.



Touch POWER WEDGE to toggle ON/OFF the AUTO WEDGE feature. AUTO WEDGE automatically moves the POWER WEDGE from the selected position, to a position of lowest drag when the boat slows. The POWER WEDGE returns to the selected position when Set Speed resumes.



Touch ENGINE DIAG to view on-screen ENGINE DIAGNOSTICS information.



Touch SYSTEM DIAG to view on-screen SYSTEM DIAGNOSTICS information concerning boat sensors and GPS signal.



Touch ACCESSORY OUTPUTS to ENABLE/DISABLE onscreen touch control buttons for optional equipment. When enabled buttons will appear on the screen.



Touch RESET to restore the system factory default settings. All previous calibration, settings, and rider presets will be PERMANENTLY DELETED.



Touch SERVICE to view maintenance schedules recommended by the engine manufacturer. Service notices will appear at each key cycle when



the service hour interval has been reached. These notices must be cleared by the user.

Touch STEREO SXM RESET to restore stereo factory default settings. Set the mode to SXM before proceeding.



Touch WEDGE SURF GATES, then WEDGE to view POWER WEDGE position and sensor voltage. Wedge position is adjustable with the +/- buttons.



Touch WEDGE SURF GATES, then SURF GATES to service and view current status. Press the SERVICE button, then follow the on-screen instructions to service the SURF GATES.



Touch WEDGE SURF GATES, then TANK LEVEL to view current BALLAST TANK and FUEL levels.



Maps Screen

The Navionics Navigation System uses GPS (Global Positioning System) satellites, and a map database to calculate and display route directions. SD Card with Map Data is required.

When a Navionics SD card is loaded into the Viper II SD Slot, map data for the region will appear as a bunch of purple boxes on the map. If the purple squares do not appear on the map, the card is missing, not installed correctly, or possibly defective.

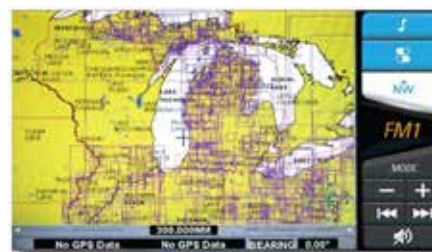

Touch ANYWHERE ON THE MAP to activate the pop-up controls. Touch the SIX DIRECTIONAL ARROW buttons along the perimeter of the map window to position the cursor. Touch the RETURN button to return the cursor to the CURRENT LOCATION and the +/- buttons to ZOOM IN/OUT.



Touch the NORTH/BEARING/COMPASS button to change the method of TRACKING position. NORTH is always at the top when NORTH is selected.

The BEARING is always pointing to the top of the screen and in the direction the boat is traveling when BEARING is selected.

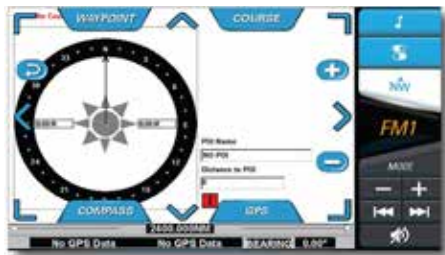

A COMPASS replaces the map with COMPASS is selected. Touch the GPS button to view available SATELLITE

STATUS. *IT CAN TAKE SEVERAL MINUTES FOR GPS SATELLITES TO LOCATE AND POSITION THE BOAT ON THE MAP.*



Touch the WAYPOINT button to place a waypoint at the cursor position. Position the cursor over the waypoint to EDIT, MOVE or DELETE it. Choose a WAYPOINT ICON to mark the waypoint with a meaningful reminder.



Touch the COURSE button to SELECT, CREATE, STOP or CANCEL a course. NEW AUTO COURSE records

the actual route the boat is traveling to be saved and recalled later. NEW COURSE allows the user to build a future course of NEW user-created waypoints.



Touch the COURSE button to SELECT, CREATE, STOP or CANCEL a course. NEW AUTO COURSE records the actual route the boat is traveling to be saved and recalled later.

NEW COURSE allows the user to build a future course of NEW user created waypoints.



To begin, touch COURSE then NEW then NEW COURSE. Touch SELECT WAYPOINT LOCATION, then position the cursor on the map for the first

waypoint. Touch the WAYPOINT button. Choose an icon and name

for the waypoint. Continue with this same procedure

to create all remaining waypoints.



The last waypoint must be a "COURSE COMPLETE" waypoint to finalize

the course. A course cannot be changed or edited once created. Touch the COURSE then SELECT button to PICK, UNPICK or

DELETE a course. Picking a course will display the course on the map. Multiple courses can be displayed on the map.



To begin, touch **COURSE**, then **NEW**, then **NEW COURSE**. Touch **SELECT WAYPOINT LOCATION**, then position the cursor on the map for the first waypoint. Touch the **WAYPOINT** button. Choose an icon and name for the waypoint. Continue with this same procedure to create all remaining waypoints.



NEW COURSE allows the user to build a future course of **NEW** user created waypoints.



To begin, touch **COURSE**, then **NEW**, then **NEW COURSE**. Touch **SELECT WAYPOINT LOCATION**, then position the cursor on the map for the first waypoint.

The last waypoint must be a **"COURSE COMPLETE"** waypoint to finalize the course. A course cannot be changed or edited once created. Touch the **COURSE**, then **SELECT** button to **PICK**, **UNPICK** or **DELETE** a course. Picking a course will display the course on the map. Multiple courses can be displayed on the map.



Touch the **WAYPOINT** button. Choose an icon and name for the waypoint. Continue with this same procedure to create all remaining waypoints. The last waypoint must be a **"COURSE COMPLETE"** waypoint to finalize the course.



Touch the **COURSE** then **SELECT** button to **PICK**, **UNPICK** or **DELETE** a course. Picking a course will display the course on the map. Multiple courses can be displayed on the map.



A course cannot be changed or edited once created. Touch the **COURSE** then **SELECT** button to **PICK**, **UNPICK** or **DELETE** a course.



Picking a course will display the course on the map. Multiple courses can be displayed on the map.

Touch the **COURSE** button to **SELECT**, **CREATE**, **STOP** or **CANCEL** a course. **NEW AUTO COURSE** records the actual route the boat is traveling to be saved and recalled later.



TXi Standard Gauges and Screen

Functionality is explained in this section. Additional information about certain aspects of the controls is also discussed in further detail in other sections of the Owner's Manual. Be sure to read the entire manual before attempting to operate the controls.

Gauges

The instrument panel features two (2) five-inch (5") gauges, which provide real-time information about important drive train functions.



The top of the left gauge is the speedometer, which shows the boat's speed as determined by the paddlewheel under the hull. The speed reads in miles per hour (mph).

The lower left of the gauge is the engine temperature reading. If the temperature sensor notes a reading above the programmed, acceptable level an alarm will sound. More information about alarms follows in this section of the Owner's Manual.

The lower right of the gauge is the engine oil pressure reading. If the oil pressure sensor notes a reading above the programmed, acceptable level an alarm will sound. More information about alarms follows in this section of the Owner's Manual.

The right side gauge is the tachometer/voltage/fuel level display.

The tachometer, which is the upper half of the gauge, shows the engine revolutions per minute (rpm) numerically-times-1,000.



The lower left portion of the gauge shows the electrical voltage at the alternator output. The desired range during engine operation is above 13.5 volts. See the battery information that follows in this section of the Owner's Manual for additional details regarding the proper charging and

battery switch designation.

The lower right side of the gauge shows the approximate level of the fuel in the fuel tank. Note that movement of the boat can affect the reading, especially as fuel levels lower. Be certain to read the *Fueling* information in the *Get Ready* section of this Owner's Manual before operating the boat for important information.

Keypad



A keypad is provided to assist in maneuvering among the functions controlled from this location. Additional information follows.

Center Screen

Located between the two gauges is an LCD screen that provides information on much of the boat's functionality. The following information provides detail.



Cruise Screen

Cruise Mode

Shows the current status of CRUISE MODE. When turned ON and ENGAGED, the cruise control system will automatically control the speed of the boat after the ACTUAL SPEED has reached the desired SET SPEED.

CRUISE ON CRUISE MODE is activated.

MODE THROTTLE More throttle is needed to reach SET SPEED.

CRUISE ENGAGED SET SPEED has been achieved and the boat can now automatically maintain consistent speed.

Engine Screen



With ZeroOff Gauge

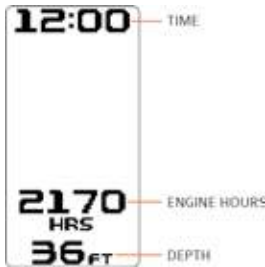

Depth Screen

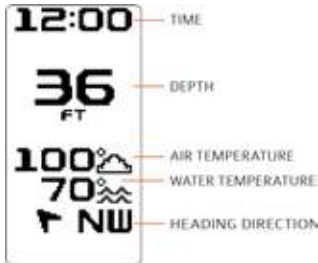

Alerts

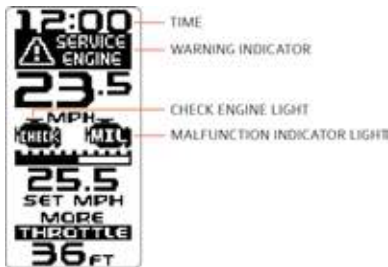

Warnings

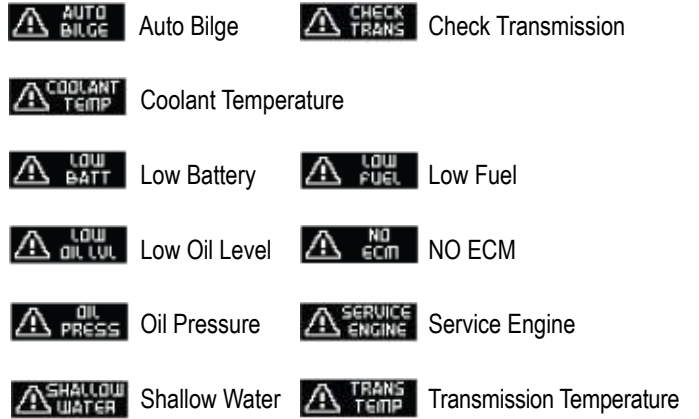

Lights Menu

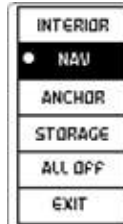

Turn OFF or ON interior, navigation and anchor lights on the boat in the LIGHTS menu.

Controls Menu

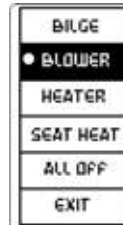

Turn OFF or ON the bilge, blower, heater and heated seats in the CONTROLS menu.

Settings Menu



Manage system settings, options, troubleshooting, and software updates in the SETTINGS Menu. Changes will automatically be saved upon exit.



UNITS

Choose from ENGLISH or METRIC units.



PADDLEWHEEL/GPS

Change the speed signal source. The boat must be at idle throttle when changing this setting.



TIME OFFSET

Allows for offset of DISPLAYED TIME. Default time is based off of GMT.

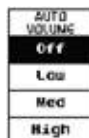

AUTO VOLUME

Adjust the loudness setting of the AUTO VOLUME.



NIGHT MODE

Adjust the brightness of the LCD display.



SHALLOW ALARM

Adjust the depth of the SHALLOW ALARM.



SPEED CALIBRATION

Calibrate the PADDLEWHEEL speed signal. Use a portable GPS such as a smartphone app or navigation product to determine ACTUAL SPEED and adjust the DISPLAYED SPEED.



RESTORE DEFAULT

Restore back to the system factory DEFAULT SETTINGS.



SOFTWARE VERSION

View the installed software version, part number and build date.



UPDATE SOFTWARE

Update current software.



AIR TEMP CALIBRATION

Allows for offset of DISPLAYED AIR TEMPERATURE.



LAKE TEMP CALIBRATION

Allows for offset of DISPLAYED LAKE TEMPERATURE.



ZERO OFF

Select if ZERO OFF gauge is installed or not. If INSTALLED, or turned ON, then the CRUISE CONTROL

MODE will be able to be controlled only through the ZERO OFF gauge.



RESTORE DEFAULT

Restore back to the system factory DEFAULT SETTINGS.



DIAGNOSTIC

View system diagnostic information concerning boat sensors and GPS signal. Follow on-screen instructions to run DIAGNOSTIC SELF-TEST. Self-Test will take three (3) seconds to begin.

Video Screens

(Optional Malibu Open Edition)

Instead of the 5" gauges, all information is displayed and controls operate through the 7" video screen rather than the LCD screen that is part of the standard package. Additional controls may be available through an optional 3" screen as well.



Engine Start Code

The driver will be prompted to enter an ENGINE START CODE each time the power button is pressed on or the ignition key is cycled. The code can be CHANGED or the prompt can be disabled, or ignition if the code prompt is disabled, the blower will turn on for four (4) minutes in preparation of the engine starting.



To CHANGE the start code, touch the CHANGE button and enter the current code followed by the NEW CODE.

To DISABLE the prompt, touch the DISABLE button and enter the current code.

To RE-ENABLE the start code prompt, go into the settings menu and select SHOW ENGINE CODE. From that menu, select the SHOW button.

Gauge View and Speed Control

The GAUGE VIEW screen provides important engine parameters and system status displayed by the speedometer, tachometer, engine temperature, oil pressure, voltage and fuel gauges. The adjustment buttons for the SPEED CONTROL cruise system are also contained with the GAUGE VIEW screen.

1. Night Mode On/Off
2. Speed Control On/Off
3. Speed Up/Down
4. Power On/Off
5. Stereo Screen
6. Media Screen
7. Controls Screen
8. Maps Screen
9. Gauge View
10. Source Select
11. Seek/Track
12. Mute On/Off
13. Volume Adjust
14. Auto Volume



Night Mode

The NIGHT mode button toggles lighting brightness between NIGHT and DAYTIME. Adjust preferences in the SETUP MENU. The lighting of the Displays, Start/Stop Button, Power Button, and Joystick Control dim to the value selected in the SETTINGS menu.

Speed Control Operation

Automatically maintain a consistent boat speed. When SPEED CONTROL is ON and ENGAGED, the cruise control system will control the speed of the boat after the ACTUAL SPEED has reached the desired SET SPEED.

1. With the ENGINE RUNNING and in NEUTRAL, turn the SPEED CONTROL ON by touching SPEED CONTROL button. The button will turn GREEN and ON will be displayed. "SPEED READY" is displayed above the THROTTLE BAR. Touching the

speed control button again turns the speed control OFF.

2. Choose a desired SET SPEED by touching the SPEED UP/DOWN BUTTONS.
3. Advance the THROTTLE POSITION until the engine takes control and "SPEED ENGAGED" is displayed. A THROTTLE TARGET WINDOW appears on the throttle bar until the engine engages cruise control.
4. Keep the ORANGE THROTTLE MARKER inside the THROTTLE TARGET WINDOW.
5. THROTTLE POSITION ADJUSTMENT is needed if the orange throttle marker moves OUTSIDE the target window. If LEFT, "MORE THROTTLE" is displayed until the marker is back inside the window. If RIGHT, "OVER SPEED MODE" is displayed until the marker is back inside the window. The DRIVER CONTROLS THE SPEED OF THE BOAT until the marker is back inside the window.
6. Touch SPEED UP/DOWN BUTTONS to adjust the desired SET SPEED in 0.1 MPH increments after the engine has control. Touch and hold the button to change the rate of change.
7. Returning the THROTTLE POSITION to NEUTRAL will DISENGAGE speed control. Speed control is still ON, but disengaged.
8. Turn the SPEED CONTROL OFF by touching the SPEED CONTROL button and DISENGAGE the engine by returning the throttle position to NEUTRAL. SPEED OFF appears above the throttle bar.

Stereo Screen

Touch the STEREO button for direct access to certain audio controls including AM/FM stereo channels, Satellite, USB, Bluetooth wireless, auxiliary and SD car input ports.

1. FM Radio
2. Satellite Radio
3. Bluetooth
4. AM Radio
5. USB 1
6. Auxiliary Input
7. Weather



AM/FM Radio/Weather

Touch AM RADIO or FM RADIO or WEATHER for AM/FM stereo channels/weather bands.

1. Source Select
2. Mixer Adjustment
3. Equalization Adjustment
4. Seek Forward/Back



Satellite Radio

Touch SATELLITE RADIO for satellite radio stations.



USB Input

Touch USB to access USB input ports.



ViperII Bluetooth

Touch BLUETOOTH to play songs on your phone or mobile device with Bluetooth technology.



Auxiliary Input

Touch AUXILIARY to access the auxiliary input port.



Volume

Adjustment

Touch VOLUME UP or VOLUME DOWN to bring up the VOLUME CONTROL menu. Control the volume of the interior or tower speakers with the INTERIOR or TOWER adjustment sliders. Control the volume of all the boat speakers with the MASTER adjustment slide. The AUTO VOLUME feature increases volume as the boat speeds up. It is controlled with the AUTO VOLUME adjustment slide.



Equalization

Touch EQ to adjust the loudness, bass, treble, fade, balance, sub, iVol, and USA or European tuning.



Media Screen

View a PDF document or video from an SD card. This feature functions ONLY when the engine is OFF.

1. PDF Viewer
2. Video Player
3. Dash Camera

PDF Viewer and Video Player

The PDF and VIDEO button will allow the user to view pdfs and play videos that have been stored on the SD card in the Malibu folder.

1. Exit
2. Play All
3. Play/Pause
4. Repeat
5. Play Next
6. Play Last
7. Stop
8. Volume Up
9. Volume Down

Rear Camera

With the BACKUP CAMERA (where equipped) turned ON in the SETTINGS Menu, the REAR CAMERA option will be selectable.

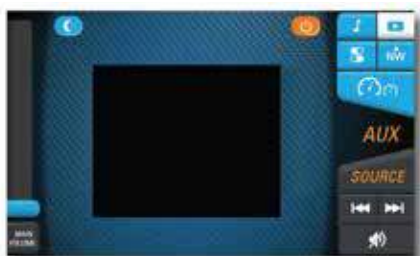

Controls Screen

Manage navigation and accent lighting, bilge pumps, blower, heater, and settings. If the buttons for any equipment are not shown, touch SETTINGS and verify that the output is ACTIVE.



- Touch NAV to toggle the NAVIGATION LIGHTS ON/OFF.
- Touch ANC to toggle the ANCHOR LIGHT ON/OFF.
- Touch INTERIOR to toggle the INTERIOR LIGHTING ON/OFF.
- Touch STORAGE to toggle the STORAGE LIGHTING ON/OFF.

Settings Screen

Touch the SETTINGS button on the CONTROLS page to manage system settings, options, troubleshooting, and software updates here. View the available settings list with the SCROLL BAR on the right side of the screen and touch an item on the list to VIEW available SETTINGS CHOICES. Touch the RED X button to EXIT the setting screen. Changes will automatically be saved upon leaving the SETTINGS screen.



Malibu Bluetooth

Touch MALIBU BLUETOOTH to enable Bluetooth and PAIRING with the PERFECT-PULL APP, and to edit the name



of the Bluetooth name of the boat. When pairing a device to the boat, the default Bluetooth name is "ViperII", but after pairing, the name changes to "Malibu Boat". Use the app to provide STREAMING AUDIO on-board with an iOS or Android device.

About (Update)

Touch ABOUT (UPDATE) to view the installed software version and instructions for how to install a software update here.



Backlighting

Touch Backlighting to adjust the BRIGHTNESS setting from 0-100% of the display in DAYTIME and NIGHT modes with the slide bar controls. The NIGHT button on the display toggles between the two settings.

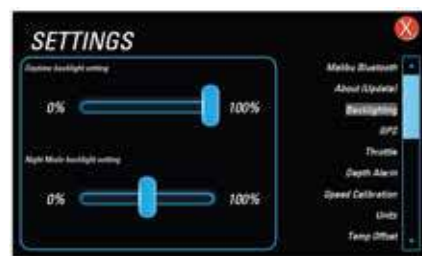

GPS

Touch GPS to change the speed signal source from Zero Off to PADDLEWHEEL. The default is Zero Off. The boat must be at idle throttle when changing this setting.



Throttle

Touch THROTTLE to change the THROTTLE sensitivity from STANDARD to AGGRESSIVE.



Depth Alarm

Touch DEPTH ALARM to adjust the SHALLOW DEPTH ALARM setting.



Speed Calibration

Touch SPEED CALIBRATION to calibrate the PADDLEWHEEL speed signal. Use a portable GPS such as a smartphone app or navigation product to determine ACTUAL SPEED and adjust the speed displayed.



Units

Touch UNITS to choose from ENGLISH to METRIC unit.



Temp Offset

Touch TEMP OFFSET to adjust the displayed air temperature to match an actual temperature reading.



Accessory Outputs

Touch ACCESSORY OUTPUTS to ENABLE/DISABLE on-screen touch control buttons for optional equipment. When enabled, the buttons will appear on the screen.



Lighting Outputs

Touch LIGHTING OUTPUTS to enable optional tower, swim, and docking lights.



Engine Diagnostics

Touch ENGINE DIAG to view on-screen ENGINE DIAGNOSTIC information.



System Diagnostics

Touch SYSTEM DIAG to view on-screen SYSTEM DIAGNOSTIC information concerning boat sensors and GPS signal.



Reset

Touch RESET to restore the system factory default settings. All previous calibration and settings will be lost.

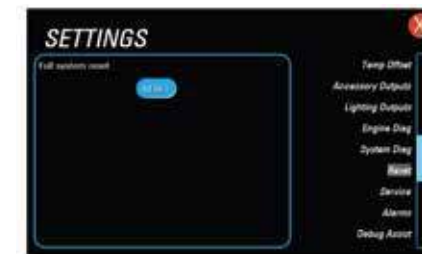

Service

Touch SERVICE to view maintenance schedules recommended by the engine manufacturer. SERVICE notices will appear at each key cycle when the service hour interval has been reached, and it must be cleared by the user.



Alarms

Touch ALARMS to view all ACTIVE and INACTIVE engine alarms.



Debug Assist

Touch DEBUG ASSIST to access controls for TRAINED SERVICE TECHS ONLY.



Stereo SXM Reset

Touch STEREO SXM RESET to restore stereo factory default settings. Set the mode to SXM before proceeding.



Cruise Option

Touch 3-EVENT CRUISE to enable/disable the Cruise Control Option.



Time Zone

Touch TIME ZONE to select the time zone.



Maps Screen

The Navionics Navigation System uses GPS (Global Positioning System) satellites, and a map database to calculate and display route directions. SD Card



with Map Data is required. The MAP button shows actual current bearing from the GPS. “..” is displayed if the data is not available.

When a Navionics SD card is loaded into the ViperII SD Slot, map data for the region will appear as a bunch of purple boxes on the map. If the purple squares do not appear on the map, the card is missing, not installed correctly, or possibly defective.

Navigation

Controls

Touch ANYWHERE on the map to activate the pop-up controls. Touch the SIX DIRECTIONAL ARROW buttons along the perimeter or the map window to position the cursor. Touch the RETURN button to return the cursor to the CURRENT LOCATION and the +/- buttons to ZOOM In/OUT.



Bearing

Touch the NORTH/ BEARING/COMPASS button to change the method of TRACKING position.

NORTH is always at the top when NORTH is selected. The BEARING is always pointing to the top of the screen and in the direction the boat is traveling when BEARING is selected.



Compass

A COMPASS replaces the map when COMPASS is selected.

Touch the GPS button to view available SATELLITE STATUS. It can take

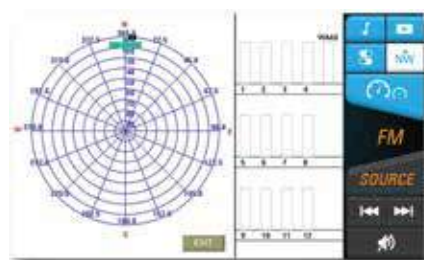

several minutes for GPS satellites to locate and position the boat on the map.

Waypoints

Touch the WAYPOINT button to place a WAYPOINT at the cursor position. Position the cursor over the WAYPOINT to EDIT, MOVE or DELETE it. Choose a WAYPOINT ICON to mark the WAYPOINT with a meaningful reminder.



Course

Touch the CURSE button to SELECT, CREATE, STOP or CANCEL a course.

NEW AUTO COURSE records the actual route the boat is traveling to be saved and recalled later.



NEW COURSE allows the user to build a future course of NEW user-created waypoints.

Select Course

Touch the COURSE, then SELECT button to PICK, UNPICK or DELETE a course. Picking a course will display the course on the map. Multiple courses can be displayed on the map.



New Auto Course

NEW AUTO COURSE records the actual route the boat is traveling, to be saved and recalled later.

NEW COURSE allows the user to build a future course of NEW user-created waypoints.

To begin, touch COURSE and then NEW for a NEW COURSE.

Touch SELECT WAYPOINT LOCATION, and then position the cursor on the map for the first waypoint.

Touch the WAYPOINT button. Choose an icon and name for the waypoint. Continue with this same procedure to create all remaining waypoints.

The last waypoint must be a "COURSE COMPLETE" waypoint to finalize the course.

A course cannot be changed or edited after it has been created.

Touch the COURSE, then SELECT button to PICK, UNPICK or DELETE a course.

Picking a course will display the course on the map. Multiple courses can be displayed on the map.



Touch the COURSE button to SELECT, CREATE, STOP or CANCEL a course.

NEW AUTO COURSE records the actual route the boat is traveling, to be saved and recalled later.

NEW COURSE allows the user to build a future course of NEW user-created waypoints.

Touch the WAYPOINT button. Choose an icon and name for the waypoint. Continue with this same procedure to create all remaining waypoints.

The last waypoint must be a "COURSE COMPLETE" waypoint to finalize the course.

A course cannot be changed or edited after it is created.

Touch the COURSE, then SELECT button to PICK, UNPICK or DELETE a course.

Picking a course will display the course on the map. Multiple courses can be displayed on the map.



3-in-1 Event Screen

Available as an option on some TXi models, the 3-in-1 Event Screen is a combination touch and push button control. The display unit is a multi-functional tool that provides GPS tracking and multi-media functions. It also enables operators to view various engine parameters and service codes.



Care and Maintenance

General maintenance is not required. However, a soft cloth can be used for cleaning the unit face. Window cleaner or alcohol can also be used to clean the glass portion of the display. Do not use harsh or abrasive cleaners on the unit.

Navigation Features

All product features are easily accessible through Quick Access Keys and Touch Point commands.

Home Screen and Buttons

The following information is displayed:

- Actual speed
- RPM
- MPH/KPH
- Number of detectable satellites
- Type of satellite signal
- ZeroOff GPS Speed Control® switch
- Set speed increase/decrease touch points
- Pull-out section for ski options
- Pop-up screen for slalom settings



GPS Information

Satellite Signals

The unit depends on satellite signals to enable the GPS. A minimum of four satellites is required to get a fix or clear signal. Satellite scenarios are described as follow:



Differential Satellite Fix: A Differential fix means that not only does the GPS have enough satellite information to calculate a position, but it also has information from ground-based reference stations. This is the most accurate type of fix. Accuracy can be as good as 10 centimeters.



Non-differential Fix: A Non-differential fix means the GPS has enough satellite information to calculate a position but not enough information from the ground-based reference stations. Average accuracy with this type of fix is usually 15 meters.



No Fix: A No Fix means the GPS cannot detect any satellites and therefore doesn't have enough information to calculate a position.

Zero Off GPS Speed Control

To turn on or off Zero Off Speed Control, touch the On/Off button at the bottom of the screen.



Adjust the Set Speed with these arrows.



Three Event Information

The unit is named for the three events that can be monitored: Slalom, Jump, and Trick.

Touch the right arrow and the screen will shift to show the following Change Event options:



Slalom

When Slalom is chosen, the screen shifts again and the following appears:



When in Training mode, the Set Speed may be set to any value.

When in Tournament mode, the Set Speeds are pre-defined and limited to the following values:

15.5	17.4	19.3	21.1	23.0	24.9
26.7	28.6	30.4	32.3	34.2	36.0

When in Tournament mode, the buoy times will be displayed while running a course:



Slalom Settings

Select Slalom, then touch the symbol in the upper left corner of the screen. The following will appear:



Buzzer Volume

The buzzer volume adjustment compensates for increased engine noise. As the boat speed increases, and therefore the noises from the engine increase, the volume of the buzzer will increase proportionately to the boat's speed between 0 and 25 mph (40.2 km/h). No further increase occurs at speeds above 25 mph (40.2 km/h). The buzzer emits a sound when the set speed is reached and when reaching the buoys at a course. Select Buzzer Volume, and the following appears:

Select the volume for High and Low speed by utilizing the up and down arrows. Touch Back to return to the Slalom Settings screen.



Timing Recap

The timing recap will display the buoy times for the last two course runs.

Touch Exit to return to the Home screen.



Timing Recap

The timing recap will display the buoy times for the last two course runs.

Touch Exit to return to the Home screen.



Slalom Wait Time

Wait Time is the amount of time a skier can wait in the water before the warning timer starts to beep, indicating it is time to pull up the skier. As the warning timer nears the end, a beeper start to indicate the amount of warning time is close to the end. The beeping continues to increase in speed and volume in relation to the amount of warning time remaining. Each press of the up or down arrow increases or decreases the time by five seconds.

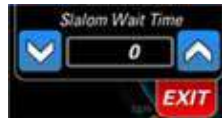

Jump Switch

This number either increases or decreases the intensity of the “bump” value upon jump switch engagement.

The number on the left side of the colon is for the first segment in the jump and the number on the right side of the colon is for the second segment of the jump. Depending on the boat, it can help jumpers achieve a balanced time.

Touch each number to view and select an alternative number.

Your authorized Malibu dealer can help you determine the strength number that is best for your boat.



Jump Settings

Select Jump, then touch the symbol in the upper left corner of the screen, and the following will appear:



Buzzer Volume

The buzzer volume adjustment compensates for increased engine noise. As the boat speed increases, and therefore the noises from the engine increase, the volume of the buzzer will increase proportionately to the boat's speed between 0 and 25 mph (40.2 km/h). No further increase occurs at speeds above 25 mph (40.2 km/h). The buzzer emits a sound when the set speed is reached and when reaching the buoys at a course. Select Buzzer Volume, and the following appears:

Select the volume for High and Low speed by utilizing the up and down arrows. Touch Back to return to the Slalom Settings screen.



Jump Switch Timeout

This is the amount of time that the boat will apply the accelerator on the jumpers counter cut (or anytime the jumper is out of the actual jump course).

This setting is adjustable for extreme headwinds or tailwinds, but it is recommended that it be left at 1.8 in nearly all instances.

Touch Back to return to the Jump Settings screen.



Trick Settings

Select Trick, then touch the symbol in the upper left corner of the screen. The following will appear:



Buzzer Volume

The buzzer volume adjustment compensates for increased engine noise. As the boat speed increases, and therefore the noises from the engine increase, the volume of the buzzer will increase proportionately to the boat's speed between 0 and 25 mph (40.2 km/h). No further increase occurs at speeds above 25 mph (40.2 km/h). The buzzer emits a sound when the set speed is reached and when reaching the buoys at a course. Select Buzzer Volume, and the following appears:



Select the volume for High and Low speed by utilizing the up and down arrows. Touch Back to return to the Slalom Settings screen.

River Mode and Offset

This feature provides speed adjustment compensation for the water current. Choices are Off, Down and Up.

Offset is the speed of the water flow used in the correction.



Course Manager

Touch Course Manager and the screen will expand to display the following:

Utilize the up and down arrows on the right to scroll through the available courses. Press Select Course when the desired course is highlighted (as in Course 3 shown in the image).



To delete a course, highlight the specific course and touch Delete.



To edit the name of a course, highlight that course and touch Edit. A keyboard will appear to rename the course.

To map or remap a course, touch Map (if not previously mapped) or Re-Map (if previously mapped) Course. The following screen will appear:

Touch the preferred course type, and the highlighting will be bright white (as shown for Slalom - 6 Buoy in the image).

Touch Continue, and the following screen will appear:



Follow the prompts as you run the course.



The blue bar will show the progress through the expected course.



Press the End Gate button when crossing the final gate. If the mapping was unsuccessful, this screen will appear.



If the remap was successful, this screen will appear.



Touching Continue will display a keyboard for the user to name the course that was just mapped.

Auto Detect

Zero Off auto-detects previously mapped courses within a 1-km radius of the boat. When an auto-detected course should be over-ridden, simply touch Auto Detect to turn it off.

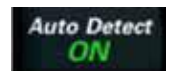

Auto detect will be re-enabled any time the user changes modes between slalom, jump or trick.

Pull Type

Touch the Pull Type Off (which means it is currently not operating) to turn this feature on, and the following screen will appear:



No two skiers are alike.

Therefore the pull types exist to customize the ride to the skier.

Keep in mind the concepts of Pull and Release. As you begin your pull, the boat speed begins to drop below the set/target speed. As you let up on your pull, the boat speed begins to rise higher than the set/target speed. The letter tells the engine how quickly to begin the apply or reduce power to get back to the set speed. The lower the letter (A being the lowest) the longer it will take for the engine to respond to the speed drop. The higher the letter (C being the highest) the faster the engine will respond to the speed drop.

Choose the appropriate type based on the following criteria:

Category A—This provides a slower engine response out of the buoy, but the boat will tend to move ahead as the skier approaches the buoy.

Category B—This provides a moderate engine response compared to A and C.

Category C—This provides a faster engine response out of the buoy, but the boat will tend to hold back as the skier approaches the buoy.

The numbers decide how strong the pull of the boat will be felt by the skier.

Setting 1—This requires the lowest amount of load before the system initiates an RPM spread, and provides for a softer pull behind the boat.

Setting 2—This provides for a moderate pull behind the boat as compared to 1 and 3.

Setting 3—this requires the highest amount of load before the system initiates an RPM spread.

Plus (+) Factor

For each letter setting, the + provides faster engine response. This will benefit skiers looking for immediate react from the engine/throttle.



NOTE: The engine will respond quicker on A+ than on C.

Touch the + Factor to turn On and Off.



Troubleshooting Guide

Display appears not to work or doesn't come on.

1. Display could be in SLEEP mode. Touch a key on the keypad to activate the display.
2. Check for loose connections at the battery and display unit.
3. Check for reversed polarity on the power connections.
4. Verify the battery has a minimum voltage of six (6) volts.

Display resets or goes OFF when starting the engine.

1. Check that the display supply wires are connected properly to the battery.
2. Verify that the battery is charged properly.
3. Check the battery for efficient starter current.

Display has no backlight.

1. Contact your authorized Malibu dealer for assistance.

Basic Electrical Components

All major boat circuits are protected from shorting and overload by resettable circuit breakers. If a problem develops with one of the circuits, switch OFF the circuit and wait about one (1) minute. Then push the appropriate breaker button fully and switch ON the circuit. If the circuit continues to trip, there is a problem somewhere in the system. Take your boat to an authorized Malibu dealer to locate and safely correct the issue.



Circuit Breakers



If a circuit breaker continues to trip, do not hold the breaker in position to activate the electrical circuit. See an authorized Malibu dealer immediately to locate and correct the issue before operating the boat.

The circuit breaker panel is located on the driver's helm shifter panel. The M235 has a control panel with circuit breakers in the walk-through. Circuit breakers are resettable, unlike fuses that require replacement.

Fuse Box

In addition to the circuit breakers that control the majority of electrical activity on the boat, Malibu engines also have a fuse box on the engine. See photo.

This fuse box aids in controlling various electronic functionality within the engine. Its purpose is to prevent electrical overload to various key electronic elements. If the fuse "kicks" off, it tends to be a signal that certain vital operations have experienced an electrical surge that could have caused significant damage to the system if the fuse had not blown.

The fuse box can be opened to replace the fuse. (Unlike circuit breakers that "trip," a fuse must be replaced.) When possible, have this function serviced by an authorized Malibu dealer, who can check

the entire system in an effort to determine the source or cause of the fuse malfunction. If the fuse blows during an outing, never pry or force open the box. The top should pop off the housing with minimal effort. Inside the housing will be several fuses, the size is denoted on the top of the fuse. There is also a Primary and Secondary fuse box under the dash that contains fuses. Each box has a labeled/detailed picture of location, fuse size, and which circuit it protects.



There are also one or two fuse boxes under the dash, depending on the model.

If a fuse blows repeatedly, it is symptomatic of a recurring issue that must be addressed. Such repair should be undertaken by your authorized Malibu dealer.

Electrical Harnesses and Wiring

Your Malibu boat is equipped with several electrical harnesses providing power within the drive train and to various ancillary functions of the boat. Due to the complexity of the boats wiring, much of which is inaccessible inside the hull and under the deck, any time an issue is suspected involving the wiring or any of the harnesses, the boat owner is strongly encouraged to have the boat serviced by an authorized Malibu dealer.



Electrical wiring or harness issues should always be addressed by an authorized Malibu dealer. Alteration of wiring from the original Malibu design could result in shock hazard, potential spark that could lead to fire, or other dangerous situations. Any disruption of the wiring from its original plan and resultant damage to components or the boat is not covered under warranty. Individuals could also be injured by such error.

Batteries

Malibu offers batteries as an option. If the boat owner chooses to equip the boat with batteries of his/her own choosing, there are certain requirements for starting and the operation of the boat, which is addressed later in this section. Please review that information

as it can be critical to avoiding a situation in which a battery(ies) is completely drained and leaves boaters stranded away from shore, or which can cause significant damage to the recharging alternator.

Batteries are located beneath the bow seat or observer seat in all models and all configurations. See the *Quick Reference Guide* in this Owner's Manual for guidance.

IMPORTANT NOTE FOR ALL FOUR (4) BATTERY SYSTEMS:

Note that the bilge pumps will continue to pull power, even when the isolator switch is in the OFF position on the boats so equipped. This is to prevent swamping of the boat and potential sinking. Bear in mind that in order for the bilge systems to work the battery will necessarily be drained, and eventually it will cause the battery to run out of charge. Therefore, under these circumstances, the boat should periodically be started and the engine run for a sufficient time to allow the voltmeter reading to return to the desired range of at least 13.6 volts. How often and how long the engine should be run to recharge the battery will vary depending on the type, brand and age of the batteries. The boat owner should frequently recharge the battery until determining the approximate time period in which the battery retains sufficient charge to operate the bilge system, and also to start the engine.

Malibu boats are equipped with one of four (4) systems, which are explained as follow:

Null Battery System. The most basic electrical supply system, this set-up allows for a single battery. There will be two battery cables, one positive (+) and one negative (-).

Two-Position Isolator System. In addition to the components in the Null Battery System, a very basic isolator switch allows the operator to turn a single battery either ON or OFF. The advantage to this system over the Null Battery System, where the system is always charging from the alternator, is that it can allow the battery to cease operation and retain residual energy within the battery until needed.

Three-Position VSR System. Very similar to the Two-Position Isolator System explained above, this system is the basic operation for a dual-battery-equipped boat. The Three-Position VSR System switch has ON, OFF and COMBINED settings. This option comes with a VSR (Volt Sensitive Relay). Customers are supposed to operate the boat in the ON position and only use the COMBINE setting in case of an emergency.

Four-Position Isolator System. Because of the electrical requirements to enjoy the Malibu boat in its fullest experience, most

models are equipped with two (2) batteries. The optional battery ON-OFF switch is located in a panel behind a door on the port side of the walk-through between the bow and center deck.

(The numbers 1, 1+2, and 2 refer to the two batteries that you purchase for the boat. The batteries are located in battery holders under the observer seat or in the bow of the boat (depending on the model). As part of the routine maintenance, boat owners should routinely verify that the batteries are secure within the holders.)

There are four markings on the knob:

- OFF
- 1
- 1 + 2
- 2

OFF means that all power to the battery and boat is shut down. The battery will not be able to re-charge while in the OFF position. This is the appropriate setting for periods of inactivity with the boat, unless you are in the boat while it is in the water. When the boat remains in the water, it will be necessary for the bilge pumps to periodically and automatically pump out residual water in the bilge system. See above description of how the bilge system operates automatically.

Battery 1 is the "house" battery or main battery. It should be rated at least 800 cold cranking amps (cca), and a spiral cell battery is preferable. Battery 2 is the back-up battery (used as a back-up, the smaller 500 cca battery is acceptable; however, you may prefer that your back-up also be 800 cca).

Normally, when the battery switch is not turned to OFF, it should be set on "1." However, if Battery 1 is somewhat drained or sluggish, turning to "1+2" can be very helpful in providing sufficient power to start the engine and begin the natural recharging process. After the engine starts and runs for a few moments, return the battery switch to "1." The electrical system is not designed to run at optimum efficiency on "1+2." The "1+2" setting is intended for limited use. For example, if the boat has not been running, but the boaters have been using the stereo, lights or other electrical components for a period of time, the running battery may not have sufficient power to return to shore. In that instance, by combining the batteries there may be sufficient power to continue underway while the batteries recharge.

On rare occasions, it may be necessary to turn the switch to "2." For brief periods of time, especially if Battery 1 is non-functional, you can run on "2" for limited periods of time.

When the stereo (or other accessories) is on for an extended period without the engine running, Malibu recommends the battery be switched to "2" so that the starting battery maintains a sufficient charge to start the engine.



All systems: If the battery has insufficient charge, use only a battery charger to recharge the battery, or remove the battery and take it to an authorized Malibu dealer or auto parts store that has the appropriate facilities to safely recharge the battery. If the boat is out of the water and/or in storage, OFF is the setting for the battery switch.

Malibu does not recommend the purchase and use of battery chargers other than the battery charger offered as an option through your authorized Malibu dealer. The battery charger offered by your dealer has been selected as best for meeting the requirements of 800 cca batteries.

NOTICE

If a battery(ies) requires a jump start, do not allow the alternator to recharge it/ them as it can lead to the alternator failing much more quickly than it would normally. Such damage would not be covered under warranty.

NOTICE

If the battery switch is in the OFF position, the automatic bilge system will continue to operate to prevent potential swamping of the boat. This could result in a drain on the battery after an extended period of time. The only manner in which the automatic bilge system is OFF is to disconnect the battery cables from the batteries or remove the batteries. Unless the boat has been removed from the water, Malibu does not recommend disconnecting the automatic bilge system.

WARNING

Inside the battery is an electrolyte fluid that allows the chemical reaction to provide power. The fluid is comprised of several components, one of which is sulfuric acid. As with most acids, this is caustic and corrosive. If it comes in contact with skin, immediately flush the area with copious amounts of fresh, clean water. Follow up with medical assistance.

DANGER

If it becomes necessary to re-charge a battery from an external source, **DO NOT attempt to charge using automotive battery cables or use another boat battery as the source for charging. Some amounts of hydrogen gas are emitted during the charging process. This can be very dangerous. It is critical to keep all sparks, including lit cigarettes, lighters or any type of flame, well away from a charging battery. Use**

the optional battery charger sold by authorized Malibu dealers, or a similar aftermarket battery charger. Using the wrong type of charging procedure or improperly charging a battery can result in an explosion and/or fire that could lead to serious injury or death.

Use marine-rated batteries only! Never use automotive batteries as they do not have the additional protection necessary to function in a boat where water and humidity are always factors.

CAUTION

Failure to use marine-rated batteries in your boat could result in electrical system interruptions that could strand your boat during an outing. Batteries are placed in molded containers under the observer seat or in the bow (depending on the model) to provide extra protection, but it is still possible for water and the high-humidity associated with operation on the water to affect batteries. If a battery, even marine-rated, becomes wet, allow it to dry before trying to start the engine. Water can cause a short at the battery terminals, which would prevent operation. Note that batteries are never covered under Malibu warranty. Damage to other components due to the use of inappropriate batteries or failure to properly maintain batteries is also not covered under warranty.

CAUTION

Batteries used in tandem must always use the same chemistry! Mixing battery types can cause damage to the electrical system, which is not covered under warranty.

Connecting/Disconnecting Batteries

NOTICE

DO NOT remove battery cables from the battery terminals while the engine is running! This will likely cause catastrophic damage to the alternator. Such damage is not covered under warranty!

The posts on a battery are marked negative (-) and positive (+), one of each on top and separate by some space. The battery cables are color-coded, black for negative and red for positive.

Malibu recommends having your authorized Malibu dealer install the batteries. Consumers can perform this procedure, provided common sense safety guides the process.

If batteries have not been previously installed:

- Step 1: Ensure the engine is OFF, and the Battery Switch is OFF on boats where equipped.
- Step 2: Place the batteries in the containers.
- Step 3: Attach the positive cable to the secondary (2) battery, attaching the positive (+) cable to the positive (+) post.
- Step 4: Attach the positive cable to the primary (1) battery, attaching the positive (+) cable to the positive (+) post.
- Step 5: Attach the negative (-) cable to the secondary (2) battery, attaching the negative (-) cable to the negative (-) post.
- Step 6: Attach the negative (-) cable to the primary (1) battery, attaching the negative (-) cable to the negative (-) post.
- Step 7: A separate cable is attached between the two negative (-) posts on the (1) and (2) batteries for additional ground.
- Step 8: Check that all cables are secure. Do not torque any connections; hand-tighten securely using a wrench. Never round off any of the nuts used to secure the cables. If a nut will not tighten, do not force it. Seek assistance to determine if the nut is the wrong size or some other issue exists.

If a battery requires replacement, reverse the steps above. Never replace a battery with the boat electrical system ON. Even if only one battery requires replacement, follow the steps and disconnect/then reconnect cables as directed above.



Never touch a positive (+) and negative (-) post or connection simultaneously

during installation! Never attempt to install or replace batteries with the boat electrical system ON, or in the presence of gas fumes. An electrical spark caused by connection to a functional battery can cause an explosion or fire, which is likely to cause serious injury or even death. This can also cause substantial damage to the electrical system, which is not covered under warranty.

Battery Maintenance

Batteries require routine maintenance to operate properly. See the *Care and Maintenance* section of this Owner's Manual for details.

Battery Charger

The charger is a three-stage electronic device that operates automatically when properly installed. There are red and green LED lights on the charger face to provide evidence that charging is occurring. When the battery or batteries are fully charged, the unit will automatically shut OFF.

The charger plugs into a socket under the observer's seat. It can be left in place without boiling electrolytes in the battery, but Malibu

recommends disconnecting and storing it when not in use. If the charger ever appears to be malfunctioning, take the boat and charger to an authorized Malibu dealer for troubleshooting.



DO NOT USE AUTOMOTIVE JUMPER CABLES TO START THE ENGINE. Never jump-start the boat from a vehicle on-shore or another boat. The presence of water and fumes create a situation in which sparks or backfire could result in serious injury or even death.



Engine Sensors

To ensure the engine runs as designed, it is equipped with several sensors that constantly monitor engine functionality. These sensors include:

- Oil temperature sensor
- Oil pressure sensor
- Manifold absolute pressure (MAP)
- Camshaft position sensor
- Crankshaft position sensor
- Coolant temperature sensor
- Knock sensor

These sensors are inaccessible to consumers because they are located inside sealed portions of the engine. Sophisticated, expensive tools are necessary to analyze the sensor activity; therefore, if any of the sensors indicates malfunction, the boat needs to be presented to the authorized Malibu dealer for diagnosis and resolution of any issues that may be present. Notice of potential malfunctions will appear on the video screen. (See Video Screen section of this Owner's Manual for more detail.)

Additionally, alarms may sound if issues arise affecting engine operation. These alarms may be visual on the video screen or may be audible alarms. Although it is possible for a sensor to be in error, it is unlikely. Experience has shown over the years that the sensors are highly accurate and offer protective warnings of malfunction that could potentially bring attention before more expensive and damaging events occur. Never ignore an alarm! Seek assistance from your authorized Malibu dealer if the issue cannot be resolved or recurs.



Never ignore visual or audible alarms! Consumers may be able to address the issue raised by the alarm, but

if the alarm persists, cease operating the boat and seek assistance from your authorized Malibu dealer. Failure to seek aid in analyzing the cause of an alarm could result in damage that is not covered under warranty. Some alarms could be for malfunctions that could also put individuals on-board in potential harm.



approximately 80 feet. The signal emitted from the wristband will weaken as distance from the boat increases, but the cessation of operation will vary, depending on conditions, location, battery strength, and other factors.

To operate the Surf Band while underway:

1. Place the Surf Band securely on the wrist of your non-dominate hand.
2. To adjust the Power Wedge, press the UP ARROW to raise the Power Wedge. It will move one "click" for each press of the button. Press the DOWN ARROW to lower the Power Wedge.
3. To adjust the Surf Gates, press the LEFT ARROW (<) above the word "Surf" to surf left (increase the wave on the left, or port, side of the boat). Press the RIGHT ARROW (>) to surf right (increased the wave on the right, or starboard, side of the boat).
4. To increase the speed of the boat, press the UP ARROW above the word "Speed." To reduce speed, press the DOWN ARROW. Each press will increase or decrease the speed 1 mph.



The Surf Band will TEMPORARILY override the driver's control of these elements of the boat operation. However, you should be aware that the driver can always resume control of all aspects at any time. Surfers should limit the amount of time spent looking at the wristband as prolonged viewing away from the boat, wave, and surroundings could result in the surfer losing control and falling from the surfboard. Injury could result.

NOTICE

The Surf Band communicates over a commonly used radio frequency. The command signals may not be successfully sent or received when subjected to radiated interference from nearby high-powered transmitters operating on the same frequency. The possibility of interference is minimal, but it is unavoidable.

Other Electrical Components

12-Volt Receptacle

All boats have 12-volt receptacles for your convenience. Some models have more than one receptacle. Verify locations with your authorized Malibu dealer. It is the responsibility of the device user to determine that the accessory is designed to be operated on a 12-volt system. If the connector will not easily and securely insert into the 12-volt receptacle, do not force it. If damage occurs to the device or the boat's electrical system by attempting to use a device that is not compatible, such damage will not be covered under warranty nor will Malibu accept responsibility.

Port Rear Breaker Board

There is a Power Wedge III and Surf Gate support breaker board in the port rear closeout adjacent to the engine compartment. The black board contains four (4) breakers. If the Power Wedge III will not operate, verify that the supplemental breakers located in the port rear storage compartment are properly set.

Surf Band

A waterproof Surf Band is standard on Wakesetter models. Worn on the wrist of a wakesurfer, wakeboarder or skier, the device allows redundant control of the Surf Gates, Power Wedge and minor cruise control adjustments. The boat operator still has primary control of the boat and can deactivate the rider controls.

The Surf Band turns ON and OFF through the SETTINGS menu on the 12.3" video screen.

The distance from the boat that the Surf Band is operational is

If the signal LED stops flashing with a button press, or communication becomes intermittent, replace the battery:

1. Rotate the battery cover counterclockwise one-eighth (1/8) of a turn with a coin or screwdriver until the cover arrow is aligned with the unlocked symbol.
2. Remove the battery cover and the battery.
3. Assure the white o-ring cover seal remains intact.
4. Replace with a Panasonic CR2016 battery, text side up.
5. Reposition the battery cover and rotate clockwise one-eighth (1/8) turn to secure.

Note: Audible alarms are functional through the instrument panel, EXCEPT the Surf Gate transfer alarm, which sounds through stereo system. Therefore, if the stereo is turned OFF persons on-board will not be able to hear an alarm. Tower lights will also flash. However, boats without tower stereo speakers or tower lights do not have this functionality. The alarm system is equipped on all boats regardless of optional equipment, and alarm information, including the Surf Gate transfer alarm information, will be available through the video screen.

The boat is equipped with several alarm systems. In general, an alarm sound is an indication that a potentially serious issue exists. The low-voltage alarm functions when the battery system charge has fallen to a level that could result in the boat becoming unable to continue the outing. The low-voltage alarm will be accompanied by an indication on the dash. Follow directions as they appear.

Sensors will also alert the boat operator when the oil pressure, engine and/or transmission temperatures are outside acceptable parameters. All alarms should be taken seriously, and boaters should

return to shore as soon as possible. Seek assistance from your authorized Malibu dealer to determine the cause and solution to any problems that have been indicated.

Alarms

(See Note above regarding functionality)

SURF GATE HIGH SPEED

Occurs when speed is above 13.6 MPH with gate active.

SURF GATE LOW SPEED

Occurs when speed is below 7 MPH with gate active.

SURF GATE GENERAL ERROR

General Error reported by module.

SURF GATE RETRACT LEFT OR RIGHT

Over current alarm when gate is trying to retract.

SURF GATE EXTEND LEFT OR RIGHT

Over current alarm when gate is trying to extend.

SURF GATE REED SWITCH LEFT OR RIGHT SEE DEALER

Failure of Surf Gate switch.

If any alarm occurs, the Surf Gate will be locked out from operation. The lock-out can only be cleared by pressing the "either" button on the tachometer and the error corrected. An error also may require cycling the battery switch off and then back on to clear.



MALIBU MONSOON ENGINES,



TRANSMISSIONS & V-DRIVES



Malibu Monsoon Engines, Transmissions & V-Drives

Malibu Boats offer a variety of outstanding powertrain options. During the inaugural year of our own Malibu Monsoon Engine, the company will offer a 6.2L version, with a 5.3L becoming available during the model year. Also available throughout the year are 6.0L, 6.2L and 6.2L Super-Charged LSA Monsoon Engines by PEG. Although each engine offers different experiences, all engines are based on the General Motors platform.

Monsoon by PEG engine information is provided by PCM/PEG in a separate manual. Boats equipped with Monsoon by PEG engines have a specific set of instructions for operation, care and maintenance which must be followed in order to keep the warranty in effect.

Boats equipped with Malibu Monsoon engines also require proper attention to adhere to warranty policy.

Note that these instructions should be followed even after the warranty period has expired. The instructions developed for the powertrains and drivetrains in Malibu boats function as the guidelines to a long-term, positive boating experience.



Failure to follow engine operation, care and maintenance instructions as provided in either the PCM/

PEG owner's manual or in this section of the Malibu Owner's Manual (depending on the equipped engine) can result in damage to the engine and transmission that is not covered under warranty. Under some circumstances, this could result in the boat becoming inoperable, stranding boaters and/or placing those on-board in situations that could result in potentially dangerous situations.

Malibu has teamed with General Motors to produce the ideal engine and transmission for the expected usage of the boat. Because Malibu boats were created to further enjoyment of watersports, the power curve and maximum performance of the package were designed to enhance every aspect of the experience.

The following information is provided for the Malibu Monsoon Engines. Unless otherwise directed, the instructions are applicable to both the 6.2L and 5.3L engines.

Safety

Significant safety information appears in the opening chapter of this Owner's Manual. It is critical to read the entire manual, with particular attention to the Safety information. All boat owners and boat operators must adhere to the safety requirements as described. It is also the responsibility of these individuals to be aware of U.S. Coast Guard regulations when boating in U.S. waterways, or the governing body(ies) of any waterway system in which the boat is operated.

Failure to read and follow this information will NOT exempt or excuse boaters from the requirements. This information also materially impacts the boat's warranty coverage. It is the owner's and/or operator's responsibility to perform all inspections and required maintenance prior to the operation of the boat, without exception.

In addition to the opening chapter, the following drive-train specific, safety-related material is provided. Please review and follow these guidelines to ensure the safety of yourself, boat operators, passengers and others who may be in the area.

Prior to Operation

Follow the instructions as described in *Before Each Use* in the *Care and Maintenance* section of this Owner's Manual.



To prevent a possible explosion, always operate the blower until it automatically shuts off, prior to starting the engine. Always operate the blower when the engine is idling or at a low running speed. Improper ventilation can lead to accumulation of gasoline or exhaust fumes in the compartment. This can lead to a fire or explosion, either of which can result in serious injury or death!



Never start the engine in the presence of fumes or signs of gasoline leakage. Always avoid smoking or open flame near the engine compartment.

Other Safety Double-Checks

Throughout this section of the Owner's Manual, additional safety issues are reiterated. Always follow these instructions. Repeating checks and inspections is far superior to ever skipping any of these requirements and suggestions.

General Information

Serial Number

Each engine is assigned a unique serial number that is different from the Hull Identification Number (HIN) found on the transom of the boat. The engine serial number can be found in several locations on the engine.

It is extremely rare that an engine requires replacement in a boat; however, if this occurs, the replacement engine's serial number must be reported to Malibu's warranty department, even if the warranty statement effective dates have expired. In the event of a safety matter or recall, serial numbers often alert the factory to which boats may be affected and allow the company to contact consumers.

Engine serial numbers that do not match factory records may lead to questions of legality also.



Engine Specifications

ENGINE DESCRIPTOR	5.3L	6.2L
TYPE / ASPIRATION	4 CYCLE – NATURALLY ASPIRATED	4 CYCLE – NATURALLY ASPIRATED
ENGINE CONFIGURATION	90 DEGREE V8	90 DEGREE V8
DISPLACEMENT (CC)	5,300 CC (327 CID)	6,200 CC (383 CID)
BORESPACING (MM)	111.76	111.76
BORE x STROKE (MM)	96.01 x 92	103.25 x 92
COMPRESSION RATIO	11:1	COMPRESSION 11:1
FUEL COMPATIBILITY	GASOLINE	GASOLINE
ENGINE ROTATION (FRONT)	CW	CW
BLOCK / HEAD MATERIAL	CAST ALUMINUM	CAST ALUMINUM
BLOCK STRUCTURE	DEEP SKIRT	DEEP SKIRT
MAIN BEARING CAPS	6 BOLT	6 BOLT
VALVETRAIN CONFIGURATION	OHV-CIB	OHV-CIB
VALVES PER CYLINDER	2V	2V
VALVE LIFTER / LASH ADJUSTER	ROLLER HYDRAULIC	ROLLER HYDRAULIC
CAM DRIVE	3/8" ROLLER CHAIN	3/8" ROLLER CHAIN
FIRING ORDER	1-8-7-2-6-5-4-3	1-8-7-2-6-5-4-3

Engine Coolant: All Malibu Monsoon engines feature a hybrid of raw water cooling and closed cooling. The closed cooling must have a **50/50 mix of marine-grade, propylene glycol coolant (such as Sierra brand) and clean, distilled water.** From an empty tank to the proper amount of coolant/water mix will require approximately four (4) gallons. Directions for maintaining proper levels are provided in the *Care and Maintenance* section of this Owner's Manual. Maintaining proper levels is required to keep the warranty in effect, and the instructions should continue to be followed for the life of the boat/engine. Boat owners should also carefully follow the raw water cleaning information provided in the *Care and Maintenance* section of this Owner's Manual, especially when

operating in salt water or brackish water conditions. Failure to do so will void the warranty. Also see the *Salt Water Information* provided in the *Care and Maintenance* section of this Owner's Manual.

Engine Oil: Use only **5W30 synthetic engine oil, regardless of which Malibu Monsoon engine is installed.** The engine requires eight (8) quarts to fill from empty. The use of any other oil or fluid may void the warranty. Instructions for proper levels, maintenance and oil changes are provided in the *Care and Maintenance* section of this Owner's Manual.

Transmission Fluid: Use standard ATF fluid, available in a variety of brand names. Approximately 2.5 quarts will be required to fill from empty. The use of any other fluid may void the warranty. Instructions for proper levels, maintenance and oil changes are provided in the *Care and Maintenance* section of this Owner's Manual.

V-Drive Oil: Use Mobil SHC 630 Gear and Bearing Oil only in the V-drive unit. The unit requires one-and-quarter (1.25) quarts of the oil to fill from empty. The use of any other fluid may void the warranty. Instructions for proper levels, maintenance and oil changes are provided in the *Care and Maintenance* section of this Owner's Manual.

Hydraulic Steering Fluid: The steering in Malibu boats may feature an optional hydraulic system that can be maintained or repaired only with specialized tools. Because of the potential for physical harm when working on this system, it cannot be checked, changed or repaired by consumers. Only an authorized Malibu dealer has access to the tools and system. While we recognize that some consumers may be located many miles from the nearest authorized Malibu dealership, seeking out and utilizing an authorized Malibu dealer is a requirement. We apologize for any inconvenience.

Fuel Filter: As with the steering system, only authorized Malibu dealers have the specialized tools needed to work on any portion of the fuel system. Again, this is a safety matter. Never attempt to work on the fuel system.



Boat owners or any person who is not an authorized Malibu dealer technician should never attempt to work on the steering or fuel systems within the boat. These systems require specialized tools not available to the public. Any alteration to or attempt to alter these systems will void the warranty. It is also highly likely that serious injury or death could occur to unauthorized persons attempting to access these systems.

Maintenance Schedule: The maintenance schedule for Malibu Monsoon Engines is provided in the *Care and Maintenance* section of this Owner's Manual. Do not attempt to operate the boat until after you have read this entire Owner's Manual.

California Emissions Information

Malibu Boats LLC has long worked with the state of California to ensure that emissions from our product remain in compliance with California's legal requirements. This means attention to aspects of the warranty statement and process, with particular attention to providing this information in clear, written style.

If you have any questions regarding this matter, please feel free to contact your authorized Malibu or Axis dealer.

CALIFORNIA EVAPORATIVE EMISSIONS CONTROL SYSTEM WARRANTY STATEMENT¹

YOUR WARRANTY RIGHTS AND OBLIGATIONS

The California Air Resources Board and Malibu Boats, Inc. are pleased to explain the evaporative emission control system's warranty on your 2019² spark-ignition marine watercraft. In California, new spark-ignition marine watercraft (SIMW) must be designed, built, and equipped to meet the State's stringent anti-smog standards. Malibu Boats LLC must warrant the evaporative emission control system on your spark-ignition marine watercraft for the period listed below provided there has been no abuse, neglect or improper maintenance of your SIMW.

Your evaporative emissions control system may include parts such as: canisters, carburetors, clamps, connectors, filters, fuel caps, fuel lines, fuel tanks, valves, vapor hoses, and other associated evaporative emissions control system components.

MANUFACTURER'S WARRANTY COVERAGE:

This evaporative emission control system is warranted for five years³. If any evaporative emission-related part on your SIMW is defective, the part will be repaired or replaced by Malibu Boats LLC.

OWNER'S WARRANTY RESPONSIBILITIES:

As the spark-ignition marine watercraft owner, you are responsible for performance of the required maintenance listed in this owner's manual. Malibu Boats LLC recommends that you retain all receipts covering maintenance on your spark-ignition marine watercraft, but Malibu Boats LLC cannot deny warranty solely for the lack of receipts.

As the spark-ignition marine watercraft owner, you should, however, be aware that the Malibu Boats LLC may deny you warranty coverage if your spark-ignition marine watercraft or a part has failed due to abuse, neglect, or improper maintenance or unapproved modifications.

You are responsible for presenting your spark-ignition marine watercraft to a Malibu Boats LLC distribution center or service center as soon as the problem exists. The warranty repairs should be completed in a reasonable amount of time, not to exceed 30 days. If you have a question regarding your warranty coverage, you should contact Malibu Boats LLC warranty department at 1-865-458-5478.

***Note:**

- (1) As they relate to the evaporative emissions control system. This statement applies only to California.
- (2) Emission warranty model year (2019) will be updated each model year and no other changes will be made.
- (3) Malibu voluntarily extended the warranty period from two years as required by the California Air Resources Board to five years.

The California evaporative emissions control system warranty covers the following list of components:

- Belts
- Canister mounting brackets
- Carbon canister
- Catalytic converters
- Clamps*
- Coolant temperature sensor
- Control linkages*
- Control valves*
- Electronic controls*
- Electronic control module
- Exhaust manifolds
- Exhaust risers
- Exhaust valves
- Flame arrestor
- Fuel cap
- Fuel injectors
- Fuel pressure regulator
- Fuel line
- Fuel line fittings
- Fuel tank
- Idle Air Control (IAC) valve
- Idlers
- Ignition coil and/or control module
- Ignition wires
- Intake manifold
- Intake valves
- Liquid/vapor separator
- Manifold Absolute Pressure (MAP) sensor
- Oil filler cap
- Oil pump and internal parts
- Oxygen sensors

- Pulleys
- Purge valves
- Spark plugs
- Throttle body-port fuel injection models
- Throttle body assembly-throttle body fuel injection models
- Throttle position sensor
- Vacuum control diaphragms*
- Vapor hoses

All other parts not listed that may affect the evaporative emissions control system, including hoses fittings, etc.

General Emissions Information

After January 1, 2009, boats sold or registered in California have a Star label on the port side of the hull adjacent to the vessel registration, as shown.

Exhaust emissions should be routinely monitored and verified throughout the life of the boat. The boat owner has responsibility to ensure that the engine is never modified in any fashion that alters the emissions occurring during operation. The engines have been constructed to meet specifications as established by governing bodies with authority in this matter. Routine maintenance performed by authorized Malibu dealers should satisfy these requirements, but having maintenance completed by an authorized Malibu dealer does not absolve the boat owner from responsibility that emissions requirements are satisfied in the area in which the boat is owned and/or operated.

Each engine has an Emissions Control Information (ECI) label affixed. A sample label is illustrated in this section. Information appearing on the label must never be altered. If the original, factory-affixed label is damaged or comes off the engine block, contact an authorized Malibu dealer immediately for a replacement. Malibu does not endorse the replacement of these labels by any unauthorized person.

Engine emissions labels with the designation "CE" in the lower right-hand corner have been constructed within the parameters of the Declaration of Conformity requirements. This means that the engine conforms to the appropriate European Community Directive.

Star Label

A Star label is also affixed to the heat exchanger of each certified engine. All Malibu engines, at minimum, have a Three Star—Ultra Low Emission rating. This means that the engine has sixty-five percent (65%) lower emissions than a One Star—Low Emission engine. It further means that the engine meets the California Air Resources Board's stern drive/inboard marine engine Tier 3 exhaust engine standard.

Engines will also have an explanatory “Star” label attached, as shown. The applicable Star level will be marked and an explanation of the label designation appears on the reverse side.

The explanations are:



One Star – Low Emission. The one star label identifies engines that meet the Air Resources Board's Personal Watercraft and Outboard marine engine 2001 exhaust emission standards. Engines meeting these standards have 75% lower emissions than conventional carbureted two-stroke engines. These engines are equivalent to the U.S. EPA's 2008 standards for marine engines.



Two Star – Very Low Emission. The two star label identifies engines that meet the Air Resources Board's Personal Watercraft and Outboard marine engine 2004 exhaust emission standards. Engines meeting these standards have 20% lower emissions than One Star – Low Emissions Engines.



Three Star – Ultra Low Emission. The three star label identifies engines that meet the Air Resources Board's Personal Watercraft and Outboard marine engine 2006 exhaust emission standards or the Sterndrive and Inboard marine engine 2003-2008 exhaust emission standards. Engines meeting these standards have 65% lower emissions than One Star – Low Emission engines.



Four Star – Super Ultra Low Emission. The four star label identifies engines that meet the Air Resources Board's Sterndrive and Inboard marine engine 2009 exhaust emission standards. Personal Watercraft and Outboard marine engines may also comply with these standards. Engines meeting these standards have 90% lower emissions than One Star – Low Emission engines.

Additional Information, Including Warranty

Malibu engines are prepared for the consumer in accordance with the applicable regulations as established by the California Air Resources Board as authorized by Chapters 1 and 2, Part 5, Division 26 of the California Health and Safety Code, and the United States Environmental Protection Agency, as described by 40 CFR 1045.

Defects resulting from any source other than that described in the Malibu Limited Warranty Statement are not covered. Parts required for routine maintenance during the warranty period are also not covered. Examples would be, but are not limited to, spark

plugs or filters or fluids. However, such components may be covered if failure occurred during the first 10-hour break-in period. The warranty will not be extended beyond its original expiration date for any reason, and the use of unapproved replacement parts may void any remaining warranty, per the Malibu Limited Warranty Statement. **Replacement parts do not extend the warranty beyond its original period. Parts replaced under the limited warranty become the property of Malibu Monsoon Engines.**

Warranty coverage may be denied in instances where the emissions component(s) had been altered or damaged by neglect, or there is evidence of failure to perform maintenance as required by information provided within this Owner's Manual. If other, non-emission parts have been damaged as a result of failure to properly maintain or repair an emissions-related component, the non-emission component(s) may also not be covered under the Malibu Limited Warranty. See the *Care and Maintenance* section of this Owner's Manual for information regarding appropriate maintenance.

Malibu Fuel System

All Malibu models are equipped with the most up-to-date fueling system available in the marine industry. The boats feature pump-in-tank (PIT) fuel systems, which means the fuel pump is located securely inside the fuel tank rather than at the engine. There are many benefits to the PIT system, most significantly in the prevention of vapor lock and improved filtration of contaminants.

To maximize the benefit of this type of fuel pump, the entire system is under high pressure. That means that access to the pump and the pump-in-tank fuel filter is only through fuel lines with a significant pounds-per-square-inch (PSI) pressure to ensure proper operation. As such, no one can or should ever attempt to access any portion of the fuel system without proper training and proper equipment.



The fuel lines are covered in orange “fire-sleeve” protective covering so that they are easily identifiable, and consumers should always avoid these lines, unless it is noted that one is squeezed or pinched. If it is possible to alleviate this situation safely, then do so. The preferable method, however, is to have an authorized Malibu dealer’s trained service technician do so and verify that no damage has been done to the line or other equipment.

The Malibu fuel system from tank to plumbing to engine meets or exceeds U.S. Coast Guard requirements (Sec. 183.540 Recreational Boating.) Because of the potential for a dangerous, even catastrophic event if any part of the system fails, Malibu strongly encourages all owners/operators to always be aware of proper operation. Follow operational directives, maintenance requirements and remain alert for visual signs or odors that indicate the presence of fuel outside the contained fuel system. Never replace any part of the fuel system except with approved parts, and Malibu recommends always using your authorized Malibu dealer for checks, service and repair of the fuel system.

Normally, if there is any issue arising from damage or leakage in the fuel system a strong odor of gasoline will be present and signifies that the engine should not be started due to the danger of explosion from fumes. Even in the absence of a gasoline odor, owners and operators should always visually check the fuel system prior to operation, as directed in the *Care and Maintenance* section of this Owner’s Manual.



The fuel system, including the fuel lines, pump-in-tank filter and pump, should never

be serviced by any person other than an authorized Malibu dealer’s trained service technician. Special tools and training are required to safely service the fuel system on all models.



The flammability of gasoline and its explosive properties must always be

respected. At the first odor of gasoline, the engine should be shut off and remain off until the source of the odor has been identified, and the issue has been rectified. NEVER START THE ENGINE IF THE ODOR OF GASOLINE IS PRESENT OR IF GASOLINE IS SEEN ANYWHERE IN THE BOAT OTHER THAN THE FUEL SYSTEM!



Never smoke or operate any spark-producing object within a fifty-foot (50’) range

of the boat when fueling. Fumes from gasoline are more likely to produce an explosion and/or fire than the actual fuel. Be sure that the fueling area is well-ventilated.



If fuel is spilled, always clean up with dry rags and dispose of properly on-shore.



Replacement parts in any portion of the fuel system must be with Malibu-authorized parts only! Use of unapproved parts could result in a failure that creates a potentially explosive situation or the potential for on-board fire.



Avoid inhaling or ingesting gasoline and/or fumes.

If gasoline gets on skin, immediately flush with copious amounts of fresh water on-shore; if gasoline gets on clothing, immediately change clothing and do not store gasoline-infused cloth on board the boat.



Do not over-fill the fuel tank. Doing so can cause spillage, which is an environmental hazard. Fuel tanks also

expand and contract slightly to adjust to ambient air temperature. Over-filling can reduce the ability of the tank to respond, which can cause damage to the fuel system and/or boat, which is not covered under warranty.



Review the *Care and Maintenance* section of this Owner’s Manual for important information regarding the proper fuel to use, how to maintain

the fuel if the boat will not be used for a period of time, and other important information regarding the safe use of gasoline in the boat. Always include a pre- and post-outing inspection of the fuel system.



Use of incorrect fuel can result in damage to the engine that is not covered by

Malibu. Failure to follow maintenance requirements may also void the warranties.

Malibu recommends returning to shore and refueling whenever the fuel gauge indicates that the fuel load has fallen below one-quarter (1/4) of a tank full. It has also been determined that continuous operation with ballast significantly loaded either port or starboard (rather than evenly distributed) can result in

damage to the fuel pump as it attempts to compensate. Even with the best of care, some water may get into the fuel tank or separate from the fuel that is pumped into it. If there is water present, it will settle on the bottom of the tank. If the pump begins to reach any water, it may cause malfunctioning in the engine.

When pumping fuel, do not leave the nozzle unattended in the fuel fill. Although the fuel system has been manufactured to avoid spit-back of fuel, and most gasoline dispensers will shut off if removed from fuel fill, it is always a wise consideration to provide full attention to the process.

Fuel Information

Whenever possible, use 93 octane gasoline! Admittedly, there are locations where only lower-grade fuel is available, but to ensure long-term, high performance, the use of 93 octane is strongly recommended. In such instances, boaters may use 89 or 91 octane fuel, but no lower grade.

Lower-octane fuel may cause deposits on the fuel injectors and intake valves, among engine components. Continued over a period of time, the lower-octane fuel could damage the engine, and such damage is not covered under warranty.

One of the first signs of improper fueling is a knocking noise resulting from spark plug misfire. Knock misfire will damage the engine over time. Because the engine is equipped with a knock sensor, operators will be alerted when the sensor triggers a warning through the video screen. **Do not ignore such warning!**

The engines are engineered to run smoothly. If there are any symptoms of misfire, hesitation, poor idling or if the engine becomes hard to start, such indications should not be ignored. If the gasoline has been in the boat's tank for an extended period (in excess of two weeks), particularly without a stabilizer, the issue sometimes may be addressed by properly replacing the fuel with new gasoline.



Always dispose of unused fuel properly on-shore. Check with local authorities

to determine the proper manner in which fuel can be off-loaded from a boat. NEVER dump fuel into the water. It is illegal to do so as well as environmentally damaging. Allowing fumes to be vented can also cause a situation in which a spark or open flame could cause a fire, which is extremely dangerous and could result in serious injury or death.

Never add diesel fuel to the fuel tank! Diesel fuel and regular gasoline do not mix. Diesel fuel will cause permanent damage to the engine, and such damage is not covered under warranty. If diesel fuel is accidentally pumped into the Malibu system, all contents of the fuel tank must be properly disposed of on-shore, and the engine

should not be started until the system is thoroughly cleared and the correct fuel pumped into the fuel tank.

When Fueling

When pumping fuel, do not leave the nozzle unattended in the fuel fill.

Although the fuel system has been manufactured to avoid spit-back of fuel, and most gasoline dispensers will shut off if removed from fuel fill, it is always a wise consideration to provide full attention to the process.



Malibu strongly recommends using 93-octane TOP TIER detergent gasoline. The additives and detergents in these fuels can reduce the amount of build-ups in engines that adversely affect performance and shorten the life of an engine. Retailers selling TOP TIER gasoline can be found at www.toptier.com.

Never use E-85 or other E- fuels. This type of fuel does not contain sufficient additives to protect the engine nor perform to expected standards.

Never use leaded fuel. Malibu engines are designed and constructed to run properly **ONLY** on unleaded gasoline. If finding unleaded gasoline is an issue for a boat owner, check with your authorized Malibu dealer to locate unleaded gasoline.

Never use gasoline containing higher than ten percent (10%) ethanol. Some fuel contains MBTE (methyl butyl tertiary ether) as a blend to enhance octane. Blended fuel is permissible as long as it is blended and does not exceed the percentage allowed.

Never use gasoline that contains any methanol. This type of fuel can cause corrosion to some of the engine parts, and such damage would not be covered under warranty.

When fueling the boat outside the United States or Canada, verify the chemical components of the available gasoline. You must use only approved fuel. Work with your authorized Malibu dealer to locate appropriate gasoline for use.

When the Boat Is Not in Operation (Fuel)

When maintained as directed in the *Care and Maintenance* section of this Owner's Manual, boats can reasonably be expected to be ready for operation when they are not used for a period of two (2) weeks or less. Longer than two (2) weeks requires particular attention to fueling, among other operations. If the engine does not start and run smoothly, it is likely that there are issues involving gasoline.

When allowed to sit for extended periods of time, fuel components can begin to separate or deteriorate. Any water that has intruded into the fueling system will separate, and because it is heavier than gasoline, will settle to the bottom of the tank. The current fuel system, which includes a spring-loaded gas cap, should not allow significant amounts of water into the system, but operators should always verify that the fuel filler cap is closed anytime the boat engine is on.



Always verify that the fuel filler access is closed when the engine is running. Failure to do so may allow water to enter into the fuel system. Such intrusion could result in damage to the engine and is not covered under warranty.

Any time the boat is not going to be used for a period in excess of two (2) weeks, Malibu recommends adding STA-BIL® fuel stabilizer to the fuel tank. Although there are other anti-degrading stabilizers on the market, Malibu has found that STA-BIL, when used properly, protects engines and fueling systems from the harmful effects of storage in most instances. Note, however, that even stabilized fuel can cause an engine to idle poorly and run less effectively until the older fuel has been used up. This kind of damage is not covered under warranty.



Use STA-BIL fuel stabilizer whenever the boat is going to be idle for periods in excess of two (2) weeks. Even with the use of STA-BIL, long-term storage with fuel in the tank and fueling system can result in degradation of the fuel. This can cause the engine to perform poorly until the fuel is used, but in some instances can cause permanent damage to the fuel system and/or engine. Such damage is not covered under warranty.

If the boat will be stored for a significant period of time, such as an entire off-season, Malibu recommends filling the fuel tank full and adding STA-BIL. Because STA-BIL will eventually degrade, boat owners should follow the instructions provided by STA-BIL regarding storage period, temperatures, amount of mix, and any other information provided by the manufacturer of STA-BIL.

Electrical System

It is important that operators/owners review the *Electrical Components* information in the *Dashes and Video Screens* section of this Owner's Manual prior to using the boat. Recommendations and requirements explained in that section can prevent unexpected issues from arising that will cause abbreviated outings or premature degrading of components.

Alarms

Note: Audible alarms are functional through the instrument panel, EXCEPT the Surf Gate transfer alarm, which sounds through stereo system. However, if the stereo is turned OFF persons on-board will not be able to hear an alarm.

Tower lights will also flash. Boats without tower stereo speakers or tower lights do not have this functionality. The alarm system is equipped on all boats regardless of optional equipment, and alarm information, including the Surf Gate transfer alarm information, and it will be available through the video screen.

The boat is equipped with several alarm systems. In general, an alarm sound is an indication that a potentially serious issue exists. The low-voltage alarm functions when the battery system charge has fallen to a level that could result in the boat becoming unable to continue the outing. The low-voltage alarm will be accompanied by an indication on the dash. Follow directions as they appear.

Sensors will also alert the boat operator when the oil pressure, engine and/or transmission temperatures are outside acceptable parameters. All alarms should be taken seriously, and boaters should return to shore as soon as possible. Seek assistance from your authorized Malibu dealer to determine the cause and solution to any problems that have been indicated.

Cooling System

Malibu utilizes a closed cooling system. This is particularly critical for operation in salt water or brackish/dirty water. Without the need for a radiator such as used in land-based engines, the functionality of cooling system is dependent upon operation within a body of water or maintaining the appropriate level of coolant/water (in the closed system). Reducing operational heat from the engine is critical to ensuring the engine continues to perform.

As Malibu Monsoon engines are configured, temperatures in excess of 200°F (93°C) are considered to be overheating situations.



NEVER run the boat engine with the boat out of a body of water! Even in closed cooling systems, some external water is used in the cooling process. Without water to circulate in the system, the engine will quickly overheat and can do permanent damage that is not covered under warranty!



Be certain to read the *Care and Maintenance* section of this Owner's Manual

for important information regard routine and regular functions that must be performed. Some of these tasks overlap engine and boat component attention and should never be skipped. Failure to perform care and maintenance can result in damage to the boat and engine that is not covered under warranty.



Regularly review the engine temperature information provided on gauges or video screen. Warning lights

and alarms also are part of the system to provide early warning when engine temperatures begin to exceed acceptable levels. Continuing to operate a boat that is overheating the engine and drive train will result in engine failure eventually. Ignoring or failing to take proper steps to reduce the engine temperature, resulting in damage, is not covered under the warranty.

If an engine overheats, consider several factors before shutting down. ***(Turning off the engine when it is overheated may not provide immediate relief, and in some instances can actually cause additional harm.)***

If the boat has been idling for a prolonged period of time and the engine became overheated, attempt to reduce the temperature by operating the boat at a higher speed, preferably at normal running speed. This will increase the speed of water flowing through the cooling system, assuming there is sufficient fluid.

If the boat has been running at a higher rate of speed for a prolonged period of time and overheats, reduce speed for a few minutes to see if the temperature reduces. Running at wide-open-throttle (WOT) for too long can challenge the cooling system.

If there is no immediately discernible cause for overheating, or if the temperature does not begin to descend back to the normal range, turn off the engine and carefully open the engine compartment **(but never if there is an odor of fuel)**. Ambient air should eventually cool the engine, but if there is resulting damage to the engine from overheating, it may not restart and the boat may need to be towed to shore.



Never directly touch an overheated engine. Temperatures can exceed 200 degrees Fahrenheit (93

degrees Celsius), which would cause instant and serious burns, even through gloves or clothing.

The water pumps on the engine that circulate water and coolant throughout the engine during operation are essentially inaccessible to the consumer. The circulation pump, which circulates coolant,

is located on the bottom of the front-end accessory drive. If it requires attention, that should be done by a service technician at an authorized Malibu dealership.

Another pump, the raw water intake pump, is utilized to bring in water from the body of water. The raw-water pump is located on the top of the front-end accessory drive, adjacent to the alternator. Its purpose is to draw and circulate water from the body of water in which the boat is operating to increase the cooling effect for the engine. Water is brought through the water pickup, which is located starboard of V-drive unit. The entire cooling system is located on the front of the engine on the transom side.

As part of the routine annual maintenance, the raw water pump should be inspected, with particular attention to the impeller. The process for inspection is explained in the *Care and Maintenance* section of this Owner's Manual. **If the boat is operated in shallow or brackish water, or if the boat is run aground, the impeller should be checked regularly. Silt, sand, dirt and weeds can accelerate the deterioration of the impeller.**

Many Malibu boats are equipped with an optional flush kit. The process for properly using a flush kit is explained in the *Care and Maintenance* section of this Owner's Manual.



Most often, the cause of overheating is either marine growth clogging the raw water intake or insufficient coolant/water. If there is debris, even in small amounts, in the body of water, during usage it is likely that some of the marine growth can accumulate in the cooling system.

To protect the system, a sea strainer is installed near the raw water intake and serves the purpose of keeping debris from entering the cooling system, causing eventual engine failure. As with any kind of strainer, it is necessary to regularly clean it so that water can flow unimpeded.



Except for the sea strainer and raw water impeller, consumers should not

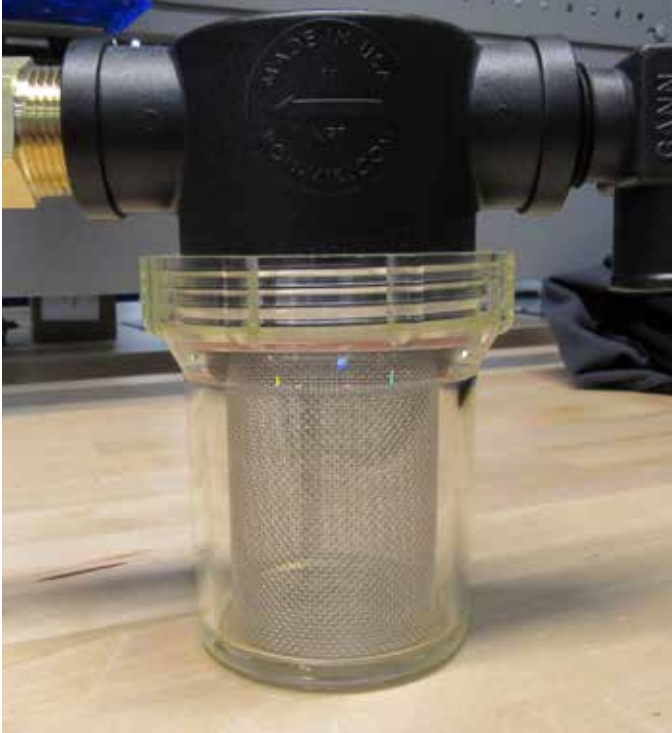

attempt to inspect or repair components of the cooling system. Most are inaccessible. All can be inadvertently damaged if not properly accessed, often necessitating specialized tools. Attempting unauthorized inspection or repair can void the warranty.

Coolant Requirements

In the closed cooling system, verify that there is sufficient coolant/water in the system. (Coolant and water may be required to be mixed, depending on the brand of coolant, most likely in a 50/50 mix.) Because a closed cooling system retains and recirculates coolant an additional step prior to every outing is necessary: Before starting the engine, while it is still cool to the touch and does not burn skin, check the coolant reservoir level. The instructions for this critical step are explained in the *Care and Maintenance* section of this Owner's Manual.



CAUTION

Use only a mix of 50/50 marine-grade propylene glycol antifreeze and distilled water in a Malibu engine closed cooling system. (Premixed coolant is commercially available, but when manually mixing use only marine-grade propylene glycol antifreeze mixed with 50 percent distilled water.) The use of any other type of coolant and/or water can void the warranty.

NOTICE

NEVER use ethylene glycol or Dex-Cool antifreeze coolant. These types of coolants are not formulated for the requirements of the Malibu Monsoon engine. NEVER mix the approved propylene glycol coolant with any other type of coolant, including ethylene glycol or Dex-Cool, even in small amounts. In fact, these different formulations do NOT mix and will not provide the required cooling protection for the Malibu Monsoon engine.

Malibu recommends using Sierra Brand, 5-Year, 100,000-mile Marine Grade Coolant in a 50/50 mix with distilled water to keep the warranty in effect. Sierra is an environmentally friendly coolant.

While some evaporation occurs naturally, it should not occur at an accelerated rate. If a closed cooling tank has significantly lost coolant, especially if it is nearly empty, a potentially serious issue exists. Present the boat to an authorized Malibu dealer for analysis and correction, prior to starting the engine.

CAUTION

Coolant should be flushed from the system and fully replaced every two years, and the cooling system carefully checked for any leaks.

The Exhaust System

Always operate the blower for several minutes (at least four

DANGER

[4] minutes) prior to starting the engine, running at a low speed or at idle. (Malibu boats are equipped with an automatic shut-off when the automatic blower system has operated prior to starting the engine.) This must be done with the engine compartment open. Failure to perform this necessary function could result in an explosion of the accumulated fumes within the compartment, resulting in serious injury or death.

Always operate the blower for the required four (4) minutes prior to starting the engine, ensuring the engine compartment is open. This should also be done when idling or running at low speed. This allows the disbursement of fumes that otherwise allowed to accumulate could result in an explosion.

The blower is controlled from an ON-OFF switch on the 7" Malibu Touch Command (MTC) screen. (See *Dashes and Video Screens* section of this Owner's Manual for more detail on how to operate the system.) **The blower should come ON automatically when the system is first powered up from the ON-OFF power button.** However, operators should always verify that the blower is ON and operating rather than relying on the automatic ON.

Although the Malibu fuel system works very efficiently, there will always be some gaseous by-product as a result of operating an internal-combustion engine. These gases, along with the water used to cool the engine (in addition to the closed cooling system) are routed out of the boat by way of the exhaust manifolds on each side of the engine to exhaust houses between the deck and hull, and it is expelled out of the system at the transom. If your boat is a Response or TXi, as part of the maintenance of the boat, pay attention to the exhaust flaps.

Some flaps and components of that exhaust system are composed of high-grade rubber and synthetics. These may deteriorate over time. Check to ensure that the flaps fit securely over the exhaust port and that they will open with ease, which is what must occur when the boat engine is running. After extended storage, also verify that birds and vermin have not made their way past the flaps and created nests inside the exhaust system.

Although much of the exhaust is disbursement into and through the water, fumes still reach the swim platform and transom area of the boat, including WakeView seating and the sun pads. Therefore, no one should ever be on the swim platform, transom seating or sun pads when the engine is operating.



Never allow anyone to be on the swim platform, transom seating or sun pads when the engine is running. Carbon monoxide fumes are colorless and odorless. Illness and death can result from breathing fumes, even before a person is aware of breathing them. See the *Safety* section of this Owner's Manual for more information regarding this critical matter.

Always allow the exhaust manifolds to cool before touching them. (The manifolds are on the upper side of the engine on both sides.) Engine operation will result in the manifolds becoming very hot, and touching could result in burns to the skin.

NOTICE

Engines equipped with catalyst exhaust manifolds may produce an unusual odor. This is typical of engines with a catalytic converter exhaust system. If you are uncertain about any odor, do not hesitate to contact an authorized Malibu dealer for assistance in determining the cause and potential for concern.

The boat is also equipped with a natural air-intake that forces air through a ventilation system on the deck of the boat. This channels air from the bilge to the transom vent.

With proper maintenance, which is the responsibility of the boat owner and/or operator, the ventilation system works efficiently and protects the people on-board from dangerous fumes. Follow the maintenance requirements as indicated in the *Care and Maintenance* section of this Owner's Manual.



The State of California has determined that the engine exhaust contains chemicals that have been known by the State to cause birth defects, cancer or other reproductive harm.

Never operate the boat if you or anyone on board suspects that the exhaust or fuel system is not performing as designed.

Break-In Period — All Boats

Breaking in marine engines is a different process from land-based vehicles. The first 10 hours of operation for your Malibu engine is critical for long life and enjoyable operation. When done properly, the break-in period will ensure peak performance.

The first hours of the boat operation have critical requirements for engine break-in. Pay close attention to the screens and monitor the readings. Pay particular attention to the oil pressure and engine temperature information as these are the earliest warnings when something is going wrong with the drivetrain. Alarms will sound if serious problems are encountered.

Also, check carefully for leaks. The break-in period is the most-likely time for leaks to appear, whether fuel, oil, water or exhaust. Verify that fluid levels are at the required levels. Listen for abnormal noises and pay attention to vibrations.

Any part of the operation that seems to be different from expectations should be checked with your authorized Malibu dealer, especially during this break-in period.

Break-In Procedure

The Malibu boats undergo a general pre-test run at the factory before shipping. The customer-based break-in period takes place for the next 10 hours of operation. (The video screen includes an hourmeter function that allows consumers to keep track of the number of hours the boat has been in operation. See *Dashes and Video Screens* in this Owner's Manual for details.)

NOTICE

Failure to follow break-in instructions can result in long-term performance

issues or damage to critical components of the drivetrain. Such failure is not covered under warranty.

The break-in procedures, which should be followed for the first ten (10) hours of operation as measured by the integrated hourmeter, allow the engine and transmission components to properly seat and function in the usage thereafter. These procedures are as follow:

- Always allow the engine to warm up after it is started. The length of time varies depending upon conditions, but it is especially critical when operating in colder weather. Oil viscosity thickens at these times. Failure to allow it to warm up can cause severe damage to the engine, which is not covered under warranty. **This is time in addition to the four (4) minutes venting the engine compartment.** Engine temperature is available on the video screen. Always verify that the engine feedback information on the video screen is within acceptable limits and no alarms show or sound before leaving the dock. Often, symptoms of potentially stranding issues will be noticeable at the beginning of the outing.
- Vary engine speed, but **do not exceed 3500 RPM** with light load for the first hour.
- After the first hour higher RPMs are allowable, but operators must avoid operating at one continuous speed (RPM). Varying the speed is important! **NEVER RUN AT WIDE OPEN THROTTLE (WOT) DURING THE BREAK-IN-PERIOD!**
- Never operate at idle speed for extended periods during the break-in period. Occasionally, return the shifter/throttle to neutral for a cool-down period, but do not operate at idle speed for extended periods. It is better to turn OFF the engine than to idle indefinitely.
- Operate above 1500 RPM carefully. If the body of water is choppy or if there are other challenges present, operate at lower RPM. Boating conditions can add strain to drivetrain operation.
- Always shift and accelerate smoothly during break-in. Avoid rapid operational changes. Plane the boat quickly as lower speeds can put more strain on the engine.
- **Do not do your first oil change before 10 hours or later than 15 hours.**

- **Do not load the boat to its maximum load capacity until after the first oil change. Maintain the correct oil level as measured on the dipstick during the break-in period.**
- Monitor the gauges and video screens closely as these are your first line of defense.
- Abnormal vibrations or unusual noises could be symptomatic of additional problems that are not registered by the gauges and video screens.
- The boat must be returned to an authorized Malibu dealer for the first service/scheduled maintenance. The purpose is to allow a trained technician to interpret any signs of malfunction or anomaly that may have occurred. Catching these symptoms early is critical to avoiding potentially damaging events that might not be covered under warranty.
- The dealer will change oil, transmission fluid and cooling fluid, clean the sea strainer, and do an alignment check on the engine.
- Verify that the propeller remains properly mounted and undamaged. Propeller information is provided in the *How It Works* section of this Owner's Manual.

NOTICE

Check the engine oil level frequently during the break-in process. It is normal for

the engine to use oil at this time, often at a greater rate than will occur later. The dipstick is located mid-block on the starboard side of the engine, between the intake and manifold. It has a circular yellow handle. Add only full-synthetic 5W30 engine oil. DO NOT USE ENGINE ADDITIVES AT ANY TIME. ENGINE ADDITIVES WILL VOID THE WARRANTY.



Never operate at wide-open-throttle (WOT) continuously, even after

the break-in period. WOT allows boat operators to quickly get the boat out of potentially dangerous situations and is intended for only brief use. WOT places exceptional stress and strain on the engine and drivetrain components. It can also test the boat operator's ability to control the vessel. Loss of control not only could cause an accident that damages the boat, but could also potentially injure persons on-board.

At 10 hours (and never later than 15 hours), the engine oil and oil filter MUST be changed. Malibu strongly recommends that this procedure be done by the authorized Malibu dealer as the service technicians are trained to look for the difference between acceptable signs of engine wear as differentiated from abnormal. This can make the difference in ensuring a long life for your drive-train.

If your dealer is not conveniently close by, instructions for oil and filter change procedures has been provided for oil changes **AFTER** the break-in, 10-hour oil change. After the break-in period, follow the instructions presented in the *Care and Maintenance* section of this Owner's Manual.

NOTICE

Failure to have the initial, 10-hour oil change performed by an authorized

Malibu dealer may result in the voiding of the engine portion of the warranty if it is determined that engine issues could have been analyzed and/or prevented through the dealer's inspection at that time.

Vapor Lock

Vapor lock seldom occurs. It can happen, most likely as a result of excessive ambient temperatures in the engine compartment following a fairly lengthy period of idling the engine, idling following a high-speed run, or increased temperatures when a hot engine is shut off and the flow of cooling water ceases too soon.

Malibu engines are equipped with an anti-vapor lock valve that separates the vapor from the fuel in the system while the engine is running. The vapor is routed back into the fuel tank while the fuel continues in its high-pressure line to the engine. In most instances, this activity eliminates the situation in which vapor lock can happen.

However, when operating the boat in excessively warm weather or with some gasoline blends/formulae, vapor lock could still occur. If it does, try the following steps:

1. Run the bilge blower as you would prior to starting the engine, for a minimum of four (4) minutes, prior to trying to start the engine.
2. Make sure the engine hatch is opened to introduce more ambient air into the engine compartment as a supplement to the system.



When the engine compartment is open, take extra care around the compartment. Rotating and moving parts could catch clothing or body parts, which could result in serious injury or death.

If the vapor lock persists, seek assistance from your authorized Malibu dealer.

Transmissions & V-Drives

Transmissions

Malibu Monsoon Engines are equipped with Velvet Drive transmissions. The internal gearing is an integral part of the boat's

propulsion, but also what allows a measure of control when docking and loading on a trailer. Inside the housing is a series of gears controlled by the shifter/throttle arm on the side panel at the driver's helm. The shifter allows the boat to move forward, backward or remain fairly stationary. (Bear in mind that boats are not equipped with brakes nor is there a way in which boats can remain stationary in the fluidity of a body of water. Neutral stops propulsion, but not movement. See the *Get Ready* section of this Owner's Manual for more information regarding this topic.)

In Wakesetter models and the M235 the transmission is attached to the back of the engine, but it will be in the boat forward of the engine's orientation because in these types of boats the engine is turned around from direct drive boats and most land-based forms of transportation. The TXi is a direct drive boat, and the engine/transmission unit face forward, so the transmission will be aft of the engine block.

Transmissions come in different gear ratios. Malibu chose the best ratio for the size and weight of the boat, expected boat gear and passengers, engine size and expected boating use (skiing versus wakeboarding, etc.). The Response and TXi features a 1:1 gear ratio. The remaining Malibu models will range from 1.5:1 to 1.76:1 to 2.0:1.

Transmissions normally require very little maintenance as long as the drivetrain is operated in a sensible manner. Slamming the shifter into a gear or being too timid in moving it can damage the system. As noted in the *How It Works* section of this Owner's Manual, a brisk, confident movement is suggested. Getting up to plane as quickly as reasonable and returning the shifter/throttle to an appropriate speed for the body of water is best.

After the first 10 hours of operation, as part of the authorized Malibu dealer's review during the oil change will be a check of the transmission. How to do the required check of the fluid is explained in *Care and Maintenance* in this Owner's Manual.

V-Drives

Unlike land-based vehicles, boats can operate with the engine in a 180-degree orientation from how it would normally set in the vehicle. In the Malibu-type boat, this has been adapted into a superior form of propulsion, but it requires a V-drive, which is a system for boats that consists of two drive shafts, a gearbox, and the propeller.

The first drive shaft connects the rear of the transmission to a gearbox mounted in the center of the boat. The second drive shaft extends from the gearbox to the rear and out the bottom of the boat to where the propeller is mounted. (The propeller's functionality is described in *How It Works* in this Owner's Manual, as part of the underwater gear.)

As with the transmission, the V-drive assembly is very durable and requires little routine attention. Your authorized Malibu dealer will check it during the 10-hour oil change. Afterwards, it will require a periodic check, which is described in the *Care and Maintenance* section of this Owner's Manual.



HOW IT WORKS





Safety First

Fire Extinguishing Equipment

Even when surrounded by water, fire is a significant concern. In fact, because safe egress from the boat is limited if it becomes necessary to abandon ship, this issue reinforces the need for easily accessible PFDs.

When boating in the United States, boats of less than 26 feet in length are required to have at least one (1) B1-rated, hand-held fire extinguisher on-board and fully charged, unless there is an automatic fire extinguishing system installed. An automatic system is available as an option on Malibu boats. Hand-held units are not included in standard equipment so that the consumer can choose from a wide range of fire extinguishers, many of which exceed the minimum requirements. **If the boat does not have an automatic fire extinguishing system installed, the boat owner MUST purchase and install at least one (1) B1-rated fire extinguisher.**

Most countries have fire-extinguishing and suppression requirements for recreational boats. It is the responsibility of the boat owner and/or operator to determine the requirements for the body of water on which the boating will occur. Being unaware of the law will likely not be an accepted excuse by law enforcement, and will likely not prevent the boater from receiving a citation or arrest.

The automatic fire extinguishing system is mounted inside the engine compartment. In the event the system's sensor recognizes extreme heat in the compartment, the system will create a chemically mixed dry suppression material. In most instances, there is sufficient suppression material to suffocate the fire and its source. In the event of a fire, boat operators should immediately turn OFF the boat's engine, which will also shut down the pressurized fuel system.

An automatic fire extinguishing system has an LED-lighted indicator located adjacent to the throttle-shifter at the driver helm. As part of the routine safety checks as the boat powers up, the operator should verify that the extinguisher system indicator is active.



Whenever fire extinguishers or suppression units have been used in fighting an on-board fire, a careful determination should be made whether it is safe to operate the boat. In most instances, it is



advisable to have the boat towed to shore rather than risk additional fire or permanent damage to the drivetrain. The boat should be thoroughly serviced by an authorized Malibu dealer prior to operation again. Operation prior to service could result in additional damage to the boat, and may result in serious injury or death.

Following discharge of fire suppression material, the system will require recharging. If an automatic system has discharged, it is unlikely that the boat can be run. Malibu recommends getting a tow to shore and having the engine compartment thoroughly cleaned and the fire suppression system recharged prior to running the boat's engine again. If hand-held units have been discharged, they will also require recharging. The chemicals in all fire suppression units can discolor upholstery and carpeting. It is recommended that the boat be cleaned as soon as practical.

The fire suppression manufacturers provide information regarding the proper and appropriate cleaning agents. Also pay attention to the cleaning instructions provided in the *Care and Maintenance* section of this Owner's Manual to avoid permanent damage to materials.

Even if systems are not discharged, fire extinguishers and suppression units require periodic maintenance. For a factory-installed automatic fire suppression system, a check of the system should be part of the routine annual maintenance. Hand-held units should be examined regularly for rust, corrosion, damage, or leakage. Weigh the unit annually to be certain that it meets the minimum listed on the label. If it has been used, even partially, it should be recharged by a qualified fire-extinguisher servicing company.

When purchasing fire extinguishing and suppression units, Malibu strongly recommends buying units that are prepared specifically for the marine environment. The standards for these units has been established by the U.S. Coast Guard and the American Boat and Yacht Council (ABYC). In other countries, follow the recommendations and requirements of local jurisdictions and boating authorities.

Malibu recommends fire extinguishing and suppression in excess of the minimum requirements. While an automatic fire suppression system is highly effective in most instances of an engine compartment fire, it is possible that a fire could occur in another area of the

boat. Therefore, Malibu recommends having at least one (1) hand-held unit fully charged and on-board at all times.

Models: (Automatic fire extinguisher in engine compartment)

Optional on all.

Emergency Engine Stop Switch

The Emergency Engine Stop Switch attaches to the boat operator by way of a lanyard for the purpose of shutting off the engine if the operator, for any reason, moves or is moved away from the driver's helm.



The switch assembly consists of an ON-OFF switch and a switch/lanyard clip. The engine will not start and/or run if the toggle is in the OFF position. Malibu recommends the clip always be inserted in the toggle switch. Connected to the operator, if (s)he moves away from the controls, the clip will pull free, pulling the switch to the OFF position. If the engine needs to be shut down very quickly, it can be done so by pulling on the lanyard to release it from the switch.

To reset the switch after activation, reinstall the lanyard clip and flip the switch to the UP position.



The emergency engine stop switch lanyard should always be connected between the switch and the operator

when the engine is running. The purpose of the switch is to immediately shut OFF the engine if the operator moves away from the driver's helm. Without the driver's control, all persons on-board or other boaters in the area could be subject to serious injury or even death. Never operate the boat without the emergency engine stop switch lanyard connected between the switch and the boat operator. Malibu recommends the operator of the vessel always remain at the helm any time the engine is running.

Lighting

All Malibu boats are equipped with multiple lights to assist boaters in low light situations.



Boat outings should conclude prior to dark. Visual sighting is critical to safe boating. In an emergency where the boat must be operated in darkness, use the boat's navigation and anchor lighting in accordance with local law and ordinances which may restrict the type of lighting to be used, plus sound signals, to alert anyone in the area, and proceed slowly. After dark, it may be impossible to see other boats, submerged hazards or the shoreline, which can result in damage to the boat that is not covered under warranty, and serious injury or even death.

EMERGENCY BACK-UP KEY SWITCH: When the emergency back-up key switch is turned to the ON position, the navigation and anchor lights on the bow and tower illuminate.

Models: *All models.*

BOW LIGHTS/NAVIGATION LIGHTS: As required by the U.S. Coast Guard and most maritime authorities, recreational vessels should display navigational lights between sunset and sunrise, as well as other periods of reduced visibility. These are available on most models either as a standard light that is on the deck, or as an optional pop-up light that pushes down into the deck and a chrome cover sits flush with the deck. To open the pop-up, push down on the chrome exterior and the light will pop open. To close, push down on the light and it will fold into the deck casing.

Bow lights are located at the front of the bow. On some models, it is a single two-colored element—red and green and operated from the dash panel, while on other models there is a green light on the starboard side and a red light on the port side.



The green light will be on the starboard side of the deck adjacent to the driver's helm, and the red light will be on the port side deck adjacent to the observer seat location.



Bow and navigation lights get hot during use, which could result in burns if touched. The light can re-

main hot for an extended period of time after it has been turned OFF.

Models: *All models.*

DOCKING LIGHTS: These are an option that offer additional visual assistance. The lights are located around the bow area, two per boat, and provide white light to the front of the boat. The docking lights are operated from a screen icon. On all Wakesetter models, the control will be from ON-OFF/HIGH/LOW. This feature is enabled through the touch screen settings. If the setting is disabled, it will function ON/OFF only.



Please note that boat operators are not allowed to operate docking lights while the boat is underway.

Models: (Optional) *All models.*

COURTESY LIGHTS: The courtesy lights vary from model to model and are found in all areas of the deck from bow to stern, as well as inside storage compartments. The lights provide white light. These lights are LED and therefore bright without excessive heat. However, leaving them on for extended periods of time shortens the life of the bulb and can become warm to the touch. Malibu recommends leaving the lights off unless they are needed. The lights operate from a screen icon. Some lights are activated from the Interior Light icon (e.g., side panel lighting)

while others are activated from the Storage Light icon (e.g., glove box, G4 dome light and OB compartment.)

Models: *All models.*



TOWER LIGHTS: All boats equipped with towers will also have a 360-degree light on top for use at anchor. This white light provides additional visual assistance ahead of the bow; however, note that **all forward and aft lighting**



cannot be used while the boat is underway as it could impair other boaters' vision. Tower lights also include optional forward and aft-facing lights, and optional RGB lights are also available. All tower lights are controlled through the video screen.

Models: *All Wakesetter boats are equipped with towers. If the standard tower has been deleted, there is a covered, two-pronged connector found on the top of the transom of boats without a tower. The all-around light is plugged into this connector when needed and stored under the rear passenger seat when not in use.*



UNDERWATER TRANSOM LIGHTS: Some models may be equipped with optional underwater transom lights, which are located under the swim board and add considerable brightness in the water. This is an added safety feature, particularly when swimming in shallow water. **Note that these lights are not allowed to be ON while the boat is underway.** These LED lights are intended to be operated under the waterline, and Malibu recommends keeping the lights OFF unless submerged. While LED lights do not generate as much heat

as many other lights, water cooling adds to the life span of the bulbs. The lights are controlled by the video screen icon.

Models: *All models as an option.*



Tie-Ups

Several methods of securing boats to shoreline and docks are available.

Although Malibu does not provide rope for tie-ups as a standard, dock lines are available through www.malibuboatsgear.com. Also, many excellent marine aftermarket suppliers offer a wide range of rope for sale.

Malibu recommends a two-strand nylon rope. (Three-strand rope may stretch too much and allow the boat to bump other objects.)

There are several different knots and hitches to secure boats to docks or shoreline. Malibu recommends making the effort to learn these marine-intended knots and hitches. Consult with your authorized Malibu dealer to determine which ones will work best in the tie-up application you will be using. Some hitches are intended for only short-term docking, while others work better for longer periods of inactivity. Always bear in mind wave action that may cause the boat to bump the shoreline (and scratch the hull, which is not covered under warranty), or bumping against a dock, or even potentially other boats (also not covered under warranty), when selecting the appropriate method to secure the boat.

CLEATS: All boat models offer optional pop-up cleats. Where equipped, the cleats will be located below the windshield on each



side of the deck, and also near both rear sides. Some models may also have two additional/optional cleats mounted on either side of the front of the bow.

Although there are multiple marine knots, the cleat hitch is a special knot used to tie the rope to a cleat. If a line is not correctly secured on the cleat using a cleat hitch, it can work itself loose.

Both the standard and pop-up cleats have two "horns" around which the line is tied. Begin by bringing the line past the center of the cleat on the outside beneath, and wrap it around under both horns. Then bring the line across and back under the first horn again in a figure-eight. Make another figure-eight loop around the second horn.

The pop-up cleats operate by pushing on the cleat. If it is flush with the deck, pull up the cleat for use; to retract, push on the cleat once more.

If the boat will be moored for a period of time or where there is fairly active wave motion, Malibu recommends the purchase of fenders, also available from reputable marine suppliers. Fenders are available in a range of sizes and materials, but the goal is to protect the boat from damage as a result of motion against the dock.

NOTICE

Malibu recommends the purchase and use of fenders to protect the boat's gel coat finish whenever a boat is at risk of contact with docks or any other object (for example: rafting up with other boats) that may damage the finish. This kind of damage is not covered under warranty.

WARNING

Cleats are used to tie the boat to a dock or to hang fenders. They are not designed for any kind of towing, including other boats. Nor should they be used for anchoring, mooring or lifting the boat; the only locations structurally certified for such "strong point" requirements are the bow and stern eyes. Abuse of the cleats is likely to result in equipment failure that will damage the boat, which is not covered under warranty, and can also result in serious injury or death.

Models: Cleats are available as an option on all models.

BOW EYE AND TRANSOM EYES: All boats are equipped with a single bow eye near the apex of the hull under the bow, and two transom eyes, which are located one each on the port and starboard sides of the transom. These semi-circular or U-shaped metal connections are made from stainless steel to reduce the effects of rust and corrosion. On boats that are not equipped with cleats, these eyes are used to tie-up the boat, and no other part of the boat, including any interior components such as the windshield extrusions or grab handles should ever be used.



NOTICE

Never tie up the boat, even temporarily, using any component of the boat except the bow eye, transom eyes and/or cleats (where equipped). Using any other component could result in damage to the boat that is not covered under warranty.

Models: All models are equipped with a bow eye and transom eyes.

FENDER LOCKS: As an option, the fender lock is a stainless steel component added permanently to the boat deck, with an eye that attaches an optional fender (sold by an authorized Malibu dealer or aftermarket supplier) to provide protection when a boat is docked. The fender eye slides into and out of the lock for ease of use. These locks help protect the finish of the boat.

Fender locks are not designed to be used to tie up the boat. They are designed only to support bumpers.

Models: (Optional) All Wakesetter models.

Anchor Locker

Some models are built with anchor lockers. Malibu does not sell anchors, preferring to have consumers select from an authorized Malibu dealer or an aftermarket supplier the anchor that best meets individual needs based on the type, location and depth of the body of water.

Anchor lockers should be cleaned regularly to avoid the growth of mold and mildew, which can result in an unpleasant odor and potentially unhealthy situation.

Models: Wakesetter 22MXZ, Wakesetter 24MXZ, M235.



Horn

All boats are equipped with a horn. The purpose of the horn is to sound an alarm in the event of an emergency, and also to draw attention as you maneuver the boat in areas where line of sight is questionable or in instances when attention seems warranted. The horn is activated by a button on the dash.

Models: All models.



Mirror

Even when accompanied by an on-board observer to assist in keeping track of passengers, skiers, boarders and others engaged in activities, operators would be well-advised to use a mirror as part of constant alertness to the surroundings. All boats can be equipped with a windshield-mounted and adjustable mirror, unless equipped with the optional PTMEdge VR140 rear view mirror. It mounts to

the G3.5 tower and has high-definition, prescription-grade optics. It features a 140-degree field of view that is enclosed with an aluminum billet housing.

Models: Mirrors are an option for all models.



Ladder

As an option, ladders are available for some bows (depending on the model) and the swim board for ease and increased safety in boarding and disembarking the boat.

The ladders are foldable, with a sliding latch that locks the ladder in place when it is fully extended for use, and also for when it is folded up and put away. On the bow, the ladder folds upward and fits inside the anchor locker. The aft ladder folds up and under the swim board for stowing. The ladders

should always be stowed when the boat is underway. Excessive force from the body of water as the boat is in motion can damage the ladder, and such damage is not covered under warranty.



NOTICE

Failure to properly stow the ladder prior to getting underway can result in damage to the ladder, and potentially to the boat, which would not be covered under warranty.

Models: Bow ladders are standard on the 22MXZ, 24MXZ and M235 models. Swim board ladders are available on some models.

Fuel Fill

Malibu boats are equipped with fuel fill fittings and vents to provide state-of-the-art safety protection in the process of adding fuel to the tank. While most of the fuel system on the boat is inaccessible to owners/operators, the fuel fill was designed to ensure the process of fueling is as safe as possible, and efficient.

Fuel fills are located on each side of the boat toward the aft on the boats. It does not matter which side is used in the filling process.



Both fills lead to a single fuel tank. Fills were installed as a convenience on both sides because consumers may be limited in options for reaching fuel pumps at the dock.

There should be no spit-back or overflow at land-based gas stations in North America. However, the requirements that eliminate those issues are not applicable to some gasoline service stations in other countries or even at some marinas in North America. Therefore, care should always be taken while fueling the boat. Do not stand too close to the fuel fill location in case some fuel is expelled from the pressurized system. You may also hear an audible release of air pressure when opening the cap. Pay attention to ensure that gasoline is entering only into the boat's fuel fill and not spilling or running outside the fuel fill.

Note that the first time the boat's fuel tank is filled, the process may seem slow. This is because fuel is displacing air that was in the tank. After the first full tank, filling should proceed at approximately the same pace as one would expect in filling land-based vehicles.



Gasoline is extremely flammable. Under some conditions, particularly those that allow fuel fumes to accumu-

late in enclosed areas, gas can be explosive as well. Avoid smoking while filling the gas tank or allowing any sparks in the area. Never run the boat engine while filling the gas tank. If any gas is spilled, clean it up with clean rags and dispose of properly on land.

Interior Performance

Steering Wheel

Steering in a boat is different from most land vehicles, although the effect is similar. Malibu boats are equipped with steering wheels. The standard, fixed-angle steering wheel is turned in the direction the operator wishes to go. Instead of wheels turning in that direction, the boat steering wheel controls a rudder, and the rudder actually turns in the opposite direction. By cutting through the water with a rudder in the opposite direction, the bow of the boat will turn in the direction the steering wheel has been turned. Note that, compared to land-based vehicles, the turning process is usually more sluggish, less tightly controlled and requires more room. It's important for new operators to practice before maneuvering in tight locations.

Boats also do not track in the same manner as land-based vehicles. They are affected by currents, wave action, and natural motion created by the propeller. At slow speeds, the effect is more pronounced and boats seem to wander slightly. Trying to steer the boat back and forth to compensate actually only worsens the effect. As long as there is sufficient depth of water and there are no obstacles close at hand, allow the boat to follow its course. The overall course will be directionally straight if the steering wheel is held in place.

Malibu boats are equipped with a tilting mechanism on the steering column. This allows the operator to adjust the steering wheel to the most comfortable angle and provide a sense of secure control. Steering columns have a lever at the underside of the column. Press down on the lever until the steering wheel is movable. Tilt it up or down to the best angle for the operator and re-engage the lever snug

against the steering column. Never force the lever. If it will not move with relative ease back into place, the steering wheel is not in one of its acceptable levels. Adjusting slightly should allow proper action of the tilt mechanism.

STEERING WHEEL CONTROLS: As an option, steering wheel controls will offer redundant control for the Surf Gates, Power Wedge, cruise control speed and audio controls.

Operators should always review the *Dashes and Video Screens* section of this Owner's Manual for important information about operational requirements that may be necessary for proper



function of these systems. Note that the most-recently touched component will override other control components. Depending on the configuration, control of the cruise system, Surf Gates and Power Wedge can be managed from the video screen, the controls on the steering wheel (including audio), and the Surf Band, where equipped.



WARNING

Communication is key to maintaining proper control of the boat. In models equipped with the optional

steering wheel controls and/or the Surf Band, either of these devices, as well as the video screen, can take temporary control of the boat, affecting maneuverability and safety. A designated individual on-board should manage the operation of these controls at all times. Failure to do so could result in serious injury or even death as a result of loss of control.

CONTROLS ON PORT SIDE OF STEERING WHEEL: (FROM TOP)

Cruise Control: Press anywhere on the button to turn Cruise Control ON. Press anywhere on the button to turn Cruise Control OFF.

Cruise Control Speed: Press left side of button to increase current speed when cruise control is engaged. Press the right side of button to decrease current speed when cruise control is engaged.

Power Wedge: Press the left side of the button to raise the Power Wedge. Press the right side of the button to lower the Power Wedge. Note that releasing the button will stop the action at whatever point the process is in. You must read the *Power Wedge* information contained in this section of the Owner's Manual before attempting to operate it.



contained in this section of the Owner's Manual before attempting to operate it.

Surf Left and Surf Right: Press the left button to move the left side Surf Gate. Press the right button to move the right side Surf Gate. You must read the *Surf Gate* information contained in this section of the Owner's Manual before attempting to operate either gate.

CONTROLS ON STARBOARD SIDE OF STEERING WHEEL: (FROM TOP)

Stereo: Press button to turn the Stereo system ON. Press button again to turn the Stereo unit OFF.

VOL: Press the left side of the button to increase the Stereo speaker volume from current level. (Whenever the Stereo is turned ON, it will automatically return to the volume level at which it was during the last operation.) Press the right side of the button to decrease the Stereo speaker volume from the current level.



MEDIA: Press the button repeatedly to move through any electronic media that has been integrated in the current system. To add or delete items, review the *Dashes and Video Screen* section of this Owner's Manual.

Button to right of MEDIA: Press the button to temporarily mute whichever media component is playing. Press again to release the mute.

Bottom button: This button is a search feature, which will work with any media component that allows the feature. Press on the left side to search left or lower-numbered ID; press right side to search right or higher-numbered ID.

Models: *Wakesetters* offer optional steering wheel controls, which are standard on the M235.

Shifter/Throttle

NOTE: *The engine will not start unless the shifter/throttle control is in the neutral position!*

To the right of the boat operator is the shift/throttle lever. Any time the boat engine is OFF, the lever should be in the center upright position, which is Neutral (meaning the boat is not in gear). Boats are not equipped with a "Park" gear as land-based vehicles are.

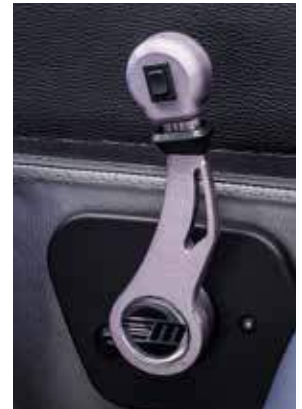

At the base of the throttle is a Push button. Pushing on the button disengages the transmission, thereby allowing use of the throttle without engaging the transmission. This is used for warm-up of the engine while it is still in Neutral. Be sure to position the throttle vertically (in Neutral) before re-engaging the transmission by again pushing the button.

When engaging the transmission from neutral either forward or backward into reverse, pull up on the safety collar located directly below the throttle lever knob. The safety collar helps avoid unintentional movement into gear.

When shifting gears, always do so smoothly and briskly. Being either too hard and slamming the gears, or too tentative is hard on the shifter/throttle system and can result in damage that is not covered under warranty.



Improper shifting and use of the throttle can result in damage to the system that is not covered under warranty.

The shifter/throttle manufacturer has included additional instructions that are part of the owner's packet. Be sure to read and follow the instructions and additional information to ensure long and safe operation of the boat.



WARNING

Do not shift from forward to reverse while the engine is at high RPM. Damage to the

transmission will result. When shifting from forward to reverse, the system requires a brief pause in the Neutral position to allow the engine to return to its idle position prior to moving into the opposite gear. Without this brief pause, it can also cause the engine to shut off. The subsequent loss of control can cause damage to the boat and/or injury to persons in or around the boat.



Before starting the engine or engaging the transmission, be certain that there are no people in the water around the boat.

Models: All models.

Electronic Throttle Control (ETC)>

Although unseen by the boat's occupants, the Electronic Throttle Control (ETC) contributes to the boat's performance in critical fashion. Never make any modifications to the throttle control.



Never make any alternations or modifications to any part of the throttle control system, including the throttle control.

Such changes renders the engine and boat warranties void, and may result in loss of control of the boat, which could result in serious injury or death.

If, for any reason (unplugged, wire cut, a short, loss of power, or sensor failure, as examples) any part of the electronic throttle control system fails, the engine controller will default to idle. The operator will essentially have no control of the throttle and the Engine Fault alarm will activate.

If this happens, the operator must turn the ignition key to OFF, and then attempt to restart the engine. This will reset the computer area network. If the condition persists, however, it will be necessary to take the boat to an authorized Malibu dealer for repair.

Additional information regarding the throttle control's safe operation and maintenance is included in additional separate material that is part of the new-boat informational package.

Models: All models.

Pylon(s)>

All models have a pylon located between the lounge lean-back seats and the sun deck area.

These pylons, which are intended for use in wakeboarding as well as skiing, are not intended for any other use.



DO NOT attempt to use the pylon for any purpose other than towing individuals behind the boat with an

appropriate towing rope. DO NOT attempt to tow another boat by attaching a rope to the pylon. This will overload the pylons and can cause damage to the boat which will not be covered under warranty.



DO NOT allow passengers to sit behind the pylon whenever someone in the water is being towed. When

the towed individual lets loose of the ski/wakeboard rope, the tension may cause the rope and its tow handle to snap back into the deck area. Individuals may not be able to deflect the rope, with the result that people hit by the rope and handle could be injured, especially if they are not paying attention.

Malibu recommends the use of two-strand towing rope only. Three-strand may stretch too much and could result in more stretch than is wise.

Models: All models.

Sport Dash>

As part of the Command Center, the Sport Dash (located on the lower port side of the dash) features several components intended to enhance enjoyment of the boating experience. The components include:



- An expandable smartphone cradle (simply slide the sides toward each other to lessen the size, or away from each other to expand);

- A water-resistant storage box with a USB charging port.
- An intuitive, analog rotary knob for Surf Gate, Power Wedge II, speed control and stereo (volume, song selection and mute). The dial allows the boat operator to keep his/her eyes on the water ahead while adjusting the controls.
- Whenever the power button and dash are ON, the rotary knob is activated to work. It offers redundant controls for the features controlled on the dash touch screen.
- Surf Gate and Power Wedge are controlled by the button.
- Speed UP/DOWN and song selection are controlled by moving the center joystick UP/DOWN and LEFT/RIGHT.
- Pushing the center knob will mute any audio.
- Twisting the knob will change the audio volume to louder or softer.

Models: (Optional) *All Wakesetter models.*

Rear and/or Dock Camera

When the shifter/throttle is put into reverse, an image from behind the transom will appear in the center of the 12" video screen display in boats equipped with a back-up (or rear) camera. This does not replace the driver's responsibility for verifying that there are no impediments to either side or behind the boat! The back-up camera serves as a redundant visual indicator.

At any time, the operator can go to the "Media" tab on the 12" video screen and select the "Camera" icon to view images on the camera. Otherwise, the camera operates automatically, as indicated, when the shifter/throttle is in reverse.



Boats may also be equipped with an optional docking camera, which can aid the driver in approaching the dock. As with the rear camera, the dock camera does not replace the driver's responsibility for verifying that there are no impediments to properly and safely docking the boat! The dock camera serves as a redundant visual indicator.

Control of this camera is available through a switch on the dash, and the LED light will be on when the camera is activated. Visual images appear in the 12" video screen.

Control for the dock camera is also available through the video screen.

Models: (Optional) *All Wakesetter models.*

Interior Luxury

Stereo Components

One of the most enjoyable aspects of boating is the stereo system, and Malibu offers a range of optional media opportunities. Most of these systems are controlled through the main stereo head unit but a stereo transom remote is available as an option.

Stereo system controls are explained in the *Dashes and Video Screens* section of this Owner's Manual.

Models: (Optional) *All models have a variety of stereo options.*

Seating

Malibu provides a variety of seating types and options to increase your boating pleasure. The standard seating is crafted

from top-quality materials, and engineered to provide the maximum allowed number of individuals on-board for the boat model's design. Please note that it is very important for passengers to be seated when the boat is underway as shown in the seating charts in the *Quick Reference Guide* section of this Owner's Manual. This provides for balance and avoidance of over-loading that could otherwise adversely affect the boat's ability to maneuver, swamp the boat or even cause injury or death.



Failure to evenly distribute the combination of passengers and additional gear brought on-board can result in loss of control of the boat, swamping and sinking,



and causing other adverse effects. Never exceed the boat capacity, paying particular attention to limits in bow seating. Failure to pay on-going attention to this can result in serious injury or death.



Never attempt to jump into the body of water from any of the seating in the boat. It can be difficult to determine

water depth, and it could be possible to misjudge clearance of the deck and gunwales.



Malibu offers WakeView transom seating, which is standard on some models and optional on others. This padded, comfortable individual seating on each side of the transom area is intended for use **ONLY** when the boat is fully stopped, without the engine running. Sitting in this area while the boat is underway could result in individuals falling off, which could result in injury or even death. It is also possible that carbon monoxide fumes from the exhaust system could reach individuals sitting here. The WakeView seating folds down to increase viewing for the driver and observers while the boat is underway. When moving the seat back up or down, take care to avoid pinching fingers, hands or other body parts as the back snaps into or out of place.



The Wake-View transom seating should never be used

while the boat is underway as passengers in those seats could be dislodged, resulting in injury or death. The seat should also never be used when the engine is running because passengers at the transom may also be subject to carbon monoxide fumes emitted from the exhaust under the swim board.

Do not have the engine running while passengers are sitting in the WakeView seats. Even while stationary, the WakeView seats should never be the location from

which individuals attempt to leap into the water. It can be difficult to determine the water depth, and people can misjudge clearance of the swim board.

No one should sit or ride on the sun pads either when the boat engine is running. Carbon monoxide is emitted from the exhaust system and vented into the water beneath the swim board. Fumes can and do reach the sun pad area. Avoidance of carbon monoxide poisoning is addressed in the *Safety* section of this Owner's Manual.

When adjusting the helm seat, note that there a handle pull under the port side of the seat. Pull down very slightly and to the left to remove the handle from its locked position; when it is in its neutral position, the driver can slide the seat forward or aft to a preferred position. Return the handle to its locked position while the boat is underway. Failure to do so could cause the seat to move, causing the the driver to lose control.



The glide handle for the driver's (helm) seat should be the locked position anytime the boat is underway. Failure

to have the handle stowed properly could result in the seat moving unexpectedly, and such action could cause the driver to be distracted and lose control of the vessel. This could result in injury to the driver and/or passengers.

The driver's seat also has a swivel feature. To activate, push down on the T-handle in front of the seat. When the desired position has been achieved, release the handle to lock the position. There are also optional features for the helm seat, which are explained immediately following.

It is critical to the long-term use and enjoyment of the boat to perform the routine maintenance required to keep all interior upholstery in top condition. Details are provided in the *Care and Maintenance* section of this Owner's Manual.

Models: All boats have standard seating that varies by model. The WakeView transom seating is standard on the Wakesetter 23LSV and Wakesetter 24MXZ; optional on other models.

Heated and/or Powered Driver's Seat

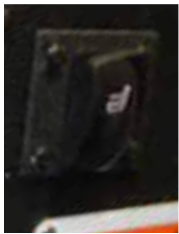

Among the options available on all models are a heated and/or powered driver's seat.

The heat option may be controlled through the video screen or from a switch on the driver's side panel. Turned ON, the heat sensor warms the driver's seat only to a predetermined, but moderate level. The heat feature should always be turned OFF at the conclusion of the outing,

if not before. If the driver forgets to turn OFF the seat, when the boat is powered down the seat heater will shut off after a predetermined amount of time since these are controlled via touch screen operation on Viper II-equipped boats.

Boat owners can also order a power option that allows the driver's seat to be moved up or down by pressing on a slide button on the starboard side of the seat base at the shifter panel. Pushing up moves the seat up; pushing down moves the seat down. All driver's seats have a mechanical lever to allow the seat to slide forward and aft, explained above in the *Seating* information.

When moving the bolster, avoid pinching fingers, hands and other body parts.

Models: (Optional) All Wakesetter models. Heated seats are an option on Response models.



Armrests

Armrests are available in the bow section of some models. While the armrests add comfort, it is important to use them properly. No one should ever sit, perch, stand or walk on an armrest. Do not use the armrest to hold satchels, bags, or any other property. The armrests will not hold excessive amounts of weight without failing. In moving armrests up and down, use caution to avoid pinching fingers or skin.



Armrests are intended to be used only as armrests. Any excessive weight placed on an armrest, even briefly, can result in failure of the armrest. Among other activities, DO NOT STAND ON THE ARMREST. This is not covered under warranty, and could also result in injury. In moving armrests up and down, use caution to avoid pinching fingers or skin.

Avoid pinching fingers or skin in moving armrests up or down.

Models: All models.

Glove Box

Malibu recommends storing this Owner's Manual in the glove box so that it will always be readily available for reference during outings. Placing the Owner's Manual in a plastic bag will increase its protection.

The glove box is convenient for storing personal items while boating. While the glove box is not waterproof, its design reduces the likelihood of damage from water that may come on-board. Malibu does not warrant the level of water-resistance available when using the glove box.

The glove box opens by pushing on the button on the front of the lid. Closing requires only lifting and shutting the lid tight. Closing requires minimal effort. If more effort is required, it is likely the glove box is overloaded and some material should be removed prior to closing.



NOTICE

Never attempt to close an overloaded glove box. Trying to force the lid closed could result in damage that is not covered under warranty. Avoid pinching fingers, hands and other body parts while closing the glove box lid.

Do not store any aerosol items in the glove box. These can overheat and leak and/or rupture. Any liquid or semi-liquid material placed in the glove box may spill or overheat. Care should always be used when placing liquids such as suntan lotion in the glove box. Malibu is not responsible for such misjudgments.

If any water does intrude into the glove box, clean it out as soon as practical. Mold and mildew can result if even small amounts of water are not removed. As with any storage location, any spills should be cleaned efficiently to avoid damage and/or odors.

Models: All models have a glove box located forward of and adjacent to the observer seat.

Storage Compartments

Malibu boats have multiple storage compartments available throughout the boat. In general, storage is available in the bow, gunwale and floor. Some models will also have transom storage. Also, some models may have interior lighting within the storage compartments.



As much as possible, gear and property brought on-board should be stowed in storage compartments to prevent movement of items during the outing. Unsecured items could strike and potentially injure individuals on-board during operation.

Be sure to distribute items throughout the boat and compensate for the persons on-board.

Weight should be as evenly distributed throughout the boat as possible to avoid negatively affecting control. Never try to close an overloaded storage compartment. Forcing a compartment closed can result in damage to the boat that is not covered under warranty.



Anything brought on-board should be stored in a designated storage compartment

if at all possible to avoid the potential of being struck by an unsecured item while underway. This could result in serious injury or even death. Items should be evenly distributed and with attention to the number of passengers and where they will sit. Even distribution of added weight is critical to a safe operation.

Storage compartments should be cleaned out in accordance with *Care and Maintenance* instructions in this Owner's Manual. At least annually, all compartments require a thorough cleaning. If anything with residual odor is placed in a storage compartment, or if anything has spilled in the compartment, cleaning should occur as quickly as possible afterwards.

NOTICE

Never force a compartment closed as overloading could cause damage to the boat, and that is not covered under warranty. Storage compartments should be kept clean. Failure to do so may result in damage or permanent discoloring and/or odors that are also not covered under warranty.

Models: All models.

Removable Cooler

Adding more convenience is a marine-grade, removable cooler. Any cooler of the same or smaller size will fit in the same location under the seating immediately aft of the driver's seat, but Malibu recommends marine-grade coolers as they use stainless-steel hardware, which is advisable in the type of atmosphere in which it

will be used. Although the supplied cooler has a liner that reduces odor absorption, it is a good idea to clean out the cooler after each use. Odors may still penetrate, and spills can stain. Such occurrences are not covered under warranty.

Models: All models, except Response/TXi.

Cup Holders



All boats are equipped with cup holders. The cup holders are sized for contemporary, normal-sized cups. Malibu recommends using only cups with covers as boat motion is likely to otherwise

slosh liquids out of the cups. If liquids are spilled into the cup holder, or anywhere else, they should be cleaned up as soon as practical to prevent any damage to the boat components or anything brought on-board. Such damage is not covered under warranty.

Models: All models.

Removable Trash Receptacle



Some models have a removable trash receptacle which is stowed under the aft, starboard seating. Malibu recommends using plastic liners in the receptacle to ease the

removal of trash. All trash, regardless of whether the boat is equipped with this feature, should be properly discarded on-shore in a legal and safe manner. Clean the receptacle as needed to prevent staining and odors.

Models: All models except the 21VLX, and Response/TXi.

Carpets and Mats

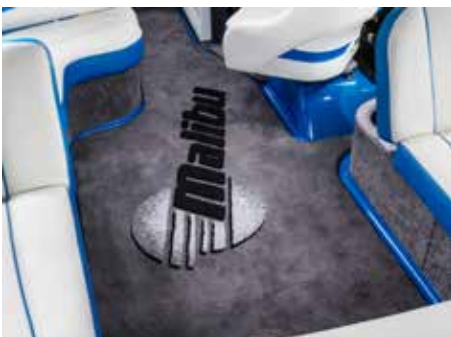

Carpets and mats add comfort and attractive appearances to the interior. These require some additional attention to the interior of the deck. It is important to allow the carpet/mat to dry before covering the deck

with a mooring cover or other canvas. (The snap-out carpets can be removed to air dry.) Although Malibu carpets and mats are construct-

ed from marine-grade materials, if they do not dry thoroughly before storage, even short-duration, mold and mildew can set in. Additional information is available in the *Care and Maintenance* section of this Owner's Manual.

The snap-out carpet hardware is made from stainless steel to resist rust and corrosion. However, boat owners and operators should routinely check that the snaps are in good condition. Any time the snap-out carpets are reinstalled on the deck, be certain that the snaps are fully seated. Otherwise, the carpet could dislodge or move, causing passengers to slip and fall.



Ensure that snap-out carpets are secure prior to walking on them. If the snaps are not fully seated, the carpet may not function as designed. When dislodged, carpets and mats could cause a passenger to slip and fall.

Models: The snap-out carpet is standard in all Wakesetter models. An optional snap-out carpet features the Malibu logo. A mat is also optional on all Wakesetter models.

Cockpit Table

A cockpit table is available as an option on all models. It consists of three pieces: a permanently installed mount that is located on the port side of the passenger area of the deck; a removable leg; and a removable table top.



The cockpit table top and leg should be securely stored in one of the storage compartments when not in use.

The cockpit table top snaps into place on top of the leg. The leg has a 45-degree bend close to the end that attaches to the permanent mount on the underside of the seat on the port side. To dismount the table, pull the top straight out.



When the cockpit table is installed for use, be certain that both ends of the leg are secure. If either is not, the table could dislodge, possibly resulting in injury to anyone close by. DO NOT sit on the table, even when it is securely installed. The table is intended for social activities

and consuming food/beverages only. The table could also collapse if too much equipment or other items are placed on it. The cockpit table top and leg should be separated from each other and kept in a storage compartment when the table is not in use. If it is left inside the deck but unsecured, it could move around and potentially cause injury to people on-board.

Models: Option for all Wakesetter models.

Grab Handles

Boats are equipped with grab handles for added convenience and safety. Handles are generally inside the deck above passenger seating and on the transom, centered above the swim board. The handles assist boarding, particularly from the swim board into the deck area. During boat operation, the grab handles inside the deck can provide additional security for passengers. (No one should ever be on the swim board during boat operation. More on this in the *Safety* section of this Owner's Manual.)



The handles are crafted from stainless steel or anodized aluminum to resist rust and corrosion. Routine maintenance should include regular cleaning.



Interior grab handles may be used by passengers to hold on to during boat operation.

The handles are sturdy surfaces, which means that if an individual makes sharp contact with a grab handle, bruising may result. If the boat is being operated in a manner that results in excessive movement of the passengers, or if people are shoving each other, even playfully, at any time, injury is possible. Malibu strongly recommends that this kind of activity be avoided at all times. Do not use the handles to secure or tie up the boat as this can cause damage that is not covered by warranty.

Models: All models. Locations vary. Operators and passengers should acquaint themselves with the locations prior to operation.

Heater

A popular option on all models is the heater. Warm air is vented to the deck from the engine. Vent locations vary by model, so owners/operators and passengers should familiarize themselves with



the locations. The vents have sliding, directional gates that can redirect the air flow, or even shut it off.

The heater is controlled on the video screen. To turn it ON (high speed), ON (low speed) or OFF, review the instructions that are provided in the *Dashes and Video Screen* section of this Owner's Manual. For the manual operation on the

Response model, it is a three-position switch.

Be aware that operation of the heater is a drain on the battery. Review the *Electrical* section in the *Dashes and Video Screen* portion of this Owner's Manual for important information regarding how to avoid becoming stranded by a fully discharged battery or batteries. Pay attention to the voltmeter reading; whenever it falls below 10.5 volts, the battery requires recharging.

In boats equipped with the Salt Water package, glycol runs through the heater core. In non-salt conditions, the heater must be drained prior to storage or even brief periods of the boat exposed to cold temperatures, or damage will occur. This is addressed in the *Care and Maintenance* section of this Owner's Manual.

Also note that air coming through the vents may be cool initially, depending on whether the engine has warmed up. The hot water to heat the heater core is pulled from the engine. Therefore, the engine must be running in order to have warm air flow from the heater. Allow a reasonable period for the air to warm. However, if it has not warmed after several minutes, it may signal an issue with the heater system. This will require attention from an authorized Malibu dealer's service department.



Never operate the heater within a confined space. This includes with a canvas cover over the cockpit or bow area, with the stern of the boat in a shallow area, or at the dock/shore with other boats or docks close by. Any situation in which exhaust fumes are trapped or limited in disbursement could result in carbon monoxide fumes within the deck. Carbon monoxide poisoning is addressed in the *Safety* section of this Owner's Manual and should be avoided.

Models: (Optional) All models.

Tower, Canvas & Accessories

G3.5 Tower



The standard tower on Wakesetter is the G3.5 tower. The G3.5 can be raised to its full height for extraordinary boating enjoyment, or lowered for towing and storage.

On each interior side of the tower legs is a large lever. During operation, the lever must be secured on each side as shown, in the locked position.



WARNING

Always ensure that the lever on each side is **secure** prior to any outing. If a lever is left unsecured, the tower will

become unstable and could fall on individuals, or become dislodged while towing if the tower is upright. Failure to turn the handle until it tops when unlatching the tower can cause latch damage by failing to activate the cam inside the latch. This could result in damage that may not be covered under warranty, and you will be unable to lock that side of the tower when it is in the UP position. This is potential very dangerous and could result in the tower falling on individuals on-board. Also, in opening and closing the lever, take care to avoid pinching fingers, hands or parts of the body.

To raise or lower the tower, Malibu strongly recommends a second person to help steady the tower into position. The tower's weight could cause loss of control, resulting in damage to the boat or potential injury to person(s).

NOTICE

A second person to assist in raising or lowering the tower is strongly recommended.

Due to the weight and angle of the tower, a lone individual could lose control, resulting in damage to the boat, which is not covered under warranty, and/or injury to people in range of the tower's movement.



Models: The G3.5 tower is standard on all Wakesetter models. It can be deleted by the purchaser at the time of order. Due to the complexity of mounting the tower, and how critical it is to the boat's stability that it be mounted in the proper location, as well as requirements for any electrical wiring, Malibu does not recommend the addition of a tower and tower accessories after the boat has been delivered. Adding any tower other than a Malibu-built tower to a boat will void the warranty. If Malibu tower accessories are added to the tower after the build process, it may be necessary to upgrade the internal tower shock absorbers to accept the additional weight and perform as designed. This kind of upgrade should be done only by an authorized Malibu dealer.

Adding any tower to a Malibu boat other than a Malibu-built tower will void the warranty. Due to the

NOTICE

complexity of adding a tower, the stresses on the deck and the potential for injury if the tower fails, Malibu strongly discourages the addition of a post-boat-construction tow-

er. If Malibu tower accessories are added to the tower after the build process, it may be necessary to upgrade the internal tower shock absorbers to accept the additional weight and perform as designed. This kind of upgrade should be done only by an authorized Malibu dealer.

GX Tower



With the battery switch ON, push the button on the side of the GX tower to turn on power to the tower.



When there is power at the tower location, the light will be ON.



Rotate the adjacent knob **counterclockwise** to **raise** the tower.



Rotate the knob **clockwise** to **lower** the tower.



When neither raising nor lowering the GX tower, turn the power to the tower OFF.

Leaving the power on will make the tower susceptible to raising or lower unexpectedly if the knob is accidentally moved in either direction. In the process, the tower could hit individuals onboard the boat in the deck area, potentially causing serious injury.

Models: (Optional) *All Wakesetter and M235 models.*

Tower Accessories

Following are descriptions of a variety of optional accessories that can be added to the G3.5 tower, depending on packages and availability. It is important to note that the towers were designed to accommodate only the specified options. Other aftermarket options may not work properly due to the electrical harness requirements. The towers can also hold only a limited amount of weight. Exceeding that limit can cause failure of the tower, which could lead to injury to people on board or people using the tower to ski or wakeboard. No additional weight should ever be added to the tower.



No components should be added to the Malibu tower beyond what is specified by the company. Other after-

market items may not be acceptable due to electrical, electronic or other wiring and power-related issues. The tower weight limit may be exceeded by adding aftermarket items. Such weight limits can also cause the tower to fail, which could result in damage that is not covered under warranty, as well as serious injury or even death to persons on-board. Never suspend any additional items from the tower. No one should ever be allowed to sit or stand on or hang from the tower. The design will not support such activity and, again, could result in serious injury or death.

Tower Lights

The optional tower lights provide a wide area of lighting off the transom. These can also serve as flashing indicators for Surf Gate transfer timing. On the G3.5 tower, there are four lights. All are controlled through the video screen. See additional information in the *Dashes and Video Screens* section of this Owner's Manual.

Bimini Top

One of the most popular options is the Bimini top, which provides protection from the sun for the driver, observer and may also offer shade to others on-board, depending on the sun's angle. It also provides storage for ropes. The deluxe version also offers surfboard storage.

The canvas cover requires thorough drying prior to the boat being stored. See the *Care and Maintenance* section of this Owner's Manual for additional information.

G-Force Icon 8 or G-Force Rev 8/Rev 10 Speakers with Horn

Wet Sounds' eight-inch tower speakers with tweeters offer full mid-bass sound and clean detailed highs. The Malibu-designed G-Force enclosure features waterproof connectors and optional swivel mounts on the Icon 8. The speakers are powered by a 500-watt amp. The Rev 8 speakers can also be teamed up with amps.

Read the *Dashes and Video Screens* section of this Owner's Manual for additional information about the speaker operation. While the ICON Rev 8 is available as an option for all Wakesetter, the M235 offers the ICON Rev 10 as an option. Some dealerships may offer the Rev 10 as an option on the Wakesetter.

G3.5 PTM Clamping Spinner Board Racks or Ski Rack

These aerospace-grade, anodized-aluminum swivel racks are corrosion-resistant and ratchet down with a slight tug on the single lever, securing the wake items. Be sure that boards are securely in place prior to operating the boat, as they can become projectiles if they are not. Also, remove boards and stow inside the boat before trailering. Highway speeds can cause damage even if the boards are secure on the rack.

The ski rack accommodates two slalom skis with easy-access bungee forks to free up storage areas on-board. The ski racks can be mounted on either the port or starboard side of the tower, or on both.



Secure boards and/or skis on the rack prior to operating the boat. If they are not secure, the boards and/or skis may come off the rack and become projectiles that could damage the boat or hurt individuals. Remove them from the racks and stow in the boat when trailering. Even if secured on the racks, highway speed can cause damage to the boards, skis, tower or boat, or even cause them to become loosened from the racks. Spinner racks should be locked prior to towing.

G3.5 Tower Mirror

Housed in an aluminum billet with an adjustable arm, the optional mirror offers high-definition, prescription-grade optics with a 140-degree field of view.

The mirror is adjustable by way of a clamp on the tower. The mirror should be removed and stowed in a storage compartment inside the boat if the boat will be towed any substantial distance.

Models: (Optional) *These accessories are available as options on all Wakesetter models. They may be supplied as part of a package.*

On and Under the Water

Blower System

One of most critical elements of the boat is the blower system. There are important things to remember when operating the boat:

Always operate the blower for several minutes prior to starting the engine, ensuring the engine compartment is open. This should also be done when idling or running at low speed. This allows the disbursement of fumes that otherwise allowed to accumulate could result in an explosion.

The blower is controlled from an ON-OFF switch on the 7" Malibu Touch Command (MTC) screen. (See *Dashes and Video Screens* section of this Owner's Manual for more detail on how to operate the system.) **The blower should come ON automatically when the system is first powered up from the ON-OFF power button.** However, operators should always verify that the blower is ON and operating rather than relying on the automatic ON.



Always operate the blower for several minutes (at least four [4] minutes) prior to starting the engine, running

at a low speed or at idle. This must be done with the engine compartment open. Failure to perform this neces-

sary function could result in an explosion of the accumulated fumes within the compartment, resulting in serious injury or death.

The blower system vents carbon monoxide, a naturally occurring by-product of the engine and drive train operation, through the exhaust manifold, muffler, exhaust lines and flap, which combine to remove dangerous carbon monoxide and other naturally occurring toxic by-products from the engine and drive train operation. The emissions primarily are eliminated through the exhaust flap(s) located beneath the swim platform. Although much of the exhaust is disbursed into and through the water, fumes still reach the swim platform and transom area of the boat, including WakeView seating and the sun pads. Therefore, no one should ever be on the swim platform, transom seating or sun pads when the engine is operating.



Never allow anyone to be on the swim platform, transom seating or sun pads when the engine is running. Carbon monoxide fumes are colorless and odorless. Illness and death can result from breathing fumes, even before a



person is aware of breathing them. See the *Safety* section of this Owner's Manual for more information regarding this critical matter.

Always allow the exhaust manifolds to cool before touching them. (The manifolds are on the upper side of the engine on both sides.) Engine operation will result in the manifolds becoming very hot, and touching could result in burns to the skin.

NOTICE

All engines are equipped with catalyst exhaust manifolds that may produce an unusual odor. This is typical of engines with a catalytic converter exhaust system. If you are uncertain about any odor, do not hesitate to contact an authorized Malibu dealer for assistance in determining the cause and potential for concern.

The boat is also equipped with a natural air-intake that forces air through a ventilation system on the deck of the boat. This channels air from the bilge to the transom vent.

With proper maintenance, which is the responsibility of the boat owner and/or operator, the ventilation system works efficiently and protects the people on-board from dangerous fumes. Follow the maintenance requirements as indicated in the *Care and Maintenance* section of this Owner's Manual.

Never operate the boat if you or anyone on board suspects that the exhaust or fuel system is not performing as designed.

Bilge System

Another critical component in the safe operation of the boat is a properly functioning bilge system. The bilge is a void between the deck and hull in which unintended water accumulates as it is drained from other areas of the boat. (It does not include the water in the ballast system, which is deliberately added to the boat and must be dealt with separately.)

As noted in the *Care and Maintenance* section of this Owner's Manual, the bilge should be routinely checked, and drained as necessary. The automatic function will often keep the system free of excess water. Too much water in the system can affect the boat's handling under operation, and can potentially swamp a boat, causing damage to other components in the bilge compartment.

There are two (2) bilge pumps in all boats. One pump is located in the center of the boat, directly below the center pie-plate. The second pump is located at the transom of the boat, aft of the engine on the port side.

Bilge pumps can be turned ON manually or automatically. To turn ON the pump manually, use the switch on the MTC screen. See the *Dashes and Video Screens* section of this Owner's Manual for addi-

tional information on operation through the screen. The bilge pumps are also equipped with a sensor to automatically trigger instant-on if water is sensed around the pump. This functions at all times. The automatic mode will always be activated, even if the battery isolator switch is turned to the OFF position. Therefore, be certain the pump is working properly and there is no kink in the output hose before storing the boat for long periods of time since the bilge pump will continue to run as long as it senses water. Otherwise, this could cause a battery to drain and could ultimately damage the pump over time.

Operators should always check that the drain plugs are installed and secure prior to every operation!



Drain plugs must always be checked to be certain they are SECURELY installed prior to every outing and operation. Visual indicators are not validation that the plugs are installed, but rather serve only as assistance in the process. Failure to install the drain plugs will allow water to intrude into the boat and can result in flooding, swamping and sinking the boat. Such action could result in damage to the boat that is not covered under warranty, as well as serious injury or death to persons on-board.

NOTICE

After manual operation of the bilge is complete, return the switch to the automatic position. If it is left in the manual position and there is insufficient water in the bilge to pump, the bilge pump will cause it to eventually fail, and such action is not covered under warranty. Malibu recommends testing the function of the bilge pump prior to each use of the boat. This can be done by simply turning the pump(s) on and making sure they are running.

There will likely be a small amount of water in the bilge at all times as the pump cannot eliminate 100% of water. A minor amount of water is acceptable. However, operators should monitor bilge water levels through the center access drain plug. In all models, this hole is located in the center of the deck near the driver's helm. (It may be under carpet or a mat.) It should remain secure during operation and opened when the boat is stationary and the engine not running. **Be certain to close the drain plug before operating the boat again.** Since the threads on the plug can sometimes be misdirected when securing, double-check. Individuals on-board could trip and injure themselves if the drain plug is not secured properly.

All boats are equipped with two (2) drain plugs, a 1/2" drain plug on the transom and a T-handle drain plug in the center of the boat.



The ½" drain plug can be accessed outside the boat, directly under the swim platform on the center back of the transom. The T-handle can be accessed inside the boat through the center access. Be certain to read the above information regarding **SECURELY** installing drain plugs prior to all outings.

The transom plug is located in the center of the transom at the bottom edge.

NOTICE

The bilge system plugs should be removed at the conclusion of any boating outing in which the boat is removed from water. This assists in the draining process. Malibu recommends keeping the handles stored in a designated storage compartment on a routine basis so that they are always easy to locate prior to the next outing. Never launch a boat without **ALL** the drain plugs reinstalled; this should be part of the routine checks prior to

launching the boat into the water. Failure to reinstall the drain plugs will result in water entering the bilge system and can sink the boat.

NOTICE

Automatic bilge systems require a small amount of electrical charge, which is drained from the battery or batteries on-board. Eventually, the battery could become fully discharged, which means that the automatic bilge will no longer work. If the boat is left in a body of water during this period and water continues to enter the bilge system, water is not drained. This could lead to damage to components in the bilge and potentially to the rest of the boat. Such damage is not covered under warranty. Therefore, if a boat will be left unattended for a period of time, owners/operators should make regular checks of the system to ensure that the battery retains a charge.

During storage or winterization, the batteries should be removed. This will cause the automatic bilge system to be temporarily inoperable. This adds to the importance to never leave the boat in a body of water without a fully charged battery installed.

Because of the frequent use of the bilge pump and its importance to the safe operation of the boat, the bilge pumps, which are located in the center bilge area below the pie plate and engine (aft) area, should be checked by an authorized Malibu dealer as part of an annual maintenance routine.



If the bilge system is not operating properly when a boat is launched, DO NOT continue with the outing.

If the bilge system ceases to function properly during an outing, have all persons on-board put on a PFD if they are not already wearing one. Return to shore immediately and disembark. Without a properly functional bilge system, the boat is in danger of sinking, placing all on board at serious risk.

Ballast System

Malibu's Quad Hard-Tank ballast system is the best, most discrete way to add significant weight or balance out your load to create the exact wake or wave you desire. Ranging from a total of 1,250 pounds to 1,450 pounds, the hard-tank ballast more than meets the need.

Hard tanks don't collect mildew on the outside and add to the maintenance requirements. Because the tanks are housed under the floorboard, storage is not compromised. The tanks also provide accurate level readings, which are displayed on the MaliView 12" display screen.

All Malibu boats are equipped with at least three (3) ballast tanks and have an optional bow tank, plus optional plumbing for Plug 'n Play.

NOTICE

Optional plumbing for Plug 'n Play bags is available at the time of the original boat order. Malibu recommends choosing bags from a Malibu-approved ballast bag list for the corresponding model year (dealers have a list available). When bags from the approved list are used the bag weight does not need to be subtracted from the total boat capacity as that is already included. However, if bags are used that are not on the approved list, weight must be subtracted from the total weight capacity. Weight distribution must also be considered. Exceeding the weight limits can lead to damage to the boat, and possible sinking.

Most of the ballast system is invisible to the consumer, but its effects are obvious and enjoyable. The tanks are located beneath the deck in locations that will assist in balancing the added weight of the water. However, in boats equipped with Surf Gate, adjustments can be made to boat balance that will allow additional wake from either side of the boat in a safer manner than would be done by shifting passengers and/or gear on-board. See more information on Surf Gate later in this section.

The tanks are filled and emptied by pumps that are controlled through the video screen. See the *Dashes and Video Screen* section of this Owner's Manual for details about how to properly fill and empty the ballast tanks. On the 12" MaliView, the user has control to fill or drain each tank to specified set levels, one tank at a time or fill/drain all with a tap of one button on the screen.

Be sure to empty the ballast tanks prior loading the boat onto the trailer and removing the boat from the water. Tanks **MUST** be empty prior to trailering the boat as the additional weight can cause damage to the trailer, tow vehicle and imbalance on the trailer that could affect safety, or overload the trailer and cause damage that is not covered under warranty.



Water in the ballast tanks should always be pumped out prior to removing the boat from the water. Never trailer

the boat with water in the ballast tanks; residual water can cause an imbalance that alters the amount of weight on the trailer tongue. Without the proper weight percentage forward, the trailer tongue can become unstable and cause loss of control of the trailer and tow vehicle. Additionally, attempting to trailer your boat without the ballast tanks and/or bags emptied can overload the trailer and cause damage that is not covered under warranty.

NOTICE

Boats that are going to be stored for more than a couple of weeks or prepared for winter, must have all of the water removed from the ballast tanks. Failure to do so can result in damage that is not covered under warranty.

When emptying the ballast tanks, watch the outlets on both sides of the boat and aft, depending on the model and number of outlets. (If you are uncertain, check with your authorized Malibu dealer for assistance in determining the bilge outlets from the ballast outlets.) Ballast pumps will continue working as long as the controller is ON. Therefore, operators must ensure that the pumping is turned OFF when the outlets show only a minute amount of water is coming out. Leaving the pumps ON will result in pump damage.

If the boat is equipped with additional ballast bags, Malibu recommends rechecking that the rear tanks are empty five (5) minutes after starting the drain process. This verifies that no extra water was left in the bags and has drained into the hard tanks.

NOTICE

Ballast pumps must be turned OFF after emptying the tanks. When only a drizzle of water is coming from the outlets, manually turn OFF the ballast pumps, via the 12" MaliView screen. Allowing the ballast pumps to continue operating when there is no water to be pumped will result in the internal components being permanently damaged, which is not covered under warranty.

Models: All Wakesetter models are equipped with ballast systems, per the customer's order. The optional plumbing for Plug 'n Play must be part of the original order.

Power Wedge III

The Power Wedge III has up to 1,500 pounds of wake-creating water displacement. The upward angle radically increases lift, allowing the driver to get a fully loaded boat on plane much more quickly. The Power Wedge III is teamed with Surf Gate to maximize the wake experience.

The Power Wedge III is controlled through the video 12" MaliView touch screen as explained in the *Dashes and Video Screen* section of this Owner's Manual. The Power Wedge can also be controlled by the optional Rotary Control Knob offered in the Sport Package; the optional Steering Wheel controls; or the optional Surf Band. Because the water displacement affects how the boat handles, Malibu recommends practicing operations with the Power Wedge III and/or Surf Gate before deploying with riders/boarders/surfers behind the boat.

The Power Wedge will not return to "stow" unless the boat speed is above one (1) mph and below ten (10) mph. Always verify there is no person or object around the Power Wedge while it is stowing. If an object is obstructing the process, damage or injury could occur if caught between the wedge and the transom. The Power Wedge III has a pressure relief valve to allow the wedge to move manually and freely in the event of a fault. Information on how to use the pressure relief valve is provided in the *Care and Maintenance* section of this Owner's Manual.

NOTICE

Never stand or sit on the Power Wedge III plate or place objects on it. Never use the Power Wedge III to mount the transom. The Power Wedge III cannot sustain added weight on it, and subsequent damage to the Power Wedge III or transom of the boat as a result will not be covered under warranty.

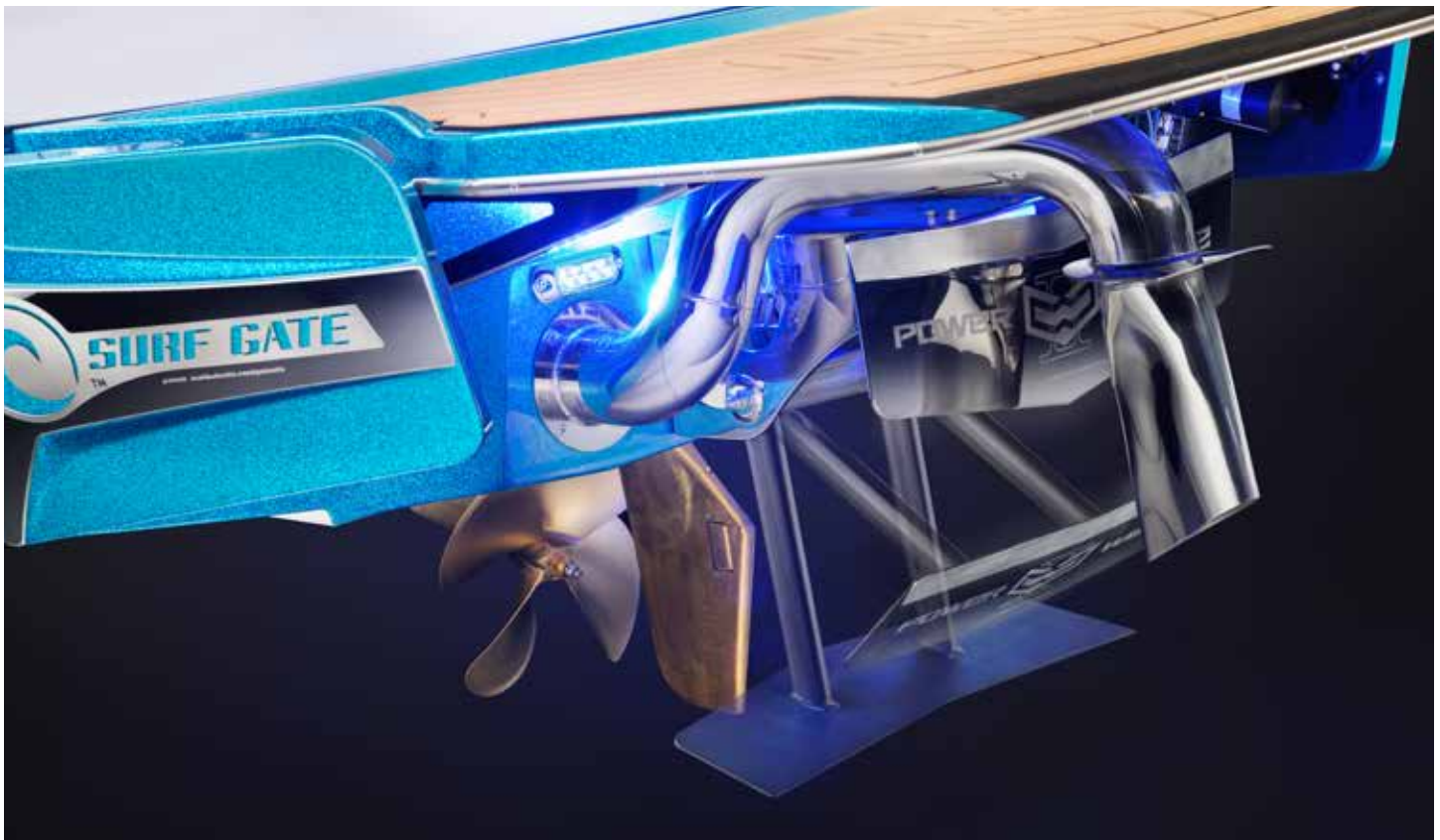

There is a breaker board in the port rear closeout adjacent to the engine compartment. The black board contains four (4) breakers. If the Power Wedge III will not operate, verify that the supplemental breakers located in the port rear storage compartment are properly set.

Note that the Power Wedge III should always be retracted when not in use.

Models: *The Power Wedge III is standard available on all Wake-setter models.*

SURF GATE®

Surf Gate, especially when teamed with the Power Wedge III, offers the most innovative wake-production in the industry. As with the Power Wedge III, control of the two transom-mounted gates is through the 12" MaliView touch screen as explained in the *Dashes and Video Screen* section of this Owner's Manual. The Surf Gates can also be controlled by the optional rotary control knob offered in the Sport Dash; the optional steering wheel controls; or the Surf Band.

The gates are controlled by selecting the desired surf side of the boat (port/left or starboard/right). When a gate is deployed, the actual desired surf wake will be created on the opposite side of the boat. For example, when the left wake is desired, select the left arrow; the right/starboard gate will be the gate that will deploy. The gate will deploy only between the speeds of seven (7) mph and thirteen (13) mph. While the boat is underway, the surf wake can be transferred from one side to the other in less than three (3) seconds. While the transfer is occurring, there is an indicator horn on the transom that signals to boarders/surfers when the surf wake is about to transfer from one side to the other. There is also an indicator light, offered with the optional tower light package, that will also indicate the surf wake is transferring. This can be deactivated as explained in the *Dashes and Video Screen* section of this Owner's Manual.

Because the gates can function independently of each other, it is important for people on board to pay attention to how the boat is leaning. Unlike earlier methods for creating a surf wake, with Surf Gates the surf wake will be at optimal performance when the boat is weighted evenly. If too much ballast, gate and passengers are loaded to one side or the other, it could create an unstable situation in which the boat could become swamped. Always use common sense and good judgment in adjusting weight on and in the boat.

The Surf Gates have a pressure relief valve, similar to the Power Wedge III pressure relief valve, which allows the gates to move manually and freely in the event of a fault. For information on how to use the pressure relief valve, refer to the *Care and Maintenance* section of this Owner's Manual.



Pay attention to how the weight is distributed on and in the boat at all times, particularly when engaged in water sports. Too much ballast, gate and passengers to one side of the boat could create an unstable condition that could create an unsafe situation for all. Even in making waves, care must be taken to put safe operation first.

Never place objects on a Surf Gate or try to use a Gate to support a person's weight. The Surf Gates are not manufactured or mounted to accept additional weight.

NOTICE

Never add any weight to a Surf Gate, nor use one to hold a person's weight. The Surf Gate cannot sustain added weight on it, and subsequent damage to the Surf Gate or transom of the boat as a result will not be covered under warranty.

The Surf Gates should always be retracted when not in use.

Models: (Optional) *The Surf Gates are standard on all Wakesetter models.*

Underwater Gear (Rudder, Fins, Strut, Propeller, Paddlewheel, Raw-Water Intake/Sea Strainer, and Bow Thruster)

Beneath the boat are several critical components for the proper and safe operation of the boat. In general, consumers do not have to give these items attention beyond routine checks and maintenance, but if any of them are damaged, it can result in a truncated outing.

Rudder: The rudder is part of the steering system. The steering wheel turns the rudder in the direction that the driver wishes to steer. More information about the steering system is available in the *Starting and Operation* section of this Owner's Manual. Note that the rudder extends below the hull of the boat. This is critical to remember when boating in shallow water or water with obstructions. Even if the water appears deep enough for the hull, it may not be deep enough for the rudder to pass unimpeded.

NOTICE

Do not operate the boat in water too shallow for the rudder to operate. Obstructions can also damage the rudder, rendering it inoperable. Such damage is not covered under warranty.



Fins: On some models, fins may be added as an option. The fins add tracking stability. As with the rudder, they extend below the hull and should be considered when boating in shallow water.

Struts (and Strut Housing): The strut and strut housing are fitted from the drive train to the propeller to create the propulsion that moves the boat forward and aft. As with the rudder, these components extend below the hull. Operation in water that is too shallow or among obstructions can damage the components and make it impossible to continue boating until fixed.

NOTICE

Do not operate the boat in water too shallow for the strut, strut housing and propeller to operate. Obstructions can also damage these components, rendering them inoperable. Such damage is not covered under warranty.

Propeller: Different conditions, including altitude or specific characteristics of individual bodies of water can impact boating enjoyment. If environmental conditions are suspected of negatively impacting performance, discuss this with an authorized Malibu dealer, who may be able to recommend minor changes to the propeller, or replacement of a propeller at the consumer's choice and expense, that will improve circumstances for that particular application. There are limits to changes that are approved by Malibu engineers. Changes that exceed those standards will void the warranty. Extreme changes can also alter the safe handling of the boat and its maneuverability.

NOTICE

Consumers may choose to change characteristics of propellers or even replace them. Malibu recommends doing so only after consulting with an authorized Malibu dealer as exceeding Malibu standards for the propulsion system will void the warranty.

Never allow anyone to be in the water forward of the bow or behind the boat when the boat engine is running, even if the boat is in neutral gear. If the shifter/throttle is inadvertently put into gear, the boat could potentially run over persons in the water. A moving propeller is extremely dangerous and could cause serious injury or death.



Care must be taken to avoid being in the water forward or aft of the boat when the engine is running, even if the boat is not in a moving gear. If the shifter/throttle goes into gear, there may not be time for people to get out of the way. Propeller edges are sharp. With motion, propellers can maim or become lethal.

Paddlewheel: There are two sources for speed that provide speed information to the Command Center or speedometer of the boat: the paddlewheel and GPS (both are standard). The method to switch between speed sources (paddlewheel and GPS) is explained in the *Dashes and Video Screen* of this Owner's Manual.

Because this affects the cruise control, be sure that the paddlewheel and GPS operation is unimpeded. To verify GPS operation is correct, verify that the GPS puck has a clear line-of-site to the sky. This is located in front of the 12" screen in the center of the dash.

Raw Water Intake/Sea Strainer: The raw-water intake brings water out of the lake or river for cooling circulation in the engine. (It is circulated and returned to the body of water via the exhaust system.)

Both the paddlewheel and raw-water intake/sea strainer must **ALWAYS** be free of debris. Any boating that takes place in brackish water or water with flora, should be interrupted periodically to be certain that no weeds have become tangled with anything under the hull. See the *Care and Maintenance* section in this Owner's Manual for information on how to properly remove debris from the raw-water intake/sea strainer.

NOTICE

Debris in the body of water, including naturally occurring vegetation, can become entwined with the components under the hull. This can result in damage to the boat, particularly if the debris interferes with the raw water intake, starving the drive train of necessary cooling water. Such damage is not covered under warranty.



Bow Thruster: The bow thruster (available only on the 24MXZ) is a propulsion device to aid in safer docking. Maneuvering in tight locations is easier by allowing the operator to turn the boat to port or starboard without forward motion. The 24MXZ utilizes a tunnel-type bow thruster that is operated by a switch on the shifter/throttle.

The bow thruster will operate only when the boat engine is running. Push the rocker switch on the handle **UP** to direct water out of the starboard side of the tunnel, **which causes the bow to move to port (left)**. Pushing the rocker switch on the handle **DOWN** will direct water out of the port side of the tunnel, **pushing the bow to the starboard side**.



Models: These components are standard on all boats, except the fins, which are an option available for all models and the bow thruster, which is available on the 24MXZ.

Shower

The shower control panel is located in the starboard motor-well storage area. The panel has an ON-OFF toggle switch. In the ON position, the knob rotates to the left for more hot water, and to the right to add colder water to the mix.

The shower nozzle pulls out of the deck at the transom. Twist the nozzle **counter-clockwise** to **start** the stream of water. When finished showering, twist the shower nozzle **clockwise** to turn it **off** and return it to its retracted position. Reset the shower control knob to the center and then turn OFF the switch.

Note that the hot water comes from the engine manifold, and the cold water is brought on-board through the starboard rear ballast tank's fill pump. The hoses connect to a pump that is located inside the engine compartment, aft of the engine and secured to the transom. The shower wand/nozzle connects to that pump.

Leaving the shower running can result in extra water intruding into the bilge compartment. This can cause issues that are addressed in detail in the *Bilge* information provided in this section of the Owner's Manual. Please review that information prior to using the shower, especially the first time.

Extended use of the shower can also result in excessive discharge from the battery, which could leave the boat non-operational, and could also potentially damage the bilge pump, rendering it non-operational. If the bilge pump does not operate, excessive water in the bilge system could sink the boat.

Showers should be as brief as possible. To have hot/warm water available, the engine must run, but as noted in many sections of this Owner's Manual, the engine has carbon monoxide as a by-product of running the engine for any period of time. The exhaust gases are released from the transom area, but even when released below the water line, those gases will work their way to the surface. The danger of breathing carbon monoxide fumes is addressed throughout this Owner's Manual, and should be viewed with the utmost caution by everyone on-board.





Avoid running the boat's engine if at all possible while anyone is on the swim platform or sun pad. Exhaust

fumes are emitted from beneath the swim platform and the odorless, colorless carbon monoxide can sicken or kill before individuals are aware there is danger. If water for the shower needs to be heated, run the boat engine as briefly as possible, and shower quickly. NEVER shower for lengthy periods of time as one might on-shore. Move away from the swim platform and/or sun pad as soon as the shower is turned off and stowed, to allow time for the fumes to dissipate.



Even if people are not on the sun pad or swim platform to avoid CO fumes, do not leave

the shower running. Turn off as soon as possible. Leaving the shower running can result in damage to the pump, which is not covered under warranty. Excess water in the bilge system as a result could also swamp the boat, resulting in sinking, which could endanger the lives of all on-board.

Models: (Optional) Available as an option on all models.

Flush Kit

Prior to using the flush kit, clean water must be added from on-shore. Run a garden-type hose from the clean-water source to inlet on the port side of the deck, outside the engine well storage compartment. Attach securely, but do not over-tighten. Fill the tank, then remove the hose and replace the fill cap on the inlet.



The control panel for the flush kit is located in the starboard engine well storage compartment. Attach the wand nozzle to the control panel. Turn ON/OFF via the toggle switch. Water ejects only when the handle grip is squeezed. Do not squeeze until you have aimed the wand.

If all the water in the holding tank is used **IMMEDIATELY** release the handle and turn OFF the toggle switch. Damage can occur to the flush kit system if the pump runs without water moving through the system. Remove and store the wand/nozzle until used again.

NOTICE

The flush kit switch should ALWAYS be in the OFF position when there is no water in the tank. Allowing the pump to run without water can result in damage to the system, which is not covered under warranty.

Swim Board and Ladders

The swim board provides additional enjoyment of the Malibu experience. While the swim platform, along with the optional under-swim platform ladder and bow ladder, can ease movement in and out of the water, Malibu reminds users to exercise caution. When jumping off the boat, always be absolutely certain that there is sufficient depth. Appearances can be deceptive, especially in clear water. When using the ladders, use the steps with care to avoid slipping or falling. Although the swim board is constructed with anti-skid properties, it is still the responsibility of users to use care when walking on it, using it to get on, using it to get into the cockpit, standing or sitting on the swim board.

As noted multiple times throughout this Owner's Manual, never allow anyone to be on the swim board or ladders when the engine is running due to exhaust fumes.



Never allow anyone to be on the swim board or ladders when the engine is running, even at idle. Exhaust fumes can quickly overcome individuals, leading to serious injury or death. More information is available in the Safety section of this Owner's Manual.

Additional information regarding the routine maintenance of the swim board is available in the *Care and Maintenance* section of this Owner's Manual.

Models: All Malibu boats are equipped with a swim board. Under-swim board ladders and bow ladders are optional on some models.



Salt Water Series

Boats that will be operated in salt water—or brackish fresh water—require several alterations to ensure that they will continue to operate properly. While care and maintenance are critical for all boats, those that are run in salt water require even more attention to detail.

Salt or polluted fresh water can quickly damage the boat, including corrosion that may result in a serious threat to the well-being of boaters.



Boats that have been operated in polluted fresh water or salt water should be thoroughly rinsed with clean, fresh water after an outing. The corrosive properties of salt water can cause damage that is not covered under warranty. Hardware that is damaged by brackish or salt water can eventually fail, which could cause malfunction of the hardware, even hardware chosen for its anti-corrosive properties, and/or the components that are held in place by the hardware, which could result in serious injury or death to persons on-board.

Among the components that are changed or adjusted for operation in salt water during construction are:

- Stainless steel gas shocks;
- Grounding and bonding of all components below waterline;
- The addition of sacrificial zinc anodes.



One of the most important salt-water components is the sacrificial zinc anodes. These are attached to the exterior of the boat, below the water line.

The purpose of an anode is to be sacrificial. There is a greater degree of attraction between the anode's metal and the corrosive action of the salt water than between the boat's metal parts and the water. In the most simplistic terms, both rust (oxidation) and metal reduction are the effects of operating in salt water. To reduce these naturally occurring results on boat components, the sacrificial anodes attract and reduce most of the effects.

IMPORTANT NOTE: The sacrificial zinc anode does not totally eliminate the corrosion process. Therefore, it is important to flush and rinse the boat after use.

As part of the routine maintenance, regularly check the anodes, which are located on the transom, driveshaft and rudder, where equipped. Verify with your authorized Malibu dealer the appropriate reduction at which it is time to replace the anode.

NOTICE

Reduction of the sacrificial zinc anode as a result of operation in brackish fresh water or salt water conditions is normal as it protects to some degree the rest of the boat. Replacement of the anode is considered part of the routine maintenance procedure and is not covered under warranty.

Models: (Optional) *The Salt Water Series is available on all models.*



A close-up photograph of a boat trailer's metal frame. The frame is made of silver-colored metal bars. A white plastic component, possibly a support or a part of a winch, is visible on the left side. The background is dark and out of focus.

TRAILERS



malibu
X-D
SERIES

MALIBU TRAILERS

Reporting Safety Defects

If you believe that your vehicle has a defect which could cause a crash or could cause injury or death, you should immediately inform the National Highway Traffic Safety Administration (NHTSA) in addition to notifying Malibu Boats, LLC.

If NHTSA receives similar complaints, it may open an investigation, and if it finds that a safety defect exists in a group of vehicles, it may order a recall and remedy campaign. However, NHTSA cannot become involved in individual problems between you, your dealer, or Malibu Boats, LLC.

To contact NHTSA, you may call the Vehicle Safety Hotline toll-free at 1-888-327-4236 (TTY: 1-800-424-9153); go to <http://nhtsa.safercar.gov>; or write to: Administrator, NHTSA, 1200 New Jersey Avenue SE, Washington, DC 20590. You can also obtain other information about motor vehicle safety from <http://www.safercar.gov>.

Legal Requirements for Towing

Be aware that many state and local jurisdictions in North America have specific laws and/or ordinances regarding towing. It is the operator's responsibility to research and become familiar with specific requirements that are in effect in the areas in which you will be towing. Information is often available online, but you can also contact your area's motor-vehicle office for direction and details.

If you will be taking your boat and trailer on vacation or to an outing in another jurisdiction in which you do not regularly tow, it is necessary to determine the appropriate laws for that area. Law enforcement officers will expect you to have knowledge of applicable laws and ordinances.

Laws can cover, but are not limited to, such components and matters as lights, brakes, safety cables, driver's license requirements, trailer licenses and permits, and overall size.

Some areas may also have insurance requirements. Determine whether you must carry liability insurance specifically for towing. If you have financed your boat and/or trailer, your lender may also require full coverage. This is also your responsibility to determine and to secure as needed. Malibu Trailers do not assume any responsibility for your knowledge and confirmation that the requirements have been met.

Basic Safety Rules

Make sure you understand all of the operating instructions prior to attempting to operate this trailer. Accidents are generally caused by the operator's failure to follow basic safety rules or written precautions. Most accidents can be avoided if the operator is completely familiar with the trailer and its operation, follows recommended practices, and is able to recognize and avoid potentially hazardous situations.

Failure to observe the safety recommendations contained in this manual may result in severe personal injury or death to you or to others. Use caution and common sense when trailering. Don't take unnecessary chances! Basic safety rules are outlined in this section of the manual.

Malibu strongly encourages people towing to read all safety material available, and to become familiar with laws and ordinances pertaining to towing and driving within applicable jurisdictions. It is advisable to also pay attention to insurance requirements and to fully insure the trailer, boat and prepare for any potential liability. Review the tow vehicle's owner's manual as well, prior to operation and towing.

CONNECTION TO THE TOW VEHICLE

Preparation

Never tow the trailer and contents, including the boat, behind a vehicle that is not rated to tow this weight. Also be certain that the tow hitch is correct. Additional information follows regarding this important factor.



The Gross Vehicle Weight Rating (GVWR) is the total



estimated weight that a road vehicle loaded to capacity (including the vehicle weight itself) can be expected to tow safely. This also includes the trailer, boat, engine, any liquids including fuel, and items carried on and in the tow vehicle and the boat. This is a maximum established by federal mandate and enforced by law enforcement authorities. Overloaded capacity can cause the trailer to disengage from the hitch, which could result in serious injury or death, in addition to damage that is not covered under warranty.

On the left front side of the trailer is a certification label that shows the maximum load-carrying capacity of the trailer. The GVWR will be indicated on this label.

⚠ WARNING

Never tow with water in the ballast or bilge systems! All water must be released prior to loading the boat on the trailer. Water on-board can cause an imbalance on the trailer that further heightens the likelihood of an accident due to loss of control when there is insufficient percentage of weight at the tongue and hitch.

⚠ WARNING

Remove wakeboards and skis from above the boat deck (i.e., from the tower). Even with careful attachment to the racks, these paraphernalia can disconnect and become projectiles that threaten other vehicles following.

Trailer Hitch

A weight-carrying hitch should be used for towing a Malibu trailer. No other hitch type meets the requirements for safely operating the trailer. The tow vehicle may have requirements regarding an acceptable hitch, so verify by reading the tow vehicle's owner's manual for direction. A weight-distributing hitch can be used, particularly in an emergency, but it will not allow the Malibu trailer's brakes to operate.

Hitch up with the trailer in a level position to the tow vehicle. Note that attempting to tow with a trailer that is not level across the length of the trailer could either cause the brakes to prematurely activate or not activate at all, potentially causing a loss of control.



WARNING

Verify that the entire length and width of the trailer is level. If the trailer is not level, it can either cause the

brakes to activate or not activate at all, which could cause loss of control of the vehicle.



If the hitch height is incorrect and does not allow the trailer to be level, it may be necessary to install air-pressure adjustable shock absorbers on the tow vehicle. If a weight-distributing hitch is installed, change out to a weight-carrying hitch instead. Or consult with the tow vehicle manufacturer's authorized dealer for other assistance.

In general, for Class 3 rigs (3,500-5,000 lbs.) a two-inch (2") ball is required. For Class 4 rigs, (5,000-10,000 lbs.) a ball of two inches (2") or two-and-five-sixteenths (2-5/16") is required.

Safety Cables

The safety cables can prevent a trailer from totally disengaging from the hitch. If it becomes necessary in the future to replace the cables, ensure that the replacement cables meet the Society of Automotive Engineers (SAE) J684 standard for trailer hitching and coupling. The cables must match or exceed the trailer's GVWR.

Cables must be as centrally attached as possible to the bumper or frame of the tow vehicle. The hitch should provide a location through which the safety cables can be attached. Holes or rings should be on both sides of the hitch ball.

Most states require that the safety cables should be criss-crossed under the trailer tongue prior to being attached to the other hole or ring location. If the trailer should disengage, these cables should be able to prevent the trailer tongue from falling onto the tow surface.

The cables should be attached as tautly as possible but still allow for turning, including close-quarters turns.

The trailer also is equipped with a surge-brake breakaway cable. This cable, explained further in this Owner's Manual, must also be attached to the tow vehicle frame, securely but allowing for turns.



WARNING

Safety cables and the breakaway cable must be securely attached to the tow vehicle, while allowing for turns. Failure to do so could result in serious injury or death, as well as property damage to other persons and vehicles on the road if the trailer becomes disengaged from the tow vehicle.

A truck or van with a "step bumper" requires eye-bolt or equivalent safety cable attachment, which meets the Society of Automotive Engineers: SAE J684 Standard.

Breakaway Cable



If the cable clip is missing, or it has been broken by the cable being pulled, first check and attempt to release the emergency brake mechanism by pressing up on the brake release tab under the actuator nose, right behind the tow ball insert location. Press up on the brake release tab, and if a metallic clunk or sound of a spring releasing

is heard, that means the emergency brake mechanism had previously been engaged. When pressing up on the brake release tab, if it moves up and down freely with just the resistance of its spring, then the emergency brake system was likely not previously engaged.

Be sure the emergency brake mechanism is not engaged prior to towing. If the cable was pulled hard enough to break the clip on the cable, the cable and clip should be replaced and the actuator checked for proper function. Your authorized Malibu dealer can obtain a cable replacement kit that is specific to the actuator model used on your trailer.

Weight Distribution

A range between five percent (5%) to ten percent (10%) of the total weight on the trailer must rest at the coupling ball when the tongue is parallel to the ground. This determination can be made with a bathroom scale, provided you know the total weight of the trailer, boat and items on-board.

Some vehicle manufacturers limit tongue weight to a maximum

of two hundred (200) pounds when using certain types of weight-carrying, bumper-mounted hitches. Check the tow vehicle's owner's manual to determine the correct distribution.



Failure to properly distribute weight in the boat and across the trailer can result in the trailer fish-tailing (swaying from side-to-side) in a dangerous fashion that puts not only the total rig at risk but also other vehicles and persons on the road. Adequate download on the hitch ball is critical!

HOW TO CONNECT TO THE TOW VEHICLE

Attaching to the Tow Vehicle

- Open the coupler mechanism. (*Instructions follow.*)
- If necessary, use the trailer jack to have the trailer at the proper height, just above the height of the hitch on the tow vehicle.
- Hitch **ONLY** to a ball that is sized properly for the coupler.
- Back up the tow vehicle **SLOWLY** to the trailer. Many tow vehicles now have a back-up camera that makes this process easier, but it will still require practice. If you do not have a back-up camera, having a second person to offer hand signals can be helpful.



When using a second person to assist in the backing up process to hitch the trailer to the tow vehicle, always watch in your mirror. Do not allow the person to stand between the tow vehicle and the trailer as they can be struck by the vehicle or caught between the tow vehicle and the trailer. Such activity requires common sense and care to avoid injury.

NOTICE

Never move the trailer toward the tow vehicle. When the trailer is not fully hitched up, the brakes are not operational.

- Release the coupler latch. The hitch pin should fit easily into the hole. If it does not, this means that the latch is not completely closed. It will not close unless the coupler fits snugly over a properly sized ball. If the hitch pin is damaged or lost, it must be replaced prior to operating the rig.

WARNING

The hitch pin must be properly installed and secure prior to operation.

If it is damaged or missing, you can operate temporarily with a one-quarter inch (1/4") or five-sixteenths inch (5/16") shank padlock. Never operate without the hitch pin or padlock as the trailer and contents can become disengaged from the tow vehicle, which may result in serious injury or death.

To Open the Coupler

- Remove the hitch pin from the hole in the side of the coupler.
- On the standard Malibu trailer, push the button on the side. (Other trailers do not have the button.)
- While holding the button, raise the handle.



To Close the Coupler

- Place the coupler over the ball.
- Lower the coupler.
- Close the handle. An audible sound will be heard. If the handle does not close easily, the ball is not fully within the socket. **DO**

NOT FORCE the handle to close as it is likely that the ball is the wrong size and should be replaced.

WARNING

NEVER tow with the coupler handle open or partially open. If the handle will not remain closed, go back through the steps to ensure that it will close and stay closed. If you are unable to get the system to perform correctly, see an authorized Malibu Trailer dealer for assistance. Failure to get the coupler secure could result in the trailer disengaging, which could lead to serious injury or even death.

Hitching Up

- The coupler should easily unlatch, but if it does not, check to see if the ball is correctly sized, or if the trailer is parked on a hill, which will inhibit the ability to successfully open the coupler.
- After securing the coupler to the hitch ball, double-check that the hitch pin is properly installed and the coupler handle secure.
- Cross the safety cables under the coupling, allowing only enough slack to enable turning when the rig is in operation.
- Attach the breakaway cable under the coupling.
- Connect the trailer's seven-wire connector to the seven-wire connector of the tow vehicle and check that the lights are working correctly. (More information on the *Lights* follows in the *Trailer Components and How They Function* section of this Owner's Manual.)

CONNECTING TO THE BOAT

Trailer Winch

The trailer winch is a manually operated device to assist loading the boat onto the trailer and maintaining it in position for proper towing. The following information is important in assuring control and protection for you and the boat:



for loading puts undue strain on the winch strap and results in excessive wear.

- Check the straps prior to each loading. The straps will wear with age, use and exposure to the elements. Because of the importance in holding the boat secure for loading, unloading and towing, never use worn straps. Replace with Malibu-approved straps only.
- As part of the maintenance program, the gears should be greased with a heavy-duty, marine-grade grease regularly. This allows for continued proper operation and will help in the ease of operating the handle as well.
- Attach the winch to the bow eye on the boat for loading. The winch should **NEVER** be attached to any other component of the boat.

WARNING Attaching the winch to any component of the boat other than the bow eye, and attempting to load the boat can result in damage to the boat. This is not covered under warranty.

- Inspect the winch prior to every use. Never use the winch if there is any sign of damage. Your authorized Malibu dealer can assist you in repairs.
- Firmly grip and hold on to the winch handle when the handle is not locked! Letting go can cause the handle to spin wildly out-of-control if there is tension on the line. Lock the ratchet lever on the handle any time you will not be using it to load or unload the boat.

WARNING Failure to lock the ratchet lever on the handle when the boat is being loaded or unloaded or when there is tension on the line, can result in loss-of-control, with the handle spinning. This could result in serious injury. Also, the boat could slip off the trailer, causing damage that is not covered under warranty.

- The winch will have a rated capacity, which must not be exceeded. This includes the weight of all items on-board. Water in the ballast and bilge systems should be released prior to loading to avoid exceeding weight limits.
- The winch should not be fully extended prior to loading. To operate properly, leave at least a couple of turns of strap on the winch.
- The boat should be partially loaded on the partially submerged trailer by engine power. More on this technique is explained later in this Owner's Manual. Using the winch as the sole method

- Do not rely on the winch to be the only manner in which the boat is held on the trailer. Use all other tie-downs as described in this Owner's Manual. The winch is insufficient to hold the boat in place.

Tie-Downs

As part of the security for towing, the boat is equipped with tie-downs fore and aft (optional on trailer) on the boat and on the trailer. Seek assistance from an authorized Malibu Trailer dealer to determine the location on your boat model and trailer as they vary. Also seek instruction for the proper way in which to tie or hitch the lines for both a secured boat and ease of unlatching the hitches when you arrive at your destination.



TRAILER COMPONENTS AND HOW THEY FUNCTION

Trailer Jack

The trailer is equipped with a trailer jack, which serves several purposes.

The trailer jack can hold and lift the trailer to position for lowering on the hitch ball of the tow vehicle. It is also useful for assisting and balancing as a trailer rests free of the tow vehicle or is moved.

Rotate the trailer jack so that it is vertical and snap the locking pin before placing any kind of load on the trailer jack. Always retract and rotate back into the horizontal position for stowing or towing.



Also snap the locking pin prior to placing any kind of load on the trailer jack. Failure to do so could result in the trailer jack collapsing or otherwise failing, which could lead to serious injury or death.



Failure to properly stow the trailer jack in a horizontal position and lock in place could result in damage to the trailer jack that is not covered under warranty.

The drive gear and rack-and-pinion that control the trailer jack movement should be periodically greased with a marine-grade grease. The wheel bearings in the jack and the coaster should also be periodically oiled to ensure that the components continue to operate as designed.

Lights



NEVER operate the trailer, even during daylight, without verifying that the lights work properly.

When the brakes are applied, it is critical that traffic following can see that you are slowing and/or stopping by seeing the lights come on. In the event of rain, lights are required in most locations to tow the trailer. Even assuming you will return prior to dark, events could occur that result in towing after dark.

Malibu Trailers will integrate with most tow vehicle wiring harness requirements. Note the plug-in in the accompanying photo. If the harness will not connect to the plug, contact either the authorized Malibu dealer for assistance or the tow vehicle's authorized dealer. A different harness or an adapter may be necessary. These should be installed only by trained service technicians. Never use any harness or adapter that is not specified by the tow vehicle manufacturer and Malibu Trailers.



The trailer is equipped with running lights as well as taillights/stoplights. As with any electrical lamp, the lights will eventually burn out. As specified, the lights have a very long lifetime, but if any ever cease to work, take the trailer to your authorized Malibu Trailer dealer to have the bulb replaced. If the exterior lens cover is damaged or broken, this should also be replaced.

Additionally, these tips can help keep the light system working at its best:

- Check for burned out/broken bulbs and lenses prior to each use.
- Use a small amount of marine-grade grease on the plug contacts and light-bulb base to prevent rust and corrosion.
- Be sure the ground wire (white) is properly connected to the trailer frame at all times.



Axles

The trailer is equipped with the VAULT bearing protector. The VAULT uses only Hybrid Oil™ lubricant, which combines the benefits of oil and grease. The VAULT protects the wheel bearings in a sealed, pressurized chamber that is unaffected by outside elements. For optimal performance, only UFP's Hybrid Oil Lubricant should be used in this system.



The system has a number of unique features not found on conventional trailer axles. Every possible leak point on the front and rear of the hub is sealed. The slight pressure inside the hub is needed to keep water out of the hub chamber when the hub is submerged underwater during loading and unloading.

Inspection or replenishment of the lubricant is not required as part of the routine maintenance.

Adding or changing the lubricant in the VAULT system is neither necessary nor recommended during the first five (5) years of service. After that time, the maintenance requirements should be undertaken only by an authorized Malibu dealer and only the lubricant specified above should be used.

If the bearings need to be adjusted or replaced, the work should be done only by an authorized Malibu dealer. Failure to contact Malibu for pre-approval during the warranty period will void the warranty.

The wheel bearings have been precisely torque-set at the factory. To assure the bearings are in good working order, check the bearing adjustment at least once a year by following this procedure: Jack up on one side of the trailer. (Be certain to use jack stands and chock the trailer wheels to keep the trailer from moving during the inspection.) Grip the edge of the tire and see if it can be rocked or moved. If the outer edge of the tire moves more than 1/8", the bearings may need to be readjusted.

A slight amount of oil seepage at the rear seal is normal and necessary to lubricate the wiper lip of the seal for long life and for sealing contaminants out. If excessive leakage is occurring, however, contact an authorized Malibu trailer dealer.

Wheels and Hubs

Because the wheels and hubs will be submerged in water at times, they require more attention than those found on a tow vehicle. Wheels should be regularly washed with mild soap or detergent to retain the finish and remove any corrosive elements. Never use harsh detergent or scrub brushes that can damage the appearance. If your boat is stored in an area that experiences snow, Malibu highly recommends periodically checking and cleaning your wheels during the winter. Salt and chemical treatments used to remove snow and ice from roads and parking lots can settle on the wheels and cause damage to the finish. Such damage is not covered under warranty.



Lug Nuts

Prior to each outing, check that the lug nuts have retained the correct torque. It is critical to use the correctly sized wrench when tightening or loosening lug nuts. The wrong size can cause the lug nuts to become rounded off, which can make them impossible to use. Never tow a trailer with a missing lug nut or lug nuts. Having the complete number of lug nuts, properly torqued, is critical for both long-term use of the product and for road safety. Even one fewer lug nut can apply stress to the remaining lug nuts and the hub, which could result in failure.

Do not replace lug nuts, even missing ones, with lug nuts other than those available through an authorized Malibu dealer. The lug nut seat angle must match the wheel seat angle. The assembly uses a specified lug nut selected for the kind of use the trailer will need. Even if the threads match, unapproved lug nuts may not hold the wheel securely enough. Lug nuts on each wheel should always match.

The torque applied when securing the lug nuts is also extremely important. If it is under-tightened, a lug nut can work loose under

operation and come off. An over-tightened lug nut can strip the threads and also come off.



Improper torque for lug nuts can cause the lug nut to disengage. Lug nuts must also be correctly sized and specified for each trailer wheel. Failure to properly install and maintain the lug nuts could result in the trailer wheel coming off during operation. Such failure can result in serious injury or death, as well as property damage.

Follow these instructions for ensuring proper installation and torque for the lug nuts:

- Use a torque wrench. No other wrenches or similar tools are appropriate for use, except in an emergency.
- Keep a record of readings. If a lug nut or nuts routinely loses torque, it is symptomatic of a bigger problem that should be brought to the attention of your authorized Malibu dealer to remedy.
- Use the following pattern to tighten lug nuts: On the first round, tighten to 45 ft.-lbs. Tighten a second time to 70 ft.-lbs. Tighten again to 90 ft.-lbs. And on the final time, tighten to 120 ft.-lbs. Do this in a “star” pattern; do not simply go around clockwise or counter-clockwise. The cross effort will ensure a correct reading.

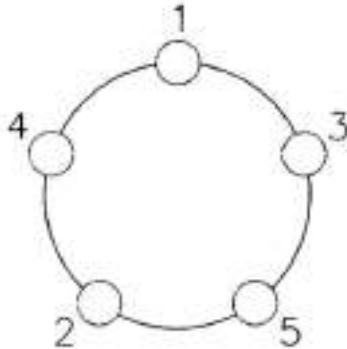

Tires

Always keep tires to the specified inflation. The tire manufacturers will indicate the proper air pressure on the sidewall of the tire; this information is also available on the tire manufacturer's website.

Be sure to have a spare tire on all outings. Even new tires can be damaged or lose air.



Follow the tire manufacturer's requirements to properly maintain tires. Failure to do so can cause tire failure while in use. This can result in loss of control of the trailer, which can lead to serious injury or death.

When storing the trailer, periodically check the tire inflation. Loss of inflation can signal a problem and can shorten the duration of the tire's life. Also shield tires from UV rays, which can significantly damage rubber. If it is possible to support the trailer frame with jack stands or concrete blocks, this can help lengthen the life of the trailer's springs on trailers so equipped, as well as relieving pressure on the tires.

Although the tires selected for the Malibu trailer are durable, eventually they will require replacement. **DO NOT mix radial and bias-ply tires. This could affect handling and, ultimately, safety. Be certain that the replacement tires meet the trailer requirements and integrate with the remaining tires.**

Brakes

The Malibu trailer brakes are “surge” brakes, which can be effective and helpful particularly when towing heavy loads. (**NOTE:** Not every jurisdiction allows surge brakes. Check with authorities in the area in which you will be towing.)

When the tow vehicle slows or stops, the trailer's momentum moves against the hitch ball and causes hydraulic pressure in the master cylinder (located in the trailer's tongue) to transfer pressure through the brake lines, causing the brakes to engage.

The trailer brakes should always be maintained in top condition. This includes checking the fluid level in the actuator regularly. The loss of brake function can result in loss of control or the inability to stop the trailer, which could lead to serious injury or death.

See the information provided above about the breakaway cable. The breakaway cable should **NEVER** be used as a substitute for braking or as a parking brake.

Note that brakes will be submerged when the trailer is backed into the body of water to unload or load the boat. If the brakes (and/or wheels) are hot, it is recommended to wait a brief period of time and allow them to cool before submerging. Excessive heat meeting cooler water can cause damage to the components, especially the calipers and rotors. Also, if the trailer is submerged in salt or brackish water, be sure to carefully and completely rinse the entire trailer after the outing. Salt and exceptionally dirty fresh water can cause damage to the trailer components, which is not covered under warranty.

NOTICE

Salt and brackish fresh water can damage trailer components, which is not covered under warranty.

Always clean the trailer with a fresh-water rinse and/or use of mild soap after an outing in which parts of the trailer are submerged.

With regard to routine maintenance, you need to be aware that small amounts of rust will build up on the brake's rotor surface if the trailer sits for a fairly short period of time, as little as a week. The brake's pads will eliminate the rust after several applications of braking, but if the trailer has been sitting for a more extended period of time, and especially following long-term storage such as over the winter off-season, the brakes may be significantly corroded. This can also happen if the trailer has been submerged in salt water and has not been sufficiently rinsed with fresh water afterwards.



If there is any concern about the condition of any component of the braking system, have an authorized Malibu trailer dealer review and rectify the matter before towing the boat.

How to Manually Bleed the Brakes

Because of the importance of correctly performing this procedure, Malibu Trailers strongly recommends that this be done only by trained service technicians at your authorized Malibu-Malibu Trailer dealer. However, recognizing that brake issues arise and may have to be addressed in situations in which the trailer cannot be taken to the dealer for repair, the following instructions are provided with the understanding that they should be utilized only in emergency.

- Check that all hydraulic fittings are secure.
 - Read and understand all instructions before starting.
 - Two people are required for manual bleeding.
1. Remove the master cylinder reservoir plug and fill the reservoir with brake fluid.
 - a. Use either DOT 3 Premium (preferred) or DOT 3 regular automotive brake fluid. Follow the instructions on the brake fluid container.
 - b. Avoid shaking the brake fluid container, and pour fluid slowly to minimize air entrapment.
 - c. Let the fluid in the reservoir stand until it is completely free of air bubbles.
 2. **IMPORTANT:** Before bleeding the brake lines, bleed the actuator master cylinder. Insert a screwdriver through the hole in the bottom of the inner member and use short strokes to pry on the push rod (while holding the safety release bracket up) until no air bubbles are seen coming from the small orifice hole in the bottom of the master cylinder reservoir.
 3. Start the bleeding procedure on the brake farthest from the master cylinder.
 4. At the brake assembly, connect a transparent bleeder hose to the bleed screw fitting on the wheel cylinder and submerge the free end into a container partially filled with brake fluid. **Do not reuse this fluid.**
 5. The first person should stroke the push rod slowly while holding the safety release bracket up.
 6. The second person opens the bleed screw fitting.
 7. He then closes the bleed screw fitting **BEFORE** the first person **SLOWLY** releases the push rod.
 8. Repeat this procedure until the fluid expelled from the bleeder hose is free of air bubbles.
 9. Remember to always tighten the bleeder screw before releasing the push rod. During this procedure, the master cylinder reservoir fluid level must be maintained at no less than half full.
 10. Repeat Steps 4-9 for the other brake, as well as the brakes on the front axle of tandem axles.
 11. If installation is on a tandem-axle trailer, repeat the bleeding procedure on the rear axle brakes for a second time to assure purging of all air in the system.
 12. As a final check after bleeding is completed, stroke the push rod and check to be sure the brake system is pressurized. This is done by attempting to rotate a tire around.
 13. Push up on the safety release bracket to ensure that the push rod is in the released position.
 14. After the bleeding is completed, recheck the fluid level in the master cylinder. Fill the master cylinder reservoir to the indicator on the reservoir plug. **Do not overfill.**

Optional Electrical Brakes

As an option, Malibu offers electrical brakes. The system uses electric power from the towing vehicle to drive the hydraulic power source. In a breakaway situation, the electric power is supplied by a breakaway battery connected to the towed vehicle brake actuation system. This battery is charged by a charger built into the control circuitry.

The actuator reacts in one of three ways: primarily, it turns on when the brake pedal of the towing vehicle is depressed. If due to road conditions it is desirable to apply only the towed vehicle brakes, this is achieved by applying the manual override on the "in-cab" brake controller. In a breakaway situation, the towed vehicle braking system is applied by the breakaway switch, which is explained elsewhere in this section of the Owner's Manual.

The system requires "in-cab" electric brake control not provided as part of the system. The system will operate from most electric brake controllers **WHEN PROPERLY INSTALLED.**

Proper electrical wiring is **CRITICAL** for the performance of the braking system. Improper wiring can result in damage to the actuation system or system failure after initial use. A pure ground and direct power (+12 VDC) with fuse or circuit breaker (30 amp) are necessary to ensure good performance. Line losses and poor grounding will result in poor performance or total loss of towed vehicle braking! The connection for the system is provided by pre-wired harnesses and the plug connectors are keyed so that they cannot be connected incorrectly. However, if the plug between the towing and towed vehicles is not wired properly, the unit will either not function at all or will function improperly.



The trailer brakes should always be maintained in top condition. This includes checking the fluid level in the actuator regularly. The actuator access location is via a cap on top of the trailer tongue. The loss of brake function can result in loss of control or the inability to stop the trailer, which could lead to serious injury or death.

See the information provided above about the breakaway cable. The breakaway cable should **NEVER** be used as a substitute for braking or as a parking brake.

If there is any concern about the condition of any component of the braking system, have an authorized Malibu trailer dealer review and rectify the matter before towing the boat.



Do not use brake fluid drained from the brake system to refill the master cylinder reservoir as such fluids contain contaminants from the system that may result in brake failure or costly repairs.

Periodic inspection should be made of the electrical connector, wiring, brake lines and hose for the entire brake system to insure there are no abraded or bare wires, damaged steel lines, or cracked and damaged hoses. During inspection verify that there are no loose or hanging lines or wire that might drag or catch on objects/debris while being towed.

Prior to towing, **EVERY TIME:**

- Check the fluid level in the reservoir on the trailer tongue. The fluid level must be maintained with 3/8" to 1/2" below the filler opening. If brake fluid is needed, add only **NEW, CLEAN DOT3**

Brake Fluid. Use caution when opening the reservoir (removing the filler cap) to prevent the admission of dirt and/or contaminants into the fluid reservoir.

- Check to be certain the breakaway battery is charged and that the breakaway works. This is accomplished by pulling the cable on the breakaway switch. If the vehicle has been parked for extended periods of time, the breakaway battery may be discharged. If that occurs, charge the breakaway battery in accordance with the manufacturer's recommendations prior to operation. If the battery is allowed to discharge in a cold environment there is a possibility of freezing, which could cause damage to the battery. Such damage may not be covered by warranty.



Appropriate installation, maintenance and repair procedures are essential for the safe, reliable operation of vehicle brakes. Anyone who undertakes to maintain or repair vehicle braking systems must establish that they neither compromise their personal safety nor the vehicle integrity by their choice of methods, tools or parts.

Optional Storage Compartment

An optional storage compartment may be located beneath the towing tongue on some trailers. This compartment can be used for carriage of tools, extra lug nuts and spare parts. Please note that the compartment is NOT watertight. If this part of the trailer will be submerged for loading and unloading of the boat, avoid leaving anything inside that is not water-resistant or could rust. Such conditions are not covered under warranty!



Towing Advice

Prior to Towing

- Be certain that you have a jack and lug wrench that will work on the tow vehicle and the trailer. The same ones may not work on both, so verify that you are prepared. You don't want to end up on the side of the road and find that you are not fully prepared.
- In addition to the spare tire that can be mounted on the trailer spare tire mount, also have available in your tow vehicle's storage area such useful additional items as:
 - extra lug nuts;
 - wheel chocks (especially important in areas in which there are hilly or mountainous driving conditions);
 - wheel bearing grease;
 - marine-grade grease;
 - spare tie-down straps;
 - additional brake fluid for the actuator;
 - a torque wrench to check and ensure the lug nuts are properly torqued;
 - road flares.

Pre-Tow Check List

- Verify the coupler, hitch and hitch ball are the correct, specified size and fit.
- Be certain the safety cables and breakaway cable are correctly attached.
- Check that tie-downs and the winch strap are secure.
- The wheel lug nuts are properly torqued.
- The tires are inflated to the air pressure level stamped on the sidewall.
- The trailer lights are operating properly.
- The brakes are functioning as designed.
- If the boat is equipped with a tower, it must be either upright and locked, or lowered and secured. If the tower is upright, you will need to determine that the total height of boat, trailer and tower will be able to clear power lines, bridges, overpasses, or any other impediment.
- The total load does not exceed the GVWR.

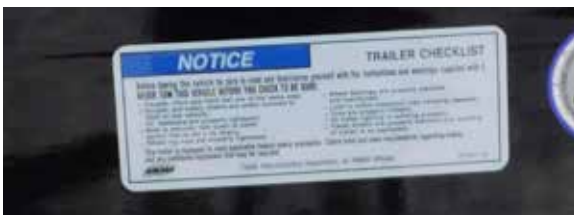

Underway

Towing is more challenging than driving down the road in a single vehicle. Therefore, you would be well-advised to **practice, practice, practice** before undertaking a genuine tow to a body of water for an outing.

Malibu Trailers cannot anticipate every possibility that will arise, and assumes no responsibility for the operation of your tow vehicle and/or trailer, but the following are some recommendations that can enhance the towing experience and better prepare drivers:

Drive sensibly. You will have a substantially greater length and weight to maneuver. This means you need more time and space to accelerate or to stop. Weather conditions are amplified. Wind especially can create more challenges in maintaining control.

Use those mirrors. Most tow vehicle manufacturers recommend adding over-sized mirrors. Some legal jurisdictions require it. Regardless, the better you are able to see, the more control over the total rig you'll have. Larger mirrors can also assist you in keeping an eye on the trailer and boat to be aware of how well they are moving down the road.

Allow extra room when making turns. You will quickly learn that turns, especially right turns, take more space. You've seen this with tractor-trailer units and other tow vehicles.

Think twice and allow extra room when passing other vehicles. It will take longer to accelerate to passing speed, and you will need considerably more room when moving back into the driving lane. Passing on grades is not recommended as it is more difficult to maintain overall control. It may be necessary to downshift gears in the tow vehicle when passing, too. Avoid road shoulders, especially narrow ones. If you go off the paved surface, especially at highway speed, you may lose control or even jack-knife the rig.

Use common sense! All the potential issues that cause potential problems when driving a regular highway vehicle are exaggerated when towing. Avoid tailgating, jack-rabbit starts and stops, or any maneuver that exceeds the capabilities of your rig. Any time your rig fish-tails, stop and determine what the cause is. Often is it shifting weight, particularly within the boat or on the trailer. Re-adjusting the towed items may take a few minutes but can save your life and others!

Launching and Re-Loading the Boat from the Trailer

Releasing the boat from the trailer requires skill as well. Conditions may vary from location to location, too. It is important to pay attention to surroundings and plan the release to avoid damage to the boat, trailer and dock/ramp.

First, you should examine the ramp. Some are unimproved, while others are paved, and many are something in-between. You will also need to know how steep the ramp is as that affects how far you will need to back the trailer into the water. You need to have confidence that the ramp surface will support the weight of the trailer and boat as you ease back, and that you will not bog down in the water or on the land surface. Sufficient width, especially if you are inexperienced in backing up, is important, too. Consider that the land may also be slippery if wet, which can affect control over the rig.

Before backing into the water, double-check that your boat is ready for launch. **This includes ensuring that the drain plugs are installed to avoid swamping and potentially flooding the boat.**

Then you should release the tie-downs except the winch.

Slowly back the trailer and boat into the water. If possible, have a second person standing by (but never directly in back of the rig) to help guide you. When backing up, note that the trailer will go in the opposite direction to the direction in which the tow vehicle steering wheel is turned. Perhaps the easiest manner to back up is to place a hand at 6:00 (the lowest point on the steering wheel). Moving the steering wheel right (counter-clockwise) will then turn the trailer to the right. If your hand or hands were higher on the wheel, it would appear that you are actually turning the steering wheel to the left.

Back up in the water until the trailer's back tire is about half-submerged in the water. If the ramp has a shallow drop, it will be necessary to back in further; if the drop-off is more significant, you may be able to stop before the wheel is half under.

Place the tow vehicle in Park (or a forward gear if the tow vehicle has a manual transmission), and shut off the tow vehicle engine. Set the parking brake.

After checking that the water depth is sufficient for your boat's hull (it should not make contact with the ramp surface or ground underwater), release the trailer winch latch-and-hook. Assuming that

all tie-downs are released, back the boat into the water and secure to a dock as described elsewhere in this Owner's Manual or anchor while you remove the tow vehicle and trailer from the ramp.

To re-load at the conclusion of your outing, reverse the process. When the trailer is in position, verify that the trailer bunks on which the boat will rest are free of dirt, sand or other debris that could scratch the boat hull. It is a good idea to back the trailer sufficiently to wet the trailer bunks completely as this will add to protection for the hull when the boat is loaded.

Directions and suggestions for driving the boat onto the trailer are provided elsewhere in this Owner's Manual. This requires practice to master, but correctly loading the boat is critical for both safety and protection of the condition of the boat and trailer.

Be sure that the tie-downs are secure prior to towing.



Submerging part of the trailer in water will cause the brakes to be wet. See the *Brake* information in this section of the Owner's Manual regarding care following an outing. Also be aware that while the brakes are wet, they will not work as quickly or efficiently as normal. As soon as they dry, the brakes should resume their normal characteristics.

When the Trailer Is Not In Use

Most boaters experience an off-season in which both the boat and trailer are not used for several weeks or months. As this period begins, many boat owners have an annual maintenance routine performed on the boat by the authorized Malibu dealer. This is the appropriate time to also perform pre-storage activity for the trailer. Most of these tasks are best done by the authorized dealer at the same time as the boat is prepared for storage.

- Have the authorized Malibu dealer:
 - service or re-pack wheel bearings;
 - touch-up any nicks, chips or rusted areas;
 - repair or replace damaged or worn tie-downs and straps;
 - lubricate moving parts so that they will be more likely to move freely when the trailer is recommissioned for use;

- check lug nuts and any other bolts or hardware on the trailer to be certain that all are secure.
- While it is good for the tie-downs and straps to be snug to the boat, especially if the boat-and-trailer will be exposed to the elements, loosening them just slightly less than you would connect them for travel is advisable. This will allow a moderate amount of air circulation and avoid imprint of the trailer bunks.
- If the boat will be stored on the trailer, allow the trailer to rest with the tongue a few degrees higher than the aft portion of the rig. With the drain plugs removed, any residual water can drain out of the boat.
- Release a small amount of air pressure in the tires, but make a note to reinflate to proper levels prior to any towing. Shield the tires from UV rays also.
- At the conclusion of storage preparation, it is advisable to leave the trailer in a covered area such as a garage or pole barn-type structure. The weather can cause damage to the trailer that is not covered under warranty.
- Relieve the load pressure on the trailer springs by using jack-stands or concrete blocks to support some of the weight.

⚠ DANGER

NEVER tow a trailer with faulty brakes. Whether the brakes are grabbing or failing to respond, the result is usually a loss of control of the entire rig. This situation can result in serious injury or death to persons on-board, and damage to the tow vehicle and/or trailer and boat, as well as to other people and vehicles on the road at the time.

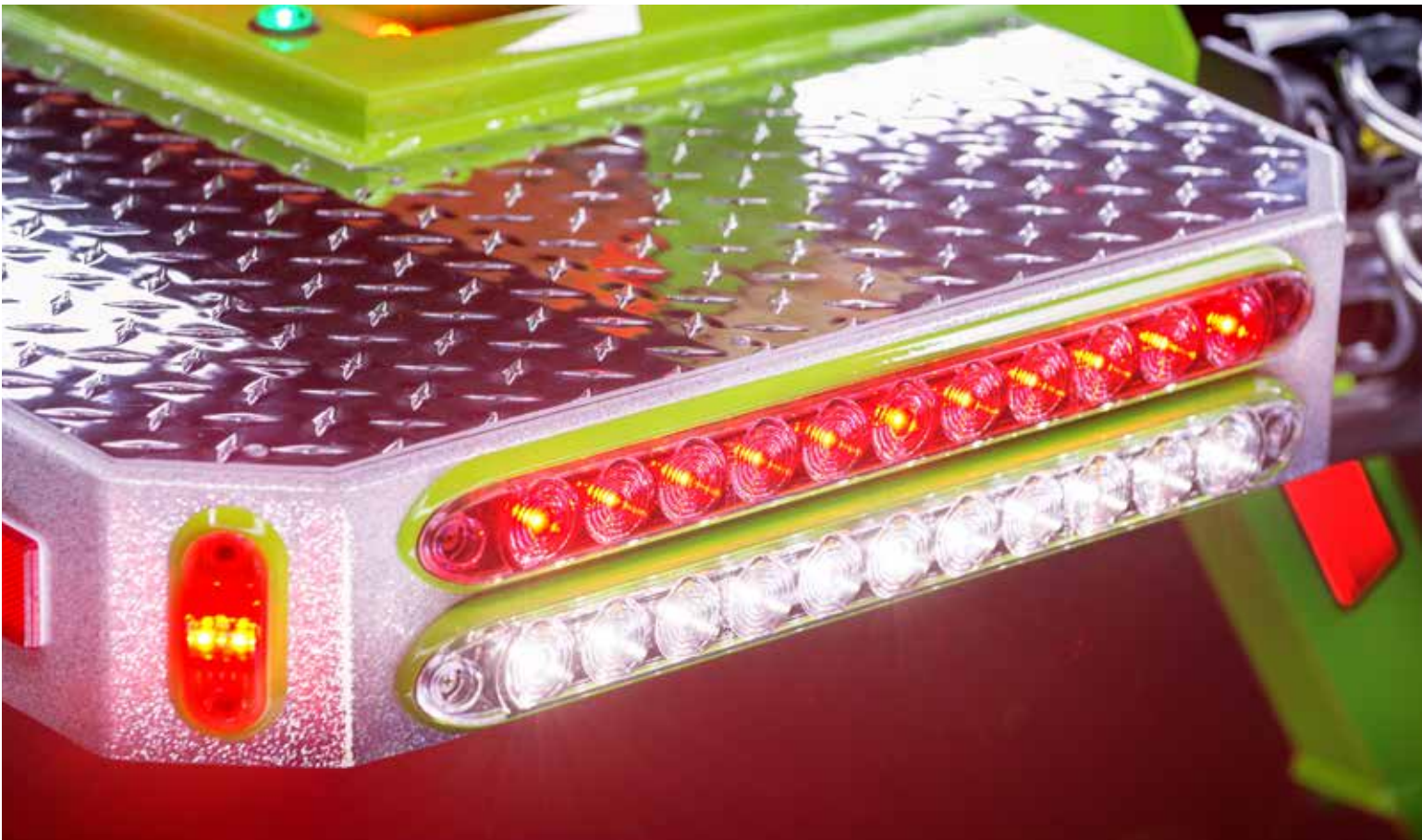



GET READY



MALIBU FUEL SYSTEM

All Malibu models are equipped with the most up-to-date fueling system available in the marine industry. The boats feature pump-in-tank (PIT) fuel systems, which means the fuel pump is located securely inside the fuel tank rather than at the engine. There are many benefits to the PIT system, most significantly in the prevention of vapor lock and improved filtration of contaminants.

To maximize the benefit of this type of fuel pump, the entire system is under high pressure. That means that access to the pump and fuel filter is only through fuel lines with a significant pounds-per-square-inch (PSI) pressure to ensure proper operation. As such, no one can or should ever attempt to access any portion of the fuel system without proper training and proper equipment. **The fuel lines are covered in orange "fire-sleeve" protective covering so that they are easily identifiable, and consumers should always avoid these lines, unless it is noted that one is squeezed or pinched.** If it is possible to alleviate this situation safely, then do so. The preferable method, however, is to have an authorized Malibu dealer's trained service technician do so and verify that no damage has been done to the line or other equipment.

Normally, if there is any issue arising from damage or leakage in the fuel system a strong odor of gasoline will be present and signifies that the engine should not be started due to the danger of explosion from fumes. Even in the absence of a gasoline odor, owners and operators should always visually check the fuel system prior to operation, as directed in the *Care and Maintenance* section of this Owner's Manual.



The fuel system, including the fuel lines, filter and pump, should never be serviced by any person other than an authorized Malibu dealer's trained service technician. Special tools and training are required to safely service the fuel system on all models.



The flammability of gasoline and its explosive properties must always be respected. At the first odor of gasoline, the engine should be shut off and remain off until the source of the odor has been identified and the issue has been rectified.



Never smoke or operate any spark-producing object

within a fifty-foot (50') range of the boat when fueling. Fumes from gasoline are more likely to produce an explosion and/or fire than the actual fuel.



If fuel is spilled, always clean up with dry rags and dispose of properly on-shore.

NOTICE

Review the engine manufacturer's owner's manual or the *Engine* section of this Owner's Manual where appropriate, for important information regarding the proper fuel to use, how to maintain the fuel if the boat will not be used for a period of time, and other important information regarding the safe use of gasoline in the boat.

NOTICE

Use of incorrect fuel can result in damage to the engine that is not covered by the engine manufacturer nor by Malibu. Failure to follow maintenance requirements may also void the warranties.

Malibu recommends returning to shore and refueling whenever the fuel gauge indicates that the fuel load has fallen below one-quarter (1/4) of a tank full. **It has been determined that continuous operation with ballast significantly loaded either port or starboard (rather than evenly distributed) can result in damage to the fuel pump as it attempts to compensate.** Also, even with the best of care, some water may get into the fuel tank or separate from the fuel that is pumped into it. If there is water present, it will settle on the bottom of the tank. If the pump begins to reach any water, it may cause malfunctioning in the engine.

When pumping fuel, do not leave the nozzle unattended in the fuel fill. Although the fuel system has been manufactured to avoid spit-back of fuel, and most gasoline dispensers will shut off if removed from fuel fill, it is always a wise consideration to provide full attention to the process.

OPERATIONS

Final Checks Before Starting

Before getting underway, operations checks should be completed to ensure a safe and enjoyable outing. Verify that:

- All safety requirements as outlined in the *Safety* section of this Owner's Manual have been met.
- Review the pre-launch requirements as outlined by the trailer manufacturer, and the preparations as required by the engine/drive-train manufacturer.
- The total number of people and gear on-board does not exceed the maximum allowed and as indicated on the capacity plate. These informational plates are located in the interior walk-through.
- All gear is properly stowed. Gear that is left loose on the deck can become dislodged, move about during operation and could potentially go overboard or strike an individual on-board, resulting in potential injury.
- A float plan or outing information has been left with someone

ashore. This means that if any issues arise, there is a person to raise an alarm if you do not return as planned. (Cell phones are helpful, but sometimes service is not available, so this should not be the only plan in the event of problems.)

- Ensure there is sufficient fuel in the fuel tank for the outing or have a plan for re-fueling.
- Be sure that the weather forecast does not include threatening conditions. Also check predicted wind and water conditions.
- Check that the drain plugs are all fully and correctly installed.
- Ensure that PFDs and other safety gear are on-board.
- Be sure that all on-board fire extinguishing equipment is fully charged and easily accessible.
- Go through the pre-outing maintenance checklist, as outlined in the *Care and Maintenance* section of this Owner's Manual.
- Give all the on-board equipment and components (such as the tower) a final check to be certain that everything is secure and ready for the expected boating conditions.



Starting and Operation

Prior to starting the boat for the first time, read this entire Owner's Manual, as well as the Engine Owner's Manual, where appropriate. Before towing to the body of water the first time, read the entire *Trailer* section of this Owner's Manual as there is important safety information contained within it also. If the boat came with additional hand-out materials or other owner's manuals specific to various boat components, also read that material in its entirety.

All of these publications have been developed to protect boaters, their passengers, other people on the highways on the way to the body of water, and others who are also boating. Information is provided to enhance enjoyment of the Malibu experience, as well as how to care for and maintain the boat, engine, drive train, components and trailer so that this will be a long-term, on-going source of enjoyment.

Starting the Engine – Wakesetter

- Step 1: Be certain the boat's shifter/throttle is fully upright in the neutral position. Additional information follows regarding shifting and throttle response.
- Step 2: Perform the pre-start routine, including the bilge inspection and engine compartment inspection. (Details are provided in the *How It Works* section.) Leave the engine compartment open for the starting process.
- Step 3: Attach the emergency safety switch tether/lanyard to the switch on the shifter/throttle, and also to a piece of the operator's clothing.



- Step 4: Verify the blower switch has operated for several minutes with the engine compartment open and the boat in the water.
- Step 5: Press the power button and check that power to the electrical system appears by way of the video screen lighting, and begin a check of the system. Enter the boat code on the 7" screen.. **The default is 1-2-3-4, but boat owners can change this by following**



directions provided in the *Dashes and Video Screen* section of this Owner's Manual.

Note: As a safety feature, when the key is turned ON, the navigation and anchor lights will also come ON.

- Step 6: If the electrical system has responded, press and hold the START-STOP button for approximately one (1) second and then release. The engine starter should engage and begin the process that will allow the engine to run. If for some reason, the engine does not start, repeat Steps 5 and 6. Never press the button for an extended period. If the engine does not start as it should, make sure the throttle/shifter is in neutral. If it still does not start, then refer to the *Troubleshooting* section at the conclusion of this Owner's Manual for assistance in determining the cause. If any alarms sound or warning lights appear, turn OFF the engine and troubleshoot. There is also a back-up ignition key on the starboard shifter panel, next to the breaker panel. Start this as you would a land-based vehicle.
- Step 7: Allow the engine to run for several minutes with the engine compartment open! It is extremely important for any accumulated fumes to be vented in this way. It also assures that any new issues that arise involving the engine, fuel system and ventilation system are noted. Accumulation of fumes within the engine compartment can also lead to an explosion.



To prevent a possible explosion, always operate the blower for several minutes prior to starting the engine, and continue to operate with the engine compartment open for several minutes after starting the engine. Always operate the blower when the engine is idling or at a low running speed. Improper ventilation can lead to accumulate of gasoline or exhaust fumes in the compartment. This can lead to a fire or explosion, either of which can result in serious injury or death!

To turn OFF – Wakesetter

On a boat equipped with a START-STOP button, press the button. If you are using the backup key, also turn the key to OFF. (Failing to do so means the electrical system will continue to function; eventually, this will drain the battery or batteries.)

Note that, unlike a dry-land vehicle, turning OFF the boat does not immediately stop its momentum. The boat will continue to move. Shifting to neutral will slow progress, but



allowance must be made for continued movement. See information following for suggestions regarding docking.

The power button is a safety measure. It allows the operator an opportunity to briefly and visually check the electrical system operation prior to starting. The key also reduces the likelihood of theft of the boat or unauthorized use. Always remove and take the key with you when the outing is done.

Starting the Engine – Response

- Step 1: Be certain the boat's shifter/throttle is fully upright in the neutral position. Additional information follows regarding shifting and throttle response.
- Step 2: Perform the pre-start routine, including the bilge inspection and engine compartment inspection. (Details are provided in the *How It Works* section.) Leave the engine compartment open for the starting process.
- Step 3: Attach the emergency safety switch tether/lanyard (shown above) to the switch on the shifter side panel, and also to a piece of the operator's clothing.
- Step 4: Verify the blower switch has operated for several minutes with the engine compartment open and the boat in the water.

Some models are equipped with a START-STOP button, while others are controlled from the ignition slot. The following are the instructions for the boats equipped with the ignition slot only, and instructions will follow for those with a START-STOP button.

Ignition Slot ONLY (Response base model)

- Step 5: Turn the key first to ON. Check that power to the electrical system appears by way of the gauge sweep.
- Step 6: If the electrical system has responded, turn the key to Start. Hold the key in the Start position for approximately one (1) second and then release the hold on the key. It will automatically return to the ON position. The engine starter should engage and begin the process that will allow the engine to run. If for some reason, the engine does not start, repeat Steps 5 and 6. Never hold the key in the Start position for an extended period. If the engine does not start as it should, refer to the *Troubleshooting* section at the conclusion of this Owner's Manual for assistance in determining the cause. If any alarms sound or warning lights appear, turn OFF the engine and troubleshoot.

Equipped with START-STOP button—Mechanical button (Response premium)

- Step 5: Press the power button and check that power to the electrical system appears by way of the video screen

lighting, and begin a check of the system. Enter the boat code on the 7th screen. **The default is 1-2-3-4, but boat owners can change this by following directions provided in the *Dashes and Video Screen* section of this Owner's Manual.**

- Step 6: If the electrical system has responded, press and hold the START-STOP button for approximately one (1) second and then release. The engine starter should engage and begin the process that will allow the engine to run. If for some reason, the engine does not start, repeat Steps 5 and 6. Never press the button for an extended period. If the engine does not start as it should, make sure the throttle/shifter is in neutral. If it still does not start, then refer to the *Troubleshooting* section at the conclusion of this Owner's Manual for assistance in determining the cause. If any alarms sound or warning lights appear, turn OFF the engine and troubleshoot. There is also a back-up ignition key on the starboard shifter panel, next to the breaker panel. Start this as you would a land-based vehicle.

For both types of starting systems

- Step 7: Allow the engine to run for several minutes with the engine compartment open! It is extremely important for any accumulated fumes to be vented in this way. It also assures that any new issues that arise involving the engine, fuel system and ventilation system are noted. Accumulation of fumes within the engine compartment can also lead to an explosion.



To prevent a possible explosion, always operate the blower for several minutes prior to starting the engine, and continue to operate with the engine compartment open for several minutes after starting the engine. Always operate the blower when the engine is idling or at a low running speed. Improper ventilation can lead to accumulation of gasoline or exhaust fumes in the compartment. This can lead to a fire or explosion, either of which can result in serious injury or death!

To Turn OFF – Response

On an ignition-only boat, turn the key to OFF. On a boat equipped with a START-STOP button, press the button. If the outing is done, also turn the key to OFF. (Failing to do so allows the electrical system to continue to function; eventually, this will drain the battery or batteries.)

Note that, unlike a dry-land vehicle, turning OFF the boat does not immediately stop its momentum. The boat will continue to move.



Shifting to neutral will slow progress, but allowance must be made for continued movement. See information following for suggestions regarding docking.

The power button is a safety measure. It allows the operator an opportunity to briefly and visually check the electrical system operation prior to starting. The key also reduces the likelihood of theft of the boat or unauthorized use. Always remove and take the key with you when the outing is done.

Break-In Period — All Boats.....➤

The first hours of the boat operation have critical requirements for engine break-in. This information is contained in the engine owner's manual or *Engine* section of this Owner's Manual, where appropriate. Be sure to review this information carefully. Failure to follow the instructions will void the engine warranty!

With regard to the boat, pay close attention to the screens, and monitor the readings. Pay particular attention to the oil pressure and engine temperature information as these are the earliest warnings when something is going wrong with the drive train. Alarms will sound

if serious problems are encountered.

Also, check carefully for leaks. The break-in period is the most-likely time for leaks to appear, whether fuel, oil, water or exhaust.

Smart Operations➤

Newcomers to boating, especially boats the size of the Malibu models, are strongly encouraged to take a U.S. Coast Guard boating class before using the boat. Reading about boating conditions and operations from websites such as the National Marine Manufacturers Association (NMMA) and the many yachting association sites can be very helpful.

Practice, practice, practice! Begin in optimum weather and water conditions, avoiding tight quarters until you are comfortable. The boat actually steers more easily when the boat is on-plane. This is achieved by speeding up briskly from idle. By throttling and increasing the speed, the boat will ride up higher on the body of water. With less friction between boat hull and water, the boat will maneuver more easily. At slower speeds, the boat is less responsive, so practice is important to achieve the kind of maneuverability that is desirable.

Remember that steering in a boat is from the rear (stern). The

unseen rudder operates from the steering wheel, but the actual steering through the rudder is different from a car. Note that stern control means that the boat will push away from the direction of the turn. The bow will follow a smaller turning circle than the stern does.

Note that the propeller does not move the boat directly forward. Due to the rotation (generally, counterclockwise), the boat's natural progress will have a slight tracking to the port side (when in forward gear) and starboard side when in reverse. At slower speeds, this phenomenon is more pronounced. Depending also on the body of water depth and width, it may be necessary for the operator to compensate for this natural movement.

Stopping

The lack of brakes requires the operator to think more quickly and react accordingly to avoid damaging contact with other boats, docks and the shore. When stopping the boat, it is acceptable to use reverse gear (much as airplanes use reverse thrust). This is a technique that takes time and practice to master. Slamming from forward to reverse gear can damage the system. Allow sufficient time to move the shifter from forward to neutral, briefly pausing with each shift, and then ease into reverse. Always slow to a no-wake speed before attempting these shifts and do not shift into reverse if the boat

is moving faster than 2 mph (3.2 km/h).



Do not disconnect the emergency safety switch as a method to stop the boat. Doing so impairs the ability to restart the engine quickly or it may create a hazardous swamping condition.

High Speed Maneuvers

Competitions may showcase the driving skills of professional operators. Tempting as it may be to try the same kind of extraordinary maneuvers, the vast majority of operators should avoid boating at top speed. Professionals are trained to plan and prepare in the event something goes wrong.

The engines are built and tuned to run at the optimum speed range for water skiing, wakeboarding, wake surfing and similar activities. Higher speeds are achievable but the intent is for only brief bursts of speed in those instances where the Malibu operator needs

to move quickly to get out of a potentially dangerous situation.



Attempting to replicate the high-speed maneuvers of professional boat drivers can lead to loss of control, damage to the boat and serious

injury or death to the operator and passengers.

Weather conditions and altitude can affect the best operating range for the engine. If you feel that you are not getting the expected performance from your boat, contact your authorized Malibu dealer to discuss changing or adjusting the propeller to compensate. Do not attempt to do this without assistance as it may void the boat and/or engine warranty.

Special Conditions

Boating regularly on the same body of water will assist the operator in anticipating conditions under normal circumstances. But for boaters who try different locations or even in instances where conditions are abnormal at a known location, operators should seek advice from local sources. Do not launch when threatening weather is in the area. If there has been recent flooding, there may be additional floating debris. If a drought is occurring, a lowered water level may result in submerged hazards becoming exposed.

Avoid brackish or weedy areas, too. The flora can become entangled in the propeller and cause problems. Smaller material can become lodged in the water intake for the engine and transmission. Fouling from natural materials can result in damage to the drive train that is not covered under warranty!

Towing and Interaction

Activities behind the boat require interaction between the driver, an observer and the sport participant. See the *Safety* section of this Owner's Manual for information about hand signals and safe pick-up of a downed skier/boarder/swimmer. The driver is responsible for the well-being of all aboard, plus any people outside the boat who are engaged in sports that are a result of operating the boat.

Under normal circumstances, Malibu boats should not be used to tow other boats. Towing other boats should be undertaken only as a last resort, when other, more appropriate, towing is unavailable. The stress caused by towing lines, along with the difficulty in controlling the disabled boat, could cause damage to the towing boat as well. Always attempt to secure assistance from shore and rescue organizations such as the U.S. Coast Guard. Never tow a boat that is the same size or larger. A tow line should attach only from the stern eyes to the bow eye, with sufficient line to avoid contact between the two boats. Do not use three-strand twisted nylon rope as it has too much elasticity. Lines need to stay free of propellers on both boats. Never hold on to the rope after it is taut.

Only boat operators with knowledge of correct technique should undertake to tow. Move slowly to prevent strain on the line, and be ready to cast loose or cut the line if conditions become hazardous.

Anchoring

Consult with your authorized Malibu dealer regarding the best selection for an anchor and how to properly attach it to your boat. Always anchor from the bow of the boat as it has less chance of breaking free if a heavy wind occurs or water conditions worsen.

Docking and Tie-Up

Docking a boat requires considerable practice to be effective and avoid damage to the boat. Docking must always be done at slow speed.

Before attempting to dock, practice in an open body of water. Slow the throttle to no-wake speed. Shift into neutral and drift slowly toward the dock. If necessary, shift the boat into reverse to further slow or stop the boat.

On the Wakesetter models, a docking mode is available. To use this, select the icon on the 12" video touch screen in the bottom right corner. It inhibits the throttle response (with a warning icon on the page), which helps the docking maneuver.



WARNING

Never insert a hand, arm or other body part between the dock and the boat, or attempt to keep the boat

from hitting the dock. The boat could push against the dock, pinning the appendage and causing severe injury.

The following are recommended guidelines for docking:

- Approach the dock with the starboard side of the boat, if possible. You will be able to see the edges of the dock and boat better.
- Come to a stop at a short distance from the dock, and then proceed slowly (no-wake).
- Have fenders (where equipped), mooring lines and crew ready.
- Observe how the wind and current are moving the boat. Approach

the dock with the boat pointed into the wind, if possible. If the wind or current is pushing you away from the dock, use a sharper angle of approach. If you must approach the dock downwind or down current, use a slow speed and shallow angle. Be ready to reverse to stop and maintain position.

- If there is no wind or current, approach the dock at a 10-to-20 degree angle.
- If possible, throw a line to a person on the dock and have that person secure a bow line.
- With the bow secure, swing the stern in with a slight throttle and turning of the steering wheel, or pull it in with a boat hook.

Before tying up the boat, it is advisable to use enough fenders (an additional, optional purchase) to protect the boat from damage. It is necessary to tie up with some slack in the line, as tying tightly will cause the boat's finish to rub repeatedly against the dock due to wave or tidal action, but if there is too much slack the side of the boat may hit (and damage) the finish.

Tie up with the bow toward the waves, if possible, with a good-quality, double-braided nylon line. Tie up only to the lifting eye (under the forward bow point) or tie-down eyes (each side of the transom), or optional cleats. Never use the handrails or windshield frame, or any other component of the boat. If the boat will be moored for an extended period of time, use chafing protectors on the lines to protect the gel coat finish.

When leaving the dock, untie the lines and return them to the boat deck to avoid snagging on any object on the dock. (Also, stow the lines so that the operator and any passengers will not trip on the lines or become entangled.) Move very slowly away from the dock, unless the wind/current are naturally pushing the boat away from the dock, where it is possible to drift until safely free of the dock.

Always be certain to visually check that the center and transom drain plugs are installed and **SECURED** prior to deploying the boat in any body of water. The boat operator still must physically check that the drain plugs are installed and properly secure.



CARE AND MAINTENANCE





ON-GOING CARE

General Cleaning

Malibu recommends keeping the boat clean at all times. Immediately after an outing, the boat's exterior and interior should get a thorough rinsing with clear, fresh water, and then should be allowed to air dry prior to covering with canvas. If this is not possible, the boat's cover should be removed as soon as you arrive at your destination and allowed to dry.

NOTICE

Boats must be thoroughly rinsed inside and out with clear, fresh water following all outings and then allowed

to completely dry prior to storage or parking. Failure to do so could result in damage to the finishes and the development of mold or mildew, or permanent stains. Such damage is not covered under warranty.

If the boat will be left in water, the exposed areas should be wiped down with clear, fresh water and allowed to dry before boat covers are installed.

NOTICE

Consumers should never add aftermarket waterproofing to canvas. The canvas must

“breathe” in order to avoid mold and mildew. If any spray-on waterproofing has been added after delivery, it will void the warranty.

Canvas

Breathability of Fabrics –Air Permeability: Air permeability is an important factor in the performance of outerwear where the wind resistance helps keep the user warm. Fabrics that have high air permeability usually have low water repellency, the latter being an important feature for mooring covers. When in a slip, mooring or parked on a trailer, the cover is not experiencing any pressure that would force air through the fabric so breathing or air permeating will not occur.

In all cases, vents that are often placed on covers provide more ability for air to move out from under the cover than the fabric's ability to breathe. It is important to note that in this “static” condition air under the cover is stagnant.

Where air permeability is most important is when towing. This is a dynamic condition and high air permeability will cause the cover to



billow and buffet, lowering its life and potentially causing damage to the surfaces it touches.

Mold & Mildew Cause and Prevention: Mold and mildew spores are ever-present in air and soil, and most will germinate when exposed to temperatures above 75°F and relative humidity (RH) of 50%, with rapid spread occurring at 80%; however, some can grow in significantly lower temperature and RH levels.

All fabrics will support growth but natural fibers like cotton, due to their cellulose component, are more susceptible than synthetics. Some synthetics are treated with an anti-microbial agent which adds to their growth resistance. Anti-microbial treatments protect the base surface itself, so that alone won't support spore growth. However, organic soiling on top of those surfaces will. Once a population is established on the cover, vinyl seating or gel-coat, an irregular stain will appear which ranges in color from gray to black; however, yellow, orange & red stains are possible. Sometimes UV exposure can fade them but most often they remain permanent stains.

Treatment: (Canvas manufacturers acknowledge this is difficult and very time-consuming, with limited expectations of success. Therefore, it is desirable to avoid the necessity of mold and mildew treatment.)

- If growth is established, vacuuming with a HEPA filter unit would be the first step followed by cleaning.
- For fabric and vinyl surfaces, shampoo lightly with an upholstery shampoo.



Focus on Prevention: The key in eliminating mold growth is controlling moisture. Remove it as a factor and growth simply will not occur, so maintaining a cool and dry condition with clean surfaces is paramount. Using a dehumidifier isn't practical for boat storage, but a simple remedy can be using desiccant bags. They must be monitored as they will absorb moisture and become ineffective but they can be replaced and this is a relatively inexpensive method. They are available in packs for a normal-sized boat and called "Boat Dry," purchasable from Sun Solutions www.sunsolutionproducts.com.

When the boat is ready to store, the best practices are:

- Clean and dry the boat thoroughly.
- Place a "Boat Dry" set of desiccant bags throughout the boat.
- Put the mooring cover on and tightly ratchet (seal will be created at the rub-rail).

Drying out a boat is difficult but the extra care you take will keep your boat looking new for a long time.

Condensation Cause and Protection: Water vapor in the atmosphere will condense onto another surface only when that surface is cooler than the dew point temperature, or when the water vapor equilibrium in the air has been exceeded. The dew point temperature is based on the air temperature and relative humidity. A typical example is with 90°F air temperature and 50% RH, the dew point temperature is about 73°F.

Many times, through the evening dew will condense onto all outdoor surfaces like grass, cars, patio furniture, toys, bikes and the like as the air temperature and surfaces cool below the "dew point." Once the morning sun heats the air temperature or those surfaces heat up enough, the dew will evaporate back into "humidity" and this cycle will continue as long as the weather conditions permit.

When you cover your boat, you are sealing the outside air in its present condition under the cover. Also, if the boat wasn't dried out, that additional moisture will add to the wetness of the trapped environment. As the air and surface temperatures cool below the dew point the water vapor in that air will condense onto all surfaces inside the boat. In the morning it will take longer to heat the air and surfaces under the cover as it affords protection thereby lengthening the time it takes to have the condensation evaporate. It's very possible if weather conditions change that the condensation may not return to vapor for quite some time.

This condition is often misunderstood as the cover "leaking" water through the fabric, but because of the fabric's high hydrostatic water resistance (160 cm) this is not possible. It's understandable to think that having the cover wet underneath is somehow due to it allowing water through, but it is just condensation forming on its surface. It's like camping in a synthetic tent; if you've ever done it you'll remember water beads form on the tent surface and bumping the tent would cause them to "rain" on you!

Pooling Water: Water can pool on a cover for various reasons. However, the Malibu cover is designed to combat this by having the overall features and characteristics work in concert to maximize its resistance. The fabric choice requires it to be lightweight, high-strength, coated, water-repellent treated and "dimensionally" stable. This minimizes the fabric adding weight, and its strength and stability allows for the necessary tight fit.

The "face" surface is treated with a water repellency, lowering the surface tension so water beads up and runs off. The "back" surface is urethane-coated, providing additional defense against water penetrating the cover. The new water repellent lowered the surface tension further over traditional treatments where the water beads move sooner joining with others making them run off the cover sooner & faster (very visible). It also increased hydrostatic water resistance (the ability of fabric to resist water penetration) from about 100 cm to 170 cm.

All "face" water repellent treatments wear off and the "water beading" will lessen eventually, allowing water to be absorbed by the fabric fibers, but the "back side" urethane coating will provide the second defense of penetration.

A traditional "face" treatment lasts about six (6) to nine (9) months, and tests on the enhanced treatment (BW+) show it will last three to four times longer.

In all cases durability of the treatment is very dependent on the environment and use the cover experiences. Providing the enhanced water repellent as a re-apply alternative isn't possible because it requires a controlled bonding process to properly attach it to the fabric surface. There are various aftermarket repellents available, but because they are mechanically attached they usually only last about one month or so—like waxing your car!

Maintaining Zippers and Hardware:

- Lubricate zippers periodically using a clear silicone spray. Spray silicone on to the zipper and work the zipper back and forth.
- Lubricate fasteners periodically using a clear silicone spray to keep corrosion to a minimum. Replace any missing fasteners or fasteners that show signs of corrosion.
- Do not use petroleum-based products; i.e. petroleum jelly.

Maintenance Tips: The real key to canvas longevity is like all things in life: maintenance. Keep the canvas clean of dust, dirt and environmental residue on a regular basis.

- Top fabrics should be cleaned of any dirt buildup at regular intervals.
- We recommend applying a mild, lukewarm soap solution, such as a liquid dishwashing soap, with a soft brush or sponge. Water temperature is not to exceed 100°F. DO NOT allow the soap to dry. The fabric must then be carefully rinsed with clear water in order to remove any remaining soap residue. Allow canvas to dry thoroughly. **DO NOT USE DETERGENTS!**
- The use of abrasive detergents and/or substrates containing solvents or gasoline will damage the fabric. If using high-pressure or steam-cleaning devices, use caution as improper use could damage the vinyl coating and/or fabric.
- Using harsh chemicals could void the fabric warranty on your top if not recommended by the manufacturer.
- **DO NOT PUT MARINE CANVAS IN YOUR HOUSEHOLD DRYER. DO NOT DRY CLEAN BOAT CANVAS.**

Upholstery

Even if you do not have or use canvas covers, read the previous material about canvas care as there is information that is applicable to upholstery use as well.

NOTE: Topical cleaners must be wiped off with clean water and dried with a clean cloth after application. If not rinsed after direct contact, the cleaner residue on the surface can cause a slight color change.

NOTICE

The performance results shown in this information are not guaranteed for all upholstery products. The evaluations are indicators after laboratory tests and may not be indicative of field performance.

Mold and Mildew: As noted in the *Canvas* information above, mold and mildew problems in the marine upholstery industry have been well-documented. The objective of this overview is to review the causes and cures of the unsightly and odoriferous problems, and to suggest actions to reduce their impact on the quality of goods as perceived by the consumers.

The Cause—Micro-organisms: The two principal causes of offensive odors and unsightly stains and growths are bacteria and fungi, commonly called micro-organisms. Bacteria are simple, single-celled organisms. Fungi, referred to as mold and mildew, are significantly more complex.

A subset of fungal organisms is a type that produces colored by-products as part of its digestive process. These by-products are recognized as stains and are typically pink, yellow, purple or black.

All micro-organisms require a source of energy, carbon for cell structure, nitrogen for amino acid synthesis, essential minerals and water.

Organisms causing problems in the marine, industrial, health care, hospitality and home environments are frequently very self-sufficient in synthesizing required bio-chemicals from the most basic molecules. Micro-organisms are ubiquitous. They are everywhere, and thus, microbial contamination is the rule. The total absence of microbes—sterility—is the exception.

Current Reality: To have a mildew problem, four elements are required. In order for mildew to proliferate, spores, food, warmth and moisture are necessary. Elimination of one of these elements would break the cycle, and the mildew problem would be eliminated.

The most likely element to control is moisture. Keep surfaces dry and the ambient air dry, and you can break the link. In actuality, this is very difficult. Marine upholstery may be dry when one sits on it, but it is constantly exposed to rain, splashes and wet bathing suits.

Dirt carried by the wind or sudden shower will carry the spores or seeds to begin the process, inoculating the surface. Surface debris can easily be washed off, but what happens to the contamination that gets into a seam or stitch holes?

A closer examination reveals that a marine seat is a very complex construction. The vinyl that you look at or sit on is a minute part of the total construction. The vinyl is usually attached to a fabric to give it dimensional stability and physical strength. Urethane foam of various thicknesses provides a cushion, and the whole seat is usually built on a piece of plastic.

If contaminated dirt carried by rain water gets inside the cushion, the biological growth cycle can begin. It is quite common for soil organisms growing in the foam cushion to produce colored by-products, the most notable of which is a pink compound.

This dye is soluble in plasticizer (an ingredient in flexible PVC) and will diffuse and migrate to the vinyl surface. Even though the vinyl compound is adequately protected against mildew growth, pink staining can occur if contact is made with components of a seat which support mildew growth. This stain cannot be removed by washing. In any case, the owner's perception of the boat's quality has been seriously affected.

The Solutions: As in most complex problems, there are a variety of actions one can take to prevent microbial problems. These



actions must be directed to the components of the product and the total construction. Working together, they will assure the highest probability of success in eliminating quality problems associated with mildew contamination.

The solution consists of four components:

1. Keep seats clean.
2. Remove or kill any surface growth.
3. Use materials that are treated to inhibit fungal growths.
4. Keep surfaces covered, if possible, when not in use.

APPROVED CLEANERS FOR MALIBU UPHOLSTERY

303 Fabric/Vinyl Cleaner

All Purpose Vinyl Cleaner

Babe's Boat Care Wash

Coverage Plus Germicidal Wipes

Fantastik Antibacterial All Purpose Cleaner-Heavy Duty

Formula 409 Antibacterial All-Purpose Cleaner

Iosso Marine Products Mold & Mildew Stain Remover (in dilution of 1 scoop [1/2 oz] per quart of water)

Above are all recommended for use, ONLY if diluted per the manufacturer's instructions.
DO NOT USE ANY PRODUCT NOT LISTED HEREIN.

<https://www.boat-manuals.com/>

Common stains and steps to treat:

<i>Type of Stain</i>	<i>Step #1</i>	<i>Step #2</i>	<i>Step #3</i>
General care	A	B	
Dirt buildup	A	B	
Ballpoint ink*	B	A	
Chewing gum	B	A	
Coffee, tea, chocolate	B	A	
Grease	C	B	A
Household soil	A	B	
Ketchup	A	B	
Latex paint	A	B	
Lipstick	C	A	B
Mildew or wet leaves*	B	A	
Motor oil	C	B	A
Oil-based paint	C	B	A
Permanent marker*	B	A	
Spray paint	B	A	
Sun tan lotion*	A	B	
Tar/asphalt	C	B	A
Yellow mustard	A	B	

- A. Medium-soft brush, warm, soapy water, rinse/dry
- B. 303 Fabric and Vinyl Cleaner rinse/dry
- C. Wipe or scrape off excess (chill gum with ice)

After all cleaning methods, rinse well with clear, warm water.

***Sun tan lotion, tree pollen, wet leaves and some other materials, including waxes, can contain dyes that stain permanently. These stains are not covered by warranty.**

No warranties or claims are hereby made that the cleaning methods will completely remove the stains and return the material to its original state.

Attempting to clean Malibu upholstery with any unapproved product may void the warranty and permanently damage the material. Failure to properly clean and maintain the upholstery will also void the warranty.



Carpets and Mats

The carpets and mats available through Malibu are constructed of durable, marine-grade material. Occasionally washing with a mild detergent (such as Dawn dishwashing soap) and warm water is required. Commercial carpet cleaners (such as Woolite Spray Carpet Cleaner) are also acceptable.

After cleaning, thoroughly rinse the detergent or cleaner out of the carpet or mat and into the bilge.

Allow the boat to remain uncovered for several days to air dry and avoid mold and mildew. See the *Canvas and Upholstery* sections for more information on mold and mildew development and how critical it is to avoid.

Swim Board

Malibu uses high quality fiberglass and rubber composites to construct swim boards. These durable boards should also periodically receive a thorough cleaning. Use only mild detergents and warm water or marine-industry based cleaners that are approved for use on fiberglass and rubber.

NOTICE

Avoid using ArmorAll or similar types of rubber-shine products. These will actually accelerate deterioration of the product, rather than protecting it. Such damage is not covered under warranty.

Hull and Deck Finishes

The majority of the finish surface of the hull and deck is a fiberglass-reinforced resin. While the boat material is sturdy, to ensure an enjoyable experience while boating, the fiberglass-and-resin layers and gel coat finish (where the paint is embedded) is very thin—only a few millimeters in depth. To keep it looking like new, it is important to keep it clean and waxed.

Only a mild detergent and warm water should be used to clean these surfaces. Avoid all harsh cleaners as they will quickly erode the finish.

NOTICE

Use only a mild detergent, such as dishwashing soap, and warm water to wash the fiberglass-and-resin and gel coat finishes on the boat. Harsh detergents and cleaners will quickly damage the finish, and this is not covered under warranty.

If you choose to wash the boat at a car wash, do so with care. Stay back from the boat surface to avoid potential damage from the high-pressure sprayer, and do not use the soap setting as most car-wash soaps are intended to deal with highway-type debris such as salt, road tar and similar environmental hazards. Wash the boat by hand with mild detergent as noted above, and then rinse carefully.

Stainless Steel, Chrome and Aluminum Components

The boat has been constructed with various metal components, all of which require special attention during routine care. Decomposition occurs, resulting in rust and/or corrosion, and it is accelerated when the boat is operated in salt water.

NOTICE

Damage that occurs to the boat as result of corrosion is not covered under the warranty!

While Malibu uses quality metal components chosen for their durability as well as attractive appearance, all metal eventually reacts to exposure to water. Therefore, part of the care and maintenance of metal requires that it is kept clean and dry. After an outing, rinse the metal pieces as well as the rest of the boat, allowing, at minimum, a thorough air drying. To avoid spotting and discoloring, drying with a soft rag or towel will keep the new-boat look for many seasons to come. It is also wise to wash all metal components when you wash your boat as this will help prevent moisture from affecting the surface. Waxing these metal components will also help to preserve the finish.



Do not wax powder-coated surfaces as the wax will collect in the textured surface and be extremely hard to remove.

If the boat owner begins to notice rust or deterioration of metal components below the water, even when operated regularly in fresh water, this should be brought to the attention of the authorized Malibu dealer. **In some instances, it is necessary to attach self-sacrificing zinc anodes, even when operated in fresh water. Be safe, rather than sorry!**

Salt Water Series Care and Maintenance

When boating in brackish or salt water, the post-outing cleaning is highly critical for the protection of the finishes. The potential for corrosion means that boats operating in this type of condition must be equipped with self-sacrificing zinc anodes. These anodes are attached in several locations, including the transom, driveshaft and rudder. (Check with your authorized Malibu dealer to be certain that you are aware of all locations of these anodes

as they will require periodic replacement.) **The anodes serve to significantly reduce the potential for corrosive damage to the permanent metal components on the boat.**

Malibu boats are equipped with a closed cooling system, (see the *Engine* section of this owner's manual), which reduces the amount of water utilized from the body of water during operation. However, **SOME** water is necessary and must be drawn on-board and circulated. This function exposes interior portions of the boat, particularly some engine components, to operational exposure to salt or brackish water. The explanation of how properly flush the engine following an outing appears later in this section.

NOTICE

Failure to follow ANY of the Salt Water Series instructions for care and maintenance will void the warranty. Significant damage occurs to the engine and boat if proper maintenance is not followed as outlined in this owner's manual.

Routine Maintenance

Attention to the mechanical components of the boat are as critical as any matter in ensuring a long, enjoyable ownership. Some boat maintenance is required prior to and following every outing, some must be done on a regular schedule, and some has to be done in accordance with proper storage and winterization. Because of the complexity of some components, such as the fuel system, you will need to seek assistance from an authorized Malibu dealer's service department. Other issues can be easily accomplished by the boat operator.

PCM/PEG engine information is provided by PCM/PEG in a separate manual. Boats equipped with PCM/PEG engines have a specific set of instructions for operation, care and maintenance which must be followed in order to keep the warranty in effect.

The following engine and drive-train-related information appearing in this section of the Owner's Manual is intended for Malibu-engines and drivetrains. The instructions must be followed in order to keep the warranty in effect.

Note that these instructions should be followed even after the warranty period has expired. The instructions developed for the powertrains and drivetrains in Malibu boats function as the guidelines to a long-term, positive boating experience.

CAUTION

Failure to follow the care and maintenance instructions as provided in either the PCM/PEG owner's manual or in this section of the Malibu Owner's Manual (depending on the equipped engine) can result in damage to the engine and transmission that is not covered under warranty. The rest of the care and maintenance information provided for the boat is also critical to long-term success in boat operations. Under some circumstances, failure to follow the instructions, especially as noted on a timely basis, could result in the boat becoming inoperable, stranding boaters and/or placing those on-board in situations that could result in potentially dangerous situations.

The following engine-related information is provided for the Malibu Monsoon Engines. Unless otherwise directed, the instructions are applicable to both the 6.2L and 5.3L engines.

BEFORE STARTING THE ENGINE*(Details follow about each.)*

- Check coolant level.
- Inspect the sea strainer.
- Check the battery holders and the connections.
- Check for odors, particularly fuel odors.

AFTER STARTING THE ENGINE*(Details follow about each.)*

- Check for odors, particularly from exhaust emissions.
- Be certain that the battery registers as fully charged and that there is sufficient fuel for the outing.

AFTER THE OUTING*(Details follow about each.)*

- Give the engine compartment a general inspection.
- Check the other components.
- Note how much fuel was used and the state of charge on the batteries.
- Give the boat a good general cleaning as outlined in the *On-Going Care* information that precedes this section.

AFTER 10 HOURS ON THE HOURMETER*(Details follow.)*

- Check the safety equipment.
- Have the oil changed by your authorized Malibu dealer. The dealership will also do several other critical inspections of the drivetrain.

AFTER 75 HOURS OR ANNUALLY [whichever comes first]*(Details follow.)*

There are certain maintenance routines that must be performed. Due to the complexity of this maintenance, Malibu recommends it be completed by your authorized Malibu dealer.

STORAGE AND WINTERIZATION*(Details follow.)*

This is critical to the life of the boat. These steps include ensuring that all water has been evacuated from the boat, the battery is properly stored, and the boat finishes are protected. Information is also provided regarding the proper lifting of the boat from the water if it will be stored at any time by that method instead of resting on a custom-built Malibu trailer.

NOTICE

Failure to follow the maintenance instructions provided in this Owner's

Manual will result in the voiding of the Limited Warranty explained in its own section of this Owner's Manual.

Routine Salt Water/Brackish Water Protection

AFTER EVERY OUTING: Perform a general cleaning of the entire boat, interior and exterior, with **CLEAN** water. (See *Flush Kit* instructions, which follow.) Then reapply the WD-40 Long-Term Corrosion Inhibitor and Corrosion Block as described in the following instructions to the **EXTERIOR** of the engine.



Boats operated in salt water, brackish water or polluted fresh water must be thoroughly rinsed with

CLEAN, fresh water after EACH outing. The corrosive properties of these types of water will cause damage that is not covered under warranty! Hardware—even hardware chose for its anti-corrosive properties—that is damaged by salt/brackish/polluted water may eventually fail, which could result in serious injury or death to persons on-board.

Although every component on the boat, including the engine, can be adversely affected by salt/brackish/polluted water, upgraded components in the Salt Water Series building process include:

- Stainless steel gas shocks;
- Grounding and bonding of all components below the waterline; and
- A sacrificial zinc anode.

Especially important to the entire protection process is the sacrificial zinc anode. The anode is attached to the exterior of the boat, on the transom below the waterline. Other metal components are attached to the transom zinc anode via grounding wire. These anodes provide a greater degree of attraction between the anode's metal and the corrosive action of the body of water than that occurring between the boat's metal parts and the water. Simply, both rust (which is oxidation) and metal reduction are the result of operating in salt water, and the anodes' purpose is to attract and draw away much of the corrosion from the boat's metal components.

NOTICE

The sacrificial zinc anodes do not totally eliminate the corrosion process from the rest of the boat and its components. It is critical for the boat to be rinsed and flushed after EACH use. Failure to do so will void the warranty.

Malibu has determined that the use of Corrosion Block is necessary to ensure long life for metal components. The use of Corrosion Block, available at www.corrosionblock.com, as directed on the bottle or can is required to keep the warranty in force. Corrosion Block comes in aerosol spray, liquid that can be placed in your own spray bottle, or as a grease.

Avoid getting Corrosion Block on other, non-metal surfaces, particularly vinyl seats or soft-grip flooring. If this occurs, clean immediately as directed by the product's directions to avoid stains that are also not covered under warranty.

NOTICE

Failure to use Corrosion Block as directed on the product label will result in the nullification of the Malibu warranty in instances of corrosion damage. Failure to clean Corrosion Block off non-metal surfaces can result in damage that is not covered under warranty.

NOTICE

Malibu uses only marine-rated and marine-grade fasteners on all models. If, at any time, it is necessary to replace any fasteners, seek guidance from an authorized Malibu dealer to ensure that such replacements meet the requirements for operation in a marine environment.

Before Starting the Engine

Check Coolant Level

Be certain the emergency safety stop switch is disconnected and the shifter/throttle is in neutral. Open the engine compartment hatch and locate the coolant reservoir. The reservoir will be located on the port side of the engine between the manifold and the intake diagonally behind the alternator. The reservoir features a "FULL" marking. This is not the same as filling the reservoir until it is completely full. The reservoir requires expansion room while in operation; therefore, the FULL marking is slightly lower than the top of the tank.



Never open the coolant reservoir when the engine has been running. This check

should be done prior to starting the engine. During operation, pressure builds up in the reservoir. Opening it before the cooling system has had time for pressure relief likely will result in an eruption of fluid. It will also be sufficiently hot to seriously burn skin. Always allow sufficient time for the fluid to cool and return to pre-operation levels.

It may be necessary to periodically add coolant as a small amount of evaporation occurs naturally. When adding coolant, use only a 5-year, extended warranty antifreeze (propylene glycol), either a premixed 50/50 mix or create a mix of 50 percent extended-warranty antifreeze plus 50 percent distilled water. (Do not use tap or other water as other elements in the water can cause build-ups

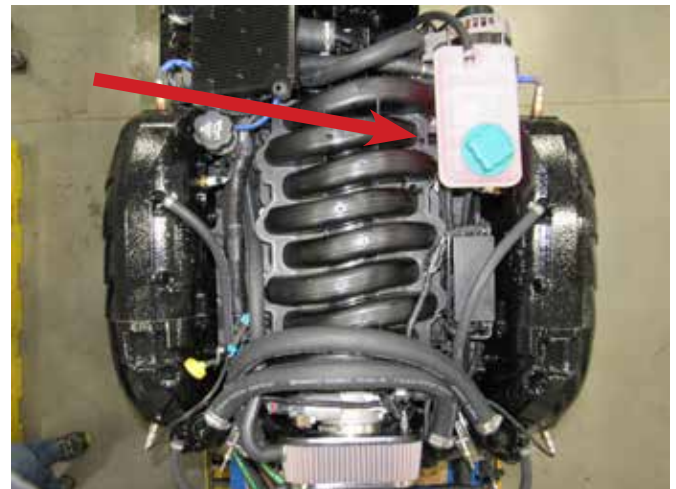

or deposits within the closed cooling system. This can interfere with proper operation and resulting damage is not covered under warranty.) **The coolant MUST BE propylene glycol coolant ONLY. Never use ethylene glycol or Dex-Cool, nor ever attempt to mix coolants as they will not properly mix. Use of unapproved coolant will void the warranty.**

Inspect the Sea Strainer

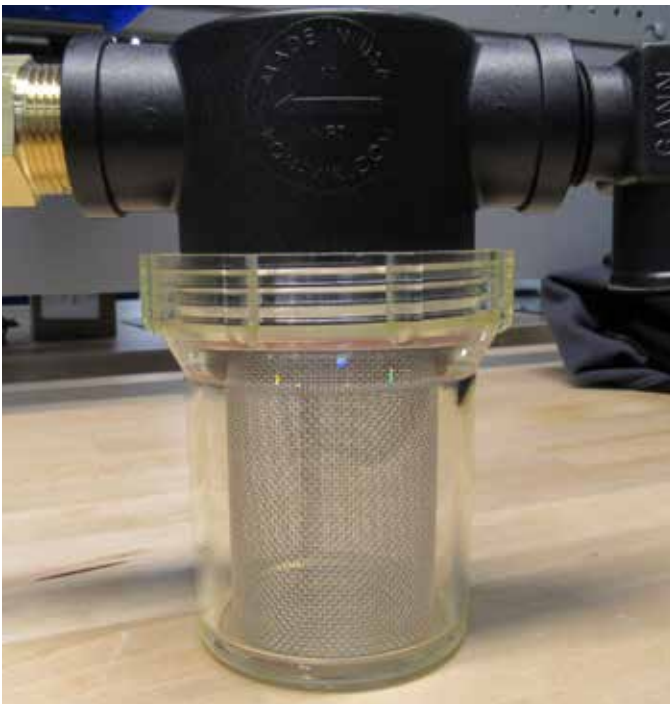

Raw water from the lake/river/sea is drawn into the boat as part of the cooling system for the engine and drive train. Even with the closed cooling systems, it is necessary to circulate additional water as part of an effective cooling system. To protect the system, a sea strainer is installed near the raw water intake, aft of the engine near the steering system's tiller arm. The sea strainer serves the purpose

of keeping debris from entering the raw water cooling system and causing eventual engine failure. **As with any kind of strainer, it is necessary to regularly clean it so that water can flow unimpeded.**

When operating the boat in "dirty" water that is brackish or has a noticeable degree of weeds and other flora, it may be necessary to clean out the strainer in boats equipped with sea strainers **even during an outing**. Pay close attention to the engine temperature, which appears on a gauge or video screen. (See the *Dashes and Video Screens* section of this Owner's Manual for more information.) An overheating engine is probably due to inadequate water flow.

NOTICE

Continuing to operate a boat that is overheating the engine and drive train will result in engine failure eventually. Boat operators should routinely review the engine temperature information provided on the gauge or video screen on the instrument panel. Ignoring or failing to take proper steps to reduce the engine temperature, resulting in damage, is not covered under the warranty.

Leave the engine OFF.

To inspect the sea strainer, open the engine compartment. Note the sea strainer's appearance as shown in the accompanying photo. (If you cannot locate the sea strainer, ask for assistance from your authorized Malibu dealer. This step is critical and cannot be overlooked. Also shown in the photo is the adjacent optional flush kit, which does not require normal consumer maintenance.)

Open and lift the cover to expose the filter.

Remove the filter and examine for any debris that has accumulated within it. When necessary, clean out the filter and then reinstall it in the housing. Hand tighten the lid so that water will not leak out and into the engine compartment.

If it is necessary to check the sea strainer during an outing, turn OFF the engine first and then close the valve on the water pickup feeding the sea strainer. Make sure you open the valve prior to running the engine; otherwise, it will overheat. Whenever the engine is running, water is being drawn in and you will not be able to inspect the sea strainer.

Check the Battery Holders and the Connections

Because batteries contain fluid that is caustic and potentially dangerous to skin and body parts, boat operators need to ensure that the batteries are securely in place. Also, if the connections are loose, erroneous readings may be sent to the boat system, which can cause running and functionality problems. To avoid becoming stranded during an outing, it is important to have accurate voltage readings



throughout the period of time the boat is in use.

To check the batteries, be sure the engine is OFF.

Locate the batteries. While they will be in different places depending on the boat model, usually they are found

under the observer seat. Check your *Quick Reference Guide* in this Owner's Manual to determine the location.

If the posts show signs of corrosion or other debris, remove the battery and clean carefully. To do so, follow these steps:

Turn the engine OFF, as well as any systems that are operating on the boat.

Make sure the battery switch is in the OFF position.

Loosen and remove the negative (-) black terminal connection first. If you are using a wrench for this process, be careful to avoid touching the positive (+) red terminal connection as you may receive an electrical shock as a result.

Next, loosen and remove the positive (+) red terminal connection.

Disconnect the hold-downs that are holding the battery in place.

Remove the battery.

Using a battery terminal cleaner, carefully clean the corrosion/debris from the battery posts.

Using a baking-soda-and-water mix, clean the battery case, taking care to avoid splashing any of the solution inside the battery vents. Rinse with clear water, again, avoiding the vents.



Inside the battery is an electrolyte fluid that allows the chemical reaction

to provide power. The fluid is comprised of several components, one of which is sulfuric acid. As with most acids, this is caustic and corrosive. If it comes in contact with skin, immediately flush the area with copious amounts of fresh, clean water. Follow up with medical assistance.

A battery terminal brush may be necessary to remove corrosion from the inside of the battery terminals. Use the same type of baking-soda-and-water mix and rinse with fresh water. Dry with a clean rag.

Check the box in which the battery is held to be certain that it is not showing signs of corrosion or dirt. Clean, if necessary, as with the above instructions for cleaning the battery. Be sure that the holding box is dry prior to reinstalling the battery.

Repeat with the steps with the second battery.

After placing the battery back in the holding box, reconnect the hold-down. Then reconnect the positive (+) red battery cable connection first. Follow with the negative (-) black battery cable connection.

Tighten both terminals and then coat with a thin covering of marine dielectric grease. Be sure that the positive terminal rubber boot completely covers the terminal.



If it becomes necessary to re-charge a battery from an external source, DO NOT attempt to charge using

automotive battery cables or use another boat battery as the source for charging.

Some amounts of hydrogen gas are emitted during the charging process. This can be very dangerous. It is critical to keep all sparks, including smoking cigarettes, lighters or any type of flame, well away from a charging battery. Use the optional battery charger sold by authorized Malibu dealers, or a similar aftermarket battery charger. Using the wrong type of charging procedure or improperly charging a battery can result in an explosion and/or fire that could lead to serious injury or death.



Check for Odors

An unexpected or strong odor can be the first sign of leakage. Both exhaust and fuel leaks have distinctive odors and should never be ignored. If either is present, do not start the engine until the source of the odor has been determined and corrected.



Because gasoline is highly flammable and vapors are more dangerous than the actual liquid fuel, never

introduce flame, spark or electrical ignition into an unknown source of a fuel emission or leak. Always verify the source of and correct any leakages prior to use of the boat.

After Starting the Engine

Check for Odors, Particularly from Exhaust Emissions

As before starting, an unexpected or strong odor can be the first sign of leakage. Both exhaust and fuel leaks have distinctive odors and should never be ignored. If either is present, do not start the engine until the source of the odor has been determined and corrected.



Because gasoline is highly flammable and vapors are more dangerous than the actual liquid fuel, never

introduce flame, spark or electrical ignition into an unknown source of a fuel emission or leak. Always verify the source of and correct any leakages prior to use of the boat.

Be Certain the Battery Registers as Fully Charged and there is Sufficient Fuel for the Outing

Depending on the model, battery voltage and fuel levels are registered either on a gauge or on the video screen. (See *Dashes and Video Screen* information elsewhere in this Owner's Manual for details.)

In verifying the battery charge, look for a reading around 13 volts, but no lower than 10.5 volts or higher than 14.5 volts. Erratic readings are usually a sign of low voltage or loose connection(s). Even if the reading appears correct, if there were any symptoms of voltage insufficiency or error during a previous outing, check with an authorized Malibu dealer before undertaking another outing. You do not want to become stranded with a dead battery away from the dock.

The current boat models are equipped with a low-voltage alarm. Even with a fully charged battery on-board, it is possible to discharge so much that the boat becomes disabled. If running the stereo components with the engine OFF, periodically check the voltage reading to ascertain how much has been discharged. To avoid difficulties in re-starting the engine, the system will shut off the stereo and sound an alarm if the voltage level falls below 10.5 volts. The alarm will continue for approximately two (2) minutes to allow everyone out of the water around the transom, and the boat operator to restart the engine to allow the engine alternator to recharge the battery.

As noted above, do not attempt to jump-start a dead battery. This is not only dangerous but puts undue stress on the boat engine's alternator, which may cause it to fail. This is not covered under warranty.

NOTICE

Attaching the wrong battery cable or using jumper cables can result in damage to electrical components on the boat. Such damage is not covered under warranty.

Fuel levels should be noted prior to an outing. Malibu recommends starting all outings with a full tank and returning to shore to refuel whenever the fuel readings drop into the one-quarter (1/4) range as falling lower can result in engine issues. (See *Fueling* information in the *Engine* section of this Owner's Manual.) Failure to pay attention to the fuel level can result in the boat running out of fuel and leaving the boat stranded. Malibu does not pay for towing.

After the Outing

Give the Engine Compartment a General Inspection

Look for signs of leaks or anything abnormal. It's a simple thing, but often the simplest, quick look can pinpoint an issue before it becomes a problem.



Check the Other Components

This is a common sense approach. If you've been boating in dirty water, cleaning out the sea strainer now instead of waiting until the debris inside it has dried (and therefore become more difficult to remove) makes sense. You want to check the paddlewheel, rudder, propeller, and driveshaft to make sure they appear intact, too, especially if you suspect that you may have struck something submerged during the outing. These are easy checks after the boat has been loaded on the trailer and removed from the water.

Check anything else on the boat that did not function as expected during the outing and seek assistance from your authorized Malibu dealer about any concerns and issues prior to the next outing.



Note How Much Fuel and Battery Charge Were Used

Malibu recommends keeping a chart or binder with information from your outing. If you note the conditions during the outing, the length of time, and the final readings, you'll have a much better idea of normal operations. That gives you the clues you need when readings are different or you are anticipating an outing that will be different and you need to prepare for those conditions.

Give the Boat a Good General Cleaning as Outlined in the On-Going Care Information that Precedes This Section

As noted earlier, *On-Going Care* is important. Read that section to determine the normal expectations regarding routine care. Read the *Salt Water/Brackish Water Extra Attention* section, which follows. Even boating in "clean" water, you add protection and quality care for your boat by following the cleaning requirements. The same components that need added protection from salt/brackish water will also retain their luster and live longer if the same attention is applied to them.

Salt Water/Brackish Water Extra Attention

To properly protect and ensure long life for vulnerable components, following the operation in salt or brackish water, provide extra attention to the cleaning process.

Begin by gathering the following supplies:

- WD-40 Long-Term Corrosion Inhibitor (as opposed to regular WD-40; the typical WD-40 does not contain all the protective ingredients of the Long-Term Corrosion Inhibitor)
- Corrosion Block
- Micro-fiber towels

WARNING Boats operated in salt water, brackish water or polluted fresh water must be thoroughly rinsed with CLEAN, fresh water after EACH outing. The corrosive properties of these types of water will cause damage that is not covered under warranty! Hardware—even hardware chose for its anti-corrosive properties—that is damaged by salt/brackish/polluted water may eventually fail, which could result in serious injury or death to persons on-board.

The following areas, where equipped, should always receive special attention when cleaning after boating in salt/brackish/polluted water:

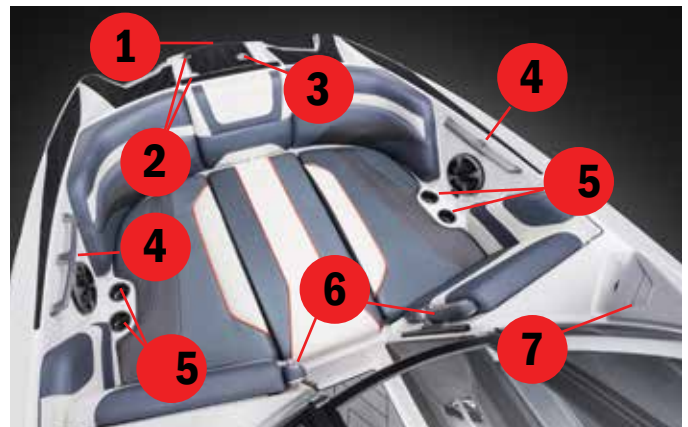

- | | |
|------------------------|------------------------|
| 1 = Ladder | 2 = Ladder door hinges |
| 3 = Ladder door handle | 4 = Bow grab handles |
| 5 = Front cup holders | 6 = Arm rests |
| 7 = Vent covers | |



- 1 = Windshield bracket
- 2 = 12" display screen mounts (both sides)
- 3 = Phone holder/Sport dash
- 4 = Power outlet mount
- 5 = Power switch mount
- 6 = Throttle
- 7 = Grab handle
- 8 = Subwoofer plate
- 9 = Seat mount

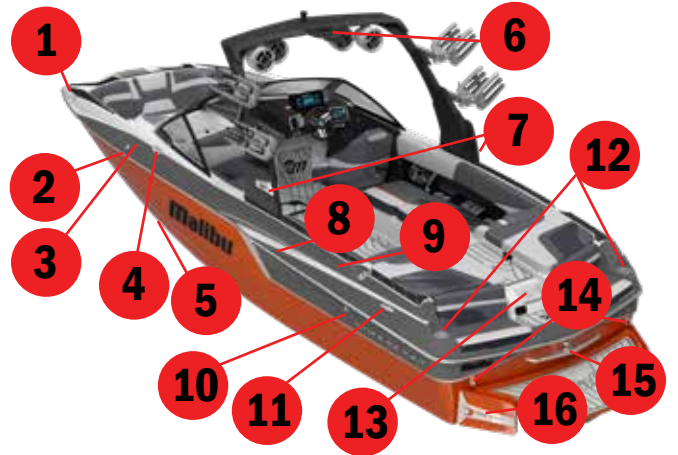

- 1 = Front cleat
- 2 = Front ballast drain
- 3 = Navigation light
- 4 = Middle cleat
- 5 = Bow thruster
- 6 = Wakeboard tow mount
- 7 = Tower logos
- 8 = Rub rail
- 9 = Fender mounts
- 10 = Rear ballast drain
- 11 = Rear cleat
- 12 = Rear cup holders
- 13 = Blower plate
- 14 = Rear lifting eye
- 15 = Transom handle
- 16 = Surf Gate logo

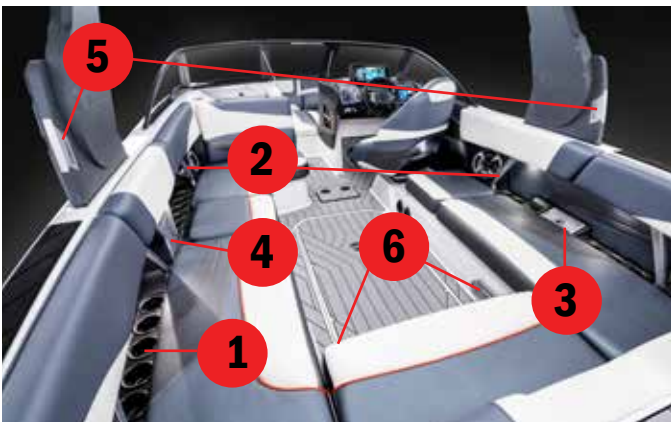

- 1 = Cup holders (all on both sides of interior)
- 2 = Grab handles
- 3 = Trash lid
- 4 = Center plate
- 5 = Tower release hinges (varies by tower)
- 6 = Rear sliding seat mounts and arms



- 1 = Rub rail
- 2 = Docking lights
- 3 = Board racks
- 4 = Tower speaker mounts
- 5 = Front ladder
- 6 = Front lifting eye

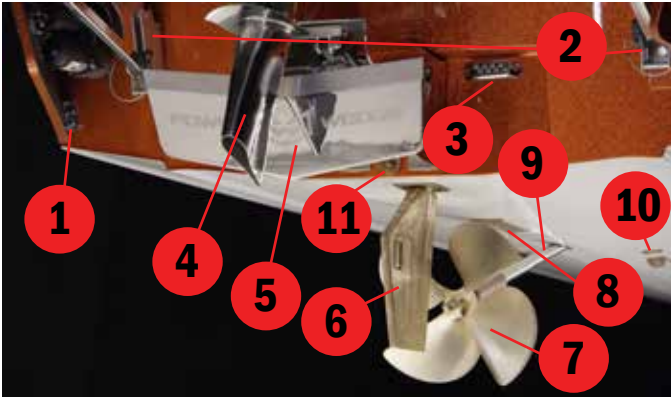

- | | |
|-----------------------|-----------------------|
| 1 = Surf Gate mounts | 2 = Swimboard mounts |
| 3 = Underwater lights | 4 = Surf pipe exhaust |
| 5 = Power Wedge | 6 = Rudder |
| 7 = Propeller | 8 = Strut |
| 9 = Driveshaft | 10 = Water inlets |
| 11 = Rear plug | |

Other Components Requiring Extra Attention (not pictured):

- Any metal seacocks or ball valves
- Any stainless steel or aluminum screws
- Stainless steel hose clamps
- Gas shocks
- Hinges
- Tracking fins
- Buss bars
- Power terminals
- Helm seat slides
- Starter
- Engine mounts
- Alternator
- Transmission coupler
- Bimini metal moving parts
- Trailer swing-tongue pin
- Underside of trailer
- Trailer tongue assembly

Examine the sacrificial zinc anodes. Your authorized Malibu dealer can offer guidance regarding the appropriate reduction rate, as well as the time at which anodes need to be replaced. Please note that because this is a natural function of operating in certain bodies of water, the cost of replacement is not covered under warranty.

Flushing the Engine

Flushing the engine is critical if the operating body of water was not clean. NOTE: In order to avoid drawing raw water in addition to city water, you will need to close the raw water intake ball valve.

The flush kit's location is adjacent to the sea strainer. The sea strainer requires frequent maintenance by the consumer; however, the flush kit should not require any consumer maintenance.

Boat owners and/or operators should never make any adjustments or attempt any maintenance to the flush kit; doing so may void the warranty.

With the boat out of the water:

- Locate the flush kit connector on the port side of the transom, above the swim platform.
- Connect a gardening-type hose to the flush kit system at the connector, and turn on the fresh water at the source.
- With the boat shifter in neutral, start the engine and allow it to idle. During the entire process, DO NOT EXCEED 1100 RPM on the engine. (The freshwater hose cannot provide sufficient water supply to adequately cool the engine at higher RPMs.) Also, never take the boat out of neutral gear.
- After approximately two (2) to three (3) minutes of flushing, shut off the engine.
- Turn off the freshwater supply.
- Disconnect the hose and reinstall the cap on the flush kit connector.

After 10 Hours on the Hourmeter

Have the Engine Oil Changed by an Authorized Malibu Monsoon Dealer

Do not do your first oil change before 10 hours or later than 15 hours.

The boat must be returned to authorized Malibu dealer for the

first service/scheduled maintenance. The purpose is to allow a trained technician to interpret any signs of malfunction or anomaly that may have occurred. Catching these symptoms early is critical to avoiding potentially damaging events that might not be covered under warranty.

The dealer will change oil, transmission fluid and cooling fluid, clean the sea strainer, and do an alignment check on the engine.

Check the Safety Equipment

If you have not done so previously, check the fire extinguishers and personal flotation devices. Check the condition of (and replace as necessary) drain plugs, bilge pumps, and exhaust flaps. Repair or replace anything that appears damaged or incapable of performing its function.

After 75 Hours or Annually (whichever comes first)

There are certain maintenance routines that must be performed. Due to the complexity of this maintenance, Malibu recommends it be completed by your authorized Malibu dealer.

Your dealer will verify many functions of the boat for you, some of which, should never be tested or checked by the consumer, such as the pressurized fuel systems that require unique tools.

Even when the authorized Malibu dealer performs the annual maintenance work, consumers are well-advised to pay attention to several components on the boat. These include:

Engine Mounts



Your engine is held firmly in place by special marine-grade engine mounts that are built and installed to withstand the kinds of stresses unique to a boating environment.

In checking the engine mounts, be sure to do this before starting the engine. Components on the engine can become hot enough to burn skin. Avoid this by checking before starting.

Any time you suspect an engine mount is loose, it must be tightened. If the engine is allowed to shake or move during operation, it adversely affects the entire drive-train and could cause damage that would not be covered under warranty.

Exhaust Flaps



On the Response, TXi, some flaps and components of the exhaust system are composed of high-grade rubber and synthetics. These may deteriorate over time. Check to ensure that the flaps fit securely over the exhaust port and that they will open with ease, which is what must occur when the boat engine is running.

Steering System



Malibu offers two types of steering systems, a standard, manual system and an optional hydraulic system. The latter is pressurized and the consumer cannot access or alter the system, nor should they try.

With the standard, manual system, there is a junction that does require occasional lubrication with marine-grade grease. This junction is accessed from the starboard side engine close-out in Wakesetters. In the Response and TXi, only the manual steering is offered.

(Never ignore any steering issues, regardless of timing for the annual maintenance check-up.)

Shift and Throttle System

As with the steering, never ignore suspicious issues with the shifter/throttle. Anytime the lever does not move smoothly or the boat does not shift/accelerate/decelerate with ease and smoothness, it is a matter to be resolved by an authorized Malibu dealer. **Do not wait for the annual maintenance period to verify safe operations.**

Battery

Your authorized Malibu dealer can check to see that the battery(ies) appear to be holding charge properly. Unless a battery has fully expended its life cycle, it's impossible to guarantee that the battery will continue to serve, but experience helps the dealer to anticipate whether there is still service to be expected from the battery.

When it is necessary to replace a battery, be certain to select a marine-grade battery with at least eight hundred (800) cold cranking amps (cca) at zero degrees (0°) Fahrenheit. Spiral cell batteries are superior in holding charges and extending the period of available usage.

Considerably more information about batteries is available in the *Dashes and Video Screen* section of this Owner's Manual.

Refer to your battery supplier for advice regarding long-term storage and/or winterization. If your battery manufacturer recommends removing the battery(ies) from the boat, verify whether the manufacturer requires that the battery(ies) is/are fully charged.



Follow common sense safety instructions regarding the removal or installation of batteries. Due to

potentially explosive fumes and corrosive battery acid, failure to wear protective items and follow instructions correctly could result in serious injury or even death.

- Because of corrosive and explosive qualities in battery acid and fumes, put on safety glasses and mechanic-type safety gloves.
- Determine the size socket required to disconnect the battery cables and bracket nuts. Extensions may be required.
- **ALWAYS DISCONNECT THE NEGATIVE (-) CABLE FIRST.**
- Ensure that the negative cable will not come in contact with the positive cable during the rest of the procedure.

- Disconnect the positive (+) cable, **TAKING CARE TO AVOID ANY CONTACT BETWEEN THE POSITIVE BATTERY CABLE AND ANY METAL.** There may be residual charge still in the electrical system, which could result in a serious electrical shock or burns.
- With the battery cables disconnected and out of the way, remove the bracket nuts holding the battery in place.
- Batteries should always be stored in a cool, dry location. Manufacturers generally prefer batteries be stored on shelving above floor level.
- Using an old toothbrush or similar bristled brush, and a mix of baking soda and water, clean off the battery terminals and cable ends, if they show any signs of corrosion. A small amount, especially as batteries age, is not uncommon, but excessive corrosion could be sign of future service interruptions, and it should be brought to the attention of your authorized Malibu dealer. Allow the terminals and cable ends to air dry.
- Clean the battery lugs with a wire brush.

Following the storage period, reverse the above steps to reinstall the battery(ies).

Pumps

The authorized Malibu dealer can inspect and repair/replace ballast and bilge pumps that are not functioning properly. This is both a safety matter and adds to the life of the boat's systems. All pumps will lose functionality over time as the internal components are designed to be self-sacrificing during use, rather than allowing debris to foul and damage more expensive and complex components of these systems. Insist upon pump evaluations during annual maintenance.

Coolant System

There are two (2) elements to the coolant system in Malibu boats: the closed-cooling system and the raw water intake system. Both require attention on a regular basis. Depending on the body of water, attention may need to be frequent.

NOTICE

Any time the engine temperature raises above normal operating levels (approximately 155-175 degrees) operators must determine the source of the overheating and address the issue. Often, it may be caused by debris in the sea strainer (raw water intake). If cleaning the sea strainer does not result in lower operating engine temperature, have the boat towed to shore and take it to an authorized Malibu dealer for analysis. Failure to immediately address overheating issues can void the warranty.

Instructions for inspecting and cleaning the sea strainer (raw water intake) are provided above, under *Before the Outing*.

The following information concerns the closed cooling system, which should be checked at least annually, even if there have been no instances of overheating during outings:

The closed cooling operates on a 50/50 mix of marine-grade coolant (such as Sierra) and clean, distilled water. (Some brands sell coolant conveniently pre-mixed. Be sure to read the label carefully, and **DO NOT** add any water to coolants that are pre-mixed. This will dilute them to unacceptable levels of mixture.) When mixing coolant and distilled water, do so in a **CLEAN** container. Dirt, oil, or other contaminants can cause damage to the cooling system, which may not be covered under warranty.

The coolant in the closed cooling system should be changed every two (2) years, but a thorough inspection is required annually.

Oil System

Replacing the oil filter and oil is an important part of the annual maintenance. Due to environmental concerns, Malibu recommends having an authorized Malibu dealer complete this important function. For those who feel confident they can complete this maintenance step with guidance, the following steps must be followed:

Have eight (8) quarts of **5W30 SYNTHETIC** engine oil, regardless of which Malibu engine is installed. **The use of any other oil or fluid may void the warranty.**

Whenever possible, run the boat for approximately five (5) minutes on the water. This will heat up the oil to a better viscosity for draining.

Draining the Oil:

1. Have a drain pan or container ready. (Never pour used oil on the ground or into the water. This is illegal in most instances. Regardless, it does not respect the environmental impact.)
2. The oil drain line is located on the starboard side of the engine oil pan through a fitting, and it is approximately four (4) feet long.



3. If a siphon pump is not available for use in this process, run the drain hose through the transom drain plug location (with the boat **OUT OF THE WATER**; removing the transom drain plug while in the water could result in the boat taking on water and sinking).
4. Because the line will not feed through the drain plug with the line cap on, raise the line above the oil pan. This creates a "P-Trap" as the end of the drain hose is fed through the transom drain plug to allow the gravitational flow of used oil.



5. If a siphon pump is available, remove the drain line cap, create a seal on the siphon hose and start the pump.
6. About eight (8) quarts of used oil should drain into the catch container. Typically, engines burn a small amount of oil during operation. An authorized Malibu dealer technician can advise you whether you should be concerned about the amount of oil used between oil changes.

Replacing the Oil Filter:

1. Oil filters are located on the front of the engine.
2. Remove the oil filter housing.
3. Use a tool designed for removal or installation of oil filters only. Other tools may crush the filter and release used oil into the engine compartment, the boat or the work area.
4. "Righty tight-y; lefty loose-y." Never force the oil filter. It necessarily must be on the engine securely, but it should release with only hand force when using an oil filter removal tool.



5. Some small amount of residual used oil may be inside the filter. Keep a shop rag or similar catch under the filter as it is removed from the boat.
6. Some mechanics choose to cut apart an oil filter to examine for any evidence of metal shavings or other unwanted signs of engine wear. If you choose to do so, be sure to cut over a container. Clean up any oil that ends up spilled.
7. Also examine the o-ring. If it sticks to the filter base, it should be replaced.
8. Pour a **SMALL** amount inside the replacement oil filter. Using your hand or a small, clean brush, spread the oil around the interior of the oil filter.
9. Using the oil filter tool, secure the oil filter in place on the engine. Tighten securely by hand, but do not force the filter as it may crush or break the seal if over-tightened.

Adding New Oil:

1. Replace the drain line cap on the drain line and thread the drain line back to adjacent to the oil pan.
2. Remove the oil fill cap on top of the valve cover.
3. Place a clean funnel within the oil fill cap.

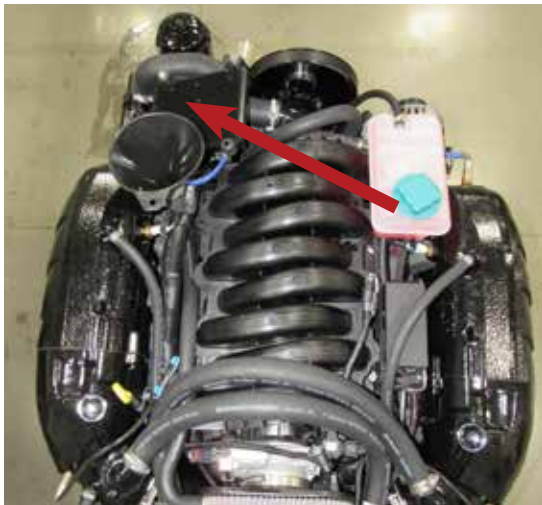

4. Pour the approximately eight (8) quarts of oil in the engine through the funnel, allowing time for the fill to occur. As you approach the eighth (8th) quart, slow down (it takes a little time for the oil to move through the oil system) and start watching the fill line on the dipstick. (Always clean the dipstick between readings to ensure accuracy.)

5. Stop filling oil into the system when you reach the **FULL** mark on the dipstick, regardless of how much oil has been added. **OVER-FILLING CAN DAMAGE THE SYSTEM!**

NEVER REUSE OIL! Only new 5W30 SYNTHETIC oil should be added to the oil system!

Transmission/V-Drive System

Transmission fluid checks must be done **ONLY** when the transmission fluid is heated. Therefore, the boat should be run in a body of water for at least five (5) minutes, and then shut down.

1. Remove and wipe down the transmission dipstick.



2. Reinsert, **BUT DO NOT SCREW DOWN FLUSH WITH THE HOUSING** (you will get an erroneous reading). Check the level.
3. Transmissions should register 2.5 quarts of ATF fluid.
4. V-drive boats: remove and wipe down the V-drive dipstick.



5. V-drives should have one-and-a-quarter (1.25) quarts of Mobil SHC 630 Gear and Bearing Oil.

6. As long as the ATF fluid and Mobil SHC 630 Gear and Bearing Oil appear clear, add the specified fluid (DO NOT add any fluid other than the specified fluid as it can damage the system and void the warranty) **ONLY** to the **FULL** line. **OVER-FILLING CAN DAMAGE THE SYSTEM!**
7. If the fluids do not appear clear, syphon off the fluid and replace with **NEW** specified fluid to the **FULL** line.
8. Even if the fluids appear clear, replace transmission and V-drive fluids every two years, regardless.

Fuel System

This is important. Debris and water may enter the fuel system, even with the careful protection built into the system. Periodic replacement of the fuel filter is required to protect the fuel pump and provide the proper fuel pressure to the engine. Due to the need to use only specialized tools that are not available to the public, and because the fuel lines are pressurized, no fuel system maintenance can be completed by a consumer. One fuel filter is located within the fuel tank, while another is on the engine. Even though it is more accessible, because it is under pressure this also is restricted to replacement by an authorized Malibu dealer.

While some boat owners may not have a dealer close at hand, this maintenance needs to be completed **ONLY** by trained technicians with the appropriate, specialized tools. We apologize for any inconvenience.

An annual replacement is recommended for both filters.

Hydraulic Steering System

The steering in Malibu boats features a hydraulic system that can be maintained or repaired only with specialized tools. Because of the potential for physical harm when working on this system, it cannot be checked, changed or repaired by consumers. Only an authorized Malibu dealer has access to the tools and system.

Check the Safety Equipment

If you have not done so previously, check the fire extinguishers and personal flotation devices. Check the condition of (and replace as necessary) drain plugs, bilge pumps, and exhaust flaps. Repair or replace anything that appears damaged or incapable of performing its function.

Power Wedge and Surf Gate Manual Extension and Retraction

For boats equipped with these optional features, it is important for the authorized Malibu dealer to verify the manual extension and retraction function is operational, in case the consumer ever has to perform this due to the failure of the automated system controlled through the video screen.

For the Power Wedge, using a small (stubby) straight screwdriver, loosen a small red screw on top until it stops. Lift or lower the wedge to the position desired and then tighten the screw snugly (but do no over-tighten). Manually cycle the wedge a couple of times after doing to ensure that the screw is snug and the wedge moves correctly.





For the Surf Gate, there is a red hex bolt on the side of the actuator. Opening this valve with a 3/8" wrench will allow the Surf Gate to be moved into a closed position. Be sure to retighten the bolt to prevent it from drifting open while operating the boat.

Salt Water Boats

Perform the normal cleaning procedures described above in the *Routine Maintenance*. Boats operated in salt/brackish/polluted water are especially vulnerable to accelerated wear-and-tear. Never ignore the care and maintenance required to keep your boat under warranty and in good condition for the life of the boat.



Storage and Winterization

Because the process of preparing a boat for long-term storage (more than two [2] weeks) and/or winterization is extremely important and takes some time to accomplish, this is often paired with the annual maintenance preparations. Regardless of timing, however, storage and winterization must never be overlooked, especially in climates where the temperature will fall below freezing.

If the boat will not be used for an extended period, regardless of season, or if the boat will be left in water full-time during boating season, there are precautions which should be taken.

Hull Gel Coat

If a boat will be left in the water all the time during boating season, Malibu recommends using a bottom, hull paint to protect it. Even with the highest-grade of gel coat, continuous exposure to water, even fresh water, will eventually result in damage to the finish. Therefore, in these circumstances, boat owners must protect the finish with an approved hull paint. Your authorized Malibu dealer can direct you to the correct paint, and can actually do the preparation for you.

NOTICE

Failure to protect the hull from excessive exposure to water or foul weather can result in damage to the hull paint and gel coat that is not covered under warranty.

Extended Non-Use

If a boat is not used for an extended period of time, and depending on weather conditions, location, and other factors, this could be from two (2) weeks to one (1) month—or beyond—owners should remove the boat from the water if possible. Perform the expected storage preparations, including removal of all ballast water, water from the bilge area, and periodically check the battery status as certain automatic functions are performed even when the boat is out of the water and the battery switch is in the OFF position. It may be necessary to occasionally charge the battery. (See information above and in the *Electrical Components* section of the *Dashes and Video Screens* chapter of the Owner's Manual regarding battery maintenance and the proper way to ensure batteries remain charged.)

Lifting the Boat

Many boat owners remove the boat from water by way of a trailer, which allows for transport as well as an excellent way to store the boat as long as the trailer was designed and built for that boat model. (Incorrect fit means that there will be undue stress on the boat's structural unit. Over time, these components could potentially fail, which would not be covered under warranty.)

However, some boaters, especially those who are privileged to live on a shoreline or due to the methods of extracting boats from specific bodies of water, must lift the boat to suspend the boat or use a boat cradle.

When the boat must be lifted, use the correct sling system or the lifting eyes only. Never allow a lifting device to wrap around the underwater gear as the weight of the boat could cause the sling to damage the gear. The boat may not be able to withstand the gravitational forces if the boat is not properly supported.

NOTICE

Never use the ski pylon or tower as part of the lifting process. These components are not designed to be utilized at any time or any point in the lifting process. Never use the cleats for lifting either. Never lift the boat with any water in the ballast or bilge systems of the boat. The additional weight could cause failure also.

When using the lifting eyes on the boat, an overhead hoist should be used to lift the boat, coupled with appropriately rated capacity straps. Each strap has to be rated for the boat weight or higher. (See the *Quick Reference Guide* in this Owner's Manual to determine the boat's base weight, without any added gear.) Spreader bars should also be used to prevent side loading of the stern eyes as well as damage to the rub rail on the bow. When lifting the boat, keep the bow slightly higher than the stern to avoid having any water run into the engine exhaust system.

When using slings, an appropriately rated capacity overhead hoist is required. Multiple slings at least six (6) inches by twenty (20) feet should be used. As with the lifting eye straps above, check the *Quick Reference Guide* in this Owner's Manual to determine the boat's base weight, without any added gear. An eight-foot spreader bar on each sling will prevent side pressure to the deck or gunwale molding that can cause damage. Such damage is not covered under warranty.

A storage cradle has to provide proper support to the boat, meaning the boat cannot be supported by resting the hull on the keel. There can be no gaps between the hull and the cradle supports. Support of at least 500 square inches is required on boats of less

than twenty-five (25) feet, and at least 600 square inches on boats greater than twenty-five (25) feet.

Protect all underwater gear protruding from the boat hull from damage. None of these components is rated to support any of the boat's weight.

Winterizing Boats Equipped with Optional Flush Kit

Begin by performing a normal flushing of the engine.



With the boat out of the water:

- Locate the flush kit connector on the port side of the transom, above the swim platform.
- Connect a gardening-type hose as shown in the accompanying photo to the flush kit system at the connector, and turn on the fresh water at the source.
- With the boat shifter in neutral, start the engine and allow it to idle. During the entire process, **DO NOT EXCEED 1100 RPM** on the engine. *(The freshwater hose cannot provide sufficient water supply to adequately cool the engine at higher RPMs.)* **Also, never take the boat out of neutral gear.**
- After approximately two (2) to three (3) minutes of flushing, shut off the engine.
- Turn off the freshwater supply.
- Disconnect the hose and reinstall the cap on the flush kit connector.

Winterizing procedure:

After flushing the engine, remove the T-handle drain plug in the bilge compartment, and the engine drain plugs located on the V-drive under the coupler, bottom of the heat exchanger, and both manifolds.



All drain plugs should be placed in a plastic bag and stored in a visible location so when recommissioning the boat, the plugs will not be overlooked.

- After flushing with fresh water, open all drain cocks. Depending upon the model, there may be several.
- When the water has fully drained, close the drain cocks and tape shut the water inlet on the bottom of the boat. Use low-tack type of tape to avoid damaging the finishes on the inlet and surrounding metal and gel coat. The water pick-up does **NOT** need to be taped.
- With the boat shifter in neutral, start the engine and allow it to idle. During the entire process, **DO NOT EXCEED 1100 RPM** on the engine. *(The freshwater hose cannot provide sufficient water supply to adequately cool the engine at higher RPMs.)* **Also, never take the boat out of neutral gear.**
- **DO NOT RUN THE ENGINE FOR MORE THAN 10 SECONDS!** This procedure allows any remaining water in the system to be forced out.

NOTICE

Allowing the engine to run more than 10 seconds could cause permanent damage from engine overheating.

Such damage is not covered under warranty!

- Remove the tape from the raw water intake, and the garden hose from the valve.

Winterizing with the Boat In Water:

- After the flushing process is complete, remove the adapter from the flush pump cap strap and insert the adapter into the flush pump valve.
- Using a piece of gardening-type hose, place the male end of the hose into the flush kit fitting and place the other end into a container of the marine-grade, 50/50 mix of distilled water and propylene glycol coolant, if not using a pre-mix of the same.

- Open all petcocks and drain the engine block and water-cooled manifolds. If the petcocks are plugged, carefully unplug the openings. When all the water has drained out, close all petcocks and replace any plugs that were removed.
- Start the engine and the pump will automatically pump the coolant from the bucket into the engine and manifolds. **DO NOT EXCEED 1100 RPM.**
- When the bucket is empty, **IMMEDIATELY** shut down the engine.

NOTICE

Always pay attention to whether all water inlets and drains are open or closed.

Failure to follow directions can result in too much water (which could result in sinking of the boat) or too little water (which could result in insufficient cooling, which could damage the drive train and is not covered under warranty)!

For Extended Storage and Winterization

There are multiple steps required to prevent damage to the boat when it will not be used for an extended period, especially during colder-weather months. Malibu recommends having an authorized Malibu dealer execute the storage/winterization process, followed by recommissioning when ready to begin use.

It is important to ensure that all required drivetrain precautions are taken; for these, see the Malibu Monsoon by PEG engine owner's manual for boats equipped with those engines.

For Malibu Monsoon engines, fill the fuel tank full. You will need to use a STA-BIL gasoline stabilizer. **Reminder: Stabilizers work in fresh gasoline only.** Adding a stabilizer after storage during the recommissioning period will not eliminate the gumming or water-separation that may have occurred. **Stabilizers are preventatives, not curatives.**

All gasoline stabilizers have a limited life. Be sure to review the requirements as stated on STA-BIL packaging or seek assistance from your authorized Malibu dealer in determining how long and under what conditions you can reasonably expect the STA-BIL to serve as designed.

Gasoline should never be stored for a period to exceed six (6) months. If it is necessary to remove gasoline from the tank and dispose of it, be certain to do so in compliance with local, state and federal environmental laws/rules/ordinances.

All water that can be removed from the boat must be. This includes water in the engine, ballast and bilge areas. Water that is not removed may freeze. Expansion and contraction that takes place as a result will damage affected areas of the boat. Such damage is not covered under warranty. This damage can be extensive and very expensive to repair.

There are four drain plugs on the Malibu Monsoon engine, in addition to the T-handle in the bilge compartment and the transom drain plug. **ALL SIX PLUGS MUST BE REMOVED AND ALL WATER DRAINED PRIOR TO STORAGE TO PREVENT POTENTIAL FREEZING AND DAMAGE TO THE ENGINE AND BOAT.**

The engine drain plugs are located:



1. On the side of a circulating hose on the starboard side and aft of the engine under the heat exchanger.



2. Under the shaft coupler on the front of the v-drive.



3 and 4: On each side of the engine, integrated into the water-circulating manifolds.



5. The transom, under the swim board, slightly starboard.



6. The T-handle in the center bilge compartment, located beneath the pihole near the driver's helm.

NOTICE

All drain plugs in the boat, regardless of the engine manufacturer, must be removed and all water drained prior to storage, particularly during winter months, to avoid potential freezing and damage to the engine and the boat. Such damage is not covered under warranty!

If the batteries are removed for storage, they should be fully charged prior to removal. Batteries should be stored in cool (but not cold), dry locations. Never store batteries near heat devices or anything that causes a spark or electrical charge. Fully recharge the battery prior to reinstallation.

(NOTE: If the battery is removed from the boat, the automatic bilge system will not operate and water will not be discharged from the bilge. Therefore, boats that are stored in water must not have the batteries removed.)

Additional steps to complete for storage:

- Thoroughly wash and clean the boat, inside and out, as instructed in the On-Going Care section of this Owner's Manual.
- Leave the bow slightly elevated so that any further draining of water from the bilge system will run out and not accumulate inside the bilge system.
- Remove the drain plug(s) and place them in see-through plastic sacks or containers. Place them inside the boat so that they will be immediately locatable for recommission.
- Using low-tack tape, tape around the exhaust flap so that vermin cannot chew their way into and nest inside the exhaust system.
- Apply wax to the entire exterior surface to protect the hull and deck finishes, particularly from dampness and condensation that may occur.
- Disconnect the heater hoses (where equipped) and blow out all water using compressed air.
- Remove the propeller and store in a safe place.
- Remove the seat cushions and store in cool, dry location. Open all storage compartments and areas to allow air circulation. (Without it, mold and mildew may invade the compartments.)
- Prop the engine compartment lid open several inches to allow for air circulation.
- If the boat will be outdoors, use an optional Malibu canvas cover that has been sewn to fit the boat deck snugly and not allow intrusions of rain and/or snow.
- Chock the trailer wheels if the boat is stored on a trailer.

When recommissioning the boat for the following boating season, reverse the above steps, plus add the following:

- Check all fluids, oil and coolant. Add, replace or change as necessary.
- Check the engine for cracks and leaks that may have been caused by freezing temperatures and/or water.
- Check all hose clamps to be certain they are secure and that the rubber hoses have not deteriorated over the period.
- Reinstall the propeller if it was removed. Grease the shaft taper prior to reinstalling the propeller.
- Have the alignment between the output flange on the transmission and the propeller shaft flange checked. An authorized Malibu dealer has the measurement detail for correct alignment.
- Prior to starting the engine in the water, key it ON and OFF two or three times, allowing several seconds between key-on cycles, prior to cranking the engine to fully start. The purpose of this is to prime the fuel system. If the engine appears reluctant to start, allow a couple minutes of cool-down for each attempt to crank and start the engine. Watch the gauges/video screen for readings and listen for abnormal sounds. Keep speeds low until the engine temperature rises to the normal operating temperature.

NOTICE

Failure to properly perform annual maintenance, plus storage/winterization procedures as described in

this Owner's Manual is likely to result in damage to the boat, components, drive train and features. Such damage is not covered under warranty!

WARRANTY

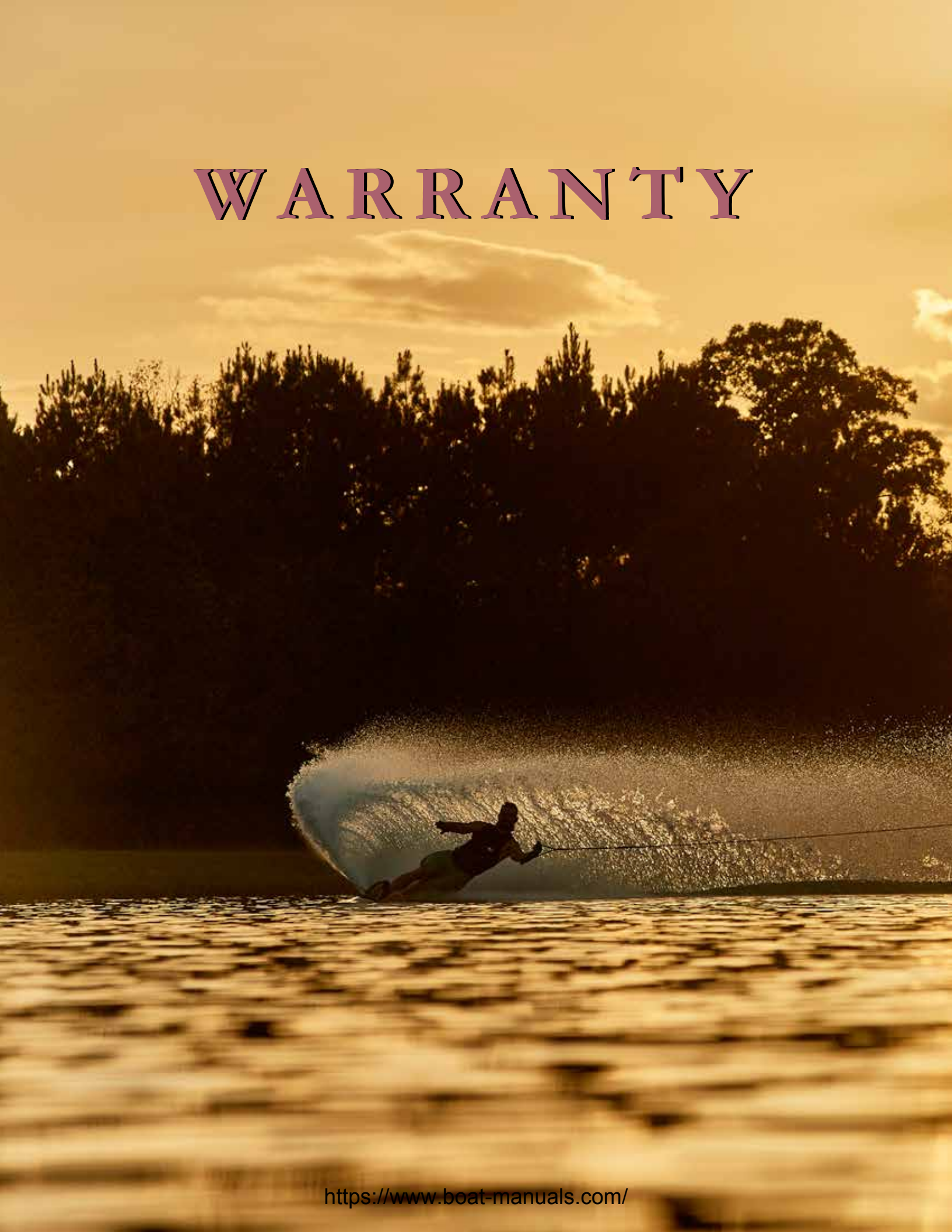



MALIBU LIMITED WARRANTY STATEMENT

Malibu Boats, LLC Limited Warranty (hereafter the "Limited Warranty")

Section 1. Certain Limitations and Disclaimer of Implied Warranties

THE LIMITED WARRANTY SET FORTH HEREIN IS IN LIEU OF ALL OTHER WARRANTIES AND REPRESENTATIONS, EXPRESS OR IMPLIED, AND TO THE MAXIMUM EXTENT PERMITTED BY APPLICABLE LAW. MALIBU BOATS, LLC DISCLAIMS, AND THE PURCHASER HEREBY EXPRESSLY WAIVES, ANY AND ALL OTHER WARRANTIES OR REPRESENTATIONS OF ANY KIND OR NATURE, INCLUDING, BUT NOT LIMITED TO, IMPLIED WARRANTIES OF MERCHANTABILITY AND FITNESS FOR A PARTICULAR PURPOSE, OTHER THAN THOSE WARRANTIES WHICH ARE IMPLIED BY, AND ARE INCAPABLE OF EXCLUSION, RESTRICTION OR MODIFICATION UNDER APPLICABLE LAW. THERE ARE NO WARRANTIES WHICH EXTEND BEYOND THE DESCRIPTION OF THE FACE HEREOF. ANY IMPLIED WARRANTY THAT IS FOUND TO ARISE BY STATE OR FEDERAL LAW, INCLUDING ANY IMPLIED WARRANTY OF MERCHANTABILITY OR ANY IMPLIED WARRANTY OF FITNESS, IS LIMITED IN DURATION TO THE DURATION SET FORTH IN THIS LIMITED WARRANTY OR THE DURATION SET FORTH BY APPLICABLE STATE OR FEDERAL LAW, WHICHEVER IS SHORTER.

PERFORMANCE OF REPAIRS AND NEEDED ADJUSTMENTS IS THE EXCLUSIVE REMEDY UNDER THIS LIMITED WARRANTY, WITHOUT EXCLUSION, MODIFICATION OR RESTRICTION, OTHER THAN UNDER APPLICABLE LAW. MALIBU BOATS, LLC SHALL NOT BE LIABLE FOR INCIDENTAL OR CONSEQUENTIAL DAMAGES, SUCH AS, BUT NOT LIMITED TO, LOST WAGES, SLIP FEES, TRANSPORTATION TO OR FROM REPAIR, OR RENTAL EXPENSES, RESULTING FROM BREACH OF THIS WRITTEN WARRANTY OR ANY IMPLIED WARRANTY, OR OTHERWISE, EVEN IF MALIBU BOATS, LLC HAS BEEN ADVISED OF OR SHOULD HAVE FORESEEN THE POSSIBILITY OF SUCH DAMAGES, AND EVEN IF ANY MALIBU BOAT OR COMPONENT PART THEREOF FAILS OF ITS ESSENTIAL PURPOSE. THIS EXCLUSIVE REMEDY SHALL NOT BE DEEMED TO HAVE FAILED OF ITS ESSENTIAL PURPOSE AS LONG AS MALIBU BOATS, LLC IS WILLING AND ABLE TO REPAIR OR REPLACE ANY DEFECTIVE GOODS SUBJECT TO THE TERMS PROVIDED

HEREIN. UNDER ANY CIRCUMSTANCE, THE ENTIRE LIABILITY OF MALIBU BOATS, LLC IS LIMITED TO THE LESSER OF THE REPAIR OR REPLACEMENT OF ANY DEFECTIVE COMPONENT OR AFFECTED PORTION OF THE MALIBU BOAT, OR THE ACTUAL PRICE PAID FOR THE MALIBU BOAT, DRIVE TRAIN, AND/OR TRAILER.

SOME STATES DO NOT ALLOW LIMITATIONS ON TIME LIMITS OR EXCLUSIONS OF INCIDENTAL OR CONSEQUENTIAL DAMAGES, SO THE ABOVE LIMITATIONS MAY NOT APPLY TO YOU. THIS LIMITED WARRANTY GIVES YOU SPECIFIC LEGAL RIGHTS WHICH MAY VARY FROM STATE TO STATE, BY JURISDICTION, AND COUNTRY. TO THE EXTENT THAT YOUR STATE DOES NOT ALLOW ANY EXCLUSION OR LIMITATION EXPRESSED HEREIN, SUCH EXCLUSION OR LIMITATION WILL NOT APPLY TO YOU. ALL OTHER ALLOWABLE LIMITATIONS OR EXCLUSIONS SHALL APPLY TO YOU.

Section 2. The Limited Warranty Application and Terms; Transferability

Malibu Boats, LLC ("Malibu Boats"), warrants to the original user or purchaser, whoever comes first (hereafter the "Purchaser"), that each new and unused Malibu boat ("Malibu Boat"), Malibu drive train manufactured by Malibu Boats, where applicable ("Malibu Drive Train"), and/or Malibu trailer ("Malibu Trailer"), shall under normal authorized use remain free from defects in craftsmanship and materials during the applicable warranty periods, in accordance with and subject to the terms, conditions and limitations as described in this Limited Warranty. Any and all references to Malibu Drive Train within this document refer to only those drive trains, complete or component, which are manufactured by Malibu Boats. Malibu Boats equipped with drive trains, complete or component, manufactured by outside suppliers are covered under, and subject to, limitations and time duration as described within the limited warranty statements provided by the supplier.

Subject to all other terms, conditions, and limitations, 1) original Purchaser(s) of the Malibu Boat, Malibu Drive Train and/or Malibu Trailer and, 2) second owners of the Malibu Boat and/or Malibu Trailer who purchase the boat within five (5) years of the earlier of (a) the date the boat was purchased by the first retail purchaser through an authorized Malibu Boats Sales facility, or (b) the date the boat was first put into service as a demonstrator or other use except for commercial purpose (from which there is no transferability of the limited warranty), and qualify for and complete a warranty transfer as explained below, are provided coverage under the Malibu Boats Limited Warranty.

Note: This Limited Warranty is expressly conditioned upon the timely completion and return of the warranty registration card to Malibu Boats. Although not obligated to and without creating such an obligation, this will enable Malibu Boats to notify you of any necessary performance or safety modifications to your Malibu Boat,



Drive Train and/or Trailer and to verify ownership in case a warranty claim is filed on your Malibu Boat, Drive Train and/or Trailer.

The Limited Warranty is expressly subject to the following terms, conditions and limitations. All warranty applications are dependent upon the Purchaser following the guidelines established for appropriate and reasonable care and maintenance of the Malibu Boat, Malibu Drive Train and/or Malibu Trailer and operating his or her Malibu Boat, Malibu Drive Train and/or operating the Malibu Trailer reasonably and as directed in this Owner's Manual, and as directed in any additional directions and/or owner's manuals relating to any specific component part or parts of the Malibu Boat, Malibu Drive Train and/or Malibu Trailer (the "Guidelines and Directions"). **Purchaser's**

failure to follow such Guidelines and Directions shall void this Limited Warranty.

All repairs performed by Malibu Boats, or its authorized service facilities, will be performed using either new or re-manufactured parts. Malibu Boats may, at its option, install parts which have substantially similar or greater performance characteristics if an identical replacement part is no longer available.

No person or entity is authorized to make any additional or revised statement or warranty, express or implied, on behalf of Malibu Boats or any component supplier beyond what appears within this Limited Warranty.

Limited Warranty Summary:

Coverage Type	Coverage Period (from date of original retail purchase or initial use of the Malibu Boat, whichever first occurs)
Structural Limited Warranty	Lifetime
Drive Train Limited Warranty	Earlier of Sixty (60) Months or 500 hours
Trailer Limited Warranty	Sixty (60) Months
Base Limited Warranty–Fresh Water Boats	Sixty (60) Months
Base Limited Warranty–Salt Water Boats	Thirty-six (36) Months
Gel Coat, & Powder Coat and Trailer Paint Limited Warranty	Twelve (12) Months

The repair and/or replacement of components or parts under warranty does not extend the warranty period beyond the original expiration date.

Section 2.1. Structural Limited Warranty.

For the life of the boat, Malibu Boats will repair structural materials or structural workmanship supplied by it during the construction of the hull, deck, floor liner, or stringer, which are determined by Malibu Boats to contain substantial manufacturing defects. This Structural Limited Warranty does not apply to the Malibu Boat's gel coat or powder coat (see below for Gel Coat & Powder Coat Limited Warranty), drive train (see below for Drive Train Limited Warranty), trailer (see below for Trailer Limited Warranty) or any cosmetic aspects of the hull, deck, liner, or stringer. The entirety of the structural warranty is limited to the specific laminates or bonding of laminates for the hull, deck, floor liner, or stringer only.

Section 2.2. Base Limited Warranty, Drive Train Warranty and Trailer Limited Warranty.

For a period of sixty (60) months or 500 hours, whichever is earlier, for fresh water boats and thirty-six (36) months for salt water boats, beginning on the date of the original retail purchase or the initial use of the Malibu Boat, whichever occurs first, Malibu Boats will repair or replace materials or workmanship supplied by it during construction of the Malibu Boat, including parts and labor, which are determined by Malibu Boats to contain substantial manufacturing defects.

For a period of sixty (60) months for drive trains manufactured by Malibu Boats, beginning on the date of the original retail purchase or the initial use of the Malibu Boat, whichever occurs first, Malibu Boats



will repair or replace materials or workmanship supplied by it during construction of the Malibu Drive Train, including parts and labor, which are determined by Malibu Boats to contain substantial manufacturing defects. Drive trains manufactured by suppliers and installed by Malibu Boats will be subject to the limitations as described and provided by the supplier.

For a period of sixty (60) months for trailers, beginning on the date of the original retail purchase or the initial use of the Malibu Boat, whichever occurs first, Malibu Boats will repair or replace materials or workmanship supplied by it during construction of the Malibu Trailer, including parts and labor, which are determined by Malibu Boats to contain substantial manufacturing defects.

This Limited Warranty does not provide coverage for any component part that is at any time covered by any warranty provided by any third party, other than Malibu Boats, including, but not limited to the manufacturer of the component part. Component parts shall include, but are not necessarily limited to, any items that are fastened to the boat through either mechanical means (screws/bolts) or chemical means (adhesives), which may or not be manufactured by Malibu Boats. Some examples of component parts include gauges, carpet, floor panels, upholstery substrates and bases, brake actuator, brakes, axles, lights, spark plugs, filters, etc. In the event that any warranty coverage for any component part is rendered or deemed void due to actions of the Purchaser or any third party other than Malibu Boats, this Limited Warranty will not provide warranty coverage for the component part.

Towers are configured by Malibu Boats for factory-installed components. The installation of any components onto the tower of any Malibu Boat after it leaves Malibu Boats' factory ("Non-Factory Tower Components") may require adjustments to the tower. Further, certain Non-Factory Tower Components may not be suitable to be installed on any Malibu Boat's tower. If Malibu Boats determines that any Non-Factory Tower Components have caused or contributed to the need for any repairs to the tower of a Malibu Boat, or to any other aspect of a Malibu Boat, Malibu Boats, in its sole discretion, may deny coverage for such repairs. It is the sole and exclusive obligation of the Purchaser to verify and ensure that all Non-Factory Tower Components are suitable to be installed on any Malibu Boat's tower, and that all Non-Factory Tower Components are properly installed on any Malibu Boat's tower.

Section 2.3. Gel Coat, Powder Coat and Trailer Paint Limited Warranty.

Note: Minor distortions or imperfections resulting from the handcrafted application of the gel coat on a Malibu Boat are considered normal and unavoidable. Gel coat, powder coat and trailer paint maintenance is the Purchaser's responsibility. Conditioned on the Purchaser having provided and performed all gel coat, powder coat and trailer paint maintenance and care described in this Owner's Manual, for a period of twelve (12) months, beginning on the date of

the original retail purchase or the initial use of the Malibu Boat and/or Malibu Trailer, whichever occurs first, Malibu Boats will repair materials, or workmanship supplied by it, in applying the gel coat and/or powder coat finish to the boat, or paint finish to the trailer, which are determined by Malibu Boats to contain substantial manufacturing defects. This Gel Coat, Powder Coat and Trailer Paint Limited Warranty shall not include or provide coverage for gel coat finish, blistering, discoloration, scratching, cracks caused by negligence, impact or collision, stress crazing, fading or osmosis, or damage caused by in-water storage, scratches and other damage caused by trailering, including normal usage.

Section 3. Limited Warranty Exclusions and Limitations

In addition to any prior limitations and exclusions, the following are **NOT** covered under this Limited Warranty:

- normal maintenance of the Malibu Boat, Malibu Drive Train and/or Malibu Trailer boat or any component thereof;
- normal wear-and-tear of the Malibu Boat, Malibu Drive Train and/or Malibu Trailer or any component thereof;
- damages or needed adjustments caused by items that are added, altered or changed after the Malibu Boat, Malibu Drive Train and/or Malibu Trailer leaves the possession of Malibu Boats, including but not limited to installation of aftermarket towers, tower accessories, ballast systems, barefoot booms, canvas accessories, and hull bottom painting;
- modification, alteration, unauthorized repair or replacement of components, including but not limited to damages resulting from such installations, on the Malibu Boat, Malibu Drive Train and/or Malibu Trailer;
- damages caused by accident (including impacts and collisions with any object), abuse, misuse, neglect, negligence, mishandling or alteration, including any damages caused by or during trailering or towing;
- damages caused by heat, fire, explosion or freezing (including the failure to perform proper winterization or preparations for storage or lack of use for periods in excess of thirty [30] days);
- damages caused by atmospheric fallout, chemical treatments, tree sap, salt, ocean spray, mold, or animal droppings, lightning, hail, rain, flooding, wind, sand, floods or other environmental or natural conditions or Acts of God;
- staining, blistering, or discolorization resulting from failure to coat the hull with marine-grade hull paint on boats that are allowed to remain in bodies of water for extended periods (more than 14 days);
- damages caused by vandalism or theft;
- corrosion or damage, including oxidation, electrolysis including that which occurs to chrome plated, stainless, anodized or aluminum finish or the colorfastness of finish. **Failure to follow the**

instructions within this Owner's Manual regarding corrosion prevention and operation in salt or brackish water may result in or contribute to these types of damage and are not covered under the Limited Warranty;

- damages caused by aftermarket cleaning products or additives not specifically approved by Malibu Boats;
- damages due to insufficient or improper maintenance, lack of maintenance, or delay of repair (unless specifically and directly authorized by Malibu Boats warranty department in writing);
- damage or contamination resulting from leaking or spilled fluids including, but not limited to, fuel or drive train fluids;
- conditions resulting from use of the boat for anything other than recreational purposes (Note: Commercial use as described in this owner's manual will affect the length of warranty coverage. Please refer to *Section 5: Commercial Use Exclusions / Restrictions* for specific details);
- manufacturing variations or imperfections in cosmetic, convenience or aesthetic components or features of the boat, including the gel coat finish, which have no effect on use or safety;
- damages caused by the use of any trailer purchased through any entity other than Malibu Boats;
- damages caused by improper support of the boat on davits, hoist system or boat lift of any kind;
- damages caused by improper weight distribution or excessive weight combinations of persons aboard, ballast or simulated ballast and gear;
- any material, component or part of the boat that has a warranty period and/or conditions as specified by the producing entity which differs from this Limited Warranty unless such warranties are administered directly by the producing entity;
- damages caused by water intrusion into any part of the boat (including, but not limited to, the glove box and various storage compartments);
- performance characteristics, such as speed, acceleration, fuel or oil consumption, etc., as they are estimated and can vary as dictated by individual conditions;
- any and all consequential damages including, but not limited to, costs incurred for haul-out, launching, towing, storage charges, telephone, expedited shipping of replacement parts, or rental charges of any type (including slip fees), inconveniences, or loss of time or income;
- components such as Surf Gate™, fins and wedges not installed at the time of manufacture. Post-manufacture installation of any of these items, as well as any other component not installed at the time of manufacture, will void the warranty and other components of the boat that have their own warranty(ies) due to potential damage to the boat and possible danger to occupants;
- damage or injury resulting from failure to comply with recall notices, service bulletins and advisories, or requests from Malibu Boats to



repair the boat or its components;

- damage or injury resulting from speeding, demonstration or any type of racing;
- damages resulting from the failure to properly maintain and care for the boat and its components in accordance with the instructions found within this Owner's Manual;
- shop supplies used in correction work, such as, but not limited to, sealants, lubricants, cleaning supplies;
- minor adjustments to the drive train, such as, but not limited to, investigation of components, clean or adjusting spark plugs, verification of fluid levels and lubricants, controls for the drive train;
- damage to water pump impellers, or any component of the cooling system that Malibu Boats determines at its sole discretion could have been avoided either through reasonable boating operation



and practices or by maintenance as required and directed in this Owner's Manual;

- damage to the engine starter motor or other assemblies and components determined by Malibu Boats at its sole discretion are the result of excessive attempts to start the engine, or by condensation/submersion of these and similar components;
- damage resulting from water intrusion in the intake or exhaust system;
- damage resulting from the use of lubricants, gasoline, or other fluids other than those specified in this Owner's Manual or by subsequent approval by Malibu Boats following publication of this Owner's Manual;
- damage to the drive train resulting from a lack of sufficient cooling or the drive train operation outside a sufficient body of water to

provide adequate cooling, or cooling failure resulting from blockage by foreign objects;

- damage resulting from erroneous service by the customer or technician not authorized by Malibu Boats to perform service or corrections;
- damage that cannot be traced to material defects in materials or workmanship, as determined by Malibu Boats;
- damages resulting from the use of any non-Malibu Boats supplied boat cover (The sole and exclusive approved color for boat covers offered by Malibu Boats is grey.); and
- the use, even temporarily, of a non-Malibu Boat Trailer will void the Gel Coat & Powder Coat Limited Warranty.

Section 4: International Exclusions/Requirements

Importing or exporting any Malibu Boat, Malibu Drive Train and/or Malibu Trailer manufactured in the United States by Malibu Boats (“US Malibu Boat”, “US Malibu Drive Train” and/or “Malibu Trailer”) into Australia or New Zealand (the act of importing or exporting any US Malibu Boat, US Malibu Drive Train and/or Malibu Trailer into Australia or New Zealand immediately and completely voids any and all coverage provided under this Limited Warranty and any and all obligations owed by Malibu Boats relative to the US Malibu Boat, US Malibu Drive Train and/or Malibu Trailer). This Limited Warranty does not provide coverage to any Malibu Boat, Malibu Drive Train and/or Malibu Trailer purchased from a dealer in another country where the primary use of the Malibu Boat, Malibu Drive Train and/or Malibu Trailer will require the Malibu Boat, Malibu Drive Train and/or Malibu Trailer to cross an international border. The Limited Warranty will not be honored by Malibu Boats for any Malibu Boat, Malibu Drive Train and/or Malibu Trailer that is acquired by the Purchaser through an international cross-border purchase. All repairs that are covered under

this Limited Warranty must be performed in the country where the Malibu Boat, Malibu Drive Train and/or Malibu Trailer was originally purchased.

Section 5: Commercial Use Exclusions/Restrictions

The use of any Malibu Boat, Malibu Drive Train and/or Malibu Trailer for commercial purposes, including but not limited to as a demonstrator, or in connection with any promotional program, ski, wakeboard, or surf school or show (“Commercial Purposes”) shall alter the Limited Warranty as set forth herein. The Limited Warranty applicable to any Malibu Boat, Malibu Drive Train and/or Malibu Trailer used for any Commercial Purpose may not be transferred to any subsequent owner of the Malibu Boat, Malibu Drive Train and/or Malibu Trailer. The Limited Warranty coverage periods for any Malibu Boat, Malibu Drive Train and/or Malibu Trailer that has been used for Commercial Purposes, while owned by the original purchaser, are as follows:

Coverage Type

- Structural Limited Warranty**
- Base Limited Warranty**
- Gel Coat Limited Warranty**
- Drive Train Warranty**
- Trailer Warranty**

The repair and/or replacement of components or parts under warranty does not extend the warranty period beyond the original expiration date.

Coverage Period (from date of original retail purchase or initial use of the Malibu Boat, whichever first occurs)

- Five (5) years**
- Twelve (12) months or 100 hours**
- Six (6) months**
- Earlier of twelve (12) months or 300 hours**
- Twelve (12) months**



Section 6: Warranty Voiding Events

The following events will automatically void and discharge Malibu Boats from its obligations under this Limited Warranty and discharge Malibu Boats from any obligations herein:

- the unauthorized disconnection, tampering with, or altering of the Malibu Boat's hour meter;
- the unauthorized disabling of any warning device or system installed in any Malibu Boat and/or Malibu Drive Train;
- the unauthorized disconnection, disturbance or compromise of any wires, hoses, tubes, cables, looms or other components of the Malibu Boat's electrical or fuel systems;
- the use of the Malibu Boat, Malibu Drive Train and/or Malibu Trailer in any criminal enterprise or to perform any criminal acts; and
- the determination by any state or federal entity or private insurance carrier that the Malibu Boat, Malibu Drive Train and/or Malibu Trailer is a total loss or fit only for salvage.

Section 7: Other Matters Related to the Limited Warranty

In addition to the Limited Warranty terms and exclusions noted above, the following are additional important considerations regarding the Limited Warranty:

Section 7.1. Pre-Delivery.

Defects and/or damage to the finish surfaces, trim, upholstery or other observable cosmetic components of your Malibu Boat, Malibu Drive Train and/or Malibu Trailer may occur during production. These items are usually detected and corrected prior to shipment to the dealership or by the retail dealer prior to delivery to the retail customer. Nonetheless, consumers are encouraged to inspect the Malibu Boat, Malibu Drive Train and/or Malibu Trailer for this type of damage prior to taking delivery, and all such defects or damage must be reported to the retail Malibu Boat dealer at the time of delivery to have any items covered by this Limited Warranty addressed, and to have any covered defects repaired at no cost to the Purchaser.

Section 7.2. Boat Operation, Care and Maintenance.

To ensure the maximum benefit from ownership of this boat, Malibu Boats requires that you follow all of the instructions in this Owner's Manual, including all accompanying maintenance or service schedules and support material. Because questions may sometimes arise relating to the cause of a particular failure, Malibu Boats strongly recommends keeping detailed records of any and all maintenance or service performed on the boat, drive train and/or trailer to assist, if necessary, in the determination of whether a failure is covered under this Limited Warranty. Damages to a Malibu Boat, Malibu Drive Train and/or Malibu Trailer caused by improper operation, care and maintenance are not covered by this Limited Warranty.

Section 7.3. Design and/or Manufacturing Changes.

Malibu Boats reserves the right to implement changes in the construction or components of any Malibu Boat, Malibu Drive Train and/or Malibu Trailer at any time, without incurring any obligation to make the same or similar changes on Malibu Boats, Malibu Drive Trains and/or Malibu Trailers previously built and/or sold.

Section 7.4. Other Warranties.

Some manufacturers of component parts included in a Malibu Boat, Malibu Drive Train and/or Malibu Trailer may provide limited warranties. Please refer to component part manufacturer's limited warranty disclosures, if any, for details, including their terms, conditions and limitations, of which Malibu Boats makes no representations or warranties.

Among other warranties, note that certain items including, but not limited to, some drive train parts, Biminis and boat covers are among those components covered by individual, separate warranties, which are explained and set forth in materials supplied by the component part manufacturer. Any and all claims or defects should be submitted directly to the manufacturers of those particular component parts.

Section 7.5. No Other Warranties.

No oral or written information, advice or communication of any nature by or from Malibu Boats or its representatives, employees, dealers, agents, distributors or suppliers shall create a warranty or in any manner increase or modify the scope of this Limited Warranty. The repair and/or replacement of components or parts under warranty does not extend the warranty period beyond the original expiration date.

Section 8. Customer Satisfaction Procedure

Section 8.1. Warranty Claim Procedure.

To obtain warranty service and/or repairs, the following steps are required:

(a) Notify a service facility or dealership authorized by Malibu Boats to perform service or repairs to Malibu Boats, Malibu Drive Trains and/or Malibu Trailers ("Authorized Service Dealer") or Malibu Boats, Malibu Drive Trains and/or Malibu Trailers of the substantial defect in materials or workmanship attributable to Malibu Boats, within thirty (30) days of discovery of the defect (which must be in the applicable Coverage Period);

(b) Promptly schedule an appointment with and deliver the Malibu Boat, Malibu Drive Train and/or Malibu Trailer to an Authorized Service Facility for repairs. Warranty service must be performed by Malibu Boats or an Authorized Service Dealer. For assistance in locating an Authorized Service Dealer, please visit www.malibuboats.com, select

the "Find a Dealer" tab, and utilize Malibu Boats' Dealer Locator, or call Malibu Boats at (865) 458-7110; and

** Malibu Boats reserves the right to require further evaluation and/or information regarding a warranty claim against a Malibu Boat, Malibu Drive Train and/or Malibu Trailer prior to its repair as well as designate the place of repair.*

Subject to the terms of this Limited Warranty, any covered Malibu Boat, Malibu Drive Train and/or Malibu Trailer or component part with a substantial defect in materials or workmanship that is returned to an Authorized Service Dealer during the appropriate Limited Warranty period will be repaired or replaced, in Malibu Boats' sole discretion, without charge to the Purchaser for parts and labor. This provision is subject to the following terms and conditions:

- (a) Malibu Boats shall be obligated only to repair or replace those items that prove defective, in Malibu Boats' sole discretion, upon examination by a qualified representative of an Authorized Service Dealer or Malibu Boats' own personnel, as applicable;
- (b) Malibu Boats warrants authorized repairs or replacements made by or on behalf of Malibu Boats, Malibu Drive Trains and/or Malibu Trailers only for the remainder of the applicable Coverage Period;
- (c) The Purchaser shall be responsible for all costs associated with the transportation of the Malibu Boat, Malibu Drive Train and/or Malibu Trailer, towing bills, trailer or component part(s) to Malibu Boats' facility and/or to the Authorized Service Dealer, as well as for any return transportation.

Note that Authorized Service Dealers, generally, are independently owned and operated businesses. Malibu Boats does not control the scheduling of service work. However, if you encounter any material delays in obtaining service at one of Malibu Boats' Authorized Service Dealers, please call Malibu Boats for assistance at (865) 458-7110.

Section 8.2. Direct Contact Information for Warranty Issues.

Boats built in the US:

Malibu Boats
 5075 Kimberly Way
 Loudon, TN 37774
 (865) 458-5478
 Malibu Boats Internet Site: www.malibuboats.com

Boats built in Australia:

Malibu Boats Australia
 813 Hope Crt
 Albury, NSW 2640
 (02) 6040 1174
 Malibu Boats Australia Internet Site:
www.malibuboats.com.au

Section 8.3. Procedure Regarding Concerns with Covered Warranty Repairs.

Concerns related to a Malibu Boat, Malibu Drive Train and/or Malibu Trailer can normally be addressed by an Authorized Service Dealer. If concerns are not satisfied, the following steps should be followed:



(a) Ask to discuss concerns with a member of the Authorized Service Dealer's management. Ordinarily this will be the Authorized Service Dealer's service manager or service foreman. If resolution of the issue is not achieved, request to speak with the Authorized Service Dealer's general manager or owner.

(b) If concerns are not resolved by the representatives of the Authorized Service Dealer, contact Malibu Boats' Customer Service Department at the address noted above. Be prepared to provide the customer service representative with your name, address and phone number, your boat's hull identification number, the Authorized Service Dealer(s) at which the boat has been serviced, and the nature of the

concerns with the boat or the service. Malibu Boats will thereafter provide assistance to the boat owner and the Authorized Service Dealer, as necessary, to attempt to resolve the matter.

Section 8.4. Dispute Resolution.

EXCEPT TO THE EXTENT PROHIBITED BY ANY APPLICABLE STATE OR FEDERAL LAW, PRIOR TO INITIATING ANY LEGAL ACTION AGAINST MALIBU BOATS, (1) YOU ARE REQUIRED TO PROVIDE MALIBU BOATS WRITTEN NOTICE, AT THE ADDRESS ABOVE, OF ANY SUBSTANTIAL DEFECT IN MATERIALS OR WORKMANSHIP THAT REMAINS UNRESOLVED TO YOUR SATISFACTION UNDER THE TERMS OF THE LIMITED WARRANTY; AND (2) TO THE EXTENT PERMITTED BY ANY STATE OR FEDERAL LAW, YOU MUST FIRST USE AN AVAILABLE DISPUTE SETTLEMENT MECHANISM OR ARBITRATION.

Section 9. Warranty Transfer

Upon the first sale of a Malibu Boat, Malibu Drive Train and/or Malibu Trailer that has not been utilized for any Commercial Purpose by the original, non-commercial, retail purchaser, within the first sixty (60) months, beginning on the date of the original retail purchase or the initial use of the Malibu Boat and/or Malibu Trailer, whichever occurs first, any unexpired Limited Warranty coverage can be transferred to a second, non-commercial, owner and remain in effect for the unexpired period (except the Gel Coat & Powder Coat Limited Warranty, which is twelve [12] months), and the Structural Warranty, which becomes ten (10) years. The Limited Warranty on all other components is as previously identified within this Limited Warranty Statement. This provision is pursuant to the requirements set forth in the Warranty Transfer information provided within this Owner's Manual. Only one transfer of the Limited Warranty within the applicable time period(s) established will be honored. All coverage under the Limited Warranty Statement will become null and void in totality with any subsequent conveyance of ownership of the Malibu Boat, Malibu Drive Train and/or Malibu Trailer or transfer of the Malibu Boat's or Malibu Trailer's title to any third party.



WARRANTY TRANSFER

INSTRUCTIONS: Please enter ALL information below.

This boat must be inspected and pass the Work Order at the bottom of this form by an authorized Malibu Boats Dealer.
 Send this form and check: Malibu Boats LLC, 5075 Kimberly Way, Loudon TN 37774; (865)458-5478
 All requests must be submitted within 10 days of Date of Resale.

ORIGINAL OWNER INFORMATION

NEW OWNER INFORMATION

NAME _____
 ADDRESS _____
 PHONE _____
 EMAIL ADDRESS _____

NAME _____
 ADDRESS _____
 PHONE _____

BOAT INFORMATION

Boat Hull Identification Number: _____ Boat Model: _____ Engine Serial Number: _____ Engine Hours: _____

Trailer Identification Number: _____

Name of Dealership submitting the transfer: _____

The remainder of any transferable warranties may be transferred to the second owner within sixty (60) months, subject to other limitations pursuant to Section 9, from the earlier of (i) the original date of retail sale or (ii) the date of first use. This transfer is subject to a boat inspection fee and applicable fees to be determined by an authorized Malibu Boats Dealer. In addition, a transfer fee of \$750 payable to Malibu Boats LLC is required along with this transfer form.

Original Purchaser
 Signature: _____

New Owner
 Signature: _____

Original Date of Sale: _____

New Date of Resale: _____

SERVICE MANAGERS WORK ORDER

Description:	Inspected
Visual inspection of exterior structure (in include all underwater gear and hardware)	<input type="checkbox"/>
Visual inspection of interior structure	<input type="checkbox"/>

COMMENTS:

The above Service Managers Work Order has been performed with full satisfaction.

Technician Signature: _____

For Malibu Dealership Use Only

\$750 sent to Malibu: Yes Check Number _____

For Malibu Factory Use Only

CS Supervisor Initials _____ Date Approved _____ AR Initials _____ Date of Deposit _____
 Welcome Package _____

CALIFORNIA AND U.S. EPA EMISSION CONTROL WARRANTY STATEMENT

Your Warranty Rights and Obligations

The California Air Resource Board ("CARB") and the United States Environmental Protection Agency ("EPA"), together with Malibu Boats, LLC ("Malibu Boats") are pleased to explain the Emission Control System Warranty ("ECS Warranty") on your 2019 inboard engine. In the United States, new inboard engines must be designed, built and equipped to meet all Federal- and State-mandated anti-smog standards.

Malibu Boats must warrant the emission control system on your inboard engine for the periods of time listed below, provided there has been no abuse, neglect or improper maintenance of the inboard engine. Your emission control system may include parts such as the fuel injection system and the ignition system. Also included may be hoses, belts, connectors and other emission-related assemblies.

Where a warrantable condition exists, Malibu Boats will repair your inboard engine at no cost to you, including diagnosis, parts and labor.

Manufacturer's Warranty Coverage

Select electronic emission-related control parts from model year 2019 forward on Malibu Boats inboard engines are warranted for five (5) years or 500 hours as recorded on the boat's hour meter, whichever comes first.

If any emission-related part on your engine is defective under warranty as described in the Malibu Boats Limited Warranty Statement, the part will be repaired or replaced by Malibu Boats.

Owner's Warranty Responsibilities

As the inboard engine owner, you are responsible for the performance of the required maintenance listed in this Owner's Manual. Malibu Boats recommends retaining all receipts received as a result of the maintenance performed on your inboard engine. Malibu Boats cannot deny warranty solely for the lack of receipts or your failure to ensure the performance of all scheduled maintenance.

Malibu Boats may deny warranty coverage if the inboard engine or component part has failed due to abuse, neglect, improper maintenance or unapproved modifications.

To receive warranty correction(s), you are responsible for presenting your inboard engine to a Malibu Boats authorized servicing dealership as soon as a problem exists. The warranty repairs will be

completed in a reasonable amount of time not to exceed thirty (30) days.

If you have questions regarding your warranty rights and responsibilities, please contact Malibu Boats at (865) 458-5478.

General Emissions Warranty Coverage

The Malibu Boats engine is designed, built and equipped to conform with all applicable regulations adopted by CARB, pursuant to its authority in Chapters 1 and 2, Part 5, Division 26, of the Health and Safety Code, and by the EPA pursuant to 40 CFR 1045. The engine is warranted that it is free of defects in materials and workmanship that could cause the failure of a warranted part. It is identical in all material respects to parts as described in the engine manufacturer's application for certification.

Exclusions

The engine's owner is referred to the Malibu Boats' Limited Warranty Statement for general guidelines regarding warranty provisions. Note that damage or failure resulting from circumstances other than those for which provision is made in the Limited Warranty Statement and this Emissions Control Warranty Statement are not covered by warranty. This warranty does not cover damage or failure resulting from owner abuse, neglect, improper maintenance, or modification with unapproved parts or components. The warranty also does not cover expendable maintenance items used in connection with routine and/or required maintenance. Such examples include, but are not limited to, filters, spark plugs or fluids. If a part or component requires repair or replacement, the life of the warranty is not extended beyond its original expiration date.

Disclaimer

This Emissions Control Warranty is applicable only where CARB and/or U.S. EPA emission control system warranty regulation is in effect. The use of additional or modified part(s) is not exempt. If a non-exempt part or component causes the failure of a warranted part or component, the warranted part or component will not be covered under warranty.

Emission Control Parts Covered Under Warranty

The following components are considered part of the emissions control system for your inboard engine and will be warranted under the guidelines of this warranty:

- exhaust manifold;
- exhaust valves;
- PCV valve;
- oil filler cap;
- oil pump, including internal parts;

intake manifold;
spark arrestor/air filter;
intake valves;
serpentine belt;
hoses;
clamps;
fittings;
pulleys/idlers;
mounting hardware;
tubing;
sealing gaskets or devices.
fuel injectors;
fuel pump;

pressure regulator;
ignition wires;
ignition coil;
spark plugs;
sensors, including, camshaft position, crankshaft position, engine coolant temperature, intake air temperature, knock, manifold absolute pressure (MAP), throttle position, electronic control unit; electronic throttle control, camshaft position actuator solenoid valve, oil pressure, and oxygen;
carbon canister;
fuel tank;
purge valve, where installed;
non-metal, low-permeation hoses.



Troubleshooting the Boat

If any of the following issues cannot be rectified by using the suggested remedies, take your boat to an authorized Malibu dealer for assistance. Do not attempt to correct problems by methods not recommended in this Troubleshooting Guide. Utilizing other attempts to correct issues could result in additional problems or damage to a system, which would not be covered under warranty.

General

The boat will not start.

- Verify that the battery switch is ON.
- Be certain the Emergency Safety Stop Switch is attached to the connection point on the driver's panel and to the boat operator.
- Be certain the engine electrical system is ON. Generally, this requires turning the ignition key ON or pressing the ON button.
- It is possible the display is in a "sleep" mode. Press a key or touch the screen to see if the affected display activates.
- Verify that the battery connections are secure.
- Refer to the Engine Owner's Manual or the engine section of this Owner's Manual, depending on the equipped engine, for additional suggestions.

The boat will not shift into gear.

- When engaging the transmission from neutral either forward or backward into reverse, pull up on the safety collar located directly below the throttle lever knob. The safety collar helps avoid unintentional movement into gear.
- When shifting gears, always do so smoothly and briskly. Being either too hard and slamming the gears, or too tentative is hard on the shifter/throttle system and can result in damage that is not covered under warranty.

The engine/drive train is not operating properly.

- Refer first to the engine owner's manual for guidance.
- Check the fuel level in the boat to be certain that the engine is not "starving" from lack of fuel or contaminated fuel.
- Check for engine warning messages on the gauges/display. If any are present, take the boat to the closest authorized Malibu dealer for evaluation and repair.

Gauges, Switches and Video Screens

A gauge or video screen does not light up and work as expected.

- Be certain the engine electrical system is ON. Generally, this requires turning the ignition key ON or pressing the ON button.

- It is possible the display is in a "sleep" mode. Press a key or touch the screen to see if the affected display activates.
- Verify that the battery connections are secure.
- Determine if other gauges, switches and/or video screens are operational. If they are, check the circuit breaker panel to determine if the breaker has tripped. Reset. If the circuit continues to trip, the boat must be serviced by an authorized Malibu dealer as it indicates a recurrent and potentially significant problem. Another cause is a loose electrical connection to the non-working gauge/switch/video screen. This matter should be addressed by an authorized Malibu dealer.
- If a video screen freezes or displays an unreadable or invalid screen, turn the entire system OFF, including the engine electrical system. Allow a few minutes for the system to re-set itself, and then try rebooting the system. If the issue persists or another issue arises, take the boat to an authorized Malibu dealer for correction. Where equipped, check the battery isolator switch.

Electrical Systems

A boat component that is electrically operated will not operate.

- Be certain the boat electrical system is ON. Generally, this requires turning the ignition key ON or pressing the ON button.
- Verify that the battery connections are secure and that there is sufficient charge and power. See the Battery information in this Owner's Manual for additional details.
- Verify that the circuit breaker has not tripped. If it has, reset it. Recurrent trips are indicative of a problem that requires the attention of an authorized Malibu dealer.
- Check for loose connections, but do not remove any closeout panels to do so. If a loose connection is suspected but cannot be seen, have the system checked by an authorized Malibu dealer.
- If the component is electronic, be certain the component is operational. If it requires reception from a satellite, tower or other supplier, Malibu cannot guarantee that it will receive the signal. It may be necessary to move the boat to another location or body of water, or pay a subscription fee.

Accessories will not recharge in the 12-volt receptacle.

- Verify that the correct charger was used for the item(s) and that the charger plug-in was fully seated in the 12-volt receptacle.

Battery Failure

- Often, a battery that will not start the boat requires recharging. Use ONLY a marine-approved battery charger. Any other can damage the electrical system, and such damage is not covered

under warranty. **NEVER** attempt to “jump” from a vehicle or another boat as there is a potential for overload that could significantly damage the boat's electrical system, which is not covered under warranty! Read the battery information provided in the *Dashes and Video Screens* section of this Owner's Manual before undertaking any attempt to replace, use both batteries simultaneously, or replace the battery.

Alarms

The low voltage alarm sounds.

- Most often, this signals the need to turn OFF and leave OFF the stereo component or similar electronics that require substantial support from the batteries. Start the engine and allow the alternator to recharge the batteries, which will require a fairly short period of time if there is no additional drain occurring during the recharging time. If this does not work, it may be that the battery or batteries are nearing their terminal life span.

Another alarm sounds.

- These occur when a sensor detects that the engine or transmission temperature range or oil pressure range have exceeded programmed limits. The boat's main system may begin shutting off peripheral activity to retain proper operation as long as possible. It is usually in the operational best interest to return to shore as soon as possible to avoid being stranded. Even if the ranges return to acceptable operating range, this matter should be shared with the service department of your authorized Malibu dealer to determine the cause and avoid a repeat.

Bilge and Ballast

The bilge pumps are not operating.

- The bilge pump(s) should operate automatically. If it does not, use the manual switch. If it still does not operate, return to shore IMMEDIATELY and terminate the outing. Failure to pump water out of the bilge can result in the boat swamping and sinking. This could result in serious injury or death to those on-board.

The ballast pump is not operating.

- If the ballast pump does not pump water into the system, and having verified that the electrical system is operational, leave the pump OFF and have it serviced by an authorized Malibu dealer. If the pump does not pump water out of the system, seek assistance by calling your Malibu dealer. You should never attempt to tow your boat on a trailer with water in the ballast system as it could cause damage to the trailer, which can result in the driver losing control while towing. Such activity could result in serious injury or death to anyone in the area.
- Additional information on the Bilge and Ballast systems can be

found in *How It Works* and *Care and Maintenance* sections of this Owner's Manual.

Blower System

The blower is not working.

- Never operate the boat without the blower system operating correctly! Accumulating fumes that are not released through the blower system can result in an explosion or other serious accident that could result in death to those on-board. If the blower ceases to work properly while boating is underway, terminate the outing IMMEDIATELY and return to shore with the engine compartment covers open. If there is an odor of fuel or exhaust present, turn OFF the engine IMMEDIATELY and seek a tow to shore. See the *Safety* section of this Owner's Manual; additional details are also available in the *How It Works* and *Care and Maintenance* sections, as well.

Steering System

The boat's steering is responding poorly.

- Anytime the steering does not respond crisply to turns by the steering wheel, discontinue the outing and return to shore as soon as possible. The steering components are, generally, inaccessible to boat operators and owners. Repairs should be completed by an authorized Malibu dealer.
- Inboard-engine boats have an inherent pull to one side due to rudder torque. While some can be adjusted, it is possible that all pull cannot be eliminated.

The Power Wedge and Surf Gates

The Power Wedge and/or the Surf Gates are not operating as designed.

- See the information provided in the *Care and Maintenance* section of this Owner's Manual for information about how to manually move these components. However, you may want to take the boat to your authorized Malibu dealer for assistance and to address warranty issues.

Lights

Any light system is not working properly.

- See the *Electrical* troubleshooting information above.

Troubleshooting the Trailer

Whenever possible, it is advisable to have issues with the trailer addressed by a trained service technician at an authorized Malibu Trailer dealer. However, there can be instances when this is not feasible, particularly in cases of emergency or distance from the dealer. The following troubleshooting advice is not guaranteed to fix the issue, and Malibu Trailers does not warrant any repair effected by other than a trained service technician at an authorized Malibu dealership. If you must troubleshoot the trailer and/or its components while the trailer is under warranty, we recommend having a follow-up consultation with the dealer.

Here are some of the more common issues that may arise:

Issue:

The coupler latch handle does not open or close, or does not open/close smoothly and easily.

Consider:

- Verify that the hitch ball is the specified, correct size.
- The hitch ball may not be fully seated within the socket.
- The trailer and tow vehicle may not be level.
- Ensure there is no debris or foreign objects interfering with the match.
- Ensure there is sufficient lubrication in the moving parts.
- Verify that there is little to no corrosion on any of the metal parts.

Issue:

The tongue actuator is making unusual noises, including, but not limited to, clunking or squawking.

Consider:

- The shock absorber inside the tongue may be worn and require replacement by an authorized Malibu Trailer dealer.
- The brakes may require bleeding as there is air in the system that is allowing the actuator to malfunction.
- The hitch ball may be too small, too worn or require some lubrication.

Issue:

Braking is uneven, including instances of the brake releasing when the driver's foot is on the brake pedal in the tow vehicle.

Consider:

- There may be an issue in the tongue actuator such as a worn shock absorber.
- The hitch ball may not be seated properly in the socket.
- There is too little or too much weight percentage on the tongue.
- The tow vehicle's shock absorbers are too worn.

- The brakes need adjustment.
- The brake lines require a re-bleeding.
- Verify that the brake linings, rotors, calipers and other components are correctly aligned and operational.
- Verify that the master cylinder is not corroded.
- Verify that the brake lines are not rusted or corroded.
- Check to determine if the breakaway cable has pulled free.

Issue:

Brakes perform poorly, beyond the intermittent issue mentioned above.

Consider:

- The brake shoes or disc pads may be worn beyond acceptable use.
- Corrosion/rust is preventing the brakes from operating as designed.
- Verify that there is a sufficient amount of brake fluid in the reservoir. Re-bleed as necessary.
- Verify that the brake lines are not damaged.
- The master cylinder may be malfunctioning.
- Adjust the "gain" control on the in-cab controller.
- Verify that the electrical wire connections are connected.

Issue:

A single brake is overheating.

Consider:

- The trailer may have been stored with the actuator compressed and rust is in the system.
- A brake line may have been pinched, broken or damaged and is inhibiting or preventing brake fluid from circulating.
- There are several other potential causes for this problem. Due to the technical nature of the potential causes, it is best to have the system checked by an authorized Malibu Trailer trained service technician.



NEVER tow a trailer with faulty brakes. Whether the brakes are grabbing or failing to respond, the result

is usually a loss of control of the entire rig. This situation can result in serious injury or death to persons on-board, and damage to the tow vehicle and/or trailer and boat, as well as to other people and vehicles on the road at the time.

Service Log

Service Performed	Date	Date	Date	
Oil Change, Including Replace Oil Filter				
Wax Exterior				
Thoroughly Clean Interior				
Replace Battery				
Charge or Replace Fire Suppression Equipment				
Check/Repair PFDs and Other Safety Equipment				
Check/Repair Engine Mounts				
Check/Repair Exhaust Flaps				
Check/Repair Steering System				
Check/Repair Shift & Throttle System				
Inspect/Repair/Replace Ballast Pumps				
Inspect/Repair/Replace Bilge Pumps				
Replace Fuel Filter/Inspect Fuel Lines				
Check/Repair Wedge & Surf Gate Operation				
Check Hull Paint (where applied)				
Prepare for Storage/Winterization				
Recommission Boat				
Other				
Other				
Other				

Index

10 Hours on the Hourmeter, After	184
12-Volt Receptacle	93
20VTX	40
21MLX	42
21VLX	44
22LSV	46
22MXZ	52
23LSV	48
24MXZ	54
25LSV	50
3-in-1 Event Screen	84
75 Hours on the Hourmeter, After	185

A

Accessories, Tower	130
Accessories, Tower, Canvas &	128
Accidents, Reporting	17
Activities, Weighting Your Boat During Watersport	15
Additional Precautions for Towed Skier/Rider	29
Advanced Lighting Controls	68
Afloat, Staying	34
After 10 Hours on the Hourmeter	184
After 75 Hours on the Hourmeter	185
After Starting the Engine	181
After the Outing	181
Aids to Navigation	24
Alarms	93, 105
Alert, Text/Phone	62
Alerts	76
Aluminum	175
Anchor Locker	118
Anchoring	166
Approved Cleaners for Malibu Upholstery	173
Armrests	124
Assistance, Rendering	17
Auto Detect	87
Axles	151

B

Ballast Screen	63
Ballast System	134
Band, Surf	93
Basic Electrical Components	89
Basic Rules of the Road	23
Basic Safety Rules (Trailers)	144
Basic Safety Rules	4
Batteries	89
Batteries, Connecting/Disconnecting	91
Battery Charger	92
Battery Fully Charged and Fuel Levels	181
Battery Holders and Connections, Check	180
Battery Maintenance	92
Battery	186
Before Starting the Engine	178
Before Starting, Final Checks	161
Bilge Pump(s)	12
Bilge System	132
Bimini Top	130
Blower System	131
Board Racks or Ski Rack, G3.5 PTM	130
Boat Is Not in Operation (Fuel)	104

Boat Owner and Operators, Responsibilities of	8
Boating Education, Owner Responsibility and	8
Boating Regulations	23
Boating Safety Education Opportunities	9
Boating Safety Topics, General	13
Boating Under the Influence	16
Bow Thruster	136
Box, Fuse	89
Brackish Water Extra Attention, Salt Water	182
Brakes	152
Breakaway Cable	147
Breaker Board, Port Rear	93
Breakers, Circuit	89
Break-In Period—All Boats	108, 164
Burdened Vessel	23
Button, Save Preset	63
Buttons, Four Corner	63
Buzzer Volume	85, 86, 87

C

Cable, Breakaway	147
Cables, Safety	146
California and U.S. EPA Emission Control Warranty Statement	207
California Emissions Information	100
Camera, Rear and/or Dock	122
Camera, Rear	80
Canvas & Accessories, Tower	128
Canvas	170
Capsizing	34
Carbon Monoxide Safety	13
Care, On-Going	170
Carpets and Mats	126, 175
Center Screen	75
Charger, Battery	92
Check Battery Holders and Connections	180
Check Coolant Level	178
Check for Odors	180
Check List, Pre-Tow	155
Check List-Before Leaving the Dock, Pre-Operation	4
Check Other Components	182
Check Safety Equipment	184, 189
Chrome	175
Circuit Breakers	89
Cleaning, General	170
Close the Coupler	148
Cockpit Table	126
Code, Engine Start	77
Code, Engine Starting	62
Collisions	34
Command Center, Wakesetter	62
Compartment (Trailer), Optional Storage	154
Compartments, Storage	125
Components, Basic Electrical	89
Components, Other Electrical	93
Components, Stereo	122
Concerns, Environmental	18
Conditions, Hazardous	17
Conditions, Special	165
Connecting to the Boat	148
Connecting/Disconnecting Batteries	91
Connections to the Tow Vehicles	144
Control Operation, Speed	78
Control, Gauge View and Speed	78
Control, Power Wedge	65

Control, Speed..... 64
 Control, Surf Gate..... 64
 Control, Zero Off GPS Speed..... 85
 Controls Menu..... 76
 Controls Screen..... 68, 80
 Controls, Advanced Lighting..... 68
 Coolant Level, Check..... 178
 Coolant System..... 186
 Cooler, Removable..... 125
 Cooling System..... 105
 Coupler, Close the..... 148
 Coupler, Open the..... 148
 Course Manager..... 87
 Crossing..... 23
 Cruise Screen..... 75
 Cup Holders..... 126

D

Deck Finishes, Hull and..... 175
 Depth Screen..... 63, 76
 Develop Water Sense..... 31
 Disconnecting Batteries, Connecting..... 91
 Distress Signals, Visual..... 12
 Dock Camera, Rear and/or..... 122
 Docking and Tie-Up..... 166
 Driver's Seat, Heated and/or Powered..... 124
 Drowning..... 35

E

Education Opportunities, Boating Safety..... 9
 Education, Owner Responsibility and Boating..... 8
 Electrical Components, Basic..... 89
 Electrical Components, Other..... 93
 Electrical Harnesses and Wiring..... 89
 Electrical System..... 105
 Electronic Throttle Control (ETC)..... 121
 Embracing Safety..... 4
 Emergency Procedures..... 33
 Emergency Safety Stop Switch..... 10, 115
 Emergency, Medical..... 35
 Emissions Information, California..... 100
 Encountering Another Vessel..... 23
 Engine Compartment General Inspection..... 181
 Engine Mounts..... 185
 Engine Screen..... 76
 Engine Sensors..... 92
 Engine Start Code..... 62, 77
 Engine, Flushing the..... 184
 Engines, Transmissions & V-Drives..... 98
 Environmental Concerns..... 18
 Equipment, Fire Extinguishing..... 114
 Equipment, Recommended Safety..... 12
 Event Information, Three..... 85
 Event Screen, 3-in-1..... 84
 Exhaust Flap..... 185
 Exhaust System..... 107
 Explosion and Fire..... 33
 Extended Non-Use..... 191
 Extended Storage Winterization..... 193
 Extinguisher, Fire..... 12
 Extinguishing Equipment, Fire..... 114
 Extra Attention, Salt Water/Brackish Water..... 182

F

Failure, Operation..... 35
 Fallen Skier or Rider..... 31
 Features, Navigation..... 84
 Final Checks Before Starting..... 161
 Finishes, Hull and Deck..... 175
 Fins..... 136
 Fire Extinguisher..... 12
 Fire Extinguishing Equipment..... 114
 Fire, Explosion and..... 33
 Flap, Exhaust..... 185
 Flooding, Swamping and..... 34
 Flotation Devices, Personal..... 11
 Flush Kit..... 139
 Flushing the Engine..... 184
 Four Corner Buttons..... 63
 Fuel and Battery Used..... 182
 Fuel Fill..... 118
 Fuel System..... 102, 158, 188
 Fuel, When the Boat Is Not in Operation..... 104
 Fuse Box..... 89

G

G3.5 PTM Board Racks or Ski Rack..... 130
 G3.5 Tower Mirror..... 130
 G3.5 Tower..... 128
 Gauge View and Speed Control..... 78
 Gauges and Screen, TXi Standard..... 75
 Gauges..... 75
 Gel Coat, Hull..... 191
 General Boating Safety Topics..... 13
 General Cleaning..... 170, 182
 General Information (Engine)..... 99
 General Prudential Rule..... 24
 Get Ready..... 158
 G-Force Icon 8 Tower Speakers..... 130
 Glove Box..... 124
 GPS Information..... 85
 GPS Speed Control, Zero Off..... 85
 Grab Handles..... 127
 Grounding..... 34
 Guidelines, Tow Line..... 31
 GX Tower..... 129

H

Hand Signals..... 28
 Handles, Grab..... 127
 Harnesses and Wiring, Electrical..... 89
 Hazardous Conditions..... 17
 Head-On, Meeting..... 24
 Heated and/or Powered Driver's Seat..... 124
 Heater..... 127
 High Speed Maneuvers..... 165
 Hitch, Trailer..... 146
 Hitching Up..... 148
 Horn or Whistle..... 12
 Horn..... 118
 How to Connect to the Tow Vehicle..... 147
 Hubs, Wheels and..... 151
 Hull and Deck Finishes..... 175
 Hull Gel Coat..... 191
 Hydraulic Steering System..... 189

I

Important Safety Information 8
 Information (Engine), General 99
 Information, California Emissions 100
 Information, GPS 85
 Information, Important Safety 8
 Information, Three Event 85
 Inspect Sea Strainer 179
 Insurance 9
 Interaction, Towing and 165
 Interior Luxury 122
 Interior Performance 119

J

Jack, Trailer 150
 Jump Settings 86
 Jump Switch Timeout 86
 Jump Switch 86

K

Keypad 75

L

Label Locations, Response TXi 22
 Label Locations, Wakesetter 20
 Label, Star 101
 Labels and Locations, Warning 19
 Labels, On Product Warning 19
 Ladder 118
 Ladders, Swim Board and 139
 Launching and Re-Launching the Boat from the Trailer 156
 Legal Requirements for Towing 144
 Licensing, Operation by Minors and 10
 Lifting the Boat 191
 Lighting Controls, Advanced 68
 Lighting 115
 Lights (Trailer) 150
 Lights Menu 76
 Lights, Navigation 10
 Lights, Tower 130
 Loading, Proper 15
 Locker, Anchor 118
 Lug Nuts 151

M

M235 56
 Maintenance, Battery 92
 Maintenance, Routine 176
 Malibu Boats LLC Limited Warranty 196
 Manager, Course 87
 Maneuvers, High Speed 165
 Maps Screen 72, 82
 Mats, Carpets and 126, 175
 Media Screen 66, 79
 Medical Emergency 35
 Meeting Head-On 24
 Menu, Controls 76
 Menu, Lights 76
 Menu, Settings 76
 Minors and Licensing, Operation by 10
 Mirror 118
 Mirror, G3.5 Tower 130
 Misuse, Product 17
 Mounts, Engine 185

N

Navigation Features 84
 Navigation Lights 10
 Navigation, Aids to 24
 Night Mode 78
 Night Running 25
 Non-Use, Extended 191

O

Odors, Check for 180, 181
 Offset, River Mode and 87
 Oil Change by Dealer 184
 Oil System 187
 On and Under the Water 131
 On Product Warning Labels 19
 On-Going Care 170
 Open the Coupler 148
 Operation by Minors and Licensing 10
 Operation Failure 35
 Operation, Speed Control 78
 Operation, Starting and 162
 Operations 161
 Operations, Smart 164
 Operator, Visibility of the 16
 Optional Storage Compartment (Trailer) 154
 Other Electrical Components 93
 Other Rules of the Road 24
 Overboard, Person 34
 Overtaking 24
 Overview, System 62
 Owner and Operators, Responsibilities of Boat 8
 Owner Responsibility and Boating Education 8

P

Paddlewheel 136
 Passenger Safety 13
 PDF View and Video Player 79
 Person Overboard 34
 Personal Flotation Devices 11
 Phone Alert, Text 62
 Plus (+) Factor 88
 Port Rear Breaker Board 93
 Power Wedge Control 65
 Power Wedge III 135
 Power Wedge Manual Extension and Retraction 189
 Powered Driver's Seat, Heated and/or 124
 Precautions for Towed Skier/Rider, Additional 29
 Precautions While Underway 5
 Pre-Operation Check List-Before Leaving the Dock 4
 Preset Button, Save 63
 Preset Screen 66
 Pre-Tow Check List 155
 Prior to Towing 155
 Privileged Vessel 23
 Procedures, Emergency 33
 Product Misuse 17
 Propeller 136
 Proper Loading 15
 Prudential Rule, General 24
 Pull Type 88
 Pump(s), Bilge 12
 Pumps 186
 Pylon(s) 121

R

Rack, G3.5 PTM Board Racks or Ski 130

Raw-Water Intake 136

Rear and/or Dock Camera 122

Rear Breaker Board, Port 93

Rear Camera 80

Recap, Timing 86

Receptacle, 12-Volt 93

Receptacle, Removable Trash 126

Recommended Safety Equipment 12

Recommended Seating 58

Registration 9

Regulations, Boating 23

Removable Cooler 125

Removable Trash Receptacle 126

Rendering Assistance 17

Reporting Accidents 17

Reporting Safety Defects (Trailers) 144

Response TXi Label Locations 22

Response TXi 38

Response, Starting the Engine 163

Response, Turn Off 163

Responsibilities of Boat Owner and Operators 8

Responsibilities, Tower Person Safety 29

Responsibility and Boating Education, Owner 8

Rider, Additional Precautions for Towed Skier 29

Rider, Fallen Skier or 31

River Mode and Offset 87

Routine Maintenance 176

Rudder 136

Rule, General Prudential 24

Rules (Trailers), Basic Safety 144

Rules of the Road, Basic 23

Rules of the Road, Other 24

Rules, Basic Safety 4

Running, Night 25

S

Safe Speed 13

Safety (Engine) 98

Safety Cables 146

Safety Education Opportunities, Boating 9

Safety Equipment, Check 184, 189

Safety Equipment, Recommended 12

Safety First 114

Safety Information, Important 8

Safety Responsibilities, Towed Person 29

Safety Rules (Trailers), Basic 144

Safety Rules, Basic 4

Safety Stop Switch, Emergency 10, 115

Safety Topics, General Boating 13

Safety While Maintaining the Vessel 7

Safety, Carbon Monoxide 13

Safety, Embracing 4

Safety, Passenger 13

Safety, Watersports 28

Salt Water Boats 190

Salt Water Series Care and Maintenance 176

Salt Water Series 40

Salt Water/Brackish Water Extra Attention 182

Save Preset Button 63

Screen, 3-in-1 Event 84

Screen, Ballast 63

Screen, Center 75

Screen, Controls 68, 80

Screen, Cruise 75

Screen, Depth 63, 76

Screen, Engine 76

Screen, Maps 72, 82

Screen, Media 66, 79

Screen, Preset 66

Screen, Settings 69, 80

Screen, Stereo 67, 78

Screen, TXi Standard Gauges and Screen 75

Screens (Optional Malibu Open Edition), Video 77

Sea Strainer 136

Sea Strainer, Inspect 179

Seat, Heated and/or Powered Driver's 124

Seating 122

Seating, Recommended 58

Sense, Develop Water 31

Sensors, Engine 92

Service Log 212

Settings Menu 76

Settings Screen 69, 80

Settings, Jump 86

Settings, Slalom 85

Settings, Trick 86

Shift and Throttle System 186

Shifter/Throttle 120

Shower 138

Signal Words and Symbols Used in This Manual 4

Signals, Hand 28

Signals, Visual Distress 12

Ski Rack, G3.5 PTM Board Racks or 130

Skier or Rider, Fallen 31

Skier/Rider, Additional Precautions for Towed 29

Slalom Settings 85

Slalom Wait Time 86

Smart Operations 164

Speakers, G-Force Icon 8 Tower 130

Special Conditions 165

Speed Control Operation 78

Speed Control 64

Speed Control, Gauge View and 78

Speed Control, Zero Off GPS 85

Speed, Safe 13

Sports Dash 121

Stainless Steel 175

Star Label 101

Start Code, Engine 77

Starting and Operation 162

Starting Code, Engine 62

Starting the Engine-Response 163

Starting the Engine-Wakesetters 162

Staying Afloat 34

Steering System 185

Steering System, Hydraulic 189

Steering Wheel 119

Stereo Components 122

Stereo Screen 67, 78

Stop Switch, Emergency Safety 10, 115

Stopping 165

Storage and Winterization 191

Storage Compartment (Trailer), Optional 154

Storage Compartments 125

Strut 136

Surf Band 93

Surf Gate Control..... 64
 Surf Gate 136
 Swamping and Flooding 34
 Swim Board and Ladders 139
 Swim Board 175
 Switch Timeout, Jump 86
 Switch, Emergency Safety Stop 10, 115
 Switch, Jump 86
 Symbols Used in This Manual, Signal Words and..... 4
 System Overview..... 62
 System, Ballast..... 134
 System, Bilge..... 132
 System, Blower..... 131
 System, Coolant 186
 System, Cooling 105
 System, Electrical 105
 System, Exhaust..... 107
 System, Fuel..... 102, 158, 188
 System, Hydraulic Steering 189
 System, Oil 187
 System, Shift and Throttle 186
 System, Steering 185
 System, Transmission/V-Drive..... 188

I

Table, Cockpit..... 126
 Text/Phone Alert 62
 Three Event Information 85
 Throttle System, Shift and 186
 Throttle, Shifter 120
 Tie-Downs 149
 Tie-Up, Docking and 166
 Tie-ups..... 117
 Timeout, Jump Switch 86
 Timing Recap 86
 Tires..... 152
 Tow Line Guidelines 31
 Tow Vehicle, Connections to the..... 144
 Tow Vehicle, How to Connect to the 147
 Towed Person Safety Responsibilities 29
 Towed Skier/Rider, Additional Precautions for..... 29
 Tower Accessories..... 130
 Tower Lights 130
 Tower Mirror, G3.5 130
 Tower Speakers, G-Force Icon 8..... 130
 Tower, Canvas & Accessories 128
 Tower, G3.5 128
 Tower, GX..... 129
 Towing Advice..... 155
 Towing and Interaction..... 165
 Towing 35
 Towing, Legal Requirements for 144
 Towing, Prior to..... 155
 Trailer Components and How They Function 150
 Trailer Hitch 146
 Trailer Is Not in Use, When the..... 156
 Trailer Jack 150
 Trailer Winch 148
 Transfer, Warranty 206
 Transmission & V-Drives, Engines 98
 Transmission/V-Drive System..... 188
 Transmissions and V-Drives 110
 Trash Receptacle, Removable 126
 Trick Settings..... 86

Troubleshooting the Boat 209
 Troubleshooting the Trailer..... 211
 Turn Off-Response 163
 Turn Off-Wakesetters 163
 TXi Standard Gauges and Screen..... 75
 TXi, Response 38

U

Under the Influence, Boating 16
 Underwater Gear 136
 Underway, Precautions While 5
 Upholstery 172
 Upholstery, Approved Cleaners for Malibu 173

V

Vapor Lock..... 110
 V-Drive System, Transmission..... 188
 V-Drives, Engines, Transmissions & 98
 V-Drives, Transmissions and 110
 Vessel, Burdened 23
 Vessel, Encountering Another 23
 Vessel, Privileged 23
 Video Player, PDF View and 79
 Video Screens (Optional Malibu Open Edition) 77
 Visibility of the Operator 16
 Visual Distress Signals 12
 Volume, Buzzer 85, 86, 87

W

Wait Time, Slalom..... 86
 Wake View 64
 Wakesetter Command Center 62
 Wakesetter Label Locations 20
 Wakesetters, Starting the Engine 162
 Wakesetters, Turn Off..... 163
 Warning Labels and Locations 19
 Warning Labels, On Product 19
 Warranty Transfer 196
 Water Sense, Develop..... 31
 Water, On and Under the..... 131
 Watersport Activities, Weighting Your Boat During 15
 Watersports Safety 28
 Weight Distribution (Trailers)..... 147
 Weighting Your Boat During Watersport Activities 15
 Wheels and Hubs 151
 When the Trailer Is Not in Use..... 156
 Whistle, Horn or 12
 Winch, Trailer..... 148
 Winterization, Storage and 191
 Winterizing Boats Equipped with Optional Flush Kit..... 192
 Wiring, Electrical Harnesses and..... 89

Z

Zero Off GPS Speed Control..... 85

 **WARNING**

Operating, service and maintaining a recreational marine vessel can expose you to chemicals including engine exhaust, carbon monoxide, phthalates, and lead, which are known to the State of California to cause cancer and birth defects or other reproductive harm. To minimize exposure, avoid breathing exhaust, service your vessel in a well-ventilated area and wear gloves or wash your hands frequently when servicing this vessel. For more information go to www.P65warnings.ca.gov/marine.

MALIBU BOATS, LLC

TENNESSEE
5075 Kimberly Way
Loudon, TN 37774
(865) 458-5478

AUSTRALIA
813 Hope Court
Albury, N.S.W. 2640
(02) 6040-1174



Additional Information

Supplement for the 2019 Malibu Boats Equipped with the Malibu-built Monsoon Engine

To assist boat owners in the appropriate care and maintenance to ensure long enjoyment of the boat, the following information is being provided:

Maintenance Schedule

Task	Service	Annually*	First 10 Hrs	Every 50 Hrs	Every 150 Hrs	Every 300 Hrs	Every Two Yrs	
Engine–Oil & filter**	Change	X	X	X				
Transmission Oil	Change	X	X					
V-Drive Oil	Change							1200 hrs/3 Yrs
Raw Water Impeller	Change	***		X				
Sea Strainer#	Inspect	X	X	X				
Engine Coolant	Inspect	X	X					
Engine Coolant	Change						X	
Serpentine Belt	Inspect	X						
Serpentine Belt#	Change					X		
Air Filter	Inspect	X						
Air Filter#	Change						X	
Engine Fuel Filter	Change				X			
Fuel Pump Filter	Change				X			
Spark Plugs	Clean					X		
Spark Plugs	Change						X	
Shaft Alignment	Inspect	X	X		X			
Heat Exchanger	Inspect	X						
Sacrificial Anodes	Replace as needed	X						

*Whichever comes first

**If the engine is subject to extreme use such as excessive ballast weight, long idle time, low use, elevations above 5,000 feet, or commercial use, it is recommended to change oil and filter every 25 hours.

***First of the season

#Replace sooner if regular inspection indicates wear or damage.

It is always recommended that these requirements be performed by an authorized Malibu dealer. Service technicians from Malibu dealerships have proper equipment, training and resources to best meet the requirements. Please note that routine maintenance is not covered by the Malibu Boats Limited Warranty. For details, please consult the limited warranty statement.

Also note a typographical error on pages 177 and 185 of the 2019 Malibu Owners Manual which references 75 Hours or Annually. The message should read instead 50 Hours or Annually. We apologize for the error.

shorter distance than a tire with a lower grade. Traction is graded from the highest to lowest as "AA," "A," "B," or "C."

Temperature grades are an indication of a tire's resistance to heat. Sustained high temperature (for example, driving long distances in hot weather), can cause a tire to deteriorate, leading to blowouts and tread separation. From highest to lowest, a tire's resistance to heat is graded as "A," "B," or "C."

Tire Fundamentals

Federal law requires tire manufacturers to place standardized information on the sidewall of all tires. This information identifies and describes the fundamental characteristics of the tire and also provides a tire identification number for safety standard certification and in case of a recall.

Information on Trailer Tires

Please refer to the photo below.



ST: The "ST" indicates that the tire is for trailer use.

Next number: This three-digit number gives the width in millimeters of the tire from sidewall edge to sidewall edge. In general, the larger the number, the wider the tire.

Next number: This two-digit number, known as the aspect ratio, gives the tire's ratio of height to width. Numbers of 70 or lower indicate a short

sidewall for improved steering response and better overall handling on dry pavement.

R: The "R" stands for radial. Radial ply construction of tires has been the industry standard for the past 20 years.

Next number: This two-digit number is the wheel or rim diameter in inches. If you change your wheel size, you will have to purchase new tires to match the new wheel diameter.

Tire Safety Tips

Preventing Tire Damage

- Slow down if you have to go over a pothole or other object in the road.
- Do not run over curbs or other foreign objects in the roadway and try not to strike the curb when parking.

Tire Safety Checklist

- Check tire pressure regularly (at least once a month or every 50 miles, whichever comes first), including the spare tire.
- Inspect tires for uneven wear patterns on the tread, cracks, foreign objects or other signs of wear or trauma.
- Remove bits of glass and other foreign objects wedged in the tread.
- Make sure your tire valves have valve caps.
- Check tire pressure before going on a long trip.
- Do not overload your vehicle. Check the tire information placard for the maximum recommended load for the vehicle.
- When towing the trailer, remember that some of the weight of the loaded trailer is transferred to the towing vehicle.

For more information, visit www.nhtsa.gov or call (888) 327-4326.

Information provided in this brochure courtesy of the National Highway Transportation & Safety Administration. Reprinted by permission.



Tire Safety Everything Runs On It

Studies of tire safety show that maintaining proper tire pressure, observing tire and vehicle load limits (not carrying more weight in your vehicle than your tires or vehicle can safely handle), avoiding road hazards, and inspecting tires for cuts, slashes, and other irregularities are the most important things you can do to avoid tire failure, such as tread separation or blowout and flat tires. These actions, along with other care and maintenance activities, can also:

- Improve vehicle handling
- Help protect you and others from avoidable breakdowns and accidents
- Improve fuel economy
- Increase the life of your tires.

This booklet presents a comprehensive overview of tire safety, including information on the following topics:

- Basic tire maintenance
- Uniform Tire Quality Grading System
- Fundamental characteristics of tires
- Tire safety tips.

Use this information to make tire safety a regular part of your vehicle maintenance routine.

Recognize that the time you spend is minimal compared with the inconvenience and safety consequences of a flat tire or other tire failure.

Safety First—Basic Tire Maintenance

Properly maintained tires improve the steering, stopping, traction, and load-carrying capability of your vehicle. Underinflated tires and overloaded vehicles are a major cause of tire failure. Therefore, as mentioned above, to avoid flat tires and other types of tire failure, you should maintain proper tire pressure, observe tire and vehicle load limits, avoid road hazards, and regularly inspect your tires.

Finding Your Vehicle's Recommended Tire Pressure and Load Limits

Tire information placards and vehicle certification labels contain information on tires and load limits. These labels indicate the vehicle

manufacturer's information including:

- Recommended tire size
- Recommended tire inflation pressure
- Vehicle capacity weight (VCW—the maximum occupant and cargo weight a vehicle is designed to carry)
- Front and rear gross axle weight rating (GAWR—the maximum weight the axle systems are designed to carry).

Both placards and certification labels are affixed to the trailer. The recommended tire pressure is on the tire, and the tire pressure and load limit appear on the trailer label.

Understanding Tire Pressure and Load Limits

Tire inflation pressure is the level of air in the tire that provides it with load-carrying capacity and affects the overall performance of the trailer. The tire inflation pressure is a number that indicates the amount of air pressure—measured in pounds per square inch (psi)—a tire requires to be properly inflated.

The proper tire pressure for the trailer is referred to as the “recommended cold inflation pressure.” (As you will read below, it is difficult to obtain the recommended tire pressure if your tires are not cold.)

Because tires are designed to be used on more than one type of vehicle, tire manufacturers list the “maximum permissible inflation pressure” on the tire sidewall. This number is the greatest amount of air pressure that should ever be put in the tire under normal driving conditions.

Remember, however, that the vehicle manufacturer, not the tire manufacturer, determines the correct tire pressure for the tires on your vehicle.

Checking Tire Pressure

It is important to check your trailer's tire pressure at least once a month or every 50 miles, whichever comes first, for the following reasons:

- Most tires may naturally lose air over time
- Tires can lose air suddenly if you drive over a pothole or other object or if you strike the curb when parking
- With radial tires, it is usually not possible to determine underinflation by visual inspection.

For convenience, purchase a tire pressure gauge to keep in your tow vehicle. Gauges can be purchased at tire dealerships, auto supply stores, and other retail outlets.

The recommended tire inflation pressure that manufacturers provide reflects the proper psi when a tire is cold. The term cold does not relate to the outside temperature. Rather, a cold tire is one that has not been driven on for at least three hours. When you drive, your tires get warmer, causing the air pressure within them to increase. Therefore, to get an accurate tire pressure reading, you must measure tire pressure when the tires are cold or compensate for the extra pressure in warm tires.

Steps for Maintaining Proper Tire Pressure

- Step 1: Locate the recommended tire pressure on the trailer label.
- Step 2: Record the tire pressure of all tires.
- Step 3: If the tire pressure is too high in any of the tires, slowly release air by gently pressing on the tire valve stem with the edge of your tire gauge until you get to the correct pressure.
- Step 4: If the tire pressure is too low, note the difference between the measured tire pressure and the correct tire pressure. These “missing” pounds of pressure are what you will need to add.
- Step 5: At a service station, add the missing pounds of air pressure to each tire that is underinflated.
- Step 6: Check all the tires to make sure they have the same air pressure.

If you have been towing your trailer and think that a tire is underinflated, fill it to the recommended cold inflation pressure indicated on your trailer label. While your tire may still be slightly underinflated due to the extra pounds of pressure in the warm tire, it is safer to drive with air pressure that is slightly lower than the vehicle manufacturer's recommended cold inflation pressure than to drive with a significantly underinflated tire. Since this is a temporary fix, don't forget to recheck and adjust the tire's pressure when you can obtain a cold reading.

Tire Size

To maintain tire safety, purchase new tires that are the same size as the trailer's original tires or another size recommended by the manufacturer. At present, the trailer manufacturer is not recommending any size differential than was originally equipped. If you have any doubt about the correct size to choose, consult with your authorized Malibu or Axis dealer.

Tire Tread

The tire tread provides the gripping action and traction that prevent your vehicle from slipping or sliding, especially when the road is wet or icy in general. Tires are not safe and should be replaced with the tread is worn down to 1/16-of-an-inch. Tires have built-in tread wear indicators that let you know when it is time to replace your tires. These indicators are raised sections spaced intermittently in the bottom of the tread grooves. When they appear “even” with the outside of the tread, it is time to replace your tires. Another method for checking tread depth is to place a penny in the tread with Lincoln's head upside down and facing you. If you can see the top of Lincoln's head, you are ready for new tires.

Tire Balance and Wheel Alignment

To avoid vibration or shaking of the vehicle when a tire rotates, the tire must be properly balanced. This balance is achieved by positioning weights on the wheel to counterbalance heavy spots on the wheel-and-tire assembly. A wheel alignment adjusts the angles of the wheels so that they are positioned correctly relative to the vehicle's frame. This adjustment maximizes the life of your tires and prevents your trailer from veering to the right or left when driving on a straight, level road. These adjustments require special equipment and should be performed by a qualified technician.

Tire Repair

The proper repair of a punctured tire requires a plug for the hole and a patch for the area inside the tire that surrounds the puncture hole. Punctures through the tread can be repaired if they are not too large, but punctures

to the sidewall should not be repaired. Tires must be removed from the rim to be properly inspected before being plugged and patched.

Tire Rotation

Rotating tires from front to back and from side to side can reduce irregular wear (for vehicles that have tires that are all the same size). The generally recommended rotation period is every 5,000 miles.

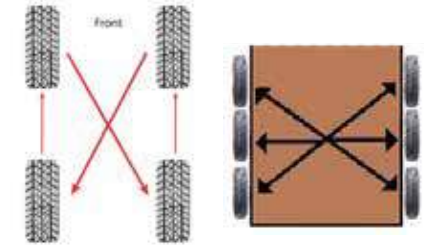

Uniform Tire Quality Grading System (UTQGS)

To help consumers compare tread wear rate, traction performance and temperature resistance, the federal government requires tire manufacturers to grade tires in these three areas. This grading system, known as the Uniform Tire Quality Grading System, provides guidelines for making relative comparisons when purchasing new tires. You also can use this information to inquire about the quality of tires placed on new vehicles.

Although this rating system is very helpful when buying new tires, it is not a safety rating or guarantee of how well a tire will perform or how long it will last. Other factors such as personal driving style, type of car, quality of the roads, and tire maintenance habits have a significant influence on your tire's performance and longevity.

Tread wear grades are an indication of a tire's relative wear rate. The higher the tread wear number is, the longer it should take for the tread to wear down. For example, a tire grade of 400 should wear twice as long as a tire grade of 200.

Traction grades are an indication of a tire's ability to stop on wet pavement. A higher graded tire should allow you to stop on wet roads in a