

INTRODUCTION

Welcome Aboard! This manual has been produced with the recreational boater in mind, as a guide to safe operating practices, general boating regulations and proper maintenance techniques. Included with this manual may be manufacturer literature for the engine, trailer and other major components. To ensure each boating experience is a safe and enjoyable one, please read all the materials carefully before operating your newly purchased craft.

If this is your first time owning or operating this style of boat, it is recommended you contact your dealer or local boating agency to find out how to enroll in a boater safety course prior to taking to the water. Please keep this manual onboard for future reference and pass it along to the new owner if you ever decide to sell the craft.

Because of our policy of continuous product improvement, the illustrations used in this manual may not be the same as on your boat and are intended only as representative reference views.

Identification Numbers

Safeguard information about your boat by recording the Hull Identification Number (HIN) and model of your boat, and model and serial numbers of the engine, trailer, and accessories on the inside front cover of this manual. The HIN is located on the upper, starboard corner of the transom. The HIN must be clearly visible and may not be removed, altered or tampered with in any way as regulated by federal law.

The identification numbers are important! Keep a copy of these numbers stored in a safe place off the boat. In case of theft, damage, etc., report these numbers to the local authorities, your insurance agent and your dealer.

Boating Terminology

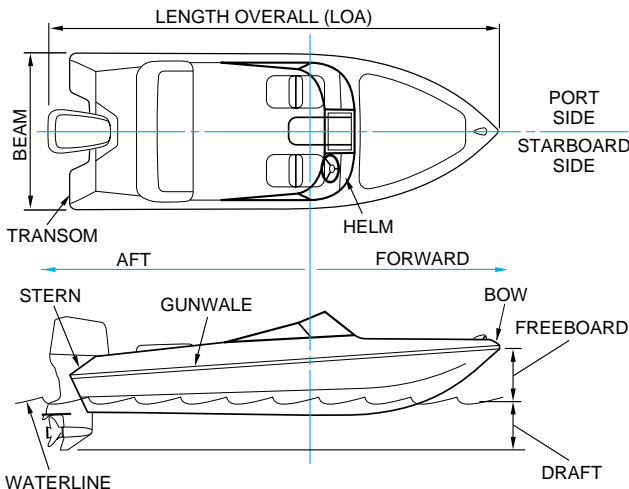

KC-0036

- * An easy way to remember PORT side from STARBOARD side is “PORT” and “LEFT” both have four letters.

TABLE OF CONTENTS

	Page		Page
1 Boating Safety	1-1	5 Getting Underway	5-1
Boating Regulations	1-1	Safety Checklist	5-1
Boater Responsibilities	1-2	Safety Equipment	5-2
Required Safety		Boarding	5-2
Equipment	1-2	6 Running	6-1
Recommended		Maneuvering	
Equipment	1-4	Techniques	6-1
Emergencies	1-5	Salt Water	6-2
Hazardous Conditions	1-6	Freezing Temperatures	6-2
Boating Under the		Towing Procedure	6-2
Influence	1-8	Anchoring	6-3
Carbon Monoxide	1-8	Performance Boating	6-4
Operation By Minors	1-9	Propellers	6-5
Passenger Safety	1-9	7 Care and Maintenance	7-1
Water Sports	1-9	Repairs and Modifications ..	7-1
General Precautions	1-10	Electrical	7-1
Our Environment	1-11	Corrosion Protection	7-3
2 Basic Rules of the Road ...	2-1	General Maintenance	7-3
Aids to Navigation	2-1	Fuel System	7-5
Right-of-Way	2-3	Steering System	7-5
3 Systems, Controls		8 Troubleshooting	8-1
and Indicators	3-1	Trouble Check Chart	8-1
Systems	3-1	9 Storage	9-1
Controls	3-3	Storage Preparation	9-1
Switches	3-4	Slinging/Lifting	9-3
Indicators	3-6	10 Trailering	10-1
4 Operation	4-1	Hitch	10-1
Fueling	4-1	Safety Chains	10-2
Lubrication (Outboards)	4-2	Trailering Checklist	10-2
Starting	4-2	Backing Up Trailers	10-3
Shifting/Running	4-2	Launching	10-4
Warning Alarm	4-3	Loading	10-4
Steering	4-3	11 Glossary of Terms	11-1
Stopping	4-4		
Docking	4-4		
Boat Trim	4-5		
Drive Trim Angle	4-6		

CHAPTER 1: BOATING SAFETY

The popularity of boating and other water sports has undergone an explosion of growth in the past few years. Because of this, safety is an important issue for everyone who shares in the use of our waterways.

This section covers general boating safety information. Throughout this manual specific precautions and symbols identify safety related information.



The Safety Alert Symbol means **ATTENTION! BECOME ALERT! YOUR SAFETY IS INVOLVED!**

DANGER

Indicates the presence of a hazard which WILL cause SEVERE injury, death or substantial property damage.

WARNING

Indicates the presence of a hazard which CAN cause SEVERE injury, death or substantial property damage.

CAUTION

Indicates the presence of a hazard which WILL or CAN cause MINOR or MODERATE personal injury or property damage.

NOTICE

Indicates installation, operation or maintenance information which is important but not hazard-related.

The precautions listed in this manual and on the boat are not all-inclusive. If a procedure, method, tool or part is not specifically recommended, you must satisfy yourself that it is safe for you and others, and that the boat will not be damaged or made unsafe as a result of your decision. **REMEMBER – ALWAYS USE COMMON SENSE WHEN OPERATING YOUR BOAT!**

Boating Regulations

The U.S. Coast Guard is the authority of the waterways; they are there to help the boating public. State boating regulations are enforced by local authorities. You are subject to marine traffic laws and “Rules of the Road” for both federal and state waterways; you must stop if signaled to do so by enforcement officers, and permit to be boarded if asked.

There are many pamphlets, prepared by the Coast Guard, available to you. These pamphlets explain “Rules of the Road”, signal lights, buoys, safety, international and inland regulations and much more than is presented in this manual. For more information contact your local U.S. Coast Guard Unit or call the Coast Guard Customer Infoline at 1-800-368-5647.

Boat Safety Labels

Your boat is affixed with various safety labels at the time of manufacture. These labels appear at specific locations on the craft where safety is of particular concern. Safety labels must remain legible. If you suspect a label is missing or one becomes damaged, contact your dealer for immediate replacement.

Boater Responsibilities**Registration**

The U.S. Coast Guard requires that all power boats operated on the navigable waters of the United States must be registered in the state of main use; also, many States require registration in that state whenever boating on waters within their state boundary. Always contact your state boating authorities (and neighboring states) for registration information on boats and trailers. Your dealer can supply you with the appropriate forms.

Education

This manual is not intended to provide complete training on all aspects of boat operation. We strongly recommend that all operators of this boat seek additional training on boat handling and safety. Some states require youths 16 years of age and younger to complete a boating safety course before operating any watercraft. Many others require operators under the age of 18 to be licensed in small boat operation.

The following is a listing of some of the agencies and organizations that offer safety training or information. To find boating safety courses in your area, call your state's local boating agency or the Coast Guard boating safety CourseLine at 1-800-336-2628 (1-800-245-2628 in Virginia).

- American Red Cross
- U.S. Power Squadrons
- U.S. Coast Guard Auxiliary
- State Boating Offices

Insurance

You must get insurance before operating your new boat. Loss by fire, theft or other causes, or liability protection against accidents is a must for responsible boaters. The boat owner is legally responsible for any damage or injury caused when he, or someone else operating the boat, is involved in an accident. Many states have laws detailing minimum insurance needs. Your insurance agent or your dealer may be able to supply you with more information.

Required Safety Equipment

Your boat has been equipped at the factory with most federally required Class 1 [4.8 m (16 ft.) to less than 7.9 m (26 ft.)] safety equipment for **inland** waters.

NOTICE

Many state equipment requirements go beyond Coast Guard requirements. Contact your state boating office for further information.

Equipment requirements for coastal and inland waters differ. Check with local authorities or the Coast Guard for further information about coastal water requirements.

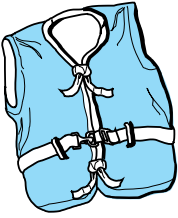

TYPE I
LIFE PRESERVERS

KC-0041

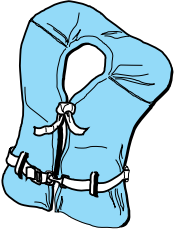

TYPE II
BUOYANT VESTS

KC-0051



TYPE III
FLOTATION AIDS

KC-0042



TYPE IV
THROWABLE DEVICES

KC-0071

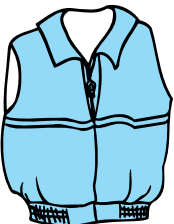

TYPE V HYBRID PFD
MUST BE WORN
WHEN UNDERWAY

KC-0043

Personal Floatation Devices

Federal law also requires at least one Type I, II, III or V Personal Floatation Device (PFD) for each person on board or being towed, and at least one Type IV throwable PFD in the boat. **As the owner, it is your responsibility to obtain PFDs and other mandatory safety equipment not provided by the boat manufacturer, and to ensure all equipment is kept in good, serviceable condition.**

PFDs are intended to help save lives. Therefore, you and your passengers should wear a PFD whenever boating. It is especially important that children and non-swimmers wear a PFD at all times. Make certain all passengers know how to put on and properly adjust their PFDs. Also, selecting the proper type PFD for your kind of outing helps ensure your time on the water can be the safest possible. There are four types of PFDs to wear and one type used for throwing in emergency situations.

Type I: Most buoyant PFD and effective on all waters, especially open, rough water.

Type II: Good for calm water near shore on most inland waters where quick rescue is likely.

Type III: Good for most inland water applications where quick rescue is likely. Come in various styles and some are designed for watersport activities.

Type IV: Intended for heavy traffic inland waters where help is always available. Designed to be thrown to a person in the water and should never be worn.

Type V: Inflatable design for special use activities and may be used instead of a Type I, II, or III PFD if used in accordance with the approval conditions on the label and if worn when the boat is underway. Some Type V PFDs provide increased protection against hypothermia.

NOTICE

- **If a Type V PFD is to be counted toward the minimum carriage requirements, it must be worn.**
- **Special PFDs are available for skiing and other watersports. These PFDs are constructed with materials suitable for high impact falls.**

Keep the following PFD points in mind:

- Set an example and wear your PFD. Require your passengers to wear them also.
- Make sure the PFD fits properly; this is especially important for children and non-swimmers.
- At the beginning of each season, check PFDs for damage and test for proper flotation.

Fire Extinguisher

At least one approved B-1 portable fire extinguisher is required on most boats. Make sure all passengers know the location and operating procedure for each fire extinguisher.

Visual Distress Signals

Federal law also requires boats 4.8 m (16 ft.) and longer to carry day and night visual distress signals when operating on coastal waters, the Great Lakes, territorial seas or those waters directly connected to them, up to a point where the body of water is less than two miles wide.

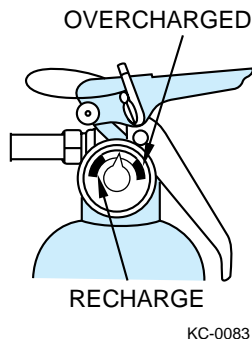

NOTICE

Some signaling devices (pyrotechnics) are restricted from use on certain bodies of water, so always check with local authorities.

Recommended Equipment

As a precaution, a good boater will avoid potential problems on an outing by having additional equipment on board. Normally, this equipment is dependent on the body of water and the length of the trip, your dealer can assist you:

- First aid kit and manual
- Anchor with at least 23 m (75 ft.) of line
- Mooring lines and fenders
- Bailing device (bucket, hand pump, etc.)
- Combination oar/boat hook
- Day/night visual distress signal
- Lubricant
- Tool kit
- Spare propeller, nut and washer
- Spare fuses
- Local charts and compass
- Waterproof flashlight
- Portable AM/FM radio with weather band
- Spare flashlight and radio batteries
- Sunglasses and sun block



Emergencies

Be prepared to deal with emergencies before they happen. Try to formulate a plan for each type in advance so that decisions can be made quickly and without hesitation. Precious moments lost can mean the difference between losing and saving a life.

Reporting Accidents

The U.S. Coast Guard requires the owner or operator of a boat involved in an accident to report the incident to the proper marine law enforcement agency for the State in which the accident occurred. Immediate notification to the nearest State boating authority is required if a person dies or disappears as a result of a recreational boating accident. If a person dies or injuries requiring more than first aid are involved, a formal report must be filed within 48 hours of the accident. A formal report must be filed within 10 days for accidents exceeding \$500 in property damage or complete loss of boat.

Giving Assistance

If you see a distress signal or suspect a boat is in trouble, you must assume it is a real emergency and render assistance immediately. By law, the operator in charge of the craft is obligated to provide assistance to any individual in danger if such assistance can be provided safely. Failure to render assistance can result in a fine and/or imprisonment.

The 1971 Boating Safety Act grants protection to a “Good Samaritan” boater providing good faith assistance, and absolves a boater from any civil liability arising from such assistance.

Fires

Most fires are the result of gasoline and oil accumulating in the bilge from careless fueling practices. Use the fire extinguisher at the **base of the flames** using a sweeping motion. Prudent and accurate use of the available chemicals should contain all but the worst fires. Verify that the fire has been extinguished. If so, check damage and get assistance immediately.

If not, get out and swim at least 23 meters (25 yards) upwind from the boat and use the visual distress signals to get assistance.



KC-0160

On board fires involving the fuel system usually result in either an explosion that completely destroys the boat, or the boat burning to the waterline and self extinguishing. Deciding on abandoning the boat or staying to fight the fire is difficult and depends on many factors. **Try to formulate a fire plan in advance to make that decision quickly and without hesitation.**



WARNING

Gasoline will float on top of water and can burn. If the boat is abandoned, swim up wind, far enough to avoid fuel that may spread over the surface of the water to avoid serious injury.

Capsizing and Swamping

A boat may capsize or swamp when least expected. Like fires, try to formulate a plan in advance on what to do if it should happen. Keep in mind the following guidelines:

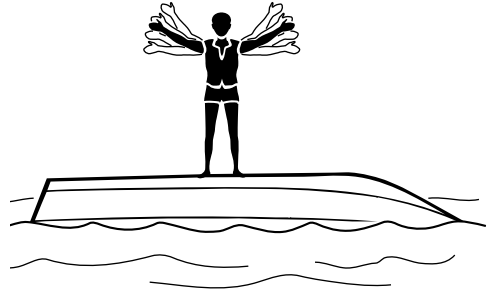
- Try to turn the engine OFF to prevent damage.
- If others were on board, try to locate them, make sure they're conscious and that they can swim.
- **Stay with the boat, it will float!** Climb up on the hull and try to get assistance.
- Don't try to swim to shore. It's usually further than it looks.



KC-0170

Hazardous Conditions

Every waterway poses hazards that you should avoid; shallow water, tree stumps, sand bars, etc. Ask local boaters for information and consult a marine chart when boating on unfamiliar waters. As the operator of the boat, you should try to avoid all hazards, known and unknown. The following information does not contain all possible water hazards.

Weather

Getting caught in severe weather is hazardous. Check with local weather stations, the U.S. Coast Guard, or Weather service broadcasts (162.55 or 162.40 Megahertz) for the latest conditions. It is recommended to check the weather not only before but periodically while you are boating.

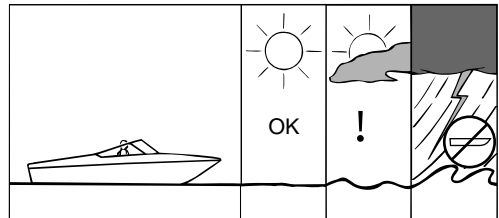

KC-0210

Dam Spillways

The water around a dam spillway is a hazardous area. It is subject to rapid changes. Boaters must keep clear of the spillway areas below dams.

Weeds

Weeds are generally a threat to your boat's engine. Weeds on the propeller may cause the engine to vibrate. They may also restrict water intake causing the engine to overheat. If you run into weeds, stop the engine and clear the propeller and water intake completely of weeds. Consult the engine operating manual for more information.

NOTICE

Weeds can sometimes be removed by shifting to neutral, pausing a moment, then shifting to reverse to unwind the weeds from the propeller.

Shallow Water Operation

Operating in shallow water presents a number of hazards. Water of any depth may contain stump fields, sand bars, rocks, or other unmarked underwater hazards.

Sand bars in narrow inlets are constantly shifting, making it difficult to mark them with buoys. Sometimes, sand bars are indicated by waves as they form into breakers when passing over the sand bar. If you ground the boat on a sand bar, seek help from another boater.

If the engine strikes an underwater hazard, check for boat and engine damage. If the engine vibrates excessively after striking an underwater obstruction, it may indicate a damaged propeller.

Warning Markers

DIVERS FLAG

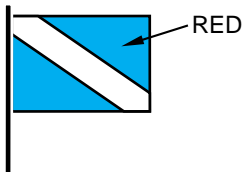

USED BY
RECREATIONAL
DIVERS -
INDICATES
DIVER'S
POSITION

ALPHA FLAG

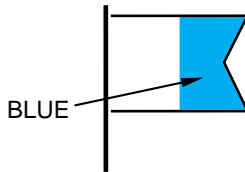

WORLDWIDE VESSELS
ENGAGED IN DIVING
OPERATIONS - DOES
NOT INDICATE
DIVER'S POSITION

DISTRESS FLAG

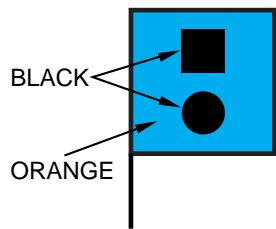

INDICATES
FELLOW
BOATER IS IN
NEED OF
ASSISTANCE

KC-0352

It is a good idea to ask local authorities if there are hazardous areas and how they are marked. Boaters must also recognize the flag designs which indicate that skin divers are present and keep well clear of the area.

Watch for swimmers. Swimming areas may not be marked. Steer clear from the area and always remain alert.



KC-0260

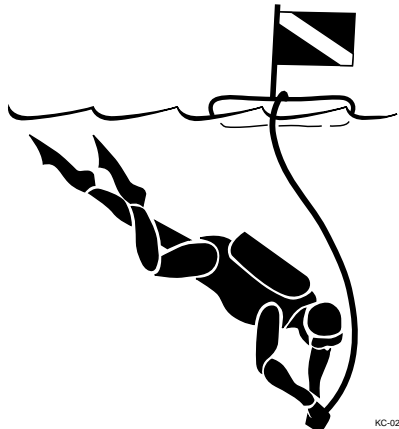

KC-0250

Navigation markers serve as a means of identifying navigable routes, and indicate water hazards. Boaters should become familiar with navigation markers and stay within marked boundaries and clear of hazards.

Boating Under the Influence



WARNING

Federal and state laws prohibit operating a boat under the influence of alcohol and other drugs. These regulations are actively enforced. Impaired operation may result in severe personal injury or death.

Boating, alcohol and the use of other drugs just doesn't mix. These substances reduce your reaction time and affect your better judgment. Combined with the sun, wind, waves, and noise of other watercraft, the effects of drugs are increased and will significantly reduce your reaction time. As the owner/operator, you are responsible for the alcohol/drug use and on-board behavior of your passengers.



KC-0153

NOTICE

If the operator's blood alcohol content is 0.10% (0.08% in some states) or above, violators are subject to a civil penalty up to \$1,000 or criminal penalty up to \$5,000, one year imprisonment or both. Operating a boat under the influence can also result in a loss of motor vehicle driving privileges.

Carbon Monoxide

Carbon Monoxide (CO) is a colorless and odorless gas produced by all engines and fuel burning appliances. Even with the best boat design and construction, plus the utmost care in inspection, operation, and maintenance, hazardous levels of CO may still be present in accommodation spaces under certain conditions. To reduce CO accumulation, always ventilate the boat interior by opening the deck hatches, windows or canvas to provide adequate ventilation.



KC-5032

⚠ **DANGER** ⚠

EXTREME HAZARD – Carbon monoxide gas (CO) is colorless, odorless and extremely dangerous. All engines and fuel burning appliances produce CO as exhaust. Direct and prolonged exposure to CO will cause **BRAIN DAMAGE** or **DEATH**. Signs of exposure to CO include nausea, dizziness and drowsiness. Sources of CO include:

1. Blockage of boat exhausts by obstruction.

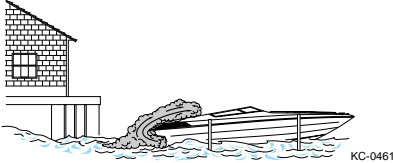

2. Exhausts traveling along obstruction.

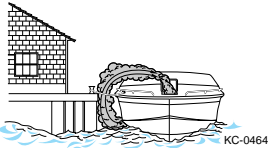

3. Operating at slow speed or while dead in the water.



4. Operating with high bow angle.



5. Exhausts from other vessels in confined areas.

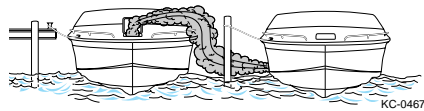

6. Operating with canvas tops and side curtains in place without ventilation.



ENSURE ADEQUATE VENTILATION FOR CORRECT AIR MOVEMENT THROUGH BOAT!

Operation By Minors

Minors must always be supervised by an adult whenever operating a boat. Many states have laws regarding the minimum age and licensing requirements of minors. Be sure to contact the state boating authorities for information.

Passenger Safety

Whenever you are going for an outing, make sure that at least one passenger is familiar with the operation and safety aspects of the boat in case of emergency. Show all passengers the location of emergency equipment and explain how to use it. Don't allow passengers to drag their feet or hands in the water, or sit on the bow, sundeck, or gunwale while the engine is running.

Water Sports

NOTICE

It is unlawful to participate in water sports while under the influence of alcohol or other drugs.

When participating in water sports, be safe and courteous and follow these guidelines:

- Be considerate to fishermen and others you share the water with.
- Do not perform water sports in congested areas.
- Stay away from navigation markers.
- Stay away from other boats and water sports participants.
- Return immediately to a fallen water sport participant.
- Regularly inspect water sport equipment to ensure it is safe.

 **WARNING**

- **Water sport participants must wear a USCG approved flotation device. A type III water ski vest is an approved and practical PFD.**
- **Keep at least 30 m (100 ft.) away from all other objects.**
- **When water sporting have an experienced driver and aft facing observer in the boat.**
- **Never water sport in shallow water or at night.**
- **Never jump from a moving boat.**
- **Always keep a downed water sporter in sight.**
- **Turn the motor OFF before you get close to someone in the water.**

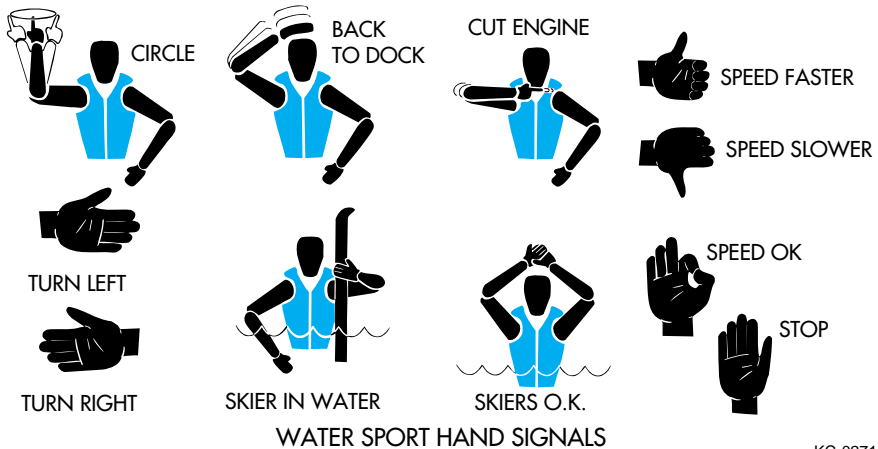

KC-0271

General Precautions

Your safety, the safety of your passengers, and other boaters are among your responsibilities as operator of this boat. Your boat must be in compliance with U.S. Coast Guard safety equipment regulations. You should know how to react correctly to adverse weather conditions, have good navigation skills, and follow the “rules of the road” as defined by the Coast Guard and state/county/local regulations.



WARNING

Read and understand this manual and the engine manual, and be sure that you understand all controls and operating instructions before attempting to operate the boat. Improper operation can be extremely hazardous.

Before each outing you should check all safety equipment, such as fire extinguishers, PFDs, flares, distress flags, flashlights, engine stop switch, etc. They should be operable, in good condition, readily visible, and easily accessed.

Tell someone of your travel plans. Check local weather reports before casting off; do not leave the dock area when strong winds and electrical storms are in the area or predicted to be in the area.

Know the weight capacity of your boat. Do not overload your boat.

Our Environment

As a boater, you already appreciate nature's beauty and the peace of the great outdoors. It is a boater's responsibility to protect the natural environment by keeping waterways clean.

Don't put anything in the water you wouldn't want to eat or drink!

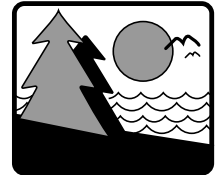

Conserve Fishery Resources

There is a tremendous drain on our fishery resources. Over-fishing and pollution have strained the fish population. Do your part by keeping only what you will eat by practicing catch-and-release.

Foreign Species

If you trailer your boat from lake to lake, you may unknowingly introduce a foreign aquatic species from one lake to the next. Thoroughly clean the boat below the water line, remove all weeds and algae, and drain the bilge and livewells before launching the boat in a new body of water.

Fuel and Oil Spillage

The spilling of fuel or oil into our waterways contaminates the environment and is dangerous to wildlife. Never discharge or dispose fuel or oil into the water; it is prohibited and you could be fined. There are two common, accidental types of discharge:

- Overfilling the fuel tank
- Pumping contaminated bilge water



WARNING

Fumes from rags can collect in bilge and be extremely hazardous. Never store rags used to wipe-up fuel or solvent spills in the boat. Dispose of rags properly ashore.

Discharge and Disposal of Waste

Waste means all forms of garbage, plastics, recyclables, food, wood, detergents, sewerage and even fish parts in certain waters - in short, nearly everything. We recommend you bring back everything you take out with you for proper disposal ashore. If you have a marine sanitation device (head or marine toilet) installed, use an approved pump-out facility at your marina. Many areas prohibit the discharge of sewerage overboard or even an operable overboard waste discharge.

Excessive Noise

Noise means engine noise, radio noise or even yelling. Many bodies of water have adopted noise limits. Don't use thru-transom exhaust unless you're well off shore. Music and loud conversation can carry a considerable distance on water, especially at night.

Wake and Wash

Be alert for NO WAKE zones. You may be responsible for any damage or injury caused by your wake/wash. Prior to entering a NO WAKE zone, come off plane to the slowest steerable speed.

Exhaust Emissions

Increased exhaust (hydrocarbon) emissions pollute our water and air. Keep your engine tuned and boat hull clean for peak performance. Consult your dealer and engine manual for information.

Paints

If your boat is kept in water where marine growth is a problem, the use of anti-fouling paint may reduce the growth rate. Be aware of environmental regulations that may govern your paint choice. Contact your local boating authorities for information.

Cleaning Agents

Household cleaners should be used sparingly and not discharged into waterways. Never mix cleaners and be sure to use plenty of ventilation in enclosed areas. DO NOT use products which contain phosphates, chlorine, solvents, non-biodegradable or petroleum based products. Citrus based cleaners are excellent for marine cleaning purposes and are safe for you and the environment. Refer to MAINTENANCE for more information.

CHAPTER 2: BASIC RULES OF THE ROAD



WARNING

The nautical rules of the road must be followed to prevent collisions between vessels. Like traffic laws for automobiles, the operator is legally required to follow the rules.

The following information outlines only the most basic of the nautical rules of the road. For more information, contact your local U.S. Coast Guard Auxiliary.

Aids to Navigation

Learn to recognize the different buoys and day markers; they are the signposts of the waterway. There are 2 primary marking systems in use in the U.S.; the Uniform State Waterway Marking System (USWMS) used on inland waters and maintained by each state, and the Federal Waterway Marking System (FWMS) used on coastal waters and rivers and maintained by the U.S. Coast Guard (USCG). In addition, the FWMS has two modified systems; Western River Buoyage, and Intracoastal Waterway Buoyage. Be sure to check with local authorities on the buoyage system in use.

The type of hazard/warning buoys and markers depends on the area of jurisdiction. Check with local boating authorities.

USWMS System

In the USWMS Lateral System, well defined channels are marked with red and black buoys. Lateral means the sides of the channel are marked and the boat should pass between them.

The USWMS Cardinal System is used when there is no well defined channel or where an obstruction may be approached from more than one direction. With the cardinal system:

- Pass north or east of BLACK-TOPPED WHITE buoy.
- Pass south or west of RED-TOPPED WHITE buoy.
- RED and WHITE VERTICALLY STRIPED buoy indicates boat should pass outside of the buoy (away from shore).

Uniform State Regulatory Markers

USWMS regulatory markers are white with international orange geometric shapes; you must obey regulatory markers.

UNIFORM STATE WATERWAY MARKING SYSTEM (USWMS)

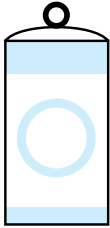

CONTROLLED AREA

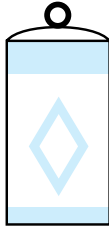

DANGER

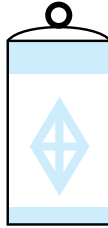

BOATS KEEP OUT



INFORMATION



DO NOT PASS BETWEEN SHORE AND BUOY



SPECIAL PURPOSE



NAVIGATE TO STARBOARD FACING UPSTREAM

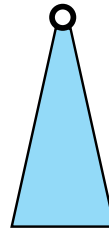

NAVIGATE TO PORT FACING UPSTREAM

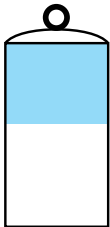

NAVIGATE TO SOUTH OR WEST



NAVIGATE TO NORTH OR EAST

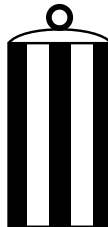

MID-CHANNEL

KC-0411

FWMS System

The FWMS Lateral System is for use on navigable waters except Western Rivers and Intracoastal Waterways.

The markings on these buoys are oriented from the perspective of being entered from seaward (the boater is going towards the port). This means that red buoys are passed on the starboard (right) side of the vessel when proceeding from open water into port, and green buoys to the port (left) side.

The right side (starboard) of the channel is marked with RED, even numbered buoys. The left (port) side of the channel is marked with GREEN, odd numbered buoys.



UNLIGHTED
BELL BUOY

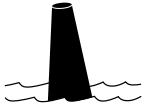

SPAR BUOY

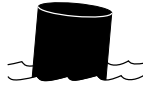

CAN BUOY



LIGHTED BUOY

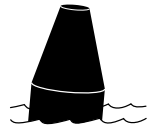

NUN BUOY

KC-0420

The middle of the channel is marked with RED and WHITE vertically striped buoys; pass close to these buoys.

Obstructions, channel junctions, etc. are marked with RED and GREEN horizontally striped buoys.

A RED band at the top means the preferred channel is to the left of the buoy; a GREEN top band means the preferred channel is to the right of the buoy.

Day markers are colored and numbered the same as buoys. RED, triangular day markers with even numbers mark the starboard side of the channel. GREEN, square day markers with odd numbers mark the port side of the channel.

Lights, bells and horns are used on buoys for night or poor visibility conditions.

Right-Of-Way

NOTICE

In general, boats with less maneuverability have right-of-way over more agile craft. You must stay clear of the vessel with right-of-way and pass to his stern.

Privileged Boats

Privileged boats have right-of-way and can hold course and speed. Sailboats and boats paddled or rowed have the right-of-way over motor boats. Sailboats under power are considered motorboats. Small pleasure craft must yield to large commercial boats in narrow channels.

Burdened Boats

The burdened boat is the boat that must make whatever adjustments to course and speed necessary to keep out of the way of the privileged boat.



SPHERICAL SAFE
WATER MARKER

KC-0430



STARBOARD
DAY
MARKER

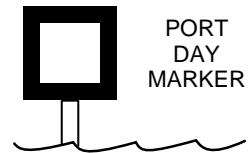

PORT
DAY
MARKER

KC-0440

Crossing Situation

In crossing situations, the boat to the right from the 12 o'clock to the 4 o'clock position has the right-of-way. It must hold course and speed. The burdened boat keeps clear and passes behind the privileged boat. Boats going up and down a river have the privilege over boats crossing the river.

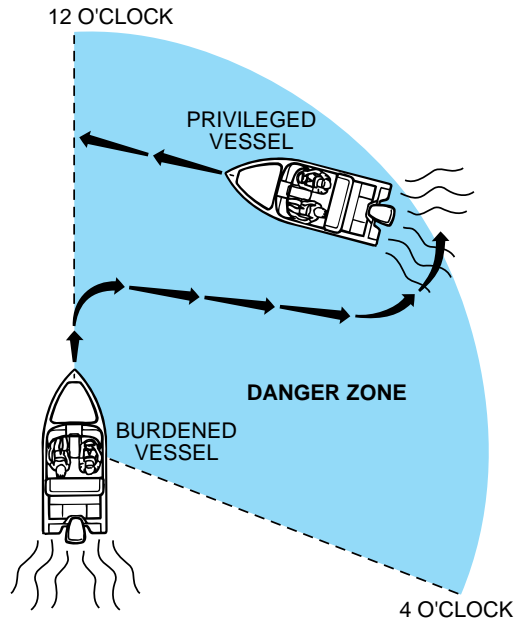

Meeting Head-On

Neither boat has the right-of-way in this situation. Both boats should decrease speed, should turn to the right, and pass port-to-port. However, if both boats are on the left side of a channel, each vessel should sound two short horn blasts and pass starboard to starboard.

KC-0471

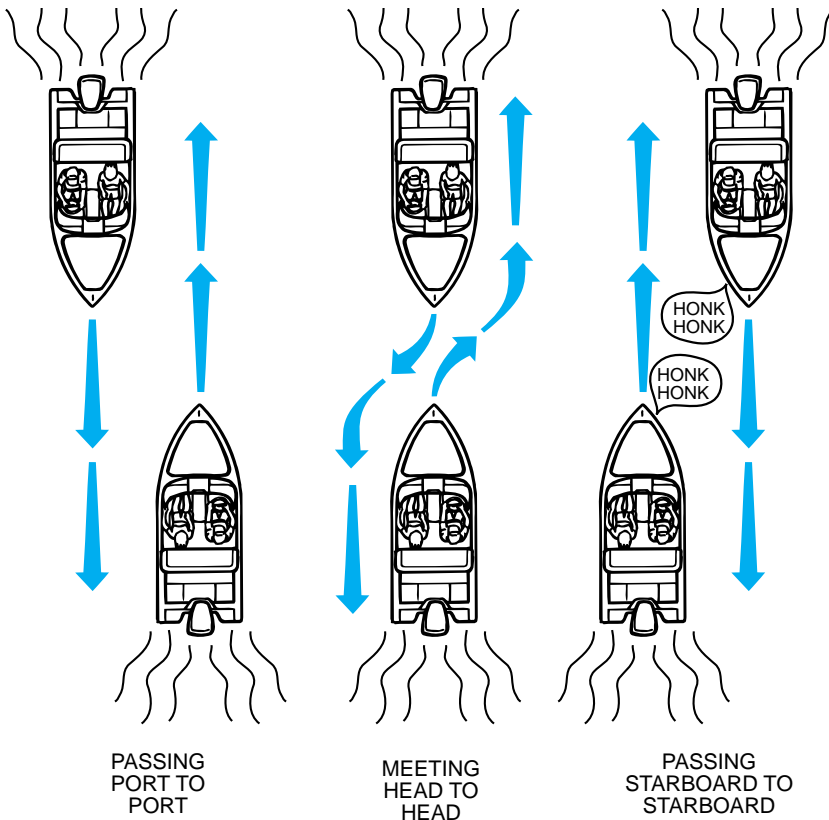

Overtaking

The boat that is overtaking one ahead of it is the burdened boat and must make any adjustments necessary to keep out of the way of the privileged boat.

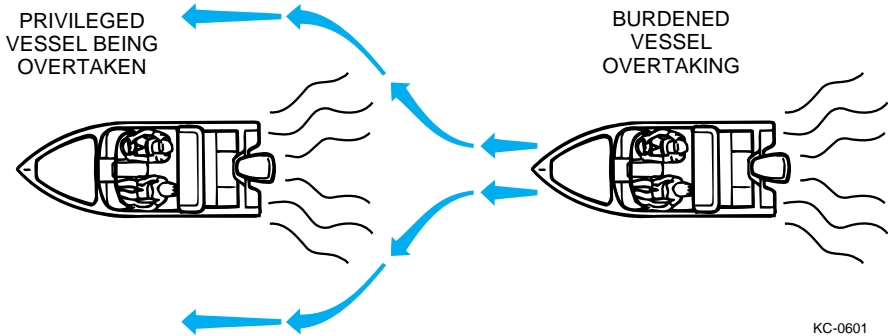

The General Prudential Rule

The general prudential rule regarding right-of-way is that if a collision appears unavoidable, neither boat has right-of-way. As prescribed in the Rules of the Road, both boats must act to avoid collision.

Night Running

Boats operating between sunset and sunrise (hours vary by state) must use navigational lights. Nighttime operation, especially during bad weather or fog can be dangerous. All Rules of Road apply at night, but it is best to slow down and stay clear of all boats, regardless of who has right-of-way. Protect your night vision by avoiding bright lights and have a passenger, if possible, help keep watch for other boats, water hazards, and aids to navigation.

CHAPTER 3: SYSTEMS, CONTROLS AND INDICATORS

Knowing the systems, controls and indicators on your boat is essential for safe and proper operation. The systems, controls and indicators shown in this section may be optional or slightly different than those on your boat.

Systems



WARNING

Regularly inspect and maintain all systems to prevent unexpected hazards associated with worn or faulty components. Always replace system components and hardware with marine grade parts, not automotive components.

Ventilation

The ventilation system is designed to remove and prevent the accumulation of explosive vapors in the hull and engine compartment. Therefore, proper ventilation is extremely important to boat safety.

Powered systems consist of a blower which “pulls” air out from the engine compartment and bilge area; one or more vents allow fresh air in. Natural systems have both intake and exhaust vents; as the boat moves, air is forced into the intake and escapes through the exhaust vents.

Fire Extinguishing

Models equipped with an Automatic Fire Extinguishing System automatically actuate when temperatures reach a preset limit. When actuation occurs, a loud popping sound may be heard followed by “rushing” air sound. When a discharge occurs, immediately shut down all electrical and mechanical systems and powered ventilation.



KC-5040



WARNING

If the fire system discharges, wait for at least 15 minutes before opening engine hatch. Fire system gas displaces oxygen to “smother” the fire. Opening the hatch too soon may feed oxygen to the fire and flashback can occur.

Fuel

The basic fuel system consists of one or more tanks, either portable or built-in, with vent, level sensor and fuel indicator. Permanent tanks are equipped with an anti-siphon valve to prevent fuel from accumulating in the bilge if a hose should break. Some models are equipped with a fuel shutoff valve to prevent fuel from reaching the engine. It is recommended that the shut-off valve be closed during long periods of inactivity or storage. Boat models with multiple fuel tanks are also equipped with a fuel selection valve for individual tank selection.

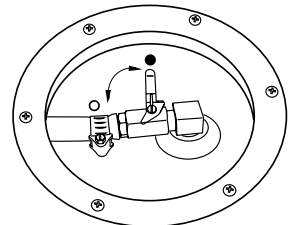

KC-1003

When the engine is operating, the fuel pump “pulls” fuel from the tank, bringing it into the engine where it is distributed to the cylinders and burned. Oil injected engines also include an oil reservoir and pump for injecting oil into the system. Consult the engine operator’s manual for fuel recommendations.

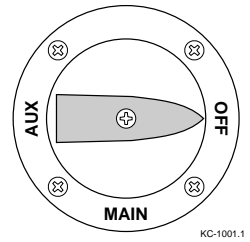

KC-1001.1

Engine Oil

Depending on engine type, your boat may be equipped with one of several engine lubrication systems. Many small to mid-range outboards are lubricated by oil mixed directly with the gasoline in the fuel tank, while other outboards may be equipped with an oil injection system. In both systems, the oil is consumed as the engine runs. Oil injection systems include a separate reservoir for oil containment and an oil pump or combination fuel/oil pump that supplies oil to the fuel system for engine lubrication.

Stern drive engines, like automobile engines, use a continuous loop lubrication system that must be periodically serviced. Consult the engine operator’s manual for oil recommendations.

Exhaust

The engine exhaust system removes the gases produced by the running engine and helps to vent them away from the boat. Inboard engines are equipped with a muffler and may use water injection as part of the exhaust system. Some stern drives are equipped with an exhaust diverter valve which, when activated, routes engine exhaust to through-transom exhaust pipes or down through the propeller hub. Through-transom exhaust is only used when well offshore. Never change or modify the standard manufactured exhaust system.

Cooling

The majority of marine engines are cooled by the continuous intake of raw lake water and circulating it around components. Inboards are equipped with seacocks and strainers at the raw water intake. Some marine engines used in saltwater may be equipped with a self-contained freshwater cooling system that pumps engine coolant through a heat exchanger to reduce engine temperature. Raw water is circulated through the other side of the heat exchanger to absorb engine heat from the coolant.

Any water intake or outlet below the water line is equipped with a seacock. Seacocks, located at the through-hull fitting, should be kept closed during long periods of inactivity and opened only when needed.

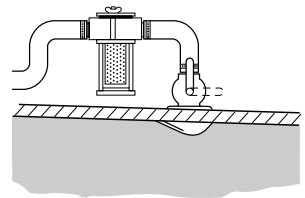

KC-2165.1



WARNING

Keep seacocks closed during periods of inactivity. A downstream hose failure could flood the boat if the seacock is left open.

Electrical

The boat is equipped with a 12-volt direct current (12 VDC) negative ground electrical system. The positive (red) wire is hot and feeds current from the battery to the electrical systems. The negative (black) wire is ground and completes the circuit back to the battery. Until the engine is running at high idle or faster, all electrical power comes from the main battery. Once the engine is started and running above 1200 RPM, electrical power is then provided by the engine alternator. The alternator provides more power as engine speed is increased. When the engine is operating, the alternator is charging the battery.

More electrical accessories than ever are being used on today's boats. Continuous operation of electrical accessories when the engine is not operating, or operating at low idle (trolling) speeds may discharge the battery to the point where it may not be able to crank the engine. A poorly maintained battery will discharge more quickly, and if corrosion is present, the engine might not start due to high electrical resistance at the battery terminals, even though there may be sufficient battery reserves to start the engine.

Controls



WARNING

Improperly maintained controls are hazardous and may cause sudden loss of control. Make sure all steering and shift/throttle hardware, cables and fluid levels are regularly inspected and maintained. Improper maintenance may result in a loss of control, resulting in serious injury or death.

Steering Control

Your boat is equipped with a steering wheel for controlling the direction of travel. The steering system itself may be mechanical, power-assisted or hydraulic in operation.

Boat steering is not self-centering. Always keep a secure grip on the steering wheel to maintain full boat control.

With mechanical steering, the helm unit transfers rotary motion of the steering wheel to linear motion in the cable which pushes or pulls the steering arm. Some boats are equipped with two cables; one cable pushes and the other pulls.

With power-assisted systems, the helm unit transfers rotary motion of the steering wheel to linear motion which pushes or pulls a cable. The cable movement is sensed and a signal is sent to a hydraulic pump which moves the hydraulic cylinder attached to the steering arm.

A hydraulic system has a pump mounted directly to the steering wheel with two hoses running from the pump to a hydraulic cylinder. When the steering wheel is turned, it moves the hydraulic cylinder which is connected to the steering arm. A reservoir, either separate or integral with the pump, holds extra fluid to prevent air from entering the system.

Shift/Throttle Control

The shift/throttle control on your boat differs from model to model and may depend on the engine used. The following single lever and dual lever controls are typical of the operation of most controls used. Be sure to consult the engine or control manual for specific operational differences.

NOTICE

All shift/throttle controls are equipped with a safety switch for “start in neutral only” operation. Be sure the control is in neutral before attempting to start the engine.

Single lever controls operate as both a gear shifter and a throttle.

- A.** Neutral Position - Safety switch will allow starting in this position only.
- B.** Forward Position - Press release button under handle to allow shifting to forward (or reverse) position.
- C.** Reverse Position - Do not shift quickly from forward to reverse.
- D.** Throttle Position - Pushing in forward or pulling in reverse increases engine speed.

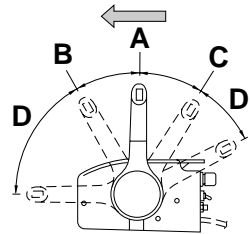

KC-0620.1

Never attempt to shift without the engine running. For engine warm-up, a separate lever on the control is used for throttle advance when in neutral.

Dual lever controls have individual levers for transmission shift and engine throttle.

- A.** Shift Lever - Neutral is in center detent position; push for forward, pull for reverse.
- B.** Throttle Lever - Full throttle is all the way up, idle is all the way down.

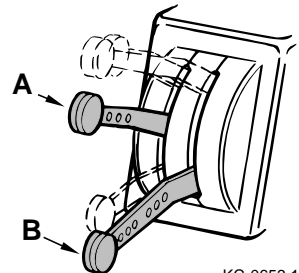

KC-0653.1

For engine warm-up, the shift lever is positioned in neutral and the throttle lever is advanced as needed.

CAUTION

Do not shift too quickly from forward to reverse. Stay in neutral, or idle position until the boat has lost most of its headway before completing the shift to reverse or engine damage may occur.

Switches

Each electrical circuit on your boat is equipped with a control switch. Some switches may have an LED indicator for easy ON/OFF identification. Most switches will have a fuse holder, or circuit breaker adjacent to the switch.

Master Power Switch – Disconnects the boat electrical systems from the batteries. When not using the boat, keep this switch in the OFF position.

Fuel Gauge Switch – Allows you to check the amount of fuel in the fuel tank when the navigation lights are OFF or the ignition switch is OFF.

Battery Switch – Connects the battery to the electrical system. Provides isolation and positive disconnect of battery to protect against tampering, electrical fire hazards, and battery rundown. Rotate switch to the OFF position when the boat is not in use.

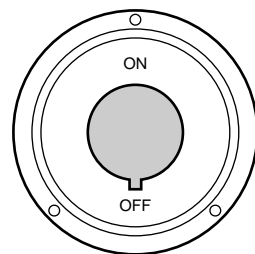

KC-0704.1

Navigation Lights Switch – Controls the running and anchor lights for night operation. NAV position will turn on the red and green navigation bow lights, white stern light, and gauge illumination. ANC position turns on only the white stern light for night anchoring.

NOTICE

Never operate the boat between sunset and sunrise with the switch in the anchor light position. Running lights are legally required to indicate direction and right-of-way at night.

Blower Switch (Stern Drive Only) – Activates the engine box ventilation blower to remove explosive fumes from the engine and bilge areas.

Bilge Switch – Activates the bilge pump to remove excess water from the bottom of the boat. Some models are equipped with an automatic bilge pump setting. Switch to AUTO whenever the boat is in operation, water will be pumped-out as it enters the bilge and the pump will automatically shutdown when the bilge is dry.

CAUTION

Be sure to switch the bilge OFF (not AUTO) when the boat is not in use. Wave action or trailer travel can cause the pump to drain the battery. Running the pump when the bilge is dry will damage the pump.

Ignition Switch – Starts and stops the engine. A built-in protection system prevents the engine from starting in any other gear than neutral. Be sure to consult the engine operator's manual for more information.

Horn Button – Push and hold to sound the horn.

Trim Switch – If your engine is equipped with power trim and tilt, this switch activates that function. Push and hold the switch until the engine is at the desired angle. Use this switch in combination with the trim gauge.

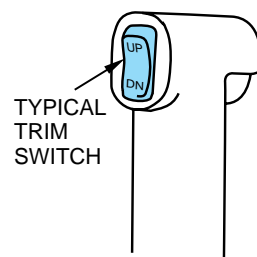

KC-0931

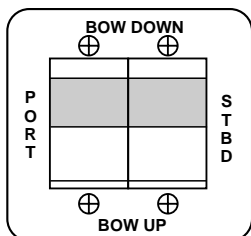

KC-0932

Trim Tab Switches – These rocker switches control the trim tabs located on the port and starboard transom. Adjusting trim tabs will improve the ride of your boat and correct listing from side to side due to varying conditions.

Engine Stop Switch and Lanyard – The engine stop switch stops the engine when engaged. Attach the lanyard to the boat operator whenever the engine is running. If the operator is thrown from the seat or moves too far from the helm, the lanyard will engage the switch and shut off the engine.

To attach the lanyard, connect one end to the safety switch and the hook on the opposite end of the lanyard to a strong piece of clothing on the operator, such as a belt loop.

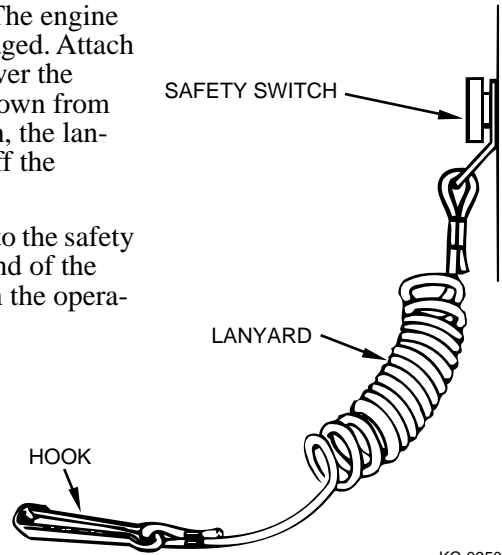

KC-0950



WARNING

Attach the Engine Stop Switch lanyard to the operator before starting the engine. This will prevent the boat from becoming a runaway if the operator is accidentally thrown away from the helm.

The Engine Stop Switch can only be effective when it is in good working condition. Observe the following:

- **Never remove or modify the Engine Stop Switch and/or lanyard.**
- **Lanyard must always be free from obstructions that could interfere with its operation.**

Once a month: Check switch for proper operation. With engine running, pull lanyard. If engine does not stop, see your DEALER for replacement of switch.

NOTICE

The engine will not start unless the engine stop switch lanyard is attached.

Indicators

NOTICE

Some boat models may be equipped with a multi-gauge instrument which integrates the functions of several single gauges.

Instruments are illuminated for night operation. Their type, number, and location vary by model; some may not appear on your model.

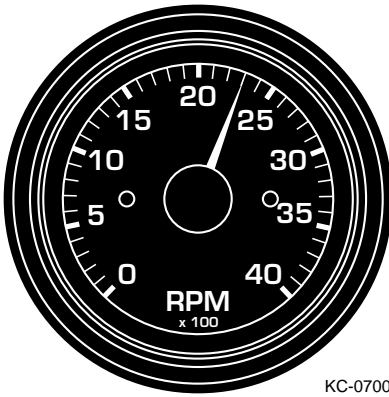

KC-0700

Tachometer

Registers engine speed in revolutions per minute (RPM). Use this gauge to keep the engine within the proper operating range. Consult the engine manual for the proper RPM operating range for your engine.

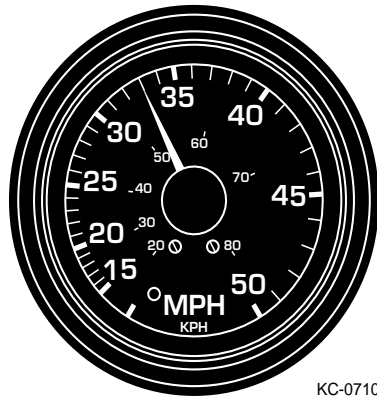

KC-0710

Speedometer

Registers forward boat speed in miles per hour. Use this gauge to monitor fuel consumption and propeller performance. Since most marine speedometers operate with water pressure, accuracy is only approximate.

Fuel Level Gauge

On models with a permanent fuel tank, this gauge registers approximate fuel level in the gas tank. The Ignition switch must be in the RUN position to activate the gauge.

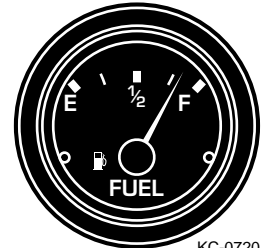

KC-0720

Water Pressure Gauge

Registers the water circulated by the water pump in pounds per square inch (PSI). Use this gauge to observe that the engine cooling system is operating properly. Consult the engine manual for the normal operating PSI range.



KC-0730

Oil Level Gauge (Oil Injection Only)

Registers the level of injection oil in the reservoir. Some injection systems may provide an indicator on the reservoir. Consult the engine manual for more information.



KC-0740

Trim Gauge

Measures engine or stern drive tilt and indicates the relative position of the bow, up or down when boat is on plane. Use this gauge to monitor boat trim.

Voltmeter

Indicates the condition of the main or cranking battery in volts DC. Normal operating range is 12+ volts.

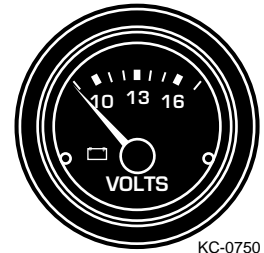

Ammeter

Measures the charging current in the electrical system. Consult the engine manual for the normal operating range.

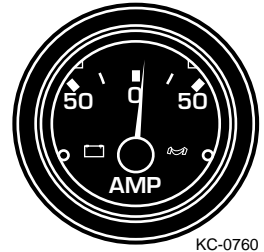

Engine Water Temperature Gauge

Indicates the water/coolant temperature inside the engine. Consult the engine manual for the normal operating range.



**Engine Oil Pressure Gauge
(Stern Drive Only)**

Indicates the pressure of the lubricating oil inside the engine. Consult the engine manual for the normal operating range.



Engine Hourmeter

Registers accumulated engine operating time, and is activated when the ignition switch is in the "ON" position. Be aware that time will be logged whenever the ignition switch is "ON", even when the engine is not running. Use the hourmeter to keep accurate logs for scheduled maintenance.

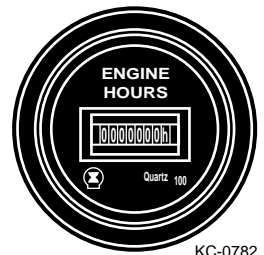

CHAPTER 4: OPERATION

This section describes the basics of fueling, starting, running, steering, trimming, docking and stopping your boat. Since there is a variety of control and engine options, be sure to consult the other owner's manuals provided with your boat.

Fueling

Portable tanks must be removed from the boat when fueling. Consult the engine operator's manual for proper procedures. Built-in tanks have the fuel filler aft in the boat. Models with oil injection also have fillers for the oil reservoir.



DANGER

Gasoline is extremely flammable and highly explosive under certain conditions. Always stop the engine and never smoke or allow open flames or sparks within 15 m (50 ft.) of the fueling area.

CAUTION

To prevent unwarranted engine damage, consult your engine operator's manual for manufacturer recommended fuel/oil ratios and mixing specifications.

Take care not to spill gasoline. If gasoline is spilled accidentally, wipe up all traces of it with dry rags and immediately dispose of the rags properly onshore. When fueling:

1. Close all doors, hatches, windows, and other compartments.
2. Extinguish cigarettes, pipes, stoves, and all other flame producing items.
3. Make sure all power is off, and do not operate any electrical switches.
4. Remove fuel fill cap. Insert hose nozzle and make sure nozzle is in contact with or grounded against fill opening. This will reduce the risk of static spark.
5. Add fuel in accordance with the engine operator's manual. Do not fill to capacity to allow for fuel expansion.
6. Tighten the fuel filler cap completely after refueling.
7. Check oil level.

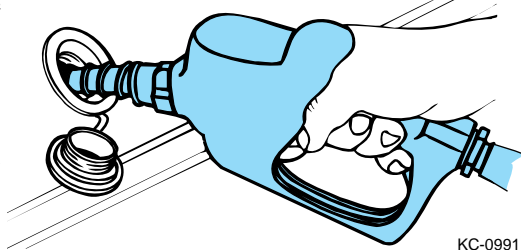

KC-0991

NOTICE

Each time you fill up, inspect fuel lines for leaks and hose deterioration.

After fueling, you should:

- Close fill cap securely and wipe up spillage.
- Open all windows, hatches, doors, and compartments.

Lubrication (Outboards)

Your engine may be equipped with an oil injection system that automatically feeds oil to the engine. Use lubricant that is recommended by the manufacturer, or NMMA TC-W3 certified. You will find the recommended lubricant listed in the engine manual. If you need assistance, consult your dealer.

Starting

1. Open vent screw on fuel tank (portable tanks).
2. Connect fuel line to fuel tank (portable tanks).
3. Squeeze fuel primer bulb several times until firm (outboard models).
4. Operate blower (stern drive models).



WARNING

The blower must be operated for a minimum of 4 minutes before each time the engine is started. In addition, the blower should be operated continuously when at idle and during slow speed running. Failure to operate the blower can cause an explosion.

5. Attach Emergency Engine Stop Switch lanyard to its switch and to the operator.
6. Place shift/throttle control handle in NEUTRAL.
7. Turn key clockwise to START position. After motor starts, release key.
8. Push control handle forward to go forward, pull back for reverse.

CAUTION

Always go slowly in reverse to avoid taking water in over the transom. You can swamp the boat by taking on too much water.

Shifting/Running

Follow these guidelines when shifting your boat:

- Pause in neutral before shifting from forward to reverse, or reverse to forward.
- Avoid shifting into reverse while the boat is traveling forward at speed.
- Keep the shifter control clean and clear of obstructions.

To shift into forward: press the neutral lock button while pushing the control lever forward.

To shift into reverse: press the neutral lock button while pushing the control lever backward.

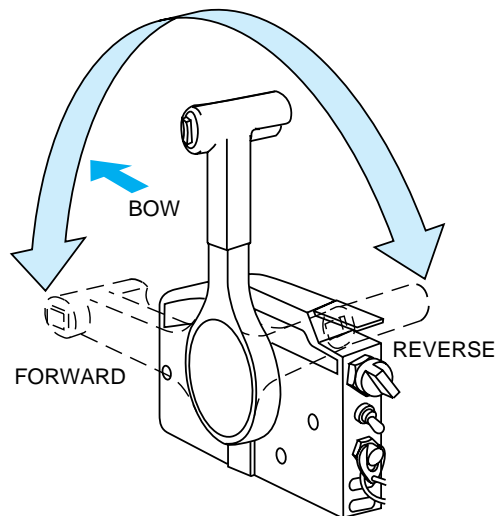

KC-1060

Warning Alarm

CAUTION

Continued operation after the warning alarm has sounded may cause severe engine damage.

Your boat may be equipped with a warning alarm that will sound if an engine problem develops. If the warning alarm sounds, **IMMEDIATELY** throttle back to idle speed and shift into neutral. **IMMEDIATELY** check the gauges and stop the engine. On some models, the horn may emit a short chirping sound during starting to verify operation.

Steering

Practice steering your boat. Make sure that the steering system is working correctly and is properly maintained. Follow these guidelines to keep your boat handling well.

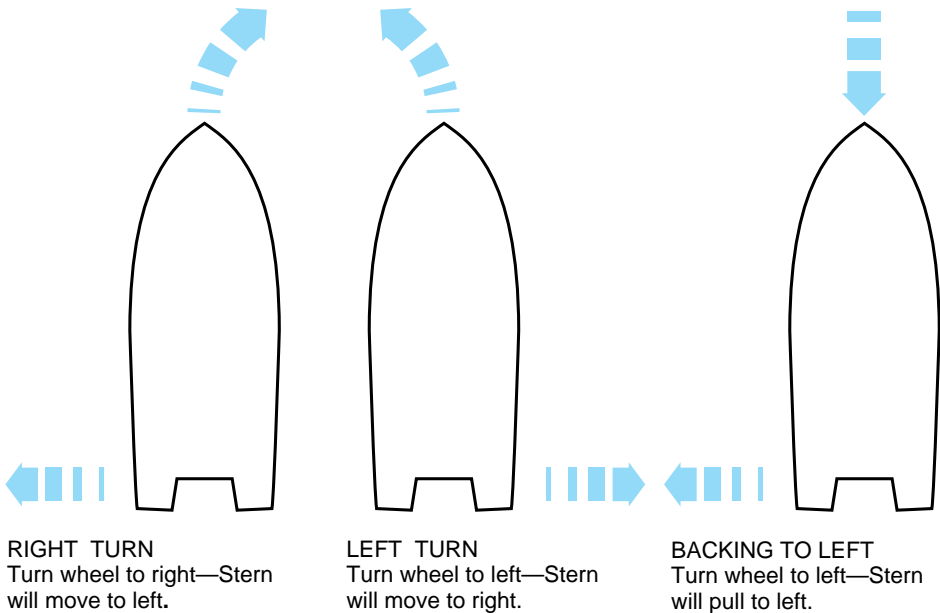

KC-1071

- Keep the cable end clear of obstructions such as wiring, control cables, fuel lines, tow lines and mooring lines.
- Keep the moving parts clean and lubricated.
- Inspect the steering cables for kinks, damage, and corrosion.



WARNING

The steering system must be in good operating condition for safe boat operation. Frequent inspection, lubrication, and adjustment by your dealer is recommended.

All boats have a tendency to wander somewhat at slow speeds. A natural reaction to this effect is to steer the boat back and forth in an attempt to compensate for wandering. Invariably, the compensation will result in oversteer and only worsen the effect. Keep the steering wheel in the center position, the boat will wander back and forth somewhat, but the overall course will be a straight one.

Stopping

1. Slowly bring the control lever to the idle position. If the boat has been driven for a long period of time at high speed, allow the engine a 2-3 minute cool-down period at low idle.
2. Turn the ignition key to the OFF position.
3. If any problems were encountered during the outing, have the boat inspected by your dealer and request any necessary repairs before the next outing.



WARNING

Do not use the engine stop switch for normal shut down. Doing so may impair your ability to re-start the engine quickly or may create a hazardous swamping condition.

Docking

Practice docking before attempting it for the first time. Use a float, like a plastic milk jug with a line and small weight, as your docking target.



WARNING

Never use your hand, arm or other part of your body to attempt to keep the boat from hitting the dock. The boat could push against the dock, causing severe injury.

Follow these guidelines when docking:

- Approach docks with the port side of the boat if possible.
- Come to a stop a short distance from the dock, then proceed slowly.
- Have fenders, mooring lines and crew ready.
- Observe how the wind and current are moving your boat. Approach the dock with the boat pointed into the wind, if possible. If the wind or current is pushing you away from the dock, use a sharper angle of approach. If you must approach the dock downwind or down current, use a slow speed and shallow angle. Be ready to reverse to stop and maintain position.
- If there is no wind or current, approach the dock at a 10 to 20 degree angle.
- If possible, throw a line to a person on the dock and have that person secure a bow line.
- With the bow secure, swing the stern in with the engine, or pull it in with a boat hook.

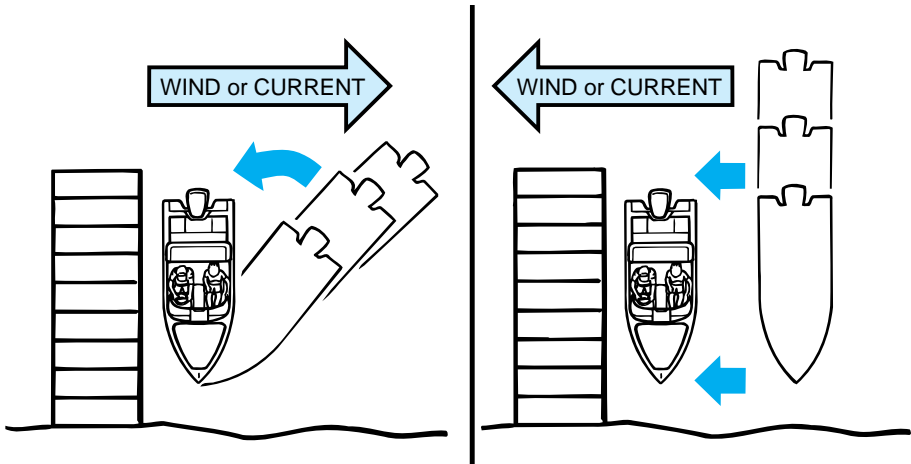

KC-1120

Before tying-up the boat, be sure to use enough fenders to protect the boat from damage. If possible, tie-up with the bow towards the waves with a good quality double-braided nylon line. Tie-up only to the lifting or tie-down eyes; never use the handrails or windshield frames. If the boat is to be moored for a long period of time, use chafing protectors on lines to protect the gelcoat finish. Leave a little slack in the lines to allow for some wave movement or tidal action if applicable.

Follow these guidelines when departing:

- Very slowly shift into forward at idle speed.
- When the stern moves away from the dock, turn the engine away from the dock.
- Cast off bow line and back away.

If the wind or current is pushing away from the dock, cast off all lines and allow to drift until you are clear.

Boat Trim

The performance of your boat depends on load weight and distribution. Distribute weight evenly, from bow to stern, and also from port to starboard. After loading, the boat's trim can be adjusted by changing the engine trim angle.

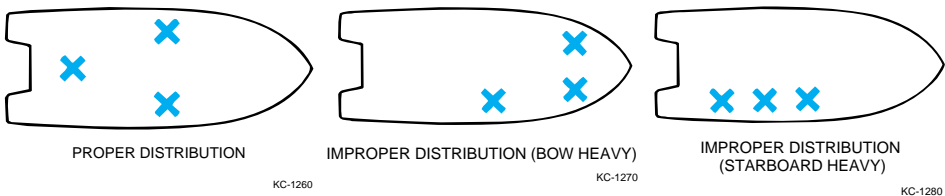

KC-1260

KC-1270

KC-1280

Drive Trim Angle

Trim angle is the angular relationship between the lower drive unit and the transom of the boat. Boat trim while underway greatly affects boat performance and efficiency. For best results, the boat should be on plane and trimmed to reduce the wetted surface. With less boat in the water, both speed and fuel economy increases. Engines with manual trim must be adjusted for best overall operation for the load and conditions. Engines with power trim should be adjusted continuously for best results.

If the engine is trimmed in too far (closer to the boat bottom), speed drops, fuel economy decreases, and the boat may not handle correctly. However, it does provide better acceleration from a stand still; and because it forces the bow down, visibility is improved. If the engine is trimmed out too far (away from the boat bottom), steering torque may increase, the boat may be difficult to get on a plane, and may bounce.

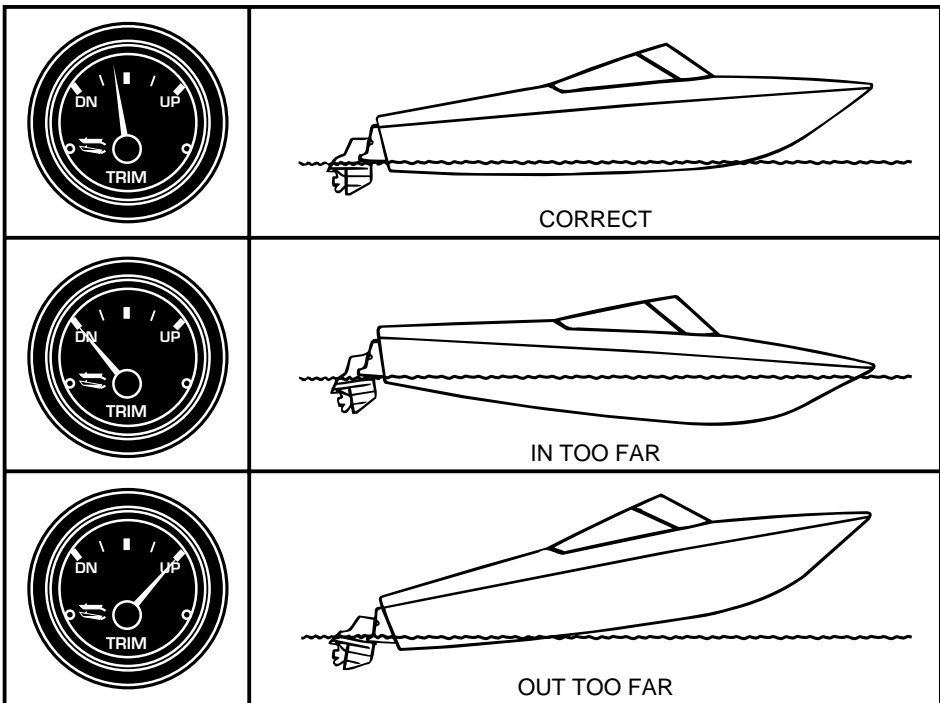

KC-1150

WARNING

Do not trim the engine out too far or the boat may begin to “porpoise” (bounce up and down). Porpoising reduces control and visibility.

To use power trim effectively, always start with the engine trimmed in. As the boat planes, increase the angle out. Experience is the best teacher for understanding proper trim.

CHAPTER 5: GETTING UNDERWAY

There are many things to consider to make your boating trip safe and enjoyable. This section includes a safety checklist, boarding guidelines, boat loading, and capacity information.

The contents of this section should be read and understood before casting off. Remember, if you have a problem during your cruise, you can't get out and fix it, or walk to safety or for help.

You are responsible for the safety of all passengers, the boat, and any damage the boat or its wake may cause. Always keep passengers from blocking your view so that you do not run into other boats, swimmers, water skiers, personal water vehicles, or aids to navigation.

Safety Checklist

The following checks are essential to safe boating and must be performed before starting the engine. Get in the habit of performing these checks in the same order each time so that it becomes routine.



WARNING

DO NOT launch the boat if any problem is found during the Safety Check. A problem could lead to an accident during the outing causing severe injury or death. Have any problem attended to immediately; see your dealer.

Pre-Operation

- Check the weather report, wind and water conditions.
- Check that the required safety equipment is on board.
- Check that the fire extinguisher is fully charged.
- Check that bilge drain plugs are installed properly.
- Check that no fuel, oil or water is leaking or has leaked into the bilge compartment.
- Check all hoses and connections for leakage and damage.
- Check the propeller for damage.
- Check the engine cooling water intake pick-up for blockage.
- Check that battery terminals are clean and tight.
- Check electrical circuits (lights, pumps, horn, etc.) for proper operation.
- Check that throttle/shift control is in neutral.
- Check that the steering system operates properly.
- Check that all required maintenance has been performed.

During Operation

- Check gauges frequently for signs of abnormal behavior.
- Check that controls operate smoothly.
- Check for excessive vibration.

After Operation

- Fill fuel tank to prevent moisture due to condensation.
- Check for fuel, oil and water leakage.
- Check the propeller for damage.

Safety Equipment

Federal and local laws require certain safety equipment to be on board at all times. In addition, responsible boaters carry other equipment in case of emergency. Check with local boating authorities for any additional requirements over and above federal requirements.

Boarding

When boarding the boat, always step in. Do not jump. Avoid stepping on fiberglass or other potentially slippery surfaces. Board one person at a time.

Do not board the boat while carrying gear. Set gear on the dock, board the boat and then pick-up the gear.

Boat Loading

The performance of your boat is dependent on load weight and distribution. Passengers should board one at a time and should distribute themselves to maintain trim. Remember to distribute weight from right to left, and also from front to back.



WARNING

All passengers should be carefully seated and not be riding on the deck, gunwale, rear sun deck, or elevated pedestal fishing seats while underway. Passengers riding in the bow rider seats should exercise extreme caution. During rough water operation, passengers in the bow rider seats should move to the aft passenger seats.

- Do not allow your passengers to ride with their feet dangling over the side, floating debris can cause serious injury.
- Avoid excess weight in the bow or stern.
- Securely stow all extra gear in stowage areas to prevent load shifting. Do not stow gear on top of safety equipment; safety equipment must be quickly accessible.
- In adverse weather, reduce the load in the boat. People/load capacity ratings are based upon normal boating conditions.
- Do not use the engine unit as a boarding ramp. Make sure engine is off when swimmers, divers, and skiers are boarding to prevent injury.

Capacity

Boats less than 6.4 m (20 ft.) are required by the USCG to have a certification plate, attached to the hull near the transom, indicating maximum person/load capacity. The person/load capacity is determined by various USCG formulas. Actual capacity is determined by the availability of proper seating on the boat. Acceptable seating determines the number of passengers, not the overall load capacity.

NOTICE

The capacity plate for outboard powered boats lists the maximum horsepower that the boat can safely use. It is unlawful to overpower a boat.

U.S. COAST GUARD MAXIMUM CAPACITIES	
8 PERSONS OR 1150 LBS.	
1600 LBS. PERSONS,	(MOTOR) GEAR
140 H.P. MOTOR	
THIS BOAT COMPLIES WITH U.S. COAST GUARD SAFETY STANDARDS IN EFFECT ON THE DATE OF CERTIFICATION	
MANUFACTURER:	
MODEL:	
DESIGN COMPLIANCE WITH NMMA REQUIREMENTS BELOW IS VERIFIED. MFGR. RESPONSIBLE FOR PRODUCTION CONTROL.	
LOAD CAPACITY • COMPARTMENT VENTILATION STEERING, FUEL AND ELECTRICAL SYSTEMS INTERNATIONAL LIGHTS • BASIC FLOTATION MANEUVERABILITY	
	NATIONAL MARINE MANUFACTURERS ASSN.

OUTBOARD
POWERED
BOATS ONLY

KC-1440



WARNING

Do not exceed the USCG certified maximum capacities under any circumstances. Overloading will reduce freeboard and increase the likelihood of swamping, especially in heavy seas. Overloading causes handling to become sluggish, making it difficult to react quickly.

Overpowering on outboard-powered craft is extremely dangerous. Overpowering will make the boat unstable and could cause loss of control.

CHAPTER 6: RUNNING

We urge you and all others operating the boat to seek certified instruction from the local boating authorities.

This section is designed to present the most basic operational principles. It is NOT intended to cover all conditions encountered during operation. Therefore, the principles presented in this manual are limited to the facts related directly to the operation of the boat, while the responsibility for the proper application of these principles belongs to you.

Maneuvering Techniques

Steering response depends on three factors: engine position, motion and throttle.

Like an automobile, high speed maneuvering is relatively easy and takes little practice to learn. Slow speed maneuvering, on the other hand, is far more difficult and requires time and practice to master.

When making tight maneuvers, it is important to understand the effects of turning. Since both thrust and steering are at the stern of the boat, the stern will push away from the direction of the turn. The bow follows a smaller turning circle than the stern.

The effects of unequal propeller thrust, wind, and current must also be kept in mind. While wind and current may not always be present, an experienced boater will use them to his advantage. Unequal thrust is an aspect shared by all single engine propeller-driven watercraft. A clockwise rotation propeller tends to cause the boat, steering in the straight ahead position, to drift to starboard when going forward, and to port when going backward. At high speed, this effect is usually unnoticed, but at slow speed; especially during backing, it can be powerful. For this reason, many veteran boaters approach the dock with the port side of the boat toward the dock, if possible.

Stopping (checking headway) is a technique that must be developed. Since a boat has no brakes, reverse thrust is used to slow and stop the boat. The momentum of the boat will vary according to the load as well as the speed. Make it a practice to slow to idle (no-wake) speed before shifting into reverse.

It is best to learn maneuvering skills in open water away from traffic. Adequate practice is the only way to develop your boating skills.

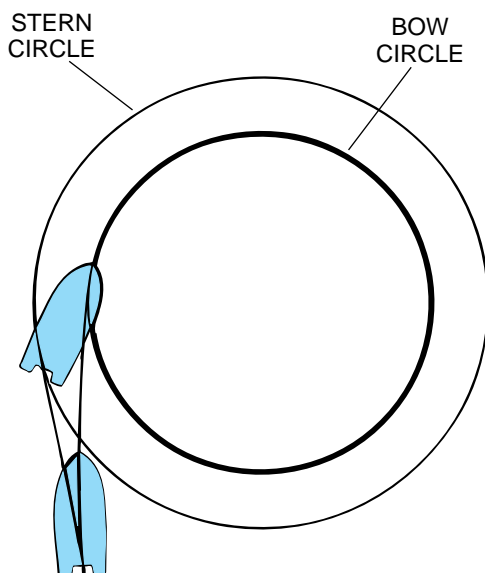

KC-1470

Salt Water

If boat is moored in salt water for long periods, tilt the engine out of the water (except during freezing temperatures). After removing the boat from the water, lower the engine to the run (down) position until the cooling system has drained thoroughly. Hose the entire hull down with fresh water and wipe dry.

Today's engines are built for operation in either fresh or salt water. Fresh water internal flushing is not normally required, however, it may be desirable after use in salt, polluted, or brackish water. Your dealer will assist you in securing the appropriate engine flushing device.

Freezing Temperatures

When the boat will be operated and left in the water and temperatures drop below freezing, the engine must remain in the tilted down (submerged) position at all times to prevent water in the engine from freezing. When the boat is removed from the water, drain the engine completely.

Towing Procedure

If seas are rough, it may not be easy to extend the tow line from one boat to another. In these cases, use a light throwing line with a weight on one end and with the heavier towing line secured to it.

Never attempt to tow a much larger or grounded vessel. Because of the tremendous stress caused by towing, use a tow line that is rated at least 4 times the gross weight of the boat being towed. Tow ropes must always be in good condition, free of any cuts or abrasions.

Attach tow line to the bow eye on the disabled boat. Attach the opposite end of the bridle only to the stern eyes of the tow boat. Wrap the bridle with chafing gear where it rubs against the boat or any corners. Leave at least 2 boat lengths between the boats for adequate movement.

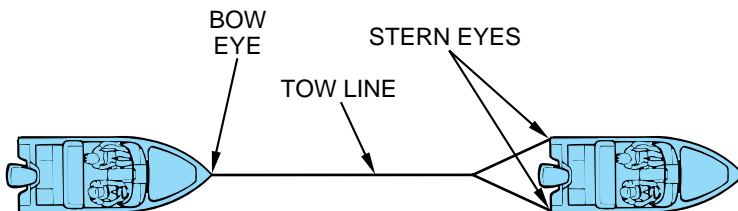

KC-2111

! DANGER !

When towing, use only the bow and stern eyes; never use cleats, hand-rails, etc. Do not allow anyone to be in line with the tow rope. If the rope should break or pull free, a dangerous recoil could occur resulting in severe injury or death to anyone in its path.

Adjust the tow line to match wave action. Keep the boats on the crest or in the trough of the waves at the same time. In protected, calm waters, shorten the line for better handling. Always tow at moderate speed, allowing for adverse wind and wave conditions. Have the operator of the towed boat steer with you if possible.

If you need a tow, or wish to tow another boat, use great care. The boat structure can be damaged by excessive pulling strain. You should always offer help to a boat in trouble. However, towing a capsized, grounded, or hull damaged boat is dangerous. Give assistance to the occupants; then call the proper authorities.

Anchoring

Dropping Anchor

There are many types of anchors available on the market. The choice of one anchor over another depends on many factors. An anchor will usually hold best in a mixture of mud and clay or in hard sand. A lightweight Danforth anchor is recommended for general boating. For more information on anchors consult your dealer.

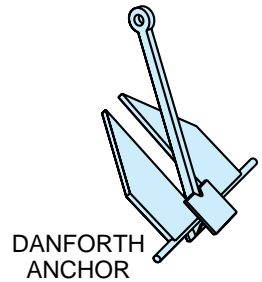

KC-1571



WARNING

Always anchor from the bow; NEVER anchor from the stern. A small amount of current will make the boat unsteady...a strong current can pull a boat, anchored by the stern, under water and keep it there.

When anchoring, it is helpful to keep a few guidelines in mind.

- Make sure the line is tied to the anchor and tie the other end of the line to the forward cleat or bow eye.
- Head the boat into the wind or current over the spot where you want to lower the anchor.
- Stop the boat before lowering the anchor.
- When the anchor hits bottom, slowly back up the boat, keeping tension on the line. Let out an anchor line that is 4 to 6 times the depth of the water. For example, if you are in 3 m (10 ft.) of water, let out 12 to 18 m (40 to 60 ft.) of line.
- Secure anchor line to the bow cleat. Pull on line to make sure anchor is holding.
- Occasionally check your position against the shoreline. If the anchor is dragging and you are drifting, reset the anchor.

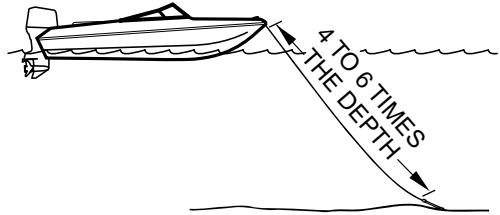

KC-1531

Weighing (Pulling In) Anchor

Start engine and move forward until anchor line is straight up and down. Pull hard to lift anchor from the bottom material.

If the anchor is stuck, attach anchor line to the bow cleat so that it is taut. The up and down motion of the bow from wave action may lift the anchor from the bottom. If the anchor remains stuck, let out a few more feet of line and attach it to the bow cleat. Slowly maneuver the boat around the anchor until the anchor pulls loose. Be sure to keep the line tight during this procedure.

Performance Boating

Some boat models; especially those with high horsepower engines, are capable of truly exhilarating performance. Don't be tempted to push your boat to its limits until you are completely familiar with the boat's operating characteristics. The operator should have at least 10 hours of experience with the boat before any extended full throttle operation.

Here are some guidelines for performance operation. Read them, practice them, and soon you will be operating your boat to its full capability.

Before Running

- Keep the bottom clean and free of scum, barnacles and other growth. Growth on the hull can slow the boat down considerably.
- Prepare the boat. Be sure all gear is properly stowed and compartments are latched.
- Weight distribution affects performance. Keep weight in the boat low and evenly distributed. Remove unnecessary weight and keep on shore.
- The propeller should be of the proper pitch to turn the recommended RPM rating for the engine and of the proper type for your average load and individual requirements. Your dealer can help you select a performance propeller.

When Underway**WARNING**

Keep one hand on the wheel and the other on the throttle at all times. If the boat begins to operate in an unsafe way, pull back on the throttle and trim the engine IN at the same time. Failure to maintain control could result in severe injury or death.

- Increase speed. The bow will start to come down.
- When the bow begins to fall, trim the engine out. Trimming the engine out at speed will cause the boat to rise up. The boat will begin accelerating without adjusting the throttle because less of the boat is dragging in the water. Steering will become easier because the propeller has less torque.

**WARNING**

Do not trim the engine out too far or the boat may begin to "porpoise" (bounce up and down). Porpoising reduces control and visibility and lowers top speed and fuel efficiency. Failure to maintain control or visibility could result in serious injury or death.

- Watch the tachometer to keep the engine within the full throttle operating range. See the engine operator's manual for the proper tachometer reading at full throttle.

High speed operation on smooth water is very stable, but quick reactions and adjustments are needed to maintain control. Know your limits and stay within them. Always keep one hand on the steering wheel and the other on the throttle; constant adjustments are necessary for rapidly changing conditions. Small inputs of throttle and steering are exaggerated at high speeds. Depending on the speed, keep watch well ahead so that you may have enough time to react.

Propellers

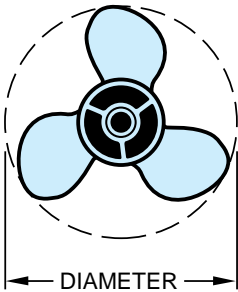

KC-1580

The propeller converts the engine's power into the thrust needed to propel the boat. Care and selection of your propeller is very important to proper boat operation. Propellers are identified by two numbers, such as 13 x 19, and a material identification, such as aluminum or stainless steel. In the number sequence, the first number is the diameter of the propeller and the second is the pitch.

Pitch is the angle of the blades expressed in the theoretical distance a propeller travels in each revolution. In

the above example, the pitch is 19, or each revolution of the propeller pushes the boat 483 mm (19 inches) through the water. A 19 pitch is considered "higher" pitched and a 15 pitch propeller is considered "lower" pitched.

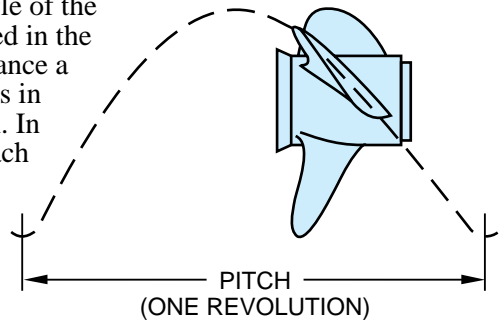

KC-1581

Keep these guidelines in mind when selecting a propeller:

- There are many different propeller designs for specific operating characteristics, including the number of blades, relief holes, cupping, etc. Do not attempt to change propellers until after you have a chance to determine your average load and individual requirements. Your dealer is best qualified to help you select a propeller.
- Engine RPM must be within the recommended operating range. Refer to the engine operator's manual.
- Higher propeller pitch reduces: RPM, acceleration, engine noise, and usually improves fuel economy and top speed.
- Lower propeller pitch increases: RPM, acceleration, engine noise, reduces fuel economy and top speed.

**WARNING**

To prevent accidental start-up, complete the following before installing or removing the propeller:

- Put the remote control in the “NEUTRAL” position.
- Put the main switch in the “OFF” position and remove the key.

Failure to observe this warning could result in severe injury

A smaller pitch propeller should be selected for water skiing or for heavy loads. A smaller pitch propeller will develop more thrust for raising skiers quickly. When a skier has fallen, or a skier is not being towed, it is important that the operator watch the tachometer to make sure engine RPM does not continuously exceed the maximum full throttle RPM range of the engine.

**WARNING**

DO NOT use your hand to hold the propeller when loosening the nut. Put a wood block between the cavitation plate and the propeller blade to prevent the propeller from turning. Failure to observe this warning could result in injury.

Problems associated with propellers include ventilation, cavitation, and blow-out. These problems have similar symptoms and are best diagnosed by an expert. If you think you have a propeller related problem, consult your dealer.

CHAPTER 7: CARE AND MAINTENANCE

This section describes how to care and maintain your boat. It includes information about maintaining electrical components, corrosion protection, and general maintenance. Use the service/maintenance log provided to track maintenance performed.

Repairs and Modifications

Your boat has been designed for safety in the harsh marine environment and thoroughly tested and certified for compliance with applicable safety standards. Because of the possibility of interference with the design of the boat, owner installation of additional equipment or modification of factory equipment is not recommended.

In addition, do not attempt to make repairs unless you are certified to do so, have the necessary authorized repair information, and use approved marine replacement parts.

Your dealer is qualified to make such repairs, additions or modifications to your boat that will not compromise safety, design integrity, or warranty coverage.

Electrical

Battery



WARNING

Batteries contain sulfuric acid which can cause severe burns. Wear protective clothing to avoid acid contact with skin, eyes, etc. Failure to observe this warning could result in severe injury.

Check the battery frequently for signs of corrosion. If corrosion is evident, clean terminal posts with a baking soda and water solution and a wire brush. Before cleaning, remove the vent caps and seal the vent wells with corks to prevent the solution from getting inside the battery.

NOTICE

Some batteries are sealed, and cannot be filled.

Check the fluid levels in the cells. Usually, a level approximately 6 to 13 mm (1/4 to 1/2 inch) above the plates is sufficient. If needed, fill with distilled water; do not overfill!

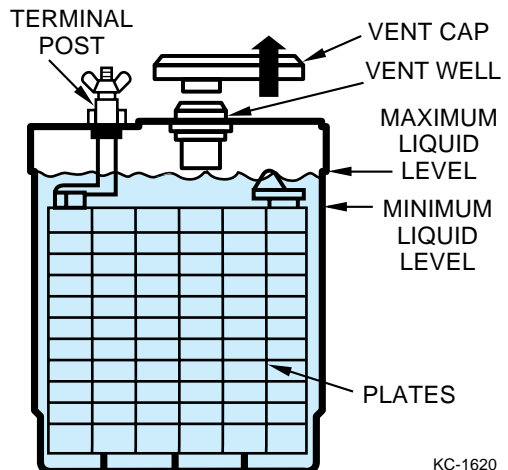

KC-1620

! WARNING

Batteries produce explosive hydrogen gas. Never attempt starting your engine with jumper cables under any circumstances. Keep all sparks, flames and smoking materials away from batteries. Risk of spark at the battery post igniting gasoline or hydrogen fumes is too great. Always wear eye protection when near batteries and have adequate ventilation when charging. An explosion can cause blindness or other serious injuries.

Batteries are perishable products and will self-discharge. If you operate your boat sparingly, you may want to charge your battery occasionally. To recharge, remove the battery from the boat and remove the battery caps (when applicable). Recharge the battery according to the directions enclosed with your battery charger. When installing the battery in the boat, make sure the battery is secured in the battery box.

Circuit Breakers and Fuses

All electrical circuits are protected from overload by the use of fuses or circuit breakers. In the event of an overload or short circuit, the fuse will blow or circuit breaker will trip. If a circuit continuously overloads under normal operating conditions, have your boat inspected by the dealer immediately.

! WARNING

Never exceed the recommended fuse sizes or bypass the fuse safeguard. Always install the proper (type and rating) fuses whenever replacing or changing fuses. Continuous fuse/breaker failures indicate a severe problem and requires immediate attention. Failure to install correct fuse may result in damage to the electrical system or severe personal injury.

Some boat models have each individual circuit protected with a circuit breaker located next to the switch. To reset a tripped circuit breaker, switch OFF the circuit, wait about one minute for the breaker to cool, push the breaker button fully, and switch ON the circuit.

Some boat models have circuits protected by fuses. If the fuse should blow-out, locate the fuse block behind the instrument panel. Use a fuse removal/installation tool to replace the fuse.

NOTICE

The electrical system is designed to protect you from short circuits and overload. Any modifications to the system, such as adding electrical accessories, should be done by a qualified technician.

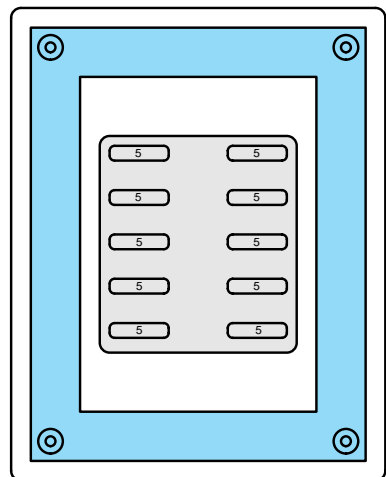

AUTOMOTIVE STYLE
FUSE PANEL

KC-1635

TYPICAL IN-LINE FUSE HOLDER

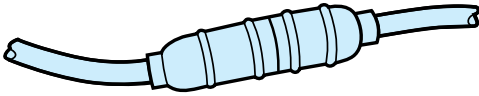

(TWIST AND PULL TO OPEN)

KC-1640

Some installed accessories, such as the stereo, have an additional fuse located in the positive lead of the stereo. Some in-line fuse holders can be found near the battery.

Corrosion Protection

Galvanic Corrosion

Galvanic corrosion (electrolysis), is the break-up of metals due to the effects of electrolytic action. When two dissimilar metals are immersed in a conductive fluid such as salt water, an electric current is produced, much like a battery. As the current flows, it takes with it tiny bits of the softer metal. If not stopped, a great deal of damage could occur.

If you operate in salt, polluted, or brackish waters, your boat should be equipped with a transom mounted zinc anode to prevent damage to those metal parts coming in contact with the water. By design, the anode is self-sacrificing. It is slowly eroded away by electrolytic action and requires periodic inspection for deterioration. If the zinc shows extreme erosion, it must be replaced for continued protection.

Most engines are equipped with one or more zinc anodes which must also be inspected regularly for deterioration. Some boat models may be equipped with an electronic cathode system. This system emits a low current electrical charge into the water close to the metal components. This charge cancels the effect of electrolysis.

CAUTION

Never paint or coat zinc anodes or cathodes with any substance. Once covered, they do not provide protection from galvanic corrosion. Replace anodes if they have deteriorated 50% or more.

Salt Water Corrosion

The entire boat should be rinsed with fresh water and washed immediately after use in salt water. If the boat is used primarily in salt water, wax the hull monthly and apply corrosion inhibitor to all hardware. See your dealer for products suitable for the marine salt water environment. Fresh water internal flushing is recommended when used in salt, polluted, or brackish waters. Flush the entire engine cooling system with fresh water for at least 5 minutes after use in these waters. See your dealer for appropriate flushing devices.

General Maintenance

Marine Growth

If accelerated marine growth is a problem in your area, an anti-fouling bottom paint may be necessary to slow growth and prevent gelcoat damage. Before selecting a bottom paint, talk with other boaters and your dealer to determine which product works best in your area. Many local variables can affect the selection of paint. Be sure to follow the paint manufacturer's directions exactly.

Cleaning

Periodic cleaning is the best way to keep your boat looking new. Regular washing and waxing keep dirt and scum from building up and deteriorating the finish. Keeping your boat in “show room” condition means greater personal satisfaction and higher resale value. Special cleaning products are available from your dealer to remove mildew.

Fiberglass Hull

When washing the boat, be sure to use a mild detergent and warm water solution. DO NOT use abrasive cleaners, solvents, ammonia or chlorine as these will damage the gelcoat surface. Under extreme conditions, special cleaners may be used to remove marine growth, such as scum or algae, from the hull; see your dealer.

Waxing the entire gelcoat surface at least twice a season is recommended for all climates. Use of a specially formulated marine gelcoat wax will prevent color fade and soil and scum adhesion. If the gelcoat has chalked or faded from lack of proper maintenance, buffing may be necessary to bring back the shiny appearance. Hand buffing with #7 rubbing compound or power buffing with glazing compound #1 will quickly restore the surface.

Upholstery

Regular washing with mild detergent and warm water or non-solvent type automotive vinyl cleaner is sufficient to keep the cushions, canopy top, and other vinyl coverings in good condition. Keep the cushions from becoming soaked and dry off thoroughly after washing to prevent mildew accumulation after the boat is covered. Prop the cushions up in the boat when covered to allow air circulation and spray with mildew repellent. Lubricate canopy top snaps with petroleum jelly.

For tough stains on vinyl such as adhesive, rust, etc., use a citrus cleaner followed by a mild detergent and warm water. For ink stains, apply denatured alcohol and wipe off. Note that some products such as suntan lotion, shoe polish and wet leaves may stain permanently.

Although not always convenient, minimizing your boat’s contact with damaging ultraviolet (UV) rays and storing removable seats and canopies indoors when not being used will increase the longevity of vinyl upholstery.

CAUTION

Certain automotive, household and industrial cleaners can cause further damage and discoloration. Solvents and dry cleaning fluids, or products that contain dyes such as waxes, should be used with caution. Whenever cleaning stubborn stains, be sure to test the treatment in an unseen area first. The following stain treatments should be used with discretion. Between steps, be sure to rinse thoroughly with plenty of clean water and allow to dry.

Carpet

Occasional vacuuming and washing with mild detergent and warm water or household carpet cleaners will keep the carpet clean. Thoroughly hose the detergent out of the carpet and into the bilge. This is usually the best time to clean the bilge. Let the carpet dry in the sun to prevent any mildew or odor caused by moisture.

Windshield

A clean windshield is important. If your boat is equipped with a glass windshield, applying a non-abrasive glass cleaner with a soft cloth will remove most dirt and smudges. Smoked plexi-glass or plastic windshields should be cleaned with a mild soap solution and damp cloth only. Harsh detergents, solvents, chemicals or dry cloths used on any glass or plastic windshield will scratch the surface.

Bilge

Your bilge accumulates oil and greasy dirt over a period of time and should be cleaned out. Usually, ordinary soap and water does not remove the accumulation, and something stronger is necessary. Consult your dealer for recommendations on special bilge cleaning products.

Holding Tank

If your boat has an optional waste holding tank installed, various chemicals are available to control odors and help break down solids. Consult your marine dealer as to what to use. After the holding tank is emptied, fill tank with fresh water and pump it out again to rinse.

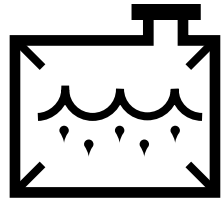

KC-4055

NOTICE

Overboard discharge of waste should only be used in approved areas.

There are many marinas that are certified to pump out your holding tank.

Stainless Steel and Chrome

Stainless steel and chrome plated parts are not totally resistant to corrosion. Occasional cleaning and polishing with a marine chrome and stainless polish will maintain and extend the useful life. In salt water areas, rinse all hardware with fresh water and apply a light coating of corrosion inhibitor oil to enhance appearance.

Fuel System

Fuel lines, vent hoses, and drain hoses should be checked frequently for leaks. Some models are equipped with removable inspection plates for fuel system component inspection. If a leak occurs around the fitting, then tightening of the hose clamps may be all that is necessary. However, if the leak continues, replace the hose immediately to prevent a build-up of fluids or gases. Surface cracking on the hose indicates wear, and replacement is recommended. Use fuel system parts certified for marine use only; do not substitute automotive parts in marine application.

Steering System

The steering system is the primary link for engine control and must be inspected and maintained regularly. The hardware at both the helm and engine end of the steering cable must be checked frequently for tightness. Refer to the engine operator's manual for the appropriate torques.

The steering bar must be lubricated monthly to ensure smooth operation. Turn the steering wheel to a full starboard turn to expose the bar. Use a high quality waterproof marine grease and fully coat the bar. Turn the steering wheel back and forth to work the grease in.

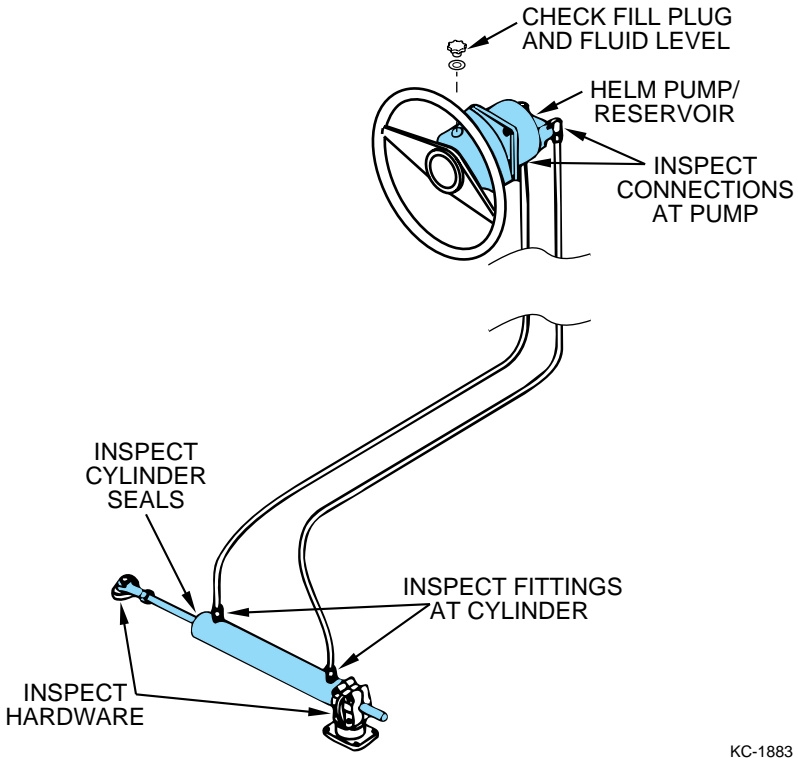
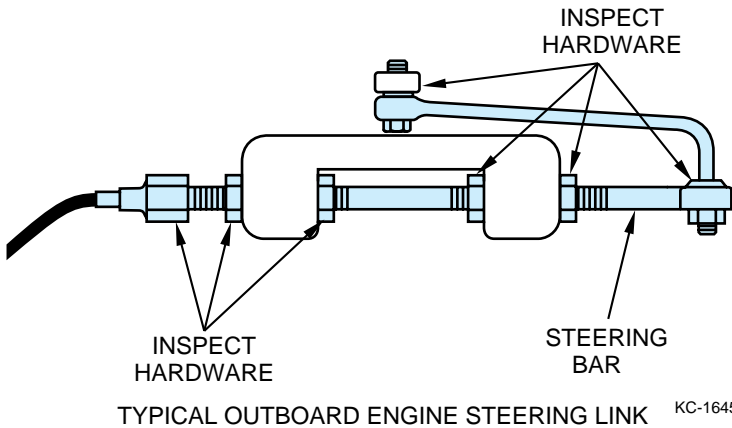

Hydraulic and power-assisted systems must also be inspected. Make sure hydraulic hoses are tight and leak-free. Cylinder seals should be checked for dampness indicating leakage. Check the fluid reservoir monthly and top-off if necessary. Consult the steering system manufacturer's manual for more information.

CHAPTER 8: TROUBLESHOOTING

The following chart will assist you in finding and correcting minor mechanical and electrical problems. If an engine problem is indicated, consult your engine owner's manual.

Some problems may require specialized skill and tools to correct them; see your dealer.

Trouble Check Chart

Symptom	Possible Cause
Engine will not crank	<ul style="list-style-type: none"> • Engine stop switch not connected • Throttle/shift control in gear • Main circuit breaker open • Battery terminals corroded • Weak battery • Loose or corroded battery wiring connections • Engine problem
Engine cranks but will not start	<ul style="list-style-type: none"> • No fuel in tank • Fuel filter clogged • Contaminated fuel • Engine problem
Poor boat performance	<ul style="list-style-type: none"> • Contaminated fuel • Uneven load distribution • Engine trim wrong • Improper propeller selection • Excessive water in bilge • Engine problem
Poor gas mileage	<ul style="list-style-type: none"> • Plugged flame arrestor (stern drive) • Engine trim wrong • Marine growth on hull • Engine problem
Throttle/shifting problems	<ul style="list-style-type: none"> • Corroded cable • Kink in cable • Engine problem
Excessive vibration	<ul style="list-style-type: none"> • Propeller damaged or fouled • Bent propeller shaft • Engine problem
Electrical problems	<ul style="list-style-type: none"> • Blown fuse or open circuit • Loose wiring connections • Defective switch or gauge

CHAPTER 9: STORAGE

Storage or winter lay-up requires special preparation to prevent damage to the boat. Perform all annual maintenance at this time.

Without proper preparation, storage for long periods of time may cause internal parts of the engine and drive unit to rust because of lack of lubrication. Or, if the boat is stored in below freezing temperatures, water inside the bilge or cooling system may freeze causing damage. Damage to the boat due to improper storage will not be covered by the warranty. The following procedures should help prevent damage to your boat.

Storage Preparation

While The Boat Is Still In The Water

1. Fill fuel tank and add the proper amount of fuel stabilizer and conditioner according to the manufacturer's recommendations.
2. Operate boat for at least 15 minutes to be sure that treated fuel has reached engine.

NOTICE

If the boat is to be stored for more than 5 months, stored in a high moisture (humidity) environment, in temperature extremes, or stored outdoors, "fog" the engine with a rust preventative fogging oil according to the manufacturer's recommendations. See your dealer.

When The Boat Is Removed From The Water

NOTICE

Remove the bilge drain plug immediately after taking the boat out of the water. After washing, raise the bow of the boat high to allow as much water as possible to drain while performing other storage preparations.

- Flush the engine cooling system with clean water. DO NOT exceed 1500 RPM when flushing.
- Perform all scheduled maintenance. For stern drives, tuning the engine and changing the oil and fuel filters (if equipped) is especially important.
- Thoroughly clean the hull, deck and interior of the boat as soon as it is removed from the water. Cleaning at this time is easier because the marine growth is still wet. Be sure to allow for a couple of days of air drying to prevent mildew due to trapped moisture.
- Apply a coat of wax to the entire surface of the boat and rust inhibitor on all metal parts.
- Clean all traces of dirt, oil, grime, and grease from the engine and bilge. Touch-up areas of engine where paint has been removed.
- Prepare the engine for storage according to the instructions contained in the engine owner's manual.

- Store the bilge drain plug in a plastic bag and tape it to the throttle control lever so that it is easily found for reactivation.
- Remove the battery from the boat. Clean, fully charge and store the battery in an area not subject to freezing temperatures. Never store batteries close to heat, spark, or flame producing devices.
- Repack trailer wheel bearings with water resistant wheel bearing grease. If the trailer is equipped with bearing protectors, squirt grease into hubs with a grease gun.
- Park trailer and boat in a protected area. If the rig is left outside, install a boat cover. See your dealer.
- Loosen tie-downs and winch line but be sure the boat is resting properly on hull supports.
- Jack up trailer and place blocks under trailer frame to relieve weight on trailer tires and springs.

Reactivating The Boat After Storage

- Charge and install battery in boat.
- Check engine and bilge for signs of nesting animals; clean as necessary.
- Check entire engine for cracks and leaks caused by freeze damage.
- Check hose condition and all hose clamps for tightness.
- Install bilge drain plugs.
- Perform daily maintenance. If not performed during lay-up, perform annual maintenance.
- If the boat is equipped with the optional fresh water cooling system (stern drive only) and was drained for storage, fill the system with fresh coolant solution.
- Check and lubricate steering system.
- Remove blocks from under trailer frame.
- Tighten tie-downs and trailer winch line.
- Check tire pressure and lug nuts on trailer.
- Take the boat to the water and start it. It may take a minute of cranking to allow the fuel system to prime. Allow a one minute cool down period for every 15 seconds of cranking. When the engine starts, keep a close watch over the gauge readings and check for leakage and abnormal noises. Keep speeds low for the first 15 minutes until the engine has reached normal operating temperature.

Slinging/Lifting

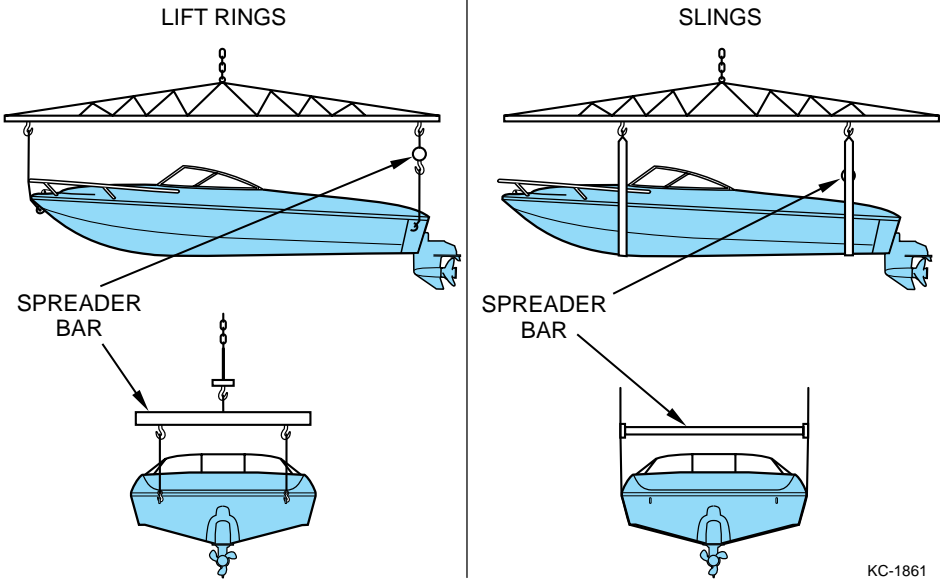

KC-1861

If the boat is to be removed from the water without a trailer, follow these guidelines:

- Never attach lifting cables to cleats, ski tow eyes or hand rails. Attach cables only to the lifting eyes in the transom and bow.
- Cover lifting cables with rubber hose or other protectors to prevent damage to the finish.
- Attach guide lines to the bow and stern to control movement.
- Use spreader bars and keep lifting pressure vertical to prevent side load damage.
- Keep the bow slightly higher than the stern to prevent engine damage.

CHAPTER 10: TRAILERING

This section provides information about trailering. It describes the hitch and safety chains, backing your trailer, preparing to launch, launching, and loading your trailer. Also included is a trailering checklist.

WARNING

- **The trailer must be matched for the boat's weight and hull.**
- **The towing vehicle must have the capability of pulling the load.**

Pulling a load that exceeds the trailer's or vehicle's towing capacity may cause loss of control.

NOTICE

Check the certification label on the left forward side of your trailer. The label is required to show the Gross Vehicle Weight Rating (GVWR), which is the load carrying capacity plus the weight of the trailer itself. Be sure that the total weight of your boat, engine, gear, and trailer do not exceed the GVWR.

Trailer laws on things such as lighting, registration, trailer brakes, gross vehicle weight, etc., vary widely from state to state. Contact your state Department of Motor Vehicles (and that of other states through which you may be traveling) for laws with which you must be in compliance.

Hitch

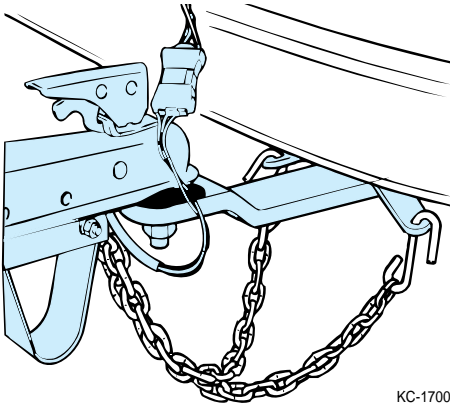

Most boat trailers connect to a ball hitch that is bolted or welded to the towing vehicle. Clamp-on bumper hitches are not recommended.

The trailer hitch coupler must match the size of the hitch ball. Never use a hitch ball that does not match the trailer coupler. The correct ball diameter is marked on the trailer coupler.

Hitches are divided into classes that specify the gross trailer weight (GTW) and maximum tongue weight for each class. Always use a hitch with the same class number as the trailer, or greater.

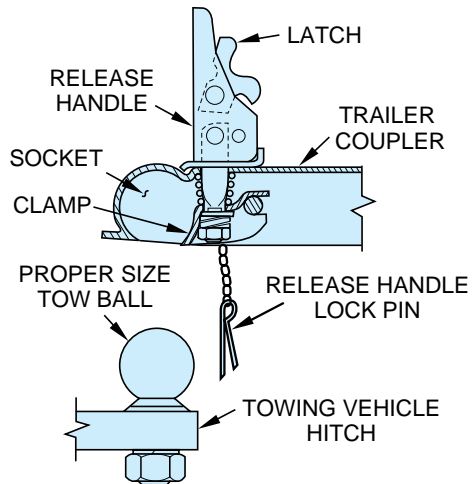

KC-1651

Safety Chains

Safety chains on your boat trailer provide added insurance that it will not become completely detached from the towing vehicle when underway.

Crisscross the chains under the trailer tongue to prevent the tongue from dropping to the road if the trailer separates from the hitch ball. Rig the chains as tight as possible with just enough slack to permit tight turns.

Make sure the proper chains are correctly attached between the towing vehicle and trailer before and during each trip.

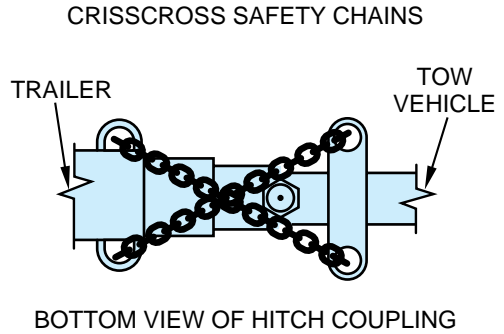

KC-1691

Trailer Checklist

Below is a checklist to follow when trailering your boat:

- Consult your state laws as to brake and axle load requirements. Check brakes for proper operation and fluid level prior to departure on each trip.
- Check springs and undercarriage for loose parts.
- Check tires for proper inflation. Under-inflated tires heat up rapidly and tire damage or failure is likely to occur.
- Wheel bearings and lug nuts should be checked before each trip.

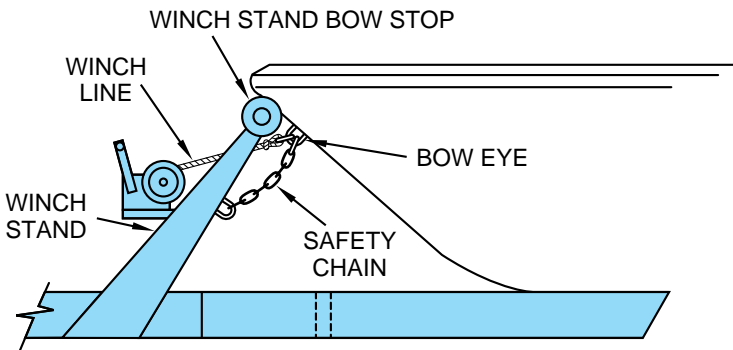

KC-1711.2

- Your boat should be fastened to the trailer with the winch line connected to the bow eye, PLUS a bow tie-down to the winch stand or trailer tongue. A safety chain, strap or rope can be used as a suitable tie down. The stern of your boat should be secured to the trailer from the stern eyes.
- Check to be sure the taillights and turning signals work prior to towing.
- Too much or too little tongue weight will cause difficult steering and will make tow vehicle sway. A rough rule of thumb is 5% to 10% of boat and trailer weight on the tongue.

- Convertible tops and detachable windshields are not designed to stay on boats at highway speeds. Before towing, take down the convertible top, side curtains, back cover and detachable windshield if so equipped.
- Carry a spare tire for both your trailer and your towing vehicle along with sufficient tools to change them.
- Consult the engine operator's manual for engine related trailering precautions.
- On extended trips, carry spare wheel bearings, seals, and races.
- While traveling, check the wheel hubs every time you stop for gas or refreshments. If the hub feels abnormally hot, the bearing should be inspected before continuing your trip.

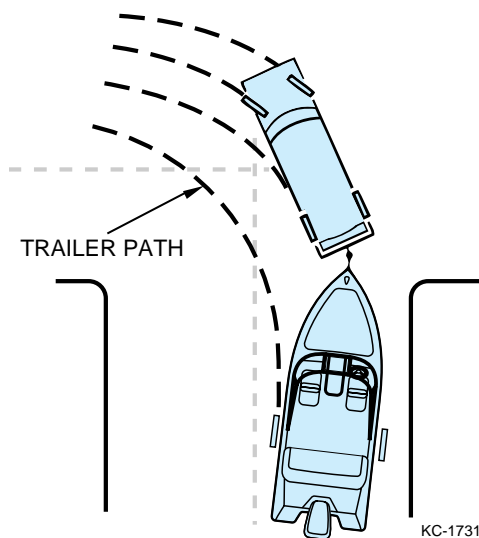

- When rounding turns on highways or streets, do not cut corners. Also, go slow over railroad tracks.
- Outboard motors should be tied in place so they will not tilt or turn due to road shock. Continuous road shocks may fatigue the boat steering system.
- Before backing your trailer into water, disconnect the light plug from the towing vehicle to reduce the likelihood of blowing out lights when they become submerged.

Backing Up Trailers

If you have never towed a trailer before, take the time to practice backing your trailer before using it for the first time. Follow these guidelines when backing:

- Back slowly and make small steering adjustments.
- Turn the car wheels in the opposite direction you want the trailer to go.
- After the trailer begins moving, turn the car to follow it.
- Have a second person assist you with hand signals.

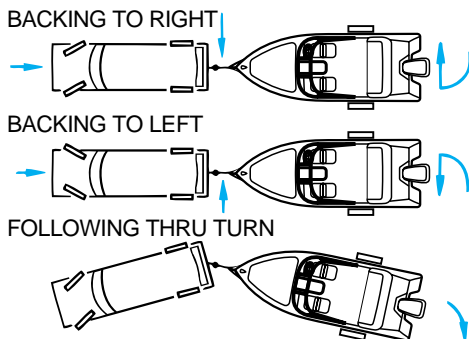

Launching

Before launching your boat, stay to one side and watch a couple of launchings to notice any problems on the ramp and the effects of the wind and current on launching. It is a common courtesy to prepare the boat for launching away from the ramp especially during busy periods. Perform the pre-launch sequence as follows:

1. Remove the boat cover, if equipped.
2. Check that bilge drain plug is in place.
3. Remove any additional trailering tie-downs from the boat.
4. Attach the bow and stern docking lines and fenders if necessary.
5. Disconnect the trailer lights from the car.

Launching with two people is recommended. Since all launches are different from each other in some way, the following procedure must be modified to fit the launch in use:

1. Back the boat down the ramp until the wheels are at least halfway submerged. Keep the trailer/car combination as straight as possible and at 90 degrees to the shore line.
2. Loosen and detach the bow strap from the bow eye.
3. Back the boat further down until the top of the fenders are about 50 mm (2 in.) above the water.
4. Board the boat and start it. If possible, remain on the trailer until the engine has warmed-up.

Loading

Loading, like launching, is best done with two people:

1. Back the trailer into the water until the top of the fenders are about 75 mm (3 in.) above the water. Keep the trailer/car combination as straight as possible and, if possible, at 90 degrees to the shoreline. Set the parking brake securely.
2. Approach the trailer in a straight line from at least 1.5 m (5 ft.) out. Use “bursts” of propeller thrust to move towards the trailer at the slowest steerable speed. Guide the boat onto the support bunks.
3. Check to see that the boat is centered on the support rails and is headed in a straight line for the bow stop (bumper board).



WARNING

Excessive throttle can cause the boat to travel over the bumper board causing extensive damage to the boat, trailer, and car and could cause severe personal injury.

4. Using a very light touch on the throttle, ease the boat forward until the bow comes to rest against the bow stop (bumper board).

CAUTION

The winch bow strap is merely a means of securing the boat to the trailer and is not intended to winch or pull the boat onto the trailer. Winching the boat onto the trailer could cause severe injury.

5. Attach and tighten the winch bow strap.
6. Pull the trailer up the ramp and attach any additional tie-downs and connect the trailer light harness.
7. Pull drain plug.

CHAPTER 11: GLOSSARY

ABOARD – On or in the boat.

AFLOAT – On the water.

AFT – Toward the rear or stern of the boat.

AGROUND – Touching bottom.

AMIDSHIP – Center or middle of the boat.

ANCHOR – (1) An iron casting shaped to grip the lake bottom to hold the boat. (2) The act of setting the anchor.

ASHORE – On the shore.

ASTERN – Toward the stern.

BAIL – To remove water from the bottom of the boat with a pump, bucket, sponge, etc.

BAITWELL – A miniature livewell used to store and keep live bait alive and healthy.

BEAM – The widest point on the boat.

BEARING – Relative position or direction of an object from the boat.

BILGE – The lowest interior section of the boat hull.

BILGE KEELS – The raised areas or aluminum extrusions on the bottom of a boat that parallel the keel.

BOARDING – To enter the boat.

BOUNDARY WATERS – A body of water between two areas of jurisdiction; i.e., a river between two states.

BOW – The front of the boat.

BULKHEAD – Vertical partition (wall) in a boat.

BUNKS – Carpeted trailer hull supports.

BURDENED BOAT – Term for the boat that must “give-way” to boats with the right-of-way.

CAPACITY PLATE – A plate that provides maximum weight capacity and engine horsepower rating information. It is located in full view of the helm.

CAPSIZE – To turn over.

CAST-OFF – To unfasten mooring lines in preparation for departure.

CENTER LINE – A lengthwise imaginary line which runs fore and aft with the boat's keel.

CHINE – The point on a boat where the side intersects (meets) the bottom.

CLEAT – A deck fitting with ears to which lines are fastened.

CONSOLE – Also called helm. The steering wheel area of the boat.

CRANKING BATTERY – The main battery used for engine starting and electrical circuits.

CURRENT – Water moving in a horizontal direction.

DECK – The open surface on the boat where the passengers walk.

DEEP CYCLE BATTERIES – Special long-running batteries which can be repeatedly discharged and recharged without significant loss of power.

DOLLY WHEEL – A rolling jack assembly at the front of the trailer used for positioning the coupler during trailer hookup.

DRAFT – The depth of the boat below the water line, measured vertically to the lowest part of the hull.

ELECTROLYSIS – The break-up of metals due to the effects of galvanic corrosion.

FATHOM – Unit of depth or measure; 1 fathom equals 6 feet.

FENDERS – Objects placed alongside the boat for cushioning. Sometimes called bumpers.

FORE – Toward the front or bow of the boat. Opposite of aft.

FREEBOARD – The distance from the water to the gunwale.

FUEL SENDING UNIT – The electrical device that is mounted on the outside of a built-in fuel tank and controls the dashboard fuel gauge.

Malibu® Boats

Pulling Ahead



Owner's Manual
1982 - 1992 Models

Manufacturers of Malibu and Flightcraft Boats

<https://www.boat-manuals.com/malibu/>

- GIVE-WAY BOAT** – (1) Term for the boat that must take whatever action necessary to keep well clear of the boat with the right-of-way in meeting or crossing situations. (2) The burdened boat.
- GUNWALE** – The rail or upper edge of a boat's side.
- HEAD** – A marine toilet.
- HELM** – The steering wheel or command area.
- HULL** – The body of the boat.
- HYPOTHERMIA** – A physical condition where the body loses heat faster than it can produce it.
- IN-LINE FUSE** – A type of protective fuse located in the power wire of a direct current (DC) circuit usually near the battery.
- KEEL** – The lowest portion of the boat; extends fore and aft along the boat's bottom.
- LIST** – Leaning or tilt of a boat toward the side.
- MAKING WAY** – Making progress through the water.
- MARINECHART** – Seagoing maps showing depths, buoys, navigation aids, etc.
- MOORING** – An anchor, chain, or similar device that holds a boat in one location.
- NAVIGATION AID** – Recognizable objects on land or sea such as buoys, towers or lights which are used to fix position to identify safe and unsafe waters.
- NO-WAKE SPEED** – The speed at which a boat travels to produce an imperceptible wake.
- PFD** – Personal flotation device.
- PITOT TUBE** – See SPEEDOMETER PICKUP TUBE.
- PLANING HULL** – A hull designed to lift, thereby reducing friction and increasing efficiency.
- PORPOISE** – A condition in which the bow bounces up and down caused by trimming the engine too far out.
- PORT** – (1) The left side of a boat when facing the bow. (2) A destination or harbor.
- PRIVILEGED BOAT** – Term used for the boat with the right-of-way.
- RIGHT-OF-WAY** – Term for the boat that has priority in meeting or crossing situations. The stand on or privileged boat.
- RULES OF THE ROAD** – Regulations for preventing collisions on the water.
- SPEEDOMETER PICKUP TUBE** – Also called pitot tube. The plastic device that extends below the bottom of the boat. It connects to the speedometer with plastic flexible tubing.
- SPLASHWELL** – The section of an outboard-equipped boat that is just forward of the transom.
- STAND ON BOAT** – Term for the boat that must maintain course and speed in meeting or crossing situations. The privileged boat.
- STARBOARD** – The right side of the boat when looking towards the bow.
- STERN** – The back of the boat.
- STOW** – To pack the cargo.
- SURGE BRAKES** – A type of trailer braking system designed to automatically actuate when the tow vehicle's brakes are applied.
- TRANSDUCER** – The unit that sends/receives signals for the depth sounder.
- TRANSOM** – The transverse beam across the stern.
- TRIM** – Fore to aft and side to side balance of the boat when loaded.
- UNDERWAY** – Boat in motion; i.e., not moored or anchored.
- USCG** – United States Coast Guard
- WAKE** – The waves that a boat leaves behind when moving through the water.
- WATERWAY** – A navigable body of water.
- V-PAD** – A modified vee hull design with a small, flat area in the keel aft.
- VISUAL DISTRESS SIGNAL** – A device used to signal the need for assistance such as flags, lights and flares.

