



## **Owner/Operator Manual**

*THIS MANUAL HAS BEEN COMPILED TO HELP YOU OPERATE YOUR CRAFT WITH SAFETY AND PLEASURE. IT CONTAINS DETAILS OF THE CRAFT, THE EQUIPMENT SUPPLIED OR FITTED, ITS SYSTEMS, AND INFORMATION ON ITS OPERATION AND MAINTENANCE. PLEASE READ IT CAREFULLY AND FAMILIARIZE YOURSELF WITH THE CRAFT BEFORE USING IT.*

*IF THIS IS YOUR FIRST CRAFT, OR IF YOU ARE CHANGING TO A TYPE OF CRAFT YOU ARE NOT FAMILIAR WITH, FOR YOUR OWN COMFORT AND SAFETY, PLEASE ENSURE THAT YOU OBTAIN*

*BECAUSE OF OUR POLICY OF CONTINUOUS PRODUCT IMPROVEMENT, THE ILLUSTRATIONS USED IN THIS MANUAL MAY NOT BE THE SAME AS YOUR BOAT AND ARE INTENDED AS REPRESENTATIVE REFERENCE VIEWS. SOME CONTROLS, INDICATORS OR INFORMATION MAY BE OPTIONAL AND NOT INCLUDED ON YOUR BOAT.*



RELAX...Take life easy for a while! You deserve it. We want to welcome you to the Lund family. You'll appreciate boat features that are well designed and serve a valuable purpose, features that are on the cutting edge of innovation. You'll appreciate our attention to uncompromising quality. These are some of the reasons why you've invested in a boat that's agile, responsive and safe. Our boats have been carefully designed and tested to guarantee this performance and comfort. You'll sense that as soon as you get behind the wheel.

Lund is one of the leading independent boat manufacturers with a worldwide dealer network. Our boats are certified by NMMA (National Marine Manufacturers Association) and CE Certified (Communaute' Europeene') to assure quality and safety with every craft. Lund boats also comply with the design requirements of the Canadian Coast Guard.

This Owner's Manual, which contains important information concerning your new boat, should be carried aboard at all times. Read it and your engine Owner's Manual before you leave the dock the first time. And then relax, enjoy yourself. We've taken care of all the details because...at Lund, "OUR BUSINESS IS YOUR PLEASURE."



# CONTENTS

<b>CONTENTS</b> .....	<b>i</b>
<b>1 INTRODUCTION</b> .....	<b>1</b>
HAZARD COMMUNICATION STATEMENTS .....	2
OWNER/OPERATOR ADVISORY STATEMENTS.....	4
PROTECTING THE ENVIRONMENT.....	4
GENERAL INFORMATION .....	5
CERTIFICATION.....	5
HIGH-PERFORMANCE PONTOON BOATS.....	5
CAPACITY PLATE .....	6
HULL IDENTIFICATION NUMBER.....	7
OWNER/OPERATOR'S LOGS AND RECORDS.....	8
EDUCATION .....	8
YOUR NEW BOAT .....	8
Dealer Responsibilities.....	8
Owner/Operator Responsibilities.....	9
WARRANTY .....	11
EQUIPMENT MANUFACTURER MANUALS .....	11
OWNER/OPERATOR RESPONSIBILITIES .....	12
BOATING LAWS AND REGULATIONS .....	13
Boat Registration .....	13
Insurance.....	13
Discharge of Oil .....	13
Disposal of Plastics and Other Garbage .....	14
MARPOL Treaty.....	14
Marine Sanitary Device .....	14
HAZARD COMMUNICATION LABELS.....	15
Warning Label Parts List.....	17
LX FLOORPLANS-CS & CW.....	<b>Error! Bookmark not defined.</b>
LX FLOORPLANS-FS & FC .....	<b>Error! Bookmark not defined.</b>
<b>2 SAFTEY</b> .....	<b>1</b>
SAFE BOATING RECOMMENDATIONS .....	1



SAFETY GEAR AND EQUIPMENT.....	3
Required Gear and Equipment.....	3
Personal Flotation Devices (PFDs).....	4
Fire Extinguisher .....	7
Sound Signaling Device .....	7
Navigation Lights.....	8
Visual Distress Signals.....	8
Recommended Additional Gear and Equipment.....	9
Basic Needs .....	9
Gear and Equipment for Extended Cruises .....	9
Tools .....	10
Spare Parts .....	10
SAFE BOATING PRACTICES .....	11
Drugs and Alcohol .....	11
Safe Operation .....	11
Fire.....	12
Passenger Safety .....	13
Propeller.....	13
First Aid.....	13
Operation by Minors .....	14
Rules of the Road.....	14
Voluntary Inspections .....	14
Safe Boating Courses.....	14
CARBON MONOXIDE .....	15
Carbon Monoxide Accumulation.....	16
CO Detector .....	18
LANYARD STOP SWITCH .....	18
WATER SPORTS .....	21
Water Skiing.....	23
<b>3 SYSTEMS AND COMPONENTS .....</b>	<b>1</b>
ELECTRICAL SYSTEM .....	1
BATTERY .....	2
Charging the Battery.....	3
Electrical Switches.....	4
Main Fuse .....	4
WIRE COLOR CHART.....	4
GAUGES .....	6

Fuel Gauge .....	6
Oil Pressure Gauge .....	7
Water Pressure Gauge .....	7
Water Temperature Gauge .....	7
Engine Multifunction Gauge or Warning Lights .....	8
Speedometer .....	8
Tachometer.....	8
Trim Gauge.....	8
Voltmeter .....	8
<b>CONTROLS .....</b>	<b>9</b>
Throttle and Gearshift .....	9
Steering .....	10
Hydraulic Steering System.....	10
Power Trim .....	11
FISH FINDER.....	11
TROLLING MOTOR OUTLET .....	11
LIVEWELL.....	13
FRESH WATER SUPPLY .....	14
PORTA-POTTI® .....	14
PROPANE GRILL.....	15
TOPS .....	16
BILGE PUMP .....	16
AM/FM MARINE STEREO .....	177
SPECIAL SEATS.....	17
<b>FULL CAMPER ENCLOSURE INSTALLATION</b>	
<b>INSTRUCTIONS – CARE &amp; USE GUIDELINES.....</b>	<b>18</b>
INSTALLATION: 18Installing your Double Canopies or Bimini Tops.....	18
Installing the Enclosure Curtains.....	19
STORAGE AND CARE.....	21
Bimini Top Storage .....	22
<b>4 TRAILERING .....</b>	<b>22</b>
TRAILER .....	22
Gross Vehicle Weight Rating .....	22
Weight Distribution.....	23
HITCH .....	24
SAFETY CHAINS .....	25



TRAILERING GUIDELINES .....	26
BACKING A TRAILER .....	28
LAUNCHING GUIDELINES .....	28
LOADING YOUR BOAT ON THE TRAILER.....	30
<b>5 UNDERWAY .....</b>	<b>1</b>
BOATER'S CHECKLIST .....	1
WARNING MARKERS .....	2
FUELING .....	3
LOADING PASSENGERS AND GEAR.....	6
STARTING THE ENGINE .....	8
Outboards .....	8
LEAVING THE DOCK.....	10
STEERING.....	12
BOAT SPEED .....	13
ACCELERATING .....	14
Pontoon Boats.....	15
TRIMMING.....	15
Pontoon Boats.....	16
GENERAL RULES OF SEAMANSHIP .....	18
STOPPING .....	18
ANCHORING .....	18
Dropping Anchor .....	20
Weighing Anchor .....	20
DOCKING .....	20
MOORING .....	21
EMERGENCY OPERATION .....	22
Fire or Explosion .....	23
Storms.....	23
Fog.....	24
Man Overboard .....	25
Unassisted Reboarding .....	25
Swamping or Flooding.....	25
Capsizing .....	25
Collisions.....	26
Running Aground .....	26
<b>6 CARING FOR YOUR BOAT.....</b>	<b>1</b>
ENGINE.....	2



ALUMINUM SURFACES .....	2
Cleaning .....	2
Painting.....	2
Corrosion .....	3
Cracked Aluminum.....	4
FIBERGLASS .....	4
PONTOONS .....	5
SALT WATER OPERATION.....	5
DECK HARDWARE AND FITTINGS .....	5
SEAT COVERINGS AND VINYL .....	6
DECK COVERINGS .....	7
Carpet.....	7
TPO Flooring Membrane.....	7
Vinyl Teak Flooring .....	7
Faux Teak Flooring.....	8
SPOTS AND STAINS.....	9
PONTOON COVER INSTALLATION INSTRUCTIONS —	
CARE & USE GUIDELINES .....	19
INSTALLATION.....	19
Positioning and Fastening the Cover.....	19
Cover Support Pole Placement- Proper Drainage ....	20
PREVENTING TEARS .....	21
STORAGE AND CARE.....	21
PONTOON OR HULL BOTTOM MAINTENANCE .....	22
FRESH WATER SYSTEM.....	22
SLIDER SEAT .....	23
CLEANING SOLUTIONS DEFINITIONS .....	24
<b>7 WINTERIZATION AND STORAGE .....</b>	<b>1</b>
PREPARATION FOR STORAGE .....	1
Lifting Your Boat .....	1
Pontoons .....	2
Deck .....	3
Engine .....	3
Batteries .....	3
Fresh Water System .....	4
Livewell.....	4
Bilge.....	4



SUPPORTING YOUR BOAT DURING STORAGE .....	5
Pontoon Boats.....	5
FITTING OUT AFTER STORAGE.....	6
<b>8 HELPFUL INFORMATION .....</b>	<b>1</b>
BOATING REGULATIONS .....	1
RULES OF SEAMANSHIP .....	2
Right-of-Way .....	2
Meeting Head-On .....	3
Crossing Situations.....	4
Overtaking.....	4
The General Prudential Rule .....	5
Night Running.....	5
Sound Signals .....	6
RECOMMENDED READING .....	7
CONTACTS .....	8
NAVIGATIONAL AIDS .....	9
International Association of Lighthouse Authorities	
System B (IALA-B) .....	9
The Uniform State Waterway Marking System .....	11
A Special Sign .....	12
OWNER'S/OPERATOR'S LOGS AND RECORDS .....	12
NAVIGATIONAL AIDS CHART .....	13
BOAT DATA SHEET .....	16
SERVICE / MAINTENANCE LOG .....	18
<b>9 BOATING TERMINOLOGY .....</b>	<b>1</b>

# INTRODUCTION

It's your leisure time! You earned it and you deserve it! You have made an excellent choice by selecting a Lund boat to round out your leisure time. Whether you're out for a day of water skiing, just taking a relaxing cruise or heading out early in the morning for a day of fishing, you know you have the best in quality and comfort.

Please take the time to read this manual before you take your boat out the first time. Also read all literature supplied with your boat by the manufacturers of the various components and accessories used on your boat. In particular, you want to become familiar with operating your engine.

If you are a novice boater, you may not be familiar with the terms experienced boaters use. Figure 1-1 will help you. They list some of the common terms and how they apply to a typical boat.

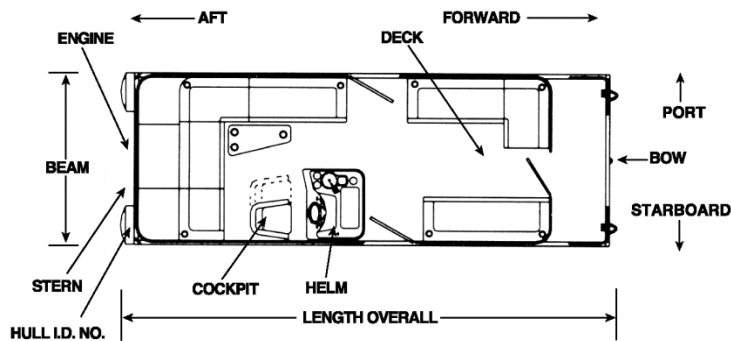

**FIGURE 1-1 TERMINOLOGY (PONTOON)**



Before your first boating excursion, look your boat over and become familiar with it. Find its components, gauges and operating equipment, and learn how to use them. Your outing will be safer and more enjoyable.

If a family member or friend operates your boat, be sure he or she fully understands the controls and operation of the boat. The helmsman is responsible for ensuring the safety of the boat's passengers and other water users.

Passengers should also be aware that courteous, responsible riding is important.

This manual is part of your boat's equipment. It does not supersede or change any of the original manufacturer's specifications, operation or maintenance instructions. Always keep it on board. If you transfer ownership of this boat to someone else, be sure to give this manual to the new owner.

## HAZARD COMMUNICATION STATEMENTS

Three types of hazard communication statements are used throughout this manual to call attention to special information, operating procedures and precautions for safe operation of your boat.



The safety alert symbol means pay attention! Your safety is involved! Failure to follow the recommendations in a hazard communication statement may result in property damage, personal injury, or death.

The signal words **DANGER**, **WARNING** and **CAUTION** identify hazards and the levels of hazard seriousness. Their selection is based on the likely consequence of human interaction with a hazard in terms of the probability of injury and the degree of severity. Failure to follow the recommendations contained in any of these statements may result in some form of personal injury. Definitions for identifying hazard levels with their respective signal words are as follows:

**⚠ DANGER**

Immediate hazards that **WILL** result in severe personal injury or death.

**⚠ WARNING**

Hazards or unsafe practices that **COULD** result in severe personal injury or death.

**⚠ CAUTION**

Hazards or unsafe practices that **COULD** result in minor personal injury or product or property damage.



## OWNER/OPERATOR ADVISORY STATEMENTS

Advisory statements alert you to conditions that affect equipment operation, maintenance and servicing practices.

An **IMPORTANT** statement indicates a procedure intended to prevent damage to equipment or associated components.

A **NOTE** statement is a general advisory statement relating to equipment operation and maintenance procedures.

## PROTECTING THE ENVIRONMENT

It's fun to be out on the water whether you're fishing, cruising or just soaking up sun. Unfortunately, not all boaters are responsible individuals and their foolish actions often spoil our waterways. Here are ten ways you can help protect the aquatic environment as recommended by the National Marine Manufacturers Association. Practice them every time you go out, and you can help assure that our waterways will remain clean and unspoiled for years to come.

- Observe local and federal marine head rules.
- Empty the waste holding tank on shore (if your boat has one).
- Know about and use legal bottom paints.
- Use biodegradable cleaning agents whenever possible.
- Don't litter on or off the water—take it home!
- Don't top off fuel tanks and always clean up fuel spills.
- Watch your wake and propeller wash.
- Keep your motors finely tuned.
- Control your bilge water.
- When fishing, practice "Catch and Release."

## GENERAL INFORMATION

This section of your boat manual contains important information about your Lund boat and general procedures to be followed before operating it.

## CERTIFICATION

The bottom half of the capacity plate indicates that all Lund boats have National Marine Manufacturers Association (NMMA) certification. This is different from the maximum capacities established by the U.S. Coast Guard. NMMA certification means that the design of specific boat systems complies with applicable federal regulations set forth by the U.S. Coast Guard. This certification covers the following components:

- Engines
- Fuel Systems
- Electrical Systems
- Mechanical Systems
- Navigation Lights

Lund boats also comply with the requirements of the Canadian Coast Guard for Canadian certification.

## HIGH-PERFORMANCE PONTOON BOATS

Lund offers an excellent line of high performance pontoon boats. All high performance pontoon boats have specially designed pontoons that have custom lift pads, also called strakes. Because of their size and shape, they are well suited for larger horsepower engines. This type of pontoon improves handling characteristics at all speeds and provides a very smooth ride. A power steering system allows the operator greater control while maneuvering. It also eliminates the prop torque that would otherwise give the boat the tendency to turn to the right.



## CAPACITY PLATE

If your boat is less than 20 feet (6.1 m) long, the U.S. Coast Guard requires that the manufacturer install a capacity plate stating the maximum load in pounds (persons and gear) the boat can carry safely under normal conditions and the motor's maximum horsepower. The U.S. Coast Guard establishes these load capacity ratings.

**You**, the operator, are responsible for using common sense and sound judgment when loading your boat. Give yourself an added margin for safety in turbulent waters. Pontoon boats tend to remain stable under most operating conditions. Whether you own a pontoon boat or a deck-boat, remember that overloading and improper distribution of weight are significant causes of accidents. *Keep weight below maximum limits for safety in turbulent waters. Overloading is a violation of U.S. Coast Guard regulations.*

### **WARNING**

Do not exceed your boat's capacity rating. An overpowered boat can become unstable, resulting in a loss of control or capsizing. An over-loaded boat can become hard to handle. Overloading can also reduce freeboard and increase the danger of flooding or swamping, particularly in rough water.

**IMPORTANT:** Your Lund warranty will be void if you exceed the recommended capacity horsepower rating.





NOTE: the capacity plate on your boat may differ from illustration if your boat was purchased outside of the United States.

## HULL IDENTIFICATION NUMBER

Along with a capacity plate, each Lund boat has a hull identification number assigned by the U.S. Coast Guard. The number on your pontoon boat is located on the top aft end of the starboard pontoon. The number for pontoon boats will begin with US LBB. For example: 0000000.



## OWNER/OPERATOR'S LOGS AND RECORDS

Two forms you will find very helpful are the following:

- Boat Data Record is used to record all important information about your boat and the major components installed.
- Service/Maintenance Log provides a record of maintenance work completed on your boat.

Refer to Chapter 8 for more information and copies of these forms.

## EDUCATION

Courses on boat handling and seamanship are conducted by volunteer organizations such as the U.S. Power Squadrons, the U.S. Coast Guard Auxiliary and the American Red Cross. These courses will sharpen your boating skills and bring you up-to-date on current rules and regulations even if you are a veteran boater. See Chapter 8 for more information.

## YOUR NEW BOAT

When you take delivery of your boat, both you and your dealer have specific responsibilities.

### Dealer Responsibilities

The dealer is responsible for the following:

Discussing the terms of all warranties, and stressing the importance of registering warranties with the appropriate manufacturers.

Providing instruction for obtaining warranty service.

Going over the pre-delivery service record with you, and then signing it to certify that all work has been done.

Providing you thorough instruction in how to operate your boat and all of its systems and components.

Completing the Lund boat warranty registration card and sending it in to the factory.

### Owner/Operator Responsibilities

As the owner, you are responsible for the following:



1. Signing off on the boat inspection sheet before delivery.
2. Warranty Register the boat with the Lund Factory
3. Keep a record of the hull number for future reference.
4. Inspecting the boat at the time of delivery to ensure that all systems and components are working properly.
5. Reviewing the pre-delivery engine service record with your dealer. Signing this record to indicate that your dealer has explained this to you.
6. Operating all equipment in accordance with the manufacturer's instructions. Reading all manuals and instructions supplied with your boat.
7. Referring to your engine warranty for initial inspection and service requirements.
8. Performing or providing for the appropriate periodic maintenance outlined in the owner's manuals and service guides.
9. Scheduling your boat's 20-hour check-up with your dealer.

NOTE: Lund advises that all rigging, installation, and prep work on any model be done by an Authorized Dealer at the Authorized Dealer's location.

## WARRANTY

Your new Lund boat is backed by a limited express warranty. The complete warranty is supplied separately within the boats document bag. It is important to understand all the terms of the warranty. If you have a problem with your boat, contact your dealer immediately to determine warranty coverage. When you contact your dealer, please have the model or serial numbers and the hull identification number readily available.

## EQUIPMENT MANUFACTURER MANUALS

Lund purchased various equipment and components from other manufacturers and installed them on your boat while it was being built. The suppliers of standard and optional equipment maintain their own manufacturer's warranty and service facilities. Warranty registration cards are in your owner's packet. Fill out each warranty card and mail it to the manufacturer to validate the warranty. Record all pertinent information on your Boat Data Record. A copy of this form is in Chapter 8.

Most OEMs (original equipment manufacturers) have also provided operation and maintenance manuals for your boat's equipment. Keep the OEM manuals with your Owner/Operator's Manual in a safe and accessible place. Be sure to pass them along to the new owner if you sell your boat.

Please note that, in some cases, information in this manual only summarizes more detailed information in the equipment manuals. If any operation or maintenance information in the OEM manuals conflicts with the information in this manual, the OEM manuals take precedence.



## OWNER/OPERATOR RESPONSIBILITIES

Boating is an enjoyable and relaxing leisure time activity. But responsibility is also a part of boating. You are responsible for the following:

- Registering your boat with state authorities
- Providing adequate insurance
- Obeying the “Rules of the Road”
- Maintaining your boat and its equipment
- Acquiring and maintaining safety equipment
- Safety training of passengers and crew
- Understanding the operation of boat systems and equipment
- Making seaworthiness/operational inspections
- Operating your boat safely
- Being aware of and understanding all safety considerations related to boat operation
- Avoiding the use of alcohol and drugs
- Complying with environmental regulations
- Filing accident reports, if necessary

Lund recommends that all boaters take safe boating courses. We also believe that boaters have one more major responsibility—the environment. While you’re out on the water, keep in mind the future of our waterways and the marine life that makes them its home. Do everything you can to preserve the natural habitats we still have. Keep them free of garbage and debris. Preserving our waterways and habitats now can help assure the pleasure of boating for others for years to come.

## BOATING LAWS AND REGULATIONS

### Boat Registration

Every boat equipped with propulsion machinery of any type must be registered in the main state of usage. In nearly all states this means registration with the designated state agency. In a few jurisdictions, the Coast Guard retains registration authority. All motor craft not documented by the U.S. Coast Guard must display registration numbers. Registration numbers and validation stickers must be displayed on the boat according to regulations. Your dealer will either supply registration forms or tell you where they may be obtained. The registration agency will issue a certificate which must be aboard when using your new boat.

Some states and localities have limits in speed, noise and trailer specifications. It is your responsibility to be aware of these laws and limits and to be sure that your boat (and trailer) comply. Consult with your local sheriff marine patrol, local Coast Guard office, or state Department of Natural Resources.

### Insurance

The boat owner is legally responsible for any damages or injuries caused by the boat. In most states this is true even if someone else is operating the boat when the accident occurs. You should carry adequate personal liability and property damage insurance on your boat as you do on your automobile. You should also protect your investment by insuring your boat against physical damage or theft.

### Discharge of Oil

The Federal Water Pollution Control Act prohibits the discharge of oil or oily waste into or upon the navigable waters of the United States or the waters of the contiguous zone if such discharge causes a film or sheen upon or a discoloration of the surface of the water or causes a sludge



or emulsion beneath the surface of the water. Violators are subject to a penalty of \$5,000.

### Disposal of Plastics and Other Garbage

Plastic refuse dumped in the water can kill fish and marine wildlife and can foul propellers and water intakes. Other forms of waterborne garbage can litter beaches and make people sick. U.S. Coast Guard regulations completely prohibit the dumping of plastic refuse or other garbage mixed with plastic anywhere and restrict the dumping of other forms of garbage within specified distances from shore.

### MARPOL Treaty

Boats 26 feet (7.9 m) or longer must display a sign stating the disposal regulations of the Federal Water Pollution Control Act. The sign warns against the discharge of plastic and other forms of garbage within the navigable waters of the United States. The placard also must note that state and local regulations may further restrict the disposal of garbage. A special placard is available for boats operating on the Great Lakes. Even if your boat is less than 26 feet (7.9 m) long, proper disposal of garbage helps protect our waterways and marine life.

### Marine Sanitary Device

If your boat has a Porta-Potti,<sup>®</sup> it is illegal to discharge the waste into the water in most areas. You are responsible for being aware of and obeying all local laws concerning waste discharge. Consult with the Coast Guard, local marina or your dealer for information.



## HAZARD COMMUNICATION LABELS

Some or all of the labels shown below can be found in various locations on your boat. The labels appropriate for your boat are determined by the standard and optional equipment actually installed on board your boat upon delivery. Check with your dealer to find out what labels your boat should have. If any label is missing, ask your dealer for a replacement.

**IMPORTANT:** The purpose of these labels is to prevent accidents, injury or death. Make sure everyone on board reads and understands them

### **BOATER'S CHECK LIST**

For maximum enjoyment and safety, check each of these

items **BEFORE** you start your engine:

- ✓ DRAIN PLUG (Securely in place?) (if applicable)
- ✓ LIFE-SAVING DEVICES  
(One for every person on board?)
- ✓ STEERING SYSTEM  
(Working smoothly and properly?)
- ✓ FUEL SYSTEM  
(Adequate fuel? Leaks? Fumes?)
- ✓ BATTERY  
(Fully charged? Cable terminals clean and tight?)
- ✓ ENGINE (In neutral?)
- ✓ CAPACITY PLATE  
(Are you overloaded or overpowered?)
- ✓ WEATHER CONDITIONS (Safe to go out?)
- ✓ ELECTRICAL EQUIPMENT  
(Lights, horn, pump, etc.?)
- ✓ EMERGENCY GEAR  
(Fire extinguisher, bailer, paddle, anchor & line, signaling device, tool kit, etc.?)

 **DANGER**

**Avoid Personal Injury.  
Do not use boarding ladder  
if engine is running.**

 **DANGER**

**Avoid Personal Injury.  
Do not occupy this area  
while boat is underway.**

 **WARNING**

**Avoid Personal Injury.  
Do not occupy this seat while boat  
is underway.**



### Warning Label Parts List

<b>PART #</b>	<b>DESCRIPTION</b>	<b>REQ / OPT - LOCATION</b>
2046477	CAUTION DO NOT LIFT BY MOORING EYES	OPTIONAL-BOW MOORING EYE
2043774	WARNING DO NOT HANG LEGS OVER BOW	OPTIONAL-BOW RUB RAIL
2110767	WARNING FUEL FILL U.S.	REQUIRED- NEAR FUEL FILL



2043420	DANGER DO NOT OCCUPY AREA , IN MOTION	OPTIONAL-REAR RUB RAIL
2054293	DANGER CO LADDER	REQUIRED-NEAR LADDER
2043419	DANGER SPINNING PROP LADDER	REQUIRED-NEAR LADDER
2043641	PATENT RUB RAIL	OPTIONAL-SIDE RUB RAIL
2043652	PATENT "M" BRACKET	OPTIONAL-STBD TUBE BRKT
2048819	WARNING FUEL FILL CANADIAN	REQUIRED-NEAR FUEL FILL
2137003	WARNING CONNECT OUTLET TO GFCI, CHARGER	REQUIRED-BY CHARGER PLUG
2047948	DANGER CONNECT SHORE POWER BEFORE ENERG.	OPTIONAL-BY CHARGER PLUG
2047947	DISCONNECT S. POWER BEFORE LEAVING DOCK	OPTIONAL-AT HELM
2043773	WARNING STAY INSIDE GATES, WHEN ENGINE ON	REQUIRED-FRONT GATE
2043423	DANGER STAY INSIDE GATES, BOAT IN MOTION	OPTIONAL-SIDE & REAR GATES
1822946	WARNING CALIFORNIA PROP 65 HANG TAG	OPTIONAL-STEERING WHEEL
2043422	WARNING DO NOT STORE FUEL, NO VENTILATION	REQUIRED-SEAT BASES ETC.
2201012	DANGER CO/PROP STRIKE, FOR/AFT FACING SEAT	OPTIONAL-FOR/AFT SEAT AREA
2029125	SAVE OUR SEAS, BOATS 26 FEET AND LONGER	REQUIRED- ANYWHERE
2059992	WARNING, CAUTION, INFO, S/D FIXED FIRE EXT.	REQUIRED-HELM,PORT, ENG
2100808	WARNING LIMITED VISIBILITY, FULL ENCLOSURE	OPTIONAL-AT HELM
2155003	DANGER CO, FULL ENCLOSURE	OPTIONAL AT HELM
2047915	DANGER DO NOT OCCUPY AREA , IN MOTION	OPTIONAL-AREA OUTSIDE RAILS
2043421	DANGER DO NOT OCCUPY SEAT, IN MOTION	OPTIONAL-SEAT OUTSIDE RAILS
2043756	DANGER PROP, GATES DRIVERS CHECKLIST	REQUIRED-AT HELM
2151075	WARNING CO HELM	REQUIRED-AT HELM

## 18 INTRODUCTION

2043790	NMMA CERTIFIED DOMED PREMIUM BOATS	OPTIONAL-WINDSCREEN
1987936	NMMA CERTIFIED FLAT, ECONOMY BOATS	OPTIONAL-WINDSCREEN
2137726	WARNING MANUVERABILITY ABOVE 55 TWIN ENG.	REQUIRED-AT HELM
2043483	WARNING PINCH POINT, IN HOUSE LADDERS	OPTIONAL-ON LADDERS
2043556	CAUTION TURN ENGINE STRAIGHT BEFORE TILTING	OPTIONAL-ON ENG. COWL
2054367	CAUTION CONNECT BATT.CABLE, AUTO BILGE, S/D	REQUIRED- POS. BATT. CABLE
2059981	POLLUTION PLACARD OIL DISCHARGE, S/D	REQUIRED-MOTOR HOOD
2209366	NOT POTABLE WATER	REQUIRED- AT FAUCET/SPIGOT
2231480	WARNING REC DEK RULES OF USE	REQUIRED-UPPER DEK FENCE
2053181	WARNING NO CHILDREN UNDER 12 UNATTENDED	REQUIRED-HELM, UD FENCE
2231479	CAUTION INTERFERENCE, SKI TOW & SLIDE	OPTIONAL-AT HELM



## LX: LUND CRUISE (LC) LAYOUTS



LC 200

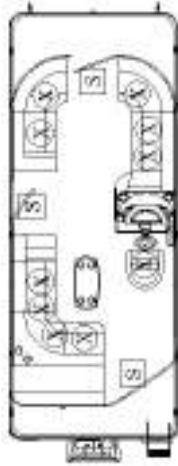

LC 220

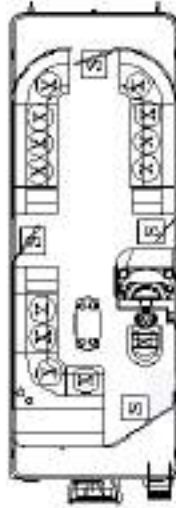

LC 240

# LX: WALK THROUGH & DUAL SEAT (WT & WTDS) LAYOUTS

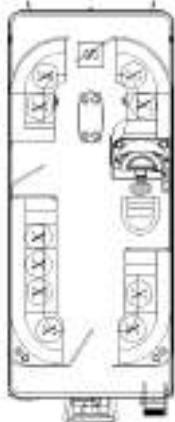

WT200

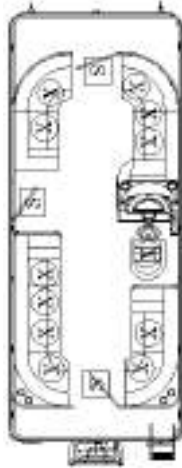

WT220

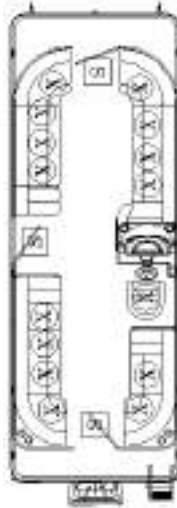

WT240

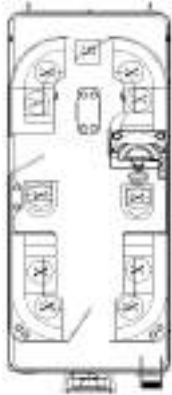

WTDS 200

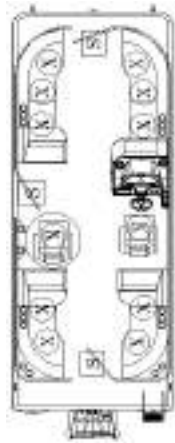

WTDS 220

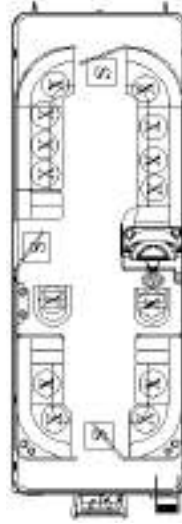

WTDS 240



LX: FISH (4 POINT) & FISH/CRUISE (2 Point) (LF & LFC) LAYOUTS



LC200

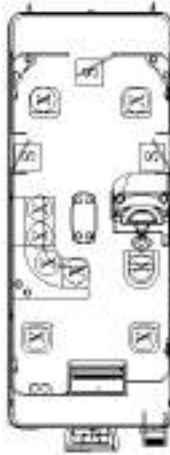

LC220



LF240



LFC200



LFC220

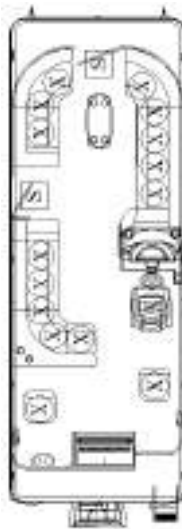

LFC240



## SAFETY

You should fully understand and become familiar with the operating procedures and safety precautions in this manual and the other information in the owner's/operator's packet before you launch your boat. Remember: "Safe boating is no accident." Always operate your boat with consideration, courtesy and common sense.

Before leaving on your boating excursion, be sure that all required safety equipment is on board. This includes the minimum required equipment and additional gear needed for your excursion. Periodically inspect all safety equipment to be sure it is in proper operating condition. Make sure all passengers know what safety equipment is on board, where it is and how to use it.

## SAFE BOATING RECOMMENDATIONS

Boating safety and the safety of your passengers is YOUR responsibility. You should fully understand all of the following safety precautions before you launch your boat.

- **Never operate a boat while under the influence of drugs or alcohol.** Doing so is a Federal offense. Make sure only qualified drivers operate your boat.
- Keep your boat and equipment in safe operating condition. Inspect the craft, engine, safety equipment and all boating gear regularly.
- Be sure lifesaving and fire extinguishing equipment is on board. This equipment must meet regulatory standards, and it should be noticeable, accessible and in safe operating condition. Your passengers should know where this equipment is and how to use it.
- Always keep accurate, updated navigation charts of the area on board.



- Before you leave shore, tell a family member, relative, friend or another responsible person ashore where you are going and when you expect to return.
- Do not allow passengers to ride on parts of your boat other than designated seating areas. All passengers should remain seated while the boat is moving. Passengers should stay inside rails, gates and gunwales while boat is underway.
- Passengers should not occupy portable or swivel fishing seats while boat is underway.
- Passengers should not occupy sundecks, bow deck, or sun lounges while boat is underway.
- Understand and obey the "Rules of the Road."
- Always maintain complete control of your boat.
- Do not overload or improperly load your boat. The capacity plate is a guide. You must use good judgment and take water and weather conditions into consideration.

## SAFETY GEAR AND EQUIPMENT

As the owner/operator of the boat, you are responsible for supplying all required safety equipment. Check state and local regulations and call the U.S. Coast Guard Boating Safety Hotline at 1-800-368-5647 for information about required safety equipment. You should also consider supplying additional equipment recommended for your safety and that of your passengers. A list of this equipment appears later in this chapter.

### Required Gear and Equipment

Most safety equipment required by federal regulations is provided as standard equipment on your boat. However, you are responsible for obtaining required safety equipment approved by the U.S. Coast Guard if it is not provided. Minimum requirements include the following:

- Personal Flotation Devices (PFD)
- Sound Signaling Device
- Fire Extinguisher
- Visual Distress Signal
- Navigation Lights

NOTE: Requirements may be stricter in some states.

## Personal Flotation Devices (PFDs)

You are required by Federal Regulations to have at least one Coast Guard approved personal flotation device for each person in your boat. You may not use your recreational boat unless all your PFDs are in serviceable condition, are readily accessible, legibly marked with the Coast Guard approval number and are of an appropriate size (within the weight range and chest size marked on the PFD) for each person on board. Your PFD provides buoyancy to help keep your head above the water and to help you remain in a satisfactory position while in the water.



**FIGURE 2-1 PFD TYPE I, WEARABLE**

PFD Type I, Wearable (Figure 2-1) has the greatest required buoyancy. Its design allows for turning most unconscious persons in the water from face down position to a vertical or slightly backward, face-up position. Type I is most effective for all waters, especially offshore when rescue may be delayed.



**FIGURE 2-2 PFD TYPE II, WEARABLE**

PFD Type II, Wearable (Figure 2-2) turns its wearer in the same way as Type I, but not as effectively. The Type II will not turn as many persons under the same conditions as a Type 1.



**FIGURE 2-3 PFD TYPE III, WEARABLE**

PFD Type III, Wearable (Figure 2-3) allows the wearers to place themselves in a vertical or slightly backward position. It has the same buoyancy as a Type II PFD. It has little or no turning ability.

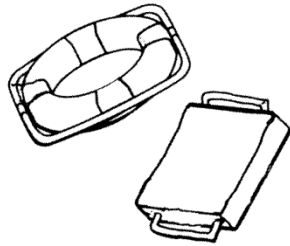

**FIGURE 2-4 PFD TYPE IV, THROWABLE**

PFD Type IV, Throwable (Figure 2-4) can be thrown to a person in the water, grasped and held by the user until rescued. The most common Type IV PFDs are a buoyant cushion or ring buoy. The throwable Type IV PFD should be immediately available for use and always in serviceable condition. This PFD is required in addition to the PFDs previously discussed.



**FIGURE 2-5 PFD TYPE V, WEARABLE**

PFD Type V, Wearable (Figure 2-5) must be worn. When inflated, it provides buoyancy equivalent to Type I, II or III PFDs. When it is deflated, it has little buoyancy. This PFD must be used according to the approval condition on the label and must be worn while underway.

## Fire Extinguisher

Class A and Class I boats (power boats 16-26 feet [4.8-7.9 m] long) must carry at least one U.S. Coast Guard approved portable fire extinguisher. Coast Guard approval is indicated on the label. The extinguisher can be any one of the following: 2-pound 9 (0.9 kg) dry chemical, 4-pound (1.8 kg) carbon dioxide, or 1-1/4 gallon (4.7 liter) foam extinguisher.

All hand portable fire extinguishers should be mounted in a readily accessible location away from the engine compartment. Everyone aboard should know where the fire extinguisher is and how to use it.

If your fire extinguisher has a charge indicator gauge, cold or hot weather may affect the gauge reading. Consult the instruction manual supplied with the fire extinguisher to determine the accuracy of the gauge.

## Sound Signaling Device

Class I boats are required to carry a hand, mouth or power operated horn or whistle. They are also recommended for Class A boats. It must produce a blast of two-second duration audible at a distance of at least 1/2 mile (0.8 km). The device should be used to promote safe passing, as a warning to other vessels in fog or confined areas or as a signal to operators of locks or drawbridges. Following are standard whistle signals:

- One Prolonged Blast = Warning signal
- One Short Blast = Pass on my port side
- Two Short Blasts = Pass on my starboard side
- Three Short Blasts = Engines in reverse
- Five or More Blasts = Danger Signal



## Navigation Lights

Navigation lights are intended to keep other vessels informed of your presence and course. If you are operating your boat between sunset and sunrise, you are required to display appropriate navigation lights.

## Visual Distress Signals

U.S. Coast Guard regulations require all recreational boats be equipped with visual, distress signal equipment. The regulations apply to boats used on coastal waters, which includes the Great Lakes, territorial seas and those waters directly connected to the Great Lakes and the territorial seas, up to a point where the waters are less than two miles (3.2 km) wide, and to boats owned in the United States when operating on the high seas.

Visual distress signal equipment may be of the pyrotechnic or non-pyrotechnic type. The equipment must be approved by the U.S. Coast Guard, be in serviceable condition, and be stowed in a readily accessible location. Equipment having a date for serviceable life must be within the specified usage date shown. *Careful selection and proper stowage of visual distress equipment is very important especially if young children are aboard.*

No one signaling device is ideal under all conditions or for all purposes. Consider carrying various types of equipment on board. Approved pyrotechnic visual distress signals and associated equipment include red flares, hand-held or aerial; orange smoke, hand-held or floating; and launchers for aerial red meteors or parachute flares. Approved non-pyrotechnic equipment includes orange distress flags and electric distress lights.



## Recommended Additional Gear and Equipment

You should consider adding all or some of the following equipment aboard. You may want to add other items depending upon your boating needs.

### Basic Needs

- Anchor and Anchor Line
- Dock Fenders
- First-Aid Kit
- Oar or Paddle
- Flashlight
- VHF Radio
- Sunburn Lotion
- Boat Hook
- Compass
- Foul Weather Gear
- Ring Life Buoy with Line
- Two Line
- Mooring Lines, qty. 2
- Flashlight or Portable Searchlight
- Sea Anchor (open waters)
- Extra Warm Clothing
- Emergency Supply of Drinking Water and Food

### Gear and Equipment for Extended Cruises

- Charts of the Area
- Dividers
- Rainwear
- Spare Battery
- Parallel Rulers



## Tools

- Screwdrivers
- Pliers
- Hammer
- Adjustable Wrench
- Sparkplug Wrench
- Jackknife
- Electrical Tape
- Lubricating Oil
- Duct Tape

## Spare Parts

- Spare Light Bulbs
- Spare Propeller
- Spare Batteries
- Sparkplugs
- Propeller Nut and Washer
- Fuses
- Flashlight Batteries

## SAFE BOATING PRACTICES

YOU are responsible for your own safety, the safety of your passengers and the safety of fellow boaters.

### Drugs and Alcohol

*Alcohol consumption and boating do not mix! Operating under the influence endangers the lives of your passengers and other boaters. Federal laws prohibit operating a boat under the influence of alcohol or drugs.*

Do not use drugs or drink alcohol while operating your boat. Like driving a car, driving a boat requires sober, attentive care. Operating a boat while intoxicated or under the influence of drugs is not only dangerous, it is also a Federal offense carrying a significant penalty. These laws are vigorously enforced. The use of drugs and alcohol, singly or in combination, decreases reaction time, impedes judgment, impairs vision and inhibits your ability to safely operate a boat.

### Safe Operation

Safe operation means that you do not misuse your boat nor do you allow your passengers to do so. Safe operation means using good judgment at all times. It includes, without limitation, the following actions:

- Load your boat within the limits listed on the capacity plate. Balance loads bow to stern and port to starboard. (See loading instructions in Chapter 5.)
- Maintain boat speed at or below the local legal limit. Avoid excessive speed or speeds not appropriate for operating conditions.
- Do not use your boat in weather or sea conditions beyond the skill or experience of the operator or the comfortable capability of the boat or passengers.
- Be sure at least one other passenger is familiar with the operation and safety aspects of the boat in case of an emergency.
- Make sure that passengers and gear do not obstruct the operator's view or ability to move.



- Do not exceed the maximum engine power rating stated on the certification plate attached to your boat.
- Always keep the bow gate closed while the boat is in motion to prevent falls overboard and possible injury by rotating propeller.
- Do not remove or modify the gates or rails. They are safety devices!
- Do not allow passengers to sit on the foredeck, seat backs, sun lounge or gunwales while the boat is moving. This will prevent falls overboard and possible injury by the rotating propeller.
- Observe the maximum maneuvering speed posted on the helm of high performance boats. High-speed turns under certain conditions can be dangerous.
- Make sure engine is off and propeller is stopped before using boarding ladder.

## Fire

### GUIDELINES FOR FIRE PREVENTION

- Check cleaning products for flammability
- Ventilate when cleaning or painting
- Disconnect electrical system from power source when performing any type of maintenance
- Use extra caution when using exposed flame around urethane foam
- Extinguish smoking materials carefully
- Ensure ventilation systems are not obstructed
- Use only approved marine cooking and heating systems
- Open flames demand constant attention
- Keep flammable materials in approved containers
- Replace circuit breaker fuse with one of the same amperage
- Electrical appliances must be within rated amperage of boat circuits
- The electrical system should be serviced by a qualified marine electrician

## Passenger Safety

Before getting underway, show all passengers where emergency and safety equipment is stowed and explain how to use it. Everyone aboard should wear shoes which resist slipping on wet surfaces and protect toes and feet from injury. While underway, passengers should remain seated inside the deck rails and gates. Don't allow them to ride on the sun lounge or engine pod, outside the rails or in other unsafe positions. Don't allow passengers to drag their feet or hands in the water. Always use handholds and other safety hardware to prevent falls.

## Propeller

Do not allow anyone near a propeller, even when the engine is off. Propeller blades can be sharp and can continue to turn even after the engine is shut off. Body contact with a rotating propeller can cause serious injury or death.

## First Aid

As a boat operator, you should be familiar with basic first aid procedures that may be needed while you are far from help. Fish hook accidents or minor cuts and abrasions may be the most serious mishaps on board a boat. You should also learn the proper procedures and be ready to deal with the truly serious problems like mouth-to-mouth resuscitation, excessive bleeding, hypothermia and burns. First aid literature and courses are available through most Red Cross chapters.



## Operation by Minors

Minors should always be supervised by an adult whenever operating a boat. Many states have laws regarding the minimum age and licensing requirements of minors. Be sure to contact the state boating authorities for information.

## Rules of the Road

As a responsible boater, you will comply with the "Rules of the Road," the marine traffic laws enforced by the U.S. Coast Guard. Navigating a boat is much the same as driving an automobile. Operating either one responsibly means complying with a set of rules intended to prevent accidents. Just as you assume other car drivers know what they are doing, other boaters assume you know what you are doing. Chapter 8 has more information about navigational rules and the Rules of the Road.

## Voluntary Inspections

State boating officials in many states or the U.S. Coast Guard Auxiliaries offer courtesy inspections to check out your craft. They will check your boat for compliance with safety standards and required safety equipment. You may voluntarily consent to one of these inspections, and you are allowed time to make corrections without prosecution. Check with the appropriate state agency or the Coast Guard Auxiliary for details.

## Safe Boating Courses

Your local U.S. Coast Guard Auxiliary and the U.S. Power Squadrons offer comprehensive safe boating classes several times a year. You may contact the Boat/U.S. Foundation at 1-800-336-BOAT (2628) or, in Virginia, 1-800-245-BOAT (2628) for a course schedule in your area. Also contact your local U.S. Coast Guard Auxiliary or Power Squadron Flotilla for the time and place of their next scheduled class.

## CARBON MONOXIDE

Burning a material containing carbon produces carbon monoxide (CO), an odorless and colorless gas. You cannot see or smell CO. Because it weighs the same as air, it can spread throughout an enclosed space without your knowledge. Any device used to burn carbon based materials on your boat or those around you can be a source of CO. Common sources of carbon monoxide include internal combustion engines and open flame devices such as charcoal grills.

The lungs absorb carbon monoxide that then reacts with the blood to reduce the blood's ability to carry oxygen. The reduced oxygen supply to body tissues results in death of the tissue. Prolonged exposure can cause death.

In high concentrations, CO can be fatal within minutes. The effects of CO in lower concentrations are cumulative and can be just as lethal over long periods of time. Symptoms of CO poisoning include: itchy and watering eyes, flushed appearance, throbbing temples, inability to think coherently, ringing in the ears, tightness across the chest, headaches, drowsiness, nausea, dizziness, fatigue, vomiting, collapse and convulsions.

If you observe any of these symptoms, begin treatment immediately. Prompt action can make the difference between life and death. Evacuate the area and move the victim to fresh air. Administer oxygen if available and get medical help. Open all canvas to ventilate the area. Investigate the source of CO and take immediate corrective action; be especially aware of sources adjacent to the boat.

 **DANGER**

Carbon monoxide can be harmful or fatal if inhaled. Keep exhaust outlets clear of blockage. Provide adequate ventilation. Open hatches, doors, windows and vents to ensure adequate ventilation. Close engine compartment doors and hatches when engine or generator is running.

## Carbon Monoxide Accumulation

Following are common situations in which carbon monoxide (CO) can accumulate within enclosed areas of your boat while docked, anchored or underway. Become familiar with these examples and their precautions and be alert to other situations to prevent CO poisoning.

### **⚠ DANGER**

Generator or hull exhaust from other vessels while either docked or anchored can accumulate within enclosed areas of your boat. Be alert for generator exhaust from other vessels alongside (Figure 2-6).

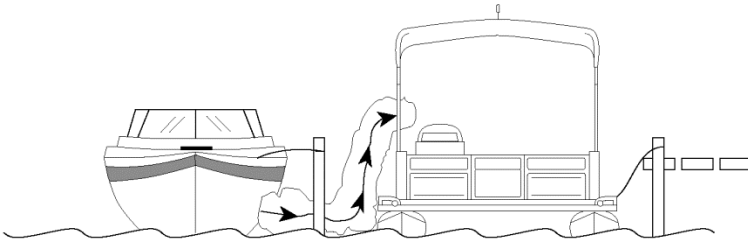
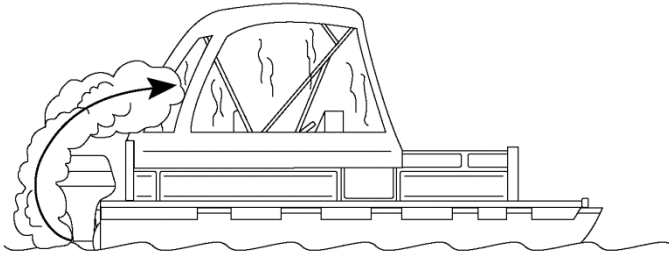

**FIGURE 2-6 VESSEL ALONGSIDE**

### **⚠ DANGER**



Under certain conditions, tail wind, boat speed or high bow angle can draw carbon monoxide into enclosed areas (back-drafting). CO can accumulate to dangerous levels without proper airflow. Open front canvas to provide adequate ventilation, redistribute the load or bring boat out of high bow angle (Figure 2-7).



**FIGURE 2-7 BACKDRAFTING**

**⚠ DANGER**

With canvas in place, hull exhaust while underway can cause CO to accumulate within enclosed areas. Provide adequate ventilation when the canvas top, side curtains and/or back curtains are in their closed protective positions (Figure 2-8).

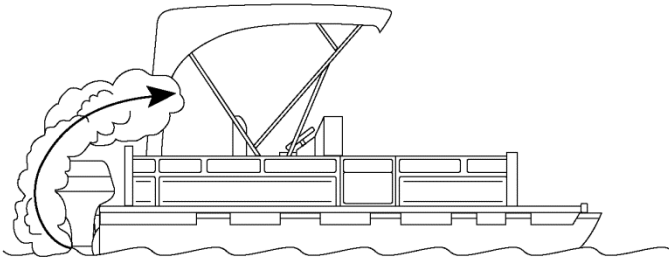

**FIGURE 2-8 WHILE UNDERWAY**

**⚠ DANGER**

When hull exhaust outlets are blocked by a pier, dock, seawall or any other means CO can accumulate within enclosed areas. Make sure hull exhaust outlets are not blocked (Figure 2-9).

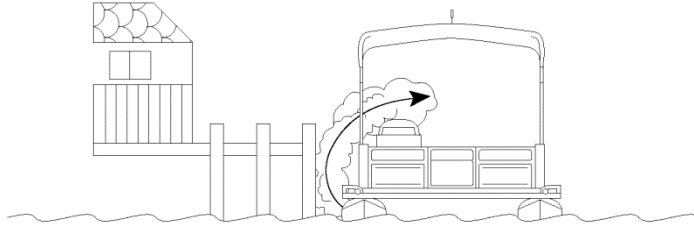

**FIGURE 2-9 BLOCKED OUTLETS**

Even with the best boat design and construction, CO may still accumulate in enclosed areas under certain conditions. Continuously observe passengers for symptoms of CO poisoning.

## CO Detector

We recommend that you have marine grade CO detectors installed in boats with canvas enclosures. Monitors are available from your dealer. Monitors should be professionally installed and calibrated.

NOTE: A CO detector is not a gas fuel vapor detector. Gas fuel vapor detectors do not monitor the buildup of carbon monoxide in an enclosed area.

## LANYARD STOP SWITCH

Your boat may have a lanyard stop switch. This safety device automatically stops the engine when lanyard is attached to the operator and the operator moves far enough away from the control station to activate the switch. The following summarizes information about this switch. The engine owner's manual may have more detailed information.

## **▲ WARNING**

Personal Injury! The lanyard stop switch must never be removed or modified and must always be kept free from obstructions that could interfere with its operation.

The stop switch (Figure 2-10) incorporates a shutoff switch, switch clip, lanyard between 4 and 5 feet (1220 and 1524 mm) long, and lanyard clip. The clip on one end of the lanyard should be securely attached to the operator's clothing, arm or leg at a place that is free of obstructions and allows free movement. The plate on the other end of the lanyard must be attached to the engine switch in order for the engine to run.

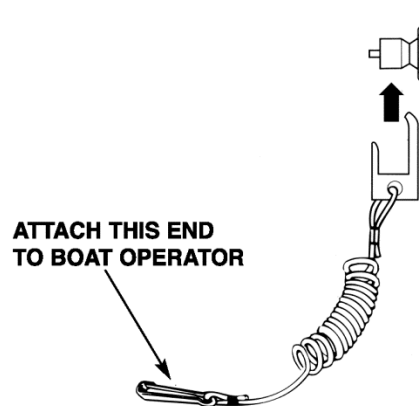

**FIGURE 2-10 LANYARD STOP SWITCH**

NOTE: The switch on your boat may be different from the typical switch illustrated here. Refer to the engine manual for more information.

If the operator moves too far away from the ignition switch, the lanyard pulls the plate out of the switch and shuts off the engine. Movement away from the switch can be the

result of poor operating practices such as a fall if the operator is standing or operating recklessly. It is not possible to identify every possible situation in this manual. Operators should use common sense and good judgment at all times.

If the switch is activated and the engine is shut down, the boat will continue to coast out of control. Loss of control could pose a safety hazard for other craft, swimmers or water skiers in the disabled boat's path. Loss of control could also pose a problem while docking and while operating in heavy seas, strong currents or high winds. Passengers could also lose their balance and fall.

## **WARNING**

Death or serious poisoning can result from exposure to carbon monoxide from engine exhaust. Turn off the boat motor and gasoline-powered generators that exhaust at or near the water level when the swim platform on the stern is in use. Swimmers should not enter the area under the swim platform.

## WATER SPORTS

### **WARNING**

To prevent personal injury, do not use your boat for pulling parasails, kites, gliders or any device which can become airborne.

Water skiing, knee boarding or riding a towed, inflatable apparatus are some of the more popular water sports. Taking part in any water sport requires increased safety awareness by the participant and the boat operator. If you have never pulled someone behind your boat before, it is a good idea to spend some hours as an observer, working with and learning from an experienced driver. It is also important to be aware of the skill and experience of the person being pulled.

Everyone participating in a water sport should observe these guidelines:

1. Allow only capable swimmers to take part in any water sport.
2. Always wear a personal flotation device (PFD) approved by the U.S. Coast Guard. Wearing a properly designed PFD will help a stunned or unconscious person stay afloat.
3. Always participate in water sports in safe areas. Stay away from other boats, docks, piers, beaches, swimmers and heavily traveled waterways.
4. Be considerate of others who share the water with you.
5. Give immediate attention to a person who has fallen. He or she is vulnerable in the water alone and may not be seen by other boaters.
6. Approach a person in the water from the lee side (opposite the direction of the wind). Stop the motor before coming close to the person.

7. Turn off engine and anchor your boat before swimming or using a boarding ladder.
8. Swim only in areas designated as safe for swimming. These are usually marked with a swim area buoy. Do not swim alone or at night.
9. Stay at least 150 feet (45 m) away from areas marked by a diver down float (Figure 2-11).

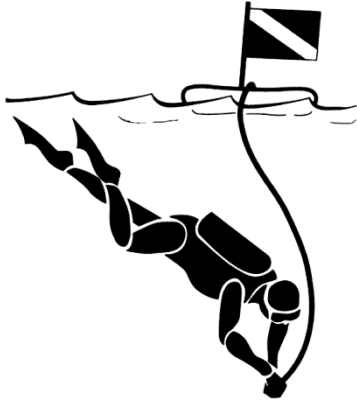
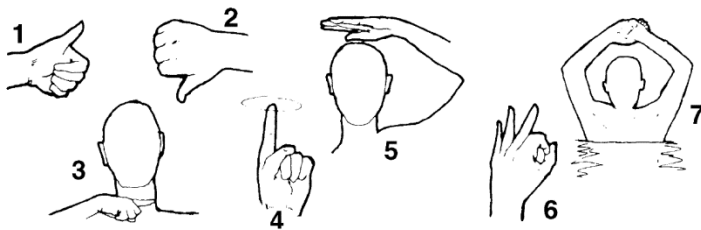

**FIGURE 2-11 DIVER DOWN FLOAT**

## Water Skiing

The popular sport of water skiing has brought a special set of safety precautions to observe in boating. The following guides, in addition to the guides listed above, will do much to reduce the hazards while water skiing. For more information about water skiing, please contact the American Water Ski Association, 799 Overlook Drive, Winter Haven, FL 33884 (1-800-533-2972).

1. Water ski only in safe areas, away from other boats and swimmers, out of channels, and in water free of underwater obstructions.
2. Allow no one who cannot swim to water ski.
3. Have a second person aboard to observe the skier and inform the driver about the skier's hand signals (Figure 2-12). The driver must give full attention to operating the boat and the waters ahead.



**FIGURE 2-12 WATER SKIER HAND SIGNALS**

1. **Thumb Up:** Speed up the boat.
2. **Thumb Down:** Slow down the boat.
3. **Cut Motor/Stop:** Immediately stop boat. Slashing motion over neck (also used by driver or observer).
4. **Turn:** Turn the boat (also used by driver). Circle motion—arms overhead. Then point in desired direction.
5. **Return to Dock:** Pat on the head.
6. **OK:** Speed and boat path OK or signals understood.

7. **I'm OK:** Skier OK after falling.
4. Give immediate attention to a fallen skier. Always keep fallen skier on operator's side of the boat when returning to attend the skier. Operator should always have fallen skier in sight. Be careful not to swamp the boat while taking a skier on board.

**⚠ DANGER**

Switch engine off before taking skiers aboard from in the water. Do not leave engine running in neutral; if the shift is accidentally engaged, rotating propeller can seriously injure skier.

5. Do not water ski between sunset and sunrise. It is illegal in most states.



# SYSTEMS AND COMPONENTS

This section provides information about your boat's electrical system, instruments, controls and other equipment.

NOTE: Some of the equipment described in this chapter may be standard for some models and optional or not available for other models. Check with your Lund dealer if you have questions about boat equipment.

## ELECTRICAL SYSTEM

Your boat's electrical system is a 12 volt, direct current (DC) type similar to the system in an automobile. A battery or batteries supply power to the system. The battery is charged through an engine-driven alternator. A voltmeter at the helm dash shows the charge level of the battery. DC circuit breakers, also at the helm dash, operate 12 volt equipment and protect it from power surges. Turning the ignition switch off does not cut power to all components.

The battery's negative terminal is connected to the engine grounding stud. This type of negative ground system is the approved system for marine DC electrical systems. The main feed has an inline fuse in the battery compartment.

The electrical system is wired at the factory to handle factory-installed electrical equipment. recommends that you have your dealer install any additional equipment. An error in wiring the electrical circuits can cause a fire or damage electrical system components. Have your dealer repair the electrical system and install additional equipment.

If you do add additional equipment, it must be adaptable to the negative ground system. When installing additional equipment be sure to take the power supply from the circuit breaker panel. Be sure to protect all electrical components from rain, water or sea spray.

NOTE: Power feeds for accessory equipment must NOT be taken from the voltmeter terminals. Consult with your dealer for additional DC power needs on your boat.

## BATTERY

### **DANGER**

**DO NOT** disconnect or reconnect battery cables if gasoline fumes are present!

The battery was installed on your boat by your dealer. Inspect the battery frequently for cleanliness and tight connections. Be sure that the battery compartment is well ventilated. If you need to replace a battery, install the same type as originally supplied with your boat.

### **WARNING**

**POISON!** Batteries contain sulfuric acid and can cause severe personal injury if mishandled. Avoid contact with eyes, skin or clothing. In case of contact, flush with water at least 15 minutes. If swallowed, drink large quantities of water or milk. Follow with Milk of Magnesia, beaten egg or vegetable oil. Get medical attention immediately.

When you install a battery, battery connections must be made properly. Attach the negative battery cable to the negative (–) terminal on the battery. Then, attach the positive cable to the positive (+) terminal.

## Charging the Battery

### **WARNING**

During charging, batteries produce gases which can explode if ignited. Explosion can shatter a battery. Battery acid can cause severe personal injury such as blindness. Keep flame, spark and smoking materials away from battery while charging. Charge battery in a well ventilated area.

Batteries produce hydrogen and oxygen gases when they are being charged. These explosive gases escape through the vent/fill caps and may form an explosive atmosphere around the battery if ventilation is poor. This gas may remain around the battery for several hours after charging. Sparks or flame can ignite the gas and cause an explosion. To avoid explosions, do not use jumper cables and a booster battery to start the engine. In particular, check to see whether any switches or lights were left on. If the starting battery is discharged, remove the battery and recharge it ashore. If your battery is discharged to the point that it will not start the engine, determine the cause of the dead battery. In particular, check to see whether any switches or lights were left on.



## Electrical Switches

Toggle or rocker switches control the power supply to boat components. The switches are illuminated to indicate when a switch is on. Switches may be two-position (off or on) or three-position with a center off position. For three-position switches, switch position determines which components are powered. Depending on model, your boat will have all or some of the following switches:

- Anchor (ANC) Lights
- Navigation (NAV) Lights
- Docking Lights
- Horn (spring-loaded switch which toggles off or pops back when released)
- Accessories (ACC)
- Courtesy (CTSY) Lights
- Bilge Blower
- Bilge Pump
- Stereo

**IMPORTANT:** Some boat components, such as the stereo, could still be powered even though the ignition switch is off. To prevent discharging the battery, turn off power to all components when they are not being used.

## Main Fuse

You will find the main circuit fuse within 18 inches of the battery on most models. This fuse has been installed to conform with U.S. Coast Guard requirements. If you have trouble finding it, ask your dealer to help you. Keep several extra AGC20 fuses on board in case you need to replace it.

All models have a DC outlet at the helm. Any 12V equipment, such as a cellular phone, can be plugged into this outlet if it has a suitable plug.

## WIRE COLOR CHART

<b>FUNCTION</b>	<b>COLOR</b>
BATTERY POWER	RED
GROUND	BLACK
ANCHOR	GREY/BLUE
NAVIGATION	GREY/GREEN
DOCKING	GREY/BLACK
HORN	ORANGE
CTSY	BLUE/YELLOW
UNDERWATER	BLUE/RED
UNDERDECK	BLUE/ORANGE
LADDER LT	BLUE/YELLOW
CUPHOLDER	BLUE/WHITE
SPEAKER RF (+)	GRY
SPEAKER RF (-)	GRY/BLK
SPEAKER LF (+)	WHT
SPEAKER LF (-)	WHT/BLK
SPEAKER RR (+)	PUR
SPEAKER RR (-)	PUR/BLK
SPEAKER LR (+)	GRN
SPEAKER LR (-)	GRN/BLK
SPEAKER R MID (+)	BRN
SPEAKER R MID (-)	BRN/BLK
SPEAKER L MID (+)	YELLOW
SPEAKER R MID (-)	YEL/BLK
LIVEWELL/TOP LIGHTS	BROWN/WHITE
BILGE 1	BROWN/RED
FLOAT AUTO	BROWN/ORANGE
IGNITION	PURPLE
FUEL	PINK
BREAKER INPUT	ORANGE/RED
STEREO MEMORY	YELLOW
POWER ANTENNA/AMP	RED/BLACK
STEREO	PURPLE



GAUGE LIGHTS	BLUE
HATCH/BIMINI UP	RED
HATCH/BIMINI DOWN	ORANGE/RED
BLOWER	YELLOW
TACH	GREY
STARTING CIRCUIT	YELLOW/RED
OIL PRESSURE	LIGHT BLUE
WATER TEMPRATURE	TAN

## GAUGES

NOTE: Some boat models do not have gauges. The gauges provided may vary from boat to boat.

The gauges installed on your boat indicate current operating conditions for the engine and related systems. When you take delivery of your boat, ask your dealer about the normal readings of the gauges. This will provide you with a reference point to evaluate how well your boat is operating. Keep in mind that the readings on some gauges tend to fluctuate. You should investigate the cause for gauge readings that show a continuous variance or a sudden, substantial variance from normal readings.

### Fuel Gauge

The fuel gauge shows the approximate amount of fuel in the fuel tank. Note that the actual fuel supply may vary slightly from that shown on the gauge. The most accurate reading of the fuel gauge is at idle speed when your boat maintains an approximately level position. While underway, the fuel gauge will usually indicate that the tank is fuller than it actually is because the bow tends to be higher than when the boat is at rest. Since gauge readings are approximate, they should be compared to the hours of use versus known fuel consumption per hour.

The most common practice of good fuel management is the one-third (1/3) rule. Use 1/3 of your total fuel to travel

to your destination, 1/3 to return, and keep 1/3 in reserve for emergencies.

### Oil Pressure Gauge

The oil pressure gauge is a good indicator of most, if not all, serious problems that may occur within your engine. A preset valve in the oil pump controls the maximum oil pressure. Check the engine oil level before every trip and fill if low. If oil level is full and gauge reading is low, contact your dealer or a qualified mechanic to correct the problem. Do not restart the engine until correcting the problem. See the engine manufacturer's specifications for correct pressure ranges.

#### CAUTION

**Engine Damage!** Operation at low oil pressure can seriously damage engine. Stop engine immediately if oil pressure is low.

### Water Pressure Gauge

The water pressure gauge measures the pressure of the engine cooling water. If the gauge registers a low pressure, the water intake may be clogged or the drive unit may be tilted up too high. Low pressure can cause the engine to overheat.

### Water Temperature Gauge

The temperature gauge measures the temperature of the engine cooling system. Check this gauge often whenever the engine is running. Outboard engines draw sea water, circulate it through the engine and expel it overboard through the exhaust system. If the temperature gauge shows that the engine is hot, stop the engine immediately. Refer to your engine owner's manual for instructions and corrective action.



## Engine Multifunction Gauge or Warning Lights

This gauge indicates the status of specific engine functions. It is designed to alert the operator to conditions which can damage the boat's engine. Refer to the engine manual for specific information about this gauge.

## Speedometer

The speedometer indicates the speed your boat is traveling over the water in miles per hour. Speedometer is GPS based resulting in a very accurate speed reading. At times geographical terrain may impact receiving a signal.

## Tachometer

The tachometer displays the engine operating speed in increments of 100 revolutions per minute (RPM). The tachometer shows engine speed in RPMs under various engine operating conditions. Some models may have an engine hour meter built into the tachometer face. The hour meter is RPM activated. Consult your dealer if you need more information.

## Trim Gauge

The trim gauge indicates the relative position of the drive unit. Read this gauge carefully, as it does not show position of unit in degrees. Proper trim should be indicated by bow attitude and engine RPM. For more information, see your engine owner's manual.

## Voltmeter

The voltmeter shows battery voltage. If the engine is running at normal speed (1000 RPMs or higher) and the alternator is charging, the reading on the meter will range between 12.0 to 15.5 volts. If the meter reading is high when the engine is not running and the ignition key or switch is ON, the battery is fully charged. Significantly higher or lower readings indicate a battery problem, alternator malfunction or heavy drain on the battery. Check the charging system and the battery system for the cause of these readings. An oscillating reading shows a loose



voltage regulator connection or loose belts. Low voltage readings after stopping the engine indicate a bad battery or a heavy load on the battery. Refer to your engine owner's manual for proper gauge readings.

## CONTROLS

Knowing how to use the controls on your boat is essential for safe and proper operation. The controls described in this section may be optional or may vary slightly from those on your boat.

### Throttle and Gearshift

The controls on your boat may vary from model to model and will depend on the engine supplied with your boat. The control described here is typical of the operation of most throttle/gearshift controls. Check the engine or control manual or see your dealer for more detailed information.

A single-lever control integrates the throttle and gearshift into a single hand lever. It allows the operator to control both the engine operating speed and the forward and aft movement of the boat. This type of design ensures safe control of the engine with one hand.

The lever functions as shifter during the first 15° of motion. Beyond 15° it functions as a throttle. Pushing the lever toward the full throttle position increases engine speed. There is no lock or detent in the shifter so caution must be taken to prevent an inadvertent move of the lever which would cause unexpected boat movement.

Following are a few helpful operating tips:

- When shifting between forward and reverse, always pause in neutral for a few seconds before reversing propeller rotation to prevent damage to the engine and drive.
- High speed acceleration in reverse, especially for deck boats, can create a wake that could wash over the



transom and flood the boat. Gradually increase speed when moving in reverse.

## Steering

Various steering systems are used on boats. Some models have a tilt steering wheel and an enclosed push-pull cable system connected to the motor. A hydraulic steering system is available as an option on some models.

Getting the “feel” of your boat’s steering system is important. Steering does vary from boat to boat depending on the type of engine, water and wind conditions and the load. Turn the wheel from full left to full right. Check that the drive unit is turning correctly, freely and smoothly. The cable output end of the steering system should be clear of fuel lines, control cables, electrical wiring and outboard gear when an engine is moved through its full operating range. Be careful not to kink the cables.

All steering systems require periodic maintenance to be trouble-free and safe. Regular checks are essential. Check the cables regularly and tighten them as needed. Be sure to read the manufacturer supplied operator’s manual before heading out on the water.

None of the steering systems are self-centering. That is, none will go back to center automatically. You must turn it back to center.

NOTE: If your boat has power steering equipment, refer to the engine owner’s manual for detailed information regarding steering system operation and maintenance.

## Hydraulic Steering System

A hydraulic steering system is available as an option for some models. Hydraulic steering makes it easier to control the boat because the wheel is easier to turn. Operators should be careful that they do not “oversteer,” that is turn the wheel so that a turn is tighter than intended.

Check the level of hydraulic fluid in the reservoir at the helm regularly and replenish if necessary. The fill cap behind the wheel has a gauge indicating the fluid level. Check the steering manual for the right fluid to be used. All other maintenance should be performed by your dealer.

### Power Trim

A power trim system is available on some models. The power trim system controls the angle of the drive unit. The power trim switch also allows the operator to adjust the motor at cruising speed to achieve an ideal planning angle. Moving the drive unit in closer to the transom is called trimming "in" or "down." Moving the drive unit farther away from the transom is called trimming "out" or "up." Refer to the engine and control manuals for specific information about trimming.

To trim the bow of the boat up, press the trim switch in the direction marked UP. Moving the bow up increases top speed, but can cause the boat to porpoise if trimmed up too far. Excessive trim up can cause propeller cavitation (propeller pushes air, not water) and damage the engine.

To trim the bow of the boat down, press the trim switch in the direction marked DOWN. Running with the bow down will help the boat accelerate and get on plane faster, especially with a heavy load, but it will reduce boat speed in most cases. Excessive trim down can make the boat difficult to steer.

### FISH FINDER

Refer to the owner's manual for information about using this instrument.

### TROLLING MOTOR OUTLET

An electric trolling motor is available as optional equipment on some models. The outlet is compatible with either 12 or 24 volt systems. Consult the trolling motor manual for proper battery installation and connection. Check with your dealer regarding a



suitable motor for your boat and operation and maintenance instructions.

## LIVEWELL

An aerated livewell and baitwell is available on some models. The well or wells provide an environment where your catch can be kept alive and healthy. Figure 3-1 shows a typical livewell. The livewell on your boat may be slightly different than the one shown.

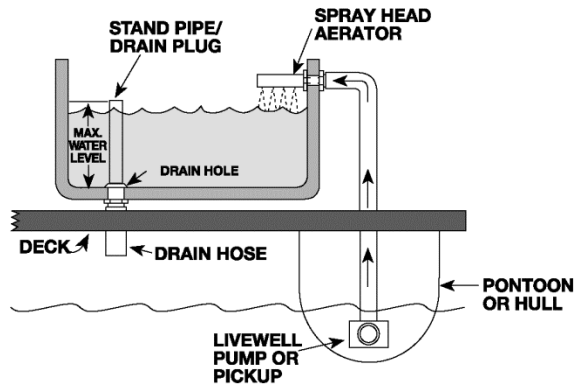

**FIGURE 3-1 TYPICAL LIVEWELL**

NOTE: You should monitor water and air temperatures to determine when and how often you should aerate the livewell.

Turning on the ACCY switch controls the operation of the livewell pump. Open the valve (if provided) on the aerator head before turning on the pump. The pump draws raw water in through a fitting below the waterline and pumps it into the livewell. The pump fills the livewell with raw water. Water sprays into the livewell through the aerator head. As the incoming water hits the surface of the water in the livewell, the water's oxygen content increases which helps keep fish alive. As water continues to spray into the well, excess water flows out through the standpipe and drains overboard. Drain locations vary by model. The livewell works best at trolling speeds or when the boat is at rest. At faster speeds, the pump does not work properly because it cannot draw water.



If you prefer you can use the livewell as a cooler. Simply remove the standpipe and insert the plug provided for this purpose.

Do not operate the livewell pump dry. The pump is water-cooled and becomes overheated if no water is flowing through the pump. If water does not come out of the discharge sprayer nozzle, stop the pump and correct the problem (for example, blown fuse, broken wires, closed flow control valve, plugged inlet). If the problem persists, check with your dealer.

If the overflow or drain becomes plugged, try back-flushing it with a garden hose set at low velocity. Some models have a screen at the pump intake. Remove the screen before back-flushing. Often the obstruction will blow back into the livewell where it can be easily removed. Be careful that you do not use too much pressure. You can blow the hoses off the fittings.

## FRESH WATER SUPPLY

A fresh water system is standard equipment on some models and optional on others. The manually pressurized fresh water system provides fresh water from a tank to the galley sink. Fill the tank only with fresh water. Refilling the tank often will help keep it a source of fresh and clean drinking water.

## PORTA-POTTI®

A self-contained porta-potti is available as optional equipment on some models. This portable toilet provides simple operation and convenient disposal of waste. The waste is transported off the boat by removing the holding tank. Dispose of the waste properly at a dump station or other appropriate location. Do not dump the tank's contents overboard.

The unit is usually stored either in the privacy area under the sun lounge or in the changing room. Special mounting

strips are provided to hold the unit in place and prevent tipping or spilling. You can install these strips once you have determined where you want to store the porta-potti. See the manufacturer's manual for safety precautions and detailed operation and maintenance instructions.

## PROPANE GRILL

Your boat may be equipped with a propane grill. Be sure passengers know when the grill is being used. Hot surfaces can cause burns. Stow the grill before getting underway. Be sure unit is cool before storing. Refer to the grill manual for details about using this accessory safely.

### **WARNING**

Use fuel approved by the manufacturer. Always provide adequate ventilation when using an open flame. Do not use stove near fuel fill or fuel vent. Propane flame is difficult to see in sunlight. Explosion can cause severe personal injury or death.

## TOPS

Your boat may have a protective covering such as a bimini top or a hardtop. Tops are subject to severe punishment. Moisture can promote the formation of mildew, especially if they are dirty. Wind can strain or damage frames and supports. Salt water can corrode metal fittings.

### **WARNING**

Tops or coverings are not to be upright under the following conditions:

- **While under motor power.** Hazardous fumes can collect inside complete canvas enclosure. Death or serious injury may result. Keep sides and aft coverings open for ventilation. Read safety information supplied with the coverings.
- **While exposed to high winds.** Supporting framework for coverings such as a bimini top may lift from mountings. Falling framework can cause injury.
- **While trailering.** Covering and framework can be damaged. Falling framework and covering can obstruct vision of nearby motorists and damage vehicles. Be sure top is down while trailering your boat. Do not trailer with cockpit mooring cover installed.
- **While underway.** Do not operate at speeds greater than 15 miles per hour with canvas top up.

## BILGE PUMP

Some boats have an automatic bilge pump or pumps. A float switch inside the pump controls pump operation to remove water from the bilge. If the pump motor runs but does not remove any water, the pump intake may be clogged. If no visible debris is clogging the pump and water is still not being removed, inspect the discharge hose for kinks or an obstruction.

If water accumulates in the bilge and the float switch fails to turn on the pump, you can start the pump manually at the helm. Toggle the bilge pump switch from the AUTO



position to the ON position. With the switch set to ON, the pump will not shut itself off automatically when the bilge is empty. Toggle the switch back to AUTO to shut off the pump. Ask your dealer to check the pump and switch as soon as possible if it is not working properly.

The pump runs on battery power if the engine is not running. Over time, the pump can draw down the battery charge if you do not run the engine to keep the battery charged. You should also be aware that a discharged battery can create a problem. If power is not available to operate the pump, rising water in the bilge can damage the engine and other components and could possibly sink the boat.

## AM/FM MARINE STEREO

An AM/FM stereo receiver with Bluetooth is available as standard or optional equipment on some models. The system has electronic circuits especially designed for radio reception on both AM and FM bands. When the stereo is not in use, be sure the switch is off to prevent drawing down the battery.

Features may vary on some stereo models. See the manufacturer's manual for a list of features and detailed instructions for use.

## SPECIAL SEATS

Some models may have a slider seat at the helm. The driver can adjust the seat's position by loosening a knob or lifting a latch and sliding the seat to the desired position. After positioning the seat, tighten the knob or release the latch to hold the seat in place. Do not attempt to adjust this seat while underway. You may lose control of the boat.





**Falling Hazard!** Fishing chairs may swivel while underway. Falls to the deck or overboard are possible. Sit in designated seating areas while boat is moving.

Some models may have fishing chairs. The posts of these chairs fit into special sockets on the deck and have an integrated lock, allowing us of these seats while underway.

## FULL CAMPER ENCLOSURE INSTALLATION INSTRUCTIONS – CARE & USE GUIDELINES

Please carefully read this entire instruction sheet before proceeding. To emphasize special information, you may see these symbols and words:

It is very important to us that you read and understand these installation instructions. If while reading these instructions you are unsure about installing the enclosure, please feel free to contact the dealer where you purchased your boat. Improper installation as a result of not following these instructions may result in damage to the canvas that is not covered by the warranty.

### INSTALLATION:

#### CAUTION

Pontoon enclosures are not designed to be trailered. The limited warranty does not cover damage caused by trailering.

### Installing your Double Canopies or Bimini Tops

Your boat dealer or the factory pre-installed the mounting hardware for the canopies or Bimini tops. Have another

person help with the installation. Locate the 4-bow top for the aft portion of your pontoon and attach the quick-release DowcoLoks to the mounting buttons on the playpen fence. Raise the top to the “up” or deployed position. Make sure the canvas is centered on the frame. Locate and attach the 3-bow top the same way at the bow of the boat. Raise it to the “up” or deployed position, but do not attach the struts until the you can zip the two tops together. Make sure the canvas is centered on this frame also. Find the matching zippers on the canvas tops and zip them together. Make sure the protective flap covers the zippers on the top side. Now you can attach the struts to complete this part of the installation.

### Installing the Enclosure Curtains

Locate and sort out the enclosure curtains laying them out on a soft surface. There is a small tag sewn into each piece indicating its location on the pontoon (Fig. 2).

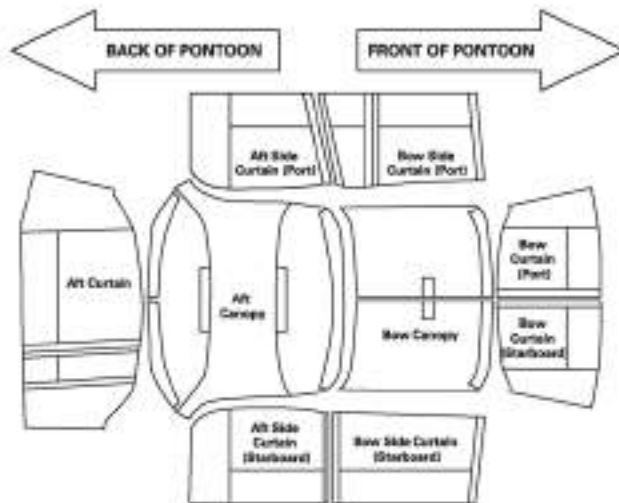



On one side of the pontoon, start installing one of the side curtains by attaching it to the canvas top with the matching zippers. Install the next curtain the same way and zip the two curtains together. Make sure your pontoon's side gate matches up to the door of the side curtain. Repeat this process on the other side of the boat.

Locate the bow curtain and zip it onto the canvas top at the front. Zip the side curtains to the bow curtain on each side. Locate the aft curtain and zip it onto the canvas top at the rear. Zip the side curtains to the aft curtain on each side. Make sure the tops' flaps overlap the zippers where the curtains join the top. All of the curtains should be hanging loose over the pontoon fence. Go around the entire pontoon to make sure all of the curtains are hanging the same length on both sides. If they are not even you may have to remove them and re-center the canvas tops.

Now go around the outside of your pontoon fence and attach the bottom edge of the enclosure curtains to the fence using the installed snaps or clips (if your boat has clips).

The windows on the curtains may be unzipped to expose the screens and allow air circulation while in use. Simply unzip the window, roll it down and fasten the web strap around it. The side gate doors unzip to allow access or can be folded back or completely removed.

## STORAGE AND CARE

Proper care and maintenance of the canvas will maximize its useful life. The ClimaShield™ fabric used for the canvas has coatings for water repellency and mildew resistance. It is important to follow these instructions to maintain these benefits.

Never store the cover while it is wet or dirty. Make sure the cover is completely dry and clean prior to storage as this will help prevent mildew growth which will damage the fabric.

Clean the cover with mild soap and water to remove dirt, bird droppings, etc. Do not steam or pressure wash.

Prevent sharp objects, solvents and hot items from coming in contact with all canvas parts.

Do not allow ice or water to accumulate on the canopy or Bimini top as this may cause damage.

The curtains are made with durable clear marine vinyl which can easily be scratched so exercise caution when removing them for storage or for cleaning. The curtains should only be rolled for storage to avoid creasing. Clear vinyl should be cleaned regularly to help maintain its useful life. Abrasive cleaners, glass cleaners or detergents should not be used. To remove dirt, use a mild vinyl cleaner or a mild soap such as Ivory mixed with lukewarm water. Use a soft cloth or microfiber towel to gently clean and dry.



## TRAILERING

A correctly selected trailer supports your boat properly, makes towing safer, and makes loading and unloading easier. Improper trailering is one of the major causes of damage to boats. The warranty does not cover damage of this type. Familiarize yourself with proper towing procedures before taking your boat out on the road.

### TRAILER

**IMPORTANT:** Selecting the right trailer is very important. The trailer must properly support the boat's size and weight, including fuel and equipment. Selecting the right trailer is very important for trailering safely and preventing damage. Your dealer will advise you and assist with trailer selection.

#### Gross Vehicle Weight Rating

Your trailer should be able to accommodate the weight of the boat, engine, full fuel tank and any other equipment that will normally be carried. Check the certification label on the frame of the trailer for the Gross Vehicle Weight Rating (GVWR). The total weight of your boat, engine, fuel, gear and trailer should not exceed the GVWR.

Remember that the published weight is the wet weight of your boat. Dry weight does not include the weights of outboard motors, batteries, gasoline, any optional items, gear or trailers. The weight of these items must be added to the dry weight to determine the proper trailer GVWR needed. If your boat is equipped with a larger than standard engine, you must allow for the engine's added weight.

**▲ WARNING**

The total weight of the trailer, boat, motor and gear must not exceed the GVWR of the trailer. Overloading can lead to accidents, causing injury.

### Weight Distribution

If your towing vehicle is equipped with a weight distribution hitch, it must be capable of handling the GVWR. The weight on the trailer should be evenly distributed and can be checked by determining the tongue weight.

Tongue weight is a percentage of the total weight of the loaded trailer on its tongue. Ideal tongue weight is not less than five percent (5%) and not more than ten percent (10%) of the GVWR. For example, if the weight of the loaded trailer is 3000 pounds (1361 kg), the weight on the tongue should be more than 150 pounds (68 kg), but less than 300 pounds (136 kg).

To avoid personal injury and property damage, be sure to balance the load when trailering. Excessive tongue weight will cause the front end of the towing vehicle to sway. Insufficient tongue weight will cause the trailer to sway or fishtail. In either case, the vehicle will be hard to handle and could become uncontrollable at high speeds.

State regulations usually require that trailers above a specified weight rating be equipped with brakes. Requirements vary; check with your dealer for additional information.

## HITCH

### **⚠ WARNING**

The total weight of your loaded trailer must not exceed the capacity marker on the hitch of your tow vehicle. Overloading can cause hitch failure leading to injury-causing accidents.

Hitches are divided into classes that specify the gross trailer weight (GTW) and maximum tongue weight for each class. Always use a hitch with the same class number as the trailer. Most boat trailers connect to a ball hitch that is bolted or welded to the towing vehicle. Special heavy-duty equalizing hitches are necessary for trailer tongue weights of 350 pounds (158 kg) or greater.

The trailer hitch coupler must match the size of the hitch ball. The correct ball diameter is marked on the trailer coupler.



## SAFETY CHAINS

Safety chains on your boat trailer provide added insurance that it will not become completely detached from the towing vehicle while underway. Crisscross the chains under the trailer tongue to prevent the tongue from dropping to the road if the trailer separates from the hitch ball (Figure 4-1). Safety chain should be of the “proof coil” type and must have a minimum breaking strength equal to the upper limit of the GVWR. Some states require chains to be locked so hooks can’t shake, bounce or vibrate off the bracket.

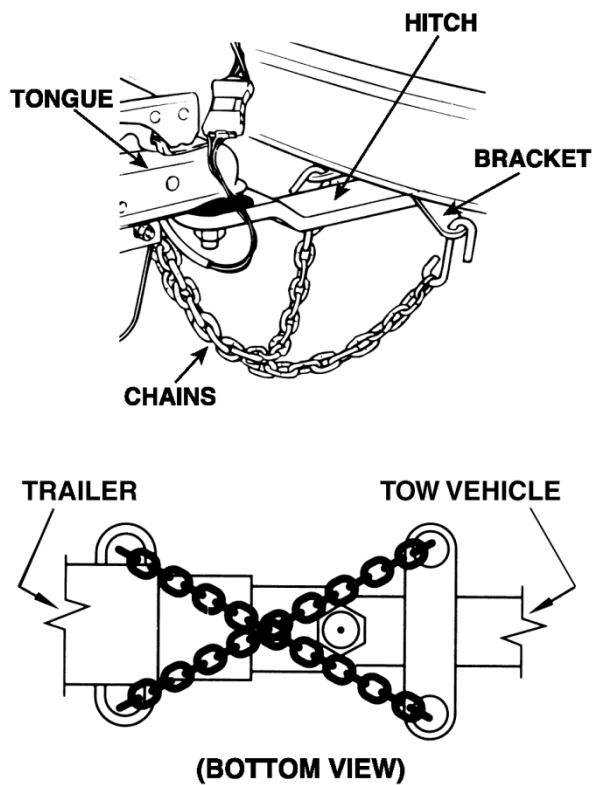

**FIGURE 4-1 SAFETY CHAINS**

## TRAILERING GUIDELINES

**⚠ DANGER**

Never allow any person to ride in the boat while it is being towed on a trailer. Personal injury or death may result.

1. Be sure that the rollers or bunks support a large amount of pontoon surfaces or bottom hull and the boat and equipment distribute evenly on the trailer.
2. Make sure your boat is properly tied down and a safety chain is used.
3. Do not trailer with your boat's top up or with playpen or mooring cover installed. They can be severely damaged while trailering. Make sure the top is down and the cover is properly stored.
4. Make sure sun lounge is securely tied down with straps. Auxiliary straps or ropes are recommended.
5. Make sure drive unit is tilted up and an outboard transom saver is used.
6. Be sure your trailer is equipped with functional tail lights and turn signals as required by state and federal laws.
7. Stow all loose items such as cushions, life jackets and coolers in their designated storage areas.
8. Check with your state Department of Motor Vehicles for registration and licensing regulations in your state. Some states require that boat trailers be registered and licensed.

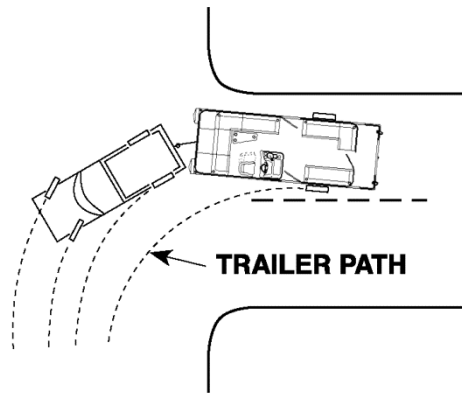

**FIGURE 4-2 TURNING WITH TRAILER**

9. Be aware that a turn for the trailer will be wider than a turn for the tow vehicle (Figure 4-2). When making a turn, be careful that your trailer does not strike another vehicle or object.
10. Inspect your trailer regularly to make sure the side supports are in good working order. Check bolts which secure rollers and supports for tightness. Check wheel bearings frequently for sufficient grease.
11. Check local and state laws for any additional requirements for trailers.

## BACKING A TRAILER

If you do not have experience in backing up with a trailer, practice backing with a trailer before you get into a confined launch site. Get accustomed to using your trailer in an open area. Take someone with you who knows how to back a trailer. Backing a trailer works the opposite of backing a car. A good practice is to grasp the steering wheel at the bottom and turn the wheel in the direction you want the boat to go. (Figure 4-3). Do not turn the wheel too far or oversteer. Turn the wheel gradually until you get the feel of safe backing.

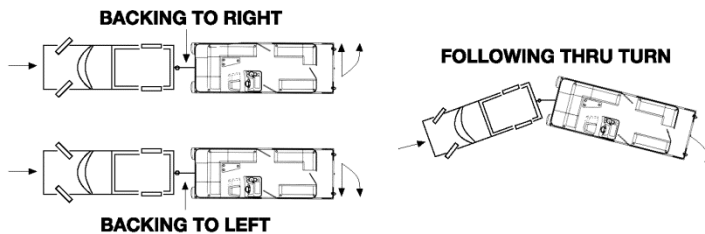

FIGURE 4-3 BACKING A TRAILER

## LAUNCHING GUIDELINES

Before launching your boat, stay to one side and watch a couple of launchings to notice any problems on the ramp and the effects of the wind and the current on launching. It's a common courtesy to prepare the boat for launching away from the ramp.

Here are some tips to remember when putting your boat in the water:

1. Before backing your boat down the launch ramp:
  - Remove all stern tie-downs.
  - Properly secure all loose gear.
  - Inventory your safety equipment.
  - Load all personal gear.
  - Lock winch and trailer unit.

- Disconnect trailer wiring from towing vehicle to prevent short circuits caused by submersion.
  - Make sure drain plugs are installed.
2. Have an individual at the launch ramp give you directions. Back slowly down the ramp. If the trailer needs to be maneuvered to the right, turn the towing vehicle's steering wheel to the left. If trailer movement to the left is required, turn the steering wheel to the right. Always remember to launch your boat at a right angle to the shoreline.
  3. If launching from a trailer, tilt the drive unit motor up to the high tilt trailer position to avoid damage during the launch.
  4. When the boat's transom is in several inches of water, stop the towing vehicle. If you have a manual transmission, leave it in gear. If you have an automatic transmission, shift to PARK.
  5. Turn off the engine and set the parking brake.
  6. Place blocks behind the vehicle's back wheels.
  7. Do not detach the winch cable from the bow eye until a mooring line has been secured to one of the boat's cleats. Attach one line to bow and one line to the stern to help control the boat. See the mooring information in Chapter 5 for suggested securing procedures.
  8. Launch the boat; move it down and OFF the trailer into the water.
  9. Secure boat to dock or have someone hold mooring lines.
  10. Lower drive unit all the way into the water.
  11. Pull your towing vehicle away from the launch ramp.
  12. Park only in designated areas. When parking, be sure your towing vehicle and trailer do not block other boaters from approaching the launch ramp or hinder their ability to maneuver a boat and trailer when launching.



## LOADING YOUR BOAT ON THE TRAILER

Follow these guidelines for loading your boat back onto the trailer:

1. Back the trailer into the water.
2. When the back of the trailer is in several inches of water:
  - STOP the towing vehicle.
  - Leave manual transmission in gear or place automatic transmission in PARK.
  - Place blocks behind the vehicle's back wheels.
  - Turn off the engine.
  - Set the parking brake.

NOTE: If you have a bunk trailer, the trailer may need to be more than several inches in the water before loading.

3. Tilt the boat's drive up to the high tilt position to avoid damage while loading.
2. Pull boat up onto trailer and secure safety chain.
3. After securing the boat to the trailer start engine on towing vehicle and pull trailer out of water to boat securing area. (If blocks are connected with a rope to the trailer tongue, you will not need to remove them before pulling trailer out.)
4. Use tie-downs to secure boat on trailer. Always use bow and stern tie downs to prevent the boat from shifting.
5. Wipe pontoons or gelcoat down to prevent water spots and keep boat clean.
6. Make sure everything in the boat is secure or tied down. Do not put other gear in your boat while trailering. Place anything loose in towing vehicle.
7. Reconnect trailer lights. Check that lights are working.

# UNDERWAY

## BOATER'S CHECKLIST

Will the weather be favorable?  
Did you get a current weather report?  
Is the drain plug installed?  
Is there a suitable licensed operator?  
Is operator impaired from drug or alcohol use?  
Are all passengers inside deck rails and away from gunwales? Are all gates properly secured?  
Are tubes or bottom and propeller free of damage, excessive dirt and marine growth?  
Are electrical system and navigation lights working?  
Is battery fully charged?  
Are connections clean and tight?  
Is your boat overloaded or underpowered (compared with capacity plate)?  
Is all required safety equipment on board?  
Does it work? Is there one PFD for each passenger? Is safety equipment easily accessible?  
Are children wearing PFDs?  
Is the lanyard safety switch working?  
Is other equipment on board such as mooring lines, anchor and line, tool kit, first aid kit, etc.?  
Do you have enough fuel for your trip? Fuel tanks should be filled to slightly less than capacity. Allow space for fuel expansion.  
Have you checked fuel system for odors, leaks and deterioration?  
Have you checked the motor for leaks or signs of deterioration? Are fluid levels OK (engine oil, battery water, power steering fluid, etc.)?  
Is the engine free of obstructions?  
Are there any persons near the propeller?  
Does the steering system work smoothly?  
Are all components tight?



Do you have navigation charts and equipment on board? Are you familiar with area where you will be boating?

Do passengers and crew know what to do in an emergency? Do they know how to use safety equipment?

Do you have an emergency supply of food and water?

Do you have all required documents on board?

Have you told a responsible party ashore where you are going and when you expect to return?

This chapter provides basic information for a typical boating excursion. All boaters are responsible for their own safety and the safety of others. Even though you may be an experienced operator, you can still benefit from reviewing the boating principles discussed in this chapter. Before you get underway, make sure you are familiar with local and governmental boating regulations and restrictions.

NOTE: This chapter may refer to equipment and components that are standard on some models and optional or unavailable on other models.

## WARNING MARKERS

Always check with local authorities concerning regional hazardous areas and how they are marked. Other considerations include:

- Boat operators must be able to recognize marine flag designs and respond accordingly.
- Caution should always be exercised relative to swimmers. Swimming areas may not always be marked.
- Navigation markers identify navigable routes and indicate water hazards. Boat operators should familiarize themselves with these important navigational tools and operate their boats accordingly.

## 2 UNDERWAY



- Be prepared to assist anyone flying a 'distress' flag as they are requesting immediate assistance.

## FUELING

If possible, fill your boat's fuel tank before loading passengers and gear. If passengers are on board, have them leave the boat until fueling is complete.

Do not use fuels containing any form of ethanol, alcohol or alcohol derivatives. Alcohol destroys marine fuel system hoses and components. Weakened hoses can lead to hazardous leaks, fire or explosion. If only gasoline containing alcohol is available, or the presence of alcohol is unknown, you must inspect the system more frequently.

Inspect fuel system for leakage, weakening, hardening, swelling or corrosion of components including fuel tanks, fuel lines, fittings, fuel filters and carburetors. If any component shows signs of leakage or deterioration, it must be replaced before starting the engine.

### **DANGER**

Fuel vapors are explosive. Fuel leaking from any part of the fuel system can lead to fire and explosion that can cause serious bodily injury or death. Do not smoke, extinguish all open flames, STOP all engines and other devices that could cause sparks, including the bilge blower (if provided). Do not use electrical switches or accessories. Close all openings into enclosed areas.



**IMPORTANT:** If 1/2 pint of gasoline explodes, it has the same power as 15 sticks of dynamite.

Before you start filling the fuel tank, securely moor boat to dock. Stop engine. Extinguish all smoking materials. Turn off all electrical equipment, engines, lights, bilge pump, etc. Do not use anything that can produce a spark or flame. Always fill tank in an area having adequate lighting. You may not see gasoline spills under poor lighting or in darkness. Make sure a fire extinguisher is readily available.

If your boat has a built-in tank:

1. Remove fuel fill cap from tank fitting and insert fuel supply nozzle.
2. Fill the tank slowly, especially if it is empty. After pumping approximately 5-10 gallons (19-38 liters) of fuel into tank, inspect engine and fuel tank area for signs of fuel leakage. If fuel cannot be pumped into the tank at a reasonable rate, check for a plugged fuel vent or a kink in the line. Continue fueling if you do not find any leaks or other problems.
3. Stop filling tank before fuel overflows. Allow space at top of tank for thermal expansion. Fuel pumped from underground tanks is cooler than outside air. Gasoline expands as it warms up and can easily overflow the tank.

**IMPORTANT:** Gas will shoot out of vent if the tank is overfilled or vent is blocked. Spilled fuel damages the environment. Fuel can damage vinyl and carpeting.

4. When you have finished fueling, replace fuel fill cap. If necessary, wash off any fuel spilled around fuel fill area. Properly dispose of rags used to wipe off fuel spillage.
5. Open fuel tank area. If canvas is in place, open it to ventilate enclosed area. Check for fuel fumes or fuel line leakage. Investigate and correct any indication of fumes or fuel leakage before starting engine.

#### 4 UNDERWAY

If your boat has a portable tank:

1. Remove fuel fill cap from tank fitting, insert fuel supply nozzle and begin pumping fuel.
2. Stop filling tank before fuel overflows. Allow space at top of tank for thermal expansion. Fuel pumped from underground tanks is cooler than outside air. Gasoline expands as it warms up and can easily overflow the tank.

**IMPORTANT:** Gas will shoot out of vent if the tank is overfilled. Fuel spilled on the boat can damage the finish.

3. When you have finished fueling, replace fuel fill cap. If necessary, wash off any fuel spilled around fuel fill area. Properly dispose of rags used to wipe off fuel spillage.
4. Carefully carry tank aboard and make fuel line connections. Check for fuel fumes or fuel line leakage. Investigate and correct any indication of fumes or fuel leakage before starting engine.

**NOTICE**

Servicing of fuel system components can be accomplished through the inspection plates in the deck of the pontoon in many cases. Sometimes it will require removal of the motor mount or the center pontoon, in both cases they can be unbolted and removed from the boat frame.

## LOADING PASSENGERS AND GEAR

**▲ WARNING**

Overloading and improper distribution of weight are significant causes of accidents. Capacity plates, located near the helm, show maximum loads under normal conditions. Keep weight below maximum limits for safety in turbulent waters. **Overloading is a violation of U.S. Coast Guard regulations. Boats under 20 feet (6.1 m) long are subject to U.S. Coast Guard safe loading and labeling requirements.**

The U.S. Coast Guard requires that a plate stating the maximum load capacity be affixed to boats up to 20 feet (6.1 m) long. This plate shows the load in pounds (persons and gear) the boat can carry safely under normal conditions. The U.S. Coast Guard establishes these load capacity ratings. (Craft over 20 feet (6.1 m) long are not subject to U.S. Coast Guard safe labeling requirements.)

You, the operator, are responsible for using common sense and sound judgment when loading your boat. When loading your boat, arrange passengers and load in the boat so the weight is evenly distributed. Weight distribution affects your boat's performance. A good rule to follow is to place 60% of the load aft and 40% forward. Keep the load low. Have someone on the dock pass your gear aboard. Secure all gear firmly so that it will not move or interfere with boat operation. *Be sure all required safety gear is aboard and easily accessible.*

Propeller cavitation or ventilation can be a severe problem if too much weight is too far forward. This can be a problem on models on which the seating area extends all the way to the front of the boat. Fish boats may also have the added weight of a trolling motor and battery at the front. For proper performance in such cases, the operator

must make sure that load is balanced by shifting the weight of passengers and gear toward the back of the boat. Also, the number of passengers must not be greater than the number of seats.

**CAUTION**

Wet surfaces can be slippery. Passengers should wear adequate deck shoes while boarding and underway to avoid accidental slipping and injury.

Passengers should board the boat one at a time. Always step onto the boat, never jump. Check that all passengers are seated in a proper seat. Do not allow passengers to ride outside the deck rails or on the sun deck, sun lounge, seat backs and gunwales. Falls from moving boats are a major cause of marine accidents.

**WARNING**

Passengers occupying swivel or high platform seats may be thrown overboard while underway or during sharp turns. Injury or drowning is possible. Be sure all passengers are seated properly inside rails, gates or gunwales. Follow instructions stated in safety labels on seat posts.

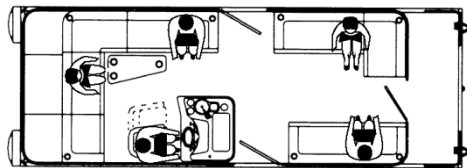

**FIGURE 5-1 SEATING**



Be sure all passengers are seated properly inside rails, gates or gunwales (Figure 5-1). Swivel and high platform seats may turn suddenly while underway. These seats are designed for use while fishing. At speeds greater than 5 mph (8 km/h) occupy only designated seats. Seats designed for use at cruising speeds are either stationary or have a locking handle. Do not occupy fishing seats while boat is underway. Passengers should remain seated in proper seats whenever the boat is running at speeds greater than trolling speed.

## STARTING THE ENGINE

### **WARNING**

**Carbon Monoxide Hazard!** A cold engine produces more carbon monoxide than a warm engine. Provide adequate ventilation in the cabin and cockpit to prevent excessive exposure and reduce the possibility of carbon monoxide accumulation.

The following information is merely a guide and not intended to explain in detail all starting procedures and instructions. Refer to the engine owner's manual for detailed pre-start and starting instructions specific to your boat's engine.

NOTE: Information about starting inboard/outboard engines follows the "Outboards" section.

### Outboards

1. Secure the boat to the dock or mooring slip before attempting to start the engine.
2. Lower outboard to the run position. Make sure all cooling water intake holes are submerged.
3. Check fuel supply to ensure you have enough fuel for your expected travel plan. Check all oil levels.

## 8 UNDERWAY

4. If you are using a portable tank, connect the fuel line to the outboard and squeeze primer bulb until it feels firm.

**⚠ DANGER**

Gasoline vapors are highly explosive. To prevent a possible explosion and fire, check for fumes or accumulation of fuel before each engine start. Run bilge blower (if provided) at least 4 minutes before starting engine.

5. Attach stop switch lanyard (if provided) to operator. Attach the switch clip to the stop switch. The engine will not start if the clip is not attached. See engine manual for specific instructions.
6. If your boat has an automatic bilge pump, turn it on to assure that the float is working. If it has a manual pump operate the bilge pump until flow of water stops. (Not all models have a bilge pump.)
7. Make sure throttle is in neutral position.
8. If you are starting a cold engine, move fast idle lever to mid-position.
9. Turn key to START position. Do not operate starter continuously for more than 10 seconds without pausing. Allow starter to cool between start attempts. See engine owner's manual for details.

NOTE: Engine will not turn over if throttle is not in the neutral position. If engine does not turn over, throttle may not be in neutral. Move throttle lever up and down slightly and try again.

NOTE: See engine owner's manual for specific instructions for starting the engine, using the choke and warming up the engine.

10. If your engine has a carburetor, run engine approximately one to two minutes at the recommended speed to warm it up. Keep boat secure at dock until engine is warmed up. Return engine to slow idle after warmup. (This step does not apply to fuel-injected engines.)

## LEAVING THE DOCK

Before getting underway, check that tables are properly secured to posts and bases. Twist them and at the same time push them down to assure that the friction lock is secure. We recommend that you take tables down at speeds above 25 mph or in heavy weather.

After the engine has warmed up, you are ready to leave the dock. Before you cast off, check all gauges for proper readings. If oil pressure reading is abnormally low or temperature reading abnormally high, **stop engine immediately**. Check the operation of the steering by turning the steering wheel to full port and to full starboard while observing outdrive movement. With boat still securely moored to the dock and engine idling, move the throttle forward, then aft, then back to neutral to check for proper shifting. Release mooring lines and stow fenders.

### **WARNING**

Passengers are to remain seated while casting off and underway. Sudden or unexpected movements may cause passenger to fall and cause personal injury. Make sure passengers seated ahead of the helm console do not obstruct driver's vision. Make sure gate is closed, and no passengers are seated on foredeck, outside rails or on gunwales.

**IMPORTANT:** Falls from moving boats are a major cause of fatal recreational boating accidents. Do not allow

10 UNDERWAY



passengers to ride on the bow with feet hanging over the side or ride while sitting on the stern, gunwales, or seat backs. The Coast Guard considers these acts to be negligent or grossly negligent operation and prohibits them by law.

When you are sure your boat is ready, check wind, tide and current or other forces that will affect the way you maneuver your boat away from the dock. Shift your boat's engine into forward or reverse depending on whether you want to move the bow or the stern away from the dock first. Move the throttle lever to neutral. Then push forward quickly and firmly to shift into forward gear or pull back to shift into reverse. Your engine should be running at a slow speed as you move away from the dock. If you move the bow out first, watch that the stern does not swing into the dock or a piling.

## STEERING

Boat steering is not self-centering. Steering is affected by engine and propeller torque, trim tab setting, wave and current action and the speed of the pontoons through the water. Constant attention to steering is required for safe operation.

**Watch the stern when you turn!** Steering a boat is like driving a car with rear-wheel drive on slippery pavement (Figure 5-2). When you turn the steering wheel, the stern responds first by swinging in the opposite direction of the bow. When you are leaving the dock or trying to avoid an object in the water, this swing can be critical.

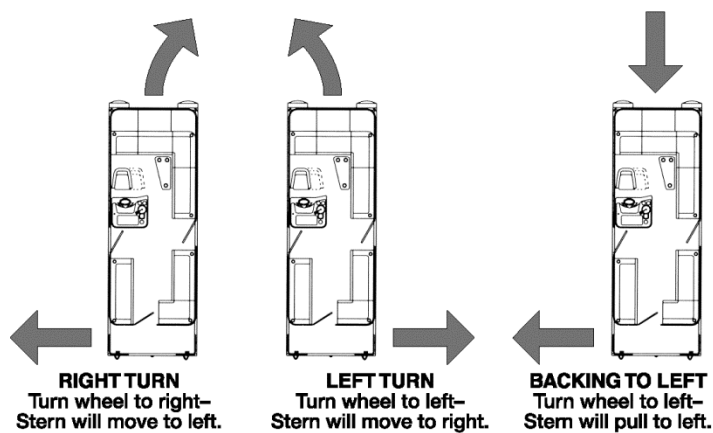

**FIGURE 5-2 STEERING**

Always give yourself plenty of room to make a turn. You should also slow the speed of your boat while turning. Never make sharp, fast turns because you can easily endanger your passengers or lose control of your boat.

When making tight turns, trim engine in for better handling. Since both the thrust and steering are at the stern of the boat, the stern will push away from the direction of the turn. The bow follows a smaller turning circle than the stern (Figure 5-3).

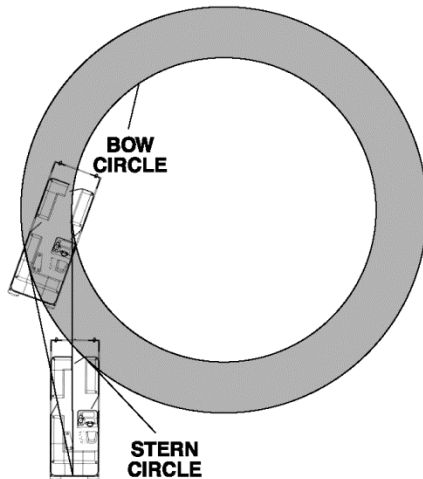

**FIGURE 5-3 TURNING**

## BOAT SPEED

The maximum speed at which you can make sudden turns without losing control of your boat is the maneuvering speed of your boat. Maneuvering speed varies depending on wind, waves and other factors. Some boats display a warning advising that maneuverability above a given speed is limited. This speed is based on tests in calm water. There are minimum safe speeds for certain conditions as well, maintaining headway in a cross wind, for example. Some careful experimentation will serve you well later on. When you encounter a potentially hazardous situation, adjust speed accordingly.

Pace your speed so that you will have enough time to respond to an emergency. Never drive your boat directly behind a water skier in case the water skier falls. For example, at 25 miles per hour (40 km/h) your boat is traveling more than 35 feet per second (10.7 m/s). If a skier falls 200 feet (61 m) ahead, your boat will overtake the fallen skier in less than 6 seconds.

## ACCELERATING

### CAUTION

Acceleration at full throttle is not recommended during the motor break-in period. Refer to the owner's manual for the correct way to break in your boat's motor.

**IMPORTANT:** While accelerating, always keep one hand on the wheel and the other on the throttle. If the boat begins to operate in an unsafe manner, reduce the throttle and trim the engine in gradually. Operate the boat only at a speed you feel comfortable with. Before accelerating, turning or slowing down make your passengers aware of your intentions so they can properly brace themselves.

### WARNING

**Poor Visibility!** While accelerating, bow rises and obstructs forward vision. To prevent accidents, be sure path is clear before accelerating. To prevent personal injury, make sure passengers know you intend to accelerate.

Before bringing the boat "on plane," check the entire area to make sure you have a clear, safe path. As you throttle up and accelerate the boat's trim angle changes, causing the bow to ride high. The drive should be trimmed all the way in to get the boat up on plane as quickly as possible without the operator losing visibility over the bow. This trim angle is sometimes called the "hump." As the boat continues to accelerate, the boat levels out to its planning attitude. A few seconds at full throttle should get the boat over the hump and into its planning attitude, then throttle down to cruising speed.

## Pontoon Boats

Pontoon boats do not come up on plane as vee-bottom deck boats do. Instead, they tend to displace (push through) water. When you throttle up and accelerate, the bow of your boat tends to ride somewhat higher. However, it should take only a few seconds at full throttle for your boat to level out and reach a comfortable cruising speed.

## TRIMMING

The following summarizes general principles to be considered when trimming your boat. For a more detailed discussion of trimming, refer to your engine owner's manual regarding the trim controls installed on your boat.

For pontoon boats, the drive must be trimmed to adjust to the ideal boat angle for load and water conditions.

Depending on the motor provided with your boat, it will have power trim controls or a manual tilt system. With either system, the drive should be trimmed so that it is perpendicular to the water when the boat is running at full speed (Figure 5-4).

On boats equipped with power trim controls, trim can be adjusted while running. Trim cannot be adjusted while running on boats equipped with a manual tilt system.

At low idle speed, an outboard can be tilted up past trim range to permit operation in shallow water. However, the engine's cooling water intake holes must always remain submerged. Otherwise the engine will overheat.

### CAUTION

**Engine Damage!** Use extreme caution when operating with drive unit raised. Cooling water intake holes must remain submerged. See owner's manual for details.

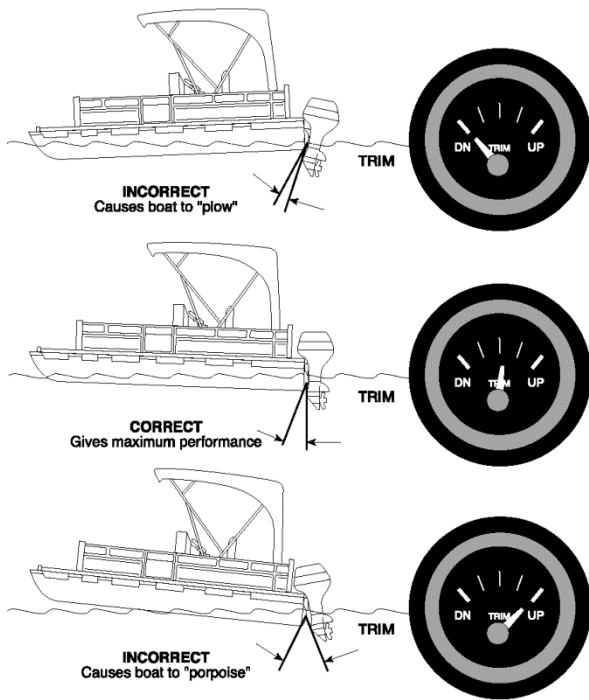

**FIGURE 5-4 TRIMMING**

NOTE: The trailering position of some sterndrives is controlled by a separate switch on the dash switch panel or throttle/shift control. Do not activate this switch while engine is running. *Doing so can severely damage the lower unit and engine.*

## Pontoon Boats

For pontoon boats, trimming the motor does not significantly affect boat attitude, but it does improve engine efficiency. You can quickly correct minor deficiencies in your boat's ride by shifting passengers or gear forward or aft. Shifting weight has the same effect as changing the angle on the drive unit and is much more effective. You will get the best results by placing 40% of the load's weight (passengers and gear) forward and 60% aft. Place passengers while loading the boat. By taking a little extra

time to carefully place passengers and load, you can create a more desirable trim.

**▲ WARNING**

**Personal Injury!** Any passenger changing position while underway must move carefully to prevent injury or falling overboard. If passenger position must be changed, operator must first reduce speed.

**▲ CAUTION**

Use extreme caution when operating with drive unit raised. Cooling water intake holes must remain submerged. See owner's manual for details.

## GENERAL RULES OF SEAMANSHIP

1. Cross waves at right angles.
2. When caught in heavy water or squalls, head either directly into the waves or at a slight angle. Reduce speed, but maintain enough power to maneuver your boat safely.
3. Keep your speed under control. Respect the rights of boaters engaged in fishing, swimming, water skiing or diving. Give them "wide berth." Never follow close behind a water skier.
4. When meeting a boat head-on, keep to the right whenever possible.
5. When two boats cross, the boat to starboard has the right of way.
6. When overtaking or passing, the boat being passed has the right of way. The boat being passed is required to maintain the same course and speed.

## STOPPING

You cannot stop a boat as quickly as a land vehicle because a boat has no brakes. Stop the boat by allowing it to slow down to less than 5 miles per hour (8 km/h). Then, put the engine in reverse. By slowly increasing reverse power, you can stop the boat in a short distance. Remember that the boat does not respond to steering in reverse as well as it does when going forward.

### **WARNING**

Check behind you before coming OFF plane. Many accidents occur each year as a result of a driver coming off plane while being followed by a boat that is unable to slow down in time to avoid collision.

## ANCHORING

Anchor your boat if you stop for recreation or an emergency. The size and weight of your boat govern the



weight of the anchor and the diameter of the anchor line. A burying anchor grips into the bottom and holds your boat secure. Holding power should be more important than weight. Your dealer can help you select the proper anchoring equipment.

The length of the anchor line should be six to eight times the depth of the water to assure that the anchor bites into the bottom. The bottom end of the anchor line should be galvanized chain. The rest of the line should be nylon anchor line.

Keep anchor secure while underway to prevent damage or injury if boat's attitude changes suddenly. If your boat has a power winch, do not use it as the primary source for securing the anchor or anchor line. See the power winch instruction manual for details about proper operation and maintenance.

These are some general guidelines for anchoring your boat:

- Secure the anchor line to the deck cleat. Do not tie line to hardware not designed to support this stress.
- If you are anchoring for more than a few hours, use more than one anchor. If you use only one anchor, make sure your boat has enough space to swing full circle in case of shifting winds.
- Keep the anchor and line in an area where it will be readily available in an emergency.

## Dropping Anchor

1. Have a crew member carefully lower the anchor, keeping a slight tension on the line as the anchor drops. Maintain tension after the anchor reaches the bottom. Simply throwing the anchor overboard usually fouls the line and requires starting over.
2. Maneuver the boat slowly aft until the proper length of line is run out.
3. Fasten the anchor line around the deck cleat. Anchor flukes should dig into the bottom and hold boat in position.
4. Check shoreline landmarks when you drop anchor. Check the position of the landmarks again 30 minutes later. If your boat's position has changed, the anchor is dragging and must be reset.

## Weighing Anchor

Weighing, or pulling in, the anchor requires moving the boat towards the anchor and pulling in the anchor line as the boat moves. When the line is vertical, pull up firmly on the anchor line to free the flukes from the bottom. If the anchor remains stuck, feed out a few feet of line and attach it to the bow cleat. Maneuver the boat around the anchor, keeping the line taut until you find an angle that will pull the anchor free.

## DOCKING

Always approach the dock slowly. If possible, come in against the wind or current, whichever is stronger. Come in at a 30-45° angle. As the boat nears the dock, slowly swing parallel to it. If wind or current is moving *toward* the dock, move parallel to the dock further out. Let the wind or current push you in. Use extreme caution if wind or current is from your stern. Approach slowly at a slight angle with engine in slow reverse. Gently swing parallel. Tie stern first, then the bow.

If the weather looks bad, use spring-lines from the bow and stern to dock amidships of the boat. Tie up on the downwind side of the dock. If the wind is changeable, place fenders over the side between the boat and the dock.

## MOORING

After you have positioned your boat next to the dock, you must secure it with mooring lines to keep it in position. Mooring lines must be long enough to secure your boat wherever it may be docked. For example, the length of the lines for a 20-foot (6.1 m) runabout should be at least 19 feet (5.8 m). An eye splice at the end of each line works well with bow or stern cleats.

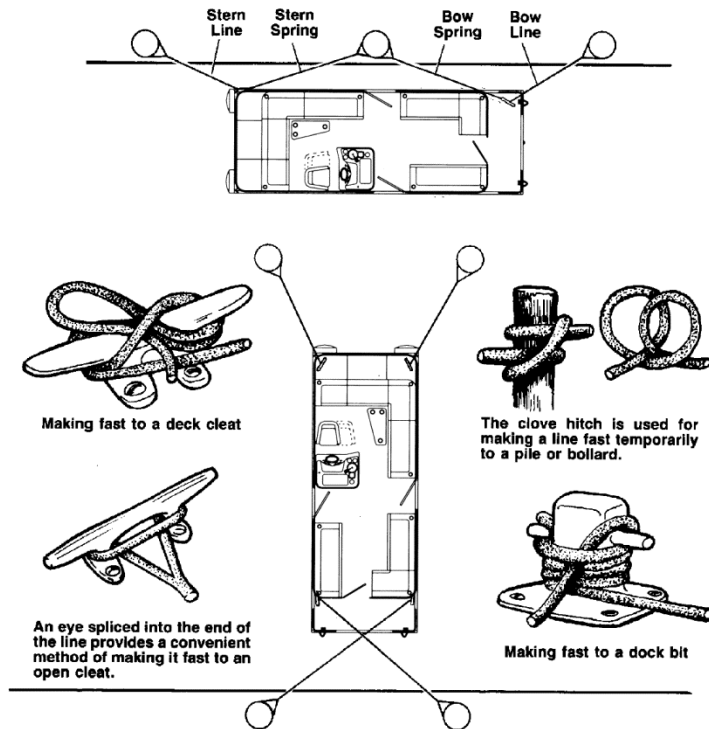

**FIGURE 5-5 MOORING**



The mooring lines you will use most often are the bow line, the stern line, and spring lines (Figure 5-5). Each line has a specific purpose. The bow line and the stern line secure your boat's bow and stern. The two spring lines keep your boat from moving forward or backward when you are moored alongside a dock. Attach mooring lines only to deck cleats or side rail mooring eyes. Do not attach lines to any other part of your boat.

If you are mooring your boat for a short time, bow and stern lines may be the only lines you will need. If you are mooring your boat for a longer time or the currents are swift, you should use spring lines. The stern spring line leads from the boat's stern cleat forward to the piling or cleat on the dock. The bow spring line leads from the bow cleat aft to the dock.

If you are mooring your boat in a slip, bow and spring lines, port and starboard, will keep your boat in position.

NOTE: Moor the boat so that the motor intake vents are leeward. Otherwise, water can be forced into the vents and cause damage to the engine.

NOTE: If tides are a consideration, be sure to leave slack in the lines to make up for the rise and fall of the water while your boat is docked.

## EMERGENCY OPERATION

Boaters should respond to emergency calls if they are nearby and can help. You are expected to proceed to the scene and render assistance. Distress calls often are made for assistance with a disabled boat. A VHF marine radio (channel 16) is the best device for calling for help. Two international emergency signals are MAYDAY (life/death situation, request immediate assistance) and PAN PAN (safety of the boat or person in jeopardy).

The Federal Boat Safety Act of 1971 requires boat operators involved in accidents to offer aid to others in the

accident and in emergencies. As a boat owner, you have accepted many responsibilities. You should know how to cope with any type of emergency that could occur on your boat or someone else's. There is a way to handle each emergency—if you do not panic! Proceed calmly using good common sense. Some tips for particular situations are listed below.

### Fire or Explosion

If a fire occurs, stop the boat immediately. Position the boat so that the fire is downwind. Boat fires involving flammable liquids, such as gasoline, can be extinguished with your dry chemical or carbon dioxide type extinguisher. Read the extinguisher directions and memorize them. Be prepared to use the extinguisher quickly if the need arises.

You must decide quickly whether to abandon ship or stay aboard and try to extinguish it. If the fire involves a trash container, smoldering upholstery or an electrical fire, try to extinguish the blaze by aiming the extinguisher nozzle at the base of the flame. However, a fire involving the fuel system greatly increases the danger of an explosion. If it is necessary to abandon ship, make sure all passengers wear a PFD or take it with them before going overboard.

Fire is an immediate danger after a gasoline vapor explosion. Gasoline floats on water and can spread out over the surface of the water. If you do abandon ship, keep yourself and your passengers clear of the burning boat.

### Storms

Storms sometimes appear without advance notice. Although weather information from meteorological observation and reporting stations is available, weather bureau predictions can sometimes be wrong or information gathering equipment can fail. Many marinas fly weather signals. You should learn to recognize these signals and monitor your local weather forecasts before leaving port. Watch the horizon for indications of an approaching storm.

The present and forecasted weather conditions are of primary consideration, but a threat of possible storms should always be a concern. There is no substitute for a strong understanding of what action to take when the weather takes a turn for the worst. Return to a safe port if time allows. If it is impossible to do so:

- Stow or tie down all loose gear.
- Reduce speed as the seas build. Prompt all persons aboard to put on their PFDs.
- Place a sea anchor out over the stern to maintain the boat's bow into the seas. If there is no sea anchor on board, use a canvas bucket or any object that will offer resistance against the flow of the current. Take care to keep anchor from tangling with the propeller. Use an anchor line which floats.
- If you lose power, keep the boat headed into the waves by rigging or using sea anchors off the bow.

## Fog

When warm air is above cooler water, its temperature drops. As the air cools, it loses its ability to hold moisture and fog will develop when the air temperature drops to the dew point temperature. Dew point temperature depends on the amount of humidity in the air. You should be aware that fog can form quickly as the air temperature drops, especially if the air is calm and humid.

Remember the following guidelines:

- Turn on running lights.
- As fog sets in, take bearings and mark your position on the chart while continuing to log your course and speed.
- Prompt all persons aboard to put on their PFDs (personal flotation device).
- If your boat has depth finding equipment, take soundings and match them with depths indicated on your charts.

- Station a person forward on the boat as a lookout.
- Reduce your speed. From time to time, stop engine and listen for fog signals.
- Sound the proper horn or fog bell at proper intervals to warn other boaters.
- If there is any doubt about continuing boat movement, anchor. Listen for other fog signals while continuing to sound the proper fog horn or bell for a boat at anchor.

### Man Overboard

If someone in your boat falls overboard, turn the steering wheel to move the propeller away from the person. Circle around quickly, approaching into the wind and waves. Turn off the engine when the person is alongside. If he is able to grasp, throw him a line or extend a paddle or a boat hook within his reach. Help the person back on board.

Do not dive over the side after an unconscious person or non-swimmer unless you are trained in lifesaving techniques. It is harder to save two people than one. If the victim has sunk out of sight, probe gently beneath the surface with a paddle or boat hook. Do not restart the engine until you have drifted clear of the victim's suspected location.

### Unassisted Reboarding

Should the need arise to reboard the boat unassisted from the water, the ladder mounted at the stern of the boat can be deployed from the water.

### Swamping or Flooding

A swamped or flooded boat could become unstable and capsize. If high waves are causing the flooding, attempt to turn the boat into the waves or shift weight to the side away from the source of the flooding.

### Capsizing

Capsizing usually occurs due to unsafe operation, overloading or poor load distribution. Your boat has been

manufactured for level upright flotation; however, if the boat does capsize, hold onto whatever you can. The boat hull is much easier for rescuers to spot than a human head sticking out of the water. Do not attempt to swim to shore. It may be farther than it appears.

## Collisions

If you are involved in a collision with a boat, or with a fixed object such as a pier, sandbar, reef or bridge, check for injuries and render first aid when necessary. Before proceeding, check out your boat thoroughly. Check steering cables for possible jamming. Raise the outboard motor and inspect for possible propeller or lower unit damage. Proceed carefully to port and remove the boat from the water to thoroughly inspect it for damage.

## Running Aground

### **WARNING**

To prevent boat damage, DO NOT use deck hardware for towing. Cleat can snap off and cause personal injury. Use a commercial towing service.

Operating in shallow water can present a number of hazards. Sand bars in narrow inlets are constantly shifting, making it difficult to mark them with buoys. Sometimes sand bars are indicated by waves as they form into breakers when passing over sand bars.

If your boat runs aground, first check persons aboard for injury. Then check for damage to the boat. If you ground your boat on a sand bar, shut down the engine and seek help from a commercial towing service, from another boater or radio for help. See your dealer as soon as possible, as sand ingested in the engine cooling system can cause major engine damage.



If the drive unit strikes an underwater hazard, check for boat and drive unit damage. pontoons still float if they are punctured. Go at a slower speed. A water-logged pontoon may change handling characteristics. If the engine vibrates excessively after striking an underwater obstruction, it may indicate a damaged propeller. If vibration is noticeable, return to port slowly to prevent further drive and engine damage from an out-of-balance condition. Watch the temperature gauge to make sure the engine does not overheat.



## CARING FOR YOUR BOAT

Proper care will help assure that your boat will continue to look like new after years of service.

We recommend that maintenance and repairs be performed by your dealer. However, some owners may prefer to take care of routine maintenance and repairs themselves. For those individuals, this chapter includes general information and basic procedures.

When your boat is not in use, protect it from the elements by storing it inside, under a roof, with a mooring cover or playpen cover over it or with furniture covers installed. Do not dock the boat under trees. Dirt, leaves and other debris will accumulate on the floor and vinyl surfaces and discolor the surface.

**IMPORTANT:** Check with your dealer before beginning any maintenance or repair if you are not sure about the proper tools, equipment and supplies to be used.

*NOTE: Always refer to the manufacturers manuals for detailed cleaning, spot and stain removal, maintenance and repair procedures for your boat's components and furnishings. If information in this manual conflicts with information in the manufacturer manuals, the manufacturer manuals must take precedence.*



## ENGINE

Refer to the engine owner's manual for recommended frequencies and detailed information about engine care and maintenance. If you have operated your boat in shallow or salt water, flush the engine with fresh water at the end of your boating excursion.

## ALUMINUM SURFACES

### Cleaning

Treat natural aluminum portions of aluminum boats with a clear protective coating to reduce natural oxidation. Rinse occasionally with clear water or mild detergent to keep these portions of the boat clean. Use water and mild detergent for cleaning and protect the surface with a liquid cleaner or wax. Do not use harsh chemicals or abrasives.

Remove stains or light corrosion with a good metal polish. Buff with a fine rubbing compound only if necessary. Remove algae, scum or other marine growth while they are still wet. They will be much harder to remove if they have had a chance to dry out.

### Painting

Some anti-fouling paints react adversely with aluminum. Do not use paints containing copper, arsenic, antimony, mercury or lead on aluminum surfaces with or without a primer.



### CAUTION

Follow bottom painting instructions carefully. Improper application of bottom paint can damage pontoons and void your warranty.

The bottom of the pontoons should be painted if you keep your boat in salt water. Anti-fouling paint may be used if

you do not run in salt water. Ask your dealer to recommend the right paint for your situation.

## Corrosion

Modern boatbuilding techniques minimize corrosion problems on aluminum models; nevertheless, corrosion can occur when dissimilar metals come in contact and are wetted by contaminated water. In general, saltier water leads to faster corrosion. To minimize this problem, use a quality caulking compound when mounting non-aluminum fixtures or hardware to aluminum. **Never use an aluminum boat as the ground wire for an electrical circuit.** Electrical equipment should be completely insulated from the vessel to eliminate electrolysis and corrosion.

NOTE: There is danger of an electric current in the water near boats linked to shore power.

We recommend that you take the following precautions to prevent corrosion:

1. Regularly rinse your boat's outdrive and all metal components with fresh water.
2. Inspect the zinc anode on your boat's engine frequently for deterioration. If you operate in salt, polluted or brackish waters, inspect the anodes more frequently. A sacrificial anode will deteriorate before the metal it protects will deteriorate. If the zinc anode erodes 50% or more, replace it to continue protection against corrosion; otherwise, other metal parts may be damaged. Never paint zinc anodes. See your engine manual for more information about the zinc anodes on your engine.
3. Regularly inspect metal components that are in contact with the water. Look for pitting or a lacy appearance to the metal. If you see damage, inspect all wiring for breaks or loose connections.



4. To prevent corrosion to pontoon tubes and other aluminum, use a wood or rubber gasket when mounting non-aluminum fixtures or hardware to aluminum. Never use the aluminum on your boat as ground for an electrical circuit. To make sure accessories are properly grounded, run the ground wire directly to the negative post of the battery.
5. Do not reverse polarity on any electrical device. If you install additional accessories, always maintain the integrity of the two-wire systems. Observing this precaution also provides protection against high voltage damage during an electrical storm.

**IMPORTANT:** Do not use pop rivets where a watertight seal or a structural fastener is needed. Attach only aluminum or stainless steel directly to the aluminum on your boat. If you must use dissimilar metals, separate them with a gasket.

### Cracked Aluminum

See your dealer about repairing cracked aluminum. Dealers have the knowledge, materials and tools needed to make the repairs.

### FIBERGLASS

Some components on your boat are fiberglass. Keep these surfaces clean to prevent dirt from scratching or dulling the surface. Clean them with a mild detergent and water. Do not use abrasives! At least twice a year, apply a coat of wax after cleaning and buff with a soft cloth to bring back the original sheen. If the fiberglass surface has oxidized (appears to have a light, milky white film), you may want to use a rubbing compound before waxing. Your dealer can recommend a good product to use.

Hairline cracks caused by weathering, impact or other factors may develop in the gelcoat or surface coating. Blisters and small gouges may also occur. Fiberglass and gelcoat repairs require professional training. These

services are usually offered by your dealer. (They are not covered by your warranty.)

## PONTOONS

If a rock, log or other obstacle punctures a pontoon, the pontoon will not fill completely with water. If water enters the pontoon, the boat will list, but it will not sink. Repairing a punctured pontoon requires specialized procedures and welding skills. Contact your dealer for pontoon repairs.

## SALT WATER OPERATION

If your boat is in daily contact with salt water, remove it from the water every three months and flush it from top to bottom with fresh water. In salt water areas hardware should be flushed with fresh water. Clean hardware and spray with a marine corrosion inhibitor every month. Pontoons that are not bottom painted and maintained per the coating manufacturer's directions can be more vulnerable to saltwater damage. Trailer bunks should be made of a non-absorbent water proof material and must not be carpeted. Wood and carpet will retain salt and brackish contaminants that will corrode pontoons. Salt water can also affect the engine. Corrosion inhibitors are available from your dealer.

Installing a transom-mounted sacrificial zinc anode is recommended if you operate your boat in salt, polluted or brackish waters. The zinc anode will deteriorate before the metal it protects. If the anode erodes 50% or more, it must be replaced; otherwise, corrosion may damage other metal parts.

## DECK HARDWARE AND FITTINGS

Clean all cleats, rails and similar equipment periodically with good chrome cleaner and polish with a marine paste wax to prevent corrosion. Replace broken or damaged hardware by bolting it through the deck and a reinforcing block underneath.



Use deck hardware only for its intended purpose. Do not use stanchions for tying off fenders, mooring lines or water ski ropes. A mooring cleat should not be used for a water ski rope.

Sunlight and ozone will eventually cause a loss of elasticity in rubber components. Inspect them frequently and replace them when signs of hardening or surface cracking are detected.

## SEAT COVERINGS AND VINYL

The vinyl used on your boat requires routine care. Keep vinyl clean and dry to keep mildew from forming. Remove seat cushions and wipe dry after each use. In very rainy weather, cover or remove cushions since seams can trap and absorb moisture. Store cushions in a dry, well-ventilated place. Keep your boat covered when not in use to prevent aging of the upholstery.

Each week, wipe vinyl surfaces with a soft damp cloth and towel dry. For dirt and stains that cannot be removed with a damp cloth, clean with a mild soap and water solution and, if necessary, a soft bristle brush. Clean remaining stains with isopropyl (rubbing) alcohol or 1:1 solution of 409® cleaner and water. Do not use silicon-based products. After using soap, alcohol or cleaner solution rinse thoroughly and towel dry.

**NOTE:** Treat all stains promptly to prevent damage.

Suntan lotion and insect repellents can stain vinyl quickly and cause vinyl surface to deteriorate. Remove these products immediately after contact and wash area with a mild soap solution. Rinse and towel dry.

**IMPORTANT:** Harsh detergents, abrasives, steel wool, bleach and solvents can cause permanent damage to vinyl upholstery. Waxes may also contain dyes or solvents that will damage the protective coating. Refer to manufacturer's instructions for recommended stain removal procedures.



## DECK COVERINGS

Several types of deck coverings are available. The following is a brief explanation of how to care for each type of covering. For more information, check the literature in your owner's/operator's packet or check with your dealer.

### Carpet

If your boat has carpeting, treat it as you would your carpeting at home. Vacuum and clean it regularly. If something is spilled on the carpet or if stains begin to appear, clean it with warm water and household detergent. For stubborn stains, consult the stain chart in this chapter or ask your dealer to recommend a suitable treatment method.

Because of the carpeting's continuous loop construction, be very careful if it is necessary to put a hole in the carpet. Refer to the manufacturer's information for the correct procedures.

### TPO Flooring Membrane

TPO decking requires periodic cleaning with Murphy's Oil Soap and a soft nylon brush or sponge. Do not use granulated cleaners because they will mar the finish. A thorough cleaning should keep the deck looking good and remove most stains. For stubborn stains, consult the stain chart in this chapter or ask your dealer to recommend a suitable treatment method.

Cuts in or damage to the TPO can be repaired with the careful application of heat. Check with your dealer before attempting to make the repair.

### Vinyl Teak Flooring

Vinyl Teak flooring is easily washed with mild soaps and other household detergents suitable for vinyl material. Brush or sweep with cool water using a deck brush or soft to medium stiff brush. Apply soap or cleaner to penetrate the dirt/stain for 2-3 minutes. Lightly scrub the area and



rinse. Should this not get the entire affected area completely clean, repeat. If the stain remains and you need to get more aggressive, a commercial automotive or marine vinyl/rubber cleaner may be used. Follow the cleaning instructions on the products. Never leave harsh detergents or chemicals on the material without cleaning off the residue.

Vinyls are not stain-proof materials. Certain dyes, inks, rubber based material, chemicals and tannin based leaves may cause permanent staining.

Never use harsh chemicals such as tar removers, acetone, kerosene or oxalic acid based cleaners on Vinyl Teak flooring.

## Faux Teak Flooring

PlasDECK is a plastic product, so it doesn't require any of the maintenance demanded by teak and it's easy to clean.

You never need to apply any protectants, oils, or other products to preserve the finish. Fish blood, food, drinks, and dirt is easily washed away.

Here are some helpful hints for the care and cleaning of PlasDECK:

- **Power Wash It!** A small household power-washer (around 1500 psi) works well to lift debris from the textured surface of PlasDECK.
- **Soap!** Soaps such as boat wash or Simple Green™ can be used to help release the dirt. Food spills, especially oily foods, should be cleaned with a safe degreaser such as dish detergent or Marine Clean™. Bleach can be used for sterilization if desired. Because PlasDECK is a PVC, it is susceptible to oil, gas, diesel, and acetone. If this type of spill occurs, clean immediately and thoroughly with a soapy detergent such as dish soap, boat wash, or Simple Green™.
- **Brush!** A nylon brush is often helpful to release stubborn debris from the surface. If desired, a short bristled wire brush can be used on **wet** decking with soap and water to help

loosen particles. **IMPORTANT:** If you use a wire brush, always move the brush in the direction of the grains in the PlasDECK.

- **Sanding!** For bad scuffs, small cigarette burns, or really stubborn stains that have been left to dry, lightly sand the area with 40 grit sandpaper. Also, if an area is worn smooth for some reason, the texture can be restored by lightly sanding. Make sure you sand in the direction of the grain with short strokes. Use a heat gun or let the sun heat your deck over time to blend tones on any areas that have been lightened during the sanding process. **Don't use a power sander on your PlasDECK!** It will warp the 'grain' that lends to PlasDECK's teak appearance.
- **Patch it!** A patch can be used to repair any serious damage to the deck. Contact PlasDECK for more information on patching by visiting our website at [www.PlasDECK.us](http://www.PlasDECK.us) or by calling us directly at 1-800-320-1841.
- **DON'T** bother wearing black-soled shoes on PlasDECK. Black shoes may leave scuffs on any decking surface. Wear boat shoes or no shoes. With PlasDECK's non-skid surface you won't have to worry about the surface being slippery when wet.
- **DON'T** put oil, varnish, paint, sealers or lacquers on your PlasDECK! Isn't that why you chose PlasDECK instead of teak? The PlasDECK doesn't need protectants and doesn't require this maintenance.
- **OUCH!** As with any deck, including teak, don't place hot metals or other hot objects on PlasDECK.

You will find that with a minimum effort your deck will retain its classic look for many years to come.

## SPOTS AND STAINS

Spots and stains should be treated immediately. The longer a spot remains untreated, the more difficult it will be to remove. Blot up spills with clean, white absorbent materials. Remove solid built-up materials with a rounded tablespoon, a spatula or the edge of a dull knife.

Use small amounts of the cleaning agents and blot frequently. Always blot, do not rub or brush. Work from the outer edge of the spot towards the center to prevent rings.



Treat the stained area with recommended spotting solution or solutions until the stain is removed. The final step is to rinse gently with water and then absorb the remaining moisture with absorbent towels.

Pre-test spot removal agents in an inconspicuous area. Apply several drops of solution on the fabric or carpet and rub gently with a soft white towel. If the color transfers to the cloth or if the fabric color changes, check with a professional cleaner.

Some stains respond to treatment slowly, while others do not respond at all. If you are not sure how to remove a spot or stain, check with a professional cleaner.

<i>Stain</i>	<i>Description</i>	<i>Cleaning Instructions</i> See page <b>6-23</b> for definitions of cleaning solutions referenced in this column.
<b>Blood</b>	<b>Red when fresh, dries to dark brown with irregular edge.</b>	<ol style="list-style-type: none"> <li>1. Apply cool detergent solution, blot.</li> <li>2. Apply cool ammonia solution, blot.</li> <li>3. Apply enzyme detergent, blot.</li> <li>4. Rinse thoroughly with water, blot until dry.</li> <li>5. If stain remains, apply rust remover or oxalic acid solution</li> <li>6. Bleaching with 3-5% hydrogen peroxide may be necessary.</li> </ol>
<b>Butter and Margarine</b>	<b>Greasy, yellowish-red. Contains vegetable dye, corn oil, milk, salt, preservatives, vegetable fats.</b>	<ol style="list-style-type: none"> <li>1. Apply dry cleaning solvent, blot.</li> <li>2. Apply detergent solution, blot until dry.</li> <li>3. Apply vinegar solution, blot.</li> <li>4. Rinse with water and blot until dry.</li> </ol>
<b>Catsup and Tomato Sauce</b>	<b>Reddish-brown, absorbed and built up. Contains</b>	<ol style="list-style-type: none"> <li>1. Apply cool detergent solution, blot.</li> <li>2. Apply ammonia</li> </ol>

	<i>tomatoes, salt, sugar, spices, tannin, vinegar.</i>	<i>solution, blot.</i> <b>3. Apply enzyme detergent, blot.</b> <b>4. If stain remains, bleaching with 3-5% hydrogen peroxide or sodium perborate.</b> <b>5. Rinse thoroughly with water, blot until dry.</b>
<i>Stain</i>	<i>Description</i>	<i>Cleaning Instructions</i>
<b>Jam and Jelly</b>	<b>Reddish or bluish, absorbed and built up.</b> <b>Contains fruit pulp, sugar, tannin, preservatives</b>	<b>1. Apply cool detergent solution, blot.</b> <b>2. Apply ammonia solution, blot.</b> <b>3. Apply enzyme detergent, blot.</b> <b>4. If stain remains, bleaching with 3-5% hydrogen peroxide or sodium perborate.</b> <b>5. Rinse thoroughly with water, blot until dry.</b>
<b>Lipstick</b>	<b>Various colors, soft and greasy.</b> <b>Contains pigment or dye in fat, waxes, and oils.</b>	<b>1. Scrape off excess with spatula or dull knife.</b> <b>2. Apply POG, blot. Make sure not to reapply stain onto fabric.</b>

		<ol style="list-style-type: none"><li><b>3. Apply dry cleaning solvent, blot.</b></li><li><b>4. Apply detergent, blot.</b></li><li><b>5. Apply ammonia solution, blot.</b></li><li><b>6. Apply vinegar solution, blot.</b></li><li><b>7. Rinse thoroughly with water, blot until dry. (Try to avoid wet cleaning on wool. Use POG and dry cleaning solvents as much as possible.)</b></li></ol>
--	--	---

<i>Stain</i>	<i>Description</i>	<i>Cleaning Instructions</i>
<b>Mildew</b>	<b>Grayish or brownish fungus with black spots. May permanently damage fibers.</b>	<ol style="list-style-type: none"> <li>1. <b>Apply enzyme detergent, blot.</b></li> <li>2. <b>Apply ammonia solution, blot.</b></li> <li>3. <b>Rinse thoroughly with water, blot.</b></li> <li>4. <b>Apply solution of oxidizing bleach (chlorine or perborate). DO NOT use chlorine bleach on wool or silk!</b></li> <li>5. <b>Rinse thoroughly with water, blot until dry.</b></li> </ol>
<b>Mud</b>	<b>Grayish, brownish, reddish, absorbed and built up. Contains soil with greases and oils, clay, iron.</b>	<ol style="list-style-type: none"> <li>1. <b>Brush or scrape off as much as possible.</b></li> <li>2. <b>Apply detergent solution, blot.</b></li> <li>3. <b>Apply ammonia solution, blot.</b></li> <li>4. <b>Rinse thoroughly with water, blot until dry.</b></li> <li>5. <b>If stain remains, apply POG and dry cleaning solvent alternately, blot until dry.</b></li> </ol>
<b>Mustard</b>	<b>Yellowish, absorbed or built</b>	<ol style="list-style-type: none"> <li>1. <b>Apply detergent solution, blot.</b></li> </ol>



	<p><i>up.</i> <b>Contains mustard seed, vinegar, salt, turmeric, oils, spices.</b></p>	<p><b>2. Apply ammonia solution, blot.</b></p> <p><b>3. Apply enzyme detergent, blot.</b></p> <p><b>2. If stain remains, rust remover (oxalic acid solution) or bleaching may be necessary. DO NOT use ammonia or alkalis.</b></p>
--	--	--

<i>Stain</i>	<i>Description</i>	<i>Cleaning Instructions</i>
<b>Nail Polish</b>	<p><i>Various colors, stiff, shiny and built up.</i></p> <p><i>Contains dye or pigment in a liquid cellulose acetate base, solvent, plasticizer.</i></p>	<ol style="list-style-type: none"> <li>1. <i>Apply dry cleaning solvent, blot.</i></li> <li>2. <i>Apply POG, blot.</i></li> <li>3. <i>Apply amyl acetate, if available, or nail polish remover – PRETEST FIRST.</i></li> <li>4. <i>If stain remains, apply detergent solution, blot until dry.</i></li> <li>5. <i>Apply ammonia solution, blot.</i></li> <li>6. <i>Apply vinegar solution, blot.</i></li> <li>7. <i>Rinse thoroughly with water, blot until dry.</i></li> </ol>
<b>Urine</b>	<p><i>Yellowish or brownish, darkened with age, absorbed.</i></p> <p><i>Contains urea, uric acid, ammonia, organic acids, cholesterol, albumins, proteoses.</i></p>	<ol style="list-style-type: none"> <li>1. <i>Blot up as much as possible if still wet.</i></li> <li>2. <i>Apply detergent solution, blot.</i></li> <li>3. <i>Apply ammonia solution, blot.</i></li> <li>4. <i>Apply vinegar solution, blot.</i></li> <li>5. <i>Rinse thoroughly with water, blot until dry.</i></li> <li>6. <i>If stain remains, apply rust remover or</i></li> </ol>

		<p><i>oxalic acid solution.</i></p> <p><b>7. Bleaching with 3-5% hydrogen peroxide or sodium perborate may be necessary. Urine may cause permanent dye removal from fibers.</b></p>
--	--	---

<i>Stain</i>	<i>Description</i>	<i>Cleaning Instructions</i>
<b>Vomit</b>	<b>Various colors, absorbed and built up. Contains food, mucus, albumins, acids.</b>	<ol style="list-style-type: none"><li><b>1. Blot up as much as possible if still wet.</b></li><li><b>2. Apply enzyme detergent, blot.</b></li><li><b>3. Apply ammonia solution, blot.</b></li><li><b>4. Apply vinegar solution, blot.</b></li><li><b>5. Rinse thoroughly with water, blot until dry.</b></li></ol>
<b>Wine</b>	<b>Reddish or purplish, absorbed. Contains alcohol, sugar, tannin, coloring matter.</b>	<ol style="list-style-type: none"><li><b>1. Apply detergent solution, blot.</b></li><li><b>2. Apply vinegar solution, blot.</b></li><li><b>3. Apply ammonia solution, blot.</b></li><li><b>4. If necessary, bleach with 3-5% hydrogen peroxide or sodium perborate.</b></li><li><b>5. Rinse thoroughly with water, blot until dry.</b></li></ol>

# PONTOON COVER INSTALLATION INSTRUCTIONS — CARE & USE GUIDELINES

Please carefully read this entire instruction sheet before proceeding.

It is very important to us that you read and understand these installation instructions. If while reading these instructions you are unsure about installing the cover, please feel free to contact the dealer where you purchased your boat. Improper installation as a result of not following these instructions may result in damage to the cover that is not covered by the warranty.

## INSTALLATION

### CAUTION

Pontoon covers are not designed to be trailered. The limited warranty does not cover damage caused by trailering

NOTE: The canopy or Bimini top must be in the position shown during installation of the cover. It may also be necessary on some pontoon models to remove and store the windshield (Fig. 1&2)

### Positioning and Fastening the Cover

Unfold the cover and locate the tag that reads "FRONT" sewn into the underside of the cover. This side of the cover should be placed toward the front of the pontoon. Unfold and lay the cover over the top of the pontoon. Pull the corners to their positions (front and rear).

Check for proper fit in all critical areas such as the corners and canopy/Bimini mount bracket openings. These



brackets should be in the center of the openings in the cover. Pull the short rope in the collar of the openings tight and tie a knot.

Make sure all corners and sides of the cover are pulled evenly and the cover is centered on the pontoon. This is critical in assuring proper fit.

After checking for proper fit you may begin attaching the cover to the pontoon. Your pontoon has the Dowco-Clip system you can snap on the clips starting at the center of the front of the pontoon. Then attach the front corner clips making sure the cover is pulled tight. Locate the rear corner clips, pulls the cover tight and fasten those. Next you can attach the remaining clips on the front, rear and sides.

If your cover has metal snaps instead of the EZ-Clip system, fasten the snaps in the same manner described for the clips.

The cover will be loose down the center of the pontoon and will be raised and tightened using the support poles supplied to create a tent affect so that water drains off to the sides properly.

### Cover Support Pole Placement for Proper Drainage

Some covers come with adjustable support poles. To place the poles you may need to crawl inside the boat under the cover. When the poles are placed in position, they will help to insure proper drainage. The poles can be adjusted to raise the cover until it is taut (no sags) and allows water to drain off.

NOTE: Avoid overextending the poles and stretching the fabric. Poles can be made shorter by removing the black end cap and placing it on the opposite end and reassemble.

For covers with plastic vents – insert the pole end without the cap into pole vent.

For covers with pole pockets – insert the pole end with the cap into the pocket sewn into the underside of the cover.

Adjust each of the poles until the entire cover is evenly raised and taut so that water can drain off.

Some poles may be positioned near rear seat cushions. In some cases, the rear seat may be flipped up and the pole placed inside and down to the deck.

## PREVENTING TEARS

At this time look for possible points of abrasion (sharp objects or angles) where the cover may rub and be damaged. Add protective padding (foam or soft cloth) as needed.

## STORAGE AND CARE

Proper care and maintenance of the cover will maximize its useful life. The ClimaShield™ fabric used for the cover has coatings for water repellency and mildew resistance. It is important to follow these instructions to maintain these benefits.

Never store the cover while it is wet or dirty. Make sure the cover is completely dry and clean prior to storage as this will help prevent mildew growth which will damage the fabric.

Clean the cover with mild soap and water to remove dirt, bird droppings, etc. Do not steam or pressure wash.

Prevent sharp objects, solvents and hot items from coming in contact with the cover.

If stored outdoors, do not allow ice or water to accumulate on the cover as this may cause damage.



## PONTOON OR HULL BOTTOM MAINTENANCE

Use a commercial hull cleaner and a brush to remove algae or scum on the pontoons or the bottom of your boat. They will be easier to remove if they are not allowed to dry out. If your boat will remain in the water for more than three months, check with your dealer about the best bottom coating to use for preventing algae or scum buildup.

## FRESH WATER SYSTEM

Refilling the water tank regularly can help assure a fresh, clean water supply. If you are not going to be using your boat for an extended period of time, you may want to drain the water container and refill it with fresh water when you are ready to use it again.

You should sanitize the fresh water system before you use it for the first time, when you fit out after winter storage or if you suspect the water system has been contaminated.

1. Drain the fresh water container completely. Open the faucet and allow water to drain from the hose.
2. Pour 1 ounce of household bleach into the container, and fill with clean fresh water.
3. Pressurize the system and bleed air from the faucet and any other outlets.
4. After 3 hours, drain the system completely.
5. Fill the container with clean, fresh water. Flush system by draining container again.
6. Fill the container with clean, fresh drinking water.

If you can smell or taste bleach in the water, a vinegar solution will neutralize the bleach. Mix a solution of 1 pint white vinegar to 2-1/2 gallons of water. Pour the solution into the container and allow to stand for an hour. Drain and flush the system with one full container of water.



## SLIDER SEAT

Keep seat rails clean. Apply a light coat of grease from time to time to assure that the seat moves easily on the rail.



## CLEANING SOLUTIONS DEFINITIONS

**Ammonia Solution:** Mix one tablespoon of clear household ammonia with one-half cup of water.

**Detergent Solution:** Mix one tablespoon of colorless, mild detergent or dishwashing liquid in a cup of lukewarm water.

**Dry Cleaning Solvent:** Volatile dry spotter or commercial spotter such as Carbona, Energine or K2R. Use in small amounts; it can be harmful to sizings, backings or stuffing materials. Do not use gasoline, lighter fluid or carbon tetrachloride.

**Enzyme Detergent:** Mix a solution of enzyme detergent following the directions on the label. Do not soak or over wet. Allow the solution to remain on the stain for the recommended length of time before removing.

**POG:** Paint, oil or grease remover available in hardware stores.

**Vinegar Solution:** Mix one-third cup of white household vinegar with two-thirds cups of water.

## WINTERIZATION AND STORAGE

This chapter includes general information for winterizing and storing your boat after the boating season. Proper winterization helps extend the life of your boat and its equipment and simplifies fitting out after storage. We recommend that you have your dealer winterize your boat and prepare it for storage.

Ventilation is very important during storage. Indoor storage is ideal, especially in areas where ice and snow accumulate. Make sure the storage building has adequate ventilation. If you use outdoor storage facilities, cover your boat with a canvas cover. Provide ventilation to keep the boat from “sweating” by building a frame over the boat to support the canvas. Build the frame several inches wider than the boat so the canvas will clear the rails. Put a mildew suppressor or dehumidifier inside a covered boat to control mildew.

Before preparing your boat for winter storage remove the bimini top and store it separately. If your boat has a hardtop, remove it and store it separately. Choose a storage location that will protect the top from damage by wind and accumulations of ice and snow. Thoroughly check the condition of the boat, its systems and equipment. Note any repairs needed. The need for repairs may become apparent during winterization. Make arrangements to have the repairs completed.

## PREPARATION FOR STORAGE

Preparing your boat for winter storage is similar to the routine exterior care. Refer to Chapter 6 for specific cleaning solutions and procedures.

### Lifting Your Boat

The best way to lift your boat out of the water is to load it on your trailer (see Chapter 4 for instructions). If a trailer is



not available, arrange to have a marina lift your boat out of the water. Workers at the marina will know the proper way to lift your boat and have the proper equipment available. See your dealer if you have questions about lifting your boat.

**IMPORTANT:** Aluminum eyelets or stainless steel U-bolts on pontoons are used only for mooring. Attaching lifting lines at these points will damage the pontoons.

### Pontoons

Scrape off any crusted marine growth and barnacles. Then scrub thoroughly to remove marine growth and scum. Check for dents and cracks. Make any necessary repairs.

**NOTE:** Clean the hull right after the boat is hauled out of the water. Marine growth and barnacles are easier to remove while they are still wet.

## Deck

Wash the deck and walkway surfaces. Clean the carpet. Clean all deck hardware with a good cleaner, then apply one coat of rust inhibitor. Corrosion inhibitors are available from your dealer.

Remove all cushions and any other items that can hold moisture and cause mildew. Cushions may be left on board only if they can be propped up where air can circulate. If you leave life jackets and other safety equipment inboard, be sure to leave space around them for adequate air circulation.

## Engine

Refer to the owner's manual for detailed information about preparing the engine for winter storage.

## Batteries

Remove the batteries and store them in a location away from freezing temperatures. Batteries should be stored in a cool, dry place on a wooden pallet. Charge the batteries once a month or apply a continuous trickle charge while they are being stored.

### **WARNING**

Battery electrolyte can cause severe eye damage and burn your skin. Wear goggles, rubber gloves and a protective apron when working with battery. If electrolyte spills, wash area with a solution of baking soda and water.

Clean the outside of the battery case, terminals and battery clamps with a baking soda and water solution. *Do not allow solution to enter battery cells.*

Clean battery posts and clamps with a piece of fine grit emery cloth. Use a light sanding motion when cleaning.



Apply a light coat of petroleum jelly to cover the ends of the battery cables.

### Fresh Water System

Remove water tank and drain. Make sure water supply hoses from the tank are drained.

### Livewell

Remove the standpipe tube and allow all water to drain from the livewell. Run the livewell pump just long enough to ensure that all water is removed. Remove the livewell inlet hose and drain. Open the aerator spray head valve and allow the water to drain.

### Bilge

NOTE: Winterization of the bilge is applicable to some models. Not all models have a bilge pump.

Clean and dry the bilge. Remove any materials, such as rags, sponges, or other cleaning material. Remove bottom drain plug. Store the plug in a plastic bag and tape it to the throttle control lever so that it does not get lost or forgotten.

The bilge pump must be drained to prevent damage if it is exposed to freezing temperatures. Pump or drain all of the water out of the bilge. Then, allow the pump to run for a few seconds to remove water from the pump before removing and draining the pump outlet hose. The bilge pump is water-cooled. *Running the pump dry for an extended period of time will damage the pump. Run pump only as long as necessary.*

# SUPPORTING YOUR BOAT DURING STORAGE

## Pontoon Boats

Your trailer is the ideal support for your boat during storage because it supports the boat under the main frames. Loosen or remove all tie downs to relieve stress on the hull. Place blocks under the axles to keep tires away from the ground. Now is also a good time to repack the trailer wheel bearings.

If your boat is not stored on the trailer, it should be stored on 4x4 inch timbers wide enough to support all tubes (Figure 7-1). Place the blocks under the keels at the seams. If not properly supported, the welds or the tubes themselves may open. Damaged welds will require repair by your dealer before launching the boat after storage.

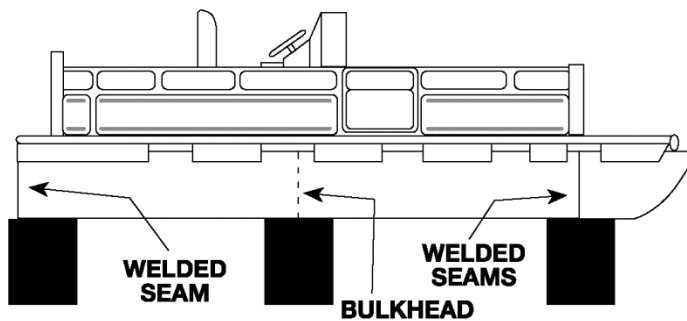

**FIGURE 7-1 PONTOON BOAT STORAGE**



## FITTING OUT AFTER STORAGE

Fitting out is not difficult if the boat was properly prepared for storage. Before launching your boat, do not load unneeded equipment or personal items until the launch and final checkout are complete. For detailed information on recommissioning your boat's systems and equipment, refer to the owner's manual for each system or component.

1. Inspect, visually and by smelling, the fuel system and all associated components for loose or damaged hoses and connections, wear, leaks or other damage and needed repair. Inspection of the fuel system is a most important safety precaution.
2. Check propellers for proper installation and tightness. Clean propeller if necessary.
3. Inspect all life jackets, anchor lines and other safety equipment for proper operation and physical condition. Repair or replace if necessary.
4. Check all safety equipment including flares, flags, fire extinguishers and first aid kits. Replace equipment as necessary.
5. Check charge on battery. Recharge or replace if necessary.
6. Clean battery terminal posts and cable terminal with wire brush or bronze wool. Inspect all battery wiring. Repair or replace if necessary.
7. Install batteries and attach cables. After cable posts are tightened down, smear posts with petroleum jelly or dielectric grease to keep out air and acid. Check all wiring connections and contacts for corrosion and tightness.
8. Inspect all wiring for fraying, wear, loose connections or other damage. Repair or replace if necessary.
9. Inspect all switches, controls and other related equipment for proper operation. Repair or replace if necessary.

## 6 WINTERIZATION AND STORAGE



10. Test operation of navigational lights and other lighting inboard. Repair or replace as necessary.
11. Reinstall hull drain plug after coating threads with teflon tape or petroleum jelly.
12. After launching, check all sources of possible leaks from bow to stern. Make this check before leaving the dock!
13. Check all steering controls, cables and linkage for free operation.
14. Test run engine as directed in the equipment manuals.
15. Check that the bilge area is clean. Check operation of bilge pump.
16. Check that water intake for livewell pump is clear.



## HELPFUL INFORMATION

### BOATING REGULATIONS

The U.S. Coast Guard is the authority of the waterways; they are there to help the boating public. State boating regulations are enforced by local authorities. Your boat is subject to the marine traffic laws known as “Rules of the Road,” which are enforced by the U.S. Coast Guard. You are subject to marine traffic laws and “Rules of the Road” for both federal and state waterways. You must stop if signaled to do so by enforcement officers, and permit to be boarded if asked. The “Rules of the Road” can be obtained from your local U.S. Coast Guard Unit or the United States Coast Guard Headquarters by calling (202) 512-1800 or faxing your request to (202) 512-2250, and asking for the publication titled “Navigational Rules, International-Inland.”

Many pamphlets prepared by the Coast Guard are available. They explain signal lights, buoys, safety, international and inland regulations and other information which goes beyond the scope of this manual. “Aids to Navigation” (U.S. Coast Guard pamphlet #123) explains the significance of various lights and buoys. Because of proposed alterations in buoys and markers, contact the U.S. Coast Guard to stay informed of changes. Other pamphlets, including the “Boating Safety Training Manual” and “Federal Requirements for Recreational Boats” are also available from the U.S. Coast Guard Headquarters.



The spoken word “MAYDAY” is the international signal of distress. MAYDAY should NEVER be used unless there is grave or imminent danger, and you are in need of immediate assistance.

## RULES OF SEAMANSHIP

### Right-of-Way

In general, boats with less maneuverability have right-of-way over more agile craft. You must stay out of the way of the following vessels:

- A vessel not under command or aground. Due to their circumstances, these vessels have no maneuverability.
- A vessel restricted in its maneuverability. These vessels are performing work which limits their maneuverability such as: surveying, dredging, laying pipe or cable or servicing navigational markers among others.
- A vessel engaged in fishing. These include boats fishing with lines, trawls or nets, but not trolling lines.
- Sailboats. Sailboats have the right-of-way over power boats. However, if a sailboat is using a propeller to move forward, it is considered a power boat even if its sails are up.

## Meeting Head-On

When two boats meet head-on, neither boat has the right-of-way. Both boats should decrease speed and pass port to port. However, if both boats are on the left side of a channel, each vessel should sound two short horn blasts and pass starboard to starboard. See Figure 8-1.

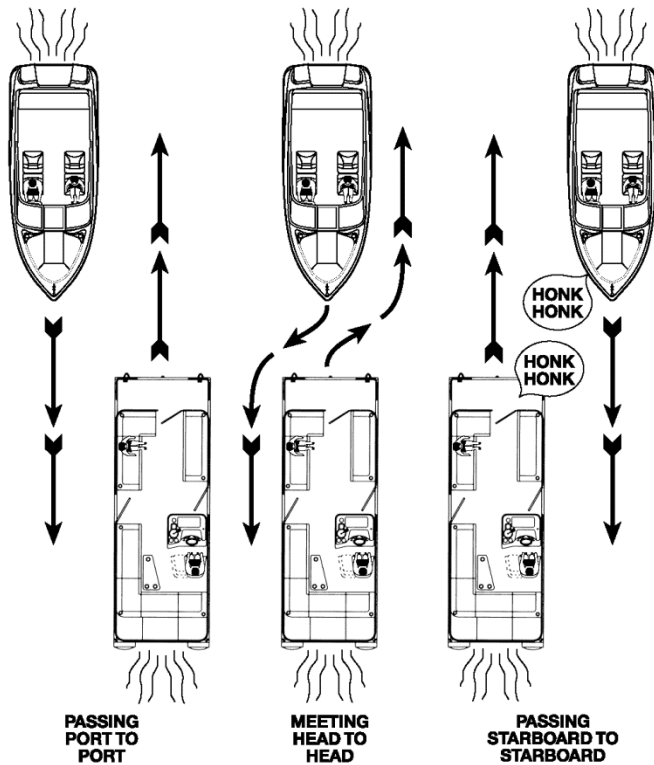

**FIGURE 8-1 MEETING HEAD-ON**

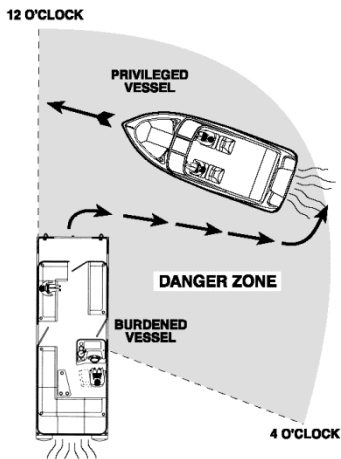

**FIGURE 8-2 CROSSING**

### Crossing Situations

In a crossing situation, the boat on the right from the 12-4 o'clock position has the right-of-way. It must hold course and speed. The boat without right-of-way must keep clear and pass to the stern. See Figure 8-2.

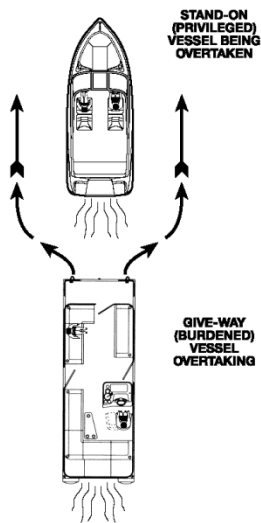

**FIGURE 8-3 OVERTAKING**

### Overtaking

The boat overtaking the one ahead must yield the right-of-way to the boat being passed. The overtaking boat must make any necessary adjustments to keep out of its path. The boat being passed should hold its course and speed. See Figure 8-3.

## The General Prudential Rule

The general prudential rule regarding right-of-way is that if a collision appears unavoidable, neither boat has right-of-way. As prescribed in the Rules of the Road, both boats must act to avoid collision.

## Night Running

Boats operating between sunset and sunrise (hours vary by state), or in conditions of reduced visibility, must use navigational lights.

Nighttime operation, especially during bad weather or fog, can be dangerous. All "Rules of the Road" apply at night, but it is best to slow down and stay clear of all boats regardless of who has right-of-way.

To see more easily at night, avoid bright lights when possible. Also, it is helpful to have a passenger keep watch for other boats, water hazards and navigational aids.

To determine the size, speed and direction of other vessels at night, you should use the running lights. A green light indicates the starboard side, and a red light indicates the port side. Generally, if you see a green light, you have the right-of-way; if you see a red light, give way to the other vessel. See Figure 8-4.

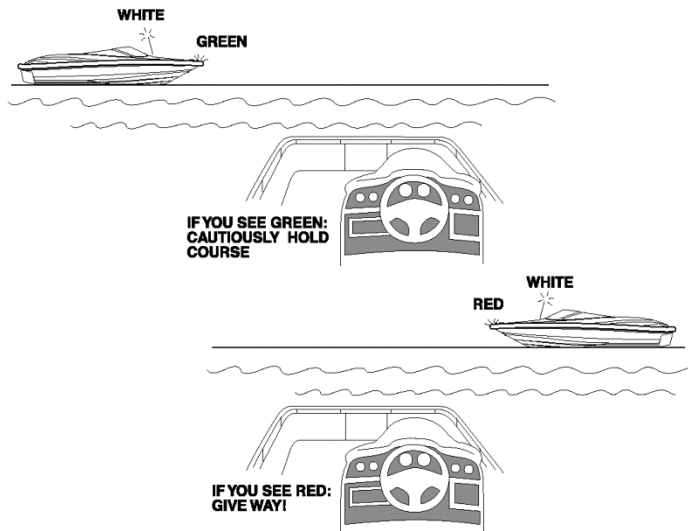

**FIGURE 8-4 NIGHT RUNNING**

## Sound Signals

Out on the water, whistle or horn signals are commonly used. Although using a signal is not necessary every time a boat is nearby, operators must signal their intentions when necessary to avoid potentially confusing or hazardous situations. *Use whistle blasts early enough to be noticed and understood by other boaters.*

It is customary for the privileged boat to signal first and the give way boat to return the same signal to acknowledge she understands and will comply. Use the danger signal (five or more short and rapid blasts) if intent is not clear. A short blast is 1 or 2 seconds long. A long blast is 4 to 6 seconds long. The Navigational Aids Chart at the end of this chapter lists the meanings of the various whistle signals.



## RECOMMENDED READING

We recommend that you read the boating literature published by your state boating agency and the U.S. Coast Guard. Other suggested reading includes the following:

Damford, Don. *Anchoring*. (ISBN 0-915160-64-1). Seven Seas.

United States Coast Guard Auxiliary. *Boating Skills and Seamanship*. LC74-164688. (illus.). (ISBN 0-930028-00-7). U.S. Coast Guard.

Bottomley, Tom. *Boatman's Handbook*, (illus.). 316 p. pap. (ISBN 0-688-03925-1, Hearst Marine Bk.). Morrow.

Whiting, John and Bottomley, Tom. *Chapman's Log and Owner's Manual*. 192 p. (ISBN 0-87851-801-0); (ISBN 0-686-96737-2). Hearst Bk.

Chapman, Charles F. and Maloney, E.S. Chapman's Piloting, *Seamanship and Small Boat Handling*. (illus.) 62 p. (ISBN 0-87851-814-2, Pub. by Hearst Bks.); deluxe ed. (ISBN 0-87851-815-0). Morrow

National Fire Protection Association. *Fire Protection Standards for Pleasure and Commercial Motor Craft*. (ISBN 0-317-07388-5, NFPA 302). Natl. Fire Protection Association.

Brotherton, Miner. *Twelve-Volt Bible*. Plastic comb. (ISBN 0-915160-81-1). Seven Seas.



## CONTACTS

There are many good boating publications that have information about your area and what other boat owners are doing, such as clubs and other activities. Education programs are sponsored by publications and organizations such as the U.S. Power Squadron, U.S. Coast Guard Auxiliary and The American Red Cross. See your dealer about special courses available in your area. For detailed information contact:

American Red Cross

Local address (see local telephone directory)

Boat U.S. Foundation for Boating Safety Hotline

1-800-336-BOAT

1-800-245-BOAT (in Virginia)

Coast Guard Boating Safety Hotline

1-800-368-5647

NMMA Sources of Waterways Information-National Marine Manufacturers Association has five (5) booklets which list sources for safety, cruising and local waterway information. Each covers a different region of the U.S. (North Central, South Central, Northeastern, Southeastern and Western). For single copies, write Sources of Waterways Information, NMMA, 401 N. Michigan Avenue, Chicago, Illinois 60611. Ask for the booklet for your region.

Skippers Course

GPO Superintendent of Documents

Washington, DC 20012

United States Coast Guard Auxiliary

Local Flotilla or contact appropriate Coast Guard District Headquarters

United States Coast Guard Headquarters

202-512-1800

202-512-2250 (fax)

United States Power Squadron  
P.O. Box 30423  
Raleigh, NC 27617

## NAVIGATIONAL AIDS

Aids to navigation (ATONS) help you to travel safely on the water. They help you get from one place to another and are most helpful if you have a nautical chart.

**IMPORTANT: NEVER** tie your vessel to an ATON. It is illegal because your boat blocks the ATON from the view of other boaters. Decreased visibility can contribute to a serious accident that may result in property damage, personal injury or death.

There are two ATON systems. The system used on federal waters is known as the International Association of Lighthouse Authorities System B (IALA-B). The Coast Guard maintains this system. The second system is the Uniform State Waterway Marking System (USWMS). This system is maintained by state authorities.

### International Association of Lighthouse Authorities System B (IALA-B)

IALA-B uses four types of ATONS. This chapter discusses the two most common markers: lateral markers and safe water markers. Other federal markers include special markers and isolated danger markers. The Navigational Aids Chart at the end of this chapter, shows these aids.

## LATERAL MARKERS

Lateral markers indicate the sides of navigable channels. They consist of lighted can or nun buoys and daymarks. Each has a number and is either red or green. The numbers on green markers are odd. Red markers have even numbers.

Buoys are red or green floating ATONS. If lighted, they have either red or green lights. Unlighted green buoys, called cans, look like cylinders. Unlighted red nun buoys have cone shaped tops with their points cut off. Don't pass too close to a buoy. You may foul your propeller in its chain.



Buoys are anchored floating objects and may not always be exactly in the same position.

Daymarks are red or green boards with numbers. They are on posts or groups of pilings tied together and called dolphins. Daymarks and their supports are daybeacons. Daybeacons may or may not have lights. If a red or green daybeacon has a light, it is the same color as the marker — red or green. Red daymarks are triangular and have even numbers. Green daymarks are square and have odd numbers.

Red, Right, Returning is a basic rule to assist you in using lateral markers. When you are returning from seaward, keep red markers on your starboard (right) side when you pass them. Keep green markers to your port side.

Returning from seaward is very clear if you have been on the ocean. You are returning to port. By agreement, going upstream on a navigational river is returning from seaward. The outlet ends of the Great Lakes are also the seaward

ends. Travelling from a large body of water to a smaller one is considered returning from seaward.

#### SAFE WATER MARKERS

Safe water markers have vertical red and white stripes and mark the center of navigable channels and fairways. Safe water markers include both lighted and unlighted buoys and daymarks. If a marker is lighted, the light will be white, and will flash the letter "A" in Morse code.

Preferred Channel markers have horizontal red and green bands. If lighted, the color of the light is the same as the top of the band. They show the preferred channel for you to use at a junction point. Be sure to notice the color of the top band, and treat it as any other marker you would of that color. If the band is red and you are returning from seaward, keep the marker to your right. Most lights on markers flash on and off. Others such as lights on aids with no lateral significance are fixed. They stay on all night. ATON lights flash in regular patterns. For example, they may flash every three seconds, or in groups such as two flashes and a pause. There are a number of flashing patterns, which help you identify the light at night. To identify a light, note its color and pattern or timing of flashes, and compare it to your chart to find its location.

#### The Uniform State Waterway Marking System

This section discusses three kinds of markers in this system: Regulatory, Informational and Lateral.

Regulatory markers in this system are either signs or buoys. Signs are square with orange borders. Regulatory buoys are white and shaped like cylinders. They have horizontal orange bands near their tops and just above the water's surface. An orange circle on a marker means a controlled area. A message such as "No Wake, Idle Speed, No Skiing, or 5 MPH" may appear on the marker. An orange diamond means danger. If the diamond has an orange cross inside it, don't enter the area. The reason



you should stay out, such as “Swim Area” may be printed in black on the marker.

Informational markers are white signs with orange borders. They give information such as direction, distance and location.

Lateral markers in the USWMS system are either numbered red or black buoys. Black buoys may have green reflectors or lights. They are the equivalent of green buoys in the IALA-B system. Red buoys may have red reflectors or lights. They are the same as red buoys in the IALA-B system. Red and black buoys are usually found in pairs — pass between them.

### A Special Sign

In Florida, you may see a special sign: “Caution, Manatee Area.” When you see this sign, slow down to idle speed. Manatees, an endangered species, are passive, large, slow-moving mammals. Many manatees are seriously injured or killed each year by boat propellers.

## OWNER’S/OPERATOR’S LOGS AND RECORDS

At the end of this chapter are several forms which you will find very helpful.

Use the Boat Data Record to record all important information about your boats and the major components installed. After you have entered all the data, remove this form from your Owner’s/Operator’s Manual and store in a safe place. Do not keep this form aboard your boat.

The Service/Maintenance Log provides a record of maintenance work completed on your boat, the date of completion and the engine hour reading. This log will also help you identify the frequency of routine maintenance work, such as engine oil changes. If you should decide to

sell your boat, it will demonstrate to prospective buyers that you have done a good job of taking care of your boat.

## NAVIGATIONAL AIDS CHART

The illustrated Navigational Aids Chart located on the next two pages contains information concerning whistle signals, storm warnings, bridge signals and buoy descriptions and information. As a safe boater, it is your responsibility to become familiar with this information. You should be able to identify each navigational aid and understand its importance.

# NAVIGATIONAL AIDS CHART

## REMEMBER THESE RULES

1. **OVERTAKING - PASSING:** Boat being passed has the right-of-way. **KEEP CLEAR.**
2. **MEETING HEAD ON:** Keep to the right.
3. **CROSSING:** Boat on right has the right-of-way. Slow down and permit boat to pass.

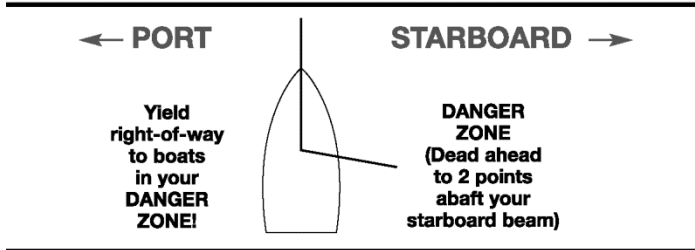





## WHISTLE SIGNALS

- ONE LONG BLAST:** Warning signal (Coming out of slip)
- ONE SHORT BLAST:** Pass on my port side
- TWO SHORT BLASTS:** Pass on my starboard side
- THREE SHORT BLASTS:** Engine(s) in reverse
- FOUR OR MORE BLASTS:** Danger signal

## BRIDGE SIGNALS

		DAY (Flag)	NIGHT (Lights)
<b>SOUND</b>	<b>VISUAL</b>		
VESSEL: Open —●	VESSEL: Open □	↑	↑
BRIDGE: OK —●	BRIDGE: OK	↓	↓ or ↓
No ●●●●●	Same		Same
VESSEL: Replies: ●●●●●	No	◁■▷	◁●▷
<b>RADIO: VHF CH. 13</b>			

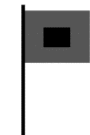
## STORM WARNINGS

			
<b>RED FLAG</b> Small craft (winds to 33 knots)	<b>2 RED FLAGS</b> Gale (winds up to 47 knots)	<b>SQUARE RED FLAG BLACK BOX</b> (Storm)	<b>2 SQUARE RED FLAGS BLACK BOX</b> (Hurricane)



# LATERAL AIDS AS SEEN ENTERING FROM SEAWARD

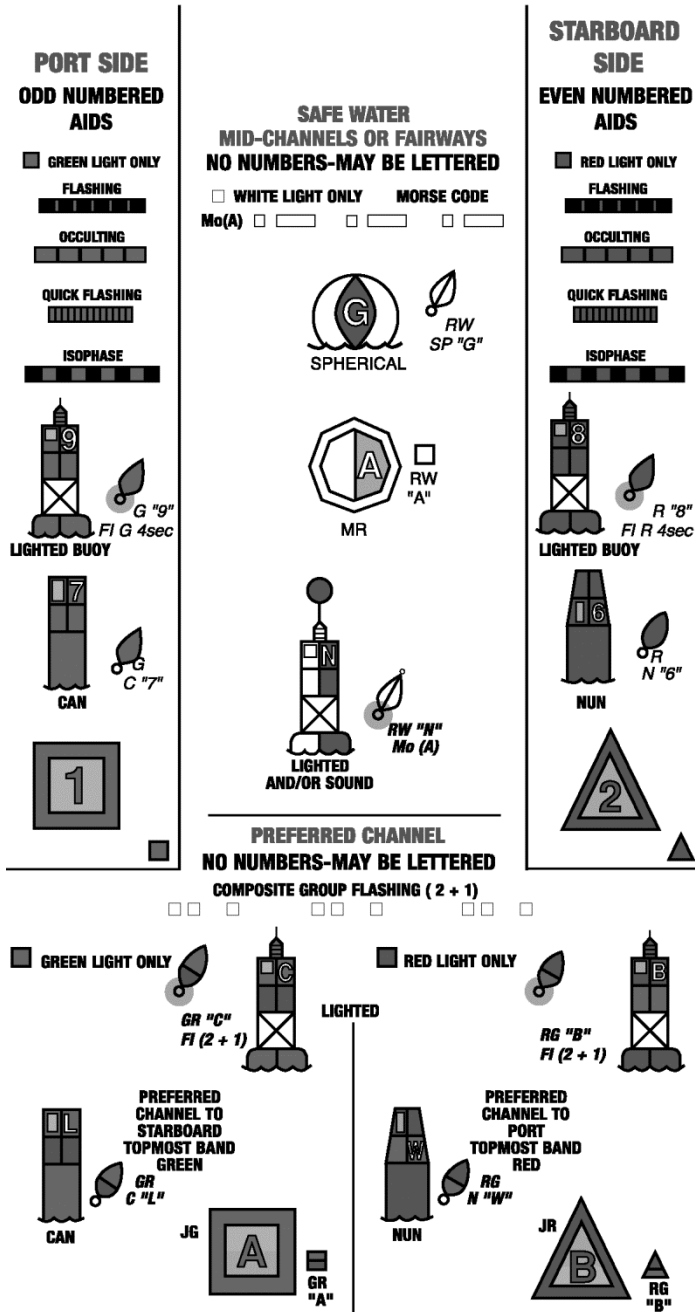



## BOAT DATA SHEET

Model Name \_\_\_\_\_

Hull Identification Number \_\_\_\_\_

Length \_\_\_\_\_ Beam \_\_\_\_\_ Weight \_\_\_\_\_

Draft (Down) \_\_\_\_\_ Draft (Up) \_\_\_\_\_

### **Engine**

Make \_\_\_\_\_ Model Name \_\_\_\_\_

Horsepower \_\_\_\_\_ Model No. \_\_\_\_\_

Serial No. \_\_\_\_\_

### **Radio**

Make \_\_\_\_\_ Type \_\_\_\_\_

Model No. \_\_\_\_\_ Serial No. \_\_\_\_\_

### **Battery**

Battery Make \_\_\_\_\_ Type \_\_\_\_\_

### **Propeller(s)**

Propeller(s) Manufacturer \_\_\_\_\_

Diameter / Pitch \_\_\_\_\_ / \_\_\_\_\_

No. of Blades \_\_\_\_\_ Style \_\_\_\_\_

Material \_\_\_\_\_

Mfg. Part No. \_\_\_\_\_

Key Numbers \_\_\_\_\_

Glove Box \_\_\_\_\_

Ignition Switch \_\_\_\_\_

Other Equipment

\_\_\_\_\_

\_\_\_\_\_

\_\_\_\_\_

Seller Dealer

Name \_\_\_\_\_

Address \_\_\_\_\_

Phone No. \_\_\_\_\_

Salesman \_\_\_\_\_

Servicing Dealer

Name \_\_\_\_\_

Address \_\_\_\_\_

Phone No. \_\_\_\_\_

Service Manager \_\_\_\_\_



# BOATING TERMINOLOGY

<b>Abaft</b>	Toward the stern.
<b>Abeam</b>	Amidships, at a right angle to the keel.
<b>Aboard</b>	On, in or into a boat.
<b>ABYC</b>	American Boat and Yacht Council, Inc., the organization that sets voluntary safety and construction standards for small craft in the USA.
<b>Adrift</b>	Without motive power and without anchor or mooring.
<b>Afloat</b>	On the water.
<b>Aft</b>	Describing the after section of a vessel or things to the rear of amidships and near the stern.
Aground	Touching bottom.
Amidships	In the center, the center portion of a vessel.
Anchor	A forging or casting shaped to grip the sea bottom and, by means of a cable or rope, hold a boat in a desired position.
Anchorage	A customary, suitable and (usually) designated harbor area in which vessels may anchor.
<b>Astern</b>	Toward the stern. An object that is aft of a boat is said to be astern of the boat.
<b>Athwart</b>	Across.
<b>Aweigh</b>	Off the bottom, said of an anchor.



<b>Aye</b>	Yes, while aboard a boat or ship. Means "I understand."
<b>Bail (Bale)</b>	To remove water from a boat by pump or bailer.
<b>Ballast</b>	Heavy material such as iron, lead or stone placed in the bottom of the vessel.
<b>Beacon</b>	A post or buoy placed over a shoal or bank to warn vessels. Also a signal mark on land.
<b>Beam</b>	Imaginary line amidships at right angles to keel of vessel. Also vessel's width amidships.
<b>Bearing</b>	The direction or point of the compass in which an object is seen.
<b>Belay</b>	To make fast to a cleat or belaying pin; to cancel an order.
<b>Below</b>	Beneath or under the deck. One goes below when going down into the cabin.
<b>Bend</b>	To fasten by means of a bend or knot.
<b>Berth</b>	A position, as a place to sleep or in which a vessel may be made fast; a margin of safety, as "a wide berth."
<b>Bilge</b>	The lower internal part of a boat's hull.
<b>Bollard</b>	A strong post for holding lines fast.
<b>Bow</b>	The forward part or front of the boat.
<b>Breakers</b>	Waves cresting as they reach shallow water, or on a beach.

<b>Breakwater</b>	A structure, usually stone or concrete, built to create a harbor or improve an existing one.
<b>Bulkhead</b>	Vertical partition in a boat.
<b>Burdened</b>	Former term for the vessel which must Vessel stay clear of vessels with the right-of-way.
<b>Calking</b>	Forcing filler material into the seams of (Caulking) the planks in a boat's deck or sides to make them watertight.
<b>Camber</b>	The arch of a deck sloping downward from the center toward the sides.
<b>Capsize</b>	To turn over.
<b>Carburetor</b>	Required equipment on all motorboats except Backfire Flame outboards and diesels. Reduces chance of fire Arrestor caused by backfires in internal combustion engines.
<b>Cardinal</b>	Points The four main points of a compass: north, east, south and west.
<b>Ceiling</b>	The inside lining of the hull.
<b>Certificate</b>	Government paper, such as a boat's license.
<b>Chart</b>	A map of a body of water that contains piloting information.
<b>Chine</b>	The intersection of sides and bottom of a boat.
<b>Cleat</b>	A piece of wood or metal with projecting ends to which lines are made fast.



<b>Clinker</b>	A method of planking in which the lower edge of each strake overlaps the upper edge of the strake next below. (Also called lapstrake.)
<b>Coaming</b>	A raised edge, as around part or all of a cockpit, that prevents seawater from entering the boat.
<b>Coast Guard</b>	The federal marine law enforcement and rescue agency in the U.S.
<b>Cockpit</b>	A well or sunken space in the afterdeck of a small boat for the use of the helmsman and crew.
<b>Companionway</b>	A hatch or entrance from deck to cabin.
<b>Compass</b>	The instrument that shows the heading of a vessel.
<b>Cowls</b>	Hooded openings used for ventilation.
<b>Cradle</b>	A frame used to support a vessel on land.
<b>Current</b>	The movement of the water in a horizontal direction.
<b>Deadrise</b>	The rise of the bottom of a midships frame from the keel to the bilge.
<b>Deck</b>	Any permanent covering over a compartment.
<b>Deep-six</b>	To discard or throw overboard.
<b>Depth Sounder</b>	An electronic depth-finding instrument measuring the time a sound wave takes to go from the vessel to the bottom and return, then displaying the result in feet, fathoms or meters.



<b>Dinghy</b>	A small, open boat.
<b>Displacement</b>	Type of hull that plows through the water even
<b>Hull</b>	when more power is added.
<b>Dock</b>	An enclosed or nearly enclosed water area; all the port installations; a place where vessels can moor, as a pier, wharf or floating dock.
<b>Documented Vessel</b>	Vessel registered with the U.S. Coast Guard.
<b>Dolphin</b>	A small group of piles in the water generally used for mooring or as a channel marker.
<b>Draft</b>	The depth of the vessel below the water line measured vertically to the lowest part of the hull.
<b>Dunnage</b>	Mats, boughs, pieces of wood or other loose materials placed under or among goods carried as cargo in the hold of a ship to keep them dry and to prevent their motion and chafing; cushioning or padding used in a shipping container to protect fragile articles against shock and breakage; baggage or personal effects.
<b>Ebb</b>	An outgoing tide.
<b>Estuary</b>	An inlet or arm of the sea.
<b>Fathom</b>	Six feet.
<b>Fenders</b>	Objects placed along the side of the boat to protect the hull from damage.

<b>Flare</b>	The outward spread of the boat's sides from the waterline to the rail at the bow. Also, a pyrotechnic signaling device that can indicate distress.
<b>Fore</b>	Used to distinguish the forward part of a boat or things forward of amidships. It is the opposite of aft or after.
<b>Forward</b>	Toward the bow.
<b>Frame</b>	Ribs of the hull extending from the keel to the highest continuous deck.
<b>Freeboard</b>	The vertical distance measured on a boat's side from the waterline to the gunwale.
<b>Galley</b>	The kitchen area of a boat.
<b>Gimbals</b>	Swivels used to keep equipment level.
<b>Give-Way Vessel</b>	The one which must stay clear of vessels which have the right-of-way.
<b>Grab Rail</b>	A convenient grip on a cabin top or along a companion ladder.
<b>Gunwale</b>	The upper edge of a boat's side. (Pronounced gunnel.)
<b>Harbor</b>	A safe anchorage protected from most storms; may be natural or man-made, with breakwaters and jetties; a place for docking and loading.
<b>Hatch</b>	An opening in a boat's deck for persons or cargo to go below.
<b>Head</b>	A marine toilet.
<b>Headway</b>	Forward motion of a vessel through the water.

<b>Helm</b>	The wheel or tiller by which a ship is steered.
<b>Holding Tank</b>	Storage tank for sewage so that it will not be pumped overboard into the water.
<b>Hull</b>	The body of a boat.
<b>Hypothermia</b>	A physical condition where the body loses heat faster than it can produce it.
<b>Inboard</b>	More toward the center of a vessel; inside; a motor fitted inside the boat.
<b>Inland Rules</b>	Rules of the road that apply to vessel operation in harbors and certain rivers, lakes and inland waterways.
<b>Intracoastal Waterways (ICWs)</b>	bays, rivers and canals along the coasts (such as Atlantic and Gulf of Mexico coasts) connected so that vessels may travel without going into the open sea.
<b>Jetty</b>	A structure, usually masonry, projecting out from the shore; a jetty may protect a harbor entrance.
<b>Keel</b>	The permanently positioned fore and aft backbone member of a boat's hull.
<b>Knot</b>	To bend a line. Also, a unit of speed equal to one nautical mile (6,076.10 feet) an hour.
<b>Launch</b>	(1) To put a vessel into the water; (2) A small open powerboat mainly used for transportation between a vessel and shore.



<b>Lee</b>	The side opposite to that from which the wind blows.
<b>Leeward</b>	Situated on the side turned away from the wind. (Opposite of windward.)
<b>Leeway</b>	The amount a boat is carried sideways by the wind's force or current.
<b>Limber Holes</b>	Drainage holes in the bilge timbers of a vessel allowing water to run to a low point for pumping out.
<b>List</b>	(1) A continuous leaning to one side often caused by an imbalance in stowage or a leak into one compartment; (2) A light list is a printed listing of aids to navigation in geographical order; or inclining of a vessel toward the side.
<b>LOA</b>	Length overall; the maximum length of a vessel's hull, excluding projecting spars or rudder.
<b>Locker</b>	A storage place, a closet.
<b>Log</b>	A record or diary of a vessel's journey.
<b>Lubber's Line</b>	A mark or permanent line on a compass that shows the course of the boat.
<b>Making Way</b>	Making progress through the water.
<b>Marina</b>	A place, essentially a dock area, where small recreational craft are kept; usually where floats or piers as well as service facilities are available.

<b>MAYDAY</b>	A radio distress call from the French m'aidez (help me); SOS in Morse Code.
<b>Mooring</b>	Commonly the anchor chain, buoy, pennant, etc., by which a boat is permanently anchored in one location.
<b>Motor</b>	A source of mechanical power.
<b>Motorboat</b>	Any watercraft 65 feet or less in length propelled by machinery, whether or not such machinery is the principal source of propulsion.
<b>Navigation</b>	The art of conducting a ship from port to port.
<b>Nautical Mile</b>	6076.12 feet, or 1852 meters, an international standard; the geographical mile, the length of one minute of latitude at the equator, is 6087.20 feet.
<b>Nun Buoy</b>	A conical, red buoy bearing an even number and marking the starboard side of a channel from seaward.
<b>Oar</b>	A long, wooden instrument with a flat blade at one end used for propelling a boat.
<b>Outboard</b>	(1) A propulsion unit for boats attached at the transom; includes motor, drive shaft and propeller; fuel tank and battery may be integral or installed separately in the boat; (2) Outside or away from a vessel's hull; opposite of inboard.
<b>Outdrive</b>	A propulsion system for boats with an inboard motor operating an exterior

drive with drive shaft, gears and propeller; also called stern drive and inboard/outboard.

<b>Overall</b>	Length The extreme length of a vessel, excluding spars or rigging fittings. See LOA.
<b>Painter</b>	A rope attached to the bow of a boat for making it fast.
<b>PFD</b>	Personal Flotation Device.
<b>Pier</b>	A structure, usually wood or masonry, extending into the water and used as a landing place for boats and ships.
<b>Pile</b>	A vertical wooden or concrete pole driven into the bottom; may be a support for a pier or floats; also used for mooring.
<b>Piling</b>	A structure of piles.
<b>Pitch</b>	(1) The up and down movement as the bow and stern rise and fall due to wave action; (2) The theoretical distance advanced by a propeller in one revolution.
<b>Planing Hull</b>	Type of hull that is shaped to lift out of the water at high speed and ride on the surface.
<b>Port</b>	The left side of a boat when you are facing the bow. Also a destination or harbor.
<b>Privileged Vessel</b>	Former term for the vessel with the right-of-way.

<b>Propeller</b>	Wheel or screw mechanism that pushes water aft to propel the boat.
<b>Rigging</b>	The general term for all lines (ropes) of a vessel.
<b>Roll</b>	The sideward motion of a boat caused by wind or waves.
<b>Rules of the Road</b>	The nautical traffic rules for preventing collisions on the water.
<b>Scope</b>	The length of the anchor rope or chain. 6 to 1 scope means that the length of the anchor rope from the boat to the anchor is 6 times the depth of the water.
<b>Scupper</b>	A hole allowing water to run off the deck.
<b>Sea Anchor</b>	A floating canvas cone held open by wire rings with an opening in the smaller end and a rope bridle at the larger end attached to a line leading to the vessel; used in storm conditions to (a) keep the bow of the boat to the wind, and (b) slow downwind drift of the boat.
<b>Seacock</b>	A thru-hull valve; a shutoff on a plumbing or drain pipe between the vessel's interior and the sea.
<b>Slip</b>	(1) A berth for a boat between two piers or floats; (2) The percentage difference between the theoretical and the actual distance that a propeller advances when turning in water under load.
<b>Sole</b>	The cabin or cockpit floor.



<b>Spar Buoy</b>	A channel marker that looks like a tall, slender pole.
<b>Stand-On Vessel</b>	The vessel with the right-of-way.
<b>Starboard</b>	The right side of a boat when you are facing the bow.
<b>Stern</b>	The after end or back of the boat.
<b>Stow</b>	To store items neatly and securely.
<b>Strake</b>	Planks running fore and aft on the outside of a vessel.
<b>Taffrail</b>	The rail around a boat's stern.
<b>Tide</b>	The alternate rise and fall of waters caused by the gravitational attraction of moon or sun.
<b>Topsides</b>	(1) The sides of a vessel above the waterline; (2) On deck as opposed to below deck.
<b>Transom</b>	The transverse planking which forms the after end of a small, square-ended boat. (Outboard motors are usually attached to a transom.)
<b>Trim</b>	To arrange weights in a vessel in such a manner as to obtain desired draft at bow and stern.
<b>Unbend</b>	To cast off or untie.
<b>Underway</b>	Vessel in motion, i.e., when not moored, at anchor or aground.
<b>USPS</b>	United States Power Squadron, a private membership organization that specializes in boating education and good boating practices.



<b>Vessel</b>	Every kind of watercraft, other than a seaplane on the water, capable of being used as a means of transportation on water.
<b>VHF Radio</b>	A Very High Frequency electronic communications and direction-finding system.
<b>Wake</b>	Moving waves created by vessel motion. Track or path that a boat leaves behind it when moving across the water.
<b>Wash</b>	The loose or broken water left behind a vessel as it moves along; the surging action of waves.
<b>Waterline</b>	The intersection of a vessel's hull and the water's surface; the line separating the bottom paint and the topsides.
<b>Way</b>	Movement of a vessel through the water. Technically it is underway when not at anchor, aground or made fast to the shore. The common usage is interpreted as progress through the water. Headway when going forward and sternway when it is going backwards.
<b>Well</b>	Area at the rear of a boat where the motor may be located.
<b>Wharf</b>	A structure, parallel to the shore, for docking vessels.
<b>Wheel</b>	(1) The steering wheel; (2) The propeller.



- Whistle Signal** A standard communication signal between boats to indicate change of course, danger or other situations.
- Windward** Situated on the side closest to the wind. (Opposite of leeward.)
- Yaw** To swing or steer off course as when running with a quartering sea.