



**Includes:**

- Important Safety Information
- Navigation Rules
- Operating Instructions
- Maintenance and Storage

# **JET SKI® 800 SX-R Watercraft**

Read this manual carefully. It contains safety information.

# OWNER'S MANUAL

<https://www.boat-manuals.com/>

 **WARNING**

**Engine exhaust, some of its constituents, and certain product components contain or emit chemicals known to the State of California to cause cancer and birth defects or other reproductive harm.**

# READ THIS FIRST!

## ⚠ WARNING

For your safety, read this Owner's Manual and understand it thoroughly before operating this JET SKI watercraft. This manual contains the warnings given here for your immediate attention plus other important information.

**To reduce the risk of SEVERE INJURY or DEATH:**

**WEAR A PERSONAL FLOTATION DEVICE (PFD).**  
All riders must wear a Coast Guard approved PFD that is suitable for personal watercraft (PWC) use.

**WEAR PROTECTIVE CLOTHING.**

Severe internal injuries can occur if water is forced into body cavities as a result of falling into water or being near jet thrust nozzle. Normal swimwear does not adequately protect against forceful water entry into lower body cavities. All riders must wear a wet suit bottom or clothing that provides equivalent protection (see Owner's Manual). Footwear, gloves, and goggles/glasses are recommended.

**KNOW BOATING LAWS.**

Kawasaki recommends a minimum operator age of 16 years old. Know the operator age and training requirements for your state. A boating safety course is recommended and may be required in your state.



**ATTACH ENGINE SHUT-OFF CORD (LANYARD)** to wrist and keep it free from handlebars so that the engine stops if operator falls off. After riding, remove cord from PWC to avoid unauthorized use by children or others.

**RIDE WITHIN YOUR LIMITS AND AVOID AGGRESSIVE MANEUVERS** to reduce the risk of loss of control, ejection, and collision. This is a high performance boat – not a toy. Sharp turns or jumping wakes or waves can increase the risk of back/spinal injury (paralysis), facial injuries, and broken legs, ankles, and other bones. Do not jump wakes or waves.

**DO NOT APPLY THROTTLE WHEN ANYONE IS AT REAR OF PWC** – turn engine off or keep engine at idle. Water and/or debris ejected from the jet thrust nozzle can cause severe injury.

**KEEP AWAY FROM INTAKE GRATE** while engine is on. Items such as long hair, loose clothing, or PFD straps can become entangled in moving parts resulting in severe injury or drowning.

**NEVER RIDE AFTER CONSUMING DRUGS OR ALCOHOL**

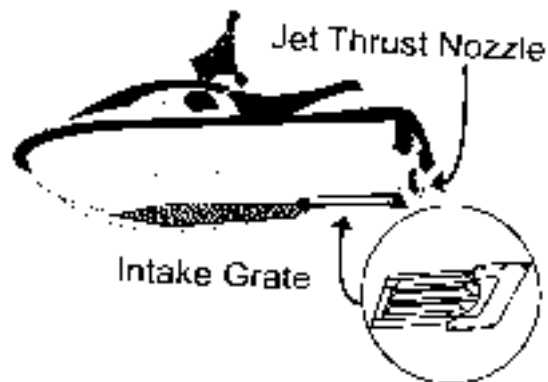

**Collisions result in more INJURIES AND DEATHS than any other type of accident for personal watercraft (PWC).**

**TO AVOID COLLISIONS:**

**SCAN CONSTANTLY** for people, objects, and other watercraft. Be alert for conditions that limit your visibility or block your vision of others.

**OPERATE DEFENSIVELY** at safe speeds and keep a safe distance away from people, objects, and other watercraft.

- Do not follow directly behind PWCs or other boats.
- Do not go near others or spray or splash them with water.
- Avoid sharp turns or other maneuvers that make it hard for others to avoid you or understand where you are going.
- Avoid areas with submerged objects or shallow water.

**TAKE EARLY ACTION** to avoid collisions. Remember, PWCs and other boats do not have brakes.

**DO NOT RELEASE THROTTLE WHEN TRYING TO STEER** away from objects – you need throttle to steer. Always check throttle and steering controls for proper operation before starting PWC.

Follow navigation rules and state and local laws that apply to PWCs.

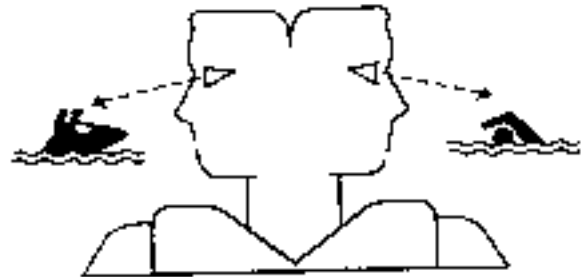

# CAUTION

Take proper care of your new JET SKI watercraft. Here are some of the cautions contained in this manual which must be followed for the protection of your watercraft. Be sure to read this Owner's Manual and understand it thoroughly before operating your watercraft.

**Always turn the boat on its port side. Rolling to the starboard side can cause water in the exhaust system to run into the engine, with possible engine damage.**

If water gets into the watercraft engine, follow the procedure on page 70 immediately. If water is left in the engine more than a few hours, it will destroy the crankshaft bearings and damage other internal engine parts.

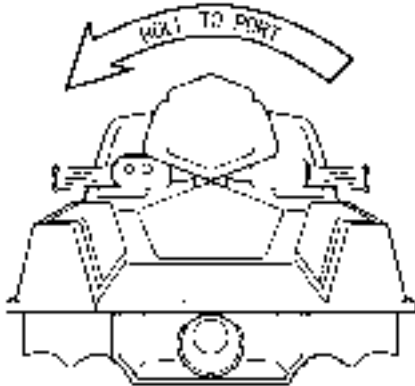

**The watercraft must be in at least 0.6 m (2 ft) of water when starting to prevent jet pump damage by objects sucked up from the bottom.**

**Do not operate in shallow or debris-laden water, or the impeller may be damaged and sand may clog the water cooling hoses.**

**Do not run the watercraft onto the shore, or severe impeller damage may occur.**

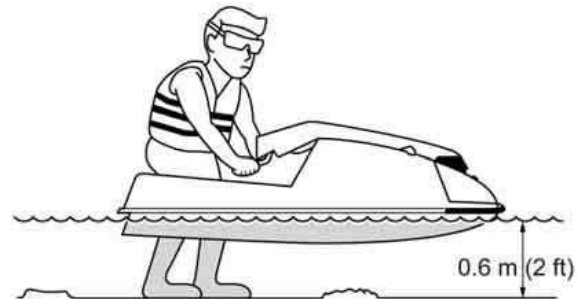

DA01006B S

Since Jet Ski personal watercraft are not designed to be docked in the water for extended periods, prolonged immersion in water will cause the hull paint to bubble and peel, as well as electrolytic erosion of some metal parts in

**the jet pump. To prevent paint damage and electrolytic erosion, remove your Jet Ski watercraft from the water at the end of each day's use; do not leave it in the water overnight. Your Jet Ski watercraft will last longer and look better if you remove it from the water at the end of every day's use.**

**The jet pump bearings and seals require periodic service. Major engine damage can occur if the jet pump bearings fail due to lack of maintenance. Have your Kawasaki dealer inspect the jet pump bearings and seals after the first 20 hours of use, and then every 50 hours or every year, whichever comes first. The jet pump bearings should also be serviced before any prolonged storage to prevent any water that may be left in the pump from corroding the bearings and causing premature failure.**

<https://www.boat-manuals.com/>



# Quick Reference Guide

This Quick Reference Guide will assist you in finding the information you're looking for.

**GENERAL INFORMATION**

**OPERATING INSTRUCTIONS**

**STORAGE**

**MAINTENANCE AND ADJUSTMENTS**

**TROUBLESHOOTING GUIDE**

**ENVIRONMENTAL PROTECTION**

A Table of Contents is included after the Foreword.

<https://www.boat-manuals.com/>

Whenever you see the symbols shown below, heed their instructions! Always follow safe operating and maintenance practices.

 **WARNING**

**This warning symbol identifies special instructions or procedures which, if not correctly followed, could result in personal injury, or loss of life.**

**CAUTION**

**This caution symbol identifies special instructions or procedures which, if not strictly observed, could result in damage to, or destruction of equipment.**

**NOTE**

○ *Indicates points of particular interest for more efficient and convenient operation.*

# FOREWORD

Congratulations on your purchase of a new Kawasaki JET SKI watercraft. Welcome to a new and exciting water sport. We are pleased you have chosen the Kawasaki JET SKI watercraft to expand the enjoyment of your recreational hours.

Kawasaki uses the latest manufacturing methods and materials to bring you a high quality recreational watercraft.

**Please read this Owner's Manual carefully before starting your new JET SKI** so that you will be thoroughly familiar with the proper operation of your watercraft's controls, its features, capabilities, and limitations. Kawasaki strongly recommends that all operators attend a boating safety course before riding the watercraft. Contact the local office of the U.S. Coast Guard Auxiliary, U.S. Power Squadrons, or school district.

## **BOAT SMART FROM THE START**

TAKE A BOATING SAFETY COURSE AND GET A FREE VESSEL SAFETY CHECK ANNUALLY FOR YOUR BOAT.

FOR MORE INFORMATION CONTACT:  
UNITED STATES COAST GUARD AUXILIARY,  
WWW.CGAUX.ORG  
UNITED STATES POWER SQUADRONS,  
888-FOR-USPS, WWW.USPS.ORG

To ensure a long, trouble-free life for your JET SKI, give it the proper care and maintenance described in this manual. For those who would like more detailed information on their JET SKI, a Service Manual is available for purchase from any authorized Kawasaki JET SKI watercraft dealer. The Service Manual contains detailed disassembly and maintenance information. Those who plan to do their own work should, of course, be competent mechanics and possess the special tools described in the Service Manual.

Keep this Owner's Manual aboard your JET SKI at all times so that you can refer to it whenever you need information. If you need further information, please contact your dealer, who will provide all the help you need.

This manual should be considered a permanent part of the JET SKI and should remain with the JET SKI when it is sold.

This craft is an inboard boat less than 4.8 m (16 ft) in length, and as such is subject to all federal rules and regulations especially pertaining to boating safety and operation as enforced by the U.S. Coast Guard. States local jurisdictions may have additional requirements for operation of powerboats in

<https://www.boat-manuals.com/>

waters under their control. Additionally, other countries may have their own standards and regulations. Please check your local boating laws and regulations before riding the watercraft.

All rights reserved. No part of this publication may be reproduced without our prior written permission.

This publication includes the latest information available at the time of printing. However, there may be minor differences between the actual product and illustrations and text in this manual.

All products are subject to change without prior notice or obligation.

**KAWASAKI HEAVY INDUSTRIES, LTD.**  
**Motorcycle & Engine Company**

© 2010 Kawasaki Heavy Industries, Ltd.

May 2010. (1).



**JETSKI** is a trademark of Kawasaki Heavy Industries, Ltd. registered in U.S.A., Japan, Austria, Benelux, Sweden, Denmark, Switzerland, France, Canada, Finland, Norway, Greece, Italy, U.K., Portugal, Thailand, and Taiwan.

**KAWASAKI JET SKI** is a trademark of Kawasaki Heavy Industries, Ltd. registered in Australia.

# TABLE OF CONTENTS

<b>SPECIFICATIONS</b> .....	13	Overtaking and Passing Situation: .....	52
<b>GENERAL INFORMATION</b> .....	15	Meeting Situation:.....	53
Serial Numbers.....	15	Crossing Situation: .....	53
Parts Location .....	16	Pre-ride Checklist .....	54
Label Location .....	18	Break-In.....	56
Registration Numbers.....	24	Stopping the Engine .....	56
Fuel and Oil .....	25	Starting the Engine .....	57
Fuel and Oil Requirements:.....	25	Launching .....	60
Mixing:.....	28	Deep Water Start:.....	60
Filling the Tank: .....	29	Shallow Water Start:.....	61
Controls .....	30	Standing Start:.....	62
Engine Hood.....	35	Stopping the JET SKI Watercraft.....	63
Tool Kit.....	42	Straight Line Stopping: .....	63
Bilge Systems.....	43	Normal Stopping:.....	64
Drain Screw.....	43	Stopping Skills:.....	64
<b>OPERATING INSTRUCTIONS</b> .....	44	Minimum Stopping Distances:.....	64
Safe Operation .....	44	Turning the JET SKI Watercraft.....	66
Operation by Children: .....	44	Riding the JET SKI Watercraft.....	68
Operator Swimming Ability: .....	44	Standing Up:.....	69
Maximum Number of Person:.....	44	Fall Recovery: .....	69
Safe Riding Rules:.....	45	Righting the Capsized Watercraft:.....	70
Jet Pump Safety: .....	47	End of the Day Checklist .....	72
Personal Flotation Device and Safety		First, Drain the Exhaust System:.....	72
Gear: .....	47	Second, Clean the Engine Compartment:..	72
Watercraft Helmets..... Something You		Third, Clean the Outside Hull: .....	72
Should Know: .....	48	Special Procedures .....	73
Fire Extinguisher: .....	49	Clearing Clogged Impeller:.....	73
Loading.....	51	Cleaning Fouled Spark Plugs:.....	74
Load Capacity Limits:.....	51	After Submerging: .....	74
Navigation Rules .....	52	Towing the JET SKI Watercraft:.....	76
Sailboats:.....	52	Jump Starting: .....	76

Engine Overheating:.....	78	Carburetor Adjustments: .....	93
<b>STORAGE</b> .....	79	Fuel Filter Screens: .....	94
Preparation for Storage .....	79	Fuel Vent Check Valve: .....	95
Cooling System: .....	79	Spark Plug.....	96
Bilge System: .....	79	Battery .....	97
Fuel System and Engine: .....	80	Lubrication.....	102
Battery: .....	81	Cooling System Flushing.....	104
Jet Pump Bearings/Seals: .....	82	Bilge System Flushing.....	106
Cleaning: .....	82	Jet Pump Bearings/Seals .....	107
Lubrication:.....	83	Fuses.....	108
Removal from Storage .....	83	<b>TROUBLESHOOTING GUIDE</b> .....	109
<b>MAINTENANCE AND ADJUSTMENTS</b> .....	85	<b>YOUR WARRANTY/OWNER SATISFACTION</b>	
EMISSION CONTROL INFORMATION .....	85	.....	111
Periodic Maintenance Chart.....	87	<b>REPORTING SAFETY DEFECTS</b> .....	115
Control Cable Adjustments.....	89	<b>ENVIRONMENTAL PROTECTION</b> .....	116
Fuel System .....	93	<b>MAINTENANCE RECORD</b> .....	117

# SPECIFICATIONS

## JET SKI WATERCRAFT - MODEL JS800A INBOARD BOAT LESS THAN 4.8 M (16 FEET) IN LENGTH

<b>Engine:</b>		
Type	2-stroke, vertical twin, crankcase reed valve, water-cooled	
Displacement	781 cm <sup>3</sup>	47.7 cu in.
Bore and Stroke	82 × 74 mm	3.23 × 2.91 in.
Compression Ratio	7.2 : 1	
Ignition System	Magnet CDI (Digital)	
Lubrication System	Gas/Oil Premix ratio 60:1	
Carburetor	Mikuni BN40-38 × 2	
Starting System	Electric	
<b>Tuning Specifications:</b>		
Spark Plug	NGK BR8ES	
Gap	0.7 - 0.8 mm	0.028 - 0.032 in.
Terminal	Solid post	
Ignition Timing	13° BTDC @1 250 r/min (rpm) ~ 20.2° BTDC @4 000 r/min (rpm)	
Idle Speed	1 250 ±100 r/min (rpm) - in water 1 700 ±100 r/min (rpm) - out of water	
Compression Pressure	1 275 kPa (130 kg/cm <sup>2</sup> )	185 psi

## 14 SPECIFICATIONS

<b>Drive System:</b>		
Coupling	Direct drive from engine	
Jet Pump: Type	Axial flow, single stage	
Thrust	3 100 N (317 kgf)	699 lb
Steering	Steerable nozzle	
Braking	Water drag	
<b>*Performance:</b>		
Minimum Turning Radius	3.2 m	10.5 ft
Fuel Consumption	32 L/h @full throttle	8.5 gal/hr (U.S.)
Cruising Range	39 km @full throttle	24 mi
	31 minutes	
<b>Dimensions:</b>		
Overall length	2 300 mm	90.6 in.
Overall width	730 mm	28.7 in.
Overall Height	735 mm	28.9 in.
Curb Mass	180 kg	397 lb
Fuel Tank Capacity	17 L including 3.0 L reserve	4.5 gal (U.S.) incl. 0.8 gal reserve
<b>Engine Oil:</b>		
Type	2-stroke, N.M.M.A. Certified for Service TC-W3	
<b>Electrical Equipment:</b>		
Battery	12 V 18 Ah	

\*The information shown here represents results under controlled conditions, and the information may not be correct under other conditions.



# GENERAL INFORMATION

## Serial Numbers

The hull and engine identification numbers are used to register the boat. They are the only means of identifying your particular machine from others of the same model. These serial numbers may be needed by your dealer when ordering parts. In the event of theft, investigating authorities will require both numbers as well as the model number and any unique features of your machine that could help identify it. Record these numbers here.



**A. Hull Identification Number (HIN)**

H.I.N.	
--------	--



**A. Engine Number**

Eng. No.	
----------	--

## 16 GENERAL INFORMATION

### Parts Location

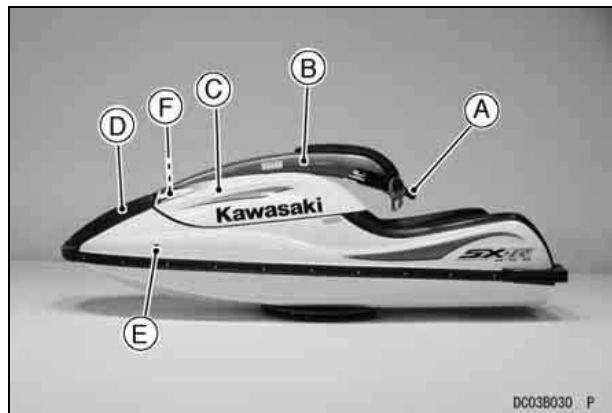

- A. Handlebar
- B. Handle Pole
- C. Engine Hood
- D. Fuel Filler Cap
- E. Bypass Outlet
- F. Auxiliary Cooling Water Inlet (under the handle pole)

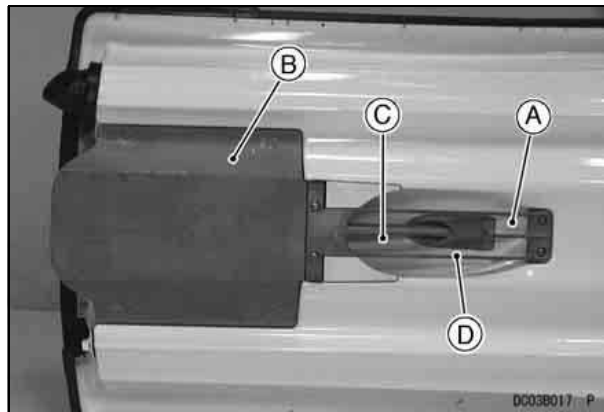

- A. Water Intake
- B. Jet Pump Cover
- C. Drive Shaft
- D. Grate

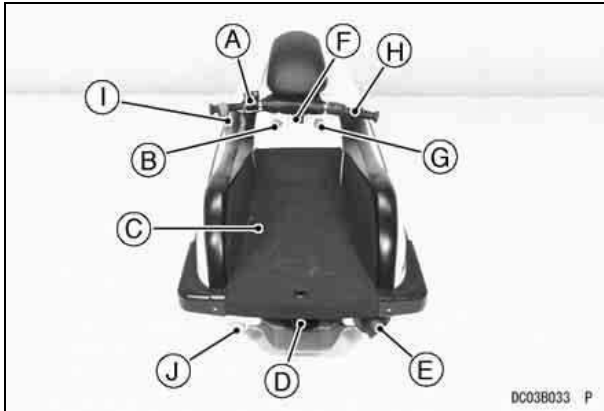

DC03B033 P

- A. Engine Start and Stop Buttons
- B. Choke Knob
- C. Riding Platform
- D. Steering Nozzle
- E. Exhaust Outlet
- F. Engine Cover Latch
- G. Fuel Valve
- H. Throttle Lever
- I. Engine Shut-off Lanyard
- J. Drain Screw

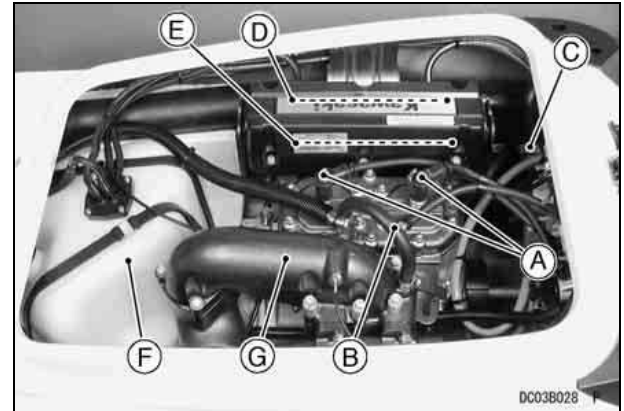

DC03B028

- A. Spark Plugs
- B. Cooling Hose
- C. Battery
- D. Flame Arrester
- E. Carburetor
- F. Fuel Tank
- G. Exhaust Pipe

## 18 GENERAL INFORMATION

### Label Location

All warning labels which are on your watercraft are repeated here. Read them and understand them thoroughly. They contain information which is important for your safety and the safety of anyone else who may operate your watercraft. Therefore, it is very important that all warning labels be on your watercraft in the locations shown. If any label is missing, damaged, or worn, get a replacement from your Kawasaki dealer and install it in the correct position.

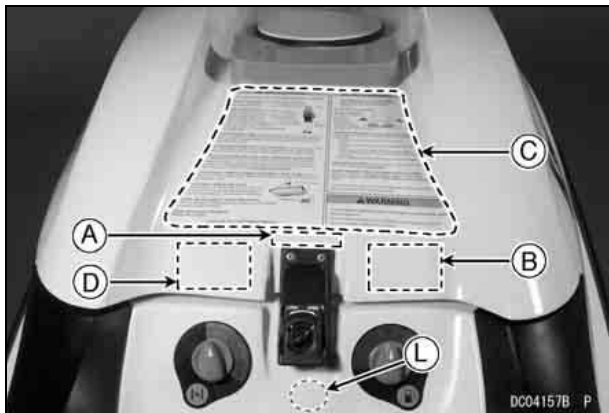

- A. Fire Extinguisher
- B. Caution
- C. Warning
- D. U.S.C.G. Exemption
- L. NMMA Certification

(A)



(B)

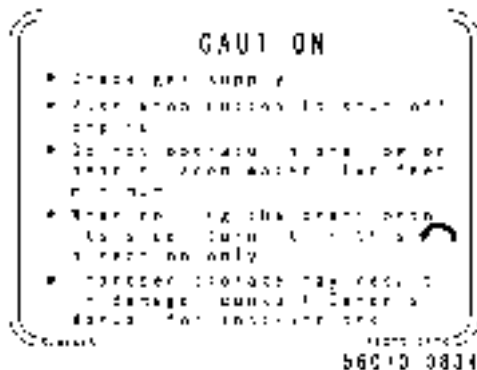

0-3554-889-2

(L)



56464-2110

0-3554-889-2

(D)

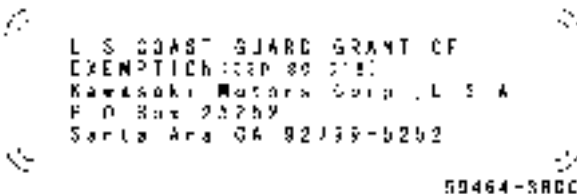

0-3554-889-2

## 20 GENERAL INFORMATION

(C)

### **⚠ WARNING**

To reduce the risk of **SEVERE INJURY** or **DEATH**:

#### **WEAR A PERSONAL FLOTATION DEVICE (PFD).**

All riders must wear a Coast Guard approved PFD that is suitable for personal watercraft (PWC) use.

**WEAR PROTECTIVE CLOTHING.** Severe internal injuries can occur if water is forced into body cavities as a result of falling into water or being near jet thrust nozzle. Normal swimwear does not adequately protect against forceful water entry into lower body cavities. All riders must wear a wet suit bottom or clothing that provides equivalent protection (see Owner's Manual). Footwear, gloves, and goggles/glasses are recommended.

**KNOW BOATING LAWS.** Kawasaki recommends a minimum operator age of 16 years old. Know the operator age and training requirements for your state. A boating safety course is recommended and may be required in your state.

**ATTACH ENGINE SHUT-OFF CORD (LANYARD)** to wrist and keep it free from handlebars so that engine stops if operator falls off. After riding, remove cord from PWC to avoid unauthorized use by children or others.

#### **RIDE WITHIN YOUR LIMITS AND AVOID AGGRESSIVE MANEUVERS**

to reduce the risk of loss of control, ejection, and collision. This is a high performance boat - not a toy. Sharp turns or jumping wakes or waves can increase the risk of back/spinal injury (paralysis), facial injuries, and broken legs, ankles, and other bones. Do not jump wakes or waves.

**DO NOT APPLY THROTTLE WHEN OTHERS ARE AT REAR OF PWC** - turn engine off or keep engine at idle. Water and/or debris ejected from jet thrust nozzle can cause severe injury.

#### **KEEP AWAY FROM INTAKE GRATE**

while engine is on. Items such as long hair, loose clothing, or PFD straps can become entangled in moving parts resulting in severe injury or drowning.

#### **AVOID LIMITED VISIBILITY WHILE REBOARDING.**

Get to a standing or kneeling position quickly, but do not expose yourself to forceful jet thrust.

**NEVER RIDE AFTER CONSUMING DRUGS OR ALCOHOL.**

**READ AND FOLLOW OWNER'S MANUAL**

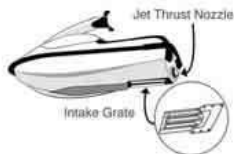

### **⚠ WARNING**

Collisions result in more **INJURIES AND DEATHS** than any other type of accident for personal watercraft (PWC).

#### **TO AVOID COLLISIONS:**

##### **SCAN CONSTANTLY**

for people, objects, and other watercraft.

Be alert for conditions that limit your visibility or block your vision of others.

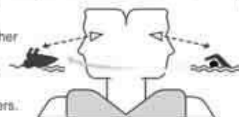

##### **OPERATE DEFENSIVELY**

at safe speeds and keep

a safe distance away from people, objects, and other watercraft.

- Do not follow directly behind PWCs or other boats.
- Do not go near others to spray or splash them with water.
- Avoid sharp turns or other maneuvers that make it hard for others to avoid you or understand where you are going.
- Avoid areas with submerged objects or shallow water.

**TAKE EARLY ACTION** to avoid collisions. Remember, PWCs and other boats do not have brakes.

##### **DO NOT RELEASE THROTTLE WHEN TRYING TO STEER**

away from objects - you need throttle to steer. Always check throttle and steering controls for proper operation before starting PWC.

Follow navigation rules and state and local laws that apply to PWCs.

See Owner's Manual for more information.

### **⚠ WARNING**

**A concentration of gasoline fumes in the engine compartment can cause a fire or explosion.**

Open the engine compartment for ventilation before starting the engine for each ride and after transporting or refueling.

Kawasaki

66070-3076

56070-3976



- E. Recommended Oil
- F. Caution
- G. Warning

(E)

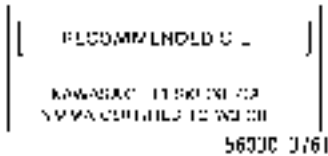

(F)



(G)

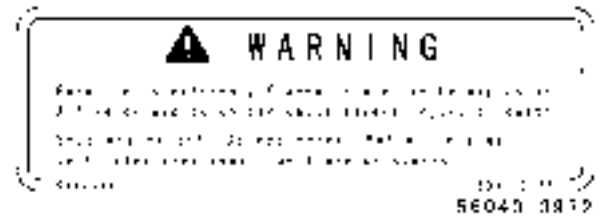

## 22 GENERAL INFORMATION



H. Caution

(H)

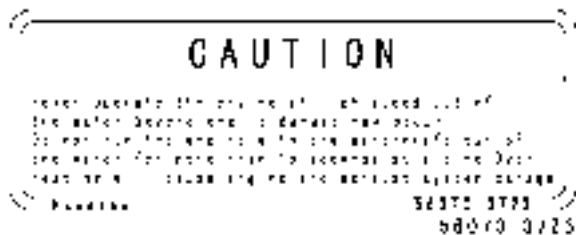

225122801 2



I. Caution

(I)



225122801 2



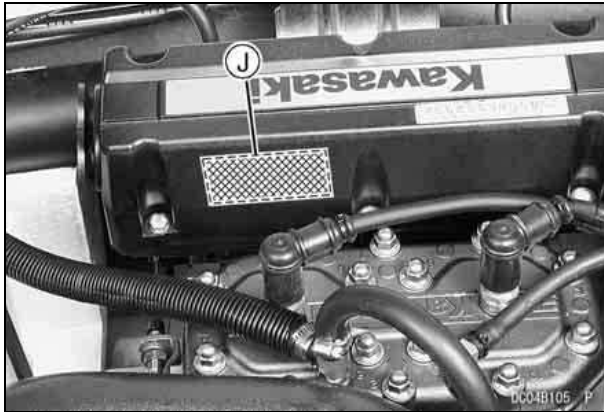

J. EPA Certification

(J)

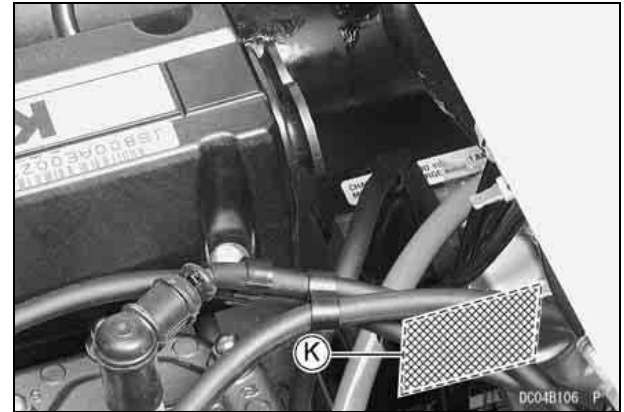

K. Battery

(K)



59465 0703  
© 2007 HONDA



26C 2 3126

© 2007 HONDA

## 24 GENERAL INFORMATION

### Registration Numbers

The graphic design of your JET SKI watercraft provides a specific location on each side for the registration numbers and validation decals.

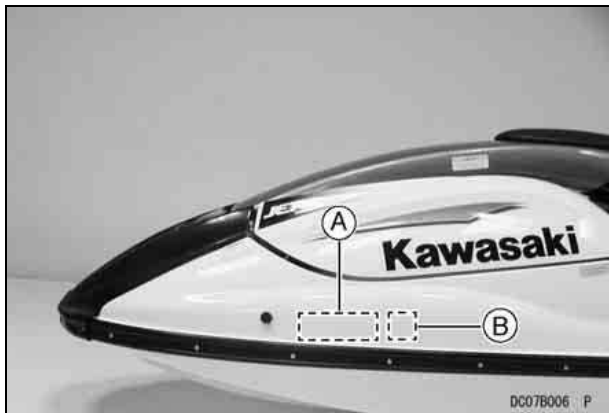

- A. Location for Registration Number
- B. Location for Validation Decal



- A. Location for Registration Number
- B. Location for Validation Decal

The registration numbers must read from left to right on both sides of the watercraft. Typically, the validation decal must be placed 3 inches (76.2 mm) beyond, and level with the first or last letter of the identification number.

#### NOTE

- *Requirements for registration numbers and validation decals may vary from those given here for your state. Always follow the directions provided at the time you register your watercraft.*

Registration numbers must be block characters no less than 3 inches (76.2 mm) in height. They should be a color contrasting with the background. The spaces between the numerals and the prefix/suffix letters must be equal to the width of any letter except "I" or any number except "1."

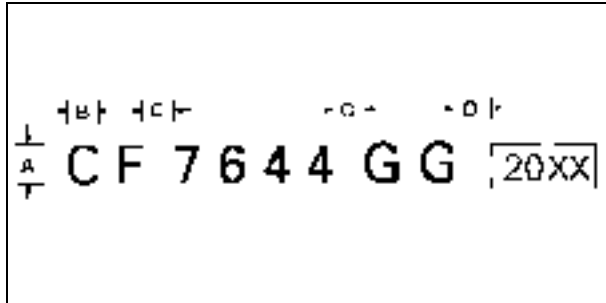

- A = 3 inches (76.2 mm) minimum
- B = C
- D = 3 inches (76.2 mm)

## Fuel and Oil

The fuel is a mixture of gasoline and oil. A 60 to 1 mixture is recommended (60 parts gasoline to 1 part oil). Mix it thoroughly before pouring it into the watercraft fuel tank. Marine premix fuels are not recommended.

### CAUTION

**Do not use racing fuels or fuel additives. This watercraft has not been tested and certified for use with such fuels. Damage to the engine and fuel system may result from the use of improper fuel.**

### Fuel and Oil Requirements:

#### *Fuel Type*

Use clean, fresh unleaded gasoline with a minimum Antiknock Index of 87. The Antiknock Index is posted on service station pumps in the U.S.A. The octane rating of a gasoline is a measure of its resistance to detonation or "knocking." The Antiknock Index is an average of the Research Octane Number (RON) and the Motor Octane Number (MON) as shown in the table below.

Octane Rating Method	Minimum Rating
Antiknock $\frac{(\text{RON} + \text{MON})}{2}$	87

### CAUTION

If engine “knocking” or “pinging” occurs, use a different brand of gasoline of a higher octane rating. If this condition is allowed to continue it can lead to severe engine damage.

Gasoline quality is important. Fuels of low quality or not meeting standard industry specifications may result in unsatisfactory performance. Operating problems that result from the use of poor quality or nonrecommended fuel may not be covered under your warranty.

#### *Fuels Containing Oxygenates*

Gasoline frequently contains oxygenates (alcohols and ethers) especially in areas of the U.S. and Canada which are required to sell such reformulated fuels as part of a strategy to reduce exhaust emissions.

The types and volume of fuel oxygenates approved for use in unleaded gasoline by the U.S. Environmental Protection Agency include a broad

range of alcohols and ethers, but only two components have seen any significant level of commercial use.

Gasoline/Alcohol Blends - Gasoline containing up to 10% ethanol (alcohol produced from agricultural products such as corn), also known as “gasohol” is approved for use.

### CAUTION

**Avoid using blends of unleaded gasoline and methanol (wood alcohol) whenever possible, and never use “gasohol” containing more than 5% methanol. Fuel system damage and performance problems may result.**

Gasoline/Ether Blends - The most common ether is methyl tertiary butyl ether (MTBE). You may use gasoline containing up to 15% MTBE.

### NOTE

○ *Other oxygenates approved for use in unleaded gasoline include TAME (up to 16.7%) and ETBE (up to 17.2%). Fuel containing these oxygenates can also be used in your Kawasaki.*

## CAUTION

**Never use gasoline with an octane rating lower than the specified by Kawasaki.**

**Never use “gasohol” with more than 10% ethanol, or more than 5% methanol. Gasoline containing methanol must also be blended with cosolvents and corrosion inhibitors.**

**Certain ingredients of gasoline may cause paint fading or damage. Be extra careful not to spill gasoline or gasoline oxygenate blends during refueling.**

**When not operating your Kawasaki for 30 to 60 days, mix a fuel stabilizer (such as STA-BIL) with the gasoline in the fuel tank. Fuel stabilizer additives inhibit oxidation of the fuel which minimizes gummy deposits.**

**Never store this product with “gasohol” in the fuel system. Before storage it is recommended that you drain all fuel from the fuel tank and carburetors. See the Storage section in this manual.**

### *Oil Type*

Kawasaki recommends using Kawasaki Jet Ski oils. There are several different products and container sizes to choose from. Ask your dealer to recommend a Kawasaki Jet Ski oil according to the way you use your watercraft. All of the Jet Ski watercraft oils are specially formulated to provide the best possible lubrication and deposit resistance under different conditions.

If Kawasaki Jet Ski oils are not available, ensure that you use only a TC-W3 certified two cycle marine oil as a substitute. Look for the National Marine Manufacturers Association (N.M.M.A.) TC-W3 certification on the oil container. The use of oil additives and oils that are not either Kawasaki Jet Ski oil, or certified by the N.M.M.A. as TC-W3 is not recommended.

**CERTIFIED**  
  
 N.M.M.A.  



## 28 GENERAL INFORMATION

### Mixing:

A convenient way to mix fuel is to use a 19 L (5 US gal) container. Add 317 mL (10.7 US oz) of oil to 9.5 L (2.5 US gal) of gas and mix thoroughly. Add another 9.5 L (2.5 US gal) of gas, and mix again to get the proper 60 : 1 ratio. Refer to the following chart for smaller quantities.

### Fuel Ratio Chart 60 : 1

Milli Liters of Oil to Liters of Gas			
mL of Oil	L of Gas	mL of Oil	L of Gas
63 mL	3.8 L	190 mL	11.4 L
95 mL	5.7 L	222 mL	13.3 L
127 mL	7.6 L	253 mL	15.2 L
158 mL	9.5 L	317 mL	19 L

Ounces of Oil to Gallons of Gas			
Ounces of Oil	Gallons of Gas	Ounces of Oil	Gallons of Gas
2.1 oz	1.0 gal	6.4 oz	3.0 gal
3.2 oz	1.5 gal	7.5 oz	3.5 gal
4.3 oz	2.0 gal	8.5 oz	4.0 gal
5.3 oz	2.5 gal	10.7 oz	5.0 gal

### Recommended Oil

**Kawasaki Performance 2-Stroke Jet Ski® Watercraft Oil\* or other 2-stroke oils with N.M.M.A. TC-W3**

**\*Kawasaki Performance Oils and Lubricants have been specifically engineered for your vehicle. Consistent use of these products meets or exceeds warranty and service requirements and can help to extend the life of your Kawasaki.**

### NOTE

- *Be sure the mixing container is completely free of any dirt, rust, or other contaminants. The watercraft fuel filter has a fine-mesh element which will become blocked if contaminated fuel is used.*

## Filling the Tank:

**⚠ WARNING**

Gasoline is extremely flammable and can be explosive under certain conditions. Pull the lanyard key off the stop button. Do not smoke. Make sure the area is well ventilated and free from any source of flame or sparks; this includes any appliance with a pilot light.

Open the engine cover to observe the fuel level in the fuel tank.

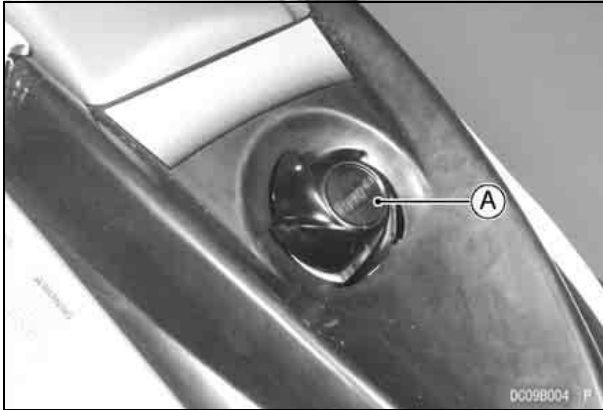

**A. Fuel Filler Cover Cap**

Fill the tank with the recommended octane rating gasoline. The use of a small diameter pour spout (or funnel) will make filling easier. Pour slowly to avoid "spit back" and allow air to escape from the tank.

**⚠ WARNING**

Never fill the tank completely to the top. As the fuel expands in a warm tank, it may overflow from the vent tube. After refueling, make sure the filler cap is closed securely.

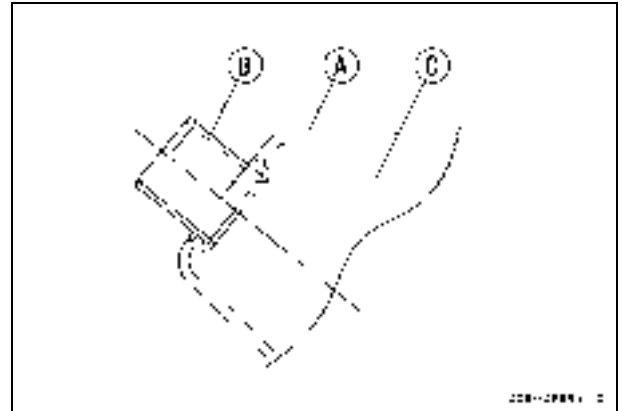

- A. Fuel Tank**
- B. Filler Neck**
- C. Top Level**

- After transporting or refueling and before starting the engine, open the engine cover for several minutes to ventilate the engine compartment.

**⚠ WARNING**

**A concentration of gasoline fumes in the engine compartment can cause a fire or explosion.**

## 30 GENERAL INFORMATION

### CAUTION

Avoid filling the tank in the rain or where heavy dust is blowing so that the fuel does not get contaminated.

---

## Controls

---

### Steering Handlebar:

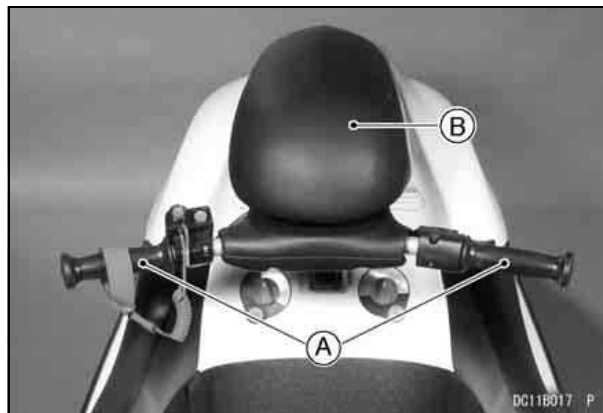

A. Handlebars

B. Handle Pole



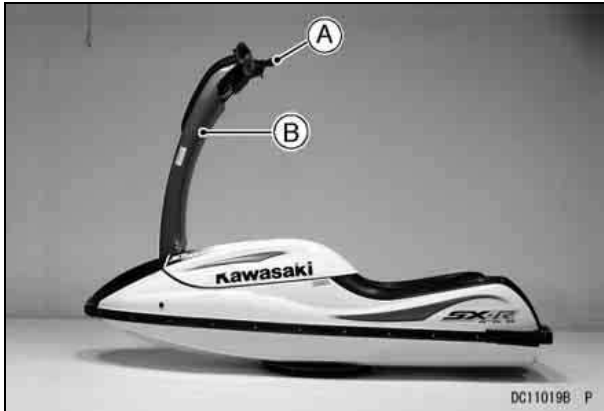

- A. Handlebars
- B. Handle Pole (upright position)

The steering handlebar functions much the same as a snowmobile or bicycle handlebar. Turning the handlebar will cause the watercraft to turn **ONLY WHEN THE ENGINE IS RUNNING AND ONLY WHEN THE THROTTLE IS APPLIED**. The handlebar is connected by a control cable to the jet pump steering nozzle at the rear of the boat.

#### Stop Button:

The stop button is in the case on the left hand side of the handlebar. The stop button is red and marked "STOP." Pushing the stop button turns off the engine.

The engine is also stopped by pulling the engine shut-off lanyard key off the stop button.

After riding, remove the engine shut-off lanyard key from watercraft to avoid unauthorized use by children or others.

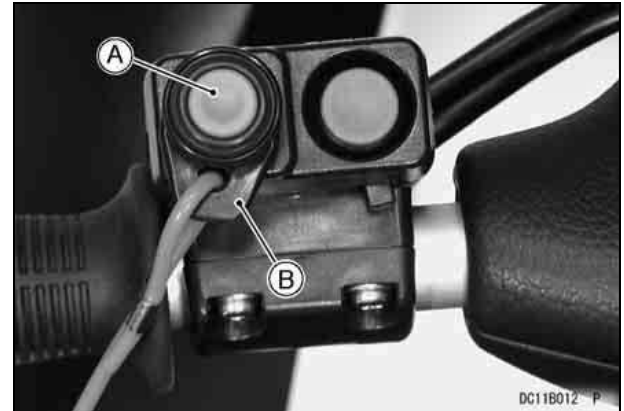

- A. Stop Button
- B. Lanyard Key

#### Starter Interlock Switch:

The purpose of the starter interlock switch is to prevent accidental starting. Only when the starter interlock switch is positioned to the right, pushing the green start button will crank the engine. The engine will not crank when the starter interlock switch is positioned to the left.

## 32 GENERAL INFORMATION

### **⚠ WARNING**

To prevent accidental rotation of the engine and possible injury, always keep the starter interlock switch positioned to the left when the engine is not running.

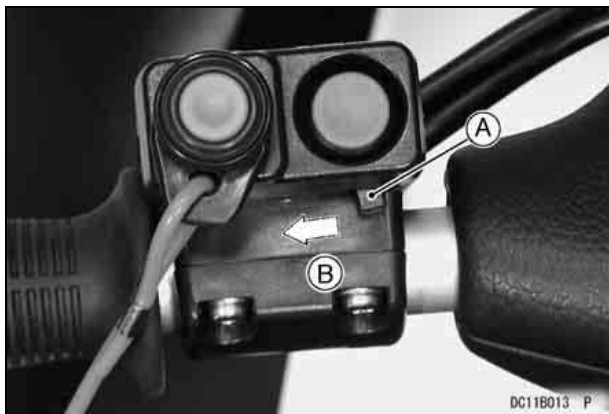

**A. Starter Interlock Switch**

**B. Locked**



**A. Unlocked**

### **Start Button:**

The start button is in the case on the left hand side of the handlebar. The start button is green and is marked "START." Pushing the start button with the engine shut-off lanyard key pushed under the stop button starts the engine. Release it when the engine starts. Without the lanyard key the engine neither cranks nor starts.

### **CAUTION**

Do not push the "START" button while the engine is running or while the starter is still spinning, as it will hasten starter wear and may cause the starter to jam.

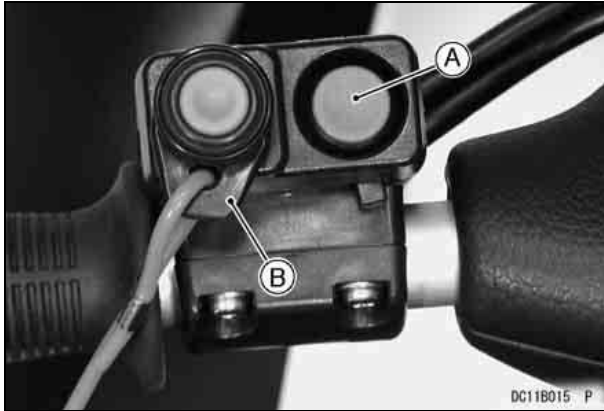

A. Start Button

B. Lanyard Key

**NOTE**

- *The start button will work only when the starter interlock switch is pushed to the right.*
- *For the engine to start, the engine shut-off lanyard key must be pushed under the stop button.*
- *Refer to the Starting the Engine section in the Operating Instructions chapter.*

**Throttle Lever:**

The throttle lever is located on the right hand side of the handlebar. Squeezing the lever towards the handlebar grip increases engine speed. When released, spring pressure returns the lever to the idle position. Always check that the throttle lever returns normally before starting the engine. In addition, there must be adequate throttle cable play. Refer to the MAINTENANCE AND ADJUSTMENTS chapter for the throttle cable adjustment procedure.



A. Throttle Lever

## 34 GENERAL INFORMATION

### Choke Knob:

The choke knob is located on the left side of the deck under the steering handlebar. Turning the choke knob to the “ON” position (all the way clockwise) provides a rich mixture for starting. After the engine fires, turn the choke knob to the “OFF” position (all the way counterclockwise).

#### NOTE

- *If the choke knob is used after the engine has started, it will waste fuel, reduce performance, and could cause spark plug fouling.*



A. Choke Knob

B. Fuel Knob

### Fuel Knob:

The fuel knob is located on the right side of the deck under the steering handlebars. It has three positions: “ON”, “OFF”, and “RES” (reserve). If you run out of fuel while the knob is in the “ON” position, turn the knob to “RES”. Reserve allows use of the last 3.0 liters (0.8 U.S. gal) of fuel. When on “RES”, reduce speed to less than half-throttle.

#### NOTE

- *Since operating distance is limited when on “RES”, refuel at the earliest opportunity.*
- *Make certain that you turn the fuel knob to “ON” (Not “RES”) after filling up the fuel tank.*

## Engine Hood

The engine hood is held in place by a latch.

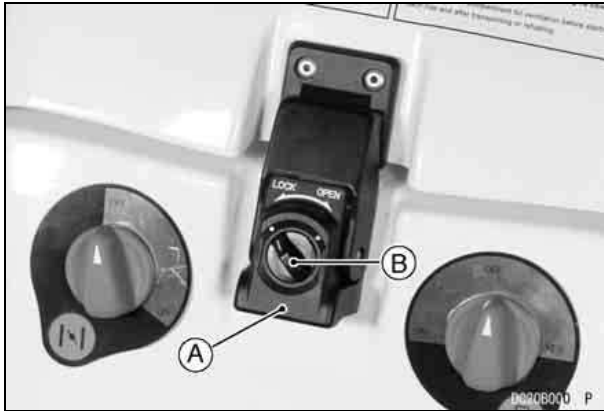

A. Latch

B. Latch Lock Knob

**To Open:** Raise the handle pole all the way up and while holding it swing up the handle pole stopper pin and hook its end into the rest in the handle pole bracket. This will lock the handle pole in an upright position while you remove the engine cover. Do not lean on the handle pole when it is locked upright.

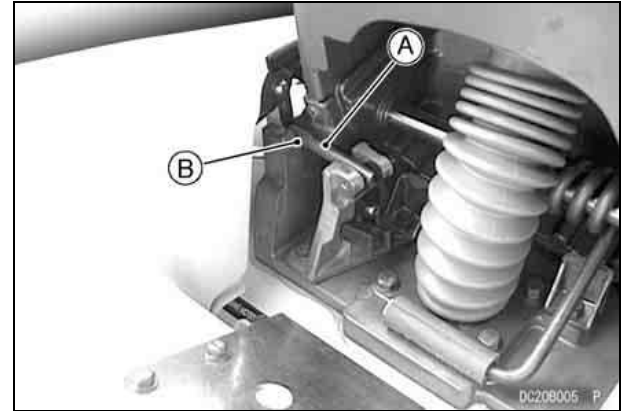

A. Stopper Pin

B. Rest

### NOTE

○ *Make sure that the stopper pin has been hooked into the rest completely.*

## 36 GENERAL INFORMATION

- Turn the latch lock knob clockwise, pull the latch all the way up and unhook its upper portion.



A. Unhook here

- Pull up [A] the rear portion of engine hood [B] a little and slide [C] it rearward, disengaging the hood hooks [D] from the brackets [E] at the handle pole pivot.

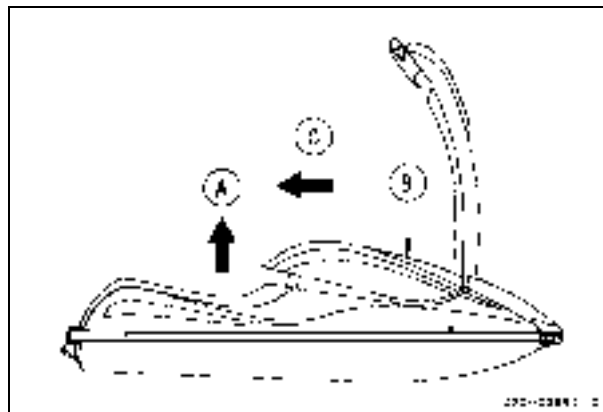

A. Pull up  
B. Engine Hood

C. Slide rearward

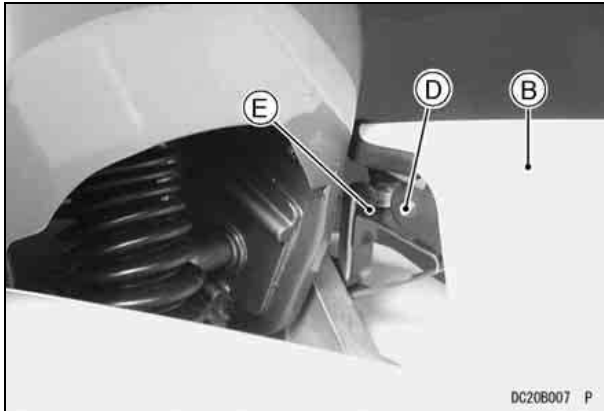

B. Engine Hood  
D. Hood Hook

E. Bracket

- Pull up [A] the engine hood [B] and remove it.

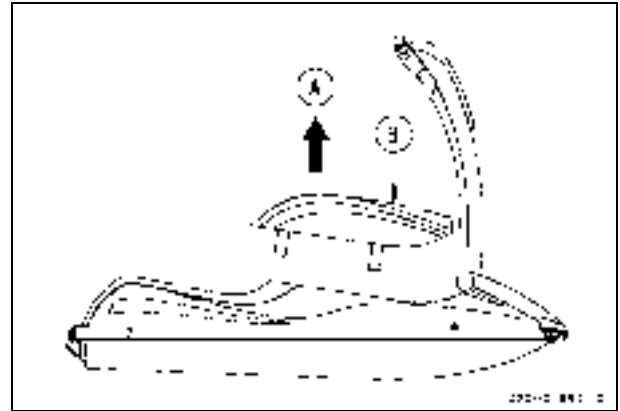

A. Pull up

B. Engine Hood

### CAUTION

Do not lift up [A] the rear portion of engine hood [B] before disengage the hood hooks from the bracket at the handle pole pivot or engine hood inside may be damaged.

## 38 GENERAL INFORMATION

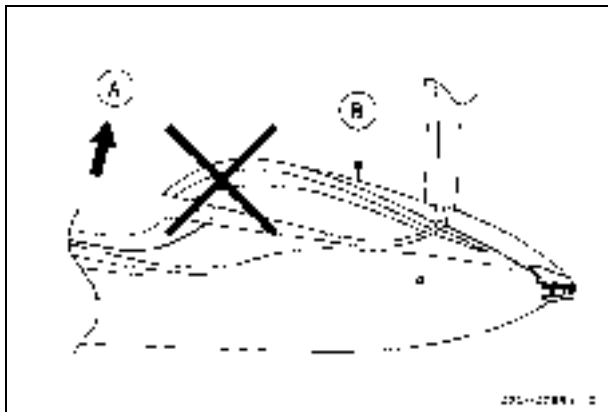

A. Do not lift up.

B. Engine Hood

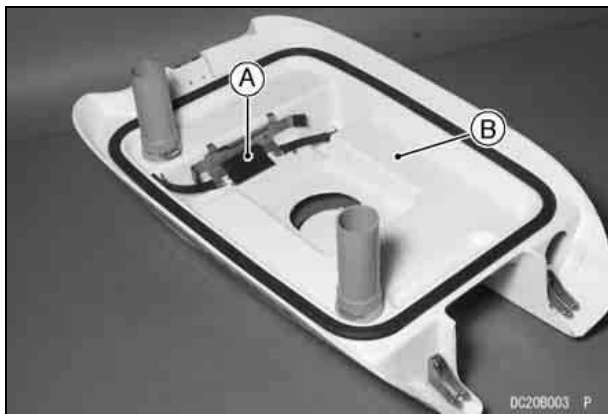

A. Fire Extinguisher Holder

B. Engine Hood

At the back of the engine hood, a fire extinguisher holder is provided.

### To Close:

- Put down [A] the engine hood [B] parallel with the engine opening [C], positioning the ducts [D] into the engine room spaces [E].

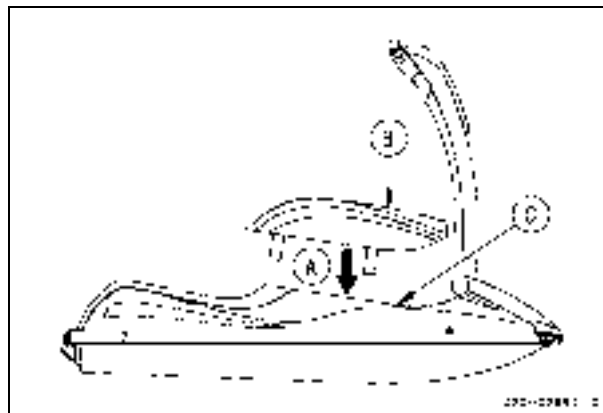

A. Put down  
B. Engine Hood

C. Engine Opening



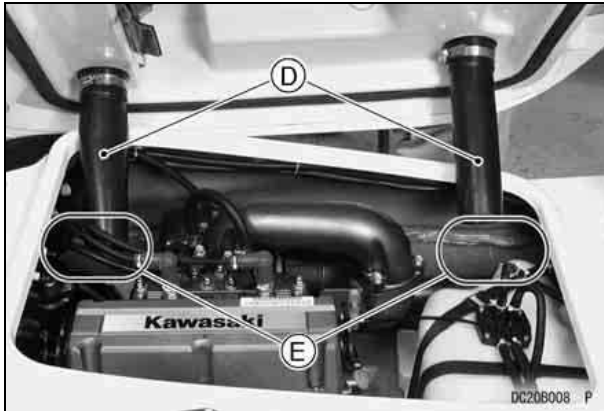

A. Ducts

B. Spaces in Engine Room

- Put the engine hood [A] on the deck [B] and line up [C] the hood and deck in center.

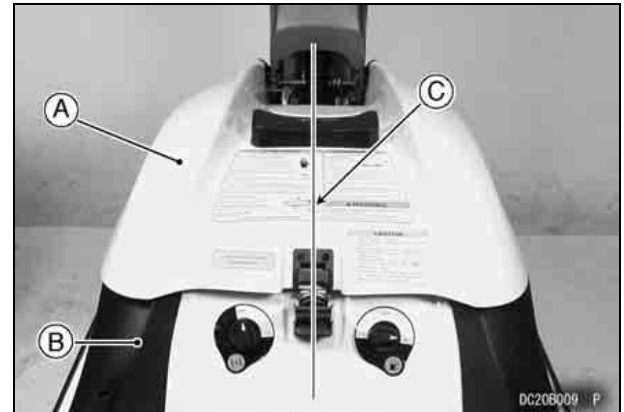

A. Engine Hood  
B. Deck

C. To be in center

## 40 GENERAL INFORMATION

- Push the engine hood [A] forward [B].

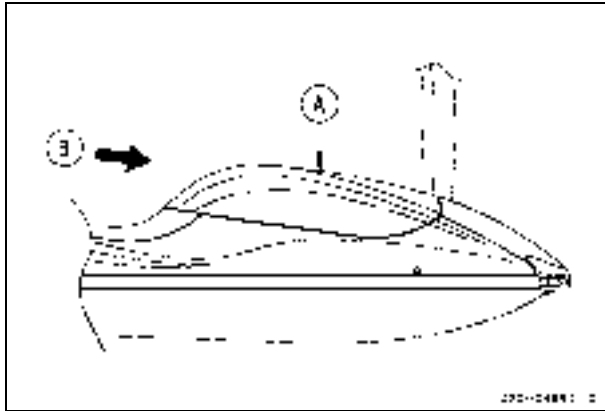

A. Engine Hood

B. Push forward

- Make sure the hood hooks [A] engage into the brackets [B] at the handle pole pivot.

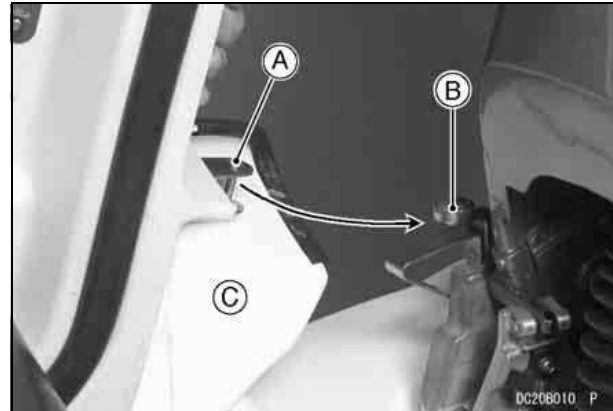

A. Hood Hook  
B. Bracket

C. Engine Hood

- Push down [A] the rear side of engine hood [B].
- Push the latch down and turn latch lock knob counterclockwise.

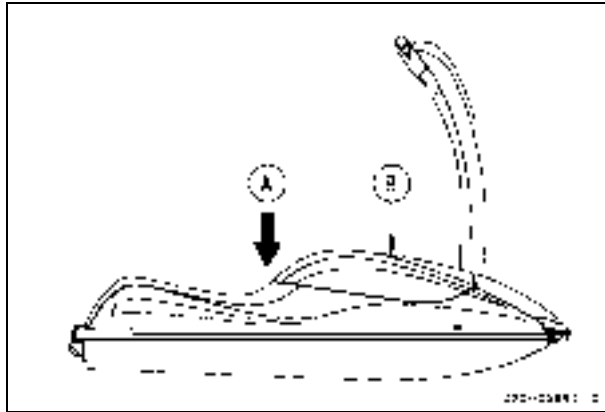

A. Push down

B. Engine Hood

### CAUTION

Do not install [A] the engine hood [B] with an angle as shown next or engine hood inside may be damaged.

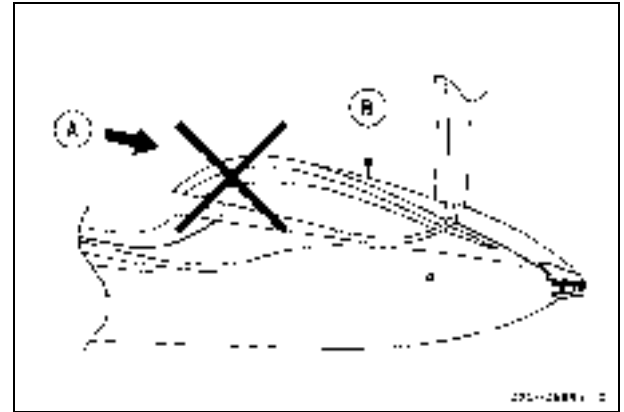

A. Do not push.

B. Engine Hood

- While holding the handle pole, pull up the stopper pin and push it back into the holder.

## 42 GENERAL INFORMATION

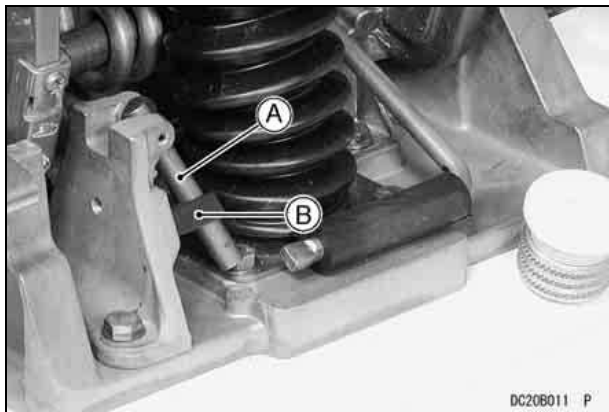

- A. Stopper Pin
- B. Holder

When transporting the watercraft, make sure the engine hood is secured to prevent it from becoming dislodged and damaged. Also, be sure to tie down the handle pole.

If not secured, a handle pole can be damaged from bouncing up and down. An unsecured handle pole can also damage the engine hood, particularly if it is misaligned.

---

## Tool Kit

---

Tool kit container is located in the engine room.

The minor adjustments and maintenance explained in this Owner's Manual can be performed with the tool kit.



- A. Tool Kit Container

## Bilge Systems

This watercraft is equipped with a jet vacuum drainage system at the rear end of the engine compartment. This system utilizes the water jet for propulsion to drain the bilge in the engine compartment. This system functions when the engine is running on the water.

### CAUTION

Check the function of the bilge system at regular interval according to the Periodic Maintenance Chart. Refer to the MAINTENANCE AND ADJUSTMENTS chapter. Clear debris from the pump inlets.

### WARNING

The capacity of the bilge pumping system is not designed to drain the craft in the case of damage.

### NOTE

- To drain the remaining bilge, remove the drain screw at the rear end when the craft is out of the water.

## Drain Screw

There is a drain screw in the stern to drain water accumulated in the engine compartment. Open it only when the craft is out of the water.

### CAUTION

Before launching be sure to securely tighten the screw to avoid flooding and swamping the craft.

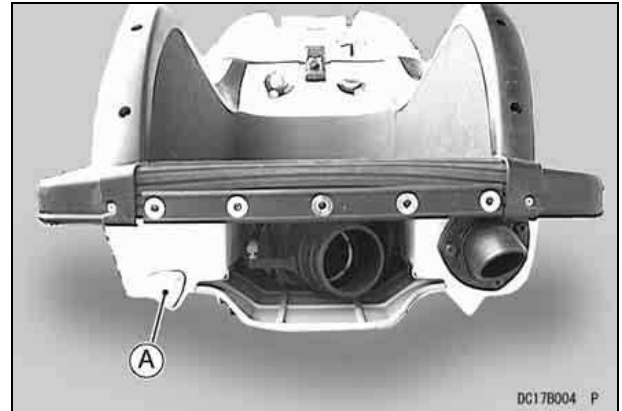

A. Drain Screw

## OPERATING INSTRUCTIONS

### Safe Operation

#### Operation by Children:

#### WARNING

The JET SKI watercraft is not a toy; It is a one-person high performance INBOARD BOAT LESS THAN 4.8 M (16 FEET) IN LENGTH. Underage operators may be hazardous to themselves and others. Kawasaki recommends a minimum operator age of 16 years old. Know the operator age and training requirements for your state. A boating safety course is recommended and may be required in your state.

#### Operator Swimming Ability:

#### WARNING

Operators of personal watercraft can fall into the water and experience exposure. Operator must be a competent swimmer and never travel farther from shore than they can swim back.

**Drowning Hazard:** a personal flotation device (PFD) must be worn by the operator. Kawasaki recommends that the operator wear a vest-type PFD (type 1, 2 or 3) at all times.

#### Maximum Number of Person:

This watercraft is designed to carry only the operator. Never carry a passenger or cargo on the watercraft.

#### WARNING

Do not exceed the maximum recommended number of persons.

Overloading this watercraft can adversely affect handling and stability which can lead to an accident.

Load capacity limits: 1 person only

**Safe Riding Rules:****⚠ WARNING**

**Always follow these rules when operating your watercraft, for your own safety and that of others.**

- Always comply with any Navigation Rules in effect in your area. The Coast Guard office or state boating authority nearest you can usually furnish you with the applicable rules. Check local and state regulations before operating. Kawasaki recommends that all operators complete an approved boating safety course.
- See the Navigation Rules section in this chapter for basic navigation rules.
- Kawasaki recommends that the operator wear a U.S. Coast Guard approved vest-type personal flotation device (type 1, 2 or 3) at all times. Other countries may have their own standards and regulations; be sure to follow them.
- Check the throttle control and steering for proper operation before starting the engine. Malfunctioning controls can cause an accident.
- Operate defensively at safe speeds and keep a safe distance away from people, objects, and other watercraft.
- Do not follow directly behind watercraft or other boats.
- Do not go near others to spray or splash them with water.
- Look carefully around you for other boats and objects in your path before starting and making quick maneuvers, especially before executing any quick turns. Because the watercraft is very maneuverable, other boaters may not be expecting you to turn as quickly as you are able (see the Turning the JET SKI Watercraft section). Before making a turn, always look over your shoulder to make sure no other watercraft is coming from behind.
- Take early action to avoid collisions. Remember, watercraft and other boats do not have brakes.
- Never carry a passenger on the watercraft. This craft is designed to carry only the operator. A passenger can adversely affect handling and stability which can lead to an accident. Also, if the operator falls off, the passenger may not be able to control the watercraft.
- The operator must always keep the engine shut-off lanyard attached to himself while operating the watercraft. If the operator falls, the lanyard stops the engine (see the Starting the Engine section).
- Alcohol and drugs impair judgement and reaction time. Never drink and ride.
- Wear suitable eye protection while operating this watercraft. In some circumstances water spray can momentarily interfere with vision and create a hazard.
- Kawasaki recommends that the operator wear foot protection. Objects hidden underwater may injure your feet.
- Kawasaki recommends that the operator of personal watercraft wear protective swimwear such as neoprene bottoms. Riders of personal watercraft

## 46 OPERATING INSTRUCTIONS

may suffer injury due to the forceful injection of water into body cavities either by falling into the water or while mounting the craft.

- You need throttle to turn. Releasing the throttle completely reduces the ability to steer and the watercraft can hit an object you are trying to avoid.
- Do not tow other watercraft, skiers, or objects behind this watercraft. The holes in the bow and rear deck are designed only as tie-down points for transporting the craft. Towing anything can cause loss of steering control and create a hazardous condition. Also, other boat operators may not expect the watercraft to be towing anything.
- Never operate the watercraft after dark. It is not designed for such use, and has no lighting equipment.
- All operators of this watercraft must know the righting procedure because this craft will not self-right if it is capsized (see Righting the Capsized Watercraft in the Riding the JET SKI Watercraft section).
- Avoid operating the watercraft in waters full of weeds or debris, as they may clog the jet pump, and cause an injury if you fall.
- Do not operate in shallow water, or the impeller may be damaged and sand may clog the water cooling hoses.
- Be very careful of other boats, especially those towing water skiers. Give them plenty of room.
- Never go over a ski jump. You could damage the watercraft or injure yourself.

- Do not operate the watercraft in ocean surf. In addition to being dangerous, it may be illegal in certain localities.
- The operator must judge what is a safe speed taking into consideration visibility, traffic, weather conditions, waves, etc. Water conditions such as converging waves can have considerable influence on the ride characteristics of a personal watercraft and can cause the operator to fall off. Additionally, attempting to achieve maximum speed in adverse conditions can cause abrupt movement of the boat causing possible injury to the operator.

### CAUTION

**Jumping waves can overstress the watercraft hull causing it to crack.**



**Jet Pump Safety:**

Although the jet pump is inherently safer than a propeller drive, certain safety precautions must always be observed.

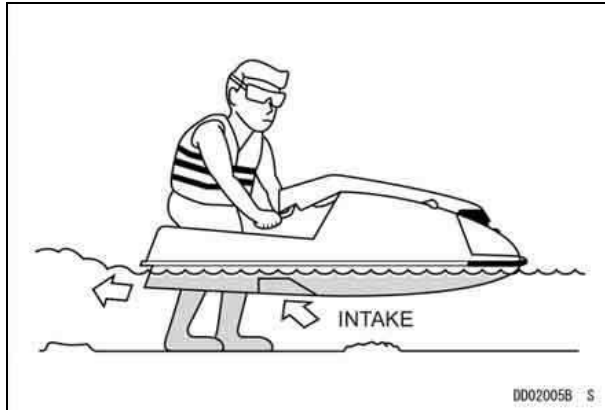

**⚠ WARNING**

**Keep your hands, feet, and clothing away from the jet pump intake (bottom of the boat, in the middle) and never stick anything into the pump outlet (steering nozzle at the back of the boat) whenever the engine is running, or a severe injury can occur.**

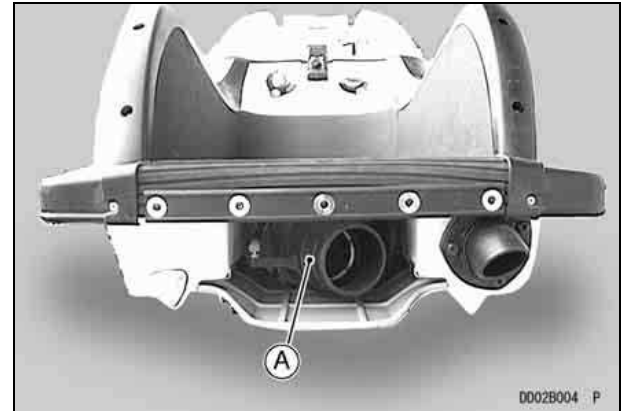

**A. Steering Nozzle**

**Personal Flotation Device and Safety Gear:**

U.S. federal regulations require that one U.S. Coast Guard approved personal flotation device (PFD) be carried when operating on water under Coast Guard jurisdiction. In some state waters not under federal jurisdiction, other flotation devices are permissible in addition to those specified by federal law. Other countries may have their own standards and regulations; be sure to follow them. As a rule, waist-type ski belts do not qualify as adequate flotation devices. The full vest type is recommended. Check local regulations to see what type of personal flotation device may be required in your area.

**⚠ WARNING**

**Drowning Hazard:** a personal flotation device (PFD) must be worn by the operator. Kawasaki recommends that the operator wear a vest-type PFD (type 1, 2 or 3) at all times.

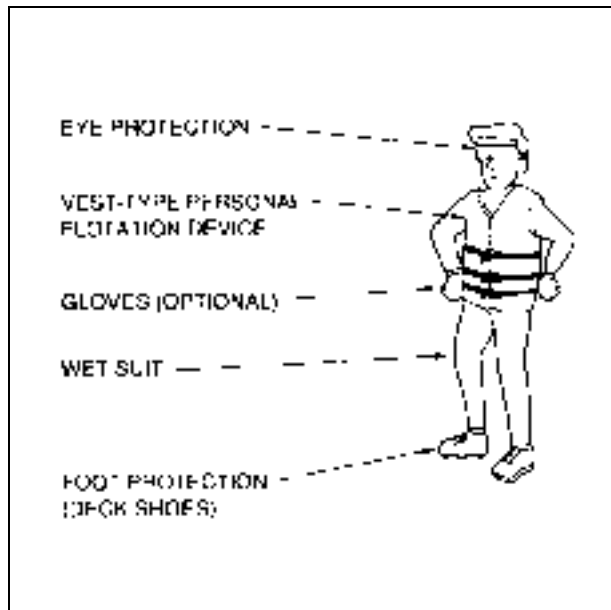

**⚠ WARNING**

In some circumstances water spray can momentarily interfere with vision which could be hazardous. Wear suitable eye protection while operating this watercraft.

Objects hidden underwater may injure your feet. Operator should wear foot protection at all times.

Riders of personal watercraft may suffer injury due to the forceful injection of water into body cavities either by falling into the water or while mounting the craft. Kawasaki recommends that the operator of personal watercraft wear protective swimwear such as wetsuit bottoms.

**Watercraft Helmets..... Something You Should Know:**

A helmet could protect your head, but could contribute to neck injuries.

Before wearing a helmet on a personal watercraft you must weigh the benefits and risks.

**Benefits:** Helmets offer some head protection from impacts with hard objects.

**Risks:** Helmets could reduce peripheral vision and increase fatigue; both of which could lead to a collision. Helmets could also increase loads on the neck and throat when you fall into the water, which could result in severe injuries.

**You must decide:**

If you plan to ride under conditions in which you believe there is a higher chance that your head may be hit by a hard object, such as falling during a race, you may choose to wear a helmet and accept the risks. On the other hand, if head impact with the water is more likely, you may choose to not wear a helmet.

**Fire Extinguisher:**

A charged and functional fire extinguisher must be carried on board.

A holder is provided for fire extinguisher at the back of the engine cover.

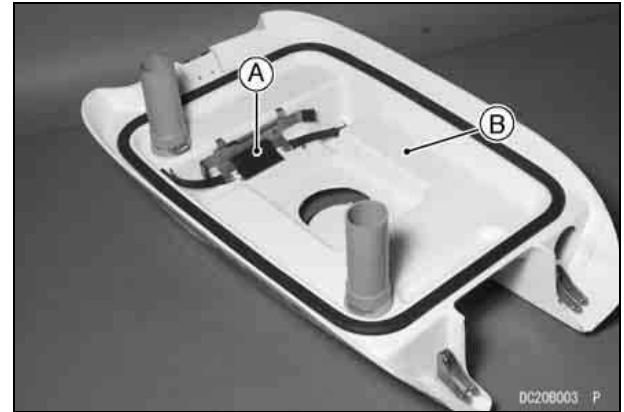

A. Fire Extinguisher Holder    B. Engine Cover

## 50 OPERATING INSTRUCTIONS

Because the watercraft is an inboard boat less than 4.8 m (16 ft) in length, federal regulations require that a fire extinguisher rated “B-1” (minimum 1 kg or 2 pound capacity) be aboard when operating on navigable waters under Coast Guard jurisdiction. In addition, most states, parks, and wildlife departments require that a U.S.C.G. approved fire extinguisher be carried aboard, even on waters not under federal jurisdiction.

Other countries may have their own standards and regulations; be sure to follow them.

### **WARNING**

**Do not use your watercraft unless it has a fire extinguisher on board.**

Standard equipment does not include a fire extinguisher. Many owners prefer to provide their own fire extinguishers. If you wish, your dealer can furnish you with an approved Kawasaki accessory fire extinguisher (P/N. W99997-101).



---

## Loading

---

### WARNING

**Loading of cargo or use of accessories, or modification of your watercraft may affect stability and handling of the watercraft and result in an unsafe riding condition.**

**Before you ride the watercraft, make sure that the watercraft is not overloaded and that you have followed these instructions.**

#### Load Capacity Limits:

1 person
----------

With the exception of genuine Kawasaki Parts and Accessories, Kawasaki has no control over the design or application of accessories. In some cases, improper installation or use of accessories, or watercraft modification, will void the warranty. In selecting and using accessories, and in loading the watercraft, you are personally responsible for your own safety and the safety of other persons involved.

#### NOTE

○ *Kawasaki Parts and Accessories have been specially designed for use on Kawasaki watercraft.*

*We strongly recommend that all parts and accessories you add to your watercraft be genuine Kawasaki components.*

Because a personal watercraft is sensitive to changes in weight distribution, you must take extreme care in the fitting of additional accessories. The following general guidelines have been prepared to assist you in making your determinations.

- This watercraft is designed for the operator only - no passengers. Carrying a passenger can adversely affect the handling and stability which can lead to an accident. Also, do not carry animals on your watercraft.
- Do not install accessories that impair the performance of the watercraft.

## 52 OPERATING INSTRUCTIONS

---

### Navigation Rules

---

The navigation rules or nautical "rules of the road" are like highway traffic laws. They dictate who has the right-of-way when boats meet in open water. As the boat operator you are obligated to know and obey these rules. They are also legally binding on boat operators.

This section provides basic navigation rules. We recommend that you obtain more information on navigation rules and navigation aids from your state when registering your craft. If you have never owned a boat before, an excellent introduction to the arts of boat handling and seamanship can be obtained from the U.S. Power Squadrons, the U.S. Coast Guard Auxiliary, or other volunteer organizations.

In nautical terms, the stand-on (privileged) boat has the right of way; and the give-way (burdened) boat must give way. Whenever you come near another boat, be cautious and use common sense. You cannot rely on other boaters to know or follow these rules.

#### Sailboats:

Sailboats have right-of-way over power boats in nearly all cases. Stay clear of these craft and do not create a wake which may cause them trouble.

### Overtaking and Passing Situation:

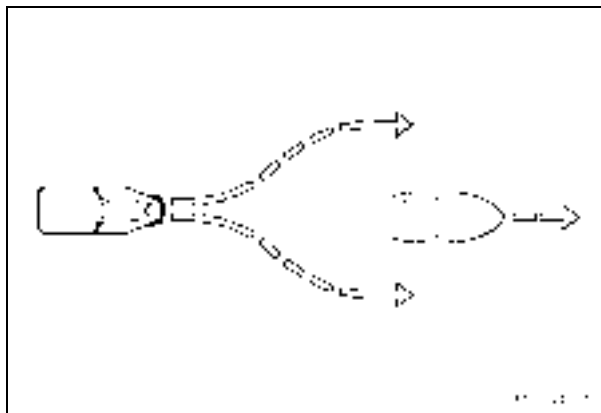

Give-way (Burdened)  
Vessel Overtaking

Stand-on (Privileged)  
Vessel Being Overtaken

If you are overtaking and passing another boat, the boat being passed has right-of-way, and you are required to stay clear.

**Meeting Situation:**

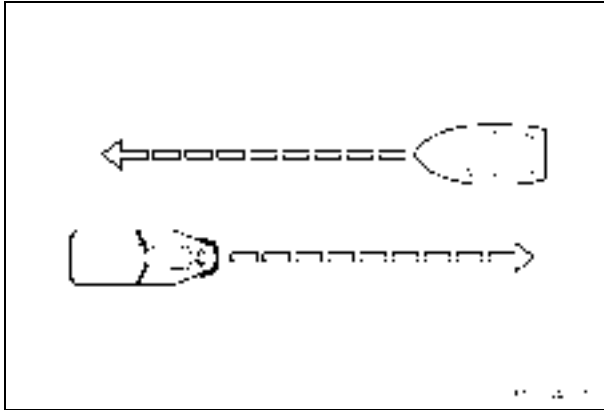

If you are meeting another power boat head on, neither you nor the other boat has right-of-way. Each boat should keep to its right.

**Crossing Situation:**

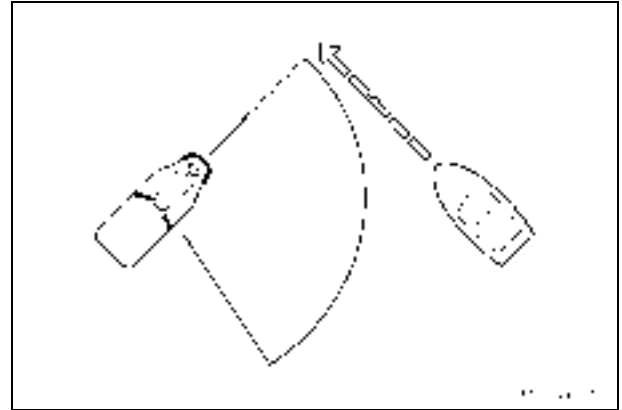

Give-way  
(Burdened)  
Vessel

Stand-on (Privileged) Vessel  
holds course and speed.

If you have another power boat on your right, the boat on the right has right-of-way. You must keep out of the way of the boat by directing your course to the starboard (right) and passing astern of (behind) the stand-on boat. If necessary, you may have to slow, stop, or reverse your craft to allow the stand-on boat to pass. Before passing behind another boat, look carefully for a water skier or any towed object. Pass behind the object in tow.

If you have another boat on the left, you have right-of-way. You must keep your course and speed.

## 54 OPERATING INSTRUCTIONS

### Pre-ride Checklist

Each day before using the watercraft, check the following items:

- FUEL PRESSURE - Loosen the fuel filler cap to relieve any pressure, then tighten the cap securely.
- VENTILATE ENGINE COMPARTMENT - Remove the engine cover for several minutes to purge gasoline fumes from the engine compartment.

#### WARNING

**A concentration of gasoline fumes in the engine compartment can cause a fire or explosion.**

- BATTERY TERMINALS - Check the battery terminal screws for tightness, and make sure terminal covers are in place.

#### WARNING

**Loose battery cables can create sparks which can cause a fire or explosion resulting in injury or death. Make sure the battery terminal screws are tightened securely and the covers are installed over the terminals.**

- FUEL LEAKS - While ventilating the engine compartment check for fuel leaks.
- DRAIN BILGE - Drain any water out of the engine compartment by removing the drain screw. Install

the drain screw securely when all the water has been drained.

- CLEAN PUMP - Clear the water inlet, jet pump, and drive shaft of foreign objects.
- PUMP COVER TIGHT - Check the jet pump cover and inlet grate for looseness. Tighten the mounting bolts, if needed.
- HULL DAMAGE - Inspect the hull for damage.
- FUEL LEVEL - Turn the watercraft upright and check the fuel tank level. Refill if necessary and turn the fuel valve to ON.
- FASTENERS - Check and tighten any loose bolts, nuts, or clamps.
- HOSE CONNECTIONS - Be sure all hose connections are secure and that all hose clamps are tight. Check all hoses for cracks or deterioration and replace if necessary.
- FIRE EXTINGUISHER - Check your fire extinguisher for a full charge.
- STEERING - Check the operation of the steering for binding, rough spots, or excessive play. Adjust the cable if needed (see the Control Cable Adjustments section in the MAINTENANCE AND ADJUSTMENTS chapter). The steering cable is sealed at both ends and does not need lubrication. If the seals are damaged, the cable must be replaced.
- DRAIN SCREW - Check that the drain screw in the stern is securely installed.
- THROTTLE CONTROL - Check the operation of the throttle for binding, rough spots or excessive play. Adjust the cable if needed (see the Control Cable Adjustments section in the MAINTENANCE



AND ADJUSTMENTS chapter). The throttle lever must return to the fully closed position when released.

**⚠ WARNING**

**If the throttle does not return freely and completely, it may cause loss of control.**

- ENGINE SHUT-OFF LANYARD KEY-Start the engine and run it for a few seconds (see the Starting the Engine section). Pull the lanyard key off the engine stop button to check that the engine stops immediately.

**⚠ WARNING**

**Do not run the engine in a closed area. Exhaust gases contain carbon monoxide: a colorless, odorless, poisonous gas. Breathing exhaust gas leads to carbon monoxide poisoning, asphyxiation, and death.**

**CAUTION**

**Do not run the engine with the watercraft out of the water for more than 15 seconds at a time. Overheating will cause engine and exhaust system damage.**

- STOP BUTTON- Again start the engine, run it for a few seconds, and then check that the engine "STOP" button works.
- ENGINE COVER - Install the engine cover, and check that the engine cover latch is secure.
- RIDER PROTECTION- Always wear the proper flotation device and protective gear.

### Break-In

A new watercraft should be ridden with care during the break-in period to allow mechanical components to "bed-in" and produce smooth, long wearing surfaces.

During the first five hours of engine operation, do not subject the engine to heavy lugging or prolonged full throttle operation. For this period, up to 3/4 throttle is recommended.

Vary the operating speed often, not running for a prolonged time at any one speed.

Careful treatment of the craft during the break-in period will result in more efficient, reliable performance and a longer life for the craft.

In addition to the break-in described above, we recommend that the owner take his watercraft to an authorized Kawasaki JET SKI dealer after the first ten hours of operation for initial maintenance service. See the Periodic Maintenance Chart in the MAINTENANCE AND ADJUSTMENTS chapter.

### Stopping the Engine

The engine can be stopped in one of the following two ways.

- Push the "RED" engine stop button. It is not necessary to hold the button "in" to stop the engine. After the engine stops, the "STOP" button resets itself and the engine is ready to start.
- Pull the engine shut-off lanyard key off the stop button. To start the engine, the lanyard key must be pushed under the stop button.

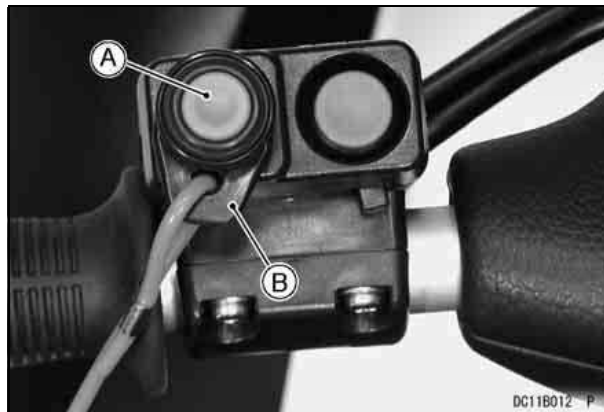

A. Engine Stop Button    B. Lanyard Key

### **WARNING**

You have no directional control of the watercraft when the engine is stopped.

If the engine must be stopped immediately in an emergency, push the “RED” engine stop button or pull the engine shut-off lanyard key off the stop button.

Some possible “EMERGENCY” situations are:

- The engine speeds out of control.
- The throttle lever does not release completely.

**⚠ WARNING**

**If the throttle fails, do not operate the watercraft until the source of the problem is found and corrected.**

**⚠ WARNING**

**After riding, remove the engine shut-off lanyard key from watercraft to avoid unauthorized use by children or others.**

---

## Starting the Engine

---

- Read the Pre-ride Checklist in this manual and follow its instructions before putting the watercraft in the water.
- After transporting or refueling and before starting the engine, open the engine cover for several minutes to ventilate the engine compartment.

**⚠ WARNING**

**A concentration of gasoline fumes in the engine compartment can cause a fire or explosion.**

- Place the watercraft in at least 0.6 m (2 ft) of water which is clear of weeds and debris. Make sure the area ahead of the watercraft is clear of swimmers, boats, and obstacles.

## 58 OPERATING INSTRUCTIONS

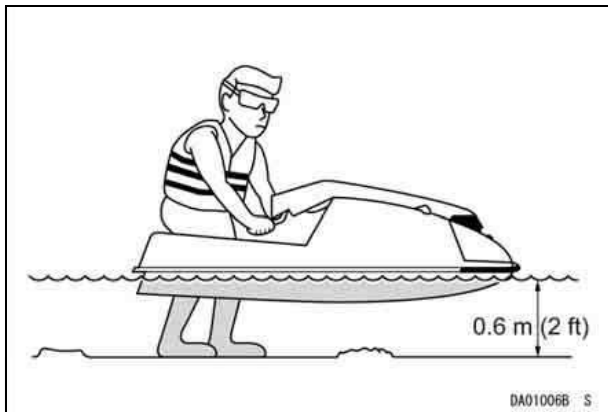

### CAUTION

The watercraft must be at least 0.6 m (2 ft) off the bottom when starting to prevent jet pump damage by objects sucked up from the bottom.

- Check that the fuel valve is ON and that the starter interlock switch is positioned to the right
- Standing in the water next to the boat, push the lanyard key under the stop button and put your left hand through the other end of the lanyard to attach

it to your wrist and keep it free from handlebars so that engine stops if operator falls off. Pull the lanyard to make sure it is securely attached.

### NOTE

- The engine neither cranks nor starts with the lanyard key removed from the stop button.
- Turn the choke knob clockwise, and with your right hand, grasp the right handlebar and apply a small amount of throttle.

### WARNING

Keep your hands, feet, and clothing away from the jet pump intake (bottom of the boat, in the middle) and never stick anything into the pump outlet (steering nozzle at the back of the boat) whenever the engine is running, or a severe injury can occur.

- With your left hand, push the green start button and release it when the engine starts. If the engine does not start within 5 seconds, release the button. Wait 15 seconds before trying again. If the engine does not start after several attempts, see the TROUBLESHOOTING GUIDE chapter.

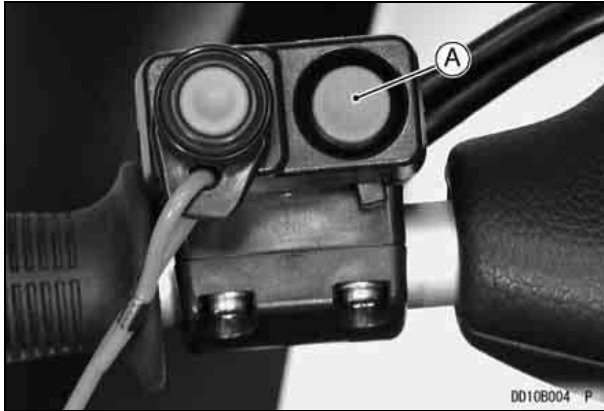

A. Start Button

**NOTE**

- Wait 15 seconds between each operation of the starter. This will extend battery and starter life significantly.
- When the engine first fires, even if it doesn't actually start, turn the choke knob to the "OFF" position. This will prevent engine flooding.
- When the engine is warm, the choke is not needed.

**CAUTION**

**Do not push the start button while the engine is running or while the starter is still spinning, as it will hasten starter wear and may cause the starter to jam.**

- After the engine has started, allow it to warm up for about 1 minute. Apply a little throttle occasionally. Excessive idling can foul the spark plugs.
- Check that water comes out of the bypass outlet in the left side of the hull when the throttle is applied. This indicates that cooling water is circulating. If there is none, shut off the engine and find the source of the trouble. When the exhaust system is dry, it can take up to 15 seconds for water to appear at the bypass outlet.



A. Bypass Outlet

## 60 OPERATING INSTRUCTIONS

### Launching

#### Deep Water Start:

Deep water starting is the primary means of starting the watercraft. It is not necessarily the easiest way to start, but it must be mastered so that you can get going again after the inevitable spill in deep water.

- Start the engine in water that is at least waist deep.
- Assume a prone position behind the boat with your hands grasping the handlebar and your forearms resting on the tail fins.
- Check that the water ahead of you is clear.

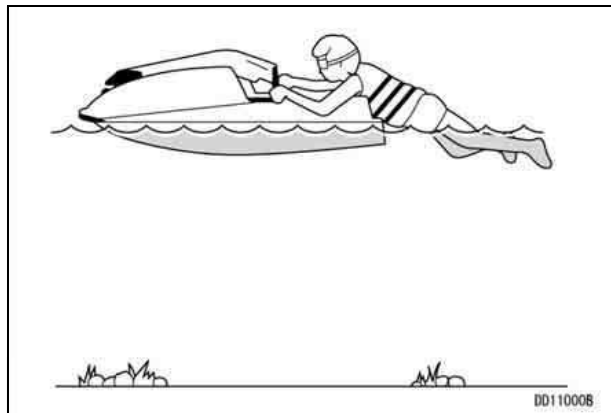

- Apply the throttle and accelerate rapidly. Both stability and steering control are provided by jet thrust. As the craft accelerates, pull your body up

onto the riding platform and onto your knees, using your elbows on the fins for leverage. Move as far forward as possible without interfering with handlebar movement.

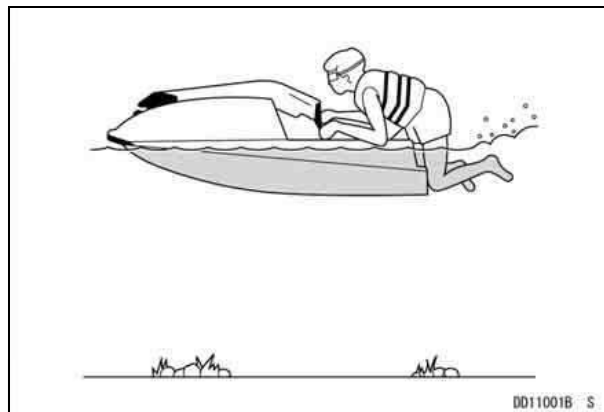

- As the watercraft increases speed, the bow will drop and the boat will level out in the water. This is called planing. It will take longer for a heavier rider than it will for a light rider. Once the boat has planed, you can back off the throttle and select your desired speed.

### WARNING

**Don't forget to watch out for other boats, swimmers, or obstructions in your path. This is especially critical during a beginner's first exciting ride.**

Deep water starting is generally more difficult if you're heavy, or if you're not in good physical condition. In these cases, return to the shore for a shallow water start. After some practice, you'll soon master the deep water start.

### **⚠ WARNING**

**Do not operate the watercraft while trailing your body behind it for extended periods of time. Your visibility is limited. You may not see other boats, swimmers, or obstructions in your path. Also, you may not see foreign objects that the jet pump could pick up and eject to the rear.**

#### **Shallow Water Start:**

This is the easiest way to launch a watercraft, but it shouldn't be relied upon merely because it's easy. The deep water start is still the most important launch to a beginner.

Whenever possible, anchor the watercraft in shallow water instead of dragging it onto shore. This will reduce scratches to the hull and prevent sand and rocks from entering into the jet pump causing damage to the pump when restarting the engine.

If the watercraft is beached, sand and rocks which are pushed into the jet pump by natural wave action can be flushed out by pushing down on the stern vigorously many times.

- Start the engine in at least 0.6 m (2 ft) of water.

### **CAUTION**

**This watercraft must be at least 0.6 m (2 ft) off the bottom when starting to prevent jet pump damage by objects sucked up from the bottom.**

- Grasp both handlebar grips and put one knee up onto the riding platform, balancing on your other foot.

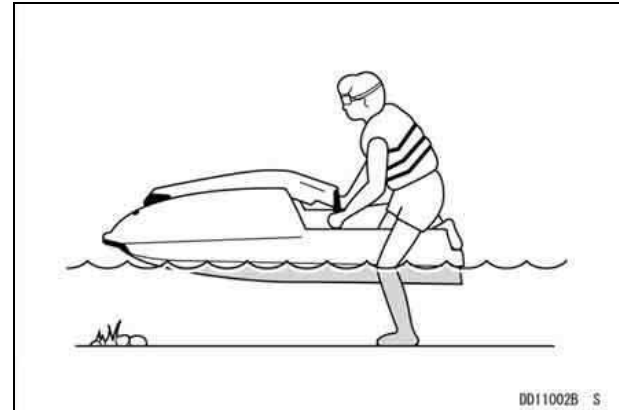

- Check that the water ahead of you is clear and point the handlebar straight ahead.
- Apply the throttle and accelerate rapidly. Both stability and steering control are provided by jet thrust.
- Keep alert for other boats, swimmers, or obstructions in your path.

## 62 OPERATING INSTRUCTIONS

- As the watercraft accelerates, pull your other knee up onto the riding platform and move as far forward as possible, without interfering with handle-bar movement. Keep your body perpendicular to the water with your weight forward and low.

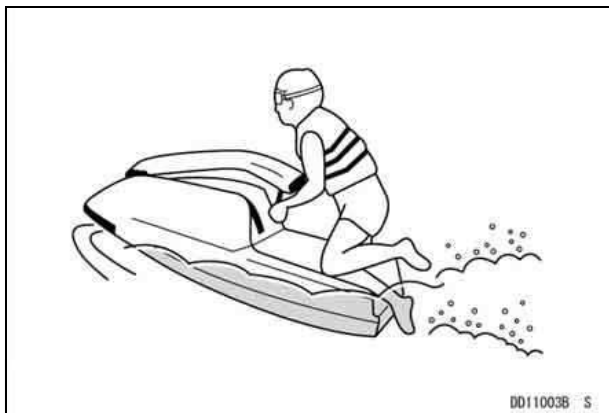

### Standing Start:

This method can be used by the more experienced watercraft rider.

- Start the engine in at least 0.6 m (2 ft) of water.
- Put one foot in the riding platform, balancing yourself with the other foot on the beach bottom.
- Accelerate quickly to planing speed, and place your other foot on the rear section of the riding platform.
- Keep alert for other boats, swimmers, or obstructions in your path.

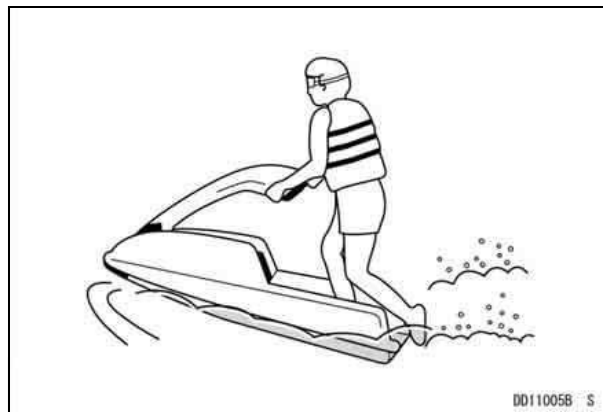
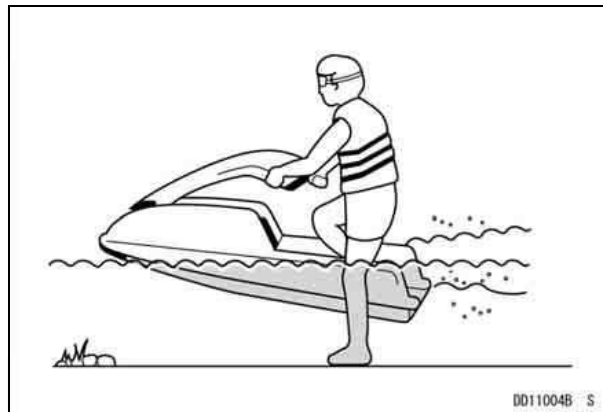



## Stopping the JET SKI Watercraft

The watercraft depends on forward motion to keep it planing (level), so the rear of the boat will usually submerge on stopping, depending on rider weight. Be prepared to get off the boat when it stops.

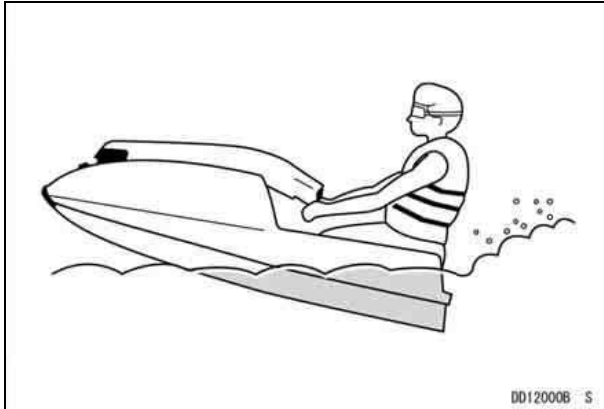

### **⚠ WARNING**

**Never directly approach any moving or stationary object closer than 100 m (328 feet) when traveling at top speed. Always throttle down before approaching your intended stopping area.**

The watercraft is normally stopped in one of two ways, both of which use natural water drag to bring the boat to a halt.

### **Straight Line Stopping:**

Push the RED engine stop button or pull the lanyard key off the stop button.

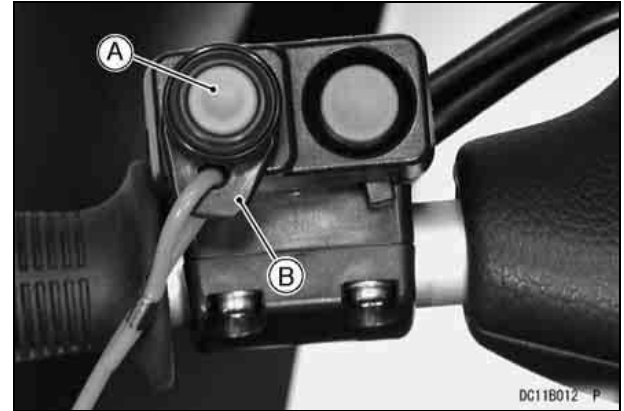

**A. Engine Stop Button    B. Lanyard Key**

Pushing the stop button or pulling the lanyard key off stops the engine immediately and permits the shortest straight-line stopping distance. The RED stop button should be used when you are approaching the shore and intend to stop. This prevents sand or debris from entering and damaging the jet pump.

### **⚠ WARNING**

**Do not stop the engine if you may need to reapply throttle to quickly steer the watercraft. You have no directional control when the engine is stopped.**

## 64 OPERATING INSTRUCTIONS

### Normal Stopping:

Release the throttle lever.



**A. Throttle Lever**

Releasing the throttle stops forward motion almost as quickly as pushing the engine stop button. More importantly, the engine will still be running, so you can steer the boat after reapplying the throttle. In this manner you can turn and move away from any obstacles.

### **⚠ WARNING**

**Releasing the throttle completely reduces the ability to steer. This can cause you to hit an object you are trying to avoid. You must have thrust to turn, so keep the throttle on or apply throttle as needed to maintain thrust at the jet nozzle.**

### Stopping Skills:

Stopping distance depends partially on rider and passenger weight and position, idle set speed, and operating speed. Experienced operators can usually shorten stopping distance by using various riding techniques. Turning the boat sharply (using the throttle) while stopping is a method which can be used to decrease stopping distance.

### **⚠ WARNING**

**If you get off the watercraft before it has completely stopped, make sure there are no other boats, swimmers, or obstacles in the path of the watercraft.**

You can always jump off the boat in an emergency to protect yourself, but you must also do your best to protect other users of the water.

### **Minimum Stopping Distances:**

The charts below indicate minimum straight-line stopping performance that can be met by the watercraft. Two methods of stopping have been used:

- A. Pushing the engine stop button.
- B. Releasing the throttle.

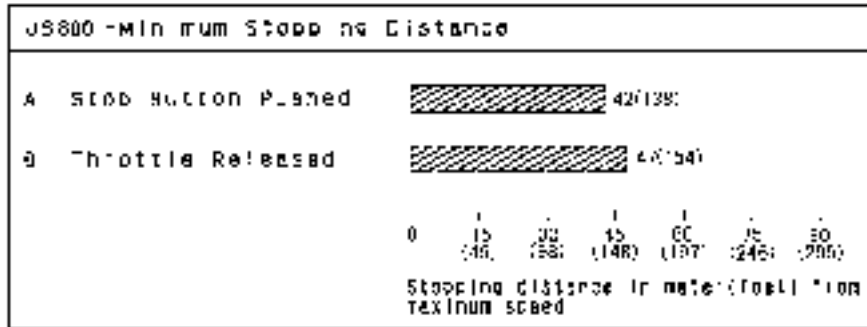

4-1-3

The information shown here represents results obtained by skilled riders of different weights under controlled conditions, and the information may not be correct under other conditions.

## 66 OPERATING INSTRUCTIONS

### Turning the JET SKI Watercraft

Turning the watercraft requires a combination of three actions:

- Turning the handlebar
- Leaning into the turn
- Using the throttle

Point the handlebar to the left for a left turn

Point the handlebar to the right for a right turn

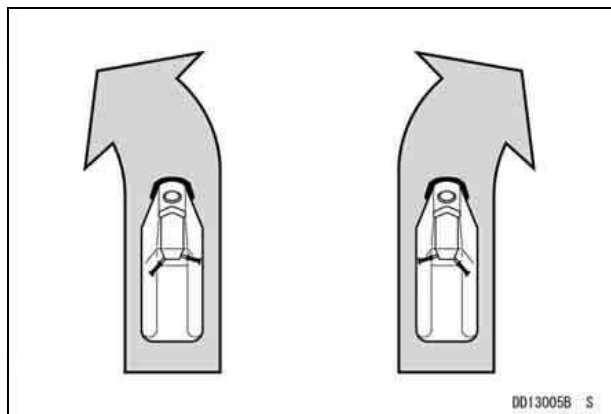

LEFT

RIGHT

Lean into the turn to maintain your balance. How much you lean depends on the tightness of the turn and your travelling speed. In general, the higher the speed or the sharper the turn, the more you lean.

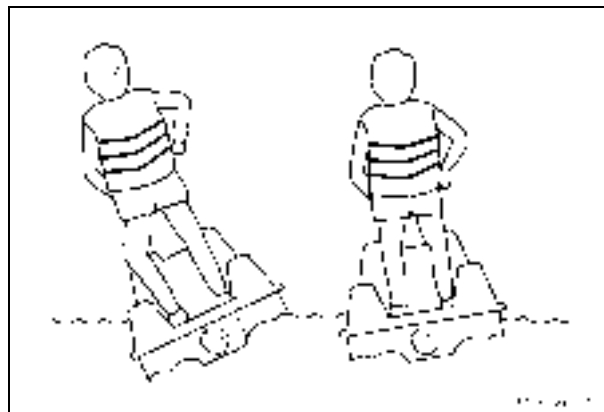

SHARP TURNS  
HIGH SPEED TURNS

WIDE TURNS  
SLOW TURNS

Using the throttle is another important part of turning maneuvers. Applying the throttle produces thrust from the jet pump giving you directional control over the watercraft.

High thrust of the jet pump makes the boat turn more sharply.

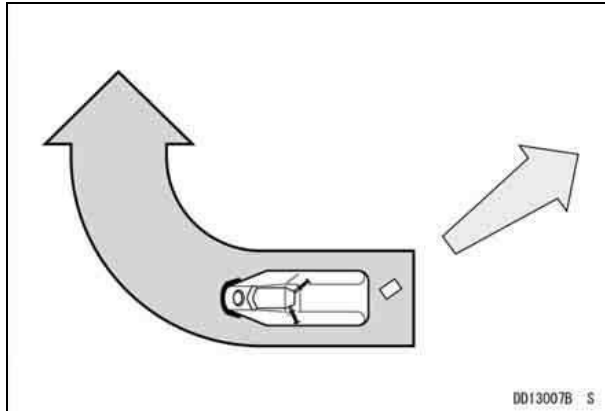

Low thrust of the jet pump makes the boat turn less sharply.

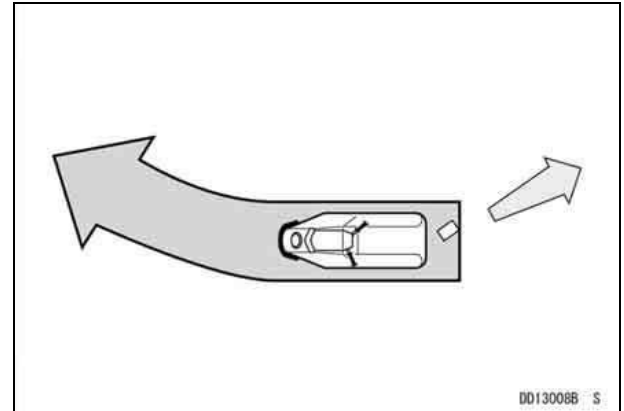

If you stop the engine while riding, there is no thrust of the jet pump. The boat goes straight ahead even though the handlebar is turned.

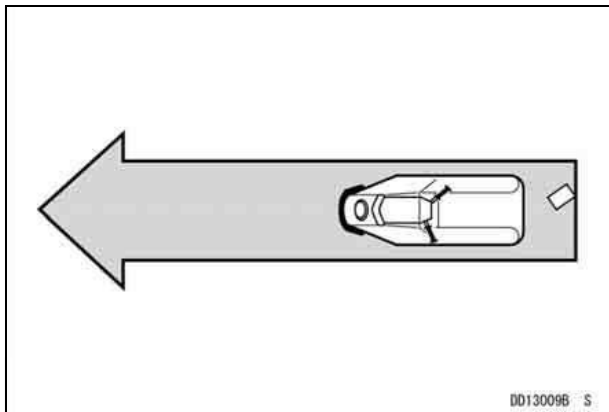

NO THRUST = NO TURN

This is one characteristic of jet drive boats which is important to remember when you make an emergency maneuver: **YOU MUST HAVE THRUST TO TURN**, so keep the throttle on or apply throttle as needed to maintain thrust at the jet nozzle.

### **⚠ WARNING**

**Releasing the throttle completely reduces the ability to steer. This can cause you to hit an object you are trying to avoid. You must have thrust to turn, so keep the throttle on or apply throttle as needed to maintain thrust at the jet nozzle.**

## **Riding the JET SKI Watercraft**

On your first ride, familiarize yourself with the handling of the boat. Vary the engine speed with the throttle lever to get the feel of throttle influence on steering. If porpoising occurs, that is, the front of the craft rises and falls rapidly, move your body weight further forward.

### **⚠ WARNING**

**Never ride with your chin immediately above the handlebar. If you should hit a wave, you might injure yourself.**

Stay alert at all times, and keep away from other boats, swimmers, and obstructions.

If the engine runs out of fuel, do not operate the choke knob. Turn the fuel knob to “RES” and push the green start button again. When on “RES”, reduce speed less than half-throttle.

### **NOTE**

- *Since operating distance is limited when on “RES”, refuel at the earliest opportunity.*
- *Make certain that the fuel knob is turned to “ON” (Not “RES”) after filling up the fuel tank.*

## CAUTION

**Do not push down on the handlebar. The handle pole rests on the engine cover and you could damage it.**

**Do not run the watercraft onto the shore, or severe impeller or hull damage may occur.**

**Do not operate in shallow or debris-laden water, or the impeller may be damaged and sand may clog the water cooling hoses.**

In general, the heavier you are, the more time it will take you to become proficient on the watercraft. Once you are familiar with the handling characteristics of the boat, you can learn to stand up.

### Standing Up:

- Maintaining a steady speed, raise the handlebar slightly and place one foot near the front of the riding platform.
- Balance yourself and slowly rise to a standing position, bringing the handlebar up with you as you rise.

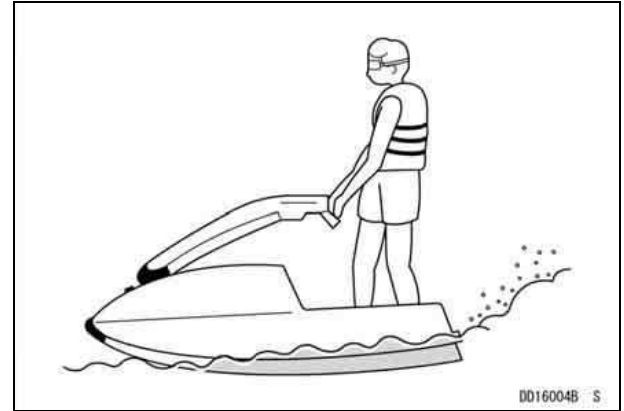

- Again keep your body perpendicular to the water and steer with the handlebar. As you become proficient, you can experiment with the effects of “body english” and leaning while turning the watercraft.

### Fall Recovery:

If you take a spill on your first attempt, as most riders do, don't feel bad. Part of the fun of a watercraft is the challenge it provides; and knowing the best way to fall, as in Judo, is essential.

As the operator falls off the craft, the lanyard key is pulled off of the engine stop button and the engine is stopped immediately.

## 70 OPERATING INSTRUCTIONS

### WARNING

When you fall, do not hang onto the handlebar. Let go, or you might injure yourself by striking the watercraft.

### CAUTION

Hanging onto the handlebar during a fall can cause misalignment of the handle pole which can cause damage to the handle pole and engine cover.

- The best way to hit the water is bottom first, legs together, with your arms over your head. This can help prevent injury from underwater objects.
- Push the lanyard key under the stop button and push the start button to start the engine. Then reboard the watercraft.
- If the watercraft doesn't self-right and stays capsized, immediately follow the righting procedure discussed next.

### NOTE

- *If the watercraft is being capsized a great deal (especially when used by beginners), it should be run at full throttle occasionally by a more experienced rider. This will allow the bilge system to pump out water which may have accumulated in the engine compartment.*
- *The watercraft is equipped with positive flotation. If the engine compartment is completely filled with*

*water, the watercraft will still float in an upright position, but with the bow completely submerged. However, if water gets inside the engine itself, a special procedure must be followed. For detailed instructions, see the "After Submerging" section.*

### Righting the Capsized Watercraft:

If the watercraft should capsize, the engine is stopped by the lanyard key being pulled off of the engine stop button by the operator. Follow this procedure immediately.

### WARNING

**This watercraft will not self-right if capsized. Operators must know the proper righting procedure or they could be stranded.**

- Make sure the engine is stopped. If it is not stopped, immediately pull the lanyard key off the stop button or push the stop button to stop the engine.

### CAUTION

**If the engine continues running with the craft capsized, water can enter the carburetor and engine, locking the engine. This will cause severe and immediate damage to internal engine parts.**

- Swim to the rear corner of the capsized craft.



- Grasp both rear corners of the deck with your hands and roll the craft clockwise.

### CAUTION

Turn the capsized boat clockwise so that the port side always faces downward. Turning counterclockwise can cause water in the exhaust system to run into the engine, with possible engine damage.

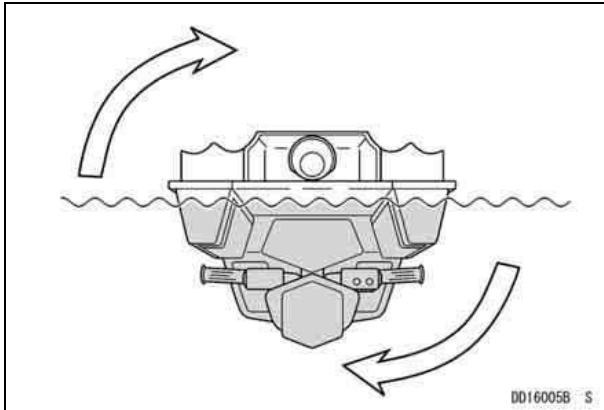

- Push the lanyard key under the stop button, and push the start button to start the engine.
- Reboard the watercraft.

### NOTE

- If the watercraft has capsized, it should be run at full throttle for a while by a more experienced operator. This allows the bilge system to pump out water which may have accumulated in the engine compartment.
- If water gets inside the engine, a special procedure must be followed. For detailed instructions, see the "After Submerging" in the Special Procedures section.

---

### End of the Day Checklist

---

#### First, Drain the Exhaust System:

- Remove the watercraft from the water.
- Start the engine and run it for several seconds to purge the exhaust system of excess water. Rev the engine repeatedly, until water stops coming out of the exhaust at the stern.

<b>CAUTION</b>
----------------

<b>Never operate the engine at maximum speed out of the water. Severe engine damage may occur.</b>
--

<b>Do not run the engine with the watercraft out of the water for more than 15 seconds at a time. Overheating will cause engine and exhaust system damage.</b>
--

- After each use in salt water, flush the cooling system with fresh water (see the Cooling System Flushing section in the MAINTENANCE AND ADJUSTMENTS chapter). This will help prevent build up of salt deposits and eventual cooling system blockage.

#### Second, Clean the Engine Compartment:

- Remove the engine cover.
- If water has accumulated in the engine compartment, remove the drain screw in the stern to drain

water out of the compartment. Be sure to reinstall the drain screw after draining.

- When the watercraft has been used at sea, rinse the engine room with fresh water.

<b>CAUTION</b>
----------------

<b>Be careful not to spray to electric equipment also prevent water from entering the air cleaner box. Fit a temporary cover to the air intake hole.</b>
--

- If you will not use the watercraft for more than one week, lubricate the internal engine components to help prevent corrosion.
- If you will not use the watercraft more than two weeks, remove the battery and keep fully charged using a maintenance charger. See MAINTENANCE & ADJUSTMENT chapter.
- Wipe the engine compartment dry, and install the engine cover.
- When the watercraft is ready for storage, install the cover loosely, and block it with 10 mm (one half inch) spacers to aid air circulation and prevent condensation from forming.

#### Third, Clean the Outside Hull:

- Wash the hull, deck, water intake, and propulsion system with fresh water.

**CAUTION**

Since Jet Ski personal watercraft are not designed to be docked in the water for extended periods, prolonged immersion in water will cause the hull paint to bubble and peel, as well as electrolytic erosion of some metal parts in the jet pump. To prevent paint damage and electrolytic erosion, remove your Jet Ski watercraft from the water at the end of each day's use; do not leave it in the water overnight. Your Jet Ski watercraft will last longer and look better if you remove it from the water at the end of every day's use.

**Special Procedures****Clearing Clogged Impeller:**

Occasionally, weeds or other debris may lodge in the impeller/jet pump, severely impairing performance. This foreign matter must be completely cleaned out for the jet pump to function properly.

- Shut off the engine, and beach the craft.

** WARNING**

**Never attempt to clear the jet pump of debris while the engine is running, or a severe injury can occur. Stop the engine and pull the lanyard key off the stop button before checking the pump for debris.**

- Position the starter interlock switch to the left.
- Remove the drain screw in the stern to drain water out of the engine compartment.

## 74 OPERATING INSTRUCTIONS



- Clean the water intake, drive shaft, impeller, jet pump housing, outlet, and steering nozzle of any seaweed, grass, or other debris.

### CAUTION

**Be sure the pump area and all its components are completely clear. Engine cooling water is supplied by the jet pump, and any loss of pump performance may cause overheating.**

- Reinstall the jet pump cover and grate. Tighten the screws securely.

### Cleaning Fouled Spark Plugs:

Fouled spark plugs can result from several causes. Among them, low idle speed, prolonged idling, and operating with the choke on. Water in the fuel or inside the engine can also cause spark plug fouling.

- Remove the fouled spark plugs and install clean, dry plugs. Fouled plugs may be cleaned with electrical contact cleaner (P/N K61080-001B). Wet plugs may be cleaned with a penetrating rust inhibitor, such as WD40 or Bel-Ray 6 in 1.

### Spark plug tightening torque:

**25 ~ 29 N·m (2.5 ~ 3.0 kgf·m, 18 ~ 21 in·lb)**

- Start the engine, using very little throttle.

### After Submerging:

### CAUTION

**If water gets into the engine, follow this procedure immediately! If water is left in the engine more than a few hours, it will destroy the crankshaft bearings and damage other internal engine parts.**

If the watercraft becomes submerged, water may enter the engine through the carburetor intake. Water may also enter the fuel tank.

1. Remove the craft from the water, and remove the engine cover.
2. Remove the drain screw in the stern to drain water out of the engine compartment.

3. Pull the spark plug caps from the spark plugs and push the caps fully onto the spark plug cap holder, and then remove the spark plugs.

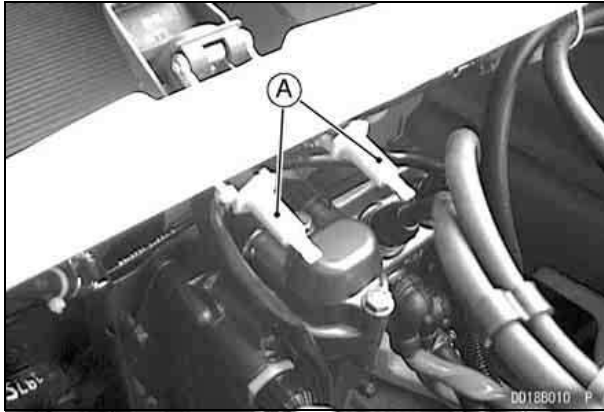

#### A. Spark Plug Cap Holders

4. Hold the engine stop button in or pull the lanyard key off the stop button and push the start button. Water in the engine will be pumped out of the spark plug holes. Do not operate the starter for longer than 5 seconds. Wait 15 seconds before using it again.

### **⚠ WARNING**

**Do not lean over the engine when performing this procedure. A water and fuel mixture will be forcibly ejected from the spark plug holes and could get into your eyes. If you do get some in your eyes, wash your eyes immediately with liberal amounts of clean, fresh water. Consult a physician as soon as possible.**

5. Spray the spark plugs clean and install them.
6. Start the engine.

### **CAUTION**

**Do not run the engine with the watercraft out of the water for more than 15 seconds at a time. Overheating will cause severe engine and exhaust system damage. Never operate the engine at high speed out of the water. Severe engine damage may occur.**

7. If the engine does not start, remove the spark plugs and check them for presence of water. Spray them clean and try to start the engine again. Continued water fouling may indicate water in the fuel system.
8. If the fuel tank has water in it, it must be emptied by pump or siphon. Clean the filter screens (see the Fuel System section in the MAINTENANCE AND ADJUSTMENTS chapter). Refill the tank with fresh fuel. Do not dump contaminated fuel in places not designated for that purpose.

### **⚠ WARNING**

Gasoline is extremely flammable and can be explosive under certain conditions. Position the starter interlock switch to the left. Do not smoke. Make sure the area is well ventilated and free from any source of flame or sparks; this includes any appliance with a pilot light.

### **⚠ WARNING**

Gasoline is a toxic substance. Dispose of gasoline properly. Contact your local authorities for approved disposal methods.

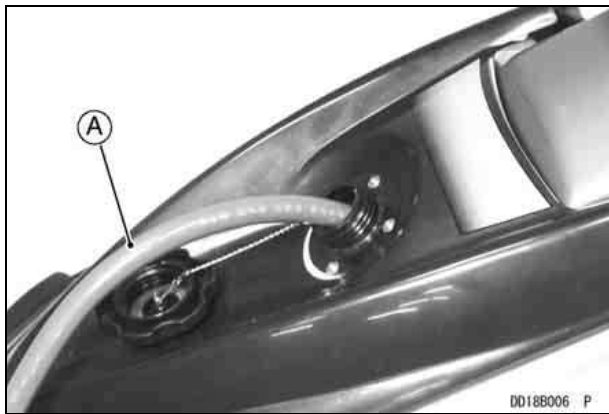

A. Siphon Hose

### **NOTE**

○ *It may be necessary to repeat these procedures several times before all water is removed from the engine. Continued trouble may require disassembly of the fuel pump to drain water. See your dealer for this service.*

9. Reinstall the engine cover and secure it.
10. Reinstall the drain screw in the stern.
11. Finally, run the boat IN WATER at least 10 minutes to dry any remaining water and blow any foreign matter (like salt) out through the exhaust.

### **Towing the JET SKI Watercraft:**

In case you run out of fuel, have engine problems or other complications, the watercraft may be towed. Attach one end of a 6 m (20 foot) tow rope to the eye in the bow and the other end to the tow boat. Towing must be slow, not over 8 km/h (5 mph).

### **CAUTION**

**It is important that these instructions be followed or the engine compartment could flood and the watercraft could partially submerge.**

### **Jump Starting:**

If your watercraft's battery is run down, it should be removed and charged. If this is not practical, a booster battery and jumper cables may be used to

start the engine. The booster battery must be of the same voltage as the watercraft battery (12 V).

### **⚠ WARNING**

Battery acid generates hydrogen gas which is flammable and explosive under certain conditions. It is present within a battery at all times, even in a discharged condition. Keep all flames and sparks (cigarettes) away from the battery. Wear eye protection when working with a battery. In the event of battery acid contact with skin, eyes, or clothing, wash the affected areas immediately with water for at least five minutes. Seek medical attention.

- Remove the filler caps from the booster battery.
- Lay a cloth over the open vents of the booster battery.
- Connect a jumper cable between the positive (+) terminals of the two batteries.
- Connect one end of the remaining jumper cable to the negative (-) terminal of the booster battery.

### **CAUTION**

Connecting two batteries in reverse polarity (+ to -) can seriously damage the electrical system.

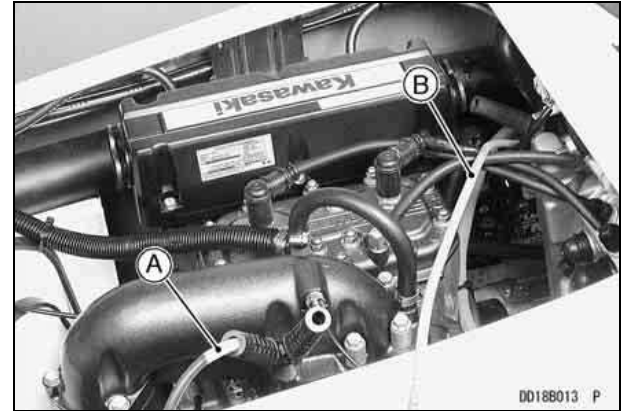

A. Negative Cable

B. Positive Cable

- Connect the other end of the remaining jumper cable to the exhaust pipe bolt.

### **⚠ WARNING**

Do not make this last connection at the carburetor or battery. Take care that you do not short the cables together, and do not lean over the battery when making this last connection. Do not jump start a frozen battery. It could explode.

## 78 OPERATING INSTRUCTIONS

### CAUTION

**Do not operate the starter continuously for more than 5 seconds or the starter will overheat. Wait 15 seconds between each operation of the starter to let it cool.**

- Start the watercraft engine following the standard engine starting procedure and then disconnect the jumper cables in the reverse of the sequence just described.
- Dispose of the cloth covering the booster battery and reinstall the filler caps.

#### **Engine Overheating:**

This watercraft is equipped with a temperature sensor which slows down the engine if the engine overheats.

- If the engine slows down even with the throttle on and the engine running, return to shore immediately and check the cooling system for clogging.

### CAUTION

**If the watercraft slows down while running, return to the shore immediately. Overheating will cause severe engine and exhaust system damage. Do not operate the craft until the source of the problem is found and corrected.**



---

# STORAGE

---

During the winter, or whenever your watercraft will not be in use for more than 30 days, proper storage is essential. It consists of checking and replacing missing or worn parts; lubricating parts to ensure that they do not become rusted; and, in general, preparing the watercraft so that when the time comes to use it again, it will be in top condition. See your Kawasaki JET SKI dealer for this service or do the following.

## CAUTION

**Since Jet Ski personal watercraft are not designed to be docked in the water for extended periods, prolonged immersion in water will cause the hull paint to bubble and peel, as well as electrolytic erosion of some metal parts in the jet pump. To prevent paint damage and electrolytic erosion, remove your Jet Ski watercraft from the water at the end of each day's use; do not leave it in the water overnight. Your Jet Ski watercraft will last longer and look better if you remove it from the water at the end of every day's use.**

---

## Preparation for Storage

---

### Cooling System:

- Clean the cooling system (see the Cooling System Flushing section in the MAINTENANCE AND ADJUSTMENTS chapter).

### Bilge System:

- Clean the bilge system (see the Bilge System Flushing section in the MAINTENANCE AND ADJUSTMENTS chapter), but before reconnecting the hoses to the plastic breather fittings, blow air through both hoses to force all water out of the bilge system.



A. Blow through both hoses.

### Fuel System and Engine:

- Wash the engine compartment with fresh water and remove the drain screw in the stern to drain the water. Wipe up any water left in the compartment.

### **⚠ WARNING**

**Gasoline is extremely flammable and can be explosive under certain conditions. Pull the lanyard key off the stop button. Do not smoke. Make sure the area is well ventilated and free from any source of flame or sparks; this includes any appliance with a pilot light.**

- Drain the fuel tank. This should be done with a siphon or pump.

### **⚠ WARNING**

**Gasoline is a toxic substance. Dispose of gasoline properly. Contact your local authorities for approved disposal methods.**

- Clean the fuel filter screens (see the Fuel and Oil Systems section in the MAINTENANCE AND ADJUSTMENTS chapter).
- Leave the fuel filler cap loose to prevent condensation in the tank.
- Remove the air intake cover from the carburetors.



A. Air Intake Cover

B. Bolts

- Take out the flame arrester elements and wash in soap and water. Allow to air dry, then reinstall the flame arrester elements. Both sides are identical.

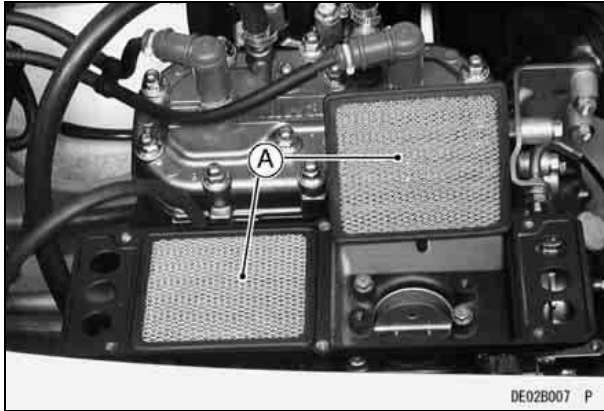

#### A. Flame Arrester Elements

- Push the lanyard key under the stop button, start the engine, and run it in fifteen second periods until all the fuel in the carburetors is used up. Wait five minutes between fifteen second running periods. While the engine is running, spray a fogging oil, into the carburetors openings.

### CAUTION

**Do not run the engine with the watercraft out of the water for more than 15 seconds at a time. Overheating will cause severe engine and exhaust system damage.**

- Reinstall the air intake cover, apply non-permanent locking agent to the bolts before tightening securely.

- Remove the spark plugs and spray fogging oil directly into each cylinder.
- While holding the stop button in or after pulling the lanyard key off the stop button, turn the engine over several times with the start button to coat the cylinder walls.

### **⚠ WARNING**

**Do not lean over the engine when performing this procedure. An air/oil mist may be forcibly ejected from the spark plug holes and could get into your eyes. If you do get some in your eyes, wash your eyes immediately with liberal amounts of clean, fresh water. Consult a physician as soon as possible.**

- Spray the spark plugs with fogging oil, and reinstall them.

#### **Spark plug tightening torque:**

**25 ~ 29 N-m (2.5 ~ 3.0 kgf-m, 18 ~ 21 in-lb)**

- Pull the lanyard key off the stop button, if attached.
- Reinstall the spark plug caps.

#### **Battery:**

- Remove the battery (see the Battery section in the MAINTENANCE AND ADJUSTMENTS chapter).
- Clean the exterior with a solution of baking soda and water (one heaping tablespoon of baking soda in one cup of water). Rinse thoroughly with water.

## 82 STORAGE

### CAUTION

**Never remove the sealed cap, or the battery can be damaged.**

- Coat both battery terminals with grease.
- Store the battery in a cool, dry place. Do not expose it to freezing temperatures. During storage it should be given a slow charge (one ampere or less) about once a month. Keep the battery well charged especially during cold weather.

### NOTE

- *Use a battery charger suitable for the sealed-type battery.*

### Jet Pump Bearings/Seals:

### CAUTION

**The jet pump bearings and seals should be serviced prior to prolonged storage to prevent any water that may be left in the pump from corroding the bearings and causing premature failure. Major engine damage can occur if the jet pump bearings fail due to lack of maintenance.**

Have your Kawasaki dealer service the jet pump bearings and seals before any prolonged storage to remove any water that may be left in the pump. Prolonged exposure to stagnant water will cause the

bearings to corrode and fail prematurely. Major engine damage can occur if the jet pump bearings fail due to lack of maintenance.

### Cleaning:

- Wash the exterior and dry it thoroughly.

### CAUTION

**Use only a mild detergent in water to wash the watercraft. Harsh solvents may attack the surface or smear the colors.**

- Apply a good grade of wax to all exterior hull surfaces.
- Lightly spray all exposed metal parts with a penetrating rust inhibitor, such as WD40 or BEL-RAY 6 in 1 to prevent corrosion.
- Install the engine cover loosely, and block it up with 10 mm (one half inch) spacers to ensure adequate ventilation and prevent condensation from forming.
- Cover the watercraft and store it in a clean, dry place.

### NOTE

- *If the watercraft is left outside, even covered, water can collect in the footwells on either side of the seat. Water left in the footwells can cause the paint to bubble and peel, and the mat to peel off the deck. If the watercraft is left on the trailer, raise*

*the trailer tongue so that water cannot accumulate in the footwells.*

### Lubrication:

- Carry out all recommended lubrication procedures (see the Lubrication section in the MAINTENANCE AND ADJUSTMENTS chapter).

---

## Removal from Storage

---

The following procedure explains the steps necessary to put the watercraft back in service following a storage period. See your Kawasaki JET SKI dealer for this service, or do the following. See the MAINTENANCE AND ADJUSTMENTS chapter for detailed procedures.

- Carry out all recommended lubrication procedures (see the Lubrication section).
- Check for binding or sticking throttle, choke, steering or shift mechanism. The throttle lever must return fully when released.
- Clean and gap spark plugs (see the Spark Plugs section).
- Check all rubber hoses for weathering, cracking, or looseness.
- Turn the craft on its **port side** on a protective pad, and remove the jet pump cover. Check cooling and bilge hoses for weathering, cracking or looseness.
- Replace them if necessary. Reinstall the cover, apply non-permanent locking agent to the bolts before tightening securely.

### **Bolt Tightening Torque:**

**7.8 N·m (0.8 kgf·m, 69 in·lb)**

- Check that the drain screw in the stern is securely tightened.
- Check the fire extinguisher for a full charge.

## 84 STORAGE

- Clean the terminals of the battery and charge if necessary. Install the battery (see the Battery section).
- Fill the fuel tank with fuel and close the filler cap securely.

### **WARNING**

**Gasoline is extremely flammable and can be explosive under certain conditions. Pull the lanyard key off the stop button. Do not smoke. Make sure the area is well ventilated and free from any source of flame or sparks; this includes any appliance with a pilot light.**

- After transporting or refueling and before starting the engine, remove the engine cover for several minutes to ventilate the engine compartment.

### **WARNING**

**A concentration of gasoline fumes in the engine compartment can cause a fire or explosion.**

- Check for fuel leaks. Repair if necessary.

### **WARNING**

**Do not run the engine in a closed area. Exhaust gases contain carbon monoxide: a colorless, odorless, poisonous gas. Breathing exhaust gas leads to carbon monoxide poisoning, asphyxiation, and death.**

- Start the engine and run it for 15 seconds. Check for fuel, oil and exhaust leaks. Any leaks must be re-paired.

### **CAUTION**

**Never run the engine with the watercraft out of the water for more than 15 seconds. Overheating will cause severe engine and exhaust system damage. Do not run the engine at maximum speed out of the water. Severe engine damage may result.**

- Install the engine cover making sure the engine cover latch is secure.

---

# MAINTENANCE AND ADJUSTMENTS

---

**Maintenance, replacement, or repair of the emission control devices and systems may be performed by any marine SI engine repair establishment or individual.**

---

## EMISSION CONTROL INFORMATION

---

To protect the environment in which we all live, Kawasaki has incorporated an exhaust emission control system in compliance with applicable regulations of the United States Environmental Protection Agency.

### Exhaust Emission Control System

This system reduces the amount of pollutants discharged into the atmosphere by the exhaust of this engine. The fuel, ignition and exhaust systems of this engine have been carefully designed and constructed to ensure an efficient engine with low exhaust pollutant levels.

### Fuel Information

**THIS ENGINE IS CERTIFIED TO OPERATE ON UNLEADED REGULAR GRADE GASOLINE ONLY.**

A minimum of 87 octane of the antiknock index is recommended. The antiknock index is posted on service station pumps in the U.S.A.

### Maintenance and Warranty

Proper maintenance is necessary to ensure that your watercraft will continue to have low emission levels. This Owner's Manual contains those maintenance recommendations for your engine. Those items identified by the Periodic Maintenance Chart are necessary to ensure compliance with the applicable standards.

As the owner of the Personal Watercraft, you have the responsibility to make sure that the recommended maintenance is carried out according to the instructions in this Owner's Manual at your own expense.

## 86 MAINTENANCE AND ADJUSTMENTS

The Kawasaki Limited Emission Control system Warranty requires that you return your Personal Watercraft to an Authorized Kawasaki Personal Watercraft dealer for remedy under warranty. Please read the warranty carefully, and keep it valid by complying with the owner's obligations it contains.

### **Tampering with Emission Control System Prohibited**

Federal law prohibits the following acts or the causing thereof: (1) the removal or rendering inoperative by any person other than for purposes of maintenance, repair, or replacement, of an device or element of design incorporated into any new engine for the purposes of emission control prior to its sale or delivery tot the ultimate purchaser or while it is in use, or (2) the use of the engine after such device or element of design has been removed or rendered inoperative by any person.

Among those acts presumed to constitute tampering are the acts listed below:

Do not tamper with the original emission related parts.

- \* Carburetor and internal parts
- \* Fuel Pump
- \* Spark Plugs
- \* CDI Ignition System



---

## Periodic Maintenance Chart

---

### NOTE

○ Complete the Pre-Ride Checklist before each outing.

\* These items must be performed with the proper tools. See your authorized Kawasaki JET SKI dealer for service, unless you have the proper equipment and mechanical proficiency (refer to the Service Manual).

Description	Frequency	Initial 10 Hours	Every 25 Hours	Every 50 Hours	Every 100 Hours
Check all hoses, hose clamps, nuts, bolts, and fasteners		●	●		
* Lube jet pump bearings and seals; inspect and replace bearings/seals if necessary		Initial 20 hours, then every 50 hours or every year whichever comes first			
Lubricate throttle cable fitting and choke cable fitting at carb			●		
Clean and gap spark plugs (replace if necessary)			●		
Lubricate choke cable and throttle cable, and throttle cable fitting at throttle case			●		
Lubricate steering cable ball joints and steering nozzle pivots			●		
* Lubricate handlebar pivot (disassemble)			●		

## 88 MAINTENANCE AND ADJUSTMENTS

Description	Frequency	Initial 10 Hours	Every 25 Hours	Every 50 Hours	Every 100 Hours
Clean fuel filter screens			●		
Inspect battery charging condition			●		
Adjust carburetor			●		
Flush bilge line and filter			●		
Flush cooling system (after each use in salt water)			●		
Inspect/clean flame arrester			●		
* Inspect fuel vent check valve			●		
* Inspect impeller blade for damage (remove)					●
* Inspect/replace coupling damper					●
* Inspect carburetor throttle shaft spring (replace carburetor if necessary)					●
* Inspect steering cable					●
Inspect hull drain screw (replace if necessary)				●	
Inspect battery terminals			●		
* Replace fuel hoses		Every 5 years			

## Control Cable Adjustments

### Choke Cable Adjustment

- When the choke knob is turned to the “OFF” position, the choke butterfly valve in the carburetor should be completely open. The choke pivot arm should stand all the way toward the starboard side of the boat with minimal cable slack.
- When the choke knob is turned to the “ON” position, the choke butterfly valve in the carburetor should be completely closed. Check that the choke pivot arm stands all the way toward the port side of the boat without cable slack.

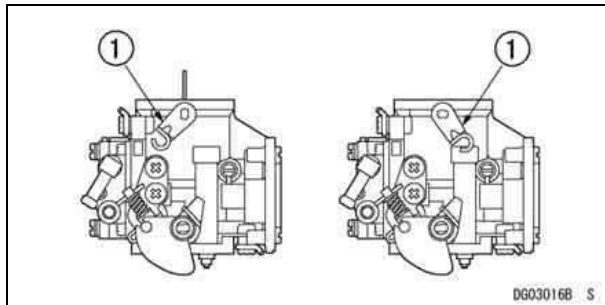

CHOKE OPEN  
(TURNED TO OFF)

1. Choke Pivot Arm

CHOKE CLOSED  
(TURNED TO ON)

- If necessary, adjust the choke cable.
  - Turn the choke knob to the OFF position (counterclockwise).
  - Loosen and turn the locknuts at the cable mounting bracket to allow a little cable slack.
  - Tighten the locknuts securely.

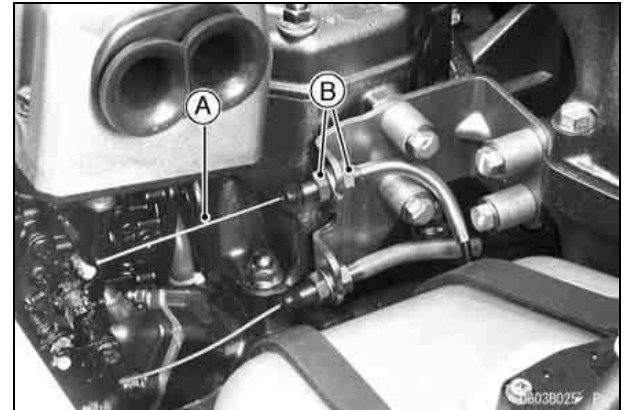

A. Choke Cable

B. Locknuts

## 90 MAINTENANCE AND ADJUSTMENTS

### Throttle Cable Adjustment

- Check throttle cable adjustment.
- With the throttle lever released, the lower stop on the throttle pivot arm should rest against the idle adjust screw, and there should be slight slack in the throttle cable.
- When the throttle lever is fully applied (pulled), the upper stop on the pivot arm should be all the way up against the stop on the carburetor.

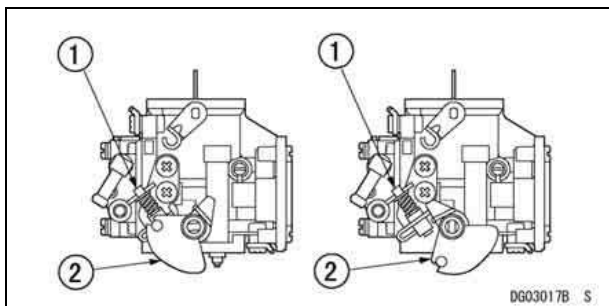

THROTTLE CLOSED  
(RELEASED)

THROTTLE OPEN  
(APPLIED)

1. Idle Adjust Screw
2. Throttle Pivot Arm

- If necessary, adjust the throttle cable.
- Loosen and turn the locknuts at the cable mounting bracket until the lower stop on the pivot arm hits against the idle adjust screw with slight cable slack.

- Tighten the locknuts securely.

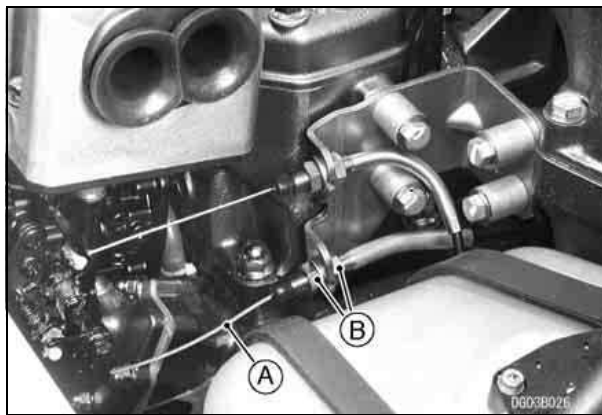

A. Throttle Cable

B. Locknuts

*Steering Cable Adjustment*

- Lower the handle pole and center the handlebar in a straight ahead steering position.

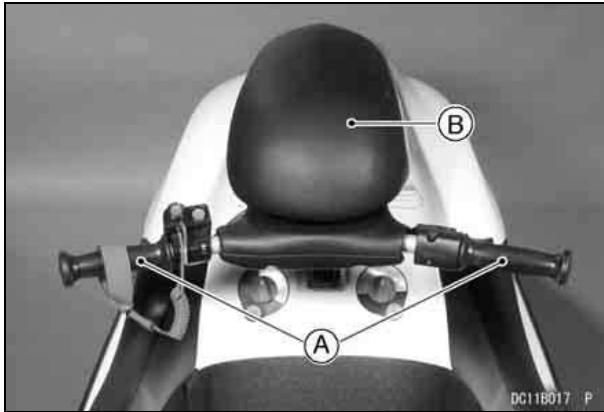

A. Handlebar

B. Handle Pole

- Check that the steering nozzle is at the same distance from each side of the pump cavity.

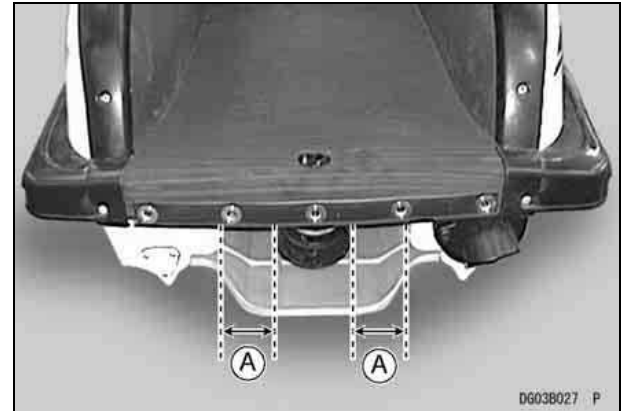

A. Equal

## 92 MAINTENANCE AND ADJUSTMENTS

- Loosen the locknut on the end of the steering link.

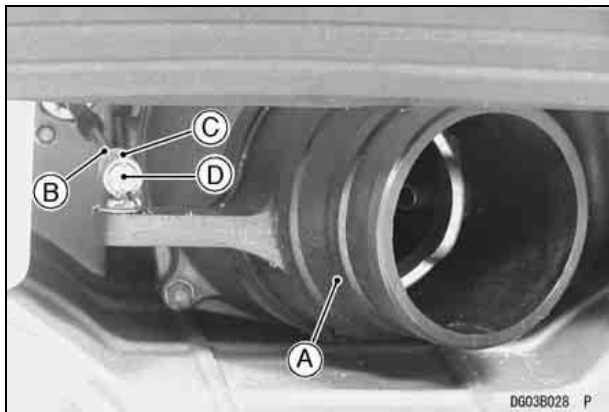

**A. Steering Nozzle**

**B. Locknut**

**C. Sleeve**

**D. Ball Joint**

- Slide back the outer sleeve and take the ball joint off the ball.
- Center the handlebar in a straight ahead steering position.
- Position the steering nozzle in the center of the pump cavity.

- Turn the ball joint until the hole on it aligns with the ball.

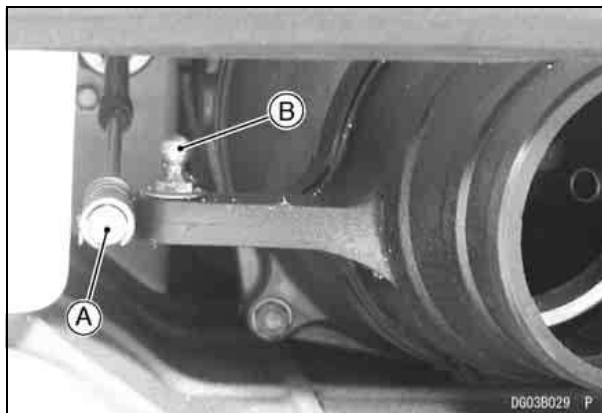

**A. Hole**

**B. Ball**

### NOTE

- *The cable end must remain screwed into the rod more than 5 mm after the above adjustment.*
- Reattach the joint and check cable adjustment again.
- When adjustment is correct, tighten the locknut.

- As an additional check, turn the handlebar all the way to the left and right, and measure the distance between the nozzle and the edge of the pump cavity. It should be equal at both extremes.

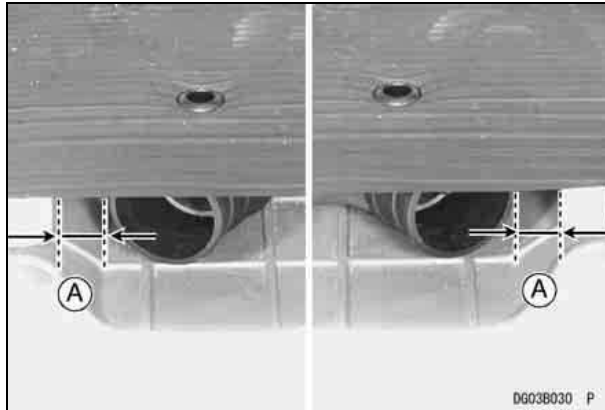

A. Equal

### Steering Cable Inspection

Steering cable inspection is best performed by your authorized Kawasaki JET SKI dealer. If the steering feels rough or "catchy," have your dealer inspect the steering cable.

#### NOTE

- *The steering cable is sealed at each end and does not require lubrication.*

## Fuel System

### Carburetor Adjustments:

#### Idle Speed

The normal idle speed is the lowest stable speed.

- Turn the idle adjust screw to the right to increase idle speed or to the left to decrease it.

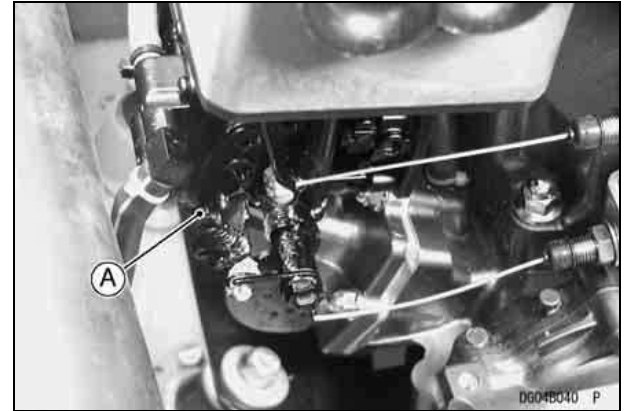

A. Idle Adjust Screw

#### Idle Speed

About 1 250 rpm - in water

About 1 700 rpm - out of water

## 94 MAINTENANCE AND ADJUSTMENTS

### *Mixture Screw*

Every carburetor is adjusted individually at the factory for optimum performance under most conditions. DO NOT CHANGE THESE SETTINGS.

### **NOTE**

○ If adjustment is needed, have it performed by your authorized Kawasaki JET SKI dealer.

### *High Altitude Use*

The original carburetor settings for this watercraft are best for sea level use. When the craft is used at high altitude, the thinner atmosphere makes the air/fuel mixture richer reducing performance and increasing fuel usage. Have the carburetor adjusted by your authorized Kawasaki JET SKI dealer if you intend to use this craft above 1 000 m (3 000 feet).

### **Fuel Filter Screens:**

The watercraft is equipped with fuel filter screens on the fuel outlet assembly and a fuel filter at the middle of the fuel line to prevent dirt or other foreign material from entering the carburetor.

Clean the screens as specified by the **Periodic Maintenance Chart**.

### *Fuel Filter Screen Inspection*

- Take off the screws and pull out the fuel outlet assembly.



**A. Screws**

### **⚠ WARNING**

**Gasoline is extremely flammable and can be explosive under certain conditions. Position the starter interlock switch to the left. Do not smoke. Make sure the area is well ventilated and free from any source of flame or sparks; this includes any appliance with a pilot light.**



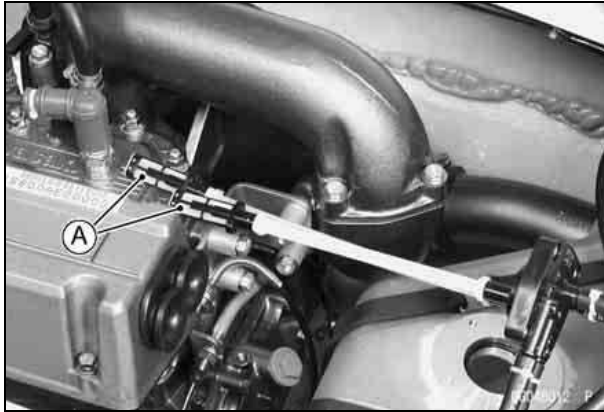

**A. Fuel Screens**

- Check the fuel screens for any breaks or deterioration. The fuel outlet assembly should be replaced if the screens are damaged.

*Fuel Filter Screen Cleaning*

- Wash the fuel filter screens in non-flammable or high flash-point solvent. Use a brush to remove any contaminants trapped in the screen.

**⚠ WARNING**

Clean the fuel filter screens in a well ventilated area, and take care that there are no sparks or flame anywhere near the working area; this includes any appliance with a pilot light. Do not use gasoline or a low flash-point solvent to clean the screens. A fire or explosion could result.

**Fuel Vent Check Valve:**

The fuel tank is equipped with a rubber vent hose. A small plastic check valve mounted in the vent hose allows air to enter the tank, but minimizes fuel spillage when the craft is tipped over. Have the check valve inspected in accordance with the **Periodic Maintenance Chart** by your authorized Kawasaki JET SKI watercraft dealer.

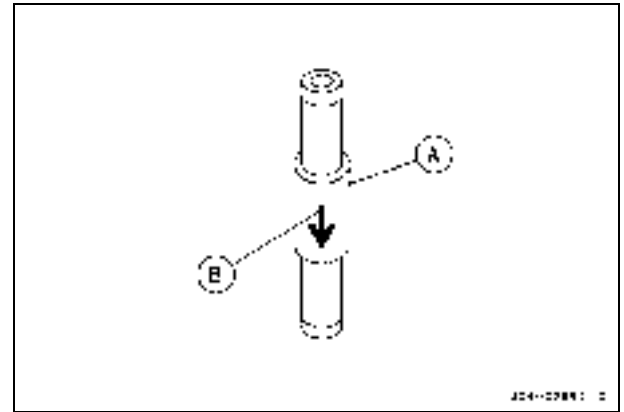

**A. Check Valve**

**B. Flow Direction**

## Spark Plug

The standard spark plug is NGK BR8ES set to a 0.7 ~ 0.8 mm (0.028 ~ 0.032 inch) gap. Since the engine is water-cooled and is generally operated at a constant throttle opening, cylinder head temperature is relatively stable. For this reason, if the engine is in good condition and properly tuned, and the proper fuel/oil mix is used, it should not be necessary to use a spark plug of a different heat range. Since a spark plug of the wrong heat range can cause extensive engine damage, only the standard spark plug is recommended.

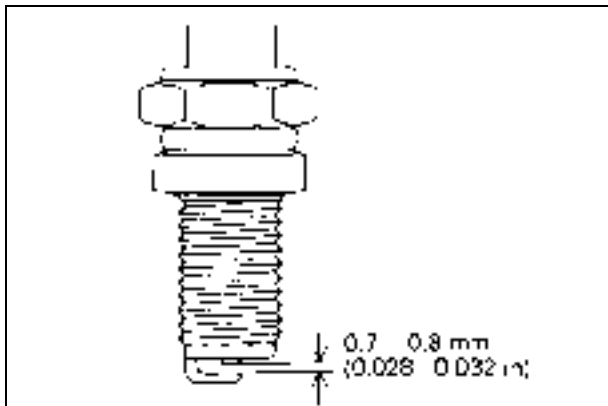

### *Spark Plug Inspection and Replacement*

Remove the spark plugs and inspect the ceramic insulators. The appearance of the insulators reflects the efficiency of the combustion

the engine is operating properly, the plug insulators should be clean and show a light brown color. If the insulators look glazed or very white, if the electrodes appear overheated, or if there are gray metallic deposits on the plugs, combustion chamber temperatures are too high. Refer to the TROUBLESHOOTING GUIDE chapter

### CAUTION

**As excessive operating temperature can cause serious engine damage, the cause should be located and corrected immediately.**

A dry, sooty black deposit on the insulators indicates an overly rich fuel/air mixture. Check for correct carburetor adjustment. If the black deposits are wet and oily, an improper oil type or mixing ratio may be the cause. Refer to the TROUBLESHOOTING GUIDE chapter.

Clean the electrodes and the ceramic insulators around the center electrode by scraping off any deposits or by using a sand blasting device. Make sure that all abrasive particles are removed from the plug and clean the plug in a high flash-point solvent. If the gap has widened, reset it to the standard 0.7 - 0.8 mm (0.028 - 0.032 inch) gap. If the electrodes are badly worn or burned, replace the plug. The spark plug must also be replaced any time there is visible damage such as cracked ceramic or damaged threads.

**Plug tightening torque:****25 ~ 29 N·m (2.5 ~ 3.0 kgf·m, 18 ~ 21 in·lb)**

---

**Battery**

---

The battery installed in this watercraft is a sealed type, and the sealing strip should not be removed at any time after the specified electrolyte has been installed in the battery for initial service. It is not necessary to check the battery electrolyte level or add distilled water.

However, in order to maximize battery life and ensure that it will provide the power needed to start your watercraft, you must properly maintain the battery's charge. When used regularly, the charging system in your watercraft helps keep the battery fully charged. If your watercraft is only used occasionally or for short periods of time, the battery is more likely to discharge.

Due to their internal composition, batteries continually self discharge. The discharge rate depends on the type of battery and ambient temperature. As temperatures rise, so does the discharge rate. Every 15°C (27°F) doubles the rate.

Electrical accessories, such as digital clocks and computer memory, also draw current from the battery even when the key is switched off. Combine such "key-off" draws with hot temperatures, and a battery can go from fully charged to completely discharged in a matter of days.

## 98 MAINTENANCE AND ADJUSTMENTS

Self-discharge		
Temperature	Approx. Number of Days From 100% Charged to 100% Discharge	
	Lead-Antimony Battery	Lead-Calcium Battery
40°C (104°F)	100 Days	300 Days
25°C (77°F)	200 Days	600 Days
0°C (32°F)	550 Days	950 Days

charged battery can withstand sub-freezing temperatures with no damaged.

Current Drain (Y50-N18L-A)		
Discharging Ampere	Days from 100% Charged to 50% Discharged	Days from 100% Charged to 100% Discharged
7 mA	60 Days	119 Days
10 mA	42 Days	83 Days
15 mA	28 Days	56 Days
20 mA	21 Days	42 Days
30 mA	14 Days	28 Days

In extremely cold weather the fluid in an inadequately charged battery can easily freeze, which can crack the case and buckle the plates. A fully

**Battery Sulfation**

A common cause of battery failure is sulfation.

Sulfation occurs when the battery is left in a discharged condition for an extended time. Sulfate is a normal by product of the chemical reactions within a battery. But when continuous discharge allows the sulfate to crystallize in the cells, the battery plates become permanently damaged and will not hold a charge. Battery failure due to sulfation is not warrantable.

**Battery Maintenance**

It is the owner’s responsibility to keep the battery fully charged. Failure to do so can lead to battery failure and leave you stranded.

If you are riding your watercraft infrequently, inspect the battery voltage weekly using a battery tester with digital voltage. If it drops below 12.6 volts, the battery should be charged using an appropriate charger (check with your Kawasaki dealer or visit [buy Kawasaki.com](http://www.kawasaki.com)).

If you will not be using your watercraft for longer than two weeks, the battery should be removed and placed on a Kawasaki-recommended charger for sealed-type use in order to maintain its charge and prolong battery life. Do not use an automotive-type quick charger that may overcharge the battery and damage it.

**Kawasaki-recommended chargers are:**

- Battery Mate 150-9
- OptiMate PRO 4-S/PRO S/PRO 2
- Yuasa MB-2040/2060
- Christie C10122S

If the above chargers are not available, use equivalent one.

For more details, ask your Kawasaki dealer.

*Battery Charging:*

- Remove the battery from the watercraft (see Battery Removal).
- Set the battery charge timer to the position indicated by the tester.
- Following the charging and checking steps of the battery charger, charge the battery.

<b>CAUTION</b>
<p><b>Never remove the sealed cap. Or the battery can be damaged.</b></p> <p><b>Do not install a conventional battery in this watercraft, or the electrical system will not work properly.</b></p>

**NOTE**

- *If you charge the sealed-type battery, never fail to observe the instructions shown in the label on the battery.*

## 100 MAINTENANCE AND ADJUSTMENTS

### Battery Removal



- A. Air Intake Cover**
- B. Bolts**

To make the battery removal easy, first dismantle the air intake cover.

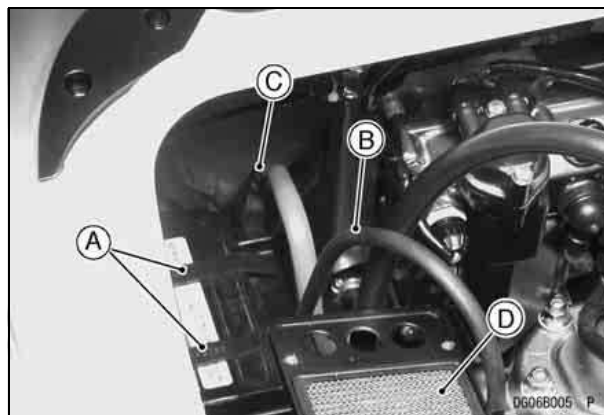

- A. Straps**
- B. Black (ground) Lead**
- C. Red Lead**
- D. Flame Arrestor**

- Disconnect the black (ground) lead from the battery first.
  - Disconnect the red lead.
  - Release the two rubber hold-down straps securing the battery.
  - Lift the battery out of the hull.
  - Clean the battery top and terminals using a solution of baking soda and water. Scrape off any obstinate deposits with a wire brush and then rinse the battery with fresh water. Dry it thoroughly and coat the terminals with waterproof grease.
  - Perform a visual inspection. Inspect for defective or cracked case and cover, and loose or damaged terminal posts or cables.
- Replace battery and/or cables immediately if any damage is found.

*Battery Installation*

- Install the battery in the reverse order of removal.
- After connecting the battery, coat the terminals with waterproof grease.

**⚠ WARNING**

Loose battery can create sparks which can cause a fire or explosion resulting in injury or death. Make sure battery terminal screws are tightened securely and the covers are installed over the terminals.

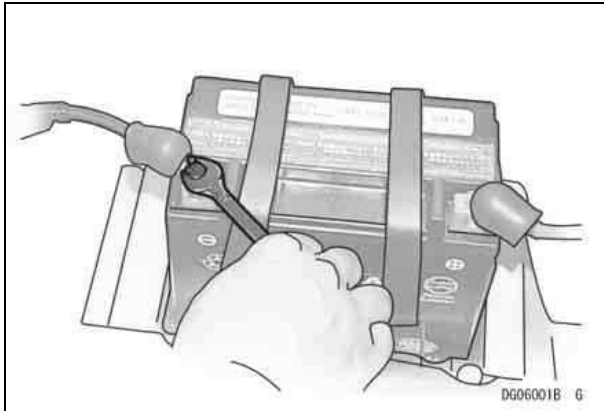

Tighten the Terminal Screws Securely.



Install the Rubber Covers.

**CAUTION**

Do not reverse the battery connections, or damage to the regulator/rectifier unit will result.

**⚠ WARNING**

Battery posts, terminals and related accessories contain lead and lead compounds. Wash hands after handling.

## 102 MAINTENANCE AND ADJUSTMENTS

### Lubrication

As in all marine craft, adequate lubrication and corrosion protection is an absolute necessity to provide long, reliable service. Refer to the **Periodic Maintenance Chart** and **Pre-ride Checklist** in the OPERATING INSTRUCTIONS chapter for the frequency of the following items:

- Lubricate the following with a penetrating rust inhibitor, such as WD40 or BEL-RAY 6 in 1:

#### Choke Cable and Throttle Cable

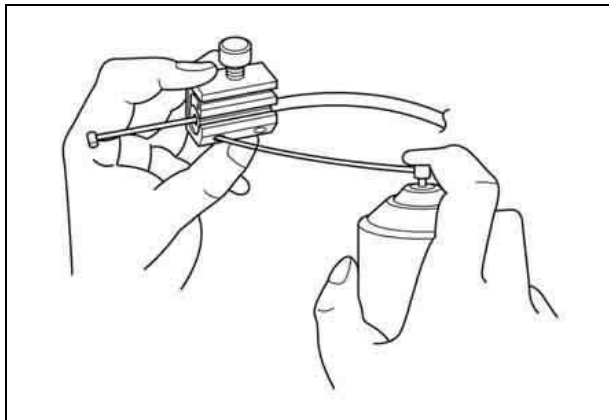

#### Pressure Cable Luber

### Steering Nozzle Pivots

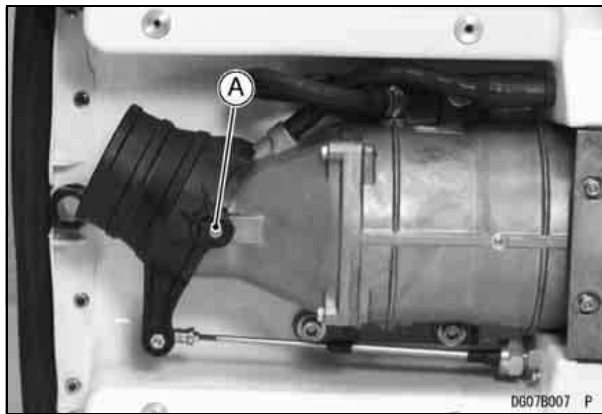

#### A. Nozzle Pivot

- Lubricate the following with a high quality water-proof marine grease.



Steering Cable Ball Joints

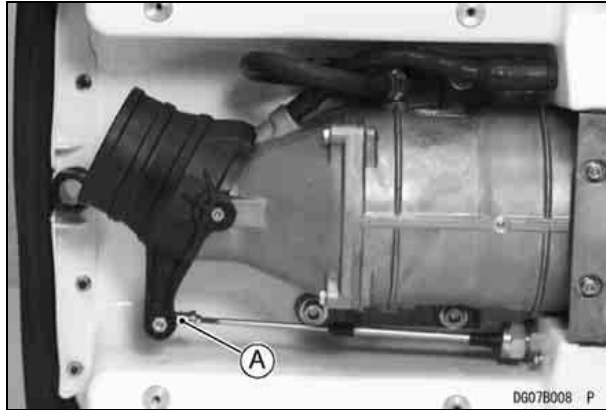

A. Ball Joint

Throttle Cable Fitting at Throttle Case

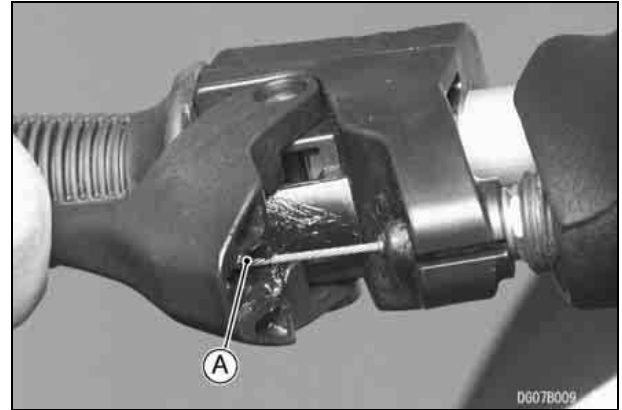

A. Apply grease.

## 104 MAINTENANCE AND ADJUSTMENTS

### Choke Cable Fitting and Throttle Cable Fitting at Carburetor

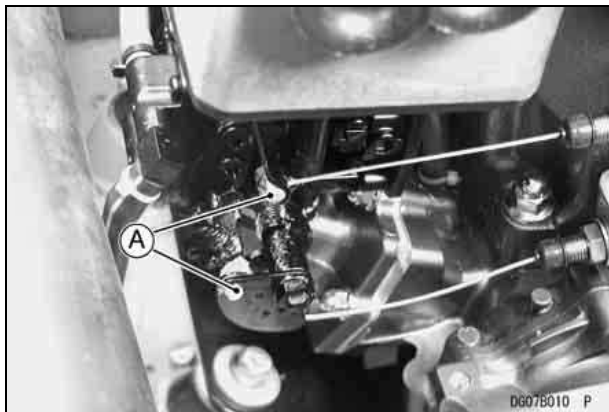

A. Apply grease.

### CAUTION

Disassemble and lubricate the handlebar pivot. This function should be performed by your Kawasaki JET SKI dealer.

### Cooling System Flushing

To prevent sand or salt deposits from accumulating in the cooling system, it must be flushed occasionally. Flush the system according to the **Periodic Maintenance Chart**, after each use in salt water, or whenever there is reduced water flow from the bypass outlet on the port side of the hull.

- An inlet for auxiliary water supply is provided on the fitting for the cooling hose at the foot of the handle pole.

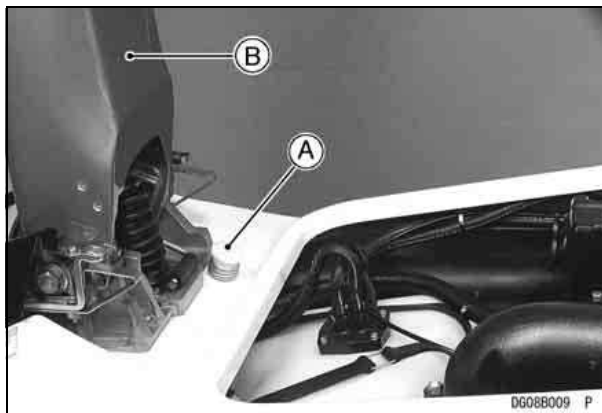

A. Water Inlet

B. Handle Pole

- Raise the handle pole and hook the stopper pin to the rest.
- Remove the engine hood.
- Remove the inlet fitting cap and connect a garden hose with a screw-in fitting on its end.

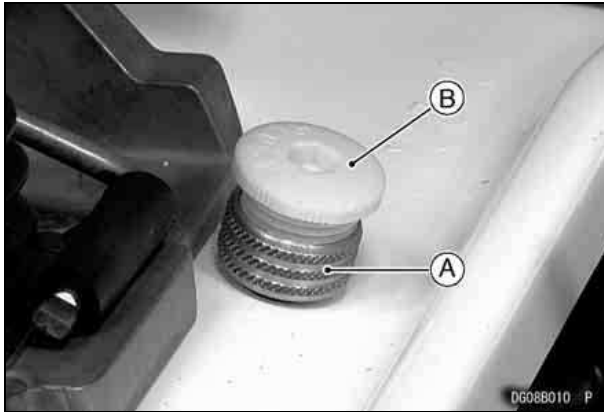

A. Inlet Fitting

B. Cap

- Start the engine and allow it to idle **before turning on the water.**

### CAUTION

**The engine must be running before the water is turned on, or water may flow back through the exhaust pipe into the engine, resulting in the possibility of severe internal damage.**

- Immediately turn on the water and adjust the flow so that a little trickle of water comes out of the bypass outlet in the port side of the hull.



A. Bypass Outlet

- Let the engine idle for several minutes with the water running.
- Turn off the water. **Leave the engine idling.**
- Rev the engine a few times to clear the water out of the exhaust system.

### CAUTION

**Do not run the engine without cooling water flow for more than 15 seconds. Overheating will cause severe engine and exhaust system damage.**

## 106 MAINTENANCE AND ADJUSTMENTS

- Switch off the engine, remove the garden hose and reinstall the cap.

---

### Bilge System Flushing

---

To prevent clogging, the bilge system should be flushed out according to the **Periodic Maintenance Chart**, or whenever you suspect it is blocked.

- Disconnect both bilge hoses at the plastic breather fitting mounted on the bulkhead.

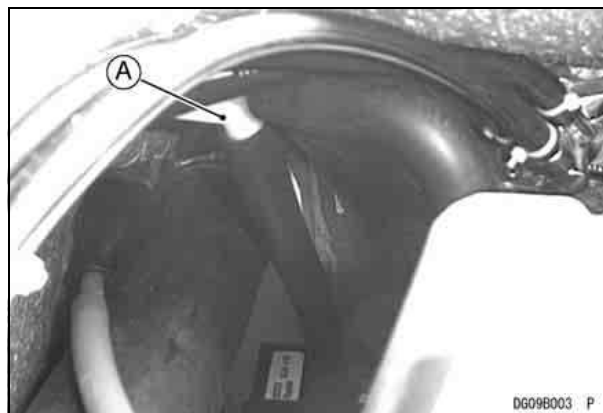

#### A. Breather Fittings

- Connect the bilge filter hose (from the hull bottom) to the garden hose, turn the water on, and flush it out for about a minute. During this procedure, water will flow into the engine compartment. Do not allow a large amount of water to accumulate in the engine compartment.
- Remove the drain screw in the stern to drain the engine compartment.

- Connect the other hose to the garden hose, turn the water on, and flush it out for several minutes.
- Before reconnecting the hoses to each plastic breather fitting, make sure the small breather hole in the fitting is clear. If the hole is clogged, the engine compartment will be filled with water when the engine stops or idles. It may be necessary to remove the fitting.

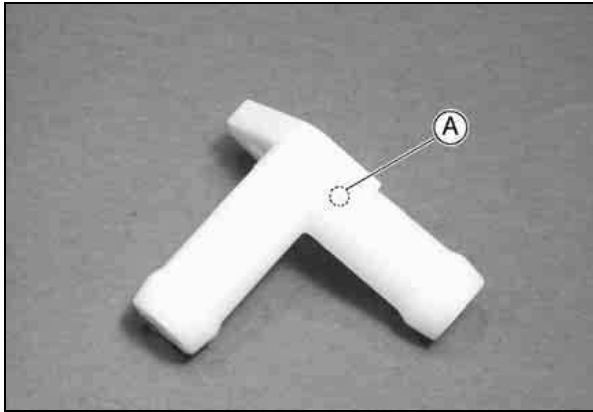

**A. Breather Hole**

- Reconnect the bilge hoses.

**NOTE**

- *If your watercraft is to be stored, blow air through both hoses at each breather fitting before they are reconnected (see the Preparation for Storage section in the **STORAGE** chapter).*

---

**Jet Pump Bearings/Seals**

---

**CAUTION**

**The jet pump bearings and seals require periodic service. Major engine damage can occur if the jet pump bearings fail due to lack of maintenance.**

Have your Kawasaki dealer inspect the jet pump bearings and seals after the first 20 hours of use, and then every 50 hours or every year, whichever comes first. The jet pump bearings should also be serviced before any prolonged storage to prevent any water that may be left in the pump from corroding the bearings and causing premature failure.

## 108 MAINTENANCE AND ADJUSTMENTS

### Fuses

The main fuse is arranged in the electric case located in the engine room. If a fuse fails during operation, inspect the electrical system to determine the cause, and then replace it with a new fuse of proper amperage.

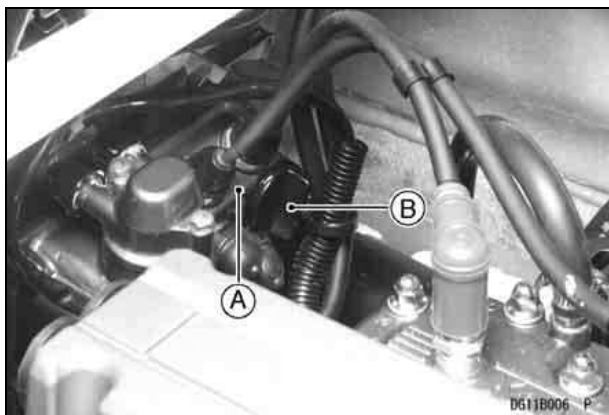

A. Electric Case

B. Cap

### CAUTION

Do not use any substitute for the standard fuse. Replace the blown fuse with a new one of the correct capacity, as specified on the electric case.

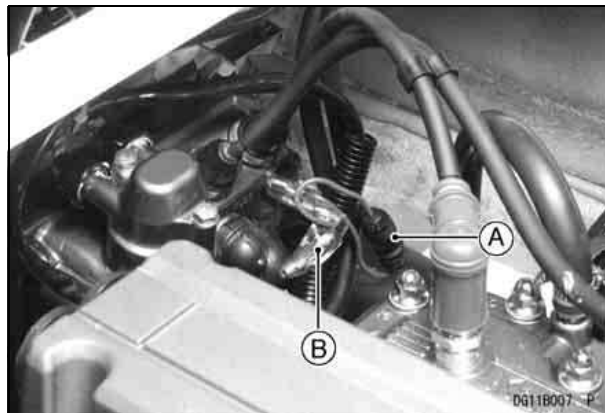

A. Main Fuse

B. Spare Fuse

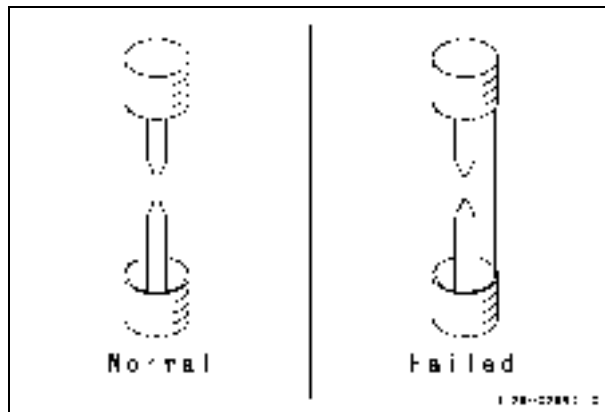

# TROUBLESHOOTING GUIDE

If this procedure does not isolate your problem, see your JET SKI dealer or refer to the Service Manual.

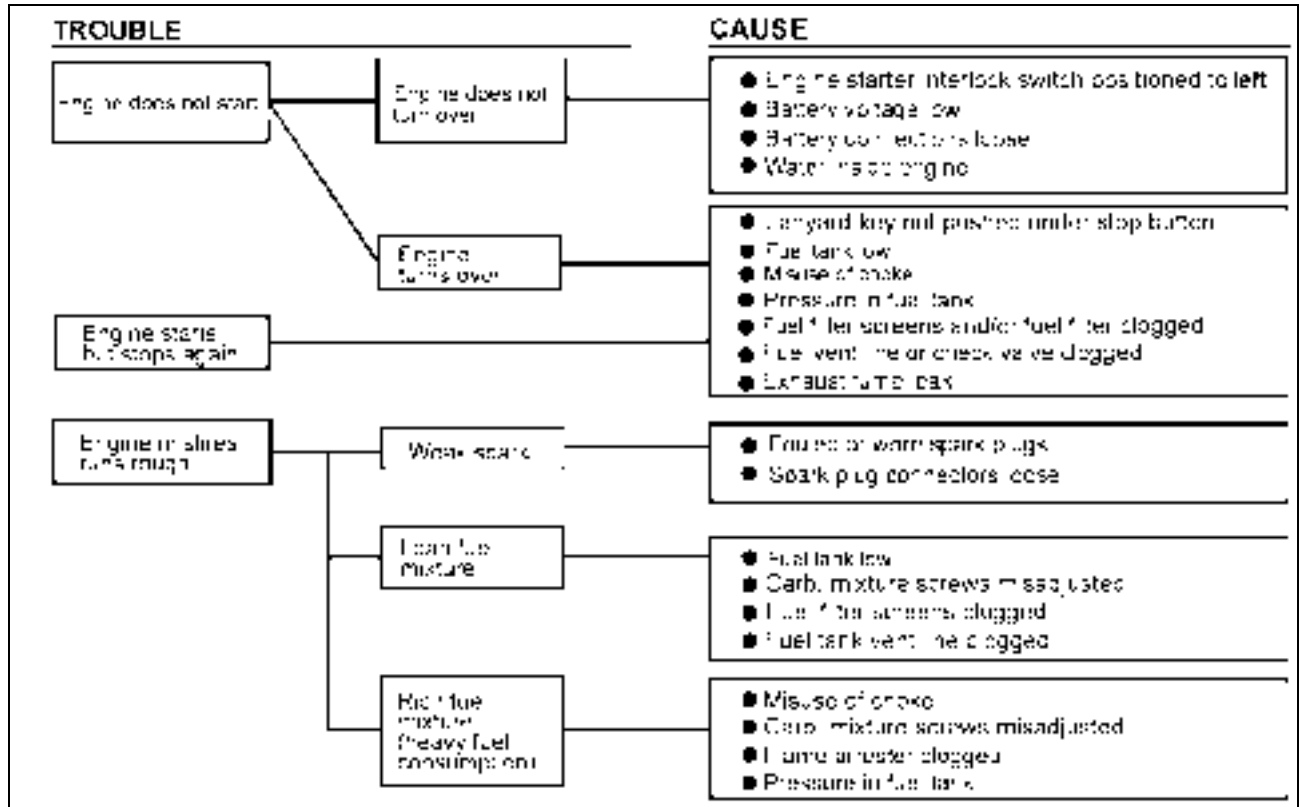

## 110 TROUBLESHOOTING GUIDE

TROUBLE	CAUSE
Engine power low	<ul style="list-style-type: none"> <li>● Check terms under "Inches" in list</li> <li>● Intake valve adjustment incorrect</li> <li>● Exhaust system clogged</li> <li>■ Water in fuel</li> </ul>
Engine overheating	<ul style="list-style-type: none"> <li>● Weeds or debris in jet pump</li> <li>● Cooling water line clogged</li> <li>● Carb. mixture screws misadjusted</li> <li>● Incorrect gas/oil mixture</li> <li>● Incorrect type of gas or oil</li> </ul>
Gas smells "pinging"	<ul style="list-style-type: none"> <li>● Poor quality gasoline</li> <li>● Incorrect gas/oil mixture</li> <li>● Spark plug heat range too high</li> </ul>
Steering hard or unalike	<ul style="list-style-type: none"> <li>■ No lubricant on steering pivot</li> <li>● Steering cable damaged or improperly routed</li> </ul>
<p style="text-align: center;"><b>⚠WARNING</b></p> <p>Since faulty steering is dangerous, this problem should be examined by an authorized JET SKI dealer.</p>	



---

# YOUR WARRANTY/OWNER SATISFACTION

---

Welcome to the Kawasaki family!

Congratulations on buying your Kawasaki Jet Ski™ watercraft. You've chosen a great, high-quality product with state-of-the-art features and built to Kawasaki's high standards. Your satisfaction is important to your authorized Kawasaki dealer and to Kawasaki Motors Corp., U.S.A. Here is some important information regarding your vehicle's limited warranty.

Frequently Asked Questions

## **What is a Limited Warranty?**

The most important thing to know about your warranty is that it protects you from manufacturing defects in material or workmanship during the warranty period. You can find the warranty period in the Kawasaki Limited Warranty Certificate your Kawasaki dealer provided to you at the time of sale. The warranty does not cover the cost of regularly-scheduled maintenance. The warranty also does not apply to the normal wear of items such as batteries, impellers, etc.

## **What is the Good Times Protection Plan?**

Much of the warranty coverage offered by the limited warranty can be extended by purchasing Kawasaki's Good Time™ Protection Plan (GTPP). See your Kawasaki dealer or go to [Kawasaki.com](http://Kawasaki.com) for more information if you don't already have the GTPP.

## **What Am I Responsible For?**

You are responsible for maintaining your watercraft according to the maintenance schedule shown in this owner's manual.

You are responsible for taking your product to the dealer immediately if there is a problem, and you, as the owner, will need to authorize the dealer to inspect the unit.

## 112 YOUR WARRANTY/OWNER SATISFACTION

You will be responsible for paying for routine maintenance, including the first scheduled service. You can have the required servicing done by your Kawasaki dealer (recommended) or an equally-qualified service facility. You can also do your own maintenance work if you have the proper tools, service references, and mechanical skills. However, if a failure is found to be caused by improper servicing, it would not be covered by the limited warranty.

You may purchase a Kawasaki Service Manual and any necessary special tools directly from your Kawasaki dealer.

You will be responsible for paying for repairs needed because of an accident, to replace worn parts such as impellers, and for repairs needed because of a lack of maintenance, misuse or racing.

Whether you do it yourself or take your vehicle to a Kawasaki dealer, be sure to record your service in the Maintenance Record section of this Owner's Manual. Keep all receipts for the service and/or items necessary to perform the maintenance so that in the event of a failure you can document the service history.

### **What Are The Dealership's Responsibilities?**

Your Kawasaki dealer offers a wide range of services, parts, accessories, and information on your product and on Kawasaki.

Each dealer is independently owned and operated and is responsible for the dealership's operations, its repair, warranty, and service work, and its personnel.

Your dealer is responsible for completing the set up and pre-delivery service of your new Kawasaki watercraft. The dealership should also explain its operation, maintenance, and warranty provisions so you understand them at the time of purchase or at any other time you have questions.

The dealership is responsible for inspecting your Kawasaki watercraft if there is a failure, determining the cause of the problem, and getting any needed authorization from Kawasaki if the repair is one that will be covered by the limited warranty. The dealership will also file all necessary paperwork. The dealership is responsible for correctly completing any necessary repairs, whether they are covered by the limited warranty or not.

### **How Do I Get Warranty Service?**

If there is a problem with your watercraft within the limited warranty period, you will need to schedule a service appointment and provide any maintenance records to an authorized Kawasaki dealer for inspection and diagnosis. You can go to any Kawasaki dealer for warranty repairs. Your Kawasaki dealer will inspect your vehicle and provide you with the results of the inspection. The dealer will perform the repairs at no cost to you if it is determined that the problem is covered by the warranty.

Kawasaki will work with your dealer to resolve any warranty issues. No authorization for warranty work can be given until your watercraft has been inspected by a Kawasaki dealer.

### **What if I am not Satisfied With My Warranty Service?**

If you aren't satisfied with your dealership's repair work or operations, it is best to discuss the situation with the appropriate dealership manager. If you have already done this, then contact the dealership's owner or general manager to request a review of the issue.

If you are unable to resolve a problem after consulting with the dealership management and need further assistance, contact Kawasaki Motors Corp., U.S.A. at the address below. Please be certain to provide the model, hull identification number (HIN), hours of use, accessories, dates that events occurred and what action has been taken by both you and your dealer. Include the name and address of the dealership. To assist us in resolving your inquiry, please include copies of related receipts and any other pertinent information including the name of the dealership personnel with whom you have been working. Upon receipt of your correspondence, Kawasaki Motors Corp., U.S.A. will contact the dealership and work with it in resolving your problem.

### **Want to Contact Kawasaki?**

This owner's manual should answer most of your questions about your Kawasaki. Your Kawasaki dealer should either be able to answer any other questions you might have immediately or be able to find the answer for you.

## **114 YOUR WARRANTY/OWNER SATISFACTION**

Please send your correspondence to:

Consumer Services

Kawasaki Motors Corp., U.S.A.

P.O. Box 25252

Santa Ana, CA 92799-5252

(949) 460-5688

---

# REPORTING SAFETY DEFECTS

---

**(For Products Sold in the United States of America, District of Columbia, and U.S. Territories Only)**

If you believe that your watercraft has a defect which could cause a crash or could cause injury or death, you should immediately inform the U.S. Coast Guard (U.S.C.G.) in addition to notifying Kawasaki Motors Corporation, U.S.A.

If the U.S.C.G. receives similar complaints, it may open an investigation, and if it finds that a safety defect exists in a group of watercrafts, it may order a recall and remedy campaign. However, the U.S.C.G. cannot become involved in individual problems between you, your dealer, or Kawasaki Motors Corporation, U.S.A.

Please send your correspondence to:

Office of Boating Safety Product Assurance Division-OBP-3  
United States Coast Guard  
2100 Second Street SW  
Washington, DC 20593-0001

---

## ENVIRONMENTAL PROTECTION

---

Kawasaki subscribes to the guidelines of Tread Lightly! a program dedicated to protecting the great outdoors through education and fostering responsible enjoyment of public lands. When using your Kawasaki Jet Ski watercraft, please follow these Tread Lightly! guidelines:

### Tread Lightly!

**T**ravel responsibly on designated waterways and launch your watercraft in designated areas.

**R**espect the rights of others including anglers, swimmers, skiers, boaters, divers and others to allow them to enjoy their recreational activities undisturbed.

**E**ducate yourself by learning rules and regulations, planning for your trip, taking recreation skills classes, and knowing how to use and to operate your equipment safely.

**A**void sensitive areas and operating your watercraft in shallow waters or near shorelines at high speeds.

**D**o your part by leaving the area better than you found it, properly disposing of fuel, oil and waste, avoiding the spread of invasive species, restoring degraded areas, and joining a local enthusiast organization.

Properly discard used batteries, engine oil, other vehicle components, or the entire vehicle that you might dispose of in the future. Consult your authorized Kawasaki dealer or local environmental waste agency for their proper disposal procedure.

# MAINTENANCE RECORD

Owner Name.....

Address .....

Phone Number .....

Hull Number .....

Engine Number .....

Selling Dealer Name .....

Address .....

Phone Number .....

Warranty Start Date .....

**Note:** Keep this information and a spare key in a secure location.

Date	Engine Hours	Maintenance Performed	Dealer Name	Dealer Address









**MAINTENANCE RECORD 121**

<b>Date</b>	<b>Engine Hours</b>	<b>Maintenance Performed</b>	<b>Dealer Name</b>	<b>Dealer Address</b>

# JS800AB



\* 9 9 9 8 7 - 1 6 3 6 \*



**KAWASAKI HEAVY INDUSTRIES, LTD.**  
Motorcycle & Engine Company

**Part No. 99987-1636**  
<https://www.boat-manuals.com/>

Printed in Japan

GB