



Includes:

- Important Safety Information
- Navigation Rules
- Operating Instructions
- Maintenance and Storage

Jet Ski® Ultra 150 Watercraft

保存版

OWNER'S MANUAL

<https://www.boat-manuals.com/>

READ THIS FIRST!

WARNING

For your safety, read this Owner's Manual and understand it thoroughly before operating this JET SKI watercraft. This manual contains the warnings given here for your immediate attention plus other important information.

The JET SKI watercraft is not a toy; it is a one or two person high performance Class A power boat with a capacity load limit of 150 kg (330 lb). Underage operators may be hazardous to themselves and others. You must know and observe your state's minimum boating age regulations. Kawasaki does not recommend operation of this watercraft by persons under the age required for a driver's license.

Don't forget to watch out for other boats, swimmers, or obstructions in your path. This is especially critical during a beginner's first exciting ride.

This is a very maneuverable, sport watercraft; other boaters may not be expecting you to turn as quickly as you are able. Look around you to make sure the path is clear before executing any sudden turns.

Drowning Hazard: a personal flotation device (PFD) must be worn by the operator and passenger. Kawasaki recommends that the operator and passenger wear a vest-type PFD (type 1, 2 or 3) at all times.

Riders of personal watercraft may suffer injury due to the forceful injection of water into body cavities either by falling into the water or while mounting the craft. Kawasaki recommends that the operator and passenger of personal watercraft wear protective swimwear such as wetsuit bottoms.

Releasing the throttle completely reduces the ability to steer. This can cause you to hit an object you are trying to avoid. You must have thrust to turn, so keep the throttle on or apply throttle as needed to maintain thrust at the jet nozzle.

In some circumstances water spray can momentarily interfere with vision which could be hazardous. Wear suitable eye protection while operating this watercraft.

Never operate the watercraft after dark. It was not designed for such use, and has no lighting equipment.

CAUTION

Take proper care of your new JET SKI watercraft. Here are some of the cautions contained in this manual which must be followed for the protection of your watercraft. Be sure to read this Owner's Manual and understand it thoroughly before operating your watercraft.

Always turn the boat on its left side. Rolling to the right side can cause water in the exhaust system to run into the engine, with possible engine damage.

If water gets into the watercraft engine, follow the procedure on page 71 immediately. If water is left in the engine more than a few hours, it will destroy the crankshaft bearings and damage other internal engine parts.

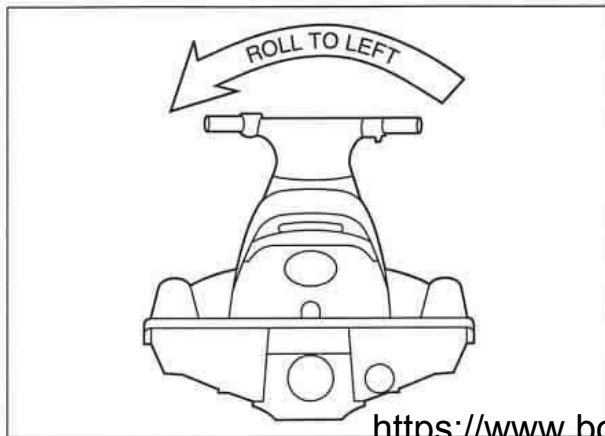

Use only the recommended, special, high-performance spark plug. Do not use other spark plug, even though they may fit, because they could cause severe damage to internal parts.

The watercraft must be in at least 0.8 m (2.5 ft) of water when starting to prevent jet pump damage by objects sucked up from the bottom.

Do not operate in shallow or debris-laden water, or the impeller may be damaged and sand may clog the water cooling hoses.

Do not run the watercraft onto the shore, or severe impeller damage may occur.

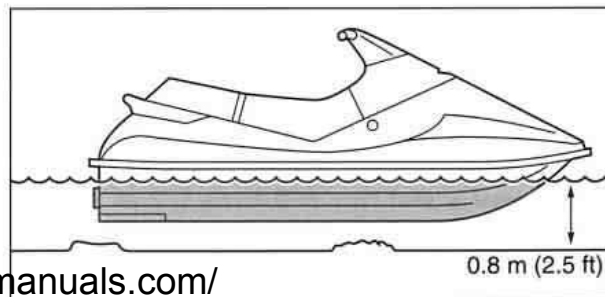

Quick Reference Guide

This Quick Reference Guide will assist you in finding the information you're looking for.

**General
Information**

**Operating
Instructions**

Storage

**Maintenance
and Adjustments**

**Troubleshooting
Guide**

A Table of Contents is included after the Foreword.

<https://www.boat-manuals.com/>

FOREWORD

Welcome to a new and exciting water sport. We are pleased you have chosen the Kawasaki JET SKI watercraft to expand the enjoyment of your recreational hours. Kawasaki uses the latest manufacturing methods and materials to bring you a high quality recreational watercraft.

This Owner's Manual is provided to aid you in the safe and reliable operation of your watercraft. **READ IT AND BECOME THOROUGHLY FAMILIAR WITH PROPER OPERATING PROCEDURES BEFORE YOUR FIRST RIDE.** Make sure anyone who operates your watercraft is fully acquainted with the proper operating procedures. Kawasaki strongly recommends that all operators attend a boating safety course before riding the watercraft. Contact the local office of the U.S. Coast Guard or other marine law enforcement agency. Careful operation and proper maintenance in accordance with this Owner's Manual will provide you with maximum riding pleasure and performance.

A Service Manual is also available for those owners who, due to personal preference or necessity, wish to perform their own service and repair. Those who plan to do their own work should, of course, be competent mechanics and should possess the required tools to work on the watercraft, including the special tools described in the Service Manual. See your dealer if you want a Service Manual and the required tools.

When you are planning to ride your watercraft, be sure to take this manual with you as a reference. This can be important should you encounter operating difficulties. If you have any additional questions about your watercraft, please contact your dealer. He has the necessary parts and service knowledge to care for your needs.

This craft is a "Class A" inboard boat, and as such is subject to all federal rules and regulations especially pertaining to boating safety and operation as enforced by the U.S. Coast Guard. Some local jurisdictions may have additional requirements for operation of power boats in waters under their control. Additionally, other countries may have their own standards and regulations. Please check your local boating laws and regulations before riding the watercraft.

Whenever you see the symbols shown below, heed their instructions! Always follow safe operating and maintenance practices.

⚠ WARNING

This warning symbol identifies special instructions or procedures which, if not correctly followed, could result in personal injury, or loss of life.

CAUTION

This caution symbol identifies special instructions or procedures which, if not strictly observed, could result in damage to, or destruction of equipment.

NOTE

- *Indicates points of particular interest for more efficient and convenient operation.*

All rights reserved. No part of this publication may be reproduced, stored in a retrieval system, or transmitted in any form or by any means, electronic mechanical photocopying, recording or otherwise, without the prior written permission of Kawasaki Heavy Industries, Ltd., Consumer Products & Machinery Group. No liability can be accepted for any inaccuracies or omissions in this publication, although every possible care has been taken to make it as complete and accurate as possible. All procedures and specifications subject to change without prior notice or obligation. Illustrations in this publication are intended for reference use only and may not depict actual model component parts.

© Kawasaki Heavy Industries, Ltd. 1999

Mar. 1999. (2). (S)

JETSKI is a trademark of Kawasaki Heavy Industries, Ltd. registered in U.S.A., Japan, Austria, Benelux, Sweden, Denmark, Switzerland, France, Canada, Finland, Norway, Greece, Italy, U.K., Portugal, Thailand, and Taiwan.

KAWASAKI JET SKI is a trademark of Kawasaki Heavy Industries, Ltd. registered in Australia.

TABLE OF CONTENTS

SPECIFICATIONS	8
GENERAL INFORMATION	10
Serial Numbers	10
Parts Location	11
Label Location	14
Registration Numbers	21
Multifunction Meter	22
Fuel	30
Engine Oil	34
Controls	35
Seat Latch	40
Storage Compartment	41
Tool Kit	42
Storage Pocket	43
Circuit Breakers	43
Drain Screws	44
OPERATING INSTRUCTIONS	45
Safe Operation	45
Loading	51
Navigation Rules	52
Pre-ride Checklist	54
Break-In	55
Stopping the Engine	56
Starting the Engine	58

Launching	61
Stopping the JET SKI Watercraft	63
Turning the JET SKI Watercraft	65
Docking the JET SKI Watercraft	68
Riding the JET SKI Watercraft	68
End of the Day Checklist	74
Special Procedures	75
Transporting	79
STORAGE	80
Preparation for Storage	80
Removal from Storage	83
MAINTENANCE AND ADJUSTMENTS	85
Periodic Maintenance Chart	85
Control Cable Adjustments	87
Fuel and Oil Systems	93
Spark Plug	96
Battery	97
Lubrication	99
Cooling System Flushing	101
Bilge System Flushing	102
Rear Mounting Plate Nuts Tightening	104
TROUBLESHOOTING GUIDE	105
Owner Satisfaction	107
Reporting Safety Defects	108
Maintenance Record.....	109

8 SPECIFICATIONS

SPECIFICATIONS

JET SKI WATERCRAFT - MODEL JH1200-A1 "CLASS A" INBOARD BOAT

Engine:		
Type	2-stroke, 3-cylinder, crankcase reed valve, water-cooled	
Displacement	1,176 mL	71.8 cu in.
Bore and Stroke	80.0 × 78.0 mm	3.15 × 3.07 in.
Compression Ratio	5.8 : 1	
Ignition System	DC-CDI	
Lubrication System	Oil injection (break-in period: Oil injection and gas/oil mixture 50 : 1)	
Carburetor	Keihin CDCV 40-35 × 3	
Starting System	Electric	
Tuning Specifications:		
Spark Plug	NGK R6918C-9	
Gap	0.55 – 0.65 mm	0.022 – 0.026 in.
Terminal	Solid post	
Ignition Timing	15° BTDC @ 1 250 r/min (rpm) ~ 22° BTDC @ 3 500 r/min (rpm)	
Carburetor		
Idle Speed	1 250 ± 100 r/min (rpm) – in water 1 800 ± 100 r/min (rpm) – out of water	
Compression Pressure	970 kPa (9.9 kg/cm ²) @ 440 r/min (rpm)	141 psi

SPECIFICATIONS 9

Drive System:		
Coupling		Direct drive from engine
Jet Pump:	Type	Mixed flow, single stage
	Thrust	410 kg 904 lb
Steering		Steerable nozzle
Braking		Water drag
*Performance:		
Minimum Turning Radius		4.0 m 13.1 ft
Fuel Consumption		50.5 L/h @full throttle 13.3 gal/hr (U.S.)
Cruising Range		119 km @full throttle 74 mi 1 hour and 9 minutes
Dimensions:		
Overall Length		2 890 mm 113.8 in.
Overall Width		1 129 mm 44.4 in.
Overall Height		1 028 mm 40.5 in.
Dry Weight		278 kg 613 lb
Fuel Tank Capacity		58 L including 7 L reserve 15.3 gal (U.S.) incl. 1.8 gal reserve
Engine Oil:		
Type		2-stroke, N.M.M.A. Certified for Service TC-W 3
Oil Tank Capacity		4.7 L 5.0 qt (U.S.)
Electrical Equipment:		
Battery		12 V 18 Ah

* The information shown here represents results under controlled conditions, and the information may not be correct under other conditions.

10 GENERAL INFORMATION

GENERAL INFORMATION

Serial Numbers

The hull and engine identification numbers are used to register the boat. They are the only means of identifying your particular machine from others of the same model. These serial numbers may be needed by your dealer when ordering parts. In the event of theft, investigating authorities will require both numbers as well as the model number and any unique features of your machine that could help identify it. Record these numbers here.

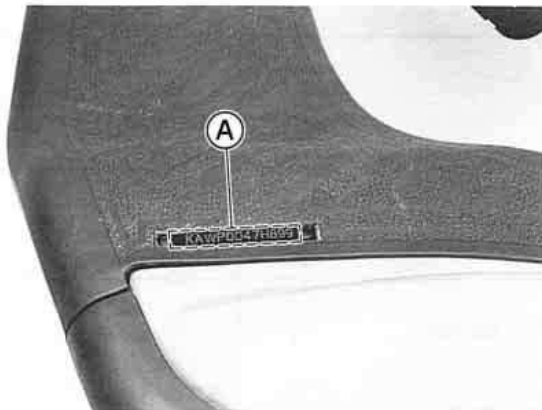

A . Hull Identification Number (HIN)

H.I.N.	
--------	--

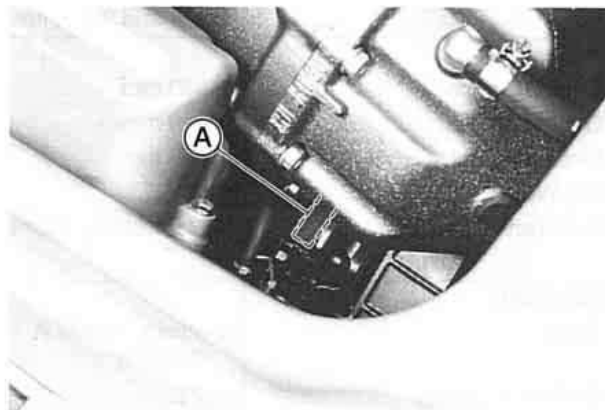

A . Engine Number

Eng. No.	
----------	--

Parts Location

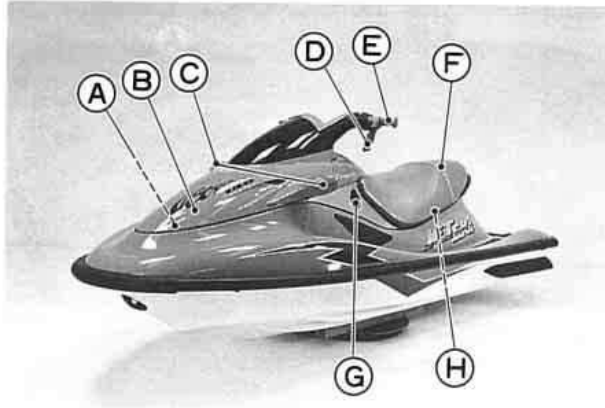

- A. Storage Compartment
- B. Hatch Cover
- C. Rear View Mirrors
- D. Engine shut-off Lanyard
- E. Handlebar
- F. Seat
- G. Choke Knob
- H. Engine Compartment

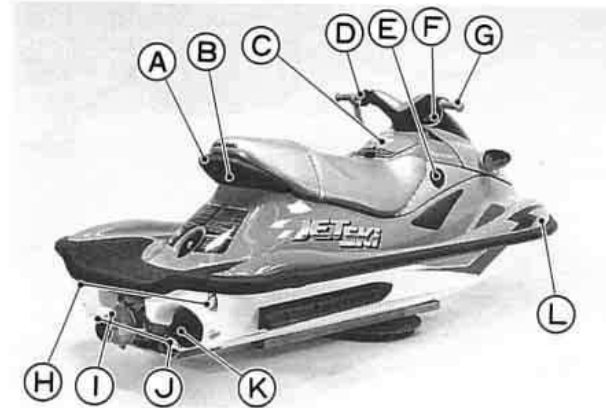

- A. Handrail
- B. Seat Latch
- C. Storage Pocket
- D. Engine Start and Stop Buttons/Trim Adjust Switch/Lanyard Switch
- E. Fuel Knob
- F. Multifunction Meter
- G. Throttle Lever
- H. Towing Eyes
- I. Steering Nozzle
- J. Drain Screws
- K. Exhaust Outlet
- L. Bypass Outlet

12 GENERAL INFORMATION



A. Ignition Switch

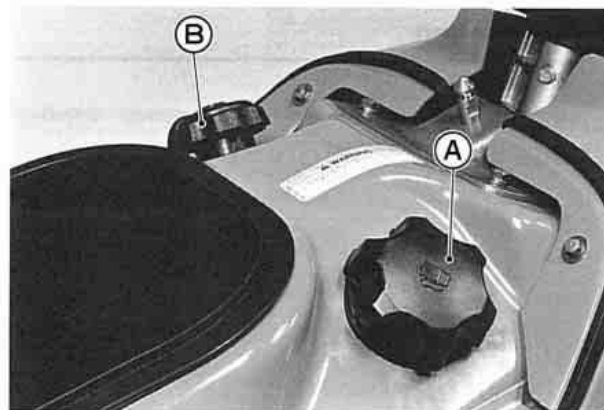

A. Fuel Filler Cap
B. Engine Oil Filler Cap

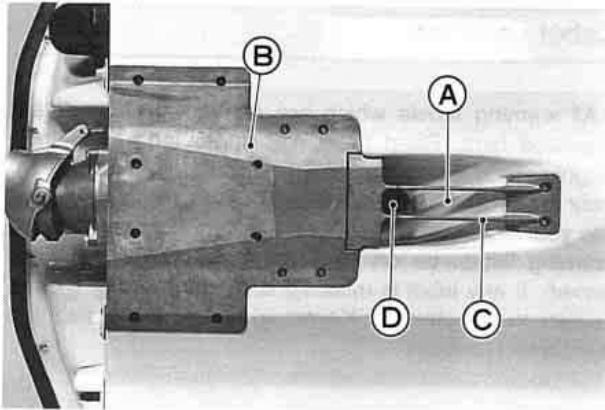

- A. Water Intake
- B. Jet Pump Cover

- C. Grate
- D. Drive Shaft

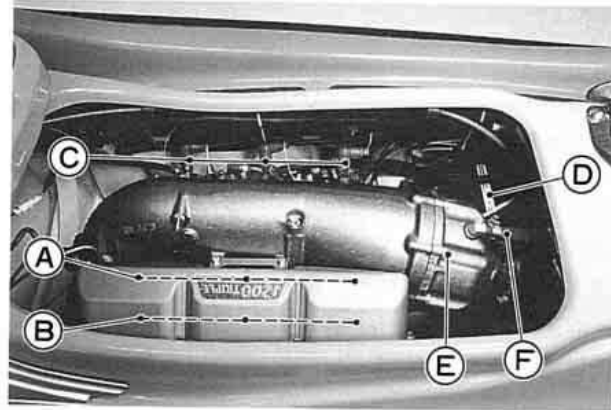

- A. Carburetor
- B. Flame Arrester
- C. Spark Plugs
- D. Battery
- E. Exhaust Pipe
- F. Cooling Hose

14 GENERAL INFORMATION

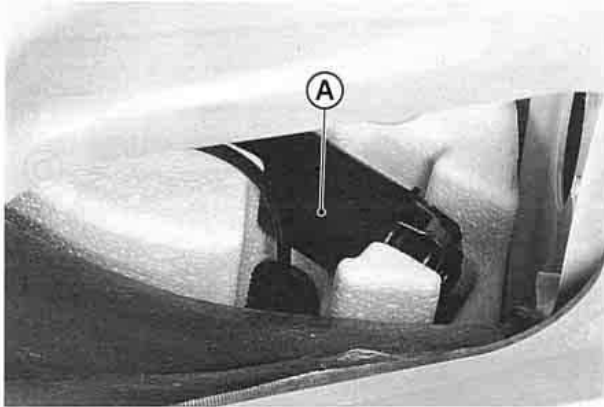

A. Tool Kit Case

Label Location

All warning labels which are on your watercraft are repeated here. Read them and understand them thoroughly. They contain information which is important for your safety and the safety of anyone else who may operate your watercraft. Therefore, it is very important that all warning labels be on your watercraft in the locations shown. If any label is missing, damaged, or worn, get a replacement from your Kawasaki dealer and install it in the correct position.

NOTE

- *The sample warning labels in this section have part numbers to help you and your dealer obtain the correct replacement.*

GENERAL INFORMATION 15

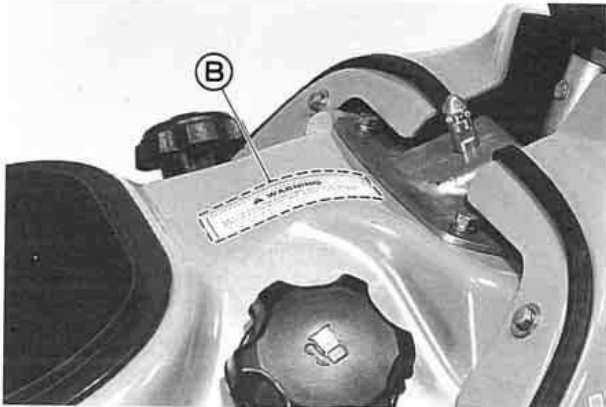
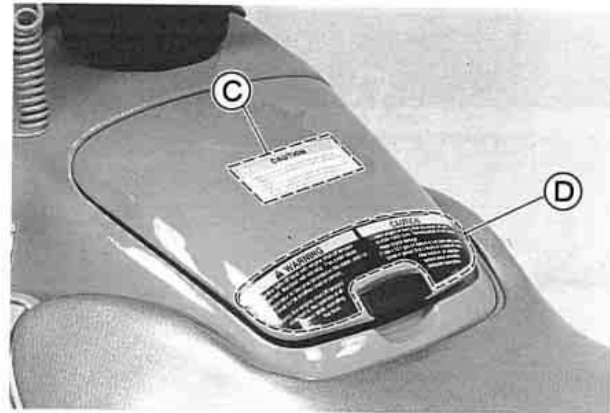
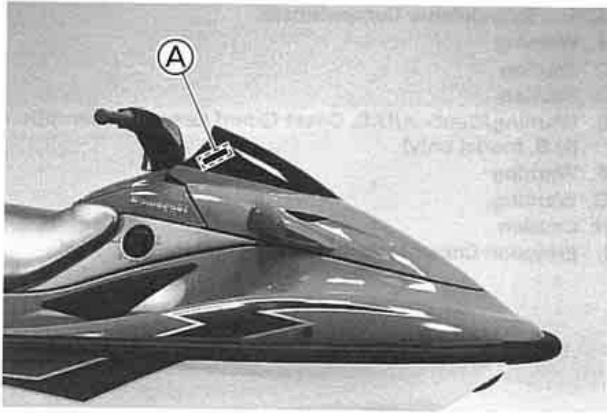

16 GENERAL INFORMATION

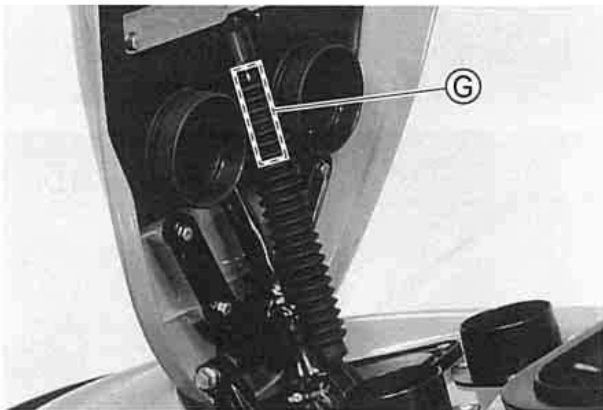

- A. Fire Extinguisher Compartment
- B. Warning
- C. Caution
- D. Caution
- E. Warning/Caution/U.S. Coast Guard Grant of Exemption (U.S. model only)
- F. Warning
- G. Warning
- H. Caution
- I. Emission Control Information (U.S. model only)

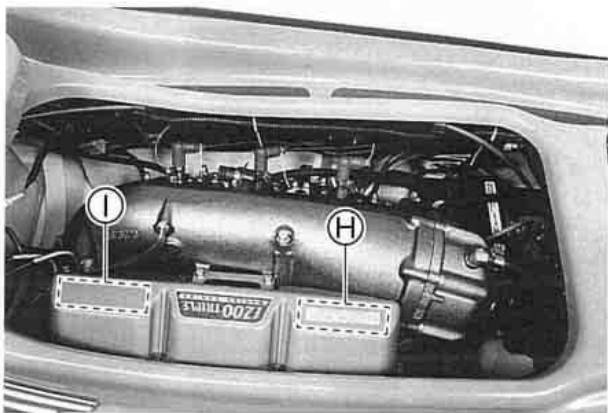

(A)

FIRE EXTINGUISHER

56030-3769

(B)

⚠ WARNING

Gasoline is extremely flammable and can be explosive. A fire or explosion can cause severe injury or death.

Shut engine off. Do not smoke. Refuel in a well ventilated area away from flame or sparks.

56040-3972

(C)

CAUTION

- Check engine oil every time you refuel. Oil tank is under storage box. Running out of oil will cause major engine damage.
- Use a 50:1 gas-oil mixture in fuel tank only during break-in period (first 5 hours or 3 tanks of fuel). After break-in, oil injection system alone provides adequate lubrication.

56070-3884

(D)

⚠ WARNING

If operator falls off boat with engine shut-off lanyard unattached, the boat will not stop. This could cause the operator to become stranded in the water, and / or the boat to hit another boat or person.

Keep the engine shut-off lanyard attached to the operator at all times while operating the boat.

CAUTION

- After turning the ignition switch ON, remove the key. Stow it in a secure place on the boat or with you while riding.
- Always turn the ignition switch OFF after stopping the engine to prevent the battery from discharging.

56070-3883

18 GENERAL INFORMATION

E



WARNING

• **The Owner's Manual and warning labels contain important information on safe operation of this watercraft.**
You must read and fully understand the Owner's Manual and warning labels before operating this watercraft.

• **This JET SKI watercraft is not a toy, it is a high performance Class A power boat.**
Under age operators may be hazardous to themselves and others. You must know and observe your state's minimum boating age regulations. Kawasaki does not recommend operation of this watercraft by persons under the age required for a driver's license.

• **Riders of personal watercraft can fall into the water and experience exposure.**
Operator and passenger must be competent swimmers and never travel farther from shore than they can swim.

• **Boating laws and navigation rules are for the safety of everyone sharing the waterways.**
You must know and observe all local, state, and federal boating laws. Kawasaki recommends that all operators complete an approved boating safety course.

• **Drowning Hazard: A personal flotation device (PFD) must be worn by operator and passenger.**
Kawasaki recommends that operator and passenger wear a vest-type PFD (type 1, 2 or 3) at all times.

• **Overloading this watercraft can adversely affect handling and stability which can lead to an accident.**
Never exceed the capacity load limit of 150kg or 330 lbs. or allow more than two persons to ride this watercraft at one time.

• **Malfunctioning controls can cause an accident.**
Check throttle control and steering for proper operation before starting engine.

• **A concentration of gasoline fumes in the engine compartment can cause a fire or explosion.**
Open the engine compartment for ventilation before starting the engine for each ride and after transporting or refueling.

• **Starting, turning, and accelerating without checking for other boats and objects in your path can cause an accident.**
Always look carefully around you for other boats and objects before starting and making quick maneuvers. This is a very maneuverable, sport watercraft.

• **Quick turns or acceleration can cause passenger to lose balance and be injured.**
Passenger should hold on to operator or hand strap and keep both feet on deck for balance.

• **Alcohol and drugs impair reaction time and judgement.**
Never drink and ride.

• **In some circumstances water spray can momentarily interfere with vision.**
Wear suitable eye protection while operating this watercraft.

• **Releasing the throttle completely reduces the ability to steer.**
This can cause you to hit an object you are trying to avoid. You must have thrust to turn.

• **Towing can cause loss of steering control and create a hazardous condition.**
Do not tow other watercraft, skiers, or objects behind this craft.

• **This watercraft will not self-right if capsized. The operator must know the proper righting procedure or he could be stranded.**
All operators of this watercraft must know the righting procedure explained in the Owner's Manual.

• **Objects hidden underwater may injure your feet.**
Operator and passenger should wear foot protection at all times.

• **Riders of personal watercraft may suffer injury due to the forceful injection of water into body cavities either by falling into the water or while mounting the craft.**
Kawasaki recommends that the operator and passenger of personal watercraft wear protective swimwear such as wetsuit bottoms.

• **High speed operation in choppy or rough water may cause back injuries.**
Slow down before crossing waves.
Do not ride if you have a back condition.

(E)

Kawasaki Motors Corp., U.S.A.
P.O. Box 25252
Santa Ana, CA 92799-5252
THIS BOAT HAS BEEN EXEMPTED
FROM COMPLIANCE WITH THE
FOLLOWING U.S. COAST GUARD
SAFETY STANDARDS IN EFFECT
ON THE DATE OF CERTIFICATION:

- Display of Capacity Information
- Safe Loading
- Floatation
- Fuel System
- Electrical System
- Powered ventilation

AS AUTHORIZED BY U.S. COAST
GUARD GRANT OF EXEMPTION
(CGD 80-018)

(E)

CAUTION

1. Do not use handrail for towing objects, lifting craft, or attaching tie-downs.
2. If engine overheats, the water temperature light comes on and the engine slows down. Return to shore immediately, to prevent engine damage, do not operate the craft until the cause of overheating is corrected.
3. When rolling the craft onto its side, turn it in this  direction only.

56070-3874

20 GENERAL INFORMATION

(F)

WARNING

Putting your hand into the jet intake or rear nozzle with the engine running can cause severe injury.

Stop the engine and pull off the engine shut-off lanyard before checking the pump for debris.

56040-3898

(H)

CAUTION

- Use only the recommended, special, high-performance spark plug. Do not use other spark plugs, even though they may fit, because they could cause severe damage to internal engine parts.

56070-3887

(G)

WARNING

• Do not incinerate, puncture or open.

56070-3876

(I)

EMISSION CONTROL INFORMATION

ENGINE FAMILY	XXAXM1.1B3CA
MODEL	JHT20-A1
FAMILY EMISSION LIMIT	161.33 g/kw-h
DATE OF MANUFACTURE	MONTH and Year

ENGINE TUNE UP SPECIFICATIONS:

SPARK PLUG: R6918C-9	GAP: 0.55-0.65MM. (0.022-0.026IN.)
IDLE SPEED : 1250RPM(IN WATER)	1800RPM(OUT OF WATER)

THIS ENGINE CONFORMS TO 1999 MODEL YEAR U.S.
EPA REGULATIONS FOR MARINE SI ENGINE.
KAWASAKI HEAVY INDUSTRIES, LTD.



Registration Numbers

The graphic design of your JET SKI watercraft provides a specific location on each side for the registration numbers and validation decals.

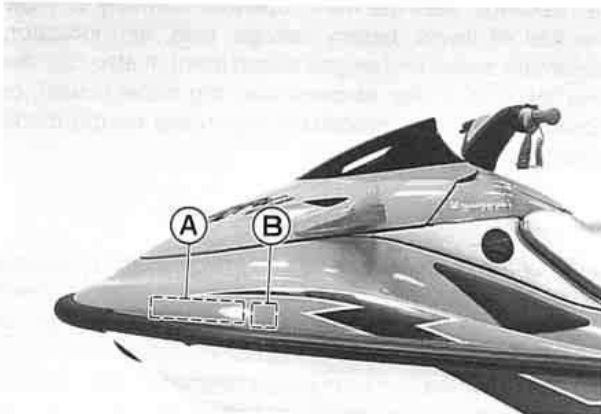

A. Location for Registration Number
B. Location for Validation Decal

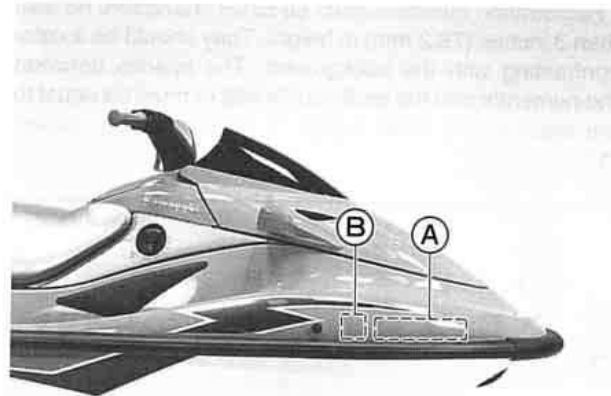

A. Location for Registration Number
B. Location for Validation Decal

The registration numbers must read from left to right on both sides of the watercraft. Typically, the validation decal must be placed 3 inches (76.2 mm) beyond, and level with the first or last letter of the identification number.

NOTE

- *Requirements for registration numbers and validation decals may vary from those given here for your state. Always follow the directions provided at the time you register your watercraft.*

22 GENERAL INFORMATION

Registration numbers must be block characters no less than 3 inches (76.2 mm) in height. They should be a color contrasting with the background. The spaces between the numerals and the prefix/suffix letters must be equal to the width of any letter except "I" or any number except "1."

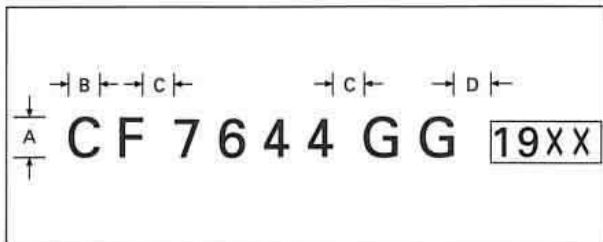

A = 3 inches (76.2 mm) minimum

B = C

D = 3 inches (76.2 mm)

Multifunction Meter

Ahead of the steering handlebar is a multifunction meter. When the ignition switch is turned on, all the LCD (Liquid Crystal Display) segments are displayed and the LED (Light Emitting Diode) warning light comes on for two seconds, then the meter operates normally to show the fuel oil levels, battery voltage, time, trim indicator, watercraft speed and engine speed (rpm). It also can display the time of day, elapsed time, trip meter (miles), or hours of operation individually depending on the mode selected.

NOTE

- Only the tachometer and trim indicator are displayed in the meter with the ignition switch turned on more than three minutes while not running the engine, or with the ignition switch turned OFF.
- The top of the fuel level gauge segments goes on only when the ignition switch is turned on, and goes off soon after its circuit functions properly. It does not go on when the amount of fuel in the fuel tank is full.
- The mode switch works only when the engine is turning slower than 3,000 rpm.

GENERAL INFORMATION 23

Speedometer:

The speedometer shows the speed of the watercraft. During a sharp turn the speed shown can be 6 to 12 mile/hr (10 to 20 km/h) lower than the actual speed.

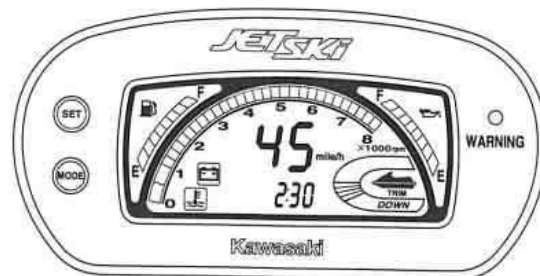
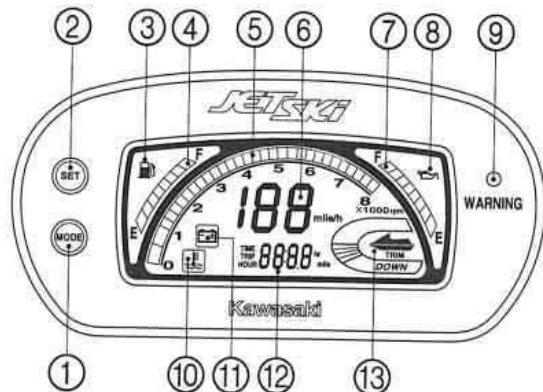

Fuel Level Gauge/Symbol/Warning Light:

The fuel in the fuel tank is shown by the number of segments displayed. When the fuel tank is full, all the segments are displayed (except the top of the fuel gauge segments). As the fuel level in the tank goes down, the segments go out one by one from the top to show the quantity of fuel left in the tank.

1. MODE Button
2. SET Button
3. Fuel Symbol
4. Fuel Level Gauge
5. Tachometer
6. Speedometer
7. Engine Oil Level Gauge
8. Engine Oil Symbol
9. LED Warning Light
10. Water Temperature Symbol
11. Buttery Symbol
12. Clock/Time/Trip/Hour Meter Display
13. Trim Indicator

24 GENERAL INFORMATION

When only the bottom segment is displayed (marked E), the fuel symbol and the bottom segment start flashing. Also the LED (red) warning light and FUEL display flashes to warn the operator. Turn the fuel knob to the RES (reserve) position and refuel at the earliest opportunity (see the Fuel and Controls sections).

NOTE

- *The top of the fuel level gauge segments goes on only when the ignition switch is turned on, and goes off soon after its circuit functions properly. It does not go on when the amount of fuel in the fuel tank is full.*

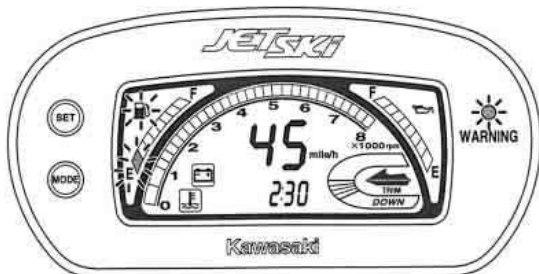

played. As the oil level in the tank goes down, the segments go out one by one from the top (marked F).

When only the bottom segment is displayed (marked E), the oil symbol and the bottom segment start flashing.

Also the LED (red) warning light and OIL display light flashes; add engine oil (see the Engine Oil section).

CAUTION

If the engine is run without oil, it will be severely damaged. If the oil tank is completely dry, add the oil, but do not operate the craft until your Kawasaki JET SKI dealer has bled the air from the oil line.

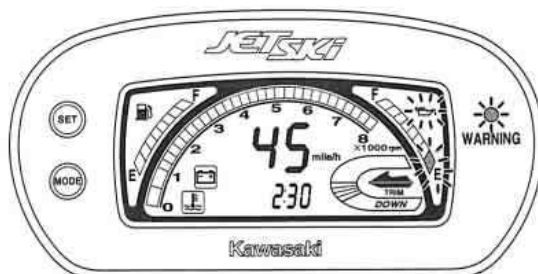

Engine Oil Level Gauge/Symbol/Warning Light:

The engine oil in the oil tank is shown by three segments. When the oil tank is full, all the segments are dis-

GENERAL INFORMATION 25

Cooling Water temperature

Symbol/Warning Light:

If the cooling water temperature gets too high, the LED (red) warning light and water temperature symbol flash; return to the shore immediately and check the cooling system for clogging (see the Special Procedures section in the Operating Instructions chapter).

CAUTION

If the engine overheats, the LED warning light and water temperature symbol flash and the engine slows down. Return to shore immediately. To prevent engine damage, do not operate the craft until the cause of overheating is corrected.

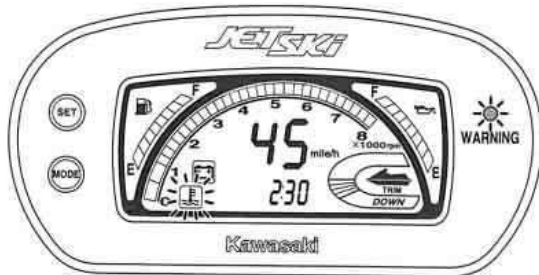

Battery Symbol/Warning Light:

The LED (red) warning light and battery symbol flash when the battery voltage is less than 12 volt. If the warning light and the symbol flashing, return to the shore immediately and your watercraft's battery should be removed and charged.

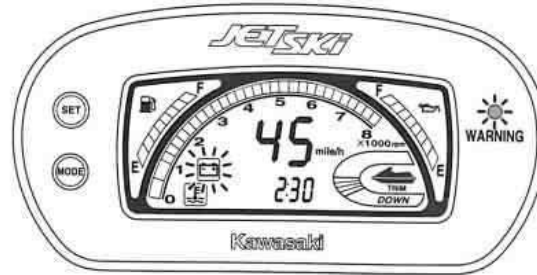

Tachometer

The tachometer shows the engine speed in the revolutions per minute (rpm); increasing or decreasing every 500 rpm within the range of 0 - 1,000 rpm and every 250 rpm over 1,000 up to 8,000 rpm.

26 GENERAL INFORMATION

NOTE

- When the ignition switch is turned on, the engine speed is shown.

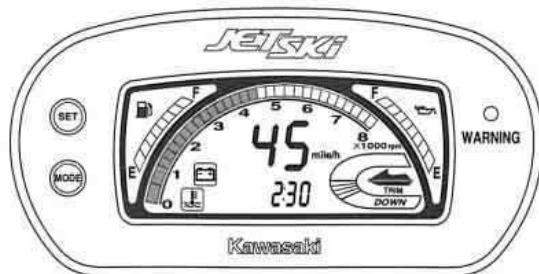

Clock/Time/Trip/Hour Meter Displays:

Pushing the MODE button momentarily shifts the middle lower display through the four modes; clock, time, trip, and hour, step by step returning to the first. Pushing and holding the MODE button continuously rotates the display through the four modes.

Clock



To adjust hours and minutes:

1. Push the SET button for more than two seconds. The hour display starts flashing.
2. Push the MODE button to advance the hours.
3. Push the SET button. The hour display stops flashing and the minutes display starts flashing.
4. Push the MODE button to advance the minutes.
5. Push the SET button. The minutes display stops flashing and the clock starts working.

NOTE

- Pushing the MODE button momentarily advances the hour or minute step by step. Pushing and holding the button advance the hour or minute continuously.
- The clock works normally from the back-up power while the ignition switch is turned off.
- When the battery is disconnected, the clock resets to 12:00, and starts working again when a battery is connected.

GENERAL INFORMATION 27

Time Meter

The time meter shows the time passed since it was last reset to zero.

To reset the time meter:

1. Push and hold the SET button. All the displays in this mode start flashing.
2. After two seconds the displays stop flashing and the hour and minute display turns back to 00:00, and then starts working, if the engine is running. The meter works on until it is next reset, unless the ignition switch is turned off.

NOTE

- The time data is maintained by the back-up power if the ignition switch is turned off, and it starts working when the craft is next operated.
- When the time comes to 99:59 when the engine is running, it turns back to 00:00 and starts counting upward again.
- When the battery is disconnected, the time display resets to 00:00.

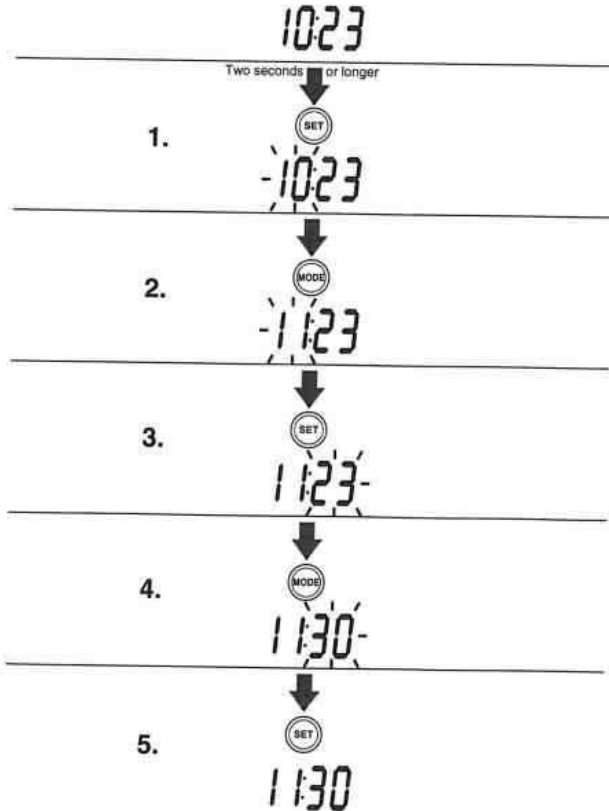

28 GENERAL INFORMATION

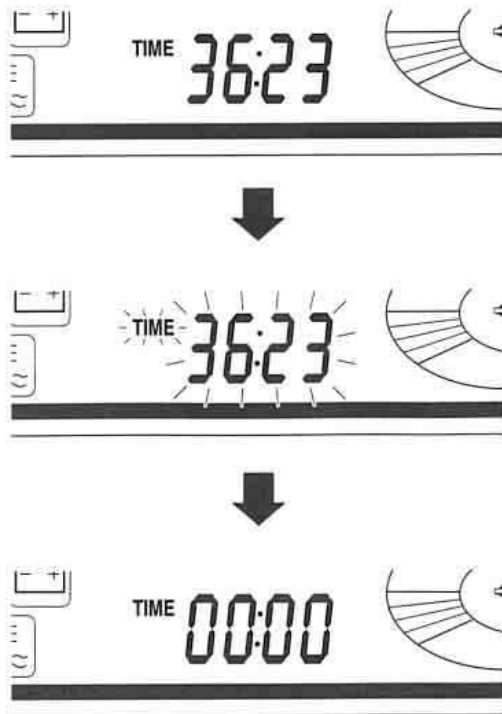

Trip Meter

The trip meter shows the distance traveled since it was last reset to zero.

To reset the trip meter:

1. Push the SET button and hold it in. All the displays in this mode start flashing.
2. After two seconds the displays stop flashing and the figure display turns to 000.0, and then starts counting when the craft is operated. The meter works on until it is next reset, unless the ignition switch is turned off.

NOTE

- *The data is maintained by the back-up power if the ignition switch is turned off.*
- *When the trip meter is reset while the craft is stopped, it starts counting as soon as the craft starts moving.*
- *When the figures come to 999.9 when the craft is running, they turn back to 000.0 and start counting again.*
- *When the battery is disconnected, the meter display resets to 000.0.*

GENERAL INFORMATION 29

Hour Meter

The hour meter shows the total hours that the watercraft has been operated. This meter cannot be reset.

NOTE

- *The data is maintained even if the battery is disconnected.*
- *When the figures come to 9999, they turn back to 0000 and start counting upward again while the craft is operated.*

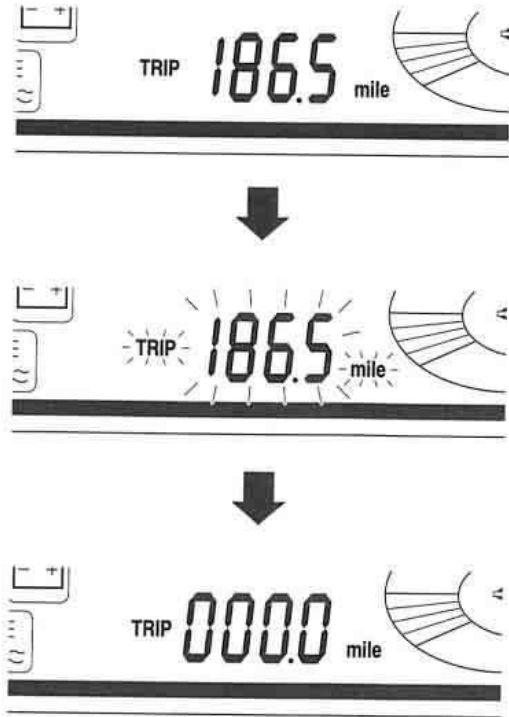

30 GENERAL INFORMATION

Trim Indicator

The trim indicator shows the vertical position of the jet pump nozzle in trimming the watercraft. The needle stays up when the ignition switch is turned off regardless of the actual nozzle position. Refer to the Controls section.

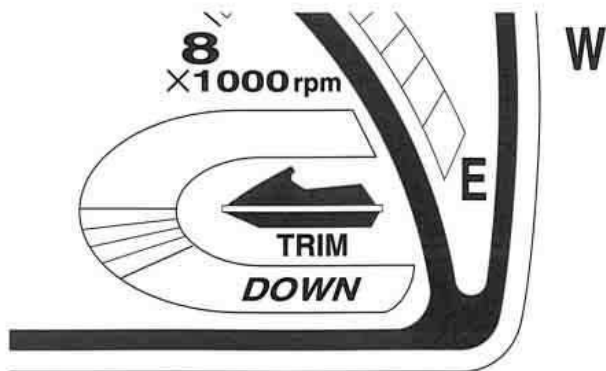

Fuel

CAUTION

Do not use racing fuels or fuel additives. This watercraft has not been tested and certified for use with such fuels. Damage to the engine and fuel system may result from the use of improper fuel.

Fuel Requirements:

Fuel Type

Use clean, fresh unleaded gasoline with a minimum Antiknock Index of 87. The Antiknock Index is posted on service station pumps in the U.S.A. The octane rating of a gasoline is a measure of its resistance to detonation or "knocking." The Antiknock Index is an average of the Research Octane Number (RON) and the Motor Octane Number (MON) as shown in the table below.

Octane Rating Method	Minimum Rating
Antiknock Index $\frac{(RON + MON)}{2}$	87
Research Octane Number (RON)	91

CAUTION

If engine "knocking" or "pinging" occurs, use a different brand of gasoline of a higher octane rating. If this condition is allowed to continue it can lead to severe engine damage.

Gasoline quality is important. Fuels of low quality or not meeting standard industry specifications may result in unsatisfactory performance. Operating problems that result from the use of poor quality or nonrecommended fuel may not be covered under your warranty.

Fuels Containing Oxygenates

Gasoline frequently contains oxygenates (alcohols and ethers) especially in areas of the U.S. and Canada which are required to sell such reformulated fuels as part of a strategy to reduce exhaust emissions.

The types and volume of fuel oxygenates approved for use in unleaded gasoline by the U.S. Environmental Protection Agency include a broad range of alcohols and ethers, but only two components have seen any significant level of commercial use.

Gasoline/Alcohol Blends – Gasoline containing up to 10% ethanol (alcohol produced from agricultural products such as corn), also known as "gasohol" is approved for use.

CAUTION

Avoid using blends of unleaded gasoline and methanol (wood alcohol) whenever possible, and never use "gasohol" containing more than 5% methanol. Fuel system damage and performance problems may result.

Gasoline/Ether Blends – The most common ether is methyl tertiary butyl ether (MTBE). You may use gasoline containing up to 15% MTBE.

NOTE

- *Other oxygenates approved for use in unleaded gasoline include TAME (up to 16.7%) and ETBE (up to 17.2%). Fuel containing these oxygenates can also be used in your Kawasaki.*

32 GENERAL INFORMATION

CAUTION

Never use gasoline with an octane rating lower than the minimum specified by Kawasaki.

Never use "gasohol" with more than 10% ethanol, or more than 5% methanol. Gasoline containing methanol must also be blended with cosolvents and corrosion inhibitors.

Certain ingredients of gasoline may cause paint fading or damage. Be extra careful not to spill gasoline or gasoline oxygenate blends during refueling.

When not operating your Kawasaki for 30 to 60 days, mix a fuel stabilizer (such as STA-BIL) with the gasoline in the fuel tank. Fuel stabilizer additives inhibit oxidation of the fuel which minimizes gummy deposits.

Never store this product with "gasohol" in the fuel system. Before storage it is recommended that you drain all fuel from the fuel tank and carburetors. See the Storage section in this manual.

Filling the Tank:

WARNING

Gasoline is extremely flammable and can be explosive under certain conditions. Pull the lanyard key off the lanyard switch. Do not smoke. Make sure the area is well ventilated and free from any source of flame or sparks; this includes any appliance with a pilot light.

The fuel tank is located inside the bow and the fuel filler cap is located under the hatch cover. Turn the cap counterclockwise and remove it.

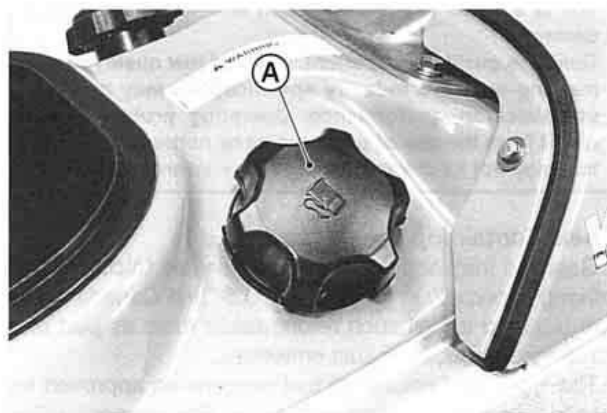

A. Fuel Filler Cap

To open the hatch cover, push the left or right hatch cover lever, and pull the hatch cover all the way up.

GENERAL INFORMATION 33

Leave about 100 mm (4 in.) between the top of the filler neck and the fuel level.

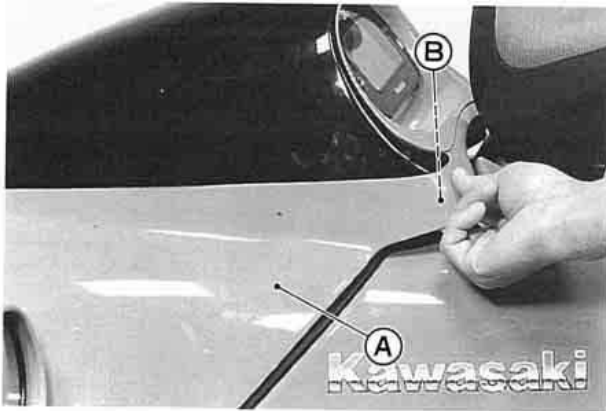

- A. Hatch Cover
- B. Lever

Fill the tank with the recommended octane rating gasoline. The use of a small diameter pour spout (or funnel) will make filling easier. Pour slowly to avoid "spit back" and allow air to escape from the tank.

⚠ WARNING

Never fill the tank completely to the top. As the fuel expands in a warm tank, it may overflow from the vent tube. After refueling, make sure the filler cap is closed securely.

After transporting or refueling and before starting the engine, open the hatch cover, take out the storage box and remove the seat (see the Seat Latch section) for several minutes to ventilate the engine compartment.

⚠ WARNING

A concentration of gasoline fumes in the engine compartment can cause a fire or explosion.

34 GENERAL INFORMATION

Engine Oil

Kawasaki recommends using Kawasaki Jet Ski oils. There are several different products and container sizes to choose from. Ask your dealer to recommend a Kawasaki Jet Ski oil according to the way you use your watercraft. All of the Jet Ski watercraft oils are specially formulated to provide the best possible lubrication and deposit resistance under different conditions.

If Kawasaki Jet Ski oils are not available, ensure that you use only a TC-W3 certified two cycle marine oil as a substitute. Look for the National Marine Manufacturers Association (N.M.M.A.) TC-W3 certification on the oil container. The use of oil additives and oils that are not either Kawasaki Jet Ski oil, or certified by the N.M.M.A. as TC-W3 are not recommended.



Adding Oil:

The oil tank is located on the fuel tank inside the bow. Open the hatch cover, and remove the oil filler cap. Add the recommended oil.

CAUTION

If the engine is run without oil, it will be severely damaged. If the oil tank is completely dry, add the oil and have your Kawasaki JET SKI dealer bleed the air from the oil line before operation.

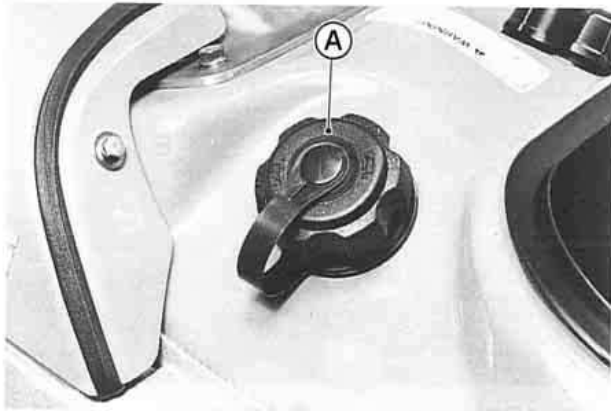

A. Oil Filler Cap

NOTE

- *Kawasaki recommends the use of a gasoline/oil premix in the fuel tank for extra lubrication during the break-in period. After the break-in period, the oil injection system provides the necessary engine lubrication without the need for premixed fuel. Refer to the Break-In section in the OPERATING INSTRUCTIONS chapter.*

Controls

Steering Handlebar:



A. Handlebar

The steering handlebar functions much the same as a snowmobile or bicycle handlebar. Turning the handlebar will cause the watercraft to turn **ONLY WHEN THE ENGINE IS RUNNING AND ONLY WHEN THE THROTTLE IS APPLIED**. The handlebar is connected by a control cable to the jet pump steering nozzle at the rear of the boat.

36 GENERAL INFORMATION

Stop Button:

The stop button is in the case on the left hand side of the handlebar. The stop button is red and marked "STOP." Pushing the stop button turns off the engine.

The engine is also stopped by pulling the engine shut-off lanyard key off the lanyard switch.

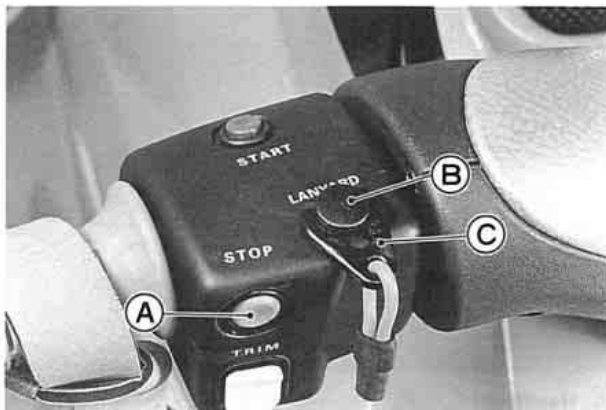

A. Stop Button
B. Lanyard Switch

C. Lanyard Key

Start Button:

The start button is in the case on the left hand side of the handlebar. The start button is green and is marked "START." Pushing the start button with the engine shut-off lanyard key pushed under the lanyard switch starts the engine. Release it when the engine starts. Without the lanyard key the engine neither starts nor runs.

CAUTION

Do not push the "START" button while the engine is running or while the starter is still spinning, as it will hasten starter wear and may cause the starter to jam.

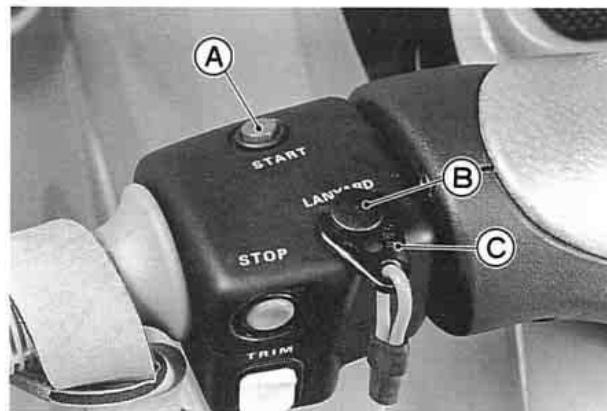

A. Start Button
B. Lanyard Switch

C. Lanyard Key

NOTE

- For the engine to start, the ignition switch must be turned to the "ON" position and the engine shut-off lanyard key must be pushed under the lanyard switch.
- Refer to the Starting the Engine section in the Operating Instructions chapter.

Trim Adjust Switch:

The rocker type trim adjust switch is located below the stop button.

Pushing on the "UP" half of the switch moves the jet pump nozzle continuously up and pushing on the "DN" half moves the nozzle continuously down to trim the boat and control porpoising. The nozzle position is shown by the trim indicator. Refer to the Multifunction Meter section.

Heavy riders will cause the bow to rise higher in the water and may contribute to porpoising which is a rhythmic rising and falling of the bow causing the hull to slap the water. Control the attitude of the boat to compensate for heavier riders by adjusting the nozzle position down. For light loads the nozzle can be raised so the bow does not plow or push too much water.



A. Trim Adjust Switch

Throttle Lever:

The throttle lever is located on the right hand side of the handlebar. Squeezing the lever toward the handlebar grip increases engine speed. When released, spring pressure returns the lever to the idle position. Always check that the throttle lever returns normally before starting the engine. In addition, there must be adequate throttle cable play. Refer to the MAINTENANCE AND ADJUSTMENTS chapter for the throttle cable adjustment procedure.

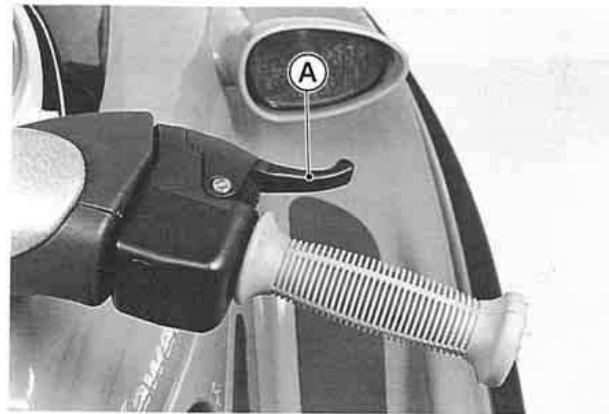

A. Throttle Lever

38 GENERAL INFORMATION

Choke Knob:

The choke knob is located on the left side of the deck under the steering handlebar. Turning the choke knob to the ON position (all the way clockwise) provides a rich mixture for starting. After the engine fires, turn the choke knob to the OFF position (all the way counterclockwise).

NOTE

- If the choke knob is used after the engine has started, it will waste fuel, reduce performance, and could cause spark plug fouling.

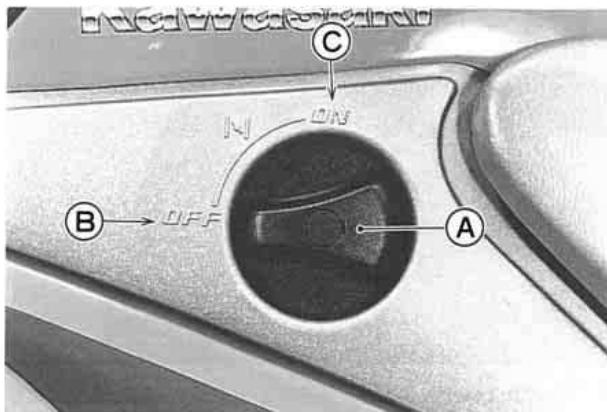

A. Choke Knob
B. OFF position

C. ON position

Fuel Knob:

The fuel knob is located on the right side of the deck under the steering handlebar. It has three positions: ON, OFF, and RES (reserve). If you run out of fuel while the knob is in the ON position (the LED warning light, fuel symbol and bottom segment flash), turn the knob to RES. Reserve allows use of the last 7 liters (1.8 U.S. gal) of fuel and about 8 minutes of running time at full throttle.

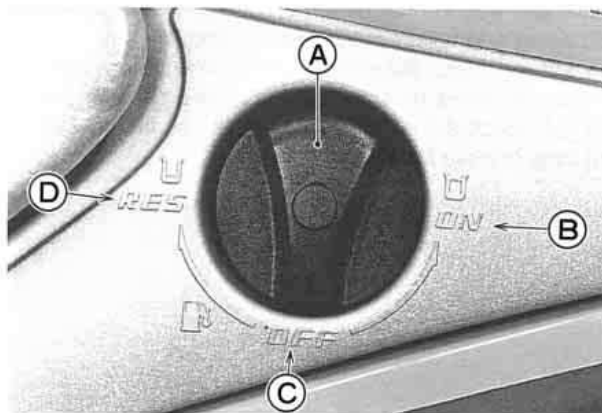

A. Fuel Knob
B. ON position

C. OFF position
D. RES position

NOTE

- Since operating distance is limited when on RES, refuel at the earliest opportunity.

- *Make certain that you turn the fuel knob to ON (Not RES) after filling up the fuel tank.*

Ignition Switch:

The ignition switch is located under the storage pocket lid. It is a 2-position, key operated switch. The key can be removed both when in the "OFF" and "ON" positions. Remove the key immediately after turning the ignition switch on and store it in the storage pocket in front of the seat. Be sure to turn the ignition switch off after stopping the engine to prevent the battery from discharging. Whenever the watercraft is not in use, turn the key "OFF" and remove it to prevent unauthorized use.

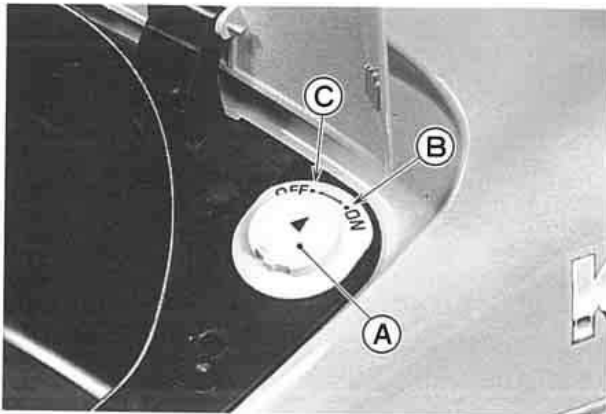

A. Ignition Switch
B. ON position

C. OFF position

CAUTION

After turning the ignition switch ON, remove the key. Stow it in a secure place on the boat or with you while riding.
Always turn the ignition switch OFF after stopping the engine to prevent the battery from discharging.

Record your ignition switch key number. In the event of loss of the key, ask your dealer to get the same key as you have lost telling the key number.

Write your key number here.

40 GENERAL INFORMATION

Seat Latch

The seat can be removed by unlocking the latch under the rear end of the seat.

To Open: Pull the latch handle and remove the seat up and to the rear.

To Close: Engage the seat front end in place and slide it all the way forward by pushing the seat end, and then push down on the rear of the seat to lock it.

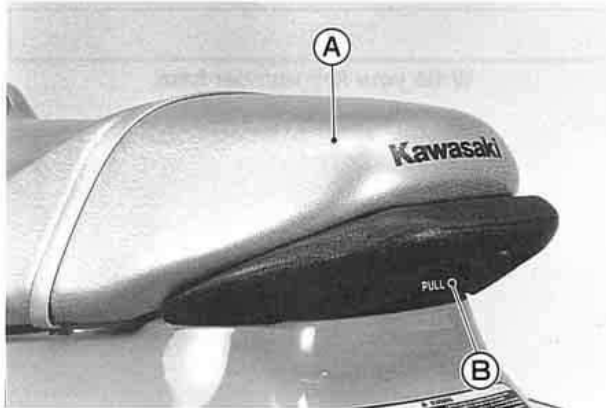

A. Seat

B. Latch Handle

When transporting the watercraft, make sure the seat is secured to prevent it from becoming dislodged and damaged as a result.

The handrail behind the seat is for boarding from deep water only, and is not designed for other purposes.

CAUTION

Do not use handrail for towing objects, lifting craft, or attaching tie-downs.

Storage Compartment

The box type storage compartment is located under the hatch cover. The storage box can be taken out easily. In the storage box is provided a container for a fire extinguisher (not standard equipment with this watercraft). Store this Owner's Manual, put in a plastic bag, in the storage compartment.

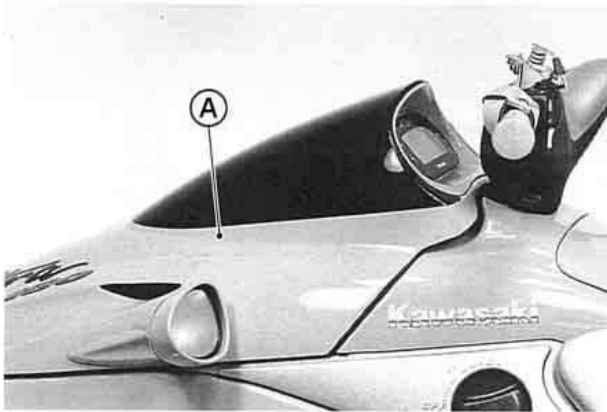

A. Hatch Cover

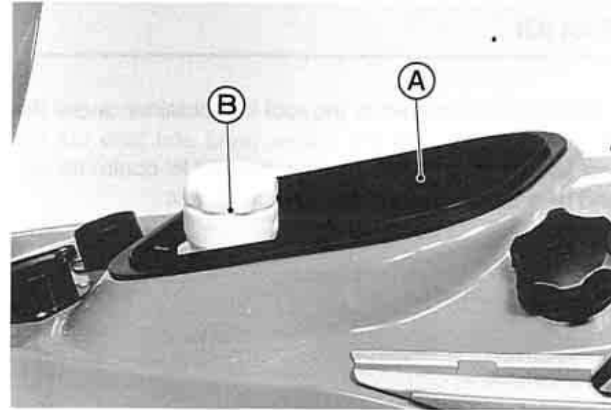

A. Storage Compartment (Box)
B. Fire Extinguisher Container

42 GENERAL INFORMATION

Tool Kit

The tool kit is stored in the tool kit container under the storage box. Unhook the rubber band and take out the tool kit container. Then unscrew the tool kit container cap and take the tool kit out from the container.

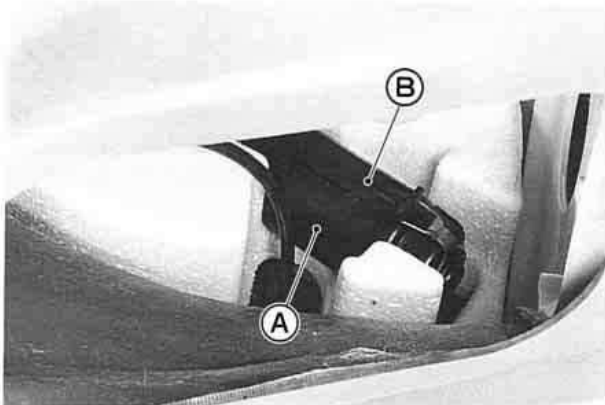

A. Tool Kit Container
B. Rubber Band

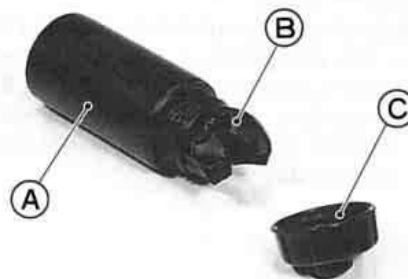

A. Tool Kit Container
B. Tool Kit
C. Cap

Storage Pocket

In front of the seat is storage pocket. Put the ignition switch key in the storage pocket after the switch is turned on. Always keep only light items in the storage pocket.

To open the lid, pull the knob all the way up until the lid latches.

To close the lid, let it down, and push on it near the knob until it latches.

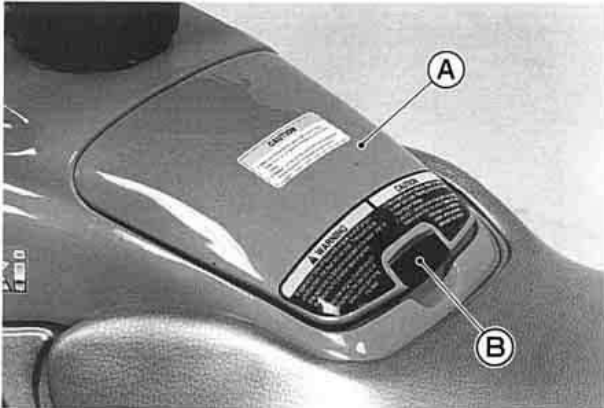

A. Storage Pocket Lid
B. Knob

Circuit Breakers

There are two circuit breakers for main system and trim system. Circuit Breakers are provided to protect the electrical system. The circuit breakers are mounted on the front right upper corner in the engine compartment. If a breaker fails during operation, inspect the electrical system to determine the cause, and then reset the breaker by pushing the button in.

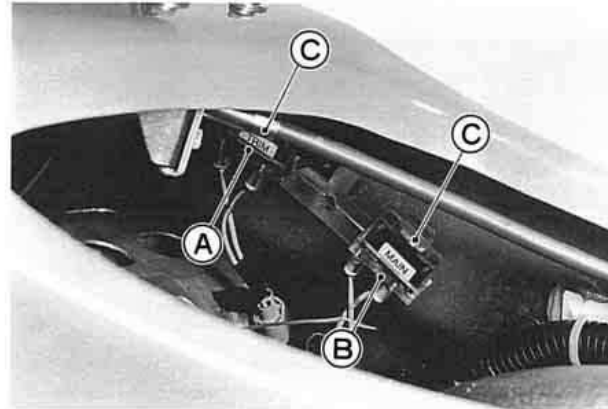

A. Trim Circuit Breaker
B. Main Circuit Breaker
C. Button

44 GENERAL INFORMATION

Drain Screws

There are two drain screws in the stern to drain water accumulated in the engine compartment. Open them only when the craft is out of the water.

CAUTION

Before launching be sure to securely tighten the screws to avoid flooding and swamping the craft.

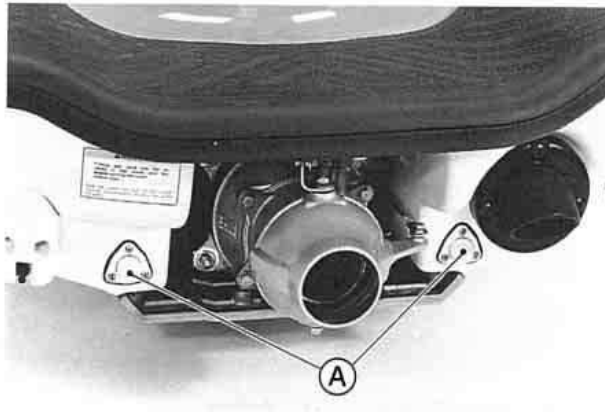

A. Drain Screws

OPERATING INSTRUCTIONS

Safe Operation

Operation by Children:

WARNING

The JET SKI watercraft is not a toy; it is a one or two person high performance Class A power boat with a capacity load limit of 150 kg (330 lb). Underage operators may be hazardous to themselves and others. You must know and observe your state's minimum boating age regulations. Kawasaki does not recommend operation of this watercraft by persons under the age required for a driver's license.

Operator Swimming Ability:

WARNING

Riders of personal watercraft can fall into the water and experience exposure. Operator and passenger must be competent swimmers and never travel farther from shore than they can swim.

Drowning Hazard: a personal flotation device (PFD) must be worn by the operator and passenger. Kawasaki recommends that the operator and passenger wear a vest-type PFD (type 1, 2 or 3) at all times.

Safe Riding Rules:

WARNING

Always follow these rules when operating your watercraft, for your own safety and that of others.

- Always comply with any Navigation Rules in effect in your area. The Coast Guard office or state boating authority nearest you can usually furnish you with the applicable rules. Check local and state regulations before operating. Kawasaki recommends that all operators complete an approved boating safety course.
- See the Navigation Rules section in this chapter for basic navigation rules.
- Kawasaki recommends that the operator and passenger wear a U.S. Coast Guard approved vest-type personal flotation device (type 1, 2 or 3) at all times. Other countries may have their own standards and regulations; be sure to follow them.
- Do not exceed the capacity load limit of 150 kg (330 lb). Do not allow more than two persons to ride this watercraft at one time. Overloading this watercraft can adversely affect handling and stability which can lead to an accident.
- Check the throttle control and steering for proper operation before starting the engine. Malfunctioning controls can cause an accident.

46 OPERATING INSTRUCTIONS

- Look carefully around you for other boats and objects in your path before starting and making quick maneuvers, especially before executing any quick turns. Because the watercraft is very maneuverable, other boaters may not be expecting you to turn as quickly as you are able (see the Turning the JET SKI Watercraft section). Before making a turn, always look over your shoulder to make sure no other watercraft is coming from behind. Do not rely solely on the rear view mirror; you may misjudge a watercraft's direction, distance or speed, or you may not see it at all.
- The passenger should hold on to the operator or hand strap while keeping both feet on the deck for balance at all times during operation, or he can lose balance and be injured.
- The operator must always keep the engine shut-off lanyard attached to himself while operating the watercraft. If the operator falls, the lanyard stops the engine (see the Starting the Engine section).
- Alcohol and drugs impair judgement and reaction time. Never drink and ride.
- Wear suitable eye protection while operating this watercraft. In some circumstances water spray can momentarily interfere with vision and create a hazard.
- Operator and passenger should wear foot protection at all times. Objects hidden underwater may injure your feet.
- Kawasaki recommends that the operator and passenger of personal watercraft wear protective swimwear such as wetsuit bottoms. Riders of personal watercraft may suffer injury due to the forceful injection of water into body cavities either by falling into the water or while mounting the craft.
- You must have thrust to turn. Releasing the throttle completely reduces the ability to steer and the watercraft can hit an object you are trying to avoid.
- Do not tow other watercraft, skiers, or objects behind this watercraft. The eyes in the bow and stern are designed only as tie-down points for transporting the craft. Towing anything can cause loss of steering control and create a hazardous condition. Also, other boat operators may not expect the watercraft to be towing anything.
- All operators of this watercraft must know the righting procedure because this craft will not self-right if it is capsized (see Righting the Capsized Watercraft in the Riding the JET SKI Watercraft section).
- Never operate the watercraft after dark. It was not designed for such use, and has no lighting equipment.
- Avoid operating the watercraft in waters full of weeds or debris, as they may clog the jet pump, and cause an injury if you fall.
- Do not operate in shallow water, or the impeller may be damaged and sand may clog the water cooling hoses.
- Be very careful of other boats, especially those towing water skiers. Give them plenty of room.
- Never go over a ski jump. You could damage the watercraft or injure yourself.
- Do not operate the watercraft in ocean surf. In addition to being dangerous, it may be illegal in certain localities.
- Slow down before crossing waves. Do not ride if you have a back condition. High speed operation in choppy or rough water may cause back injuries.

- The operator must judge what is a safe speed taking into consideration visibility, traffic, weather conditions, waves, etc. Water conditions such as converging waves can have considerable influence on the ride characteristics of a personal watercraft and can cause the operator and passenger to fall off. Additionally, attempting to achieve maximum speed in adverse conditions can cause abrupt movement of the boat causing possible injury to the riders.

CAUTION

Jumping waves can overstress the watercraft hull causing it to crack.

Jet Pump Safety:

Although the jet pump is inherently safer than a propeller drive, certain safety precautions must always be observed.

⚠ WARNING

Keep your hands, feet, and clothing away from the jet pump intake (bottom of the boat, in the middle) and never stick anything into the pump outlet (steering nozzle at the back of the boat) whenever the engine is running, or a severe injury can occur.

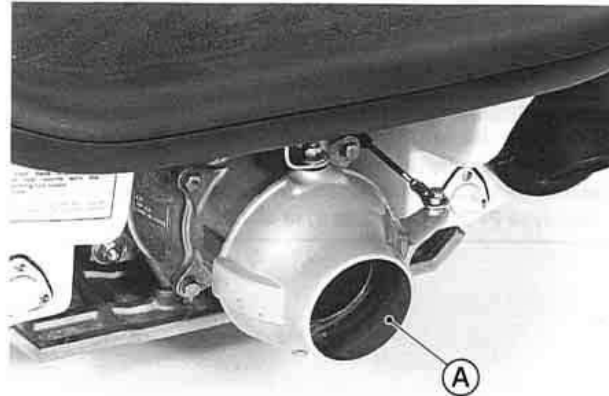
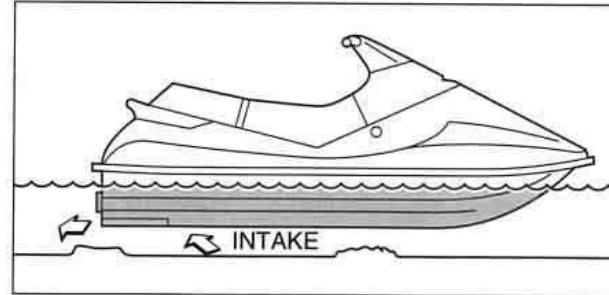

A. Steering Nozzle

48 OPERATING INSTRUCTIONS

Personal Flotation Device and Safety Gear:

U.S. federal regulations require that one U.S. Coast Guard approved personal flotation device (PFD) be carried for each person aboard when operating on water under Coast Guard jurisdiction. In some state waters not under federal jurisdiction, other flotation devices are permissible in addition to those specified by federal law. Other countries may have their own standards and regulations; be sure to follow them. As a rule, waist-type ski belts do not qualify as adequate flotation devices. The full vest type is recommended. Check local regulations to see what type of personal flotation device may be required in your area.

WARNING

Drowning Hazard: a personal flotation device (PFD) must be worn by the operator and passenger. Kawasaki recommends that the operator and passenger wear a vest-type PFD (type 1, 2 or 3) at all times.

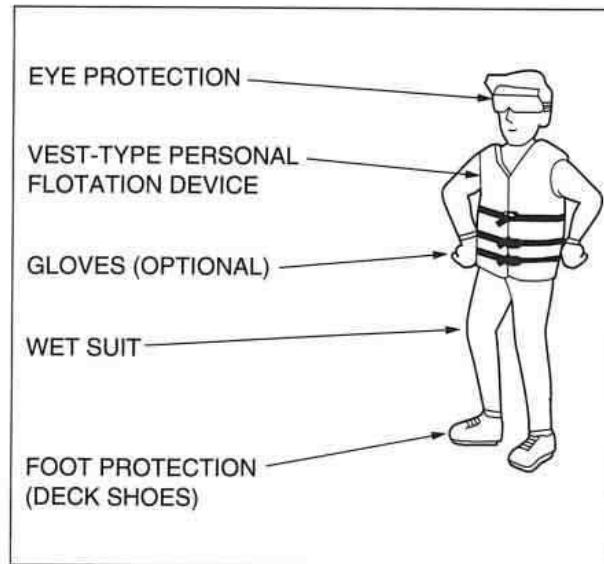

⚠ WARNING

In some circumstances water spray can momentarily interfere with vision which could be hazardous. Wear suitable eye protection while operating this watercraft.

Objects hidden underwater may injure your feet. Operator and passenger should wear foot protection at all times.

Riders of personal watercraft may suffer injury due to the forceful injection of water into body cavities either by falling into the water or while mounting the craft. Kawasaki recommends that the operator and passenger of personal watercraft wear protective swimwear such as wetsuit bottoms.

You must decide.

If you plan to ride under conditions in which you believe there is a higher chance that your head may be hit by a hard object, such as falling during a race, you may choose to wear a helmet and accept the risks. On the other hand, if head impact with the water is more likely, you may choose to not wear a helmet.

Fire Extinguisher:

A charged and functional fire extinguisher must be carried on board, and may be stored in the container provided in the storage box under the hatch cover (see the Storage Compartment section in the GENERAL INFORMATION chapter). Be sure to install the container cap securely.

Watercraft Helmets.....

Something You Should Know:

A helmet could protect your head, but could contribute to neck injuries.

Before wearing a helmet on a personal watercraft you must weigh the benefits and risks.

Benefits: Helmets offer some head protection from impacts with hard objects.

Risks: Helmets could reduce peripheral vision and increase fatigue; both of which could lead to a collision. Helmets could also increase loads on the neck and throat when you fall into the water, which could result in severe injuries.

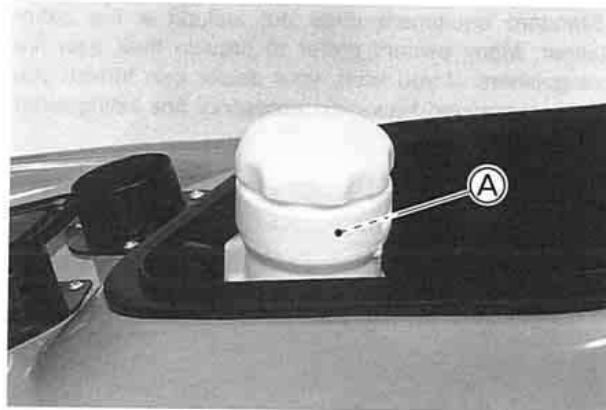

50 OPERATING INSTRUCTIONS

Because the watercraft is a "Class A" inboard boat, federal regulations require that a fire extinguisher rated "B-1" (minimum 1 kg or 2 pound capacity) be aboard when operating on navigable waters under Coast Guard jurisdiction. In addition, most states, parks, and wildlife departments require that a U.S.C.G. approved fire extinguisher be carried aboard, even on waters not under federal jurisdiction.

Other countries may have their own standards and regulations; be sure to follow them.

WARNING

Do not use your watercraft unless it has a fire extinguisher on board.

Standard equipment does not include a fire extinguisher. Many owners prefer to provide their own fire extinguishers. If you wish, your dealer can furnish you with an approved Kawasaki accessory fire extinguisher (P/N. W99997-101).



Loading

WARNING

Incorrect loading or use of accessories, or modification of your watercraft may affect stability and handling of the watercraft and result in an unsafe riding condition. Before you ride the watercraft, make sure that the watercraft is not overloaded and that you have followed these instructions.

Load Capacity Limits:

2 persons or 150 kg (330 lb) including cargo

With the exception of genuine Kawasaki Parts and Accessories, Kawasaki has no control over the design or application of accessories. In some cases, improper installation or use of accessories, or watercraft modification, will void the warranty. In selecting and using accessories, and in loading the watercraft, you are personally responsible for your own safety and the safety of other persons involved.

NOTE

- *Kawasaki Parts and Accessories have been specially designed for use on Kawasaki watercraft. We strongly recommend that all parts and accessories you add to your watercraft be genuine Kawasaki components.*

Because a personal watercraft is sensitive to changes in weight distribution, you must take extreme care in carrying cargo, passengers and/or in the fitting of additional accessories. The following general guidelines have been prepared to assist you in making your determinations.

- Passengers can affect control of the watercraft by improper positioning or sudden movements. It is important that passengers sit still while the watercraft is in motion and not interfere with the operation of the watercraft. Do not carry animals on your watercraft.
- You should instruct any passenger before riding to hold on to the operator, hand strap, or handrail, and keep both feet on the deck for balance.
- Do not install accessories that impair the performance of the watercraft.

52 OPERATING INSTRUCTIONS

Navigation Rules

The navigation rules or nautical "rules of the road" are like highway traffic laws. They dictate who has the right-of-way when boats meet in open water. As the boat operator you are obligated to know and obey these rules. They are also legally binding on boat operators.

This section provides basic navigation rules. We recommend that you obtain more information on navigation rules and navigation aids from your state when registering your craft. If you have never owned a boat before, an excellent introduction to the arts of boat handling and seamanship can be obtained from the U.S. Power Squadrons, the U.S. Coast Guard Auxiliary, or other volunteer organizations.

In nautical terms, the stand-on (privileged) boat has the right of way; and the give-way (burdened) boat must give way. Whenever you come near another boat, be cautious and use common sense. You cannot rely on other boaters to know or follow these rules.

Sailboats:

Sailboats have right-of-way over power boats in nearly all cases. Stay clear of these craft and do not create a wake which may cause them trouble.

Overtaking and Passing Situation:

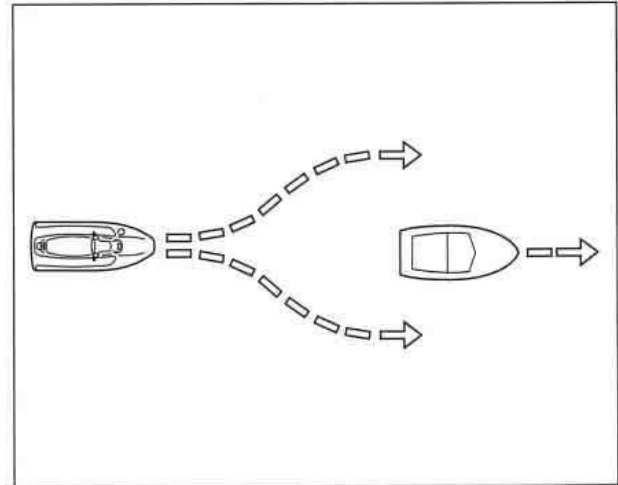

Give-way (Burdened)
Vessel Overtaking

Stand-on (Privileged)
Vessel Being Overtaken

If you are overtaking and passing another boat, the boat being passed has right-of-way, and you are required to stay clear.

Meeting Situation:

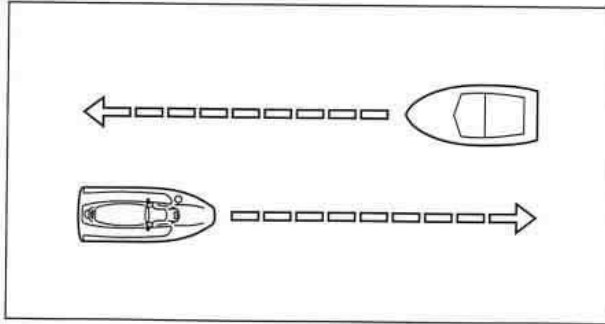

If you are meeting another power boat head on, neither you nor the other boat has right-of-way. Each boat should keep to its right.

Crossing Situation:

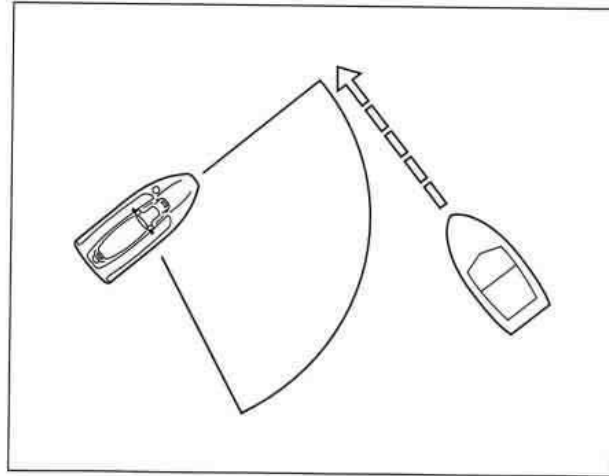

Give-way
(Burdened)
Vessel

Stand-on (Privileged) Vessel
holds course and speed.

If you have another power boat on your right, the boat on the right has right-of-way. You must keep out of the way of the boat by directing your course to the starboard (right) and passing astern of (behind) the stand-on boat. If necessary, you may have to slow, stop, or reverse your craft to allow the stand-on boat to pass. Before passing behind another boat, look carefully for a water skier or any towed object. Pass behind the object in tow.

If you have another boat on the left, you have right-of-way. You must keep your course and speed.

54 OPERATING INSTRUCTIONS

Pre-ride Checklist

Each day before using the watercraft, check the following items:

Check Outside Craft:

- CLEAN PUMP – Clear the water inlet, jet pump, and drive shaft of foreign objects.
- PUMP COVER TIGHT – Check the jet pump cover and inlet grate for looseness. Tighten the mounting bolts, if needed.
- HULL DAMAGE – Inspect the hull for damage.
- DRAIN SCREWS – Check that the drain screws in the stern are securely installed.
- STEERING – Check the operation of the steering for binding, rough spots, or excessive play. Adjust the cable if needed (see the Control Cable Adjustments section in the MAINTENANCE AND ADJUSTMENTS chapter). The steering cable is sealed at both ends and does not need lubrication. If the seals are damaged, the cable must be replaced.

Check Inside Craft:

- THROTTLE CONTROL – Check the operation of the throttle for binding, rough spots or excessive play. Adjust the cable if needed (see the Control Cable Adjustments section in the MAINTENANCE AND ADJUSTMENTS chapter). The throttle lever must return to the fully closed position when released.

WARNING

If the throttle does not return freely and completely, it may cause loss of control.

- VENTILATE ENGINE COMPARTMENT – Open the hatch cover, take out the storage box and remove the seat, and keep open for several minutes to purge gasoline fumes from the engine compartment.

WARNING

A concentration of gasoline fumes in the engine compartment can cause a fire or explosion.

- FIRE EXTINGUISHER – Check your fire extinguisher for a full charge.
- FUEL PRESSURE – Loosen the fuel tank cap to relieve any pressure, then tighten the cap securely.
- FUEL LEVEL – Check the fuel level. Refill if necessary and turn the fuel knob to the ON position.
- ENGINE OIL LEVEL – Check the oil level in the oil tank. Refill if necessary.
- FUEL LEAKS – Check the engine compartment for fuel leaks.
- OIL LEAKS – Check the engine compartment for oil leaks.
- FASTENERS – Check and tighten any loose bolts, nuts, or clamps.
- HOSE CONNECTIONS – Be sure all hose connections are secure and that all hose clamps are tight.

Check all hoses for cracks or deterioration and replace if necessary.

- DRAIN BILGE – Drain any water out of the engine compartment by removing the drain screws. Install the drain screws securely when all the water has been drained.
- ENGINE SHUT-OFF LANYARD KEY – Start the engine and run it for a few seconds (see the Starting the Engine section). Pull the lanyard key off the lanyard switch to check that the engine stops immediately.

WARNING

Do not run the engine in a closed area. Exhaust gases contain carbon monoxide: a colorless, odorless, poisonous gas. Breathing exhaust gas leads to carbon monoxide poisoning, asphyxiation, and death.

CAUTION

Do not run the engine with the watercraft out of the water for more than 15 seconds at a time. Overheating will cause engine and exhaust system damage.

- STOP BUTTON – Again start the engine, run it for a few seconds, and then check that the engine STOP button works.
- SEAT – Check that the seat latch is secure.
- RIDER PROTECTION – Always wear the proper flotation device and protective gear.

Break-In

A new watercraft should be ridden with care during the break-in period to allow mechanical components to “bed-in” and produce smooth, long wearing surfaces.

Kawasaki recommends use of a 50 : 1 gas/oil premix in the fuel tank for extra lubrication during the break-in period. Use premixed fuel for the first five hours (approx. three tanks of fuel). After the break-in period, the oil injection system provides the necessary engine lubrication without the need for premixed fuel. During the first five hours of engine operation, do not subject the engine to heavy lugging or prolonged full throttle operation. For this period, up to $\frac{3}{4}$ throttle is recommended.

Vary the operating speed often, not running for a prolonged time at any one speed.

Mixing:

A convenient way to mix fuel is to use a 19 L (5 U.S. gal) container. Add 380 mL (12.8 U.S. oz) of oil to 9.5 L (2.5 U.S. gal) of gas and mix thoroughly. Add another 9.5 L (2.5 U.S. gal) of gas, and mix again to get the proper 50 : 1 ratio. Refer to the following chart for smaller quantities.

Recommended Oil

**Kawasaki JET SKI Oils or
N.M.M.A. Certified TC-W 3 Oils**

56 OPERATING INSTRUCTIONS

Fuel Ratio Chart 50 : 1

Milli Liters of Oil to Liters of Gas			
mL of Oil	L of Gas	mL of Oil	L of Gas
76 mL	3.8 L	228 mL	11.4 L
114 mL	5.7 L	266 mL	13.3 L
152 mL	7.6 L	304 mL	15.2 L
190 mL	9.5 L	380 mL	19 L

Ounces of Oil to Gallons of Gas (U.S)			
Ounces of Oil	Gallons of Gas	Ounces of Oil	Gallons of Gas
2.6 oz	1.0 gal	7.7 oz	3.0 gal
3.8 oz	1.5 gal	9.0 oz	3.5 gal
5.1 oz	2.0 gal	10.2 oz	4.0 gal
6.4 oz	2.5 gal	12.8 oz	5.0 gal

Careful treatment of the craft during the break-in period will result in more efficient, reliable performance and a longer life for the craft.

In addition to the break-in described above, we recommend that the owner take his watercraft to an authorized Kawasaki JET SKI dealer after the first ten hours of operation for initial maintenance service. See the Periodic Maintenance Chart in the MAINTENANCE AND ADJUSTMENTS chapter.

Stopping the Engine

The engine can be stopped in one of the following two ways.

- Push the RED engine stop button. It is not necessary to hold the button "in" to stop the engine. After the engine stops, the STOP button resets itself and the engine is ready to start.
- Pull the engine shut-off lanyard key off the lanyard switch. To start the engine the lanyard key must be pushed under the lanyard switch.

Turn the ignition switch off after stopping the engine in either case.

WARNING

You have no directional control of the watercraft when the engine is stopped.

CAUTION

Always turn the ignition switch OFF after stopping the engine to prevent the battery from discharging.

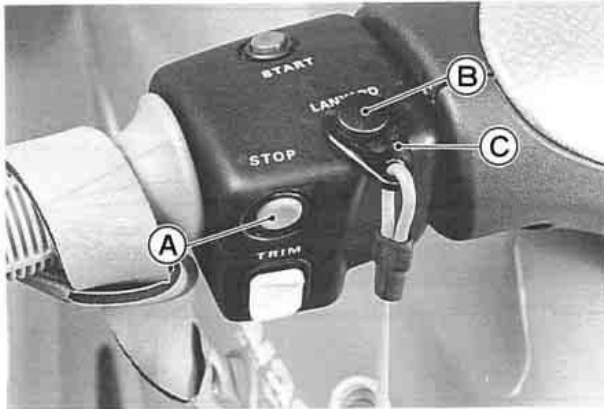

A. Engine Stop Button

C. Lanyard Key

B. Lanyard Switch

If the engine must be stopped immediately in an emergency, push the RED engine stop button or pull the engine shut-off lanyard key off the lanyard switch.

Some possible EMERGENCY situations are:

- The engine speeds out of control.
- The throttle lever will not release completely.

WARNING

If the throttle fails, do not operate the watercraft until the source of the problem is found and corrected.

58 OPERATING INSTRUCTIONS

Starting the Engine

- Read the Pre-ride Checklist in this manual and follow its instructions before putting the watercraft in the water.
- After transporting or refueling and before starting the engine, open the hatch cover, take out the storage box and remove the seat for several minutes to ventilate the engine compartment.

WARNING

A concentration of gasoline fumes in the engine compartment can cause a fire or explosion.

- Place the watercraft in at least 0.8 m (2.5 ft) of water which is clear of weeds and debris. Make sure the area ahead of the watercraft is clear of swimmers, boats, and obstacles.

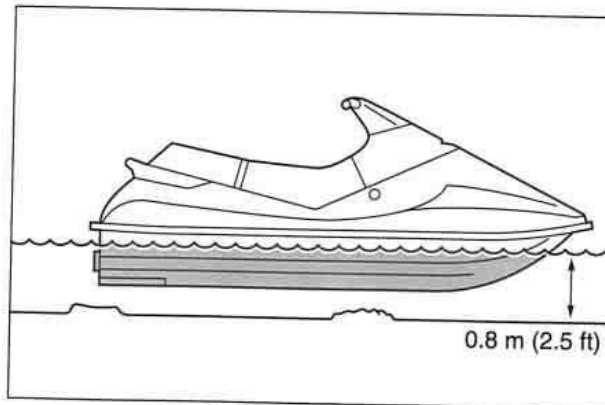

CAUTION

The watercraft must be at least 0.8 m (2.5 ft) off the bottom when starting to prevent jet pump damage by objects sucked up from the bottom.

- Check that the fuel knob is in the ON position.

OPERATING INSTRUCTIONS 59

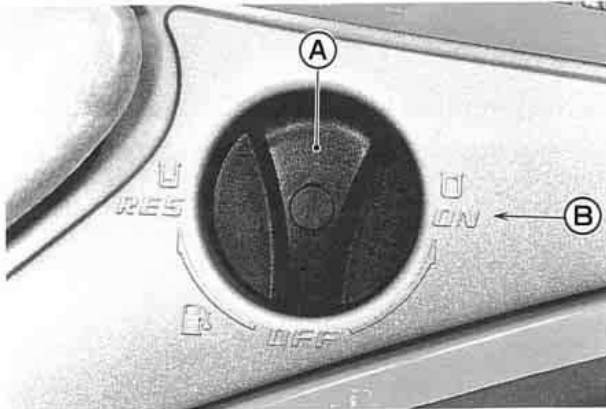

A. Fuel Knob

B. ON position

- In the seated position push the lanyard key under the lanyard switch and put your left hand through the other end of the lanyard to attach it to your wrist. Pull the lanyard to make sure it is securely attached.

NOTE

- *The engine neither cranks nor starts with the lanyard key removed from the lanyard switch.*

- Open the storage pocket lid.
- Attach the ignition switch key to the switch with the arrow forward and while pushing the key turn it to the "ON" position. Be sure to remove the key immediately and store it in the storage pocket.

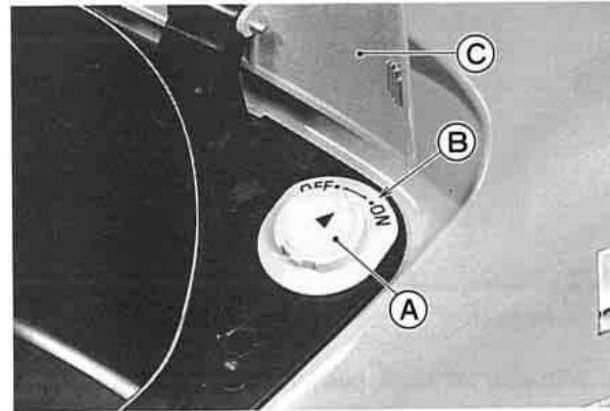

A. Ignition Switch

C. Storage Pocket Lid

B. ON Position

CAUTION

After turning the ignition switch ON, remove the key. Stow it in a secure place on the boat or with you while riding.

- Close the storage pocket lid.

60 OPERATING INSTRUCTIONS

- Turn the choke knob to the ON position.

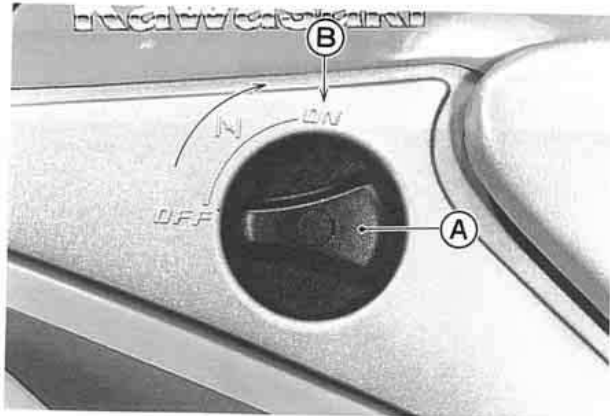

A. Choke Knob

B. ON position

- With your left hand, push the green start button and release it when the engine starts. If the engine does not start within 5 seconds, release the button. Wait 15 seconds before trying again. If the engine will not start after several attempts, see the TROUBLESHOOTING GUIDE chapter.

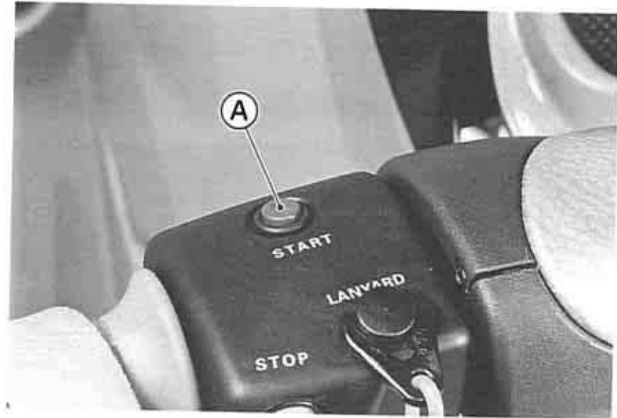

A. Start Button

NOTE

- Wait 15 seconds between each operation of the starter. This will extend battery and starter life significantly.
- When the engine first fires, even if it doesn't actually start, turn the choke knob to the OFF position. This will prevent engine flooding.
- When the engine is warm, the choke is not needed.

CAUTION

Do not push the start button while the engine is running or while the starter is still spinning, as it will hasten starter wear and may cause the starter to jam.

- After the engine has started, allow it to warm up for about 1 minute. Apply a little throttle occasionally. Excessive idling can foul the spark plugs.
- Check that water comes out of the bypass outlet in the right side of the hull when the throttle is applied. This indicates that cooling water is circulating. If there is none, shut off the engine and find the source of the trouble. When the exhaust system is dry, it can take up to 15 seconds for water to appear at the bypass outlet.

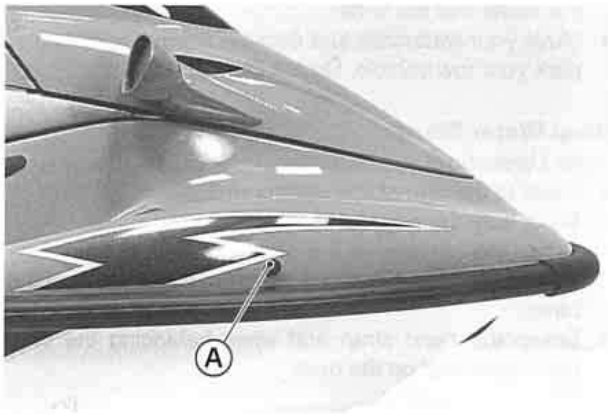

A. Bypass Outlet

Launching

Launching from a Dock:

- Do not jump onto the watercraft from the dock.
- First place one foot on the deck near the dock, then while holding the handlebar and balancing the craft by transferring body weight straddle the craft and sit down on the seat.
- When leaving the dock, either push the watercraft away from the dock or run at a slight angle away from it until there is enough room for the rear of the craft to swing, since the watercraft turns at the stern and not at the bow.
- Check that the water in your path is clear and move the handlebar in the direction you want to go.

⚠ WARNING

Don't forget to watch out for other boats or obstructions in your path. This is especially critical during a beginner's first exciting ride.

- Apply the throttle to produce enough thrust from the jet pump to allow directional control over the watercraft.

62 OPERATING INSTRUCTIONS

CAUTION

Avoid quick turns or acceleration when leaving the dock, or you might hit the dock and damage the watercraft. The operator should make sure there is room for a turn before making any quick maneuvers.

- Accelerate gradually as you proceed into open water. Remember to observe "No Wake" zones and speed limits.
- As speed increases the boat will level out in the water. This is called planing.
- Once the boat has planed, you can back off the throttle and select your desired speed.
- If the craft "porpoises" excessively, try adjusting nozzle position. Refer to the Controls section in the General Information chapter.
- Keep alert for other boats, swimmers, or obstructions in your path.

Launching from a Ramp:

- Before putting the watercraft in the water be sure you have followed the Pre-ride Checklist.
- Before launching, check the ramp for suitable surface conditions, inclination and width for both the trailer and tow vehicle.

- Attach a bow line to the watercraft and detach the trailer tie-downs.

CAUTION

Be sure the drain screws in the stern are securely installed to prevent the craft from flooding and swamping.

- Wait until it's your turn then back the trailer to the water. Unlock the winch and push the craft slowly off the trailer into the water.
- Move your watercraft to a docking or loading area and park your tow vehicle. Do not block the ramp.

Deep Water Start:

Solo Operation

- Move to the rear of the watercraft.
- Make sure the engine is stopped.
- Grasp the handrail at the seat rear end, pull yourself up and place one knee on the deck rear end, then the other.
- Grasp the hand strap and while balancing the craft place your feet on the deck.
- Sit astride the seat.

Operator and Passenger

- While the operator is balancing the craft, the passenger climbs aboard from the rear of the craft in the same way as in Solo Operation.

Shallow Water Start:

CAUTION

The watercraft must be at least 0.8 m (2.5 ft) off the bottom when starting to prevent jet pump damage by objects sucked up from the bottom.

- You can board either from the side of the craft or from the rear. In either case balance the craft when going aboard for more stability.

Stopping the JET SKI Watercraft

Normal Stopping:

WARNING

Never directly approach any moving or stationary object closer than 150 m (500 ft) when traveling at top speed. Always throttle down before approaching your intended stopping area.

This watercraft is stopped by using natural water drag to bring the craft to a halt.

1. Release the throttle before you reach your intended stopping area.

64 OPERATING INSTRUCTIONS



A. Throttle Lever

2. Coast towards the stopping area with the engine idling.

CAUTION

Stop the engine before the craft is less than 0.8 m (2.5 ft) off the bottom to prevent jet pump damage by objects sucked up from the bottom.

3. Press the engine stop button or pull the lanyard key off the lanyard switch to come to a complete stop.

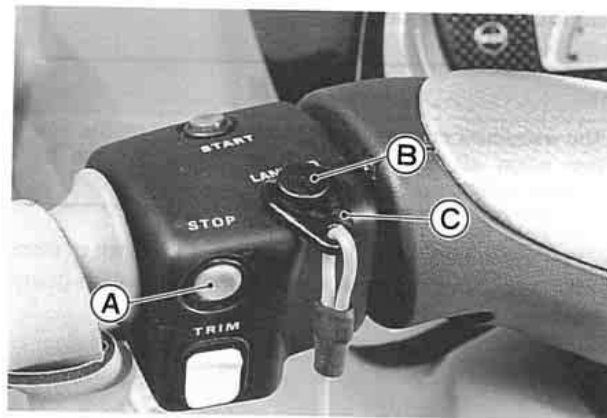

A. Engine Stop Button

B. Lanyard Switch

C. Lanyard Key

Releasing the throttle slows forward motion but the engine will still be running, so you can steer the boat after reapplying the throttle. In this manner you can turn and move away from any obstacles.

⚠ WARNING

Releasing the throttle completely reduces the ability to steer. This can cause you to hit an object you are trying to avoid. You must have thrust to turn, so keep the throttle on or apply throttle as needed to maintain thrust at the jet nozzle.

Push the engine stop button when you are approaching the shore and intend to stop. The engine stops immediately, so it prevents sand or debris from entering and damaging the jet pump. Never run the engine in water less than 0.8 m (2.5 ft) deep.

WARNING

Do not stop the engine if you may need to reapply throttle to quickly steer the watercraft. You have no directional control when the engine is stopped.

Stopping Skills:

Stopping distance depends partially on rider and passenger weight and position, idle set speed, and operating speed. Experienced operators can usually shorten stopping distance by using various riding techniques. Turning the boat sharply (using the throttle) while stopping is a method which can be used to decrease stopping distance.

Minimum Stopping Distances:

The minimum stopping distance of this watercraft with the operator and passenger from maximum speed is 106 m (348 ft).

This information represents results obtained under controlled conditions, and the information may not be correct under other conditions.

Turning the JET SKI Watercraft

Turning the watercraft requires a combination of two actions:

- Turning the handlebar
- Using the throttle

Point the handlebar to the left for a left turn

Point the handlebar to the right for a right turn

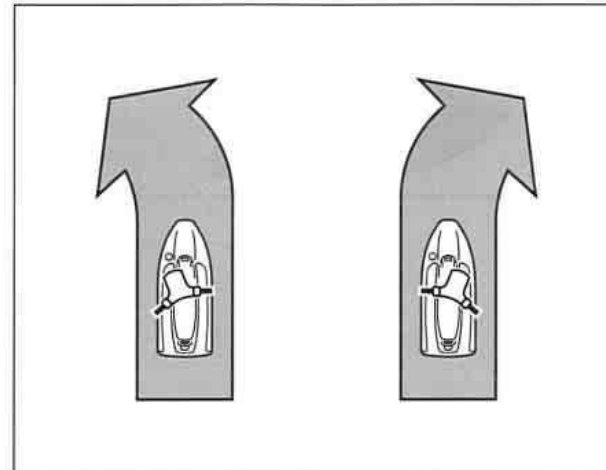

LEFT

RIGHT

66 OPERATING INSTRUCTIONS

Using the throttle is another important part of turning maneuvers. Applying the throttle produces thrust from the jet pump giving you directional control over the watercraft.

High thrust of the jet pump makes the boat turn more sharply.

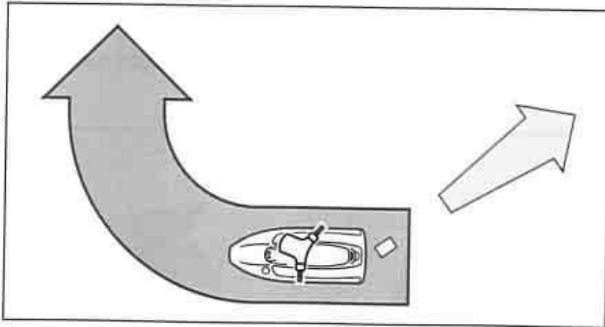

Low thrust of the jet pump makes the boat turn less sharply.

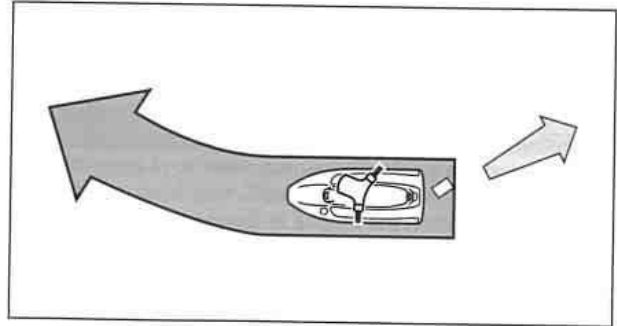

If you release the throttle completely, there is little thrust of the jet pump. The boat turns slowly and steering ability is reduced.

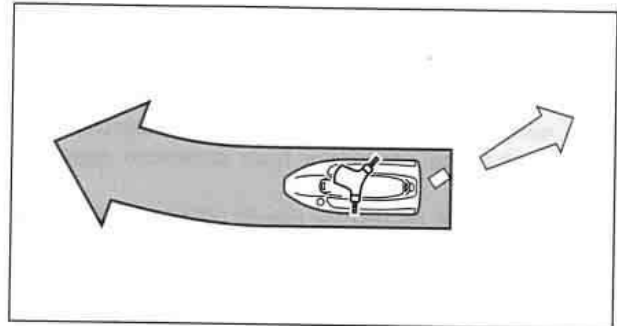

IDLE = SLOW, GRADUAL TURN

OPERATING INSTRUCTIONS 67

⚠ WARNING

Releasing the throttle completely reduces the ability to steer. This can cause you to hit an object you are trying to avoid. You must have thrust to turn, so keep the throttle on or apply throttle as needed to maintain thrust at the jet nozzle.

If you stop the engine while riding, there is no thrust of the jet pump. The boat goes straight ahead even though the handlebar is turned.

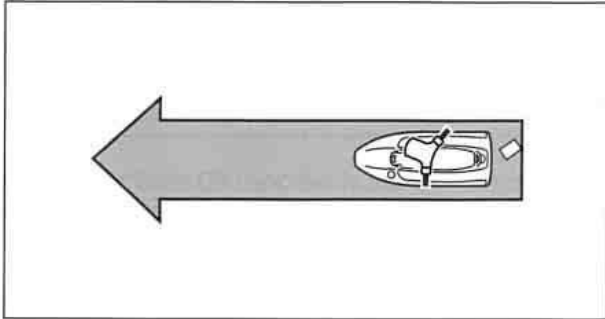

NO THRUST = NO TURN

⚠ WARNING

Do not stop the engine if you may need to reapply throttle to quickly steer the watercraft. You have no directional control when the engine is stopped.

This is one characteristic of jet drive boats which is important to remember when you make an emergency maneuver: **YOU MUST HAVE THRUST TO TURN**, so keep the throttle on or apply throttle as needed to maintain thrust at the jet nozzle.

- Throttle down before entering a turn.

⚠ WARNING

This is a very maneuverable, sport watercraft. Quick turns or acceleration can cause the passenger to fall overboard, and can cause an accident with other boats. The operator should look carefully for other boats before making any quick maneuvers. The passenger should hold on during quick turns.

68 OPERATING INSTRUCTIONS

Docking the JET SKI Watercraft

- When docking use the throttle efficiently both to control the craft's speed and to keep directional control over the craft.
- When you are approaching the shore where you intend to land, push the engine stop button to prevent sand from entering the jet pump and the impeller. Do not operate the engine in water shallower than 0.8 m (2.5 ft).

CAUTION

Do not run the watercraft onto the shore, or severe impeller or hull damage may occur and the water wheel at the stern may be damaged causing the speedometer to malfunction.

Do not operate in shallow or debris-laden water, or the impeller may be damaged and sand may clog the water cooling hoses.

- Remember that stopping the engine causes you to lose steering control, so cut the engine only after you have reduced speed and maneuvered into your final approaching position. You cannot make any emergency maneuvers with the engine stopped.

Riding the JET SKI Watercraft

On your first ride, straddle the craft and sit down on the seat. Familiarize yourself with the handling of the boat. Vary the engine speed with the throttle lever to get the feel of throttle influence on steering. If porpoising occurs, that is, the front of the craft rises and falls rapidly, move your body weight further forward or adjust the jet pump nozzle with the trim adjust switch. Refer to the Controls section in the General Information chapter.

⚠ WARNING

Never ride with your chin immediately above the handlebar. If you should hit a wave, you might injure yourself.

If the engine runs out of fuel (the LED warning light, fuel symbol and bottom segment flash), do not operate the choke knob. Turn the fuel knob to RES and push the green start button again.

Stay alert at all times, and keep away from other boats, swimmers, and obstructions.

NOTE

- *Since operating distance is limited when on RES, refuel at the earliest opportunity.*
- *Make certain that the fuel knob is turned to ON (Not RES) after filling up the fuel tank.*

Fall Recovery:

If the operator falls off the craft, the lanyard key is pulled off of the lanyard switch and the engine is stopped immediately.

WARNING

When you fall, do not hang onto the handlebar. Let go, or you might injure yourself by striking the watercraft.

- The best way to hit the water is bottom first, legs together, with your arms over your head. This can help prevent injury from underwater objects.
- Go back aboard from the rear of the craft. Push the lanyard key under the lanyard switch, and push the start button to start the engine.

Righting the Capsized Watercraft:

If the watercraft should capsize, the engine is stopped by the lanyard key being pulled off of the lanyard switch by the operator. Follow this procedure **immediately**.

WARNING

This watercraft will not self-right if capsized. Operators must know the proper righting procedure or they could be stranded.

- Make sure the engine is stopped. If it is not stopped, immediately pull the lanyard key off the lanyard switch or push the stop button to stop the engine.

CAUTION

If the engine continues running with the craft capsized, water can enter the carburetor and engine, locking the engine. This will cause severe and immediate damage to internal engine parts.

Do Not operate the watercraft with water in the engine. **Do Not** try to start the engine until it is completely empty of water; internal engine parts could be severely and immediately damaged.

If water gets into the engine, follow the procedure described in the After Submerging section.

- Swim to the rear corner of the capsized craft.
- Push down on the port side of the craft with one hand and reach across the hull and grasp the rear of the deck with the other, as though trying to pull yourself up onto the bottom of the hull.
- Now, push down on the rear corner of the hull with one foot, using your body weight to roll the capsized craft toward you.
- As the craft rolls over toward you, reach for the far side of the hull, if needed, and pull it on over.

70 OPERATING INSTRUCTIONS

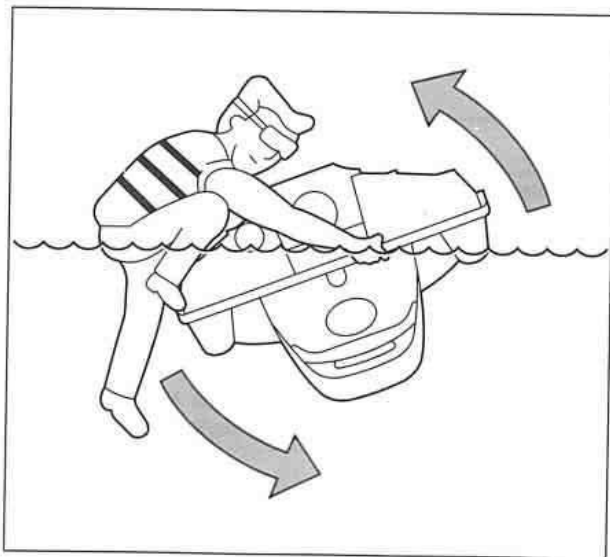

- Push the lanyard key under the lanyard switch, and push the start button to start the engine.
- Ride the watercraft slowly to shore, beach it, and drain the water out of the engine compartment. This will help prevent getting water in the engine, which could cause severe and immediate damage to internal engine parts.

- After the watercraft has capsized and been righted, it will have water in the engine compartment. Carefully go back aboard from the rear, trying not to let more water into the engine compartment under the seat.

NOTE

- *If you have a passenger, he or she may want to return to shore on another watercraft to decrease the load on yours, and prevent it taking on more water.*

After Submerging:**CAUTION**

Do Not operate the craft with water in the engine. Do Not try to start the engine until it is completely empty of water; internal engine parts could be severely and immediately damaged.

If water gets into the engine, follow this procedure immediately! If water is left in the engine more than a few hours, it will destroy the crankshaft bearings and damage other internal engine parts.

If the watercraft becomes swamped, water may enter the engine through the carburetor intake. Water may also enter the fuel tank and oil tank.

1. Remove the craft from the water, and remove the seat.
2. Remove the drain screws in the stern to drain water out of the engine compartment.
3. Pull the spark plug caps from the spark plugs and push the caps fully onto the spark plug cap holder mounted on the electric case, and then remove the spark plugs.

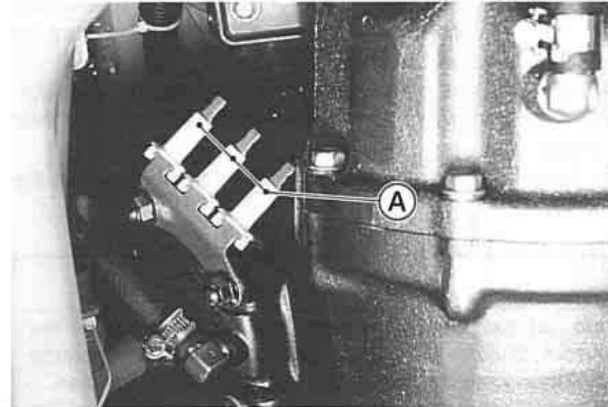

A. Spark Plug Cap Holder

4. Turn the ignition switch on, push the lanyard key under the lanyard switch, and push the start button. Water in the engine will be pumped out of the spark plug holes.

⚠ WARNING

Do not lean over the engine when performing this procedure. A water and gasoline mixture will be forcibly ejected from the spark plug holes and could get into your eyes. If you do get some in your eyes, wash your eyes immediately with liberal amounts of clean, fresh water. Consult a physician as soon as possible.

72 OPERATING INSTRUCTIONS

Do not operate the starter for longer than 5 seconds. Wait 15 seconds before using it again. Be sure all water is out of the engine.

5. Pull the spark plug caps off the spark plug cap holder.
6. Spray the spark plugs clean and install them and their caps.
7. Turn the choke knob to the ON position and start the engine.

CAUTION

Do not run the engine with the watercraft out of the water for more than 15 seconds at a time. Overheating will cause severe engine and exhaust system damage. Never operate the engine at maximum speed out of the water. Severe engine damage may occur.

8. If the engine will not start, remove the spark plugs and check them for presence of water. Spray them clean and try to start the engine again. Continued water fouling may indicate water in the fuel system.
9. If the fuel tank has water in it, it must be emptied by pump or siphon. Clean the fuel filter screens and fuel filter (see the Fuel and Oil Systems section in the MAINTENANCE AND ADJUSTMENTS chapter). Refill the tank with fresh fuel. Do not dump contaminated fuel in places not designated for that purpose.

⚠ WARNING

Gasoline is extremely flammable and can be explosive under certain conditions. Pull the lanyard key off the lanyard switch. Do not smoke. Make sure the area is well ventilated and free from any source of flame or sparks; this includes any appliance with a pilot light.

⚠ WARNING

Gasoline is a toxic substance. Dispose of gasoline properly. Contact your local authorities for approved disposal methods.



A. Siphon Hose

NOTE

- *It may be necessary to repeat these procedures several times before all water is removed from the engine. Continued trouble may require disassembly of the fuel pump to drain water. See your dealer for this service.*

10.If the oil tank has water in it, it must be emptied. Disconnect the oil intake hose from the oil pump and run the hose into a container.

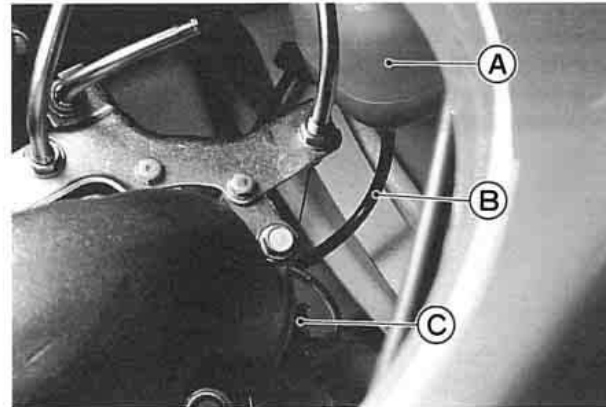

A. Oil Tank

B. Intake Hose

C. Oil Pump

11.Reconnect the hose to the oil pump and refill with fresh engine oil. Do not dump contaminated engine oil in places not designated for that purpose.

▲ WARNING

Engine oil is a toxic substance. Dispose of contaminated oil properly. Contact your local authorities for approved disposal methods or possible recycling.

12.Bleed the air inside the oil line (see the Fuel and Oil Systems section in the MAINTENANCE AND ADJUSTMENTS chapter).

74 OPERATING INSTRUCTIONS

- 13.Reinstall the seat and secure it.
- 14.Reinstall the drain screws in the stern.
- 15.Finally, run the craft IN WATER for at least 10 minutes to dry any remaining water and blow any foreign matter (like salt) out through the exhaust.

End of the Day Checklist

These watercraft are not meant to be left in the water for extended periods. Boats that are left in the water are hauled out periodically, the bottoms scraped and repainted with antifouling paint. Also electrolysis can cause pump failure through erosion of metal parts.

First, Drain the Exhaust System:

- Remove the watercraft from the water.
- Start the engine and run it for several seconds to purge the exhaust system of excess water. Rev the engine repeatedly, until water stops coming out of the exhaust at the stern.

CAUTION
<p>Never operate the engine at maximum speed out of the water. Severe engine damage may occur. Do not run the engine with the watercraft out of the water for more than 15 seconds at a time. Overheating will cause engine and exhaust system damage.</p>

- After each use in salt water, flush the cooling system with fresh water (see the Cooling System Flushing section in the MAINTENANCE AND ADJUSTMENTS chapter). This will help prevent build up of salt deposits and eventual cooling system blockage.

Second, Clean the Engine Compartment:

- Remove the seat.
- If water has accumulated in the engine compartment, remove the drain screws in the stern to drain water out of the compartment. Be sure to reinstall the drain screws after draining.
- Wipe the engine compartment dry, and install the seat.
- When the watercraft is ready for storage, leave the seat off, or block it up with 10 mm (one half inch) spacers to aid air circulation and prevent condensation from forming.

NOTE

- *Personal watercraft are not meant to be left in the water for extended periods. Continuous exposure to water over a long period of time will cause the hull paint to bubble and peel. It also causes electrolytic erosion of the metal parts of the jet pump, decreasing its service life. Larger boats which are left in the water must be hauled out periodically, so the bottom of the hull can be scraped and repainted with anti-fouling paint. They also usually have a sacrificial anode to reduce electrolytic erosion of metal parts in contact with the water. Your watercraft will last longer and look better, if you remove it from the water at the end of every day's use.*

Special Procedures**Clearing Clogged Impeller:**

Occasionally, weeds or other debris may lodge in the impeller/jet pump, severely impairing performance. This foreign matter must be completely cleaned out for the jet pump to function properly.

- Shut off the engine, and beach the craft.

⚠ WARNING

Never attempt to clear the jet pump of debris while the engine is running, or a severe injury can occur. Stop the engine and pull the lanyard key off the lanyard switch before checking the pump for debris.

- Pull the lanyard key off the lanyard switch.
- Place a protective pad next to the boat.
- Tip the boat on its **left side** and remove the jet pump grate and cover, if necessary.

76 OPERATING INSTRUCTIONS

CAUTION

Always turn the boat on its left side when rolling. Rolling to the right side can cause water in the exhaust system to run into the engine, with possible engine damage.

- Clean the water intake, drive shaft, impeller, jet pump housing, outlet, and steering nozzle of any seaweed, grass, or other debris.

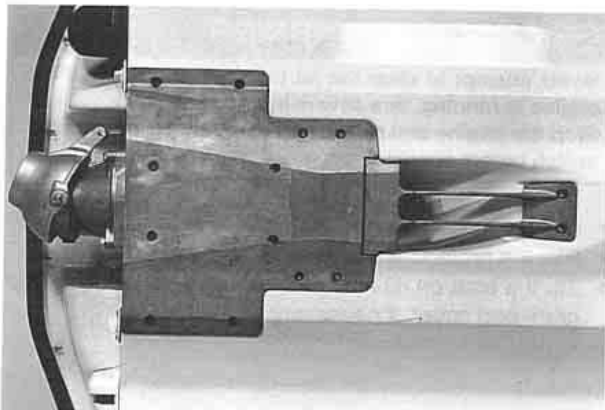

CAUTION

Be sure the pump area and all its components are completely clear. Engine cooling water is supplied by the jet pump, and any loss of pump performance may cause overheating.

- Apply silicone sealant to the jet pump cover and grate, then reinstall them. Tighten the screws securely.

Cleaning Fouled Spark Plugs:

Fouled spark plugs can result from several causes. Among them, low idle speed, prolonged idling, and operating with the choke on. Water in the fuel or inside the engine can also cause spark plug fouling.

- Remove the fouled spark plugs and install clean, dry plugs. Fouled plugs may be cleaned with electrical contact cleaner (P/N K61080-001B). Wet plugs may be cleaned with a penetrating rust inhibitor, such as WD40 or Bel-Ray 6 in 1.
- Start the engine, using very little throttle.

Towing the JET SKI Watercraft:

In case you run out of fuel, have engine problems or other complications, the watercraft may be towed. Attach one end of a 6 m (20 foot) tow rope to the eye in the bow and the other end to the tow boat. Towing must be slow, not over 8 km/h (5 mph).

CAUTION

It is important that these instructions be followed or the engine compartment could flood and the watercraft could partially submerge.

Jump Starting:

If your watercraft's battery is run down, it should be removed and charged. If this is not practical, a booster battery and jumper cables may be used to start the engine. The booster battery must be of the same voltage as the watercraft battery (12 V).

WARNING

Battery acid generates hydrogen gas which is flammable and explosive under certain conditions. It is present within a battery at all times, even in a discharged condition. Keep all flames and sparks (cigarettes) away from the battery. Wear eye protection when working with a battery. In the event of battery acid contact with skin, eyes, or clothing, wash the affected areas immediately with water for at least five minutes. Seek medical attention.

- Turn the ignition switch off.
- Remove the seat.
- Remove the filler caps from the booster battery.
- Lay a cloth over the open vents of the booster battery.
- Connect a jumper cable between the positive (+) terminals of the two batteries.
- Connect one end of the remaining jumper cable to the negative (-) terminal of the booster battery.

CAUTION

Connecting two batteries in reverse polarity (+ to -) can seriously damage the electrical system

78 OPERATING INSTRUCTIONS

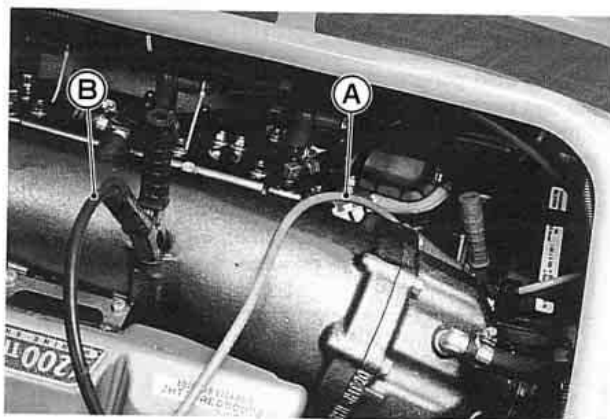

A. Positive Cable

B. Negative Cable

- Connect the other end of the remaining jumper cable to the exhaust pipe bolt.

WARNING

Do not make this last connection at the carburetor or battery. Take care that you do not short the cables together, and do not lean over the battery when making this last connection. Do not jump start a frozen battery. It could explode.

CAUTION

Do not operate the starter continuously for more than 5 seconds or the starter will overheat. Wait 15 seconds between each operation of the starter to let it cool.

- Start the watercraft engine following the standard engine starting procedure and then disconnect the jumper cables in the reverse of the sequence just described.
- Dispose of the cloth covering the booster battery and reinstall the filler caps.

Engine Overheating:

This watercraft is equipped with a temperature sensor which flashes the LED warning light and cooling water temperature symbol, and slows down the engine if the engine overheats.

- If the warning light and water temperature symbol flash, and the watercraft slows down, return to the shore immediately and check the cooling system for clogging.

CAUTION

If engine overheats, the LED warning light and water temperature symbol flash and the engine slows down. Return to shore immediately. To prevent engine damage, do not operate the craft until the cause of overheating is corrected.

Transporting

- When transporting the watercraft on a trailer, observe the trailer laws and regulations in your area.
- Be sure the trailer matches with the craft's weight and hull design.
- Turn the fuel knob to the "OFF" position.
- Securely fasten the watercraft to prevent movement between the craft and trailer.

CAUTION
Never attach tie-downs to the handrail behind the seat. Do not allow anything to touch the water wheel at the stern, or it may be damaged causing the speedometer to malfunction.

STORAGE

During the winter, or whenever your watercraft will not be in use for more than 30 days, proper storage is essential. It consists of checking and replacing missing or worn parts; lubricating parts to ensure that they do not become rusted; and, in general, preparing the watercraft so that when the time comes to use it again, it will be in top condition. See your Kawasaki JET SKI dealer for this service or do the following.

NOTE

- *Personal watercraft are not meant to be left in the water for extended periods. Continuous exposure to water over a long period of time will cause the hull paint to bubble and peel. It also causes electrolytic erosion of the metal parts of the jet pump, decreasing its service life. Larger boats which are left in the water must be hauled out periodically, so the bottom of the hull can be scraped and repainted with anti-fouling paint. They also usually have a sacrificial anode to reduce electrolytic erosion of metal parts in contact with the water. Your watercraft will last longer and look better, if you remove it from the water at the end of every day's use.*

Preparation for Storage

Cooling System:

- Clean the cooling system (see the Cooling System Flushing section in the MAINTENANCE AND ADJUSTMENTS chapter).

Bilge System:

- Clean the bilge system (see the Bilge System Flushing section in the MAINTENANCE AND ADJUSTMENTS chapter), but before reconnecting the hoses to the plastic breather fitting, blow air through both hoses to force all water out of the bilge system.

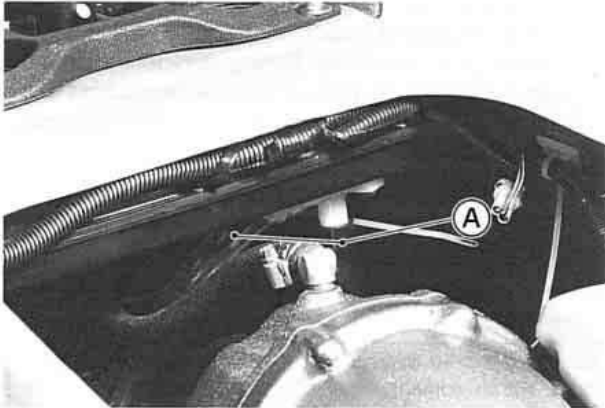

A. Blow through both hoses.

Fuel System and Engine:

- Wash the engine compartment with fresh water and remove the drain screws in the stern to drain the water. Wipe up any water left in the compartment.

⚠ WARNING

Gasoline is extremely flammable and can be explosive under certain conditions. Pull the lanyard key off the lanyard switch. Do not smoke. Make sure the area is well ventilated and free from any source of flame or sparks; this includes any appliance with a pilot light.

- Drain the fuel tank. This should be done with a siphon or pump.

⚠ WARNING

Gasoline is a toxic substance. Dispose of gasoline properly. Contact your local authorities for approved disposal methods.

- Inspect/clean the fuel filter screens and inspect/replace the fuel filter (see the Fuel and Oil Systems section in the MAINTENANCE AND ADJUSTMENTS chapter).
- Leave the fuel filler cap loose to prevent condensation in the tank.
- Wash the flame arrester elements should be done by Kawasaki JET SKI dealer.
- Remove the spark plugs and push the plug caps fully onto the plug cap holder on the electric case.
- Spray fogging oil directly into each cylinder.
- Turn the engine over several times with the start button to coat the cylinder walls.

82 STORAGE

WARNING

Do not lean over the engine when performing this procedure. An air/oil mist may be forcibly ejected from the spark plug holes and could get into your eyes. If you do get some in your eyes, wash your eyes immediately with liberal amounts of clean, fresh water. Consult a physician as soon as possible.

- Spray the spark plugs with fogging oil, and reinstall them.
- Pull the lanyard key off the lanyard switch and turn the ignition switch off.
- Reinstall the spark plug caps.

Battery:

- Remove the battery (see the Battery section in the MAINTENANCE AND ADJUSTMENTS chapter).
- Clean the exterior with a solution of baking soda and water (one heaping tablespoon of baking soda in one cup of water). Rinse thoroughly with water.

CAUTION

Never remove the sealing strip, or the battery can be damaged.

- Coat both battery terminals with grease.
- Store the battery in a cool, dry place. Do not expose it to freezing temperatures. During storage it should be given a slow charge (one ampere or less) about once a month. Keep the battery well charged especially during cold weather.

Cleaning:

- Wash the exterior and dry it thoroughly.

CAUTION

Use only a mild detergent in water to wash the watercraft. Harsh solvents may attack the surface or smear the colors.

- Apply a good grade of wax to all exterior hull surfaces.
- Lightly spray all exposed metal parts with a penetrating rust inhibitor, such as WD40 or BEL-RAY 6 in 1 to prevent corrosion.
- Remove the seat, or block it up with 10 mm (one half inch) spacers to insure adequate ventilation and prevent condensation from forming.
- Cover the watercraft and store it in a clean, dry place.

NOTE

- *If the watercraft is left outside, even covered, water can collect in the footwells on either side of the seat. Water left in the footwells can cause the paint to bubble and peel, and the mat to peel off the deck. If the watercraft is left on the trailer, raise the tongue so that any water that gets in can run out of the footwells.*

Lubrication:

- Carry out all recommended lubrication procedures (see the Lubrication section in the MAINTENANCE AND ADJUSTMENTS chapter).

Removal from Storage

The following procedure explains the steps necessary to put the watercraft back in service following a storage period. See your Kawasaki JET SKI dealer for this service, or do the following. See the MAINTENANCE AND ADJUSTMENTS chapter for detailed procedures.

- Carry out all recommended lubrication procedures (see the Lubrication section).
- Check for binding or sticking throttle, choke, steering or trim mechanism. The throttle lever must return fully when released.
- Clean and gap spark plugs (see the Spark Plug section).
- Check all rubber hoses for weathering, cracking, or looseness.
- Turn the craft on its **left side** on a protective pad, and remove the jet pump cover. Check cooling and bilge hoses for weathering, cracking or looseness.
- Replace them if necessary. Reinstall the cover and tighten securely.
- Check that the drain screws in the stern are securely tightened.
- Check the fire extinguisher for a full charge.
- Clean the terminals of the battery and charge if necessary. Install the battery (see the Battery section).
- Inspect/replace the fuel filter screens and fuel filter (see the Fuel and Oil Systems section).

84 STORAGE

- Fill the fuel tank with fuel and close the filler cap securely.

WARNING

Gasoline is extremely flammable and can be explosive under certain conditions. Pull the lanyard key off the lanyard switch. Do not smoke. Make sure the area is well ventilated and free from any source of flame or sparks; this includes any appliance with a pilot light.

- After transporting or refueling and before starting the engine, open the hatch cover, take out the storage box and remove the seat for several minutes to ventilate the engine compartment.

WARNING

A concentration of gasoline fumes in the engine compartment can cause a fire or explosion.

- Check for fuel leaks. Repair if necessary.
- Check/clean the oil filter.
- Check the engine oil level. Fill the oil tank with the specified oil.

WARNING

Do not run the engine in a closed area. Exhaust gases contain carbon monoxide: a colorless, odorless, poisonous gas. Breathing exhaust gas leads to carbon monoxide poisoning, asphyxiation, and death.

- Start the engine and run it for 15 seconds. Check for fuel, oil and exhaust leaks. Any leaks must be repaired.

CAUTION

Never run the engine with the watercraft out of the water for more than 15 seconds. Overheating will cause severe engine and exhaust system damage. Do not run the engine at maximum speed out of the water. Severe engine damage may result.

- Install the seat making sure it is locked.

MAINTENANCE AND ADJUSTMENTS

Periodic Maintenance Chart

NOTE

- Complete the Pre-ride Checklist before each outing.

Description	Frequency	Initial 10 Hours	Every 25 Hours	Every 100 Hours
Check all hose clamps, nuts, bolts, and fasteners		●	●	
Torque rear mounting plate nuts		●		
Lubricate throttle cable fitting and choke cable fitting at carburetor			●	
Clean and gap spark plugs (replace if necessary)			●	
Lubricate choke cable and throttle cable, and throttle cable fitting at throttle case			●	
Lubricate steering cable joint at steering shaft and steering nozzle/trim nozzle pivots			●	
* Lubricate handlebar pivot (disassemble)			●	
* Clean fuel filter screen			●	

86 MAINTENANCE AND ADJUSTMENTS

Description	Frequency	Initial 10 Hours	Every 25 Hours	Every 100 Hours
* Inspect/replace fuel filter				●
Adjust carburetor			●	
Flush bilge line and filter			●	
Flush cooling system (after each use in salt water)			●	
* Inspect/clean flame arrester			●	
* Inspect impeller blades for damage (remove)				●
* Inspect/replace coupling damper				●
* Inspect steering cable / trim cable		●		●

*These items must be performed with the proper tools. See your authorized Kawasaki JET SKI dealer for service, unless you have the proper equipment and mechanical proficiency (refer to the Service Manual).

Control Cable Adjustments

Choke Cable Adjustment

- Check choke cable adjustment.
- When the choke knob is turned to the OFF position, the choke butterfly valve in the carburetor should be completely open. The choke pivot arm should stand all the way toward the port side of the boat with cable slack.
- When the choke knob is turned to the ON position, the choke butterfly valve in the carburetor should be completely closed. Check that the choke pivot arm stands all the way toward the starboard side of the boat and that the arm will not turn farther by hand.

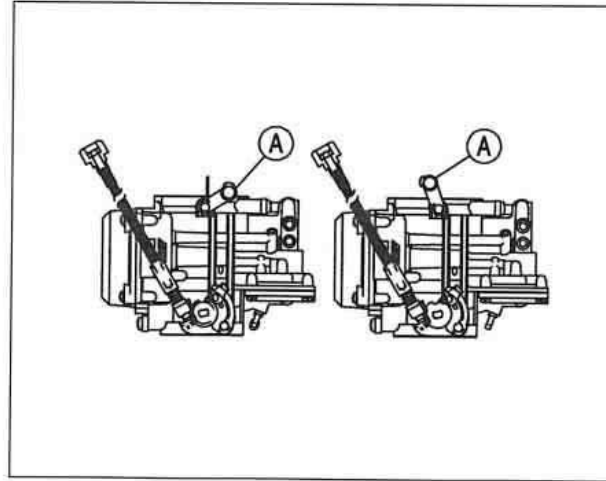

Choke Open
(Turned to OFF)

Choke Closed
(Turned to ON)

A. Choke Pivot Arm

- If the choke pivot arm does turn, adjust the choke cable.
- Loosen the locknuts at the cable bracket and turn the choke knob to the ON position.

88 MAINTENANCE AND ADJUSTMENTS

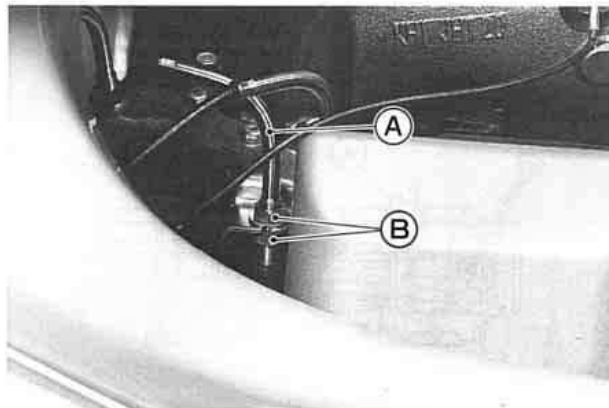

A. Choke Cable

B. Locknuts

- Push the choke pivot arm all the way toward the starboard side of the boat by hand, and turn the locknuts at the cable bracket until the arm can not turn farther, and then tighten the locknut.
- Turn the choke knob to the OFF position.
- Check that the choke pivot arm stands all the way toward the port side of the boat with cable slack.

Throttle Control Cable Adjustment

The throttle control cable is actually an assembly of three cables: the throttle cable, the carburetor cable, and the oil pump cable. The throttle cable runs from the throttle lever to the cable assembly junction where it connects to both the carburetor cable which leads to the carburetor, and the oil pump cable which leads to the oil pump.

Since the throttle lever controls both the carburetor and the oil pump simultaneously, it is important that each cable be adjusted to its designed base position so that the oil and fuel/air mixture reach the engine in the correct proportion at all throttle openings. Cable stretch creates excess play at the throttle lever and alters the base positions of the cables at the carburetor and the oil pump, necessitating periodic adjustment.

NOTE

- *Be sure to inspect and adjust the carburetor and oil pump cables at the same time.*

MAINTENANCE AND ADJUSTMENTS 89

Carburetor Cable Adjustment:

- Check carburetor cable adjustment.
- With the throttle lever released, the lower stop on the throttle pivot arm should rest against the idle adjust screw, and there should be slight slack in the carburetor cable.
- When the throttle lever is fully applied (pulled), the upper stop on the pivot arm should be all the way up against the stop on the carburetor.

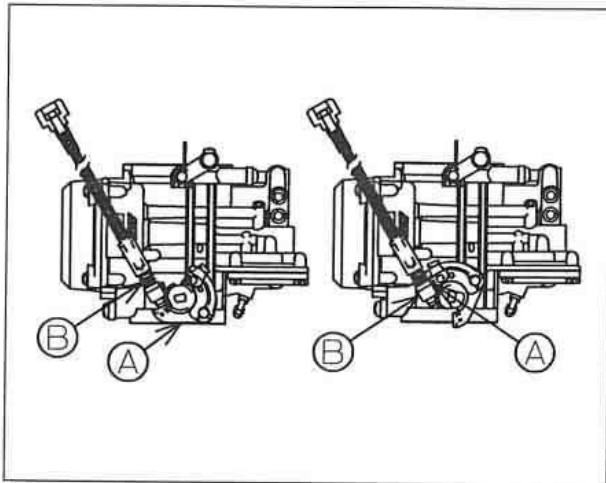

THROTTLE CLOSED
(RELEASED)

THROTTLE OPEN
(APPLIED)

- A. Throttle Pivot Arm
- B. Idle Adjust Screw

- If necessary, adjust the carburetor cable.
- Loosen and turn the locknuts at the cable holder until the lower stop on the pivot arm hits against the idle adjust screw with slight cable slack.
- Tighten the locknuts securely.

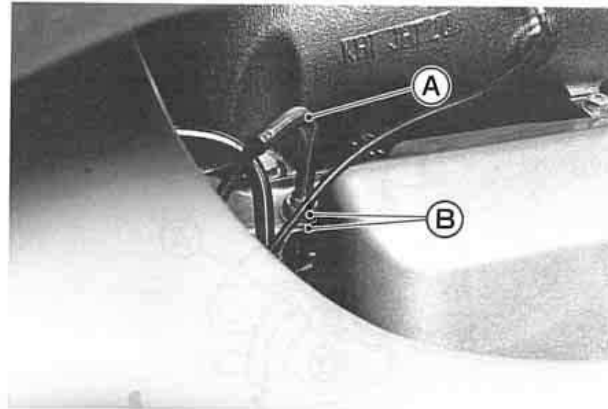

A. Carburetor Cable

B. Locknuts

- Check the oil pump cable adjustment (see Oil Pump Cable Adjustment).
- If necessary, adjust the oil pump cable.

90 MAINTENANCE AND ADJUSTMENTS

Oil Pump Cable Adjustment:

- Check carburetor cable adjustment.
- If necessary, adjust the carburetor cable.
- Check oil pump cable adjustment.
- When the throttle lever is fully applied (pulled), check to see that the stop on the oil pump pulley contacts the stopper pin on the oil pump body. At this time, the oil pump pulley is fully opened.

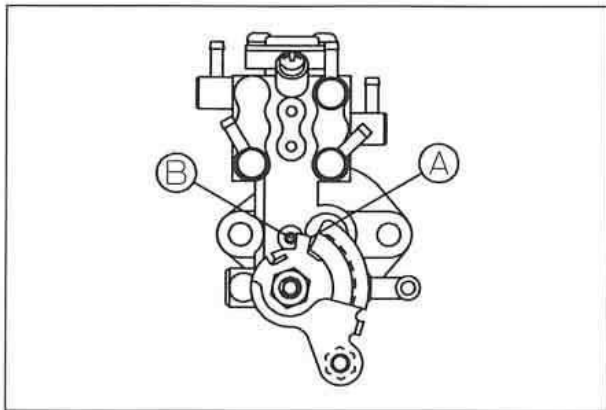

A. Stop

B. Stopper Pin

- If necessary, adjust the oil pump cable.
- Hold the throttle lever fully applied (pulled).
- Turn the oil pump pulley till the stop on the pulley contacts to the stopper pin on the oil pump body. At this time, the oil pump pulley is fully open. And then give the oil pump cable tension by turning the upper adjusting nut clockwise.
- Loosen the upper adjusting nut by turning counter-clockwise 1/2 times and then fix the oil pump cable by tightening the lower adjusting nut securely.

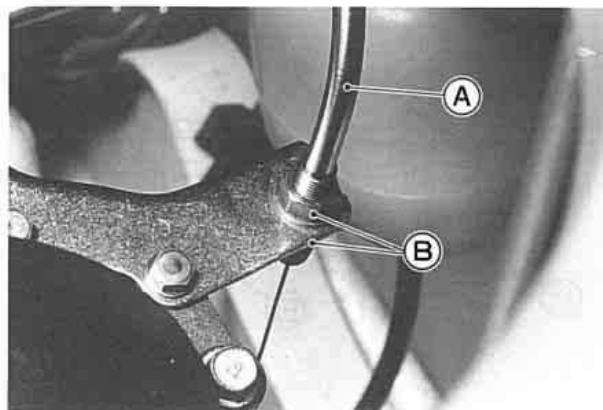

A. Oil Pump Cable

B. Adjusting Nuts

MAINTENANCE AND ADJUSTMENTS 91

Steering Cable Adjustment

- Center the handlebar in a straight ahead steering position.



- Check that the steering nozzle is the same distance from each side of the pump cavity.

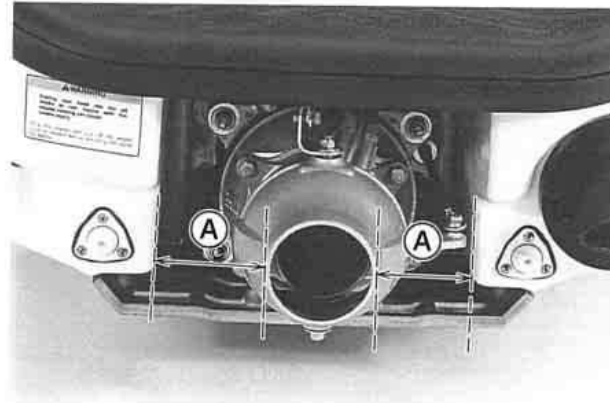

A. Equal

- If it is not, adjust the steering cable.

92 MAINTENANCE AND ADJUSTMENTS

- Loosen the locknut on the end of the steering cable located to the right of the steering nozzle.

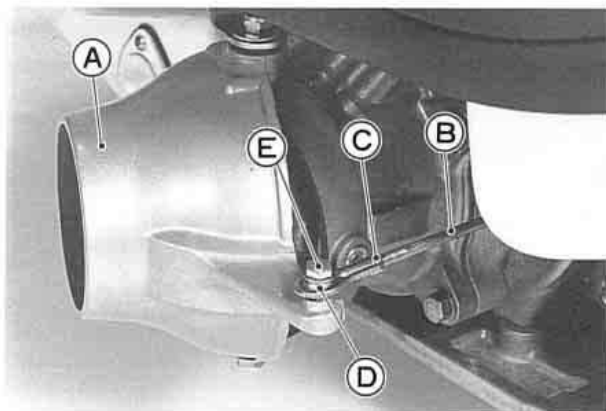

- A. Steering Nozzle
- B. Steering Cable
- C. Locknut
- D. Joint
- E. Bolt

- Remove the bolt and disconnect the cable joint from the steering nozzle.
- Center the handlebar in a straight ahead steering position.

- Turn the joint on the cable to adjust the steering.

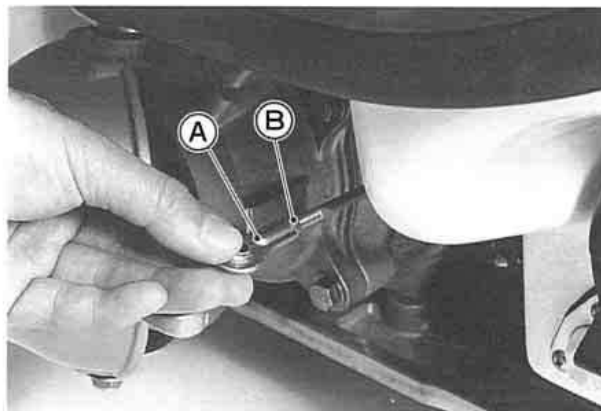

- A. Joint
- B. Locknut

- Reattach the joint and check cable adjustment again.
- When adjustment is correct, tighten the bolt and locknut.

MAINTENANCE AND ADJUSTMENTS 93

- As an additional check, turn the handlebar all the way to the left and right, and measure the distance between the nozzle and the edge of the pump cavity. It should be equal at both extremes.



A. Equal

Steering Cable/Trim Cable Inspection

Steering cable and trim cable inspection are best performed by your authorized Kawasaki JET SKI dealer. If the steering feels rough or "catchy," have your dealer inspect the steering cable.

NOTE

- The steering cable and trim cable are sealed at each end and does not require lubrication.

Fuel and Oil Systems

Carburetor Adjustments:

Idle Speed

The normal idle speed is the lowest stable speed.

- Turn the idle adjust screw to the right to increase idle speed or to the left to decrease it.

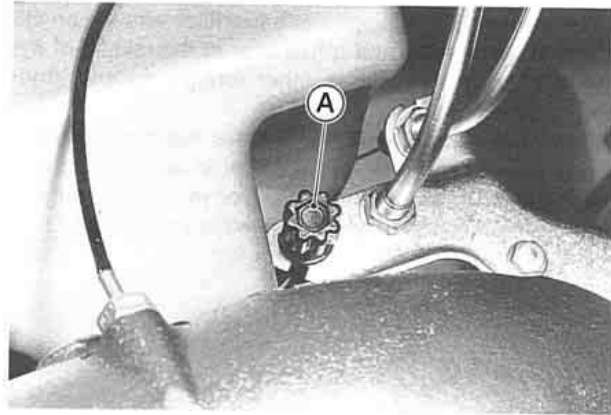

A. Idle Adjust Screw

Idle Speed

About 1 250 rpm – in water

About 1 800 rpm – out of water

94 MAINTENANCE AND ADJUSTMENTS

High Altitude Use

The original carburetor settings for this watercraft are best for sea level use. When the craft is used at high altitude, the thinner atmosphere makes the air/fuel mixture richer reducing performance and increasing fuel usage. Have the carburetor adjusted by your authorized Kawasaki JET SKI dealer if you intend to use this craft above 1,000 m (3,000 ft).

Fuel Filter Screens/Fuel Filter:

The watercraft is equipped with fuel filter screens on the fuel outlet assembly and a fuel filter at the middle of the fuel line to prevent dirt or other foreign material from entering the carburetor.

Have your Kawasaki JET SKI dealer inspect and clean or replace the screens and fuel filter in accordance with the **Periodic Maintenance Chart**, or whenever you see any foreign material or water trapped in the fuel filter.

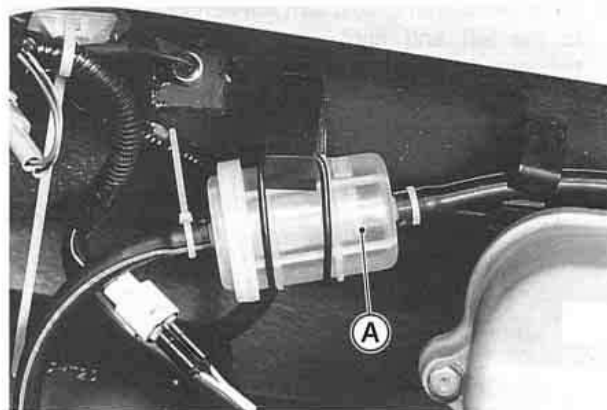

A. Fuel Filter

Oil Filter:

The oil tank is equipped with an oil filter in the oil filler. Check the oil filter for foreign particles every time you add the oil. If there are any foreign particles, the oil filter must be cleaned.

Oil Filter Cleaning

- Take out the oil filter out of the oil filler.

MAINTENANCE AND ADJUSTMENTS 95

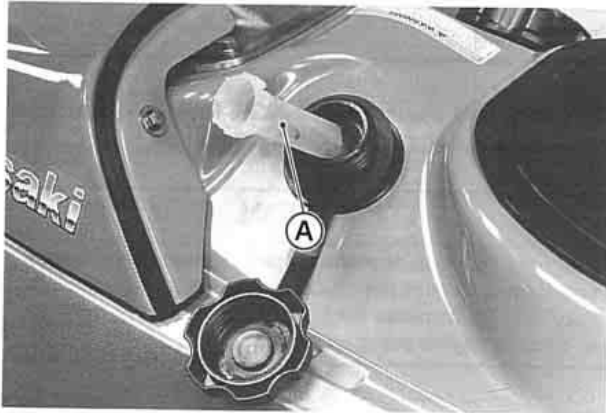

A. Oil Filter

- Wash the oil filter in a non-flammable or high flash-point solvent. Use a brush to remove any contaminants trapped in the filter.

WARNING

Clean the oil filter in a well ventilated area, and take care that there are no sparks or flame anywhere near the working area; this includes any appliance with a pilot light. Do not use gasoline or a low flash-point solvent to clean the filter. A fire or explosion could result.

Oil Pump Bleeding:

When any of the oil pump hoses has been removed, air may become trapped inside, which will then obstruct oil flow.

- Make sure that there is plenty of engine oil in the oil tank and that oil flow is not restricted.
- Place a rag under the oil pump.
- Loosen the air bleeder screw on the oil pump a couple of turns until oil flows out, and then tighten the bleeder screw securely.

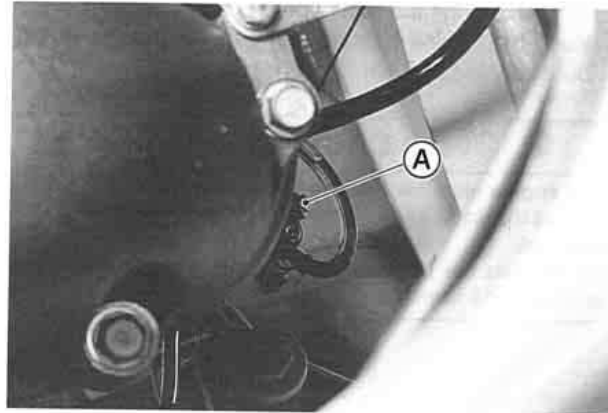

A. Bleeder Screw

- Check the oil line from the oil tank to the oil pump for air bubbles left inside.

96 MAINTENANCE AND ADJUSTMENTS

CAUTION

Air trapped in the oil line will cause obstruction of oil flow and subsequent engine damage. If any air bubbles will not disappear, have an authorized Kawasaki JET SKI dealer bleed the air from the oil line.

- Provide sufficient engine cooling by running water through the cooling hose (see the Cooling System Flushing section).
- Start the engine, keep it at idling speed and check the oil flow through the transparent outlet hose.
- Keep the engine running until the air bubbles in the outlet hose disappear.

CAUTION

The engine must be running before the water is turned on and the water must be turned off before the engine is stopped.
Do not run the engine without cooling water flow for more than 15 seconds.

Spark Plug

The standard spark plug is NGK R6918C-9 set to a 0.55 – 0.65 mm (0.022 – 0.026 in.) gap.

CAUTION

Use only the recommended, special, high-performance spark plug. Do not use other spark plugs, even though they may fit, because they could cause severe damage to internal engine parts.

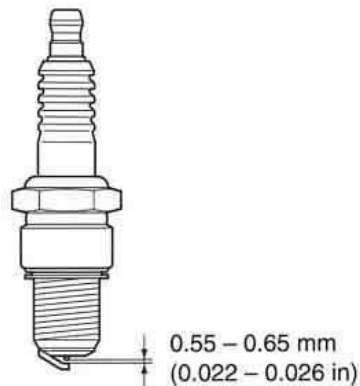

Spark Plug Inspection and Replacement

Remove the spark plugs and inspect the ceramic insulators. The appearance of the insulators reflects the efficiency of the combustion process. When the engine is operating properly, the plug insulators should be clean and show a light brown color. If the insulators look glazed or very white, if the electrodes appear overheated, or if there are gray metallic deposits on the plugs, combustion chamber temperatures are too high. Refer to the TROUBLESHOOTING GUIDE.

CAUTION

As excessive operating temperature can cause serious engine damage, the cause should be located and corrected immediately.

A dry, sooty black deposit on the insulators indicates an overly rich fuel/air mixture. Check for correct carburetor adjustment. If the black deposits are wet and oily, an improper oil type or an excessive oil pump output may be the cause. Refer to the TROUBLESHOOTING GUIDE.

Clean the electrodes and the ceramic insulators around the center electrode by scraping off any deposits or by using a sand blasting device. Make sure that all abrasive particles are removed from the plug and clean the plug in a high flash-point solvent. If the gap has widened, reset it to the standard 0.55 – 0.65 mm (0.022 – 0.026 in.) gap. If the electrodes are badly worn or burned, replace the plug. The spark plug must also be replaced any time there is visible damage such as cracked ceramic or damaged threads.

Battery

The battery installed in this watercraft is a maintenance-free type, so it is not necessary to check the battery electrolyte level or add distilled water.

The sealing strip, should not be pulled off once the specified electrolyte has been installed in the battery for initial service.

Since the electrical system of this watercraft is designed to use only a maintenance-free battery, do not replace it with a conventional battery.

CAUTION

**Never remove the sealing strip, or the battery can be damaged.
Do not install a conventional battery in this watercraft, or the electrical system will not work properly.**

98 MAINTENANCE AND ADJUSTMENTS

NOTE

- If you charge the maintenance-free battery, never fail to observe the instructions shown in the label on the battery.

Battery Removal

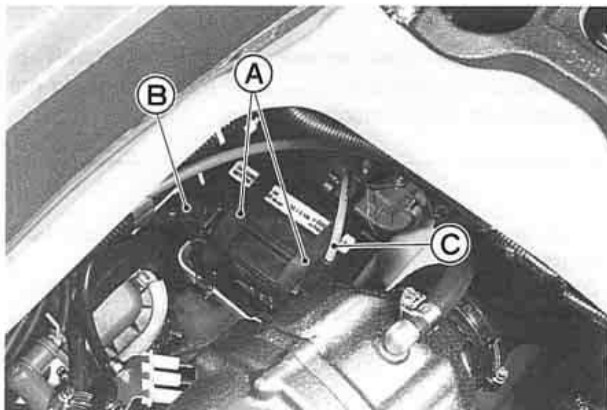

A. Straps

C. Red Lead

B. Black (ground) Lead

- Disconnect the black (ground) lead from the battery first.
- Disconnect the red lead.
- Release the two rubber hold-down straps securing the battery.
- Lift the battery out of the hull. <https://www.boat-manuals.com/>

- Clean the battery top and terminals using a solution of baking soda and water. Scrape off any obstinate deposits with a wire brush or sand blasting device, and then rinse the battery with fresh water. Dry it thoroughly and coat the terminals with waterproof grease.

Battery Installation

- Install the battery in the reverse order of removal.
- After connecting the battery, coat the terminals with waterproof grease.

CAUTION

Do not reverse the battery connections, or damage to the regulator/rectifier unit will result.

Lubrication

As in all marine craft, adequate lubrication and corrosion protection is an absolute necessity to provide long, reliable service. Refer to the **Periodic Maintenance Chart** and **Pre-ride Checklist** in the OPERATING INSTRUCTIONS chapter for the frequency of the following items:

- Lubricate the following with a penetrating rust inhibitor, such as WD40 or BEL-RAY 6 in 1:

Choke Cable, Throttle Cable and Oil Pump Cable

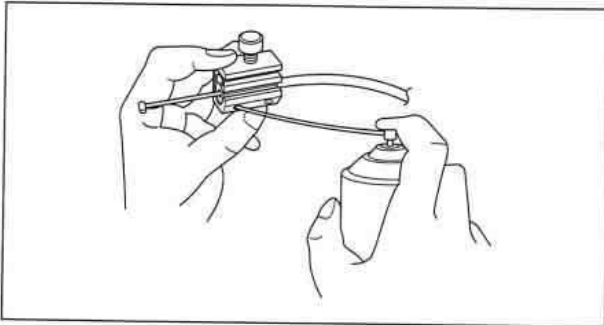

Pressure Cable Luber
Part Number K56019-021

Steering Nozzle/Trim Nozzle Pivots

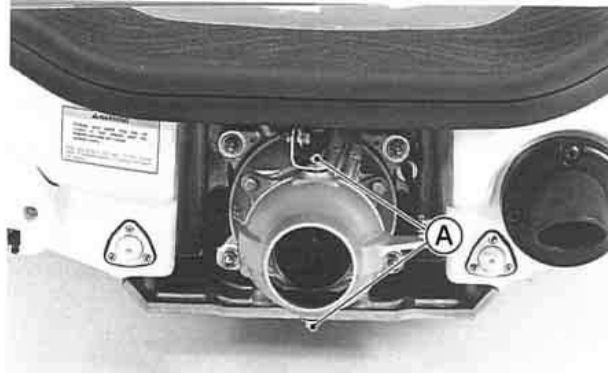

A. Nozzle Pivots

100 MAINTENANCE AND ADJUSTMENTS

- Lubricate the following with a high quality waterproof marine grease.

Throttle Cable Fitting at Throttle Case



A. Apply grease.

Choke Cable Fitting and Throttle Cable Fitting at Carburetor

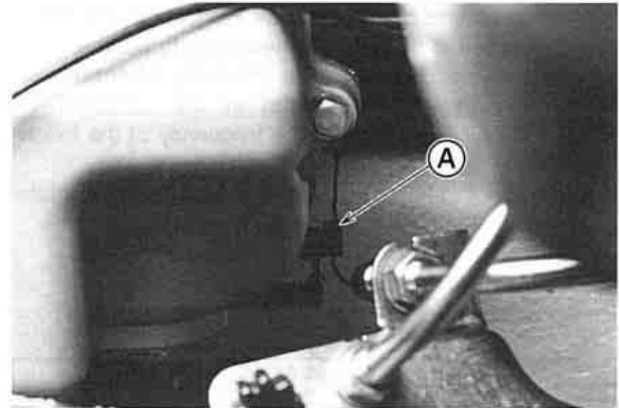

A. Apply grease.

CAUTION

Disassemble and lubricate the handlebar pivot. This function should be performed by your Kawasaki JET SKI dealer.

MAINTENANCE AND ADJUSTMENTS 101

Cooling System Flushing

To prevent sand or salt deposits from accumulating in the cooling system, it must be flushed occasionally. Flush the system according to the **Periodic Maintenance Chart**, after each use in salt water, or whenever there is reduced water flow from the bypass outlet in the right side of the hull.

This procedure is also used to provide auxiliary cooling when needed (for example during Oil Pump Bleeding).

- An inlet for auxiliary water supply is provided fitting on the exhaust pipe.

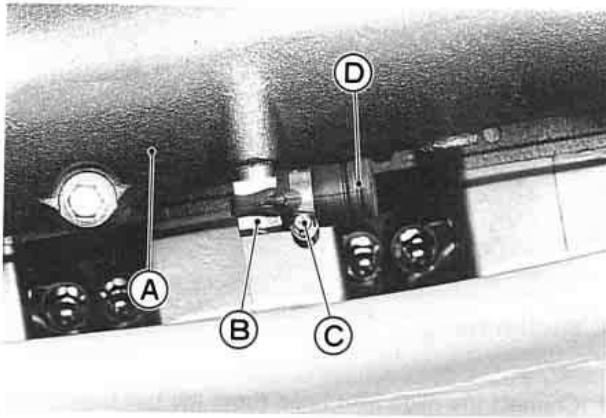

A. Exhaust Pipe
B. Fitting

C. Clamp
D. Cap

- Loosen the clamp and remove the cap, and then connect a garden hose.

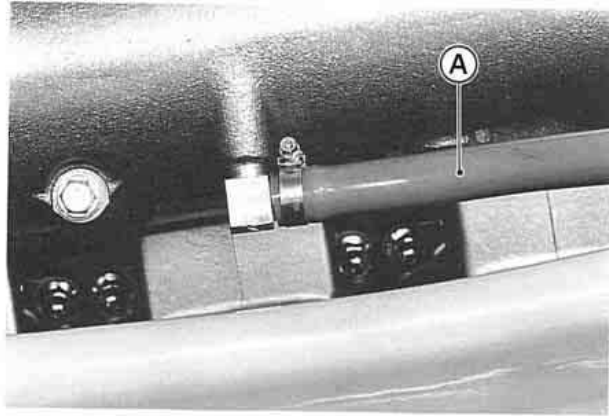

A. Garden Hose

- Start the engine and allow it to idle **before turning on the water**.

CAUTION

The engine must be running before the water is turned on or water may flow back through the exhaust pipe into the engine, resulting in the possibility of severe internal damage.

- Immediately turn on the water and adjust the flow so that a little trickle of water comes out of the bypass outlet in the right side of the hull.

102 MAINTENANCE AND ADJUSTMENTS

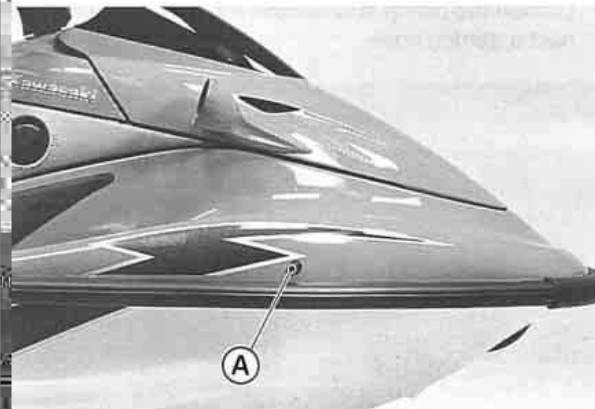

Bypass Outlet

Let the engine idle for several minutes with the water running.

Turn off the water. **Leave the engine idling.**

Rev the engine a few times to clear the water out of the exhaust system.

CAUTION

Do not run the engine without cooling water flow for more than 15 seconds. Overheating will cause severe engine and exhaust system damage.

Switch off the engine, remove the garden hose, reinstall the cap and secure the clamp.

Bilge System Flushing

To prevent clogging, the bilge system should be flushed out according to the **Periodic Maintenance Chart**, or whenever you suspect it is blocked.

- Disconnect both bilge hoses at the plastic breather fitting. It is mounted on the rear left upper corner in the engine compartment.



A. Breather Fitting

- Connect the bilge filter hose (from the hull bottom) to the garden hose, turn the water on, and flush it out for about a minute. During this procedure, water will flow into the engine compartment. Do not allow a large

MAINTENANCE AND ADJUSTMENTS 103

amount of water to accumulate in the engine compartment. Remove the drain screws in the stern to drain the engine compartment.

- Connect the other hose to the garden hose, turn the water on, and flush it out for several minutes.
- Before reconnecting the hoses to the plastic breather fitting, make sure the small breather hole in the fitting is clear. If the hole is clogged, the engine compartment will fill with water when the engine stops or idles. It may be necessary to remove the fitting.

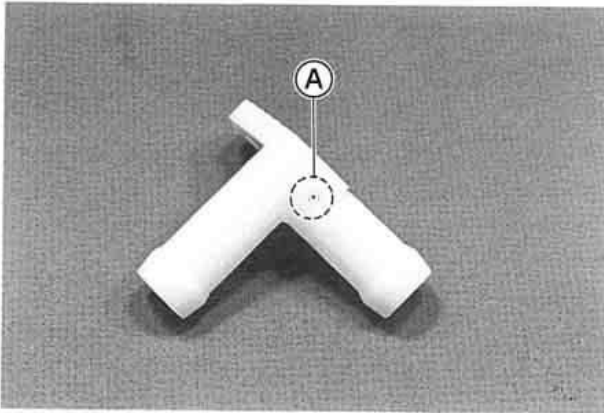

A. Breather Hole

- Reconnect the bilge hoses.

NOTE

- *If your watercraft is to be stored, blow air through both hoses before they are reconnected (see the Preparation for Storage section in the STORAGE chapter).*

104 MAINTENANCE AND ADJUSTMENTS

Rear Mounting Plate Nuts Tightening

In accordance with the Periodic Maintenance Chart, tighten the rear mounting plate nuts (below the rear deck) to the specified torque.

Rear Mounting Plate Nuts Tightening Torque:
25 N-m (2.5 kg-m, 18 ft-lb)

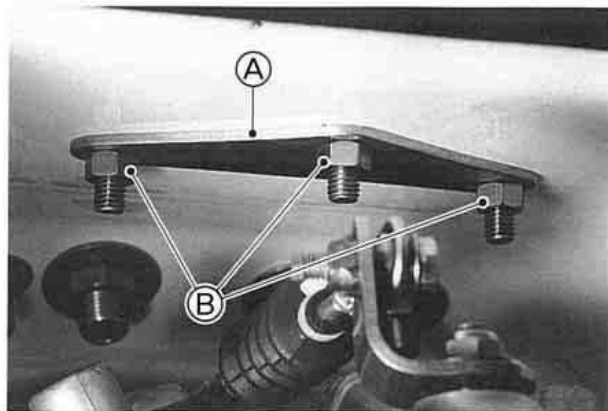

A. Rear Mounting Plate

B. Nuts

TROUBLESHOOTING GUIDE

If this procedure does not isolate your problem, see your JET SKI dealer or refer to the Service Manual.

TROUBLE

CAUSE

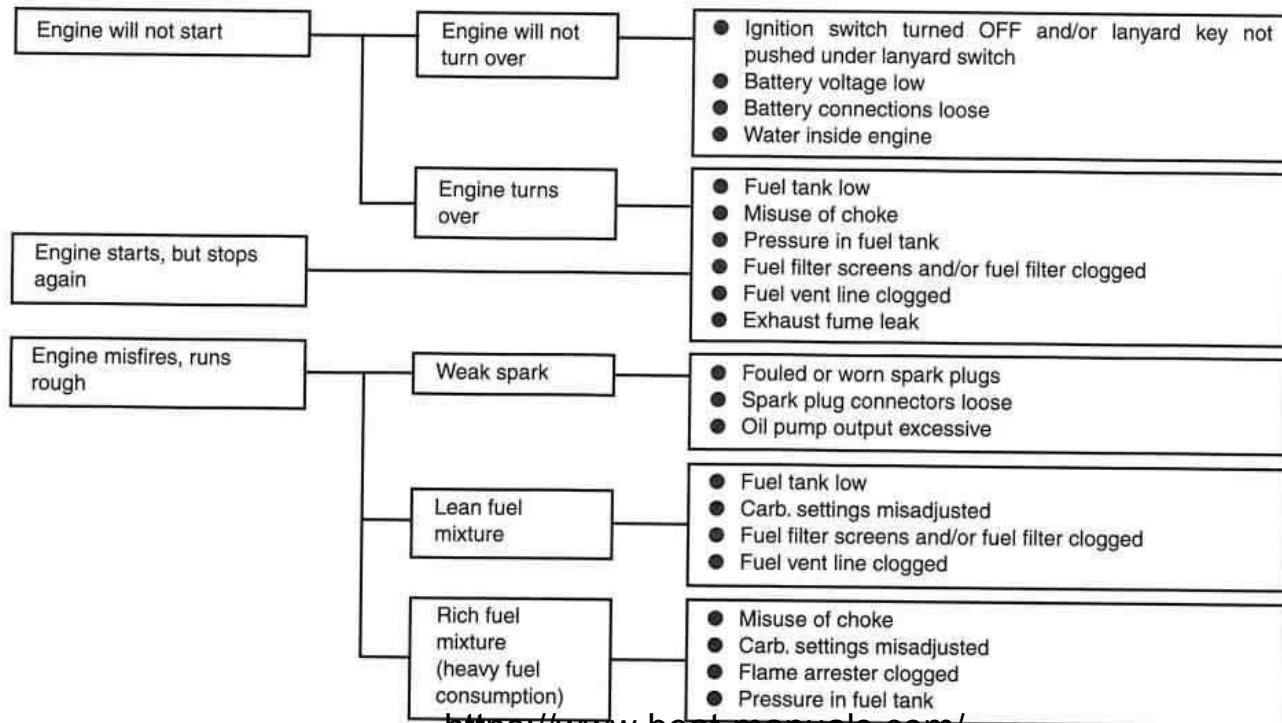

106 TROUBLESHOOTING GUIDE

TROUBLE

CAUSE

Engine power low

- Check items under "misfires," plus:
- Throttle valve adjustment incorrect
- Exhaust system clogged
- Water in gasoline or engine oil

Engine overheating

- Weeds or debris in jet pump
- Cooling water line clogged
- Carb. settings misadjusted
- Engine oil tank vent clogged
- Incorrect type of gas or oil

Gas knock "pinging"

- Poor quality gasoline

Steering hard or erratic

- No lubricant on steering pivot
- Steering cable damaged or improperly routed

Multifunction meter display incorrect

- Standard spark plugs and/or plug caps not installed

WARNING

Since faulty steering is dangerous, this problem should be examined by an authorized JET SKI dealer.

OWNER SATISFACTION

(For Products Sold in the Continental United States of America Only)

Your satisfaction is important to your authorized Kawasaki dealer and to Kawasaki Motors Corp., U.S.A. If you have a problem concerning warranty or service, please take the following action:

Contact the owner and/or service manager of your authorized Kawasaki dealer. Fully explain your problem and ask for assistance in resolving the situation. The OWNER of the dealership is an independent business person and is concerned with your satisfaction and your future business. For this reason the owner is in the best position to assist you. Also, all warranty and service matters are handled and resolved through the authorized Kawasaki dealer network.

If you are unsatisfied after working with your Kawasaki dealer and feel you still require further assistance, write to the address below. Please be certain to provide the model, product identification number, mileage or hours of use, accessories, dates that events occurred and what action has been taken by both you and your dealer. Include the name and address of the dealership. To assist us in resolving your inquiry, please include copies of related receipts and any other pertinent information including the names of the dealership personnel with whom you have been working in the resolution of your problem.

Upon receipt of your correspondence we will contact the dealership and work with them in resolving your problem.

In order to provide a permanent record, all warranty and service resolutions take place only through written correspondence.

Please send your correspondence to:

CONSUMER RELATIONS
KAWASAKI MOTORS CORP., U.S.A.
P.O. Box 25252
SANTA ANA, CA. 92799-5252
(949) 460-5688

<https://www.boat-manuals.com/>

108 OWNER SATISFACTION (US ONLY)

REPORTING SAFETY DEFECTS

(For Products Sold in the United States of America Only)

If you believe that your watercraft has a defect which could cause a crash or could cause injury or death, you should immediately inform the U.S. Coast Guard (U.S.C.G.) in addition to notifying Kawasaki Motors Corporation, U.S.A.

If the U.S.C.G receives similar complaints, it may open an investigation, and if it finds that a safety defect exists in a group of watercrafts, it may order a recall and remedy campaign. However, the U.S.C.G cannot become involved in individual problems between you, your dealer, or Kawasaki Motors Corporation, U.S.A.

Please send your correspondence to:

Office of Boating Safety Product Assurance Division-OPB-3
United States Coast Guard
2100 Second Street SW
Washington, DC 20593-0001

MAINTENANCE RECORD

Owner Name

Address

Phone Number

Hull Number

Engine Number

Selling Dealer Name

Address

Phone Number

Warranty Start Date

Note: Keep this information and a spare key in a secure location.

Date	Traveled Distance	Maintenance Performed	Dealer Name	Dealer Address

110 MAINTENANCE RECORD

Date	Traveled Distance	Maintenance Performed	Dealer Name	Dealer Address

112 MAINTENANCE RECORD

Date	Traveled Distance	Maintenance Performed	Dealer Name	Dealer Address

<https://www.boat-manuals.com/>

JH1200-A1



KAWASAKI HEAVY INDUSTRIES,LTD.
Consumer Products & Machinery Group

Part No. 99920-1848-02

Printed in Japan

English

英語

<https://www.boat-manuals.com/>