



**Includes:**

- Important Safety Information
- Navigation Rules
- Operating Instructions
- Maintenance and Storage

# **JET SKI® STX Watercraft**

**Read this manual carefully. It contains safety information.**

# **OWNER'S MANUAL**

<https://www.boat-manuals.com/>

# READ THIS FIRST!

## ⚠ WARNING

For your safety, read this Owner's Manual and understand it thoroughly before operating this JET SKI watercraft. This manual contains the warnings given here for your immediate attention plus other important information.

To reduce the risk of **SEVERE INJURY** or **DEATH**:

**WEAR A PERSONAL FLOTATION DEVICE (PFD).**  
All riders must wear a Coast Guard approved PFD that is suitable for personal watercraft (PWC) use.

**WEAR PROTECTIVE CLOTHING.**

Severe internal injuries can occur if water is forced into body cavities as a result of falling into water or being near the jet thrust nozzle. Normal swimwear does not adequately protect against forceful water entry into lower body cavities. All riders must wear a wet suit bottom or clothing that provides equivalent protection (see Owner's Manual). Footwear, gloves, and goggles/glasses are recommended.

**KNOW BOATING LAWS.**

Kawasaki recommends a minimum operator age of 16 years old. Know the operator age and training requirements for your state. A boating safety course is recommended and may be required in your state.



**ATTACH ENGINE SHUT-OFF CORD (LANYARD) to wrist and keep it free from handlebars so that the engine stops if operator falls off. After riding, remove cord from PWC to avoid unauthorized use by children or others.**

**RIDE WITHIN YOUR LIMITS AND AVOID AGGRESSIVE MANEUVERS** to reduce the risk of loss of control, ejection, and collision. This is a high performance boat – not a toy. Sharp turns or jumping wakes or waves can increase the risk of back/spinal injury (paralysis), facial injuries, and broken legs, ankles, and other bones. Do not jump wakes or waves. **DO NOT APPLY THROTTLE WHEN ANYONE IS AT REAR OF PWC** – turn engine off or keep engine at idle. Water and/or debris ejected from the jet thrust nozzle can cause severe injury. **KEEP AWAY FROM INTAKE GRATE** while engine is on. Items such as long hair, loose clothing, or PFD straps can become entangled in moving parts resulting in severe injury or drowning.

**NEVER RIDE AFTER CONSUMING DRUGS OR ALCOHOL**

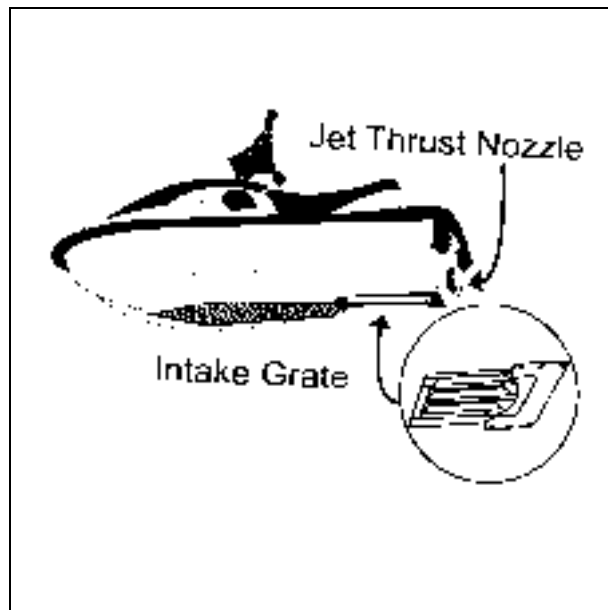

**Collisions result in more INJURIES AND DEATHS than any other type of accident for personal watercraft (PWC).**

**TO AVOID COLLISIONS:**

**SCAN CONSTANTLY** for people, objects, and other watercraft. Be alert for conditions that limit your visibility or block your vision of others.

**OPERATE DEFENSIVELY** at safe speeds and keep a safe distance away from people, objects, and other watercraft.

- Do not follow directly behind PWCs or other boats.
- Do not go near others to spray or splash them with water.
- Avoid sharp turns or other maneuvers that make it hard for others to avoid you or understand where you are going.
- Avoid areas with submerged objects or shallow water.

**TAKE EARLY ACTION** to avoid collisions. Remember, PWCs and other boats do not have brakes.

**DO NOT RELEASE THROTTLE WHEN TRYING TO STEER** away from objects – you need throttle to steer. Always check throttle and steering controls for proper operation before starting PWC.

Follow navigation rules and state and local laws that apply to PWCs.

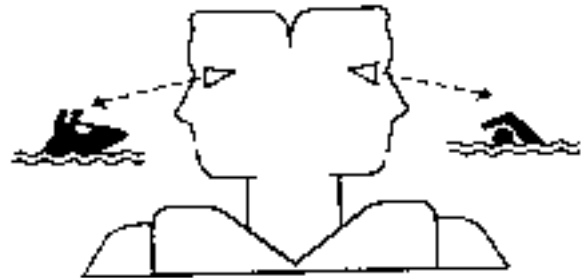

# CAUTION

Take proper care of your new JET SKI watercraft. Here are some of the cautions contained in this manual which must be followed for the protection of your watercraft. Be sure to read this Owner's Manual and understand it thoroughly before operating your watercraft.

**Always turn the boat on PORT side. Rolling to the STARBOARD side can cause water in the exhaust system to run into the engine, with possible engine damage.**

**If the watercraft has capsized, follow the righting procedure on page 83 immediately. If water is left in the engine more than a few hours, it will destroy the crankshaft bearings and damage other internal engine parts.**

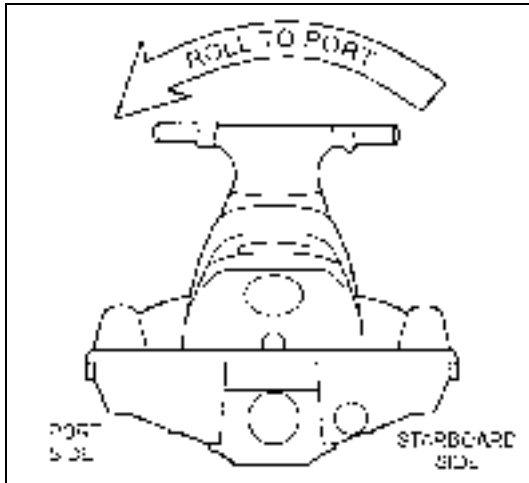

**The watercraft must be in water at least 0.8 m (2.5 ft) deep when starting to prevent jet pump damage by objects sucked up from the bottom.**

**Do not operate in shallow or debris-laden water, or the impeller may be damaged and sand may clog the water cooling hoses.**

**Do not run the watercraft onto the shore, or severe impeller damage may occur.**

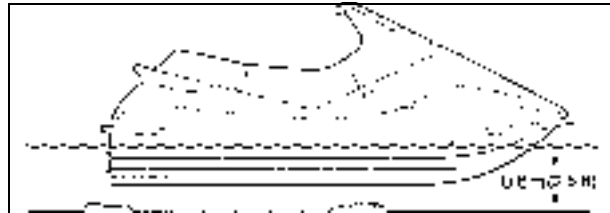

## Quick Reference Guide

This Quick Reference Guide will assist you in finding the information you're looking for.

**GENERAL INFORMATION**

**OPERATING INSTRUCTIONS**

**STORAGE**

**MAINTENANCE AND ADJUSTMENTS**

**TROUBLESHOOTING GUIDE**

A Table of Contents is included after the Foreword.

<https://www.boat-manuals.com/>

Whenever you see the symbols shown below, heed their instructions! Always follow safe operating and maintenance practices.

**⚠ WARNING**

**This warning symbol identifies special instructions or procedures which, if not correctly followed, could result in personal injury, or loss of life.**

**CAUTION**

**This caution symbol identifies special instructions or procedures which, if not strictly observed, could result in damage to or destruction of equipment.**

**NOTE**

○ *Indicates points of particular interest for more efficient and convenient operation.*

# FOREWORD

Congratulations on your purchase of a new Kawasaki JET SKI watercraft. Welcome to a new and exciting water sport. We are pleased you have chosen the Kawasaki JET SKI watercraft to expand the enjoyment of your recreational hours.

Kawasaki uses the latest manufacturing methods and materials to bring you a high quality recreational watercraft.

**Please read this Owner's Manual carefully before starting your new JET SKI watercraft** so that you will be thoroughly familiar with the proper operation of your watercraft's controls, its features, capabilities, and limitations. Kawasaki strongly recommends that all operators attend a boating safety course before riding the watercraft. Contact the local office of the U.S. Coast Guard Auxiliary, U.S. Power Squadrons, or school district.

## **BOAT SMART FROM THE START**

TAKE A BOATING SAFETY COURSE AND GET A FREE VESSEL SAFETY CHECK ANNUALLY FOR YOUR BOAT.

FOR MORE INFORMATION CONTACT:

UNITED STATES COAST GUARD AUXILIARY,  
WWW. CGAUX. ORG UNITED STATES POWER  
SQUADRONS, 888-FOR-USPS, WWW. USPS.  
ORG

To ensure a long, trouble-free life for your JET SKI watercraft, give it the proper care and maintenance

described in this manual. For those who would like more detailed information on their JET SKI watercraft, a Service Manual is available for purchase from any authorized Kawasaki JET SKI watercraft dealer. The Service Manual contains detailed disassembly and maintenance information. Those who plan to do their own work should, of course, be competent mechanics and possess the special tools described in the Service Manual.

Keep this Owner's Manual aboard your JET SKI watercraft at all times so that you can refer to it whenever you need information. If you need further information, please contact your dealer, who will provide all the help you need.

This manual should be considered a permanent part of the JET SKI watercraft and should remain with the JET SKI watercraft when it is sold.

This craft is an inboard boat less than 4.8 m (16 ft) in length, and as such is subject to all federal rules and regulations especially pertaining to boating safety and operation as enforced by the U.S. Coast Guard. States and local jurisdictions may have additional requirements for operation of powerboats in waters under their control. Additionally, other counties may have their own standards and regulations. Please check your local boating laws and regulations before riding the watercraft.



All rights reserved. No part of this publication may be reproduced without our prior written permission.

This publication includes the latest information available at the time of printing. However, there may be minor differences between the actual product and illustrations and text in this manual.

All products are subject to change without prior notice or obligation.

**KAWASAKI HEAVY INDUSTRIES, LTD.**  
**Consumer Products & Machinery Company**

© 2009 Kawasaki Heavy Industries, Ltd.

March 2009. (1) (D, Ke)



**JETSKI** is a trademark of Kawasaki Heavy Industries, Ltd. registered in U.S.A., Japan, Austria, Benelux, Sweden, Denmark, Switzerland, France, Canada, Finland, Norway, Greece, Italy, U.K., Portugal, Thailand, and Taiwan.

**KAWASAKI JET SKI** is a trademark of Kawasaki Heavy Industries, Ltd. registered in Australia.

# TABLE OF CONTENTS

<b>SPECIFICATIONS</b> .....	12	<b>Controls</b> .....	47
<b>GENERAL INFORMATION</b> .....	15	Kawasaki Smart Steering™ (KSS™) .....	48
Serial Numbers.....	15	Important Information: .....	48
Parts Location .....	16	Smart Learning Operation mode ( SLO ) ...	48
Label Location .....	18	Important Information for Handlebar	
Environmental Hang Tag .....	27	Cover:.....	49
Registration Numbers.....	29	Stop Button:.....	49
Multifunction Meter .....	30	Start Button: .....	49
Smart Learning Operation mode (SLO): ....	31	Throttle Lever: .....	50
Speedometer:.....	32	Ignition Switch: .....	50
Fuel Level Gauge Indicator/"FUEL"		Seat Latch .....	52
Character/Warning Light: .....	33	Storage Compartment .....	53
Engine Oil Pressure Indicator/"OILP"		Center & Rear Storage Case .....	54
Character/Warning Light: .....	33	Tool Kit.....	55
Engine Cooling Water Temperature		Bilge Systems.....	55
Indicator/"HEAT" character/Warning		Drain Screws .....	56
Light: .....	34	<b>OPERATING INSTRUCTIONS</b> .....	57
Low Battery Voltage Indicator/"bAt"		Safe Operation .....	57
Character/Warning Light: .....	35	Operation by Children: .....	57
Engine Oil Temperature indicator/ "OILt"		Operation by unskilled riders:.....	57
Character/Warning Light .....	35	Operator Swimming Ability:.....	57
Engine Oil Overheat Indicator/"OILH"		Maximum Number of Persons.....	57
Character/Warning Light: .....	36	Safe Riding Rules:.....	58
FI Indicator/"FI" Character/Warning Light:..	36	Jet Pump Safety: .....	60
Multifunction Displays:.....	37	Personal Flotation Device and Safety	
Fuel .....	42	Gear: .....	60
Fuel Requirements: .....	42	Watercraft Helmet.... Something You	
Filling the Tank: .....	44	Should Know: .....	61
Engine Oil.....	45	Fire Extinguisher: .....	62
Oil Requirements:.....	45	Loading.....	63
Oil Level Inspection: .....	46	Load Capacity Limits:.....	63

Pulling a Water Skier, Tuber, Wakerboarder, etc.....	65	Towing the JET SKI Watercraft:.....	92
Navigation Rules .....	67	Jump Starting: .....	93
Sailboats:.....	67	Engine Overheating:.....	94
Overtaking and Passing Situation: .....	67	Transporting .....	95
Meeting Situation:.....	68	<b>STORAGE</b> .....	96
Crossing Situation: .....	68	Preparation for Storage .....	96
Pre-ride Checklist .....	69	Cooling System: .....	96
Check Outside Craft: .....	69	Bilge System: .....	98
Check Inside Craft:.....	69	Fuel System and Engine: .....	98
Break-In .....	71	Air Filter:.....	100
Stopping the Engine .....	72	Battery: .....	101
Starting the Engine .....	73	Engine Mount Bracket Bolts: .....	101
Launching .....	75	Cleaning: .....	101
Launching from a Dock: .....	75	Lubrication:.....	102
Launching from a Ramp: .....	76	Removal from Storage .....	102
Deep Water Start:.....	76	<b>MAINTENANCE AND ADJUSTMENTS</b> .....	104
Shallow Water Start:.....	76	EMISSION CONTROL INFORMATION .....	104
Stopping the JET SKI Watercraft.....	77	Periodic Maintenance Chart .....	106
Normal Stopping:.....	77	Control Cable .....	108
Stopping Skills:.....	78	Fuel System .....	111
Minimum Stopping Distances:.....	79	Throttle Adjustments: .....	111
Turning the JET SKI Watercraft.....	79	Fuel Vent Check Valve: .....	111
Docking the JET SKI Watercraft.....	82	Fuel Pump Screen:.....	111
Riding the JET SKI Watercraft.....	83	Engine Oil System.....	112
Fall Recovery: .....	83	Valve Clearance .....	116
Righting the Capsized Watercraft:.....	83	Spark Plug.....	116
After Submerging: .....	85	Battery .....	118
End of the Day Checklist .....	90	Lubrication .....	121
First, Drain the Exhaust System:.....	90	Cooling System Flushing.....	123
Second, Clean the Engine Compartment:..	90	Bilge System Flushing.....	125
Special Procedures .....	91	Fuses.....	126
Clearing Clogged Impeller:.....	91	<b>TROUBLESHOOTING GUIDE</b> .....	127
Cleaning Fouled Spark Plugs:.....	91	<b>OWNER SATISFACTION</b> .....	130
		<b>SAFETY DEFECTS</b> .....	131

**ENVIRONMENTAL PROTECTION..... 132**

**MAINTENANCE RECORD ..... 133**

# SPECIFICATIONS

## JET SKI WATERCRAFT - MODEL JT1500D INBOARD BOAT LESS THAN 4.8 M (16 FEET) IN LENGTH

<b>Engine:</b>		
Type	4-stroke, 4-cylinder, water-cooled	
Displacement	1 498 cm <sup>3</sup>	91.4 cu in.
Bore and Stroke	83 × 69.2 mm	3.27 × 2.72 in.
Compression Ratio	10.6 : 1	
Ignition System	Digital transistor	
Lubrication System	Semi-drysump	
Fuel System	Digital fuel injection	
Starting System	Electric starter	
<b>Tuning Specifications:</b>		
Spark Plug	NGK CR9EK	
Gap	0.7 ~ 0.8 mm	0.028 ~ 0.032 in.
Terminal	Solid post	
Ignition Timing	3° ATDC @1 300 r/min (rpm) ~ 32° BTDC @3 000 r/min (rpm)	
Idle Speed	1 300 ±100 r/min (rpm) - in water 1 300 ±100 r/min (rpm) - out of water	
<b>Drive System:</b>		
Coupling	Direct drive from engine	
Jet Pump:	Type	

**SPECIFICATIONS 13**

	Thrust	4 250 N (434 kg)	955 lb
Steering		Steerable nozzle	
Braking		Water drag	
<b>*Performance:</b>			
	Minimum Turning Radius	4.0 m	13.1 ft
	Fuel Consumption	43 L/h @full throttle	11.4 gal (U.S.)/hr
	Cruising Range	134 km @full throttle	83.3 mi
		1 hour and 26 minutes	
<b>Dimensions:</b>			
	Overall length	3 120 mm	122.8 in.
	Overall width	1 180 mm	46.5 in.
	Overall Height	1 050 mm	41.3 in.
	Curb Mass	378 kg	833.5 lb
	Maximum Draft	370 mm	14.6 in.
	Fuel Tank Capacity	62 L	16.38 gal (U.S.)
<b>Engine Oil:</b>			
	Type	API SG, SH, SJ, SL or SM with JASO MA, MA1 or MA2 SAE10W-40	
	Oil Capacity	5.0 L	5.3 qt (U.S.)
<b>Electrical Equipment:</b>			
	Battery	12 V 18 Ah	

## 14 SPECIFICATIONS

\* The information shown here represents results under controlled conditions, and the information may not be correct under other conditions.

# GENERAL INFORMATION

## Serial Numbers

The hull and engine identification numbers are used to register the boat. They are the only means of identifying your particular machine from others of the same model. These serial numbers may be needed by your dealer when ordering parts. In the event of theft, investigating authorities will require both numbers as well as the model number and any unique features of your machine that could help identify it. Record these numbers here.

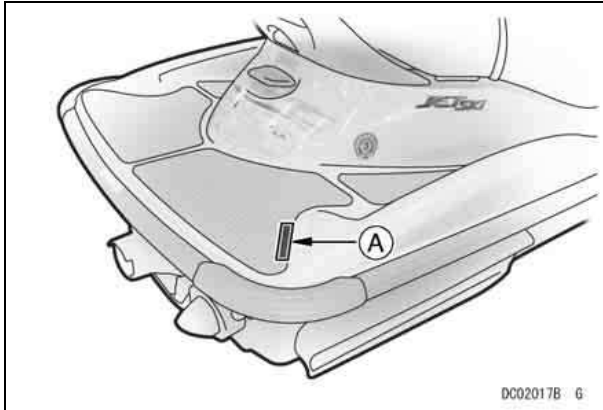

**A. Hull Identification Number (HIN)**

H.I.N.	
--------	--

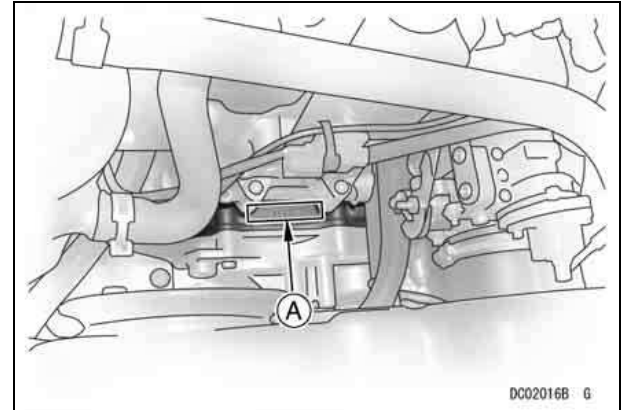

**A. Engine Number**

Eng. No.	
----------	--



## 16 GENERAL INFORMATION

### Parts Location

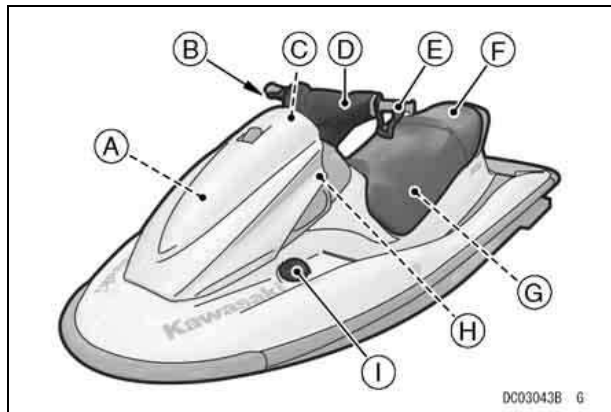

- A. Front Storage Case
- B. Throttle Lever
- C. Multifunction Meter
- D. Handlebars
- E. Engine Shut-off Lanyard
- F. Seat
- G. Engine Compartment
- H. Water Supply Inlet Fitting (under the hatch cover)
- I. Fuel Filler Cap

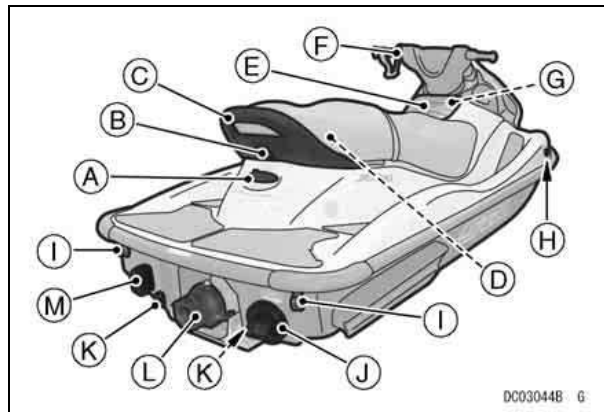

- A. Towing Hook
- B. Seat Latch
- C. Handrail
- D. Rear Storage Case
- E. Center storage Case
- F. Engine Start and Stop Buttons
- G. Ignition Switch ( under the cover )
- H. Bypass Outlet
- I. Towing Eyes
- J. Exhaust Outlet
- K. Drain Screws
- L. Steering Nozzle
- M. Waterwheel for Speedometer

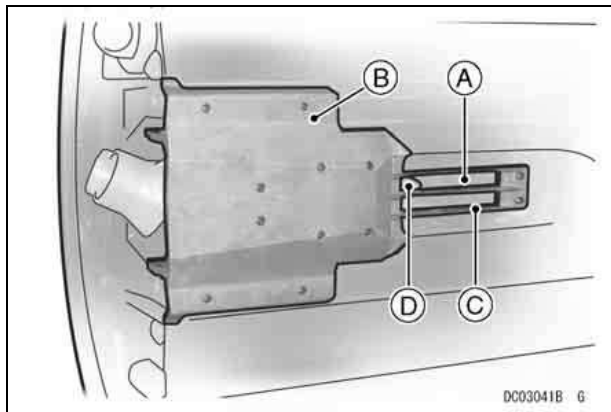

- A. Water Intake
- B. Jet Pump Cover
- C. Grate
- D. Drive Shaft

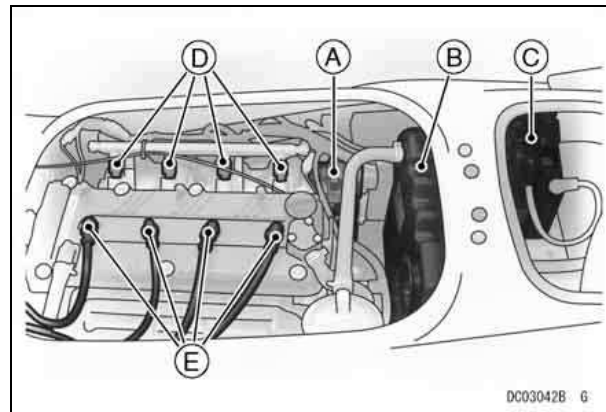

- A. Throttle Assembly
- B. Air Filter
- C. Battery
- D. Injection Nozzles
- E. Spark Plugs

## 18 GENERAL INFORMATION

### Label Location

All warning labels which are on your watercraft are repeated here. Read them and understand them thoroughly. They contain information which is important for your safety and the safety of anyone else who may operate your watercraft. Therefore, it is very important that all warning labels be on your watercraft in the locations shown. If any label is missing, damaged, or worn, get a replacement from your Kawasaki dealer and install it in the correct position.

#### NOTE

○ *The sample warning labels in this section have part numbers to help you and your dealer obtain the correct replacement.*

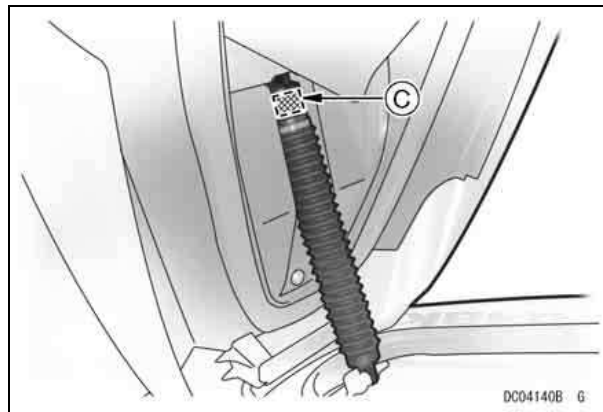
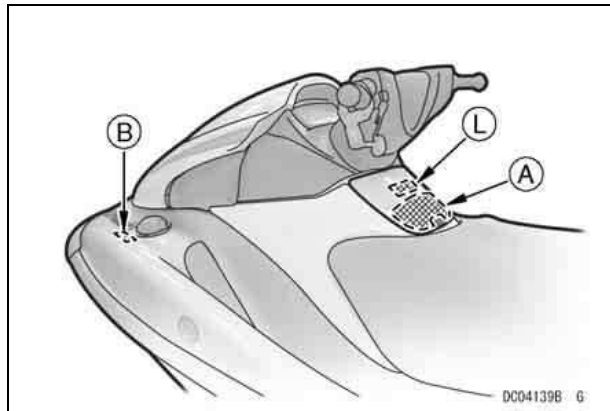

- A. Caution/Warning
- B. Warning
- C. Warning
- L. Warning

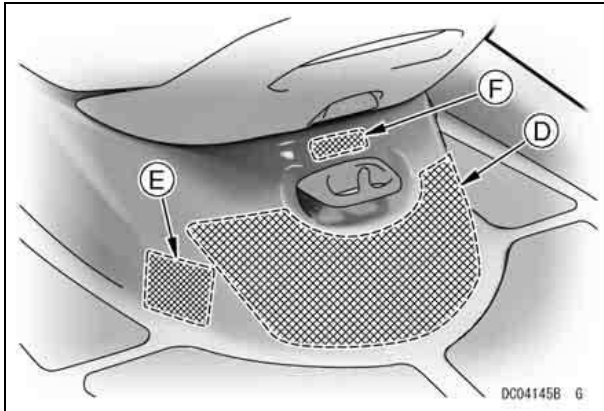

- D. Caution/Warning
- E. Caution/Warning
- F. Fire Extinguisher

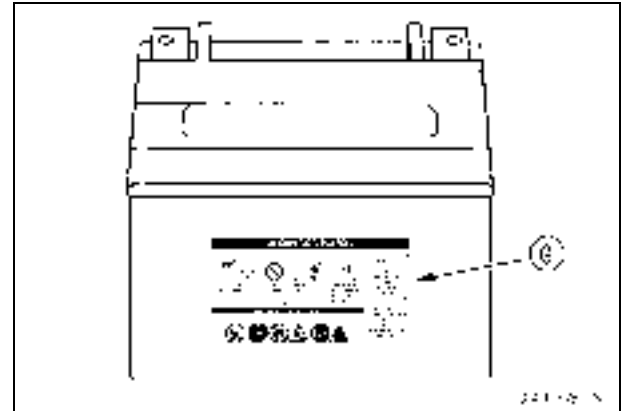

- G. Battery Danger/Poison

## 20 GENERAL INFORMATION

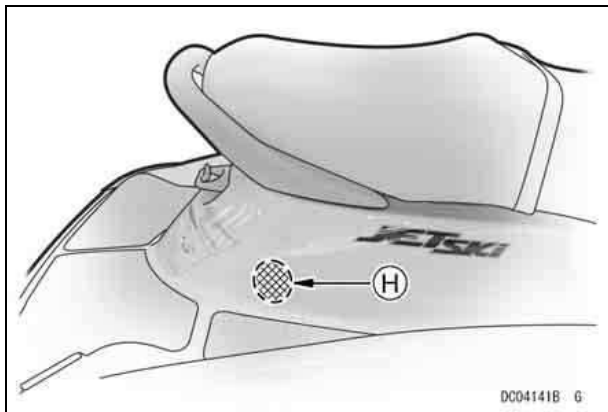

**H. NMMA Label**

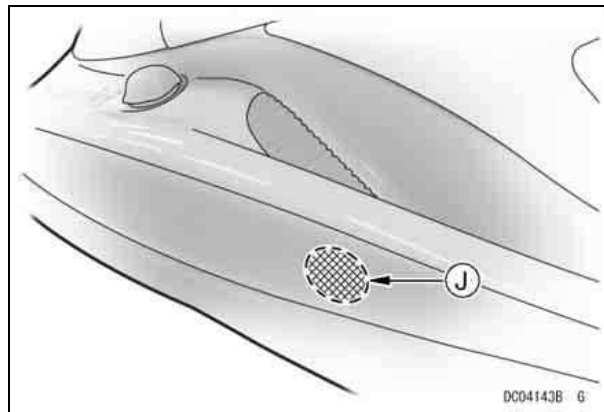

**J. Ultra Low Emission Label**

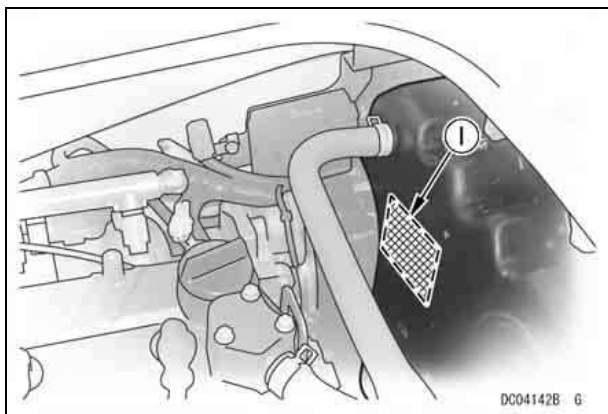

**I. Exhaust Emission Information**

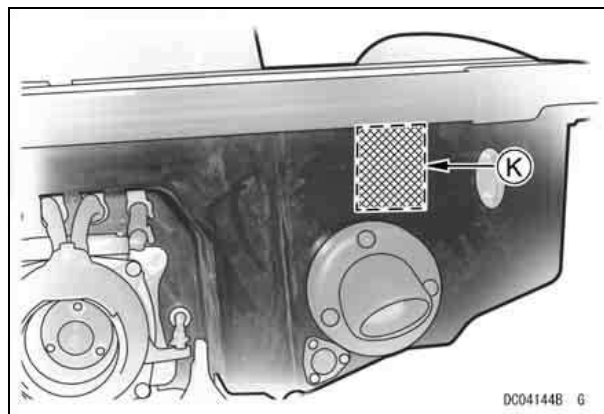

**K. Caution**

(A)

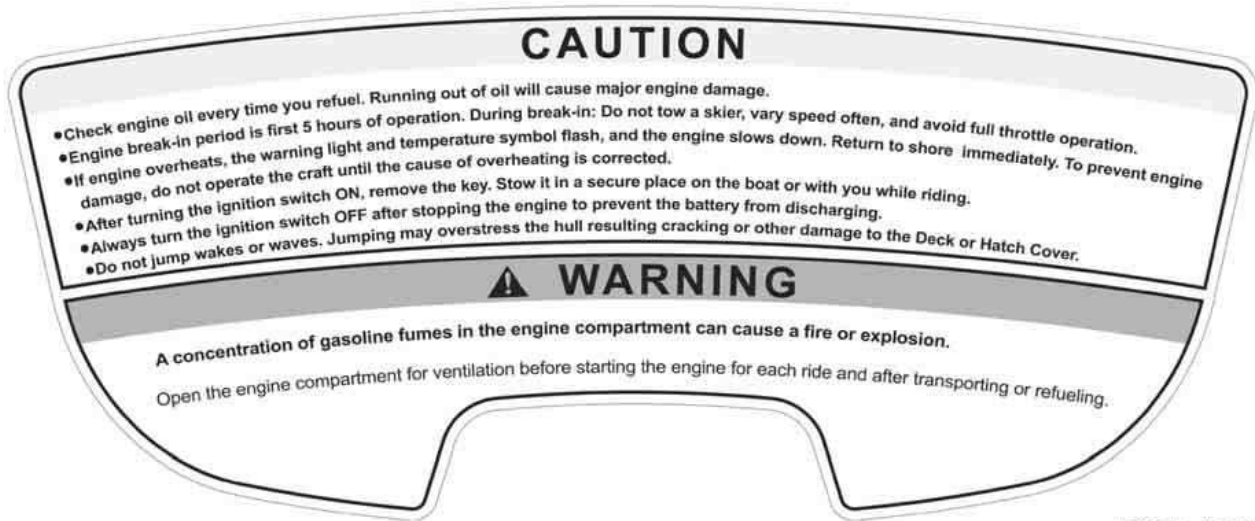

56071-3726

## 22 GENERAL INFORMATION

(B)

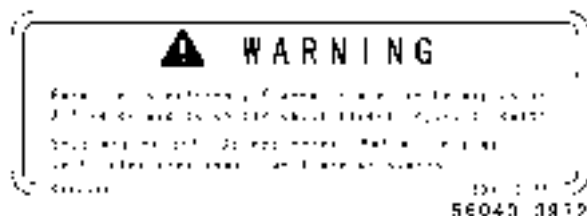

(E)

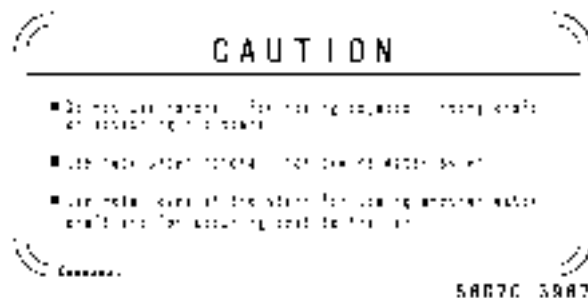

(C)



(D)

**CAUTION**

• When rolling the craft onto its side, turn it in this  direction only.

---

**WARNING** To reduce the risk of SEVERE INJURY or DEATH:

All riders must wear a Coast Guard approved PFD that is suitable for personal watercraft (PWC) use.

**WEAR PROTECTIVE CLOTHING.** Severe internal injuries can occur if water is forced into body cavities as a result of falling into water or being near jet thrust nozzle. Normal swimwear does not adequately protect against forceful water entry into lower body cavities. All riders must wear a wet suit bottom or clothing that provides equivalent protection (see Owner's Manual).

Footwear, gloves, and goggles/glasses are recommended.

**KNOW BOATING LAWS.** Kawasaki recommends a minimum operator age of 16 years old, recommended age and training requirements for your state. A boating safety course is recommended and may be required in your state.

**ATTACH ENGINE SHUT-OFF CORD (LANYARD)** to wrist and keep it free from handbars so that engine stops if operator falls off. After riding, remove cord from PWC to avoid unauthorized use by children or others.

**RIDE WITHIN YOUR LIMITS AND AVOID AGGRESSIVE MANEUVERS** to reduce the risk of loss of control, ejection, and collision. This is a high performance boat - not a toy. Sharp turns or jumping wakes or waves can increase the risk of back/spinal injury (paralysis), facial injuries, and broken legs, ankles, and other bones.

Do not jump wakes or waves.

**DO NOT APPLY THROTTLE WHEN ANYONE IS AT REAR OF PWC** - turn engine off or keep engine at idle. Water and/or debris exiting jet thrust nozzle can cause severe injury.

**KEEP AWAY FROM INTAKE GRATE** while engine is on. Items such as long hair, loose clothing, or PFD straps can become entangled in moving parts resulting in severe injury or drowning.

**NEVER RIDE AFTER CONSUMING DRUGS OR ALCOHOL**

**READ AND FOLLOW OWNER'S MANUAL**



PFD  
Wet Suit Bottom



Jet Thrust Nozzle  
Intake Grate

56070-3957



(D)

**Kawasaki Motor Corp., U.S.A.**  
P.O. Box 25252 Santa Ana, CA 92799-5252  
**THIS BOAT HAS BEEN EXEMPTED FROM COMPLIANCE WITH THE  
FOLLOWING U.S. COAST GUARD SAFETY STANDARDS IN EFFECT  
ON THE DATE OF CERTIFICATION:**

- Display of Capacity Information
- Safe Loading
- Flotation
- Fuel System
- Electrical System
- Powerd Ventilation

**AS AUTHORIZED BY U.S. COAST GUARD  
GRANT OF EXEMPTION  
(CGD 80-018)**

---

**⚠ WARNING**

Collisions result in more **INJURIES AND DEATHS** than any other type of accident for personal watercraft (PWC).

**TO AVOID COLLISIONS:**

**SCAN CONSTANTLY** for people, objects, and other watercraft. Be alert for conditions that limit your visibility or block your vision of others.



**OPERATE DEFENSIVELY** at safe speeds and keep a safe distance away from people, objects, and other watercraft.

- Do not follow directly behind PWCs or other boats.
- Do not go near others to spray or splash them with water.
- Avoid sharp turns or other maneuvers that make it hard for others to avoid you or understand where you are going.
- Avoid areas with submerged objects or shallow water.

**TAKE EARLY ACTION** to avoid collisions. Remember, PWCs and other boats do not have brakes.

**DO NOT RELEASE THROTTLE WHEN TRYING TO STEER** away from objects - you need throttle to steer. Always check throttle and steering controls for proper operation before starting PWC.

Follow navigation rules and state and local laws that apply to PWCs.  
See Owner's Manual for more information.

56070-3957

DC053128 S

(F)



2007-2009

(G)

DANGER/POISON			
<p><b>SHIELD EYES</b></p> <p>EXPLOSIVE GASES CAN CAUSE BLINDNESS IF INHALED.</p>	<p><b>NO</b></p> <p>• SMOKING • FLAMING • SMOKE</p>	<p><b>SHUT OFF ACID</b></p> <p>CALL FOR HELP IF ACID GETS ON SKIN OR EYES.</p>	<p><b>FLUSH EYES IMMEDIATELY WITH WATER. GET MEDICAL HELP FAST.</b></p>
<p>PROPOSITION 65 WARNING: MAY CONTAIN SOME CHEMICALS KNOWN TO THE STATE OF CALIFORNIA TO CAUSE CANCER OR REPRODUCTIVE HARM. FOR MORE INFORMATION, CALL 1-800-438-8861.</p>			

2902-3128

2007-2009

(H)



59454-3175

2007-2009

(I)

WARRANTY INFORMATION	
<p>DATE OF PURCHASE</p> <p>DATE OF INSTALLATION</p> <p>DATE OF REGISTRATION</p> <p>DATE OF DELIVERY</p> <p>DATE OF DELIVERY</p>	<p>WARRANTY PERIOD</p> <p>WARRANTY PERIOD</p> <p>WARRANTY PERIOD</p> <p>WARRANTY PERIOD</p> <p>WARRANTY PERIOD</p>
<p>FOR MORE INFORMATION, CONTACT:</p> <p>1-800-438-8861</p>	

59464-3195

2007-2009

## 26 GENERAL INFORMATION

(J)



59464-3704

DC05137B S

(K)



56070-3986

DC05186B S

(L)



56031-3708

DC05186B L

---

## Environmental Hang Tag

---

This engine has been certified as a



*The Symbol for Outboard Marine Engines.*

**Cleaner Air and Water** – for a healthier lifestyle and environment.

**Better Fuel Economy** – burns up to 30-40 percent less gas and oil than conventional carbureted two-stroke engines, saving money and resources.

**Longer Emissions Warranty** – protects consumer for worry-free operation.

## 28 GENERAL INFORMATION



### One Star – Low-Emission

The one-star label identifies engines that meet the California Air Resources Board's 2001 exhaust emission standards. Engines meeting these standards have 75% lower emissions than conventional carbureted two-stroke engines. These engines are equivalent to the U.S. EPA's 2006 standards for marine engines.



### Two Stars – Very Low-Emission

The two-star label identifies engines that meet the California Air Resources Board's 2004 exhaust emission standards. Engines meeting these standards have 20% lower emissions than One-Star-Low-Emission engines.



DC06001B S

### Three Stars - Ultra Low Emission

The three-star label identifies engines that meet the Air Resources Board's 2008 exhaust emission standards. Engines meeting these standards have 65% lower emissions than One-Star Low Emission engines.



S \* 4

### Four Stars - Super Ultra Low Emission

The four-star label identifies engines that meet the Air Resources Board's Sterndrive and Inboard marine engine 2009 exhaust emission standards. Personal Watercraft may also comply with these standards. Engines meeting these standards have 90 % lower emission than One Star-Low Emission engines.

## Registration Numbers

The graphic design of your JET SKI watercraft provides a specific location on each side for the registration numbers and validation decals.

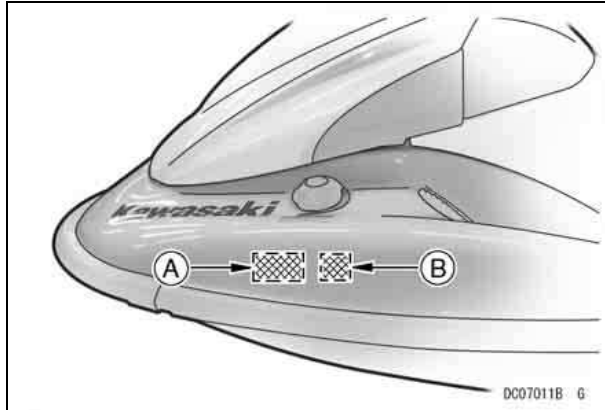

- A. Location for Registration Number
- B. Location for Validation Decal

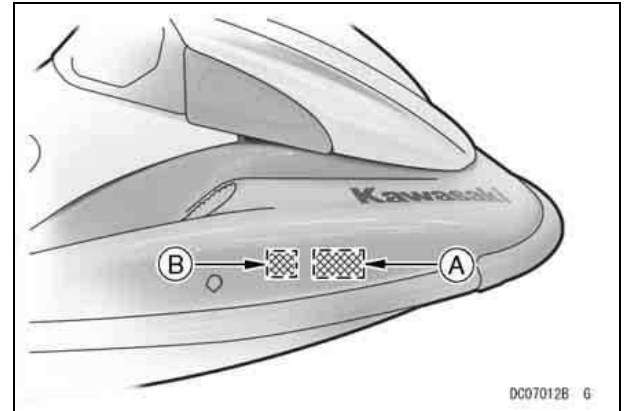

- A. Location for Registration Number
- B. Location for Validation Decal

The registration numbers must read from left to right on both sides of the watercraft. Typically, the validation decal must be placed 3 inches (76.2 mm) beyond, and level with the first or last letter of the identification number.

### NOTE

○ *Requirements for registration numbers and validation decals may vary from those given here for your state. Always follow the directions provided at the time you register your watercraft.*

Registration numbers must be block characters no less than 3 inches (76.2 mm) in height. They should be a color contrasting with the background. The spaces between the numerals and the prefix/suffix

## 30 GENERAL INFORMATION

letters must be equal to the width of any letter except "I" or any number except "1."

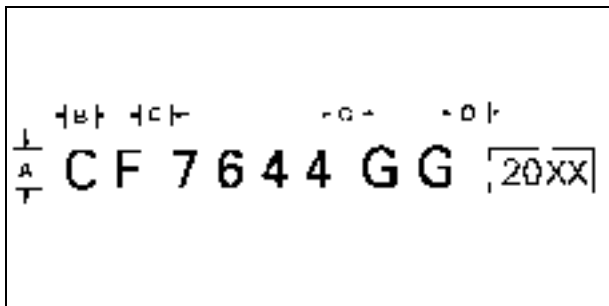

A = 3 inches (76.2 mm) minimum

B = C

D = 3 inches (76.2 mm)

### Multifunction Meter

Ahead of the steering handlebar is a multifunction meter. When the ignition switch is turned on, "Kawasaki" marks are first shown followed by the tachometer reading together with buzzer sound twice and then, the whole displays on the panel are shown. After these initial displays, the normal meter displays and their readings are shown.

#### NOTE

- The display will go off 3 minutes after stopping the engine using the engine stop lanyard or stop button. The display will go off immediately when the ignition switch is turned off.
- The MODE button operates when the engine is running slower than 3 000 rpm.
- When the warning light goes off, an intermittent buzzer sound accompanies. This buzzer sound can be stopped by pushing either "SET" or "Mode" button.
- To turn off the flashing warning lights, it is necessary to hold down either SET or MODE button for more than one second.
- Then the MODE button can be operated normally.

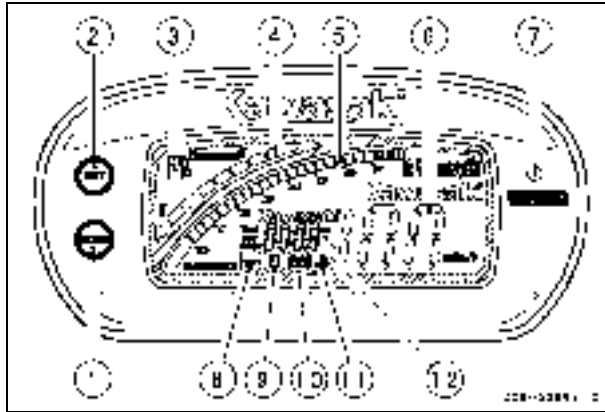

1. "MODE" Button
2. "SET" Button
3. Fuel Indicator
4. Fuel Level Gauge
5. Tachometer
6. Speedometer
7. "LED" Warning Light
8. Engine Oil Pressure Indicator
9. FI Indicator
10. Low Battery Voltage Indicator
11. Engine Cooling Water Temperature Indicator
12. Multifunction Display

### Smart Learning Operation mode (SLO):

This watercraft is equipped with the Smart Learning Operation mode (SLO). This mode reduces the maximum watercraft speed for a use by unskilled operators.

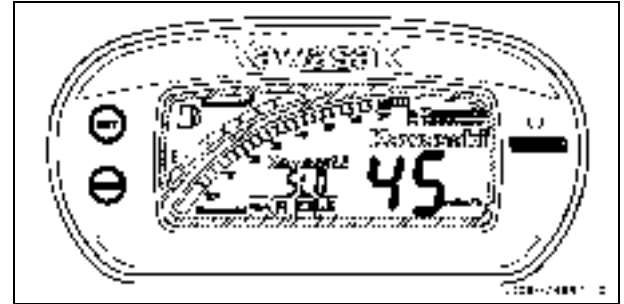

**SLO Mode Display**

Normal operation mode (Full Power Operation mode, FPO) is shown by FPO display.

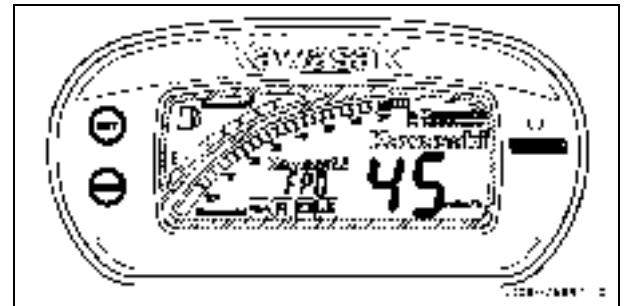

**FPO Mode Display**



## 32 GENERAL INFORMATION

To change the SLO mode to FPO mode, and back again, push the “MODE” button for 7 seconds. The buzzer sounds two times. Again push the “MODE” button for 7 seconds or more.

### NOTE

- *When shifted to the SLO mode, the initial display, as shown when the ignition switch is turned on, is shown together with a buzzer sound.*
- *Then, “SLO” is shown blinking at every three seconds.*
- *When shifted to the normal operation mode (Full Power Operation mode, FPO), the same initial display is first shown and followed by “FPO” for two seconds. However, “FPO” is shown only once when shifted and is not displayed thereafter.*
- *When the ignition switch is turned off and on again, the same mode when turned off is displayed again.*
- *Under the SLO mode, all the meter displays and other functions work in the same manner as the normal operation (Full Power Operation, FPO) mode.*

### Speedometer:

The speedometer shows the speed of the watercraft. During a sharp turn the speed shown can be 6 to 12 mph (10 to 20 km/h) lower than the actual speed.

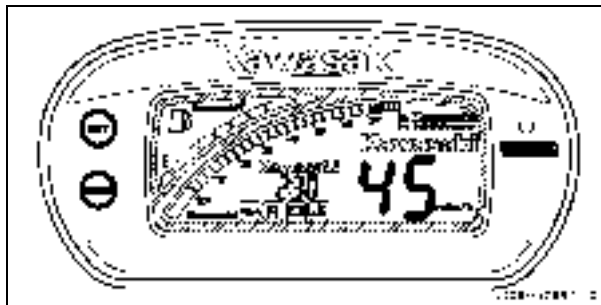

### NOTE

- *You can change the speedometer display from mile/h to Km/h and vice-versa, see Hour Meter section for the details.*

### Fuel Level Gauge Indicator/"FUEL" Character/Warning Light:

The fuel in the fuel tank is shown in segments. All fuel segments are displayed when the fuel tank is full. As the fuel is consumed, the segments go out accordingly. The fuel indicator and the last segment begin flashing when only 1 bottom segment remains (E mark). The warning light and the "FUEL" character beside the speedometer flash with buzzer sound to warn the operator as well. Buzzer sound will stop when any button is held down for more than one second. When they begin flashing, 16 liters (4.23 U.S. gal) of fuel remain. Reduce speed to less than half-throttle and fill the fuel tank as soon as possible because there is no reserve tank in this watercraft (see the Fuel and Controls sections).

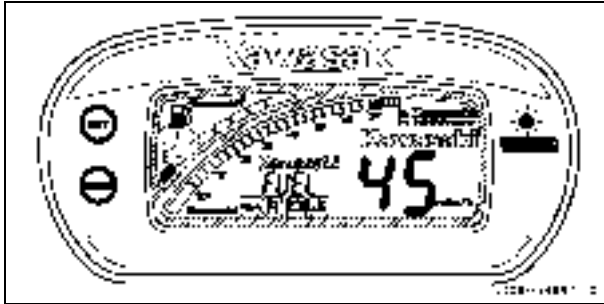

### Engine Oil Pressure Indicator/"OILP" Character/Warning Light:

The engine oil pressure indicator flashes with buzzer sound to warn the operator whenever the oil pressure is dangerously low. Also the warning light and "OILP" character beside the speedometer flash. The engine revolution is automatically controlled to 3 000 rpm. Return to shore immediately and fill the oil as soon as possible (Refer to "ENGINE OIL"). Hold down any button for more than one second to stop the buzzer sound.

#### NOTE

- It is normal that the oil warning light will remain **on** after the watercraft is capsized and up-righted if the ignition key is on.

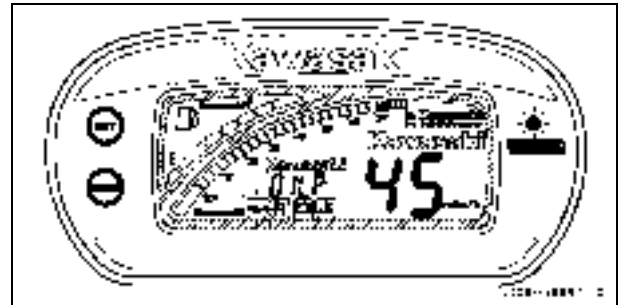

## 34 GENERAL INFORMATION

### Engine Cooling Water Temperature Indicator/"HEAT" character/Warning Light:

If the engine cooling water temperature gets too high, the warning light and the engine cooling water temperature indicator flash with buzzer sound to warn the operator. Also "HEAT" character beside the speedometer flashes. The engine revolution is automatically controlled to 3 000 rpm. Return to shore immediately and check the cooling system for clogging (see the Special Procedures section in the Operating Instructions chapter). Buzzer sound will stop when any button is held down for more than one second.

#### CAUTION

If the engine overheats, the "LED" warning light including water temperature indicator, "HEAT" character flash and the engine slows down. Return to shore immediately. To prevent engine damage, do not operate the craft until the cause of overheating is corrected.

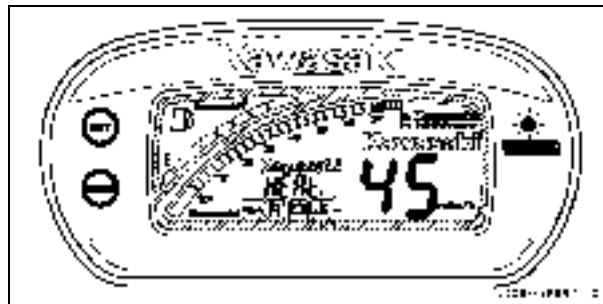

### Low Battery Voltage Indicator/"bAt" Character/Warning Light:

The red "LED" warning light, low battery voltage indicator and "bAt" character flash when the battery voltage is less than 12 volts. If they flash, return to the shore immediately. The buzzer sound also goes off.

Remove your watercraft's battery and charge it. Buzzer sound will stop when any button is held down for more than one second.

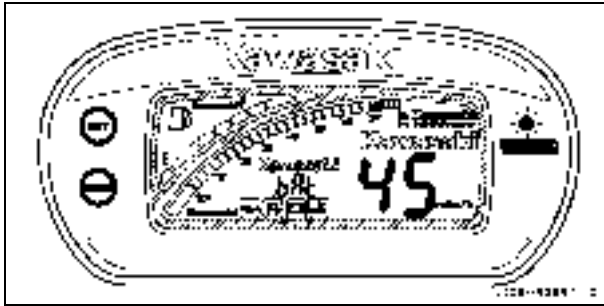

### Engine Oil Temperature indicator/ "OILt" Character/Warning Light

If the engine oil temperature sensor should fail to function properly, the red "LED" warning light, the engine oil pressure indicator and the "OILt" character begin flashing. The buzzer sound also goes off. Under this condition, the engine revolution is automatically controlled to 3 000 rpm.

Return to the shore immediately and have your authorized Kawasaki JET SKI watercraft dealer check your boat to determine the suspected problem. Hold down any button for more than one second to stop the buzzer sound.

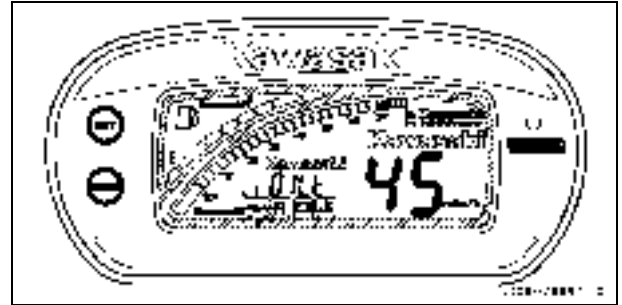

## 36 GENERAL INFORMATION

### Engine Oil Overheat Indicator/"OILH" Character/Warning Light:

If the engine oil temperature gets too high, the warning light and the engine oil pressure indicator flash with buzzer sound to warn the operator. Also "OILH" character starts flashing.

Under this condition, the engine revolution is automatically controlled to 3 000 rpm. Return to shore immediately and check the cooling system for clogging and engine oil level. If the cause is other than the above two, have your authorized Kawasaki JET SKI watercraft dealer check your boat to determine the suspected problem. (See the TROUBLE SHOOTING for the causes listed Engine RPM does not increase more than 3 000).

Hold down any button for more than one second to stop the buzzer sound.

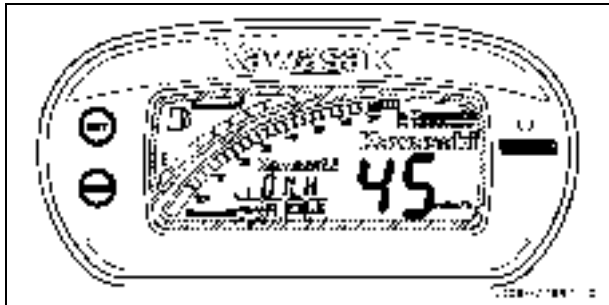

### FI Indicator/"FI" Character/Warning Light:

If the fuel injection-related parts should fail to function properly, the red "LED" warning light, the FI indicator and the "FI" character begin flashing. The buzzer sound goes off.

Return to the shore immediately and have your authorized Kawasaki JET SKI watercraft dealer check your boat to determine the suspected problem. Hold down any button for more than one second to stop the buzzer sound.

Depending on the nature of the trouble, the engine revolution is automatically controlled to 3 000 rpm.

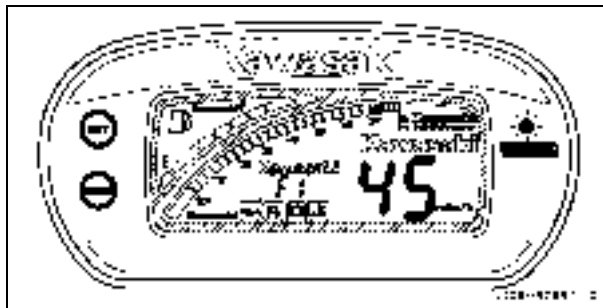

### Tachometer

The tachometer shows the engine speed in revolutions per minute (rpm); increasing or decreasing every 333 rpm within the range of 0 – 7 000 rpm and every 167 rpm over 7 000 up to 8 000 rpm.

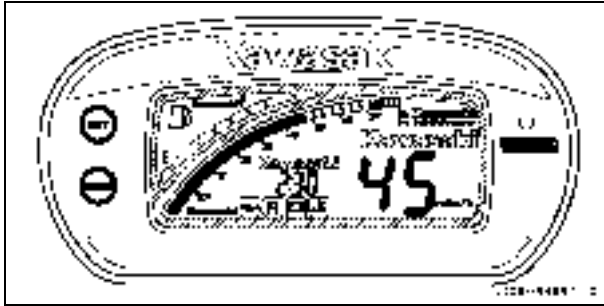

### Multifunction Displays:

The Clock, Time, Trip and Hour Meter will be displayed beside the speedometer. These modes will shift in series if the "MODE" button is pressed for 1 second or more.

### Clock

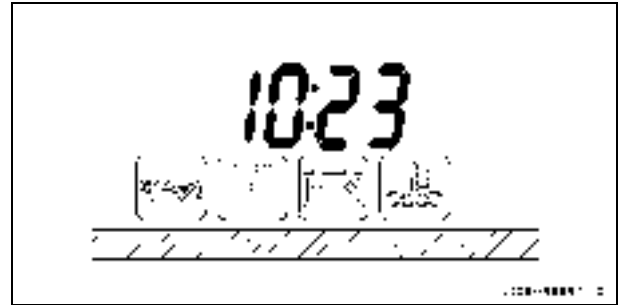

## 38 GENERAL INFORMATION

1. Push the "SET" button for two seconds or more. The hour display starts flashing.
2. Push the "MODE" button to advance the hours.
3. Push the "SET" button. The hour display stops flashing and the minutes display starts flashing.
4. Push the "MODE" button to advance the minutes.
5. Push the "SET" button. The minutes display stops flashing and the clock starts working.

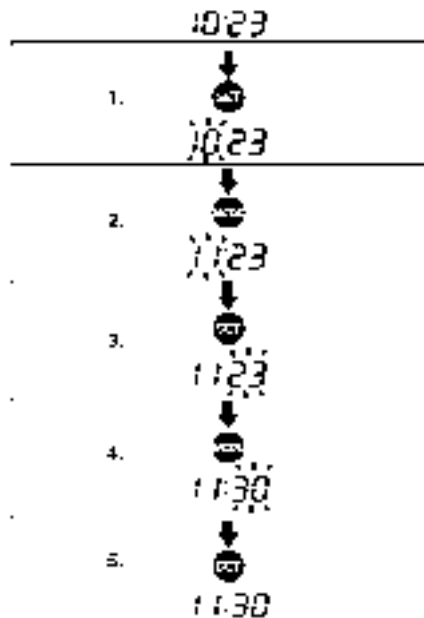

10-18-15

**NOTE**

- *Pushing the "MODE" button momentarily advances the hour or minute step by step. Holding the button down advances the hour or minute continuously.*
- *The clock works normally from the back-up power while the ignition switch is turned off.*
- *When the battery is disconnected, the clock resets to 12:00, and starts working again when a battery is connected.*

**Time Meter**

The time meter shows the time passed since it was last reset to zero.

To reset the time meter:

1. Push and hold the "SET" button. All the displays in this mode start flashing.
2. After two seconds the displays stop flashing and the hour and minute display turns back to 00:00, and then starts working, if the engine is running. The meter works on until it is next reset, unless the ignition switch is turned off.

**NOTE**

- *The time data is maintained by the back-up power if the ignition switch is turned off, and it starts working when the craft is next operated.*
- *When the time comes to 99:59 when the engine is running, it turns back to 00:00 and starts counting upward again.*
- *When the battery is disconnected, the time display resets to 00:00.*



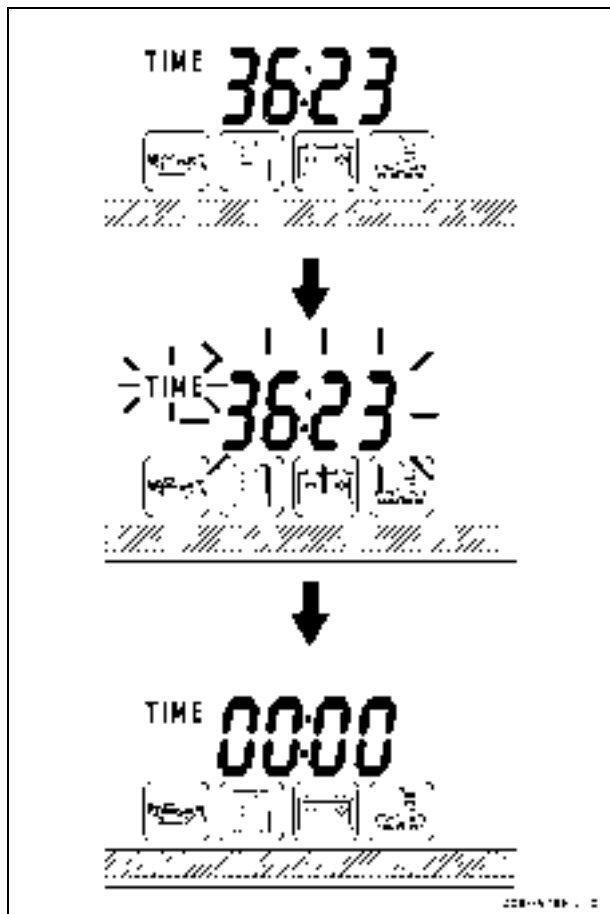

### Trip Meter

The trip meter shows the distance traveled since it was last reset to zero.

To reset the trip meter:

1. Push the "SET" button and hold it in. All the displays in this mode start flashing.
2. After two seconds the displays stop flashing and the figure display turns to 000.0, and then starts counting when the craft is operated. The meter works on until it is next reset, unless the ignition switch is turned off.

### NOTE

- *The data is maintained by the back-up power if the ignition switch is turned off.*
- *When the trip meter is reset while the craft is stopped, it starts counting as soon as the craft starts moving.*
- *When the figures come to 999.9 when the craft is running, they turn back to 000.0 and start counting again.*
- *When the battery is disconnected, the meter display resets to 000.0.*

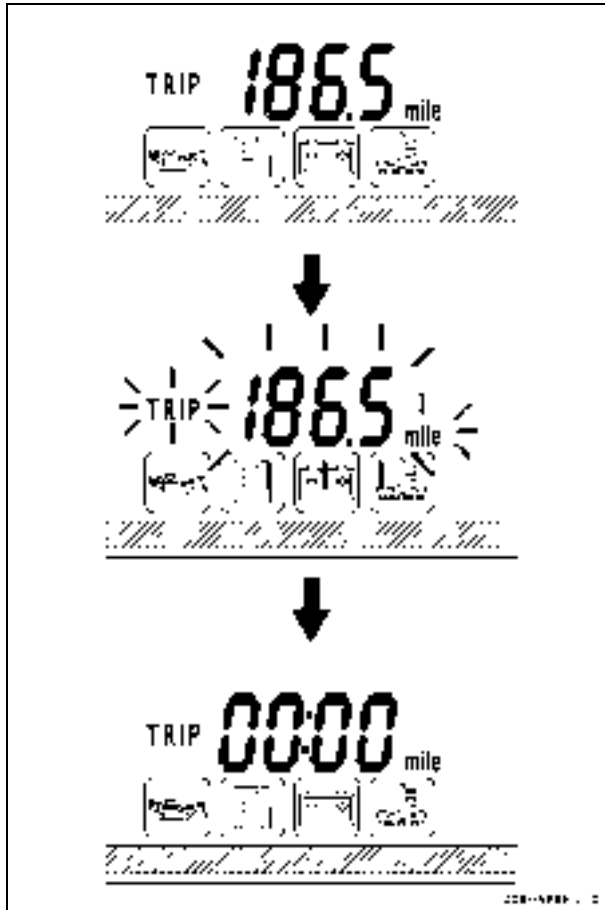

### Hour Meter

The hour meter shows the total hours that the watercraft has been operated. This meter cannot be reset.

### NOTE

- The data is maintained even if the battery is disconnected.
- When the figures come to 9999, they turn back to 0000 and start counting upward again while the craft is operated.

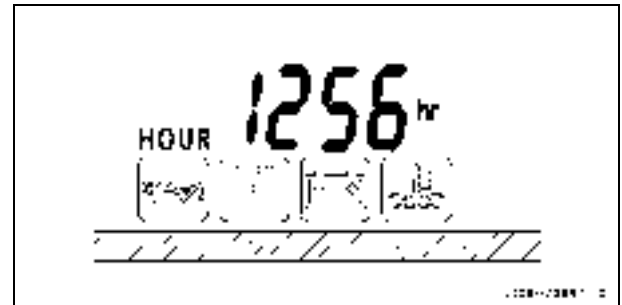

- With the Hour Meter display, you can change the speedometer display from mile/h to Km/h and vice versa by pushing the "SET" button for more than three seconds.

## 42 GENERAL INFORMATION

### Fuel

#### CAUTION

Do not use racing fuels or fuel additives. This watercraft has not been tested and certified for use with such fuels. Damage to the engine and fuel system may result from the use of improper fuel.

#### Fuel Requirements:

##### *Fuel Type*

Use clean, fresh unleaded gasoline with a minimum Antiknock Index of 87. The Antiknock Index is posted on service station pumps in the U.S.A. The octane rating of a gasoline is a measure of its resistance to detonation or "knocking". The Antiknock Index is an average of the Research Octane Number (RON) and the Motor Octane Number (MON) as shown in the table below.

Octane Rating Method	Minimum Rating
Antiknock Index $\frac{(\text{RON} + \text{MON})}{2}$	87

#### CAUTION

If engine "knocking" or "pinging" occurs, use a different brand of gasoline of a higher octane rating. If this condition is allowed to continue it can lead to severe engine damage.

Gasoline quality is important. Fuels of low quality or not meeting standard industry specifications may result in unsatisfactory performance. Operating problems that result from the use of poor quality or nonrecommended fuel may not be covered under your warranty.

##### *Fuels Containing Oxygenates*

Gasoline frequently contains oxygenates (alcohols and ethers) especially in areas of the U.S. and Canada which are required to sell such reformulated fuels as part of a strategy to reduce exhaust emissions.

The types and volume of fuel oxygenates approved for use in unleaded gasoline by the U.S. Environmental Protection Agency include a broad range of alcohols and ethers, but only two components have seen any significant level of commercial use.

Gasoline/Alcohol Blends - Gasoline containing up to 10% ethanol (alcohol produced from agricultural products such as corn), also known as "gasohol" is approved for use.

**CAUTION**

**Avoid using blends of unleaded gasoline and methanol (wood alcohol) whenever possible, and never use "gasohol" containing more than 5% methanol. Fuel system damage and performance problems may result.**

Gasoline/Ether Blends - The most common ether is methyl tertiary butyl ether (MTBE). You may use gasoline containing up to 15% MTBE.

**NOTE**

- *Other oxygenates approved for use in unleaded gasoline include TAME (up to 16.7%) and ETBE (up to 17.2%). Fuel containing these oxygenates can also be used in your Kawasaki.*

**CAUTION**

**Never use gasoline with an octane rating lower than the minimum specified by Kawasaki.**

**Never use "gasohol" with more than 10% ethanol, or more than 5% methanol. Gasoline containing methanol must also be blended with cosolvents and corrosion inhibitors.**

**Certain ingredients of gasoline may cause paint fading or damage. Be extra careful not to spill gasoline or gasoline oxygenate blends during refueling.**

**When not operating your Kawasaki for 30 to 60 days, mix a fuel stabilizer (such as STA-BIL) with the gasoline in the fuel tank. Fuel stabilizer additives inhibit oxidation of the fuel which minimizes gummy deposits.**

**Never store this product with "gasohol" in the fuel system. Before storage it is recommended that you drain all fuel from the fuel tank and fuel system. See the Storage section in this manual.**

## 44 GENERAL INFORMATION

### Filling the Tank:

#### **⚠ WARNING**

**Gasoline is extremely flammable and can be explosive under certain conditions. Pull the lanyard key off the stop button. Do not smoke. Make sure the area is well ventilated and free from any source of flame or sparks; this includes any appliance with a pilot light.**

Avoid filling the tank in the rain or where heavy dust is blowing so that the fuel does not get contaminated.

The fuel tank is located inside the bow and the fuel filler cap is on the left side of the bow. Turn the cap counterclockwise and remove it.

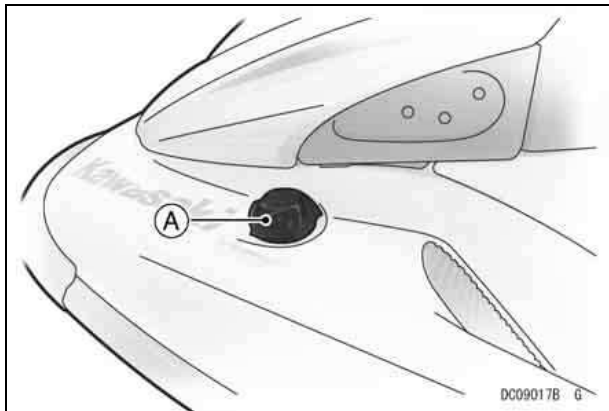

A. Fuel Filler Cap

Open the storage compartment lid to observe the fuel level in the fuel tank.

Fill the tank with the recommended octane rating gasoline. The use of a small diameter pour spout (or funnel) will make filling easier. Pour slowly to avoid "spit back" and allow air to escape from the tank.

#### **⚠ WARNING**

**Never fill the tank completely to the top. As the fuel expands in a warm tank, it may overflow from the vent tube. After refueling, make sure the filler cap is closed securely.**

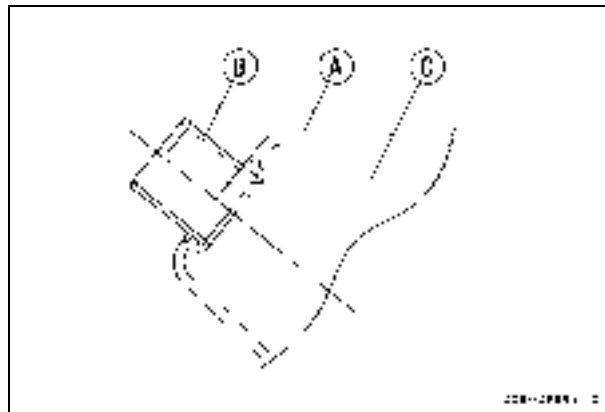

- A. Fuel Tank
- B. Filler Neck
- C. Top Level

After transporting or refueling and before starting the engine, open the storage compartment lid, remove the seats (see the Seat Latch section) and take out the storage pocket for several minutes to ventilate the engine compartment.

### WARNING

**A concentration of gasoline fumes in the engine compartment can cause a fire or explosion.**

## Engine Oil

In order for the engine to function properly, maintain the engine oil at the proper level, and change the oil and replace the oil filter in accordance with the Periodic Maintenance Chart. Not only do dirt and metal particles collect in the oil, but the oil itself loses its lubricative quality if used too long.

### Oil Requirements:

Type:	API SG, SH, SJ, SL or SM with JASO MA, MA1 or MA2 SAE10W-40
Capacity:	4.0 L (4.2 US qt) 5.0 L (5.3 US qt) when engine is completely dry.

### NOTE

○ *Do not add any chemical additive to the oil. Oils fulfilling the above requirements are fully formulated and provide adequate lubrication for both the engine and the clutch.*

Although 10W-40 engine oil is the recommended oil for most conditions, the oil viscosity may need to be changed to accommodate atmospheric conditions in your riding area.

## 46 GENERAL INFORMATION

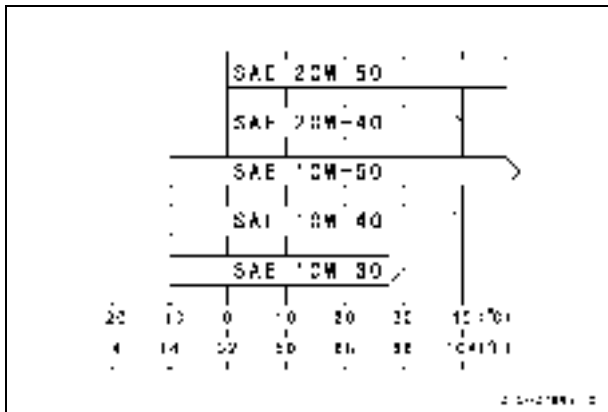

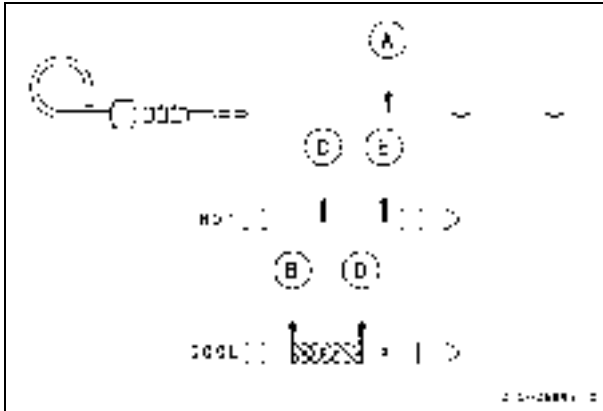

- A. Dipstick
- B. "H" (High) Line when cold
- C. "H" (High) Line when hot
- D. "L" (Low) Line when cold
- E. "L" (Low) Line when hot

- If the oil level is too low, add oil to reach the Low Line level. Use the same type and brand of oil that is already in the engine.
- See Maintenance and Adjustment chapter for adding oil procedure.

### CAUTION

**Be careful not to allow any dirt or foreign materials to enter the engine.**

## Controls

### Steering Handlebars:

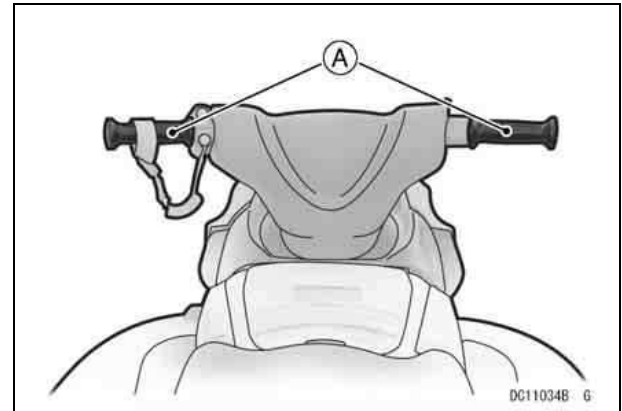

#### A. Handlebars

The steering handlebars function much the same as snowmobile or bicycle handlebars. Turning the handlebars will cause the watercraft to turn **ONLY WHEN THE ENGINE IS RUNNING AND ONLY WHEN THE THROTTLE IS APPLIED**. The handlebars are connected by a control cable to the jet pump steering nozzle at the rear of the boat.



## 48 GENERAL INFORMATION

### Kawasaki Smart Steering™ (KSS™)

Your JET SKI watercraft provides turning action under certain conditions when the throttle is released. There must be thrust at the jet nozzle to initiate and complete turns. This is a supplemental steering system which assists operators in learning to negotiate turns and maneuver.

Your JET SKI watercraft continuously detects the operator's steering input as well as boat speed. When the throttle is released while boat speed is high and a turn is initiated, the your JET SKI watercraft automatically increases engine speed to provide additional thrust. The system does not work when the engine is off or boat speed is low.

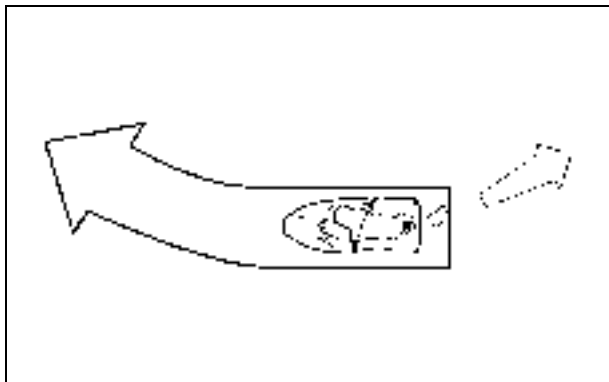

### Important Information:

When you make an emergency maneuver: **YOU MUST HAVE THRUST TO TURN**, so keep the throttle on or apply throttle as needed to maintain thrust at the jet nozzle.

You can turn quicker by applying the throttle as needed and not relying upon the steering system. The system functions when all of these conditions are present:

- engine speed averages more than 3 000 RPM for a specified time
- the throttle is released completely
- and the handlebars are held fully to the left or right.

### Smart Learning Operation mode ( SLO )

This watercraft is equipped with the Smart Learning Operation mode (SLO ), which reduces the maximum watercraft speed by approximately 30 percent.

SLO mode is displayed on the meter as SLO, whereas the non-restricted ordinary mode ( Full Power Operation mode, FPO ) is displayed as FPO.

Under the SLO mode, all the functions of the multifunction meter and KSS function remain the same as the ordinary mode, FPO.

To switch from FPO to SLO and vice versa, push the MODE button for 7 seconds. The buzzer sounds two times. Again push the MODE button for 7 seconds or more.

See the Multifunction Meter section of this chapter.

We suggest that the owner/operator become familiar with the SLO mode so that they can assist others in understanding how it works.

**Important Information for Handlebar Cover:**

The fuel tank vent hose is routed in the handlebar cover and improper installation of the handlebar cover can allow the vent hose to be kinked, pinched or plugged creating the possibility of a fuel leak resulting in fire or explosion.

**⚠ WARNING**

**Improper installation of the handlebar cover can allow the fuel tank vent hose to be kinked, pinched, or plugged creating the possibility of a fuel leak resulting in fire or explosion. See your authorized Kawasaki JET SKI watercraft dealer, if you must remove/install the handlebar or handlebar cover.**

**Stop Button:**

The stop button is in the case on the left hand side of the handlebar. The stop button is red and marked "STOP." Pushing the stop button turns off the engine.

The engine is also stopped by pulling the engine shut-off lanyard key off the stop button.

After riding, remove the engine shut-off lanyard key from watercraft to avoid unauthorized use by children or others.

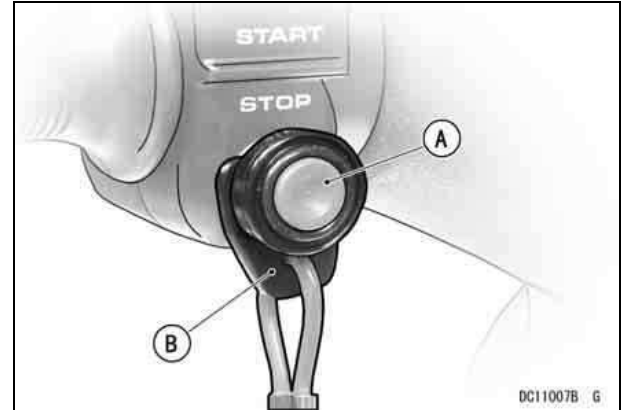

**A. Stop Button  
B. Lanyard Key**

**Start Button:**

The start button is in the case on the left hand side of the handlebar. The start button is green and is marked "START." Pushing the start button with the engine shut-off lanyard key pushed under the stop button starts the engine. Release it when the engine starts. Without the lanyard key the engine neither cranks nor starts.

**CAUTION**

**Do not push the "START" button while the engine is running or while the starter is still spinning, as it will hasten starter wear and may cause the starter to jam.**

## 50 GENERAL INFORMATION

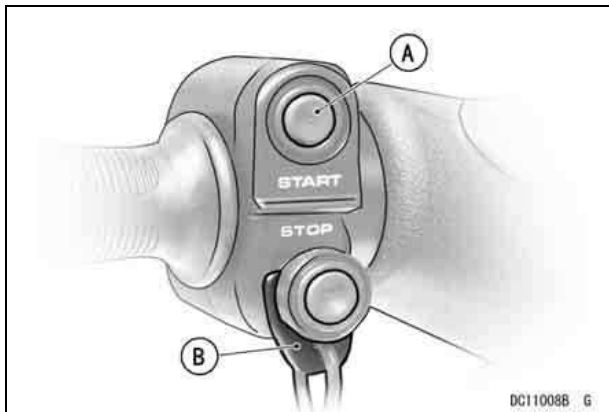

- A. Start Button
- B. Lanyard Key

### NOTE

- For the engine to start, the ignition switch must be turned to the "ON" position and the engine shut-off lanyard key must be pushed under the stop button.
- Refer to the Starting the Engine section in the Operating Instructions chapter.

### Throttle Lever:

The throttle lever is located on the right hand side of the handlebar. Squeezing the lever towards the handlebar grip increases engine speed. When released, spring pressure returns the lever to the idle position. Always check that the throttle lever returns normally before starting the engine. In addition, there must be adequate throttle cable play

Refer to the MAINTENANCE AND ADJUSTMENTS chapter for the throttle cable adjustment procedure.

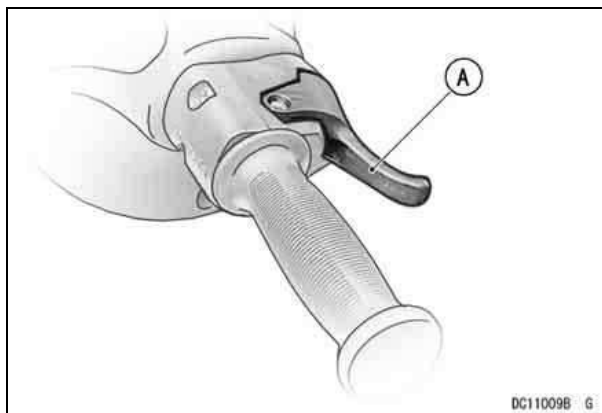

- A. Throttle Lever

### Ignition Switch:

The ignition switch is located under the center storage case lid. It is a 2-position, key operated switch. The key can be removed when in the "OFF" and "ON" positions. Remove the key immediately after turning the ignition switch on and store it in the storage case in front of the seat. Be sure to turn the ignition switch off after stopping the engine to prevent the battery from discharging. Whenever the watercraft is not in use, turn the key "OFF" and remove it to prevent unauthorized use.

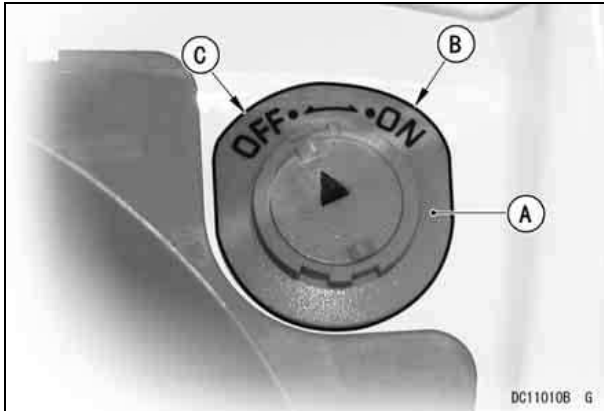

- A. Ignition Switch
- B. "ON" position
- C. "OFF" position

### CAUTION

After turning the ignition switch "ON", remove the key. Stow it in a secure place on the boat or with you while riding. Always turn the ignition switch "OFF" after stopping the engine to prevent the battery from discharging.

Record your ignition switch key number. In the event of loss of the key, ask your dealer to get the same key number.

Write your key number here.

## 52 GENERAL INFORMATION

### Seat Latch

The seat can be removed by unlocking the latch under the end of the seat.

**To Open:** Pull the latch handle and remove the seat up and to the rear.

**To Close:** Engage the front of the seat in place and slide it all the way forward by pushing the rear of the seat and then push down on the rear of the seat to lock it.

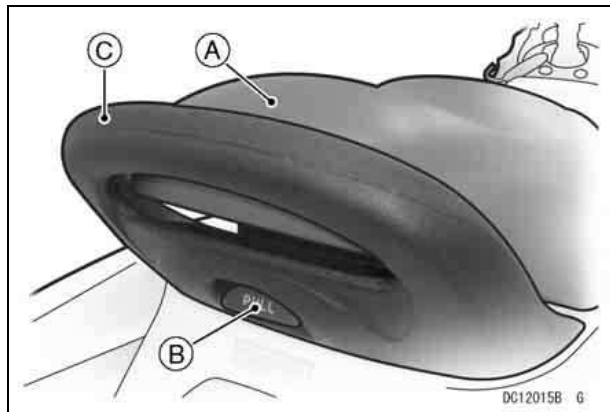

- A. Seat
- B. Latch Handle
- C. Handrail

When transporting the watercraft, make sure the seat is secured to prevent it from becoming dislodged and damaged or lost.

The handrail behind the seat is for boarding from deep water. Also, when towing a water skier, the handrail should be held by the observer who faces rearward to watch the water skier. It is not designed for any other purposes.

See page 66 for instructions on where to attach tow ropes.

### CAUTION

**Do not use handrail and hook for towing another watercraft, lifting craft, or attaching tie-downs.**

## Storage Compartment

The box type storage case is located in the bow. Store this Owner's Manual, put in a plastic bag, in the storage case.

To open the lid, pull the knob and raise the lid all the way up.

To close the lid, push on it near the knob until it latches.

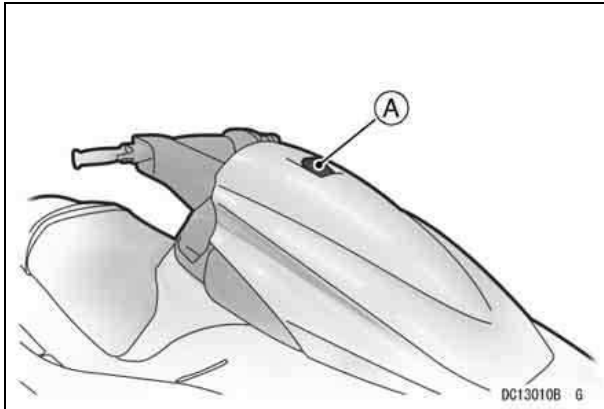

A. Knob

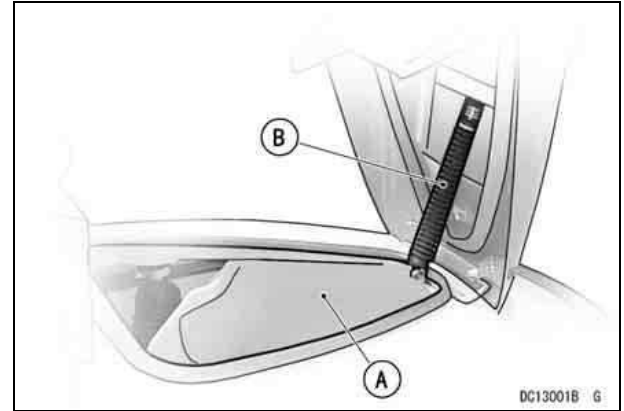

A. Front Storage Case  
B. Damper

### NOTE

- Make sure that the storage compartment lid is properly secured before operating the watercraft.

## 54 GENERAL INFORMATION

### Center & Rear Storage Case

There is a center storage case in front of the seat.  
To open the lid, pull the knob.  
To close the lid, push the knob until it latches.

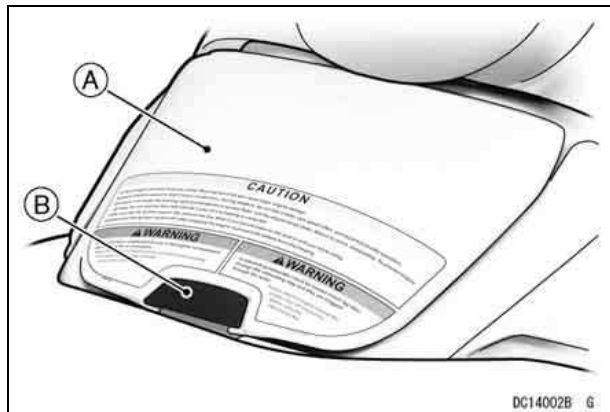

- A. Center Storage Case
- B. Knob

The box type rear storage case is located under the seat. Only keep light items in these storage cases.

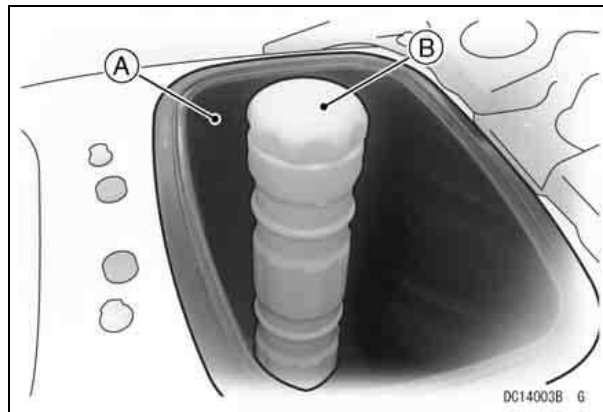

- A. Rear Storage Case
- B. Fire Extinguisher Container

You will find a container for a fire extinguisher attached in the rear storage case.  
(The fire extinguisher is not standard equipment with this watercraft.)

## Tool Kit

The tool kit container is stored at the back of the seat. Unhook the rubber straps to take out the tool kit.

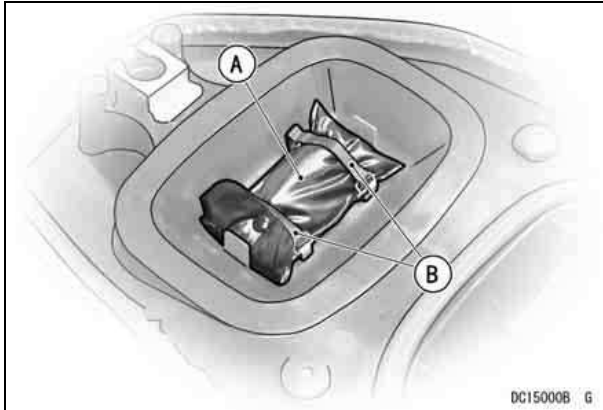

- A. Tool Kit
- B. Rubber Straps

## Bilge Systems

This watercraft is equipped with a jet vacuum drainage system at the rear end of the engine compartment. This system utilizes the water jet for propulsion to drain the bilge in the engine compartment. This system functions when the engine is running on the water.

### CAUTION

**Check the function of the bilge system at regular interval according to the Periodic Maintenance Chart. Refer to the MAINTENANCE AND ADJUSTMENTS chapter. Clear debris from the pump inlets.**

### ⚠ WARNING

**The capacity of the bilge pumping system is not designed to drain the craft in the case of damage.**

### NOTE

- *To drain the remaining bilge, remove the drain screws at the rear end when the craft is out of the water.*



## 56 GENERAL INFORMATION

### Drain Screws

There are two drain screws in the stern to drain water accumulated in the engine compartment. Open them only when the craft is out of the water.

#### **CAUTION**

**Before launching be sure to securely tighten the screws to avoid flooding and swamping the craft.**

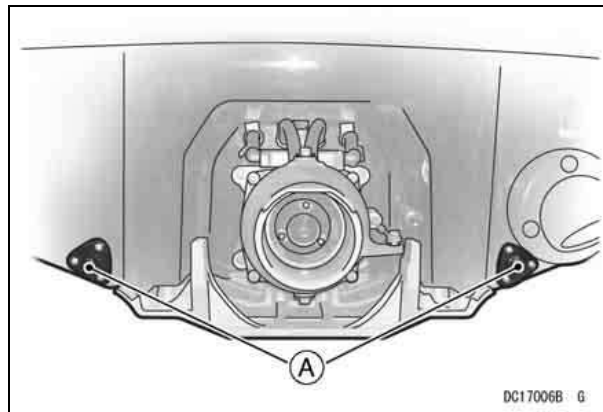

**A. Drain Screws**

DC17006B · 6

---

# OPERATING INSTRUCTIONS

---

---

## Safe Operation

---

### Operation by Children:

#### WARNING

The JET SKI watercraft is not a toy; it is a one to three person high performance IN-BOARD BOAT LESS THAN 4.8 M (16 FEET) IN LENGTH with a capacity load limit of 225 kg (496 lb). Underage operators may be hazardous to themselves and others. Kawasaki recommends a minimum operator age of 16 years old. Know the operator age and training requirements for your state. A boating safety course is recommended and may be required in your state.

### Operation by unskilled riders:

- This watercraft is equipped with the Smart Learning Operation mode (SLO ), which reduces the maximum watercraft speed by approximately 30 percent. Unskilled operators should practice operation of the craft using the SLO mode until they become more familiar with its operation.

See the Multifunction Meter and Controls in the GENERAL INFORMATION chapter.

### Operator Swimming Ability:

#### WARNING

Riders of personal watercraft can fall into the water and experience exposure. Operator and passengers must be competent swimmers and never travel farther from shore than they can swim.

Drowning Hazard: a personal flotation device (PFD) must be worn by the operator and passengers. Kawasaki recommends that the operator and passengers wear a vest-type PFD (type 1, 2 or 3) at all times.

### Maximum Number of Persons

This watercraft is designed to carry the operator and up to 2 passengers. Never exceed the maximum load limit or allow more than 3 persons (or 2 persons if water-skier is being towed) to ride the watercraft at one time.

## 58 OPERATING INSTRUCTIONS

### **⚠ WARNING**

**Do not exceed the maximum recommended number of persons. Regardless of the number of persons on board, the total weight of persons and cargo must never exceed the load capacity limit.**

**Overloading this watercraft can adversely affect handling and stability which can lead to an accident. Always use the seats.**

Load capacity limits: 3 persons or 225 Kg (496 lb) including cargo.

Cargo carried in open storage area must not exceed 23 Kg (50 lb)

### **Safe Riding Rules:**

### **⚠ WARNING**

**Always follow these rules when operating your watercraft, for your own safety and that of others.**

- Always comply with any Navigation Rules in effect in your area. The Coast Guard office or state boating authority nearest you can usually furnish you with the applicable rules. Check local and state regulations before operating. Kawasaki recommends that all operators complete an approved boating safety course.
- See the Navigation Rules section in this chapter for basic navigation rules.

- Kawasaki recommends that the operator and passengers wear a U.S. Coast Guard approved vest -type personal flotation device (type 1, 2 or 3) at all times. Other countries may have their own standards and regulations; be sure to follow them.
- Check the throttle control and steering for proper operation before starting the engine. Malfunctioning controls can cause an accident.
- Operate defensively at safe speeds and keep a safe distance away from people, objects, and other watercraft.
- Do not follow directly behind watercraft or other boats.
- Do not go near others to spray or splash them with water.
- Look carefully around you for other boats and objects in your path before starting and making quick maneuvers, especially before executing any quick turns. Because the watercraft is very maneuverable, other boaters may not be expecting you to turn as quickly as you are able (see the Turning the JET SKI Watercraft section). Before making a turn, always look over your shoulder to make sure no other watercraft is coming from behind.
- Take early action to avoid collisions. Remember, watercraft and other boats do not have brakes.
- Passengers should hold on to the person in front of them or a hand strap while keeping both feet on the deck for balance during operation or they can lose balance and be injured. Never allow the passenger to ride in front of the operator.
- The operator must always keep the engine shut off and be secured to himself while operating the

- watercraft. If the operator falls, the lanyard stops the engine (see the Starting the Engine section).
- Alcohol and drugs impair judgement and reaction time. Never drink and ride.
  - Wear suitable eye protection while operating this watercraft. In some circumstances water spray can momentarily interfere with vision and create a hazard.
  - Operator and passengers should wear foot protection at all times. Objects hidden underwater may injure your feet.
  - Kawasaki recommends that the operator and passengers of personal watercraft wear protective swimwear such as wet-suit bottoms. Riders of personal watercraft may suffer injury due to the forceful injection of water into body cavities either by falling into the water or while mounting the craft.
  - You need throttle to turn. Releasing the throttle completely reduces the ability to steer and the watercraft can hit an object you are trying to avoid.
  - Use caution when towing another watercraft. Towing affects steering control and can create a hazardous condition.
  - All operators of this watercraft must know the righting procedure because this craft will not self-right if it is capsized (see Righting the Capsized Watercraft in the Riding the JET SKI Watercraft section).
  - Never operate the watercraft after dark. It was not designed for such use, and has no lighting equipment.

- Avoid operating the watercraft in waters full of weeds or debris, as they may clog the jet pump, and cause an injury if you fall.
- Do not operate in shallow water, or the impeller may be damaged and sand may clog the water cooling hoses.
- Be very careful of other boats, especially those towing water skiers. Give them plenty of room.
- Never go over a ski jump. You could damage the watercraft or injure yourself.
- Do not operate the watercraft in ocean surf. In addition to being dangerous, it may be illegal in certain localities.
- Slow down before crossing waves. Do not ride if you have a back condition. High speed operation in choppy or rough water may cause back injuries.
- The operator must judge what is a safe speed taking into consideration visibility, traffic, weather conditions, waves, etc. Water conditions such as converging waves can have considerable influence on the ride characteristics of a personal watercraft and can cause the operator and passengers to fall off. Additionally, attempting to achieve maximum speed in adverse conditions can cause abrupt movement of the boat causing possible injury to the riders.

**CAUTION**

**Jumping waves can overstress the watercraft hull causing it to crack.**

## 60 OPERATING INSTRUCTIONS

### Jet Pump Safety:

Although the jet pump is inherently safer than a propeller drive, certain safety precautions must always be observed.

### **⚠ WARNING**

Keep your hands, feet, and clothing away from the jet pump intake (bottom of the boat, in the middle) and never stick anything into the pump outlet (steering nozzle at the back of the boat) whenever the engine is running, or a severe injury can occur.

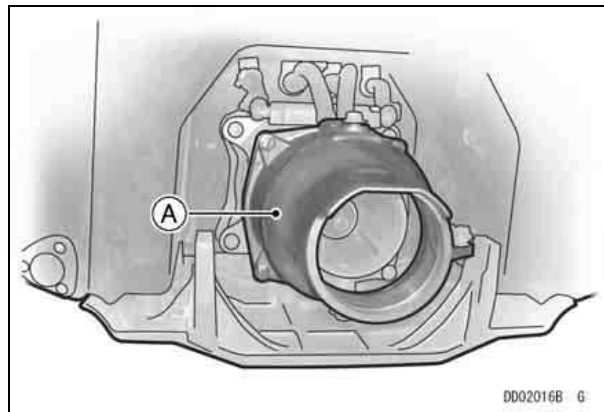
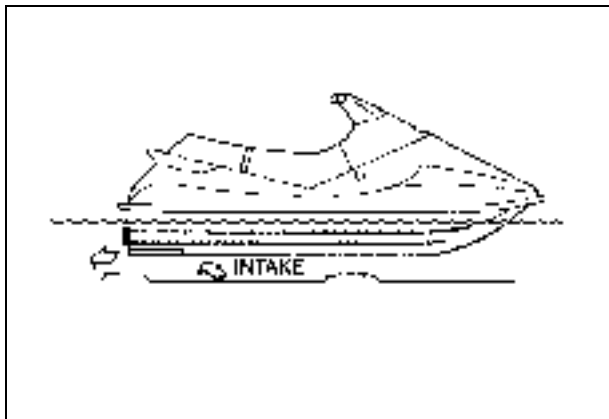

**A. Steering Nozzle**

### Personal Flotation Device and Safety Gear:

U.S. federal regulations require that one U.S. Coast Guard approved personal flotation device (PFD) be carried for each person aboard when operating on water under Coast Guard jurisdiction. In some state waters not under federal jurisdiction, other flotation devices are permissible in addition to those specified by federal law. Other countries may have their own standards and regulations; be sure to follow them. As a rule, waist-type ski belts do not qualify as adequate flotation devices. The full vest type is recommended. Check local regulations to see what type of personal flotation device may be required in your area.

**⚠ WARNING**

**Drowning Hazard:** a personal flotation device (PFD) must be worn by the operator and passengers. Kawasaki recommends that the operator and passengers wear a vest-type PFD (type 1, 2 or 3) at all times.

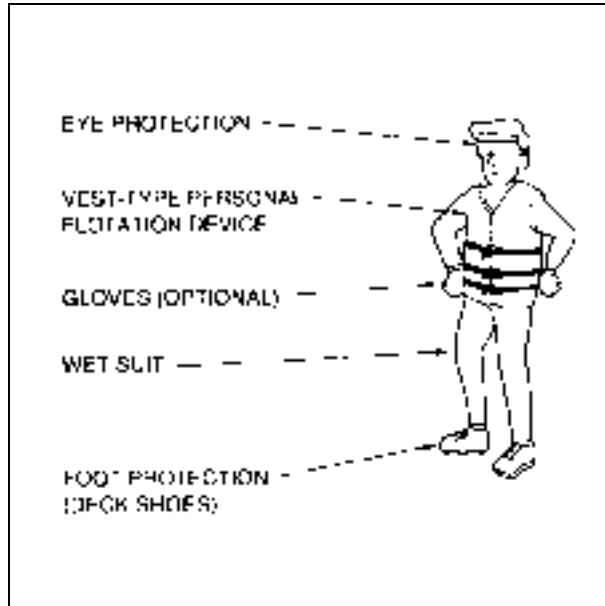
**⚠ WARNING**

In some circumstances water spray can momentarily interfere with vision which could be hazardous. Wear suitable eye protection while operating this watercraft.

Objects hidden underwater may injure your feet. Operator and passengers should wear foot protection at all times.

Riders of personal watercraft may suffer injury due to the forceful injection of water into body cavities either by falling into the water or while mounting the craft. Kawasaki recommends that the operator and passengers of personal watercraft wear protective swimwear such as wetsuit bottoms.

#### **Watercraft Helmet..... Something You Should Know:**

A helmet could protect your head, but could contribute to neck injuries.

Before wearing a helmet on a personal watercraft you must weigh the benefits and risks.

**Benefits:** Helmets offer some head protection from impacts with hard objects.

**Risks:** Helmets could reduce peripheral vision and increase fatigue; both of which could lead to a collision. Helmets could also increase loads on the neck and throat when you fall into the water, which could result in severe injuries.

## 62 OPERATING INSTRUCTIONS

### You must decide.

If you plan to ride under conditions in which you believe there is a higher chance that your head may be hit by a hard object, such as falling during a race, you may choose to wear a helmet and accept the risks. On the other hand, if head impact with the water is more likely, you may choose to not wear a helmet.

### Fire Extinguisher:

A charged and functional fire extinguisher must be carried on board, and may be stored in the storage compartment (see the Storage Compartment section in the GENERAL INFORMATION chapter). Be sure to install the fire extinguisher securely.

Because the watercraft is an inboard boat less than 4.8 m (16 ft) in length, federal regulations require that a fire extinguisher rated "B-1" (minimum 1 kg or 2 pound capacity) be aboard when operating on navigable waters under Coast Guard Jurisdiction. In addition, most states, parks, and wildlife departments require that a U.S.C.G. approved fire extinguisher be carried aboard, even on waters not under federal jurisdiction.

Other countries may have their own standards and regulations; be sure to follow them.

Standard equipment does not include a fire extinguisher. Many owners prefer to provide their own fire extinguishers. If you wish, your dealer can furnish you with an approved Kawasaki accessory fire extinguisher (P/N. W99997-101A).



### **⚠ WARNING**

**Do not use your watercraft unless it has a fire extinguisher on board.**

---

## Loading

---

### WARNING

**Incorrect loading or use of accessories, or modification of your watercraft may affect stability and handling of the watercraft and result in an unsafe riding condition.**

**Before you ride the watercraft, make sure that the watercraft is not overloaded and that you have followed these instructions.**

#### Load Capacity Limits:

3 persons or 225 kg (496 lb) including cargo. Cargo carried in open storage area must not exceed 23 kg (50 lb).

With the exception of genuine Kawasaki Parts and Accessories, Kawasaki has no control over the design or application of accessories. In some cases, improper installation or use of accessories, or watercraft modification, will void the warranty. In selecting and using accessories, and in loading the watercraft, you are personally responsible for your own safety and the safety of other persons involved.

#### NOTE

○ *Kawasaki Parts and Accessories have been specially designed for use on Kawasaki watercraft.*

*We strongly recommend that all parts and accessories you add to your watercraft be genuine Kawasaki components.*

Because a personal watercraft is sensitive to changes in weight distribution, you must take extreme care in carrying cargo, passengers and/or in the fitting of additional accessories. The following general guidelines have been prepared to assist you in making your determinations.

- Passengers can affect control of the watercraft by improper positioning or sudden movements. It is important that passengers sit still while the watercraft is in motion and not interfere with the operation of the watercraft. Do not carry animals on your watercraft.
- You should instruct any passenger before riding to hold on to the person in front of them, hand strap, or handrail; and keep both feet on the deck for balance.
- Use the open storage area aft of the seat for carrying cargo. Be sure that any loose items are packed in a buoyant container to prevent them from falling overboard and becoming lost. Loose articles or rope could fall overboard and become lodged in the intake grate or pump.
- Use the cargo net (not standard equipment with this watercraft) or other suitable tie-down straps to secure cargo on the open storage area. The hook under the rear end of the seat and the towing eyes at the stern are available. Do not overload



## 64 OPERATING INSTRUCTIONS

the storage area, maximum cargo weight must not exceed 23 kg (50 lb).

- Make sure that the cargo will not move around while you are riding. Recheck cargo security as often as possible and adjust as necessary.
- Do not carry large or bulky items affecting visibility or operator ability to control the watercraft. Do not install accessories or carry cargo that impairs the performance of the watercraft.

### **⚠ WARNING**

**Cargo in the open storage area could interfere with reboarding by causing a loss of balance and possible injury.**

**Do not stack cargo in such a way that it interferes with reboarding.**

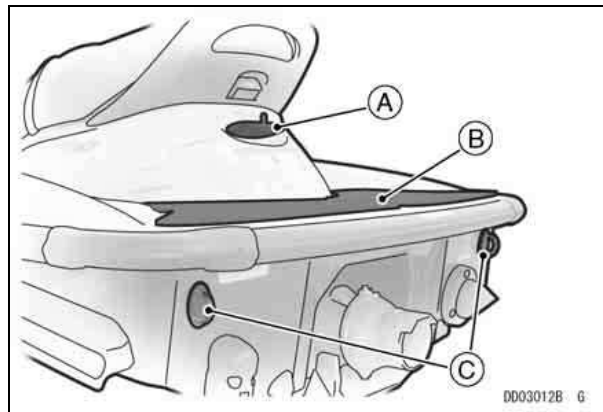

- A. Hook
- B. Open Storage Area
- C. Towing Eyes

---

## **Pulling a Water Skier, Tuber, Wakerboarder, etc.**

---

Water skiing should be considered a three person team sport. Do not consider the rear view mirrors as an observer. As a team, the boat operator, the backward-facing observer, and the skier must know their equipment, boating laws, each person's responsibilities, communication signals, and the fundamentals of the sport. The navigation rules do not provide any special privileges for vessels towing skiers.

Minimize the danger of collisions with other boats, fixed objects, or swimmers by staying out of congested areas. Keep the skier at least twice the length of the tow rope away from shore and shallow water. Do not pull the tow rope in front of another boat. Many lakes have designated ski areas. Always follow local regulations regarding the towing of water skiers.

### **To the Operator:**

As the skipper you are responsible for the conduct and safety of your team. Be extra observant when pulling a water skier, tuber, wakerboarder, etc; other boats may not be expecting a personal watercraft to be pulling someone behind it. Always display a ski flag to indicate a downed skier or a skier getting ready to ski. Return to a fallen skier without delay, but always approach slowly.

Start off by idling ahead until the tow rope is tight. When the skier signals he or she is ready, be sure

the water ahead is clear and start off with enough power to raise the skier. Ease up on the throttle once the skier is up. Remember, before pulling up the skier, double check the path ahead for boats or obstacles and be sure the tow rope is not wrapped around the skier.

Always judge the speed according to the skier's ability. A good speed for beginners is 29 to 40 km or 18 to 25 miles per hour. Give skiers a smooth, easy ride and let them signal what they want to do. Boats pulling skiers must follow all speed limits.

A skier's weight and speed in turns can affect the steering of the watercraft by pulling it off course. Both the operator and the skier must coordinate their actions so that the craft is not misdirected. Always anticipate the added length of the tow rope and skier by allowing extra time and space for maneuvering. Turn wide and not too fast to avoid whipping the skier at excessive speeds.

The operator should not accelerate or continue moving when the observer or passenger is bringing in the ski rope or otherwise not in a secure position.

### **To the Observer:**

The observer's job is to relay all signals from the skier to the operator, inform the operator immediately if the skier falls, and display the ski flag. The observer should hold the handrail securely as he or she faces rearward to watch the water skier. The observer must also tend the ski rope to prevent it from entering the pump intake and winding around the impeller.

## 66 OPERATING INSTRUCTIONS

### Where to Attach a Tow Rope:

When towing a water skier, tuber, waterboarder, etc., do not tie the towrope other than the towing hook under the rear end of the seat. When towing another watercraft, secure the tow rope to the towing eyes at the stern. Use caution when towing another watercraft. Towing affects steering control and can create a hazardous condition. Also, other boat operators may not expect the watercraft to be towing anything.



**A. Towing Hook**

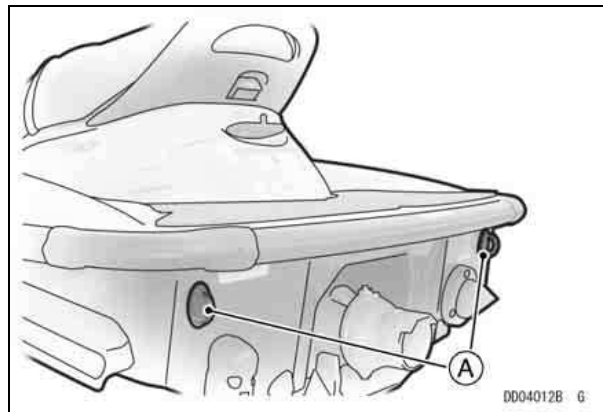

**A. Towing Eyes**

---

## Navigation Rules

---

The navigation rules or nautical "rules of the road" are like highway traffic laws. They dictate who has the right-of-way when boats meet in open water. As the boat operator you are obligated to know and obey these rules. They are also legally binding on boat operators.

This section provides basic navigation rules. We recommend that you obtain more information on navigation rules and navigation aids from your state when registering your craft. If you have never owned a boat before, an excellent introduction to the arts of boat handling and seamanship can be obtained from the U.S. Power Squadrons, the U.S. Coast Guard Auxiliary, or other volunteer organizations.

In nautical terms, the stand-on (privileged) boat has the right of way; and the give-way (burdened) boat must give way. Whenever you come near another boat, be cautious and use common sense. You cannot rely on other boaters to know or follow these rules.

### Sailboats:

Sailboats have right-of-way over power boats in nearly all cases. Stay clear of these craft and do not create a wake which may cause them trouble.

### Overtaking and Passing Situation:

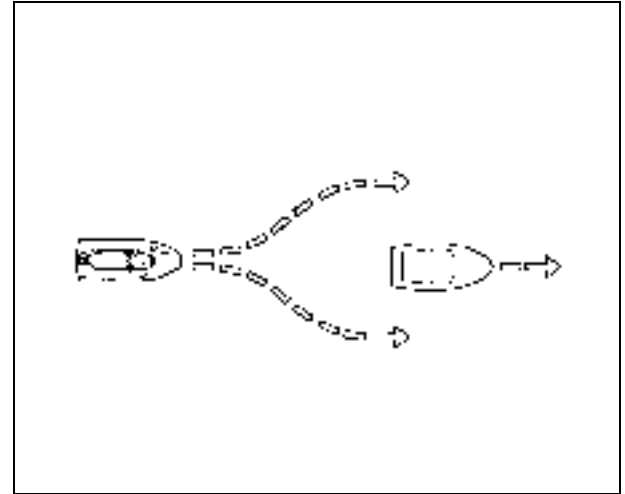

**Give-way (Burdened)  
Vessel Overtaking**

**Stand-on (Privileged)  
Vessel Being Overtaken**

If you are overtaking and passing another boat, the boat being passed has right-of-way, and you are required to stay clear.

## 68 OPERATING INSTRUCTIONS

### Meeting Situation:

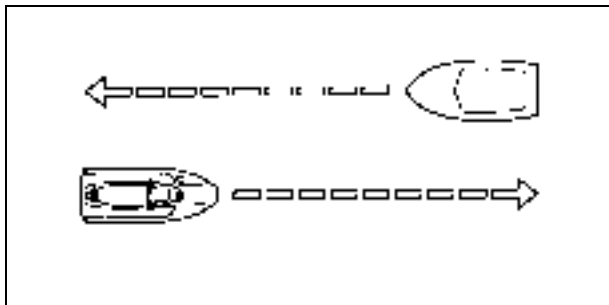

If you are meeting another power boat head on, neither you nor the other boat has right-of-way. Each boat should keep to its right.

### Crossing Situation:

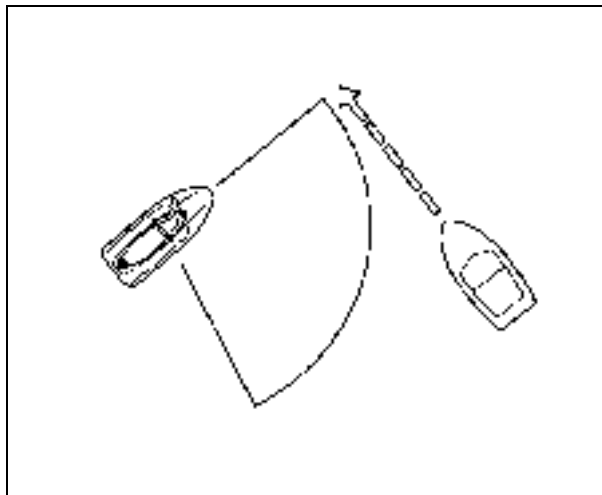

**Give-way  
(Burdened)  
Vessel**

**Stand-on (Privileged) Vessel  
holds course and speed.**

If you have another power boat on your right, the boat on the right has right-of-way. You must keep out of the way of the boat by directing your course to the starboard (right) and passing astern of (behind) the stand-on boat. If necessary, you may have to slow, stop, or reverse your craft to allow the stand-on boat to pass. Before passing behind another boat, look carefully for a water skier or any towed object. Pass behind the object in tow.

If you have another boat on the left, you have right-of-way. You must keep your course and speed.

---

## Pre-ride Checklist

---

Each day before using the watercraft, check the following items:

### Check Outside Craft:

- CLEAN PUMP - Clear the water inlet, jet pump, and drive shaft of foreign objects.
- PUMP COVER TIGHT - Check the jet pump cover and inlet grate for looseness. Tighten the mounting bolts, if needed.
- HULL DAMAGE - Inspect the hull for damage.
- DRAIN SCREWS - Check that the drain screws in the stern are securely installed.
- STEERING-Check the operation of the steering for binding, rough spots, or excessive play. Adjust the cable if needed (see the Control Cable Adjustments section in the MAINTENANCE AND ADJUSTMENTS chapter). The steering cable is sealed at both ends and does not need lubrication. If the seals are damaged, the cable must be replaced.

### Check Inside Craft:

- THROTTLE CONTROL - Check the operation of the throttle for binding, rough spots or excessive play. Adjust the cable if needed (see the Control Cable Adjustments section in the MAINTENANCE AND ADJUSTMENTS chapter). The throttle lever must return to the fully closed position when released.

## 70 OPERATING INSTRUCTIONS

### **⚠ WARNING**

**If the throttle does not return freely and completely, it may cause loss of control.**

- VENTILATE ENGINE COMPARTMENT - Open the front storage case lid, remove the seats and take out the rear storage case and keep open for several minutes to purge gasoline fumes from the engine compartment.

### **⚠ WARNING**

**A concentration of gasoline fumes in the engine compartment can cause a fire or explosion.**

- BATTERY TERMINALS - Check the battery terminal screws for tightness, and make sure terminal covers are in place.

### **⚠ WARNING**

**Loose battery cables can create sparks which can cause a fire or explosion resulting in injury or death. Make sure the battery terminal screws are tightened securely and the covers are installed over the terminals.**

- FIRE EXTINGUISHER - Check your fire extinguisher for a full charge.
- FUEL PRESSURE - Loosen the fuel tank cap to relieve any pressure, then tighten the cap securely.

- FUEL LEVEL - Check the fuel level. Refill if necessary.
- ENGINE OIL LEVEL - Check the oil level in the engine. Refill if necessary. Refer to GENERAL INFORMATION CHAPTER, Engine Oil section.
- FUEL LEAKS - Check the engine compartment for fuel leaks.
- OIL LEAKS - Check the engine compartment for oil leaks.
- FASTENERS - Check and tighten any loose bolts, nuts, or clamps.
- HOSE CONNECTIONS - Be sure all hose connections are secure and that all hose clamps are tight. Check all hoses for cracks or deterioration and replace if necessary.
- DRAIN BILGE - Drain any water out of the engine compartment by removing the drain screws. Install the drain screws securely when all the water has been drained.
- ENGINE SHUT-OFF LANYARD KEY - Start the engine and run it for a few seconds (see the Starting the Engine section). Pull the lanyard key off the engine stop button to check that the engine stops immediately.

### **⚠ WARNING**

**Do not run the engine in a closed area. Exhaust gases contain carbon monoxide: a colorless, odorless, poisonous gas. Breathing exhaust gas leads to carbon monoxide poisoning, asphyxiation, and death.**

**CAUTION**

**Do not run the engine with the watercraft out of the water for more than 15 seconds at a time. Overheating will cause engine and exhaust system damage.**

- STOP BUTTON- Again start the engine, run it for a few seconds, and then check that the engine "STOP" button works.
- SEAT- Check that the seat latch is secure.
- STORAGE COMPARTMENT- Check that the lid is secure.
- RIDER PROTECTION- Always wear the proper flotation device and protective gear.
- MULTIFUNCTION METER- Check the operation of the multifunction meter. See GENERAL INFORMATION chapter for the detail.

---

**Break-In**

---

A new watercraft should be ridden with care during the break-in period to allow mechanical components to "bed-in" and produce smooth, long wearing surfaces.

During the first five minutes of engine operation, do not exceed the engine revolution more than 2 500 rpm.

During the first five hours of engine operation, do not subject the engine to heavy lugging or prolonged full throttle operation. For this period, up to 3/4 throttle is recommended.

Vary the operating speed often, not running for a prolonged time at any one speed. Avoid full throttle starts.

Careful treatment of the craft during the break-in period will result in more efficient, reliable performance and a longer life for the craft.

In addition to the break-in described above, we recommend that the owner take his watercraft to an authorized Kawasaki JET SKI dealer after the first ten hours of operation for initial maintenance service. See the Periodic Maintenance Chart in the MAINTENANCE AND ADJUSTMENTS chapter.



## 72 OPERATING INSTRUCTIONS

### Stopping the Engine

The engine can be stopped in one of the following two ways.

- Push the red "STOP" button. It is not necessary to hold the button "in" to stop the engine. After the engine stops, the "STOP" button resets itself and the engine is ready to start.
- Pull the engine shut-off lanyard key off the stop button. To start the engine the lanyard key must be pushed under the stop button.

Turn the ignition switch off after stopping the engine in either case.

#### **⚠ WARNING**

**You have no directional control of the watercraft when the engine is stopped.**

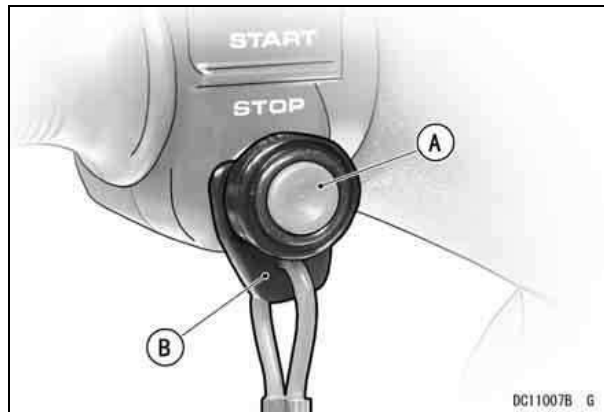

- A. Engine Stop Button**
- B. Lanyard Key**

If the engine must be stopped immediately in an emergency, push the red "STOP" button or pull the engine shut-off lanyard key off the stop button.

Some possible "EMERGENCY" situations are:

- The engine speeds out of control.
- The throttle lever does not release completely.

#### **⚠ WARNING**

**If the throttle fails, do not operate the watercraft until the source of the problem is found and corrected.**

**⚠ WARNING**

After riding, remove the engine shut-off lanyard key from watercraft to avoid unauthorized use by children or others.

**CAUTION**

Always turn the ignition switch "OFF" after stopping the engine to prevent the battery from discharging.

**Starting the Engine**

- Read the Pre-ride Checklist in this manual and follow its instructions before putting the watercraft in the water.
- After transporting or refueling and before starting the engine, open the storage compartment lid, remove the seats and take out the storage pocket for several minutes to ventilate the engine compartment.

**⚠ WARNING**

**A concentration of gasoline fumes in the engine compartment can cause a fire or explosion.**

- Place the watercraft in at least 0.8 m (2.5 feet) of water which is clear of weeds and debris. Make sure the area ahead of the watercraft is clear of swimmers, boats, and obstacles.

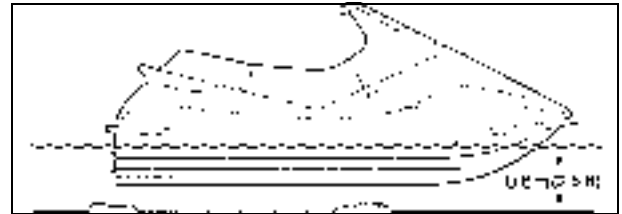

## 74 OPERATING INSTRUCTIONS

### CAUTION

**The watercraft must be in water at least 0.8 m (2.5 ft) deep when starting to prevent jet pump damage by objects sucked up from the bottom.**

- In the seated position push the lanyard key under the stop button and put your left hand through the other end of the lanyard to attach it to your wrist and keep it free from handlebars so that engine stops if operator falls off. Pull the lanyard to make sure it is securely attached.

### NOTE

- *The engine neither cranks nor starts with the lanyard key removed from the stop button.*
- Attach the ignition switch key to the switch with the arrow forward and while pushing the key turn it to the "ON" position. Be sure to remove the key immediately and store it in the front storage pocket.

### CAUTION

**After turning the ignition switch "ON", remove the key. Stow it in a secure place on the boat or with you while riding.**

- With your left hand, push the green start button and release it when the engine starts. If the engine does not start within 5 seconds, release the button. Wait 15 seconds before trying again. If the

engine does not start after several attempts, see the TROUBLESHOOTING GUIDE chapter.

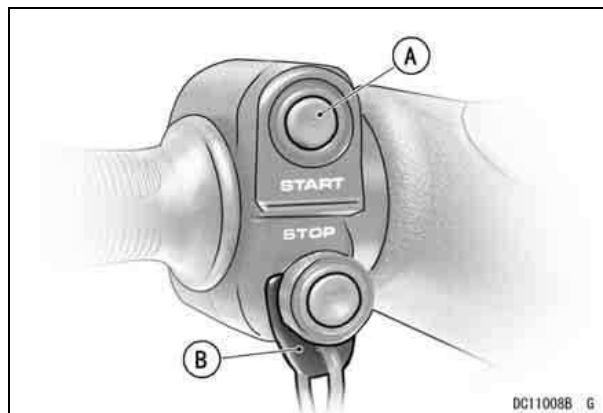

- A. Start Button**
- B. Lanyard Key**

### NOTE

- *Wait 15 seconds between each operation of the starter. This will extend battery and starter life significantly.*

### CAUTION

**Do not push the start button while the engine is running or while the starter is still spinning, as it will hasten starter wear and may cause the starter to jam.**

- After the engine has started, allow it to warm up for about 1 minute. Apply a little throttle occasionally. Excessive idling can foul the spark plugs.
- Check that water comes out of the bypass outlet in the right side of the hull when the throttle is applied. This indicates that cooling water is circulating. If there is none, shut off the engine and find the source of the trouble. When the exhaust system is dry, it can take up to 15 seconds for water to appear at the bypass outlet.

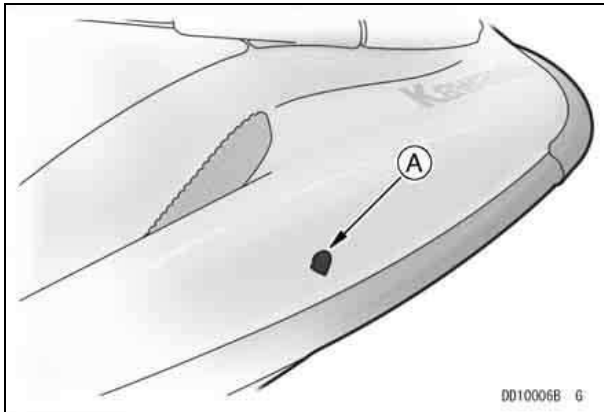

**A. Bypass Outlet**

## Launching

### Launching from a Dock:

- Do not jump onto the watercraft from the dock.
- First place one foot on the deck near the dock, then while holding the handlebar and balancing the craft by transferring body weight straddle the craft and sit down on the seat.
- When leaving the dock, either push the watercraft away from the dock or run at a slight angle away from it until there is enough room for the rear of the craft to swing, since the watercraft turns at the stern and not at the bow.
- Check that the water in your path is clear and move the handlebar in the direction you want to go.

### **⚠ WARNING**

**Don't forget to watch out for other boats or obstructions in your path. This is especially critical during a beginner's first exciting ride.**

- Apply the throttle to produce enough thrust from the jet pump to allow directional control over the watercraft.

## 76 OPERATING INSTRUCTIONS

### CAUTION

**Avoid quick turns or acceleration when leaving the dock, or you might hit the dock and damage the watercraft. The operator should make sure there is room for a turn before making any quick maneuvers.**

- Accelerate gradually as you proceed into open water. Remember to observe "No Wake" zones and speed limits.
- As speed increases the boat will level out in the water. This is called planing.
- Once the boat has planed, you can back off the throttle and select your desired speed.
- Keep alert for other boats, swimmers, or obstructions in your path.

#### **Launching from a Ramp:**

- Before putting the watercraft in the water, be sure you have followed the Pre-ride Checklist.
- Before launching, check the ramp for suitable surface conditions, inclination and width for both the trailer and tow vehicle.
- Attach a bow line to the watercraft and detach the trailer tie-downs.

### CAUTION

**Be sure the drain screws in the stern are securely installed to prevent the craft from flooding and swamping.**

- Wait until it's your turn then back the trailer to the water. Unlock the winch and push the craft slowly off the trailer into the water.
- Move your watercraft to a docking or loading area and park your tow vehicle. Do not block the ramp.

#### **Deep Water Start:**

##### *Solo Operation*

- Move to the rear of the watercraft.
- Make sure the engine is stopped.
- Grasp either the handrail behind the seat or the towing hook under the handrail, pull yourself up onto the deck. Place one knee on the deck rear end, then the other. Be careful not to slip on the boat as you reboard.
- Grasp the hand strap and while balancing the craft place your feet on the deck.
- Sit astride the seat.

##### *Operator and Passengers*

- While the operator is balancing the craft, the passengers climb aboard from the rear of the craft in the same way as in Solo Operation.

#### **Shallow Water Start:**

Whenever possible, anchor the watercraft in shallow water instead of dragging it onto shore. This will reduce scratches to the hull and prevent sand and rocks from entering into the jet pump causing damage to the pump when restarting the engine.

If the watercraft is beached, sand and rocks which are pushed into the jet pump by natural wave action can be flushed out by pushing down on the stern vigorously many times.

### CAUTION

**The watercraft must be in water at least 0.8 m (2.5 ft) deep when starting to prevent jet pump damage by objects sucked up from the bottom.**

- You can board either from the side of the craft or from the rear. In either case balance the craft when going aboard for more stability.

## Stopping the JET SKI Watercraft

### Normal Stopping:

### WARNING

**Never directly approach any moving or stationary object closer than 100 m (328 feet) when traveling at top speed. Always throttle down before approaching your intended stopping area.**

This watercraft is stopped by using natural water drag to bring the craft to a halt.

1. Release the throttle before you reach your intended stopping area.
2. Coast towards the stopping area with the engine idling.

### CAUTION

**Stop the engine before the water is less than 0.8 m (2.5 ft) deep from the seabed to prevent jet pump damage by objects sucked up from the bottom.**

3. Press the engine stop button or pull the lanyard key off the stop button to come to a complete stop.

## 78 OPERATING INSTRUCTIONS

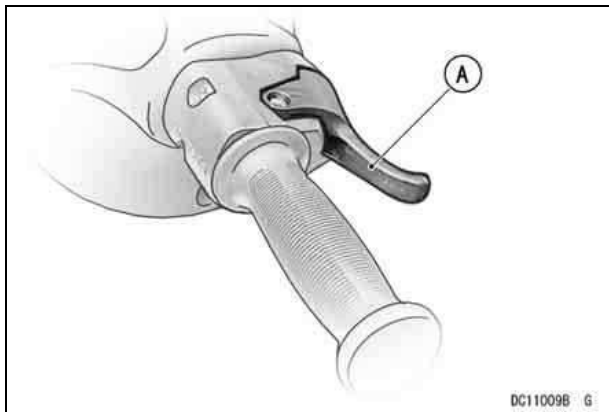

**A. Throttle Lever**

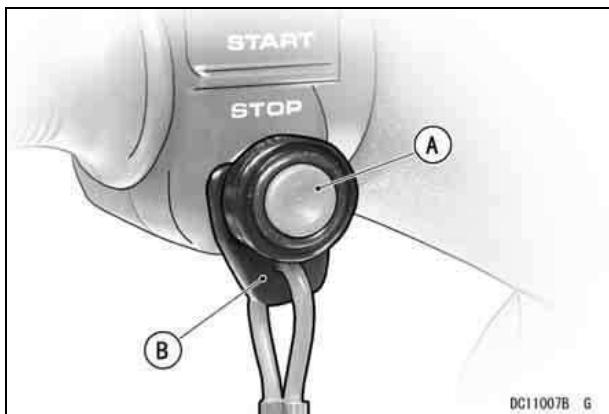

**A. Engine Stop Button**  
**B. Lanyard Key**

Releasing the throttle slows forward motion but the engine will still be running, so you can steer the boat after reapplying the throttle. In this manner you can turn and move away from any obstacles.

### **⚠ WARNING**

**Releasing the throttle completely reduces the ability to steer. This can cause you to hit an object you are trying to avoid. You must have thrust to turn, so keep the throttle on or apply throttle as needed to maintain thrust at the jet nozzle.**

Push the engine stop button when you are approaching the shore and intend to stop. The engine stops immediately, so it prevents sand or debris from entering and damaging the jet pump. Never run the engine in water less than 0.8 m (2.5 ft) deep.

### **⚠ WARNING**

**Do not stop the engine if you may need to reapply throttle to quickly steer the watercraft. You have no directional control when the engine is stopped.**

### **Stopping Skills:**

Stopping distance depends partially on rider and passenger weight and position, idle set speed, and operating speed. Experienced operators can usually shorten stopping distance by using various riding techniques. Turning the boat sharply (using the

throttle) while stopping is a method which can be used to decrease stopping distance.

**Minimum Stopping Distances:**

The minimum stopping distance of this watercraft with the operator and passengers from maximum speed is 86 m (282 ft).

This information represents results obtained under controlled conditions, and the information may not be correct under other conditions.

---

**Turning the JET SKI Watercraft**

---

Turning the watercraft requires a combination of two actions:

- Turning the handlebar
- Using the throttle

Point the handlebar to the left for a left turn

Point the handlebar to the right for a right turn

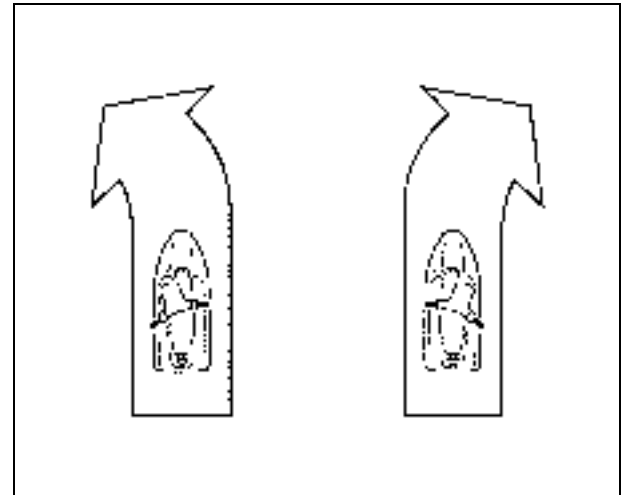

LEFT

RIGHT



## 80 OPERATING INSTRUCTIONS

Using the throttle is another important part of turning maneuvers. Applying the throttle produces thrust from the jet pump giving you directional control over the watercraft.

High thrust of the jet pump makes the boat turn more sharply.

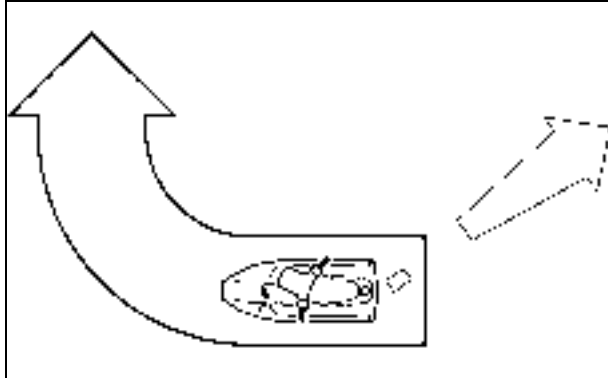

Low thrust of the jet pump makes the boat turn less sharply.

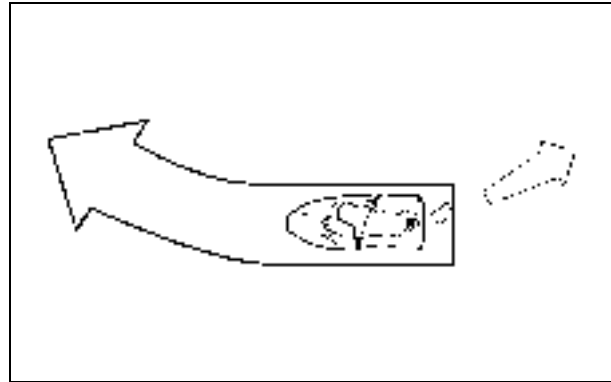

If you release the throttle completely, there is little thrust of the jet pump. The boat turns slowly and steering ability is reduced.

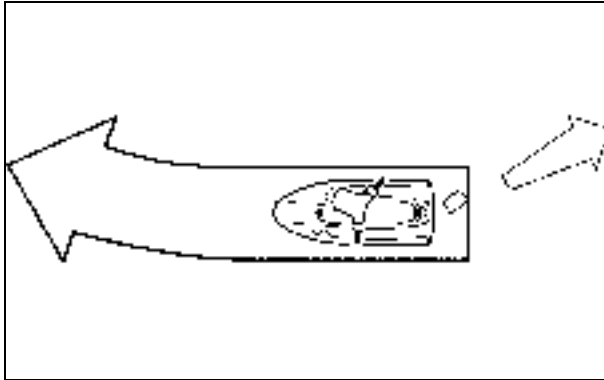

IDLE = SLOW, GRADUAL TURN

**⚠ WARNING**

Releasing the throttle completely reduces the ability to steer. This can cause you to hit an object you are trying to avoid. You must have thrust to turn, so keep the throttle on or apply throttle as needed to maintain thrust at the jet nozzle.

If you stop the engine while riding, there is no thrust of the jet pump. The boat goes straight ahead even though the handlebar is turned.

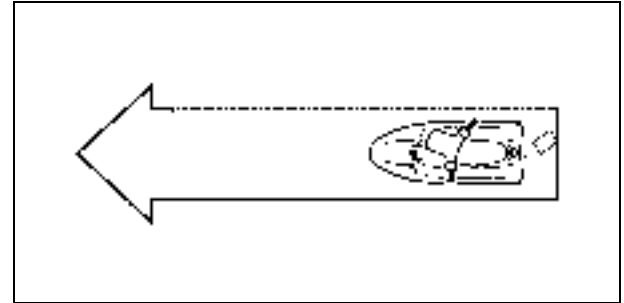

NO THRUST = NO TURN

**⚠ WARNING**

Do not stop the engine if you may need to reapply throttle to quickly steer the watercraft. You have no directional control when the engine is stopped.

This is one characteristic of jet drive boats which is important to remember when you make an emergency maneuver: YOU MUST HAVE THRUST TO TURN, so keep the throttle on or apply throttle as needed to maintain thrust at the jet nozzle.

- Throttle down before entering a turn.

### **⚠ WARNING**

This is a very maneuverable, sport watercraft. Quick turns or acceleration can cause the passengers to fall overboard, and can cause an accident with other boats.

The operator should look carefully for other boats before making any quick maneuvers. The passengers should hold on during quick turns.

Your Kawasaki Smart Steering™ (KSS™) JET SKI watercraft assists you in learning to negotiate turns and maneuver. Refer to the Control section in the GENERAL INFORMATION chapter.

### **Docking the JET SKI Watercraft**

- When docking use the throttle efficiently both to control the craft's speed and to keep directional control over the craft.
- When you are approaching the shore where you intend to land, push the engine stop button to prevent sand from entering the jet pump and the impeller. Do not operate the engine in water shallower than 0.8 m (2.5 ft).

### **CAUTION**

**Do not run the watercraft onto the shore, or severe impeller or hull damage may occur and the water wheel at the stern may be damaged causing the speedometer to malfunction.**

**Do not operate in shallow or debris-laden water, or the impeller may be damaged and sand may clog the water cooling hoses.**

- Remember that stopping the engine causes you to lose steering control, so cut the engine only after you have reduced speed and maneuvered into your final approaching position. You cannot make any emergency maneuvers with the engine stopped.

---

## Riding the JET SKI Watercraft

---

On your first ride, straddle the craft and sit down on the seat. Familiarize yourself with the handling of the boat. Vary the engine speed with the throttle lever to get the feel of throttle influence on steering. If porpoising occurs, that is, the front of the craft rises and falls rapidly, move your body weight further forward.

### WARNING

**Never ride with your chin immediately above the handlebar. If you should hit a wave, you might injure yourself.**

The engine revolution of the watercraft will be automatically controlled to 3 000 rpm if some engine-related parts fail to function properly.

If the warning light, FI indicator and “FI” character start flashing with buzzer sound or the warning light, engine oil pressure indicator and “OIL” character start flashing with buzzer sound, return to shore immediately and have the engine checked by your authorized Kawasaki JET SKI dealer.

The engine revolution will also be controlled to 3 000 rpm automatically when the water temperature and/or engine oil pressure warning start flashing. Return to shore immediately and check the cooling system or engine oil level and add the recommended oil if necessary.

If other causes are suspected, see your authorized Kawasaki JET SKI dealer.

When the “LED” warning light, “FUEL” character, and the segment of the level gauge begin flashing, 16 liters (4.23 U.S. gal) of fuel remain. Reduce the speed to less than half-throttle and fill the fuel tank as soon as possible because there is no reserve tank in this watercraft. (See the Multifunction Meter section in the GENERAL INFORMATION chapter for more detail.)

Stay alert at all times, and keep away from other boats, swimmers, and obstructions.

### Fall Recovery:

If the operator falls off the craft, the lanyard key is pulled off of the engine stop button and the engine is stopped immediately.

### WARNING

**When you fall, do not hang onto the handlebar. Let go, or you might injure yourself by striking the watercraft.**

- The best way to hit the water is bottom first, legs together, with your arms over your head. This can help prevent injury from underwater objects.
- Go back aboard from the rear of the craft. Push the lanyard key under the stop button, and push the start button to start the engine.

### Righting the Capsized Watercraft:

If the watercraft should capsize, the engine is stopped by the lanyard key being pulled off of the

## 84 OPERATING INSTRUCTIONS

engine stop button by the operator. Use the following procedure immediately to right the craft.

### **⚠ WARNING**

**This watercraft will not self-right if capsized. Operators must know the proper righting procedure or they could be stranded.**

- Make sure the engine is stopped. If it is not stopped, immediately pull the lanyard key off the stop button or push the stop button to stop the engine.

### **CAUTION**

**If the engine continues running with the craft capsized, water can enter the throttle body and engine, locking the engine. This will cause severe and immediate damage to internal engine parts.**

**Do not operate the watercraft with water in the engine.**

**Do not try to start the engine until it is completely empty of water; internal engine parts could be severely and immediately damaged. If water gets into the engine, follow the procedure described in the After Submerging section.**

- Swim to the rear corner of the capsized craft.
- Push down on the port side of the craft with one hand and reach across the hull and grasp the rear

of the deck with the other, as though trying to pull yourself up onto the bottom of the hull.

- Now, push down on the rear corner of the hull with one foot, using your body weight to roll the capsized craft toward you.
- As the craft rolls over toward you, reach for the far side of the hull, if needed, and pull it on over.

### **CAUTION**

**Turn the capsized boat clockwise so that the port side always faces downward. Turning counterclockwise can cause water in the exhaust system to run into the engine, with possible engine damage.**

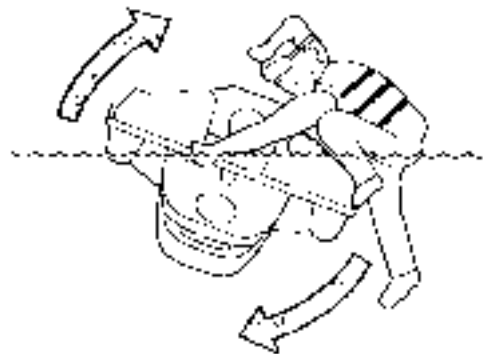

- After the watercraft has capsized and been righted, it may have water in the engine compartment. Carefully go back aboard from the

rear, trying not to let more water into the engine compartment under the seat.

### NOTE

- *If you have a passenger, he or she may want to return to shore on another watercraft to decrease the load on yours, and prevent it from taking on more water.*
- Tow the watercraft slowly to shore, beach it, and drain the water out of the engine compartment. This will help prevent getting water in the engine, which could cause severe and immediate damage to internal engine parts.

#### After Submerging:

### CAUTION

**Do not operate the watercraft with water in the engine.**  
**Do not try to start the engine until it is completely empty of water; internal engine parts could be severely and immediately damaged.**  
**If water gets into the engine, follow this procedure immediately! If water is left in the engine more than a few hours, it will destroy the crankshaft bearings and damage other internal engine parts.**

If the watercraft becomes swamped, water may enter the engine through the throttle body. Water may also enter the fuel tank.

You need systematic inspections and remedies for the swamped PWC. The following procedures explain the necessary steps you must provide.

Carefully read the summary of the procedure first, then their detailed steps.

## 86 OPERATING INSTRUCTIONS

### Summary of the steps



Page 4 of 4

### Details of the steps

1. Remove the craft from the water, and remove the seat.
2. Remove the drain screws in the stern to drain water out of the engine compartment.
3. Remove the center storage case for obtaining access for the following work.

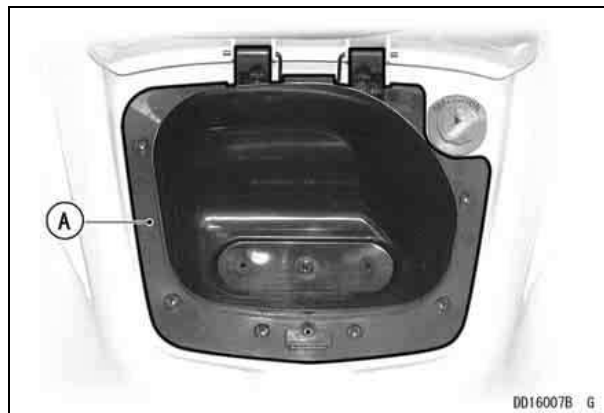

#### A. Center Storage Case

4. Disconnect the two connectors on the primary ignition cables located in front of the ignition coil.

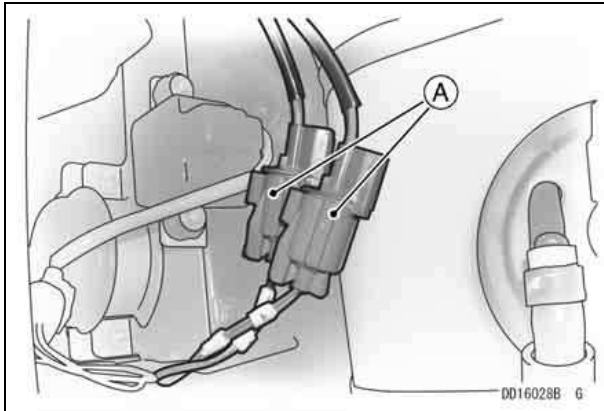

#### A. Cable Connectors

5. Pull and remove all the spark plug caps.
6. Remove all spark plugs.
7. Turn the ignition switch on, push the lanyard key under the stop button, and push the start button.
8. If there is any water in the engine, it will be pumped out of the spark plug holes. Do not operate the starter for longer than 5 seconds. Wait 15 seconds before using it again. Be sure that all the water is out of the engine.

### **⚠ WARNING**

Do not lean over the engine when performing this procedure. A water and gasoline mixture will be forcibly ejected from the spark plug holes and could get into your eyes. If you do get some in your eyes, wash your eyes immediately with liberal amounts of clean, fresh water. Consult a physician as soon as possible.

9. Remove the rear storage case, and check the air filter drain caps for water.

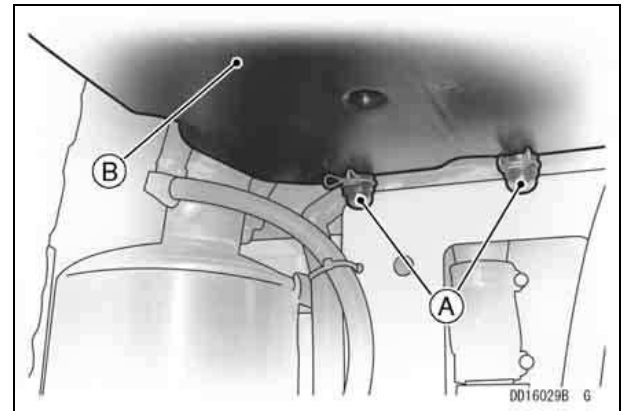

#### A. Drain Caps

#### B. Air Filter

10. If you see water in the caps, then remove both caps and discharge the water. Be sure to have a rag or cloth underneath for possible oily water.



## 88 OPERATING INSTRUCTIONS

And proceed to the next step (item 11). If there is no water in the air filter inspection caps, then proceed to item 12.

### NOTE

○ If you see water in the drain caps, there is a great possibility that water has entered the intake manifold. Take the watercraft to a Kawasaki dealer for service that requires removing some adjacent components for access.

11. Remove the drain plug of the intake manifold and discharge water, if any, into a rag or cloth. Then take the watercraft to the Dealer.
12. Spray the spark plugs clean with air and then install them with their plug caps.
13. Reconnect the primary cable ignition connectors.

### NOTE

- Reconnect the primary ignition coil cable connectors noting #1 & #4 coil connector (A) and #2 & #3 coil connector (B). The #1 & #4 connector has red/yellow and green/blue cables from the main harness.
- The #2 & #3 coil connector has red/yellow and green/black cables from the main harness.
- Before reconnecting apply a high quality water-proof marine grease to the connectors.

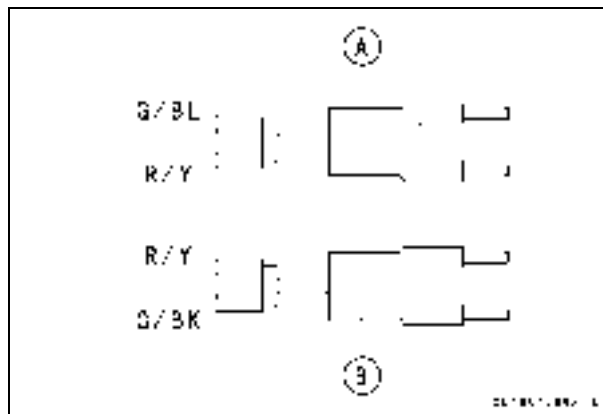

**A. #1 & #4 coil connector**

**B. #2 & #3 coil connector**

14. Start the engine by pressing the starter button and run less than 15 seconds.

### CAUTION

**Do not run the engine with the watercraft out of the water for more than 15 seconds at a time. Overheating will cause severe engine and exhaust system damage.**

**Never operate the engine at maximum speed out of the water. Severe engine damage may occur.**

15. Remove the dipstick and check for the water presence in the engine oil. (If there is water in it, oil looks milky.)

16. If the oil looks milky, then change the oil and repeat items 14 & 15 until the oil does not turn milky any more.
17. If the engine does not start, there may be water in the fuel system.
18. If the fuel tank has water in it, it must be emptied by pump or siphon. Refill the tank with fresh fuel. Dispose of the contaminated fuel at an appropriate hazardous waste site.

**⚠ WARNING**

**Gasoline is extremely flammable and can be explosive under certain conditions. Pull the lanyard key off the stop button. Do not smoke. Make sure the area is well ventilated and free from any source of flame or sparks; this includes any appliance with a pilot light.**

**⚠ WARNING**

**Gasoline is a toxic substance. Dispose of gasoline properly. Contact your local authorities for approved disposal methods.**

19. Continued trouble may require cleaning of the fuel line to drain water.
20. Reinstall the seat and secure it.
21. Reinstall the drain screws in the stern.

22. Finally, run the watercraft IN WATER for at least 10 minutes to dry any remaining water and blow any foreign matter (like salt) out through the exhaust.

**NOTE**

- *See a Kawasaki dealer if any item listed above seems difficult for you and have the watercraft serviced as listed above.*

## 90 OPERATING INSTRUCTIONS

### End of the Day Checklist

These watercraft are not meant to be left in the water for extended periods. Boats that are left in the water are hauled out periodically, the bottoms scraped and repainted with antifouling paint. Also electrolysis can cause pump failure through erosion of metal parts.

#### First, Drain the Exhaust System:

- Remove the watercraft from the water.
- Start the engine and run it for several seconds to purge the exhaust system of excess water. Rev the engine repeatedly, until water stops coming out of the exhaust at the stern.

#### CAUTION

**Never operate the engine at maximum speed out of the water. Severe engine damage may occur.**

**Do not run the engine with the watercraft out of the water for more than 15 seconds at a time. overheating will cause engine and exhaust system damage.**

- After each use in salt water, flush the cooling system with fresh water (see the Cooling System Flushing section in the MAINTENANCE AND ADJUSTMENTS chapter). This will help prevent build up of salt deposits and eventual cooling system blockage.

#### Second, Clean the Engine Compartment:

- Remove the seat.
- If water has accumulated in the engine compartment, remove the drain screws in the stern to drain water out of the compartment. Be sure to reinstall the drain screws after draining.
- When the watercraft has been used at sea, rinse the engine room with fresh water.

#### CAUTION

**Be careful not to spray to electric equipment also prevent water from entering the air cleaner box. Fit a temporary cover to the air intake hole.**

- If you will not use the watercraft for more than one week, lubricate the internal engine components to help prevent corrosion.
- If you will not use the watercraft more than two weeks, remove the battery and keep fully charged using a maintenance charger. See MAINTENANCE & ADJUSTMENT chapter.
- Wipe the engine compartment dry, and install the seat.
- When the watercraft is ready for storage, leave the seats off, or block it up with 10 mm (one half inch) spacers to aid air circulation and prevent condensation from forming.

#### Third, Clean the Outside Hull:

- Wash the hull, deck, water intake, and propulsion system with fresh water.

**NOTE**

- *Personal watercraft are not meant to be left in the water for extended periods. Continuous exposure to water over a long period of time will cause the hull paint to bubble and peel. It also causes electrolytic erosion of the metal parts of the jet pump, decreasing its service life. Larger boats which are left in the water must be hauled out periodically, so the bottom of the hull can be scraped and repainted with anti-fouling paint. They also usually have a sacrificial anode to reduce electrolytic erosion of metal parts in contact with the water. Your watercraft will last longer and look better, if you remove it from the water at the end of every day's use.*

**Special Procedures****Clearing Clogged Impeller:**

Occasionally, weeds or other debris may lodge in the impeller/jet pump, severely impairing performance. This foreign matter must be completely cleaned out for the jet pump to function properly.

- Shut off the engine, and beach the craft.

**⚠ WARNING**

**Never attempt to clear the jet pump of debris while the engine is running, or a severe injury can occur. Stop the engine and pull the lanyard key off the stop button before checking the pump for debris.**

- Pull the lanyard key off the stop button.
- Place a protective pad next to the boat.
- Tip the boat on **port side** and remove the jet pump grate and cover, if necessary.

**CAUTION**

**Always turn the boat on port side when rolling. Rolling to the starboard side can cause water in the exhaust system to run into the engine, with possible engine damage.**

## 92 OPERATING INSTRUCTIONS

- Clean the water intake, drive shaft, impeller, jet pump housing, outlet, and steering nozzle of any seaweed, grass, or other debris.

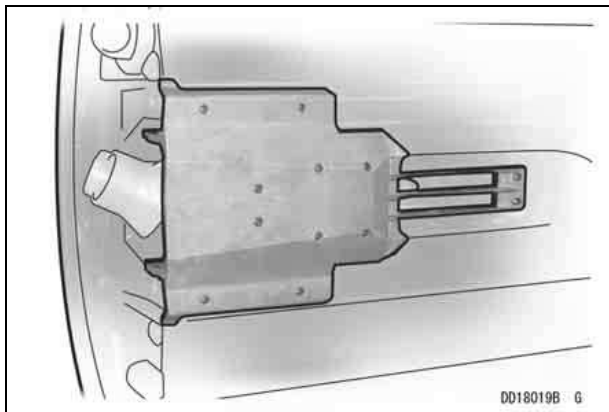

### CAUTION

**Be sure the pump area and all its components are completely clear. Engine cooling water is supplied by the jet pump, and any loss of pump performance may cause overheating.**

- Reinstall the jet pump cover and grate, apply non-permanent locking agent to the bolts before securely tightening.

**Bolts Tightening Torque:**  
7.8 N·m (0.8 kgf·m, 69 in·lb)

### Cleaning Fouled Spark Plugs:

Fouled spark plugs can result from several causes. Among them, low idle speed and prolonged idling. Water in the fuel or inside the engine can also cause spark plug fouling.

- Remove the fouled spark plugs and install clean, dry plugs. Fouled plugs may be cleaned with electrical contact cleaner (P/N K61080-001B). Wet plugs may be cleaned with a penetrating rust inhibitor, such as WD40 or Bel-Ray 6 in 1.

**Spark Plugs Tightening Torque:**  
11 ~ 15 N·m (1.1 ~ 1.5 kgf·m, 8 ~11 ft·lb)

- Start the engine, using very little throttle.

### Towing the JET SKI Watercraft:

In case you run out of fuel, have engine problems or other complications, the watercraft may be towed. Attach one end of a 6 m (20 foot) tow rope to the eye in the bow and the other end to the tow boat. Towing must be slow, not over 8 km/h (5 mph).

### CAUTION

**It is important that these instructions be followed or the engine compartment could flood and the watercraft could partially submerge.**

**Jump Starting:**

If your watercraft's battery is run down, it should be removed and charged. If this is not practical, a booster battery and jumper cables may be used to start the engine. The booster battery must be of the same voltage as the watercraft battery (12 V).

**⚠ WARNING**

Battery acid generates hydrogen gas which is flammable and explosive under certain conditions. It is present within a battery at all times, even in a discharged condition. Keep all flames and sparks (cigarettes) away from the battery. Wear eye protection when working with a battery. In the event of battery acid contact with skin, eyes, or clothing, wash the affected areas immediately with water for at least five minutes. Seek medical attention.

- Turn the ignition switch off.
- Remove the seat and take off the rear storage case.
- Lay a cloth over the open vents of the booster battery.
- Connect a jumper cable between the positive (+) terminals of the two batteries.
- Connect one end of the remaining jumper cable to the negative (-) terminal of the booster battery.

**CAUTION**

Connecting two batteries in reverse polarity (+ to -) can seriously damage the electrical system.

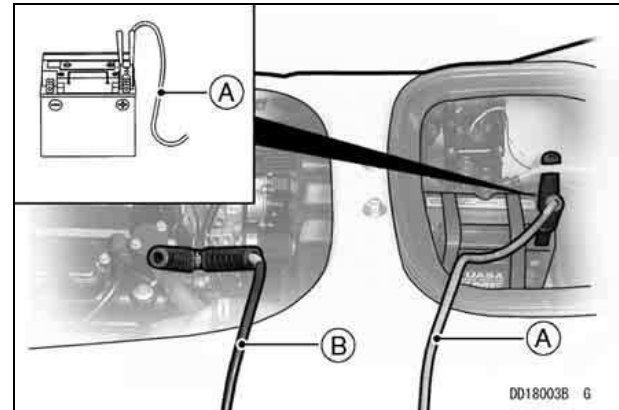

- A. Positive Cable
- B. Negative Cable

- Connect the other end of the remaining jumper cable to the exhaust pipe bolt.

**⚠ WARNING**

Do not make this last connection at the throttle body, injector or battery. Take care that you do not short the cables together, and do not lean over the battery when making this last connection. Do not jump start a frozen battery. It could explode.

## 94 OPERATING INSTRUCTIONS

### CAUTION

**Do not operate the starter continuously for more than 5 seconds or the starter will overheat. Wait 15 seconds between each operation of the starter to let it cool.**

- Start the watercraft engine following the standard engine starting procedure and then disconnect the jumper cables in the reverse of the sequence just described.
- Dispose of the cloth covering the booster battery.

### Engine Overheating:

This watercraft is equipped with temperature sensors for cooling water and engine oil, and it will flash the warning light, engine cooling water temperature indicator, and “HEAT” character or engine oil pressure indicator and “OILH” character depending on which sensor is activated.

A buzzer will also sound.

The engine revolution is automatically controlled to 3 000 rpm if the engine overheats.

- If the above warning is made and the watercraft slows down, return to shore immediately and check the cooling system for clogging or engine oil for the level. If you suspect other causes, see your authorized Kawasaki JET SKI watercraft dealer.

### CAUTION

**If the engine overheats, the “LED” warning light including “HEAT” or “OILH” characters, and engine cooling water temperature indicator or engine oil pressure indicator flash and the engine slows down, return to shore immediately. To prevent engine damage, do not operate the craft until the cause of overheating is corrected.**

---

## Transporting

---

- When transporting the watercraft on a trailer, observe the trailer laws and regulations in your area.
- Be sure the trailer matches with the craft's weight and hull design.
- Securely fasten the watercraft to prevent movement between the craft and trailer.

### CAUTION

**Never attach tie-downs to the handrail behind the seat nor to the hook under the seat rear end.**

**Do not allow anything to touch the water wheel at the stern, or it may be damaged causing the speedometer to malfunction.**



---

## STORAGE

---

During the winter, or whenever your watercraft will not be in use for more than 30 days, proper storage is essential. It consists of checking and replacing missing or worn parts; lubricating parts to ensure that they do not become rusted; and, in general, preparing the watercraft so that when the time comes to use it again, it will be in top condition. See your Kawasaki JET SKI dealer for this service or do the following.

### NOTE

- *Personal watercraft are not meant to be left in the water for extended periods. Continuous exposure to water over a long period of time will cause the hull paint to bubble and peel. It also causes electrolytic erosion of the metal parts of the jet pump, decreasing its service life. Larger boats which are left in the water must be hauled out periodically, so the bottom of the hull can be scraped and repainted with anti-fouling paint. They also usually have a sacrificial anode to reduce electrolytic erosion of metal parts in contact with the water. Your watercraft will last longer and look better, if you remove it from the water at the end of every day's use.*

---

### Preparation for Storage

---

#### Cooling System:

- Clean the cooling system (See the Cooling System Flushing section in the MAINTENANCE AND ADJUSTMENTS chapter).
- When storing the watercraft in an area where the temperature drops below freezing, perform the following.

#### *Discharging water in the exhaust system*

CAUTION
<p><b>Discharge water from the exhaust system after flushing the cooling system. Water remaining in the exhaust system during cold weather could freeze and damage the exhaust pipe.</b></p>
<ul style="list-style-type: none"> <li>● After flushing, remove the cooling water hose from the fitting on the engine output cover at the rear of the engine. Lead the hose to the lowest level in the engine room so that water remaining in the exhaust pipe drains out.</li> </ul>

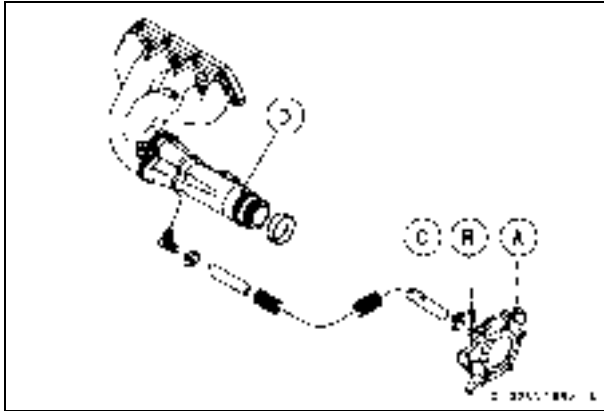

- A. Engine Output Cover
- B. Fitting
- C. Cooling Water Hose
- D. Exhaust Pipe

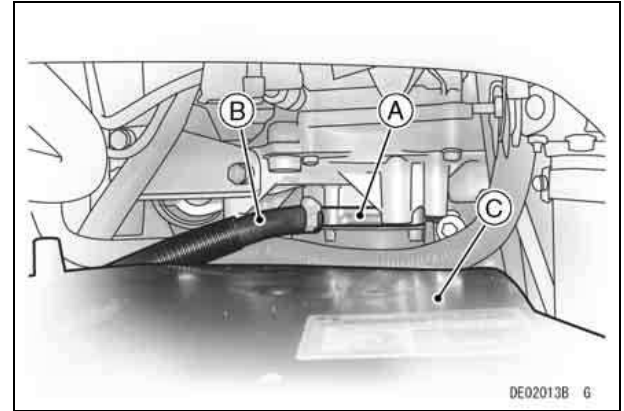

- A. Engine Output Cover
- B. Cooling Water Hose
- C. Air Filter Box

- Connect the hose to the fitting on the output cover and tighten the clamp securely.

### CAUTION

**Connect the hose securely to the fitting. If the hose comes off during operation, cooling water could swamp the boat. If you are not confident you can perform storage procedures, ask your Kawasaki JET SKI watercraft dealer for this service.**

## 98 STORAGE

### Bilge System:

- Clean the bilge system (see the Bilge System Flushing section in the MAINTENANCE AND ADJUSTMENTS chapter), and before reconnecting the four hoses to the plastic breather fittings, blow air through the hoses to force all water out of the bilge system.

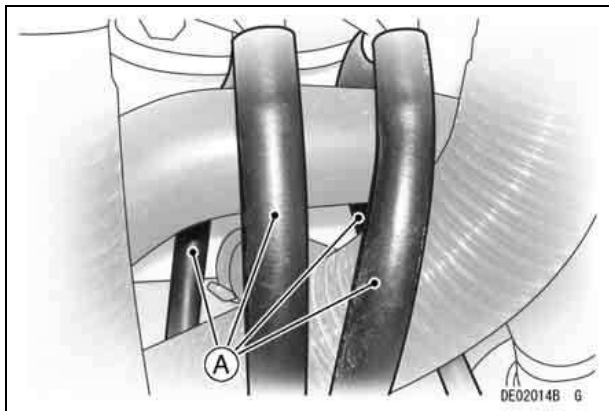

**A. Blow air through all four hoses.**

### Engine Oil

- Change the engine oil. See MAINTENANCE AND ADJUSTMENT chapter for the changing procedure.

### Fuel System and Engine:

- Wash the engine compartment with fresh water and remove the drain screws in the stern to drain

the water. Wipe up any water left in the compartment.

### **⚠ WARNING**

**Gasoline is extremely flammable and can be explosive under certain conditions. Pull the lanyard key off the stop button. Do not smoke. Make sure the area is well ventilated and free from any source of flame or sparks; this includes any appliance with a pilot light.**

- Lift the stern upward a little so that fuel and water in the bottom of the fuel tank may flow toward the fuel filler to completely drain the fuel tank. This should be done with a siphon or pump.

### **⚠ WARNING**

**Gasoline is a toxic substance. Dispose of gasoline properly. Contact your local authorities for approved disposal methods.**

- Inspect/clean the fuel pump screen. (See the Fuel System in the MAINTENANCE AND ADJUSTMENT chapter.)
- Refill the fuel tank with fresh fuel approximately 10 L (2.6 gal U.S.).
- Turn the ignition switch on.
- Push the lanyard key under the stop button, start the engine, and run it in fifteen second periods until the fuel in the fuel system is changed with the fresh fuel. Wait five minutes between fifteen second running periods.

**CAUTION**

**Do not run the engine with the watercraft out of the water for more than 15 seconds at a time. overheating will cause severe engine and exhaust system damage.**

- Drain the fuel tank according to the method mentioned before.
- Leave the fuel filler cap loose to prevent condensation in the tank.
- Remove the center storage case to obtain access for the next job.

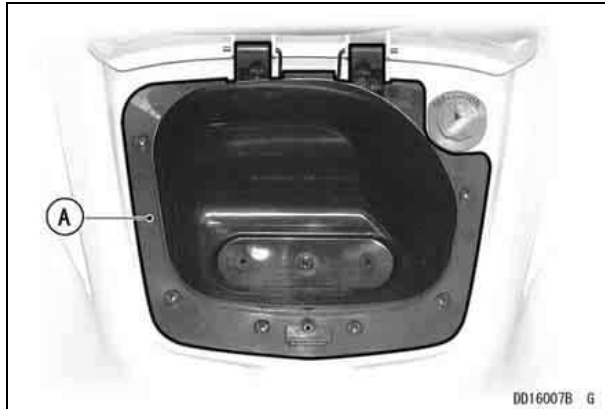

**A. Center Storage Case**

- Disconnect the two connectors on the primary ignition cables located in front of the ignition coil.

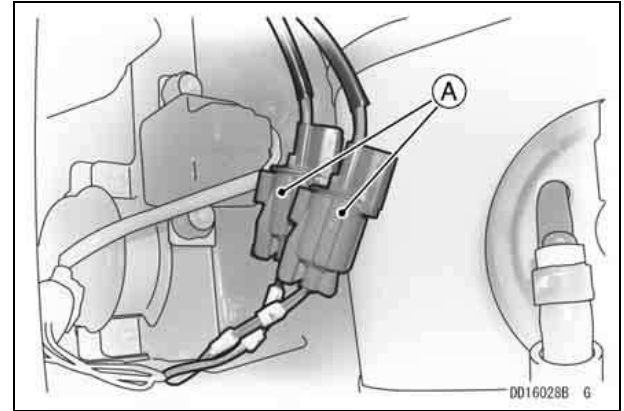

**A. Cable Connectors**

- Remove the spark plugs.
- Spray fogging oil directly into each cylinder.
- Turn the engine over several times with the start button to coat the cylinder walls.

**⚠ WARNING**

**Do not lean over the engine when performing this procedure. An air/oil mist may be forcibly ejected from the spark plug holes and could get into your eyes. If you do get some in your eyes, wash your eyes immediately with liberal amounts of clean, fresh water. Consult a physician as soon as possible.**

- Spray the spark plugs with fogging oil, and reinstall them.

## 100 STORAGE

### Spark Plugs Tightening Torque:

11 ~ 15 N·m (1.1 ~ 1.5 kgf·m, 8.1 ~ 11 ft·lb)

- Pull the lanyard key off the stop button and turn the ignition switch off.
- Reinstall the spark plug caps.
- Connect the primary ignition cable connectors.

### NOTE

- Reconnect the primary ignition coil cable connectors noting #1 & #4 coil connector (A) and #2 & #3 coil connector (B). The #1 & #4 connector has red/yellow and green/blue cables from the main harness.

The #2 & #3 coil connector has red/yellow and green/black cables from the main harness.

- Before reconnecting apply a high quality water-proof marine grease to the connectors.

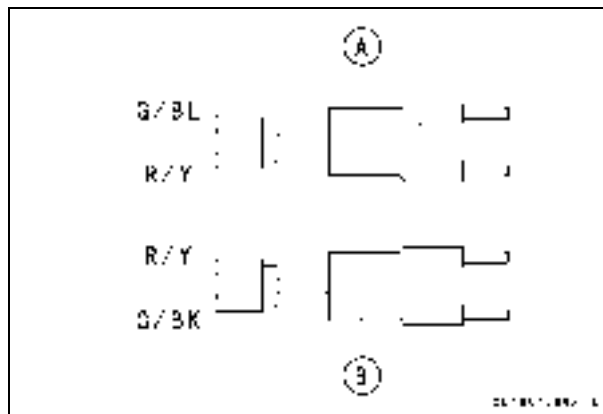

**A. #1 & #4 coil connector**

**B. #2 & #3 coil connector**

- Install the front storage pocket in place.

### Air Filter:

- Open the air filter case.
- Wash and dry the air filter in the air filter case.
- Reassemble the air filter making sure that all components are in their original positions.

### NOTE

- We recommend that you have this service done by your authorized dealer since it requires removing the air filter case.

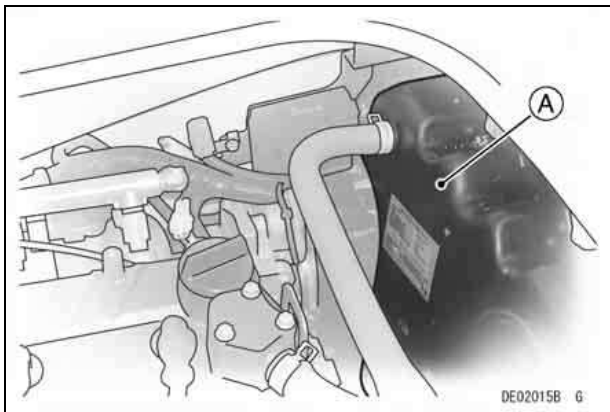

A. Air Filter Case

**Battery:**

- Remove the battery (see the battery section in the MAINTENANCE AND ADJUSTMENTS chapter).
- Clean the exterior with a solution of baking soda and water (one heaping tablespoon of baking soda in one cup of water). Rinse thoroughly with water.

**CAUTION**

**Never remove the sealed cap, or the battery can be damaged.**

- Coat both battery terminals with grease.
- Store the battery in a cool, dry place. Do not expose it to freezing temperatures. During storage it should be given a slow charge (one ampere or

less) about once a month. Keep the battery well charged especially during cold weather.

**Engine Mount Bracket Bolts:**

- Tighten all engine mount bracket bolts.

**Tightening Torque**

29 N·m (3.0 kgf·m, 22 ft·lb)

**NOTE**

- *We recommend that you have this service done by your authorized dealer since it requires special tools.*

**Cleaning:**

- Wash the exterior and dry it thoroughly.

**CAUTION**

**Use only a mild detergent in water to wash the watercraft. Harsh solvents may attack the surface or smear the colors.**

- Apply a good grade of wax to all exterior hull surfaces.
- Lightly spray all exposed metal parts with a penetrating rust inhibitor, such as WD40 or BEL-RAY 6 in 1 to prevent corrosion.
- Remove the seat, or block it up with 10 mm (one half inch) spacers to insure adequate ventilation and prevent condensation from forming.
- Cover the watercraft and store it in a clean, dry

## 102 STORAGE

### NOTE

○ *If the watercraft is left outside, even covered, water can collect in the footwells on either side of the seat. Water left in the footwells can cause the paint to bubble and peel, and the mat to peel off the deck. If the watercraft is left on the trailer, raise the tongue so that any water that gets in can run out of the footwells.*

### Lubrication:

- Carry out all recommended lubrication procedures (see the Lubrication section in the MAINTENANCE AND ADJUSTMENTS chapter).

---

## Removal from Storage

---

The following procedure explains the steps necessary to put the watercraft back in service following a storage period. See your Kawasaki JET SKI dealer for this service, or do the following. See the MAINTENANCE AND ADJUSTMENTS chapter for detailed procedures.

- Carry out all recommended lubrication procedures (see the Lubrication section).
- Check for binding or sticking throttle and steering mechanism. The throttle lever must return fully when released.
- Clean and gap spark plugs (see the Spark Plugs section).
- Check all rubber hoses for weathering, cracking, or looseness.
- Turn the craft on **port side** on a protective pad, and remove the jet pump cover. Check cooling and bilge hoses for weathering, cracking or looseness.
- Replace them if necessary. Reinstall the cover, apply non-permanent locking agent to the bolts before tightening securely.

Bolts Tightening Torque: 7.8 N·m (0.8 kgf·m, 69 ft·lb)
---

- Check that the drain screws in the stern are securely tightened.

- Clean the terminals of the battery and charge if necessary. Install the battery (see the battery section).
- Check the fire extinguisher for a full charge.
- Fill the fuel tank with fuel and close the filler cap securely.

### WARNING

**Gasoline is extremely flammable and can be explosive under certain conditions. Pull the lanyard key off the stop button. Do not smoke. Make sure the area is well ventilated and free from any source of flame or sparks; this includes any appliance with a pilot light.**

- After transporting or refueling and before starting the engine, open the front storage case lid, remove the seats and take out the rear storage case for several minutes to ventilate the engine compartment.

### WARNING

**A concentration of gasoline fumes in the engine compartment can cause a fire or explosion.**

- Check for fuel leaks. Repair if necessary.
- Check the engine oil level. Fill the engine with the specified oil.

### WARNING

**Do not run the engine in a closed area. Exhaust gases contain carbon monoxide: a colorless, odorless, poisonous gas. Breathing exhaust gas leads to carbon monoxide poisoning, asphyxiation, and death.**

- Start the engine and run it for 15 seconds. Check for fuel, oil and exhaust leaks. Any leaks must be repaired.

### CAUTION

**Never run the engine with the watercraft out of the water for more than 15 seconds. overheating will cause severe engine and exhaust system damage. Do not run the engine at maximum speed out of the water. Severe engine damage may result.**

- Install the seat, making sure that it is locked in place.



---

# MAINTENANCE AND ADJUSTMENTS

---

Maintenance, replacement, or repair of the emission control devices and systems may be performed by any marine SI engine repair establishment or individual.

---

## EMISSION CONTROL INFORMATION

---

To protect the environment in which we all live, Kawasaki has incorporated an exhaust emission control system in compliance with applicable regulations of the United States Environment Protection Agency and California Air Resources Board.

Additionally Kawasaki has incorporated an evaporative emission control system in compliance with applicable regulations of the United States Environment Protection Agency.

### Exhaust Emission Control System

This system reduces the amount of pollutants discharged into the atmosphere by the exhaust of this engine. The fuel, ignition and exhaust systems of this engine have been carefully designed and constructed to ensure an efficient engine with low exhaust pollutant levels.

### Evaporative Emission Control System

The evaporative emission control system for this watercraft consists of low permeation fuel hoses.

### Fuel Information

THIS ENGINE IS CERTIFIED TO OPERATE ON UNLEADED REGULAR GRADE GASOLINE ONLY.

A minimum of 87 octane of the antiknock index is recommended. The antiknock index is posted on service station pumps in the U.S.A.

### **Maintenance and Warranty**

Proper maintenance is necessary to ensure that your watercraft will continue to have low emission levels. This Owner's Manual contains those maintenance recommendations for your engine. Those items identified by the Periodic Maintenance Chart are necessary to ensure compliance with the applicable standards.

As the owner of the Personal Watercraft, you have the responsibility to make sure that the recommended maintenance is carried out according to the instructions in this Owner's Manual at your own expense.

The Kawasaki Limited Emission Control System Warranty requires that you return your Personal Watercraft to an authorized Kawasaki Personal Watercraft dealer for remedy under warranty. Please read the warranty carefully, and keep it valid by complying with the owner's obligations it contains.

### **Tampering with Emission Control System Prohibited**

Federal law prohibits the following acts or the causing thereof: (1) the removal or rendering inoperative by any person other than for purposes of maintenance, repair, or replacement, of any device or element of design incorporated into any new engine for the purposes of emission control prior to its sale or delivery to the ultimate purchaser or while it is in use, or (2) the use of the engine after such device or element of design has been removed or rendered inoperative by any person.

Among those acts presumed to constitute tampering are the acts listed below:  
Do not tamper with the original emission related parts.

- \* Electronic Control Unit (ECU)
- \* Fuel Pump
- \* Spark Plugs
- \* Fuel Injectors

## 106 MAINTENANCE AND ADJUSTMENTS

### Periodic Maintenance Chart

#### NOTE

○ Complete the Pre-Ride Checklist before each outing.

Description	Frequency	Initial 10 Hours	Every 25 Hours	Every 50 Hours	Every 100 Hours
Inspect all hoses, hose clamps, nuts, bolts, and fasteners		●	●		
Lubricate throttle body cable fitting at throttle body			●		
Lubricate throttle control cable and throttle cable fitting at throttle case			●		
○ Clean and gap spark plugs (replace if necessary)			●		
Lubricate steering cable ball joints and steering nozzle pivots			●		
* Lubricate handlebar pivot (disassemble)			●		
○* Clean fuel pump screen			●		
○* Inspect/adjust valve clearances					●
Inspect/clean air filter drain caps			●		
* Inspect/clean air filter				● (or every year)	
Replace engine oil				● (or every year)	

## MAINTENANCE AND ADJUSTMENTS 107

Frequency	Initial 10 Hours	Every 25 Hours	Every 50 Hours	Every 100 Hours
<b>Description</b>				
Replace engine oil filter				●
* Inspect/tighten engine mount bolts			● (or every year)	
* Inspect fuel vent check valve		●		
○ Inspect throttle control system		●		
Flush bilge line and filter		●		
Flush cooling system (after each use in salt water)		●		
* Inspect air suction valve				●
* Inspect impeller blades for damage (remove)				●
* Inspect/replace coupling damper				●
○* Inspect throttle shaft spring (replace throttle body if necessary)				●
* Inspect steering cable				●
Inspect hull drain screws (replace if necessary.)			●	
Inspect battery terminals		●		
* Replace fuel hoses	Every 4 years			

\*: These items must be performed with the proper tools. See your authorized Kawasaki JET SKI dealer for service, unless you have the proper equipment and mechanical proficiency (refer to the Service Manual).

○: Emission Related      <https://www.boat-manuals.com/>

## 108 MAINTENANCE AND ADJUSTMENTS

### Control Cable

There must be free play in the throttle mechanism. Measure the distance the throttle lever moves before the engine begins to pick up speed. Free play should be about 2 mm (0.08 in.).

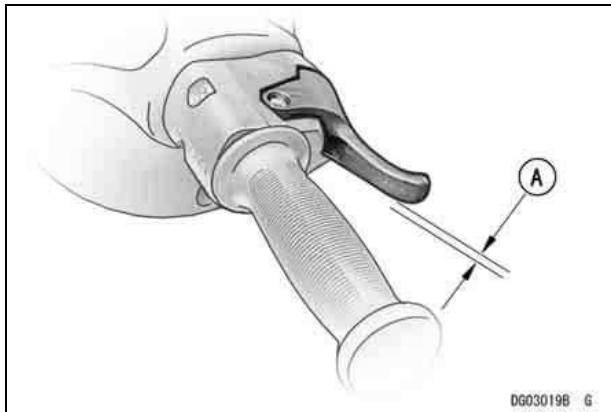

**A. about 2 mm (0.08 in.)**

#### *Throttle Cable Adjustment*

Loosen and turn the locknuts at the end of the throttle cable until the suitable free play is obtained.

Tighten the locknuts securely.

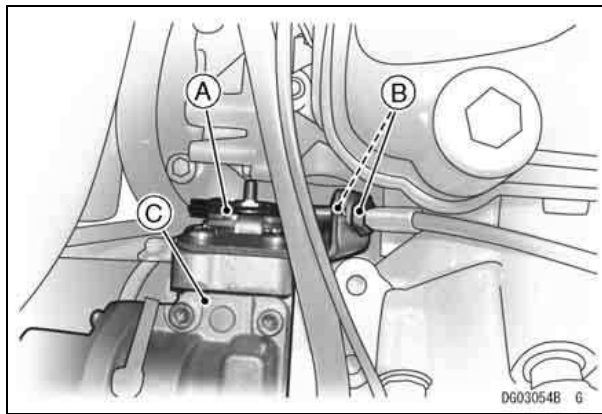

- A. Throttle Cable**
- B. Locknuts**
- C. Throttle Assembly**

#### *Steering Cable Adjustment*

- Center the handlebar in a straight ahead steering position.

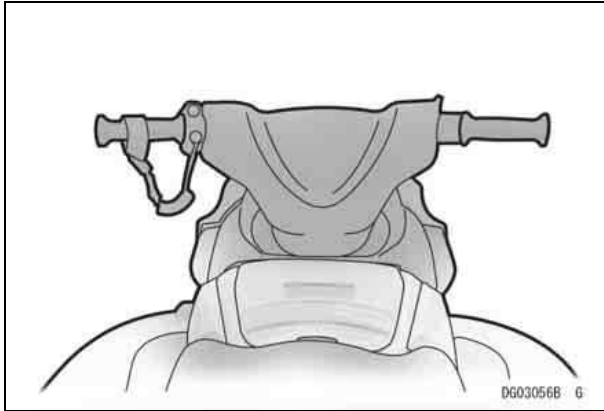

- Check that the steering nozzle is at the same distance from each side of the pump cavity.

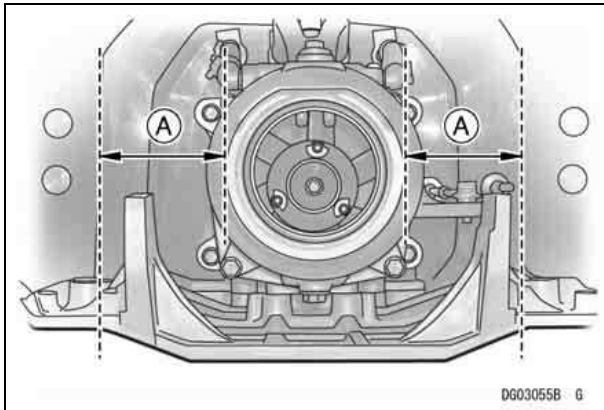

**A. Equal**

- If it is not, adjust the steering cable.
- Loosen the locknut on the end of the steering cable located to the right of the steering nozzle.

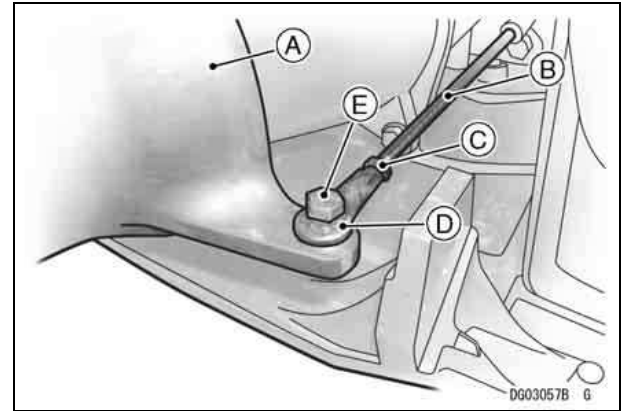

- A. Steering Nozzle**
- B. Steering Cable**
- C. Locknut**
- D. Joint**
- E. Bolt**

- Remove the bolt and disconnect the cable joint from the steering nozzle.
- Center the handlebar in a straight ahead steering position.
- Turn the joint on the cable to adjust the steering.

## 110 MAINTENANCE AND ADJUSTMENTS

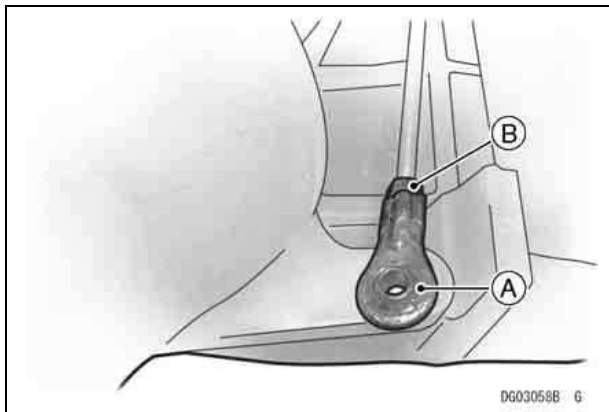

- A. Joint
- B. Locknut

- Reattach the joint and check cable adjustment again.
- Apply non-permanent locking agent to the bolt before tightening it and locknut if adjusted correctly.

Bolt Tightening Torque:

9.8 N·m (1.0 kgf·m, 87 in·lb)

- As an additional check, turn the handlebar all the way to the left and right, and measure the distance between the nozzle and the edge of the pump cavity. It should be equal at both extremes.

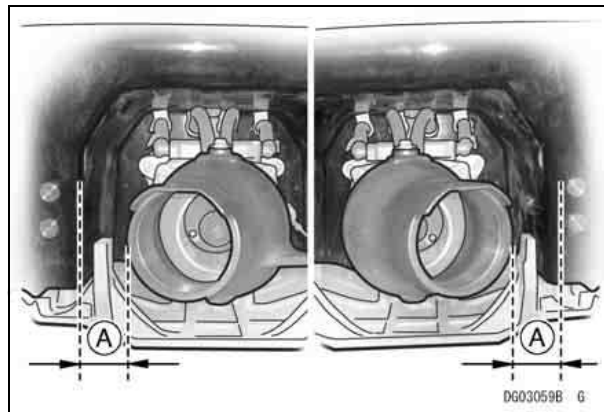

- A. Equal

### *Steering Cable Inspection*

Steering cable inspection is best performed by your authorized Kawasaki JET SKI dealer. If the steering feels rough or “catchy,” have your dealer inspect the steering cable.

### **NOTE**

- *The steering cable is sealed at each end and does not require lubrication.*

---

## Fuel System

---

### Throttle Adjustments:

#### *Idle Speed*

Idle speed adjustment is best performed by your authorized Kawasaki JET SKI dealer. If the idle speed is unstable have your dealer inspect the throttle body.

#### **Idle Speed**

- 1 300 ±100 rpm - in water
- 1 300 ±100 rpm - out of water

#### *High Altitude Use*

High altitude adjustment is not required as the E.C.U. (electronic control unit) controls the air/fuel mixture automatically.

#### **Fuel Vent Check Valve:**

The fuel tank is equipped with a vent hose. A small plastic check valve mounted in the vent hose allows air to enter the tank, but minimizes fuel spillage when the craft is tipped over. Have the check valve inspected in accordance with the **Periodic Maintenance Chart** by your authorized Kawasaki JET SKI watercraft dealer.

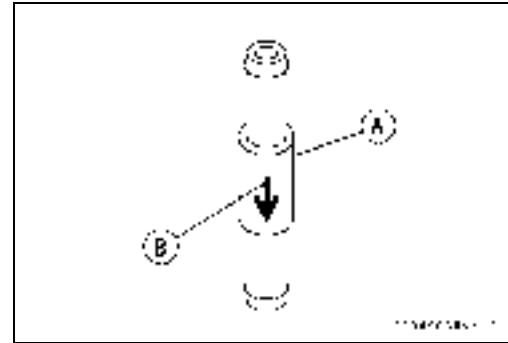

- A. Check Valve**
- B. Flow Direction**

#### **Fuel Pump Screen:**

The watercraft is equipped with fuel pump screens on the fuel pump to prevent dirt or other foreign material from entering the fuel line.

Have your Kawasaki JET SKI watercraft dealer clean the fuel pump screen in accordance with the **Periodic Maintenance Chart**.



### Engine Oil System

In order for the engine to function properly, maintain the engine oil at the proper level, and change the oil and replace the oil filter in accordance with the Periodic Maintenance Chart. Not only do dirt and metal particles collect in the oil, but the oil itself loses its lubricative quality if used too long.

#### Oil and/or Oil Filter Changes

In accordance with the Maintenance Chart, change the engine oil and oil filter with the following procedure.

- Level the watercraft port to starboard as well as fore to aft.
- In a well-ventilated area, start the engine while flushing the cooling system.

#### CAUTION

**The engine must be running before the water is turned on and the water must be turned off before the engine is stopped.  
Do not run the engine without cooling water flow for more than 15 seconds.**

- Warm up the engine and stop it.
- Remove the oil filler cap and the dipstick.

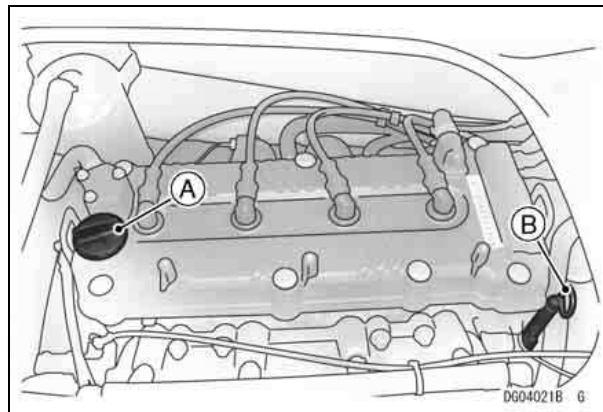

- A. Oil Filler Cap
- B. Dipstick

#### CAUTION

**Be careful not to allow any dirt or foreign materials to enter the engine.**

- Drain the oil thoroughly from the dipstick tube using a commercially-available vacuum pump.

#### ⚠ WARNING

**Do not discard the engine oil as the engine oil is toxic substance and will pollute the environment.  
Contact your local authority for approved disposal methods.**

- Put a rag or cloth under the oil filter to receive the remaining oil.
- Remove the oil filter.

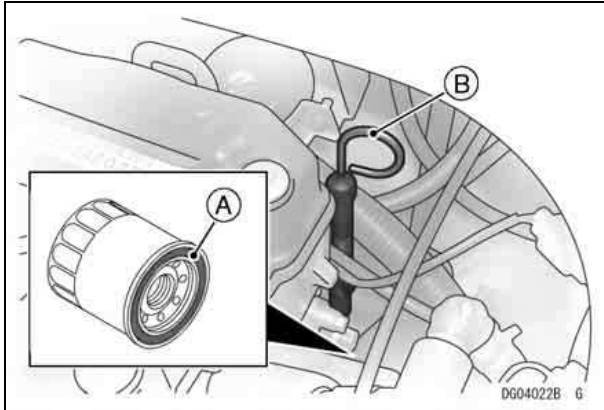

**A. Oil Filter Cartridge**  
**B. Dipstick**

- Apply a thin film of oil to the gasket and tighten the cartridge to the specified torque.

Cartridge Tightening Torque:  
25 ~ 29 N·m (2.5 ~ 2.9 kgf·m, 18.4 ~ 21.4 ft·lb)

- Fill the engine with the oil specified in the table up to the "H" (High) line on the dipstick. (Use a cold level mark.)

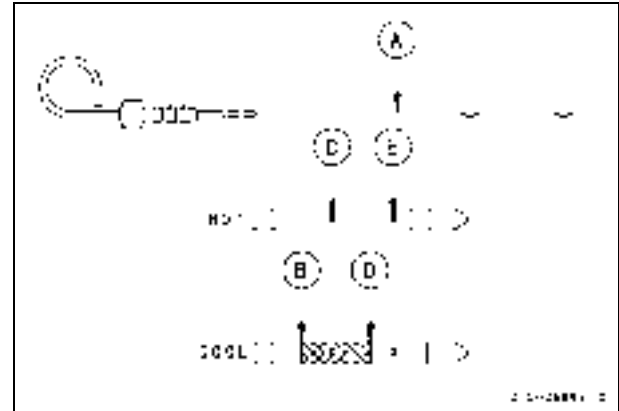

- A. Dipstick**
- B. "H" (High) Line when cold**
- C. "H" (High) Line when hot**
- D. "L" (Low) Line when cold**
- E. "L" (Low) Line when hot**

### Engine Oil

Grade:	API SG, SH, SJ, SL or SM with JASO MA, MA1 or MA2
Viscosity:	SAE 10W-40
Capacity	4.0 L (4.2 US qt) 5.0 L (5.3 US qt) [when engine is completely dry]

## 114 MAINTENANCE AND ADJUSTMENTS

### NOTE

○ Do not add any chemical additive to the oil. Oils fulfilling the above requirements are fully formulated and provide adequate lubrication for both the engine and the clutch.

- Run the engine for several minutes while flushing the cooling system.
- Check the oil level.

Although 10W-40 engine oil is the recommended oil for most conditions, the oil viscosity may need to be changed to accommodate atmospheric conditions in your riding area.

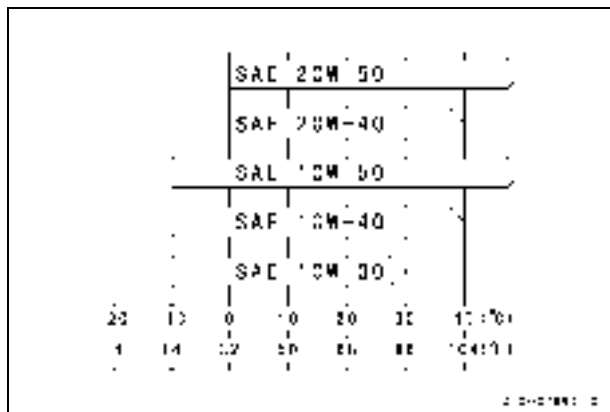

- Install the oil filler cap and dipstick securely.
- Check for oil leaks.

### NOTE

○ This procedure requires mechanical skills and tools. If you see it beyond your skill, ask your Kawasaki dealer for the services.

After the oil is filled, measure the oil level carefully by taking the following procedure.

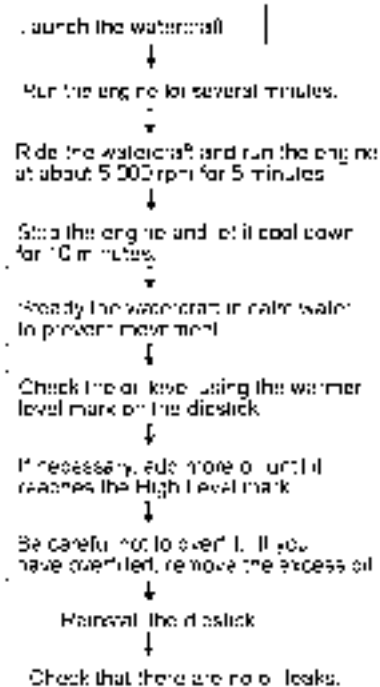

**NOTE**

- Since the trim and list of the watercraft will significantly affect the oil level, be sure that the operator and/or cargo are not aboard the watercraft when measuring the oil level. Also fill up the fuel tank if it is not full.
- This measuring procedure with the watercraft afloat should be followed when the oil level is found low and to be added. See OPERATING INSTRUCTIONS chapter.

## 116 MAINTENANCE AND ADJUSTMENTS

### Valve Clearance

Valve and valve seats wear decreasing valve clearances, and upsetting valve timing.

#### CAUTION

**If valve clearance is left unadjusted, wear will eventually cause the valves to remain partially open, which lowers performance, burns the valves and valve seats, and may cause serious engine damage.**

Valve clearance for each valve should be checked and adjusted in accordance with the Periodic Maintenance Chart.

Inspection and adjustment should be done by an authorized Kawasaki dealer.

INTAKE	0.15 ~ 0.24 mm (0.0059 ~ 0.0094 in.)
EXHAUST	0.22 ~ 0.31 mm (0.0087 ~ 0.0122 in.)

### Spark Plug

The standard spark plug is NGK CR9EK set to a 0.7 ~ 0.8 mm (0.028 ~ 0.032 inch) gap. Since the engine is water-cooled and is generally operated at a constant throttle opening, cylinder head temperature is relatively stable. For this reason, if the engine is in good condition and properly tuned, it should not be necessary to use a spark plug of a different heat range. Since a spark plug of the wrong heat range can cause extensive engine damage, only the standard spark plug is recommended.

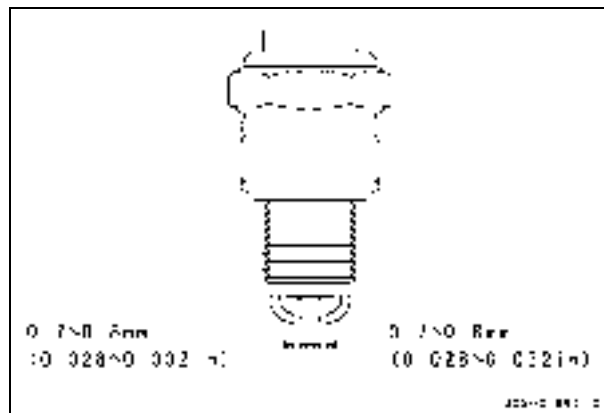

*Spark Plug Inspection and Replacement*

Remove the spark plugs and inspect the ceramic insulators. The appearance of the insulators reflects the efficiency of the combustion process. When the engine is operating properly, the plug insulators should be clean and show a light brown color. If the insulators look glazed or very white, if the electrodes appear overheated, or if there are gray metallic deposits on the plugs, combustion chamber temperatures are too high. Refer to the TROUBLESHOOTING GUIDE.

**CAUTION**

**As excessive operating temperature can cause serious engine damage, the cause should be located and corrected immediately.**

A dry, sooty black deposit on the insulators indicates an overly rich fuel/air mixture. Check for correct throttle control cable adjustment. Refer to the TROUBLESHOOTING GUIDE.

Clean the electrodes and the ceramic insulators around the center electrode by scraping off any deposits or by using a sand blasting device. Make sure that all abrasive particles are removed from the plug and clean the plug in a high flash-point solvent. If the gap has widened, reset it to the standard 0.7 - 0.8 mm (0.028 - 0.032 inch) gap. If the electrodes are badly worn or burned, replace the plug. The spark

plug must also be replaced any time there is visible damage such as cracked ceramic or damaged threads.

Tightening Torque:

11 ~ 15 N·m (1.1 ~ 1.5 kgf·m, 8.1~ 11.1 ft·lb)

*Spark Plug Fitting*

- Insert the plugs into the plug holes.
- Tighten the plugs with the specified torque.
- Put the spark plug caps in place and pull up lightly to make sure of its good fitting.
- Install the spark plug cap onto the spark plug securely.

## 118 MAINTENANCE AND ADJUSTMENTS

### Battery

The battery installed in this watercraft is a sealed type, and the sealing strip should not be removed at any time after the specified electrolyte has been installed in the battery for initial service. It is not necessary to check the battery electrolyte level or add distilled water.

However, in order to maximize battery life and ensure that it will provide the power needed to start your watercraft, you must properly maintain the battery's charge. When used regularly, the charging system in your watercraft helps keep the battery fully charged. If your watercraft is only used occasionally or for short periods of time, the battery is more likely to discharge.

Due to their internal composition, batteries continually self discharge. The discharge rate depends on the type of battery and ambient temperature. As temperatures rise, so does the discharge rate. Every 15°C (27°F) doubles the rate.

Electrical accessories, such as digital clocks and computer memory, also draw current from the battery even when the key is switched off. Combine such "key-off" draws with hot temperatures, and a battery can go from fully charged to completely discharged in a matter of days.

Self-discharge		
Temperature	Approx. Number of Days from 100% Charged to 100% Discharged	
	Lead-Antimony Battery	Lead-Calcium Battery
40°C (104°F)	100 Days	300 Days
25°C (77°F)	200 Days	600 Days
0°C (32°F)	550 Days	950 Days

Current Drain (Y50-N18L-A)		
Discharging Ampere	Days from 100% Charged to 50% Discharged	Days from 100% Charged to 100% Discharged
7 mA	60 Days	119 Days
10 mA	42 Days	83 Days
15 mA	28 Days	56 Days
20 mA	21 Days	42 Days
30 mA	14 Days	28 Days

In extremely cold weather the fluid in an inadequately charged battery can easily freeze, which can crack the case and buckle the plates. A fully charged battery can withstand sub-freezing temperatures with no damage.

**⚠ WARNING**

**Battery posts, terminals and related accessories contain lead and lead compounds. Wash hands after handling.**

**Battery Sulfation**

A common cause of battery failure is sulfation.

Sulfation occurs when the battery is left in a discharged condition for an extended time. Sulfate is a normal by product of the chemical reactions within a battery. But when continuous discharge allows the sulfate to crystallize in the cells, the battery plates become permanently damaged and will not hold a charge. Battery failure due to salvation is not warrantable.

**Battery Maintenance**

It is the owner's responsibility to keep the battery fully charged. Failure to do so can lead to battery failure and leave you stranded.

If you are riding your watercraft infrequently, inspect the battery voltage weekly using a voltmeter. If it drops below 12.6 volts, the battery should be charged using an appropriate charger (check with our Kawasaki dealer or visit [buy.kawasaki.com](http://buy.kawasaki.com)) at a rate of 1/10th of the battery capacity.

If you will not be using your watercraft for longer than two weeks, the battery should be charged using an appropriate charger. Do not use an automotive -type quick charger that may overcharge the battery and damage it.

**Kawasaki-recommended chargers are:**

- Opti Mate III
- Yuasa 1.5 Amp Automatic charger
- Battery Mate 150–9

If the above chargers are not available, use equivalent one.

For more details, ask your Kawasaki dealer.

***Battery Charging:***

- Remove the battery from the watercraft (See Battery Removal).
- Set the battery charge timer to the position indicated by the tester.
- Following the charging and checking steps of the battery charger, charge the battery.

**CAUTION**

**Never remove the sealed cap, or the battery can be damaged.**

**Do not install a conventional battery in this watercraft, or the electrical system will not work properly.**

**NOTE**

- *If you charge the sealed type battery, never fail to observe the instructions shown in the label on the battery.*



## 120 MAINTENANCE AND ADJUSTMENTS

### Battery Removal

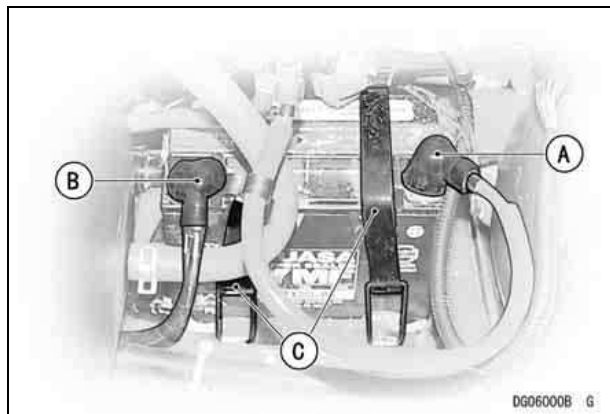

- A. Red Cable
- B. Black (ground) Cable
- C. Straps

- Disconnect the black (ground) cable and black sub cable from the battery first.
- Disconnect the red cable.
- Release the two rubber hold-down straps securing the battery.
- Lift the battery out of the hull.
- Clean the battery top and terminals using a solution of baking soda and water. Scrape off any obstinate deposits with a wire brush and then rinse the battery with fresh water. Dry it thoroughly and coat the terminals with waterproof grease.
- Perform a visual inspection. Inspect for defective or cracked case and cover, and loose or damaged

terminal posts or cables. Replace battery and/or cables immediately if any damage is found.

### Battery Installation

- Install the battery in the reverse order of removal. Connect the red cable to the positive terminal first and the black (ground) cable and black sub cable to the negative terminal.
- After connecting the battery, coat the terminals with waterproof grease.

### **⚠ WARNING**

**Loose battery cables can create sparks which can cause a fire or explosion resulting in injury or death. Make sure the battery terminal screws are tightened securely and the covers are installed over the terminals.**

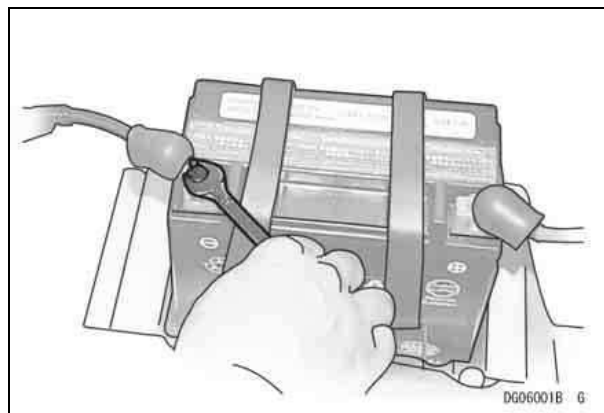

<https://www.boat-manuals.com/> Tighten the Terminal Screws Securely.

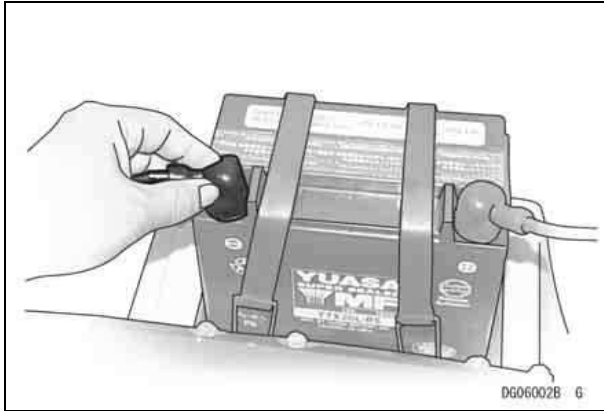

Install the Rubber Covers.

### CAUTION

Do not reverse the battery connections, or damage to the regulator/rectifier unit will result.

## Lubrication

As in all marine craft, adequate lubrication and corrosion protection is an absolute necessity to provide long, reliable service. Refer to the **Periodic Maintenance Chart** and **Pre-ride Checklist** in the OPERATING INSTRUCTIONS chapter for the frequency of the following items:

- Lubricate the following with a penetrating rust inhibitor, such as WD40 or BEL-RAY 6 in 1:

### Lubricate the Throttle Control Cable with a Pressure Cable Lubber

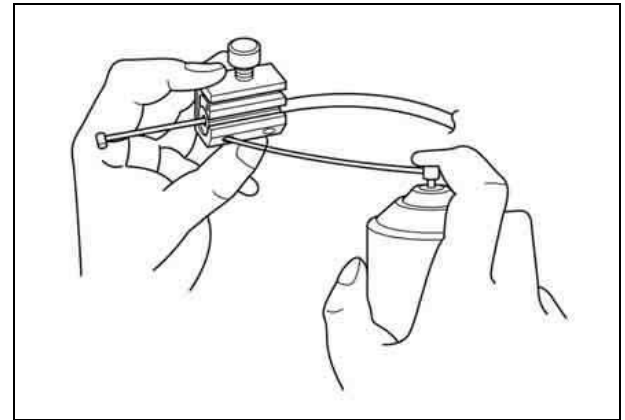

## 122 MAINTENANCE AND ADJUSTMENTS

### Steering Nozzle Pivots

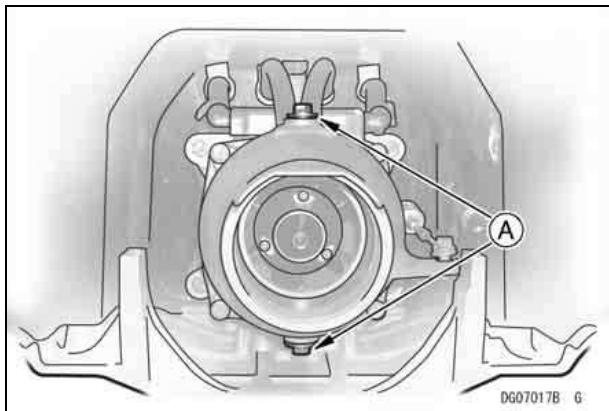

#### A. Steering Nozzle Pivot

- Lubricate the following with a high quality water-proof marine grease.

### Steering Link Ball Joint

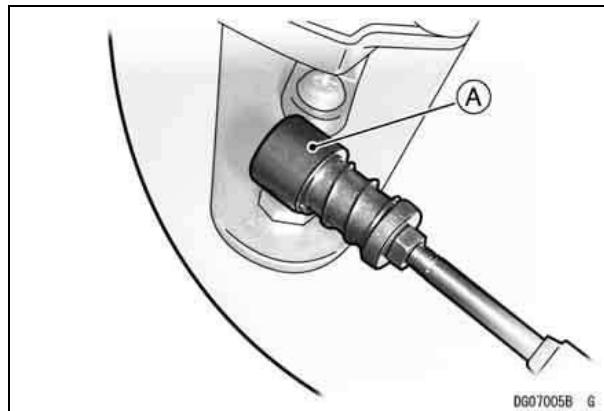

#### A. Steering Ball Joint at Steering Shaft (located in the front storage compartment)

### Throttle Cable Fitting at Throttle Case

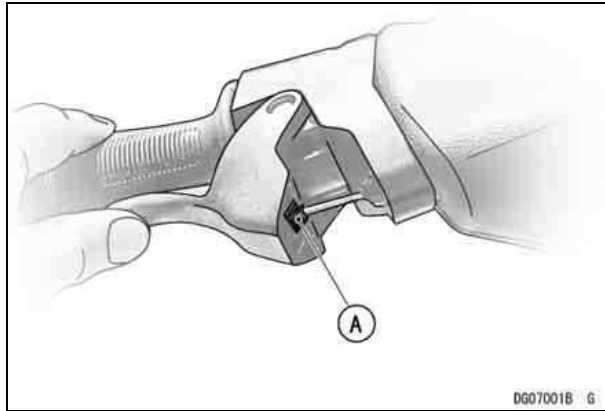

A. Apply grease.

### CAUTION

Disassemble and lubricate the handlebar pivot. This should be performed by your Kawasaki JET SKI dealer.

### Cooling System Flushing

To prevent sand or salt deposits from accumulating in the cooling system, it must be flushed occasionally. Flush the system according to the **Periodic Maintenance Chart**, after each use in salt water, or whenever there is reduced water flow from the bypass outlet on the right side of the hull.

This procedure is also used to provide auxiliary cooling when needed (for example during engine oil change).

- An inlet for auxiliary water supply is provided on the fitting for the cooling hose on the brim of the front storage opening.

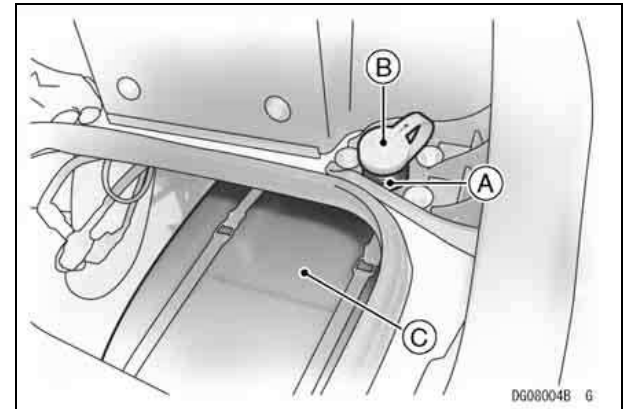

A. Inlet Fitting

B. Cap

C. Front Storage Opening

## 124 MAINTENANCE AND ADJUSTMENTS

- Remove the cap and connect a garden hose with a screw-in fitting on its end.
- Start the engine and allow it to idle **before turning on the water**.

### CAUTION

The engine must be running before the water is turned on, or water may flow back through the exhaust pipe into the engine, resulting in the possibility of severe internal damage.

- Immediately turn on the water and adjust the flow so that a little trickle of water comes out of the bypass outlet in the right side of the hull.

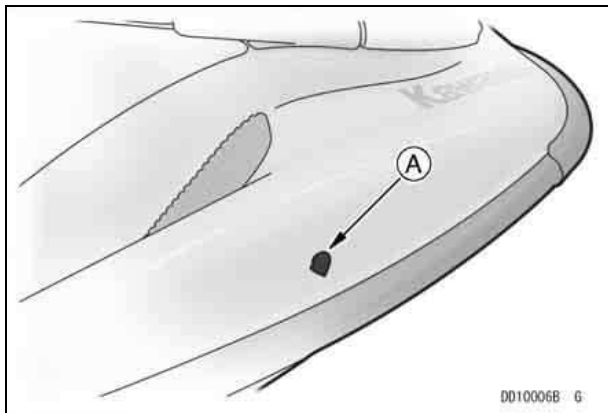

A. Bypass Outlet

- Let the engine idle for several minutes with the water running.
- Turn off the water. **Leave the engine idling.**
- Rev the engine few times to clear the water out of the exhaust system.

### CAUTION

Do not run the engine without cooling water flow for more than 15 seconds. Overheating will cause severe engine and exhaust system damage.

- Switch off the engine, remove the garden hose, reinstall the cap securely.

## Bilge System Flushing

To prevent clogging, the bilge system should be flushed out according to the **Periodic Maintenance Chart**, or whenever you suspect it is blocked.

- Disconnect all bilge hoses at each plastic breather fitting. They are mounted on the rear upper corner in the engine compartment.

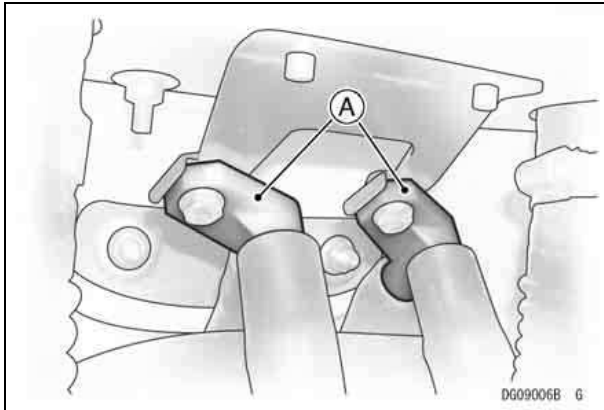

**A. Breather Fittings**

- Connect the bilge filter hose (from the hull bottom) to the garden hose, turn the water on, and flush it out for about a minute. During this procedure, water will flow into the engine compartment. Do not allow a large amount of water to accumulate in the engine compartment. Remove the drain screws in the stern to drain the engine compartment.

- Connect the other hose to the garden hose, turn the water on, and flush it out for several minutes.
- Repeat the above two steps for the other bilge hoses.
- Before reconnecting the hoses to each plastic breather fitting, make sure the small breather hole in the fitting is clear. If the hole is clogged, the engine compartment will be filled with water when the engine stops or idles. It may be necessary to remove the fitting.

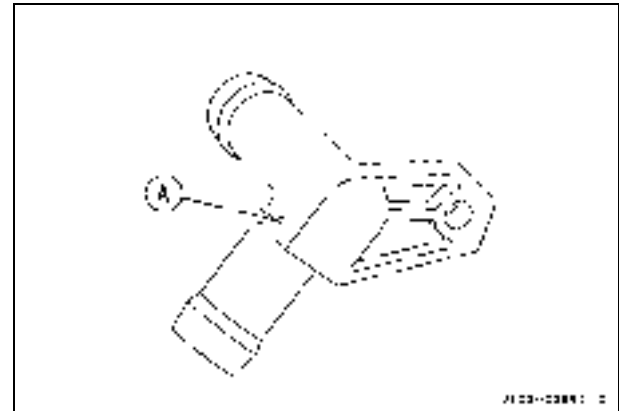

**A. Breather Hole**

- Reconnect the bilge hoses.

### NOTE

- If your watercraft is to be stored, blow air through both hoses at each breather fitting before they are reconnected (see the *Preparation for Storage* section in the **STORAGE** chapter).

## 126 MAINTENANCE AND ADJUSTMENTS

### Fuses

A 20 A main fuse is arranged in the fuse case located on starboard side in the engine room. If a fuse fails during operation, inspect the electrical system to determine the cause, and then replace it with a new fuse of proper amperage.

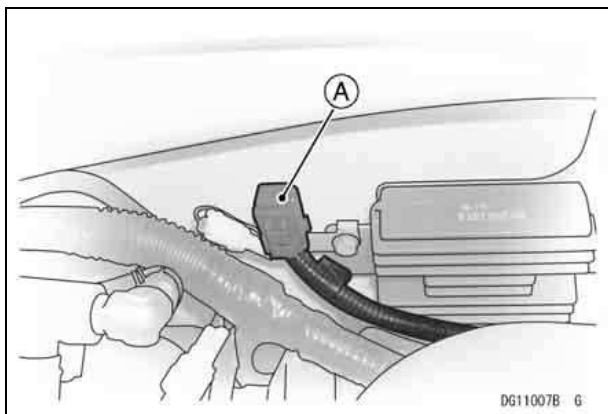

A. Fuse Case

### CAUTION

Do not use any substitute for the standard fuse.

Replace the blown fuse with a new one of the correct capacity, as specified on the electric case.

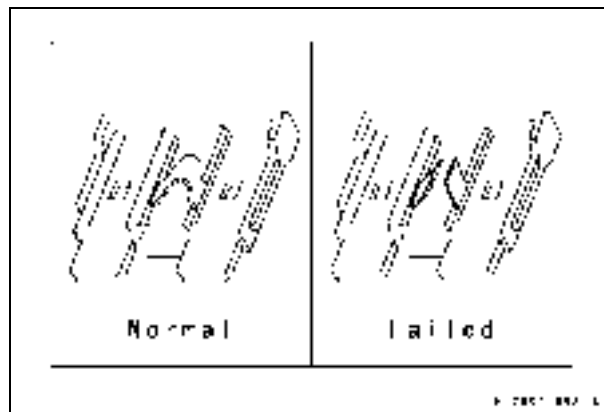

# TROUBLESHOOTING GUIDE

If this procedure does not isolate your problem, see your JET SKI dealer or refer to the Service Manual.

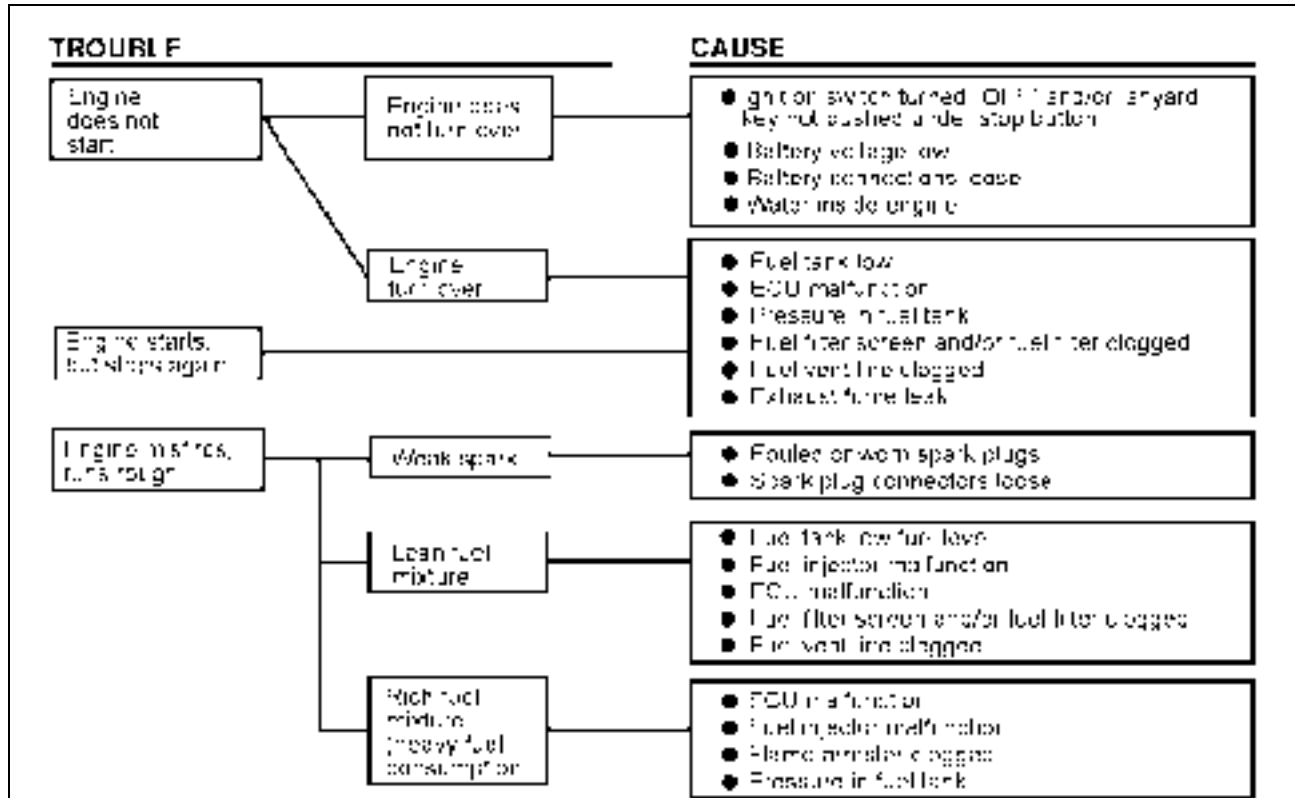



## 128 TROUBLESHOOTING GUIDE

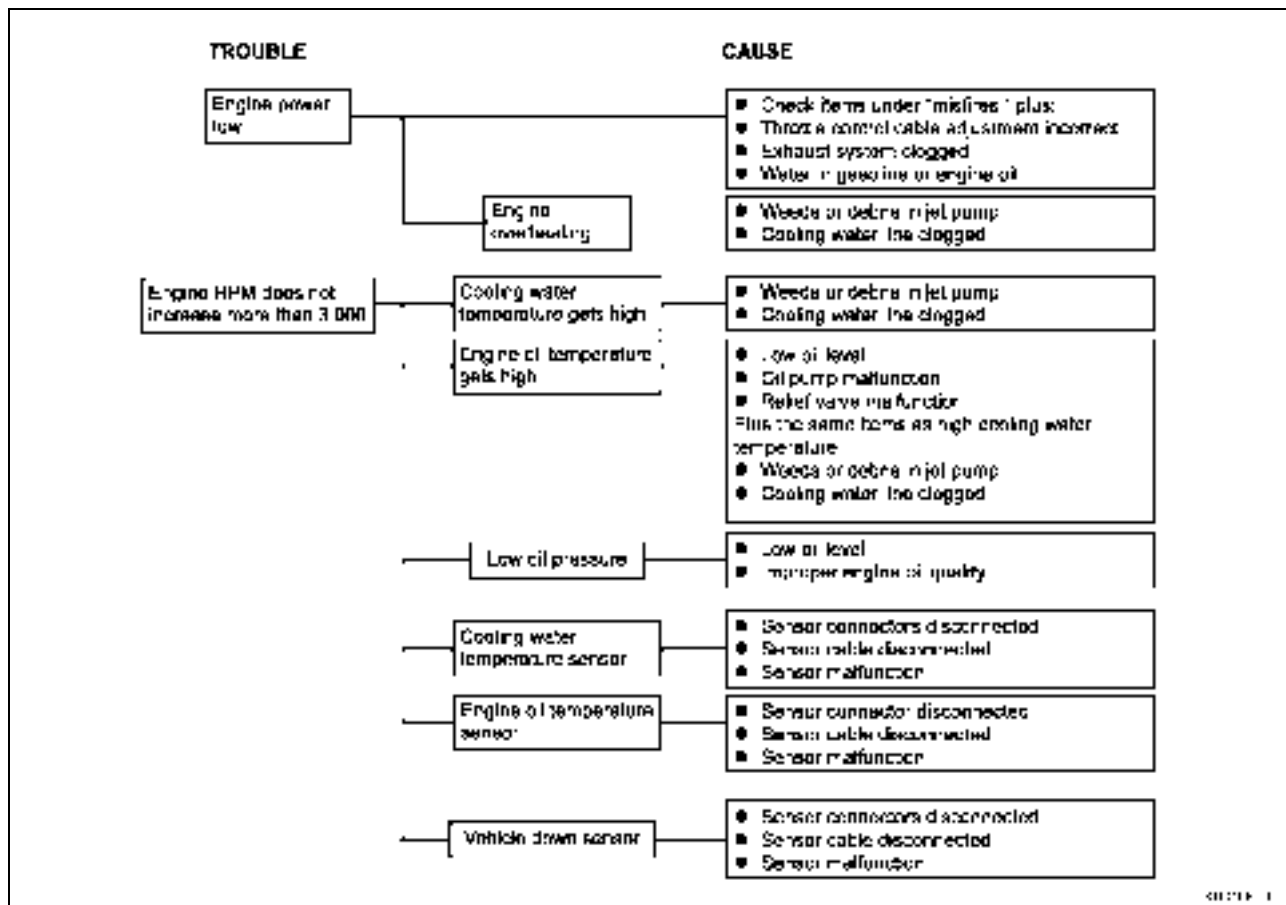

00111-1

TROUBLE	CAUSE
Gas engine 'bucking'	<ul style="list-style-type: none"><li>● Poor quality gasoline</li></ul>
Steering hard or erratic	<ul style="list-style-type: none"><li>● No lock cable on steering unit</li><li>● Steering cable damaged or improperly routed</li></ul>

**⚠ WARNING**

Since faulty steering is dangerous, this problem should be examined by an authorized JET SKI dealer.

---

## OWNER SATISFACTION

---

Your satisfaction is important to your authorized Kawasaki dealer and to Kawasaki Motors Corp., U.S.A. If you have a problem concerning warranty or service, please take the following action:

Contact the owner and/or service manager of your authorized Kawasaki dealer. Fully explain your problem and ask for assistance in resolving the situation. The OWNER of the dealership is an independent business person and is concerned with your satisfaction and your future business. For this reason the owner is in the best position to assist you. Also, all warranty and service matters are handled and resolved through the authorized Kawasaki dealer network.

If you are unsatisfied after working with your Kawasaki dealer and feel you still require further assistance, WRITE to the address below. Please be certain to provide the model, product identification number, mileage or hours of use, accessories, dates that events occurred and what action has been taken by both you and your dealer. Include the name and address of the dealership. To assist us in resolving your inquiry, please include copies of related receipts and any other pertinent information including the names of the dealership personnel with whom you have been working in the resolution of your problem.

Upon receipt of your WRITTEN correspondence we will contact the dealership and work with them in resolving your problem.

In order to provide a permanent record, all warranty and service resolutions take place only through WRITTEN correspondence.

Please send your correspondence to:  
CONSUMER RELATIONS  
KAWASAKI MOTORS CORP., U.S.A.  
P.O. Box 25252  
SANTA ANA, CA. 92799-5252  
(949) 460-5688

---

## REPORTING SAFETY DEFECTS

---

**(For Products Sold in the Continental United States of America Only)**

If you believe that your watercraft has a defect which could cause a crash or could cause injury or death, you should immediately inform the U.S. Coast Guard (U.S.C.G.) in addition to notifying Kawasaki Motors Corporation, U.S.A.

If the U.S.C.G. receives similar complaints, it may open an investigation, and if it finds that a safety defect exists in a group of watercrafts, it may order a recall and remedy campaign. However, the U.S.C.G. cannot become involved in individual problems between you, your dealer, or Kawasaki Motors Corporation, U.S.A.

Please send your correspondence to:

Office of Boating Safety Product Assurance Division-OPB-3  
United States Coast Guard  
2100 Second Street SW  
Washington, DC 20593-0001

---

## ENVIRONMENTAL PROTECTION

---

To ensure a clean environment, observe the following:

- Properly dispose of your own trash (it is against the law to litter).
- Do not soil the beaches, coasts, and waters with fuel or oil.
- Take care to preserve natural habitats and living things.
- Properly discard used batteries, engine oil, or other JET SKI watercraft components that you might dispose of in the future. Consult your authorized Kawasaki dealer or local environmental waste agency for their proper disposal procedure.

# MAINTENANCE RECORD

Owner Name.....

Address .....

Phone Number .....

Hull Number .....

Engine Number .....

Selling Dealer Name .....

Address .....

Phone Number .....

Warranty Start Date .....

**Note:** Keep this information and a spare key in a secure location.

Date	Engine Hours	Maintenance Performed	Dealer Name	Dealer Address











# JT1500DA



\* 9 9 9 8 7 - 1 5 8 6 \*



KAWASAKI HEAVY INDUSTRIES, LTD.  
Consumer Products & Machinery Company

Part No. 99987-1586  
<https://www.boat-manuals.com/>

Printed in Japan