



**Includes:**

- Important Safety Information**
- Navigation Rules**
- Operating Instructions**
- Maintenance and Storage**

# Jet Ski<sup>®</sup> 1200 STX-R Watercraft

保存版

# OWNER'S MANUAL

<https://www.boat-manuals.com/>

**⚠ WARNING**

Engine exhaust, some of its constituents, and certain vehicle components contain or emit chemicals known to the State of California to cause cancer and birth defects or other reproductive harm.

# READ THIS FIRST!

## ⚠ WARNING

For your safety, read this Owner's Manual and understand it thoroughly before operating this JET SKI watercraft. This manual contains the warnings given here for your immediate attention plus other important information.

To reduce the risk of **SEVERE INJURY** or **DEATH**:

### WEAR A PERSONAL FLOTATION DEVICE (PFD).

All riders must wear a Coast Guard approved PFD that is suitable for personal watercraft (PWC) use.

### WEAR PROTECTIVE CLOTHING.

Severe internal injuries can occur if water is forced into body cavities as a result of falling into water or being near jet thrust nozzle. Normal swimwear does not adequately protect against forceful water entry into lower body cavities. All riders must wear a wet suit bottom or clothing that provides equivalent protection (see Owner's Manual).

Footwear, gloves, and goggles/glasses are recommended.

### KNOW BOATING LAWS.

Kawasaki recommends a minimum operator age of 16 years old. Know the operator age and training requirements for your state. A boating safety course is recommended and may be required in your state.



3A010008 1

**ATTACH ENGINE SHUT-OFF CORD (LANYARD) to wrist and keep it free from handlebars so that the engine stops if operator falls off. After riding, remove cord from PWC to avoid unauthorized use by children or others.**

**RIDE WITHIN YOUR LIMITS AND AVOID AGGRESSIVE MANEUVERS** to reduce the risk of loss of control, ejection, and collision. This is a high performance boat – not a toy. Sharp turns or jumping wakes or waves can increase the risk of back/spinal injury (paralysis), facial injuries, and broken legs, ankles, and other bones. Do not jump wakes or waves.

**DO NOT APPLY THROTTLE WHEN ANYONE IS AT REAR OF PWC** – turn engine off or keep engine at idle. Water and/or debris exiting jet thrust nozzle can cause severe injury.

**KEEP AWAY FROM INTAKE GRATE** while engine is on. Items such as long hair, loose clothing, or PFD straps can become entangled in moving parts resulting in severe injury or drowning.

**NEVER RIDE AFTER CONSUMING DRUGS OR ALCOHOL.**

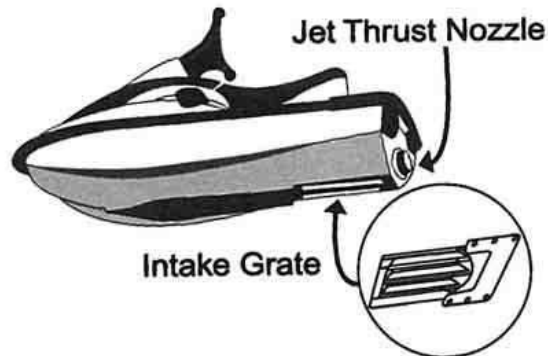

DA01001B S

Collisions result in more **INJURIES AND DEATHS** than any other type of accident for personal watercraft (PWC).

**TO AVOID COLLISIONS:**

**SCAN CONSTANTLY** for people, objects, and other watercraft. Be alert for conditions that limit your visibility or block your vision of others.

**OPERATE DEFENSIVELY** at safe speeds and keep a safe distance away from people, objects, and other watercraft.

- Do not follow directly behind other PWCs or boats.
- Do not go near others to spray or splash them with water.
- Avoid sharp turns or other maneuvers that make it hard for others to avoid you or understand where you are going.
- Avoid areas with submerged objects or shallow water.

**TAKE EARLY ACTION** to avoid collisions. Remember, PWCs and other boats do not have brakes.

**DO NOT RELEASE THROTTLE** WHEN TRYING TO **STEER** away from objects – you need throttle to steer. Always check throttle and steering controls for proper operation before starting PWC.

Follow navigation rules and state and local laws that apply to PWCs.

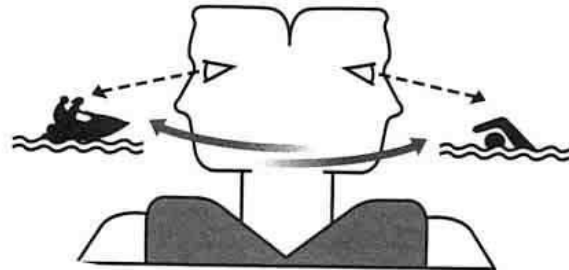

## CAUTION

Take proper care of your new JET SKI watercraft. Here are some of the cautions contained in this manual which must be followed for the protection of your watercraft. Be sure to read this Owner's Manual and understand it thoroughly before operating your watercraft.

**Always turn the boat on PORT side. Rolling to the STARBOARD side can cause water in the exhaust system to run into the engine, with possible engine damage.**

If the watercraft has capsized, follow the righting procedure on page 73 immediately. If water is left in the engine more than a few hours, it will destroy the crankshaft bearings and damage other internal engine parts.

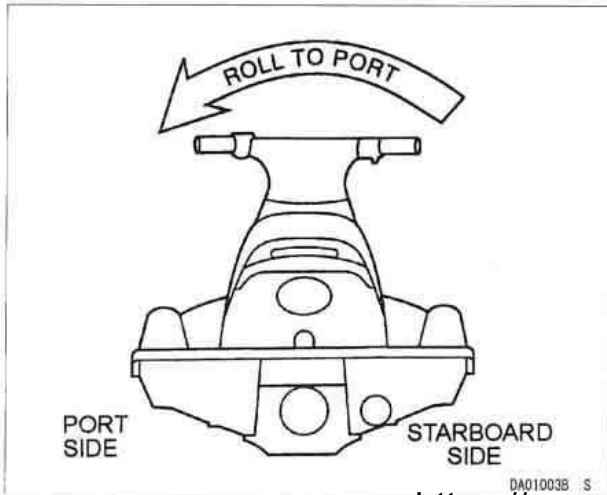

**The watercraft must be in at least 0.8 m of water when starting to prevent jet pump damage by objects sucked up from the bottom.**

**Do not operate in shallow or debris-laden water, or the impeller may be damaged and sand may clog the water cooling hoses.**

**Do not run the watercraft onto the shore, or severe impeller damage may occur.**

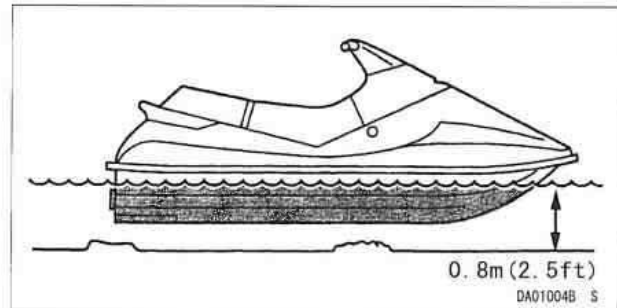

## Quick Reference Guide

This Quick Reference Guide will assist you in finding the information you're looking for.

**General  
Information**

**Operating  
Instructions**

**Storage**

**Maintenance  
and Adjustments**

**Troubleshooting  
Guide**

A Table of Contents is included after the Foreword.





Whenever you see the symbols shown below, heed their instructions! Always follow safe operating and maintenance practices.

### **⚠ WARNING**

This warning symbol identifies special instructions or procedures which, if not correctly followed, could result in personal injury, or loss of life.

### **CAUTION**

This caution symbol identifies special instructions or procedures which, if not strictly observed, could result in damage to or destruction of equipment.

### **NOTE**

○ Indicates points of particular interest for more efficient and convenient operation.

# FOREWORD

Congratulations on your purchase of a new Kawasaki JET SKI watercraft. Welcome to a new and exciting water sport. We are pleased you have chosen the Kawasaki JET SKI watercraft to expand the enjoyment of your recreational hours.

Kawasaki uses the latest manufacturing methods and materials to bring you a high quality recreational watercraft.

**Please read this Owner's Manual carefully before starting your new JET SKI** so that you will be thoroughly familiar with the proper operation of your watercraft's controls, its features, capabilities, and limitations. Kawasaki strongly recommends that all operators attend a boating safety course before riding the watercraft. Contact the local office of the U.S. Coast Guard Auxiliary, U.S. Power Squadrons, or school district.

The Kawasaki 1200 STX-R provides experienced riders with a personal watercraft that highlights exceptional acceleration with competition-level handling. With this boat's race-bred handling characteristics, Kawasaki recommends that riders learn this boat's response to steering input under various riding conditions by practicing at lower speeds in an open area.

The design focus of the 1200 STX-R on optimizing sporting performance for a single rider may result in

reduced recreational abilities such as rider comfort for two or three riders under certain conditions.

## **BOAT SMART FROM THE START**

TAKE A BOATING SAFETY COURSE AND GET A FREE VESSEL SAFETY CHECK ANNUALLY FOR YOUR BOAT.

FOR MORE INFORMATION CONTACT:

UNITED STATES COAST GUARD AUXILIARY, 800-368-5647, WWW.CGAUX.ORG.

UNITED STATES POWER SQUADRONS, 888-FOR-USPS, WWW.USPS.ORG

To ensure a long, trouble-free life for your JET SKI, give it the proper care and maintenance described in this manual. For those who would like more detailed information on their JET SKI, a Service Manual is available for purchase from any authorized Kawasaki JET SKI watercraft dealer. The Service Manual contains detailed disassembly and maintenance information. Those who plan to do their own work should, of course, be competent mechanics and possess the special tools described in the Service Manual.

Keep this Owner's Manual aboard your JET SKI at all times so that you can refer to it whenever you need information. If you need further information, please contact your dealer, who will provide all the help you need.

This manual should be considered a permanent part of the JET SKI and should remain with the JET SKI when it is sold.

This craft is a "Class A" inboard boat, and as such is subject to all federal rules and regulations especially pertaining to boating safety and operation as enforced by the U.S. Coast Guard. States and local jurisdictions may have additional requirements for operation of powerboats in waters under their control. Additionally, other counties may have their own standards and regulations. Please check your local boating laws and regulations before riding the watercraft.

© 2002 Kawasaki Heavy Industries, Ltd.

All rights reserved. No part of this publication may be reproduced without our prior written permission.

This publication includes the latest information available at the time of printing. However, there may be minor differences between the actual product and illustrations and text in this manual.

All products are subject to change without prior notice or obligation.

**KAWASAKI HEAVY INDUSTRIES, LTD.**  
Consumer Products & Machinery Company

Jan. 2002 (1) (S)



**JETSKI** is a trademark of Kawasaki Heavy Industries, Ltd. registered in U.S.A., Japan, Austria, Benelux, Sweden, Denmark, Switzerland, France, Canada, Finland, Norway, Greece, Italy, U.K., Portugal, Thailand, and Taiwan.

**KAWASAKI JET SKI** is a trademark of Kawasaki Heavy Industries, Ltd. registered in Australia.

## ..... TABLE OF CONTENTS .....

<b>SPECIFICATIONS</b> .....	12	Stop Button:.....	39
<b>GENERAL INFORMATION</b> .....	14	Start Button:.....	39
Serial Numbers.....	14	Throttle Lever:.....	40
Parts Location.....	15	Ignition Switch:.....	40
Label Location.....	17	Choke Knob:.....	41
Registration Numbers.....	25	Fuel Knob:.....	42
Multifunction Meter.....	26	Seat Latches.....	43
Speedometer:.....	27	Storage Compartment.....	44
Fuel Level Gauge/Symbol/"FUEL"Characters/ Warning Light:.....	28	Storage Pockets.....	45
Engine Oil Level Gauge/Symbol/"OIL"Characters/ Warning Light:.....	28	Tool Kit.....	46
Cooling Water Temperature Symbol/"HEAT" Characters/Warning Light:.....	29	Drain Screws.....	46
Battery Symbol/"BATTERY" Characters/Warning Light:.....	29	<b>OPERATING INSTRUCTIONS</b> .....	47
Tachometer:.....	30	Safe Operation.....	47
Clock/Time/Trip/Hour Meter Displays:.....	30	Operation by Children:.....	47
Fuel.....	34	Operator Swimming Ability:.....	47
Fuel Requirement:.....	34	Safe Riding Rules:.....	47
Engine Oil.....	37	Jet Pump Safety:.....	49
Adding Oil:.....	38	Personal Flotation Device and Safety Gear:.....	50
Controls.....	39	Watercraft Helmets ... Something You Should Know:.....	51
Steering Handlebar:.....	39	Loading.....	53
		Load Capacity Limits.....	53
		Pulling a Water Skier.....	54
			55

Sailboats:	55
Pre-ride Checklist	57
Check Outside Craft:	57
Check Inside Craft:	57
Break-In	59
Mixing:	59
Stopping the Engine	60
Starting the Engine	62
Launching	64
Launching from a Dock:	64
Launching from a Ramp:	65
Deep Water Start:	65
Shallow Water Start:	66
Stopping the JET SKI Watercraft	66
Normal Stopping:	66
Stopping Skills:	67
Minimum Stopping Distances:	68
Turning the JET SKI Watercraft	68
Docking the JET SKI Watercraft	71
Riding the JET SKI Watercraft	72
Fall Recovery:	72
Righting the Capsized Watercraft:	72
After Submerging:	74
End of the Day Checklist	77
First, Drain the Exhaust System:	77
Second, Clean the Engine Compartment:	77
Special Procedures	78
Clearing Clogged Impeller:	78
Towing the JET SKI Watercraft:	79
Jump Starting:	79
Engine Overheating:	80
Transporting	81

<b>STORAGE</b>	82
Preparation for Storage	82
Cooling System:	82
Bilge System:	82
Fuel System and Engine:	83
Battery:	84
Cleaning:	84
Lubrication:	85
Removal from Storage	85
<b>MAINTENANCE AND ADJUSTMENTS</b>	87
EMISSION CONTROL INFORMATION	87
Periodic Maintenance Chart	89
Control Cable Adjustments	91
Throttle Control Cable Adjustment	92
Carburetor Cable Adjustment:	92
Fuel and Oil Systems	97
Carburetor Adjustments:	97
Fuel Vent Check Valve:	97
Fuel Filter Screens/Fuel Filter:	98
Oil Filter:	98
Oil Pump Bleeding:	99
Spark Plug	100
Battery	101
Lubrication	104
Cooling System Flushing	106
Bilge System Flushing	108
Fuses	109
<b>TROUBLESHOOTING GUIDE</b>	111
<b>OWNER SATISFACTION</b>	113
<b>REPORTING SAFETY DEFECTS</b>	114
<b>ENVIRONMENTAL PROTECTION</b>	115
<b>MAINTENANCE RECORD</b>	116

## 12 SPECIFICATIONS

# SPECIFICATIONS

### JET SKI WATERCRAFT - MODEL JT1200-A1

#### "CLASS A" INBOARD BOAT

#### Engine:

Type

2-stroke, 3-cylinder, crankcase reed valve,  
water-cooled

Displacement

1,176 mL

Bore and Stroke

80.0 x 78 mm

Compression Ratio

5.8 : 1

Compression Pressure

970 kPa (9.9 kgf/cm<sup>2</sup>) @440 r/min (rpm)

Ignition System

DC-CDI

Lubrication System

Oil injection (break-in period: Oil injection and  
gas/oil mixture 50 : 1)

Carburetor

Keihin CDCV 40 - 35 x 3

Starting System

Electric

---

#### Tuning Specifications:

Spark Plug

NGK BR9ES

Gap

0.7 - 0.8 mm

Terminal

Solid post

Ignition Timing

15° BTDC @1,250 r/min (rpm) ~ 22° BTDC @3,500 r/min (rpm)

Carburetor

Idle Speed

1,250 ±100 r/min (rpm) - in water

1,800 ±100 r/min (rpm) - out of water

<b>Drive System:</b>		
Coupling		Direct drive from engine
Jet Pump:	Type	Axial flow, single stage
	Thrust	4 020 N (410 kgf)
Steering		Steerable nozzle
Braking		Water drag
<b>*Performance:</b>		
Minimum Turning Radius		4.0 m
Fuel Consumption		50.5 L/h @full throttle
Cruising Range		102 km @full throttle
		1 hour and 3 minutes (with 3 persons onboard)
<b>Dimensions:</b>		
Overall length		3,120 mm
Overall width		1,180 mm
Overall Height		1,020 mm
Dry Weight		2,844 N (290 kg)
Fuel Tank Capacity		53 L including 7 L reserve
<b>Engine Oil:</b>		
Type		2-stroke, N.M.M.A. Certified for Service TC-W 3
Oil Tank Capacity		5 L
<b>Electrical Equipment:</b>		
Battery		12 V 18 Ah

\* The information shown here represents results under controlled conditions, and the information may not be correct under other conditions.

## 14 GENERAL INFORMATION

# GENERAL INFORMATION

### Serial Numbers

The hull and engine identification numbers are used to register the boat. They are the only means of identifying your particular machine from others of the same model. These serial numbers may be needed by your dealer when ordering parts. In the event of theft, investigating authorities will require both numbers as well as the model number and any unique features of your machine that could help identify it. Record these numbers here.

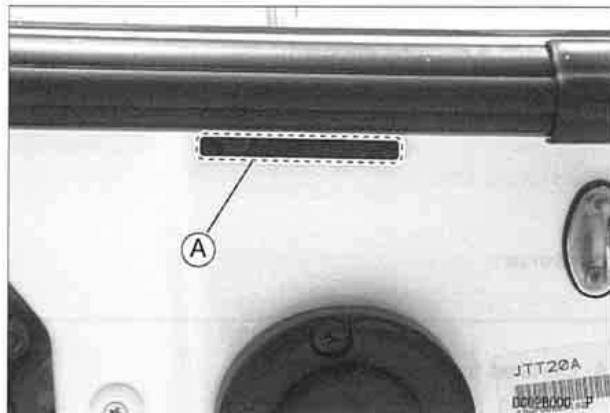

**A. Hull Identification Number (HIN)**

H.I.N.	
--------	--

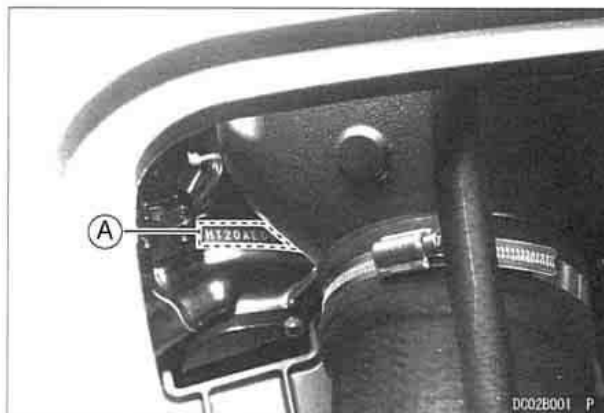

**A. Engine Number**

Eng. No.	
----------	--



Parts Location

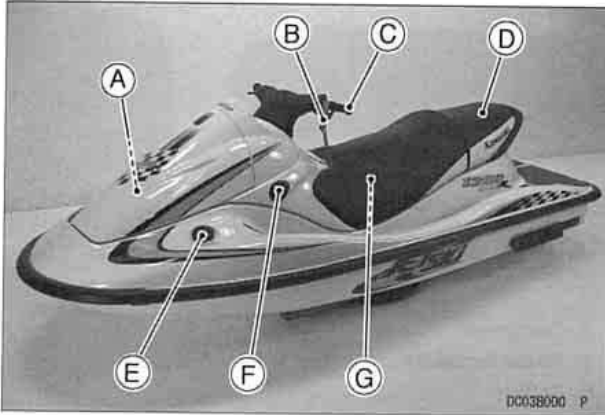

- A. Storage Compartment
- B. Engine Shut-off Lanyard
- C. Handlebar
- D. Seat
- E. Fuel Filler Cap
- F. Choke Knob
- G. Engine Compartment

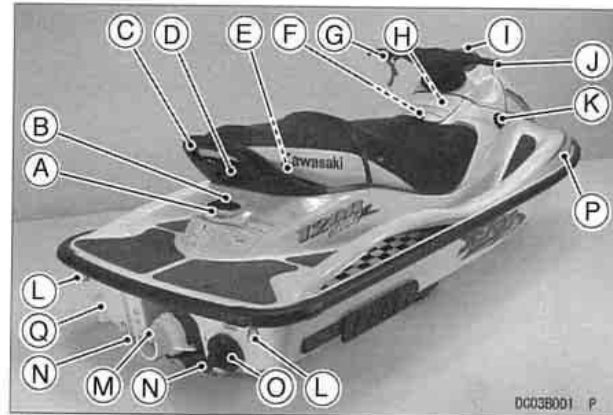

- A. Reboarding Grip
- B. Towing Hook
- C. Handrail
- D. Seat Latch
- E. Storage Pocket (Rear)
- F. Storage Pocket (Front)
- G. Engine Start and Stop Button
- H. Ignition Switch
- I. Multifunction Meter
- J. Throttle Lever
- K. Fuel Knob
- L. Towing Eyes
- M. Steering Nozzle
- N. Drain Screws
- O. Exhaust Outlet
- P. Bypass Outlet
- Q. Waterwheel for Speedometer

## 16 GENERAL INFORMATION

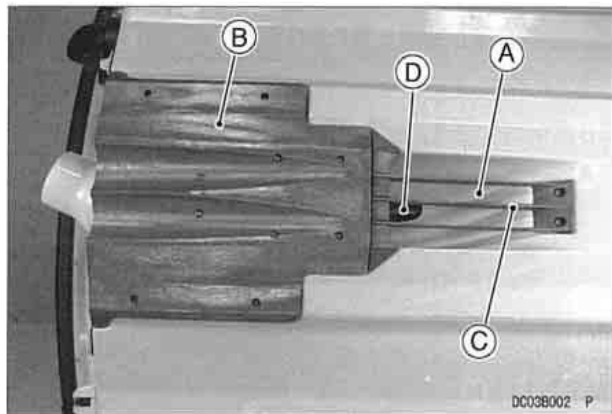

A. Water Intake

B. Jet Pump Cover

C. Grate

D. Drive Shaft

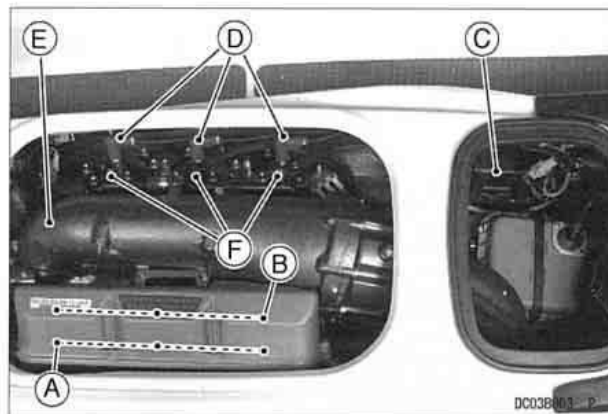

A. Carburetor

B. Flame Arresters

C. Battery

D. Spark Plugs

E. Exhaust Pipe

F. Cooling Hoses

---

## Label Location

---

All warning labels that are on your watercraft are repeated here. Read them and understand them thoroughly. They contain information that is important for your safety and the safety of anyone else who may operate your watercraft. Therefore, it is very important that all warning labels be on your watercraft in the locations shown. If any label is missing, damaged, or worn, get a replacement from your Kawasaki dealer and install it in the correct position.

### NOTE

- *The sample warning labels in this section have part numbers to help you and your dealer obtain the correct replacement.*

- A. Caution/Warning
- B. Warning
- C. Warning
- H. Fire Extinguisher

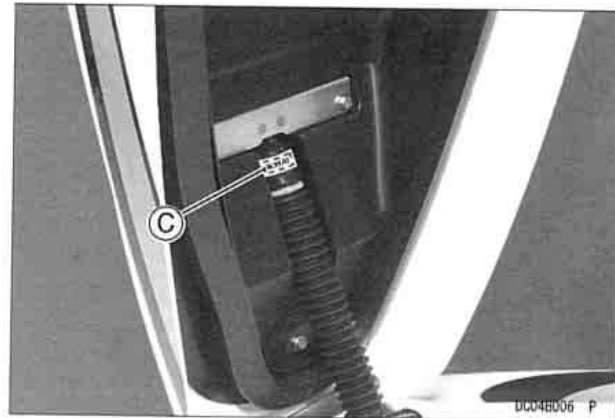
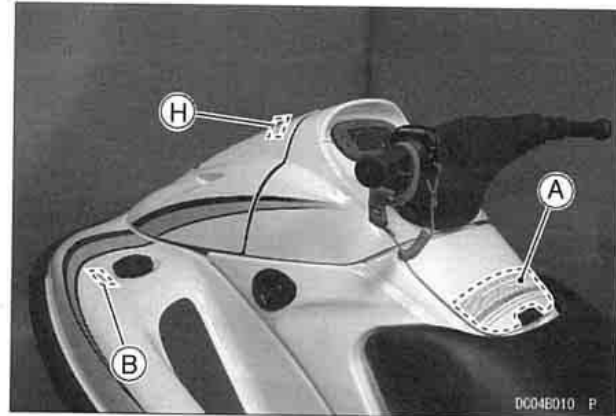

## 18 GENERAL INFORMATION

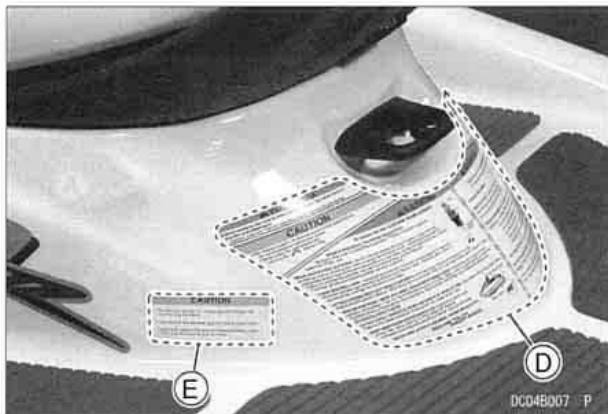

D. Caution/Warning

E. Caution

G. Battery Danger/Poison

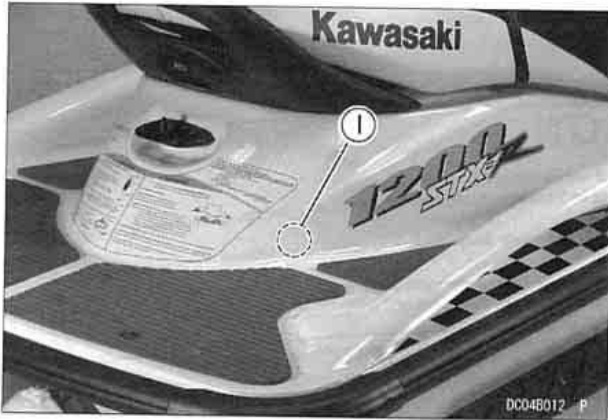

I. NMMA Label

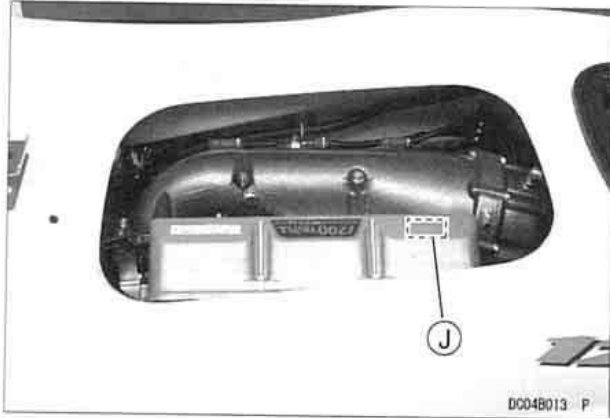

J. Exhaust Emission Information

## 20 GENERAL INFORMATION

A

### CAUTION

- Check engine oil every time you refuel. Oil tank is in the bow. Running out of oil will cause major engine damage.
- Use a 50:1 gas-oil mixture in fuel tank only during break-in period (first 5 hours or 3 tanks of fuel). After break-in, oil injection system alone provides adequate lubrication.
- If engine overheats, the warning light and temperature symbol flash, and the engine slows down. Return to shore immediately. To prevent engine damage, do not operate the craft until the cause of overheating is corrected.
- After turning the ignition switch ON, remove the key. Stow it in a secure place on the boat or with you while riding.
- Always turn the ignition switch OFF after stopping the engine to prevent the battery from discharging.

### ⚠ WARNING

A concentration of gasoline fumes in the engine compartment can cause a fire or explosion.

Open the engine compartment for ventilation before starting the engine for each ride and after transporting or refueling.

Kawasaki

56070-3912

56070-3912

B



### WARNING

Gasoline is extremely flammable and can be explosive. A fire or explosion can cause severe injury or death.

Shut engine off. Do not smoke. Refuel in a well ventilated area away from flame or sparks.

Kawasaki

56040-3972

56040-3972

C



### WARNING

- Do not incinerate, puncture or open.

Kawasaki

56070-3876

56070-3876

## CAUTION

When rolling the craft onto its side, turn it in this  direction only.

D

## WARNING

**WEAR A PERSONAL FLOTATION DEVICE (PFD).** To reduce the risk of SEVERE INJURY or DEATH:  
All riders must wear a Coast Guard approved PFD that is suitable for personal watercraft (PWC) use.

**WEAR PROTECTIVE CLOTHING.** Severe internal injuries can occur if water is forced into body cavities as a result of falling into water or being rear jet thrust nozzle. Normal swimwear does not adequately protect against forceful water entry into lower body cavities. All riders must wear a wet suit bottom or clothing that provides equivalent protection (see Owner's Manual). Footwear, gloves, and goggles/glasses are recommended.

**KNOW BOATING LAWS.** Kawasaki recommends a minimum operator age of 16 years old. Know the operator age and training requirements for your state. A boating safety course is recommended and may be required in your state.

**ATTACH ENGINE SHUT-OFF CORD (LANYARD)** to wrist and keep it free from handbars so that engine stops if operator falls off. After riding, remove cord from PWC to avoid unauthorized use by children or others.

**RIDE WITHIN YOUR LIMITS AND AVOID AGGRESSIVE MANEUVERS** to reduce the risk of loss of control, ejection, and collision. This is a high performance boat - not a toy. Sharp turns or jumping wakes or waves can increase the risk of backspinal injury (paralysis), facial injuries, and broken legs, ankles, and other bones. Do not jump wakes or waves.

**DO NOT APPLY THROTTLE WHEN ANYONE IS AT REAR OF PWC** - turn engine off or keep engine at idle. Water and/or debris exiting jet thrust nozzle can cause severe injury.

**KEEP AWAY FROM INTAKE GRATE** while engine is on. Items such as long hair, loose clothing, or PFD straps can become entangled in moving parts resulting in severe injury or drowning.

**NEVER RIDE AFTER CONSUMING DRUGS OR ALCOHOL.**  
**READ AND FOLLOW OWNER'S MANUAL.**

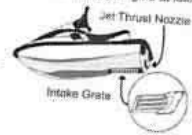

56070-3957

## 22 GENERAL INFORMATION

D

Kawasaki Motor Corp., U.S.A.  
P.O. Box 25252 Santa Ana, CA 92799-5252  
THIS BOAT HAS BEEN EXEMPTED FROM COMPLIANCE WITH THE  
FOLLOWING U.S. COAST GUARD SAFETY STANDARDS IN EFFECT  
ON THE DATE OF CERTIFICATION:

- Display of Capacity Information
- Safe Loading
- Flotation
- Fuel System
- Electrical System
- Powerd Ventilation

AS AUTHORIZED BY U.S. COAST GUARD  
GRANT OF EXEMPTION  
(CGD 80-018)

### **▲ WARNING**

Collisions result in more **INJURIES AND DEATHS** than any other type of accident for personal watercraft (PWC).

#### **TO AVOID COLLISIONS:**

**SCAN CONSTANTLY** for people, objects, and other watercraft. Be alert for conditions that limit your visibility or block your vision of others.



**OPERATE DEFENSIVELY** at safe speeds and keep a safe distance away from people, objects, and other watercraft.

- Do not follow directly behind PWCs or other boats.
- Do not go near others to spray or splash them with water.
- Avoid sharp turns or other maneuvers that make it hard for others to avoid you or understand where you are going.
- Avoid areas with submerged objects or shallow water.

**TAKE EARLY ACTION** to avoid collisions. Remember, PWCs and other boats do not have brakes.

**DO NOT RELEASE THROTTLE WHEN TRYING TO STEER** away from objects - you need throttle to steer. Always check throttle and steering controls for proper operation before starting PWC.

Follow navigation rules and state and local laws that apply to PWCs.  
See Owner's Manual for more information.

56070-3937



E

**CAUTION**

- Do not use handrail for towing objects, lifting craft, or attaching tie-downs.
- Use hook at the stainless grip for towing water skier.
- Use metal eyes at the stern for towing another watercraft, and for securing boat to trailer.

KAWASAKI 56070-3944

56070-3944

I

THIS CRAFT COMPLIES WITH ISO 13500 • NOTIFICATION

NATIONAL MARINE MANUFACTURERS ASSOCIATION CERTIFIED

RATED PERSON CAPACITY

3

MODEL: JT1200A  
MFG: KMC-USA

ELECTRICAL SYSTEMS • VENTILATION • FLOURATION • PETROL FUEL SYSTEMS

59463-3761

G

**⚠ DANGER/POISON**

 <b>SHIELD EYES</b> <b>EXPLOSIVE GASES CAN CAUSE BLINDNESS OR INJURY.</b>	 <b>NO</b> <b>• SPARKS</b> <b>• FLAMES</b> <b>• SMOKING</b>	 <b>SULFURIC ACID</b> <b>CAN CAUSE BLINDNESS OR SEVERE BURNS.</b>
<b>FLUSH EYES IMMEDIATELY WITH WATER. GET MEDICAL HELP FAST.</b> 	<b>PROPOSITION 65 WARNING</b> BATTERY POSTS, TERMINALS, AND RELATED ACCESSORIES CONTAIN LEAD AND LEAD COMPOUNDS, CHEMICALS KNOWN TO THE STATE OF CALIFORNIA TO CAUSE CANCER AND REPRODUCTIVE HARM. WASH HANDS AFTER HANDLING.	
<b>KEEP OUT OF REACH OF CHILDREN</b> IN U.S.A., SERVICED BY: YUASA, READING, PA 19605		
		

SYSYMBTPD

26012-1384

H

**FIRE EXTINGUISHER**

56030-3769

Ⓝ

EMISSION CONTROL INFORMATION

ENGINE FAMILY -----	2KAXM1.183CA
MODEL -----	JTT20-A1
FAMILY EMISSION LIMIT -----	164.00 g/kW-h
DATE OF MANUFACTURE -----	<span style="border: 1px solid black; padding: 2px;">Month and Year</span>

ENGINE TUNE UP SPECIFICATIONS

SPARK PLUG: BR9ES      GAP: 0.7 - 0.8 MM. (0.028-0.032 IN.)  
 IDLE SPEED : 1250RPM (IN WATER)    1800RPM (OUT OF WATER)

THIS ENGINE CONFORMS TO 2002 MODEL YEAR U.S.  
 EPA REGULATIONS FOR MARINE SI ENGINE.  
 KAWASAKI HEAVY INDUSTRIES, LTD.



## Registration Numbers

The graphic design of your JET SKI watercraft provides a specific location on each side for the registration numbers and validation decals.

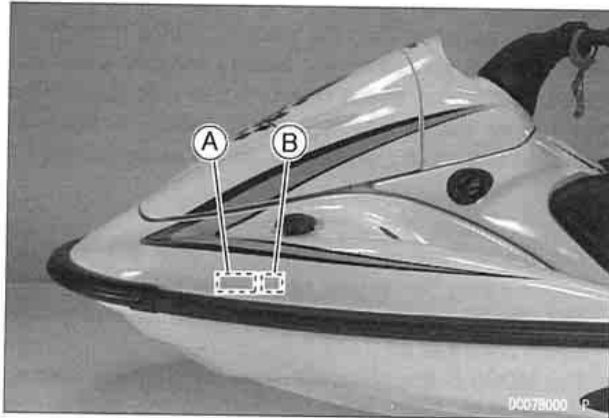

- A. Location for Registration Number
- B. Location for Validation Decal

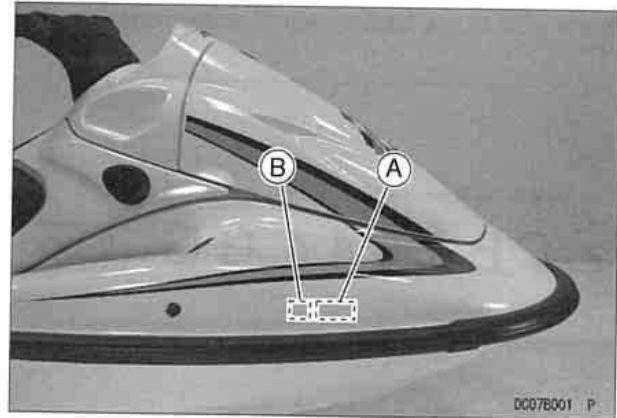

- A. Location for Registration Number
- B. Location for Validation Decal

The registration numbers must read from left to right on both sides of the watercraft. Typically, the validation decal must be placed 3 inches (76.2 mm) beyond, and level with the first or last letter of the registration number.

### NOTE

- Requirements for registration numbers and validation decals may vary from those given here for your state. Always follow the directions provided at the time you register your watercraft.

Registration numbers must be block characters no less than 3 inches (76.2 mm) in height. They should be a color contrasting with the background. The spaces between the prefix/suffix letters must be equal

## 26 GENERAL INFORMATION

to the width of any letter except "l" or any number except "1."

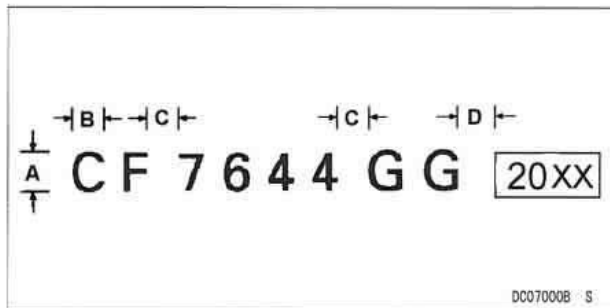

A = 3 inches (76.2 mm) minimum

B = C

D = 3 inches (76.2 mm)

---

### Multifunction Meter

---

Ahead of the steering handlebar is a multifunction meter. When the ignition switch is turned on, all the "LCD" (Liquid Crystal Display) segments are displayed and the "LED" (Light Emitting Diode) warning light comes on for two seconds, then the meter operates normally to show the fuel and oil levels, battery voltage, watercraft speed and engine speed (rpm). It can also display the time of day, elapse time, trip meter (miles), or hours of operation individually depending on the mode selected.

#### NOTE

- *The display will go off 3 minutes after stopping the engine using the engine stop lanyard or stop button. The display will go off immediately when the ignition switch is turned off.*
- *The MODE button operates when the engine is running slower than 3,000 rpm and the warning light is not flashing.*
- *To turn off the warning light, it is necessary to hold down either SET or MODE button for more than one second. Then the MODE button can be operated normally.*

## GENERAL INFORMATION 27

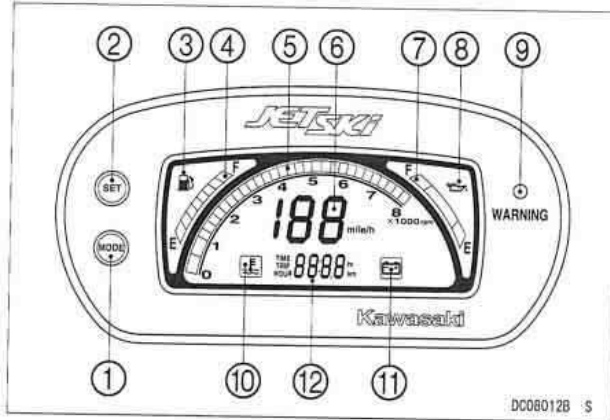

1. "MODE" Button
2. "SET" Button
3. Fuel Symbol
4. Fuel Level Gauge
5. Tachometer
6. Speedometer
7. Engine Oil Level Gauge
8. Engine Oil Symbol
9. "LED" Warning Light
10. Water Temperature Symbol
11. Battery Symbol
12. Clock/Time/Trip/Hour Meter Display

### Speedometer:

The speedometer shows the speed of the watercraft. During a sharp turn the speed shown can be 6 to 12 mile/hr (10 to 20 km/h) lower than the actual speed.

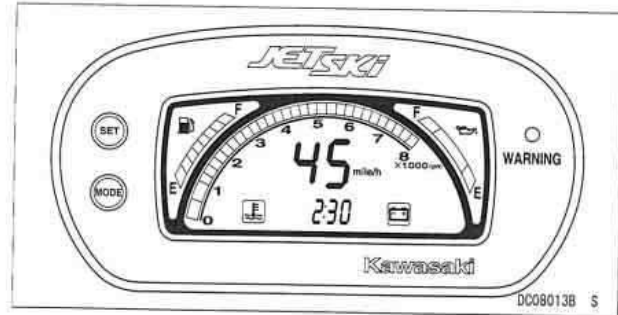

## 28 GENERAL INFORMATION

### Fuel Level Gauge/Symbol/"FUEL"Characters/Warning Light:

The fuel in the fuel tank is shown in segments. All 8 segments are displayed when the fuel tank is full. As fuel is consumed the segments go out accordingly. The fuel symbol and gauge begin flashing when only 1 bottom segment remains (E mark). The "LED" Warning Light (red) and the "FUEL" characters below the speedometer flash to warn the operator as well. Flashing will stop when any button is held down for more than one second. Turn the fuel tap to the "RES" position and fill the fuel tank as soon as possible (see the Fuel and Controls sections).

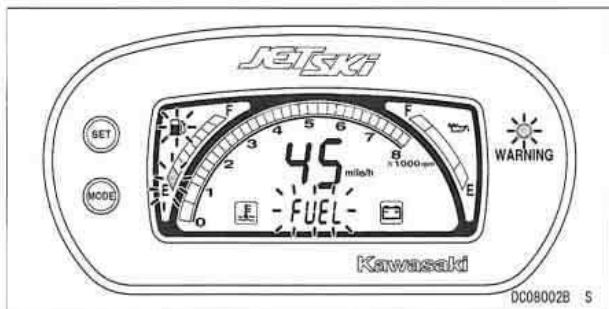

### Engine Oil Level Gauge/Symbol/"OIL"Characters/Warning Light:

The engine oil level is shown by 3 segments. All the segments are displayed when the oil tank is full. The segments will go off one by one from the top (F) according to oil consumption. Both the oil symbol and gauge flash when only one segment remains (E mark). The

"LED" Warning Light (red) and "OIL" characters below the speedometer flash to warn the operator. Flashing will stop when any button is held down for more than one second. Fill the oil as soon as possible (Refer to "ENGINE OIL").

### CAUTION

**If the engine is run without oil, it will be severely damaged. If the oil tank is completely dry, add oil, but do not operate the craft until your Kawasaki JET SKI dealer can bleed the air from the oil line.**

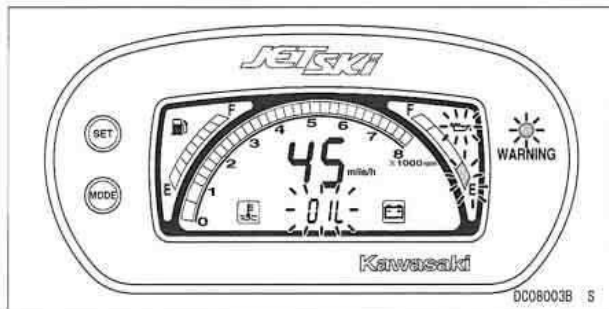

### Cooling Water Temperature Symbol/"HEAT" Characters/Warning Light:

If the cooling water temperature gets too high, the "LED" (red) warning light, water temperature symbol and "HEAT" characters flash; return to shore immediately and check the cooling system for clogging (see the Special Procedures section in the Operating Instructions chapter). Flashing will stop when any button is held down for more than one second.

### CAUTION

If the engine overheats, the "LED" warning light, water temperature symbol and "HEAT" characters flash and the engine slows down. Return to shore immediately. To prevent engine damage, do not operate the craft until the cause of overheating is corrected.

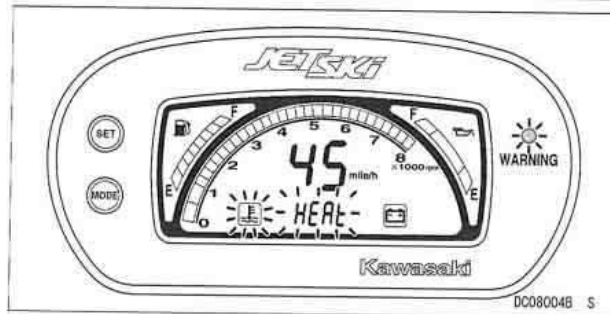

### Battery Symbol/"BATTERY" Characters/Warning Light:

The "LED" (red) warning light, battery symbol and "battery" characters flash when the battery voltage is less than 12 volts. If they are flashing, return to shore immediately. Remove your watercraft's battery and charge it. Hold down any button for more than one second to stop the flashing symbols and light.

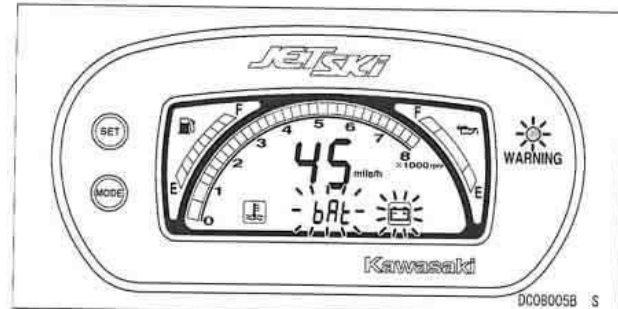

## 30 GENERAL INFORMATION

### Tachometer:

The tachometer shows the engine speed in revolutions per minute (rpm); increasing or decreasing every 500 rpm within the range of 0 – 1,000 rpm and every 250 rpm over 1,000 up to 8,000 rpm.

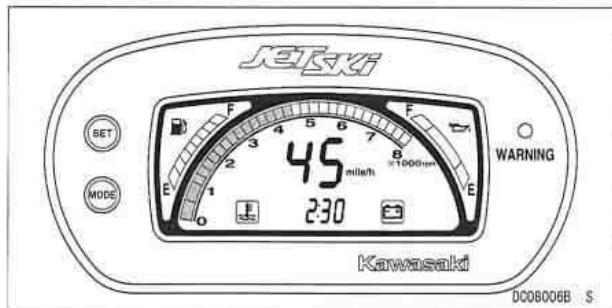

### Clock/Time/Trip/Hour Meter Displays:

The Clock, Time, Trip and Hour Meter will be displayed in the center of the multifunction meter below the speedometer. These modes will shift in series if the "MODE" button is pressed for 2 seconds or more.

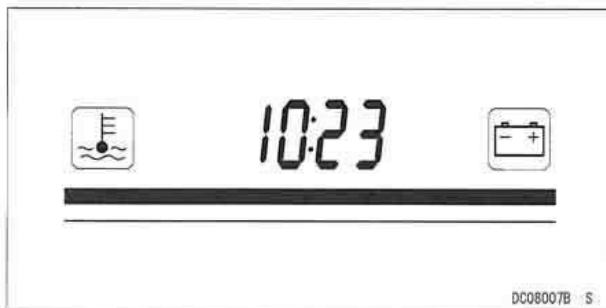

### To set the clock

1. Push the "SET" button for two seconds or more. The hour display starts flashing.
2. Push the "MODE" button to advance the hours.
3. Push the "SET" button. The hour display stops flashing and the minutes display starts flashing.
4. Push the "MODE" button to advance the minutes.
5. Push the "SET" button. The minutes display stops flashing and the clock starts working.

### NOTE

- Pushing the "MODE" button momentarily advances the hour or minute step by step. Holding after pushing the button advances the hour or minute continuously.



## GENERAL INFORMATION 31

- The clock works normally from the back-up power while the ignition switch is turned off.
- When the battery is disconnected, the clock resets to 12:00, and starts working again when a battery is connected.

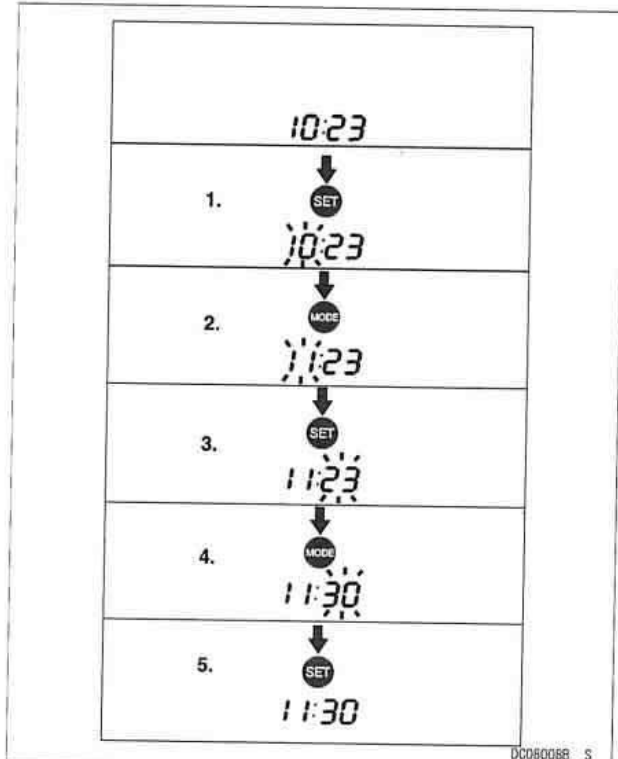

### Time Meter

The time meter shows the time passed since it was last reset to zero.

To reset the time meter:

1. Push and hold the "SET" button. All the displays in this mode start flashing.
2. After two seconds the displays stop flashing and the hour and minute display turns back to 00:00, and then starts working, if the engine is running. The meter works on until it is next reset, unless the ignition switch is turned off.

### NOTE

- The time data is maintained by the back-up power if the ignition switch is turned off, and it starts working when the craft is next operated.
- When the time comes to 99:59 when the engine is running, it turns back to 00:00 and starts counting upward again.
- When the battery is disconnected, the time display resets to 00:00.

## 32 GENERAL INFORMATION

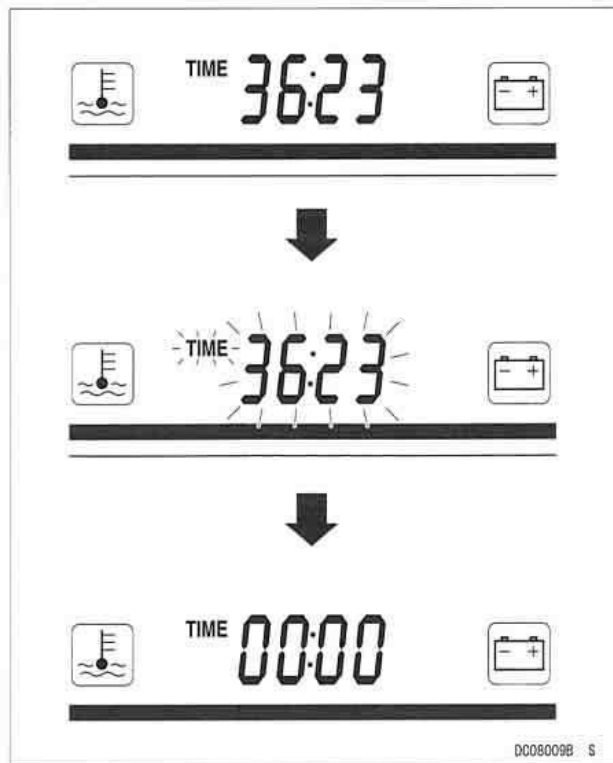

### Trip Meter

The trip meter shows the distance traveled since it was last reset to zero.

To reset the trip meter:

1. Push the "SET" button and hold it in. All the displays in this mode start flashing.
2. After two seconds the displays stop flashing and the figure display turns to 000.0, and then starts counting when the craft is operated. The meter works on until it is next reset, unless the ignition switch is turned off.

### NOTE

- The data is maintained by the back-up power if the ignition switch is turned off.
- When the trip meter is reset while the craft is stopped, it starts counting as soon as the craft starts moving.
- When the figures come to 999.9 when the craft is running, they turn back to 000.0 and start counting again.
- When the battery is disconnected, the meter display resets to 000.0.

## GENERAL INFORMATION 33

### NOTE

- The data is maintained even if the battery is disconnected.
- When the figures come to 9999, they turn back to 0000 and start counting upward again while the craft is operated.

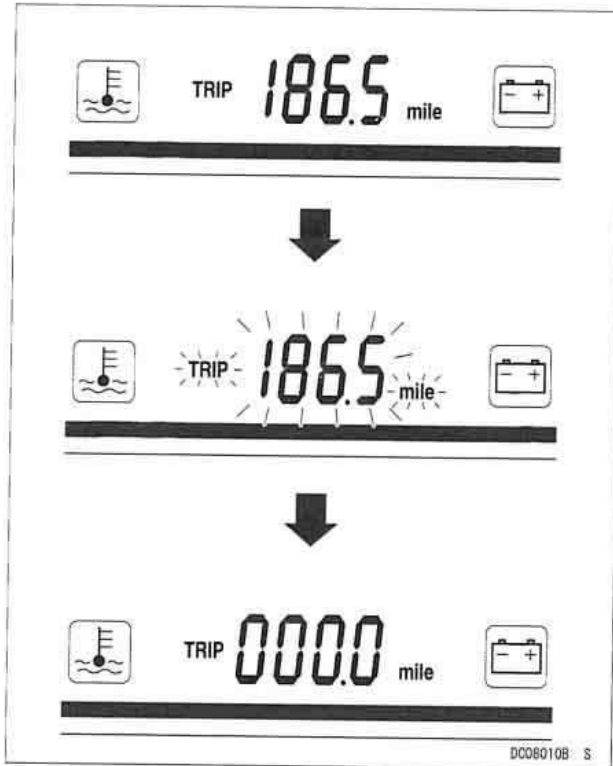

### Hour Meter

The hour meter shows the total hours that the watercraft has been operated. This meter cannot be reset.



## 34 GENERAL INFORMATION

### Fuel

#### Fuel Requirement:

#### CAUTION

Do not use racing fuels or fuel additives. This watercraft has not been tested and certified for use with such fuels. Damage to the engine and fuel system may result from the use of improper fuel.

The octane rating of gasoline is a measure of its resistance to detonation or "knocking." Use a gasoline with an octane rating equal to or higher than that shown in the table below.

Octane Rating Method	Minimum Rating
Antiknock Index $\frac{(\text{RON} + \text{MON})}{2}$	87
Research Octane No. (RON)	91

The Antiknock Index is an average of the Research Octane Number (RON) and the Motor Octane Number (MON). The Antiknock Index is posted on service station pumps in the U.S.A. If the Antiknock Index is not posted, be sure the Research Number is adequate.

#### CAUTION

If engine "knocking" or "pinging" occurs, use a different brand of gasoline of a higher octane rating. If this condition is allowed to continue it can lead to severe engine damage.

Gasoline quality is important. Fuels of low quality or not meeting standard industry specifications may result in unsatisfactory performance. Operating problems that result from the use of poor quality or nonrecommended fuel may not be covered under your warranty.

#### *Fuels Containing Oxygenates*

Gasoline frequently contains oxygenates (alcohols and ethers) especially in areas of the U.S. and Canada which are required to sell such reformulated fuels as part of a strategy to reduce exhaust emissions.

The types and volume of fuel oxygenates approved for use in unleaded gasoline by the U.S. Environmental Protection Agency include a broad range of alcohols and ethers, but only two components have seen any significant level of commercial use.

Gasoline/Alcohol Blends - Gasoline containing up to 10% ethanol (alcohol produced from agricultural products such as corn), also known as "gasohol" is approved for use.

**CAUTION**

Avoid using blends of unleaded gasoline and methanol (wood alcohol) whenever possible, and never use "gasohol" containing more than 5% methanol. Fuel system damage and performance problems may result.

Gasoline/Ether Blends - The most common ether is methyl tertiary butyl ether (MTBE). You may use gasoline containing up to 15% MTBE.

**NOTE**

- Other oxygenates approved for use in unleaded gasoline include TAME (up to 16.7%) and ETBE (up to 172%). Fuel containing these oxygenates can also be used in your Kawasaki.

**CAUTION**

Never use gasoline with an octane rating lower than the minimum specified by Kawasaki. Never use "gasohol" with more than 10% ethanol, or more than 5% methanol. Gasoline containing methanol must also be blended with cosolvents and corrosion inhibitors. Certain ingredients of gasoline may cause paint fading or damage. Be extra careful not to spill gasoline or gasoline oxygenate blends during refueling.

**CAUTION**

When not operating your Kawasaki for 30 to 60 days, mix a fuel stabilizer (such as STABIL) with the gasoline in the fuel tank. Fuel stabilizer additives inhibit oxydation of the fuel which minimizes gummy deposits.

Never store this product with "gasohol" in the fuel system. Before storage it is recommended that you drain all fuel from the fuel tank and carburetors. See the Storage section in this manual.

**▲WARNING**

Gasoline is extremely flammable and can be explosive under certain conditions. Pull the lanyard key off the stop button. Do not smoke. Make sure the area is well ventilated and free from any source of flame or sparks; this includes any appliance with a pilot light.

Avoid filling the tank in the rain or where heavy dust is blowing so that the fuel does not get contaminated.

The fuel tank is located inside the bow and the fuel filler cap is on the left side of the bow. Turn the cap counterclockwise and remove it.

## 36 GENERAL INFORMATION

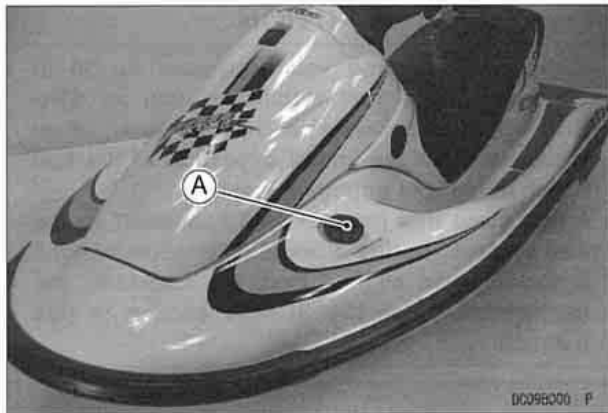

**A. Fuel Filler Cap**

Fill the tank with the recommended octane rating gasoline. The use of a small diameter pour spout (or funnel) will make filling easier. Pour slowly to avoid "spit back" and allow air to escape from the tank.

Leave about 100 mm between the top of the filler neck and the fuel level.

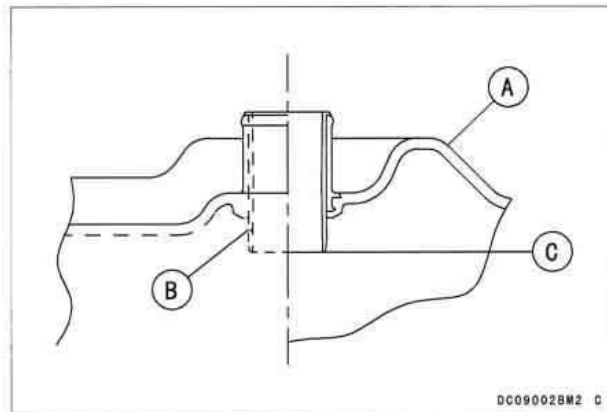

**A. fuel Tank  
B. Filler Neck**

**C. Top Level**

### **⚠ WARNING**

**Never fill the tank completely to the top. As the fuel expands in a warm tank, it may overflow from the vent tube. After refueling, make sure the filler cap is closed securely.**

After transporting or refueling and before starting the engine, open the storage compartment lid, remove the seats (see the Seat Latches section) and take out the storage pocket for several minutes to ventilate the engine compartment.

**⚠ WARNING**

A concentration of gasoline fumes in the engine compartment can cause a fire or explosion.

---

**Engine Oil**

---

Kawasaki recommends using Kawasaki Jet Ski oils. There are several different products and container sizes to choose from. Ask your dealer to recommend a Kawasaki Jet Ski oil according to the way you use your watercraft. All of the Jet Ski watercraft oils are specially formulated to provide the best possible lubrication and deposit resistance under different conditions.

If Kawasaki Jet Ski oils are not available, ensure that you use only a TC-W3 certified two cycle marine oil as a substitute. Look for the National Marine Manufacturers Association (N.M.M.A.) TC-W3 certification on the oil container. The use of oil additives and oils that are not either Kawasaki Jet Ski oil, or certified by the N.M.M.A. as TC-W3 are not recommended.



DC10000B S

## 38 GENERAL INFORMATION



### Adding Oil:

The oil tank is located on the fuel tank inside the bow. Open the storage compartment lid, and remove the oil filler cap (see the Storage Compartment section). Add the recommended oil.

### CAUTION

If the engine is run without oil, it will be severely damaged. If the oil tank is completely dry, add the oil and have your Kawasaki JET SKI dealer bleed the air from the oil line before operation.

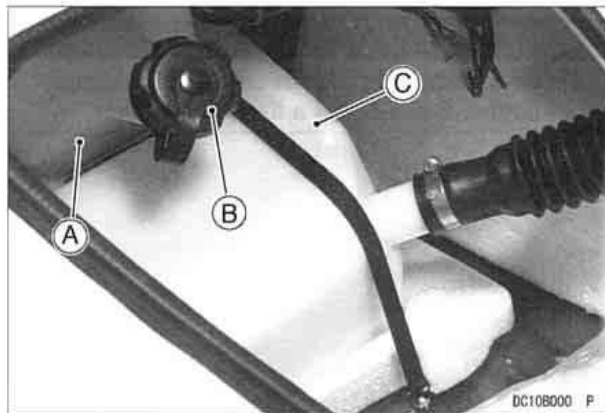

A. Engine Oil Tank

B. Oil Filler Cap

C. Fuel Tank

### NOTE

- *Kawasaki recommends the use of a gasoline/oil premix in the fuel tank for extra lubrication during the break-in period. After the break-in period, the oil injection system provides the necessary engine lubrication without the need for premixed fuel. Refer to the Break-In section in the OPERATING INSTRUCTIONS chapter.*



**Controls**

**Steering Handlebar:**

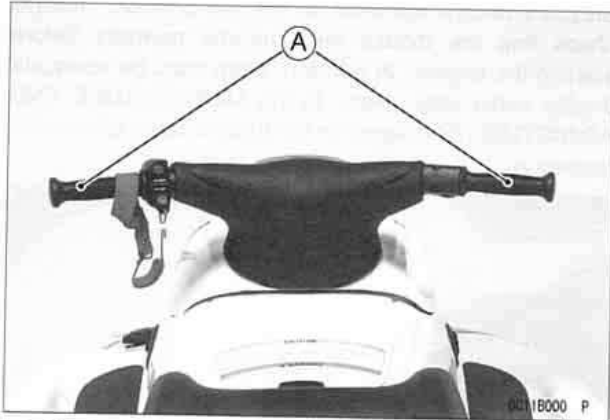

**A. Handlebar**

The steering handlebar functions much the same as a snowmobile or bicycle handlebar. Turning the handlebar will cause the watercraft to turn **ONLY WHEN THE ENGINE IS RUNNING AND ONLY WHEN THE THROTTLE IS APPLIED**. The handlebar is connected by a control cable to the jet pump steering nozzle at the rear of the boat.

**Stop Button:**

The stop button is in the case on the left hand side of the handlebar. The stop button is red and marked "STOP." Pushing the stop button turns off the engine.

The engine is also stopped by pulling the engine shut-off lanyard key off the stop button.

After riding, remove the engine shut-off lanyard key from watercraft to avoid unauthorized use by children or others.

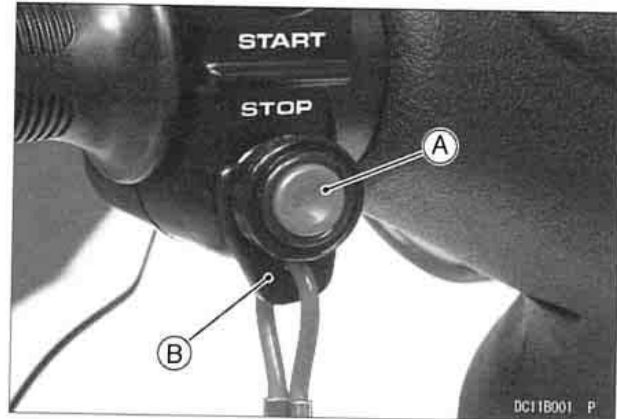

**A. Stop Button**

**B. Lanyard Key**

**Start Button:**

The start button is in the case on the left hand side of the handlebar. The start button is green and is marked "START." Pushing the start button with the engine shut-off lanyard key pushed under the stop button starts the engine. Release it when the engine starts. Without the lanyard key the engine neither cranks nor starts.

## 40 GENERAL INFORMATION

### CAUTION

Do not push the "START" button while the engine is running or while the starter is still spinning, as it will hasten starter wear and may cause the starter to jam.

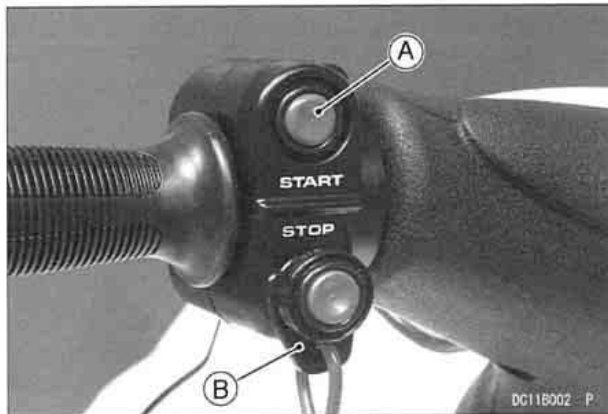

A. Start Button

B. Lanyard Key

### NOTE

- For the engine to start, the ignition switch must be turned to the "ON" position and the engine shut-off lanyard key must be pushed under the stop button.
- Refer to the Starting the Engine section in the Operating Instructions chapter.

### Throttle Lever:

The throttle lever is located on the right hand side of the handlebar. Squeezing the lever towards the handlebar grip increases engine speed. When released, spring pressure returns the lever to the idle position. Always check that the throttle lever returns normally before starting the engine. In addition, there must be adequate throttle cable play. Refer to the MAINTENANCE AND ADJUSTMENTS chapter for the throttle cable adjustment procedure.

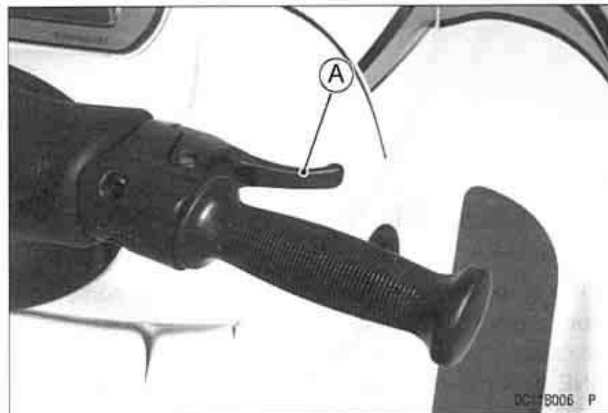

A. Throttle Lever

### Ignition Switch:

The ignition switch is located under the front storage pocket lid. It is a 2-position, key operated switch. The key can be removed either when in the "OFF" or "ON"

## GENERAL INFORMATION 41

positions. Remove the key immediately after turning the ignition switch on and store it in the storage pocket in front of the seat. Be sure to turn the ignition switch off after stopping the engine to prevent the battery from discharging. Whenever the watercraft is not in use, turn the key "OFF" and remove it to prevent unauthorized use.

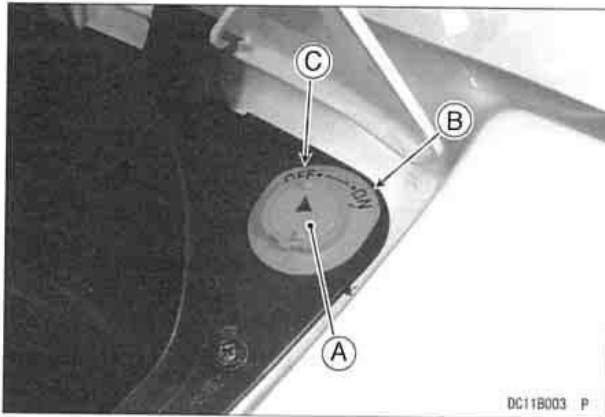

A. Ignition Switch  
B. "ON" position

C. "OFF" position

### CAUTION

After turning the ignition switch "ON", remove the key. Stow it in a secure place on the boat or with you while riding.

Always turn the ignition switch "OFF" after stopping the engine to prevent the battery from discharging.

Record your ignition switch key number. In the event of loss of the key, ask your dealer to get the same key number.

Write your key number here.

### Choke Knob:

The choke knob is located on the left side of the deck under the steering handlebar. Turning the choke knob to the "ON" position (all the way clockwise) provides a rich mixture for starting. After the engine fires, turn the choke knob to the "OFF" position (all the way counterclockwise).

### NOTE

- If the choke knob is used after the engine has started, it will waste fuel, reduce performance, and could cause spark plug fouling.

## 42 GENERAL INFORMATION

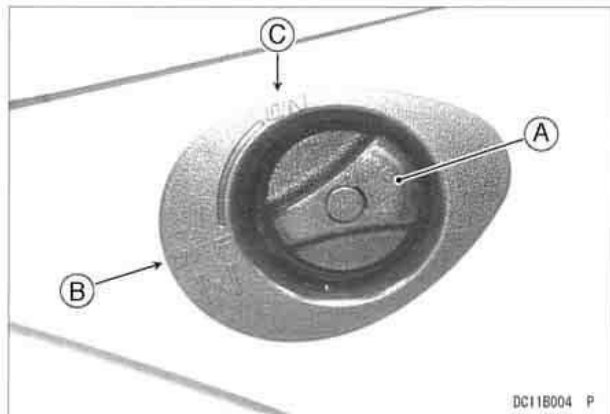

A. Choke Knob  
B. "OFF" position  
C. "ON" position

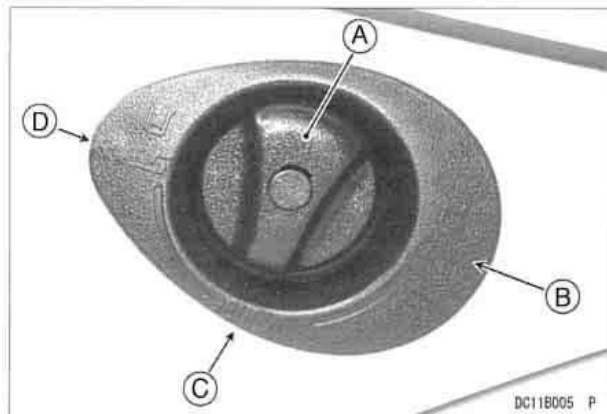

A. Fuel Knob  
B. "ON" position  
C. "OFF" position  
D. "RES" position

### Fuel Knob:

The fuel knob is located on the right side of the deck under the steering handlebar. It has three positions: "ON", "OFF", and "RES" (reserve). If you run out of fuel while the knob is in the "ON" position (the "LED" warning light, fuel symbol "FUEL" character and bottom segment flash), turn the knob to "RES". Reserve allows use of the last 7 liters (1.8 U.S. gal) of fuel and about 9 minutes of running time at full throttle

### NOTE

- *Since operating distance is limited when on "RES", refuel at the earliest opportunity.*
- *Make certain that you turn the fuel knob to "ON" (Not "RES") after filling up the fuel tank.*

### Seat Latches

The seat can be removed using the latch under the rear end of the seat.

**To Open:** Pull the latch handle and remove the seat up and to the rear.

**To Close:** Engage the seat front end in place and slide it all the way forward by pushing the seat end, and then push down on the rear of the seat to lock it.

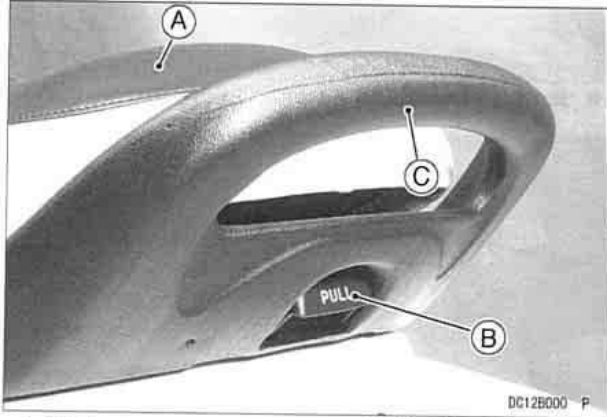

A. Seat

B. Latch Handle

C. Hand Rail

When transporting the watercraft, make sure the seat is secured to prevent them from becoming dislodged and damaged.

The handrail behind the seat is for boarding from deep water only, and is not designed for other purposes.

### CAUTION

Do not use handrail for towing objects, lifting craft, or attaching tie-downs.

## 44 GENERAL INFORMATION

### Storage Compartment

The box type storage compartment is located in the bow. Store this Owner's Manual, enclosed in a plastic bag, in the storage compartment.

To open the lid, pull the knob all the way up until the lid unlatches.

To close the lid, push on it near the knob until it latches.



A. Knob

In the storage compartment is a container for a fire extinguisher. (not standard equipment with this watercraft)

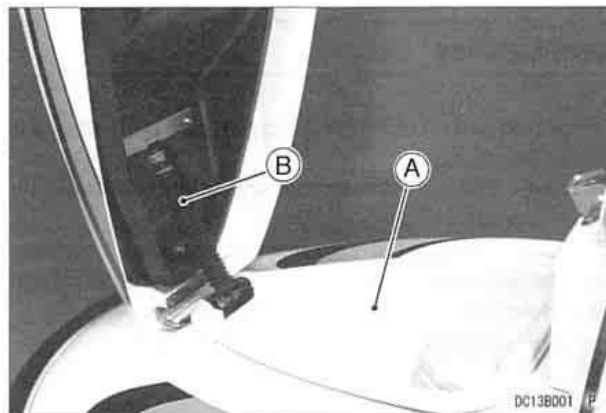

A. Storage Compartment (Box)

B. Damper

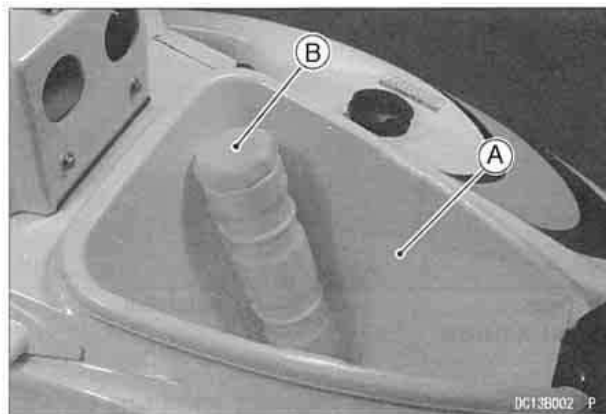

A. Storage Compartment (Box)

B. Fire Extinguisher Container

## Storage Pockets

There is a front storage pocket in front of the seat. Put the ignition switch key in the front storage pocket after the switch is turned on.

To open the front pocket lid, pull the knob all the way up until the lid unlatches.

To close the lid, push the knob until it latches.

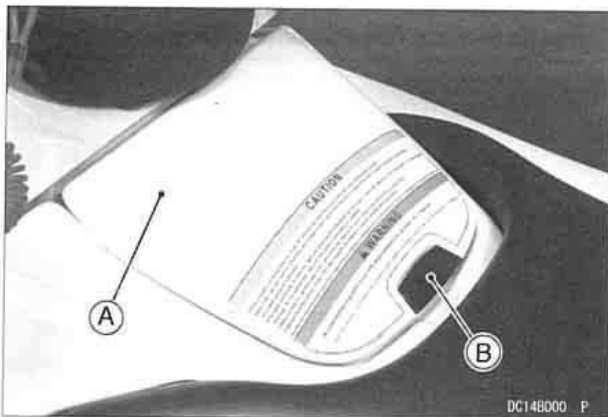

**A. Front Storage Pocket**

**B. Knob**

The box type rear storage pocket is located under the seat. Only keep light items in these storage pockets.



**A. Rear Storage Pocket**

## 46 GENERAL INFORMATION

### Tool Kit

The tool kit container is stored behind the seat. Unhook the strap bands to remove the tool kit.

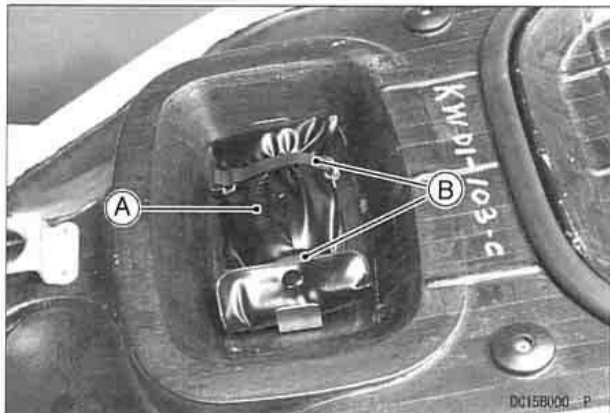

A. Tool Kit

B. Rubber Straps

### Drain Screws

There are two drain screws in the stern to drain water accumulated in the engine compartment. Open them only when the craft is out of the water.

#### CAUTION

Before launching, be sure to securely tighten the screws to avoid flooding and swamping the craft.

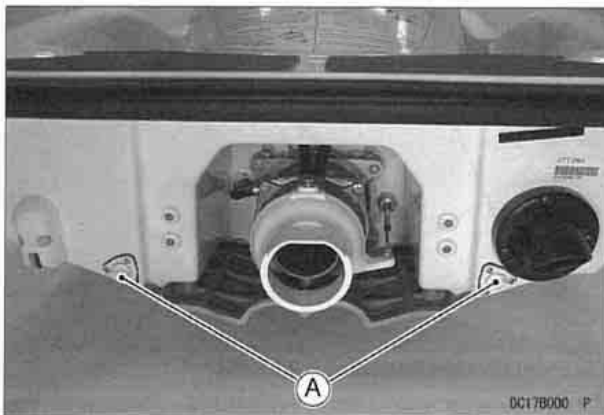

A. Drain Screws



# OPERATING INSTRUCTIONS

## Safe Operation

### Operation by Children:

#### **⚠ WARNING**

The JET SKI watercraft is not a toy; it is a one to three person high performance Class A power boat with a capacity load limit of 225 kg. Underage operators may be hazardous to themselves and others.

Kawasaki recommends a minimum operator age of 16 years old. Know the operator age and training requirements for your state. A boating safety course is recommended and may be required in your state.

### Operator Swimming Ability:

#### **⚠ WARNING**

Riders of personal watercraft can fall into the water and experience exposure. Operator and passengers must be competent swimmers and never travel farther from shore than they can swim.

**Drowning Hazard:** a personal flotation device (PFD) must be worn by the operator and passengers. Kawasaki recommends that the operator and passengers wear a vest-type PFD (type 1, 2 or 3) at all times.

### Safe Riding Rules:

#### **⚠ WARNING**

**Always follow these rules when operating your watercraft, for your own safety and that of others.**

- Always comply with any Navigation Rules in effect in your area. The Coast Guard office or state boating authority nearest you can usually furnish you with the applicable rules. Check local and state regulations before operating. Kawasaki recommends that all operators complete an approved boating safety course.

## 48 OPERATING INSTRUCTIONS

- See the Navigation Rules section in this chapter for basic navigation rules.
- Kawasaki recommends that the operator and passengers wear a U.S. Coast Guard approved vest-type personal flotation device (type 1, 2 or 3) at all times. Other countries may have their own standards and regulations; be sure to follow them.
- The capacity load limit of this watercraft is 225 kg (for operator, passenger and cargo). Do not exceed the weight capacity or allow more than three persons (or two persons with a skier) to ride this watercraft at one time. Overloading this watercraft can adversely affect handling and stability which can lead to an accident.
- Check the throttle control and steering for proper operation before starting the engine. Malfunctioning controls can cause an accident.
- Operate defensively at safe speeds and keep a safe distance away from people, objects, and other watercraft.
- Do not follow directly behind watercraft or other boats.
- Do not go near others to spray or splash them with water.
- Look carefully around you for other boats and objects in your path before starting and making quick maneuvers, especially before executing any quick turns. Because the watercraft is very maneuverable, other boaters may not be expecting you to turn as quickly as you are able (see the Turning the JET SKI Watercraft section). Before making a turn, always look over your shoulder to make sure no other watercraft is coming from behind.
- Take early action to avoid collisions. Remember, watercraft and other boats do not have brakes.
- Passengers should hold on to the person in front of them or a seat band while keeping both feet on the deck for balance during operation or they can lose balance and be injured. Never allow the passenger to ride in front of the operator.
- Operators must always keep the engine shut-off lanyards attached to themselves while operating the watercraft. If the operator falls, the lanyard stops the engine (see the Starting the Engine section).
- Alcohol and drugs impair judgement and reaction time. Never drink and ride.
- Wear suitable eye protection while operating this watercraft. In some circumstances water spray can momentarily interfere with vision and create a hazard.
- Operator and passengers should wear foot protection at all times. Objects hidden underwater may injure your feet.
- Kawasaki recommends that the operator and passengers of personal watercraft wear protective swimwear such as wetsuit bottoms. Riders of personal watercraft may suffer injury due to the forceful injection of water into body cavities either by falling into the water or while mounting the craft.
- You need throttle to turn. Releasing the throttle completely reduces the ability to steer and the watercraft can hit an object you are trying to avoid.
- Use caution when towing another watercraft. Towing affects steering control and can create a hazardous

## OPERATING INSTRUCTIONS 49

- All operators of this watercraft must know the righting procedure because this craft will not self-right if it is capsized (see Righting the Capsized Watercraft in the Riding the JET SKI Watercraft section).
- Never operate the watercraft after dark. It was not designed for such use, and has no lighting equipment.
- Avoid operating the watercraft in waters full of weeds or debris, as they may clog the jet pump, and cause an injury if you fall.
- Do not operate in shallow water, or the impeller may be damaged and sand may clog the water cooling hoses.
- Be very careful of other boats, especially those towing water skiers. Give them plenty of room.
- Never go over a ski jump. You could damage the watercraft or injure yourself.
- Do not operate the watercraft in ocean surf. In addition to being dangerous, it may be illegal in certain localities.
- Slow down before crossing waves. Do not ride if you have a back condition. High speed operation in choppy or rough water may cause back injuries.
- The operator must always stop the engine and pull the engine shut-off lanyard key before a passenger tries reboarding the watercraft. The passenger must not try reboarding while the engine is running.
- The operator must judge what is a safe speed taking into consideration visibility, traffic, weather conditions, waves, etc. Water conditions such as converging waves can have considerable influence on the ride characteristics of a personal watercraft and can cause the operator and passengers to fall off. Additionally, attempting to achieve maximum speed in adverse

conditions can cause abrupt movement of the boat causing possible injury to the riders.

### CAUTION

**Jumping waves can overstress the watercraft hull causing it to crack.**

#### Jet Pump Safety:

Although the jet pump is inherently safer than a propeller drive, certain safety precautions must always be observed.

### ⚠ WARNING

**Keep your hands, feet, and clothing away from the jet pump intake (bottom of the boat, in the middle) and never stick anything into the pump outlet (steering nozzle at the back of the boat) whenever the engine is running, or a severe injury can occur.**

## 50 OPERATING INSTRUCTIONS

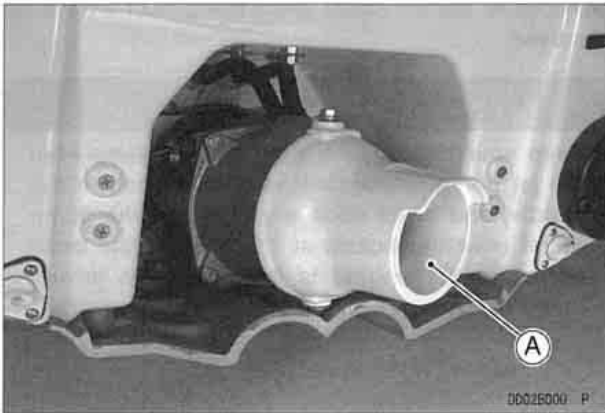
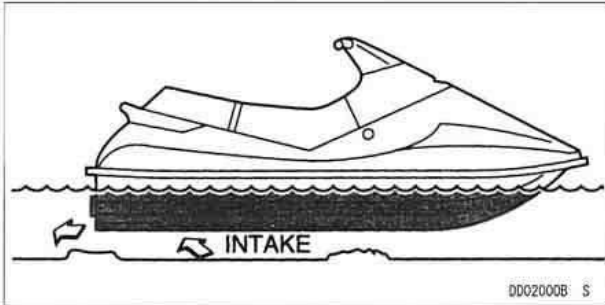

A. Steering Nozzle

### Personal Flotation Device and Safety Gear:

U.S. federal regulations require that one U.S. Coast Guard approved personal flotation device (PFD) be carried for each person aboard when operating on water under Coast Guard jurisdiction. In some states, waters be-

ing not under federal jurisdiction, other flotation devices are permissible in addition to those specified by the federal law. Other countries may have their own standards and regulations; be sure to follow them. As a rule, waist-type ski belts do not qualify as adequate flotation devices. The full vest type is recommended. Check local regulations to see what type of personal flotation device may be required in your area.

### **⚠ WARNING**

**Drowning Hazard: a personal flotation device (PFD) must be worn by the operator and passengers. Kawasaki recommends that the operator and passengers wear a vest-type PFD (type 1, 2 or 3) at all times.**

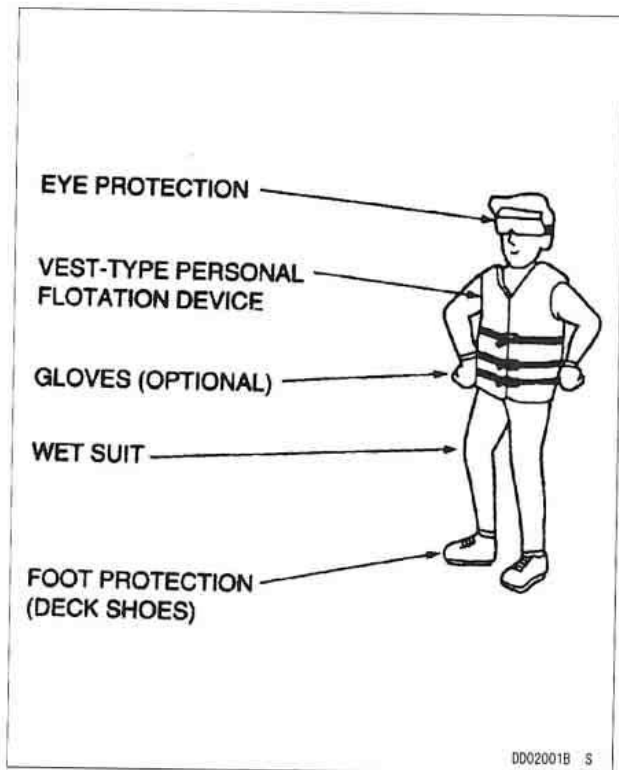

**⚠ WARNING**

In some circumstances water spray can momentarily interfere with vision which could be hazardous. Wear suitable eye protection while operating this watercraft.

Objects hidden underwater may injure your feet. Operator and passengers should wear foot protection at all times.

Riders of personal watercraft may suffer injury due to the forceful injection of water into body cavities either by falling into the water or while mounting the craft. Kawasaki recommends that the operator and passengers of personal watercraft wear protective swimwear such as wetsuit bottoms.

**Watercraft Helmets ... Something You Should Know:**

A helmet could protect your head, but could contribute to neck injuries.

Before wearing a helmet on a personal watercraft you must weigh the benefits and risks.

**Benefits:** Helmets offer some head protection from impacts with hard objects.

**Risks:** Helmets could reduce peripheral vision and increase fatigue; both of which could lead to a collision. Helmets could also increase loads on the neck and throat when you fall into the water, which could result in severe injuries.

**You must decide:** If you plan to ride under conditions where there is a higher chance that your

## 52 OPERATING INSTRUCTIONS

head may be hit by a hard object, such as falling during a race, you may choose to wear a helmet and accept the risks. On the other hand, if head impact with the water is more likely, you may choose not to wear a helmet.

**Fire Extinguisher** A charged and functional fire extinguisher must be carried onboard and be stored in the front storage compartment. Be sure to install the container cap securely.

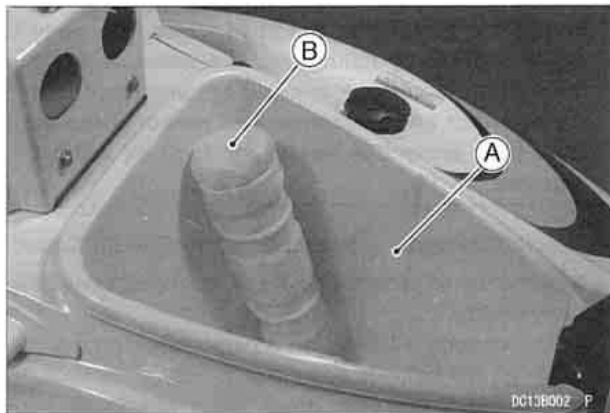

- A. Storage Compartment**
- B. Fire Extinguisher Container**

Because the watercraft is a "Class A" inboard boat, federal regulations require that a fire extinguisher rated "B-1" (minimum 1 kg or 2 pound capacity) be aboard when operating on navigable waters under Coast Guard Jurisdiction. In addition, most states, parks, and wildlife departments require that a U.S.C.G. approved

be carried aboard, even on waters not under federal jurisdiction.

Other countries may have their own standards and regulations; be sure to follow them.

### **⚠ WARNING**

**Do not use your watercraft unless it has a fire extinguisher on board.**

Standard equipment does not include a fire extinguisher. Many owners prefer to provide their own fire extinguishers. If you wish, your dealer can furnish you with an approved Kawasaki accessory fire extinguisher (P/N. W99997-101A).

## Loading

### ⚠ WARNING

**Incorrect loading or use of accessories, or modification of your watercraft may affect stability and handling of the watercraft and result in an unsafe riding condition.**

**Before you ride the watercraft, make sure that the watercraft is not overloaded and that you have followed these instructions.**

### Load Capacity Limits

3 persons or 225 kg (496 lb)

With the exception of genuine Kawasaki Parts and Accessories, Kawasaki has no control over the design or application of accessories. In some cases, improper installation or use of accessories, or watercraft modification, will void the warranty. In selecting and using accessories, and in loading the watercraft, you are personally responsible for your own safety and the safety of other persons involved.

### NOTE

- *Kawasaki Parts and Accessories have been specially designed for use on Kawasaki watercraft. We strongly recommend that all parts and accessories you add to your watercraft be genuine Kawasaki components.*

Because a personal watercraft is sensitive to changes in weight distribution, you must take extreme care in carrying passengers and/or in the fitting of additional accessories. The following general guidelines have been prepared to assist you in making your determinations.

- Passengers can affect control of the watercraft by improper positioning or sudden movements. It is important that passengers sit still while the watercraft is in motion and not interfere with the operation of the watercraft. Do not carry animals on your watercraft.
- You should instruct any passenger before riding to hold on to the person in front of them, hand strap, or handrail; and keep both feet on the deck for balance.
- Do not install accessories or carry cargo that impairs the performance of the watercraft.

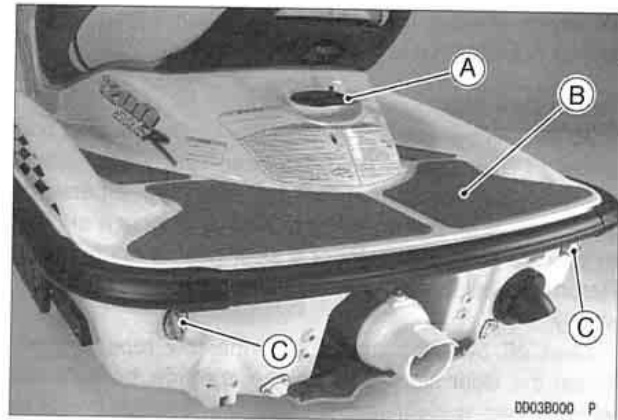

A. Reboarding Grip

C. Towing Eyes

## 54 OPERATING INSTRUCTIONS

---

### Pulling a Water Skier

---

Water skiing should be considered a three person team sport. As a team, the boat operator, the backward-facing observer, and the skier must know their equipment, boating laws, each person's responsibilities, communication signals, and the fundamentals of the sport. The navigation rules do not provide any special privileges for vessels towing skiers.

Minimize the danger of collisions with other boats, fixed objects, or swimmers by staying out of congested areas. Keep the skier at least twice the length of the tow rope away from shore and shallow water. Do not pull the tow rope in front of another boat. Many lakes have designated ski areas. Always follow local regulations regarding the towing of water skiers.

#### To the Operator

As the skipper you are responsible for the conduct and safety of your team. Be extra observant when pulling a skier; other boats may not be expecting a personal watercraft to be pulling a skier. Always display a ski flag to indicate a downed skier or a skier getting ready to ski. Return to a fallen skier without delay, but always approach slowly.

Start off by idling ahead until the tow rope is tight. When the skier signals he or she is ready, be sure the water ahead is clear and start off with enough power to raise the skier. Ease up on the throttle once the skier is up. Remember, before pulling up the skier, check

the path ahead for boats or obstacles and be sure the tow rope is not wrapped around the skier.

Always judge the speed according to the skier's ability. A good speed for beginners is 29 to 40 km/h. Give skiers a smooth, easy ride and let them signal what they want to do. Boats pulling skiers must follow all speed limits.

A skier's weight and speed in turns can affect the steering of the watercraft by pulling it off course. The operator must anticipate and compensate for the pull of the skier. Always anticipate the added length of the tow rope and skier by allowing extra time and space for maneuvering. Turn wide and not too fast to avoid whipping the skier at excessive speeds.

#### To the Observer

The observer's job is to relay all signals from the skier to the operator, inform the operator immediately if the skier falls, and display the ski flag. The observer should hold the handrail securely as he or she faces rearward to watch the water skier. The observer must also tend the ski rope to prevent it from entering the pump intake and winding around the impeller.

#### Where to Attach a Tow Rope

When towing a water skier, use the towing hook at the middle of the reboarding grip located under the rear end of the seat. When towing another watercraft secure the tow line to the towing eyes at the stern.



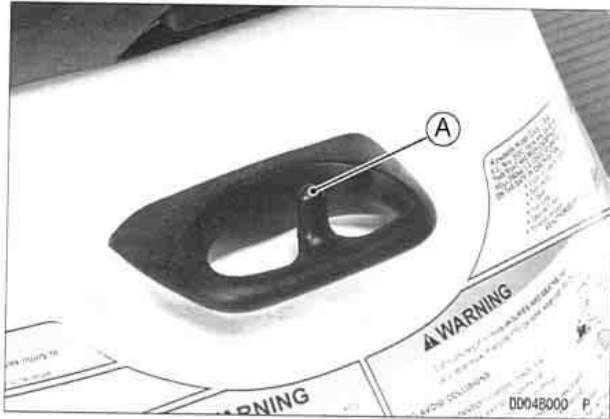

**A. Towing Hook**

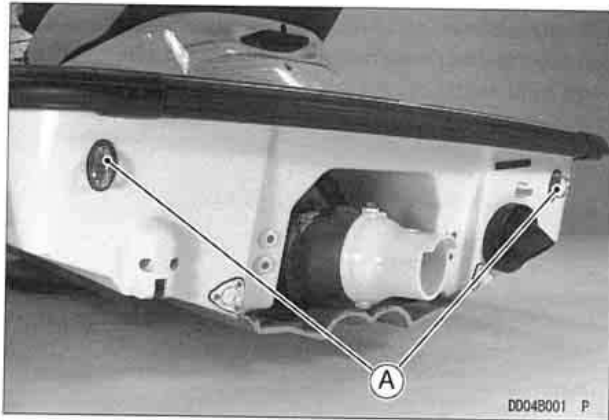

**A. Towing Eyes**

## Navigation Rules

The navigation rules or nautical "rules of the road" are like highway traffic laws. They dictate who has the right-of-way when boats meet in open water. As the boat operator you are obligated to know and obey these rules. They are also legally binding on boat operators.

This section provides basic navigation rules. We recommend that you obtain more information on navigation rules and navigation aids from your state when registering your craft. If you have never owned a boat before, an excellent introduction to the arts of boat handling and seamanship can be obtained from the U.S. Power Squadrons, the U.S. Coast Guard Auxiliary, or other volunteer organizations.

In nautical terms, the stand-on (privileged) boat has the right of way; and the give-way (burdened) boat must give way. Whenever you come near another boat, be cautious and use common sense. You cannot rely on other boaters to know or follow these rules.

### Sailboats:

Sailboats have right-of-way over power boats in nearly all cases. Stay clear of these craft and do not create a wake which may cause them trouble.

## 56 OPERATING INSTRUCTIONS

### Overtaking and Passing Situation

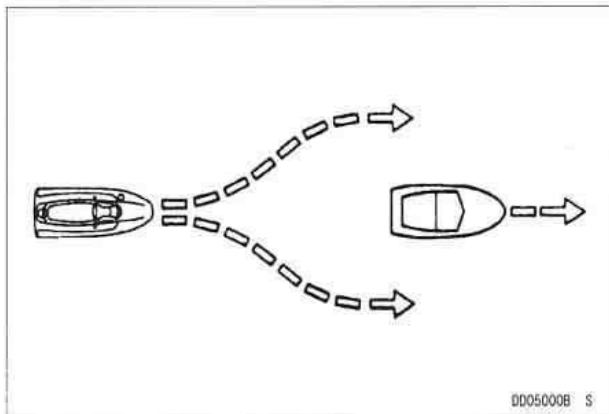

Give-way (Burdened)

Vessel Overtaking

Stand-on (Privileged)

Vessel Being Overtaken

If you are overtaking and passing another boat, the boat being passed has right-of-way, and you are required to stay clear.

### Meeting Situation

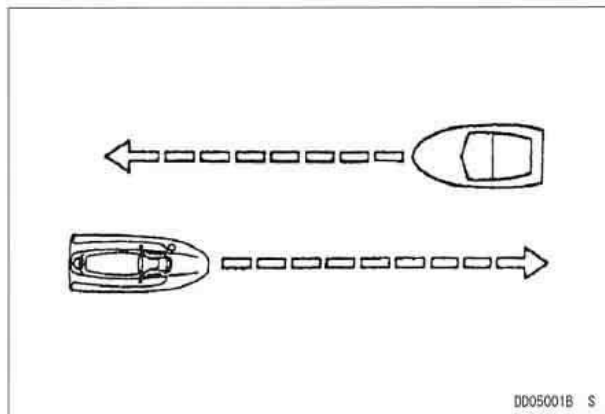

If you are meeting another power boat head on, neither you nor the other boat has right-of-way. Each boat should keep to its right.

**Crossing Situation**

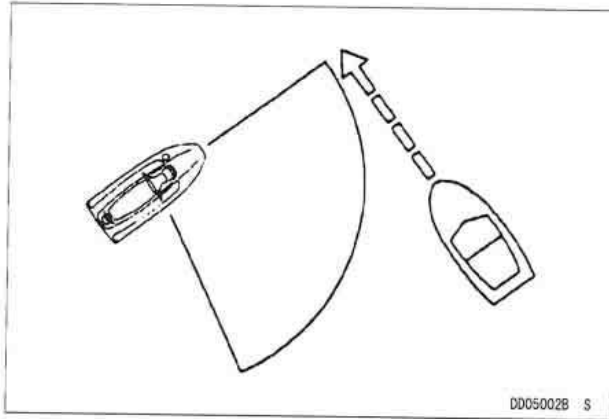

Give-way  
(Burdened)  
Vessel

Stand-on (Privileged) Vessel  
holds course and speed.

If you have another power boat on your right, the boat on the right has right-of-way. You must keep out of the way of the boat by directing your course to the starboard (right) and passing astern of (behind) the stand-on boat. If necessary, you may have to slow, stop, or reverse your craft to allow the stand-on boat to pass. Before passing behind another boat, look carefully for a water skier or any towed object. Pass behind the object in tow.

If you have another boat on the left, you have right-of-way. You must keep your course and speed.

**Pre-ride Checklist**

Each day before using the watercraft, check the following items:

**Check Outside Craft:**

- CLEAN PUMP - Clear the water inlet, jet pump, and drive shaft of foreign objects.
- PUMP COVER TIGHT - Check the jet pump cover and inlet grate for looseness. Tighten the mounting bolts, if needed.
- HULL DAMAGE - Inspect the hull for damage.
- DRAIN SCREWS - Check that the drain screws in the stern are securely installed.
- STEERING-Check the operation of the steering for binding, rough spots, or excessive play. Adjust the cable if needed (see the Control Cable Adjustments section in the MAINTENANCE AND ADJUSTMENTS chapter). The steering cable is sealed at both ends and does not need lubrication. If the seals are damaged, the cable must be replaced.

**Check Inside Craft:**

- THROTTLE CONTROL - Check the operation of the throttle for binding, rough spots or excessive play. Adjust the cable if needed (see the Control Cable Adjustments section in the MAINTENANCE AND ADJUSTMENTS chapter). The throttle lever must return to the fully closed position when released.

## 58 OPERATING INSTRUCTIONS

### **⚠ WARNING**

**If the throttle does not return freely and completely, it may cause loss of control.**

- VENTILATE ENGINE COMPARTMENT - Open the storage compartment lid, remove the seat and take out the rear storage pocket and keep open for several minutes to purge gasoline fumes from the engine compartment.

### **⚠ WARNING**

**A concentration of gasoline fumes in the engine compartment can cause a fire or explosion.**

- BATTERY TERMINALS - Check the battery terminal screws for tightness, and make sure terminal covers are in place.

### **⚠ WARNING**

**Loose battery cables can create sparks which can cause a fire or explosion resulting in injury or death. Make sure the battery terminal screws are tightened securely and the covers are installed over the terminals.**

- FUEL PRESSURE - Loosen the fuel tank cap to relieve any pressure, then tighten the cap securely.
- FUEL LEVEL - Check the fuel level. Refill if necessary and turn the fuel knob to the "ON" position.

- FIRE EXTINGUISHER - Check your fire extinguisher for a full charge.
- ENGINE OIL LEVEL - Check the oil level in the oil tank. Refill if necessary.
- FUEL LEAKS - Check the engine compartment for fuel leaks.
- OIL LEAKS - Check the engine compartment for oil leaks.
- FASTENERS - Check and tighten any loose bolts, nuts, or clamps.
- HOSE CONNECTIONS - Be sure all hose connections are secure and that all hose clamps are tight. Check all hoses for cracks or deterioration and replace if necessary.
- DRAIN BILGE - Drain any water out of the engine compartment by removing the drain screws. Install the drain screws securely when all the water has been drained.
- ENGINE SHUT-OFF LANYARD KEY - Start the engine and run it for a few seconds (see the Starting the Engine section). Pull the lanyard key off the engine stop button to check that the engine stops immediately.

### **⚠ WARNING**

**Do not run the engine in a closed area. Exhaust gases contain carbon monoxide: a colorless, odorless, poisonous gas. Breathing exhaust gas leads to carbon monoxide poisoning, asphyxiation, and death.**

---

### Break-In

---

A new watercraft should be ridden with care during the break-in period to allow mechanical components to "bed-in" and produce smooth, long wearing surfaces.

Kawasaki recommends use of a 50 : 1 gas/oil premix in the fuel tank for extra lubrication during the break-in period. Use premixed fuel for the first five hours (approx. three tanks of fuel). After the break-in period, the oil injection system provides the necessary engine lubrication without the need for premixed fuel. During the first five hours of engine operation, do not subject the engine to heavy lugging or prolonged full throttle operation. For this period, up to 3/4 throttle is recommended.

Vary the operating speed often, not running for a prolonged time at any one speed.

#### Mixing:

A convenient way to mix fuel is to use a 19 L (5 US gal) container. Add 380 mL (12.8 US oz) of oil to 9.5 L (2.5 US gal) of gas and mix thoroughly. Add another 9.5 L (2.5 US gal) of gas, and mix again to get the proper 50 : 1 ratio. Refer to the following chart for smaller quantities.

Watercraft out  
boards at a  
and exhaust

run it for a  
minute "STOP"

proper flota-

## 60 OPERATING INSTRUCTIONS

### Fuel Ratio Chart 50 : 1

Milli Liters of Oil to Liters of Gas			
mL of Oil	L of Gas	mL of Oil	L of Gas
76 mL	3.8 L	228 mL	11.4 L
114 mL	5.7 L	266 mL	13.3 L
152 mL	7.6 L	304 mL	15.2 L
190 mL	9.5 L	380 mL	19.0 L

### Recommended Oil

Kawasaki JET SKI Oils or  
N.M.M.A. Certified TC-W 3 Oils

Careful treatment of the craft during the break-in period will result in more efficient, reliable performance and a longer life for the craft.

In addition to the break-in described above, we recommend that the owner take his watercraft to an authorized Kawasaki JET SKI dealer after the first ten hours of operation for initial maintenance service. See the Periodic Maintenance Chart in the MAINTENANCE AND ADJUSTMENTS chapter.

## Stopping the Engine

The engine can be stopped in one of the following two ways.

- Push the "RED" engine stop button. It is not necessary to hold the button "in" to stop the engine. After the engine stops, the "STOP" button resets itself and the engine is ready to start.
- Pull the engine shut-off lanyard key off the stop button. To start the engine the lanyard key must be pushed under the stop button.

Turn the ignition switch off after stopping the engine in either case.

### WARNING

**You have no directional control of the watercraft when the engine is stopped.**

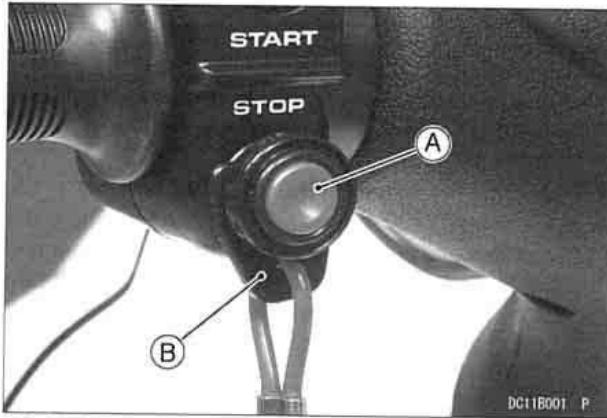

A. Engine Stop Button

B. Lanyard Key

If the engine must be stopped immediately in an emergency, push the "RED" engine stop button or pull the engine shut-off lanyard key off the stop button.

Some possible "EMERGENCY" situations are:

- The engine speeds out of control.
- The throttle lever does not release completely.

**⚠ WARNING**

If the throttle fails, do not operate the watercraft until the source of the problem is found and corrected.

**⚠ WARNING**

After riding, remove the engine shut-off lanyard key from watercraft to avoid unauthorized use by children or others.

**CAUTION**

Always turn the ignition switch "OFF" after stopping the engine to prevent the battery from discharging.

## 62 OPERATING INSTRUCTIONS

### Starting the Engine

- Read the Pre-ride Checklist in this manual and follow its instructions before putting the watercraft in the water.
- After transporting or refueling and before starting the engine, open the storage compartment lid, remove the seats and take out the storage pocket for several minutes to ventilate the engine compartment.

#### **▲WARNING**

**A concentration of gasoline fumes in the engine compartment can cause a fire or explosion.**

- Place the watercraft in at least 0.8 m (2.5 ft) of water which is clear of weeds and debris. Make sure the area ahead of the watercraft is clear of swimmers, boats, and obstacles.

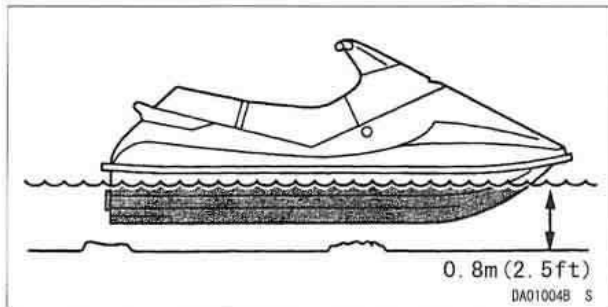

#### **CAUTION**

**The water must be at least 0.8 m (2.5 ft) deep off the seabed when starting to prevent jet pump damage by objects sucked up from the bottom.**

- Check that the fuel knob is in the "ON" position.
- In the seated position push the lanyard key under the stop button and put your left hand through the other end of the lanyard to attach it to your wrist and keep it free from handlebars so that engine stops if operator falls. Pull the lanyard to make sure it is securely attached.

#### **NOTE**

- *The engine neither cranks nor starts when the lanyard key is removed from the stop button.*
- Attach the ignition switch key to the switch with the arrow forward and while pushing the key turn it to the "ON" position. Be sure to remove the key immediately and store it in the front storage pocket.

#### **CAUTION**

**After turning the ignition switch "ON", remove the key. Stow it in a secure place on the boat or with you while riding.**

- Turn the choke knob to the "ON" position.
- With your left hand, push the green start button and release it when the engine starts. If the engine does not start with the second push, release the button. Wait 15 seconds with the key in the "ON" position, release the button. Wait 15 seconds with the key in the "ON" position, release the button. Wait 15 seconds with the key in the "ON" position, release the button.



## OPERATING INSTRUCTIONS 63

onds before trying again. If the engine does not start after several attempts, see the TROUBLESHOOTING GUIDE chapter.

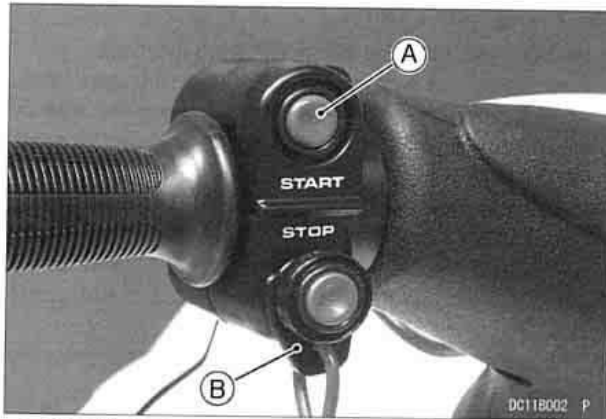

A. Start Button

B. Lanyard Key

### NOTE

- Wait 15 seconds between each operation of the starter. This will extend battery and starter life significantly.
- When the engine first fires, even if it doesn't actually start, turn the choke knob to the "OFF" position. This will prevent engine flooding.
- When the engine is warm, the choke is not needed.

### CAUTION

**Do not push the start button while the engine is running or while the starter is still spinning, as it will hasten starter wear and may cause the starter to jam.**

- After the engine has started, allow it to warm up for about 1 minute. Apply a little throttle occasionally. Excessive idling can foul the spark plugs.
- Check that water comes out of the bypass outlet in the right side of the hull when the throttle is applied. This indicates that cooling water is circulating. If there is none, shut off the engine and find the source of the trouble. When the exhaust system is dry, it can take up to 15 seconds for water to appear at the bypass outlet.

## 64 OPERATING INSTRUCTIONS

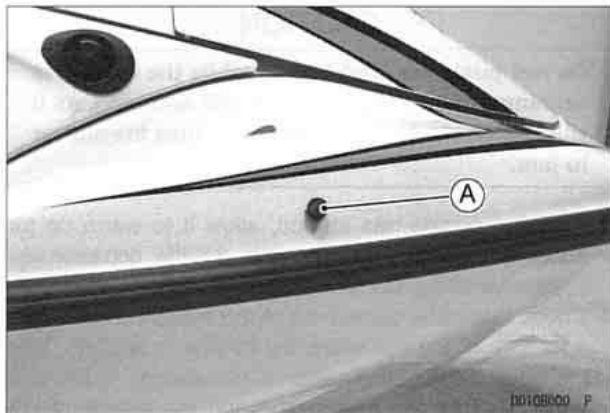

A. Bypass Outlet

---

### Launching

---

#### Launching from a Dock:

- Do not jump onto the watercraft from the dock.
- First place one foot on the deck near the dock, then while holding the handlebar and balancing the craft by transferring body weight, straddle the craft and sit down on the seat.
- When leaving the dock, either push the watercraft away from the dock or run at a slight angle away from it until there is enough room for the rear of the craft to swing, since the watercraft turns at the stern and not at the bow.
- Check that the water in your path is clear and move the handlebar in the direction you want to go.

#### **⚠ WARNING**

**Don't forget to watch out for other boats or obstructions in your path. This is especially critical during a beginner's first exciting ride.**

- Apply the throttle to produce enough thrust from the jet pump to allow directional control over the watercraft.

**CAUTION**

Avoid quick turns or acceleration when leaving the dock, or you might hit the dock and damage the watercraft. The operator should make sure there is room for a turn before making any quick maneuvers.

- Accelerate gradually as you proceed into open water. Remember to observe "No Wake" zones and speed limits.
- As speed increases the boat will level out in the water. This is called planing.
- Once the boat has planed, you can back off the throttle and select your desired speed.
- Keep alert for other boats, swimmers, or obstructions in your path.

**Launching from a Ramp:**

- Before putting the watercraft in the water be sure you have followed the Pre-ride Checklist.
- Before launching, check the ramp for suitable surface conditions, inclination and width for both the trailer and tow vehicle.
- Attach a bow line to the watercraft and detach the trailer tie-downs.

**CAUTION**

Be sure the drain screws in the stern are securely installed to prevent the craft from flooding and swamping.

- Wait until it's your turn then back the trailer to the water. Unlock the winch and push the craft slowly off the trailer into the water.
- Move your watercraft to a docking or loading area and park your tow vehicle. Do not block the ramp.

**Deep Water Start:***Solo Operation*

- Move to the rear of the watercraft.
- Make sure the engine is stopped.
- Get aboard by grasping either the handrail behind the seat or the reboarding grip under the handrail. Be careful not to slip on the boat as you reboard.
- Grasp the hand strap and while balancing the craft place your feet on the deck.
- Sit astride the seat.

*Operator and Passengers*

- While the operator is balancing the craft, the passengers climb aboard from the rear of the craft in the same way as in Solo Operation.

## 66 OPERATING INSTRUCTIONS

### **⚠ WARNING**

The operator should always stop the engine and pull the engine shut-off lanyard key when a passenger is reboarding.

#### **Shallow Water Start:**

Whenever possible, anchor the watercraft in shallow water instead of dragging it onto shore. This will reduce scratches to the hull and prevent sand and rocks from entering into the jet pump causing damage to the pump when restarting the engine.

If the watercraft is beached, sand and rocks which are pushed into the jet pump by natural wave action can be flushed out by pushing down on the stern vigorously many times.

### **CAUTION**

The water craft must be in the water at least 0.8 m (2.5 ft) deep when starting to prevent jet pump damage by objects sucked up from the bottom.

- You can board either from the side of the craft or from the rear. In either case balance the craft when going aboard for more stability.

## Stopping the JET SKI Watercraft

#### **Normal Stopping:**

### **⚠ WARNING**

Never directly approach any moving or stationary object closer than 100 m when traveling at top speed. Always throttle down before approaching your intended stopping area.

This watercraft is stopped by using natural water drag to bring the craft to a halt.

1. Release the throttle before you reach your intended stopping area.
2. Coast towards the stopping area with the engine idling.

### **CAUTION**

Stop the engine before the craft is in the water less than 0.8 m deep to prevent jet pump damage by objects sucked up from the bottom.

3. Press the engine stop button or pull the lanyard key off the stop button to come to a complete stop.

## OPERATING INSTRUCTIONS 67

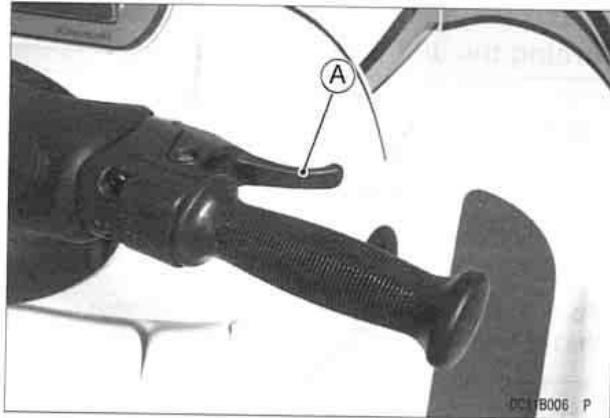

A. Throttle Lever

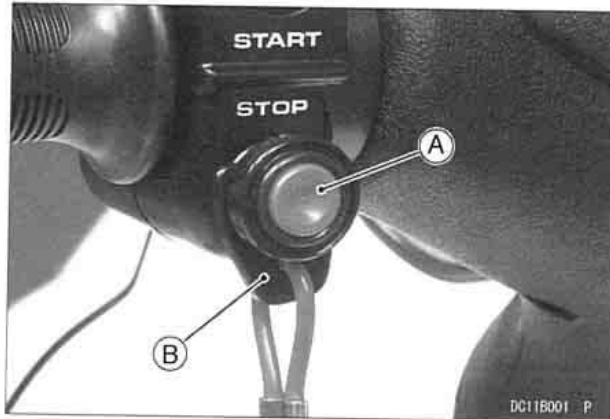

A. Engine Stop Button

B. Lanyard Key

Releasing the throttle slows forward motion but the engine will still be running, so you can steer the boat after reapplying the throttle. In this manner you can turn and move away from any obstacles.

### **⚠ WARNING**

Releasing the throttle completely reduces the ability to steer. This can cause you to hit an object you are trying to avoid. You must have thrust to turn, so keep the throttle on or apply throttle as needed to maintain thrust at the jet nozzle.

Push the engine stop button when you are approaching the shore and intend to stop. The engine stops immediately, so it prevents sand or debris from entering and damaging the jet pump. Never run the engine in water less than 0.8 m deep.

### **⚠ WARNING**

Do not stop the engine if you may need to reapply throttle to quickly steer the watercraft. You have no directional control when the engine is stopped.

#### Stopping Skills:

Stopping distance depends partially on rider and passenger weight and position, idle set speed, and operating speed. Experienced operators can usually shorten stop-

## 68 OPERATING INSTRUCTIONS

ping distance by using various riding techniques. Turning the boat sharply (using the throttle) while stopping is a method which can be used to decrease stopping distance.

### Minimum Stopping Distances:

The minimum stopping distance of this watercraft with the operator and passengers from maximum speed is 110 m (361 ft) with throttle lever released.

This information represents results obtained under controlled conditions, and the information may not be correct under other conditions.

---

### Turning the JET SKI Watercraft

---

Turning the watercraft requires a combination of two actions:

- Turning the handlebar
- Using the throttle

Point the handlebar to the left for a left turn

Point the handlebar to the right for a right turn

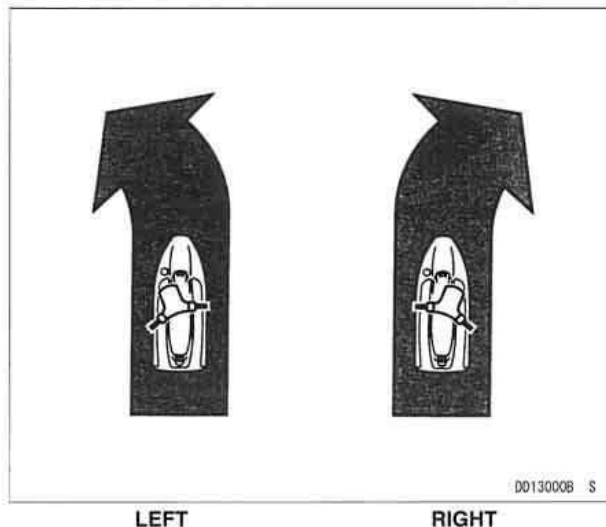

## OPERATING INSTRUCTIONS 69

Using the throttle is another important part of turning maneuvers. Applying the throttle produces thrust from the jet pump giving you directional control over the watercraft.

High thrust of the jet pump makes the boat turn more sharply.

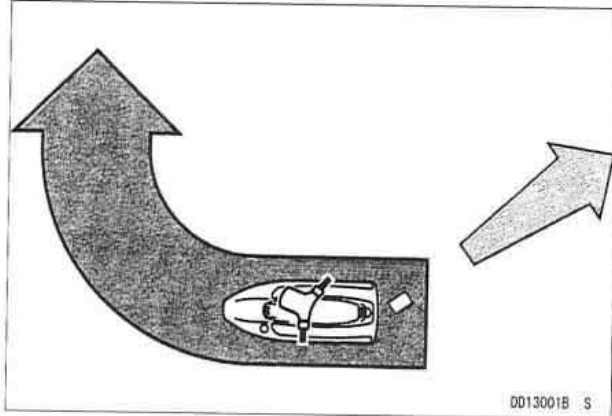

Low thrust of the jet pump makes the boat turn less sharply.

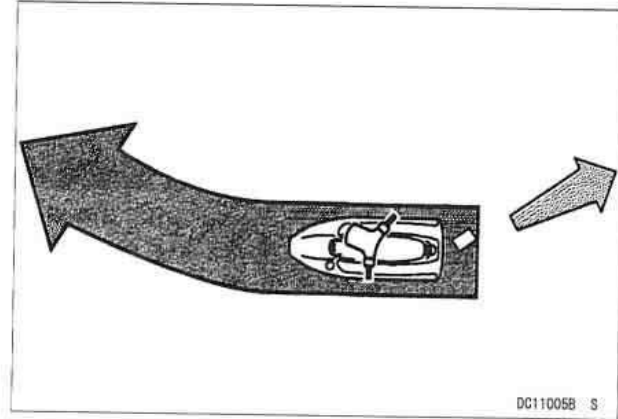

## 70 OPERATING INSTRUCTIONS

If you release the throttle completely, there is little thrust of the jet pump. The boat turns slowly and steering ability is reduced.

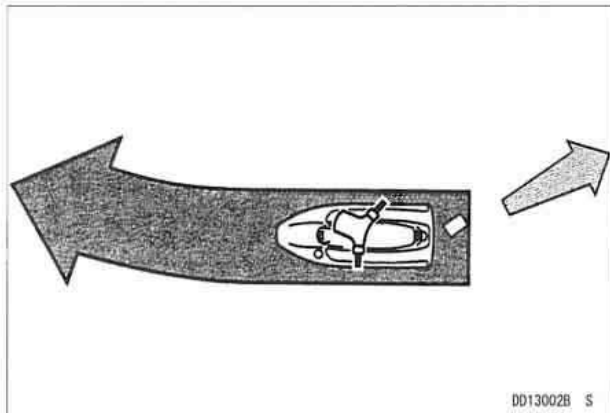

IDLE = SLOW, GRADUAL TURN

### ⚠ WARNING

Releasing the throttle completely reduces the ability to steer. This can cause you to hit an object you are trying to avoid. You must have thrust to turn, so keep the throttle on or apply throttle as needed to maintain thrust at the jet nozzle.

If you stop the engine while riding, there is no thrust of the jet pump. The boat goes straight ahead even though the handlebar is turned.

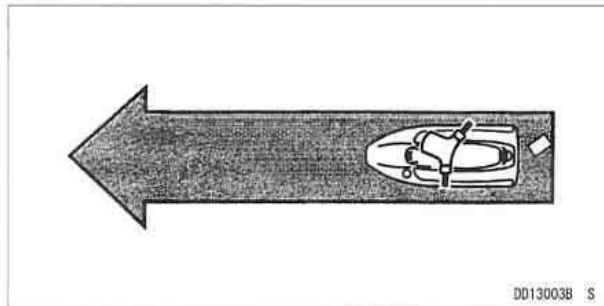

NO THRUST = NO TURN

### ⚠ WARNING

Do not stop the engine if you may need to reapply throttle to quickly steer the watercraft. You have no directional control when the engine is stopped.

This is one characteristic of jet drive boats which is important to remember when you make an emergency maneuver: **YOU MUST HAVE THRUST TO TURN**, so keep the throttle on or apply throttle as needed to maintain thrust at the jet nozzle.

- Throttle down before entering a turn.



**⚠ WARNING**

This is a very maneuverable, sport watercraft. Quick turns or acceleration can cause the passengers to fall overboard, and can cause an accident with other boats.

The operator should look carefully for other boats before making any quick maneuvers.

The passengers should hold on during quick turns.

The Kawasaki 1200 STX-R provides experienced riders with a personal watercraft that highlights exceptional acceleration with competition-level handling. With this boat's race-bred handling characteristics, Kawasaki recommends that riders learn this boat's response to steering input under various riding conditions by practicing at lower speeds in an open area.

**Docking the JET SKI Watercraft**

- When docking, use the throttle efficiently both to control the craft's speed and to keep directional control over the craft.
- When you are approaching the shore where you intend to land, push the engine stop button to prevent sand from entering the jet pump and the impeller. Do not operate the engine in water shallower than 0.8 m.

**CAUTION**

**Do not run the watercraft onto the shore, or severe impeller or hull damage may occur and the water wheel at the stern may be damaged causing the speedometer to malfunction.**

**Do not operate in shallow or debris-laden water, or the impeller may be damaged and sand may clog the water cooling hoses.**

- Remember that stopping the engine causes you to lose steering control, so cut the engine only after you have reduced speed and maneuvered into your final approaching position. You cannot make any emergency maneuvers with the engine stopped.

## 72 OPERATING INSTRUCTIONS

### Riding the JET SKI Watercraft

On your first ride, straddle the craft and sit down on the seat. Familiarize yourself with the handling of the boat. Vary the engine speed with the throttle lever to get the feel of throttle influence on steering. If porpoising occurs, that is, the front of the craft rises and falls rapidly, move your body weight further forward.

#### **⚠ WARNING**

**Never ride with your chin immediately above the handlebar. If you should hit a wave, you might injure yourself.**

If the engine runs out of fuel (the "LED" warning light, fuel symbol, "FUEL" characters and bottom segment flash), do not operate the choke knob. Turn the fuel knob to "RES" and push the green start button again.

Stay alert at all times, and keep away from other boats, swimmers, and obstructions.

#### **NOTE**

- *Since operating distance is limited when on "RES", refuel at the earliest opportunity.*
- *Make certain that the fuel knob is turned to "ON" (Not "RES") after filling up the fuel tank.*

#### **Fall Recovery:**

If the operator falls off the craft, the lanyard key is pulled off of the engine stop button and the engine is stopped immediately.

#### **⚠ WARNING**

**When you fall, do not hang onto the handlebar. Let go, or you might injure yourself by striking the watercraft.**

- The best way to hit the water is bottom first, legs together, with your arms over your head. This can help prevent injury from underwater objects.
- Go back aboard from the rear of the craft. Push the lanyard key under the stop button, and push the start button to start the engine.

#### **Righting the Capsized Watercraft:**

If the watercraft should capsize, the engine is stopped by the lanyard key being pulled off of the engine stop button by the operator. Follow this procedure immediately.

#### **⚠ WARNING**

**This watercraft will not self-right if capsized. Operators must know the proper righting procedure or they could be stranded.**

- Make sure the engine is stopped. If it is not stopped, immediately pull the lanyard key off the stop button or push the stop button to stop the engine.

### CAUTION

If the engine continues running with the craft capsized, water can enter the carburetor and engine, locking the engine. This will cause severe and immediate damage to internal engine parts.

Do not operate the watercraft with water in the engine.

Do not try to start the engine until it is completely empty of water; internal engine parts could be severely and immediately damaged.

If water gets into the engine, follow the procedure described in the After Submerging section.

- Swim to the rear corner of the capsized craft.
- Push down on the port side of the craft with one hand and reach across the hull and grasp the rear of the deck with the other, as though trying to pull yourself up onto the bottom of the hull.
- Now, push down on the rear corner of the hull with one foot, using your body weight to roll the capsized craft toward you.
- As the craft rolls over toward you, reach for the far side of the hull, if needed, and pull it on over.

### CAUTION

Turn the capsized boat clockwise so that the port side always faces downward. Turning counter-clockwise can cause water in the exhaust system to run into the engine, with possible engine damage.



DD16001B S

- After the watercraft has capsized and been righted, it may have water in the engine compartment. Carefully go back aboard from the rear, trying not to let more water into the engine compartment under the seat.

### NOTE

- If you have a passenger, he or she may want to return to shore on another watercraft to decrease the load on yours, and prevent it taking on more water.

## 74 OPERATING INSTRUCTIONS

- Push the lanyard key under the stop button and push the start button to start the engine.
- Ride the watercraft slowly to shore, beach it, and drain the water out of the engine compartment. This will help prevent getting water in the engine, which could cause severe and immediate damage to internal engine parts.

### After Submerging:

#### CAUTION

**Do not operate the craft with water in the engine. Do not try to start the engine until it is completely empty of water; internal engine parts could be severely and immediately damaged.**

**If water gets into the engine, follow this procedure immediately! If water is left in the engine more than a few hours, it will destroy the crankshaft bearings and damage other internal engine parts.**

If the watercraft becomes swamped, water may enter the engine through the carburetor intake. Water may also enter the fuel tank and oil tank.

1. Remove the craft from the water, and remove the seat.
2. Remove the drain screws in the stern to drain water out of the engine compartment.
3. Pull the spark plug caps from the spark plugs and push the caps fully onto the spark plug cap holders mounted on the cylinder head, and then remove the spark plugs.



A. Spark Plug Cap Holders

4. Turn the ignition switch on, push the lanyard key under the stop button, and push the start button. Water in the engine will be pumped out of the spark plug holes.

#### ⚠ WARNING

**Do not lean over the engine when performing this procedure. A water and gasoline mixture will be forcibly ejected from the spark plug holes and could get into your eyes. If you do get some in your eyes, wash your eyes immediately with liberal amounts of clean, fresh water. Consult a physician as soon as possible.**

5. Do not operate the starter for longer than 5 seconds.

6. Wait 15 seconds before using it again. Be sure all water is out of the engine.
7. Pull the spark plug caps off the spark plug cap holders.
8. Spray the spark plugs clean and install them and their caps.
9. Turn the choke knob to the "ON" position and start the engine.

### CAUTION

**Do not run the engine with the watercraft out of the water for more than 15 seconds at a time. Overheating will cause severe engine and exhaust system damage.**

**Never operate the engine at maximum speed out of the water. Severe engine damage may occur.**

10. If the engine does not start, remove the spark plugs and check them for presence of water. Spray them clean and try to start the engine again. Continued water fouling may indicate water in the fuel system.
11. If the fuel tank has water in it, it must be emptied by pump or siphon. Clean the fuel filter screens and fuel filter (see the Fuel and Oil Systems section in the MAINTENANCE AND ADJUSTMENTS chapter). Refill the tank with fresh fuel. Do not dump contaminated fuel in places not designated for that purpose.

Spark Plugs Tightening Torque:

25 ~ 29 N·m (2.5 ~ 3.0 kgf·m, 18 ~ 22 ft·lb)

### ⚠ WARNING

**Gasoline is extremely flammable and can be explosive under certain conditions. Pull the lanyard key off the stop button. Do not smoke. Make sure the area is well ventilated and free from any source of flame or sparks; this includes any appliance with a pilot light.**

### ⚠ WARNING

**Gasoline is a toxic substance. Dispose of gasoline properly. Contact your local authorities for approved disposal methods.**

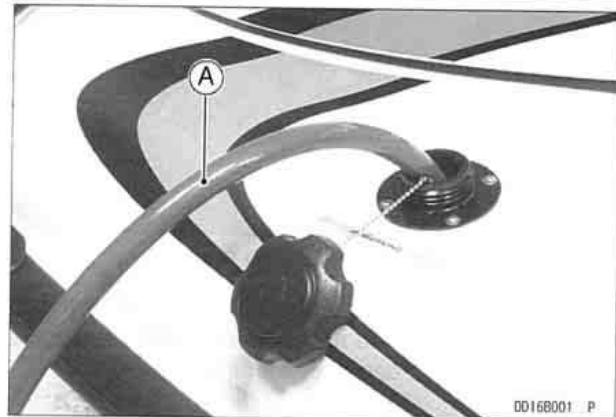

A. Siphon Hose

DD16B001 P

## 76 OPERATING INSTRUCTIONS

### NOTE

○ *It may be necessary to repeat these procedures several times before all water is removed from the engine. Continued trouble may require disassembly of the fuel pump to drain water. See your dealer for this service.*

12. If the oil tank has water in it, it must be emptied. Disconnect the oil intake hose from the oil pump and run the hose into a container.

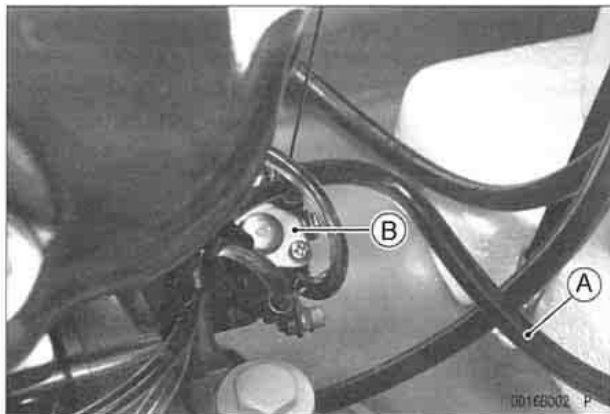

**A. Intake Hose**

**B. Oil Pump**

13. Reconnect the hose to the oil pump and refill with fresh engine oil. Do not dump contaminated engine oil in places not designated for that purpose.

### ⚠ WARNING

**Engine oil is a toxic substance. Dispose of contaminated oil properly. Contact your local authorities for approved disposal methods or possible recycling.**

14. Bleed the air inside the oil line (see the Fuel and Oil Systems section in the MAINTENANCE AND ADJUSTMENTS chapter).
15. Reinstall the seat and secure it.
16. Reinstall the drain screws in the stern.
17. Finally, run the craft IN WATER for at least 10 minutes to dry any remaining water and blow any foreign matter (like salt) out through the exhaust.

---

## End of the Day Checklist

---

These watercraft are not meant to be left in the water for extended periods. Boats that are left in the water must be hauled out periodically, the bottoms scraped and repainted with antifouling paint. Also electrolysis can cause pump failure through erosion of metal parts.

### First, Drain the Exhaust System:

- Remove the watercraft from the water.
- Start the engine and run it for several seconds to purge the exhaust system of excess water. Rev the engine repeatedly, until water stops coming out of the exhaust at the stern.

### CAUTION

**Never operate the engine at maximum speed out of the water. Severe engine damage may occur. Do not run the engine with the watercraft out of the water for more than 15 seconds at a time. Overheating will cause engine and exhaust system damage.**

- After each use in salt water, flush the cooling system with fresh water (see the Cooling System Flushing section in the MAINTENANCE AND ADJUSTMENTS chapter). This will help prevent build-up of salt deposits and eventual cooling system blockage.

### Second, Clean the Engine Compartment:

- Remove the seat.
- If water has accumulated in the engine compartment, remove the drain screws in the stern to drain water out of the compartment. Be sure to reinstall the drain screws after draining.
- Wipe the engine compartment dry, and install the seat.
- When the watercraft is ready for storage, leave the seat off, or block it up with 10 mm spacers to aid air circulation and prevent condensation from forming.

### NOTE

- *Personal watercraft are not meant to be left in the water for extended periods. Continuous exposure to water over a long period of time will cause the hull paint to bubble and peel. It also causes electrolytic erosion of the metal parts of the jet pump, decreasing its service life. Larger boats which are left in the water must be hauled out periodically, so the bottom of the hull can be scraped and repainted with anti-fouling paint. They also usually have a sacrificial anode to reduce electrolytic erosion of metal parts in contact with the water. Your watercraft will last longer and look better, if you remove it from the water at the end of every day's use.*

## 78 OPERATING INSTRUCTIONS

### Special Procedures

#### Clearing Clogged Impeller:

Occasionally, weeds or other debris may lodge in the impeller/jet pump, severely impairing performance. This foreign matter must be completely cleaned out for the jet pump to function properly.

- Shut off the engine, and beach the craft.

#### ⚠ WARNING

Never attempt to clear the jet pump of debris while the engine is running, or a severe injury can occur. Stop the engine and pull the lanyard key off the stop button before checking the pump for debris.

- Pull the lanyard key off the stop button.
- Place a protective pad next to the boat.
- Tip the boat on **port side** and remove the jet pump grate and cover, if necessary.

#### CAUTION

Always turn the boat on port side when rolling. Rolling to the starboard side can cause water in the exhaust system to run into the engine, with possible engine damage.

- Clear the water intake, drive shaft, impeller, jet pump housing, outlet, and steering nozzle of any seaweed, grass, or other debris.

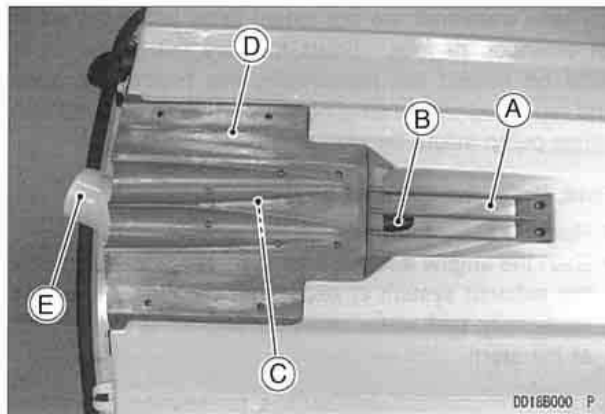

- A. Water Intake
- B. Drive Shaft
- C. Impeller

- D. Jet Pump Housing (Cover)
- E. Outlet & Steering Nozzle

#### CAUTION

Be sure the pump area and all its components are completely clear. Engine cooling water is supplied by the jet pump, and any loss of pump performance may cause overheating.

- Reinstall the jet pump cover and grate, apply non-permanent locking agent to the bolt before tightening



### Bolt Tightening Torque:

7.8 N·m (0.8 kgf·m, 5.8 ft·lb)

### Cleaning Fouled Spark Plugs

Spark plugs can foul due to several causes; among them, low idle speed, prolonged idling, and operating with the choke on. Water in the fuel or inside the engine can also cause spark plug fouling.

- Remove the fouled spark plugs and install clean, dry plugs. Fouled plugs may be cleaned with electrical contact cleaner (P/N K61080-001B). Wet plugs may be cleaned with a penetrating rust inhibitor, such as WD40 or Bel-Rey 6 in 1.

### Spark Plugs Tightening Torque:

25 ~ 29 N·m (2.5 ~ 3.0 kgf·m, 18 ~ 22 ft·lb)

- Start the engine, using very little throttle.

### Towing the JET SKI Watercraft:

In case you run out of fuel, have engine problems or other complications, the watercraft may be towed. Attach one end of a 20-foot tow rope to the eye in the bow and the other end to the tow boat. Towing must be slow, not over 5 mile/h.

### CAUTION

**It is important that these instructions be followed or the engine compartment could flood and the watercraft could partially submerge.**

### Jump Starting:

If your watercraft's battery is run down, it should be removed and charged. If this is not practical, a booster battery and jumper cables may be used to start the engine. The booster battery must be of the same voltage as the watercraft battery (12 V).

### ⚠ WARNING

**Battery acid generates hydrogen gas which is flammable and explosive under certain conditions. It is present within a battery at all times, even in a discharged condition. Keep all flames and sparks (cigarettes) away from the battery. Wear eye protection when working with a battery. In the event of battery acid contact with skin, eyes, or clothing, wash the affected areas immediately with water for at least five minutes. Seek medical attention.**

- Turn the ignition switch off.
- Remove the seat and take off the rear storage pocket.
- Lay a cloth over the open vents of the booster battery.
- Connect a jumper cable between the positive (+) terminals of the two batteries.
- Connect one end of the remaining jumper cable to the negative (-) terminal of the booster battery.

## 80 OPERATING INSTRUCTIONS

### CAUTION

Connecting two batteries in reverse polarity (+ to -) can seriously damage the electrical system.

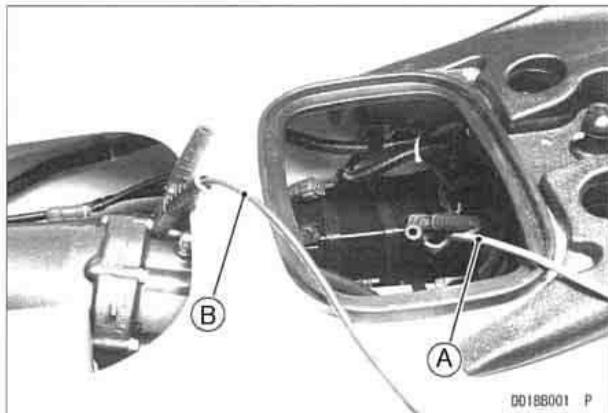

A. Positive Cable

B. Negative Cable

- Connect the other end of the remaining jumper cable to the exhaust pipe bolt.

### ⚠ WARNING

Do not make this last connection at the carburetor or battery. Take care that you do not short the cables together, and do not lean over the battery when making this last connection. Do not jump start a frozen battery. It could explode.

### CAUTION

Do not operate the starter continuously for more than 5 seconds or the starter will overheat. Wait 15 seconds between each operation of the starter to let it cool.

- Start the watercraft engine following the standard engine starting procedure and then disconnect the jumper cables in the reverse of the sequence just described.
- Dispose of the cloth covering the booster battery and reinstall the filler caps.

#### Engine Overheating:

This watercraft is equipped with a temperature sensor which flashes the "LED" warning light, cooling water temperature symbol and "HEAT" characters flash, and slows down the engine if the engine overheats.

- If the warning light, water temperature symbol and "HEAT" characters flash, and the watercraft slows down, return to shore immediately and check the cooling system for clogging.

### CAUTION

If the engine overheats, the "LED" warning light, "HEAT" characters and water temperature symbol flash and the engine slows down. Return to shore immediately. To prevent engine damage, do not operate the craft until the cause of overheating is corrected.

---

## Transporting

---

- When transporting the watercraft on a trailer, observe the trailer laws and regulations in your area.
- Be sure the trailer matches with the craft's weight and hull design.
- Turn the fuel knob to the "OFF" position.
- Securely fasten the watercraft to prevent movement between the craft and trailer.

<b>CAUTION</b>
----------------

<p><b>Never attach tie-downs to the handrail behind the seat nor to the reboarding grip under the seat rear end.</b></p>
--

<p><b>Do not allow anything to touch the water wheel at the stern, or it may be damaged causing the speedometer to malfunction.</b></p>
---

# STORAGE

During the winter, or whenever your watercraft will not be in use for more than 30 days, proper storage is essential. It consists of checking and replacing missing or worn parts; lubricating parts to ensure that they do not become rusted; and, in general, preparing the watercraft so that when the time comes to use it again, it will be in top condition. See your Kawasaki JET SKI dealer for this service or do the following.

### NOTE

- *Personal watercraft are not meant to be left in the water for extended periods. Continuous exposure to water over a long period of time will cause the hull paint to bubble and peel. It also causes electrolytic erosion of the metal parts of the jet pump, decreasing its service life. Larger boats which are left in the water must be hauled out periodically, so the bottom of the hull can be scraped and repainted with anti-fouling paint. They also usually have a sacrificial anode to reduce electrolytic erosion of metal parts in contact with the water. Your watercraft will last longer and look better, if you remove it from the water at the end of every day's use.*

---

### Preparation for Storage

---

#### Cooling System:

- Clean the cooling system (see the Cooling System Flushing section in the MAINTENANCE AND ADJUSTMENTS chapter).

#### Bilge System:

- Clean the bilge system (see the Bilge System Flushing section in the MAINTENANCE AND ADJUSTMENTS chapter), but before reconnecting the hoses to the plastic breather fittings, blow air through both hoses to force all water out of the bilge system.

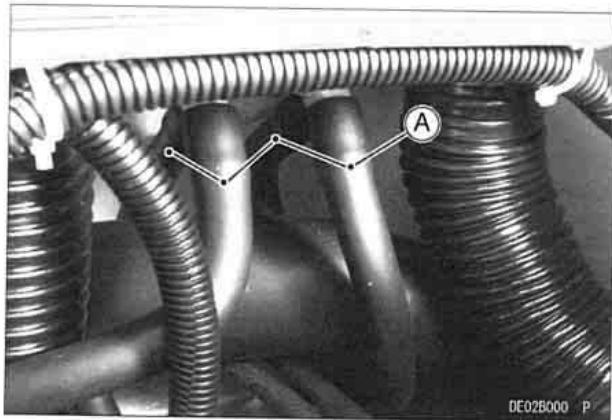

A. Blow through both hoses.

#### Fuel System and Engine:

- Wash the engine compartment with fresh water and remove the drain screws in the stern to drain the water. Wipe up any water left in the compartment.

#### ⚠ WARNING

Gasoline is extremely flammable and can be explosive under certain conditions. Pull the lanyard key off the stop button. Do not smoke. Make sure the area is well ventilated and free from any source of flame or sparks; this includes any appliance with a pilot light.

- Lift the stern upward a little so that fuel and water of the bottom in the fuel tank may approach toward the fuel filler to drain completely the fuel tank.

#### ⚠ WARNING

Gasoline is a toxic substance. Dispose of gasoline properly. Contact your local authorities for approved disposal methods.

- Inspect/clean the filter screens and inspect/replace the fuel filter (see the Fuel and Oil Systems section in the MAINTENANCE AND ADJUSTMENTS chapter).
- Leave the fuel filler cap loose to prevent condensation in the tank.
- Washing the flame arrester elements should be done by Kawasaki JET SKI dealer.
- Remove the spark plugs and push the plug caps fully onto the plug cap holders on the cylinder head.
- Spray fogging oil directly into each cylinder.
- Turn the engine over several times with the start button to coat the cylinder walls.

## 84 STORAGE

### **⚠ WARNING**

**Do not lean over the engine when performing this procedure. An air/oil mixture may be forcibly ejected from the spark plug holes and could get into your eyes. If you do get some in your eyes, wash your eyes immediately with liberal amounts of clean, fresh water. Consult a physician as soon as possible.**

- Spray the spark plugs with fogging oil, and reinstall them.

#### Spark Plugs Tightening Torque:

25 ~ 29 N·m (2.5 ~ 3.0 kgf·m, 18 ~ 22 ft·lb)

- Pull the lanyard key off the stop button and turn the ignition switch off.
- Reinstall the spark plug caps.

#### Battery:

- Remove the battery (see the Battery section in the MAINTENANCE AND ADJUSTMENTS chapter).
- Clean the exterior with a solution of baking soda and water (one heaping tablespoon of baking soda in one cup of water). Rinse thoroughly with water.

### **CAUTION**

**Never remove the sealed cap, or the battery can be damaged.**

- Coat both battery terminals with grease.
- Store the battery in a cool, dry place. Do not expose it to freezing temperatures. During storage it should be given a slow charge (one ampere or less) about once a month. Keep the battery well charged, especially during cold weather.

#### Cleaning:

- Wash the exterior and dry it thoroughly.

### **CAUTION**

**Use only a mild detergent in water to wash the watercraft. Harsh solvents may attack the surface or smear the colors.**

- Apply a good grade of wax to all exterior hull surfaces.
- Lightly spray all exposed metal parts with a penetrating rust inhibitor, such as WD40 or BEL-RAY 6 in 1 to prevent corrosion.
- Remove the seat, or block it up with 10 mm spacers to insure adequate ventilation and prevent condensation from forming.
- Cover the watercraft and store it in a clean, dry place.

**NOTE**

- *If the watercraft is left outside, even covered, water can collect in the footwells on either side of the seats. Water left in the footwells can cause the paint to bubble and peel, and the mat to peel off the deck. If the watercraft is left on the trailer, raise the tongue so that any water that gets in can run out of the footwells.*

**Lubrication:**

- Carry out all recommended lubrication procedures (see the Lubrication section in the MAINTENANCE AND ADJUSTMENTS chapter).

**Removal from Storage**

The following procedure explains the steps necessary to put the watercraft back in service following a storage period. See your Kawasaki JET SKI dealer for this service, or do the following. See the MAINTENANCE AND ADJUSTMENTS chapter for detailed procedures.

- Carry out all recommended lubrication procedures (see the Lubrication section).
- Check for binding or sticking throttle, choke, or steering mechanism. The throttle lever must return fully when released.
- Clean and gap spark plugs (see the Spark Plugs section).
- Check all rubber hoses for weathering, cracking, or looseness.
- Turn the craft on **PORT SIDE** on a protective pad, and remove the jet pump cover. Check cooling and bilge hoses for weathering, cracking or looseness.
- Replace them if necessary. Reinstall the cover, apply non-permanent locking agent to the bolts before tightening securely.

**Bolt Tightening Torque:**

7.8 N·m (0.8 kgf·m, 5.8 ft·lb)

- Check that the drain screws in the stern are securely tightened.
- Clean the terminals of the battery and charge if necessary (see the Battery section).

## 86 STORAGE

- Inspect/replace the fuel filter screens and fuel filter (see the Fuel and Oil Systems section).
- Fill the fuel tank with fuel and close the filler cap securely.

### **▲WARNING**

**Gasoline is extremely flammable and can be explosive under certain conditions. Pull the lanyard key off the stop button. Do not smoke. Make sure the area is well ventilated and free from any source of flame or sparks; this includes any appliance with a pilot light.**

- After transporting or refueling and before starting the engine, open the storage compartment lid, remove the seats and take out the storage pocket for several minutes to ventilate the engine compartment.

### **▲WARNING**

**A concentration of gasoline fumes in the engine compartment can cause a fire or explosion.**

- Check for fuel leaks. Repair if necessary.
- Check/clean the oil filter.
- Check the engine oil level. Fill the oil tank with the specified oil.

### **▲WARNING**

**Do not run the engine in a closed area. Exhaust gases contain carbon monoxide: a colorless, odorless, poisonous gas. Breathing exhaust gas leads to carbon monoxide poisoning, asphyxiation, and death.**

- Start the engine and run it for 15 seconds. Check for fuel, oil and exhaust leaks. Any leaks must be repaired.

### **CAUTION**

**Never run the engine with the watercraft out of the water for more than 15 seconds. Overheating will cause severe engine and exhaust system damage. Do not run the engine at maximum speed out of the water. Severe engine damage may result.**

- Install the seat making sure it is locked.



# MAINTENANCE AND ADJUSTMENTS

Maintenance, replacement, or repair of the emission control devices and systems may be performed by any marine SI engine repair establishment or individual.

---

## EMISSION CONTROL INFORMATION

---

### Fuel Information

THIS ENGINE IS CERTIFIED TO OPERATE ON UNLEADED REGULAR GRADE GASOLINE ONLY.

A minimum of 87 octane of the antiknock index is recommended. The antiknock index is posted on service station pumps in the U.S.A.

### Emission Control Information

To protect the environment in which we all live, Kawasaki has incorporated an exhaust emission control system in compliance with applicable regulations of the United States Environmental Protection Agency.

### Exhaust Emission Control System

This system reduces the amount of pollutants discharged into the atmosphere by the exhaust of this engine. The fuel, ignition and exhaust systems of this engine have been carefully designed and constructed to ensure an efficient engine with low exhaust pollutant levels.

### Maintenance and Warranty

Proper maintenance is necessary to ensure that your watercraft will continue to have low emission levels. This Owner's Manual contains those maintenance recommendations for your engine. Those items identified by the Periodic Maintenance Chart are necessary to ensure compliance with the applicable standards.

As the owner of the Personal Watercraft, you have the responsibility to make sure that the recommended maintenance is carried out according to the instructions in this Owner's Manual at your own expense.

## 88 MAINTENANCE AND ADJUSTMENTS

The Kawasaki Limited Emission Control system Warranty requires that you return your Personal Watercraft to an Authorized Kawasaki Personal Watercraft dealer for remedy under warranty. Please read the warranty carefully, and keep it valid by complying with the owner's obligations it contains.

### **Tampering with Emission Control System Prohibited**

Federal law prohibits the following acts or the causing thereof: (1) the removal or rendering inoperative by any person other than for purposes of maintenance, repair, or replacement, of an device or element of design incorporated into any new engine for the purposes of emission control prior to its sale or delivery to the ultimate purchaser or while it is in use, or (2) the use of the engine after such device or element of design has been removed or rendered inoperative by any person.

Among those acts presumed to constitute tampering are the acts listed below:

Do not tamper with the original emission related parts.

- \* Carburetor and internal parts
- \* Fuel Pump
- \* Spark Plugs
- \* CDI Ignition System

**Periodic Maintenance Chart**

**NOTE**

○ Complete the Pre-Ride Checklist before each outing.

Description	Frequency	Initial 10 Hours	Every 25 Hours	Every 100 Hours
Check all hoses, hose clamps, nuts, bolts, and fasteners		●	●	
Lubricate carburetor cable fitting and choke cable fitting at carburetor			●	
○ Clean and gap spark plugs (replace if necessary)			●	
Lubricate choke cable and throttle control cable, and throttle cable fitting at throttle case			●	
Lubricate steering cable joint at steering shaft and steering nozzle.			●	
* Lubricate handlebar pivot (disassemble)			●	
○* Clean fuel filter screen			●	
** Battery			●	

## 90 MAINTENANCE AND ADJUSTMENTS

Description	Frequency	Initial 10 Hours	Every 25 Hours	Every 100 Hours
* Inspect/replace fuel filter				●
* Inspect fuel vent check valve			●	
○ Adjust carburetor			●	
Flush bilge line and filter			●	
Flush cooling system (after each use in salt water)			●	
○* Inspect/clean flame arrester			●	
○* Inspect throttle shaft spring (replace carburetor if necessary)				●
* Inspect impeller blades for damage (remove)				●
* Inspect/replace coupling damper				●
* Inspect steering cable				●

\*: These items must be performed with the proper tools. See your authorized Kawasaki JET SKI dealer for service, unless you have the proper equipment and mechanical proficiency (refer to the Service Manual).

\*\* : Never allow a battery to remain discharged, or permanent damage will result. Follow the instructions in the battery section.

○: Emission related items

## Control Cable Adjustments

### Choke Cable Adjustment

- Check choke cable adjustment.
- When the choke knob is turned to the "OFF" position, the choke butterfly valve in the carburetor should be completely open. The choke pivot arm should stand all the way toward the port side of the boat with cable slack.
- When the choke knob is turned to the "ON" position, the choke butterfly valve in the carburetor should be completely closed. Check that the choke pivot arm stands all the way toward the starboard side of the boat and that the arm will not turn farther by hand.

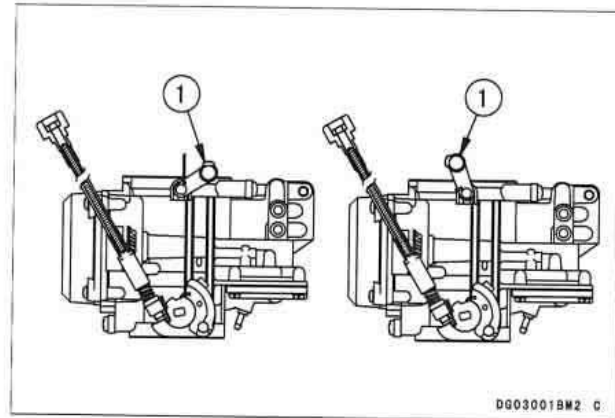

CHOKE OPEN  
(Turned to "OFF")

CHOKE CLOSED  
(Turned to "ON")

1. Choke Pivot Arm

## 92 MAINTENANCE AND ADJUSTMENTS

- If the choke pivot arm does turn, adjust the choke cable.
- Loosen the locknuts at the cable bracket and turn the choke knob to the ON position.

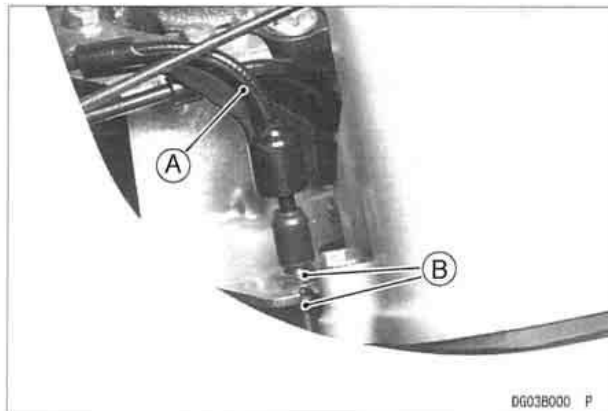

A. Choke Cable

B. Locknuts

- Push the choke pivot arm all the way toward the starboard side of the boat by hand, and turn the locknuts at the cable bracket until the arm can not turn farther, and then tighten the locknut.
- Turn the choke knob to the OFF position.
- Check that the choke pivot arm stands all the way toward the port side of the boat with cable slack.

### Throttle Control Cable Adjustment

The throttle control cable is actually an assembly of three cables: the throttle cable, the carburetor cable, and the oil pump cable. The throttle cable runs from

the throttle lever to the cable assembly junction where it connects to both the carburetor cable which leads to the carburetor, and the oil pump cable which leads to the oil pump.

Since the throttle lever controls both the carburetor and the oil pump simultaneously, it is important that each cable be adjusted to its designed base position so that the oil and fuel/air mixture reach the engine in the correct proportion at all throttle openings. Cable stretch creates excess play at the throttle lever and alters the base positions of the cables at the carburetor and the oil pump, necessitating periodic adjustment.

### NOTE

- *Be sure to inspect and adjust the carburetor and oil pump cables at the same time.*

### Carburetor Cable Adjustment:

- Check carburetor cable adjustment.
- With the throttle lever released, the lower stop on the throttle pivot arm should rest against the idle adjust screw, and there should be slight slack in the carburetor cable.
- When the throttle lever is fully applied (pulled), the upper stop on the pivot arm should be all the way up against the stop on the carburetor.

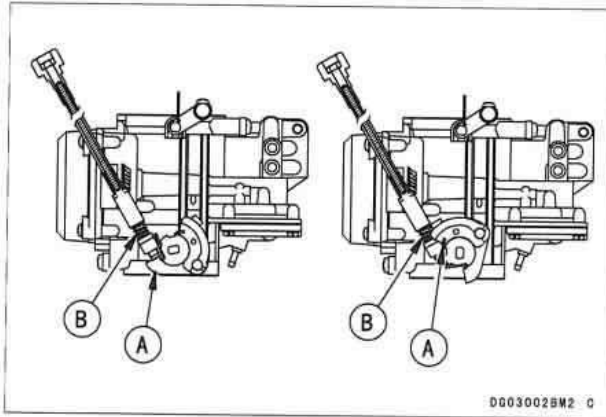

THROTTLE CLOSED  
(RELEASED)

THROTTLE OPEN  
(APPLIED)

**A. Throttle Pivot Arm**  
**B. Idle Adjust Screw**

- If necessary, adjust the carburetor cable.
- Loosen and turn the locknuts at the cable holder until the lower stop on the pivot arm hits against the idle adjust screw with slight cable slack.
- Tighten the locknuts securely.

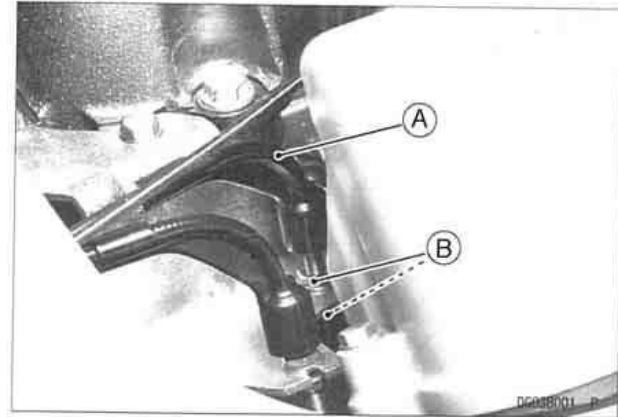

**A. Carburetor Cable**

**B. Locknuts**

- Check the oil pump cable adjustment (see Oil Pump Cable Adjustment).
- If necessary, adjust the oil pump cable.

### *Oil Pump Cable Adjustment:*

- Check carburetor cable adjustment.
- If necessary, adjust the carburetor cable.
- Check oil pump cable adjustment.
- When the throttle lever is fully applied (pulled), check to see that there is a clearance (approx. 0.6 mm) between the stop on the oil pump pulley and the stopper pin on the oil pump body.

## 94 MAINTENANCE AND ADJUSTMENTS

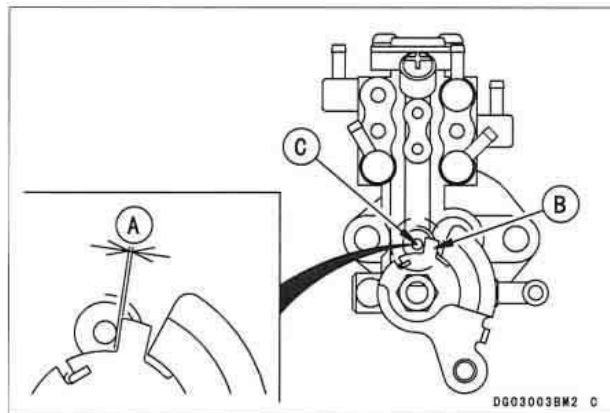

- A. Clearance (approx. 0.6 mm)
- B. Stop
- C. Stopper Pin

- If necessary, adjust the oil pump cable.
- Hold the throttle lever fully applied (pulled).
- Turn the oil pump pulley until the stop on the pulley contacts the stopper pin on the oil pump body. At this time, the oil pump pulley is fully open. Give the oil pump cable tension by turning the upper adjusting nut clockwise.
- Loosen the upper adjusting nut by turning counterclockwise 1/2 turn and then fix the oil pump cable by tightening the lower adjusting nut securely.

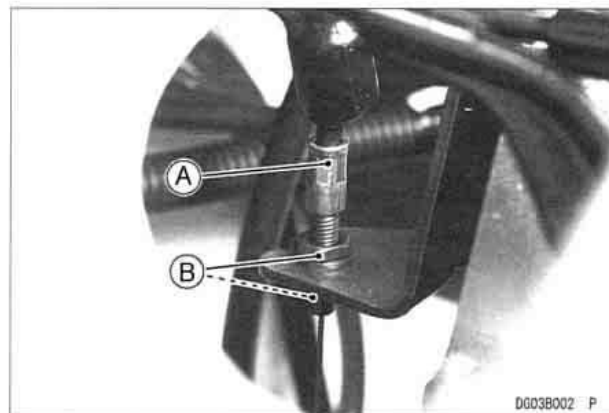

- A. Oil Pump Cable
- B. Adjusting Nuts

### *Steering Cable Adjustment*

- Center the handlebar in a straight ahead steering position.



## MAINTENANCE AND ADJUSTMENTS 95

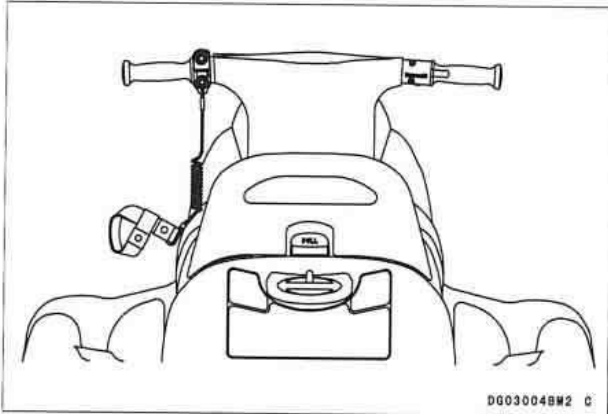

- Check that the steering nozzle is at the same distance from each side of the pump cavity.

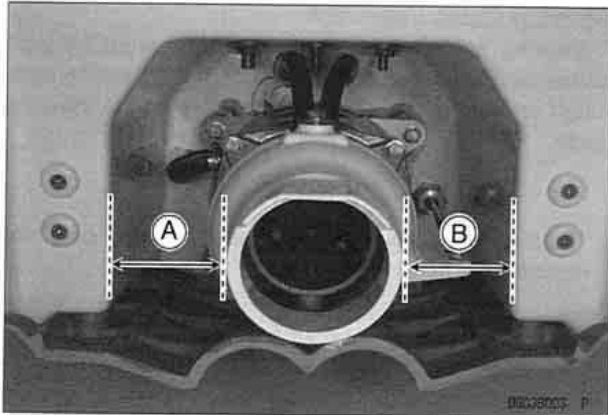

A = B (must be equal)

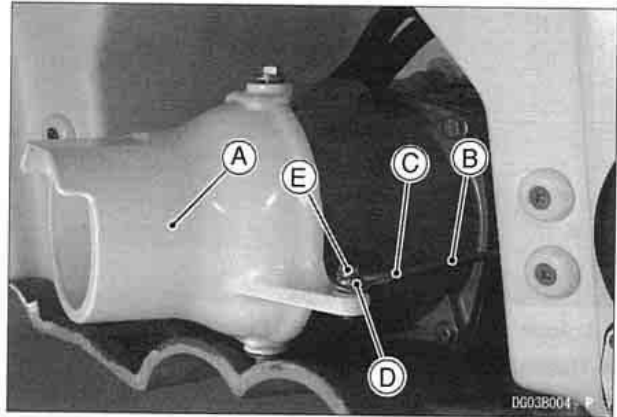

- A. Steering Nozzle
- B. Steering Cable
- C. Locknut
- D. Joint
- E. Bolt

- Remove the bolt and disconnect the cable joint from the steering nozzle.
- Center the handlebar in a straight ahead steering position.
- Turn the joint on the cable to adjust the steering.

## 96 MAINTENANCE AND ADJUSTMENTS

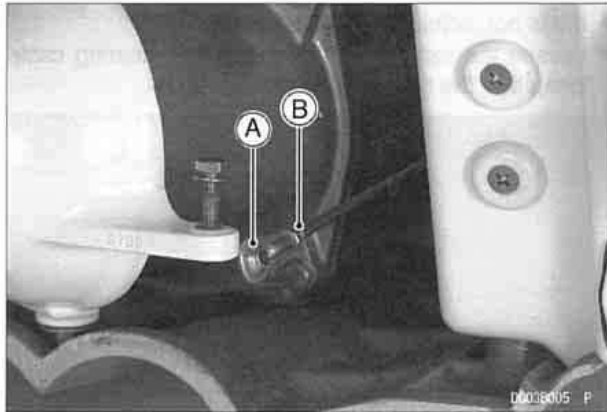

A. Joint

B. Locknut

- Reattach the joint and check cable adjustment again.
- When adjustment is correct, tighten the bolt and locknut.

Bolt Tightening Torque: 9.8 N·m (1.0 kgf·m, 87 in·lb)

- As an additional check, turn the handlebar all the way to the left and right, and measure the distance between the nozzle and the edge of the pump cavity. It should be equal at both extremes.

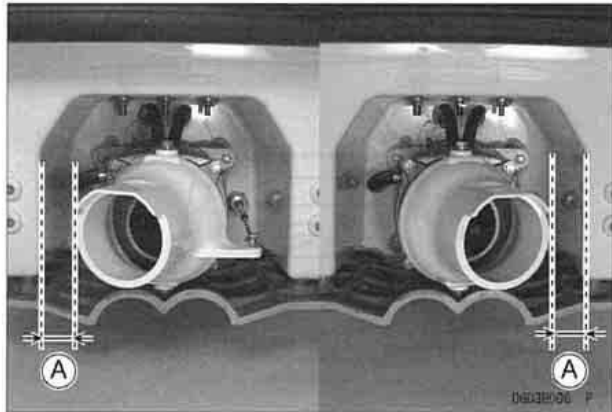

A. Equal

### Steering Cable Inspection

Steering cable inspection is best performed by your authorized Kawasaki JET SKI dealer. If the steering feels rough or "catchy," have your dealer inspect the steering cable.

### NOTE

- The steering cable is sealed at each end and does not require lubrication.

### Fuel and Oil Systems

#### Carburetor Adjustments:

##### Idle Speed

The normal idle speed is the lowest stable speed.

- Turn the idle adjust screw to the right to increase idle speed or to the left to decrease it.

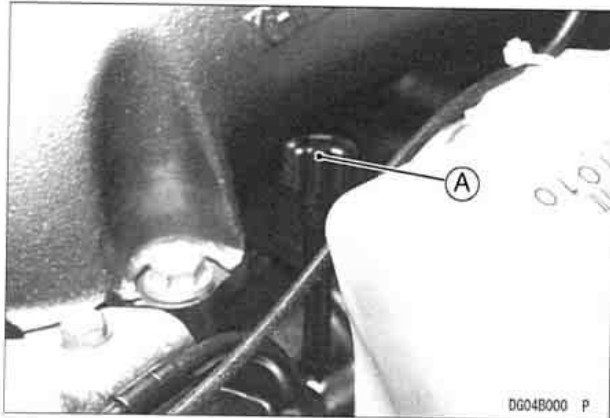

A. Idle Adjust Screw

##### Idle Speed

approx. 1,250 rpm - in water

approx. 1,800 rpm - out of water

##### High Altitude Use

The original carburetor settings for this watercraft are best for sea level use. When the craft is used at high altitude, the thinner atmosphere makes the air/fuel mixture richer reducing performance and increasing fuel usage. Have the carburetor adjusted by your authorized Kawasaki JET SKI dealer if you intend to use this craft above 1,000 m (3,000 ft).

##### Fuel Vent Check Valve:

The fuel tank is equipped with a rubber vent hose. A small plastic check valve mounted in the vent hose allows air to enter the tank, but minimizes fuel spillage when the craft is tipped over. Have the check valve inspected in accordance with the **Periodic Maintenance Chart** by your authorized Kawasaki JET SKI watercraft dealer.

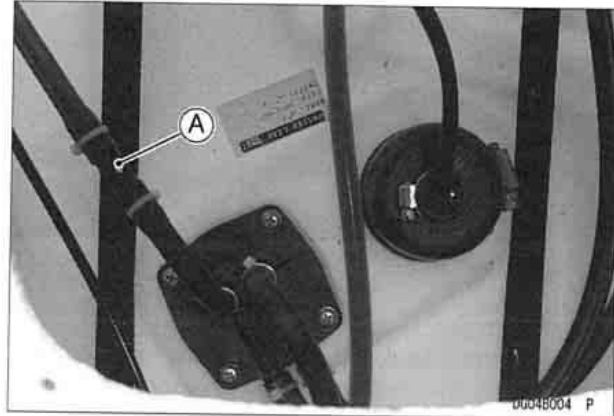

## 98 MAINTENANCE AND ADJUSTMENTS

### Fuel Filter Screens/Fuel Filter:

The watercraft is equipped with fuel filter screens on the fuel outlet assembly and a fuel filter at the middle of the fuel line to prevent dirt or other foreign material from entering the carburetor.

Have your Kawasaki JET SKI dealer inspect and clean or replace the screens and fuel filter in accordance with the **Periodic Maintenance Chart**, or whenever you find from outside any foreign material or water trapped in the fuel filter.

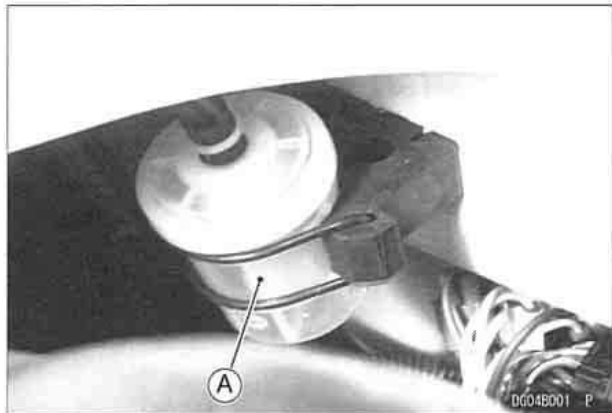

A. Fuel Filter

### Oil Filter:

The oil tank is equipped with an oil filter in the oil filler. Check the oil filter for foreign particles every time you add

the oil. If there are any foreign particles, the oil filter must be cleaned.

### Oil Filter Cleaning

- Take out the oil filter out of the oil filler.

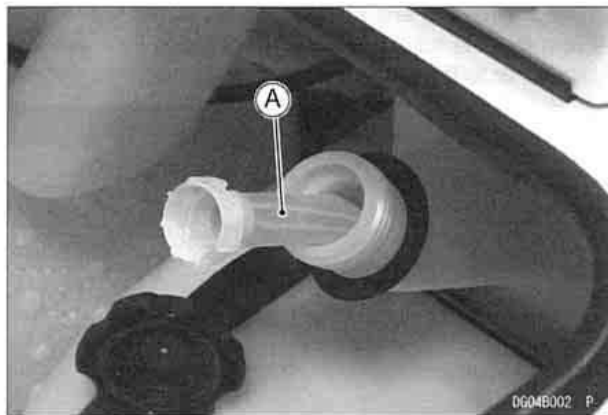

A. Oil Filter

- Wash the oil filter in a non-flammable or high flash-point solvent. Use a brush to remove any contaminants trapped in the filter.

### **⚠ WARNING**

Clean the oil filter in a well ventilated area, and take care that there are no sparks or flame anywhere near the working area; this includes any appliance with a pilot light. Do not use gasoline or a low flash-point solvent to clean the filter. A fire or explosion could result.

### **Oil Pump Bleeding:**

When any of the oil pump hoses have been removed, air may become trapped inside, which will then obstruct oil flow.

- Make sure that there is plenty of engine oil in the oil tank and that oil flow is not restricted.
- Place a rag under the oil pump.
- Loosen the air bleeder screw on the oil pump a couple of turns until oil flows out, and then tighten the bleeder screw securely.

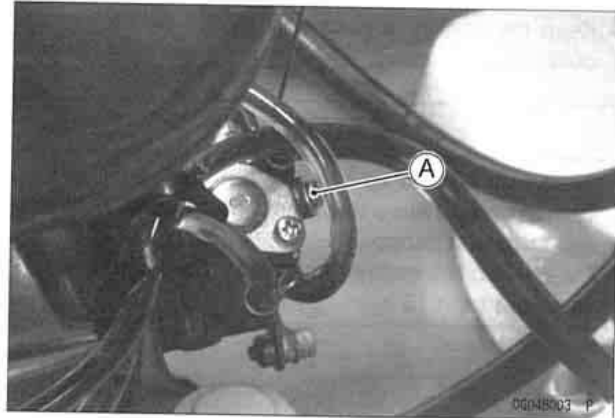

**A. Bleeder Screw**

- Check the oil line from the oil tank to the oil pump for air bubbles left inside.

### **CAUTION**

**Air trapped in the oil line will cause obstruction of oil flow and subsequent engine damage. If any air bubbles do not disappear, have an authorized Kawasaki JET SKI dealer bleed the air from the oil line.**

- Provide sufficient engine cooling by running water through the cooling hose (see the Cooling System Flushing section).
- Start the engine, keep it at idling speed and check the oil flow through the transparent outlet hose.

## 100 MAINTENANCE AND ADJUSTMENTS

- Keep the engine running until the air bubbles in the outlet hose disappear.

### CAUTION

The engine must be running before the water is turned on and the water must be turned off before the engine is stopped.  
Do not run the engine without cooling water flow for more than 15 seconds.

## Spark Plug

The standard spark plug is NGK BR9ES set to a 0.7 - 0.8 mm (0.028 - 0.032 in.) gap.

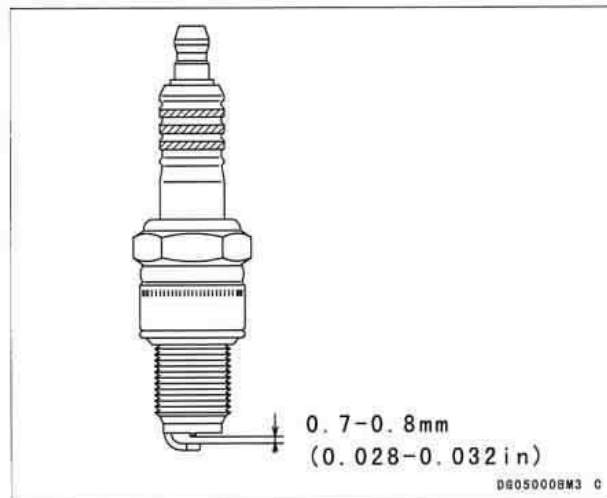

### *Spark Plug Inspection and Replacement*

Remove the spark plugs and inspect the ceramic insulators. The appearance of the insulators reflects the efficiency of the combustion process. When the engine is operating properly, the plug insulators should be clean and show a light brown color. If the insulators look glazed or very white, if the electrodes appear overheated, or if there are gray metallic deposits on the plugs,

combustion chamber temperatures are too high. Refer to the TROUBLESHOOTING GUIDE.

### CAUTION

**As excessive operating temperature can cause serious engine damage, the cause should be located and corrected immediately.**

A dry, sooty black deposit on the insulators indicates an overly rich fuel/air mixture. Check for correct carburetor adjustment. If the black deposits are wet and oily, an improper oil type or an excessive oil pump output may be the cause. Refer to the TROUBLESHOOTING GUIDE.

Clean the electrodes and the ceramic insulators around the center electrode by scraping off any deposits or by using a sand blasting device. Make sure that all abrasive particles are removed from the plug and clean the plug in a high flash-point solvent. If the gap has widened, reset it to the standard 0.7 - 0.8 mm gap. If the electrodes are badly worn or burned, replace the plug. The spark plug must also be replaced any time there is visible damage such as cracked ceramic or damaged threads.

Spark Plug Tightening Torque:

25 ~ 29 N·m (2.5 ~ 3.0 kgf·m, 18 ~ 22 ft·lb )

### Battery

The battery installed in this watercraft is a sealed type, and the sealing strip should not be removed at any time after the specified electrolyte has been installed in the battery for initial service. It is not necessary to check the battery electrolyte level or add distilled water.

However, in order to maximize battery life and ensure that it will provide the power needed to start your watercraft, you must properly maintain the battery's charge. When used regularly, the charging system in your watercraft helps keep the battery fully charged. If your watercraft is only used occasionally or for short periods of time, the battery is more likely to discharge.

Due to their internal composition, batteries continually self discharge. The discharge rate depends on the type of battery and ambient temperature. As temperatures rise, so does the discharge rate. Every 18 degrees F doubles the rate.

Electrical accessories, such as digital clocks and computer memory, also draw current from the battery even when the key is switched off. Combine such "key-off"

## 102 MAINTENANCE AND ADJUSTMENTS

draws with hot temperatures, and a battery can go from fully charged to completely discharged in a matter of days.

Self-discharge		
Temperature	Approx. Number of Days From 100% Charged to 100% Discharged	
	Lead-Antimony Battery	Lead-Calcium Battery
104°F	100 Days	300 Days
77°F	200 Days	600 Days
32°F	550 Days	950 Days

Current Drain (Y50-N18L-A)		
Discharging Ampere	Days from 100% Charged to 50% Discharged	Days from 100% Charged to 100% Discharged
7 mA	60 Days	119 days
10 mA	42 Days	83 Days
15 mA	28 Days	56 Days
20 mA	21 Days	42 Days
30 mA	14 Days	28 Days

In extremely cold weather the fluid in an inadequately charged battery can easily freeze, which can crack the case and buckle the plates. A fully charged battery can withstand sub-freezing temperatures with no damage.

### Battery Sulfation

A common cause of battery failure is sulfation. Sulfation occurs when the battery is left in a discharged condition for an extended time. Sulfate is a normal by product of the chemical reactions within a battery. But when continuous discharge allows the sulfate to crystallize in the cells, the battery plates become permanently damaged and will not hold a charge. Battery failure due to sulfation is not warrantable.

### Battery Maintenance

It is the owner's responsibility to keep the battery fully charged. Failure to do so can lead to battery failure and leave you stranded.

If you are riding your watercraft infrequently, inspect the battery voltage weekly using a voltmeter. If it drops below 12.6 volts, the battery should be charged using an appropriate charger (check with our Kawasaki dealer or visit [buy.kawasaki.com](http://buy.kawasaki.com)) at a rate of 1/10th of the battery capacity. If you will not be using your watercraft for longer than two weeks, the battery should be charged using an appropriate charger. Do not use an automotive-type quick charger that may overcharge the battery and damage it.

### Battery Charging:

- Remove the battery from the watercraft (see Battery Removal).
- Attach the leads from the charger and charge the battery at a rate that is 1/10th of the battery capacity. For example, the charging rate for a 10 Ah battery would be 1.0 ampere.





**C. Red Lead**

Lead from the battery

n straps securing the

nals using a solution  
pe off any obstinate  
hen rinse the battery  
ughly and coat the

## 104 MAINTENANCE AND ADJUSTMENTS

- After connecting the battery, coat the terminals with waterproof grease.

### **▲WARNING**

Loose battery cables can create sparks which can cause a fire or explosion resulting in injury or death.

Make sure the battery terminal screws are tightened securely and the covers are installed over the terminals.

### **CAUTION**

Do not reverse the battery connections, or damage to the regulator/rectifier unit will result.

## Lubrication

As in all marine craft, adequate lubrication and corrosion protection is an absolute necessity to provide long, reliable service. Refer to the **Periodic Maintenance Chart** and **Pre-ride Checklist** in the OPERATING INSTRUCTIONS chapter for the frequency of the following items:

- Lubricate the following with a penetrating rust inhibitor, such as WD40 or BEL-RAY 6 in 1:

### Choke Cable, Throttle Cable and Oil Pump Cable

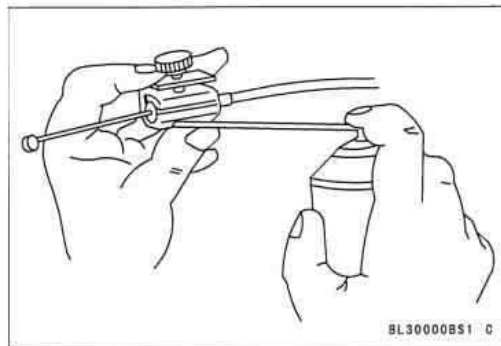

Pressure Cable Luber

### Steering Nozzle Pivots

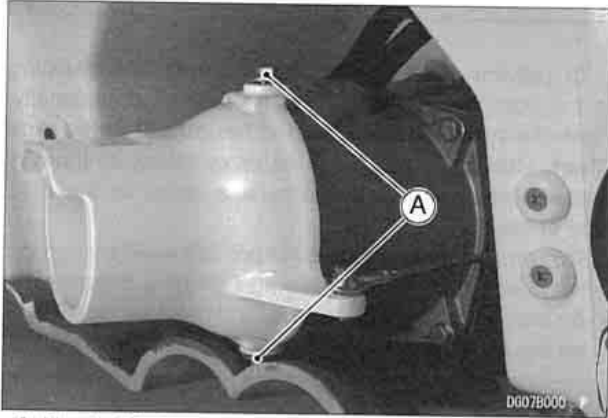

**A. Nozzle Pivots**

- Lubricate the following with a high quality waterproof marine grease.

### Throttle Cable Fitting at Throttle Case

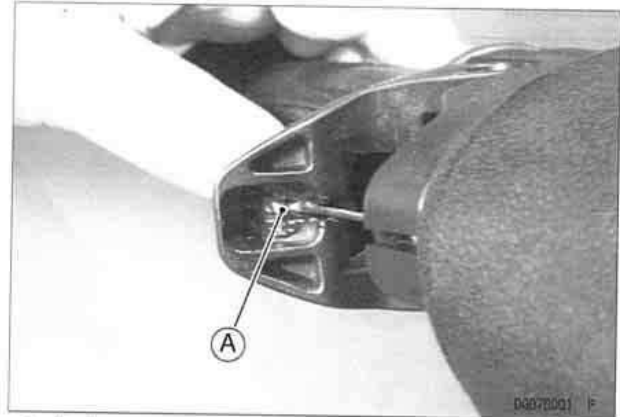

**A. Apply grease.**

## 106 MAINTENANCE AND ADJUSTMENTS

### Choke Cable Fitting and Throttle Cable Fitting at Carburetor

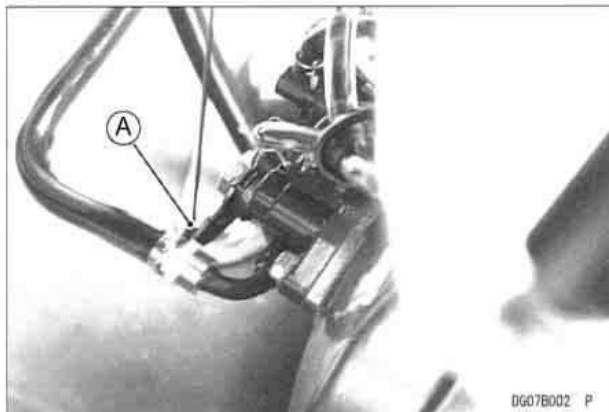

A. Apply grease.

### CAUTION

Disassemble and lubricate the handlebar pivot. this function should be performed by your Kawasaki JET SKI dealer.

### Cooling System Flushing

To prevent sand or salt deposits from accumulating in the cooling system, it must be flushed occasionally. Flush the system according to the **Periodic Maintenance Chart**, after each use in salt water, or whenever there is reduced water flow from the bypass outlet on the right side of the hull.

This procedure is also used to provide auxiliary cooling when needed (for example during Oil Pump Bleeding).

- An inlet for auxiliary water supply is provided as a fitting on the exhaust pipe.

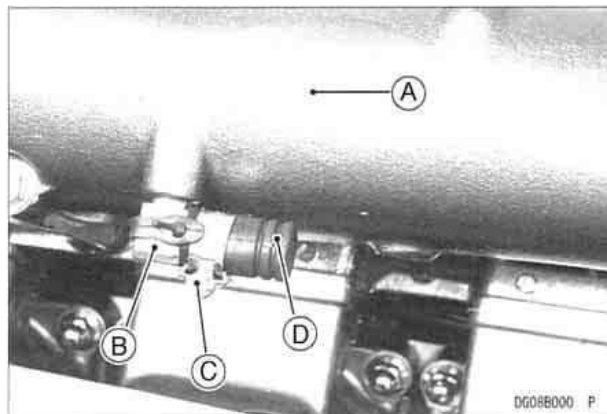

A. Exhaust Pipe

B. Fitting

C. Clamp

D. Cap

- Loosen the clamp and remove the cap, and then connect the garden hose.

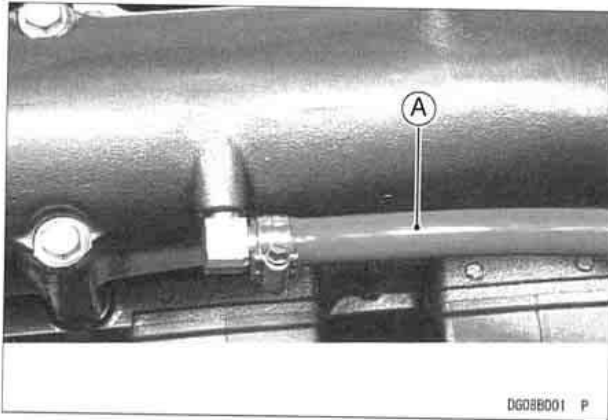

A. Garden Hose

- Start the engine and allow it to idle **before turning on the water.**

**CAUTION**

The engine must be running before the water is turned on, or water may flow back through the exhaust pipe into the engine, resulting in the possibility of severe internal damage.

- Immediately turn on the water and adjust the flow so that a little trickle of water comes out of the bypass outlet in the right side of the hull.

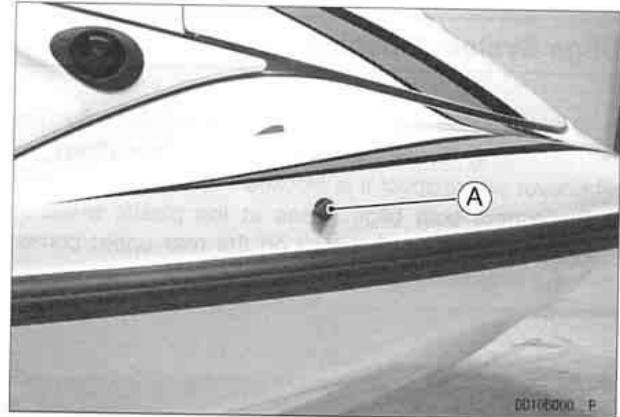

A. Bypass Outlet

- Let the engine idle for several minutes with the water running.
- Turn off the water. **Leave the engine idling.**
- Rev the engine a few times to clear the water out of the exhaust system.

**CAUTION**

Do not run the engine without cooling water flow for more than 15 seconds. Overheating will cause severe engine and exhaust system damage.

- Switch off the engine, remove the garden hose, reinstall the cap and secure the clamp.

## 108 MAINTENANCE AND ADJUSTMENTS

### Bilge System Flushing

To prevent clogging, the bilge system should be flushed out according to the **Periodic Maintenance Chart**, or whenever you suspect it is blocked.

- Disconnect both bilge hoses at the plastic breather fittings. They are mounted on the rear upper corner in the engine compartment.

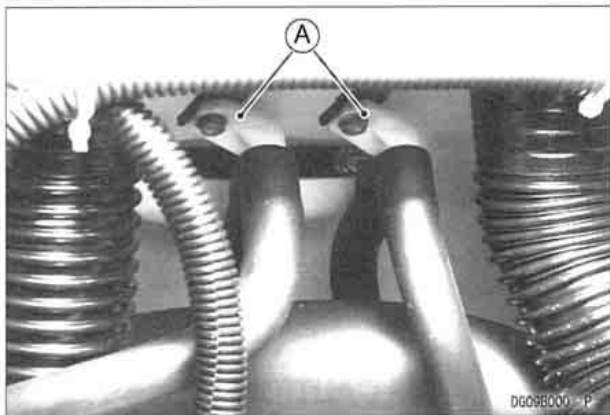

**A. Breather Fittings**

- Connect the bilge filter hose (from the hull bottom) to the garden hose, turn the water on, and flush it out for about a minute. During this procedure, water will flow into the engine compartment. Do not allow a large amount of water to accumulate in the engine

compartment. Remove the drain screws in the stern to drain the engine compartment.

- Connect the other hose to the garden hose, turn the water on, and flush it out for several minutes.
- Repeat the above two steps for the other bilge hoses.
- Before reconnecting the hoses to each plastic breather fitting, make sure the small breather hole in the fitting is clear. If the hole is clogged, the engine compartment will fill with water when the engine stops or idles. It may be necessary to remove the fitting.

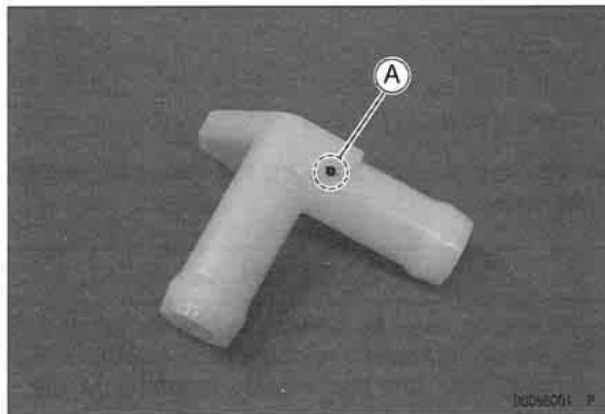

**A. Breather Hole**

- Reconnect the bilge hoses.

### NOTE

- If your watercraft is to be stored, blow air through both hoses at each breather fitting before they are reconnected (see the Preparation for Storage section in the **STORAGE** chapter).

### Fuses

The main and clock fuses are arranged in the fuse case located under the seat. If a fuse fails during operation, inspect the electrical system to determine the cause, and then replace it with a new fuse of proper amperage.

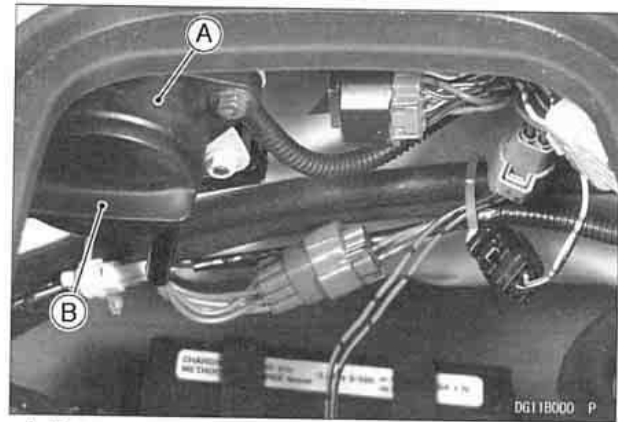

A. Fuse

B. Cap

## 110 MAINTENANCE AND ADJUSTMENTS

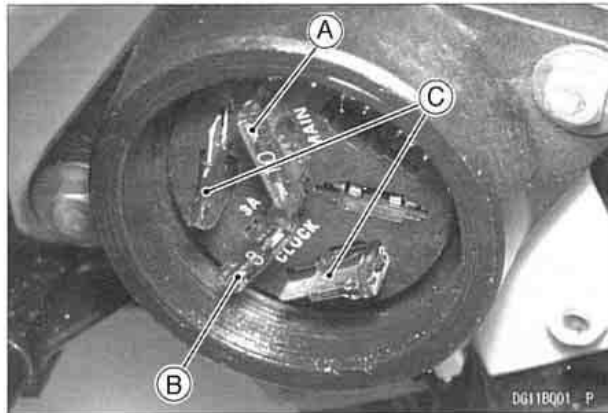

A. Main Fuse  
B. Clock Fuse

C. Spare Fuses

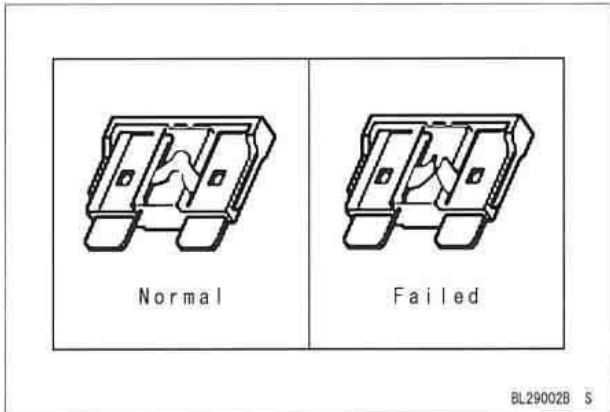

### CAUTION

Do not use any substitute for the standard fuse. Replace the blown fuse with a new one of the correct capacity, as specified on the electric case.



# TROUBLESHOOTING GUIDE

If this procedure does not isolate your problem, see your JET SKI dealer or refer to the Service Manual.

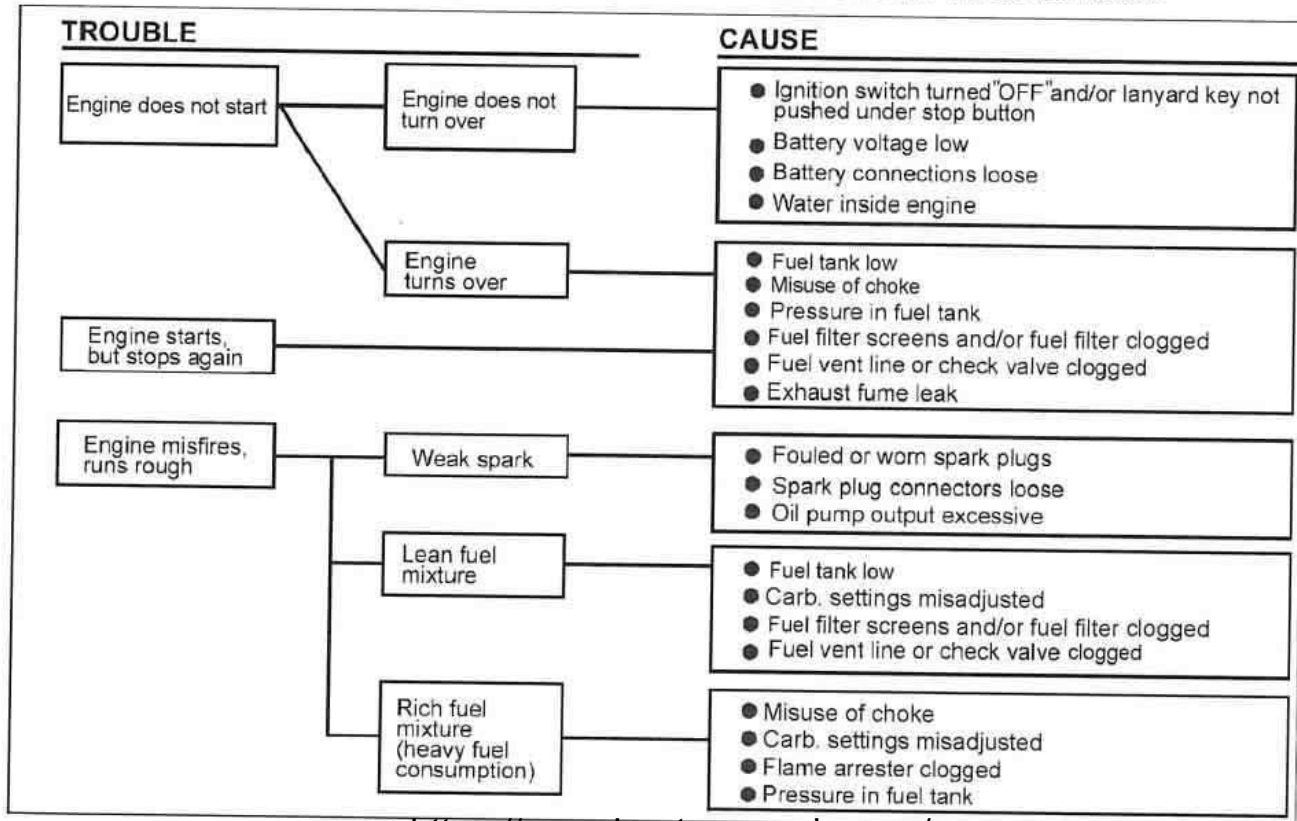

## 112 OWNER SATISFACTION

### TROUBLE

Engine power low

Engine overheating

Gas knock  
"pinging"

Steering hard or erratic

Multifunction meter display incorrect

### CAUSE

- Check items under "misfires," plus:
- Throttle control cable adjustment incorrect
- Exhaust system clogged
- Water in gasoline or engine oil

- Weeds or debris in jet pump
- Cooling water line clogged
- Carb. settings misadjusted
- Engine oil tank vent clogged
- Incorrect type of gas or oil

- Poor quality gasoline
- Spark plug heat range too high

- No lubricant on steering pivot
- Steering cable damaged or improperly routed

- Standard spark plugs and/or plug caps not installed

### WARNING

Since faulty steering is dangerous, this problem should be examined by an authorized JET SKI dealer.

## OWNER SATISFACTION

**(For Products Sold in the Continental United States of AMERICA Only)**

Your satisfaction is important to your authorized Kawasaki dealer and to Kawasaki Motors Corp., U.S.A. If you have a problem concerning warranty or service, please take the following action:

foreContact the owner and/or service manager of your authorized Kawasaki dealer. Fully explain your problem and ask for assistance in resolving the situation. The OWNER of the dealership is an independent business person and is concerned with your satisfaction and your future business. For this reason the owner is in the best position to assist you. Also, all warranty and service matters are handled and resolved through the authorized Kawasaki dealer network.

If you are unsatisfied after working with your Kawasaki dealer and feel you still require further assistance, WRITE to the address below. Please be certain to provide the model, product identification number, mileage or hours of use, accessories, dates that events occurred and what action has been taken by both you and your dealer. Include the name and address of the dealership. To assist us in resolving your inquiry, please include copies of related receipts and any other pertinent information including the names of the dealership personnel with whom you have been working in the resolution of your problem.

Upon receipt of your WRITTEN correspondence we will contact the dealership and work with them in resolving your problem.

In order to provide a permanent record, all warranty and service resolutions take place only through WRITTEN correspondence.

Please send your correspondence to:

CONSUMER RELATIONS  
KAWASAKI MOTORS CORP., U.S.A.  
P.O. Box 25252  
SANTA ANA, CA. 92799-5252  
(949) 460-5688

<https://www.boat-manuals.com/>

## REPORTING SAFETY DEFECTS

**(For Products Sold in the Continental United States of America Only)**

If you believe that your watercraft has a defect which could cause a crash or could cause injury or death, you should immediately inform the U.S. Coast Guard (U.S.C.G.) in addition to notifying Kawasaki Motors Corporation, U.S.A.

If the U.S.C.G receives similar complaints, it may open an investigation, and if it finds that a safety defect exists in a group of watercrafts, it may order a recall and remedy campaign. However, the U.S.C.G. cannot become involved in individual problems between you, your dealer, or Kawasaki Motors Corporation, U.S.A.

Please send your correspondence to:

Office of Boating Safety Product Assurance Division-OPB-3  
United States Coast Guard  
2100 Second Street SW  
Washington, DC 20593-0001

## ENVIRONMENTAL PROTECTION

To ensure a clean environment, observe the following:

- Properly dispose of your own trash (it is against the law to litter).
- Do not soil the beaches, coasts, and waters with fuel or oil.
- Take care to preserve natural habitats and living things.
- Properly discard used batteries, engine oil, or other Jet Ski TM watercraft components that you might dispose of in the future. Consult your authorized Kawasaki dealer or local environmental waste agency for their proper disposal procedure.

# MAINTENANCE RECORD

Owner Name.....

Address.....

Phone Number.....

Hull Number.....

Engine Number.....

Selling Dealer Name.....

Address.....

Phone Number.....

Warranty Start Date.....

**Note:** Keep this information and a spare key in a secure location.

Date	Engine Hours	Maintenance Performed	Dealer Name	Dealer Address













MEMO



# JT1200-A1



KAWASAKI HEAVY INDUSTRIES, LTD.  
Consumer Products & Machinery Company

Part No. 99987-1038

<https://www.boat-manuals.com/>

Printed in Japan