

# OWNER'S MANUAL

保存版

**JETSKI**  
*watercraft*

SS

## INCLUDES:

- IMPORTANT SAFETY INFORMATION
- NAVIGATION RULES
- OPERATING INSTRUCTIONS
- MAINTENANCE AND STORAGE

<https://www.boat-manuals.com/>



## READ THIS FIRST!

### ⚠ WARNING

For your safety, read this Owner's Manual and understand it thoroughly before operating this JET SKI watercraft. This manual contains the warnings given here for your immediate attention plus other important information.

The JET SKI watercraft is not a toy; it is a one or two person high performance Class A power boat with a capacity load limit of 150 kg (330 lb). Underage operators may be hazardous to themselves and others. You must know and observe your state's minimum boating age regulations. Kawasaki does not recommend operation of this watercraft by persons under the age required for a driver's license.

Don't forget to watch out for other boats, swimmers, or obstructions in your path. This is especially critical during a beginner's first exciting ride.

This is a very maneuverable, sport watercraft; other boaters may not be expecting you to turn as quickly as you are able. Look around you to make sure the path is clear before executing any sudden turns.

**Drowning Hazard:** a personal flotation device (PFD) must be worn by the operator and passenger. Kawasaki recommends that the operator and passenger wear a vest-type PFD (type 1, 2 or 3) at all times.

Riders of personal watercraft may suffer injury due to the forceful injection of water into body cavities either by falling into the water or while mounting the craft. Kawasaki recommends that the operator and passenger of personal watercraft wear protective swimwear such as wetsuit bottoms.

Releasing the throttle completely reduces the ability to steer. This can cause you to hit an object you are trying to avoid. You must have thrust to turn, so keep the throttle on or apply throttle as needed to maintain thrust at the jet nozzle.

In some circumstances water spray can momentarily interfere with vision which could be hazardous. Wear suitable eye protection while operating this watercraft.

Never operate the watercraft after dark. It was not designed for such use, and has no lighting equipment.

## CAUTION

Take proper care of your new JET SKI watercraft. Here are some of the cautions contained in this manual which must be followed for the protection of your watercraft. Be sure to read this Owner's Manual and understand it thoroughly before operating your watercraft.

Always turn the boat on its right side. Rolling to the left side can cause water in the exhaust system to run into the engine, with possible engine damage.

If water gets into the watercraft engine, follow the procedure on page 55 immediately. If water is left in the engine more than a few hours, it will destroy the crankshaft bearings and damage other internal engine parts.

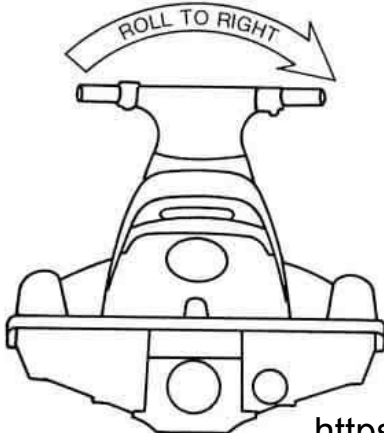

The watercraft must be in at least 0.6 m (two feet) of water when starting to prevent jet pump damage by objects sucked up from the bottom.

Do not operate in shallow or debris-laden water, or the impeller may be damaged and sand may clog the water cooling hoses.

Do not run the watercraft onto the shore, or severe impeller damage may occur.

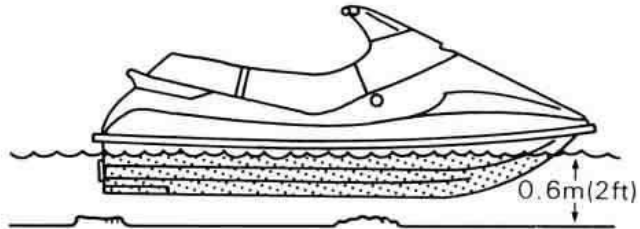

## **Quick Reference Guide**

This Quick Reference Guide will assist you in finding the information you're looking for.

**General  
Information**

**Operating  
Instructions**

**Storage**

**Maintenance  
and Adjustments**

**Troubleshooting  
Guide**

A Table of Contents is included after the Foreword.

<https://www.boat-manuals.com/>

## FOREWORD

Welcome to a new and exciting water sport. We are pleased you have chosen the Kawasaki JET SKI watercraft to expand the enjoyment of your recreational hours. Kawasaki uses the latest manufacturing methods and materials to bring you a high quality recreational watercraft.

This Owner's Manual is provided to aid you in the safe and reliable operation of your watercraft. **READ IT AND BECOME THOROUGHLY FAMILIAR WITH PROPER OPERATING PROCEDURES BEFORE YOUR FIRST RIDE.** Make sure anyone who operates your watercraft is fully acquainted with the proper operating procedures. Kawasaki strongly recommends that all operators attend a boating safety course before riding the watercraft. Contact the local office of the U.S. Coast Guard or other marine law enforcement agency. Careful operation and proper maintenance in accordance with this Owner's Manual will provide you with maximum riding pleasure and performance.

A Service Manual is also available for those owners who, due to personal preference or necessity, wish to perform their own service and repair. Those who plan to do their own work should, of course, be competent mechanics and should possess the required tools to work on

the watercraft, including the special tools described in the Service Manual. See your dealer if you want a Service Manual and the required tools.

When you are planning to ride your watercraft, be sure to take this manual with you as a reference. This can be important should you encounter operating difficulties. If you have any additional questions about your watercraft, please contact your dealer. He has the necessary parts and service knowledge to care for your needs.

This craft is a "Class A" inboard boat, and as such is subject to all federal rules and regulations especially pertaining to boating safety and operation as enforced by the U.S. Coast Guard. Some local jurisdictions may have additional requirements for operation of power boats in waters under their control. Additionally, other countries may have their own standards and regulations. Please check your local boating laws and regulations before riding the watercraft.

Whenever you see the symbols shown below, heed their instructions! Always follow safe operating and maintenance practices.

### **WARNING**

This warning symbol identifies special instructions or procedures which, if not correctly followed, could result in personal injury, or loss of life.

### **CAUTION**

This caution symbol identifies special instructions or procedures which, if not strictly observed, could result in damage to, or destruction of equipment.

### **NOTE**

*○ Indicates points of particular interest for more efficient and convenient operation.*

All rights reserved. No part of this publication may be reproduced, stored in a retrieval system, or transmitted in any form or by any means, electronic mechanical photocopying, recording or otherwise, without the prior written permission of Kawasaki Heavy Industries, Ltd., Consumer Products Group. No liability can be accepted for any inaccuracies or omissions in this publication, although every possible care has been taken to make it as complete and accurate as possible. All procedures and specifications subject to change without prior notice or obligation. Illustrations in this publication are intended for reference use only and may not depict actual model component parts.

© Kawasaki Heavy Industries, Ltd. 1996

Apr. 1996. (1). (S)

**JETSKI**  
waterscraft

is a trademark of Kawasaki Heavy Industries, Ltd. registered in U.S.A., Japan, Austria, Benelux, Sweden, Denmark, Switzerland, France, Canada, Finland, Norway, Greece, Italy, U.K., Portugal, Thailand, and Taiwan.

KAWASAKI JET SKI is a trademark of Kawasaki Heavy Industries, Ltd. registered in Australia.

## TABLE OF CONTENTS

Specifications .....	8
General Information .....	10
Serial Numbers .....	10
Parts Location .....	11
Label Location .....	13
Registration Numbers .....	19
Warning/Indicator Lights .....	20
Fuel .....	21
Engine Oil .....	23
Controls .....	25
Seat Latch .....	29
Storage Compartment/Box .....	29
Storage Pocket .....	30
Tool Kit .....	31
Drain Screw .....	31
Operating Instructions .....	32
Safe Operation .....	32
Navigation Rules .....	37
Pre-ride Checklist .....	39
Break-In .....	41
Stopping the Engine .....	42
Starting the Engine .....	43



Launching .....	45
Stopping the JET SKI Watercraft.....	47
Turning the JET SKI Watercraft .....	49
Docking the JET SKI Watercraft .....	51
Riding the JET SKI Watercraft .....	52
End of the Day Checklist.....	54
Special Procedures .....	54
Transporting.....	60
Storage .....	61
Preparation for Storage.....	61
Removal from Storage.....	64
Maintenance and Adjustments.....	66
Periodic Maintenance Chart.....	66
Control Cable Adjustments .....	68
Fuel and Oil Systems.....	72
Spark Plug .....	77
Battery .....	78
Lubrication .....	80
Cooling System Flushing .....	83
Bilge System Flushing.....	85
Troubleshooting Guide.....	87
Owner Satisfaction .....	89

## 8 SPECIFICATIONS

### SPECIFICATIONS

#### JET SKI WATERCRAFT - MODEL JH750-E2 "CLASS A" INBOARD BOAT

<b>Engine:</b>		
Type	2-stroke, vertical twin, crankcase reed valve, water-cooled	
Displacement	743 mL	45.3 cu in.
Bore and Stroke	80.0 x 74.0 mm	3.15 x 2.91 in.
Compression Ratio	7.0 : 1	
Ignition System	Magneto CDI (Digital)	
Lubrication System	Oil injection (break-in period: Oil injection and gas/oil mixture 50 : 1)	
Carburetor	Keihin CDK 40 - 34	
Starting System	Electric	
<b>Tuning Specifications:</b>		
Spark Plug	NGK BR8ES	
Gap	0.7 - 0.8 mm	0.028 - 0.032 in.
Ignition Timing	13° BTDC @1 250 r/min (rpm) ~ 16° BTDC @2 500 r/min (rpm)	
Carburetor		
Idle Speed	1 250 ±100 r/min (rpm) - in water 1 700 ±100 r/min (rpm) - out of water	
Compression Pressure	1 196 kPa (12.2 kg/cm <sup>2</sup> )	173 psi

## SPECIFICATIONS 9

<b>Drive System:</b>	Direct drive from engine Axial flow, single stage 270 kg Steerable nozzle Water drag	595 lb
Coupling Jet Pump:   Type Thrust  Steering Braking		
<b>*Performance:</b>	3.3 m 27 L/h @full throttle 88 km @full throttle 1 hour and 13 minutes	10.8 ft 7.1 gal/hr (U.S.) 54.7 mi
Minimum Turning Radius Fuel Consumption Cruising Range		
<b>Dimensions:</b>	2 530 mm 1 030 mm 945 mm 182 kg 33 L including 6 L reserve	99.6 in. 40.6 in. 37.2 in. 401 lb 8.7 gal (U.S.) incl. 1.6 gal reserve
Length Width Height Dry Weight Fuel Tank Capacity		
<b>Engine Oil:</b>	2-stroke, N.M.M.A. Certified for Service TC-W II or TC-W 3  2.3 L	2.4 qt (U.S.)
Type  Oil Tank Capacity		
<b>Electrical Equipment:</b>	12 V 19 Ah	
Battery		

\* The information shown here represents results under controlled conditions, and the information may not be correct under other conditions.

## 10 GENERAL INFORMATION

### GENERAL INFORMATION

---

#### Serial Numbers

---

The hull and engine identification numbers are used to register the boat. They are the only means of identifying your particular machine from others of the same model. These serial numbers may be needed by your dealer when ordering parts. In the event of theft, investigating authorities will require both numbers as well as the model number and any unique features of your machine that could help identify it. Record these numbers here.

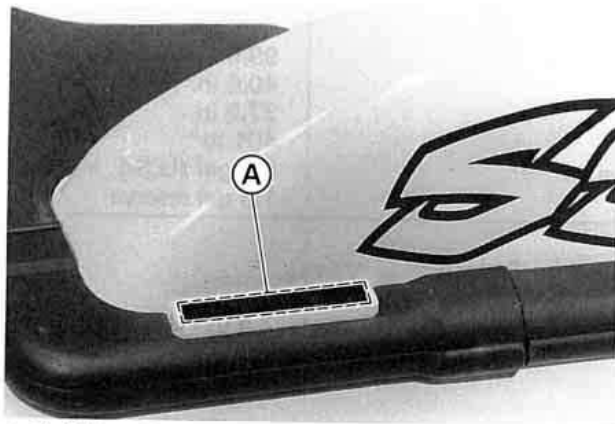

A. Hull Identification Number (HIN)

H.I.N.	
--------	--

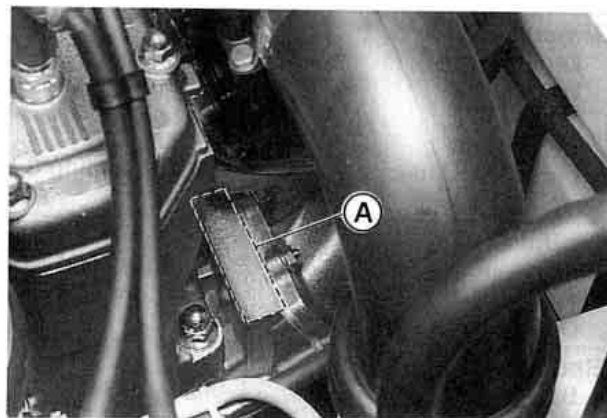

A. Engine Number

Eng. No.	
----------	--

Parts Location

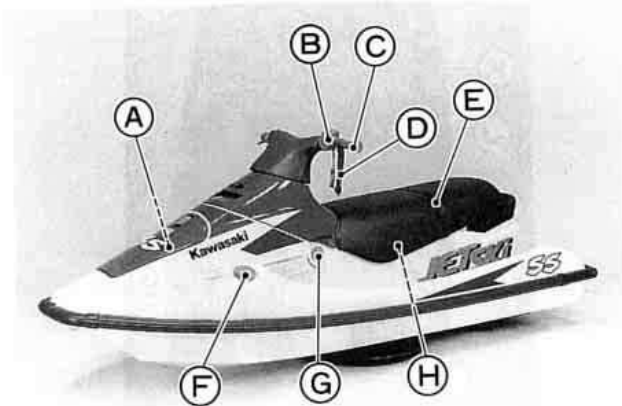

- |                                  |                       |
|----------------------------------|-----------------------|
| A. Storage Compartment/Box       | E. Seat               |
| B. Engine Start and Stop Buttons | F. Fuel Filler Cap    |
| C. Handlebar                     | G. Choke Knob         |
| D. Engine Shut-off Lanyard       | H. Engine Compartment |



- |  |                    |
|--|--------------------|
| A. Storage Pocket                        | E. Steering Nozzle |
| B. Seat Latch                            | F. Exhaust Outlet  |
| C. Warning/Indicator Light Display Panel | G. Fuel Knob       |
| D. Throttle Lever                        | H. Bypass Outlet   |

## 12 GENERAL INFORMATION

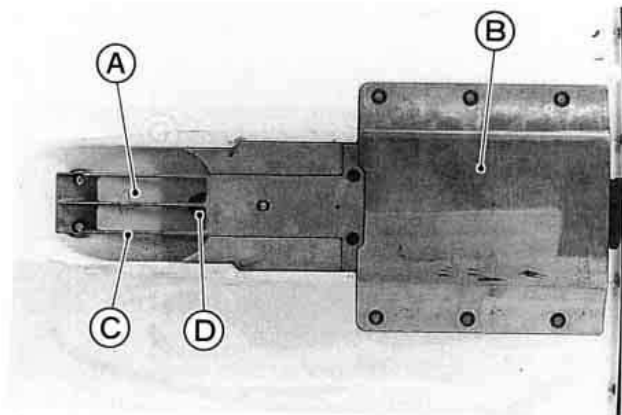

A. Water Intake  
B. Jet Pump Cover

C. Grate  
D. Drive Shaft

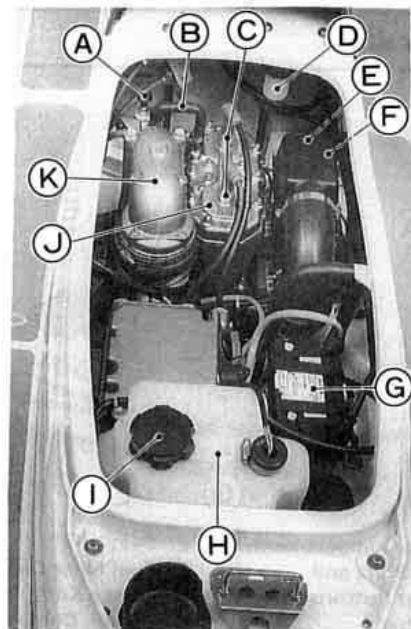

A. Drain Valve Knob  
B. Cooling Hose  
C. Spark Plugs  
D. Sediment Bowl  
E. Flame Arrester  
F. Carburetor  
G. Battery  
H. Oil Tank  
I. Oil Filler Cap  
J. Cylinder Head  
K. Exhaust Pipe

## Label Location

All warning labels which are on your watercraft are repeated here. Read them and understand them thoroughly. They contain information which is important for your safety and the safety of anyone else who may operate your watercraft. Therefore, it is very important that all warning labels be on your watercraft in the locations shown. If any label is missing, damaged, or worn, get a replacement from your Kawasaki dealer and install it in the correct position.

### NOTE

- *The sample warning labels in this section have part numbers to help you and your dealer obtain the correct replacement.*

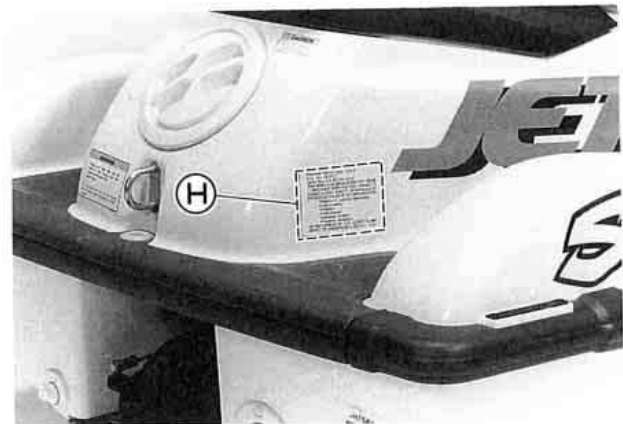
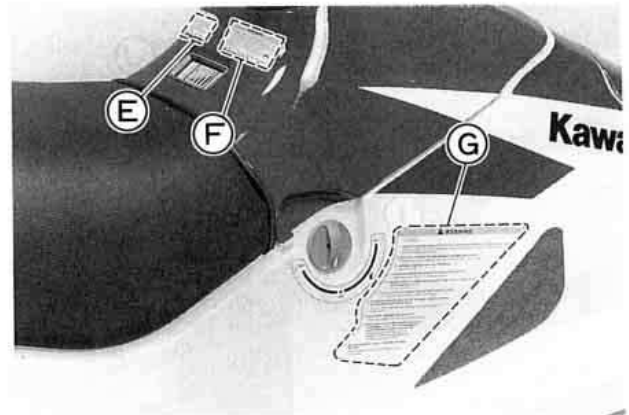
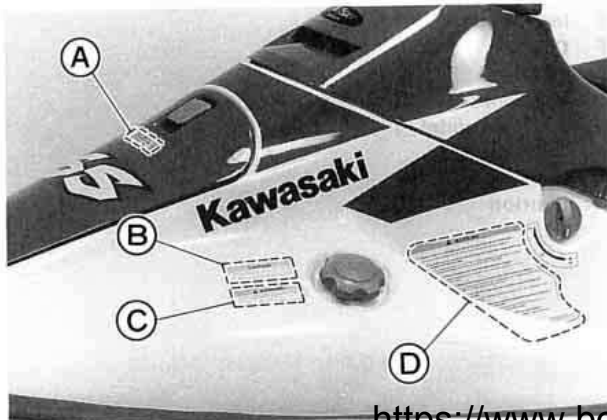

## 14 GENERAL INFORMATION

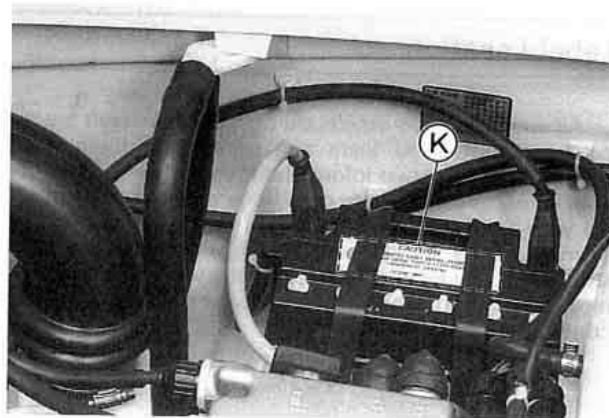
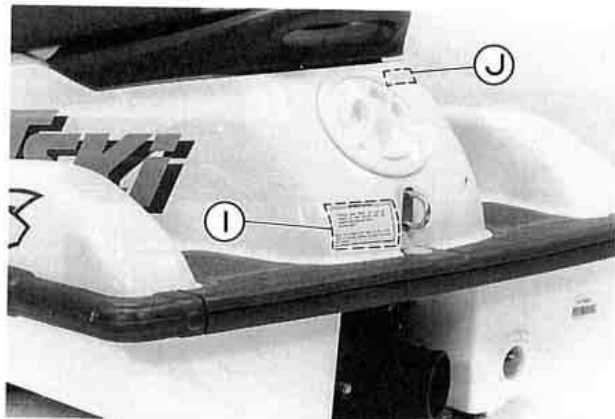

- A. Fire Extinguisher Compartment
- B. Caution
- C. Warning
- D. Warning
- E. Important
- F. Caution
- G. Warning
- H. U.S. Coast Guard Grant of Exemption  
(US model only)
- I. Warning
- J. Caution
- K. Caution



(A)

**FIRE EXTINGUISHER  
COMPARTMENT UNDER  
THE STORAGE CASE**

56030-3790

(C)

**▲WARNING**

Gasoline is extremely flammable and can be explosive. A fire or explosion can cause severe injury or death.

Shut engine off. Do not smoke. Refuel in a well ventilated area away from flame or sparks.

56040-3972

(B)

**CAUTION**

1. Check engine oil every time you refuel. Oil tank is under seat. Running out of oil will cause major engine damage.
2. Use a 50 : 1 gas-oil mixture in fuel tank only during break-in period (first 5 hours or 3 tanks of fuel). After break-in, oil injection system alone provides adequate lubrication.

56040-3969

(E)

**IMPORTANT**

Keep the engine shut-off lanyard attached to the operator while operating this watercraft. The lanyard stops the engine if the operator falls.

56040-3970

## 16 GENERAL INFORMATION

(D)

### ⚠ WARNING

- 1. The Owner's Manual and warning labels contain important information on safe operation of this watercraft.**  
You must read and fully understand the Owner's Manual and warning labels before operating this watercraft.
- 2. The JET SKI watercraft is not a toy; it is a high performance Class A power boat. Underage operators may be hazardous to themselves and others.**  
You must know and observe your state's minimum boating age regulations. Kawasaki does not recommend operation of this watercraft by persons under the age required for a driver's license.
- 3. Riders of personal watercraft can fall into the water and experience exposure.**  
Operator and passenger must be competent swimmers and never travel farther from shore than they can swim.
- 4. Boating laws and navigation rules are for the safety of everyone sharing the waterways.**  
You must know and observe all local, state, and federal boating laws. Kawasaki recommends that all operators complete an approved boating safety course.
- 5. Drowning Hazard: a personal flotation device (PFD) must be worn by operator and passenger.**  
Kawasaki recommends that operator and passenger wear a vest-type PFD (type 1, 2 or 3) at all times.
- 6. Overloading this watercraft can adversely affect handling and stability which can lead to an accident.**  
Never exceed the capacity load limit of 330 lbs or allow more than two persons to ride this watercraft at one time.
- 7. Malfunctioning controls can cause an accident.**  
Check throttle control and steering for proper operation before starting engine.

56070-3752

G

**▲WARNING**

- 8. Starting, turning, and accelerating without checking for other boats and objects in your path can cause an accident.**  
Always look carefully around you for other boats and objects before starting and making quick maneuvers. This is a very maneuverable, sport watercraft.
- 9. Quick turns or acceleration can cause passenger to lose balance and be injured.**  
Passenger should hold onto operator or hand strap and keep both feet on deck for balance.
- 10. Alcohol and drugs impair reaction time and judgement.**  
Never drink and ride.
- 11. In some circumstances water spray can momentarily interfere with vision.**  
Wear suitable eye protection while operating this watercraft.
- 12. Releasing the throttle completely reduces the ability to steer. This can cause you to hit an object you are trying to avoid.**  
You must have thrust to turn.
- 13. Towing can cause loss of steering control and create a hazardous condition.**  
Do not tow other watercraft, skiers, or objects behind the craft.
- 14. This watercraft will not self-right if capsized. The operator must know the proper righting procedure or he could be stranded.**  
All operators of this watercraft must know the righting procedure explained in the Owner's Manual.
- 15. Objects hidden underwater may injure your feet.**  
Operator and passenger should wear foot protection at all times.
- 16. Riders of personal watercraft may suffer injury due to the forceful injection of water into body cavities either by falling into the water or while mounting the craft.**  
Kawasaki recommends that the operator and passenger of personal watercraft wear protective swimwear such as wetsuit bottoms.
- 17. High speed operation in choppy or rough water may cause back injuries.**  
Slow down before crossing waves. Do not ride if you have a back condition.

56070-3753

## 18 GENERAL INFORMATION

(F)

### CAUTION

1. If engine overheats, the water temperature light comes on and the engine slows down. Return to shore immediately. To prevent engine damage, do not operate the craft until the cause of overheating is corrected.
2. When rolling the craft onto its side, turn it in this direction only.



56040-3974

(H)

Kawasaki Motors Corp., U.S.A.  
P. O. Box 25252  
Santa Ana, CA 92799-5252

THIS BOAT HAS BEEN EXEMPTED FROM COMPLIANCE WITH THE FOLLOWING U.S. COAST GUARD SAFETY STANDARDS IN EFFECT ON THE DATE OF CERTIFICATION:

- Display of Capacity Information
- Safe Loading
- Flotation
- Fuel System
- Electrical System
- Powered Ventilation

AS AUTHORIZED BY U.S. COAST GUARD  
GRANT OF EXEMPTION (CGD 80-018)

59462-3716

(I)

### ⚠ WARNING

Putting your hand into the jet intake or rear nozzle with the engine running can cause severe injury.

Stop the engine and pull off the engine shut-off lanyard before checking the pump for debris.

56040-3898

(J)

### CAUTION

Do not use handrail for towing objects, lifting craft, or attaching tie-downs.

56040-3973

(K)

### CAUTION

INCORRECT CABLE INSTALLATION  
COULD CAUSE COSTLY ELECTRICAL  
COMPONENT FAILURE.

BOW ←

---

### Registration Numbers

---

The graphic design of your JET SKI watercraft provides a specific location on each side for the registration numbers and validation decals.

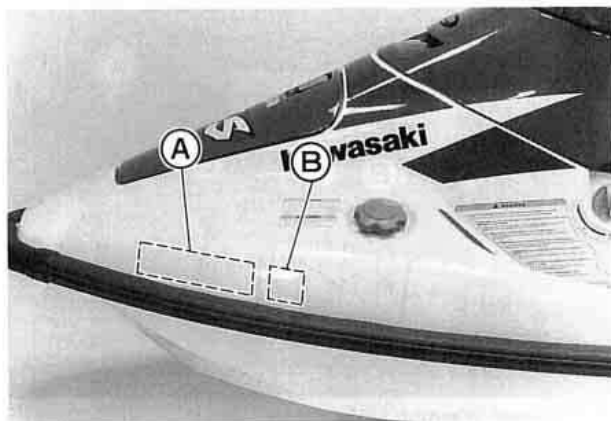

A. Location for Registration Number  
B. Location for Validation Decal



A. Location for Registration Number  
B. Location for Validation Decal

The registration numbers must read from left to right on both sides of the watercraft. Typically, the validation decal must be placed three inches beyond, and level with the first or last letter of the identification number.

#### NOTE

○ *Requirements for registration numbers and validation decals may vary from those given here for your state. Always follow the directions provided at the time you register your watercraft.*

## 20 GENERAL INFORMATION

Registration numbers must be block characters no less than 3 inches (76.2 mm) in height. They should be a color contrasting with the background. The spaces between the numerals and the prefix/suffix letters must be equal to the width of any letter except "I" or any number except "1."

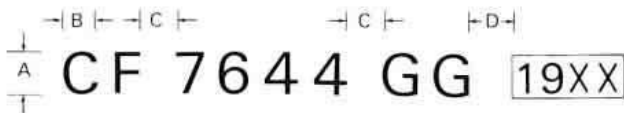

A = 3 inches (76.2 mm) minimum

B = C

D = 3 inches

## Warning/Indicator Lights

In front of the seat is a warning and indicator light display panel. These lights go on only when the engine is running.

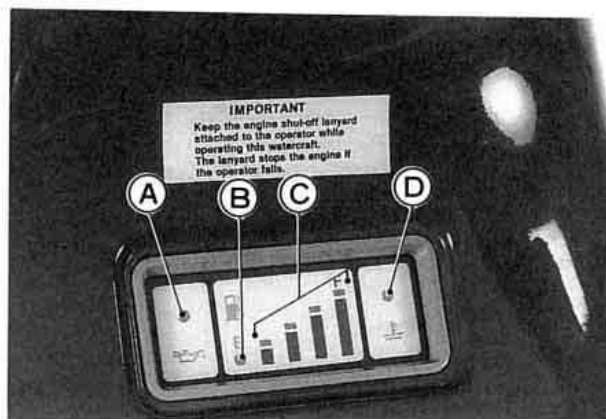

- A. Oil Level Warning Light
- B. Low Fuel Warning Light
- C. Fuel Indicator Lights
- D. Cooling Water Temperature Warning Light

### : Oil Level Warning Light

When the oil level in the oil tank gets low, the warning light comes on to warn the riders; add engine oil (see the Engine Oil section).

**CAUTION**

If the engine is run without oil, it will be severely damaged. If the oil tank is completely dry, add the oil and have your Kawasaki JET SKI dealer bleed the air from the oil line before operation.



**: Fuel Indicator Lights and Low Fuel Warning Light**

When the fuel tank is full, all the indicator lights go on. As the fuel level in the tank goes down, the lights go off one by one from right (marked F) to left to show quantity of the fuel left in the tank. When the fuel has decreased to about 6 L (1.6 U.S. gal), the warning light (marked E) goes on to warn the riders; turn the fuel knob to RES (reserve) position and refuel at the earliest opportunity (see the Fuel and Controls sections.)



**: Cooling Water Temperature Warning Light**

If the cooling water temperature gets too high, the warning light comes on to warn the riders; return to the shore immediately and check the cooling system for clogging (see the Special Procedures section in the Operating Instructions chapter).

**CAUTION**

If engine overheats, the water temperature warning light comes on and the engine slows down. Return to shore immediately. To prevent engine damage, do not operate the craft until the cause of overheating is corrected.

---

**Fuel**

---

**CAUTION**

Do not use racing fuels or fuel additives. This watercraft has not been tested and certified for use with such fuels. Damage to the engine and fuel system may result from the use of improper fuel.

The octane rating of gasoline is a measure of its resistance to detonation or "knocking." Use a gasoline with an octane rating equal to or higher than that shown in the table below.

## 22 GENERAL INFORMATION

Octane Rating Method	Minimum Rating
Antiknock Index $\frac{(\text{RON} + \text{MON})}{2}$	87
Research Octane No. (RON)	91

The Antiknock Index is an average of the Research Octane Number (RON) and the Motor Octane Number (MON). The Antiknock Index is posted on service station pumps in the U.S.A. If the Antiknock Index is not posted, be sure the Research Octane Number is adequate.

### *Gasoline Containing Oxygenates (Alcohols and ethers)*

Gasoline frequently contains oxygenates (alcohols and ethers) especially in areas of the U.S. and Canada which are required to sell such reformulated fuels as part of a strategy to reduce exhaust emissions. The types and volume of fuel oxygenates approved for use in unleaded gasoline include a broad range of alcohols and ethers. Gasoline quality is important. Fuels of low quality or not meeting industry specifications may result in unsatisfactory performance. Heed the following cautions:

## CAUTION

Operating problems that result from the use of poor quality or nonrecommended fuel may not be covered under your warranty.

Never use gasohol with an octane rating lower than the minimum octane rating specified by Kawasaki for this product.

Never use gasohol containing more than 10% ethanol (grain alcohol).

Never use gasohol containing more than 5% methanol (wood alcohol). Gasoline containing methanol must also be blended with cosolvents and corrosion inhibitors.

Never store this product with gasohol in the fuel system.

Gasoline containing alcohol can cause paint damage. Be extra careful not to spill gasohol during refueling.

### Filling the Tank:

## ⚠ WARNING

Gasoline is extremely flammable and can be explosive under certain conditions. Pull the lanyard key off the stop button. Do not smoke. Make sure the area is well ventilated and free from any source of flame or sparks; this includes any appliance with a pilot light.

The fuel tank is located inside the bow and the fuel filler cap is on the left side of the bow. Turn the cap counter-clockwise and remove it.



## GENERAL INFORMATION 23

After transporting or refueling and before starting the engine, open the storage compartment lid, take out the storage box and remove the seat (see the Seat Latch section) for several minutes to ventilate the engine compartment.

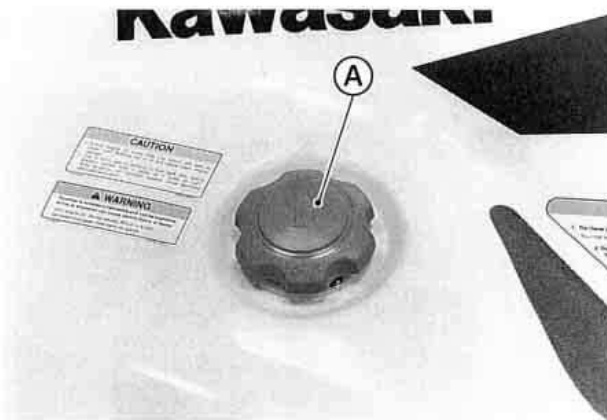

**A. Fuel Filler Cap**

Fill the tank with the recommended octane rating gasoline. The use of a small diameter pour spout (or funnel) will make filling easier. Pour slowly to avoid "spit back" and allow air to escape from the tank.

Leave about 100 mm (4 in.) between the top of the filler neck and the fuel level.

### **⚠ WARNING**

Never fill the tank completely to the top. As the fuel expands in a warm tank, it may overflow from the vent tube. After refueling, make sure the filler cap is closed securely.

### **⚠ WARNING**

A concentration of gasoline fumes in the engine compartment can cause a fire or explosion.

---

## Engine Oil

---

Kawasaki recommends using Kawasaki Jet Ski Oil (P/N W61020-102) or Kawasaki Jet Ski High Performance Oil (W61020-103) for extra protection under severe use conditions. Both oils are specially formulated for Kawasaki Jet Ski watercraft to minimize piston ring varnish and combustion chamber deposits, and provide excellent lubrication qualities.

If Kawasaki Jet Ski Oils are not available, ensure that you use only a high quality two cycle marine oil as a substitute. Look for the National Marine Manufacturers Association (N.M.M.A.) TC-W II or TC-W 3 certification on the container. The use of oil additives or products that are

## 24 GENERAL INFORMATION

not certified by N.M.M.A. as TC-W II or TC-W 3 are not recommended.

### NOTE

○ *TC-W II and TC-W 3 are later classifications than TC-W with additional engine testing procedures in their qualification process that eliminate some of the inferior marine two cycle oils that exist in the marketplace. Kawasaki Jet Ski High Performance Oil is a certified TC-W II product. Although Kawasaki Jet Ski Oil has a TC-W classification, it is a high quality oil that performs as well as or better than TC-W II or TC-W 3 oils in this application and has proven its performance over many years of use.*

# CERTIFIED



### Adding Oil:

The oil tank is located in the engine compartment. Remove the seat (see the Seat Latch section) and remove the oil filler cap. Add the recommended oil.

**CAUTION**

If the engine is run without oil, it will be severely damaged. If the oil tank is completely dry, add the oil and have your Kawasaki JET SKI dealer bleed the air from the oil line before operation.

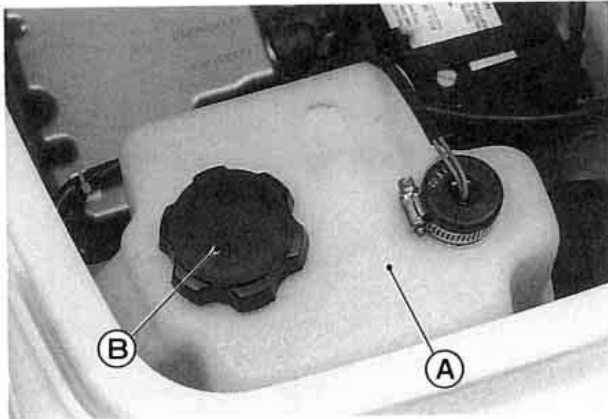

A. Engine Oil Tank

B. Oil Filler Cap

**NOTE**

○Kawasaki recommends the use of a gasoline/oil premix in the fuel tank for extra lubrication during the break-in period. After the break-in period, the oil injection system provides the necessary engine lubrication without the need for premixed fuel. Refer to the Break-In section in the OPERATING INSTRUCTIONS chapter.

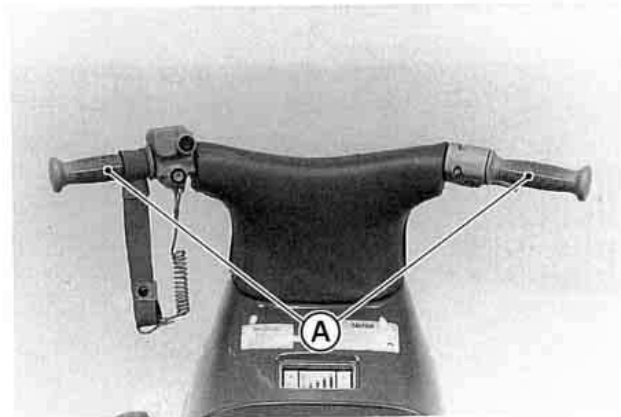
**Controls****Steering Handlebar:**

A. Handlebar

The steering handlebar functions much the same as a snowmobile or bicycle handlebar. Turning the handlebar will cause the watercraft to turn **ONLY WHEN THE ENGINE IS RUNNING AND ONLY WHEN THE THROTTLE IS APPLIED**. The handlebar is connected by a control cable to the jet pump steering nozzle at the rear of the boat.

## 26 GENERAL INFORMATION

### Stop Button:

The stop button is in the case on the left hand side of the handlebar. The stop button is red and marked "STOP." Pushing the stop button turns off the engine.

The engine is also stopped by pulling the engine shut-off lanyard key off the stop button.

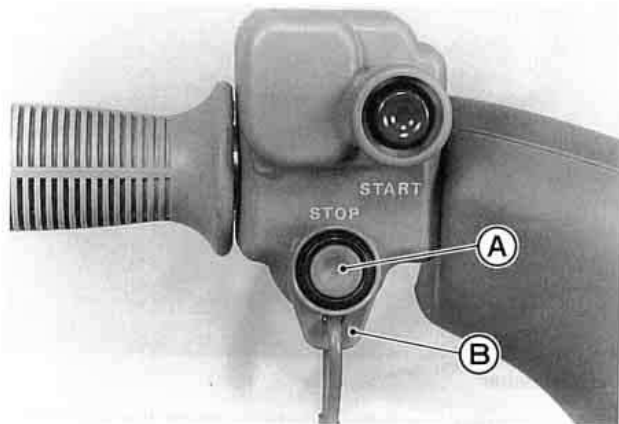

A. Stop Button

B. Lanyard Key

### Start Button:

The start button is in the case on the left hand side of the handlebar. The start button is green and is marked "START." Pushing the start button with the engine shut-off lanyard key pushed under the stop button starts the engine. Release it when the engine starts. Without the lanyard key the engine neither cranks nor starts.

## CAUTION

Do not push the "START" button while the engine is running or while the starter is still spinning, as it will hasten starter wear and may cause the starter to jam.

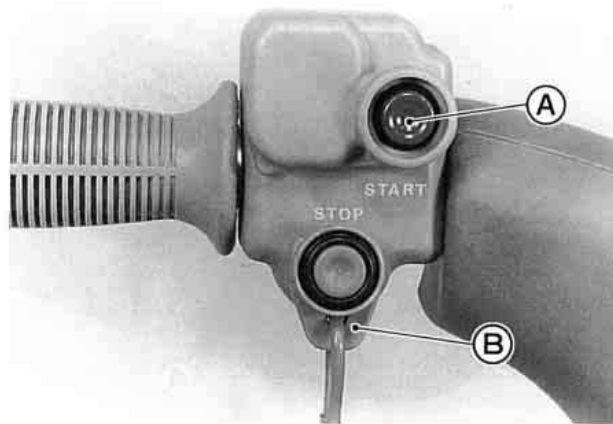

A. Start Button

B. Lanyard Key

## NOTE

- For the engine to start, the engine shut-off lanyard key must be pushed under the stop button.
- Refer to the Starting the Engine section in the Operating Instructions chapter.

## GENERAL INFORMATION 27

### Throttle Limiter:

The watercraft is equipped with a throttle limiter to decrease maximum engine power for an unskilled rider. The limiter functions by restricting the moving distance of the throttle lever. Turn the limiter in or out. Turning out decreases the maximum engine power available. The other way increases the maximum engine power.

### CAUTION

If the throttle limiter is adjusted, verify the changes in throttle in an open non-traffic area. Never try to adjust the limiter by racing the engine out of the water or the engine may be damaged.

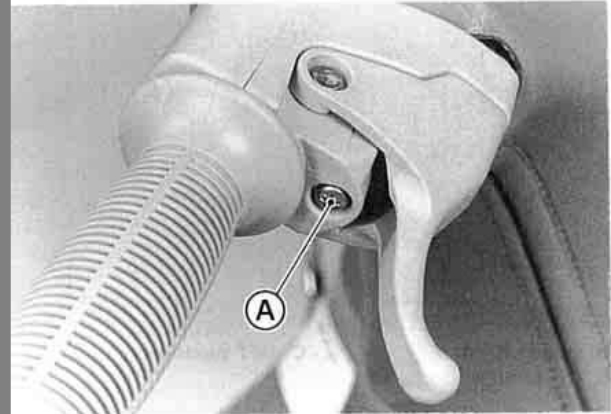

A. Throttle Limiter

## 28 GENERAL INFORMATION

### Choke Knob:

The choke knob is located on the left side of the deck under the steering handlebar. Turning the choke knob to the ON position (all the way clockwise) provides a rich mixture for starting. After the engine fires, turn the choke knob to the OFF position (all the way counterclockwise).

#### NOTE

○ If the choke knob is used after the engine has started, it will waste fuel, reduce performance, and could cause spark plug fouling.

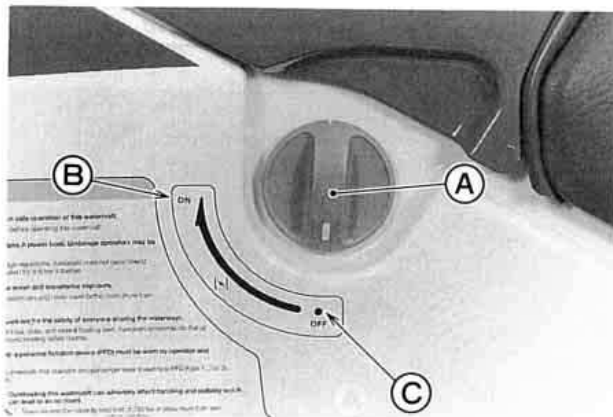

A. Choke Knob  
B. ON position

C. OFF position

### Fuel Knob:

The fuel knob is on the right side of the deck under the steering handlebar. It has three positions: ON, OFF, and RES (reserve). If you run out of fuel while the knob is in the ON position (the low fuel warning light comes on), turn the knob to RES. Reserve allows use of the last 6 liters (1.6 U.S. gal) of fuel and about 15 minutes of running time at full throttle.

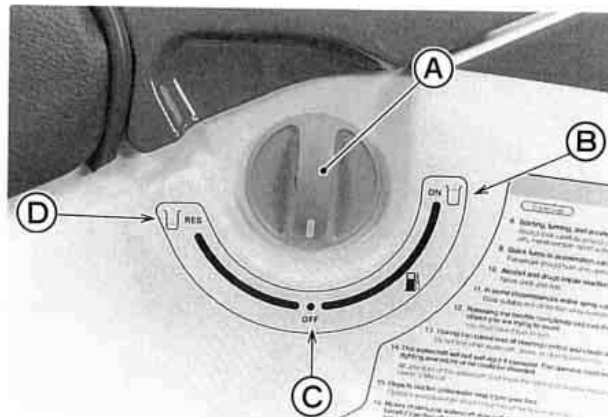

A. Fuel Knob  
B. ON position

C. OFF position  
D. RES position

#### NOTE

- Since operating distance is limited when on RES, refuel at the earliest opportunity.
- Make certain that you turn the fuel knob to ON (Not RES) after filling up the fuel tank.

## GENERAL INFORMATION 29

The handrail behind the seat is for boarding from deep water only, and is not designed for other purposes.

---

### Seat Latch

---

The seat can be removed by unlocking the latch under the rear end of the seat.

**To Open:** Pull the latch handle and remove the seat to the rear.

**To Close:** Engage the seat front end in place and slide it all the way forward by pushing the seat end, and then push down on the rear of the seat to lock it.

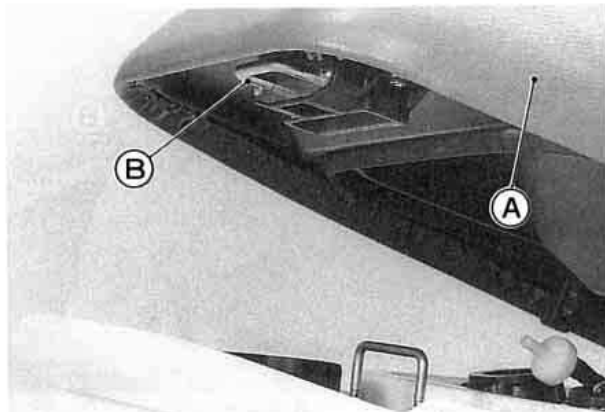

A. Seat

B. Latch Handle

When transporting the watercraft, make sure the seat is secured to prevent it from becoming dislodged and damaged as a result.

<b>CAUTION</b>
Do not use handrail for towing objects, lifting craft, or attaching tie-downs.

---

### Storage Compartment/Box

---

The storage compartment is located in the bow. Inside the compartment is a storage box which can be taken out easily. On the bottom of the compartment are provided bands for securing a fire extinguisher (not standard equipment with this watercraft).

To open the lid, pull the knob up.

To close the lid, push on the knob until it latches.

## 30 GENERAL INFORMATION

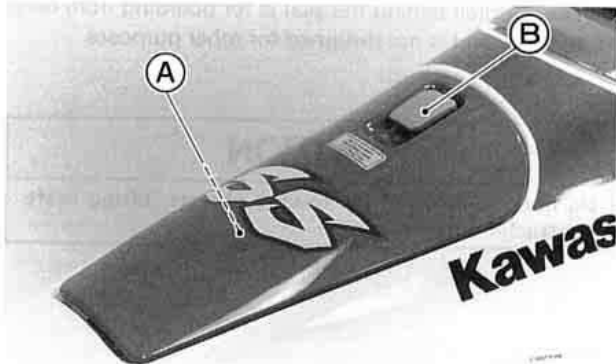

A. Storage Compartment      B. Knob

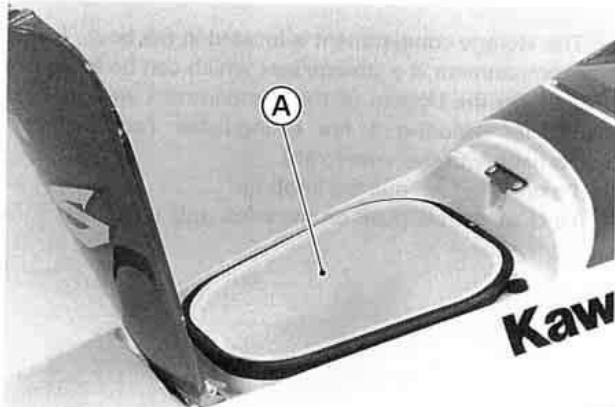

A. Storage Box

---

### Storage Pocket

---

Under the handrail behind the seat is a storage pocket with a lid. Store this Owner's Manual in the waterproof plastic bag in this storage pocket. Also keep only light items here.

To open the lid, turn it counterclockwise.

To close the lid, turn it all the way clockwise.

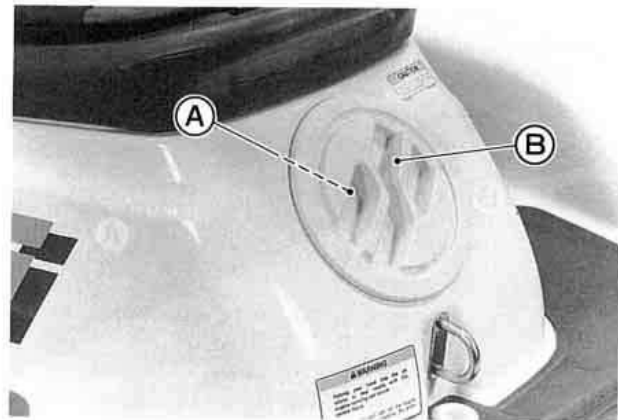

A. Storage Pocket

B. Knob



### Tool Kit

The tool kit is stored inside the storage compartment in the bow, under the storage box. Be sure it is secured with the bands together with the fire extinguisher.

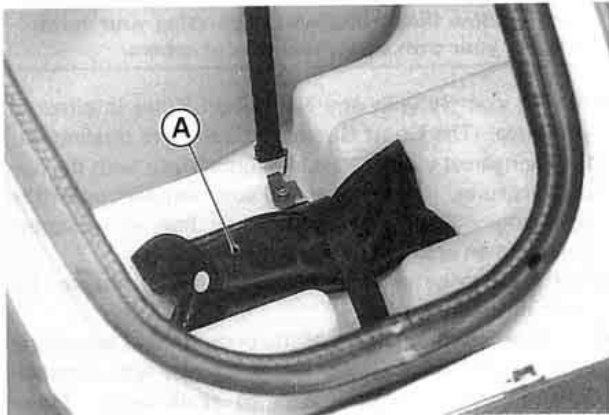

A. Tool Kit

### Drain Screw

There is a drain screw in the stern to drain water accumulated in the engine compartment. Open it only when the craft is out of the water.

### CAUTION

Before launching be sure to securely tighten the screw to avoid flooding and swamping the craft.

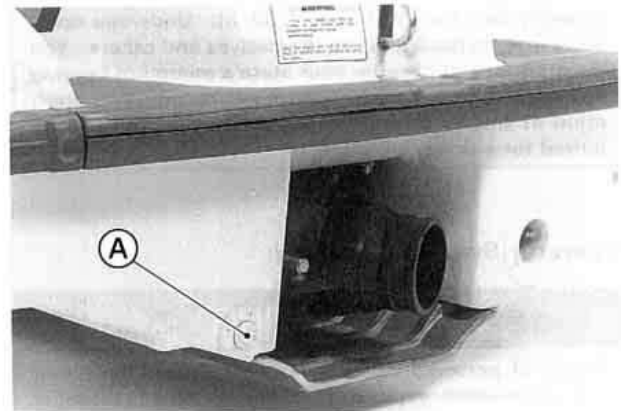

A. Drain Screw

# OPERATING INSTRUCTIONS

### Safe Operation

#### Operation by Children:

#### **⚠ WARNING**

The JET SKI watercraft is not a toy; it is a one or two person high performance Class A power boat with a capacity load limit of 150 kg (330 lb). Underage operators may be hazardous to themselves and others. You must know and observe your state's minimum boating age regulations. Kawasaki does not recommend operation of this watercraft by persons under the age required for a driver's license.

#### Operator Swimming Ability:

#### **⚠ WARNING**

Riders of personal watercraft can fall into the water and experience exposure. Operator and passenger must be competent swimmers and never travel farther from shore than they can swim.

Drowning Hazard: a personal flotation device (PFD) must be worn by the operator and passenger. Kawasaki recommends that the operator and passenger wear a vest-type PFD (type 1, 2 or 3).

#### Safe Riding Rules:

#### **⚠ WARNING**

Always follow these rules when operating your watercraft, for your own safety and that of others.

- Always comply with any Navigation Rules in effect in your area. The Coast Guard office or state boating authority nearest you can usually furnish you with the applicable rules. Check local and state regulations before operating. Kawasaki recommends that all operators complete an approved boating safety course.
- See the Navigation Rules section in this chapter for basic navigation rules.
- Kawasaki recommends that the operator and passenger wear a U.S. Coast Guard approved vest-type personal flotation device (type 1, 2 or 3) at all times. Other countries may have their own standards and regulations; be sure to follow them.
- Do not exceed the capacity load limit of 150 kg (330 lb). Do not allow more than two persons to ride this watercraft at one time. Overloading this watercraft can adversely affect handling and stability which can lead to an accident.
- Check the throttle control and steering for proper operation before starting the engine. Malfunctioning controls can cause an accident.

## OPERATING INSTRUCTIONS 33

- Look carefully around you for other boats and objects in your path before starting and making quick maneuvers, especially before executing any quick turns. Because the watercraft is very maneuverable, other boaters may not be expecting you to turn as quickly as you are able (see the Turning the JET SKI Watercraft section).
- The passenger should hold on to the operator or hand strap while keeping both feet on the deck for balance at all times during operation, or he can lose balance and be injured.
- The operator must always keep the engine shut-off lanyard attached to himself while operating the watercraft. If the operator falls, the lanyard stops the engine (see the Starting the Engine section).
- Alcohol and drugs impair judgement and reaction time. Never drink and ride.
- Wear suitable eye protection while operating this watercraft. In some circumstances water spray can momentarily interfere with vision and create a hazard.
- Operator and passenger should wear foot protection at all times. Objects hidden underwater may injure your feet.
- Kawasaki recommends that the operator and passenger of personal watercraft wear protective swimwear such as wetsuit bottoms. Riders of personal watercraft may suffer injury due to the forceful injection of water into body cavities either by falling into the water or while mounting the craft.
- You must have thrust to turn. Releasing the throttle completely reduces the ability to steer and the watercraft can hit an object you are trying to avoid.
- Do not tow other watercraft, skiers, or objects behind this watercraft. The eyes in the bow and stern are designed only as tie-down points for transporting the craft. Towing anything can cause loss of steering control and create a hazardous condition. Also, other boat operators may not expect the watercraft to be towing anything.
- All operators of this watercraft must know the righting procedure because this craft will not self-right if it is capsized (see Righting the Capsized Watercraft in the Riding the JET SKI Watercraft section).
- Never operate the watercraft after dark. It was not designed for such use, and has no lighting equipment.
- Avoid operating the watercraft in waters full of weeds or debris, as they may clog the jet pump, and cause an injury if you fall.
- Do not operate in shallow water, or the impeller may be damaged and sand may clog the water cooling hoses.
- Be very careful of other boats, especially those towing water skiers. Give them plenty of room.
- Never go over a ski jump. You could damage the watercraft or injure yourself.
- Do not operate the watercraft in ocean surf. In addition to being dangerous, it may be illegal in certain localities.
- Slow down before crossing waves. Do not ride if you have a back condition. High speed operation in choppy or rough water may cause back injuries.

## 34 OPERATING INSTRUCTIONS

### CAUTION

Jumping waves can overstress the watercraft hull causing it to crack.

### Jet Pump Safety:

Although the jet pump is inherently safer than a propeller drive, certain safety precautions must always be observed.

### ⚠ WARNING

Keep your hands, feet, and clothing away from the jet pump intake (bottom of the boat, in the middle) and never stick anything into the pump outlet (steering nozzle at the back of the boat) whenever the engine is running, or a severe injury can occur.

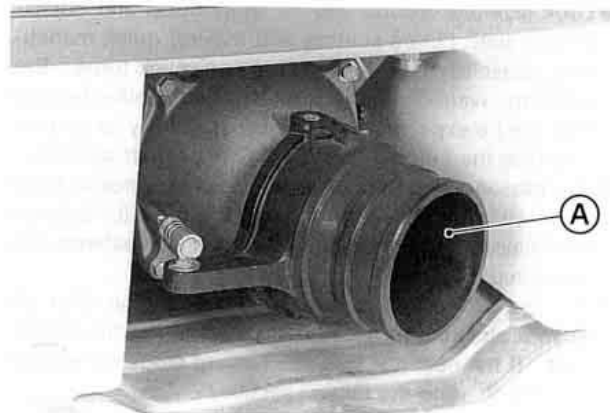
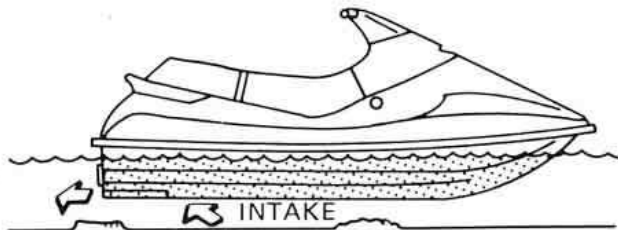

A. Steering Nozzle

### Personal Flotation Device and Safety Gear:

U.S. federal regulations require that one U.S. Coast Guard approved personal flotation device (PFD) be carried for each person aboard when operating on water under Coast Guard jurisdiction. In some state waters not under federal jurisdiction, other flotation devices are permissible in addition to those specified by federal law. Other countries may have their own standards and regulations; be sure to follow them. As a rule, waist-type ski belts do not qualify as adequate flotation devices. The full vest type is recommended. Check local regulations to see what type of personal flotation device may be required in your area.

**⚠ WARNING**

Drowning Hazard: a personal flotation device (PFD) must be worn by the operator and passenger. Kawasaki recommends that the operator and passenger wear a vest-type PFD (type 1, 2 or 3) at all times.

EYE PROTECTION

VEST-TYPE PERSONAL FLOTATION DEVICE

GLOVES (OPTIONAL)

WET SUIT

FOOT PROTECTION (DECK SHOES)

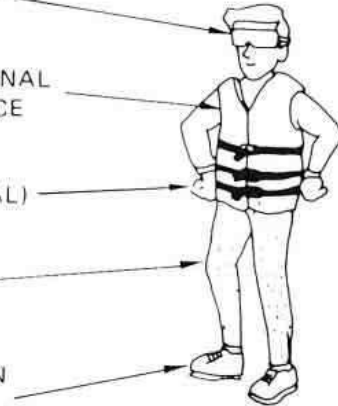

**⚠ WARNING**

In some circumstances water spray can momentarily interfere with vision which could be hazardous. Wear suitable eye protection while operating this watercraft.

Objects hidden underwater may injure your feet. Operator and passenger should wear foot protection at all times.

Riders of personal watercraft may suffer injury due to the forceful injection of water into body cavities either by falling into the water or while mounting the craft. Kawasaki recommends that the operator and passenger of personal watercraft wear protective swimwear such as wetsuit bottoms.

**Fire Extinguisher:**

A charged and functional fire extinguisher must be carried on board, and may be stored under the storage box in the bow (see the Storage Compartment/Box section in the GENERAL INFORMATION chapter). Be sure it is secured with the bands provided.

## 36 OPERATING INSTRUCTIONS

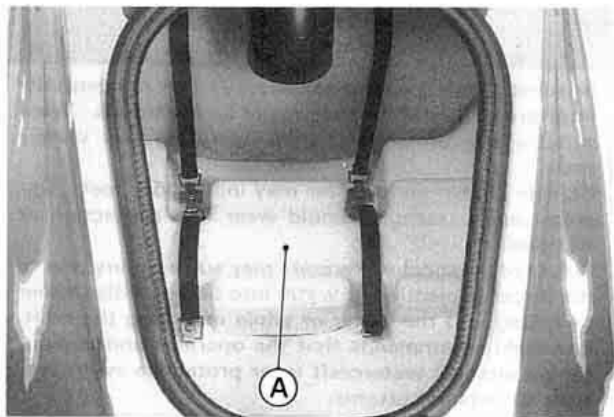

A. Store here.

Because the watercraft is a "Class A" inboard boat, federal regulations require that a fire extinguisher rated "B-1" (minimum 2 pound capacity) be aboard when operating on navigable waters under Coast Guard jurisdiction. In addition, most states, parks, and wildlife departments require that a U.S.C.G. approved fire extinguisher be carried aboard, even on waters not under federal jurisdiction.

Other countries may have their own standards and regulations; be sure to follow them.

Standard equipment does not include a fire extinguisher. Many owners prefer to provide their own fire extinguishers. If you wish, your dealer can furnish you with an approved Kawasaki accessory fire extinguisher (P/N. W99997-101).



### **⚠ WARNING**

Do not use your watercraft unless it has a fire extinguisher on board.

<https://www.boat-manuals.com/>

---

### Navigation Rules

---

The navigation rules or nautical "rules of the road" are like highway traffic laws. They dictate who has the right-of-way when boats meet in open water. As the boat operator you are obligated to know and obey these rules. They are also legally binding on boat operators.

This section provides basic navigation rules. We recommend that you obtain more information on navigation rules and navigation aids from your state when registering your craft. If you have never owned a boat before, an excellent introduction to the arts of boat handling and seamanship can be obtained from the U.S. Power Squadrons, the U.S. Coast Guard Auxiliary, or other volunteer organizations.

In nautical terms, the stand-on (privileged) boat has the right of way; and the give-way (burdened) boat must give way. Whenever you come near another boat, be cautious and use common sense. You cannot rely on other boaters to know or follow these rules.

#### Sailboats:

Sailboats have right-of-way over power boats in nearly all cases. Stay clear of these craft and do not create a wake which may cause them trouble.

#### Overtaking and Passing Situation:

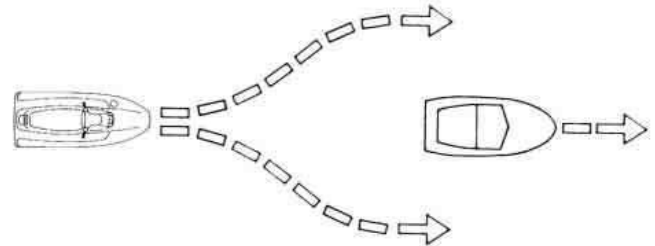

Give-way (Burdened)  
Vessel Overtaking

Stand-on (Privileged)  
Vessel Being Overtaken

If you are overtaking and passing another boat, the boat being passed has right-of-way, and you are required to stay clear.

## 38 OPERATING INSTRUCTIONS

### Meeting Situation:

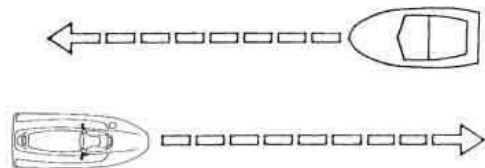

If you are meeting another power boat head on, neither you nor the other boat has right-of-way. Each boat should keep to its right.

### Crossing Situation:

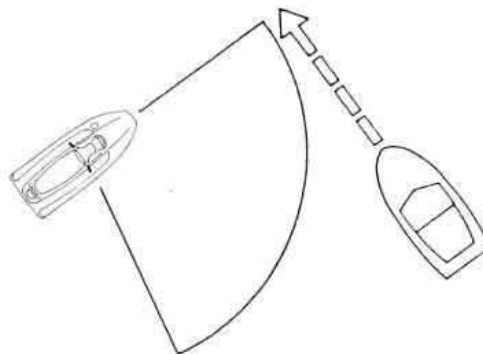

Give-way  
(Burdened)  
Vessel

Stand-on (Privileged) Vessel  
holds course and speed.

If you have another power boat on your right, the boat on the right has right-of-way. You must keep out of the way of the boat by directing your course to the starboard (right) and passing astern of (behind) the stand-on boat. If necessary, you may have to slow, stop, or reverse your craft to allow the stand-on boat to pass. Before passing behind another boat, look carefully for a water skier or any towed object. Pass behind the object in tow.

If you have another boat on the left, you have right-of-way. You must keep your course and speed.



---

## Pre-ride Checklist

---

Each day before using the watercraft, check the following items:

### Check Outside Craft:

- CLEAN PUMP – Clear the water inlet, jet pump, and drive shaft of foreign objects.
- PUMP COVER TIGHT – Check the jet pump cover and inlet grate for looseness. Tighten the mounting bolts, if needed.
- HULL DAMAGE – Inspect the hull for damage.
- DRAIN SCREW – Check that the drain screw in the stern is securely installed.
- STEERING – Check the operation of the steering for binding, rough spots, or excessive play. Adjust the cable if needed (see the Control Cable Adjustments section in the MAINTENANCE AND ADJUSTMENTS chapter). The steering cable is sealed at both ends and does not need lubrication. If the seals are damaged, the cable must be replaced.

### Check Inside Craft:

- THROTTLE CONTROL – Check the operation of the throttle for binding, rough spots or excessive play. Adjust the cable if needed (see the Control Cable Adjustments section in the MAINTENANCE AND ADJUSTMENTS chapter). The throttle lever must return to the fully closed position when released.

## ⚠ WARNING

If the throttle does not return freely and completely, it may cause loss of control.

- VENTILATE ENGINE COMPARTMENT – Open the storage compartment lid, take out the storage box and remove the seat, and keep open for several minutes to purge gasoline fumes from the engine compartment.

## ⚠ WARNING

A concentration of gasoline fumes in the engine compartment can cause a fire or explosion.

- FIRE EXTINGUISHER – Check your fire extinguisher for a full charge.
- FUEL PRESSURE – Loosen the fuel tank cap to relieve any pressure, then tighten the cap securely.
- FUEL LEVEL – Check the fuel level. Refill if necessary and turn the fuel knob to the ON position.
- BATTERY – Check that the electrolyte level in each cell is between the upper and lower level lines.
- ENGINE OIL LEVEL – Check the oil level in the oil tank. Refill if necessary.
- FUEL LEAKS – Check the engine compartment for fuel leaks.
- OIL LEAKS – Check the engine compartment for oil leaks.

## 40 OPERATING INSTRUCTIONS

- SEDIMENT BOWL – Drain any water out of the sediment bowl and clean it.
- FASTENERS – Check and tighten any loose bolts, nuts, or clamps.
- HOSE CONNECTIONS – Be sure all hose connections are secure and that all hose clamps are tight. Check all hoses for cracks or deterioration and replace if necessary.
- DRAIN BILGE – Drain any water out of the engine compartment by removing the drain screw. Install the drain screw securely when all the water has been drained.
- ENGINE SHUT-OFF LANYARD KEY – Start the engine and run it for a few seconds (see the Starting the Engine section). Pull the lanyard key off the engine stop button to check that the engine stops immediately.
- STOP BUTTON – Again start the engine, run it for a few seconds, and then check that the engine STOP button works.
- SEAT – Check that the seat latch is secure.
- RIDER PROTECTION – Always wear the proper flotation device and protective gear.

### **⚠ WARNING**

Do not run the engine in a closed area. Exhaust gases contain carbon monoxide: a colorless, odorless, poisonous gas. Breathing exhaust gas leads to carbon monoxide poisoning, asphyxiation, and death.

### **CAUTION**

Do not run the engine with the watercraft out of the water for more than 15 seconds at a time. Overheating will cause engine and exhaust system damage.

## OPERATING INSTRUCTIONS 41

---

### Break-In

---

A new watercraft should be ridden with care during the break-in period to allow mechanical components to "bed-in" and produce smooth, long wearing surfaces.

Kawasaki recommends use of a 50 : 1 gas/oil premix in the fuel tank for extra lubrication during the break-in period. Use premixed fuel for the first five hours (approx. three tanks of fuel). After the break-in period, the oil injection system provides the necessary engine lubrication without the need for premixed fuel. During the first five hours of engine operation, do not subject the engine to heavy lugging or prolonged full throttle operation. For this period, up to  $\frac{3}{4}$  throttle is recommended. Turn out the throttle limiter by  $\frac{1}{2}$  of its full travel from the unlimited position (throttle fully opening).

Vary the operating speed often, not running for a prolonged time at any one speed.

### Mixing:

A convenient way to mix fuel is to use a five gallon container. Add 12.8 ounces of oil to 2½ gallons of gas and mix thoroughly. Add another 2½ gallons of gas, and mix again to get the proper 50 : 1 ratio. Refer to the following chart for smaller quantities.

### Fuel Ratio Chart 50 : 1

Ounces of Oil to Gallons of Gas (U.S)			
Ounces of Oil	Gallons of Gas	Ounces of Oil	Gallons of Gas
2.6 oz	1.0 gal	7.7 oz	3.0 gal
3.8 oz	1.5 gal	9.0 oz	3.5 gal
5.1 oz	2.0 gal	10.2 oz	4.0 gal
6.4 oz	2.5 gal	12.8 oz	5.0 gal

### Recommended Oil

**Kawasaki JET SKI Oils or**

**N.M.M.A. Certified TC-W II or TC-W 3 Oils**

Careful treatment of the craft during the break-in period will result in more efficient, reliable performance and a longer life for the craft.

In addition to the break-in described above, we recommend that the owner take his watercraft to an authorized Kawasaki JET SKI dealer after the first ten hours of operation for initial maintenance service. See the Periodic Maintenance Chart in the MAINTENANCE AND ADJUSTMENTS chapter.

## 42 OPERATING INSTRUCTIONS

### Stopping the Engine

The engine can be stopped in one of the following two ways.

- Push the RED engine stop button. It is not necessary to hold the button "in" to stop the engine. After the engine stops, the STOP button resets itself and the engine is ready to start.
- Pull the engine shut-off lanyard key off the stop button. To start the engine the lanyard key must be pushed under the stop button.

#### **⚠ WARNING**

You have no directional control of the watercraft when the engine is stopped.

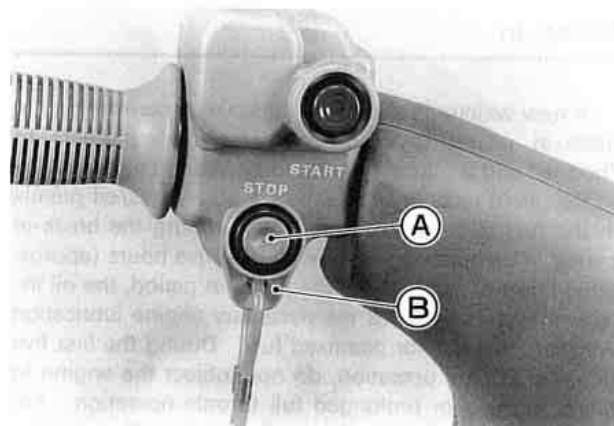

A. Engine Stop Button

B. Lanyard Key

If the engine must be stopped immediately in an emergency, push the RED engine stop button or pull the engine shut-off lanyard key off the stop button.

Some possible EMERGENCY situations are:

- The engine speeds out of control.
- The throttle lever will not release completely.

#### **⚠ WARNING**

If the throttle fails, do not operate the watercraft until the source of the problem is found and corrected.

## Starting the Engine

- Read the Pre-ride Checklist in this manual and follow its instructions before putting the watercraft in the water.
- After transporting or refueling and before starting the engine, open the storage compartment lid, take out the storage box and remove the seat for several minutes to ventilate the engine compartment.

### ⚠ WARNING

A concentration of gasoline fumes in the engine compartment can cause a fire or explosion.

- Place the watercraft in at least 0.6 m (two feet) of water which is clear of weeds and debris. Make sure the area ahead of the watercraft is clear of swimmers, boats, and obstacles.

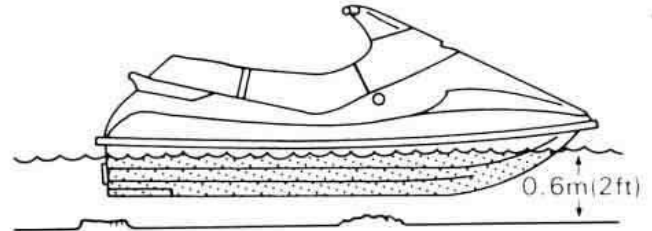

### CAUTION

The watercraft must be at least 0.6 m (2 ft) off the bottom when starting to prevent jet pump damage by objects sucked up from the bottom.

- Check that the fuel knob is in the ON position.
- In the seated position push the lanyard key under the stop button and put your left hand through the other end of the lanyard to attach it to your wrist. Pull the lanyard to make sure it is securely attached.

### NOTE

- The engine neither cranks nor starts with the lanyard key removed from the stop button.

## 44 OPERATING INSTRUCTIONS

- Turn the choke knob to the ON position (all the way clockwise) and apply a small amount of throttle.
- With your left hand, push the green start button and release it when the engine starts. If the engine does not start within 5 seconds, release the button. Wait 15 seconds before trying again. If the engine will not start after several attempts, see the TROUBLESHOOTING GUIDE chapter.

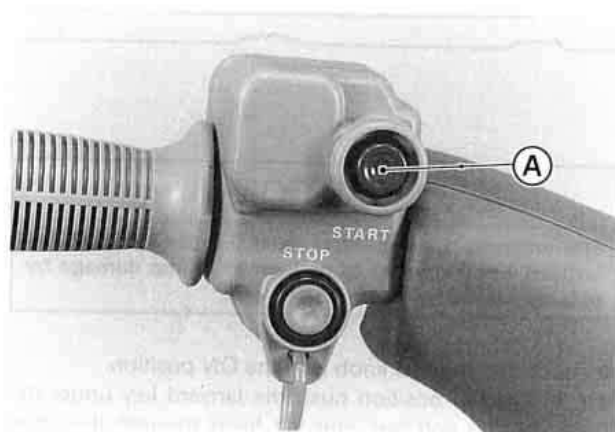

A. Start Button

### NOTE

- Wait 15 seconds between each operation of the starter. This will extend battery and starter life significantly.
- When the engine first fires, even if it doesn't actually start, turn the choke knob to the OFF position (all the

way counterclockwise). This will prevent engine flooding.

- When the engine is warm, the choke is not needed.

### CAUTION

Do not push the start button while the engine is running or while the starter is still spinning, as it will hasten starter wear and may cause the starter to jam.

- After the engine has started, allow it to warm up for about 1 minute. Apply a little throttle occasionally. Excessive idling can foul the spark plugs.
- Check that water comes out of the bypass outlet in the right side of the hull when the throttle is applied. This indicates that cooling water is circulating. If there is none, shut off the engine and find the source of the trouble. When the exhaust system is dry, it can take up to 15 seconds for water to appear at the bypass outlet.

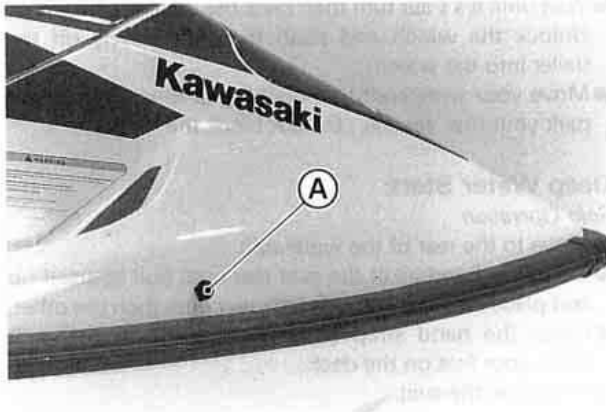

A. Bypass Outlet

---

### Launching

---

#### Launching from a Dock:

- Do not jump onto the watercraft from the dock.
- First place one foot on the deck near the dock, then while holding the handlebar and balancing the craft by transferring body weight straddle the craft and sit down on the seat.
- When leaving the dock, either push the watercraft away from the dock or run at a slight angle away from it until there is enough room for the rear of the craft to swing, since the watercraft turns at the stern and not at the bow.
- Check that the water in your path is clear and move the handlebar in the direction you want to go.

#### **⚠ WARNING**

Don't forget to watch out for other boats or obstructions in your path. This is especially critical during a beginner's first exciting ride.

- Apply the throttle to produce enough thrust from the jet pump to allow directional control over the watercraft.

## 46 OPERATING INSTRUCTIONS

### CAUTION

Avoid quick turns or acceleration when leaving the dock, or you might hit the dock and damage the watercraft. The operator should make sure there is room for a turn before making any quick maneuvers.

- Accelerate gradually as you proceed into open water. Remember to observe "No Wake" zones and speed limits.
- As speed increases the boat will level out in the water. This is called planing.
- Once the boat has planed, you can back off the throttle and select your desired speed.
- Keep alert for other boats, swimmers, or obstructions in your path.

#### Launching from a Ramp:

- Before putting the watercraft in the water be sure you have followed the Pre-ride Checklist.
- Before launching, check the ramp for suitable surface conditions, inclination and width for both the trailer and tow vehicle.
- Attach a bow line to the watercraft and detach the trailer tie-downs.

### CAUTION

Be sure the drain screw in the stern is securely installed to prevent the craft from flooding and swamping.

- Wait until it's your turn then back the trailer to the water. Unlock the winch and push the craft slowly off the trailer into the water.
- Move your watercraft to a docking or loading area and park your tow vehicle. Do not block the ramp.

#### Deep Water Start:

##### *Solo Operation*

- Move to the rear of the watercraft.
- Grasp the handrail at the seat rear end, pull yourself up and place one knee on the deck rear end, then the other.
- Grasp the hand strap and while balancing the craft place your feet on the deck.
- Sit astride the seat.

##### *Operator and Passenger*

- While the operator is balancing the craft, the passenger climbs aboard from the rear of the craft in the same way as in Solo Operation.

#### Shallow Water Start:

### CAUTION

The watercraft must be at least 0.6 m (2 ft) off the bottom when starting to prevent jet pump damage by objects sucked up from the bottom.



- You can board either from the side of the craft or from the rear. In either case balance the craft when going aboard for more stability.

---

### Stopping the JET SKI Watercraft

---

#### Normal Stopping:

#### **⚠ WARNING**

Never directly approach any moving or stationary object closer than 100 m (330 feet) when traveling at top speed. Always throttle down before approaching your intended stopping area.

This watercraft is stopped by using natural water drag to bring the craft to a halt.

1. Release the throttle before you reach your intended stopping area.
2. Coast towards the stopping area with the engine idling.

#### **CAUTION**

Stop the engine before the craft is less than 0.6 m (2 ft) off the bottom to prevent jet pump damage by objects sucked up from the bottom.

3. Press the engine stop button or pull the lanyard key off the stop button to come to a complete stop.

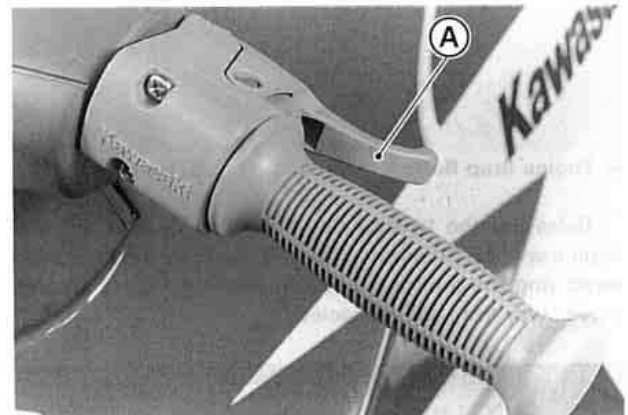

A. Throttle Lever

## 48 OPERATING INSTRUCTIONS

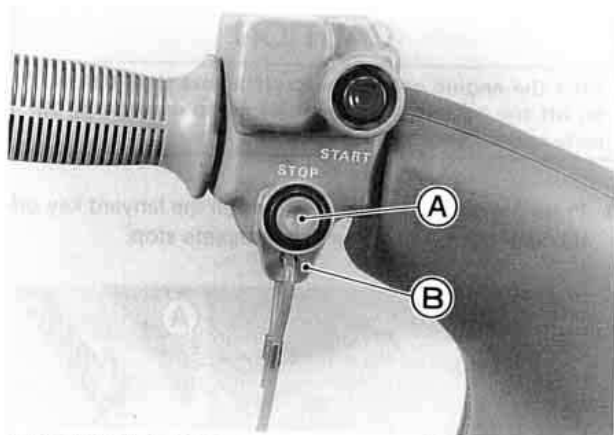

A. Engine Stop Button

B. Lanyard Key

Releasing the throttle slows forward motion but the engine will still be running, so you can steer the boat after reapplying the throttle. In this manner you can turn and move away from any obstacles.

### **⚠ WARNING**

Releasing the throttle completely reduces the ability to steer. This can cause you to hit an object you are trying to avoid. You must have thrust to turn, so keep the throttle on or apply throttle as needed to maintain thrust at the jet nozzle.

Push the engine stop button when you are approaching the shore and intend to stop. The engine stops im-

mediately, so it prevents sand or debris from entering and damaging the jet pump. Never run the engine in water less than 0.6 m (2 ft) deep.

### **⚠ WARNING**

Do not stop the engine if you may need to reapply throttle to quickly steer the watercraft. You have no directional control when the engine is stopped.

### **Stopping Skills:**

Stopping distance depends partially on rider and passenger weight and position, idle set speed, and operating speed. Experienced operators can usually shorten stopping distance by using various riding techniques. Turning the boat sharply (using the throttle) while stopping is a method which can be used to decrease stopping distance.

### **Minimum Stopping Distances:**

The minimum stopping distance of this watercraft with the operator and passenger from maximum speed is 63 m (207 ft).

This information represents results obtained under controlled conditions, and the information may not be correct under other conditions.

## OPERATING INSTRUCTIONS 49

---

### Turning the JET SKI Watercraft

---

Turning the watercraft requires a combination of two actions:

- Turning the handlebar
- Using the throttle

Point the handlebar to the left for a left turn



LEFT

Point the handlebar to the right for a right turn



RIGHT

Using the throttle is another important part of turning maneuvers. Applying the throttle produces thrust from the jet pump giving you directional control over the watercraft.

High thrust of the jet pump makes the boat turn more sharply.

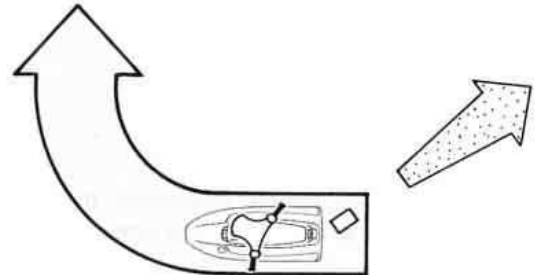

## 50 OPERATING INSTRUCTIONS

Low thrust of the jet pump makes the boat turn less sharply.

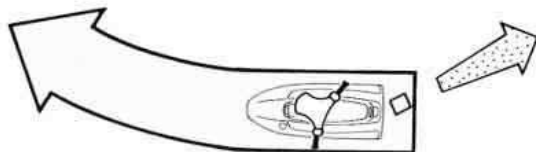

If you release the throttle completely, there is little thrust of the jet pump. The boat turns slowly and steering ability is reduced.

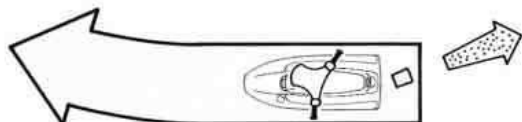

### **⚠ WARNING**

Releasing the throttle completely reduces the ability to steer. This can cause you to hit an object you are trying to avoid. You must have thrust to turn, so keep the throttle on or apply throttle as needed to maintain thrust at the jet nozzle.

If you stop the engine while riding, there is no thrust of the jet pump. The boat goes straight ahead even though the handlebar is turned.

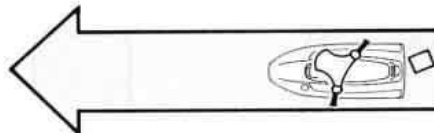

**NO THRUST = NO TURN**

### **⚠ WARNING**

**Do not stop the engine if you may need to reapply throttle to quickly steer the watercraft. You have no directional control when the engine is stopped.**

This is one characteristic of jet drive boats which is important to remember when you make an emergency maneuver: **YOU MUST HAVE THRUST TO TURN**, so keep the throttle on or apply throttle as needed to maintain thrust at the jet nozzle.

- Throttle down before entering a turn.

### **⚠ WARNING**

**This is a very maneuverable, sport watercraft. Quick turns or acceleration can cause the passenger to fall overboard, and can cause an accident with other boats. The operator should look carefully for other boats before making any quick maneuvers. The passenger should hold on during quick turns.**

### **Docking the JET SKI Watercraft**

- When docking use the throttle efficiently both to control the craft's speed and to keep directional control over the craft.
- When you are approaching the shore where you intend to land, push the engine stop button to prevent sand from entering the jet pump and the impeller. Do not operate the engine in water shallower than 0.6 m (2 ft).

### **CAUTION**

**Do not run the watercraft onto the shore, or severe impeller or hull damage may occur. Do not operate in shallow or debris-laden water, or the impeller may be damaged and sand may clog the water cooling hoses.**

- Remember that stopping the engine causes you to lose steering control, so cut the engine only after you have reduced speed and maneuvered into your final approaching position. You cannot make any emergency maneuvers with the engine stopped.

## 52 OPERATING INSTRUCTIONS

### Riding the JET SKI Watercraft

On your first ride, straddle the craft and sit down on the seat. Familiarize yourself with the handling of the boat. Vary the engine speed with the throttle lever to get the feel of throttle influence on steering.

#### **⚠ WARNING**

Never ride with your chin immediately above the handlebar. If you should hit a wave, you might injure yourself.

If the engine runs out of fuel (the low fuel warning light comes on), do not operate the choke knob. Turn the fuel knob to RES and push the green start button again.

Stay alert at all times, and keep away from other boats, swimmers, and obstructions.

#### **NOTE**

- *Since operating distance is limited when on RES, refuel at the earliest opportunity.*
- *Make certain that the fuel knob is turned to ON (Not RES) after filling up the fuel tank.*

#### **Fall Recovery:**

If the operator falls off the craft, the lanyard key is pulled off of the engine stop button and the engine is stopped immediately.

#### **⚠ WARNING**

When you fall, do not hang onto the handlebar. Let go, or you might injure yourself by striking the watercraft.

- The best way to hit the water is bottom first, legs together, with your arms over your head. This can help prevent injury from underwater objects.
- Go back aboard from the rear of the craft. Push the lanyard key under the stop button, and push the start button to start the engine.

#### **Righting the Capsized Watercraft:**

If the watercraft should capsize, the engine is stopped by the lanyard key being pulled off of the engine stop button by the operator. Follow this procedure immediately.

#### **⚠ WARNING**

This watercraft will not self-right if capsized. Operators must know the proper righting procedure or they could be stranded.

- Make sure the engine is stopped. If it is not stopped, immediately pull the lanyard key off the stop button or push the stop button to stop the engine.

### CAUTION

If the engine continues running with the craft capsized, water can enter the carburetor and engine causing damage to internal engine parts.

- Swim to the rear corner of the capsized craft.
- Push down on the side of the craft nearest you with one hand and reach across the hull and grasp the rear of the deck with the other, as though trying to pull yourself up onto the bottom of the hull.
- Now, push down on the rear corner of the hull with one foot, using your body weight to roll the capsized craft toward you.
- As the craft rolls over toward you, reach for the far side of the hull, if needed, and pull it on over.

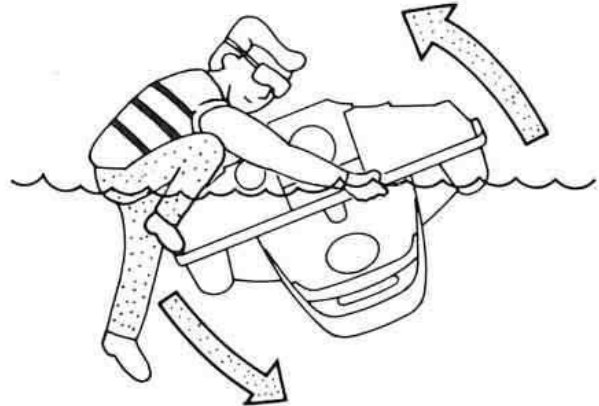

- Go back aboard from the rear. Push the lanyard key under the stop button, and push the start button to start the engine.

### NOTE

- If the watercraft has capsized, it should be run at full throttle for a while by a more experienced operator. This allows the bilge system to pump out water which may have accumulated in the engine compartment.
- If water gets inside the engine, a special procedure must be followed. For detailed instructions, see the "After Submerging" in the Special Procedures section.

## 54 OPERATING INSTRUCTIONS

---

### End of the Day Checklist

---

#### First, Drain the Exhaust System:

- Remove the watercraft from the water.
- Start the engine and run it for several seconds to purge the exhaust system of excess water. Rev the engine repeatedly, until water stops coming out of the exhaust at the stern.

### CAUTION

Never operate the engine at maximum speed out of the water. Severe engine damage may occur. Do not run the engine with the watercraft out of the water for more than 15 seconds at a time. Overheating will cause engine and exhaust system damage.

- After each use in salt water, flush the cooling system with fresh water (see the Cooling System Flushing section in the MAINTENANCE AND ADJUSTMENTS chapter). This will help prevent build up of salt deposits and eventual cooling system blockage.

#### Second, Clean the Engine Compartment:

- Remove the seat.
- If water has accumulated in the engine compartment, remove the drain screw in the stern to drain water out of the compartment. Be sure to reinstall the drain screw after draining.
- Wipe the engine compartment dry, and reinstall the seat.

- When the watercraft is ready for storage, leave the seat off, or block it up with 10 mm (one half inch) spacers to aid air circulation and prevent condensation from forming.

---

### Special Procedures

---

#### Clearing Clogged Impeller:

Occasionally, weeds or other debris may lodge in the impeller/jet pump, severely impairing performance. This foreign matter must be completely cleaned out for the jet pump to function properly.

- Shut off the engine, and beach the craft.

### ⚠ WARNING

Never attempt to clear the jet pump of debris while the engine is running, or a severe injury can occur. Stop the engine and pull the lanyard key off the stop button before checking the pump for debris.

- Pull the lanyard key off the stop button.
- Place a protective pad next to the boat.
- Tip the boat on its **right side** and remove the jet pump grate and cover, if necessary.



### CAUTION

Always turn the boat on its right side when rolling. Rolling to the left side can cause water in the exhaust system to run into the engine, with possible engine damage.

- Clean the water intake, drive shaft, impeller, jet pump housing, outlet, and steering nozzle of any seaweed, grass, or other debris.

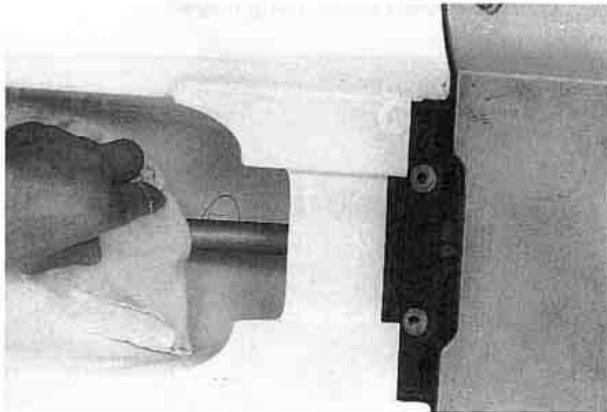

### CAUTION

Be sure the pump area and all its components are completely clear. Engine cooling water is supplied by the jet pump, and any loss of pump performance may cause overheating.

- Reinstall the jet pump cover and grate. Tighten the screws securely.

### Cleaning Fouled Spark Plugs:

Fouled spark plugs can result from several causes. Among them, low idle speed, prolonged idling, and operating with the choke on. Water in the fuel or inside the engine can also cause spark plug fouling.

- Remove the fouled spark plugs and install clean, dry plugs. Fouled plugs may be cleaned with electrical contact cleaner (P/N K61080-001B). Wet plugs may be cleaned with a penetrating rust inhibitor, such as WD40 or Bel-Ray 6 in 1.
- Start the engine, using very little throttle.

### After Submerging:

### CAUTION

If water gets into the engine, follow this procedure immediately! If water is left in the engine more than a few hours, it will destroy the crankshaft bearings and damage other internal engine parts.

## 56 OPERATING INSTRUCTIONS

If the watercraft becomes swamped, water may enter the engine through the carburetor intake. Water may also enter the fuel tank and oil tank.

1. Remove the craft from the water, and remove the seat.
2. Remove the drain screw in the stern to drain water out of the engine compartment.
3. Pull the spark plug caps from the spark plugs and push the caps fully onto the spark plug cap holder mounted on the electric case, and then remove the spark plugs.

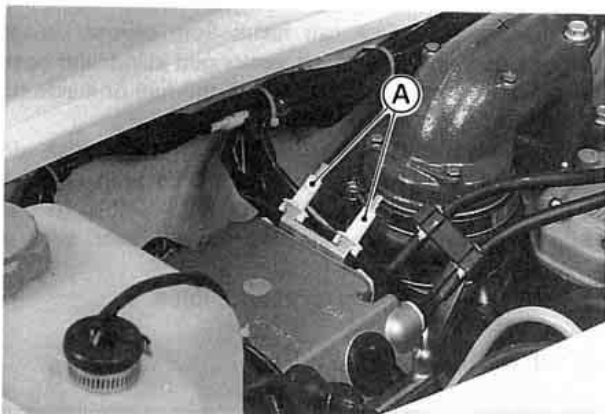

A. Spark Plug Cap Holder

4. Push the lanyard key under the stop button, and while pulling up the engine drain valve knob push the start button. Water in the engine will be pumped out of the crankcase.

### **⚠ WARNING**

Do not lean over the engine when performing this procedure. A water and gasoline mixture will be forcibly ejected from the spark plug holes and could get into your eyes. If you do get some in your eyes, wash your eyes immediately with liberal amounts of clean, fresh water. Consult a physician as soon as possible.

Do not operate the starter for longer than 5 seconds. Wait 15 seconds before using it again.

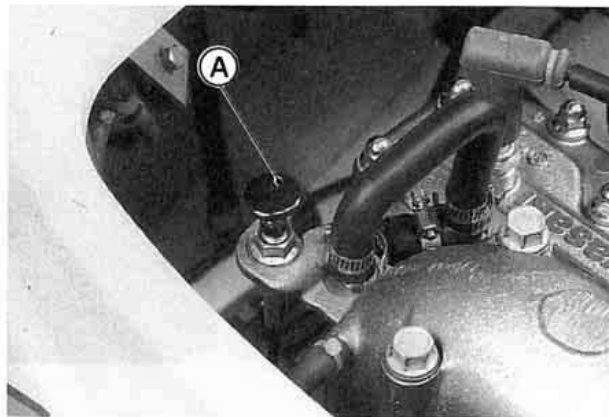

A. Drain Valve Knob

5. Release the drain valve knob.

6. With the engine drain valve knob pulled up, crank the engine over again to be sure all water is out of the engine.
7. Pull the spark plug caps off the spark plug cap holder.
8. Spray the spark plugs clean and install them and their caps.
9. Turn the choke knob to the ON position (clockwise) and start the engine.

### CAUTION

Do not run the engine with the watercraft out of the water for more than 15 seconds at a time. Overheating will cause severe engine and exhaust system damage.

Never operate the engine at maximum speed out of the water. Severe engine damage may occur.

10. If the engine will not start, remove the spark plugs and check them for presence of water. Spray them clean and try to start the engine again. Continued water fouling may indicate water in the fuel system.
11. If the fuel tank has water in it, it must be emptied by pump or siphon. Clean the filter screens (see the Fuel and Oil Systems section in the MAINTENANCE AND ADJUSTMENTS chapter). Refill the tank with fresh fuel. Do not dump contaminated fuel in places not designated for that purpose.

### ⚠ WARNING

Gasoline is extremely flammable and can be explosive under certain conditions. Pull the lanyard key off the stop button. Do not smoke. Make sure the area is well ventilated and free from any source of flame or sparks; this includes any appliance with a pilot light.

### ⚠ WARNING

Gasoline is a toxic substance. Dispose of gasoline properly. Contact your local authorities for approved disposal methods.



A. Siphon Hose

## 58 OPERATING INSTRUCTIONS

### NOTE

○ It may be necessary to repeat these procedures several times before all water is removed from the engine. Continued trouble may require disassembly of the fuel pump to drain water. See your dealer for this service.

12. If the oil tank has water in it, it must be emptied. Disconnect the oil intake hose from the oil pump and run the hose into a container.

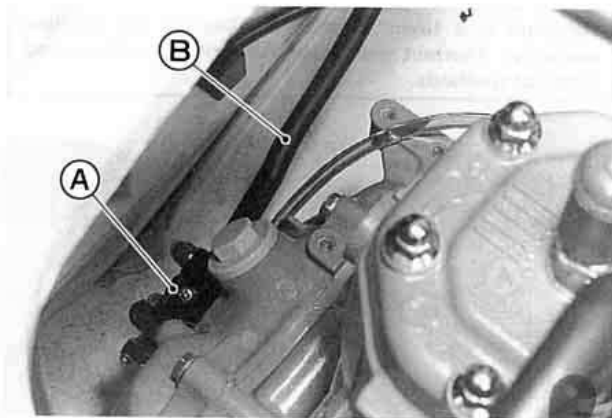

A. Oil Pump

B. Intake Hose

13. Reconnect the hose to the oil pump and refill with fresh engine oil. Do not dump contaminated engine oil in places not designated for that purpose.

### ⚠ WARNING

Engine oil is a toxic substance. Dispose of contaminated oil properly. Contact your local authorities for approved disposal methods or possible recycling.

14. Bleed the air inside the oil line (see the Fuel and Oil Systems section in the MAINTENANCE AND ADJUSTMENTS chapter).
15. Reinstall the seat and secure it.
16. Reinstall the drain screw in the stern.
17. Finally, run the craft IN WATER for at least 10 minutes to dry any remaining water and blow any foreign matter (like salt) out through the exhaust.

### Towing the JET SKI Watercraft:

In case you run out of fuel, have engine problems or other complications, the watercraft may be towed. Attach one end of a 6 m (20 foot) tow rope to the eye in the bow and the other end to the tow boat. Towing must be slow, not over 8 km/h (5 mph).

### CAUTION

It is important that these instructions be followed or the engine compartment could flood and the watercraft could partially submerge.

**Jump Starting:**

If your watercraft's battery is run down, it should be removed and charged. If this is not practical, a booster battery and jumper cables may be used to start the engine. The booster battery must be of the same voltage as the watercraft battery (12 V).

**⚠ WARNING**

Battery acid generates hydrogen gas which is flammable and explosive under certain conditions. It is present within a battery at all times, even in a discharged condition. Keep all flames and sparks (cigarettes) away from the battery. Wear eye protection when working with a battery. In the event of battery acid contact with skin, eyes, or clothing, wash the affected areas immediately with water for at least five minutes. Seek medical attention.

- Remove all the filler caps from both the booster and watercraft batteries.
- Lay a cloth over the open vents of each battery.
- Connect a jumper cable between the positive (+) terminals of the two batteries.
- Connect one end of the remaining jumper cable to the negative (-) terminal of the booster battery.

**CAUTION**

Connecting two batteries in reverse polarity (+ to -) can seriously damage the electrical system.

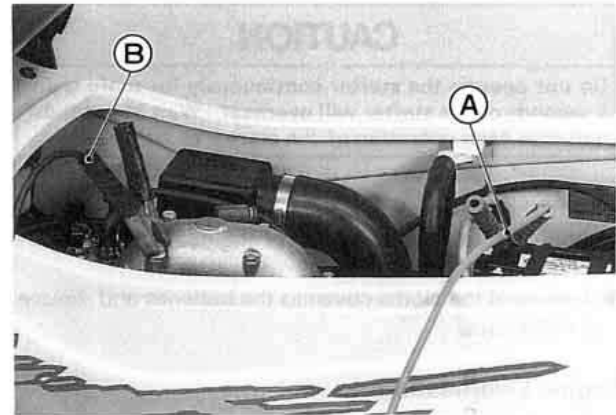

A. Positive Cable

B. Negative Cable

- Connect the other end of the remaining jumper cable to the exhaust pipe bolt.

**⚠ WARNING**

Do not make this last connection at the carburetor or battery. Take care that you do not short the cables together, and do not lean over the battery when making this last connection. Do not jump start a frozen battery. It could explode.

## 60 OPERATING INSTRUCTIONS

### CAUTION

Do not operate the starter continuously for more than 5 seconds or the starter will overheat. Wait 15 seconds between each operation of the starter to let it cool.

- Start the watercraft engine and then disconnect the jumper cables in the reverse of the sequence just described.
- Dispose of the cloths covering the batteries and replace the filler caps.

#### Engine Overheating:

This watercraft is equipped with a temperature sensor which turns on the cooling water temperature warning light and slows down the engine if the engine overheats.

- If the warning light comes on and the watercraft slows down, return to the shore immediately and check the cooling system for clogging.

### CAUTION

If engine overheats, the water temperature warning light comes on and the engine slows down. Return to shore immediately. To prevent engine damage, do not operate the craft until the cause of overheating is corrected.

### Transporting

- When transporting the watercraft on a trailer, observe the trailer laws and regulations in your area.
- Be sure the trailer matches with the craft's weight and hull design.
- Turn the fuel knob to the "OFF" position.
- Securely fasten the watercraft to prevent movement between the craft and trailer.

### CAUTION

Never attach tie-downs to the handrail behind the seat.

## STORAGE

During the winter, or whenever your watercraft will not be in use for more than 30 days, proper storage is essential. It consists of checking and replacing missing or worn parts; lubricating parts to ensure that they do not become rusted; and, in general, preparing the watercraft so that when the time comes to use it again, it will be in top condition. See your Kawasaki JET SKI dealer for this service or do the following.

---

### Preparation for Storage

---

#### Cooling System:

- Clean the cooling system (see the Cooling System Flushing section in the MAINTENANCE AND ADJUSTMENTS chapter).

#### Bilge System:

- Clean the bilge system (see the Bilge System Flushing section in the MAINTENANCE AND ADJUSTMENTS chapter), but before reconnecting the hoses to the plastic breather fitting, blow air through both hoses to force all water out of the bilge system.

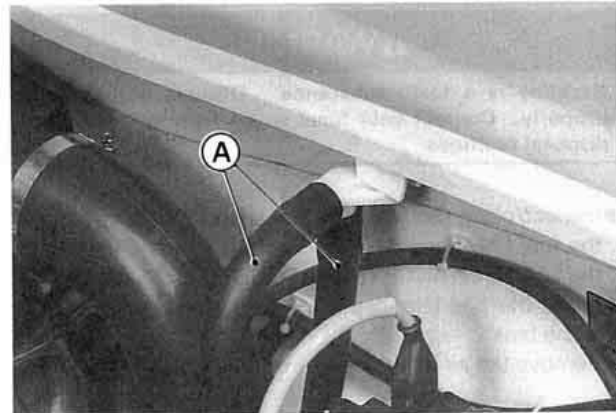

A. Blow through both hoses.

#### Fuel System and Engine:

- Wash the engine compartment with fresh water and remove the drain screw in the stern to drain the water. Wipe up any water left in the compartment.

### **⚠ WARNING**

Gasoline is extremely flammable and can be explosive under certain conditions. Pull the lanyard key off the stop button. Do not smoke. Make sure the area is well ventilated and free from any source of flame or sparks; this includes any appliance with a pilot light.

## 62 STORAGE

- Drain the fuel tank. This should be done with a siphon or pump.

### ⚠ WARNING

Gasoline is a toxic substance. Dispose of gasoline properly. Contact your local authorities for approved disposal methods.

- Inspect/clean the fuel filter screens and inspect/replace the fuel filter (see the Fuel and Oil Systems section in the MAINTENANCE AND ADJUSTMENTS chapter).
- Leave the fuel filler cap loose to prevent condensation in the tank.
- Remove the air intake cover from the carburetor.

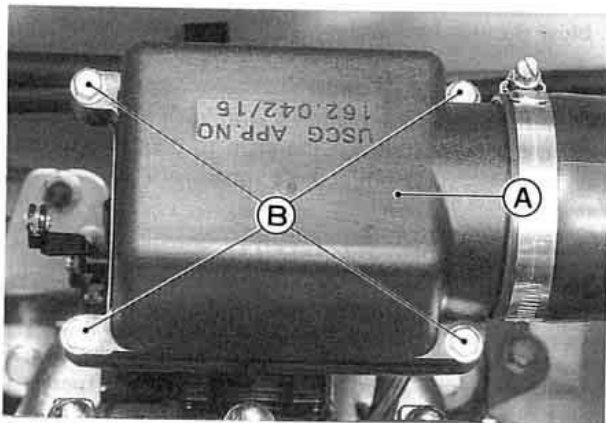

A. Air Intake Cover

B. Bolts

- Take out the flame arrester element and wash in soap and water. Allow to air dry, then reinstall the flame arrester element. Both sides are identical.

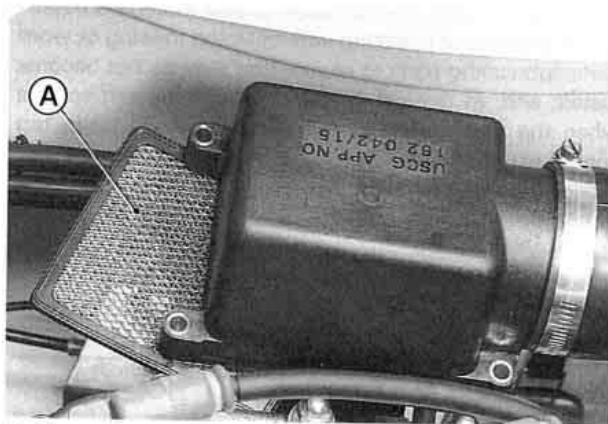

A. Flame Arrester Element

- Turn the ignition switch on.
- Push the lanyard key under the stop button, start the engine, and run it in fifteen second periods until all the fuel in the carburetor is used up. Wait five minutes between fifteen second running periods. While the engine is running, spray a fogging oil, such as Kawasaki K-Kare Fogging Oil (part number K61030-002), into the carburetor opening.



**CAUTION**

Do not run the engine with the watercraft out of the water for more than 15 seconds at a time. Overheating will cause severe engine and exhaust system damage.

- Reinstall the air intake cover, tightening the bolts securely.
- Remove the spark plugs and push the plug caps fully onto the plug cap holder on the electric case.
- Spray fogging oil directly into each cylinder.
- Turn the engine over several times with the start button to coat the cylinder walls.

**⚠ WARNING**

Do not lean over the engine when performing this procedure. An air/oil mist may be forcibly ejected from the spark plug holes and could get into your eyes. If you do get some in your eyes, wash your eyes immediately with liberal amounts of clean, fresh water. Consult a physician as soon as possible.

- Spray the spark plugs with fogging oil, and reinstall them.
- Pull the lanyard key off the stop button and turn the ignition switch off.
- Reinstall the spark plug caps.

**Battery:**

- Remove the battery (see the Battery section in the MAINTENANCE AND ADJUSTMENTS chapter).
- Clean the exterior with a solution of baking soda and water (one heaping tablespoon of baking soda in one cup of water). Rinse thoroughly with water.

**CAUTION**

Do not allow any soda solution to enter the battery.

- Check the electrolyte and fill to the upper level mark with distilled water, if necessary.
- Check the specific gravity with a hydrometer and recharge if necessary.
- Cover both battery terminals with grease.
- Store the battery in a cool, dry place. Do not expose it to freezing temperatures.

**NOTE**

- *Check the battery at least every 30 days and recharge if necessary. A neglected battery will gradually lose its charge and begin to sulfate (plates turn white). Once this reaction has begun, the battery usually cannot be salvaged.*

## 64 STORAGE

### Cleaning:

- Wash the exterior and dry it thoroughly.

### CAUTION

Use only a mild detergent in water to wash the watercraft. Harsh solvents may attack the surface or smear the colors.

- Apply a good grade of wax to all exterior hull surfaces.
- Lightly spray all exposed metal parts with a penetrating rust inhibitor, such as WD40 or BEL-RAY 6 in 1 to prevent corrosion.
- Remove the seat, or block it up with 10 mm (one half inch) spacers to insure adequate ventilation and prevent condensation from forming.
- Cover the watercraft and store it in a clean, dry place.

### Lubrication:

- Carry out all recommended lubrication procedures (see the Lubrication section in the MAINTENANCE AND ADJUSTMENTS chapter).

---

## Removal from Storage

---

The following procedure explains the steps necessary to put the watercraft back in service following a storage period. See your Kawasaki JET SKI dealer for this service, or do the following. See the MAINTENANCE AND ADJUSTMENTS chapter for detailed procedures.

- Carry out all recommended lubrication procedures (see the Lubrication section).
- Check for binding or sticking throttle, choke or steering mechanism. The throttle lever must return fully when released.
- Clean and gap spark plugs (see the Spark Plugs section).
- Check all rubber hoses for weathering, cracking, or looseness.
- Turn the craft on its **right side** on a protective pad, and remove the jet pump cover. Check cooling and bilge hoses for weathering, cracking or looseness.
- Replace them if necessary. Reinstall the cover and tighten securely.
- Check that the drain screw in the stern is securely tightened.
- Check the fire extinguisher for a full charge.
- Check the battery, charge if necessary, and clean the terminals. Install the battery (see the Battery section).
- Inspect/replace the fuel filter screens and fuel filter (see the Fuel and Oil Systems section).
- Inspect the fuel vent check valve (see the Fuel and Oil Systems section).

- Fill the fuel tank with fuel and close the filler cap securely.

### **⚠ WARNING**

Gasoline is extremely flammable and can be explosive under certain conditions. Pull the lanyard key off the stop button. Do not smoke. Make sure the area is well ventilated and free from any source of flame or sparks; this includes any appliance with a pilot light.

- After transporting or refueling and before starting the engine, open the storage compartment lid, take out the storage box and remove the seat for several minutes to ventilate the engine compartment.

### **⚠ WARNING**

A concentration of gasoline fumes in the engine compartment can cause a fire or explosion.

- Check for fuel leaks. Repair if necessary.
- Check/clean the oil filter.
- Check the engine oil level. Fill the oil tank with the specified oil.

### **⚠ WARNING**

Do not run the engine in a closed area. Exhaust gases contain carbon monoxide: a colorless, odorless, poisonous gas. Breathing exhaust gas leads to carbon monoxide poisoning, asphyxiation, and death.

- Start the engine and run it for 15 seconds. Check for fuel, oil and exhaust leaks. Any leaks must be repaired.

### **CAUTION**

Never run the engine with the watercraft out of the water for more than 15 seconds. Overheating will cause severe engine and exhaust system damage. Do not run the engine at maximum speed out of the water. Severe engine damage may result.

- Install the seat making sure it is locked.

## 66 MAINTENANCE AND ADJUSTMENTS

### MAINTENANCE AND ADJUSTMENTS

#### Periodic Maintenance Chart

#### NOTE

○ Complete the Pre-Ride Checklist before each outing.

Description	Frequency	Initial 10 Hours	Every 25 Hours	Every 100 Hours
Check all hose clamps, nuts, bolts, and fasteners		●	●	
* Torque cylinder head nuts		●	●	
Lubricate throttle cable fitting and choke cable fitting at carb			●	
Clean and gap spark plugs (replace if necessary)			●	
Check battery level and terminals			●	
Lubricate choke cable and throttle cable, and throttle cable fitting at throttle case			●	
Lubricate steering cable ball joints and steering nozzle pivots			●	
* Lubricate handlebar pivot			●	

## MAINTENANCE AND ADJUSTMENTS 67

Description	Frequency	Initial 10 Hours	Every 25 Hours	Every 100 Hours
* Inspect/clean fuel filter screens			●	
* Inspect/replace fuel filter				●
Inspect fuel vent check valve			●	
Adjust carburetor			●	
Flush bilge line and filter			●	
Flush cooling system (after each use in salt water)			●	
Inspect/clean flame arrester			●	
* Inspect impeller blades for damage (remove)				●
* Inspect/replace coupling damper				●
* Inspect carburetor throttle shaft spring (replace carburetor if necessary)				●
* Inspect steering cable				●

\* These items must be performed with the proper tools. See your authorized Kawasaki JET SKI dealer for service, unless you have the proper equipment and mechanical proficiency (refer to the Service Manual).

## 68 MAINTENANCE AND ADJUSTMENTS

### Control Cable Adjustments

#### *Choke Cable Adjustment*

- When the choke knob is turned to the OFF position, the choke butterfly valve in the carburetor should be completely open. Check that the choke pivot arm is up all the way with minimal cable slack.

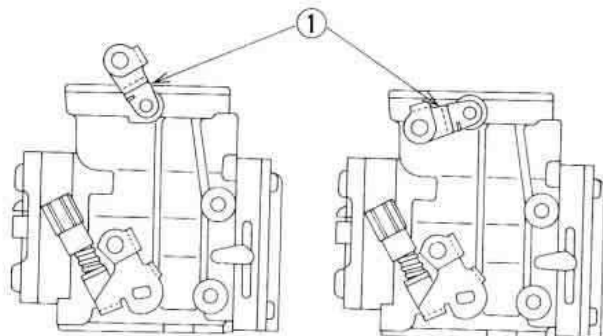

CHOKE OPEN  
(TURNED TO OFF)

CHOKE CLOSED  
(TURNED TO ON)

1. Choke Pivot Arm

- If necessary, adjust the choke cable.
- Turn the choke knob to the OFF position (counterclockwise).
- Loosen and turn the locknuts at the carburetor control bracket to allow a little cable slack.
- Tighten the locknuts securely.

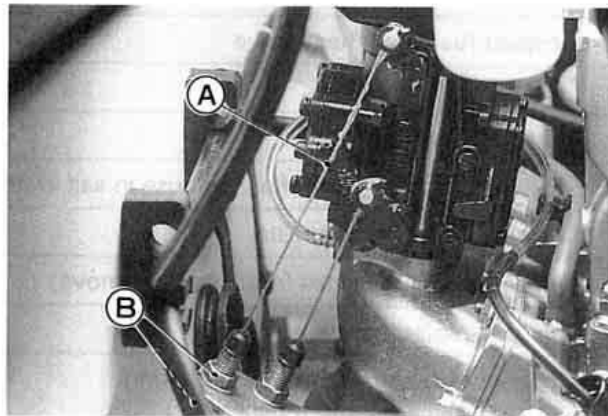

A. Choke Cable

B. Locknuts

## MAINTENANCE AND ADJUSTMENTS 69

### Throttle Cable Adjustment

- Check throttle cable adjustment.
- With the throttle lever released, the lower stop on the throttle pivot arm should rest against the idle adjust screw, and there should be slight slack in the throttle cable.
- When the throttle lever is fully applied (pulled), the upper stop on the pivot arm should be all the way up against the stop on the carburetor.

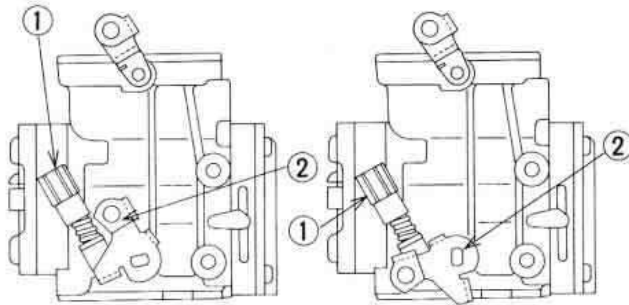

THROTTLE CLOSED  
(RELEASED)

THROTTLE OPEN  
(APPLIED)

- 1. Idle Adjust Screw
- 2. Throttle Pivot Arm

- If necessary, adjust the throttle cable.
- Loosen and turn the locknuts at the carburetor control bracket until the lower stop on the pivot arm hits against the idle adjust screw with slight cable slack.
- Tighten the locknuts securely.

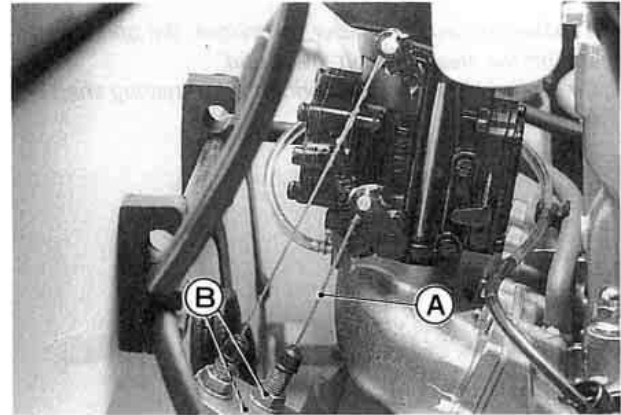

A. Throttle Cable

B. Locknuts

## 70 MAINTENANCE AND ADJUSTMENTS

### Steering Cable Adjustment

- Center the handlebar in a straight ahead steering position.

### NOTE

- It makes adjustment easier to unhook the spring right end off the steering shaft lower end.
- Be sure to reconnect the spring to the steering shaft after adjustment.



- Check that the steering nozzle is the same distance from each side of the pump cavity.

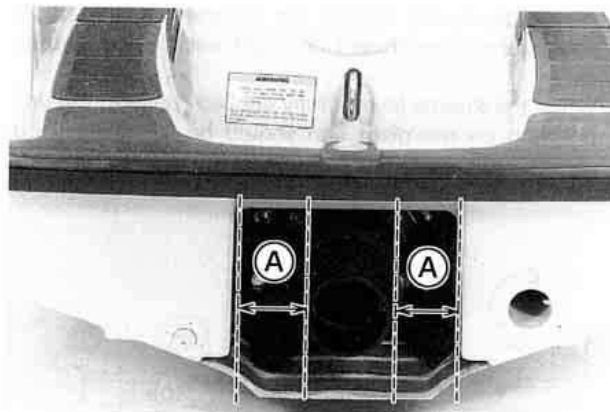

A. Equal

- If it is not, adjust the steering cable.



## MAINTENANCE AND ADJUSTMENTS 71

- Loosen the locknut on the end of the steering link located to the left of the steering nozzle.

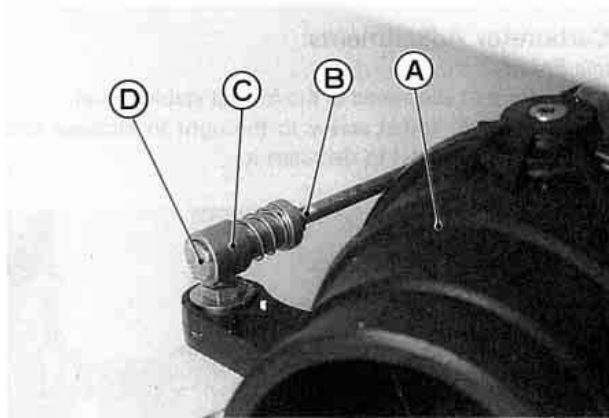

A. Steering Nozzle  
B. Locknut

C. Sleeve  
D. Ball Joint

- Slide back the outer sleeve and take the ball joint off the ball.
- Center the handlebar in a straight ahead steering position.

- Turn the ball joint until the hole in it aligns with the ball when the steering nozzle is positioned in the center of the pump cavity.

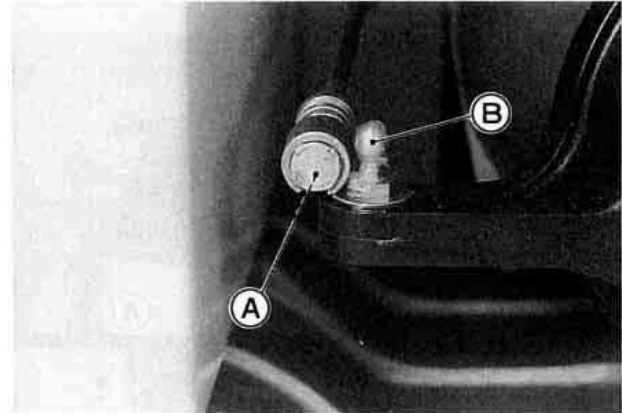

A. Hole

B. Ball

- Reattach the ball joint and check cable adjustment again.
- When adjustment is correct, tighten the locknut.

## 72 MAINTENANCE AND ADJUSTMENTS

- As an additional check, turn the handlebar all the way to the left and right, and measure the distance between the nozzle and the edge of the pump cavity. It should be equal at both extremes.

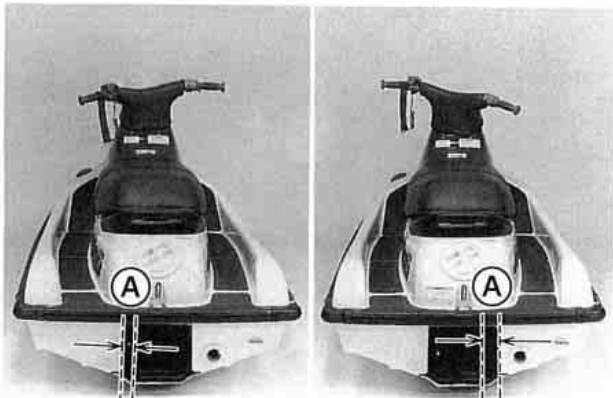

A. Equal

### *Steering Cable Inspection*

Steering cable inspection is best performed by your authorized Kawasaki JET SKI dealer. If the steering feels rough or "catchy," have your dealer inspect the steering cable.

### **NOTE**

- *The steering cable is sealed at each end and does not require lubrication.*

---

## Fuel and Oil Systems

---

### **Carburetor Adjustments:**

#### *Idle Speed*

The normal idle speed is the lowest stable speed.

- Turn the idle adjust screw to the right to increase idle speed or to the left to decrease it.

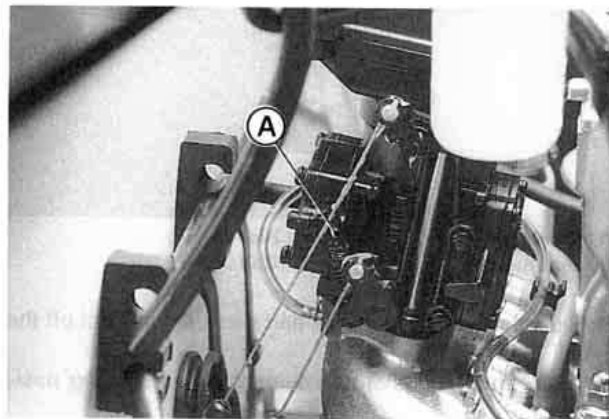

A. Idle Adjust Screw

#### **Idle Speed**

About 1 250 rpm – in water

About 1 700 rpm – out of water

## MAINTENANCE AND ADJUSTMENTS 73

### Mixture Screws

Every carburetor is adjusted individually at the factory for optimum performance under most conditions. **DO NOT CHANGE THESE SETTINGS.**

### NOTE

○ *If adjustment is needed, have it performed by your authorized Kawasaki JET SKI dealer.*

### High Altitude Use

The original carburetor settings for this watercraft are best for sea level use. When the craft is used at high altitude, the thinner atmosphere makes the air/fuel mixture richer reducing performance and increasing fuel usage. Have the carburetor adjusted by your authorized Kawasaki JET SKI dealer if you intend to use this craft above 3,000 feet (1,000 m).

### Fuel Vent Check Valve:

The fuel tank is equipped with a rubber vent hose which terminates in the sediment bowl. A small plastic check valve mounted in the vent hose allows air to enter the tank, but minimizes fuel spillage when the craft is tipped over. Inspect the check valve in accordance with the **Periodic Maintenance Chart**.

### Fuel Vent Check Valve Inspection

#### **⚠ WARNING**

Loosen the fuel filler cap to relieve pressure before disconnecting any fuel lines.

- Remove the check valve from the fuel vent hose to the sediment bowl.

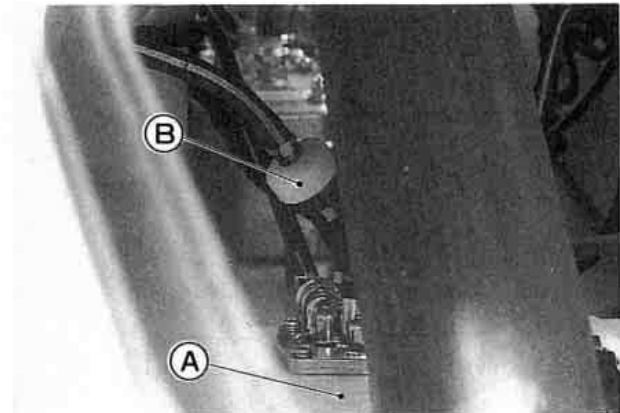

A. Fuel Tank

B. Check Valve

## 74 MAINTENANCE AND ADJUSTMENTS

- Try to blow through each end of the check valve.  
Air should pass through freely in this direction:

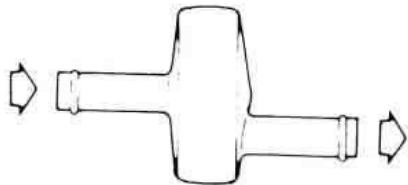

and not in this direction:

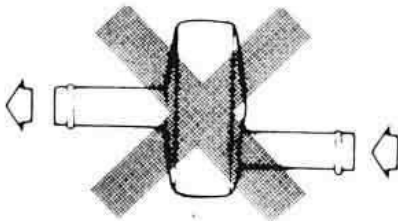

- If the check valve fails one of these tests, it must be replaced.
- Install the check valve with the arrow pointing toward the fuel tank.

### Sediment Bowl:

The rubber vent hose has a sediment bowl to prevent water from entering the fuel tank.

Drain any water out of the sediment bowl and clean it.

#### *Sediment Bowl Cleaning*

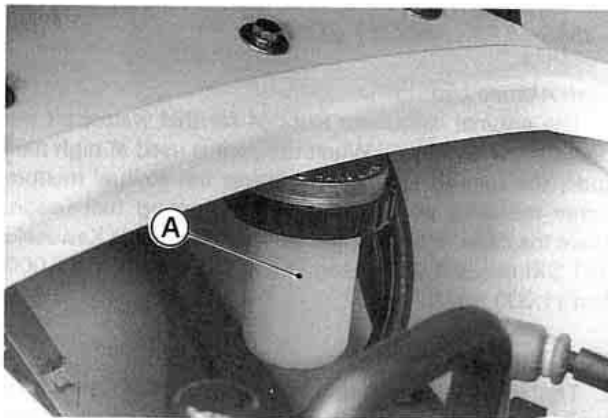

**A. Sediment Bowl**

- Unscrew the sediment bowl ring, and remove the bowl.
- Drain and clean the bowl.

## MAINTENANCE AND ADJUSTMENTS 75

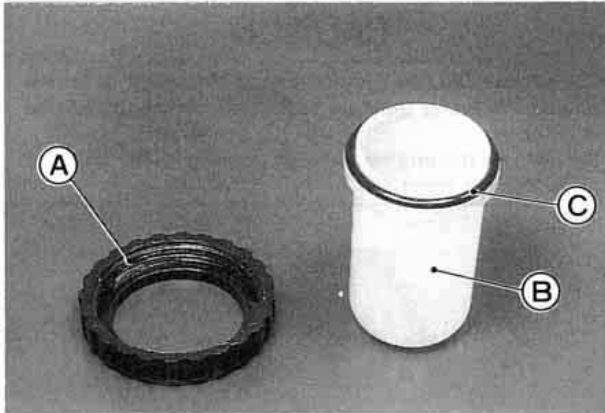

A. Ring  
B. Sediment Bowl

C. O-ring

- Install the bowl with its large O-ring, tightening the sediment bowl ring securely.

### Fuel Filter Screens/Fuel Filter:

The watercraft is equipped with fuel filter screens on the fuel outlet assembly and a fuel filter at the middle of the fuel line to prevent dirt or other foreign material from entering the carburetor.

Have your Kawasaki JET SKI dealer inspect and clean or replace the screens and fuel filter in accordance with the **Periodic Maintenance Chart**, or whenever you find from outside any foreign material or water trapped in the fuel filter.

### Oil Filter:

The oil tank is equipped with an oil filter in the oil filler. Check the oil filter for foreign particles every time you add the oil. If there are any foreign particles, the oil filter must be cleaned.

#### *Oil Filter Cleaning*

- Take out the oil filter out of the oil filler.

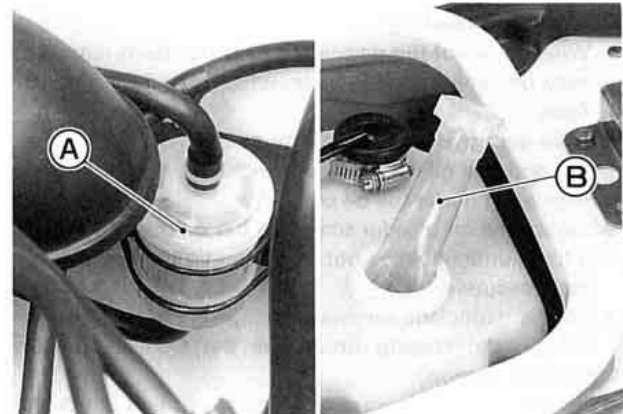

A. Fuel Filter

B. Oil Filter

- Wash the oil filter in a non-flammable or high flash-point solvent. Use a brush to remove any contaminants trapped in the filter.

## 76 MAINTENANCE AND ADJUSTMENTS

### **⚠ WARNING**

Clean the oil filter in a well ventilated area, and take care that there are no sparks or flame anywhere near the working area; this includes any appliance with a pilot light. Do not use gasoline or a low flash-point solvent to clean the filter. A fire or explosion could result.

### **CAUTION**

The engine must be running before the water is turned on and the water must be turned off before the engine is stopped.

Do not run the engine without cooling water flow for more than 15 seconds.

### **Oil Pump Bleeding:**

When either of the oil pump hoses has been removed, air may become trapped inside, which will then obstruct oil flow.

- Make sure that there is plenty of engine oil in the oil tank and that oil flow is not restricted.
- Place a rag under the oil pump.
- Loosen the air bleeder screw on the oil pump a couple of turns until oil flows out, and then tighten the bleeder screw securely.
- Provide sufficient engine cooling by running water through the cooling hose (see the Cooling System Flushing section).
- Start the engine, keep it at idling speed and check the oil flow through the transparent outlet hose.
- Keep the engine running until the air bubbles in the outlet hose disappear.

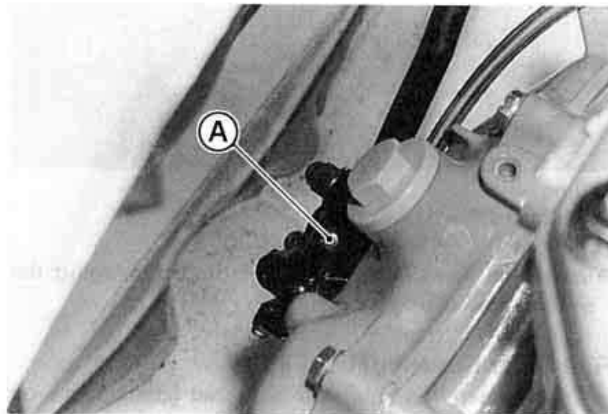

**A. Bleeder Screw**

## MAINTENANCE AND ADJUSTMENTS 77

### Spark Plug

The standard spark plug is NGK BR8ES set to a 0.7 – 0.8 mm (0.028 – 0.032 inch) gap. Since the engine is water-cooled and is generally operated at a constant throttle opening, cylinder head temperature is relatively stable. For this reason, if the engine is in good condition and properly tuned, and the oil pump is operating properly, it should not be necessary to use a spark plug of a different heat range. Since a spark plug of the wrong heat range can cause extensive engine damage, only the standard spark plug is recommended.

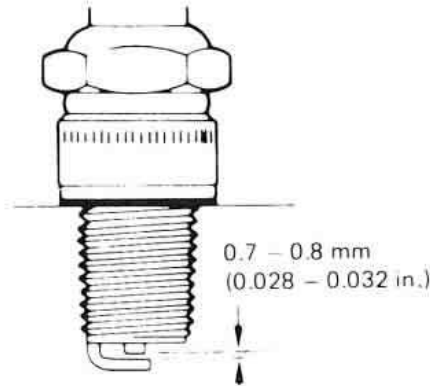

#### *Spark Plug Inspection and Replacement*

Remove the spark plugs and inspect the ceramic insulators. The appearance of the insulators reflects the

efficiency of the combustion process. When the engine is operating properly, the plug insulators should be clean and show a light brown color. If the insulators look glazed or very white, if the electrodes appear overheated, or if there are gray metallic deposits on the plugs, combustion chamber temperatures are too high. Refer to the TROUBLESHOOTING GUIDE.

### CAUTION

**As excessive operating temperature can cause serious engine damage, the cause should be located and corrected immediately.**

A dry, sooty black deposit on the insulators indicates an overly rich fuel/air mixture. Check for correct carburetor adjustment. If the black deposits are wet and oily, an improper oil type or an excessive oil pump output may be the cause. Refer to the TROUBLESHOOTING GUIDE.

Clean the electrodes and the ceramic insulators around the center electrode by scraping off any deposits or by using a sand blasting device. Make sure that all abrasive particles are removed from the plug and clean the plug in a high flash-point solvent. If the gap has widened, reset it to the standard 0.7 – 0.8 mm (0.028 – 0.032 inch) gap. If the electrodes are badly worn or burned, replace the plug. The spark plug must also be replaced any time there is visible damage such as cracked ceramic or damaged threads.

## 78 MAINTENANCE AND ADJUSTMENTS

### Battery

In accordance with the **Periodic Maintenance Chart**, inspect the battery electrolyte level and clean the terminals.

#### **⚠ WARNING**

Heed the battery safety label shown here.

#### **DANGER EXPLOSIVE GASES**

Cigarettes, flames or sparks could cause battery to explode. Always shield eyes and face from battery. Do not charge without proper instruction and training. Connect cables to the proper terminals securely. Check vent tube to avoid any crimping or obstruction to the tube.

#### **KEEP FILLING PLUGS TIGHT AND LEVEL**

#### **POISON CAUSES SEVERE BURNS**

Contains sulfuric acid. Avoid contact with skin, eyes, or clothing. In event of accident flush with water and call a physician immediately.

**KEEP OUT OF REACH OF CHILDREN**

### Electrolyte Level:

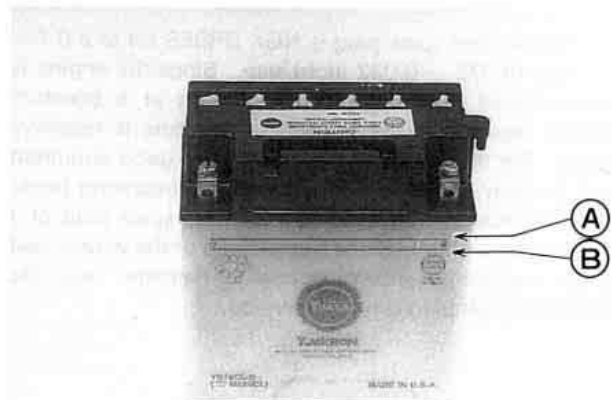

A. Upper Level Mark

B. Lower Level Mark

Keep the electrolyte level between the upper and lower level marks on the side of the battery case. When it gets low, remove the battery filler caps and add only distilled water until the electrolyte level in each cell reaches the upper level mark.

#### **CAUTION**

Add only distilled water to the battery. Ordinary tap water contains impurities which will shorten the life of the battery.



## MAINTENANCE AND ADJUSTMENTS 79

### Battery Charging:

Removal and charging of the battery is necessary when the electrolyte specific gravity reading is below 1.20 at 20°C (68°F).

### Battery Removal

### CAUTION

Always remove the battery from the craft for charging. If the battery is charged while still installed, battery electrolyte may spill and corrode parts of the craft.

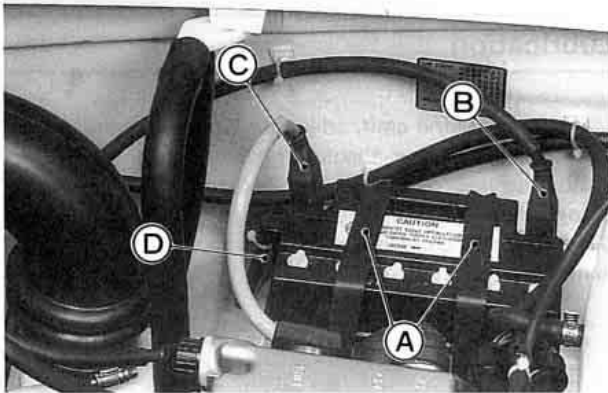

A. Straps

B. Black (ground) Lead

C. Red Lead

D. Vent Hose

- Disconnect the black (ground) lead from the battery first.
- Disconnect the red lead.
- Pull the vent hose off the battery.
- Release the two rubber hold-down straps securing the battery.
- Lift the battery out of the hull.
- Clean the terminals.

### Battery Charging

### ⚠ WARNING

Keep the battery away from sparks and open flame during charging, since the battery gives off an explosive gas mixture of hydrogen and oxygen. When using a battery charger, connect the battery to the charger before turning on the charger. This procedure prevents sparks at the battery terminals which could ignite any battery gases.

- Leaving the caps off the cells, connect the battery to a charger. Set the charging rate at 1.9 amps, and charge it for 10 hours.

### CAUTION

If the temperature of the electrolyte rises above 45°C (115°F) during charging, reduce the charging rate to bring down the temperature and increase charging time proportionately.

## 80 MAINTENANCE AND ADJUSTMENTS

- After charging, check the electrolyte level in each cell. If the level has dropped, add distilled water to bring it back up to the upper level mark.
- Check the results of charging by measuring the specific gravity of each cell, and by measuring battery voltage. The specific gravity of the electrolyte should be equal to that of the electrolyte which was installed in the battery during initial service. Normally this will be 1.28 at room temperature, but it may vary by geographic location. Battery voltage should be 14.5 – 15.5 V.

### Battery Terminals:

#### *Battery Terminal Cleaning*

- Clean the battery top and terminals using a solution of baking soda and water. Scrape off any obstinate deposits with a wire brush or sand blasting device, and then rinse the battery with fresh water. Dry it thoroughly and coat the terminals with waterproof grease.

### CAUTION

Be sure not to allow any cleaning solution into the battery cells, or the battery life will be shortened.

#### *Battery Installation*

- Install the battery in the reverse order of removal.
- After connecting the battery, coat the terminals with waterproof grease.

### CAUTION

Do not reverse the battery connections, or damage to the regulator/rectifier unit will result.

---

## Lubrication

---

As in all marine craft, adequate lubrication and corrosion protection is an absolute necessity to provide long, reliable service. Refer to the **Periodic Maintenance Chart** and **Pre-ride Checklist** in the OPERATING INSTRUCTIONS chapter for the frequency of the following items:

- Lubricate the following with a penetrating rust inhibitor, such as WD40 or BEL-RAY 6 in 1:

### Choke Cable and Throttle Cable



Pressure Cable Luber  
Part Number K56019-021

### Steering Nozzle Pivots

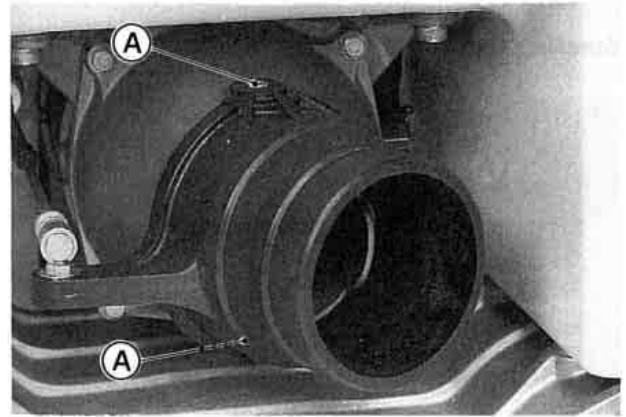

A. Nozzle Pivots

## 82 MAINTENANCE AND ADJUSTMENTS

- Lubricate the following with a high quality waterproof marine grease.

### Steering Cable Ball Joints

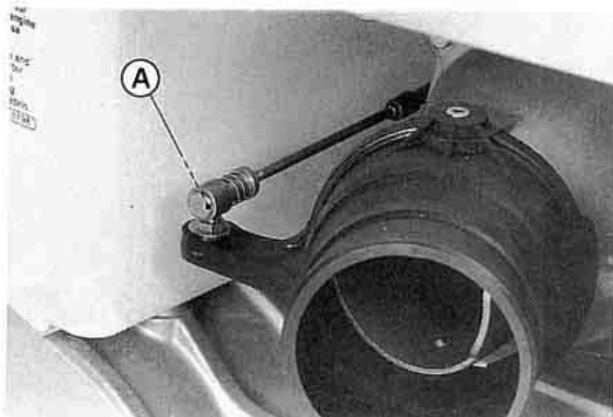

A. Ball Joint

### Throttle Cable Fitting at Throttle Case

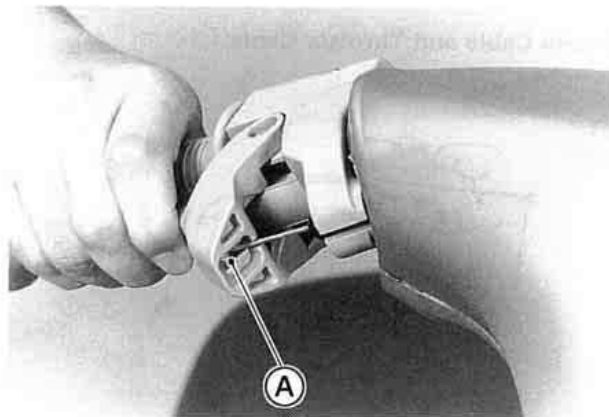

A. Apply grease.

### Choke Cable Fitting and Throttle Cable Fitting at Carburetor

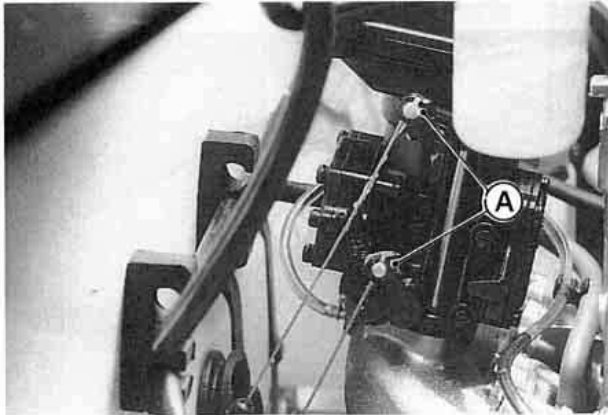

A. Apply grease.

### CAUTION

Disassemble and lubricate the handlebar pivot. This function should be performed by your Kawasaki JET SKI dealer.

### Cooling System Flushing

To prevent sand or salt deposits from accumulating in the cooling system, it must be flushed occasionally. Flush the system according to the **Periodic Maintenance Chart**, after each use in salt water, or whenever there is reduced water flow from the bypass outlet on the right side of the hull.

This procedure is also used to provide auxiliary cooling when needed (for example during Oil Pump Bleeding).

- An inlet for auxiliary water supply is provided on the fitting for the cooling hose just above the cylinder head.

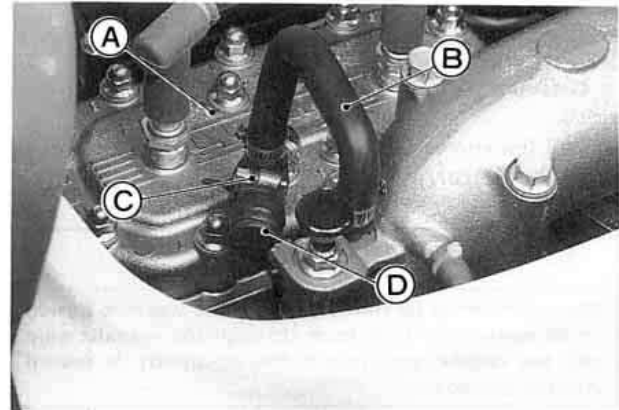

A. Cylinder Head  
B. Cooling Hose

C. Clamp  
D. Cap

## 84 MAINTENANCE AND ADJUSTMENTS

- Loosen the clamp and remove the cap, and then connect a garden hose.

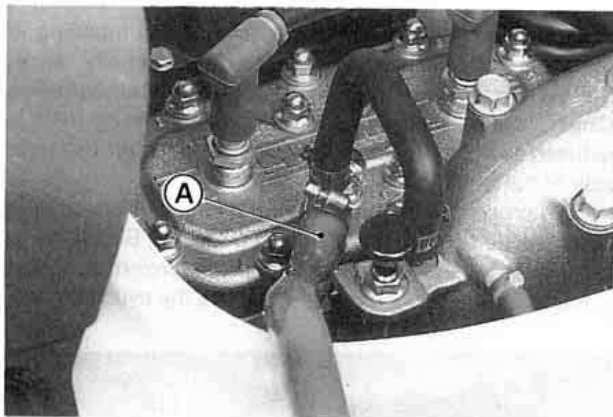

A. Garden Hose

- Start the engine and allow it to idle **before turning on the water.**

### CAUTION

The engine must be running before the water is turned on or water may flow back through the exhaust pipe into the engine, resulting in the possibility of severe internal damage.

- Immediately turn on the water and adjust the flow so that a little trickle of water comes out of the bypass outlet in the right side of the hull.

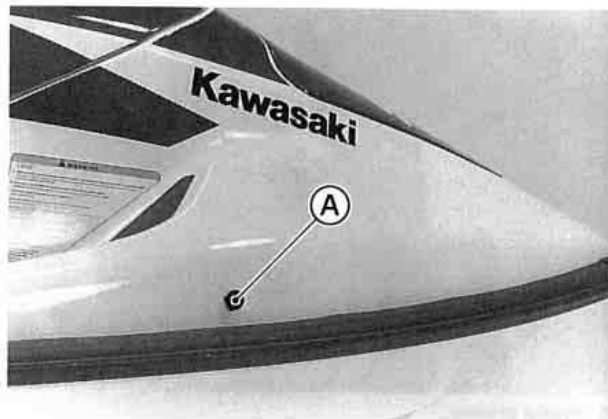

A. Bypass Outlet

- Let the engine idle for several minutes with the water running.
- Turn off the water. **Leave the engine idling.**
- Rev the engine a few times to clear the water out of the exhaust system.

### CAUTION

Do not run the engine without cooling water flow for more than 15 seconds. Overheating will cause severe engine and exhaust system damage.

- Switch off the engine, remove the garden hose, reinstall the cap and secure the clamp.

---

### Bilge System Flushing

---

To prevent clogging, the bilge system should be flushed out according to the **Periodic Maintenance Chart**, or whenever you suspect it is blocked.

- Disconnect both bilge hoses at the plastic breather fitting. It is mounted on the right side in the engine compartment.

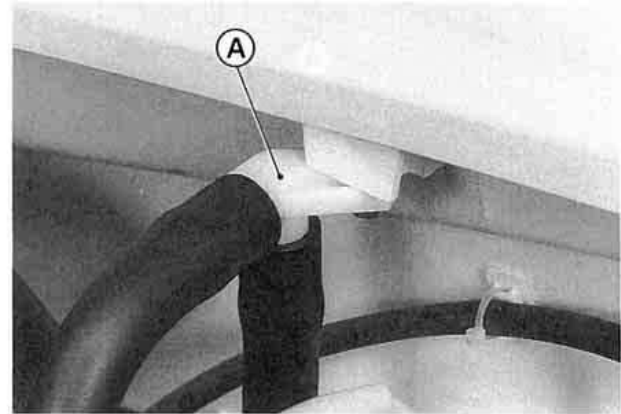

A. Breather Fitting

- Connect the bilge filter hose (from the hull bottom) to the garden hose, turn the water on, and flush it out for about a minute. During this procedure, water will flow into the engine compartment. Do not allow a large amount of water to accumulate in the engine compartment. Remove the drain screw in the stern to drain the engine compartment.
- Connect the other hose to the garden hose, turn the water on, and flush it out for several minutes.
- Before reconnecting the hoses to the plastic breather fitting, make sure the small breather hole in the fitting is clear. If the hole is clogged, the engine compartment will fill with water when the engine stops or idles. It may be necessary to remove the fitting.

## 86 MAINTENANCE AND ADJUSTMENTS

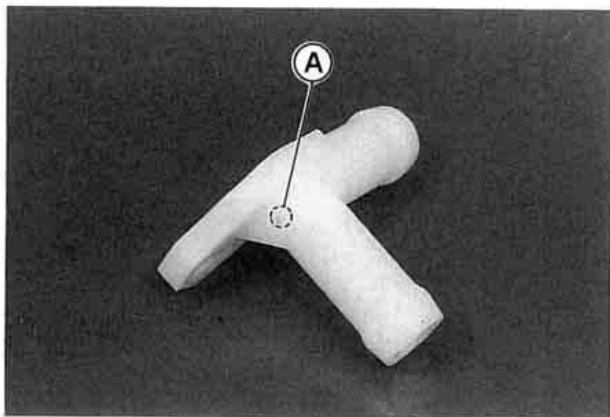

A. Breather Hole

- Reconnect the bilge hoses.

### NOTE

- *If your watercraft is to be stored, blow air through both hoses before they are reconnected (see the Preparation for Storage section in the STORAGE chapter).*



## TROUBLESHOOTING GUIDE

If this procedure does not isolate your problem, see your JET SKI dealer or refer to the Service Manual.

### TROUBLE

### CAUSE

Engine will not start

Engine will not turn over

- Lanyard key not pushed under stop button
- Battery voltage low
- Battery connections loose
- Water inside engine

Engine starts, but stops again

Engine turns over

- Fuel tank low
- Misuse of choke
- Pressure in fuel tank
- Fuel filter screens clogged
- Fuel vent line or check valve clogged
- Exhaust fume leak

Engine misfires, runs rough

Weak spark

- Fouled or worn spark plugs
- Spark plug connectors loose
- Oil pump output excessive

Lean fuel mixture

- Fuel tank low
- Carb. mixture screws misadjusted
- Fuel filter screens clogged
- Fuel vent line or check valve clogged

Rich fuel mixture (heavy fuel)

- Misuse of choke
- Carb. mixture screws misadjusted
- Flame arrester clogged
- Fuel tank

## 88 TROUBLESHOOTING GUIDE

TROUBLE	CAUSE
Engine power low	<ul style="list-style-type: none"><li>● Check items under "misfires," plus:</li><li>● Throttle valve adjustment incorrect</li><li>● Exhaust system clogged</li><li>● Water in gasoline or engine oil</li></ul>
Engine overheating	<ul style="list-style-type: none"><li>● Weeds or debris in jet pump</li><li>● Cooling water line clogged</li><li>● Carb. mixture screws misadjusted</li><li>● Engine oil tank vent clogged</li><li>● Incorrect type of gas or oil</li></ul>
Gas knock "pinging"	<ul style="list-style-type: none"><li>● Poor quality gasoline</li><li>● Spark plug heat range too high</li></ul>
Steering hard or erratic	<ul style="list-style-type: none"><li>● No lubricant on steering pivot</li><li>● Steering cable damaged or improperly routed</li></ul>

### **⚠ WARNING**

Since faulty steering is dangerous, this problem should be examined by an authorized JET SKI dealer.

## OWNER SATISFACTION (US ONLY) 89

### OWNER SATISFACTION (US only)

Your satisfaction is important to your authorized Kawasaki dealer and to Kawasaki Motors Corp., U.S.A. If you have a problem concerning warranty or service, please take the following action:

Contact the owner and/or service manager of your authorized Kawasaki dealer. Fully explain your problem and ask for assistance in resolving the situation. The OWNER of the dealership is an independent business person and is concerned with your satisfaction and your future business. For this reason the owner is in the best position to assist you. Also, all warranty and service matters are handled and resolved through the authorized Kawasaki dealer network.

If you are unsatisfied after working with your Kawasaki dealer and feel you still require further assistance, write to the address below. Please be certain to provide the model, product identification number, mileage or hours of use, accessories, dates that events occurred and what action has been taken by both you and your dealer. Include the name and address of the dealership. To assist us in resolving your inquiry, please include copies of related receipts and any other pertinent information including the names of the dealership personnel with whom you have been working in the resolution of your problem.

Upon receipt of your correspondence we will contact the dealership and work with them in resolving your problem.

In order to provide a permanent record, all warranty and service resolutions take place only through written correspondence.

Please send your correspondence to:

CONSUMER RELATIONS  
KAWASAKI MOTORS CORP., U.S.A.  
P.O. Box 25252  
SANTA ANA, CA. 92799-5252  
(714) 460-5688

**MEMO**



# JH750-E2



KAWASAKI HEAVY INDUSTRIES, LTD.  
Consumer Products Group

Part No. 99920-1797-01

<https://www.boat-manuals.com/>

Printed in Japan