



保存版

793 model

2 = 版

jet ski[®] 650SX

jet ski[®] OWNER'S MANUAL

READ THIS FIRST!

For your safety, read this Owner's Manual and understand it thoroughly before operating this JET SKI watercraft. This manual contains the warnings given here for your immediate attention plus other important information.

⚠ WARNING

The Jet Ski watercraft is not a toy; it is a high performance class A power boat. Underage operators may be hazardous to themselves and others. You must know and observe your state's minimum boating age regulations. Kawasaki does not recommend operation of this watercraft by persons under the age required for a driver's license.

⚠ WARNING

Operators of personal watercraft can fall into the water and experience exposure. Operator must be a competent swimmer and never travel farther from shore than he can swim.

⚠ WARNING

Drowning Hazard: a personal flotation device (PFD) must be worn by any operator. Kawasaki recommends that the operator wear a vest-type PFD (type 1, 2 or 3) at all times.

EYE PROTECTION

VEST-TYPE PERSONAL FLOTATION DEVICE

GLOVES (OPTIONAL)

WET SUIT (OPTIONAL)

FOOT PROTECTION (DECK SHOES)



⚠ WARNING

In some circumstances water spray can momentarily interfere with vision which could be hazardous. Wear suitable eye protection while operating this watercraft.

⚠ WARNING

Objects hidden underwater may injure your feet. For your protection, Kawasaki recommends that the operator wear foot protection.

⚠ WARNING

Keep your hands, feet, and clothing away from the jet pump intake (bottom of the boat, in the middle) and never stick anything into the pump outlet (steering nozzle at the back of the boat) whenever the engine is running, or a severe injury can occur.

⚠ WARNING

Don't forget to watch out for other boats, swimmers, or obstructions in your path. This is especially critical during a beginner's first exciting ride. This is a very maneuverable, sport watercraft; other boaters may not be expecting you to turn as quickly as you are able. Look around you to make sure the path is clear before executing any sudden turns.

⚠ WARNING

Never operate the watercraft after dark. It was not designed for such use, and has no lighting equipment.

⚠ WARNING

Releasing the throttle completely reduces the ability to steer. This can cause you to hit an object you are trying to avoid. You must have thrust to turn, so keep the throttle on or apply throttle as needed to maintain thrust at the jet nozzle.

⚠ WARNING

Do not operate the watercraft while trailing your body behind it for extended periods of time. Your visibility is limited. You may not see other boats, swimmers, or obstructions in your path. Also, you may not see foreign objects that the jet pump could pick up and eject to the rear.

Take proper care of your new JET SKI watercraft. Here are some of the cautions contained in this manual which must be followed for the protection of your watercraft. Be sure to read this Owner's Manual and understand it thoroughly before operating the watercraft

CAUTION
Always turn the boat on its left side. Rolling to the right side can cause water in the exhaust system to run into the engine, with possible engine damage.

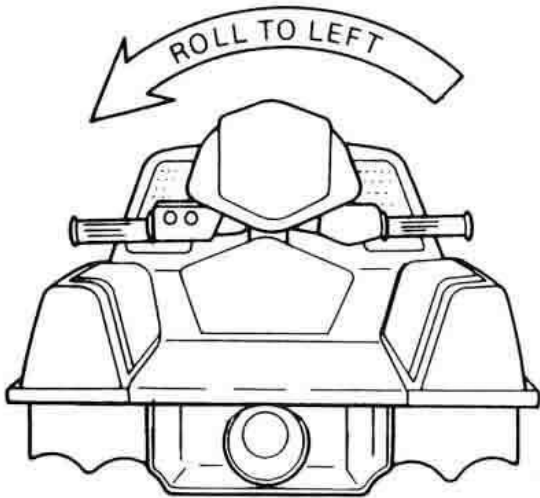

CAUTION
The watercraft must be in at least 0.6 m (two feet) of water when starting to prevent jet pump damage by objects sucked up from the bottom. Do not operate in shallow or debris-laden water, or the impeller may be damaged and sand may clog the water cooling hoses.



CAUTION
Never operate the engine at maximum speed out of the water. Severe engine damage may occur. Do not run the engine with the watercraft out of the water for more than 15 seconds at a time. Overheating will cause engine and exhaust system damage.

CAUTION
If water gets into the watercraft engine, follow the procedure on page 30 immediately. If water is left in the engine more than a few hours, it will destroy the crankshaft bearings and damage other internal engine parts.

CAUTION
Do not operate the starter continuously for more than 5 seconds or the starter will overheat. Wait 15 seconds between each operation of the starter to let it cool.

CAUTION
Do not push down on the handlebar. The handle pole rests on the engine cover and you could damage it. Do not run the watercraft onto the shore, or severe impeller damage may occur.

CAUTION
Do not use racing fuels or fuel additives. This watercraft has not been tested and certified for use with such fuels. Damage to the engine and fuel system may result from the use of improper fuel.

FOREWORD

Welcome to a new and exciting water sport. We are pleased you have chosen the Kawasaki JET SKI watercraft to expand the enjoyment of your recreational hours. Kawasaki uses the latest manufacturing methods and materials to bring you a high quality recreational watercraft.

This Owner's Manual is provided to aid you in the safe and reliable operation of your watercraft. **READ IT AND BECOME THOROUGHLY FAMILIAR WITH PROPER OPERATING PROCEDURES BEFORE YOUR FIRST RIDE.** Make sure anyone who operates your watercraft is fully acquainted with the proper operating procedures. Kawasaki strongly recommends that all operators attend a boating safety course before riding the watercraft. Contact the local office of the U.S. Coast Guard or other marine law enforcement agency. Careful operation and proper maintenance in accordance with this Owner's Manual will provide you with maximum riding pleasure and performance.

A Service Manual is also available for those owners who, due to personal preference or necessity, wish to perform their own service and repair. Those who plan to do their own work should, of course, be competent mechanics and should possess the required tools to work on the watercraft, including the special tools described in the Service Manual. See your dealer if you want a Service Manual and the required tools.

When you are planning to ride your watercraft, be sure to take this manual with you as a reference. This can be important should you encounter operating difficulties. If you have any additional questions about your watercraft, please contact your dealer. He has the necessary parts and service knowledge to care for your needs.

This craft is a "Class A" inboard boat, and as such is subject to all federal rules and regulations especially pertaining to boating safety and operation as enforced by the U.S. Coast Guard. Some local jurisdictions may have additional requirements for operation of power boats in waters under their control. Additionally, other countries may have their own standards and regulations. Please check your local boating laws and regulations before riding the watercraft.

Whenever you see the symbols shown below, heed their instructions! Always follow safe operating and maintenance practices.

WARNING

This warning symbol identifies special instructions or procedures which, if not correctly followed, could result in personal injury, or loss of life.

CAUTION

This caution symbol identifies special instructions or procedures which, if not strictly observed, could result in damage to, or destruction of equipment.

NOTE

○Indicates points of particular interest for more efficient and convenient operation.

All rights reserved. No part of this publication may be reproduced, stored in a retrieval system, or transmitted in any form or by any means, electronic mechanical photocopying, recording or otherwise, without the prior written permission of Kawasaki Heavy Industries, Ltd., Consumer Products & Components Group. No liability can be accepted for any inaccuracies or omissions in this publication, although every possible care has been taken to make it as complete and accurate as possible. All procedures and specifications subject to change without prior notice or obligation. Illustrations in this publication are intended for reference use only and may not depict actual model component parts.

jet ski is a trademark of Kawasaki Heavy Industries, Ltd. registered in U.S.A., Japan, Australia, Austria, Benelux, Sweden, Denmark, Switzerland, France, Canada, Finland, Norway, Greece, and Italy.

TABLE OF CONTENTS

Specifications	6
General Information	7
Serial Numbers	7
Parts Location	7
Label Location	9
Registration Numbers	12
Fuel	12
Engine Oil	13
Controls	14
Engine Cover	16
Storage Compartment	17
Tool Kit	17
Operating Instructions	18
Safe Operation	18
Navigation Rules	20
Pre-ride Checklist	21
Break-In	22
Stopping the Engine	22
Starting the Engine	23
Launching	24
Stopping the JET SKI Watercraft	25
Turning the JET SKI Watercraft	27
Riding the JET SKI Watercraft	28
End of the Day Checklist	29
Special Procedures	29
Storage	33
Preparation for Storage	33
Removal from Storage	35
Maintenance and Adjustments	36
Periodic Maintenance Chart	36
Control Cable Adjustments	37
Fuel and Oil System	39
Spark Plug	42
Battery	43
Lubrication	44
Cooling System Flushing	45
Bilge System Flushing	46
Troubleshooting Guide	48
Owner Satisfaction (US only)	49

SPECIFICATION

JET SKI WATERCRAFT - MODEL JS650-B3 "CLASS A" INBOARD BOAT

Engine:		
Type	2-stroke, vertical twin, crankcase reed valve, water-cooled	
Displacement	635 mL	38.7 cu in.
Bore and Stroke	76.0 x 70.0 mm	2.99 x 2.75 in.
Compression Ratio	7.2 : 1	
Ignition System	Magneto CDI	
Lubrication System	Oil injection (break-in period: Oil injection and gas/oil mixture 50 : 1)	
Carburetor	Keihin CDK 38 – 32	
Starting System	Electric	
Tuning Specifications:		
Spark Plug	NGK BR7ES	
Gap	0.7 – 0.8 mm	0.028 – 0.032 in.
Ignition Timing	17° BTDC @6 000 r/min (rpm) 2.0 mm @6 000 r/min (rpm)	0.08 in.
Carburetor		
Idle Speed	1 250 ± 100 r/min (rpm) – in water 2 300 ± 100 r/min (rpm) – out of water	
Compression Pressure	1 225 kPa (12.5 kg/cm ²)	178 psi
Drive System:		
Coupling	Direct drive from engine	
Jet Pump: Type	Axial flow, single stage	
Static Thrust	210 kg	463 lb
Steering	Steerable nozzle	
Braking	Water drag	
*Performance:		
Minimum Turning Radius	2.8 m	9.3 ft
Draft (Stationary)	220 mm	8.7 in.
Fuel Consumption	19 L/hr. @full throttle	5.0 gal/hr (U.S.)
Cruising Range	61 km @full throttle 55 minutes	38 mi
Dimensions:		
Length	2 205 mm	86.8 in.
Width	680 mm	26.8 in.
Height	760 mm	29.9 in.
Dry Weight	128 kg	282.2 lb
Fuel Tank Capacity	17.5 L including 4.5 L reserve	4.6 gal (U.S.) incl. 1.2 gal reserve
Engine Oil:		
Type	2-stroke, NMMA Certified for Service TC-WII	
Oil Tank Capacity	2.8 L	3.0 qt (U.S.)
Electrical Equipment:		
Battery	12 V 19 Ah	

*The information shown here represents results under controlled conditions, and the information may not be correct under other conditions.

GENERAL INFORMATION

Serial Numbers

The hull and engine identification numbers are used to register the boat. They are the only means of identifying your particular machine from others of the same model. These serial numbers may be needed by your dealer when ordering parts. In the event of theft, investigating authorities will require both numbers as well as the model number and any unique features of your machine that could help identify it. Record these numbers here.

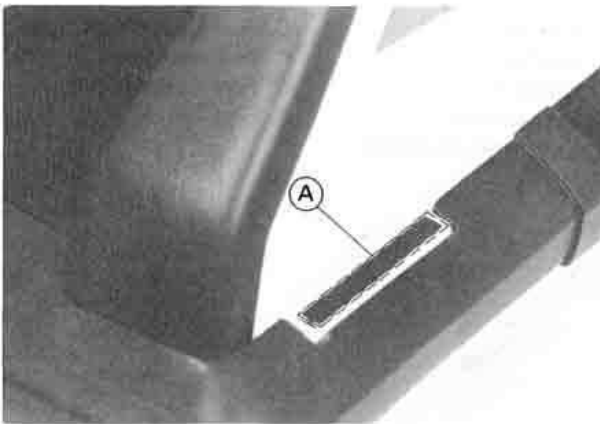

A. Hull Identification Number (HIN)

H.I.N.	
--------	--

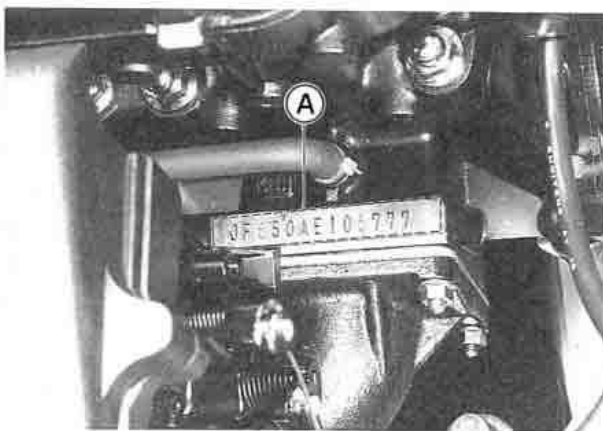

A. Engine Number

Eng. No.	
----------	--

Parts Location

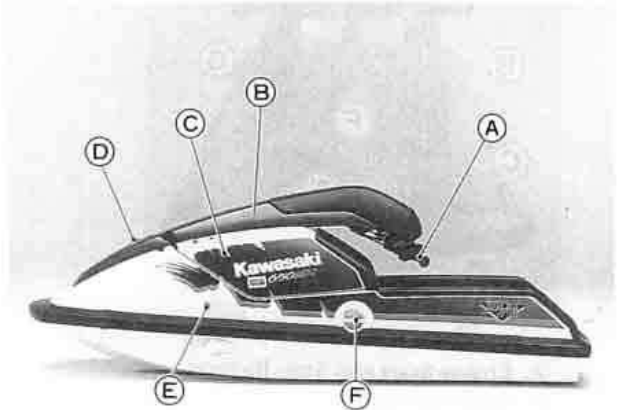

- A. Handlebar
- B. Handle Pole
- C. Engine Cover
- D. Fuel Tank Cap Cover
- E. Bypass Outlet
- F. Fire Extinguisher Compartment

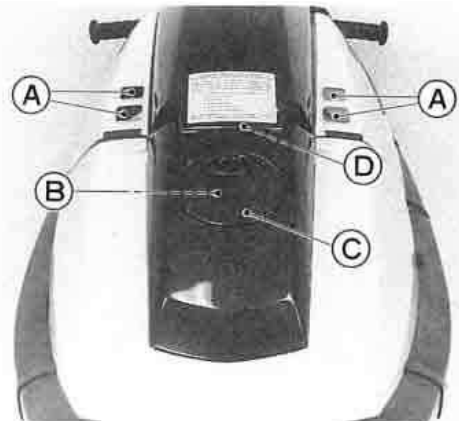

- A. Air Inlet
- B. Fuel Tank Cap
- C. Fuel Tank Cap Cover
- D. Handle Pole Bracket

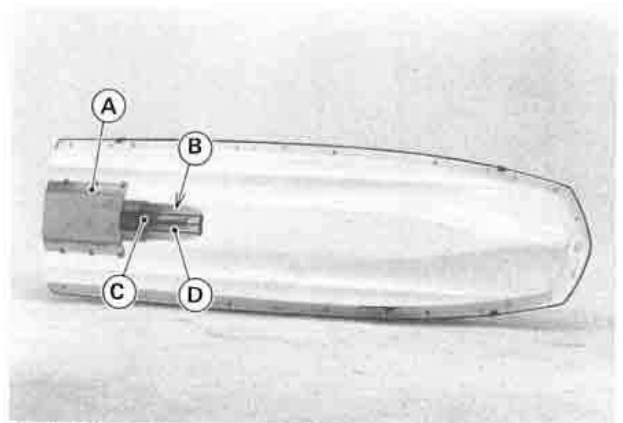

- A. Jet Pump Cover
- B. Water Intake
- C. Grate
- D. Drive Shaft

8 GENERAL INFORMATION

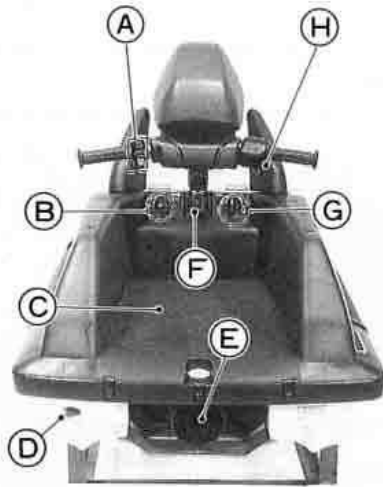

- A. Engine Start and Stop Buttons
- B. Choke Knob
- C. Riding Platform
- D. Exhaust Outlet
- E. Jet Pump Nozzle
- F. Engine Cover Latch
- G. Fuel Valve
- H. Throttle Lever

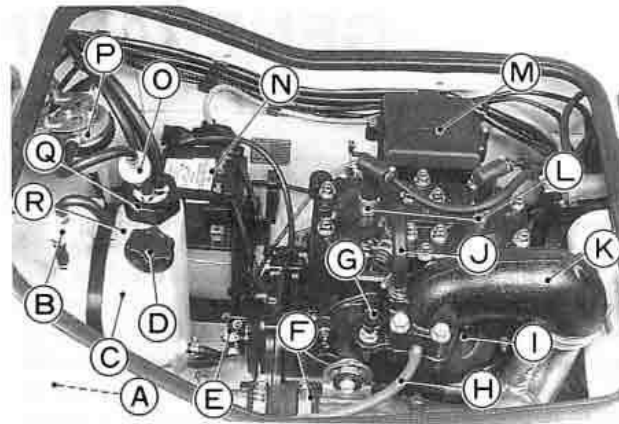

- A. Storage Compartment/
Tool Kit
- B. Oil Vent Check Valve
- C. Oil Tank
- D. Oil Tank Cap
- E. Oil Pump
- F. Muffler
- G. Drain Valve
- H. Bypass Hose
- I. Expansion Chamber
- J. Cooling Hose
- K. Exhaust Pipe
- L. Spark Plugs
- M. Flame Arrester
- N. Battery
- O. Fuel Vent Check Valve
- P. Sediment Bowl
- Q. Fuel Retainer Nut
- R. Fuel Tank

Label Location

All warning labels which are on your watercraft are repeated here. Read them and understand them thoroughly. They contain information which is important for your safety and the safety of anyone else who may operate your watercraft. Therefore, it is very important that all warning labels be on your watercraft in the locations shown. If any label is missing, damaged, or worn, get a replacement from your Kawasaki dealer and install it in the correct position.

NOTE

○ *The sample warning labels in this section have part numbers to help you and your dealer obtain the correct replacement.*



A. Warning
B. U.S. Coast Guard Grant of Exemption (US model only)
C. Caution

Ⓐ

⚠ WARNING

1. **The Owner's Manual and warning labels contain important information on safe operation of this watercraft.**
You must read and fully understand the Owner's Manual and warning labels before operating this watercraft.
2. **The Jet ski watercraft is not a toy; it is a high performance Class A power boat. Underage operators may be hazardous to themselves and others.**
You must know and observe your state's minimum boating age regulations. Kawasaki does not recommend operation of this watercraft by persons under the age required for a driver's license.
3. **Operators of personal watercraft can fall into the water and experience exposure.**
Operators must be a competent swimmer and never travel farther from shore than he can swim.
4. **Boating laws and navigation rules are for the safety of everyone sharing the waterways.**
You must know and observe all local, state, and federal boating laws. Kawasaki recommends that all operators complete an approved boating safety course.
5. **Drowning Hazard: a personal flotation device (PFD) must be worn by operator.**
Kawasaki recommends that operator wear a vest-type PFD (type 1, 2 or 3) at all times.
6. **Malfunctioning controls can cause an accident.**
Check throttle control and steering for proper operation before starting engine.
7. **Starting, turning, and accelerating without checking for other boats and objects in your path can cause an accident.**
Always look carefully around you for other boats and objects before starting and making quick maneuvers. This is a very maneuverable, sport watercraft.
8. **Carrying a passenger can adversely affect handling and stability which can lead to an accident.**
Never carry a passenger on this watercraft.
OPERATOR ONLY. NO PASSENGER.
9. **Alcohol and drugs impair reaction time and judgement.**
Never drink and ride.
10. **In some circumstances water spray can momentarily interfere with vision.**
Wear suitable eye protection while operating this watercraft.
11. **Releasing the throttle completely reduces the ability to steer. This can cause you to hit an object you are trying to avoid.**
You must have thrust to turn.
12. **Towing can cause loss of steering control and create a hazardous condition.**
Do not tow other watercraft, skiers, or objects behind this craft.
13. **Objects hidden underwater may injure your feet.**
Wear foot protection at all times.

56040-3932

10 GENERAL INFORMATION

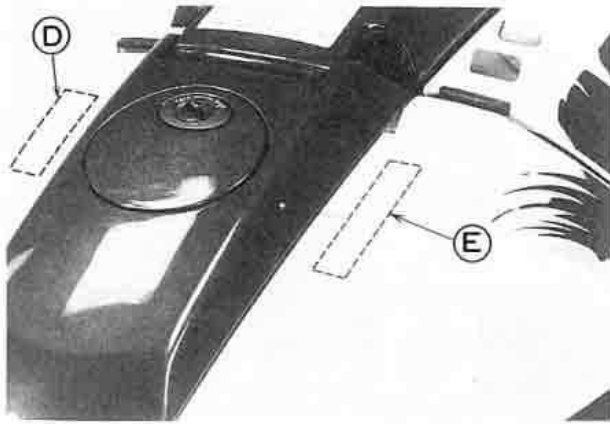

D. Caution
E. Warning

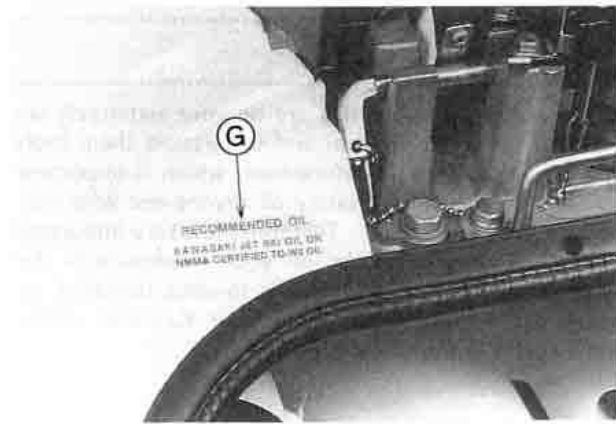

G. Recommended Oil

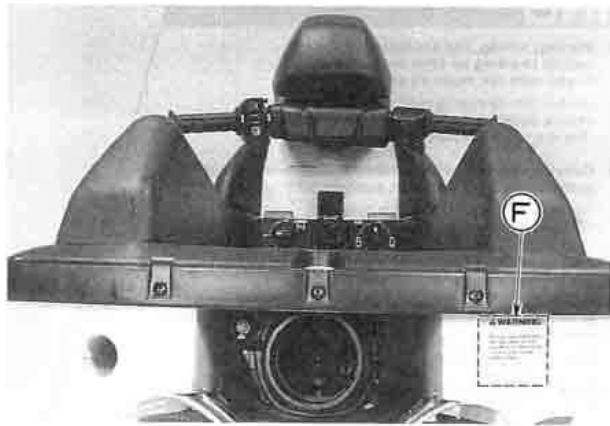

F. Warning

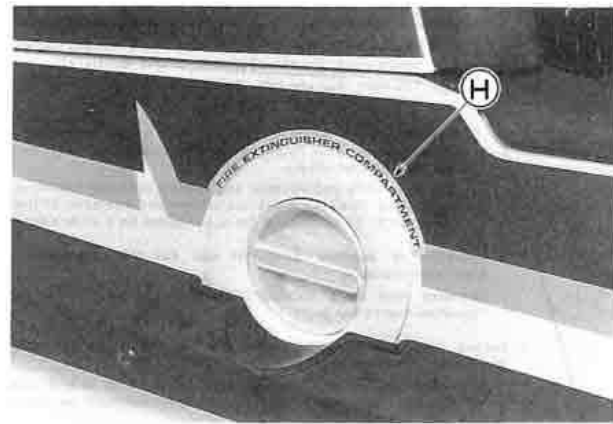

H. Fire Extinguisher Compartment

(B)

Kawasaki Motors Corp., U.S.A.
 P.O. Box 25252
 Santa Ana, CA 92799-5252
THIS BOAT HAS BEEN EXEMPTED FROM COMPLIANCE WITH THE FOLLOWING U.S. COAST GUARD SAFETY STANDARDS IN EFFECT ON THE DATE OF CERTIFICATION:

- Display of capacity information
- Safe loading
- Flotation
- Fuel System
- Electrical System
- Powered Ventilation

AS AUTHORIZED BY U.S. COAST GUARD GRANT OF EXEMPTION (CGD 80-018)

59462-3716

(C)

CAUTION

1. Check gas and oil supply.
2. Push stop button to shut off engine.
3. Do not operate in shallow or debris-laden water; two feet minimum.
4. When rolling the craft onto its side, turn it in this  direction only.
5. Improper storage may result in damage; consult Owner's Manual for Instructions.

56040-3933

(D)

CAUTION

1. CHECK ENGINE OIL EVERY TIME YOU REFUEL. OIL TANK IS IN ENGINE COMPARTMENT. RUNNING OUT OF OIL WILL CAUSE MAJOR ENGINE DAMAGE.
2. USE A 50:1 GAS-OIL MIXTURE IN FUEL TANK ONLY DURING BREAK-IN PERIOD (FIRST 5 HOURS OR 3 TANKS OF FUEL). AFTER BREAK-IN, OIL INJECTION SYSTEM ALONE PROVIDES ADEQUATE LUBRICATION.

56040-3935

(E)

▲WARNING

Gasoline is extremely flammable and can be explosive. A fire or explosion can cause severe injury or death.

Shut engine off. Do not smoke. Refuel in a well ventilated area away from flame or sparks.

56040-3934

(F)

▲WARNING

Putting your hand into the jet intake or rear nozzle with the engine running can cause severe injury.

Stop the engine and push in the starter interlock switch before checking the pump for debris.

56040-3971

(G)

RECOMMENDED OIL

KAWASAKI JET SKI OIL or NMMA CERTIFIED TC-WII OIL

56030-3761

(H)

FIRE EXTINGUISHER COMPARTMENT

56030-3726

12 GENERAL INFORMATION

Registration Numbers

The graphic design of your JET SKI watercraft provides a specific location on each side for the registration numbers and validation decals.

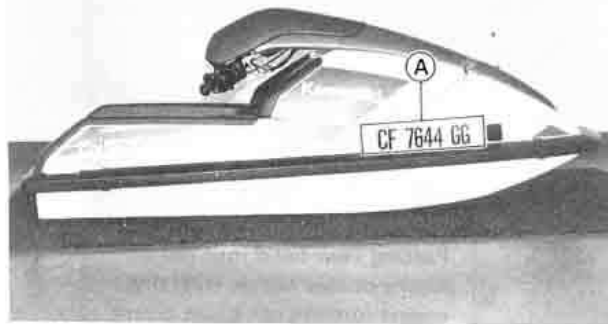

A. Location for Registration Numbers

The registration numbers must read from left to right on both sides of the watercraft. Typically, the validation decal must be placed three inches beyond, and level with the first or last letter of the identification number.

NOTE

○ Requirements for registration numbers and validation decals may vary from those given here for your state. Always follow the directions provided at the time you register your watercraft.

Registration numbers must be block characters no less than 3 inches (76.2 mm) in height. They should be a color contrasting with the background. The spaces between the numerals and the prefix/suffix letters must be equal to the width of any letter except "I" or any number except "1."

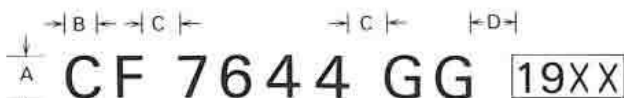

A = 3 inches (76.2 mm) minimum

B = C

D = 3 inches

Fuel

CAUTION

Do not use racing fuels or fuel additives. This watercraft has not been tested and certified for use with such fuels. Damage to the engine and fuel system may result from the use of improper fuel.

The octane rating of gasoline is a measure of its resistance to detonation or "knocking". Use a gasoline with an octane rating equal to or higher than that shown in the table below.

Octane Rating Method	Minimum Rating
Antiknock Index $\frac{(\text{RON} + \text{MON})}{2}$	87
Research Octane Number (RON)	91

The Antiknock Index is an average of the Research Octane Number (RON) and the Motor Octane Number (MON). The Antiknock Index is posted on service station pumps in the U.S.A. If the Antiknock Index is not posted, be sure the Research Octane Number is adequate.

Gasoline and Alcohol Blends (US model)

Blends of gasoline and alcohol called "gasohol" can be used on an occasional basis, however continued use is not recommended. Switch back immediately to gasoline which does not contain alcohol if you experience any operating irregularities. Any deterioration of fuel system components or degradation of performance resulting from the use of gasohol will not be covered by Kawasaki's Limited Warranty or Good Times Protection Plan. If you decide to use gasohol, be sure to follow these simple cautions:

CAUTION

Never use gasohol with an octane rating lower than the minimum octane rating specified by Kawasaki for this product.

Never use gasohol containing more than 10% ethanol (grain alcohol).

Never use gasohol containing more than 5% methanol (wood alcohol). Gasoline containing methanol must also be blended with cosolvents and corrosion inhibitors.

Never use gasohol for extended periods and never store this product with gasohol in the fuel system.

Gasoline containing alcohol can cause paint damage. Be extra careful not to spill gasohol during refueling.

Filling the Tank:**⚠ WARNING**

Gasoline is extremely flammable and can be explosive under certain conditions. Push in the starter interlock switch. Do not smoke. Make sure the area is well ventilated and free from any source of flame or sparks; this includes any appliance with a pilot light.

The fuel tank cap is under the cover on the bow of the boat. Open the cover and remove the filler cap. Fill the tank with the recommended octane rating gasoline. The use of a small diameter pour spout (or funnel) will make filling easier. Pour slowly to avoid "spit back" and allow air to escape from the tank.



Leave about 100 mm (4 inches) between the top of the filler neck and the fuel level.

⚠ WARNING

Never fill the tank completely to the top. As the fuel expands in a warm tank, it may overflow from the vent tube. After refueling, make sure the tank cap is closed securely.

- After transporting or refueling and before starting the watercraft, open the engine cover for several minutes to ventilate the engine compartment.

⚠ WARNING

A concentration of gasoline fumes in the engine compartment can cause a fire or explosion.

Engine Oil

Kawasaki recommends using Kawasaki JET SKI Oil (P/N W61020-101A). This oil is specially formulated to give minimum piston ring varnish and combustion chamber deposits along with excellent lubrication qualities. The use of lubricants such as "tune-up tonics" and "super oils" is NOT RECOMMENDED. In an emergency situation when Kawasaki JET SKI Oil is not available, an N.M.M.A. (formerly B.I.A.) certified TC-WII oil may be substituted. All certified oils will indicate the TC-WII rating on the container. If the N.M.M.A. certification does not appear on the container, the oil must not be used.

CERTIFIED

 N.M.M.A.
 ®

**Adding Oil:**

The oil tank is in the engine compartment. Remove the engine cover and take off the oil tank cap. Fill the oil tank with the recommended engine oil.

CAUTION

If the engine is run without oil, it will be severely damaged. If the oil tank is completely dry, add the oil and have your Kawasaki JET SKI dealer bleed the air from the oil line before operation.

14 GENERAL INFORMATION

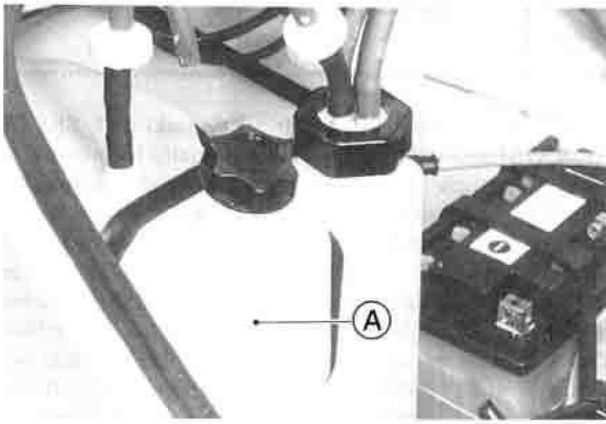

A. Engine Oil Tank

NOTE

○Kawasaki recommends the use of a gasoline/oil premix in the fuel tank for extra lubrication during the break-in period. After the break-in period, the oil injection system provides the necessary engine lubrication without the need for premixed fuel. Refer to the "Break-In" section in the Operating INSTRUCTIONS chapter.

Controls

Steering Handlebar:

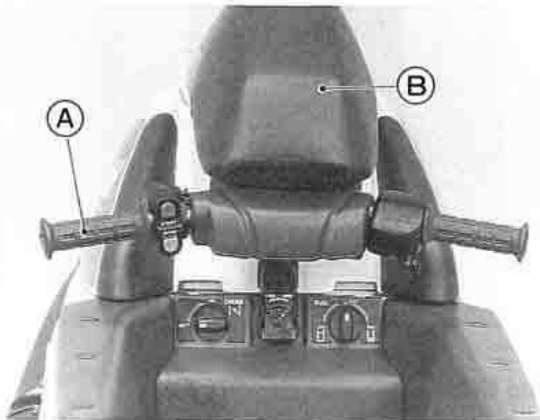

A. Handlebar

B. Handle Pole

The steering handlebar is mounted on a pivot at the end of the handle pole. It functions much the same as a snowmobile or bicycle handlebar. Turning the handlebar will cause the watercraft to turn **ONLY WHEN THE ENGINE IS RUNNING AND ONLY WHEN THE THROTTLE IS APPLIED**. The handlebar is connected by a control cable to the jet pump steering nozzle at the rear of the boat.

Stop Button:

The stop button is in the case on the left hand side of the handlebar. The stop button is red and marked "STOP." Pushing the stop button turns off the engine.



A. Stop Button

Starter Interlock Switch:

The purpose of the starter interlock switch is to prevent accidental starting. Only when the starter interlock switch is pulled out will pushing the green start button crank the engine. The engine will not crank when the starter interlock switch is pushed in.

⚠WARNING

To prevent accidental rotation of the engine and possible injury, always keep the starter interlock switch pushed in when the engine is not running.

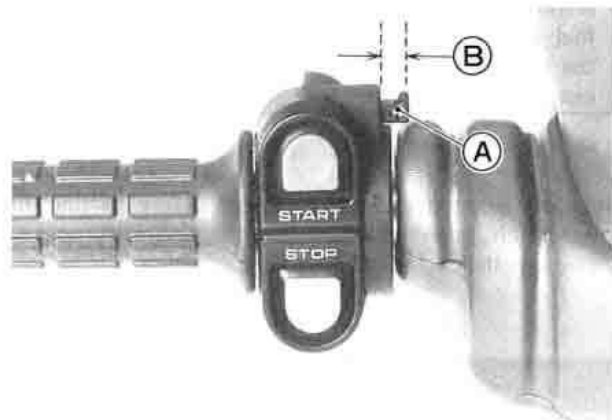

A. Starter Interlock Switch B. Push in. (Locked)

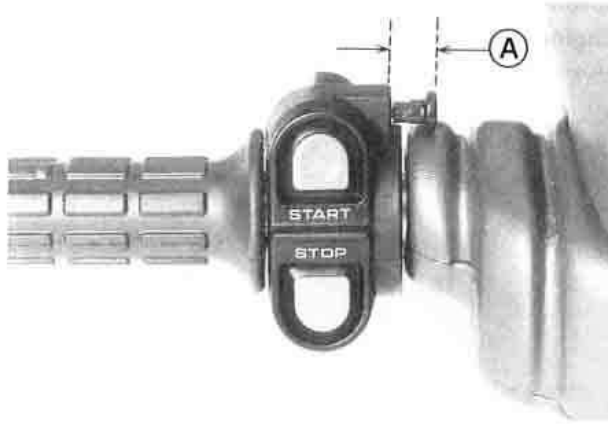

A. Pull out. (Unlocked)

Start Button:

The start button is in the case on the left hand side of the handlebar. The start button is green and is marked "START." Pushing the start button cranks the engine for starting. Release it when the engine starts.

CAUTION

Do not push the "START" button while the engine is running or while the starter is still spinning, as it will hasten starter wear and may cause the starter to jam.

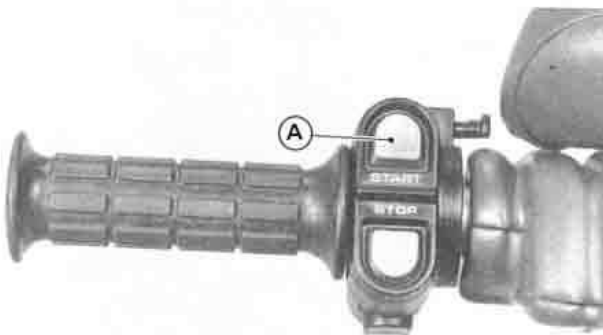

A. Start Button

NOTE

○The start button will work only when the starter interlock switch is pulled out.

Throttle Lever:

The throttle lever is located on the right hand side of the handlebar. Pushing the lever forward increases engine speed. When released, spring pressure returns the lever to the rear. Always check that the throttle lever returns normally before starting the engine. In addition, there must be adequate throttle cable play. Refer to the MAINTENANCE AND ADJUSTMENT chapter for the throttle cable adjustment procedure.

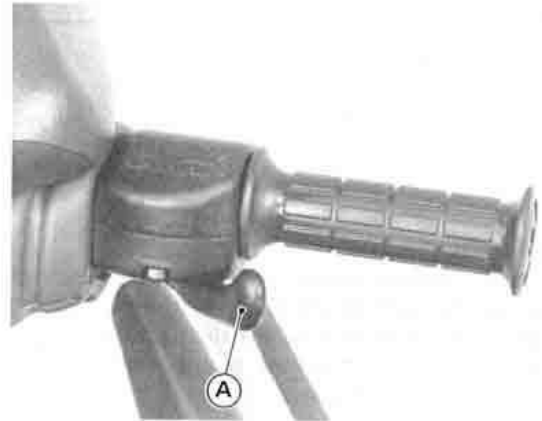

A. Throttle Lever

Throttle Limiter:

The watercraft is equipped with a throttle limiter to decrease maximum engine power for an unskilled rider. The limiter functions by restricting the moving distance of the throttle lever. Loosen the bolt and slide the limiter back and forth. Sliding forward decreases the maximum engine power. The other way increases the maximum engine power.

CAUTION

If the throttle limiter is adjusted, verify the changes in throttle in an open non-traffic area. Never try to adjust the limiter by racing the engine out of the water or the engine may be damaged.

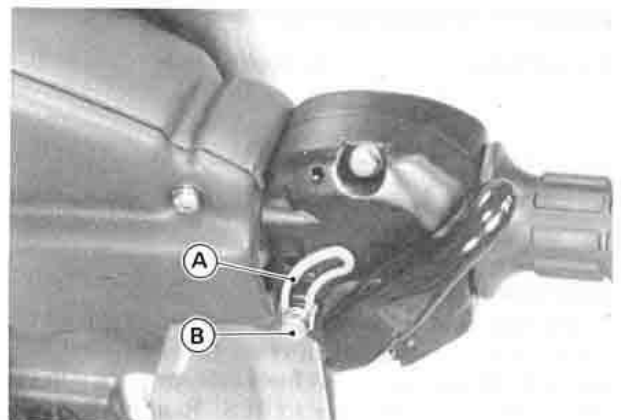

A. Throttle Limiter

B. Lockbolt

16 GENERAL INFORMATION

After adjusting the limiter, be sure to tighten the lockbolt.

⚠ WARNING

After adjusting the limiter, be sure to tighten the lockbolt. If the adjustment slips, the rider may be able to open the throttle more than originally intended.

Choke Knob:

The choke knob is located on the left hand side of the panel at the front of the riding platform. Turning the choke knob all the way to the right provides a rich mixture for starting. After the engine fires, turn the choke knob counterclockwise.

NOTE

ⓘ If the choke knob is used after the engine has started, it will waste fuel, reduce performance, and could cause spark plug fouling.

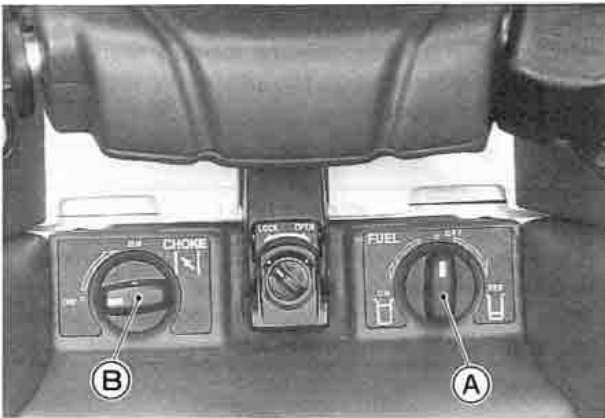

A. Fuel Valve

B. Choke Knob

Fuel Valve

The fuel valve is located on the right hand side of the panel. It is a three-position valve: ON, OFF, and RES (reserve). If you run out of fuel while the valve is in the ON position, turn the valve to RES. Reserve allows use of the last 4.5 liters (1.2 U.S. gal) of fuel and about 15 minutes of running time at full throttle.

Engine Cover

The engine cover is held in place by a latch.

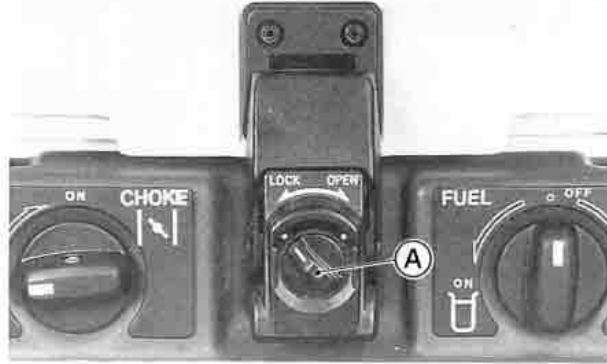

A. Latch

To Open: Raise the handle pole all the way up and while holding it pull up the handle pole stopper lever so that the stopper lever hooks into the groove in the handle pole bracket. This will lock the handle pole in an upright position while you remove the engine cover. Do not lean on the handle pole when it is locked upright.

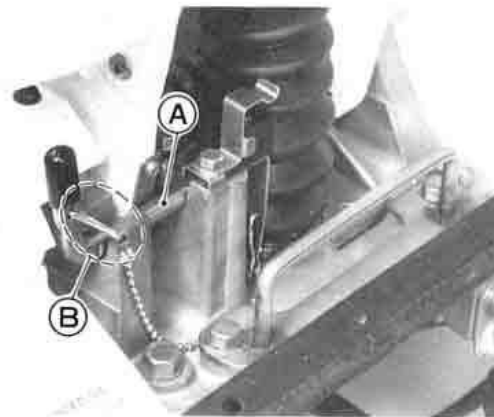

A. Stopper Lever

B. Groove

NOTE

ⓘ Make sure that the stopper lever has gone into the groove completely.

Turn the latch lock knob clockwise, pull the latch all the way up and unhook its upper portion. Then remove the engine cover.



A. Unhook here

To Close: Replace the engine cover making sure to engage the hooks at its front end onto the bracket under the handle pole stopper. Hook the upper portion of the latch onto the bracket on the engine cover, push the latch down and turn the latch lock knob counter-clockwise. While holding the handle pole pull back the stopper lever to the right and push it down into the stopper lever bracket.

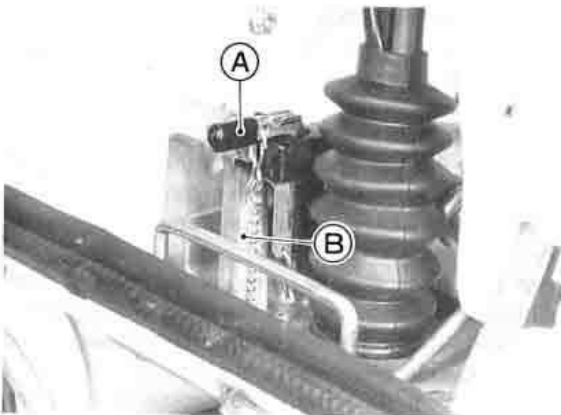

A. Stopper Lever B. Stopper Lever Bracket

When transporting the watercraft, make sure the engine cover is secured to prevent it from becoming dislodged and damaged as a result. Also, be sure to tie down the handle pole.

If not secured, a handle pole can be damaged from bouncing up and down. An unsecured handle pole can also damage the engine cover, particularly if it is misaligned.

Storage Compartment

A compartment has been provided in the left front corner of the engine compartment. Use this compartment to store the tool kit and/or to keep this Owner's Manual and any papers or documents which should be kept with the watercraft.

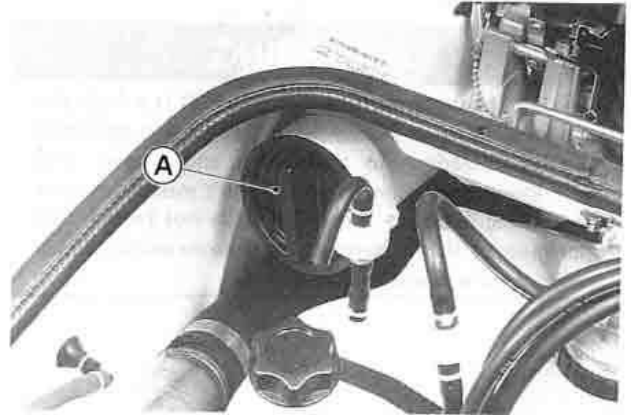

A. Storage Compartment

Tool Kit

The minor adjustments and maintenance explained in this Owner's Manual can be performed with the tool kit.

OPERATING INSTRUCTIONS

Safe Operation

Operation by Children:

⚠ WARNING

The Jet Ski watercraft is not a toy; it is a high performance Class A power boat. Underage operators may be hazardous to themselves and others. You must know and observe your state's minimum boating age regulations. Kawasaki does not recommend operation of this watercraft by persons under the age required for a driver's license.

Operator Swimming Ability:

⚠ WARNING

Operators of personal watercraft can fall into the water and experience exposure. Operator must be a competent swimmer and never travel farther from shore than he can swim.

Drowning Hazard: a personal flotation device (PFD) must be worn by any operator. Kawasaki recommends that the operator wear a vest-type PFD (type 1, 2 or 3) at all times.

Safe Riding Rules:

⚠ WARNING

Always follow these rules when operating your watercraft, for your own safety and that of others.

- Always comply with any Navigation Rules in effect in your area. The Coast Guard office or state boating authority nearest you can usually furnish you with the applicable rules. Check local and state regulations before operating. Kawasaki recommends that all operators complete an approved boating safety course.
- See the Navigation Rules section in this chapter for basic navigation rules.
- Kawasaki recommends that the operator wear a U.S. Coast Guard approved vest-type personal flotation device (type 1, 2 or 3) at all times. Other countries may have their own standards and regulations; be sure to follow them.

- Check the throttle control and steering for proper operation before starting the engine. Malfunctioning controls can cause an accident.
- Look carefully around you for other boats and objects in your path before starting and making quick maneuvers, especially before executing any quick turns. Because the watercraft is very maneuverable, other boaters may not be expecting you to turn as quickly as you are able (see the Turning the JET SKI Watercraft section).
- Never carry a passenger on the watercraft. This craft was designed to carry only the operator. A passenger can adversely affect handling and stability which can lead to an accident. Also, if the operator falls off, the passenger may not be able to control the watercraft.
- Alcohol and drugs impair judgement and reaction time. Never drink and ride.
- Wear suitable eye protection while operating this watercraft. In some circumstances water spray can momentarily interfere with vision and create a hazard.
- Kawasaki recommends that the operator wear foot protection. Objects hidden underwater may injure your feet.
- You must have thrust to turn. Releasing the throttle completely will reduce your ability to steer and the watercraft can hit an object you are trying to avoid.
- Do not tow other watercraft, skiers, or objects behind this watercraft. The holes in the bow and rear deck are designed only as tie-down points for transporting the craft. Towing anything can cause loss of steering control and create a hazardous condition. Also, other boat operators may not expect the watercraft to be towing anything.
- Never operate the watercraft after dark. It was not designed for such use, and has no lighting equipment.
- Avoid operating the watercraft in waters full of weeds or debris, as they may clog the jet pump, and cause an injury if you fall.
- Do not operate in shallow water, or the impeller may be damaged and sand may clog the water cooling hoses.
- Be very careful of other boats, especially those towing water skiers. Give them plenty of room.
- Never go over a ski jump. You could damage the watercraft or injure yourself.
- Do not operate the watercraft in ocean surf. In addition to being dangerous, it may be illegal in certain localities.
- Do not ride the watercraft under very windy or rough water conditions. The boat may not circle properly if you fall off.

CAUTION

Jumping waves can overstress the watercraft hull causing it to crack.

Jet Pump Safety:

Although the jet pump is inherently safer than a propeller drive, certain safety precautions must always be observed.



⚠ WARNING
 Keep your hands, feet, and clothing away from the jet pump intake (bottom of the boat, in the middle) and never stick anything into the pump outlet (steering nozzle at the back of the boat) whenever the engine is running, or a severe injury can occur.

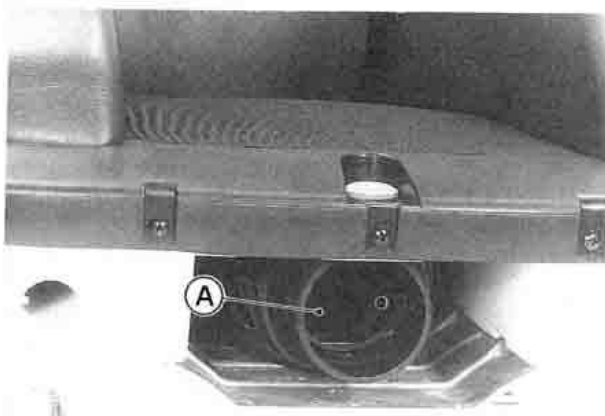

A. Steering Nozzle

Personal Flotation Device and Safety Gear:

U.S. federal regulations require that a U.S. Coast Guard approved personal flotation device (PFD) be carried when operating on water under Coast Guard jurisdiction. In some state waters not under federal jurisdiction, other flotation devices are permissible in addition to those specified by federal law. Other countries may have their own standards and regulations; be sure to follow them. As a rule, waist-type ski belts do not qualify as adequate flotation devices. The full vest type is recommended. Check local regulations to see what type of personal flotation device may be required in your area.

⚠ WARNING
 Drowning Hazard: a personal flotation device (PFD) must be worn by any operator. Kawasaki recommends that the operator wear a vest-type PFD (type 1, 2 or 3) at all times.

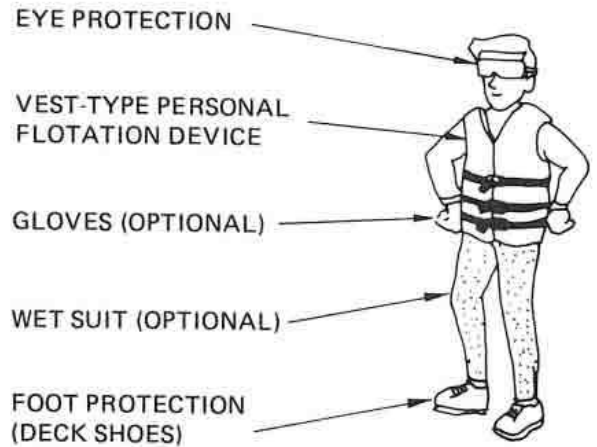

⚠ WARNING
 In some circumstances water spray can momentarily interfere with vision which could be hazardous. Wear suitable eye protection while operating this watercraft.

⚠ WARNING
 Objects hidden underwater may injure your feet. For your protection, Kawasaki recommends that the operator wear foot protection.

Fire Extinguisher:

A charged and functional fire extinguisher must be carried on board. A compartment has been provided for a fire extinguisher in the left side of the watercraft. The compartment is indicated by the label shown.

To open: Turn the cap counterclockwise, and pull.
To close: Push the cap into the container, and turn it clockwise.

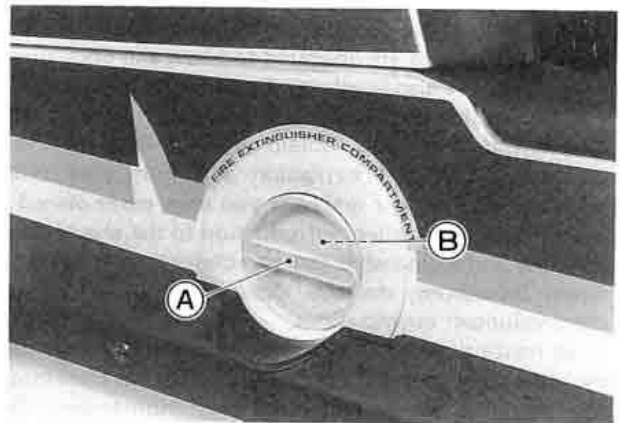

A. Cap

B. Fire Extinguisher Container

20 OPERATING INSTRUCTIONS

Because the watercraft is a "Class A" inboard boat, federal regulations require that a fire extinguisher rated "B-1" (minimum 2 pound capacity) be aboard when operating on navigable waters under Coast Guard jurisdiction. In addition, most states, parks, and wildlife departments require that a U.S.C.G. approved fire extinguisher be carried aboard, even on waters not under federal jurisdiction.

Other countries may have their own standards and regulations; be sure to follow them.

⚠ WARNING

Do not use your watercraft unless it has a fire extinguisher on board.

Standard equipment does not include a fire extinguisher. Many owners prefer to provide their own fire extinguishers. If you wish, your dealer can furnish you with an approved Kawasaki accessory fire extinguisher (P/N W99997-101).



Navigation Rules

The navigation rules or nautical "rules of the road" are like highway traffic laws. They dictate who has the right-of-way when boats meet in open water. As the boat operator you are obligated to know and obey these rules. They are also legally binding on boat operators.

This section provides basic navigation rules. We recommend that you obtain more information on navigation rules and navigation aids from your state when registering your craft. If you have never owned a boat before, an excellent introduction to the arts of boat handling and seamanship can be obtained from the U.S. Power Squadrons, the U.S. Coast Guard Auxiliary, or other volunteer organizations.

In nautical terms, the stand-on (privileged) boat has the right of way; and the give-way (burdened) boat must give way. Whenever you come near another boat, be cautious and use common sense. You cannot rely on other boaters to know or follow these rules.

Sailboats:

Sailboats have right-of-way over power boats in nearly all cases. Stay clear of these craft and do not create a wake which may cause them trouble.

Overtaking and Passing Situation:

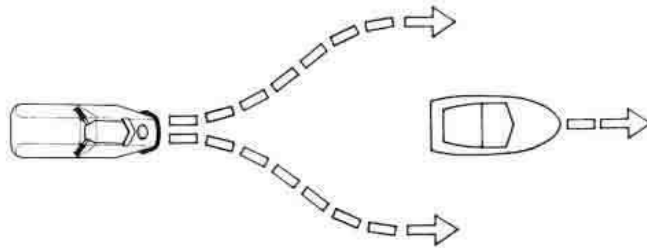

Give-way (Burdened)
Vessel Overtaking

Stand-on (Privileged)
Vessel Being Overtaken

If you are overtaking and passing another boat, the boat being passed has right-of-way, and you are required to stay clear.

Meeting Situation:

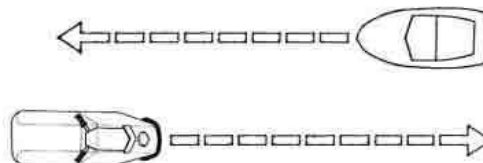

If you are meeting another power boat head on, neither you nor the other boat has right-of way. Each boat should keep to its right.

Crossing Situation:

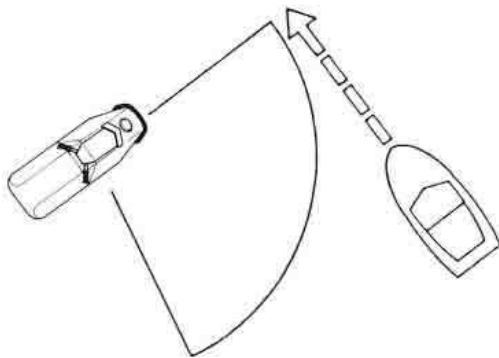

Give-way
(Burdened)
Vessel

Stand-on (Privileged) Vessel
holds course and speed.

If you have another power boat on your right, the boat on the right has right-of-way. You must keep out of the way of the boat by directing your course to the starboard (right) and passing astern of (behind) the stand-on boat. If necessary, you may have to slow, stop, or reverse your craft to allow the stand-on boat to pass. Before passing behind another boat, look carefully for a water skier or any towed object. Pass behind the object in tow.

If you have another boat on the left, you have right-of-way. You must keep your course and speed.

.....
Pre-ride Checklist
.....

Each day before using the watercraft, check the following items:

- FUEL PRESSURE** – Loosen the fuel filler cap to relieve any pressure, then tighten the cap securely.
- VENTILATE ENGINE COMPARTMENT** – Remove engine cover for several minutes to purge gasoline fumes from engine compartment.

⚠ WARNING

A concentration of gasoline fumes in the engine compartment can cause a fire or explosion.

- FUEL LEAKS** – While ventilating the engine compartment check for fuel leaks.
- OIL LEAKS** – While ventilating the engine compartment check for oil leaks.
- DRAIN BILGE** – Drain any water out of the engine compartment by rolling the watercraft on its **LEFT SIDE**. Be sure to protect the finish by placing a towel or pad on the left side.

CAUTION

Always turn the boat on its left side. Rolling to the right side can cause water in the exhaust system to run into the engine, with possible engine damage.

- CLEAN PUMP** – Clear the water inlet, jet pump, and drive shaft of foreign objects.
- PUMP COVER TIGHT** – Check the jet pump cover and inlet grate for looseness. Tighten the mounting bolts, if needed.
- HULL DAMAGE** – Inspect the hull for damage.
- FUEL LEVEL** – Turn the watercraft upright and check the fuel tank level. Refill if necessary and turn the fuel valve to ON.
- ENGINE OIL LEVEL** – Check the oil tank level. Refill if necessary.
- SEDIMENT BOWL** – Drain any water out of the sediment bowl and clean it.
- FASTENERS** – Check and tighten any loose bolts, nuts, or clamps.
- HOSE CONNECTIONS** – Be sure all hose connections are secure and that all hose clamps are tight. Check all hoses for cracks or deterioration and replace if necessary.
- FIRE EXTINGUISHER** – Check your fire extinguisher for a full charge.
- STEERING** – Check the operation of the steering for binding, rough spots, or excessive play. Adjust the cable, if needed (see Control Cable Adjustments in the MAINTENANCE AND ADJUSTMENTS chapter). The steering cable is sealed at both ends and does not need lubrication. If the seals are damaged, the cable must be replaced.
- THROTTLE CONTROL** – Check the operation of the throttle for binding, rough spots or excessive play. Adjust the cable if needed (see Control Cable Adjustments in the MAINTENANCE AND ADJUSTMENTS chapter). The throttle lever must return to the fully closed position when released.

⚠ WARNING

If the throttle does not return freely and completely, it may cause loss of control.

22 OPERATING INSTRUCTIONS

- **STOP BUTTON** — Start the engine, run it for a few seconds, and then check that the engine STOP button works.

⚠ WARNING

Do not run the engine in a closed area. Exhaust gases contain carbon monoxide: a colorless, odorless, poisonous gas. Breathing exhaust gas leads to carbon monoxide poisoning, asphyxiation, and death.

CAUTION

Do not run the engine with the watercraft out of the water for more than 15 seconds at a time. Overheating will cause engine and exhaust system damage.

- **ENGINE COVER** — Replace the engine cover, and check that the engine cover latch is secure.
- **RIDER PROTECTION** — Always wear the proper flotation device and protective gear.

Break-In

A new watercraft should be ridden with care during the break-in period to allow mechanical components to "bed-in" and produce smooth, long wearing surfaces.

Kawasaki recommends use of a 50:1 gas/oil premix in the fuel tank for extra lubrication during the break-in period. Use premixed fuel for the first five hours (approx. three tanks of fuel). After the break-in period, the oil injection system provides the necessary engine lubrication without the need for premixed fuel. During the first five hours of engine operation, do not subject the engine to heavy lugging or prolonged full throttle operation. For this period, up to $\frac{3}{4}$ throttle is recommended. Slide back the throttle limiter by $\frac{1}{2}$ of its full travel from the unlimited position (throttle fully opening).

Vary the operating speed often, not running for a prolonged time at any one speed.

Mixing:

A convenient way to mix fuel is to use a five gallon container. Add 12.8 ounces of oil to 2½ gallons of gas and mix thoroughly. Add another 2½ gallons of gas, and mix again to get the proper 50:1 ratio. Refer to the following chart for smaller quantities.

Fuel Ratio Chart 50:1

Ounces of Oil to Gallons of Gas (U.S.)			
Ounces of Oil	Gallons of Gas	Ounces of Oil	Gallons of Gas
2.6 oz	1.0 gal	7.7 oz	3.0 gal
3.8 oz	1.5 gal	9.0 oz	3.5 gal
5.1 oz	2.0 gal	10.2 oz	4.0 gal
6.4 oz	2.5 gal	12.8 oz	5.0 gal

Recommended Oil

Kawasaki JET SKI Oil or
NMMA Certified TC-WII Oil

Careful treatment of the boat during the break-in period will result in more efficient, reliable performance and a longer life for the boat.

In addition to the break-in described above, we recommend that the owner take his watercraft to an authorized Kawasaki JET SKI dealer after the first ten hours of operation for initial maintenance service. See the Periodic Maintenance Chart in the MAINTENANCE AND ADJUSTMENTS chapter.

Stopping the Engine

Push the RED engine stop button. It is not necessary to hold the button "in" to stop the engine. After the engine stops, the STOP button resets itself and the engine is ready to start.



A. Engine Stop Button

⚠ WARNING

You have no directional control of the watercraft when the engine is stopped.

If the engine must be stopped immediately in an emergency, push the RED engine stop button.

Some possible EMERGENCY situations are:

- The engine speeds out of control.
- The throttle lever will not release completely.
- The rider panics and "freezes," holding the throttle open.

⚠ WARNING

If the throttle fails, do not operate the watercraft until the source of the problem is found and corrected.

Starting the Engine

- Read the Pre-ride Checklist in this manual and follow its instructions before putting the watercraft in the water.
- After transporting or refueling and before starting the watercraft, remove the engine cover for several minutes to ventilate the engine compartment.

⚠ WARNING

A concentration of gasoline fumes in the engine compartment can cause a fire or explosion.

- Place the watercraft in at least 0.6 m (two feet) of water which is clear of weeds and debris. Make sure the area ahead of the watercraft is clear of swimmers, boats, and obstacles.

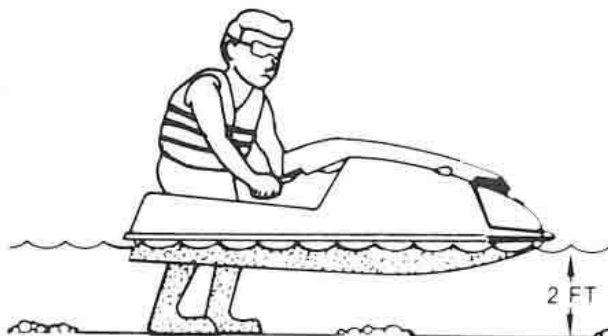

CAUTION

The watercraft must be at least 0.6 m (two feet) off the bottom when starting to prevent jet pump damage by objects sucked up from the bottom.

- Check that the fuel valve is ON and that the starter interlock switch is pulled out to the ON position.
- Stand in the water next to the boat, turn the choke knob clockwise, and with your right hand, grasp the right handlebar and apply a small amount of throttle.

⚠ WARNING

Keep your hands, feet, and clothing away from the jet pump intake (bottom of the boat, in the middle) and never stick anything into the pump outlet (steering nozzle at the back of the boat) whenever the engine is running, or a severe injury can occur.

- With your left hand, push the green start button and release it when the engine starts. If the engine does not start within 5 seconds, release the button. Wait 15 seconds before trying again. If the engine will not start after several attempts, see the Troubleshooting Guide chapter.

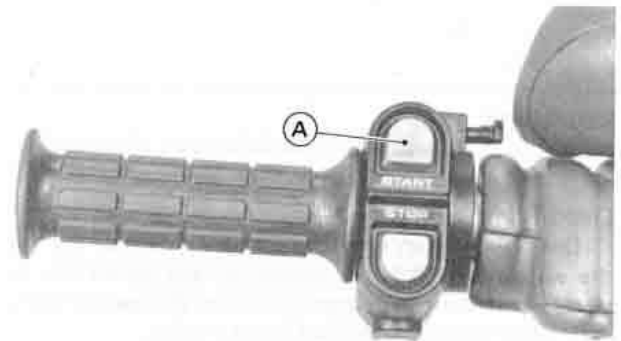

A. Start Button

NOTE

- Wait 15 seconds between each operation of the starter. This will extend battery and starter life significantly.
- When the engine first fires, even if it doesn't actually start, turn the choke knob counterclockwise. This will prevent engine flooding.
- When the engine is warm, the choke is not needed.

CAUTION

Do not push the start button while the engine is running or while the starter is still spinning, as it will hasten starter wear and may cause the starter to jam.

24 OPERATING INSTRUCTIONS

- After the engine has started, allow it to warm up for about 1 minute. Apply a little throttle occasionally. Excessive idling can foul the spark plugs.
- Check that water comes out of the bypass outlet on the left side of the hull when the throttle is applied. This indicates that cooling water is circulating. If there is none, shut off the engine and find the source of the trouble. When the exhaust system is dry, it can take up to 15 seconds for water to appear at the bypass outlet.

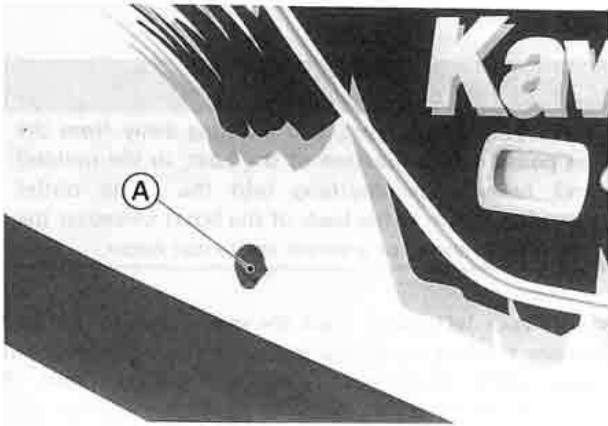

A. Bypass Outlet

Launching

Deep Water Start:

Deep water starting is the primary means of starting the watercraft. It is not necessarily the easiest way to start, but it must be mastered so that you can get going again after the inevitable spill in deep water.

- Start the engine in water that is at least waist deep.
- Assume a prone position behind the boat with your hands grasping the handlebar and your forearms resting on the tail fins.
- Check that the water ahead of you is clear.



- Apply the throttle and accelerate rapidly. Both stability and steering control are provided by jet thrust. As the craft accelerates, pull your body up onto the riding platform and onto your knees, using your elbows on the fins for leverage. Move as far forward as possible without interfering with handlebar movement.



- As the watercraft increases speed, the bow will drop and the boat will level out in the water. This is called planing. It will take longer for a heavier rider than it will for a light rider. Once the boat has planed, you can back off the throttle and select your desired speed.

⚠ WARNING

Don't forget to watch out for other boats, swimmers, or obstructions in your path. This is especially critical during a beginner's first exciting ride.

Deep water starting is generally more difficult if you're heavy, or if you're not in good physical condition. In these cases, return to the shore for a shallow water start. After some practice, you'll soon master the deep water start.

⚠ WARNING

Do not operate the watercraft while trailing your body behind it for extended periods of time. Your visibility is limited. You may not see other boats, swimmers, or obstructions in your path. Also, you may not see foreign objects that the jet pump could pick up and eject to the rear.

Shallow Water Start:

This is the easiest way to launch a watercraft, but it shouldn't be relied upon merely because it's easy. The deep water start is still the most important launch to a beginner.

- Start the engine in at least 0.6 m (two feet) of water.

CAUTION

The watercraft must be at least 0.6 m (2 ft) off the bottom when starting to prevent jet pump damage by objects sucked up from the bottom.

- Grasp both handlebar grips and put one knee up onto the riding platform, balancing on your other foot.

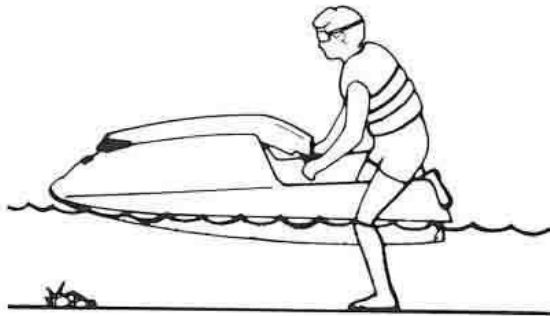
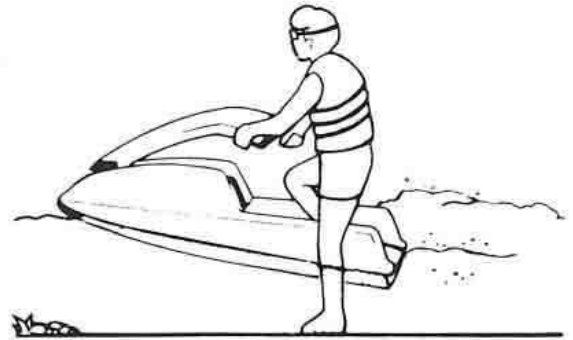

- Accelerate quickly to planing speed, and place your other foot on the rear section of the riding platform.
- Keep alert for other boats, swimmers, or obstructions in your path.



- Check that the water ahead of you is clear and point the handlebar straight ahead.
- Apply the throttle and accelerate rapidly. Both stability and steering control are provided by jet thrust.
- Keep alert for other boats, swimmers, or obstructions in your path.
- As the watercraft accelerates, pull your other knee up onto the riding platform and move as far forward as possible, without interfering with handlebar movement. Keep your body perpendicular to the water with your weight forward and low.



Standing Start:

This method can be used by the more experienced watercraft rider.

- Start the engine in at least 0.6 m (two feet) of water.
- Put one foot in the riding platform, balancing yourself with the other foot on the beach bottom.

.....
Stopping the JET SKI Watercraft

The watercraft depends on forward motion to keep it planing (level), so the rear of the boat will usually submerge on stopping, depending on rider weight. Be prepared to get off the boat when it stops.

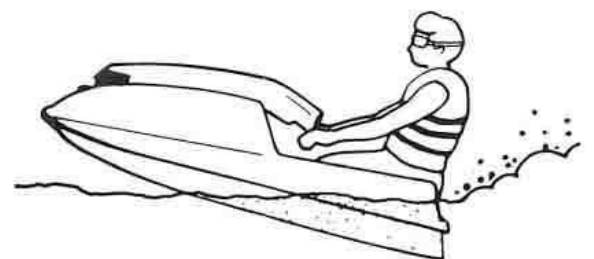

26 OPERATING INSTRUCTIONS

⚠ WARNING

Never directly approach any moving or stationary object closer than 60 m (200 feet) when traveling at top speed. Always throttle down before approaching your intended stopping area.

The watercraft is normally stopped in one of two ways, both of which use natural water drag to bring the boat to a halt.

Straight Line Stopping:

Push the RED engine stop button.

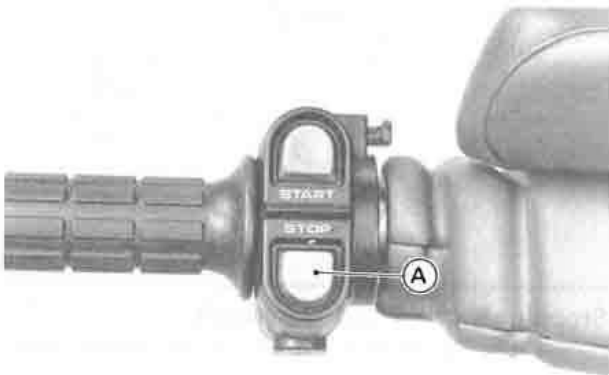

A. Engine Stop Button

Pushing the stop button stops the engine immediately and permits the shortest straight-line stopping distance. The RED stop button should be used when you are approaching the shore and intend to stop. This prevents sand or debris from entering and damaging the jet pump.

⚠ WARNING

Do not stop the engine if you want to steer the watercraft. You have no directional control when the engine is stopped.

Normal Stopping:

Release the throttle lever.

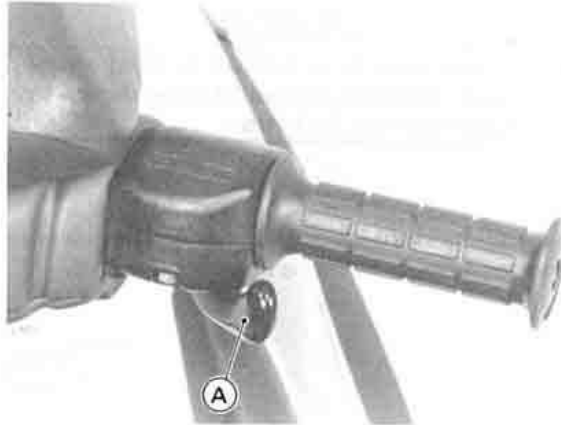

A. Throttle Lever

Releasing the throttle stops forward motion almost as quickly as pushing the engine stop button. More importantly, the engine will still be running, so you can steer the boat after reapplying the throttle. In this manner you can turn and move away from any obstacles.

⚠ WARNING

Releasing the throttle completely reduces the ability to steer. This can cause you to hit an object you are trying to avoid. You must have thrust to turn, so keep the throttle on or apply throttle as needed to maintain thrust at the jet nozzle.

Stopping Skills:

Stopping distance depends partially on rider weight and position, idle set speed, and operating speed. Experienced riders can usually shorten stopping distance by using various riding techniques. Shifting weight to the rear, or turning the boat sharply (using the throttle) while stopping are two methods which can be used to decrease stopping distance.

⚠ WARNING

If you get off the watercraft before it has completely stopped, make sure there are no other boats, swimmers, or obstacles in the path of the watercraft.

You can always jump off the boat in an emergency to protect yourself, but you must also do your best to protect other users of the water.

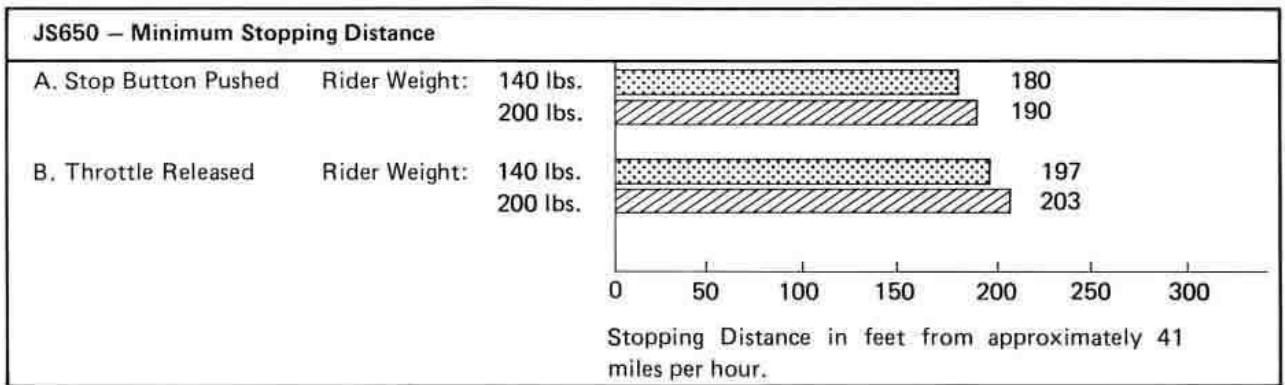

Minimum Stopping Distances:

The charts above indicate minimum straight-line stopping performance that can be met by the watercraft. Two methods of stopping have been used:

- A. Pushing the engine stop button.
- B. Releasing the throttle.

The information shown here represents results obtained by skilled riders of different weights under controlled conditions, and the information may not be correct under other conditions.

Lean into the turn to maintain your balance. How much you lean depends on the tightness of the turn and your traveling speed. In general, the higher the speed or the sharper the turn, the more you lean.

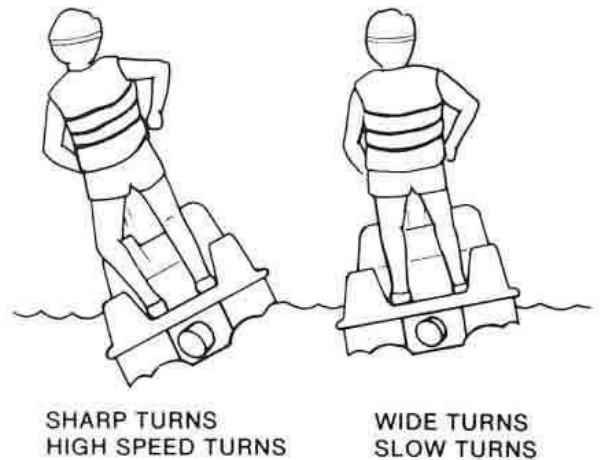

Turning the JET SKI Watercraft

Turning the watercraft requires a combination of three actions:

- Turning the handlebar
- Leaning into the turn
- Using the throttle

Point the handlebar to the left for a left turn

Point the handlebar to the right for a right turn



LEFT

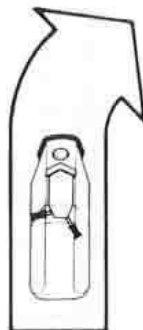

RIGHT

28 OPERATING INSTRUCTIONS

Using the throttle is another important part of turning maneuvers. Applying the throttle produces thrust from the jet pump giving you directional control over the watercraft.

High thrust of the jet pump makes the boat turn more sharply.

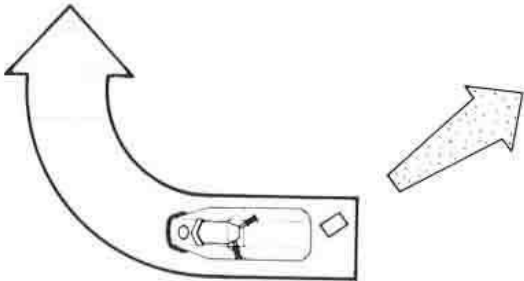

Low thrust of the jet pump makes the boat turn less sharply.

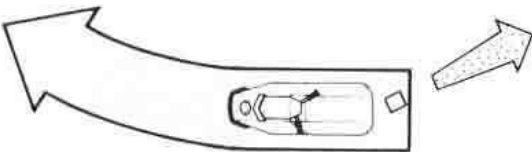

If you stop the engine while riding, there is no thrust of the jet pump. The boat goes straight ahead even though the handlebars are turned.

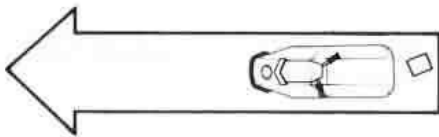

NO THRUST = NO TURN

This is one characteristic of jet drive boats which is important to remember when you make an emergency maneuver: **YOU MUST HAVE THRUST TO TURN**, so keep the throttle on or apply throttle as needed to maintain thrust at the jet nozzle.

⚠ WARNING

Releasing the throttle completely reduces the ability to steer. This can cause you to hit an object you are trying to avoid. You must have thrust to turn, so keep the throttle on or apply throttle as needed to maintain thrust at the jet nozzle.

Riding the JET SKI Watercraft

On your first ride, stay on your knees and leave the handle pole down. Familiarize yourself with the handling of the boat. Vary the engine speed with the throttle lever to get the feel of throttle influence on steering. If porpoising occurs, that is, the front of the watercraft rises and falls rapidly, move your body weight further forward.

⚠ WARNING

Never ride with your chin immediately above the handle pole. If you should hit a wave, you might injure yourself.

If the engine runs out of fuel, do not operate the choke knob. Turn the fuel valve to RES and push the green start button again.

Stay alert at all times, and keep away from other boats, swimmers, and structures.

CAUTION

Do not push down on the handlebar. The handle pole rests on the engine cover and you could damage it.

Do not run the watercraft onto the shore, or severe impeller or hull damage may occur.

Do not operate in shallow or debris-laden water, or the impeller may be damaged and sand may clog the water cooling hoses.

In general, the heavier you are, the more time it will take you to become proficient on the watercraft. Once you are familiar with the handling characteristics of the boat, you can learn to stand up.

Standing Up:

- Maintaining a steady speed, raise the handlebar slightly and place one foot near the front of the riding platform.
- Balance yourself and slowly rise to a standing position, bringing the handlebar up with you as you rise.



- Again keep your body perpendicular to the water and steer with the handlebar. As you become proficient, you can experiment with the effects of "body english" and leaning while turning the watercraft.

Fall Recovery:

If you take a spill on your first attempt, as most riders do, don't feel bad. Part of the fun of a watercraft is the challenge it provides; and knowing the best way to fall, as in Judo, is essential.

⚠ WARNING
When you fall, do not hang onto the handlebar. Let go, or you might injure yourself by striking the watercraft.

CAUTION
Hanging onto the handlebar during a fall can cause misalignment of the handle pole which can cause damage to the handle pole and engine cover.

- The best way to hit the water is bottom first, legs together, with your arms over your head. This can help prevent injury from underwater objects.
- When you let go of the handlebar and throttle, the watercraft will turn upright, throttle down to idle, and circle slowly until you can climb back on.
- The speed of the watercraft when you fall from it determines the distance it travels before it starts circling. If the watercraft does not circle properly due to wind or water conditions, check the idle speed. It may have to be increased slightly.

NOTE

- If the watercraft is being capsized a great deal (especially when used by beginners), it should be run at full throttle occasionally by a more experienced rider. This will allow the bilge system to pump out water which may accumulate in the engine compartment.
- The watercraft is equipped with self-righting, positive flotation. If the engine compartment is completely filled with water, the watercraft will still float in an upright position, but with the bow completely submerged. However, if water gets inside the engine itself, a special procedure must be followed. For detailed instructions, see the "After Submerging" section.

.....
End of the Day Checklist

First, Drain the Exhaust System:

- Remove the watercraft from the water.
- Start the engine and run it for several seconds to purge the exhaust system of excess water. Rev the engine repeatedly, until water stops coming out of the exhaust at the stern.

CAUTION
Never operate the engine at maximum speed out of the water. Severe engine damage may occur. Do not run the engine with the watercraft out of the water for more than 15 seconds at a time. Overheating will cause engine and exhaust system damage.

- After each use in salt water, flush the cooling system with fresh water (see Cooling System Flushing in the MAINTENANCE AND ADJUSTMENTS chapter). This will prevent build up of salt deposits and eventual cooling system blockage.

Second, Clean the Engine Compartment:

- Remove the engine cover.
- If water has accumulated in the engine compartment, tip the watercraft on its left side to drain water out of the compartment. Be sure to place a towel or pad under the boat to protect its finish.
- Wipe the engine compartment dry, and install the engine cover.
- When the watercraft is ready for storage, install the cover loosely, and block it up with 10 mm (one half inch) spacers to aid air circulation and prevent condensation from forming.

.....
Special Procedures

Clearing Clogged Impeller:

Occasionally, weeds or other debris may lodge in the impeller/jet pump, severely impairing performance. This foreign matter must be completely cleaned out for the jet pump to function properly.

30 OPERATING INSTRUCTIONS

- Shut off the engine, and beach the watercraft.

⚠ WARNING

Never attempt to clear the jet pump of debris while the engine is running, or a severe injury can occur. Stop the engine and push in the starter interlock switch before checking the pump for debris.

- Push in the starter interlock switch.
- Place a protective pad next to the boat.
- Tip the boat on its left side and remove the jet pump grate and cover, if necessary.

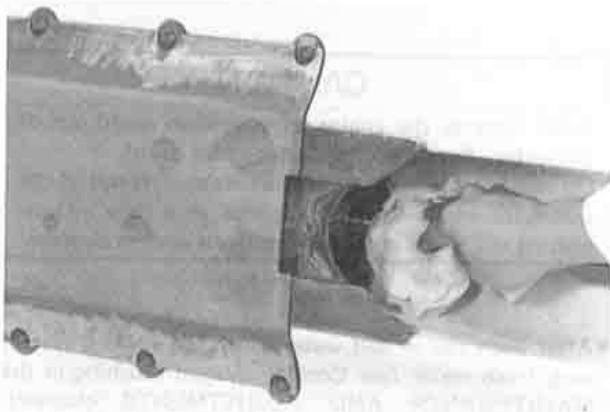

- Clean the water intake, drive shaft, impeller, jet pump housing, outlet, and steering nozzle of any seaweed, grass, or other debris.

CAUTION

Be sure the pump area and all its components are completely clear. Engine cooling water is supplied by the jet pump, and any loss of pump performance may cause overheating.

- Replace the jet pump cover and grate. Tighten the screws securely.

Cleaning Fouled Spark Plugs:

Fouled spark plugs can result from several causes. Among them, low idle speed, prolonged idling, and operating with the choke on. Water in the fuel or inside the engine can also cause spark plug fouling.

- Remove the fouled spark plugs and install clean, dry plugs. Fouled plugs may be cleaned with electrical contact cleaner (P/N K61080-001B). Wet plugs may be cleaned with a penetrating rust inhibitor, such as WD40 or Bel-Ray 6 in 1.
- Start the engine, using very little throttle.

After Submerging:

CAUTION

If water gets into the engine, follow this procedure immediately! If water is left in the engine more than a few hours, it will destroy the crankshaft bearings and damage other internal engine parts.

If the watercraft becomes submerged, water may enter the engine through the carburetor intake. Water may also enter the fuel tank and oil tank.

1. Remove the craft from the water, and remove the engine cover.
2. Tip the craft onto its **left side** to drain water out of the engine compartment.
3. Remove the spark plugs.
4. While pulling up the engine drain valve knob, hold the engine stop button and push the start button. Water in the engine will be pumped out of the crankcase. Do not operate the starter for longer than 5 seconds. Wait 15 seconds before using it again.

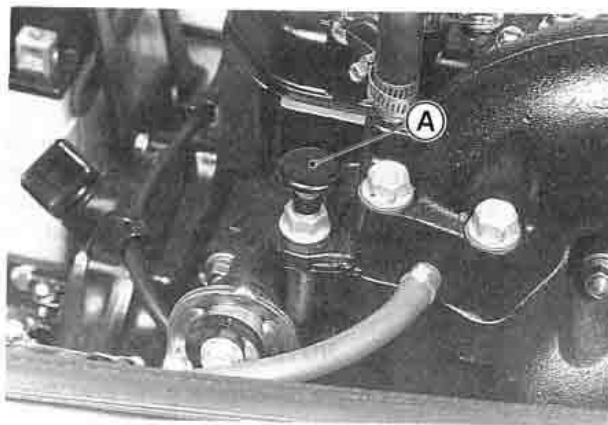

A. Drain Value Knob

5. Release the drain valve knob.
6. Tip the watercraft onto its **left side** again to drain water out of the engine compartment.
7. With the engine drain valve knob pulled up, crank the engine over again to be sure all water is out of the engine.
8. Spray the spark plugs clean and install them.
9. Start the engine.

CAUTION

Do not run the engine with the watercraft out of the water for more than 15 seconds at a time. Overheating will cause severe engine and exhaust system damage.

Never operate the engine at maximum speed out of the water. Severe engine damage may occur.

10. If the engine will not start, remove the spark plugs and check them for presence of water. Spray them clean and try to start the engine again. Continued water fouling may indicate water in the fuel system.
11. If the fuel tank has water in it, it must be emptied by pump or siphon. Clean the filter screens (see the Fuel and Oil Systems section in the MAINTENANCE AND ADJUSTMENTS chapter). Refill the tank with fresh fuel. Do not dump contaminated fuel in places not designated for that purpose.

⚠ WARNING

Gasoline is extremely flammable and can be explosive under certain conditions. Push in the starter interlock switch. Do not smoke. Make sure the area is well ventilated and free from any source of flame or sparks; this includes any appliance with a pilot light.

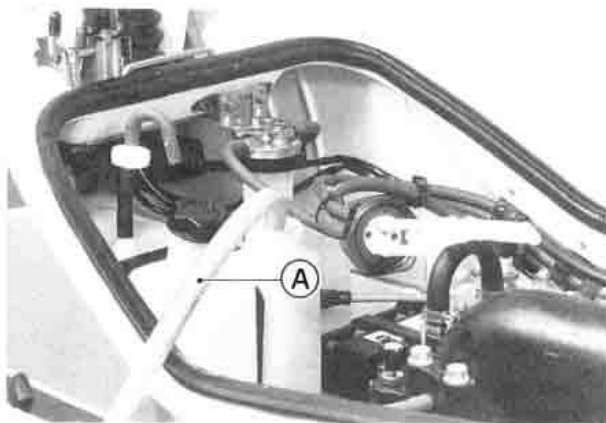

A. Siphon Hose

NOTE

It may be necessary to repeat these procedures several times before all water is removed from the engine. Continued trouble may require disassembly of the fuel pump to drain water. See your dealer for this service.

12. If the oil tank has water in it, it must be emptied. Disconnect the oil intake hose from the oil pump and run the hose into a container.

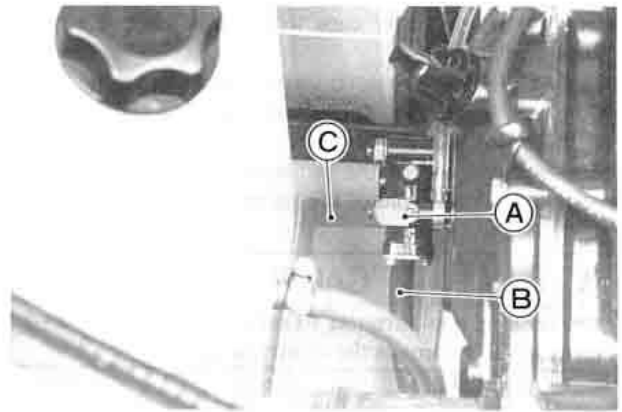

A. Oil Pump
B. Intake Hose
C. Container

13. Reconnect the hose to the oil pump and refill with fresh engine oil. Do not dump contaminated engine oil in places not designated for that purpose.
14. Bleed the air inside the oil line (see the Fuel and Oil Systems section in the MAINTENANCE AND ADJUSTMENTS chapter).
15. Reinstall the engine cover and secure it.
16. Finally, run the boat IN WATER at least 10 minutes to dry any remaining water and blow any foreign matter (like salt) out through the exhaust.

Towing the JET SKI Watercraft:

In case you run out of fuel, have engine problems or other complications, the watercraft may be towed. Attach one end of a 6 m (20 foot) tow rope to the eye in the bow and the other end to the tow boat. Towing must be slow, not over 8 km/h (5 mph).

CAUTION

It is important that these instructions be followed or the engine compartment could flood and the watercraft could partially submerge.

Jump Starting:

If your watercraft's battery is run down, it should be removed and charged. If this is not practical, a booster battery and jumper cables may be used to start the engine. The booster battery must be of the same voltage as the watercraft battery (12 V).

⚠ WARNING

Battery acid generates hydrogen gas which is flammable and explosive under certain conditions. It is present within a battery at all times, even in a discharged condition. Keep all flames and sparks (cigarettes) away from the battery. Wear eye protection when working with a battery. In the event of battery acid contact with skin, eyes, or clothing, wash the affected areas immediately with water for at least five minutes. Seek medical attention.

32 OPERATING INSTRUCTIONS

- Remove all the filler caps from both the booster and watercraft batteries.
- Lay a cloth over the open vents of each battery.
- Connect a jumper cable between the positive (+) terminals of the two batteries.
- Connect one end of the remaining jumper cable to the negative (-) terminal of the booster battery.

CAUTION

Connecting two batteries in reverse polarity (+ to -) can seriously damage the electrical system.

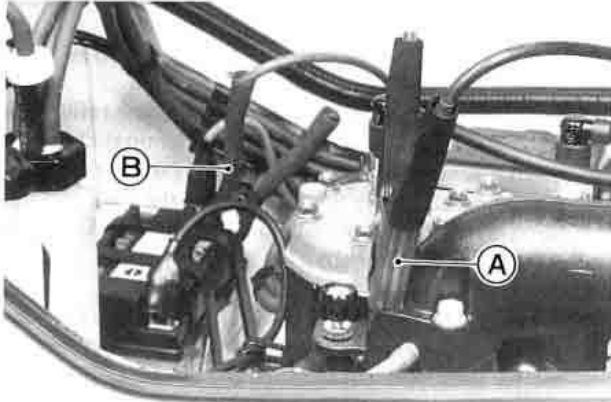

A. Negative Cable B. Positive Cable

- Connect the other end of the remaining jumper cable to the exhaust pipe bolt.

⚠ WARNING

Do not make this last connection at the carburetor or battery. Take care that you do not short the cables together, and do not lean over the battery when making this last connection. Do not jump start a frozen battery. It could explode.

CAUTION

Do not operate the starter continuously for more than 5 seconds or the starter will overheat. Wait 15 seconds between each operation of the starter to let it cool.

- Start the watercraft engine and then disconnect the jumper cables in the reverse of the sequence just described.
- Dispose of the cloths covering the batteries and replace the filler caps.

STORAGE

During the winter, or whenever your watercraft will not be in use for more than 30 days, proper storage is essential. It consists of checking and replacing missing or worn parts; lubricating parts to ensure that they do not become rusted; and, in general, preparing the watercraft so that when the time comes to use it again, it will be in top condition. See your Kawasaki JET SKI dealer for this service or do the following.

Preparation for Storage

Cooling System:

- Clean the cooling system (see Cooling System Flushing section in the MAINTENANCE AND ADJUSTMENTS chapter).

Bilge System:

- Clean the bilge system (see Bilge System Flushing section in the MAINTENANCE AND ADJUSTMENTS chapter), but before reconnecting the hoses to the plastic breather fitting, blow air through both hoses to force all water out of the bilge system.

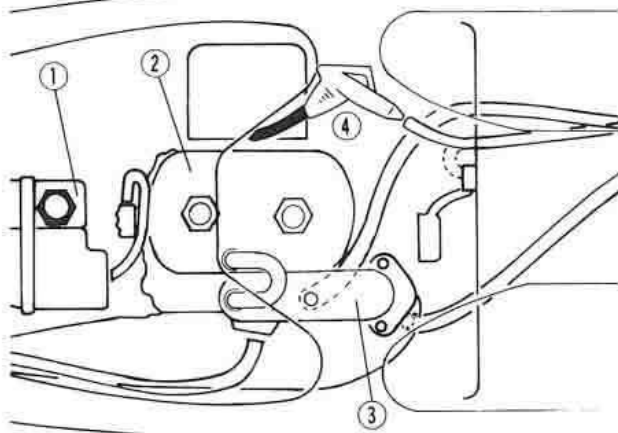

- | | |
|------------------|------------------------------|
| 1. Fuel Tank | 3. Exhaust Pipe |
| 2. Cylinder Head | 4. Blow with compressed air. |



A. Blow through both hoses.

Fuel System:

⚠ WARNING

Gasoline is extremely flammable and can be explosive under certain conditions. Push in the starter interlock switch. Do not smoke. Make sure the area is well ventilated and free from any source of flame or sparks; this includes any appliance with a pilot light.

- Drain the fuel tank. This should be done with a siphon or pump.
- Clean the filter screens (see Fuel Filter Screen Cleaning section in Fuel and Oil System in the MAINTENANCE AND ADJUSTMENTS chapter).
- Leave the outlet retainer nut loose to prevent condensation in the tank.

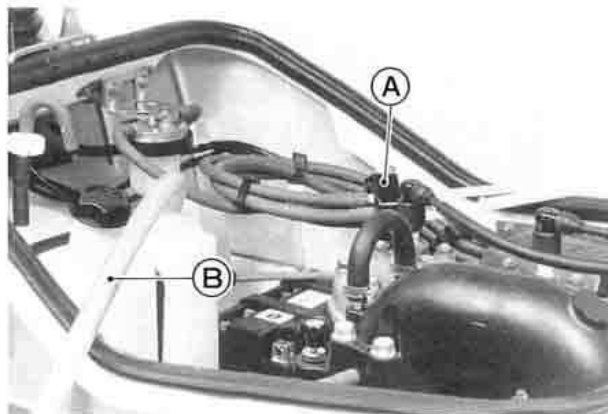

A. Retainer Nut B. Siphon Hose

- Drain the sediment bowl, and clean it (see Sediment Bowl Cleaning section).
- Start the engine and run it in 15 second periods until all fuel in the carburetor is used up. Wait 5 minutes between 15 second running periods.

CAUTION

Do not run the engine with the watercraft out of the water for more than 15 seconds at a time. Overheating will cause severe engine and exhaust system damage.

- Remove the air intake cover from the carburetor.

34 STORAGE

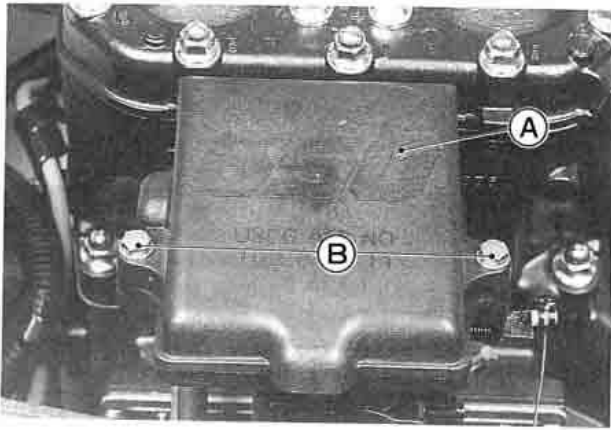

A. Air Intake Cover

B. Bolts

- Lift out the flame arrester element with expanded metals and clean the element with compressed air, if necessary.

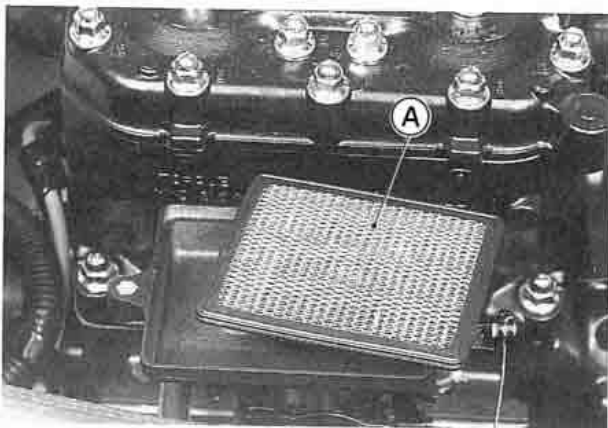

A. Element

- Spray a penetrating rust inhibitor, such as WD40 or BEL-RAY 6 in 1 down the carburetor bore.
- Install the flame arrester element in place. Both sides are identical.
- Reinstall the cover, tightening the bolts securely.

Engine:

- Remove the spark plugs and pour one ounce of motor oil into each cylinder.

CAUTION

Do not use too much oil, or the crank seals may be damaged when the engine is next started.

- Ground the spark plugs, turn the engine over several times with the starter motor to coat the cylinder walls with oil, then replace the spark plugs.

Battery:

- Remove the battery (see Battery Removal section in Battery in the MAINTENANCE AND ADJUSTMENTS chapter).
- Clean the exterior with a solution of baking soda and water (one heaping tablespoon of baking soda in one cup of water). Rinse thoroughly with water.

CAUTION

Do not allow any soda solution to enter the battery.

- Check the electrolyte and fill to the upper level mark with distilled water, if necessary.
- Check the specific gravity with a hydrometer and recharge if necessary.
- Coat both battery terminals with grease.
- Store the battery in a cool, dry place. Do not expose it to freezing temperatures.

NOTE

● Check the battery at least every 30 days and recharge if necessary. A neglected battery will gradually lose its charge and begin to sulfate (plates turn white). Once this reaction has begun, the battery usually cannot be salvaged.

Lubrication:

- Carry out all recommended lubrication procedures (see Lubrication in the MAINTENANCE AND ADJUSTMENTS chapter).

General:

- Wash the watercraft and dry it thoroughly, making sure to drain the engine compartment completely.

CAUTION

Use only a mild detergent in water to wash the watercraft. Harsh solvents may attack the surface or smear the colors.

- Apply a good grade of wax to all exterior hull surfaces.
- Lightly spray all exposed metal parts with a penetrating rust inhibitor, such as WD40 or BEL-RAY 6 in 1 to prevent corrosion.
- Install the engine cover loosely, and block it up with 10 mm (one half inch) spacers to insure adequate ventilation, and prevent condensation from forming.
- Cover the watercraft and store it in a clean, dry place.

Removal from Storage

The following procedure explains the steps necessary to put the watercraft back in service following a storage period. See your Kawasaki JET SKI dealer for this service, or do the following. See the MAINTENANCE AND ADJUSTMENTS chapter for detailed procedures.

- Carry out all recommended lubrication procedures (see Lubrication in the MAINTENANCE AND ADJUSTMENTS chapter).
- Check for binding or sticking throttle, choke, or steering mechanism. The throttle lever must return fully when released.
- Clean and gap spark plugs (see Spark Plug in the MAINTENANCE AND ADJUSTMENTS chapter).
- Check all rubber hoses for weathering, cracking, or looseness.
- Turn the watercraft on its left side on a protective pad, and remove the jet pump cover. Check cooling and bilge hoses for weathering, cracking or looseness.
- Replace them if necessary. Replace the cover and tighten securely.
- Check the fire extinguisher for a full charge.
- Check the battery, charge if necessary, and clean the terminals. Install the battery (see Battery Installation section in Battery in the MAINTENANCE AND ADJUSTMENTS chapter).
- Check/replace the fuel filter (see Fuel Filter section in Fuel and Oil System in the MAINTENANCE AND ADJUSTMENTS chapter).
- Inspect the fuel vent check valve (see Fuel Vent Check Valve Inspection section in Fuel and Oil System in the MAINTENANCE AND ADJUSTMENTS chapter).
- Inspect the engine oil vent check valve (see Engine Oil Vent Check Valve Inspection section in Fuel and Oil System in the MAINTENANCE AND ADJUSTMENTS chapter).
- Tighten the fuel tank outlet retainer nut and fill the tank with fuel.

⚠ WARNING

Gasoline is extremely flammable and can be explosive under certain conditions. Push in the starter interlock switch. Do not smoke. Make sure the area is well ventilated and free from any source of flame or sparks; this includes any appliance with a pilot light.

- After transporting or refueling and before starting the watercraft, remove the engine cover for several minutes to ventilate the engine compartment.

⚠ WARNING

A concentration of gasoline fumes in the engine compartment can cause a fire or explosion.

- Check for fuel leaks. Repair if necessary.
- Check the engine oil level. Fill the oil tank with the specified oil.

⚠ WARNING

Do not run the engine in a closed area. Exhaust gases contain carbon monoxide: a colorless, odorless, poisonous gas. Breathing exhaust gas leads to carbon monoxide poisoning, asphyxiation, and death.

- Start the engine and run it for 15 seconds. Check for fuel, oil and exhaust leaks. Any leaks must be repaired.

CAUTION

Never run the engine with the watercraft out of the water for more than 15 seconds. Overheating will cause severe engine and exhaust system damage. Do not run the engine at maximum speed out of the water. Severe engine damage may result.

- Install the engine cover making sure the engine cover latch is secure.

MAINTENANCE AND ADJUSTMENTS

.....
Periodic Maintenance Chart

NOTE

○Complete the Pre-Ride Checklist before each outing.

Description	Frequency	Initial 10 Hours	Every 25 Hours	Every 100 Hours
Check all hose clamps, nuts, bolts, and fasteners		•	•	
*Torque cylinder head nuts		•	•	
Lubricate throttle cable fitting and choke cable fitting at carb			•	
Clean and gap spark plugs (replace if necessary)			•	
Check battery level and terminals			•	
Lubricate choke cable and (*) throttle case and cable			•	
Lubricate steering cable ball joints and steering nozzle pivots			•	
*Lubricate handlebar pivot (disassemble)			•	
Clean fuel filter screens			•	
Inspect fuel vent and engine oil vent check valves			•	
Adjust carburetor			•	
Flush bilge line and filter			•	
Flush cooling system (after each use in salt water)			•	
Inspect/clean flame arrester			•	
*Inspect impeller blade for damage (remove)				•
*Inspect/replace coupling rubber				•
*Inspect carburetor throttle shaft spring (replace carburetor if necessary)				•
*Inspect steering cable				•

*These items must be performed with the proper tools. See your authorized Kawasaki JET SKI dealer for service, unless you have the proper equipment and mechanical proficiency (refer to the Service Manual).

Control Cable Adjustments

Choke Cable Adjustment

- When the choke knob is turned all the way to the left, the choke butterfly valve in the carburetor should be completely open. Check that the choke pivot arm is up all the way with minimal cable slack.

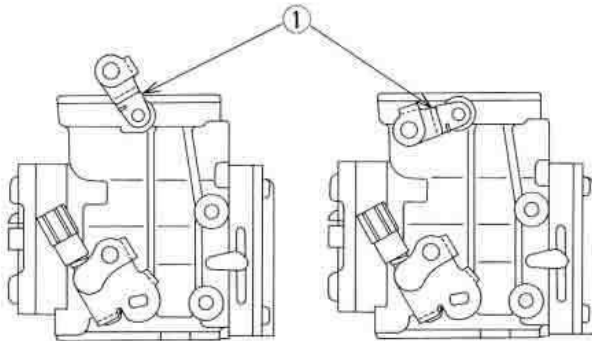

CHOKE OPEN
(RELEASED)

CHOKE CLOSED
(TURNED TO RIGHT)

1. Choke Pivot Arm

- If necessary, adjust the choke cable.
 - Turn the choke knob all the way to the left.
 - Loosen and turn the locknuts at the cable mounting bracket to allow a little cable slack.
 - Tighten the locknuts securely.

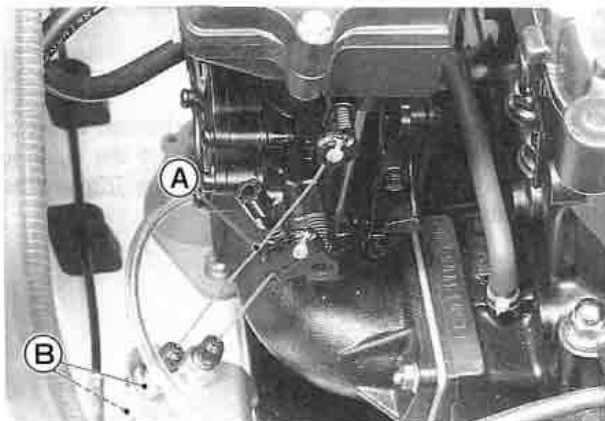

A. Choke Cable

B. Locknuts

Throttle Cable Adjustment

- Check throttle cable adjustment.
 - With the throttle lever released, the lower stop on the throttle pivot arm should rest against the idle adjust screw, and there should be slight slack in the throttle cable.
 - When the throttle lever is fully applied (pushed), the upper stop on the pivot arm should be all the way up against the stop on the carburetor.

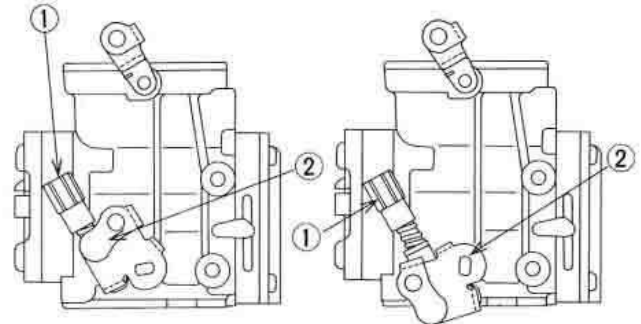

THROTTLE CLOSED
(RELEASED)

THROTTLE OPEN
(APPLIED)

**1. Idle Adjust Screw
2. Throttle Pivot Arm**

- If necessary, adjust the cable.
 - Loosen and turn the locknuts at the cable mounting bracket until the lower stop on the pivot arm hits against the idle adjust screw with slight cable slack.
 - Tighten the locknuts securely.

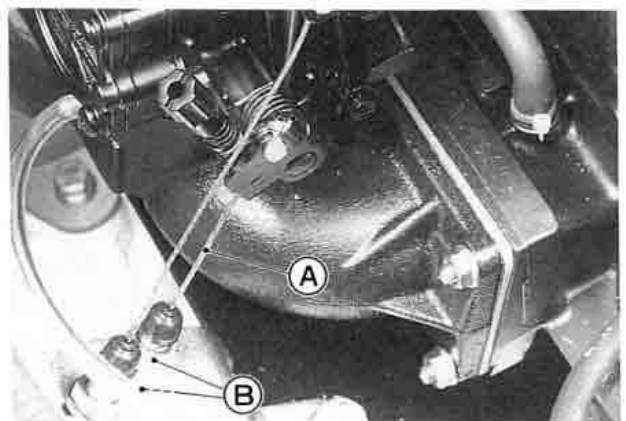

A. Throttle Cable

B. Locknuts

38 MAINTENANCE AND ADJUSTMENTS

Steering Cable Adjustment

- Lower the handle pole and center the handlebar in a straight ahead steering position.

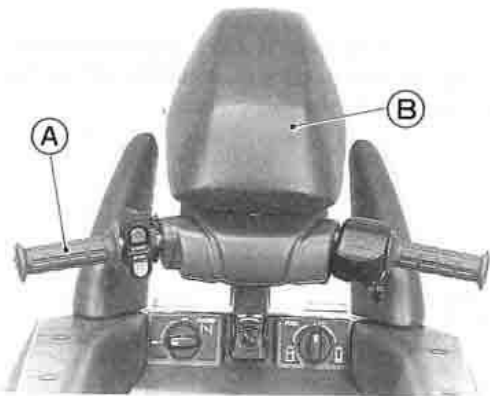

A. Handlebar

B. Handle Pole

- Check that the steering nozzle is the same distance from each side of the pump cavity.

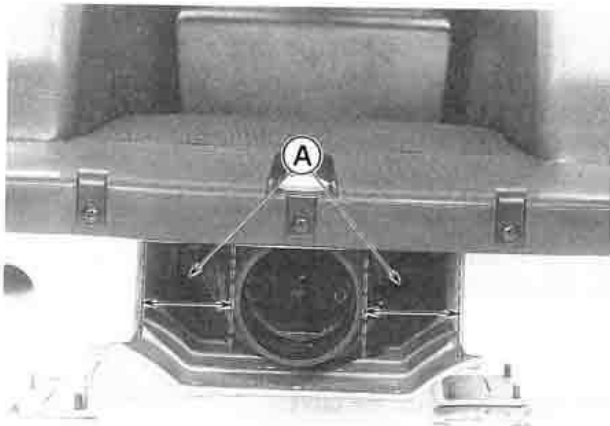

A. Equal

- If it is not, raise the handle pole.
- Loosen the locknut on the steering link.

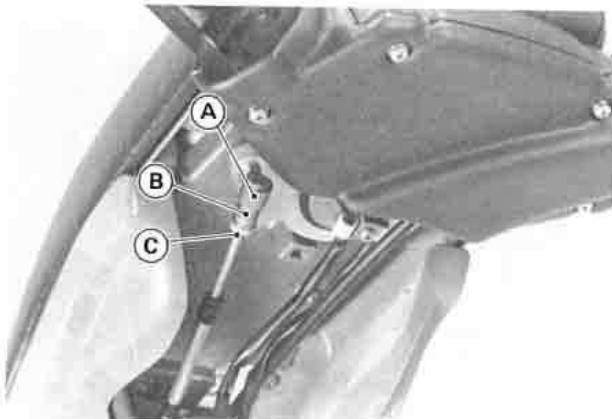

A. Sleeve
B. Ball Joint

C. Locknut

- Slide back the outer sleeve and take the ball joint off the ball.
- Center the handlebar in a straight ahead steering position.
- Position the steering nozzle in the center of the pump cavity.
- Turn the ball joint until the hole in it aligns with the ball.
- Reattach the ball joint and check cable adjustment again.
- When adjustment is correct, tighten the steering link locknut.
- As an additional check, turn the handlebar all the way to the left and right, and measure the distance between the nozzle and the edge of the pump cavity. It should be equal at both extremes.

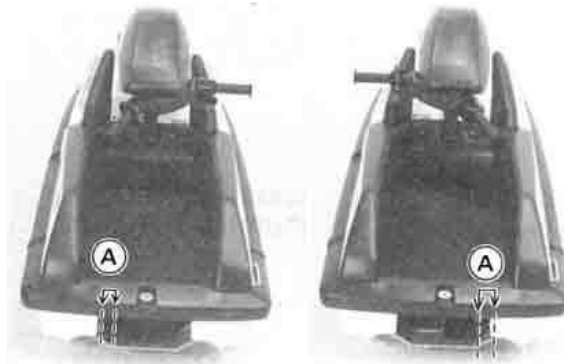

A. Equal

Steering Cable Inspection

Steering cable inspection is best performed by your authorized Kawasaki JET SKI dealer. If the steering feels rough or "catchy," have your dealer inspect the steering cable.

NOTE

○ The steering cable is sealed at each end and does not require lubrication.

.....
Fuel and Oil System

Carburetor Adjustment:

Idle Speed Adjustment

The normal idle speed setting is the lowest at which the watercraft will run reliably while still producing enough thrust to circle back to the rider after a spill. Turn the idle adjustment screw as required to reach this setting.

Too high an idle speed setting may cause the watercraft not to circle back properly.

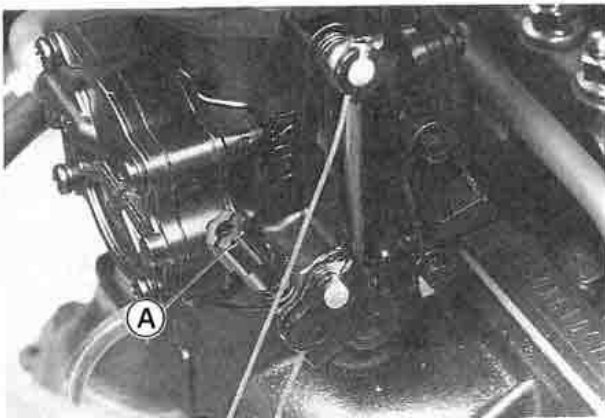

A. Idle Adjustment Screw

Idle Speed
 In water – about 1 250 r/min (rpm)
 Out of water – about 2 300 r/min (rpm)

Mixture Screws

Every carburetor is adjusted individually at the factory for optimum performance under most conditions. **DO NOT CHANGE THESE SETTINGS.**

NOTE

○If adjustment is needed, have it performed by your authorized Kawasaki JET SKI dealer.

High Altitude Use

The original carburetor settings for this watercraft are best for sea level use. When the craft is used at high altitude, the thinner atmosphere makes the air/fuel mixture richer reducing performance and increasing fuel usage. Have the carburetor adjusted by your authorized Kawasaki JET SKI dealer if you intend to use this craft above 3,000 feet (1,000 m).

Fuel Vent Check Valve:

The fuel tank is equipped with a rubber vent hose which terminates in the sediment bowl. A small plastic check valve in the line on the fuel tank allows air to enter the tank, but minimizes fuel spillage when the boat is tipped over. Inspect the check valve when specified by the **Periodic Maintenance Chart**.

Fuel Vent Check Valve Inspection

⚠ WARNING

Loosen the fuel filler cap to relieve pressure before disconnecting any fuel lines.



A. Check Valve

40 MAINTENANCE AND ADJUSTMENTS

- Remove the check valve from the fuel vent line to the sediment bowl.
- Try to blow through each end of the check valve. Air should pass through freely in this direction:

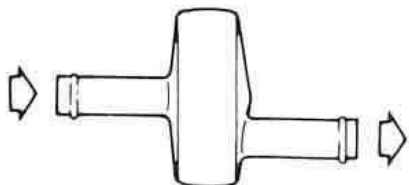

and not in this direction:

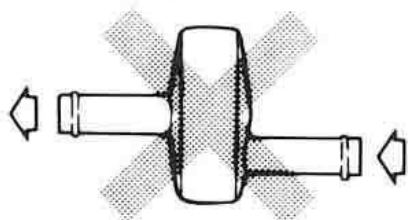

- If the check valve fails one of these tests, it must be replaced.
- Install the check valve with the arrow pointing toward the fuel tank.

Fuel Filter:

The watercraft is equipped with fuel filter screens on the fuel outlet assembly to prevent dirt or other foreign material from entering the carburetor.

Clean the screens when specified by the **Periodic Maintenance Chart**.

Fuel Filter Screen Inspection

- Unscrew the fuel outlet ring nut.

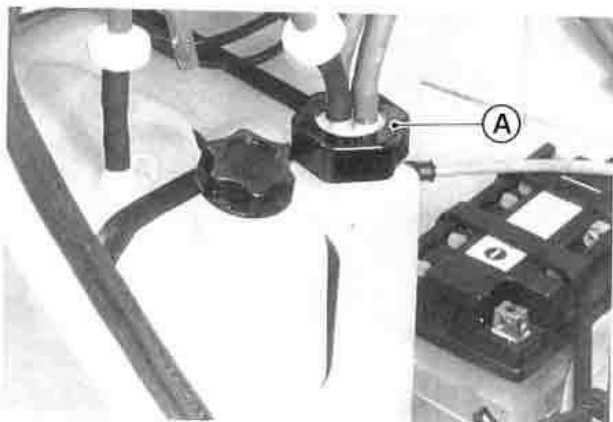

A. Outlet Ring Nut

- Pull out the fuel outlet assembly.

⚠ WARNING

Gasoline is extremely flammable and can be explosive under certain conditions. Push in the starter interlock switch. Do not smoke. Make sure the area is well ventilated and free from any source of flame or sparks; this includes any appliance with a pilot light.

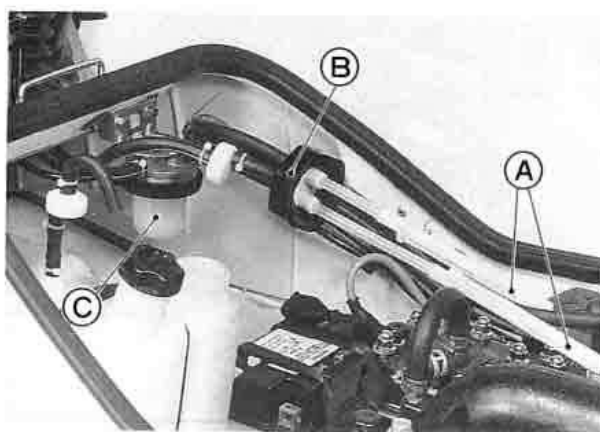

A. Screens

B. Outlet Ring Nut

C. Sediment Bowl

- Check the fuel filter screens for any breaks or deterioration. The fuel outlet assembly should be replaced if the screens are damaged.

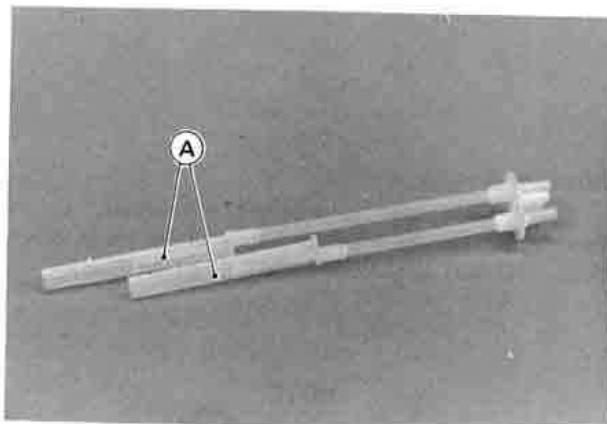

A. Screens

Fuel Filter Screen Cleaning

- Wash the fuel filter screens in non-flammable or high flash-point solvent. Use a brush to remove any contaminants trapped in the screen.

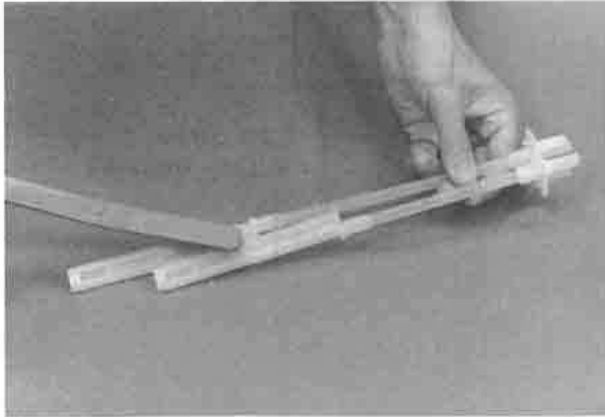

⚠ WARNING

Clean the fuel filter screens in a well-ventilated area, and take care that there are no sparks or flame anywhere near the working area; this includes any appliance with a pilot light. Do not use gasoline or a low flash-point solvent to clean the screens. A fire or explosion could result.

Sediment Bowl Cleaning

- Unscrew the sediment bowl ring, and remove the bowl.
- Clean the bowl.

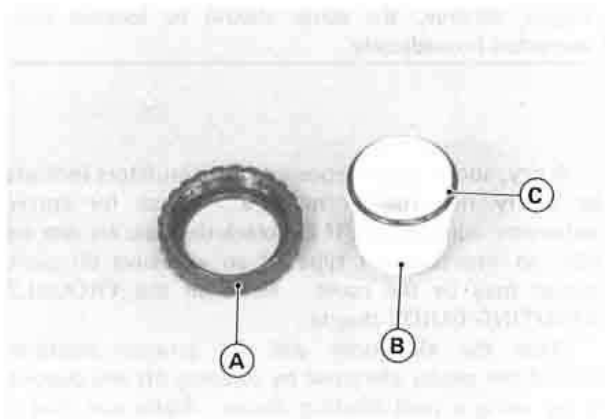

A. Ring
B. Sediment Bowl

C. O-ring

- Install the bowl with its large O-ring, tightening the sediment bowl ring securely.

Engine Oil Vent Check Valve:

The oil vent check valve is mounted in the oil tank vent hose to prevent oil from spilling during riding. Air can flow into the tank to allow oil to be drawn out by the oil pump, but oil cannot flow out the check valve.

Inspect the check valve when specified by the Periodic Maintenance Chart.

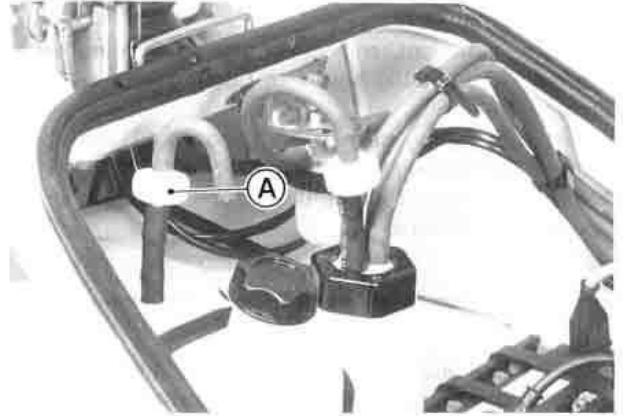

A. Check Valve

Engine Oil Vent Check Valve Inspection

- Remove the check valve and blow through it from each end.
- ★ If the check valve will allow air to flow as shown, it is OK.
- ★ If air will flow through the check valve in both directions or in neither direction, the check valve must be replaced.

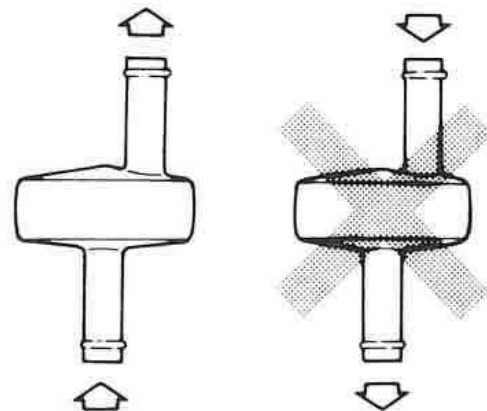

- The oil vent check valve must be mounted so that the arrows on its case are pointing toward the oil tank.

42 MAINTENANCE AND ADJUSTMENTS

Oil Pump Bleeding:

When either of the oil pump hoses has been removed, air may become trapped inside, which will then obstruct oil flow.

- Make sure that there is plenty of engine oil in the oil tank and that oil flow is not restricted.
- Place a container beneath the oil pump.
- Loosen the air bleeder screw on the oil pump a couple of turns until oil flows out, and then tighten the bleeder screw securely.
- Provide sufficient engine cooling by feeding water through the cooling hose (see Cooling System Flushing).
- Start the engine, keep it at idling speed and check the oil flow through the transparent outlet hose.
- Keep the engine running until the air bubbles in the outlet hose disappear.

CAUTION

The engine must be running before the water is turned on and the water must be turned off before the engine is stopped.
Do not run the engine without cooling water flow for more than 15 seconds.

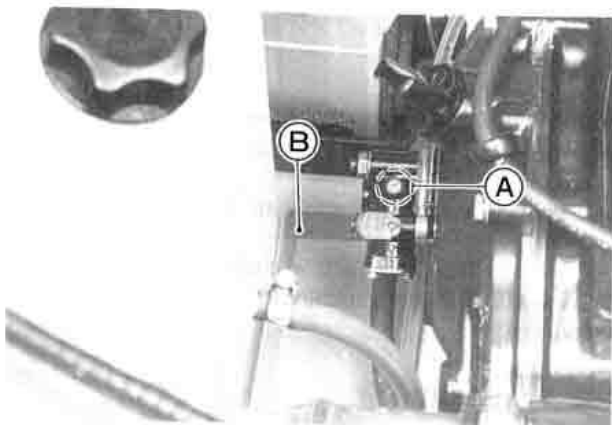

A. Bleeder Screw

B. Container

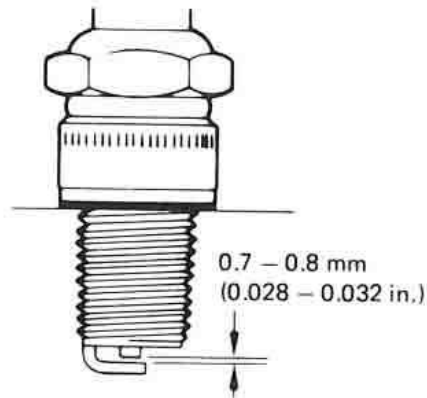

Spark Plug Inspection and Replacement

Remove the spark plugs and inspect the ceramic insulators. The appearance of the insulators reflects the efficiency of the combustion process. When the engine is operating properly, the plug insulators should be clean and show a light brown color. If the insulators look glazed or very white, if the electrodes appear overheated, or if there are gray metallic deposits on the plugs, combustion chamber temperatures are too high. Refer to the TROUBLESHOOTING GUIDE chapter.

CAUTION

As excessive operating temperature can cause serious engine damage, the cause should be located and corrected immediately.

Spark Plug

The standard spark plug is NGK BR7ES set to a 0.7 – 0.8 mm (0.028 – 0.032 in.) gap. Since the engine is water-cooled and is generally operated at a constant throttle opening, cylinder head temperature is relatively stable. For this reason, if the engine is in good condition and properly tuned, and the oil pump is operating properly, it should not be necessary to use a spark plug of a different heat range. Since a spark plug of the wrong heat range can cause extensive engine damage, only the standard spark plug is recommended.

A dry, sooty black deposit on the insulators indicates an overly rich fuel/air mixture. Check for correct carburetor adjustment. If the black deposits are wet and oily, an improper oil type or an excessive oil pump output may be the cause. Refer to the TROUBLESHOOTING GUIDE chapter.

Clean the electrodes and the ceramic insulators around the center electrode by scraping off any deposits or by using a sand blasting device. Make sure that all abrasive particles are removed from the plug and clean the plug in a high flash-point solvent. If the gap has widened, reset it to the standard 0.7 – 0.8 mm gap. If the electrodes are badly worn or burned, replace the plug. The spark plug must also be replaced any time there is visible damage such as cracked ceramic or damaged threads.

Battery

In accordance with the Periodic Maintenance Chart, inspect the battery electrolyte level and clean the terminals.

⚠WARNING
Heed the battery safety label shown here.

DANGER EXPLOSIVE GASES
Cigarettes, flames or sparks could cause battery to explode. Always shield eyes and face from battery. Do not charge without proper instruction and training. Connect cables to the proper terminals securely. Check vent tube to avoid any crimping or obstruction to the tube.

KEEP FILLING PLUGS TIGHT AND LEVEL

POISON CAUSES SEVERE BURNS
Contains sulfuric acid. Avoid contact with skin, eyes, or clothing. In event of accident flush with water and call a physician immediately.

KEEP OUT OF REACH OF CHILDREN

Electrolyte Level:



Keep the electrolyte level between the upper and lower level marks on the side of the battery case. When it gets low, remove the battery filler caps and add only distilled water until the electrolyte level in each cell reaches the upper level mark.

CAUTION
Add only distilled water to the battery. Ordinary tap water contains impurities which will shorten the life of the battery.

Battery Charging:

Removal and charging of the battery is necessary when the electrolyte specific gravity reading is below 1.20 at 20°C (68°F).

Battery Removal

CAUTION
Always remove the battery from the craft for charging. If the battery is charged while still installed, battery electrolyte may spill and corrode parts of the craft.

- Disconnect the black (ground) lead from the battery first.
- Disconnect the red lead.
- Release the two rubber hold-down straps securing the battery.
- Lift the battery out of the hull.
- Clean the terminals.

Battery Charging

⚠WARNING
Keep the battery away from sparks and open flame during charging, since the battery gives off an explosive gas mixture of hydrogen and oxygen. When using a battery charger, connect the battery to the charger before turning on the charger. This procedure prevents sparks at the battery terminals which could ignite any battery gases.

- Leaving the caps off the cells, connect the battery to a charger. Set the charging rate at 1.9 amps, and charge it for 10 hours.

CAUTION
If the temperature of the electrolyte rises above 45°C (115°F) during charging, reduce the charging rate to bring down the temperature and increase charging time proportionately.

- After charging, check the electrolyte level in each cell. If the level has dropped, add distilled water to bring it back up to the upper line.
- Check the results of charging by measuring the specific gravity of each cell, and by measuring battery voltage. The specific gravity of the electrolyte should be equal to that of the electrolyte which was installed in the battery during initial service. Normally this will be 1.28 at room temperature, but it may vary by geographic location. Battery voltage should be 14.5 – 15.5 V.

44 MAINTENANCE AND ADJUSTMENTS

Battery Terminals:

Battery Terminal Cleaning

- Clean the battery top and terminals using a solution of baking soda and water. Scrape off any obstinate deposits with a wire brush or sand blasting device, and then rinse the battery with fresh water. Dry it thoroughly.

CAUTION

Be sure not to allow any cleaning solution into the battery cells, or the battery life will be shortened.

Battery Installation

- Install the battery in the reverse order of removal.
- After connecting the battery, coat the terminals with waterproof grease.

CAUTION

Do not reverse the battery connections, or damage to the regulator/rectifier unit will result.

Lubrication

As in all marine craft, adequate lubrication and corrosion protection is an absolute necessity to provide long, reliable service. Refer to the **Periodic Maintenance Chart** and **Pre-ride Checklist** in the OPERATING INSTRUCTIONS chapter for the frequency of the following items:

- Lubricate the following with a penetrating rust inhibitor, such as WD40 or BEL-RAY 6 in 1:

Choke Cable and Throttle Cable

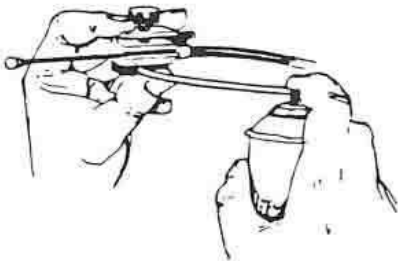

Pressure Cable Luber

Part Number K56019-021

Steering Nozzle Pivots

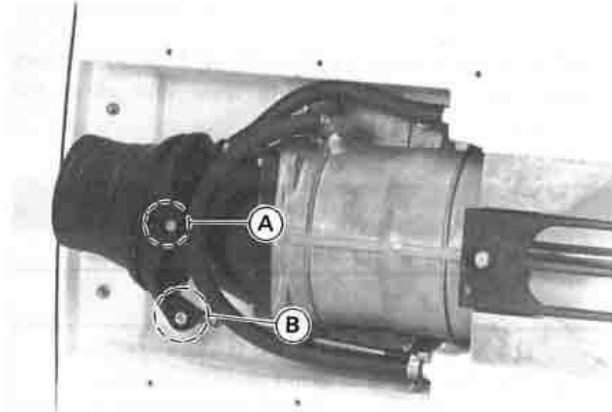

A. Nozzle Pivot

B. Ball Joint

- Lubricate the following with a high quality waterproof marine grease.

Ball Joints

Throttle Case and Cable

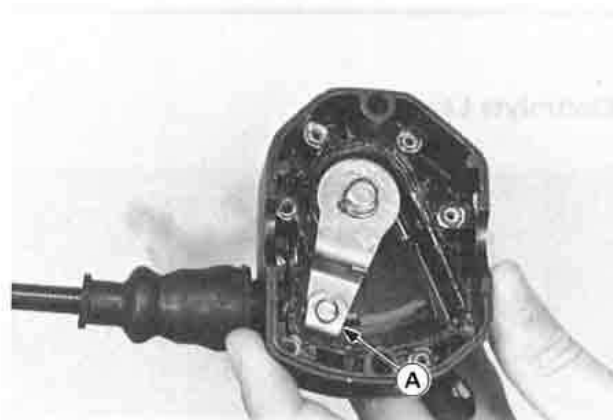

A. Apply grease.

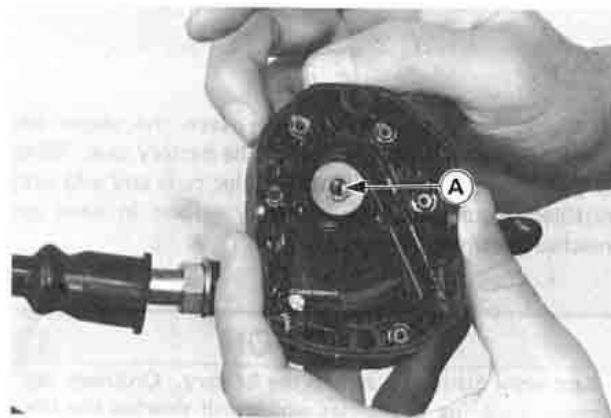

A. Apply grease.

CAUTION

Disassembly and lubrication of the throttle case should be performed by your Kawasaki JET SKI dealer.

Choke Cable Fitting and Throttle Cable Fitting at Carburetor

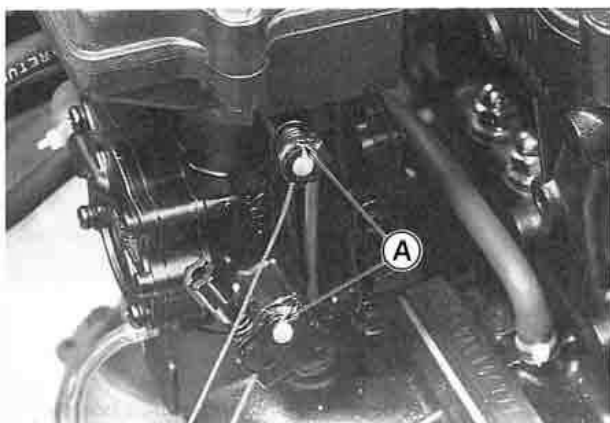

A. Apply grease.

CAUTION

Disassemble and lubricate the handlebar pivot. This function should be performed by your Kawasaki JET SKI dealer.

.....
Cooling System Flushing

To prevent sand or salt deposits from accumulating in the cooling system, it must be flushed occasionally. Flush the system according to the **Periodic Maintenance Chart**, after each use in salt water, or whenever there is reduced water flow from the bypass outlet in the left side of the hull.

- An inlet for auxiliary water supply is provided on the fitting for the cooling hose just above the cylinder head.

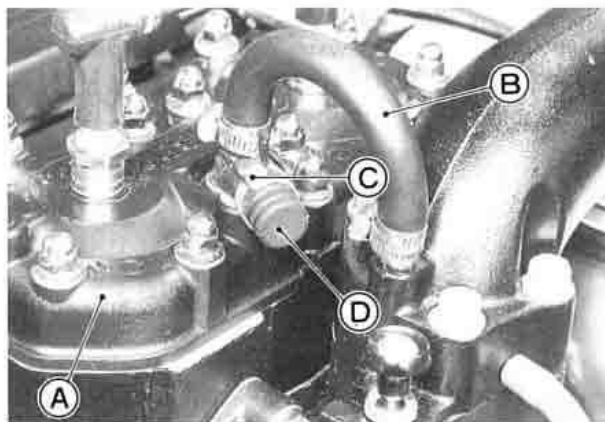

A. Cylinder Head C. Clamp
 B. Cooling Hose D. Cap

- Loosen the clamp and remove the cap, and then connect a garden hose.

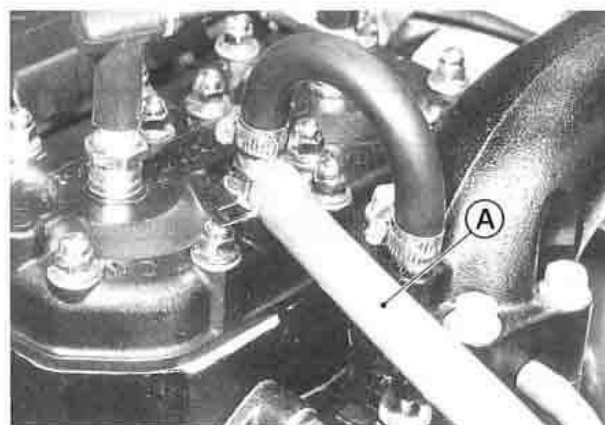

A. Garden Hose

- Start the engine and allow it to idle, before turning on the water.

CAUTION

The engine must be running before the water is turned on or water may flow back through the exhaust pipe into the engine, resulting in the possibility of severe internal damage.

46 MAINTENANCE AND ADJUSTMENTS

- Immediately turn on the water and adjust the flow so that a little trickle of water comes out of the bypass outlet in the left side of the hull.

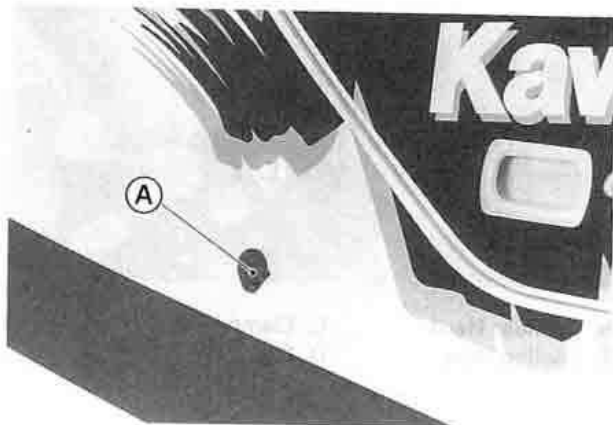

A. Bypass Outlet

- Let the engine idle for several minutes with the water running.
- Turn off the water. **Leave the engine idling.**
- Raise the front of the craft and rev the engine a few times to clear the water out of the exhaust system.

CAUTION

Do not run the engine without cooling water flow for more than 15 seconds. Overheating will cause severe engine and exhaust system damage.

- Switch off the engine, remove the garden hose, reinstall the cap and secure the clamp.

Bilge System Flushing

To prevent clogging, the bilge system should be flushed out according to the **Periodic Maintenance Chart**, or whenever you suspect it is blocked.

- Disconnect both bilge hoses at the plastic breather fitting mounted on the bulkhead.

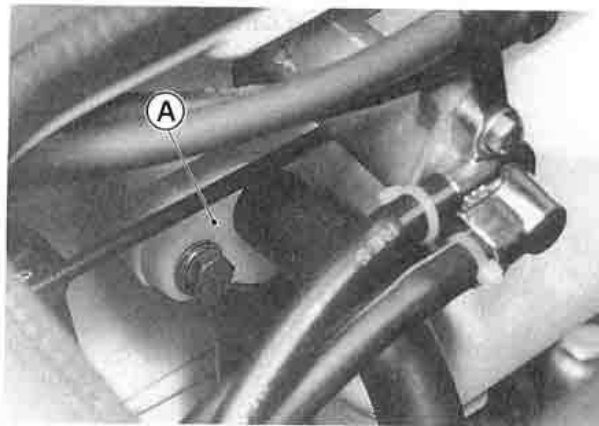

A. Breather Fitting

- Connect the bilge filter hose (from the hull bottom) to the garden hose, turn the water on, and flush it out for about a minute. During this procedure, water will flow into the engine compartment. Do not allow a large amount of water to accumulate in the engine compartment. Place a protective pad next to the boat, and turn the watercraft on its **left side** to empty the engine compartment.
- Connect the other hose (from the hull bulkhead) to the garden hose, turn the water on, and flush it out for several minutes.
- Before reconnecting the hoses to the plastic breather fitting, make sure the small breather hole in the fitting is clear. If the hole is clogged, the engine compartment will fill with water when the engine stops or idles. It may be necessary to remove the fitting.

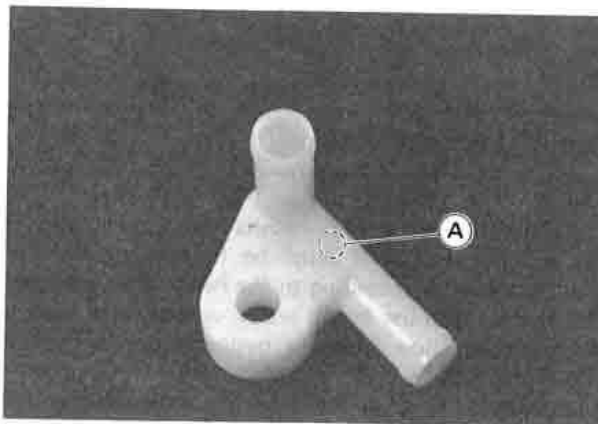

A. Breather Hole

- Reconnect the bilge hoses.

NOTE

○ *If your watercraft is to be stored, blow air through both hoses before they are reconnected (see Bilge System section in Preparation for Storage in the STORAGE chapter).*

TROUBLESHOOTING GUIDE

If this procedure does not isolate your problem, see your JET SKI dealer or refer to the Service Manual.

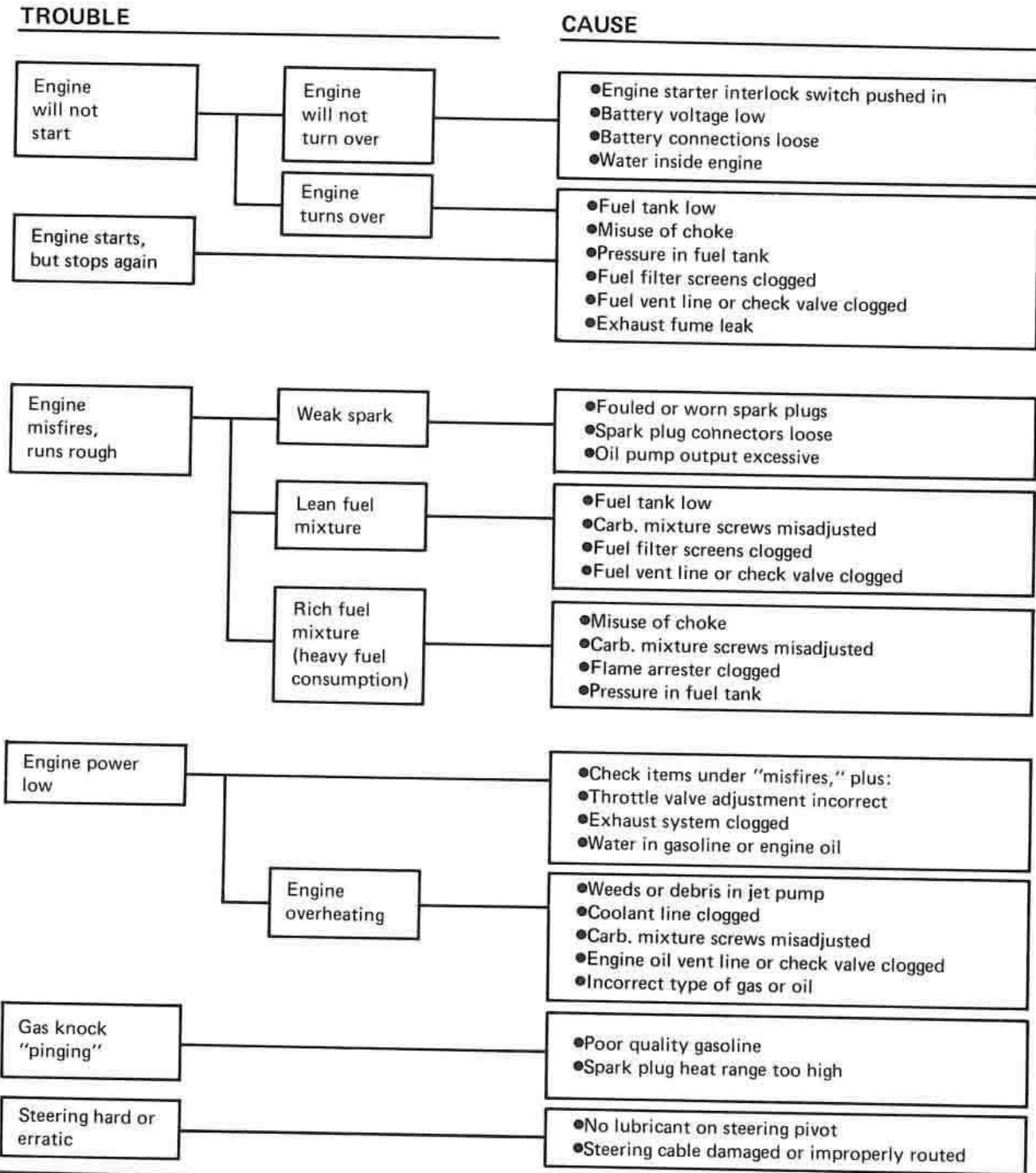

⚠ WARNING

Since faulty steering is dangerous, this problem should be examined by an authorized JET SKI dealer.

OWNER SATISFACTION (US only)

Your satisfaction is important to your authorized Kawasaki dealer and to Kawasaki Motors Corp., U.S.A. If you have a problem concerning warranty or service, please take the following action:

Contact the owner and/or service manager of your authorized Kawasaki dealer. Fully explain your problem and ask for assistance in resolving the situation. The OWNER of the dealership is concerned with your satisfaction and your future business. For this reason the owner is in the best position to assist you. Also, all warranty and service matters are handled and resolved through the authorized Kawasaki dealer network.

If you are unsatisfied after working with your Kawasaki dealer and feel you still require further assistance, WRITE to the address below. Please be certain to provide the model, product identification number, mileage or hours of use, accessories, dates that events occurred and what action has been taken by both you and your dealer. Include the name and address of the dealership. To assist us in resolving your inquiry, please include copies of related receipts and any other pertinent information including the names of the dealership personnel with whom you have been working in the resolution of your problem.

Upon receipt of your WRITTEN correspondence we will contact the dealership and work with them in resolving your problem.

In order to provide a permanent record, all warranty and service resolutions take place only through WRITTEN correspondence.

Please send your correspondence to:

CONSUMER RELATIONS
KAWASAKI MOTORS CORP., U.S.A.
P. O. Box 25252
SANTA ANA, CA. 92799-5252

MEMO

MEMO

MEMO

JS650-B3

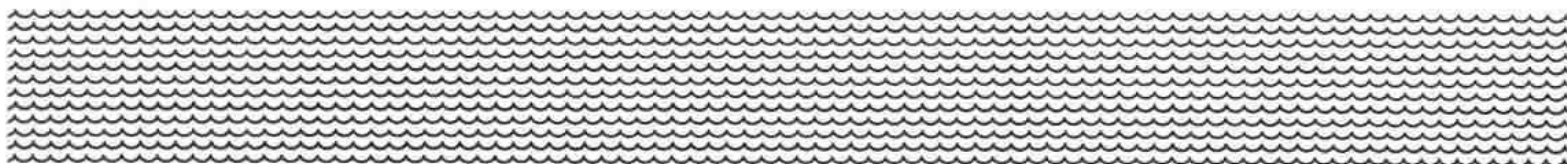

KAWASAKI
HEAVY INDUSTRIES, LTD.
CONSUMER PRODUCTS & COMPONENTS GROUP

Part No. 99920-1625-02

Printed in Japan