

OWNER'S MANUAL

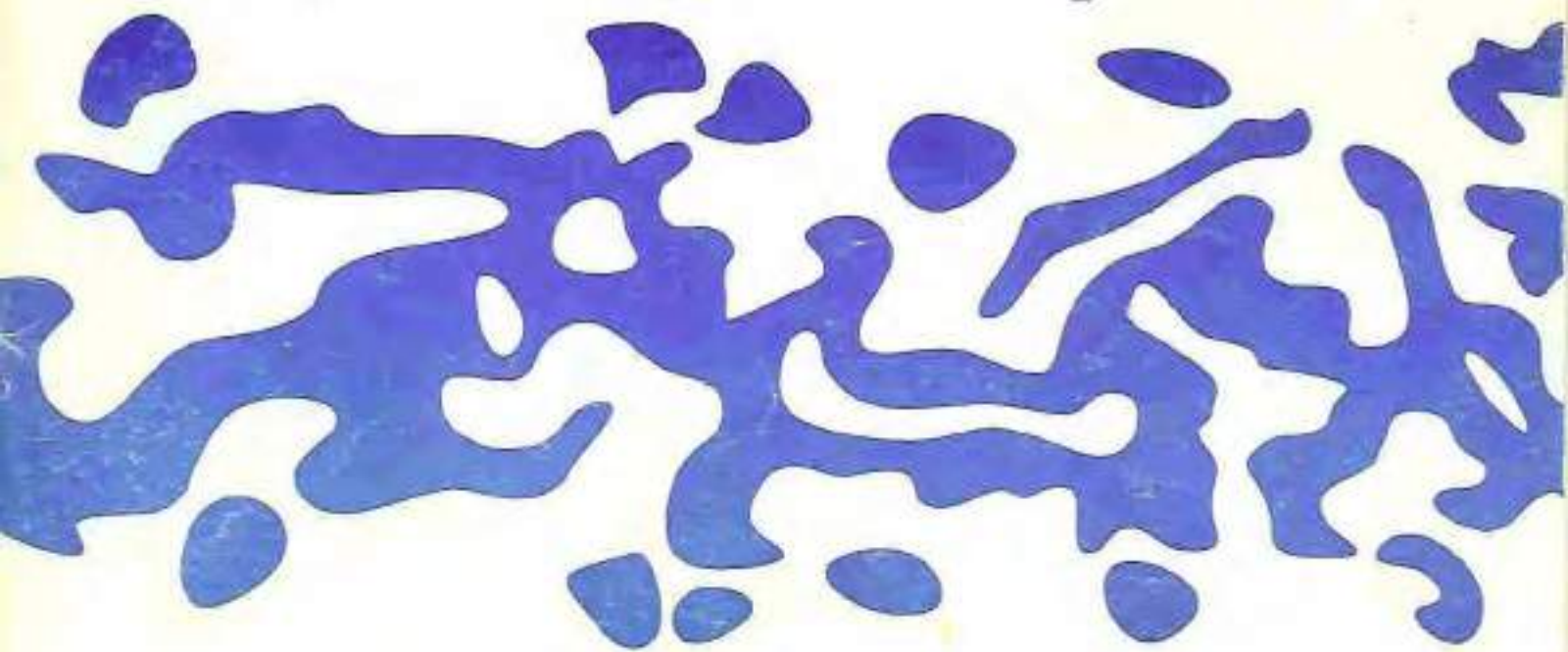
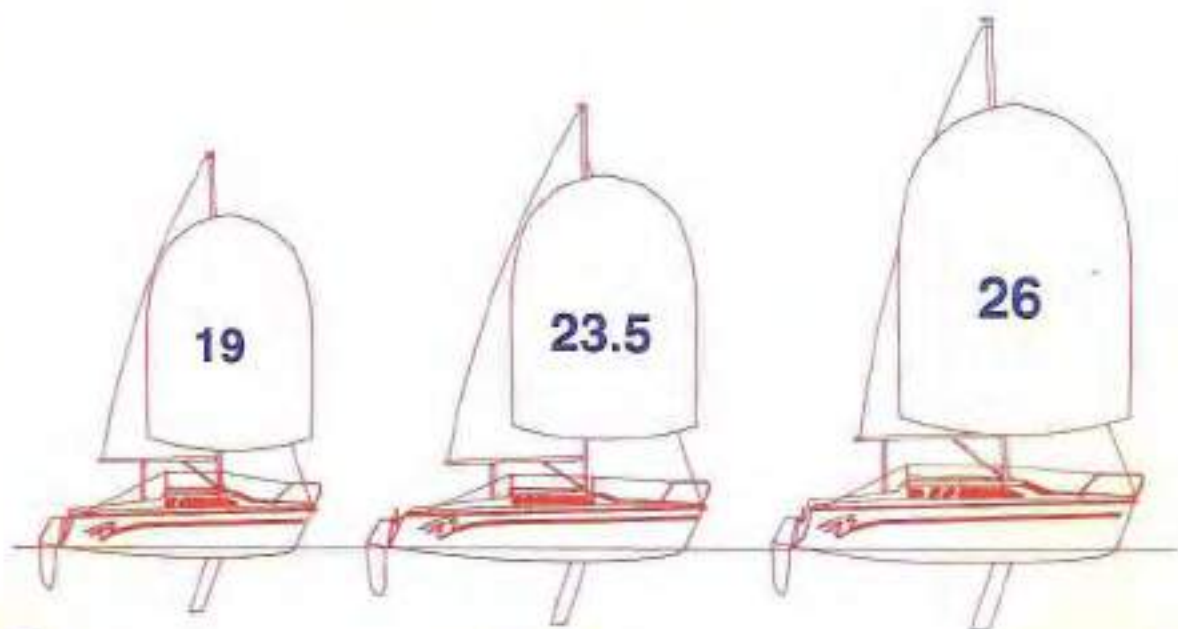

HUNTER WATER BALLAST SERIES

HUNTER MARINE LIMITED WARRANTY

The following warranties apply to all 1993 and later model year boats produced by HUNTER MARINE CORPORATION:

LIMITED ONE YEAR WARRANTY

Hunter Marine warrants to the first-use purchaser and any subsequent owner during the warranty period that any part manufactured by Hunter will be free of defects caused by faulty workmanship or materials for a period of twelve (12) months from the date of delivery to the first-use purchaser under normal use and service. During this period, Hunter will repair or replace any part judged to be defective by Hunter.

LIMITED FIVE YEAR HULL STRUCTURE AND BOTTOM BLISTER WARRANTY

Hunter warrants to the first-use purchaser and any subsequent owner during the warranty period that the hull of each boat will be free from structural defects in materials and workmanship for a period of five (5) years from the date of delivery to the first-use purchaser under normal use and service.

This limited warranty applies only to the structural integrity of the hull and the supporting pan/grid or stringer system. Hulls, pan/grid or stringers modified in any way or powered with engines other than the type and size installed or specified by Hunter are not covered by this limited warranty. The obligation of Hunter under this limited warranty is limited to the repair or replacement of hulls, that it determines to be structurally defective. This is your sole and exclusive remedy.

Hunter also warrants to the first-use purchaser and any subsequent owner during the warranty period that the boat will be free from gel-coat blistering on underwater surfaces of the hull, excluding the keel and rudder, for a period of five (5) years from the date of delivery to the first-use purchaser under normal use and service. During this period, Hunter will supply or reimburse an authorized Hunter dealer for all of the parts and labor required to repair a blistered underwater surface of the hull. The labor cost reimbursement will be based on the Labor Allowance Schedule established by Hunter from time to time, however if the repair is performed by a non-Hunter dealer, the repair cost must be authorized by Hunter in advance and be based on a reasonable number of hours as determined by Hunter. Transportation, hauling, launching, bottom paint, storage, dockage, cradling rental, rigging and derigging, or other similar costs will not be paid by Hunter. It is recommended that the repair be done during a seasonal haul out for service or storage.

The following circumstances will void the bottom blister limited warranty:

(1) If the gel-coat has been sanded, sandblasted, or subjected to abrasion or impact.

(2) If the instructions provided in the Hunter Owner's Manual are not followed according to Hunter's required bottom preparation procedures.

HUNTER MARINE LIMITED WARRANTY

RESTRICTIONS APPLICABLE TO WARRANTIES

These limited warranties do not cover:

- (1.) Paint, window glass, gelcoat, upholstery damage, plastic finishes, engines, engine parts, bilge pumps, stoves, blowers, pressure water pumps, propellers, shafts, rudders, controls, instruments, keels and equipment not manufactured by HUNTER. Any warranty made by the manufacturer of such items will be, if possible, given on to the first use purchaser.
- (2.) Problems caused by improper maintenance, storage, cradling, blocking, normal wear and tear, misuse, neglect, accident, corrosion, electrolysis or improper operation.
- (3.) Boats used for commercial activities including charter.

THIS WARRANTY IS EXPRESSLY IN LIEU OF ANY AND ALL OTHER REMEDIES AND WARRANTIES EXPRESSED AND IMPLIED, INCLUDING THE WARRANTIES OF MERCHANTABILITY AND FITNESS. SOME STATES DO NOT ALLOW LIMITATIONS ON HOW LONG AN IMPLIED WARRANTY LASTS, SO THE ABOVE LIMITATION MAY NOT APPLY TO YOU. THE PURCHASER ACKNOWLEDGES THAT NO OTHER REPRESENTATIONS WERE MADE TO HIM OR HER WITH RESPECT TO THE QUALITY AND FUNCTION OF THE BOAT. ANY CONSEQUENTIAL DAMAGES WHICH MAY BE INCURRED ARE EXCLUDED AND PURCHASER'S REMEDY IS LIMITED TO REPAIRS OR REPLACEMENT OF ANY PART(S) JUDGED DEFECTIVE BY HUNTER. SOME STATES DO NOT ALLOW THE EXCLUSION OR LIMITATION OF INCIDENTAL OR CONSEQUENTIAL DAMAGES, SO THE ABOVE LIMITATION OR EXCLUSION MAY NOT APPLY TO YOU. THIS WARRANTY GIVES YOU SPECIFIC LEGAL RIGHTS, AND YOU MAY ALSO HAVE OTHER RIGHTS WHICH VARY FROM STATE TO STATE.

WARRANTY REGISTRATION

These limited warranties shall not be effective unless the HUNTER Warranty Registration Form and Pre-Delivery Service Record, which are furnished with each new boat, are filled out completely and returned to HUNTER within fifteen (15) days of delivery. Responsibility for sending the completed Registration Form remains with the dealer.

Return of the Warranty Registration Form to HUNTER, signed by both Dealer and Owner, is critical. Warranty coverage cannot be initiated until the completed form is received at HUNTER.

All repairs and/or replacements will be made by an authorized Hunter dealer, or at the option of Hunter, at the Hunter plant. If the repairs are of such a nature that the warranty work must be performed at the HUNTER plant, transportation costs to and from the HUNTER plant shall be paid by the owner. The labor cost reimbursement will be based on a Labor Allowance Schedule established by HUNTER and where not applicable, on a reasonable number of hours as determined by HUNTER. Any repairs and replacements must be approved in advance by an authorized HUNTER service representative.

HUNTER MARINE LIMITED WARRANTY

TRANSFER OF LIMITED WARRANTIES

Effective with 1993 hull numbers, the limited warranties will be transferred to a subsequent purchaser of the boat if:

(1) A notice of the transfer of ownership of the boat is given by the subsequent purchaser in writing to Hunter within thirty (30) days of the transfer.

(2) The notice shall include the name, address and telephone number of the subsequent purchaser, the date of purchase, the hull number and the name of the seller of the boat.

Hunter will mail to the subsequent purchaser notice of the expiration dates of the limited warranties. The transfer of the ownership of the boat will not extend the expiration dates of the limited warranties.

CUSTOMER SATISFACTION SURVEYS

During the first year of ownership, the first purchaser will receive two Customer Satisfaction Surveys - the first (CSS#1) will be received shortly after taking delivery and focuses on the dealer's ability to sell and commission the boat, and the Owner's initial satisfaction. The second survey (CSS#2), nine to ten months into ownership, "measures" dealer service capability and allows the owner to evaluate most of the boat's functional systems and characteristics. Both surveys are dependent upon receipt of the first purchaser's Warranty Registration Form. (See section5-14)

V

OWNER'S MANUAL

TABLE OF CONTENTS

I. INTRODUCTION

- A. Appended Information to Owner's Manual
- B. Brief History
- C. Welcome To The Hunter Marine Family
- D. Glossary of Sailing Terms

II. GENERAL HANDLING & OPERATION

- A. Pre-Departure Check List
- B. Float Plan
- C. Closing Up Your Boat After Sailing
- D. For Safe Boating
- E. General Handling & Operation
- F. Mast Raising & Lowering System
- G. Launching & Retrieving Procedures

III. SAILS & RIGGING

- A. Getting Ready to Sail
- B. Reefing
- C. Detail Drawings
 - 1. The Fractional Rig
 - 2. Boom and Reef Layout
 - 3. Rudder Detail
 - 4. Ballast Tank Valve Detail
 - 5. Jib Sheet Detail
 - 6. Cleat Knot
 - 7. Running Rigging

OWNER'S MANUAL

TABLE OF CONTENTS

IV. MAINTENANCE

- A. Electrical Systems
- B. Plumbing Systems
- C. General Care
- D. Winch Maintenance
- E. General Hardware Maintenance
- F. Engine
- G. Instructions for Preparation for Bottom Painting
- H. Vinyl Coated Fabrics Care & Cleaning
- I. Acrylics Care & Cleaning
- J. Marine Rigging
- K. Electrolysis and Galvanic Protection
- L. Storage & Winterization
- M. Water Ballast Tank Freezing
- N. Exotic Aquatic Plants and Animals

V. WARRANTY INFORMATION

- A. Hunter Marine's Limited Warranty

VI. APPENDIX H19

- A. Sailplan
- B. Rigging Specifications
- C. Spreader Detail
- D. Deck Hardware
- E. Spinnaker Layout
- F. Accommodation Plan
- G. Lighting Layout
- H. Wiring Harnesses
- I. Bilge Pump Layout
- J. Thru-hull Layout
- K. Centerboard Control System

OWNER'S MANUAL

TABLE OF CONTENTS

VII. APPENDIX H23.5

- A. Sailplan
- B. Rigging Specifications
- C. Spreader Detail
- D. Deck Hardware
- E. Spinnaker Layout
- F. Accommodation Plan
- G. Lighting Layout
- H. Wiring Harnesses
- I. Bilge Pump Layout
- J. Thru-hull Layout
- K. Centerboard Control System

VIII. APPENDIX H26

- A. Sailplan
- B. Rigging Specifications
- C. Z-Spar Spreader Detail
- D. Deck Hardware
- E. Spinnaker Layout
- F. Accommodation Plan
- G. 12 VDC System
- H. Piping, Bilge Pump and Thru-Hulls
- I. Centerboard Control System
- J. Mast Wiring (H26, H23.5 & H19)

IX. TRAILER MAINTENANCE

APPENDED INFORMATION TO OWNER'S MANUAL

Item No.	Description	H19	H23.5	H26
1.	Warranty Registration	X	X	X
2.	Pop Up Top	X	X	X
3.	Stove Origo 1500 Stove Origo 4000	X	X	X
4.	Sanipottie	X	X	X
5.	Marine Rigging		X	X
6.	Sail Information	X	X	X
7.	Z-Spar			X
8.	Z-Spar	X	X	
9.	Bilge Pump	X	X	X
10.	Lewmar Winches		X	X
11.	Trailer Axle Service Manual	X	X	X*
12.	Carlisle Tire Warranty Card	X	X	X*
13.	Dico Drum Brakes Service Manual	X*	X	X*
14.	Brake Actuator Service Manual	X*	X	X*
15.	Boating Basics	X	X	X
16.	Tips for Safe Boating	X	X	X
17.	Hunter Collection	X	X	X

* = Optional Equipment

HUNTER MARINE'S OWNER AND FOUNDER
WARREN R. LUHRS
BRIEF HISTORY

Born in 1944 in East Orange, New Jersey, Warren R. Luhrs' ancestry goes back to his Great-grandfather, Henry, who helped pioneer railroading and clipper ships in America, and to his great-uncle, John, who helped build the famous St. Petersburg-to-Moscow railroad for Czar Alexander II.

Henry Luhrs owned shares in twenty-two different ocean-going vessels - barks, brigs and schooners - and was principal owner of the bark, "Sophia R. Luhrs", named after his wife. He was also a partner with Albert Sprout, who managed a shipyard in Melbridge, Maine, where the "Sophia R. Luhrs" was built.

The Luhrs' family sea tradition was carried on during the Great Depression by Warren Luhrs' father, Henry, who worked at a small boat manufacturer in Morgan, New Jersey, and later started his own company. When war broke out in Europe, the Coast Guard asked Henry Luhrs to repair their boats and install ice sheathing on their bows.

After World War II, Henry built 27-foot fishing boats and in 1948 began to construct custom-built pleasure craft. He then turned to skiffs and in 1952 incorporated as Henry Luhrs Sea Skiffs. He constructed lap strake sea skiffs using assembly-line techniques. Henry personally "shook down" his prototypes with family trips up the Hudson River to Lake Champlain.

The sea skiff is a class of boat which has been very popular, owing to its seaworthiness. It features a sharp bow, which reduces pounding in surf or choppy seas, and a hull whose forward section is rounded below the water line to increase stability in rough water or a following sea. Such skiffs can either be smooth-sided or of lapstrake construction.

Henry Luhrs' basic philosophy was to emulate the late Henry Ford in building an inexpensive boat for the average man, thus enabling him to enjoy the luxury of boating. He was both designer and engineer, creating innovative and progressive new models. He designed the change in the line of the bow from straight to curved at a time when all boats were being built with the straight square effect. It is believed he was also the first designer-builder to popularize a small boat with a fly-bridge.

In 1960, Luhrs acquired the Ulrichsen Boat Company, Marlboro, New Jersey. It was here, to, that the Luhrs' Alura Fiberglass Division was located. In 1965, Henry sold his company to Bangor Arrostook Railroad, which was to become the recreational conglomerate, Bangor-Punta. It was also during this period that Silverton of Tom's River, New Jersey was purchased by John and Warren Luhrs.

Today, Warren R. Luhrs and his brother John, own Hunter Marine Corporation, Silverton Marine Corporation, Mainship Motor Yachts and Luhrs Fishing Boats with its Alura Division. Hunter Marine produces sailboats while the other companies produce powerboats.

Welcome To THE HUNTER MARINE FAMILY

Congratulations on your new sailing yacht manufactured by Hunter Marine. We have engineered and constructed your boat to be as fine a yacht as any afloat. In order to get the best performance and most enjoyment from your boat you should be familiar with its various elements and functions. Please take the time to study this manual and its recommendations for trouble-free sailing pleasure.

We stand behind the quality of your boat with a warranty which you should also review. *To insure your warranty is valid, please fill out the enclosed form and send it to us within ten (10) days of the purchase date.* Section 15 of the Federal Boat Safety Act requires first owners to be registered. The warranty data should also be recorded in the space below for your own reference.

You also need to fill out and mail the warranty cards on your outboard, battery, stove, head, and other accessories. These are enclosed in the manufacturers' manuals which are included in your owner's pouch.

OWNER INFORMATION CARD

HULL IDENTIFICATION NUMBER IS ON THE STARBOARD AFT SIDE OF THE HULL OR TRANSOM
THIS NUMBER MUST BE GIVEN IN ALL NECESSARY COMMUNICATIONS.

HULL NO. DATE DELIVERED TO OWNER

YACHT NAME

OWNER NAME

STREET ADDRESS

CITY STATE ZIP CODE

HOME PORT

MODEL SIZE HULL#SAIL #

ENGINE MODEL SERIAL NO. PROPELLER SIZE

DEALER

STREET ADDRESS

CITY STATE ZIP CODE

DEALER SIGNATURE

OWNER SIGNATURE

A copy of Chapman's *Piloting, Seamanship and Small Boat Handling* is provided with your Hunter Marine boat as part of the standard equipment. Any questions regarding the meaning of terminology used in this manual may be referenced in your Chapman's.

PRE-DEPARTURE CHECK-LIST

- Check bilge for excess water.
- Check weather conditions and tides.**
- Check food supply.
- Foul weather gear.
- Linen, sleeping bags.
- Fuel.
- Water.
- Sunscreens and sunglasses.
- Tools.
- Docking and anchor gear.
- Check radio operations.
- Navigation charts and instruments.
- Float plans to a friend or Coast Guard. (See next page.)**
- Fuel for stove.
- Cooking and eating utensils.
- Check battery water level.
- Check outboard is secure and operational.
- Check for loose electrical connections.
- Check rudder down and clamped.
- Check mast for rigging irregularities and tightness.
- Halyards and sheets are clear and ready to run.
- No lines or other obstructions near the propeller or bow.
- Anchor ready to run.
- Check lifelines for tightness.
- Stow all loose gear.

II

FLOAT PLAN

1. Name of person reporting and telephone number:

2. Description of boat:

NAME		TYPE
MAKE	LENGTH	REGISTRATION #
HULL COLOR	STRIPE COLOR	DECK COLOR
OTHER DISTINGUISHING MARKS		

3. Persons aboard:

	NUMBER		
NAME	AGE	PHONE #	
ADDRESS			
NAME	AGE	PHONE #	
ADDRESS			
NAME	AGE	PHONE #	
ADDRESS			

4. Engine:

TYPE	HP.	FUEL CAPACITY
------	-----	---------------

5. Safety equipment:

PFDs Flares Mirror Flashlight
 Food Water EPIRB Raft/Dinghy

6. Radio:

TYPE	FREQUENCIES
------	-------------

7. Trip expectations:

DEPARTING AT (APPROX. TIME)	ON (DATE)	FROM (LOCATION)
GOING TO (LOCATION)	RETURNING (DATE)	IN NO EVENT LATER THAN (TIME & DATE)

8. Automobile:

LICENSE #	STATE	
MAKE	COLOR	PARKED AT

9. If not returned by _____, call the Coast Guard or:

at: _____

CLOSING UP YOUR BOAT AFTER SAILING

When leaving your Hunter at the dock for more than a short time, it is a good idea to review the following check list to make sure everything is in order. This will help protect the various parts of your boat and add considerably to their attractiveness and usable life. **II**

- Fold and bag headsails and stow below.
- Furl mainsail and cover, or remove and also bag.
- Remove and stow all portable deck hardware such as blocks, winch handles, etc.
- Secure the boom to the topping lift and set it firmly amidships with the mainsheet purchase. (It is also a good idea to rig a line from the tiller to a convenient cleat to keep the rudder from swinging back and forth with the motion of the water.)
- Attach the shackle ends of all halyards to convenient fittings and take up slack.
- Cleat and coil halyard tails and permanent sheets, hanging them off the deck to promote drying.
- Coil and stow all other lines.
- Cover the winches when leaving the boat for several days or more.
- Close all fuel lines.
- Pump the bilge.
- Check air vents, secure ports and hatches, and swab the deck, particularly if you have operated on saltwater.
- Make a final check of mooring lines, chafing gear, fenders, etc.

FOR SAFE BOATING

BE PREPARED

Take a safe boating course from the Coast Guard. You can call 800-336-BOAT for information on courses in your area.

Carry all safety equipment required by federal and state law. Federal requirements are discussed in "Federal Requirements for Recreational Boats" which can be acquired from U.S. Coast Guard Office of Boating, Public, and Consumer Affairs, Washington, D.C. 20593. State requirements will come from your local State Boating Administration. The Coast Guard also recommends a first-aid kit, a pump or bailer, a transistor or weather radio, extra fuel, a paddle, anchor and line, and extra drinking water; also, if not a requirement, flares.

Get a Coast Guard Auxiliary Courtesy Examination. This is a free, confidential safety inspection. Call your local Coast Guard Auxiliary for details.

Be familiar with the use of distress signals and PFDs.

AVOID FIRES

Handle fuels carefully.

Read labels on any stove fuels.

Read the engine owner's manual for proper fuel-system maintenance and inspect your engine's fuel system periodically.

Heed fire extinguisher regulations and keep them in good condition.

While refueling:

- a. Fill the portable tanks on the dock.
- b. Tie the boat securely.
- c. Extinguish cigarettes and all flames on the boat. Turn off all engines and electrical equipment.
- d. Keep the hose nozzle in contact with the fuel can or fill.
- e. Wipe up all fuel spillage.
- f. Ventilate the engine and fuel compartment.
- g. Check boat for fumes.

BEFORE GETTING UNDERWAY

Leave a float plan. (See example under Float Plan)

Perform pre-departure check list. (See Pre-departure Check List)

Check the weather; do not venture out if the weather is threatening.

WHILE UNDERWAY

PFDs should be worn by children and non-swimmers **at all times**. *Everyone should wear them if conditions become hazardous.*

Do not operate a boat if intoxicated, fatigued or stressed. These human factors cause 50 percent of all boating accidents.

Keep a good lookout. This is especially true of sailboats. Keep a watch to leeward under the headsail. Keep away from swimmers, divers and skiers.

Obey state and federal laws. Know your local laws and "rules of the road."

Respect bad weather: try to get to shore if the weather turns bad. Get and carry a radio with a NOAA "weather band" on FM 162.40-162.55MHZ.

IF TROUBLE OCCURS

Radio for help. Use the emergency VHF, channel (i.e., 156.8MHZ.)

Put on PFDs immediately.

Stay with the boat. In cold water, huddle together to prevent hypothermia.

FLOAT PLAN

Make copies of the Float Plan page and use before each trip. Fill it out and leave it with a reliable person who will notify the Coast Guard or other rescue organizations if you fail to return on time. **Do not forget to cancel the float plan upon your return.**

GLOSSARY OF SAILING TERMS

Terms which are referred to in the text without a full explanation are included in the glossary. Some other terms which are clearly defined in the book are not included.

A

Aback: describes a sail when the wind strikes it on its lee side.

Abaft: towards the boat's stern.

Abeam: at right angles to the *center-line* of the boat.

Aft: at or near the stern.

Amidships: the center of the boat, *athwartships* and fore and aft.

Anti-fouling: a poisonous paint compound used to protect the underwater part of a hull from marine growths.

Apparent wind: the direction and speed of the wind felt by the crew. It is a combination of *true wind* and that created by the movement of the boat.

Astern: behind the boat; to go astern is to drive the boat in reverse.

Athwartships: at right angles to the fore-and-aft line of the boat.

B

Back: when a wind backs, it shifts anticlockwise.

Back a sail: to sheet it to windward so that the wind fills on the side that is normally to *leeward*.

Backstay: a stay that supports the mast from aft and prevents its forward movement.

Baggywrinkle: rope, teased out, plated together and wound around *stays*, *shrouds* etc., to prevent chafing.

Ballast: extra weight, usually lead or iron, placed low in the boat or externally on the keel to provide stability.

Ballast keel: a mass of ballast bolted to the keel to increase stability and prevent a keel boat from capsizing.

Batten: a light, flexible strip, fed into a batten pocket at the *leech* of the sail to support the *roach*.

Beam: 1, the maximum breadth of a boat; 2, a transverse *member* which supports the deck; 3, on the beam means that an object is at right angles to the *center-line*.

Bear away: to steer the boat away from the wind.

Bearing: the direction of an object from an observer, measured in degrees true or magnetic.

Beat: to sail a zigzag *course* towards the wind, *close-hauled* on alternate *tacks*.

Belay: to make fast a rope around a *cleat*, usually with a figure-of-eight knot.

Bend: 1, to secure a sail to a *spar* before hoisting; 2, to connect two ropes with a knot.

Berth: 1, a place occupied by a boat in harbour; 2, to moor a boat; 3, a sleeping place on board.

Bight: a *bend* or loop in a rope.

Bilge: the lower, round part inside the hull where water collects.

Block: a pulley in a wooden or plastic case, consisting of a *sheave* around which a rope runs. It is used to change the direction of pull.

Boot-topping: a narrow coloured stripe painted between the bottom paint and the *topside* enamel.

Bottlescrew: see Rigging I screw.

Broach: when a boat *running* downwind slews broadside to the wind and *heels* dangerously. It is caused by heavy following seas or helmsman's error.

Broad reach: the point of sailing between a beam *reach* and a *run*, when the wind blows over the *quarter*.

Bulkhead: partition wall in a boat normally fitted *athwartships*

C

Catamaran: a sailing boat with twin hulls, connected by crossbeams, developed from Polynesian craft.

Catboat: a boat with a single sail.

Caulk: to make the seams between wooden planks watertight by filling with cotton, oakum or a compound.

Cavitation: the formation of a vacuum around a propeller, causing loss in efficiency.

Center-board: a board lowered through a slot in the *keel* to reduce *leeway*.

Center-line: center of the boat in a fore and aft line, point at which all the forces acting on the sails are concentrated.

Center of lateral resistance (CLR): the underwater center of pressure about which a boat pivots when changing *course*.

Chain pawl: a short lug which drops into a toothed rack to prevent the anchor chain running back.

Chain plate: a metal plate bolted to ... boat to which the *shrouds* or *backstays* are attached.

GLOSSARY OF SAILING TERMS

Chart datum: reference level on a chart below which the tide is unlikely to fall. Soundings are given below chart datum. The datum level varies according to country and area.

Chine: the line where the bottom of the hull meets the side at an angle.

Claw ring: a fitting, which slips over the boom like a claw, to which the main *sheet* is attached after *reefing* the mainsail.

Cleat: a wooden, metal or plastic fitting around which a rope is secured.

Clevis pin: a locking pin through which a split ring is passed to prevent accidental withdrawal.

Clew: the after, lower corner of a sail where the foot and *leech* meet.

Close-hauled: *the point of sailing* closest to the wind; see also *Beat*.

Close reach: *the point of sailing* between *close-hauled* and a *beam reach*, when the wind blows forward of the *beam*.

Close-winded: describes a boat able to sail very close to the wind.

Coamings: the raised structure surrounding a *hatch*, cockpit etc., which prevents water entering.

Contrail: a trail of condensation left behind a jet aircraft, giving weather clues.

Cotter pin: soft, metal pin folded back on itself to form an eye.

Course: the direction in which a vessel is steered, usually given in degrees: true, magnetic or compass.

Cringle: 1, a rope loop, found at either end of a line of *reef* points; 2, an eye in a sail.

D

Dead run: running with the wind blowing exactly aft, in line with the *center-line*.

Deviation: the difference between the direction indicated by the compass needle and the magnetic *meridian*; caused by object aboard.

Displacement: 1, the weight of water displaced by a boat is equal to the weight of the boat; 2, a displacement hull is one that displaces its own weight in water and is only supported by buoyancy, as opposed to a planing hull which can exceed its hull, or displacement, speed.

Downhaul: a rope fitted to pull down a sail or *spar*.

Draft: the vertical distance from the *waterline* to the lowest point of the *keel*.

Drag: 1, an anchor drags when it fails to hold; 2, the force of wind on the sails, or water on the hull, which impedes the boat's progress.

Drift: 1, to float with the current or wind; 2, US the speed of a current (rate UK); 3, UK: the distance a boat is carried by a current in a given time.

Drogue: a sea anchor put over the stern of a boat or liferaft to retard *drift*.

Drop keel: a retractable *keel* which can be drawn into the hull, when entering shallow waters and recovering on to a trailer.

E

Eye of the wind: direction from which the *true wind* blows.

F

Fair: a well-faired line or surface is smooth with no bumps, hollows or abrupt changes in direction.

Fairlead: a fitting through which a line is run to alter the direction of the lead of the line.

Fathom: the measurement used for depths of water and lengths of rope. 1 fathom=6ft.=1.83m.

Fid: a tapered tool used for *splicing* heavy rope and for sail-making, often hollow.

Fiddle: a raised border for a cabin table, chart table etc., to prevent objects falling off when the boat *heels*.

Fix: the position of the vessel as plotted from two or more *position lines*.

Forestay: the foremost *stay*, running from the masthead to the stemhead, to which the headsail is hanked.

Freeboard: vertical distance between the *waterline* and the top of the deck.

G

Genoa: a large headsail, in various sizes, which overlaps the mainsail and is hoisted in light to fresh winds on all *points of sailing*.

Gimbals: two concentric rings, pivoted at right angles which keep objects horizontal despite the boat's motion, e.g. compass and cooker.

Go about: to turn the boat through the *eye of the wind* to change *tack*.

Gooseneck: the fitting attaching the boom to the mast, allowing it to move in all directions.

GLOSSARY OF SAILING TERMS

Goosewing: to boom-out the headsail to *windward* on a *run* by using a *whisker pole* to hold the sail on the opposite side to the main-sail.

Ground tackle: general term used for anchoring gear.

Guard rail: a metal rail fitted around the boat to prevent the crew falling overboard.

Gudgeon: a rudder fitting. It is the eye into which the *pintle* fits.

Guy: a steadying rope for a *spar*; a spinnaker guy controls the fore-and-aft position of the spinnaker pole; the foreguy holds the spinnaker pole forward and down.

Gybe: to change from one *tack* to another by turning the stern through the wind.

H

Halyard: rope used to hoist and lower sails.

Hank: fitting used to attach the *luff* of a sail to a *stay*.

Hatch: an opening in the deck giving access to the interior.

Hawse pipe: see Navel pipe.

Head-to-wind: when the bows are pointing right into the wind.

Headfoil: a streamlined surround to a *forestay*, with a groove into which a headsail *luff* slides.

Heads: the toilet.

Headway: the forward movement of a boat through the water.

Heave-to: to *back* the jib and lash the tiller to *leeward*; used in heavy weather to encourage the boat to lie quietly and to reduce *headway*.

Heaving line: a light line suitable for throwing ashore.

Heel: to lean over to one side.

I

Isobars: lines on a weather map joining places of equal atmospheric pressure.

J

Jackstay: a line running fore-and-aft, on both sides of the boat, to which safety harnesses are clipped.

Jury: a temporary device to replace lost or damaged gear.

K

Kedge: a small, light second anchor.

Keel: the main backbone of the boat to which a *ballast keel* is bolted or through which the *center-board* passes.

Ketch: a two-masted sailing vessel with a *mizzen* mast slightly smaller than the main and stepped forward of the rudder stock/post.

Kicking strap: a line used to pull the boom down, to keep it horizontal, particularly on a *reach* or *run*.

L

Lanyard: a short line attached to one object, such as a knife, with which it is secured to another.

Leech: 1, the after edge of a triangular sail; 2, both side edges of a square sail.

Leehelm: the tendency of a boat to *bear away* from the wind

Lee shore: a shore on to which the wind is blowing. **I**

Leeward: away from the wind; the direction to which the wind blows.

Leeway: the sideways movement of a boat off its *course* as a result of the wind blowing on one side of the sails.

Let fly: to let a *sheet* go instantly, spilling the wind from the sails.

Lifeline: a wire or rope rigged around the deck to prevent the crew falling overboard.

Limber holes: gaps left at the lower end of frames above the *keel* to allow water to drain to the lowest point of the *bilges*.

List: a boat's more or less permanent lean to one side, owing to the improper distribution of weight, e.g., *ballast* or water.

Log: 1, an instrument for measuring a boat's speed and distance travelled through the water; 2, to record in a book the details of a voyage, usually distances covered and weather.

Luff: the forward edge of a sail. To luff up is to turn the boat's head right into the wind.

Luff groove: a groove in a wooden or metal spar into which the *luff* of the headsail is fed.

Lurch: the sudden rolling of a boat.

M

Marlin spike: a pointed steel or wooden spike used to open up the strands of rope or wire then splicing.

Mast Step: the socket in which the base of the mast is located.

GLOSSARY OF SAILING

Measured mile: a distance of one nautical mile measured between buoys or *transits/ranges* ashore, and marked on the chart.

Member: a part of the skeleton of the hull, such as a *stringer* laminated into a fiberglass hull to strengthen it.

Meridian: an imaginary line encircling the Earth which passes through the poles and cuts at right angles through the Equator. All lines of longitude are meridians.

Mizzen: 1, the shorter, after-mast on a *ketch* or *yawl*, 2, the fore-and-aft sail set on this mast.

N

Navel pipe: a metal pipe in the foredeck through which the anchor chain passes to the locker below.

Noon sight: a vessel's latitude can be found, using a sextant, when a heavenly body on the observer's *meridian* is at its greatest altitude. The sight of the sun at noon is the one most frequently taken.

O

Off the wind: with the *sheets* slacked off, not *close-hauled*.

On the wind: *close-hauled*.

Outhaul: a rope used to pull out the foot of a sail.

Overall length (LOA): the boat's extreme length, measured from the foremost part of the bow to the aftermost part of the stern, excluding bowsprit, self-steering gear etc.

P

Painter: the bow line by which a dinghy, or *tender*, is towed or made fast.

Pay out: to let a rope out gradually.

Pintle: a rudder fitting with a long pin which slips into the *gudgeon* to form a hinged pivot for the rudder.

Pitch: 1, the up and down motion of the bows of a boat plunging over the waves, 2, the angle of the propeller blades.

Point of sailing: the different angles from the wind on which a boat may sail; the boat's *course* relative to the direction of the wind.

Port: the left-hand side of a boat, looking forward (opp. of *starboard*).

Port tack: a boat is on a port tack when the wind strikes the port side first and the mainsail is out to *starboard*. A boat on the port tack gives way to a boat on a *starboard tack*.

Position line/line of position: a line drawn on a chart, as a result of taking a *bearing*, along which the boat's position must lie. Two position lines give a *fix*.

Pulpit: a metal *guard rail* fitted at the bows of a boat to provide safety for the crew.

Pushpit: a metal *guard rail* fitted at the stern.

Q

Quarter: the portion of the boat mid-way between the stern and the *beam*; on the quarter means about 45 degrees *abaft* the beam.

R

Rake: the fore-and-aft deviation from the perpendic-

ular of a mast or other feature of a boat.

Range: 1, see **Transit**; 2, of tides, the difference between the high- and low-water levels of a *tide*; 3, the distance at which a light can be seen.

Rating: a method of measuring certain dimensions of a yacht to enable it to take part in handicap races.

Reach: to sail with the wind approximately on the *beam*; all sailing points between running and *close-hauled*.

Reef: to reduce the sail area by folding or rolling surplus material on the boom or *forestay*.

Reefing pennant: strong line with which the *luff* or leech *cringle* is pulled down to the boom when reefing.

Rhumb line: a line cutting all *meridians* at the same angle; the *course* followed by a boat sailing in a fixed direction.

Riding light or anchor light: an all-round white light, usually hoisted on the *forestay*, to show that a boat under 50 ft (15 m) is at anchor. It must be visible for 2 mls (3km).

Riding sail: a small sail hoisted to enable a boat to maintain *steerage way* during a storm.

Rigging screw: a deck fitting with which the tension of *standing rigging*, e.g. *stays*, *shrouds*, is adjusted.

Roach: the curved part of the *leech* of a sail which extends beyond the direct line from head to *clew*.

Run: to sail with the wind *aft* and with the *sheets* eased well out.

Running rigging: all the moving lines, such as *sheets* and *halyards*, used in the *setting* and *trimming* of sails.

S

Sailmaker's palm: a strong leather protective loop which fits across the palm of the hand. It has a hole for the thumb and metal reinforced plate on the palm to accept the eye of a needle, and is worn when mending sails or *splicing* ropes.

Schooner: a boat with two or more masts, with the mainmast aftermost.

Scope: the length of rope or cable paid out when mooring or anchoring.

Scuppers: holes in the *toe rail* which allow water to drain off the deck.

Seacock: a valve which shuts off an underwater inlet or outlet passing through the hull.

Sea room: room in which a boat can manoeuvre, clear of land or dangers.

Seize: to bind two ropes together, or a rope to a *spar*, with a light line.

Serve: to cover and protect a *splice* or part of a rope with twine bound tightly against the lay.

Serving mallet: tool with a grooved head, used when serving a rope to keep the twine at a constant and high tension.

Set: 1, to hoist a sail; 2, the way in which the sails fit; 3, the direction of tidal current or stream.

Shackle: a metal link with a removable bolt across the open end; of various shapes: D, U.

Sheave: a grooved wheel in a *block* or *spar* for a rope to run on.

Sheet: the rope attached to the *clew* of a sail or to the boom, enabling it to be controlled or *trimmed*.

Shrouds: ropes or wires, usually in pairs, led from the mast to *chain plates* at deck level to prevent the mast falling sideways; part of the *standing rigging*.

Sloop: a single-masted sailing boat with a mainsail and one headsail.

Spar: a general term for any wood or metal pole, e.g., mast or boom, used to carry or give shape to sails.

Spindrift: spray blown along the surface of the sea.

Spinnaker: a large, light, balloon-shaped sail set when *reaching* or *running*.

Splice: to join ropes or wires by unlaying the strands and interweaving them.

Split pin: see **Cotter pin**.

Spreaders: horizontal struts attached to the mast, which extend to the *shrouds* and help to support the mast.

Stall: a sail stalls when the airflow over it breaks up, causing the boat to lose way.

Stanchion: upright metal post bolted to the deck to support *guard rails* or *lifelines*.

Standing part: the part of a line not used when making a knot; the part of a rope which is made fast, or around which the knot is tied.

Standing rigging: the *shrouds* and *stays* which are permanently set up and support the masts.

Starboard: right-hand side of a boat looking forward (opp. of *port*).

Starboard tack: a boat is on the starboard tack when the wind strikes the starboard side first and the boom is out to *port*.

Stay: wire or rope which supports the mast in a fore-and-aft direction; part of the *standing rigging*.

Steerage way: a boat has steerage way when it has sufficient speed to allow it to be steered, or to answer the helm.

Stem: the timber at the bow, from the *keel* upwards, to which the planking is attached.

Sternway: the backward, stern-first movement of a boat.

Stringer: a fore-and-aft *member*, fitted to strengthen the frames.

T

Tack: 1, the lower forward corner of a sail; 2, to turn the boat through the wind so that it blows on the opposite side of the sails.

Tacking: working to windward by sailing *close-hauled* on alternate *courses* so that the wind is first on one side of the boat, then on the other.

Tack pennant: a length or wire with an eye in each end, used to raise the *tack* of a headsail some distance off the deck.

Tackle: a purchase system comprising rope and *blocks* which is used to gain mechanical advantage.

Tang: a strong metal fitting by which *standing rigging* is attached to the mast or other spar.

Tender or dinghy: a small boat used to ferry stores and people to a yacht.

Terminal fitting: fitting at the end of a wire rope by which a *shroud* or *stay* can be attached to the mast, a *tang* or a *rigging screw/turn-buckle*.

Tide: the vertical rise and fall of the oceans, caused principally by the gravitational attraction of the moon.

GLOSSARY OF SAILING TERMS

Toe rail: a low strip of metal or moulding running around the edge of the deck.

Topping lift: a line from the masthead to a *spar*, normally the boom, which is used to raise it.

Topsides: the part of a boat's hull which is above the *waterline*.

Track: 1, the *course* a boat has made good; 2, a fitting on the mast or boom into which the slides on a sail fit; 3, a fitting along which a *traveller* runs; used to alter the tension of the *sheets*.

Transit: two fixed objects are in transit when seen in line; two transits give position *fix*.

Traveller: 1, a ring or hoop which can be hauled along a *spar*; 2, a fitting which slides in a *track* and is used to alter the angle of the *sheets*.

Trim: 1, to adjust the angle of the sails, by means of *sheets*, so that they work most efficiently; 2, to adjust the boat's load, and thus the fore-and-aft angle at which it floats.

True wind: the direction and speed of the wind felt when stationary, at anchor or on land.

Turnbuckle see **Rigging screw**.

U

Under way: a boat is under way when it is not made fast to the shore, at anchor or aground.

Uphaul: a *haul* used to raise something vertically, e.g., the spinnaker pole.

V

Veer: 1, the wind veers when

it shifts in a clockwise direction; 2, to pay out anchor cable or rope in a gradual, controlled way.

W

Wake: the disturbed water left *astern* of a boat.

Waterline: the line along the hull at which a boat floats

Waterline length (WL): the length of a boat from *stem* to stern at the *waterline*. It governs the maximum speed of a *displacement hull* and affects a boat's *rating*.

Weather helm: (opp. of *lee helm*).

Weather side: the side of a boat on which the wind is blowing.

Wetted surface: the area of the hull under water.

Whisker pole: a light pole used to hold out the *clew* of a headsail when *running*.

Winch: a mechanical device, consisting usually of a metal drum turned by a handle, around which a line is wound to give the crew more purchasing power when hauling taut a line, e.g., a *jib sheet*.

Windage: those parts of a boat which increase *drag*, e.g., rigging, *spars*, crew, etc.

Windlass: a *winch* with a horizontal shaft and a vertical handle, used to haul up the anchor chain.

Windward: the direction from which the wind blows; towards the wind (opp. of *leeward*).

Y

Yaw: a two-masted boat with the *mizzen* stepped *aft* of the rudder stock/post.

GENERAL HANDLING & OPERATION

Pumps:

All pumps should be checked frequently to insure proper operation. *This is an especially important regular maintenance item since functioning of a pump could save your vessel from serious damage at some future time.*

II

Inspect all hoses for chafing and dry rot. See that hose clamps are tight. Check that the pump impeller area is clean and free of obstructions. Inspect electrical wiring for corrosion. Make sure float switch moves freely and is making an electrical connection.

Docking:

Docking your boat should be handled carefully to avoid potential damage. Under normal wind and water conditions, the following considerations should be made:

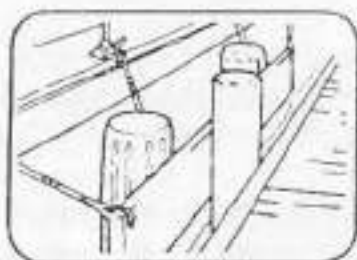

1. Whenever possible, your approach should be made against the prevailing wind and current to assist in stopping the boat. Where these conditions are contrary, the strongest should be used to determine approach.

2. Approaching the dock-dock lines and fenders should be at ready, loose gear stowed and decks cleared. Determine the

direction of wind and current, and, once you decide which side of the boat will be against the dock, rig dock lines and fenders on the appropriate side. One dock line should be attached to the bow cleat, another to the stem cleat opposite the side that will lie against the dock. *NOTE:* If the boat is to lie against a piling, rig a fender board across two or more fenders

3. Tying up-attach bow and stern lines to dock, hauling boat in with fenders against dock. Rig crossing spring lines to limit motion forward and aft. Be sure to allow some slack in all lines to compensate for tidal activity if present. Never use bow rail, stem rail or stanchions to secure vessel, even for brief periods. For other types of moorings, or for abnormal wind or water conditions, consult your *Chapman's* or other approved boating guide.



GENERAL HANDLING & OPERATION

Anchoring:

Your Hunter comes with an on-deck anchor well and a burying-type anchor as standard equipment. The anchor is selected to suit the size and weight of your boat under normal anchoring conditions, and provides its best holding characteristic in muddy or sandy bottoms.

When anchoring, pay particular attention to the scope of your anchor rode (i.e., the relationship between the depth of the water and the length of the rode). A good rule of thumb is to allow a scope of about 7:1 (a rode seven times as long as the vertical distance from the bow to the bottom). A helpful aid is to mark the rode every 20 feet or so with knots or other types of indicators. Before dropping anchor, make sure the bitter end is secured to the forward cleat.

Also, be sure to consider wind direction, currents, mean low tide depths and other local conditions when anchoring, as well as the positions of any boats already anchored nearby.

CAUTION: Anchoring in unusual water and/or weather conditions will require additional precautions. Consult your *Chapman's* or other approved guide for suggestions.

To weigh anchor, motor or sail (under main only) slowly forward. When at a point directly above the anchor, a quick tug should free it from the bottom. Take care not to damage the topsides when hauling the anchor aboard. It is good practice to thoroughly clean the anchor prior to placing it in the anchor well.

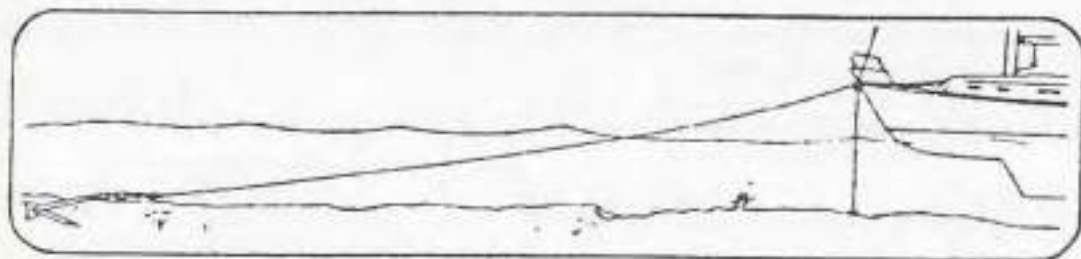

MAST RAISING & LOWERING SYSTEM

WARNING: MAKE SURE THAT THE MAST AND RIGGING IS CLEAR OF ALL OVERHEAD ELECTRICAL CABLES WHEN BEING RAISED OR LOWERED OR MANEUVERED ABOUT THE LAUNCH AREA. CONTACT WITH AN ELECTRICAL CABLE CAN CAUSE SEVERE INJURY OR DEATH.

1. Confirm that all standing rigging and spreaders are connected to the spar as per the drawings in the owners manual. The spreader retaining pins should be installed and pinned, the spreader tip tightened in the correct location and all black rubber retainer plugs installed in the rigging terminals on the mast. These plugs prevent the the shrouds from falling out of the mast when the mast is lowered. All halyards should be installed and the mast light installed. **II**
2. Confirm that the white "boots" are installed over each shroud tumbuckle and the tumbuckles are attached to the chain plate "U" bolts with the cotter pins located inboard. The boots must be forced down over the tumbuckle toggles to prevent the tumbuckles binding on the "U" bolts and bending during the stepping process.
3. Untie the mast from the bow pulpit and support crutch, and slide the mast aft on the support crutch roller until the base of the mast is over the mast step. At this point the mast will be balanced on the roller only, so do not let go of the mast base.
4. Remove the stainless steel mast step pin from the mast step casting being careful not to lose the boom vang strap.
5. Push the mast base down until the retaining pin holes in the base align with the corresponding holes in the step and re-install the SS retaining pin being careful to re-install the boom vang strap at this time. Install the split ring to the retaining pin.
6. Insert the mast raising bridle wires into fittings on spar (Note: these stainless steel hooks can be forced open slightly to ease their insertion).
7. Attach the pelican hooks on the bottom ends of these mast raising bridle wires to the welded eyes on the forward stanchions. Make sure that the bridle wires are equally snug port and starboard. The wires may become slightly tighter as the mast is raised, therefore, do not overtighten in down position.
8. Open the anchor locker and attach the lower end of the mainsheet tackle (the end with the jam cleat) to the "U" bolt inside the locker.
9. Insert the mast raising tube into the hole in the base of the spar making sure the notch in the end of the pole straddles the bolt rope extrusion on the inside aft face of the spar.
10. Holding the pole in a vertical position, connect the jib halyard shackle to the aft loop at the top end of the pole. Tension the halyard by pulling it from the exit in the side of the spar (make sure that the jib halyard is being tensioned, and not the main halyard) until the mast raising pole is angled aft approximately 10 degrees. Securely cleat the halyard to the black plastic cleat on the side of the mast below the exit. See illustration in owners manual showing the proper cleating of a line.

MAST RAISING & LOWERING SYSTEM

11. While still holding the mast raising pole at the ten degree angle aft, connect the upper end of the mainsheet tackle to the forward loop at the end of the mast raising pole and take up the slack through the jam on the lower block of the mainsheet.
12. Check to make sure that the forestay is not twisted around the jib halyard, that the upper and lower shrouds are not twisted around each other and are outside the life lines, that the turnbuckles are vertical on the "U" bolts, the spar is clear of all overhead electrical wiring, all shrouds, mast raising bridles and forestay are properly attached to the spar, all shackles on the mainsheet and jib halyard are properly closed, the jib halyard is properly cleated to the spar, no one is standing in the cockpit or under the mast and, in all respects, the mast is ready to be raised.
13. Pull on the mainsheet tackle to raise the spar making sure that the mainsheet always runs through, and is being held by, the jam. With the mast raising bridles installed, the mast is prevented from moving from side to side, so you can rest between pulls and it is not necessary to have anyone pushing the spar up from behind as you are pulling on the tackle, although this will reduce the load on the tackle and speed up the process. The load on the tackle will be at a maximum at the beginning of the raising process and will reduce progressively as the spar is raised, reducing to almost nothing when the spar is up. With the anchor locker opened the bow of the boat has limited space in which to work, so be careful and watch your footing. There is no need to hurry.
14. When raised, leave the mainsheet jammed and tensioned. Take the bottom end of the forestay forward and connect to the forward of the two holes in the sternhead fitting.
15. Connect mast wiring plug to deck fitting at starboard base of spar.
16. Refer to GETTING READY TO SAIL.

MAST LOWERING

1. Remove sails, boom vang, and boom.
2. Reinstall mast raising bridles to mast and stanchion eyes and install mast support crutch to transom, if not already done.
3. Install mast raising pole to hole in base of mast, making sure that notch on pole is keyed to bolt rope extrusion in back of spar.
4. Attach jib halyard shackle to upper spliced eye at forward end of mast raising pole.
5. Tension jib halyard from halyard exit in side of spar (again confirming that it is the jib halyard being tensioned and not the main halyard-check the color coding) so that pole angles up at the front end approximately 10 degrees. Secure halyard to cleat on side of mast (see illustration in owners manual).

MAST RAISING & LOWERING SYSTEM

6. Attach bottom end of mainsheet to "U" bolt in anchor locker and top end to bottom loop at end of mast raising pole. Tension mainsheet tackle so jib halyard takes the load. Make sure main sheet is jammed and for extra security secure to bow mooring cleat.
7. Loosen forestay turnbuckle and remove forestay from stemhead fitting.
8. Check for overhead electrical cables, make sure that no one is standing in cockpit or under the spar, and confirm that the spar is in all respects ready to lower.
9. Allowing the mainsheet to hook around the bow mooring cleat, unjam the mainsheet and, holding the mainsheet tail in one hand, ease tension on the mainsheet tackle while pushing the spar aft with your other hand. Retaining the deflection of the mainsheet around the cleat ease the mainsheet further until the spar begins to rotate aft.
10. Continue lowering the spar, remembering that the load on the tackle will increase as the spar is being lowered, until the spar rests in the mast crutch.
11. Disconnect the mast raising bridles, mast raising pole, mast electrical wiring and uncleat halyards aft so the spar can slide forward.
12. Remove mast step pin and disconnect mast base from step while restraining bottom end of mast and retaining boom vang strap. Replace pin, vang strap and cotter pin.
13. Slide mast forward on mast crutch roller until base of mast rests in bow pulpit. Secure mast in place at pulpit and at mast crutch. Take slack out of shrouds and secure forestay forward.

II

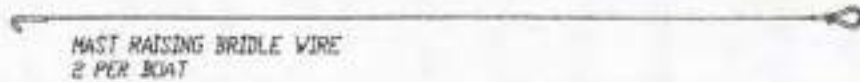
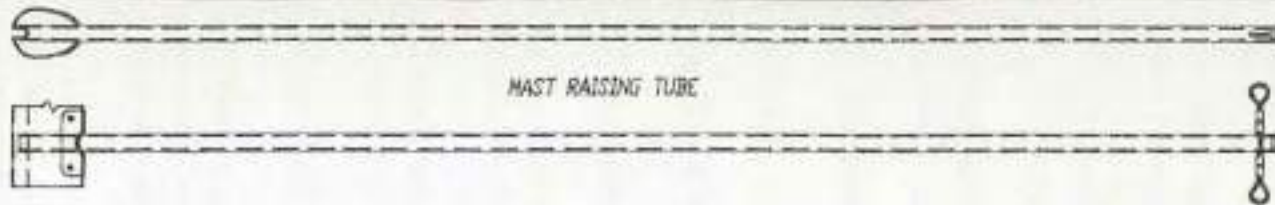

STEPPED

RAISING

MOUNTING

MAST RAISING TUBE

MAST CRUTCH

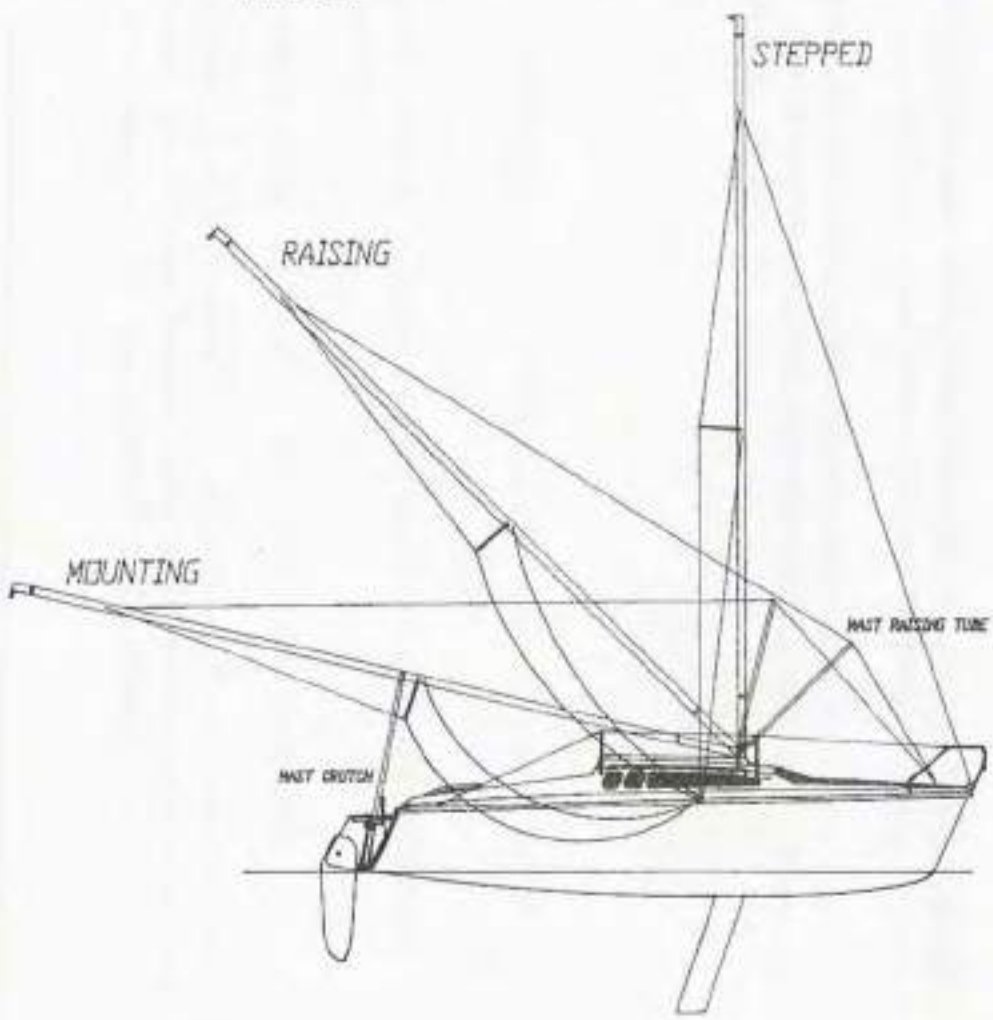

TIE OFF JIB HALYARD
TO CLEAT BEFORE
RAISING AND
LOWERING MAST

MAST RAISING BRIDLE WIRE

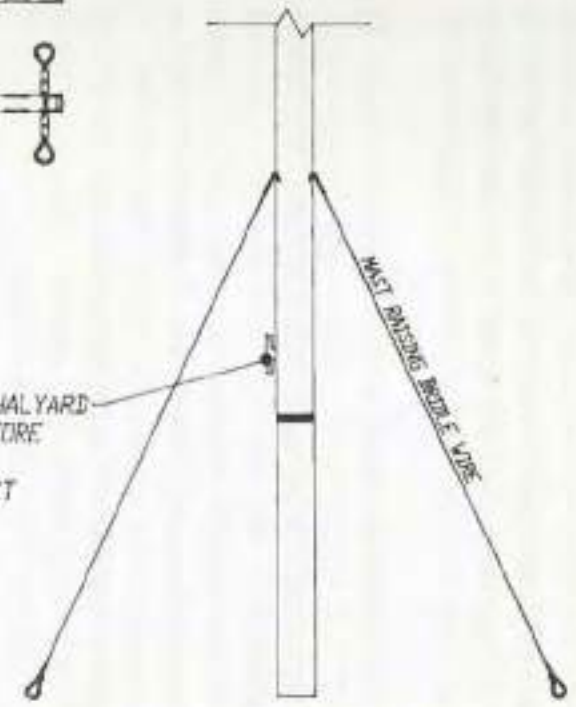

VIEW FROM FWD

TRAILERING

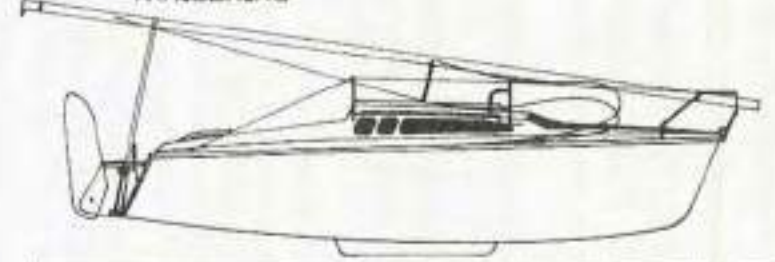

HUNTER

MAST RAISING SYSTEM H23-A-2615

LAUNCHING & RETRIEVING PROCEDURES

1. Extend the trailer tongue, if necessary, by lowering the forward support wheel, chocking the main wheels, unplugging the electrical connection, removing the tongue positioning pin and cotter pin and sliding the tongue out to its full extended length and reinstalling the pin and cotter pin. This can be done with the vehicle still connected to the trailer, using the vehicle to slowly move the extension while a second person watches the trailer, but should at all times only be done with the trailer on level ground. Whether the tongue needs extending will depend on the slope of the launch ramp and the depth of water available when the boat is backed in. In the majority of cases, for launching, the tongue may not need extending. However, for recovery, because the boat is floating lower with the full ballast tank, the tongue may need extending.

2. Remove any and all tie down straps and ropes retaining the boat to the trailer, as well as any lines retaining the rudder in the upright position or on centerline. The only attachment of boat to trailer should be the strap from the bow eye to the trailer winch.

3. The spar can be raised before or after launch, depending on the time available before and the docking facilities available after launch.

4. Attach the necessary bow and stern mooring lines and fenders if required. Do not lower the fenders over the side until the boat is clear of the trailer.

5. Initially slacken the trailer winch and familiarize yourself with its gear switch action and return the winch to the locked position.

6. Load all loose gear and provisions aboard by lowering the swim ladder in the transom.

7. Open the ballast tank valve located under the step of the companionway ladder. This valve loosens counter-clockwise but must be pushed down to force the sealing plate and gasket away from the recessed portion of the hull. Remove the vent plug located next to the valve from its hole in the vent box.

8. Back the boat and trailer down the ramp until the back wheels of the vehicle are just clear of the water. Retrieve the bow and stern lines as necessary. Loosen the trailer winch and bow strap.

9. Once the boat is floating free, push the boat clear of the trailer guides to the available dock, maintaining control with the mooring lines.

10. Slowly pull the empty trailer out of the water, being careful to make sure the boat and people stay clear.

11. Park the trailer and vehicle and return to the boat.

12. Check to make sure the ballast tank is full by sighting through the vent hole or by using a short length of dowel or wood as a "dip stick". Sometimes the "venturi effect" of water rushing past the valve plate

II

LAUNCHING & RETRIEVING PROCEDURES

the continued filling of the ballast tank.

13. When full, close the valve by turning the bar clockwise until it is tight and reinstall the vent plug in the down position. Close the step. NOTE: DO NOT leave water in ballast tank during freezing conditions. Water expands when it becomes ice and will do severe damage to the hull or ballast tank or both.

RETRIEVAL

1. Raise centerboard and rudder.
2. Back trailer into water, remembering boat will be floating lower with ballast tank full than when it was launched.
3. Open and depress the ballast tank valve and remove tank vent, both located under the companionway step.
4. Maneuver boat between trailer guides and up to the winch.
5. Connect bow strap and with winch in correct gear winch boat up and snug against bow stop.
6. Center boat between upright aft trailer guides.
7. Slowly pull boat from water until the weight of the boat is on the trailer.
8. Allow ballast tank to drain and confirm alignment on trailer. Put trailer back in water if necessary to realign boat.
9. Make sure that rudder is clamped and tied in upright position so that the tip doesn't drag on ground.
10. De-rig and unstep mast if not already done.
11. Tie boat to trailer, and mast to bow pulpit and aft support.
12. Chock trailer wheels, retract and repin trailer tongue.
13. Connect trailer wiring and check lights.

GETTING READY TO SAIL

Note: the mast may be raised while the boat is on the trailer or after the boat is launched. However, if the mast is raised after launching, make sure that the ballast tank is filled before the mast is raised. Also make sure that all halyards and reefing lines are installed using the messenger lines already run in the spar.

WARNING: MAKE SURE THAT THE MAST AND RIGGING ARE CLEAR OF ALL OVERHEAD ELECTRICAL CABLES WHEN BEING RAISED OR LOWERED OR MANEUVERED ABOUT A LAUNCHING AREA. CONTACT WITH AN OVERHEAD ELECTRICAL CABLE CAN CAUSE SEVERE INJURY OR DEATH.

1. After the rig has been raised, attach the forestay turnbuckle to the most forward of two holes in the stem fitting. Turnbuckle should be 3/4 open. Confirm that the upper and lower shrouds are supporting the spar.
2. Remove the mast raising pole and side support guy wires. The mast crutch may be left on the transom or removed, as you prefer.
3. Return the mainsheet to its aft position, attaching the block with the jam to the "U" bolt at the front end of the cockpit. Install the forward end of the boom to the gooseneck fitting on the mast. Tie the bottom end of the topping lift rope (the other end is fixed to the top of the mast) to the casting at the back of the boom. Attach the top block of the mainsheet system to the eye on the bottom of the boom which is immediately above the mainsheet "U" bolt in the cockpit.
4. Attach the jam block of the boom vang to the stainless steel bail on the mast step pin with the small shackle provided. The block should be oriented so that the line exits the vee jam on the bottom aft side. Attach the upper block of the jam to the eye on the boom.
5. If not already done on the H23.5 and H26, lead the main and jib halyards from the exits in the spar, through the sheaves molded into the mast base (main halyard through the aft sheave), around the deflector blocks and aft to the inner of the two jams on the house top. The main and jib halyards remain on the mast on the Hunter 19.
6. Using the main halyard, center the rig in the middle of the boat by first jamming the halyard in a position so that the halyard shackle just contacts a known point on the toe rail adjacent to the spar on the port side. Transfer the halyard to the starboard side and applying the same amount of tension see if the shackle contacts the corresponding position on the starboard toe rail. If the shackle falls short ease the port upper shroud turnbuckle and tension the starboard always maintaining some tension on each shroud so they are not slack. If the shackle over shoots the mark on the toe rail, ease the starboard upper shroud turnbuckle and shorten the opposite side until the halyard shackle does contact both points on the opposite toe rail uniformly.
7. After the rig is centered, set the amount of mast rake to approximately 1 degree of aft angle. This can be measured by hanging a weight, such as an adjustable wrench from the main halyard shackle and adjusting the halyard so the wrench is suspended immediately above the boom. With the boat level this wrench when hanging from the main halyard above the gooseneck should be 6" from the aft face of the

III

GETTING READY TO SAIL

mast. Adjust the forestay turnbuckle as necessary to achieve this position.

8. Tension the upper shrouds uniformly, alternately taking six half turns on one then the other until the upper shrouds are tight. The upper shrouds maintain tension on the forestay. The tighter the shrouds are the tighter the forestay will be and the less forestay "sag" there will be. A turnbuckle is tensioned by turning the center portion counter clockwise and loosened by turning it clockwise. The upper swage on the wire should be held with pliers, vice grips, or wrench to prevent it from turning as the turnbuckle rotates.
9. Tension the lower shrouds until the mast appears straight when sighted up the trailing edge, using the bolt rope slot as the guide. If the mast appears to bow to one side ease the lower shroud on that side and tension the shroud on the opposite side until the mast appears straight.
10. Once the mast is straightened transversely, sight up the mast from the side to see if there is any fore and aft bend. The mast should be bowed forward at the spreaders by approximately 2". Ease or tension the lower shrouds uniformly until this slight amount of bend is achieved. When finished the lower shroud should be slightly less tight than the main shrouds. If you sail in a predominantly heavy air region, slightly more mast bend, in the 3 to 4 inch range, may be desirable in order to flatten and depower the main sail.
11. After tuning the rig install cotter pins in all turnbuckles to prevent them from backing off while sailing.
12. Install the battens in the mainsail and install the mainsail onto the boom from the forward end. Remove the stop pin in the mast and install the luff slides into the track on the back of the spar. Reinstall the stop pin to prevent the slides from falling back out again.
13. Install the out haul rope (the shorter of the two) in the boom with the messenger line provided and lead from the sheave at the back of the boom through the lower cringle at the back of the sail and aft to the end of the casting - see dwg. #H19A-2615 boom and reef layout..
14. Install the reefing line (the longer of the two) in the boom with the messenger line provided and lead from the sheave through the upper cringle at the back of the sail and then down to the sliding eye on the bottom of the boom. Pull enough slack into the reef line so that the sail can be fully raised unimpeded by the reef line. Tie the mainsail onto the boom with the sail ties provided.
15. Install the jib sheet onto the jib as illustrated in the owners manual (dwg# H23A2626) and lead the sheets inside the shrouds to the lead blocks on the cabin top and aft to the jams or winches on the house top. Tie figure eight knots in the end of the sheets to prevent them from running back through the jams. Shackle the bottom of the jib to the aft of the two holes in the stemhead fitting and hank the jib onto the forestay. Bunch and tie the jib to prevent it blowing over board before it is ready to hoist.
16. Attach jib and main halyards to their respective sails.
17. Lower the rudder blade, if depth of water permits, to full down position. If water depth does not permit

GETTING READY TO SAIL

this before leaving the dock or ramp, make sure that the rudder is lowered before raising sail. The rudder must be down to achieve the correct balance for the proper helm loading. A rudder which is not lowered will load up excessively in severe conditions preventing the helmsman from responding to puffs and thus allowing the boat to "round up". Do Not cleat the pull down line in the down position. Use the tensioning clamp for this purpose. If you do run aground the rudder should be allowed to ride up against the friction of the clamp and not be retained down by the pull down rope. Otherwise severe damage can result. The cleat is provided to retain the blade in the upright position for launch, retrieval and trailering. Helm "feel" can be fine tuned by adjusting the fore and aft angle of the rudder in the down position.

III

18. Install the tiller extension to the tiller (standard on the H23.5 and H26, optional on the H19).

19. Raise sails, beginning with the main and then the jib while powering into the wind. Remember to lower the centerboard before you raise sail and confirm that the water ballast is full and sealed. Once each halyard, beginning with the main, is tensioned by the winch the halyard can be pushed down into its respective jam and the halyard removed from the winch, freeing the winch for the next halyard and, in the case of the H23.5 and H26, ultimately for the jib sheets. However, care should be taken not to inadvertently pull the halyards out of the jams, since the sails will lower rapidly if this is done (on the H19, back up cleats are provided). When the sails are raised the boat can be laid off and the engine turned off and tilted upward to clear the water.

20. Once the main is sheeted in and you are sailing upwind, confirm the main topping lift position. The main should be capable of sheeting in hard without the topping lift being tight. With the main sheeted in hard the topping lift should have eight to ten inches of sag and should be adjusted accordingly. When at dock or at a mooring the topping lift can be readjusted to raise the boom to a comfortable height above the cockpit.

21. Final confirmation of mast tune as well as finer tuning, if you desire it, will take place when sailing by sighting up the spar while going upwind in about ten to 12 knots of breeze. The mast should maintain its 2" fore and aft bend, but should also still appear straight transversely with the leeward main shroud still retaining its tension and not going noticeably slack. If the leeward rigging does go slack when sailing apply more tension uniformly to both shrouds by first tightening the leeward rigging three half turns and then after tacking tension the new leeward rigging the same amount. Continue this procedure, as necessary until the leeward upper shrouds no longer appear slack and forestay sag has been reduced. Removal and reinstallation of the tumbuckle cotter pins will be necessary to make these fine tuning adjustments.

22. Once the upper shrouds are tensioned, again sight up the spar to make sure that the middle of the spar at the spreaders is not either falling to leeward or bending to weather. Adjust and uniformly retension the lower shrouds as necessary.

Note: standing rigging will stretch slightly when initially loaded. Therefore, the rigging may have to be further tensioned slightly after a few sails in a strong breeze to compensate for this initial stretch.

GETTING READY TO SAIL

Once the mast is tuned and initial stretch is taken out, the rig should need retuning only at the beginning of each season.

23. After a day of sailing the sails should be lowered while again powering into the wind, with the jib lowered first and then the main.

LDA		19'0"
LWL		16'11"
BEAM		7'9"
DRAFT:	BOARD UP	14"
	BOARD DOWN	4'9"
BALLAST (FULL TANK)		600#
DISPLACEMENT (FULL TANK)		2100#
SAIL AREA		165.1 SQ. FT.
I		21'
J		6'9"
P		22'2"
E		8'6"
MAST HEIGHT ABOVE DWL		29'4"



HUNTER

H19 SAIL PLAN H19-A-2624

HUNTER 19 RIGGING SPECIFICATIONS

STANDING RIGGING

Item	Quantity	Wire Diameter	Mast Fitting	Deck Fitting	Length	Measurement Points
Forestay	1	1/8" 1x19 SS	T-Ball	Tumbuckle w/ Toggle	22' 6-3/4"	Inside of T-Ball to Center of Pin
Upper Shroud	2	1/8" 1x19 SS	T-Ball	Tumbuckle w/ Toggle	22' 5"	Inside of T-Ball to Center of Pin
Lower Shroud	2	1/8" 1x19 SS	T-Ball	Tumbuckle w/ Toggle	11' 11"	Inside of T-Ball to Center of Pin
Mast Raising Bridle Wires	2	1/8" 1x19 SS	Hook	Pelican Hook	5' 1"	Inside of Hook to Center of Pelican Hook

RUNNING RIGGING

Item	Quantity	Line Spec	Length	Fittings
Main Halyard	1	5/16"	57'	Headboard Shackle
Genoa Halyard	1	5/16"	46'	Headboard Shackle
Spinnaker Halyard	1 (Optional)	5/16"	52'	Headboard Shackle
Main Sheet	1	3/8"	35'	BBE, Snap Shackle Blocks: Fiddle w/ Cam Cleat, Single w/Becket, Schaefer 35-01
Genoa Sheet	1	3/8"	30'	BBE
Spinnaker Sheet	2 (Optional)	3/8"	22'	Snap Shackle
Spinnaker Pole Up/Downhaul	1 (Optional)	5/16"	30'	2 Headboard Shackles
Reefing Pennant	1	1/4"	25'	BBE
Furling Pennant	1 (Optional)	3/16"	32'	BBE
Vang	1 (Optional)	1/4"	20'	BBE, D Shackle Blocks: Fiddle w/"V" Jam Cleat, Fiddle, Schaefer 35-20
Outhaul	1	1/4"	14'	BBE
Topping Lift	1	1/4"	26'	BBE
Rudder Uphaul	1	3/8" (RI0312)	10'	BBE
CB Uphaul	1	7/16" (RI0313)	12'	BBE
CB Cascade	1	3/8" (RI0312)	10'	BBE, 2 Swivel Single Blocks
Anchor Line	1	3/8" TW Nylon	100'	Shackle, Thimble

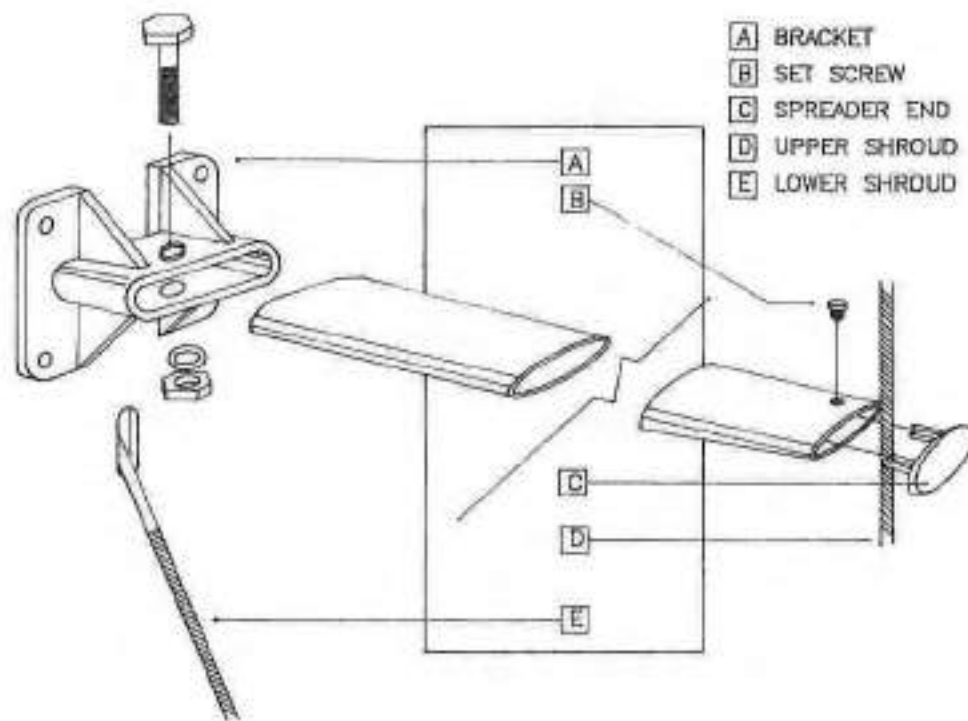

HUNTER 

H19 Z-SPAR SPREADER DETAIL H19-A-2614

VI

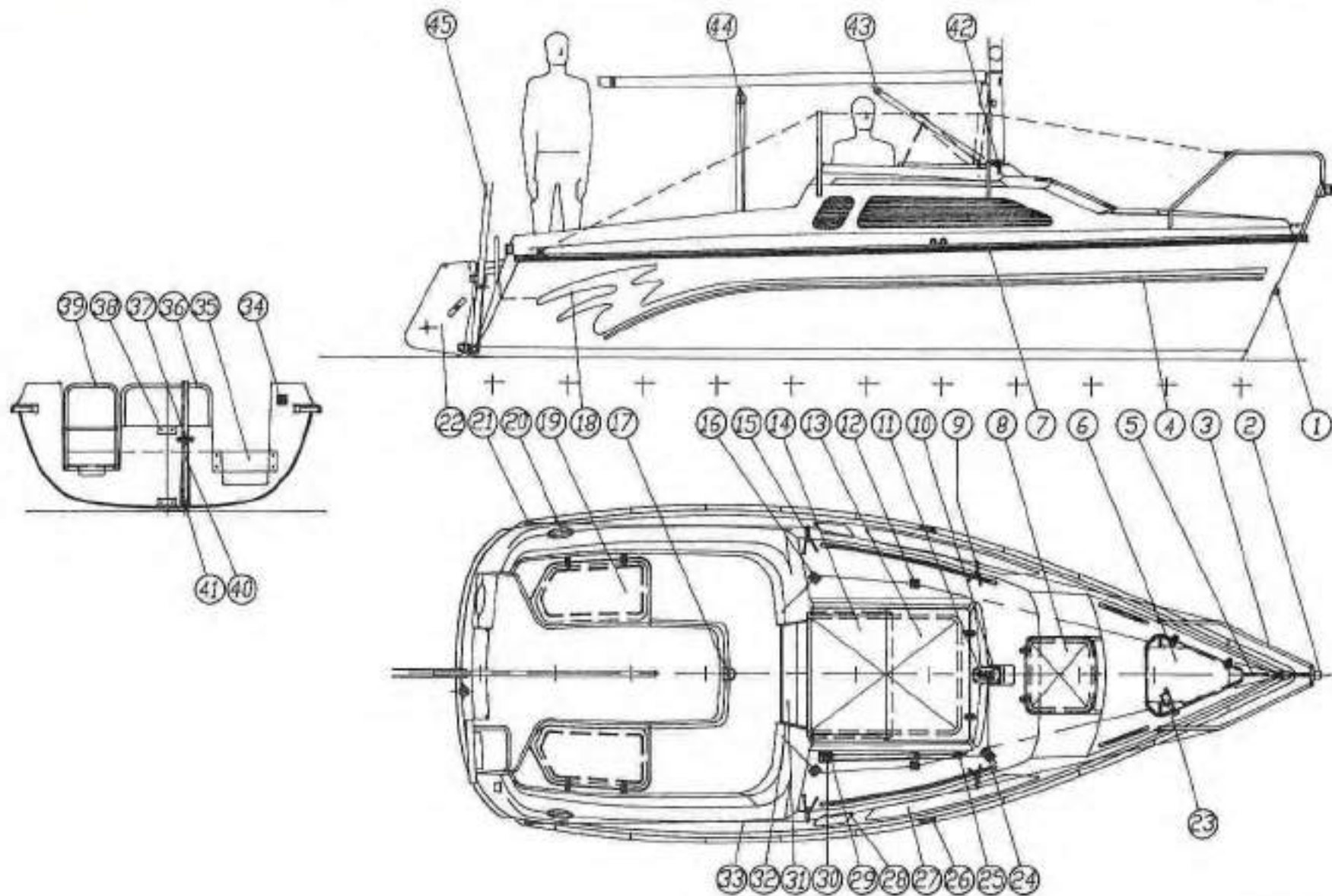

HUNTER 

H19 DECK HARDWARE H19-A-2626

HUNTER 19 DECK HARDWARE LAYOUT (See Diag.)

ITEM	REFERENCE NUMBER	
1. Bow Light	EL0380	
2. Towing "U"-Bolt	HW5511	
3. Bow Pulpit	PR1903	
4. Striping	CO0035	
5. Bow Cleat	HW0228	
6. Anchorwell Lid	AA270010	
7. Rub Rail (black)	HW2449	
Rub Rail Insert (white)	HW2448	
Rub Rail End Caps	HW2447	
8. Forehatch	AA270035	
9. Fwd. Stanchions	HW2060	
10. Mast Step Base Plate	HW3894	
11. Mast Step	RI0473	
12. Jib Block	HW0186	(Schaeffer 03-62)
13. Sea Hood	AA270045	
14. Plexi Slider	AF920001	
15. Aft Stanchions	HW2061	
16. Jib Sheet Jams	HW0218	
17. Mainsheet "U"-Bolt	HW5511	
18. Wave Decal	CO0034	
Hunter Logo	CO0040	
19. Port Seat Locker	AA270075	
Stbd. Seat Locker	AA270080	
20. Aft Mooring Cleat	HW0228	
21. Life Line "U"-Bolt	HW5511	
22. Rudderhead	AH050010	
23. Anchorwell Latch	HW4479	
Striker Plate	HW2132	
24. Centerboard Deflection Block	HW0262	(Schaeffer 303-09)
25. Centerboard Pennant Block	HW0235	(Schaeffer 03-05)
26. Chainplates	HW5511	
Backup Plates	HW3740	
27. Port Fwd. Fixed Window	PX0018	
Stbd. Fwd. Fixed Window	PX0017	
28. Port Aft Fixed Window	PX0235	
Stbd. Aft Fixed Window	PX0236	
29. Centerboard Jam	HW0218	
30. Centerboard Eye	HW0851	(Schaeffer 78-05)
31. Top Pin Board	AF85PF02	
Bottom Pin Board	AF85PF03	
32. Port Pin Board Retainer	AF85XW05	
Stbd. Pin Board Retainer	AF85XW06	
33. Life Line	RI1221	

VI

HUNTER 19 DECK HARDWARE LAYOUT (See Diag.)

ITEM	REFERENCE NUMBER	
34. Stern Light	EL0390	
35. Motor Mount	AF87MJ03	
36. Stern Rail	HW2258	
37. Mast Crutch Upper Support	HW2730	
38. Rudder Gudgeons	HW1903	
39. Swim Ladder	HW2148	
40. Mast Crutch	HW1698	
41. Mast Crutch Lower Support	HW2731	
42. Centerboard Sheave	HW0103	
Centerboard Pin	HW1803	
Centerboard Pennant Thru-Hull	PL0850	
43. Boom Vang (Optional)	HW0278	(Schaeffer 35-20)
44. Main Sheet	HW0271	(Schaeffer 35-01)
45. Bilge Pump Thru-Hull	PL0850	
46. Port Seat Locker Hardware	AC030270	
Stbd. Seat Locker Hardware	AC030280	
47. Forehatch Hardware	AC090010	
48. Anchor Locker Hardware	AC030050	
49. Mast Raising "U"-Bolt	HW5511	
50. Sea Hood Hardware (Mounting)	AC030205	
Sea Hood Hardware (Construction)	AF920001	
51. Connector Exit	EL0075	
52. Anchor Locker Drain	AD030005	

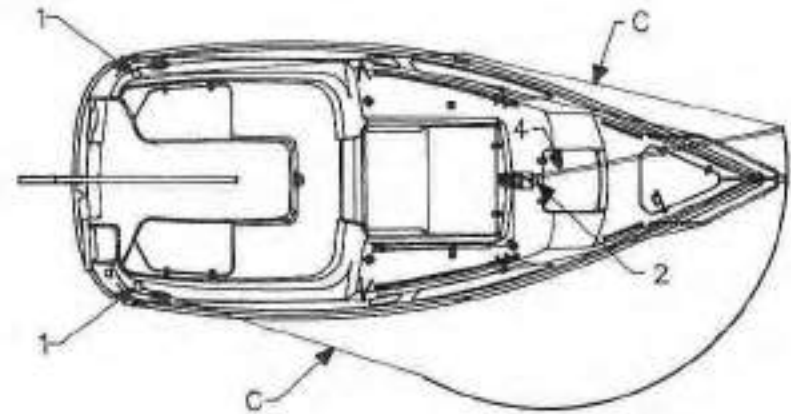
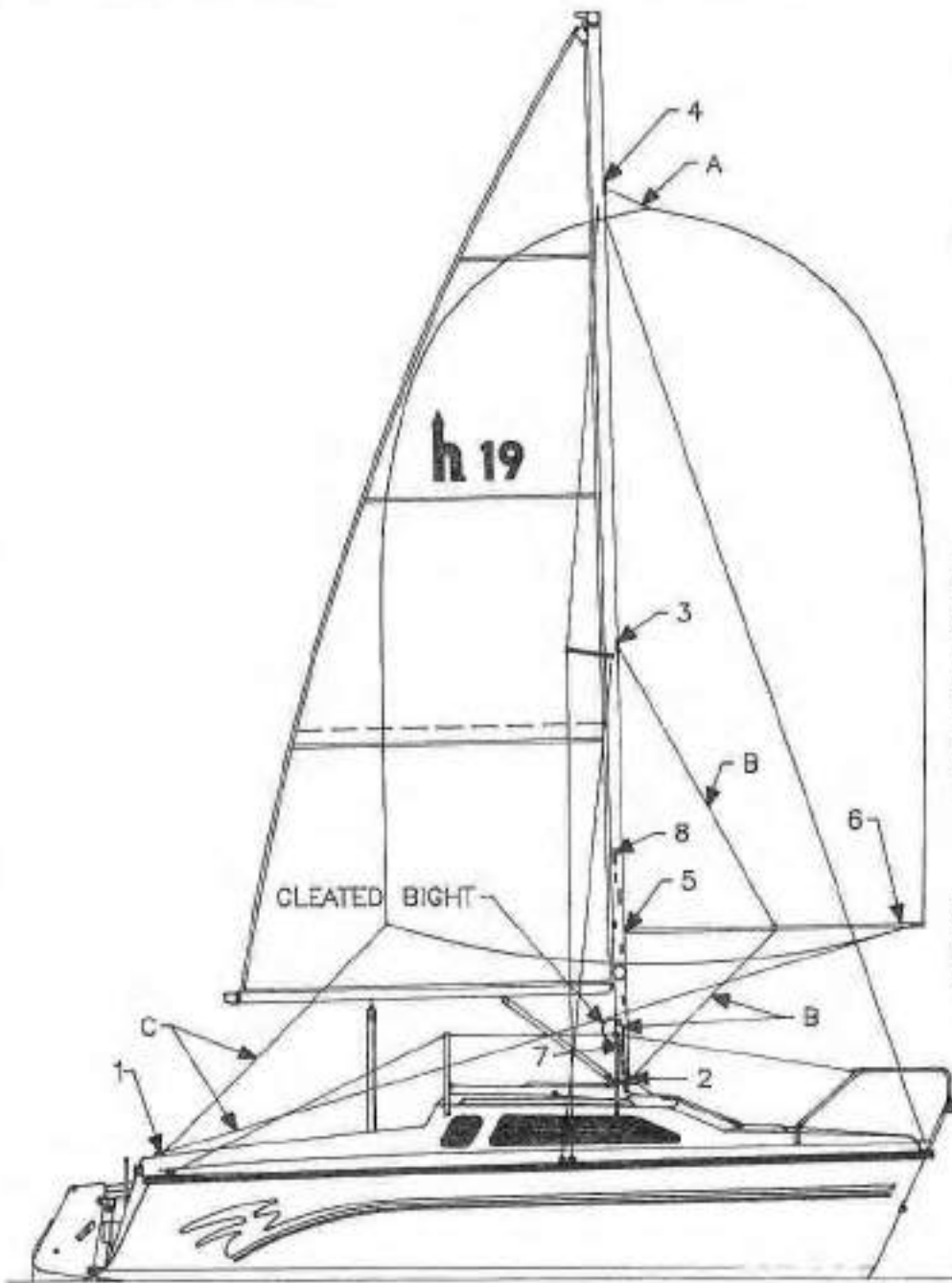

FITTINGS

ITEMS

1. SHEET BLOCKS (1 PER SIDE)
2. FOREGUY BLOCK
3. TOP LIFT EXIT W/ SHEAVE
4. SPI HAL EXIT W/ SHEAVE
5. POLE BAIL
6. POLE
7. FOREGUY CLEAT
8. SPI HAL EXIT

MANUFACTURER

1. SCHAEFFER 303-71
2. SCHAEFFER 303-62
3. Z-SPAR
4. Z-SPAR
5. Z-SPAR
6. Z-SPAR
7. Z-SPAR
8. Z-SPAR

LINES

ITEMS

- A. HALYARD
- B. FOREGUY/TOPPING LIFT
- C. SHEETS (1 PER SIDE)

LINE SIZE

LENGTH

- | | |
|-------|-----|
| 5/16" | 57' |
| 5/16" | 30' |
| 3/8" | 22' |

HUNTER 

H19 SPINNAKER LAYOUT H19-A-2630

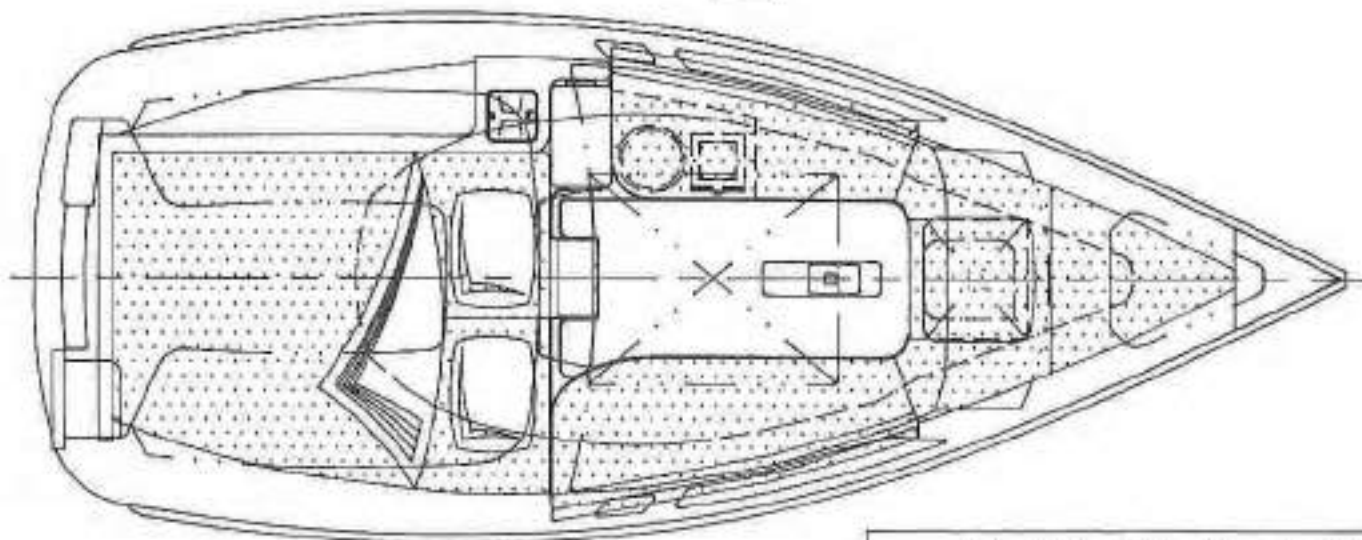
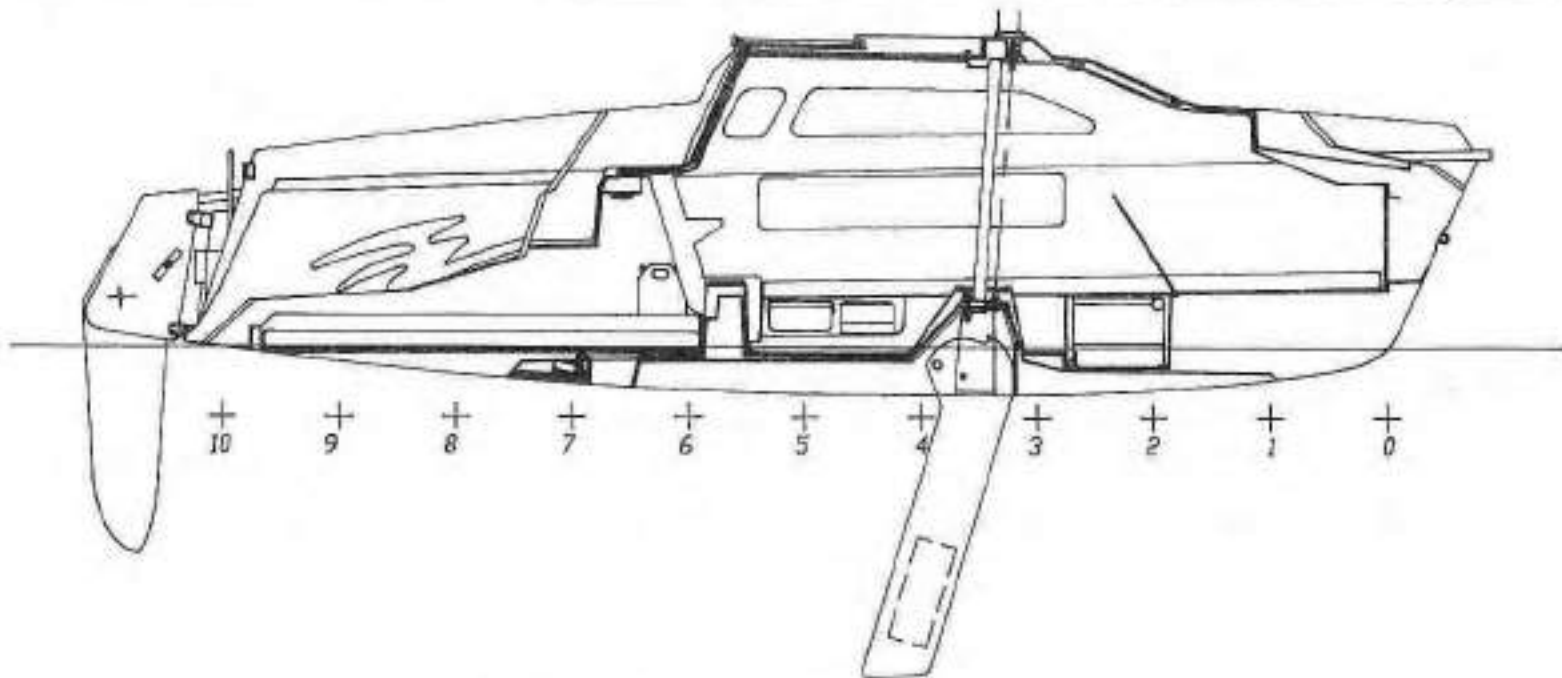

HUNTER 

H19 ACCOMMODATION PLAN H19-A-2618

- Ⓚ DOME LIGHT
- Ⓛ BOW LIGHT
- Ⓢ STERN LIGHT

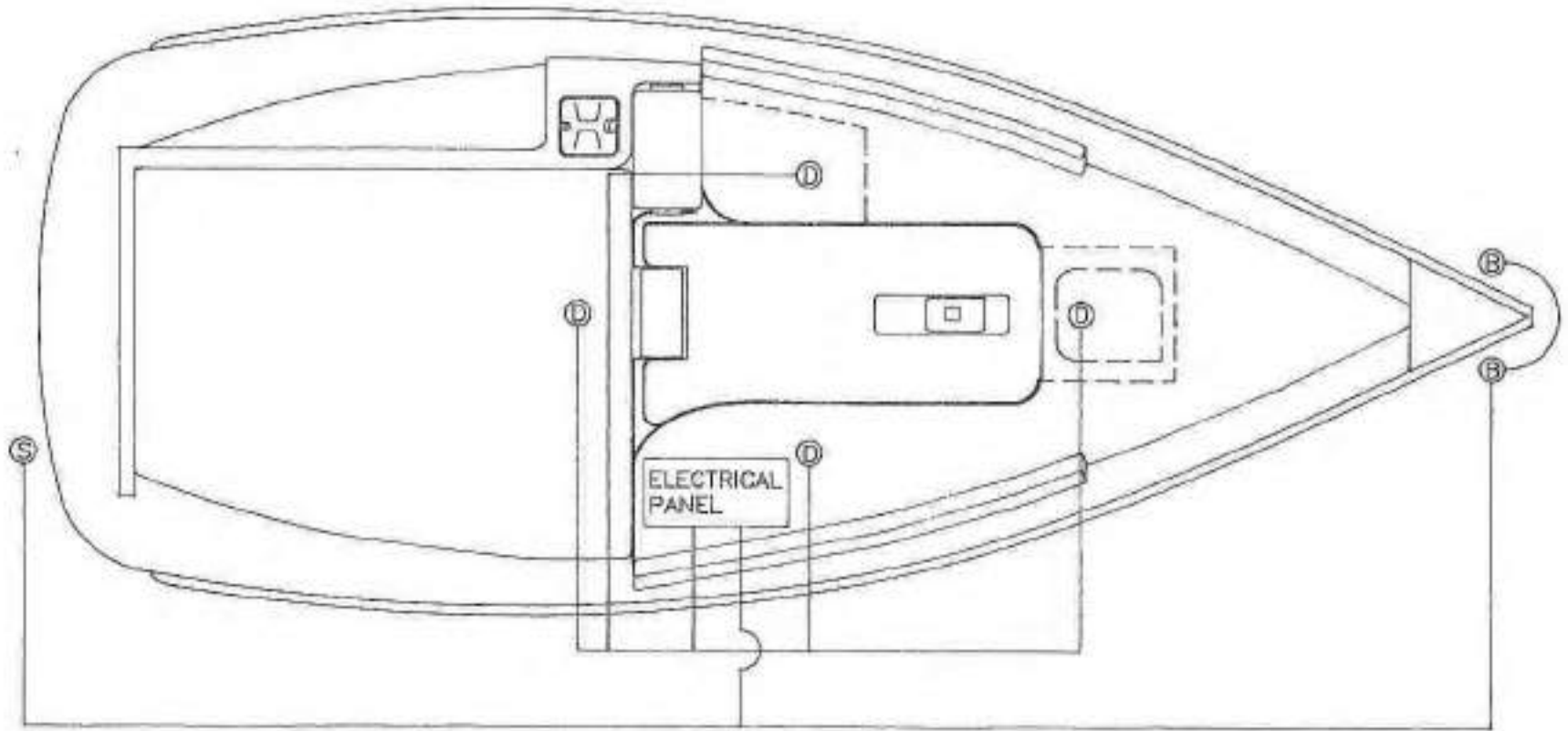

HUNTER 

H19 LIGHTING LAYOUT H19-A-2623

VI

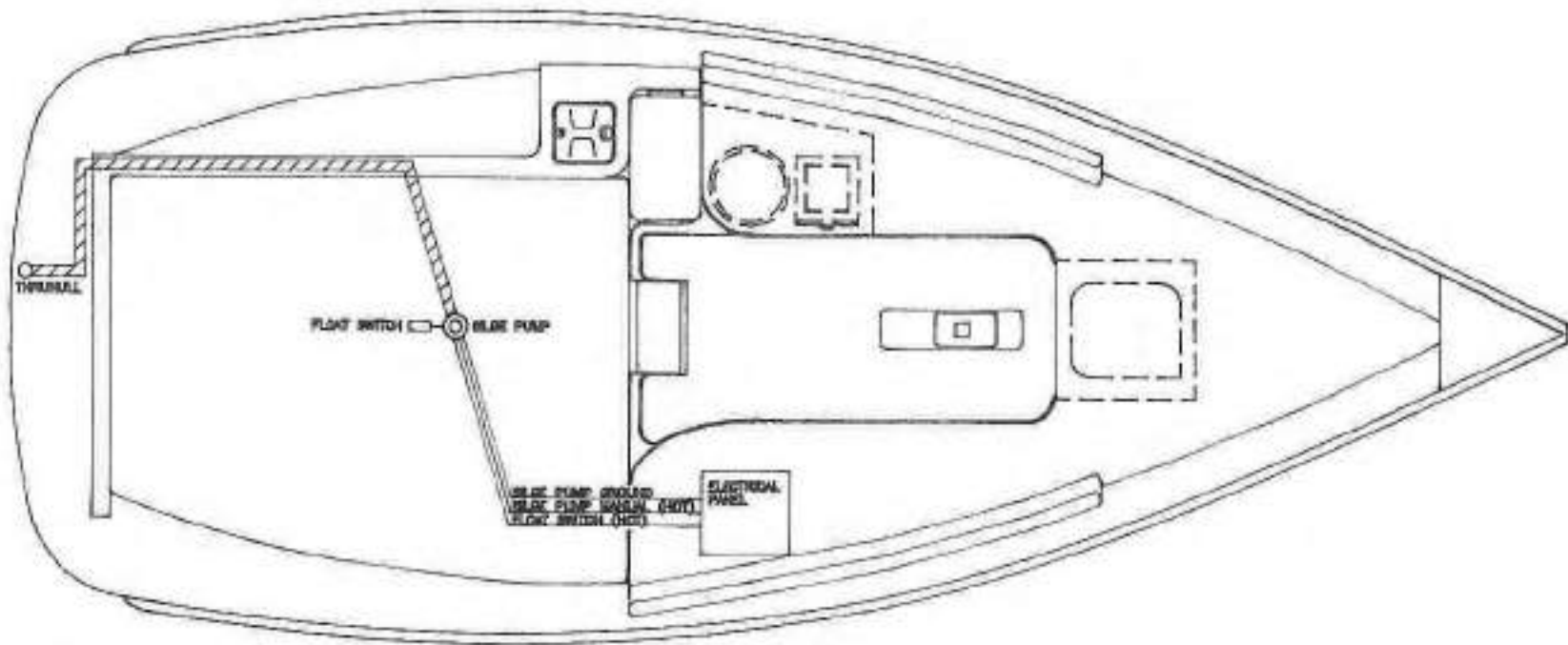

HUNTER 

H19 BILGE PUMP LAYOUT H19-A-2621

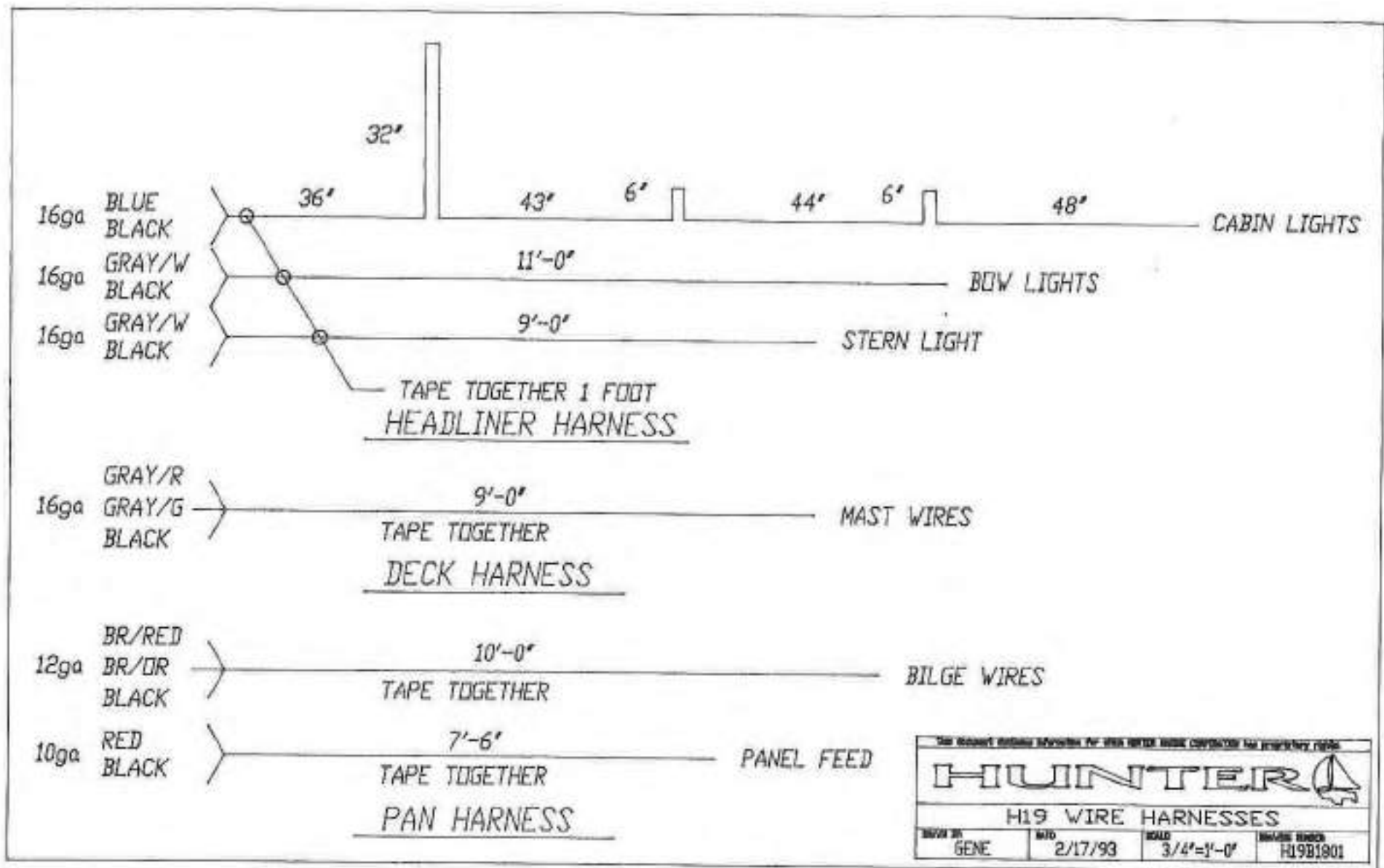

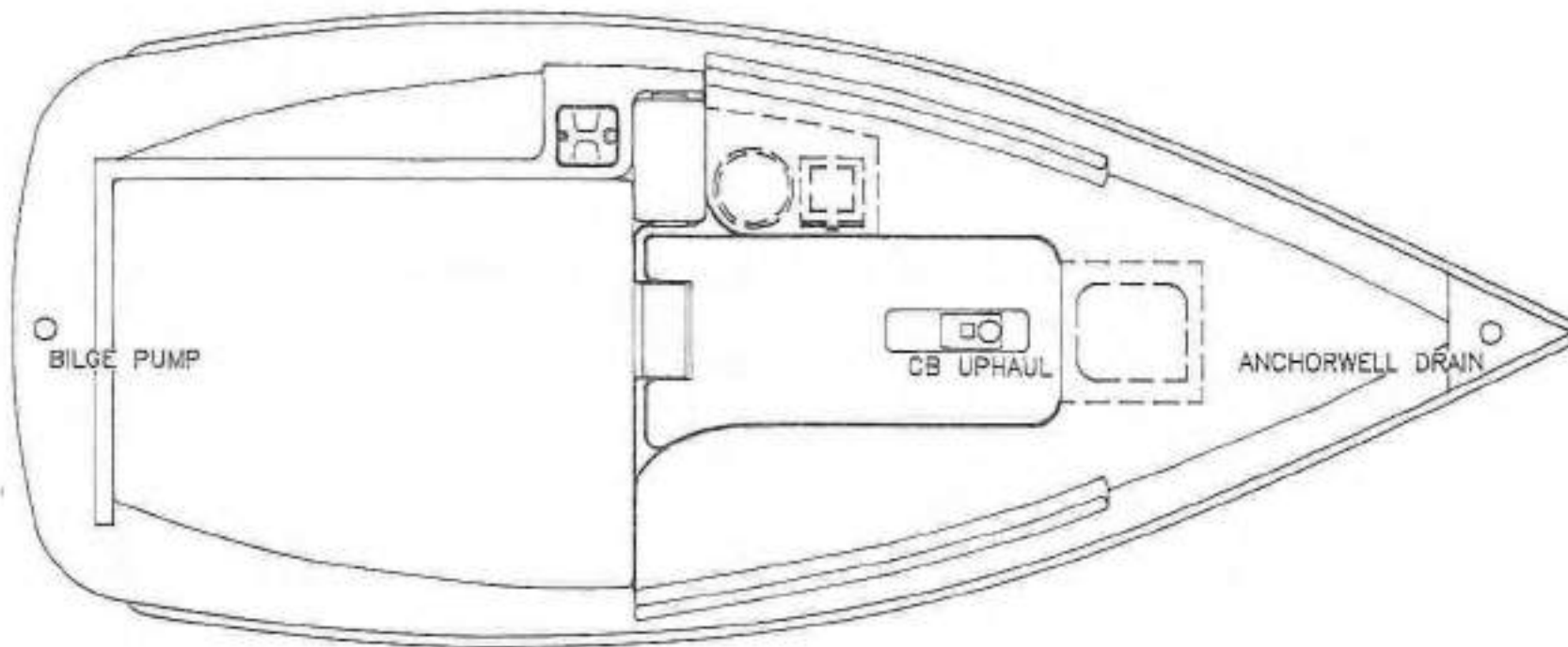

HUNTER 

H19 THRUHULL LOCATIONS H19-A-2622

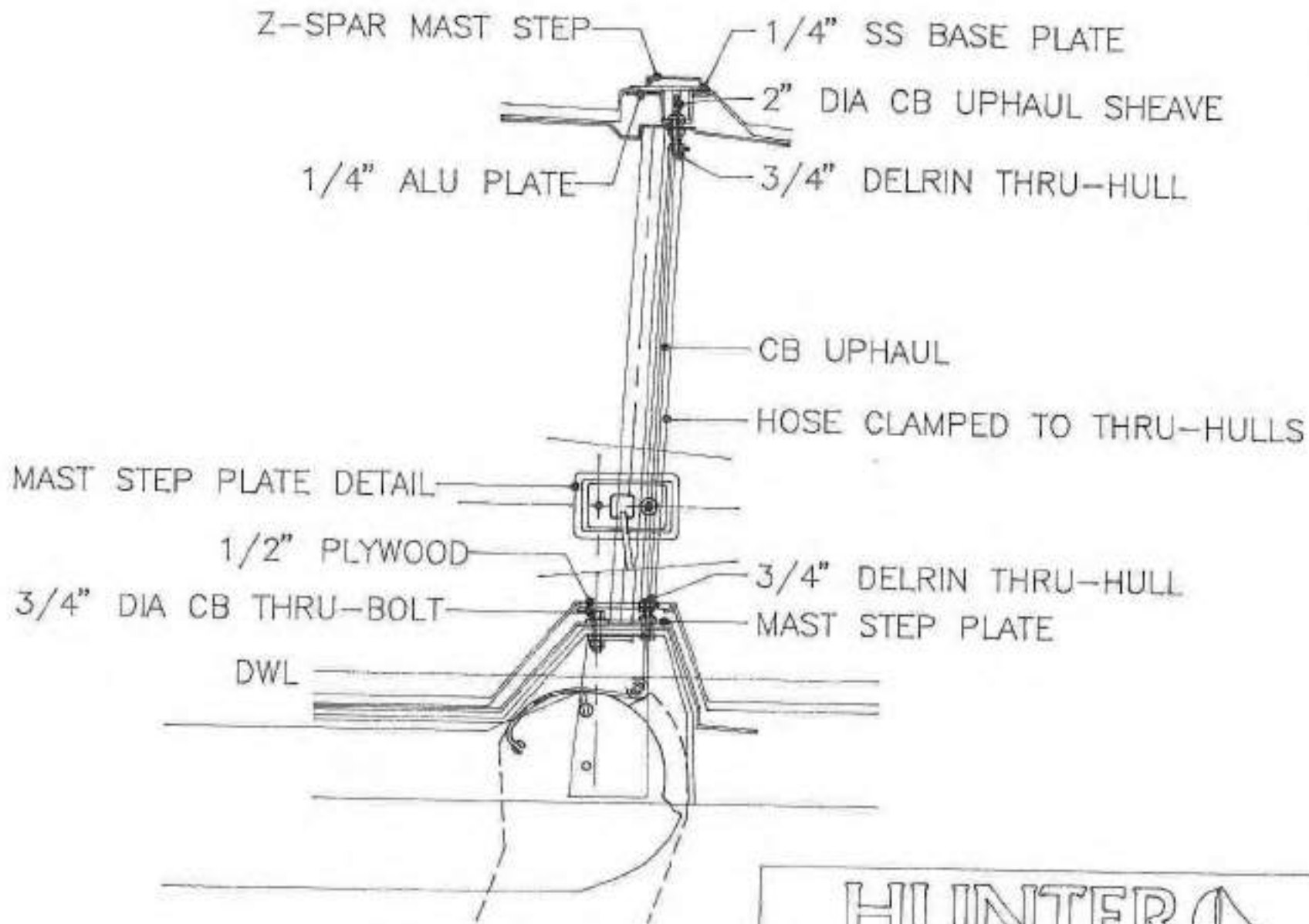

HUNTER 

H19 CENTERBOARD CONTROL SYSTEM H19-A-2631

VI

MAST: Z-190
BOOM: Z-160

LOA 27'8" 7.2M
LWL 21'0" 6.5M
BEAM 8'4" 2.5M
DRAFT 18" .46M (BOARD UP)
DRAFT 5'6" 1.68M (BOARD DOWN)
DISPLACEMENT 3000 LBS 1360 KG
BALLAST 1000 LBS 454 KG (TANK FULL)
DRY WEIGHT 2000 LBS 907 KG (NO BALLAST)
SAIL AREA 206 SQ. FT. 21.95 SQ. M
L 25'6" 7.7M
J 8'6" 2.5M
P 25'8" 7.8M
E 10'0" 3M
MAST HT 33'6" 10.2M (ABOVE DWL)



HUNTER
H-23.5 SAIL PLAN H23-A-2609

VII

HUNTER 23.5 RIGGING SPECIFICATIONS

STANDING RIGGING

Item	Quantity	Wire Diameter	Mast Fitting	Deck Fitting	Length	Measurement Points
Forestay	1	5/32" 1x19 SS	T-Ball	Turnbuckle w/ Toggle	27' 4 1/2"	Inside of T-Ball to Center of Pin
Upper Shroud	2	5/32" 1x19 SS	T-Ball	Turnbuckle w/ Toggle	27' 0 3/4"	Inside of T-Ball to Center of Pin
Lower Shroud	2	5/32" 1x19 SS	T-Ball	Turnbuckle w/ Toggle	14' 8"	Inside of T-Ball to Center of Pin
Mast Raising Bridle Wires	2	1/8" 1x19 SS	Hook	Pelican Hook	5' 1"	Inside of Hook to Center of Pelican Hook

RUNNING RIGGING

Item	Quantity	Line Spec	Length	Fittings
Main Halyard	1	5/16"	73'	Headboard Shackle
Genoa Halyard	1	5/16"	65'	Headboard Shackle
Spinnaker Halyard	1 (Optional)	5/16"	68'	Headboard Shackle
Main Sheet	1	3/8"	40'	BBE, Snap Shackle Blocks: Fiddle w/ Cam Cleat, Single w/Becket, Schaefer 35-03
Genoa Sheet	1	7/16"	35'	BBE
Spinnaker Sheet	2 (Optional)	3/8"	24'	Snap Shackle
Spinnaker Pole Up/Downhaul	1 (Optional)	5/16"	30'	2 Headboard Shackles
Reefing Pennant	1	1/4"	32'	BBE
Furling Pennant	1 (Optional)	3/16"	34'	BBE
Vang	1	1/4"	20'	BBE, D Shackle Blocks: Fiddle w/"V" Jam Cleat, Fiddle, Schaefer 35-20
Outhaul	1	1/4"	13'	BBE
Topping Lift	1	1/4"	31'	BBE
Rudder Uphaul	1	3/8" (RI0312)	10'	BBE
CB Uphaul	1	7/16" (RI0313)	12'	BBE
CB Cascade	1	3/8" (RI0312)	10'	BBE, 2 Swivel Single Blocks
Anchor Line	1	3/8" TW Nylon	100'	Shackle, Thimble

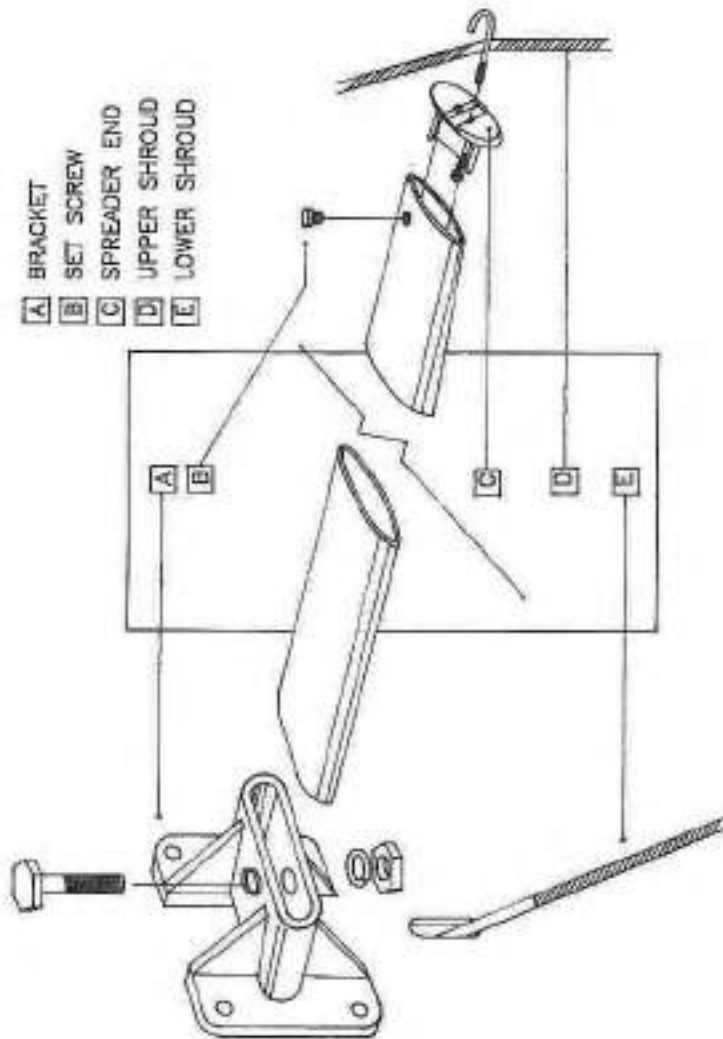

- A BRACKET
- B SET SCREW
- C SPREADER END
- D UPPER SHROUD
- E LOWER SHROUD

HUNTER

Z-SPAR SPREADER DETAIL H26-A-2605

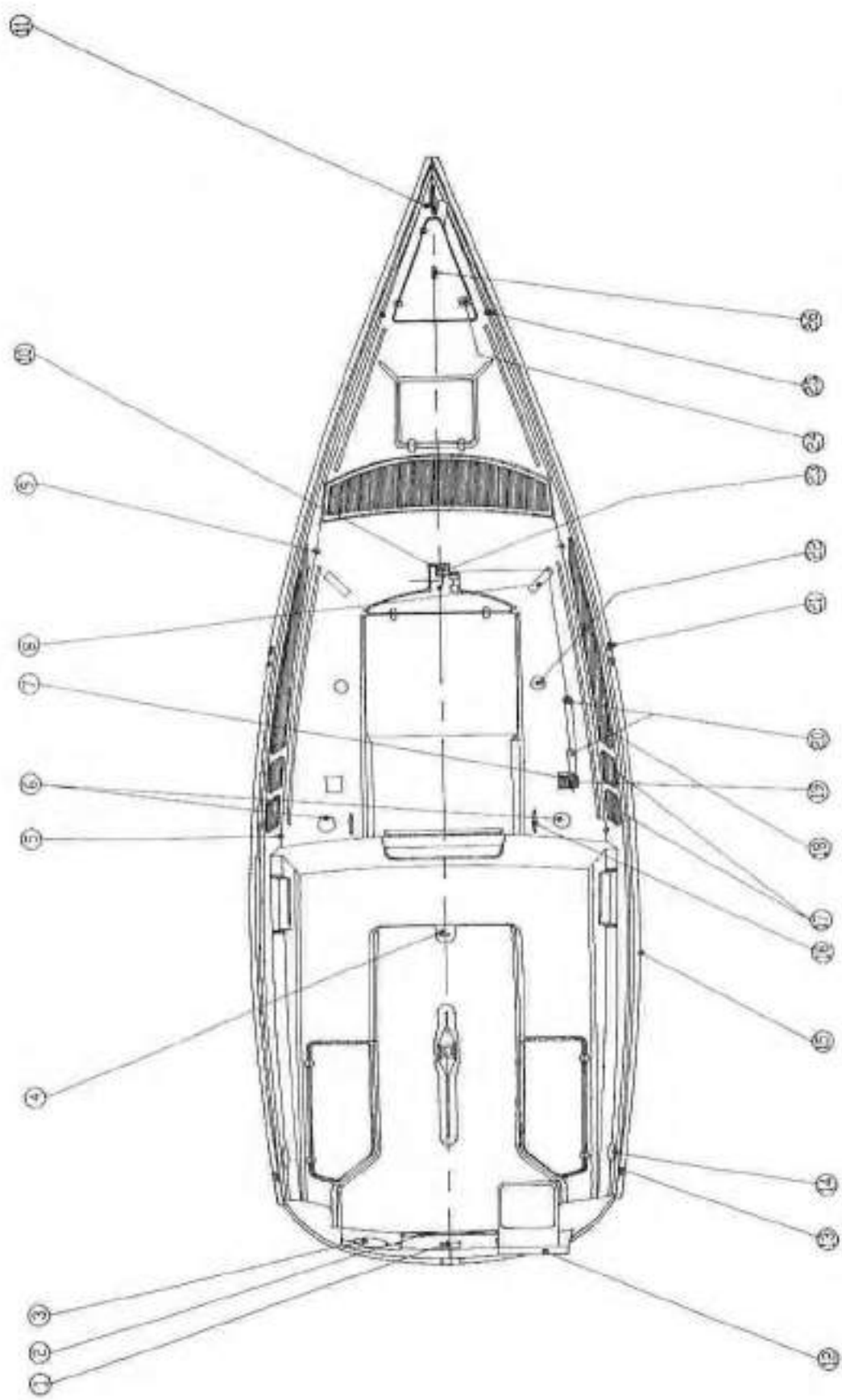

HUNTER

H-23.5 DECK HARDWARE H23-A-262I

HUNTER 23.5 DECK HARDWARE LAYOUT (See Diag.)

1. Gudgeons	Southcoast	N/A
2. Stern Rail	Southcoast	N/A
3. Swim Ladder	Southcoast	N/A
4. Mainsheet Bail	3/8" U-Bolt	N/A
5. Aft Stanchions	Southcoast	N/A
6. Winches	Bariant	#8
7. Clam Cleats	Z-Spar	N/A
8. Deck Organizer	Garhauer	N/A
9. FWD Stanchions	Southcoast	N/A
10. Mast Step	Z-Spar	N/A
11. Bow Cleat	Forespar	941014
12. Engine Bracket	Custom	N/A
13. Life Line End	3/8" U-Bolt	N/A
14. Stern Cleats	Forespar	941014
15. Rub Rail	Barbour Plastics	1078, 878
16. Jib Sheet Cleats	Shaefer	70-79
17. Aft Windows	3/16" Plexi	N/A
18. Fwd Windows	3/16" Plexi	N/A
19. Centerboard Padeye	Shaefer	78-05
20. Centerboard Blocks	Shaefer	03-05
21. Chainplates	3/8" U-Bolts	N/A
22. Jib Turning Blocks	Shaefer	35-03
23. Sheaves	Shaefer	62-051
24. Anchor Locker Latch	Southcoast	N/A
25. Bowrail	Southcoast	N/A
26. Anchor Dead End	3/8" U-Bolt	N/A

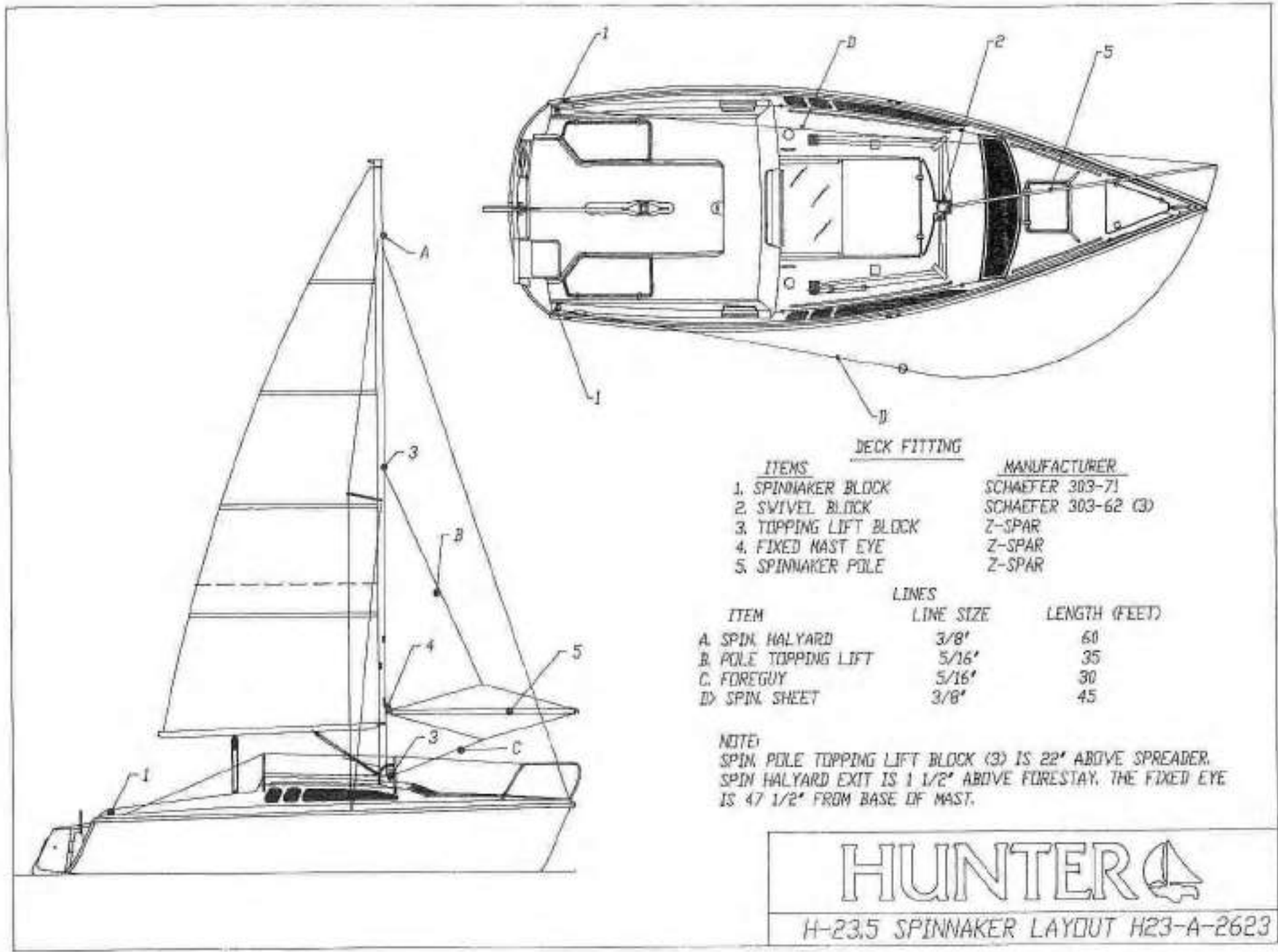

DECK FITTING

ITEMS	MANUFACTURER
1. SPINNAKER BLOCK	SCHAEFER 303-71
2. SWIVEL BLOCK	SCHAEFER 303-62 (3)
3. TOPPING LIFT BLOCK	Z-SPAR
4. FIXED MAST EYE	Z-SPAR
5. SPINNAKER POLE	Z-SPAR

ITEM	LINES	
	LINE SIZE	LENGTH (FEET)
A. SPIN. HALYARD	3/8"	60
B. POLE TOPPING LIFT	5/16"	35
C. FOREGUY	5/16"	30
D. SPIN. SHEET	3/8"	45

NOTE:
 SPIN. POLE TOPPING LIFT BLOCK (3) IS 22" ABOVE SPREADER.
 SPIN HALYARD EXIT IS 1 1/2" ABOVE FORESTAY. THE FIXED EYE
 IS 47 1/2" FROM BASE OF MAST.

HUNTER 

H-23.5 SPINNAKER LAYOUT H23-A-2623



VIEW LOOKING FWD

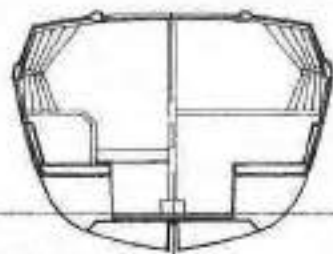

VIEW LOOKING FWD

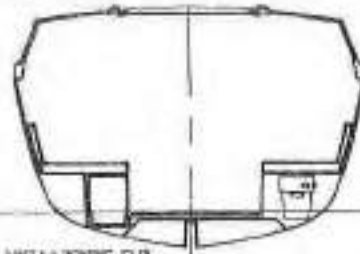

VIEW LOOKING FWD

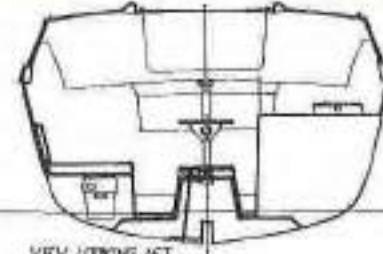

VIEW LOOKING AFT

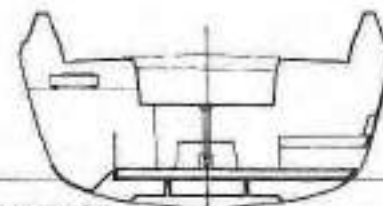
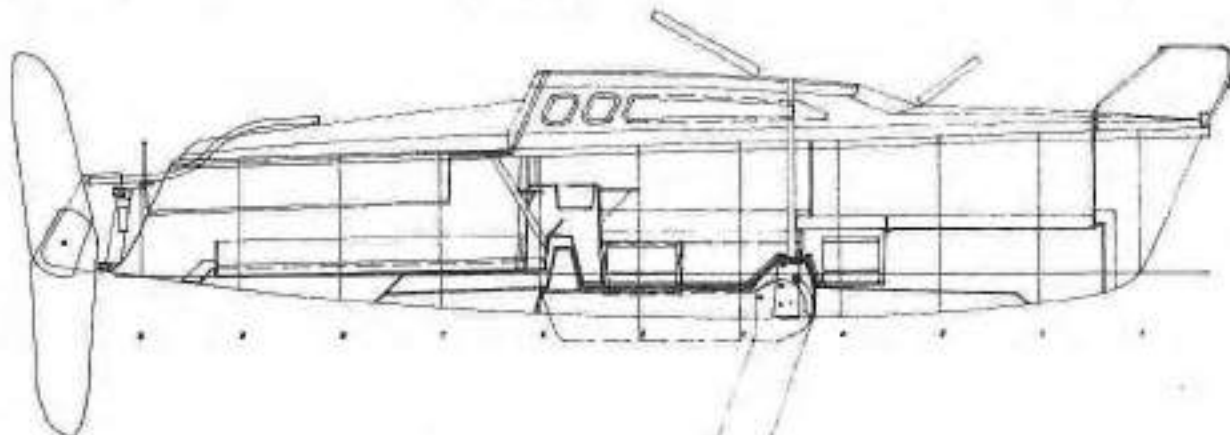

VIEW LOOKING FWD

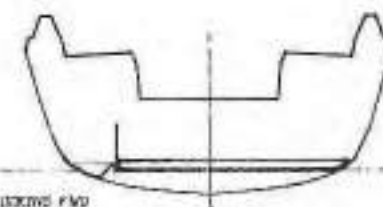

VIEW LOOKING FWD

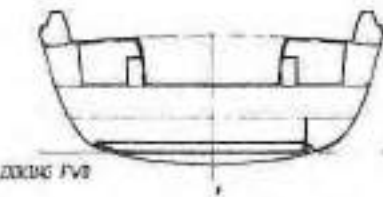
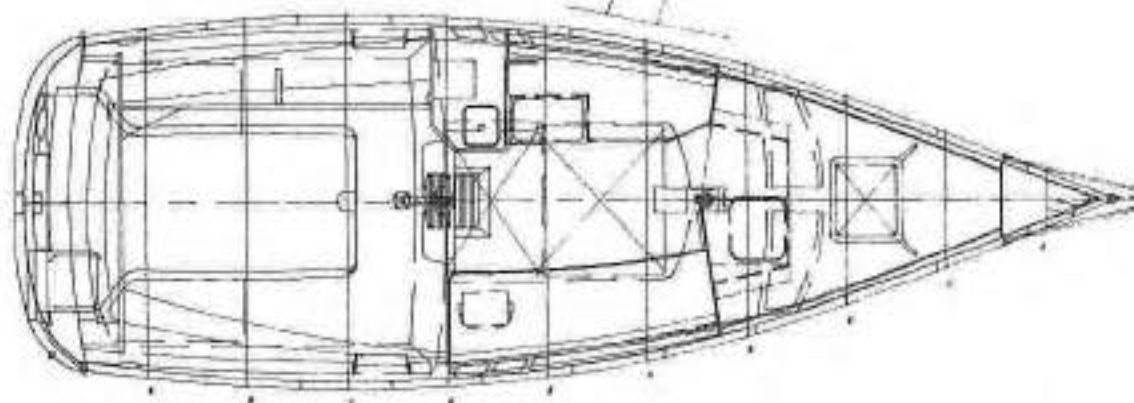



VIEW LOOKING FWD

HUNTER

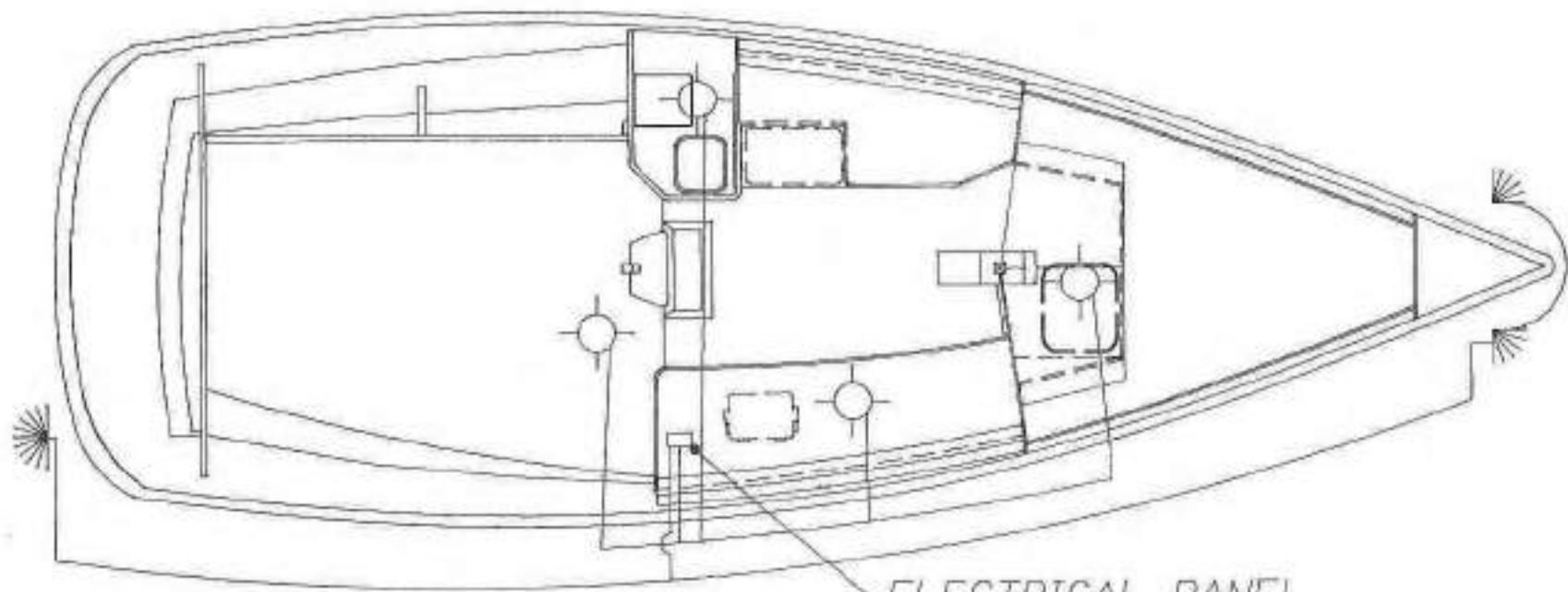
H-23.5 ACCOMMODATION PLAN H23-A-2625



ELECTRICAL PANEL

-  DOME LIGHT
-  BOW LIGHTS
-  STERN LIGHT

ALL WIRES 16 GA.

HUNTER 

<https://www.boat-manuals.com/>
H-235 LIGHTING LAYOUT HES-A-2819

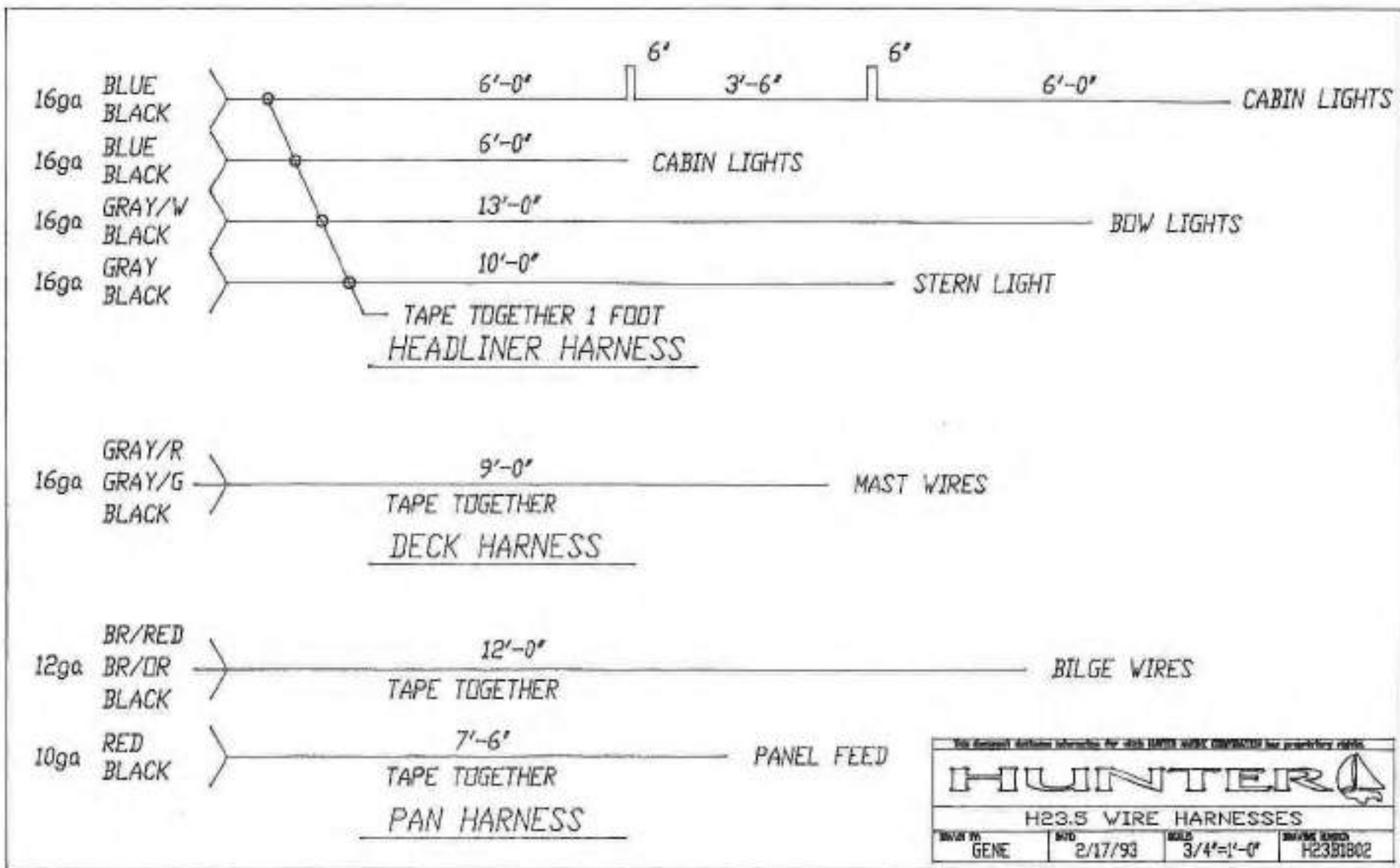

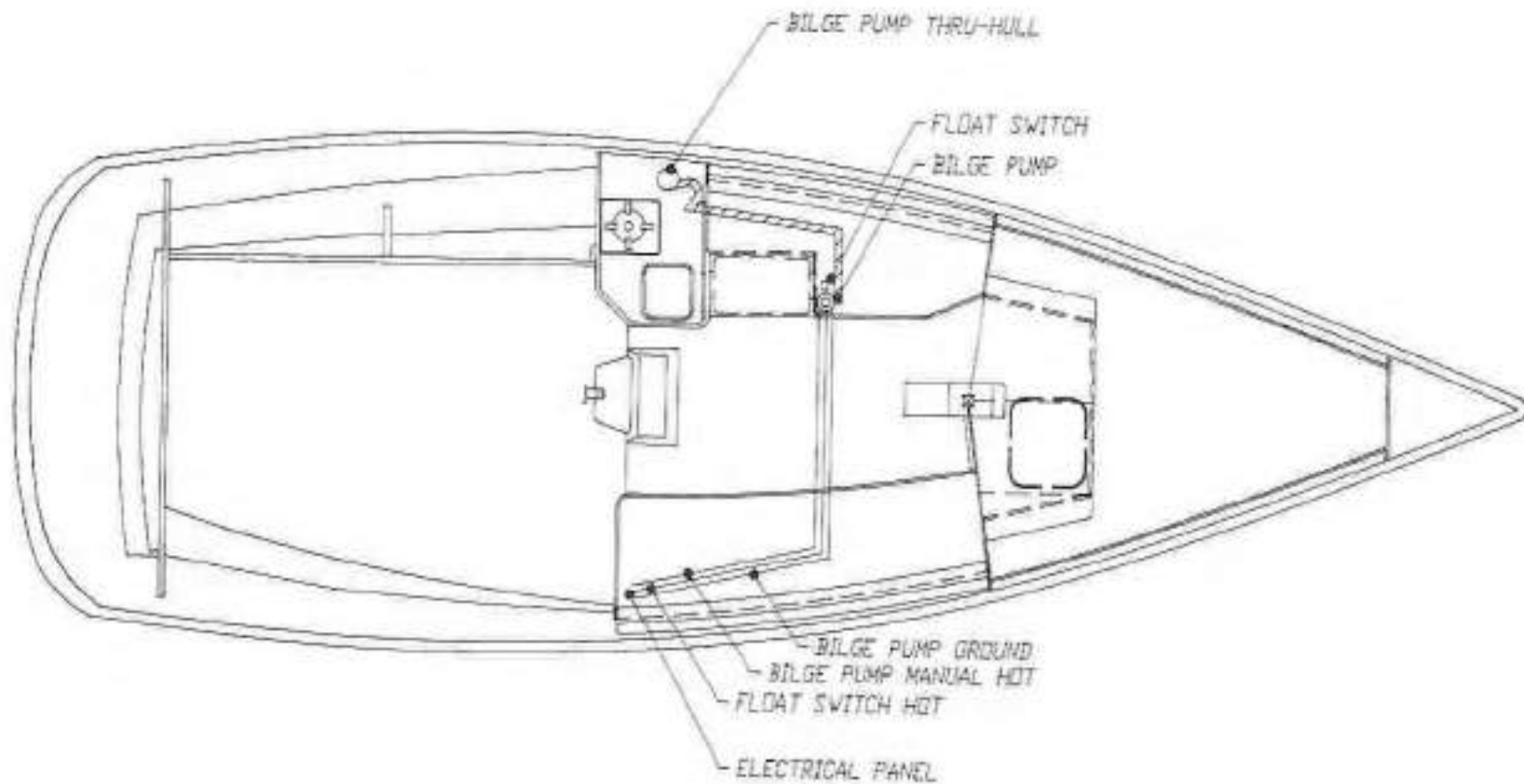

ALL WIRES 16 GA.

HUNTER 

H-23.5 BILGE PUMP LAYOUT H23-A-2518 <https://www.boat-manuals.com/>

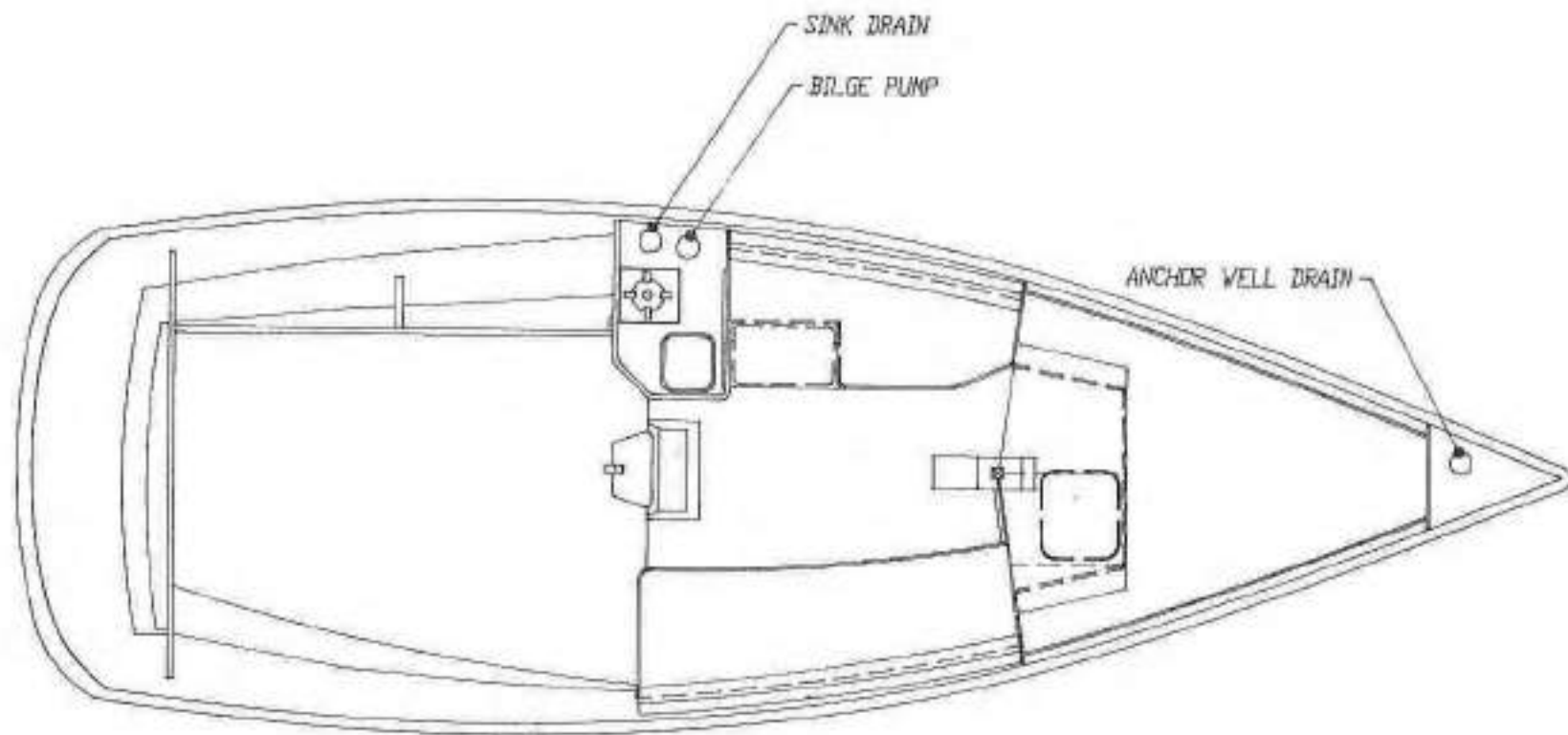

HUNTER 

H-23.5 THRU HULL LOCATIONS HES-A-2617 <https://www.boat-manuals.com/>

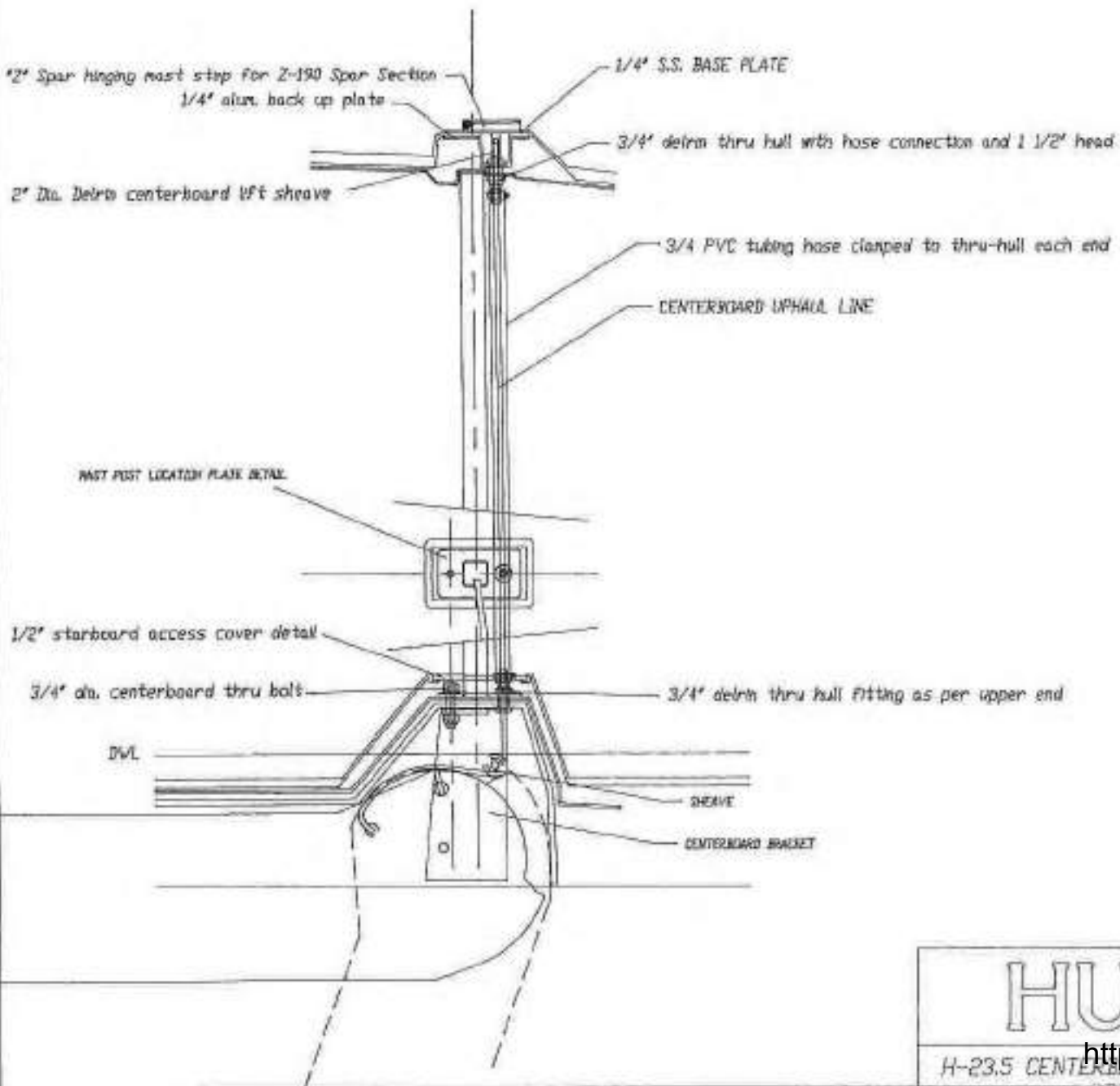

2" Spar hinging mast step for Z-190 Spar Section
 1/4" alum. back up plate
 2" Dia. Deirts centerboard lift sheave

1/4" S.S. BASE PLATE

3/4" deirt thru hull with hose connection and 1 1/2" head

3/4" PVC tubing hose clamped to thru-hull each end

CENTERBOARD UPHAUL LINE

MAST POST LOCATION PLATE DETAIL

1/2" starboard access cover detail

3/4" dia. centerboard thru bolts

3/4" deirt thru hull fitting as per upper end

DVL

SHEAVE

CENTERBOARD BRACKET

HUNTER 

<https://www.boat-manuals.com/>
 H-23.5 CENTERBOARD CONTROL SYSTEM HES-A-2616

Z SPAR'S
SAILMAKERS INFORMATION

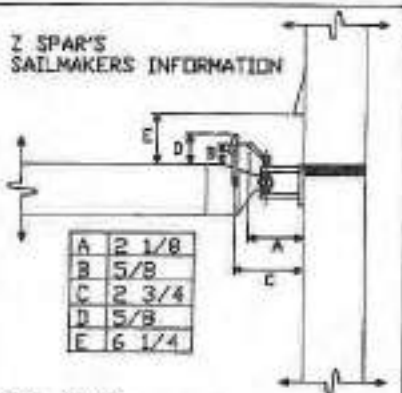

A	2 1/8
B	5/8
C	2 3/4
D	5/8
E	6 1/4

SAIL NOTES

- 11 AQUABATTEN A017 SAIL SLIDES ON MAINSAIL
- 1' LENGTH OF 1" WEBBING FOR JIB TACK FITTING
- 10 HANKS ON JIB LUFF
- TELLTALES ON LEECH OF MAIN AND LUFF OF JIB
- 4 FULL LENGTH BATTENS ON MAINSAIL
- 1 SLUG AT MAINSAIL CLEV
- 3/8" BOLTROPE AT FOOT OF MAINSAIL

PRINCIPAL DIMENSIONS

LWA	25'-9"	DRAFT, BOARD UP	1'-9"
LVL	23'-1 1/2"	DRAFT, BOARD DOWN	6'-8"
BMAX	9'-11 1/2"	DISPLACEMENT	4700 LBS
BVL	7'-3"	BALLAST	2900 LBS
DRAFT, FAIRBODY	1'-0 1/2"	WETTED SURFACE (FAIRBODY)	121 SQFT
		HEIGHT ABOVE WATER	39'-9"

HUNTER

SAILPLAN H26-A-2610

H-26 - 5' Spinnaker. Halyard Exit 4" ABOVE FORESTAY.

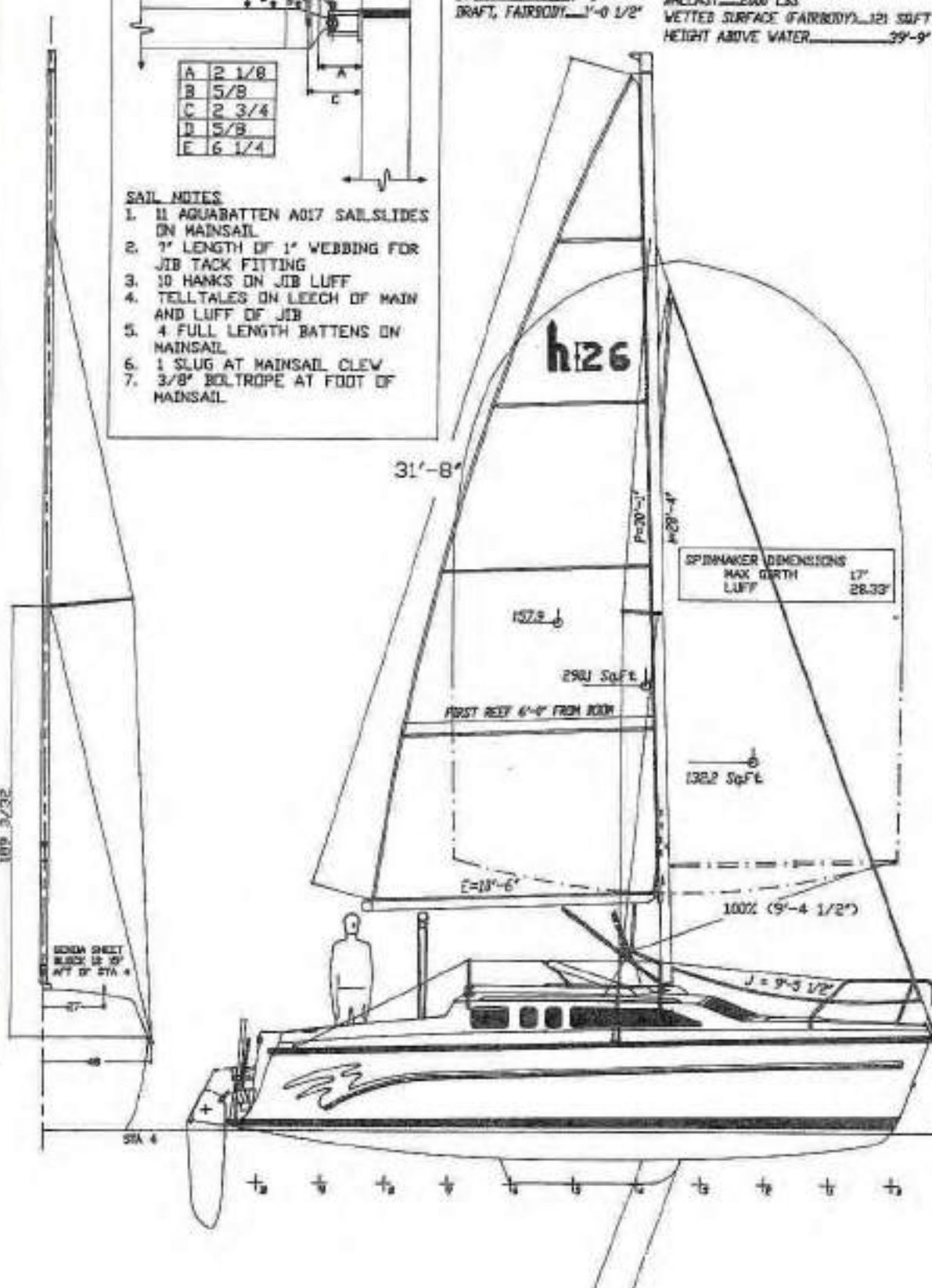

SPINNAKER DIMENSIONS	
MAX GIRTH	17'
LUFF	26.33'

VIII

HUNTER 26 RIGGING SPECIFICATIONS

STANDING RIGGING

Item	Quantity	Wire Diameter	Mast Fitting	Deck Fitting	Length	Measurement Points
Forestay <i>Hook's Lead 35' 00"</i>	1	3/16" 1x19 SS	Stem Ball	Turnbuckle w/ Toggle	30'-7 5/8"	Inside of Stem Ball to Center of Pin
Upper Shroud	2	3/16" 1x19 SS	T-Ball	Turnbuckle w/ Toggle	29'-11"	Inside of T Ball to Center of Pin
Lower Shroud	2	3/16" 1x19 SS	T-Ball	Turnbuckle w/ Toggle	16'-0"	Inside of Stem Ball to Center of Pin
Mast Raising Bridle Wires	2	1/8" 1x19 SS	T-Ball	Pelican Hook	5'-11"	Inside of T-Ball to Center of Pelican Hook

RUNNING RIGGING

Item	Quantity	Line Spec	Length	Fittings
Main Halyard	1	5/16 Yacht Braid	81'	Shackle
Jib Halyard	1	5/16 Yacht Braid	72'	Shackle
Spin Halyard	1	5/16 Yacht Braid	73'	Shackle (Optional)
Main Sheet	1	3/8 Yacht Braid	70'	Eye Splice
Jib Sheets	1	3/8 Yacht Braid	50'	B.B.E.
Spinnaker Sheets	2	3/8 Yacht Braid	40'	Snap Shackles (Optional)
Topp. Lift	1	1/4 Yacht Braid	35'	B.B.E.*
Spin. Pole up/down	1	5/16 Yacht Braid	38'	Snap Shackles (Optional)
Vang	1	1/4 Yacht Braid	20'	Eye Splice
Outhaul	1	5/16 Yacht Braid	16'	B.B.E.
Reef	1	5/16 Yacht Braid	32'	B.B.E.
Rudder Uphaul	1	3/8 Yacht Braid	10'	B.B.E. (Hunter)#RI0312
C/B Uphaul	1	7/16 Yacht Braid	11'	B.B.E. (Hunter)#RI0312
C/B Cascade	1	5/16 Yacht Braid	12'	B.B.E.
Anchor Rode	1	3/8 Nylon	100'	Shackle & Thimble
Furling Pennant	1	3/16 Yacht Braid	40'	B.B.E. (Optional)

*B.B.E. - Burned Both Ends

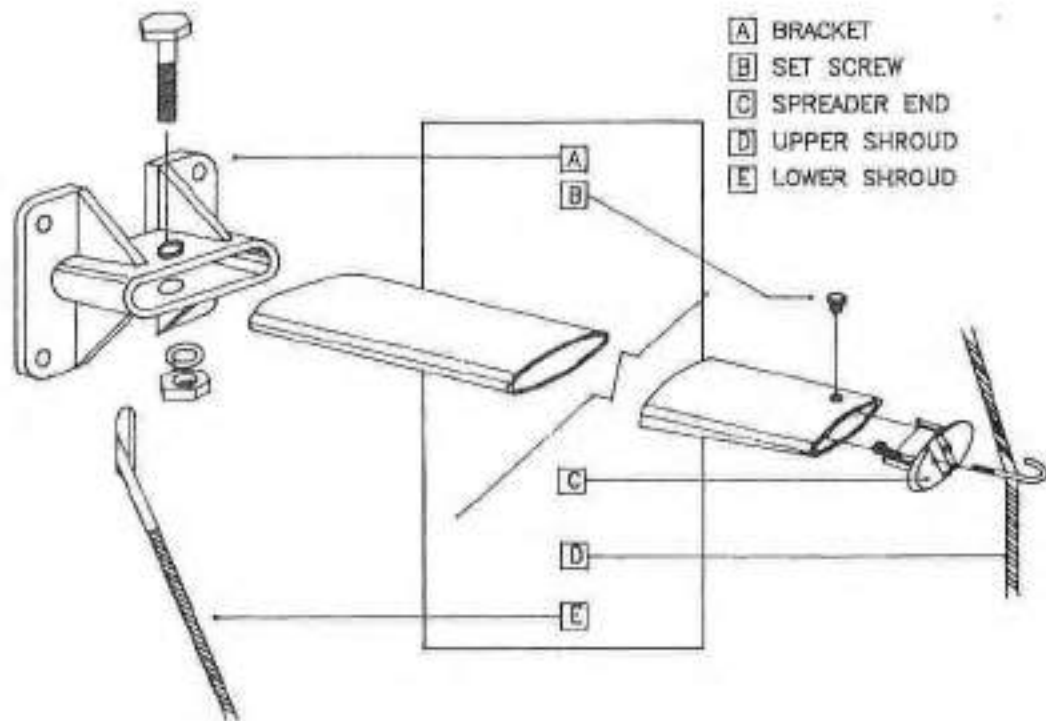

HUNTER 

<https://www.boat-manuals.com/>
Z-SPAR SPREADER DETAIL H26-A-2605

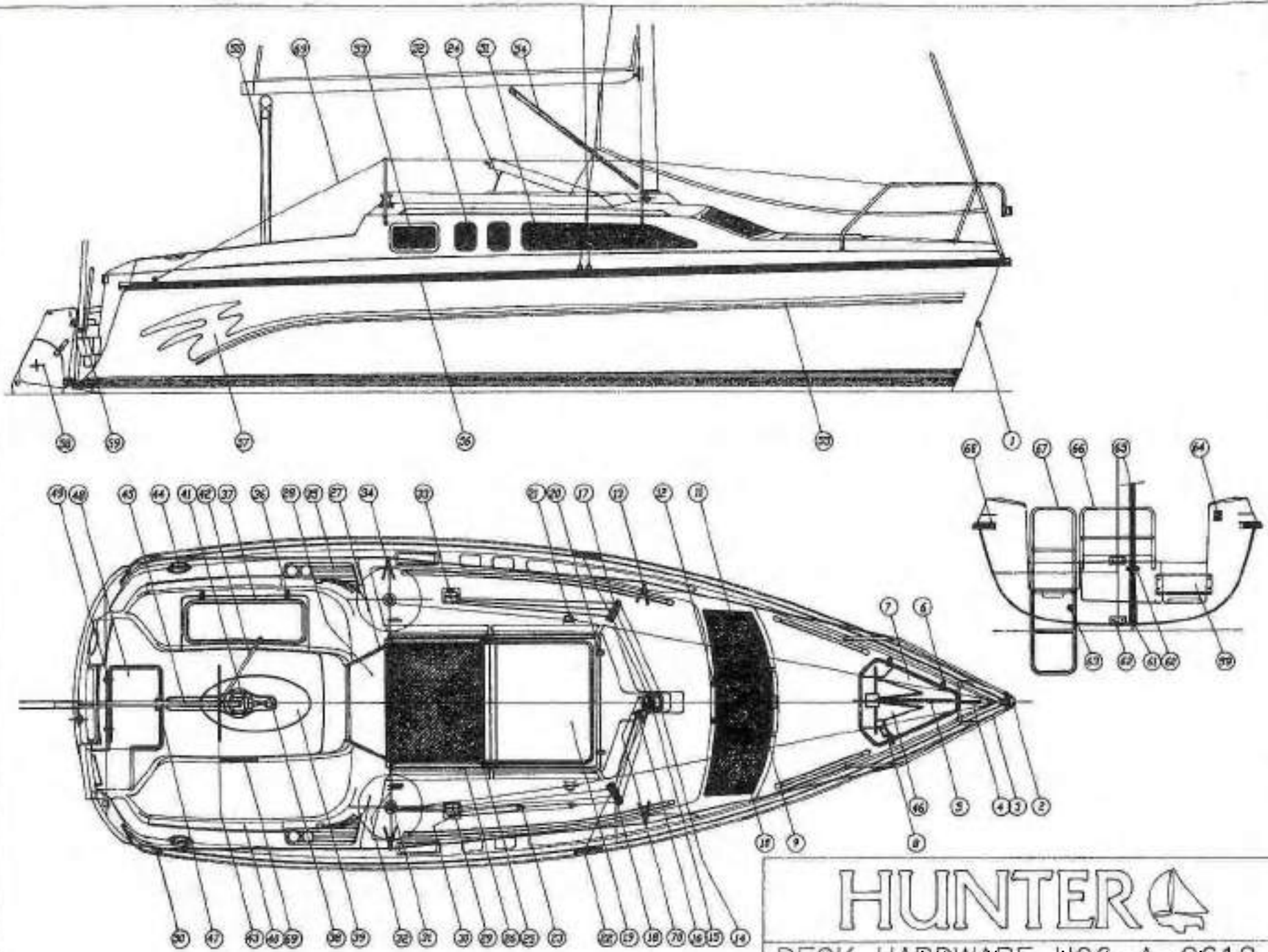

HUNTER 

DECK HARDWARE 186 A 0610 <https://www.boat-manuals.com/>

HUNTER 26 DECK HARDWARE LAYOUT (See Diag.)

ITEM	REFERENCE NUMBER
1. U Bolt Bow/Tow eye	EL0380
2. Bow Light	HW5510
3. Bow Rail	PR2607
4. Bow Cleat	HW0228
5. Anchorwell U Bolt	HW5511
6. Anchorwell Hinge	HW4250
7. Anchorwell Lid	DA270010
8. Anchorwell Lid Handle/Latch	HW4479
9. Forward Deck Hatch/Center Windshield	PR2624
10. Starboard windshield	PR2618
11. Port Windshield	PR2614
12. Forward Deck Hatch Hinges w/Gaskets	HW4250 & HW3272
13. Forward Stanchions	PR2612 & PR2610
14. Mast Step	PR2601
15. Sheave Pin 1 1/2" w/Centerboard Sheave	PR2617 & HW0103
16. Sheave Pin 4" w/Halyard Sheaves	PR2616 & HW0103
17. Port Triple Deck Organizer	HW0162 (Dealer Option)
18. Stbd Triple Deck Organizer	HW0162
19. Pop Top Seahood	DA270045
20. Pop Top Seahood Hinges	HW4250
21. Jib Sheet Blocks	HW0186
22. Chainplate U Bolts	HW5511
23. Center Board Control Line System	HW0235
24. Pop Top Seahood Support Rods	PR2611
25. Plexiglass Sliding Hatch	DF920001
26. Sliding Hatch Keeper	DF920001
27. Pinboard Tracks	DF920001
28. Pinboards	DF920001
29. Starboard Triple Sheet Stopper	PR2626
30. Padeye (for centerboard system)	HW0851
31. Halyard Winches	HW2515
32. Jib Cleats	HW0383
33. Port Triple Sheet Stopper	PR2626 (Dealer Option)
34. Aft Stanchions	HW2061
35. Cockpit Coaming Pads	DF85TX10 & DF85TX11
36. Port Cockpit Seat Hinge	HW4250
37. Port Cockpit Seat	DA270075
38. Mainsheet U Bolt	DA270096
39. Table Support Brackets & Legs	HW1724, HW1722, PR2603 & PR2620
40. Cockpit Cushion	PR2620
41. Cockpit Table Leg Retainer	DF85XV12
42. Tiller Extension w/Retaining Clip	LG0128 & LG0138-A
43. Wheel steering System Unit	PR2632 (Dealer Option)

HUNTER 26 DECK HARDWARE LAYOUT (See Diag.)

ITEM	REFERENCE NUMBER
44. Aft Mooring Cleats	HW0228
45. Tiller	HW2300
46. 13S Danforth Anchor & Rode	DI050020
47. Swim Ladder	PR2604
48. Gas Tank Locker Lid	DA270250
49. Gas Tank Locker Lid Hinges	HW4250
50. Life Line U Bolts	HW5511
51. Forward Fixed Deck Windows	PR2623 & PR2630
52. Center Fixed Deck Windows	PR2627 & PR2609
53. Aft Deck Opening Ports	PR2622 & PR2625
54. Boom Vang System	HW0278
55. Mainsheet Traveler Control System	HW0230
56. Rub Rail (Black & White)	HW2448-B & HW2449-B
57. Wave Decal Set	PR2615
58. Rudder Head	PR2614
59. Outboard Motor Mount Bracket Set	PR2629
60. Upper Mast Crutch Bracket	HW2730
61. Lower Mast Crutch Bracket	HW2731
62. Upper and Lower Rudder Gudgeons	HW1903
63. Bilge Pump Drain	PL0840
64. Stern Light	EL0390
65. Mast Crutch	PR2619
66. Center Stern Rail	PR2613
67. Swim Ladder	PR2631
68. Rub Rail End Caps	HW2447

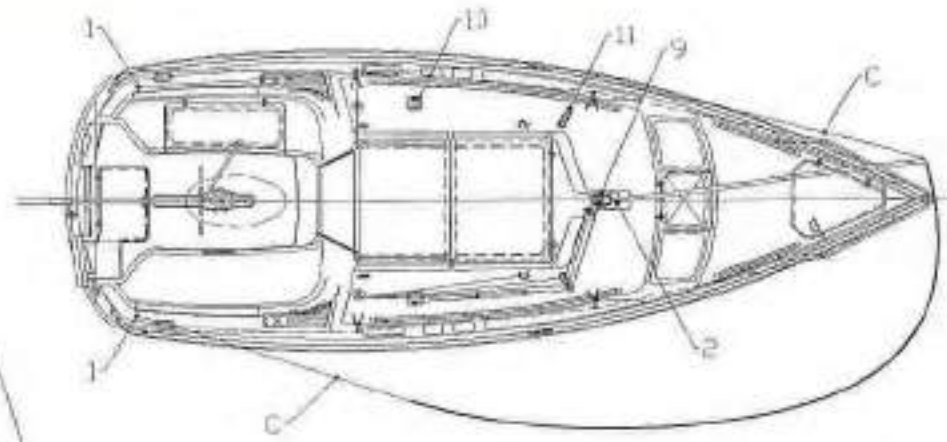
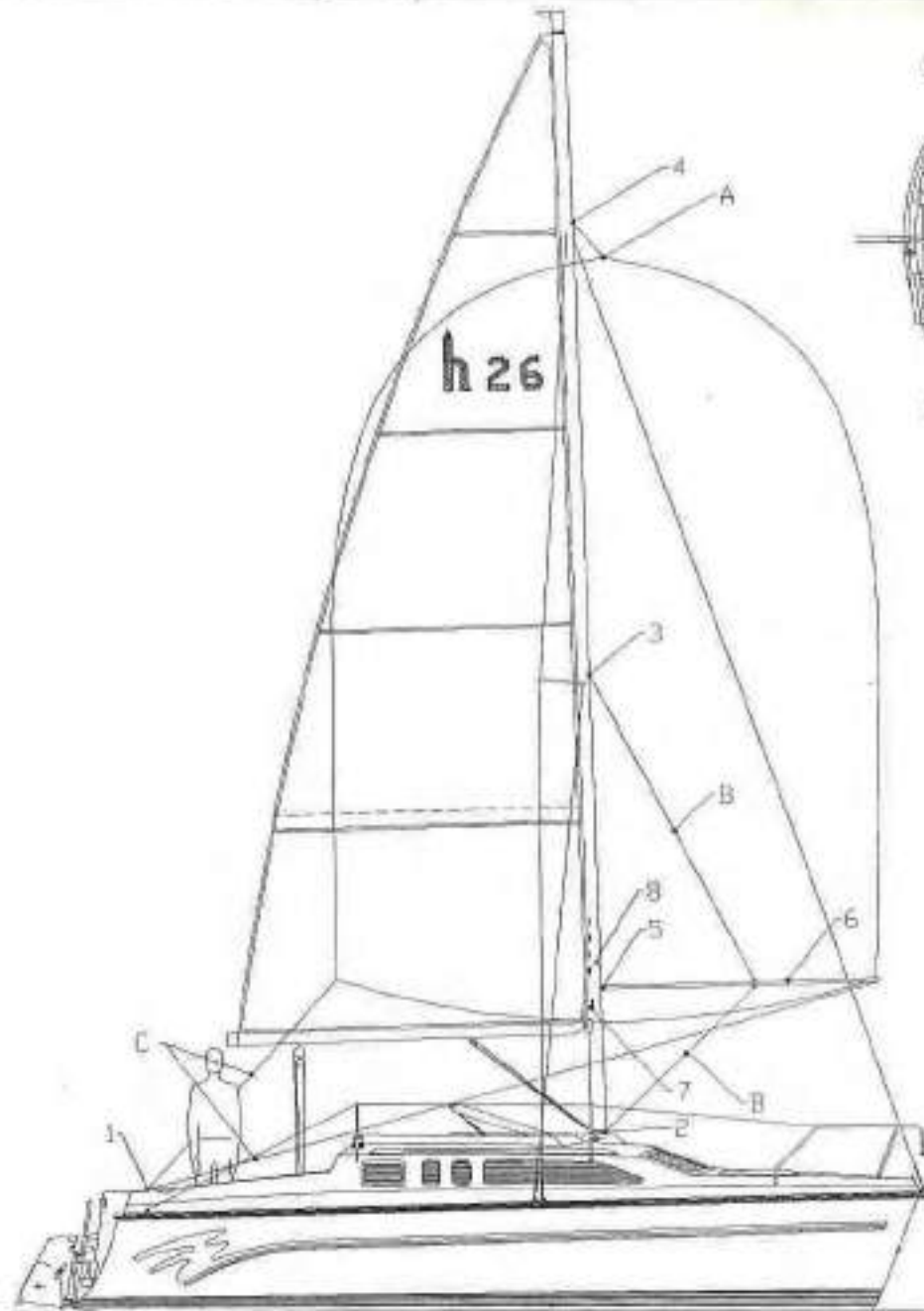

FITTINGS

ITEMS	MANUFACTURER
1. TWO SHEET BLOCKS	1. SCHAEFER 03-04
2. FOREGUY BLOCK	2. SCHAEFER 303-62
3. TOP LIFT EXIT W/ SHEAVE	3. Z-SPAR
4. SPI HAL EXIT W/ SHEAVE	4. Z-SPAR
5. POLE BAIL	5. Z-SPAR
6. POLE	6. Z-SPAR
7. FOREGUY CLEAT	7. Z-SPAR
8. SPI HAL EXIT	8. Z-SPAR
9. HALYARD BLOCK	9. SCHAEFER 02-62
10. STOPPER	10. GARHAUER TRI-DECK
11. DECK ORGANIZER	11. GARHAUER TRIPLE

LINES

ITEMS	LINE SIZE	LENGTH
A. HALYARD	5/16"	73'
B. FOREGUY/TOPPING LIFT	5/16"	30'
C. SHEETS (1 PER SIDE)	3/8"	40'

HUNTER 

SPINNAKER LAYOUT H26-A-2613

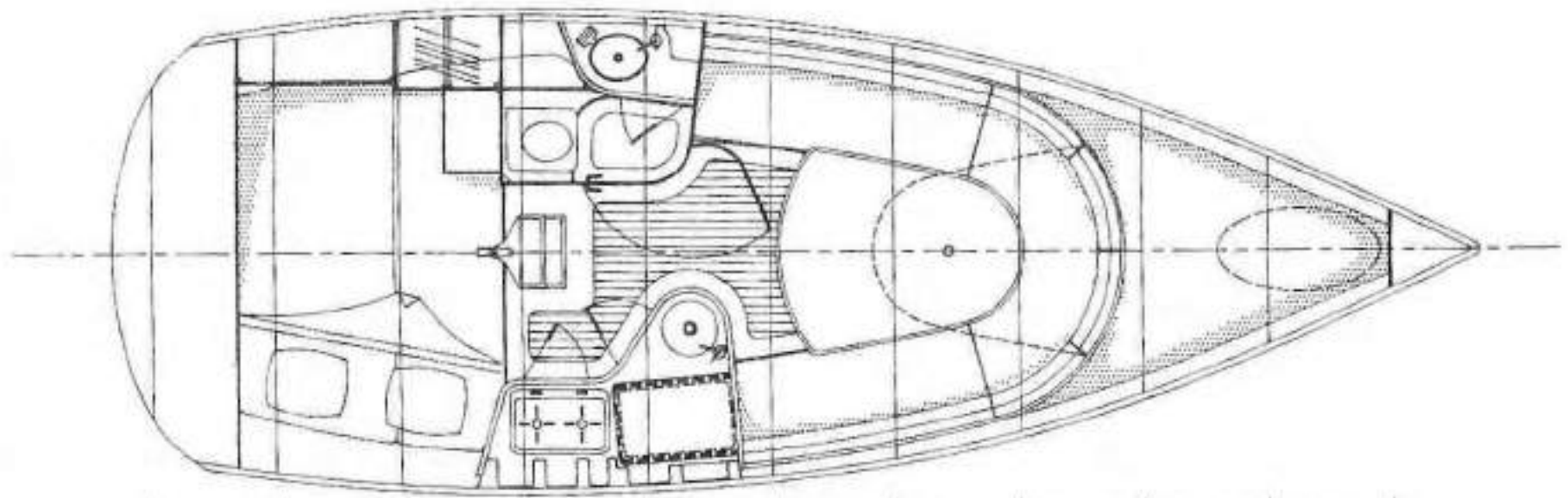

10 9 8 7 6 5 4 3 2 1 0

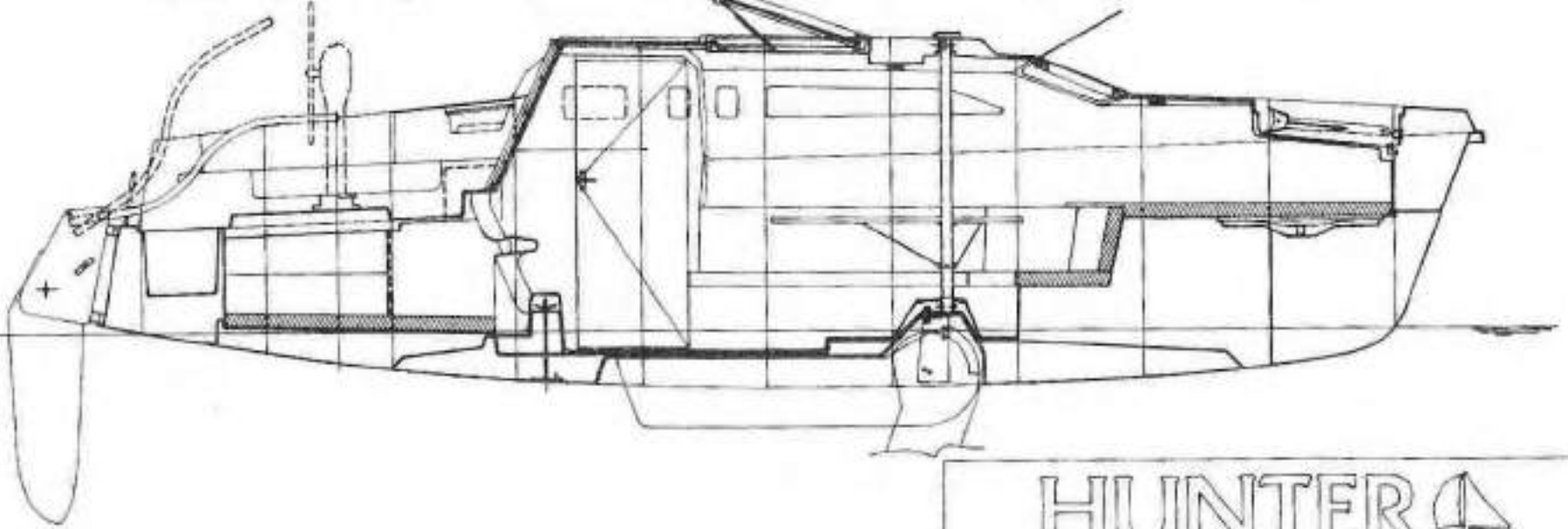

HUNTER 

ACCOCOMODATIONS H26-A-2614 <https://www.boat-manuals.com/>

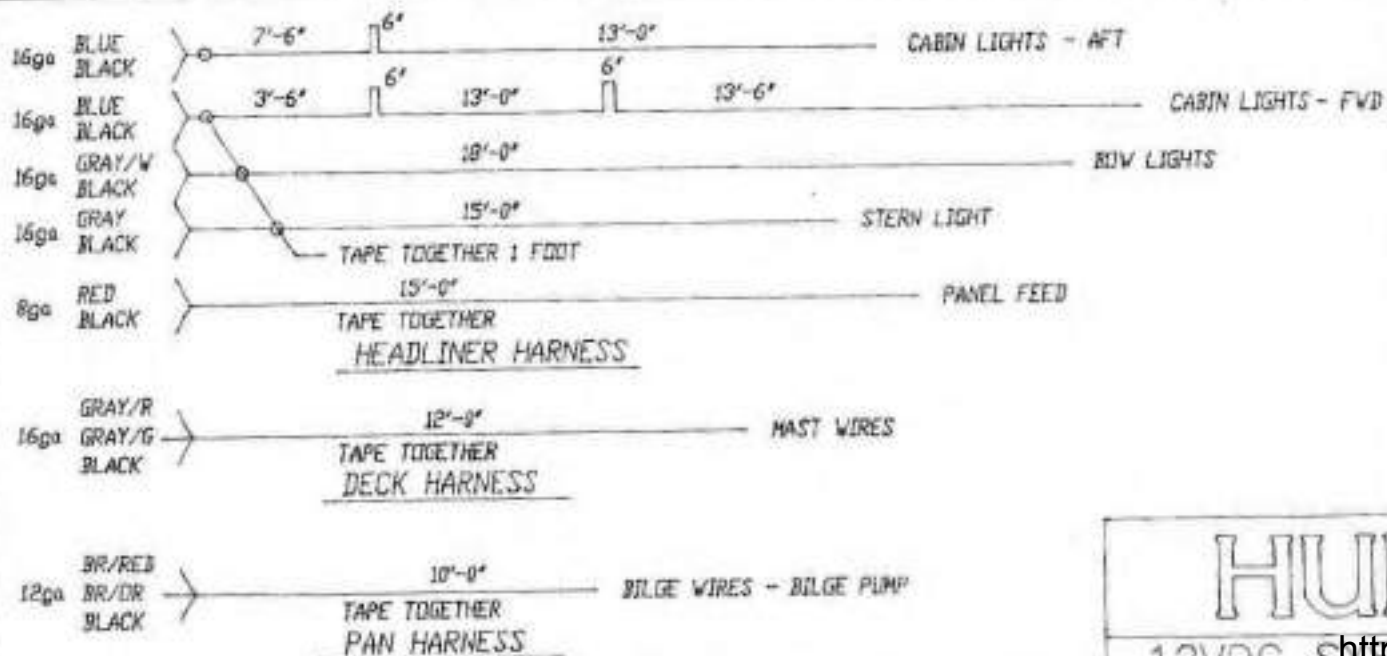
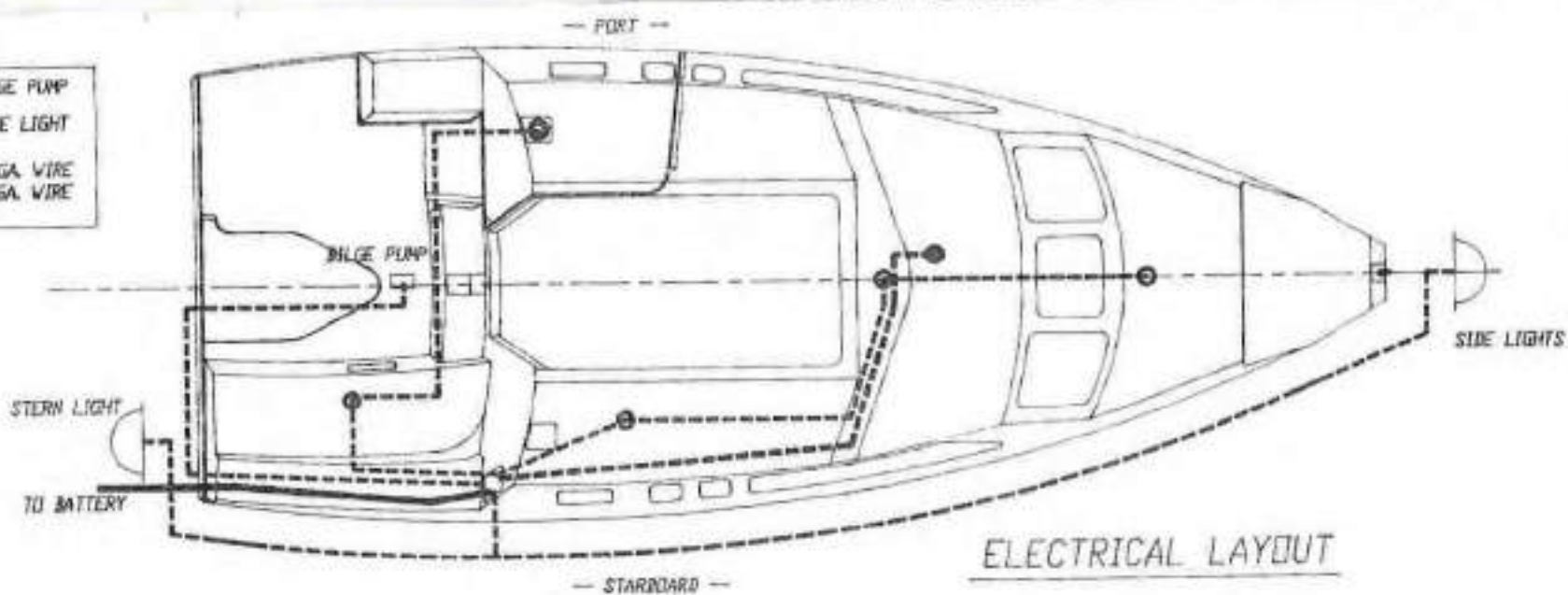
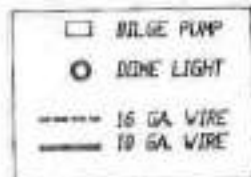

HUNTER 

12VDC SYSTEM WIRING MANUAL <https://www.boat-manuals.com/>

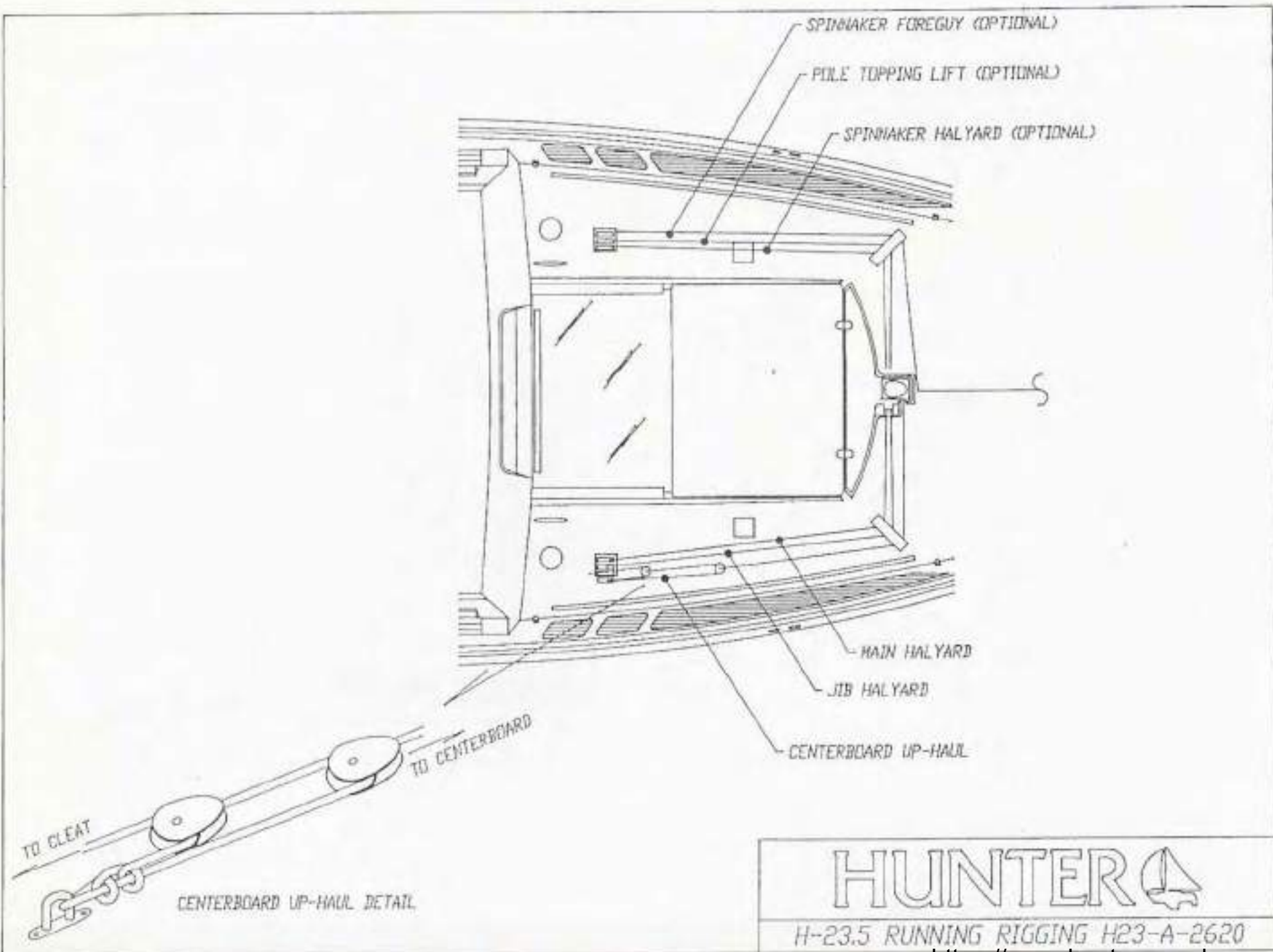

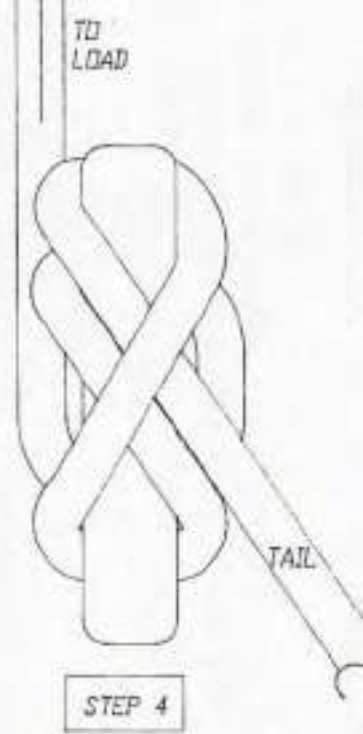
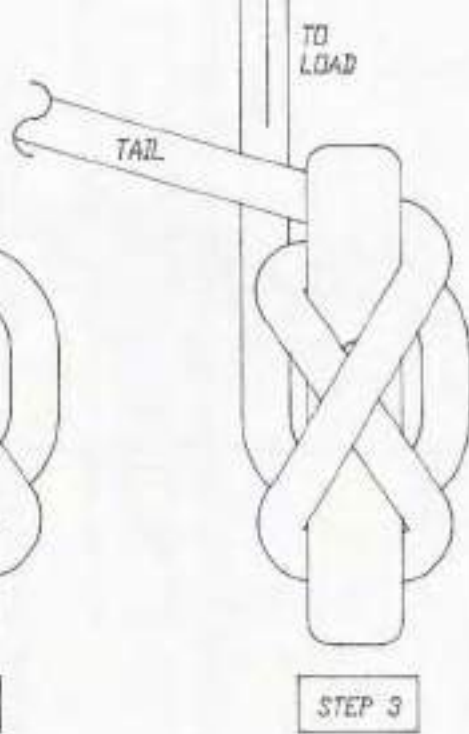
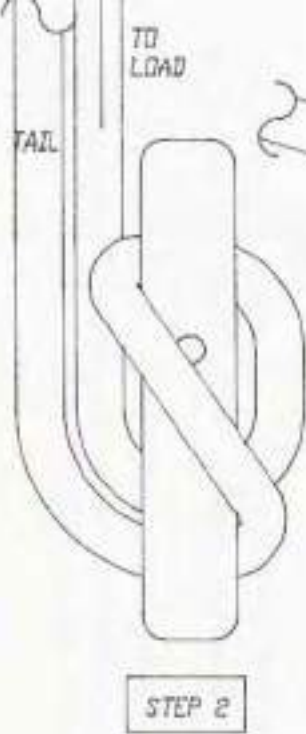
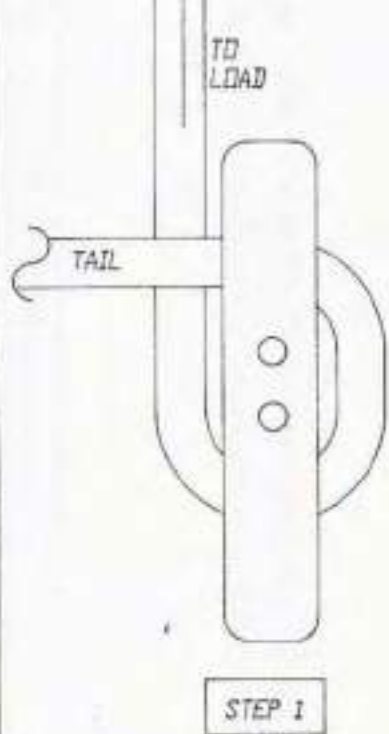

HUNTER 

PROPER CLEAT KNOT GEN-A-262





CENTER OF SINGLE JIB SHEET

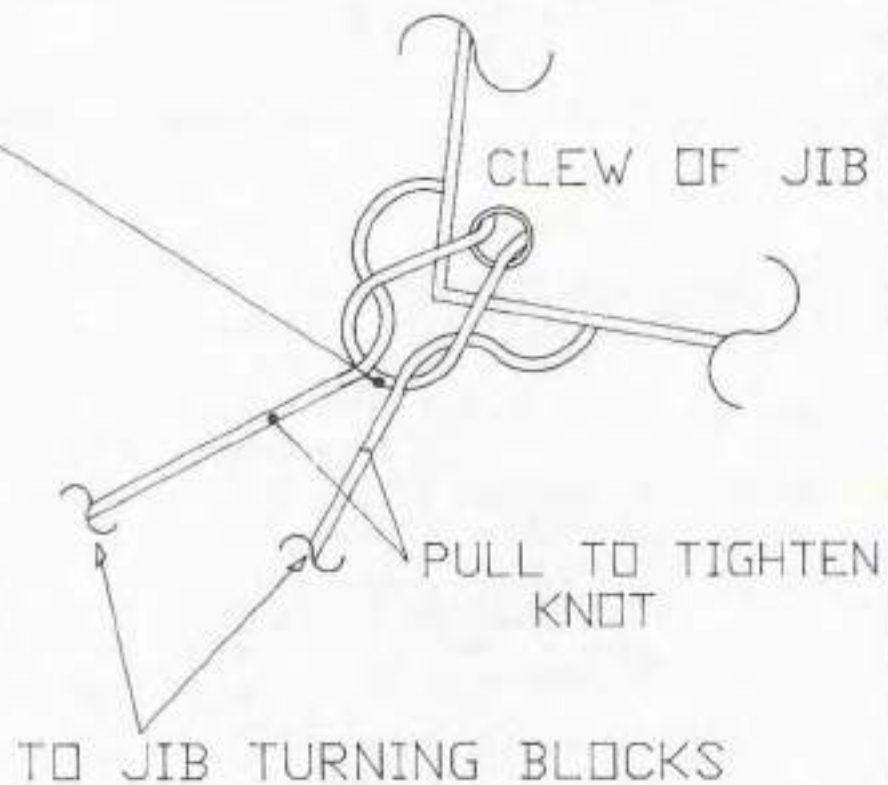

CLEW OF JIB

PULL TO TIGHTEN
KNOT

TO JIB TURNING BLOCKS

HUNTER 

JIB SHEET DETAIL H19-A-2627

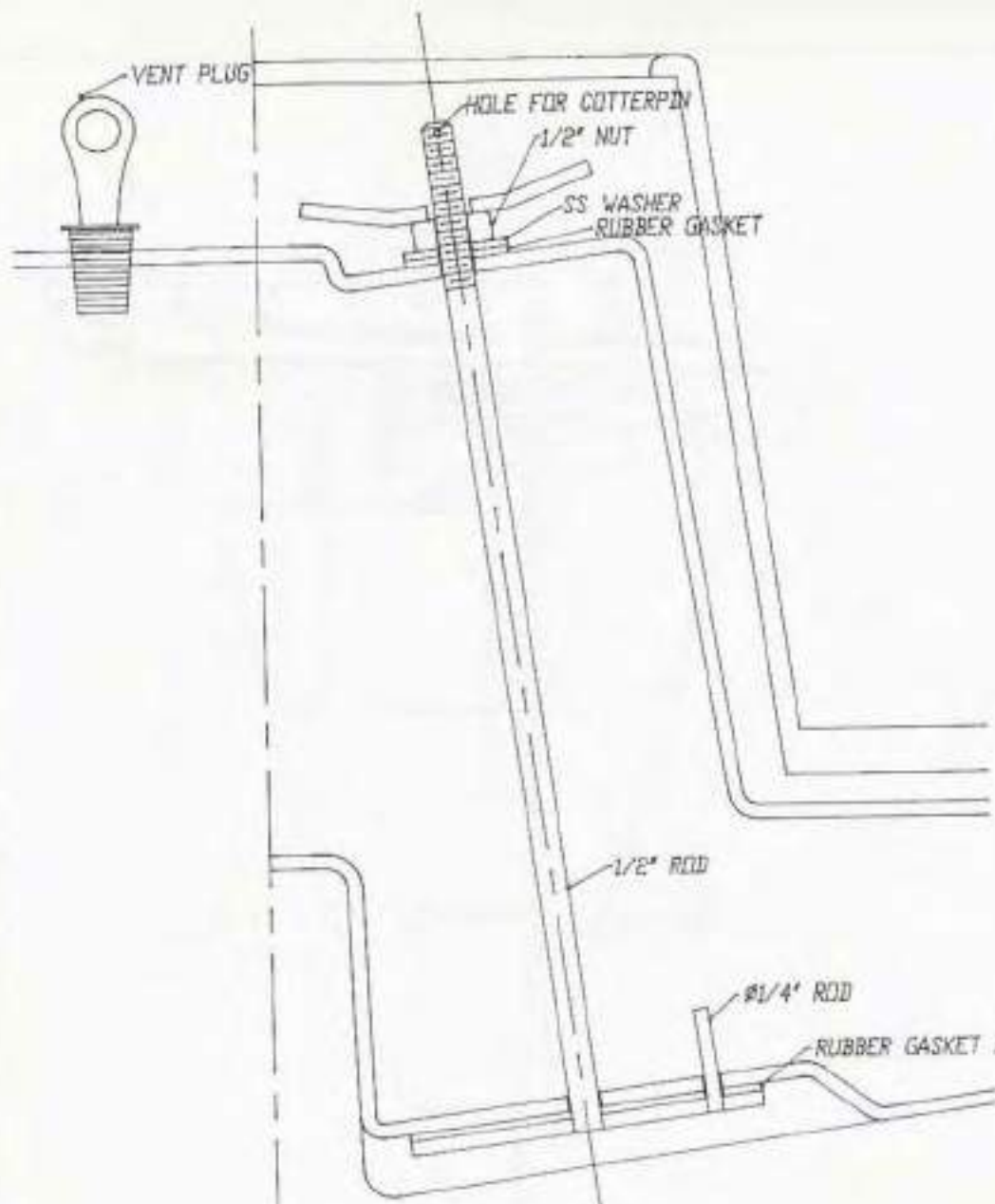

VENT PLUG

HOLE FOR CUTTER PIN

1/2" NUT

SS WASHER

RUBBER GASKET

1/2" ROD

#1/4" ROD

RUBBER GASKET BONDED TO SS PLATE

VALVE IS AFT OF CB IN H26

FILLING INSTRUCTIONS:

1. LAUNCH BOAT.
2. REMOVE VENT PLUG.
3. OPEN PLUNGER BY TURNING WING NUT AND SLIDING ROD DOWN.
4. ALLOW TANK TO FILL (TILL NO MORE AIR IS COMING OUT OF VENT).
5. REINSTALL VENT PLUG.
6. TIGHTEN WING NUT ON PLUNGER.

DRAINING INSTRUCTIONS

1. WHILE STILL IN THE WATER, BUT ON THE TRAILER, REMOVE VENT PLUG AND LOOSEN WING NUT ON PLUNGER AND PUSH DOWN.
2. PULL BOAT OUT OF WATER AND TANK WILL DRAIN.
3. REPLACE VENT PLUG (PLUNGER MAY BE LEFT OPEN FOR NEXT TIME).

HUNTER 

BALLAST TANK VALVE H19-A-2616

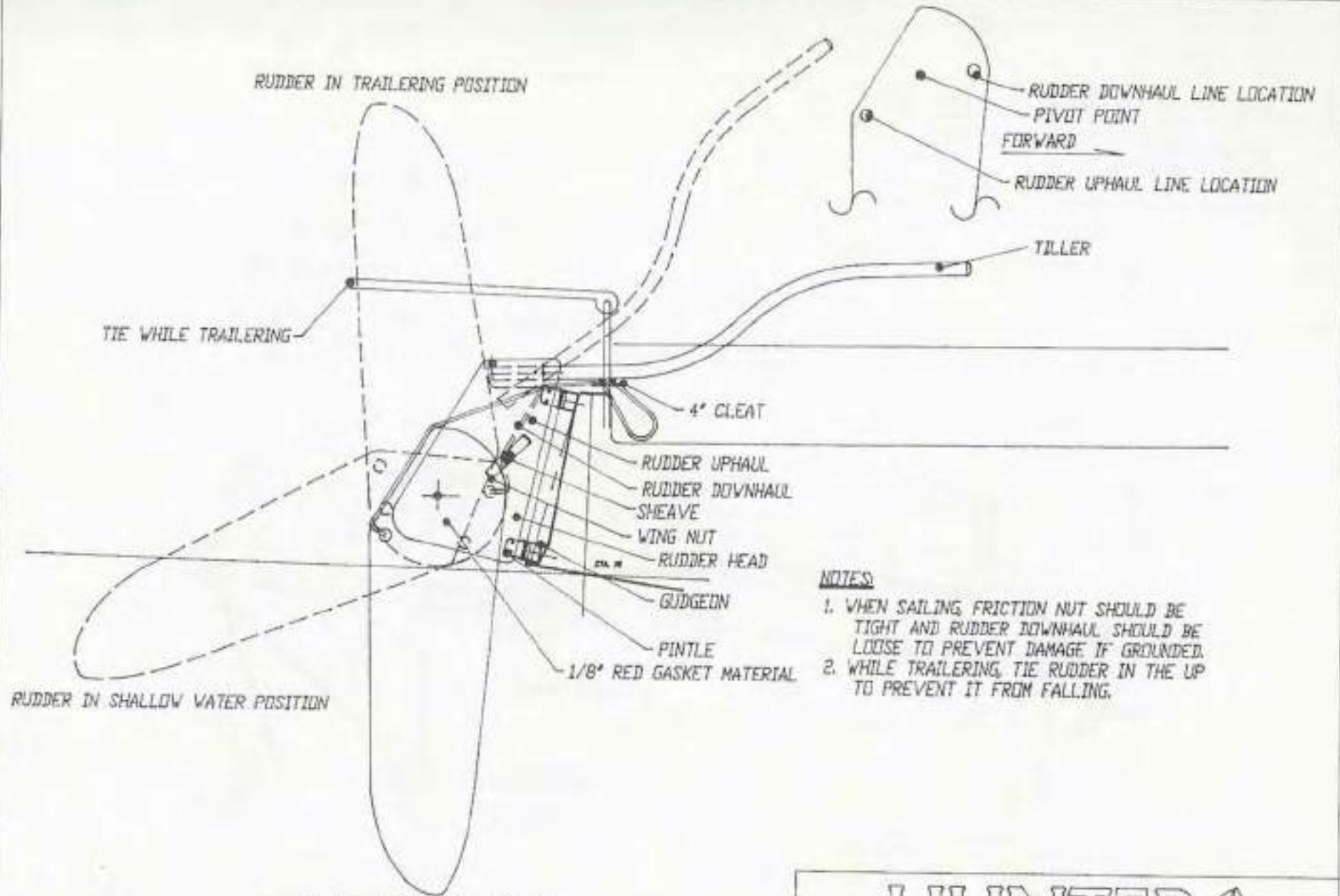

NOTES:

1. WHEN SAILING, FRICTION NUT SHOULD BE TIGHT AND RUDDER DOWNHAUL SHOULD BE LOOSE TO PREVENT DAMAGE IF GROUNDED.
2. WHILE TRAILERING, TIE RUDDER IN THE UP TO PREVENT IT FROM FALLING.

HUNTER

RUDDER DETAIL H19-A-2617

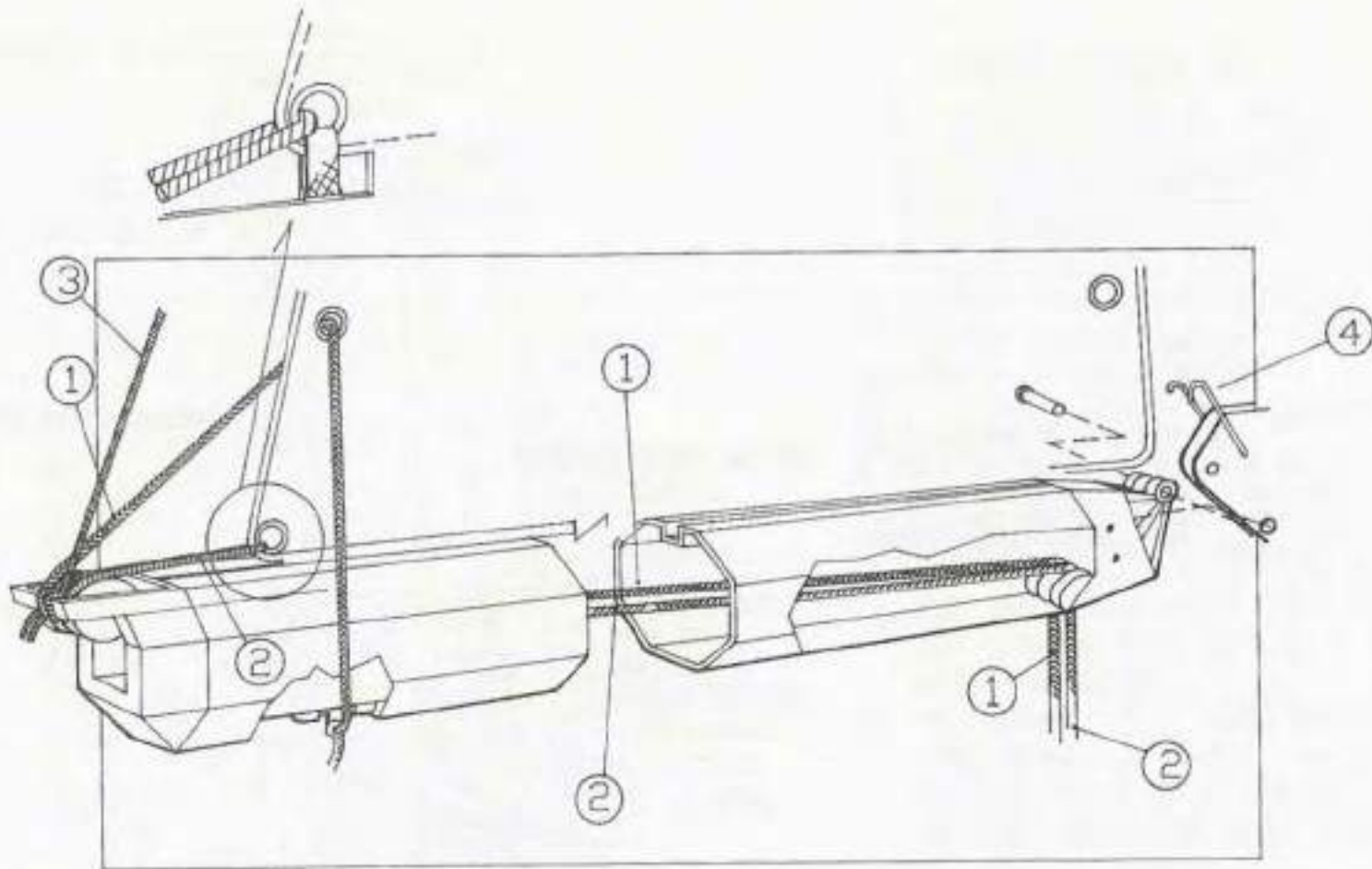

- ① REEF LINE
- ② OUTHAUL
- ③ BOOM TOPPING LIFT
- ④ RAMSHEAD HOOKS

HUNTER 

BOOM AND REEF LAYOUT H19-A-2615

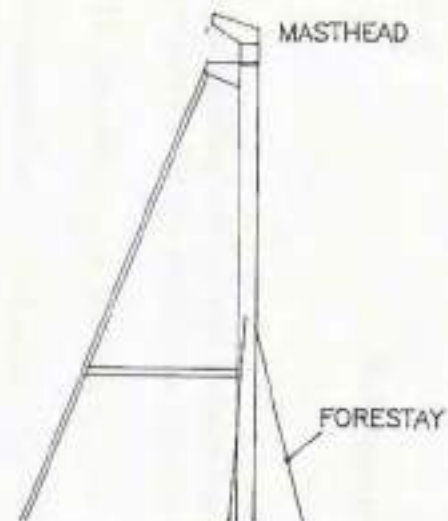
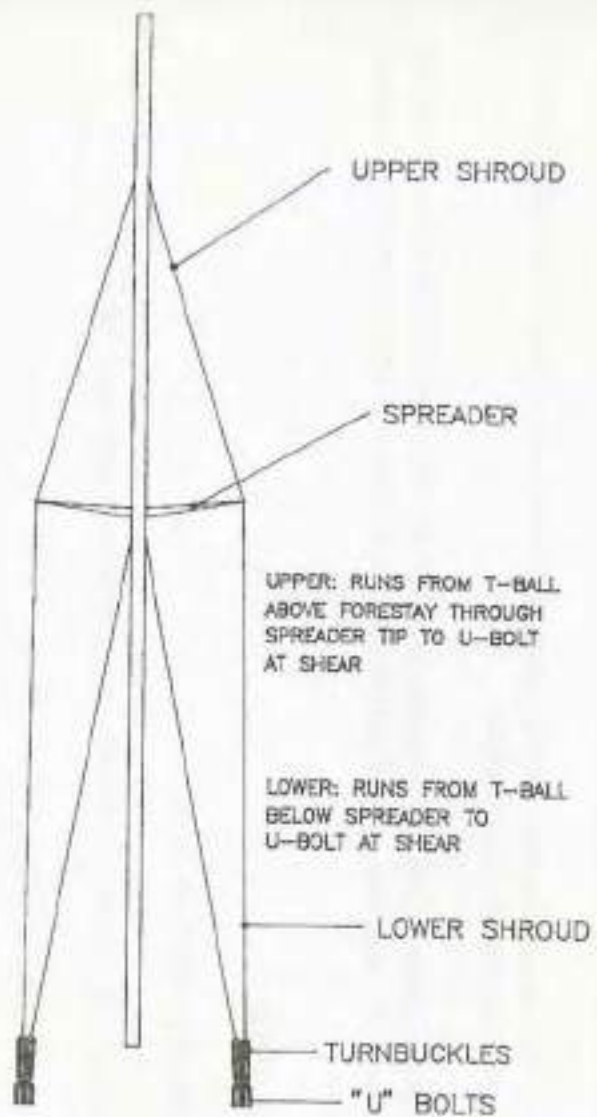

HUNTER 

REEFING

If the wind strength builds to the point where the boat heels excessively or uncomfortably, you may reduce sail area by taking in a reef. Reefing is easiest done on the starboard tack (wind blowing from starboard side) since on the H23.5 and H26 the jib sheet is on the port side and the halyard winch is then free, and on the H19, the halyard winch is on the starboard side of the mast. However, reefing can be done on either tack.

1. Feather the boat into the wind slightly to reduce heel.
2. Ease the tension on the mainsheet.
3. For the H23.5 and H26, make sure starboard winch is free by either putting the boat on the starboard tack or by taking the jib sheet and jamming it in the centerboard jam before removing from the winch.
4. Transfer the main halyard to the winch, taking tension and popping the halyard out of its jam.
5. Lower the main halyard until the reef hook on the boom gooseneck can be inserted into the forward reef cringle on the sail.
6. Tension the halyard until all slack and wrinkles are removed from the luff.
7. Tighten the reef line at the forward end of the boom by pulling down through the sheave and jam until the aft reefing cringle is against the boom and the line cannot be tensioned any more. The mainsheet and vang may have to be loosened more to achieve this.
8. Jam the reef line at the gooseneck, retension the vang and mainsheet, rejam the main halyard and transfer the jib sheet back to the winch if necessary.
9. If the wind continues to increase, you may drop the jib completely and lash on deck with a sail tie and sail on reefed main alone. In some cases you may find that dropping the jib first before you take a reef will be more effective.

III

SHAKING OUT A REEF

1. Transfer main halyard to winch as above.
2. Ease halyard down enough to remove forward reef cringle from gooseneck hook.
3. Unjam reef line at forward end of boom.
4. Raise main halyard at winch making sure reefing line continues to run through cringles and jam.
5. Tension main halyard and rejam.
6. Adjust sheet and vang as necessary.

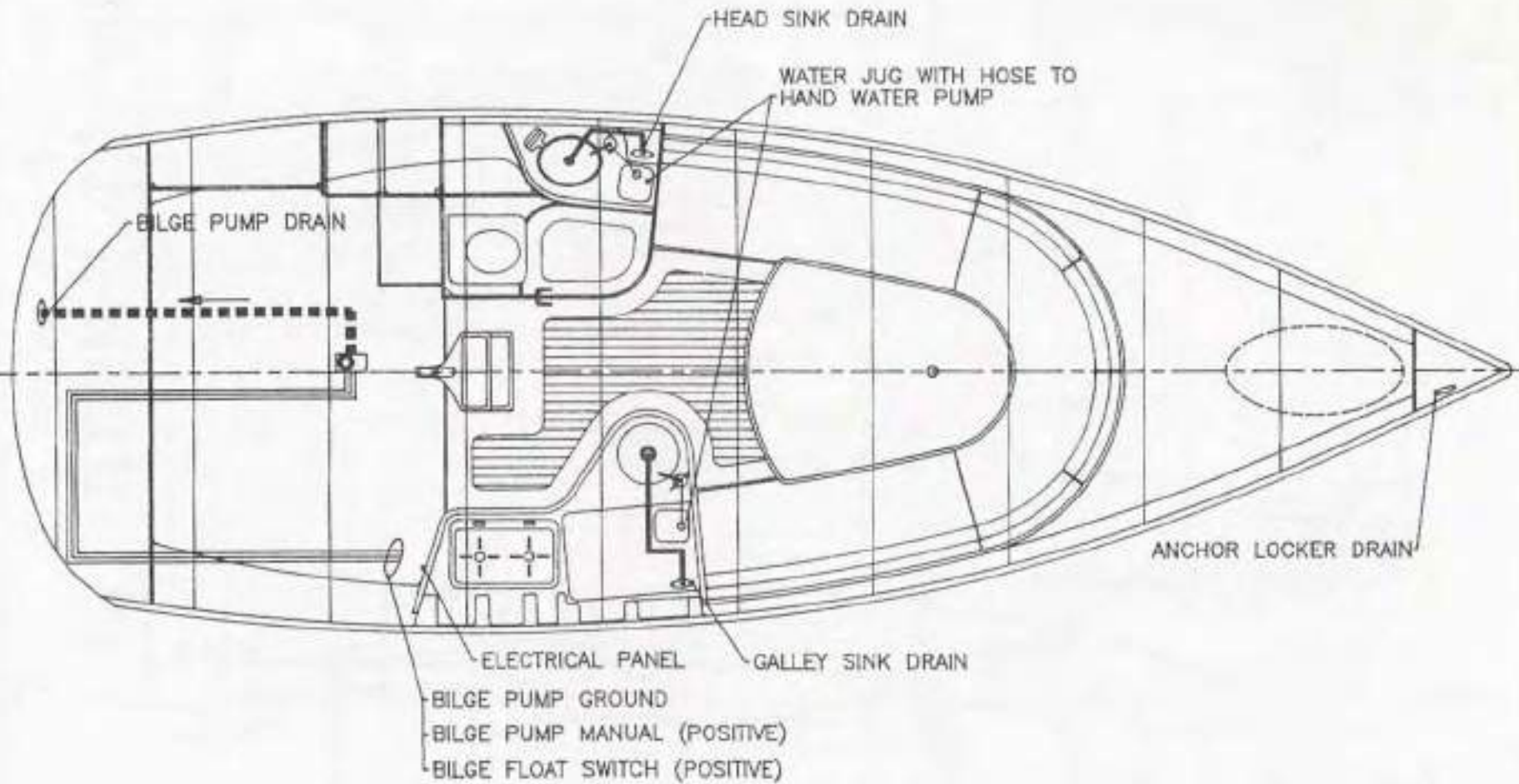

HUNTER 

TRAILER MAINTENANCE

BEFORE USING YOUR TRAILER

- 1) Check all bolts and nuts for tightness, including the lug nuts for the wheels.
- 2) Check to insure that all lights are working properly.
- 3) Always maintain the tire's recommended air pressure.
- 4) For improved tire life, have your tires spin balanced by a qualified tire service center.
- 5) When the trailer has been hitched to your vehicle, remove the 2 speed winch handle before departing.
- 6) Always check hitch and safety chain connection and boat tie downs prior to departing.

PROTECTING AND MAINTAINING YOUR TRAILER

- 1) Before launching your boat, we recommend that the light harness be disconnected from your vehicle with enough time to allow the bulbs to cool. This will greatly extend the life of your trailer lights.
- 2) This trailer has a galvanized frame, however some parts including the brakes, axles, hubs, springs, U bolts and plates are not galvanized. Most of these parts have been painted with a high gloss black rust resistant paint, plus a clear coating. After launching (especially in salt water locations), rinse your trailer, including these painted components. As a continuing measure to protect your trailer, you should from time to time, refinish and repaint surfaces that show signs of rusting.
- 3) Periodically and regularly check your wheel bearing for sufficient grease and tightness. The more launching you do, the more likely for the need to re-grease these bearings.

Proper maintenance and care will help insure more trouble free trailering for you.

Also, familiarize yourself with the trailering regulation for your state, and the other states you may be traveling with your boat. Some states require a special permit for loads over 8' wide. Other regulations may apply as well.

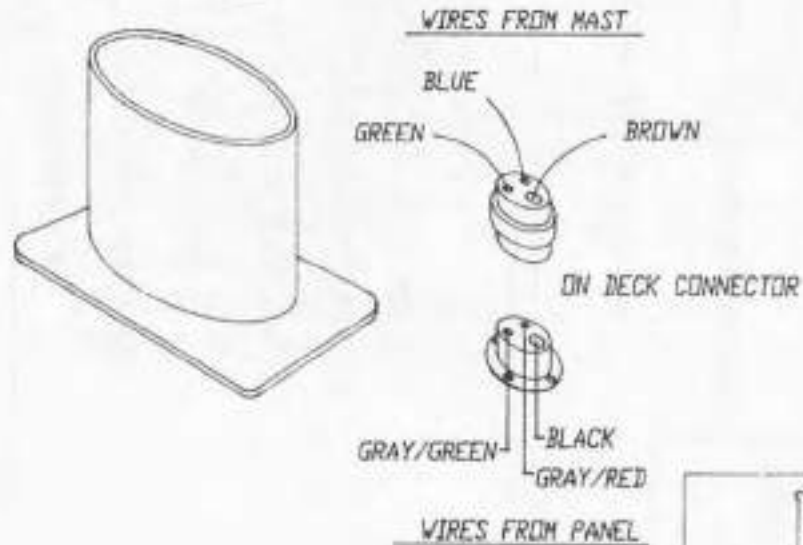
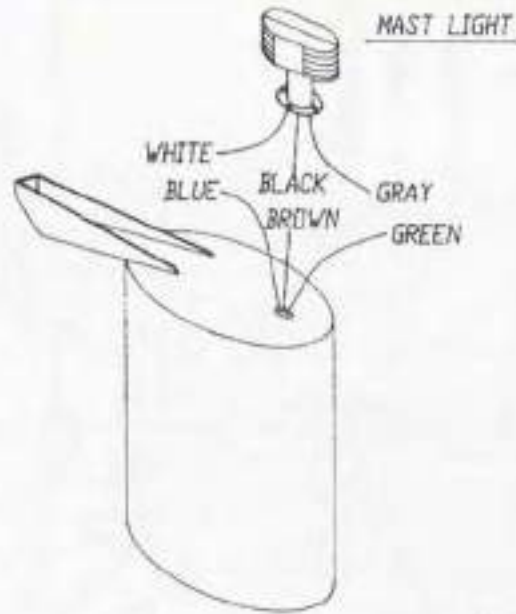

HUNTER 

HUNTER

CENTERBOARD SYSTEM H26-A-2617

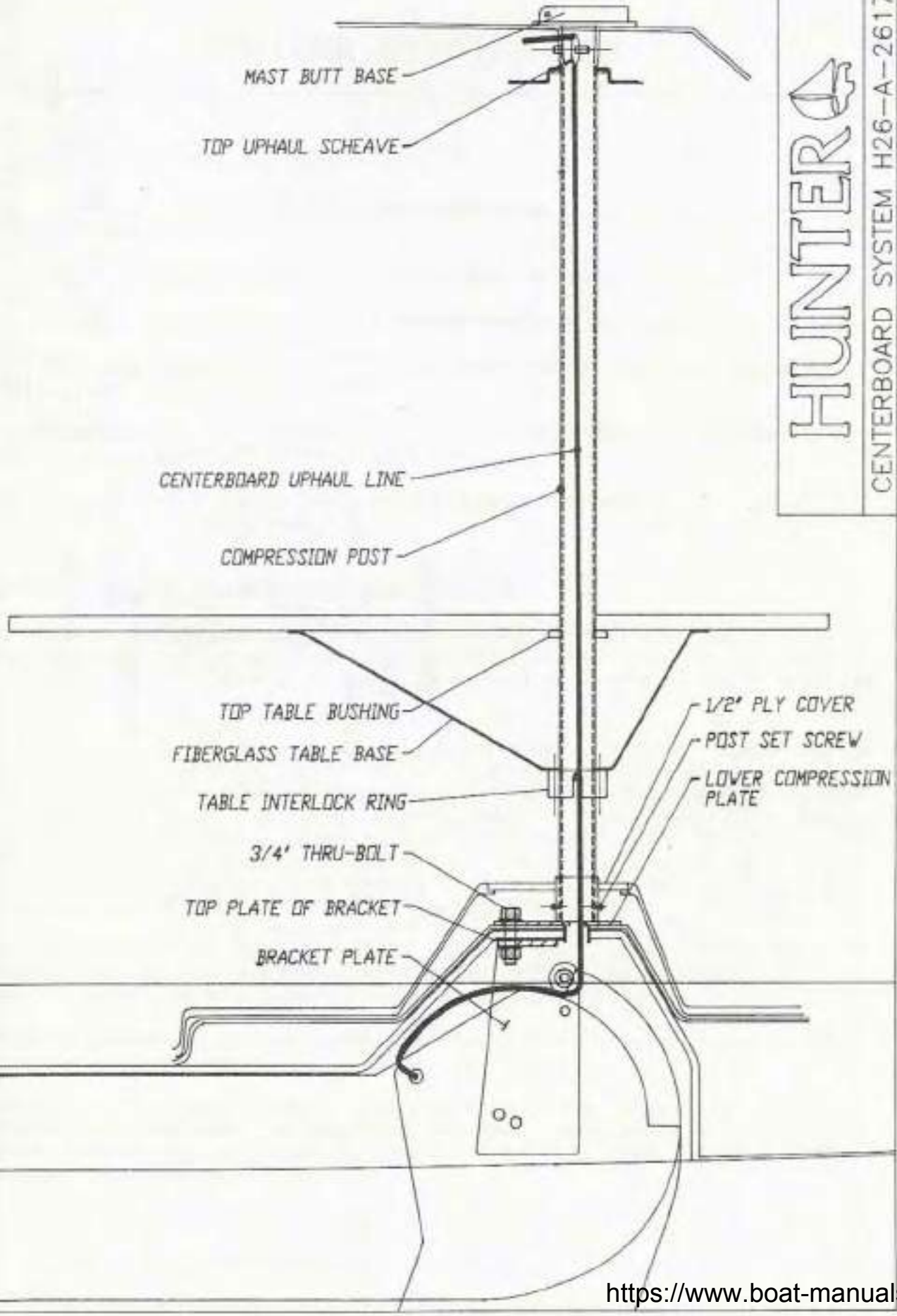

MAINTENANCE

N. Owner Information On Exotic Aquatic Plants and Animals

This information is provided in an effort to assist boat owners in the promotion and preservation of the ecological balance in the inland and Great Lakes areas of North America; and to help prevent the migration of the plants and animals listed below to other uncontaminated waters.

The exotic aquatic plants and animals being addressed are Zebra Mussels, Rulle, Spiny Water Flea, Eurasian Water milfoil, Purple Loosestrife. In the midwest regions they are Common Carp, Sea Lamprey, Rusty Crayfish, White Perch, Flowering Rush, and Curly-leaf Pondweed.

It is our hope that you will join us in an effort to be concious of the detrimental effects of the continued spread of these plants and animals. As an owner of one of our water ballast, trailerable sailboats you will want to review the enclosed brochures to familiarize yourself with these plants and animals; the detrimental effect they can have; and the best approach you as an owner can take with your boat to prevent their spread to other areas.

We encourage you to join us in the preservation of recreational boating and fishing areas.

MAINTENANCE

M. Water Ballast Tank Freezing

This information is presented to prevent you from having problems or causing destructive damage to your new H19, H23.5, or H26 water ballast sailboat built by Hunter Marine.

When your water ballast tank is empty or has been drained and the valve left in the open position, there will never be a problem with freezing.

The danger exists when the water ballast tank has water inside it. If subjected to freezing conditions, the water inside the tank can freeze and expand. The expansion will cause the tank to rupture or break its joint where it is sealed to the hull. This damage will render the boat unuseable.

Because the hulls are constructed with end grain balsa coring for stiffness, strength and lasting integrity, they also act as insulators. The temperature of the surrounding water will not (because of the insulating qualities of the balsa core) prevent the tank from freezing when air temperatures go below the freezing point.

Heating the interior of the boat is not recommended by Hunter Marine, because of safety and reliability considerations.

Hunter recommends that the boat be removed from the water during freezing conditions; and that the ballast tank be drained and the valve left in the open position.

MAINTENANCE

J. PROTECTING YOUR RIGGING

No matter how good your rigging is, without careful inspection and proper maintenance it is subject to fatigue, wear, discoloration, and therefore, product failure. Remembering to inspect and clean will increase the life of your investment and secure your rigging. We would like to suggest the following:

- Always rinse your rigging with fresh water after sailing. Especially after saltwater sailing. Salt can create corrosion pits, causing cracks and deterioration.
- Clean with a water soluble detergent without chlorine. Non-abrasive cleansers are best for hard white vinyl coated cables.
- Inspect rigging for stains. Rust stains may indicate stress cracks or corrosion. Remove stains with synthetic or brass pads. Never use steel wool pads.
- Look for broken wires - a sign of fatigue in rigging. Replace standing rigging if wires are broken.
- Never mix stainless steel and galvanized metals on cable, fittings, pins, cotter keys, etc. If mixing dissimilar metals, electric currents may conduct between metal causing rapid deterioration.
- After un-stepping, make sure to release all standing rigging to avoid bending, crushing, and kinking.
- Store rigging in a dry place. Never store in a plastic bag, which can cause corrosion.

MAINTENANCE

G. INSTRUCTIONS FOR PREPARATION FOR BOTTOM PAINTING

WARNING!

Do not use any sanding, sandblasting or other abrasive preparation of the bottom as this will void your hull blistering warranty. More information on the warranty is available in this owner's manual.

BOTTOM PAINTING

Choose a bottom paint system that suits the environment in your area.

Follow the procedure recommended by the manufacturer of the paint, while making sure not to void the Hunter Hull Blistering Warranty. The procedure for preparing for and painting the bottom varies between paint manufacturers, but should always include dewaxing, etching and sometimes priming of the surface.

IV

The rudder should always be bottom painted using a white bottom paint, to avoid heat build-up in the rudder, which colored paints can contribute to, when the boat is on land.

Should a customer wish to have an epoxy barrier coat applied to his hull, example Interlux Interprotect 1000, 2000 or West Systems or Vc Tar this will not void his Five Year Blister Warranty.

We are referring to epoxy barrier coatings as mentioned above not epoxy primer paints.

If an epoxy barrier coat is applied to a Hunter vessel it must be registered with the Warranty Department prior to application of the product. If you are going to apply bottom paint only, sanding will not be allowed and the no sanding system must be used.

MAINTENANCE

Sail care continued.

The headsail, neatly rolled and fastened, can be temporarily stowed along the lifelines. To stow below, flake it into a length; 1. then roll from luff to leech, 2. Take care not to crease the leech. Pack in a clearly marked bag.

D. Winch Maintenance

Follow the maintenance instructions prescribed by the winch manufacturer. We recommend a minimum of an annual cleaning and light greasing.

E. General Hardware Maintenance

Check all fittings regularly to be sure screws are tight. Occasionally lubricate (use silicone lubricants) all moving parts on such fittings as blocks, turnbuckles and cam cleats, as well as the locking pins of snatch blocks, track slides, spinnaker poles, etc. Inspect cleats and fairleads for roughness and smooth with fine grained emery paper if necessary. Also, replace any missing or damaged cotter pins in turnbuckles and shackles, and either tape them or use protective covers manufactured for that purpose.

F. Engine

ENGINE: Follow the fuel and lubrication requirements in the Engine Manual.

MAINTENANCE

A. Electrical Systems

The electrical system is a 12-volt, negative ground installation. The owner should weekly inspect battery(ies), terminals and cables for signs of corrosion, cracks, and electrolyte leakage. Battery terminals are to be kept clean and greased. Refer to separate instructions on batteries, wiring diagram, and electronics.

B. Plumbing Systems

All pumps should be checked frequently to insure proper operation. **This is an especially important regular maintenance item since proper functioning of a pump could save your vessel from serious damage in the future.**

Inspect all hoses for chafing and dry rot. See that hose clamps are tight. Check that the pump impeller area is clean and free of obstructions.

Inspect electrical wiring for corrosion. Make sure float switches move freely and are making an electrical connection.

IV

C. General Care

CLEANING FIBERGLASS SURFACES: Fiberglass surfaces should be cleaned regularly. Normal accumulations of surface dirt can be removed simply by occasional rinsings with water. If your boat is operated in salt water, more frequent rinsing will be required. To remove stubborn dirt, grease or oil, use a mild detergent and a soft brush. Rinse with clean fresh water.

It is also a good idea to wax the fiberglass once or twice a year to maintain a deep, glossy appearance. Your local marine supply should be able to provide an appropriate wax.

Sail Care: Sunlight is a sail's worst enemy, so cover the sails when they are not in use. An ultraviolet guard, fitted down the leech of a roller headsail, will protect the exposed part from the weathering effect of the sun and from dirt and grit. Mildew, which discolors, is prevented by storing sails dry and by hand-washing twice a season.

Check all sails regularly for chafe, particularly where they chafe on deck fittings or rigging, at reef points, batten sleeves and the foot of the headsail. Sail batten pockets should be inspected on a regular basis.

To stow the mainsail, start at the leech and flake it onto the boom, left and right, in about 18-in. (46-cm) folds, while pulling the leech aft. Secure with a sail tie and continue to the luff. Lash to the boom with sail ties or shock cord.

MAINTENANCE

I. ACRYLICS FOR MARINE USE

CARE AND CLEANING

Don't

- Do not subject acrylic material to high temperature when polishing
- Do not use glass cleaning sprays, scouring compounds, or solvents like acetone, gasoline, benzine, carbon tetrachloride or laquer thinner.
- Do not use masking tapes, duct tapes or packing tapes on your acrylic materials.
- Do not drill holes without proper drill bits in your acrylic materials (special bits are used in acrylic material to avoid damage).

Do's

- Wash your acrylic hatches, windshields, and other acrylic components on your boat with a mild soap and plenty of lukewarm water.
- Use a clean soft cloth, applying only light pressure.
- Rinse with clear water and dry by blotting with a damp cloth of chamois.
- Grease, oil or tar may be removed with a good grade of hexane, aliphatic naphtha, or kerosene. These solvents may be obtained at a paint or hardware store and should be used in accordance with the manufacturer's recommendations.
- To maintain a high-luster finish on your acrylics, we recommend that after properly cleaning, apply Meguiars Mirror Glaze #10 with a soft towel. Note: If slight scratches appear on acrylics, use Meguiars Mirror Glaze #17.

MAINTENANCE

H. Cleaning Instructions for Marine Vinyl Coated Fabrics

These patterns, like all upholstery fabrics and vinyls, require a regularly scheduled cleaning program. A thorough cleaning should be administered on a daily, weekly or monthly basis depending on use and exposure to dirt and/or staining agents. It is important that efforts begin immediately after a spill to remove any potential staining agent. It is advisable to clean these products as soon as the first signs of dinginess occur, otherwise, delaying clean-up will require a much greater effort to restore the product to its original appearance.

Regular cleaning requires the use of a mild cleaner such as Murphy's Oil soap and water. In situations where the vinyl has not been washed regularly and there is a build-up of dirt, stronger vinyl cleaners such as Simonize's Tuff Stuff or Turtle Wax's vinyl/fabric cleaner are recommended. We do not recommend the use of any other cleaners. The use of cleaners other than those recommended may result in irreparable damage to the product.

In order for the above listed cleaning solutions to work effectively on stubborn stains, please allow time for the cleaning solution to soak in thoroughly. Be sure to remove the cleaning solution before it has had time to dry. Regardless of the type of cleaner used, it is necessary to finish up with a thorough rinse using fresh water on a clean sponge or rag. A soft bristled nylon or natural fiber brush can be used to remove built-up dirt and staining agents.

Finally, please remember that all of our fabric grain vinyls require a greater cleaning effort to maintain than comparable smooth grain vinyls. These products will provide an attractive and durable alternative to conventional fabrics and vinyls if properly maintained. One must realize that the proper installation and use of our fabric grain vinyls require additional attention to the establishment and maintenance of a well thought out cleaning program.