



# Owners Manual

## Pro-Line 2950

Copyright © 1996 Evinrude Outboard Motors, Inc. P.O. Box 1328  
Muskegon, MI 49763. All rights reserved. 06-27-96.

# Table of Contents

## I Introduction Pg 4

Dealer / Customer responsibilities

Registration

Insurance

## II Safety Pg 5

Regulations

Equipment

Passenger safety

Rules of the road

Hazardous conditions

Alcohol

Carbon monoxide

## III Controls Pg 8

Ignition

Choke

Safety shut down

Shift / Throttle / Trim

Steering

Instruments: Fuel Gauge, Water Temperature, Volt, Tachometer,

Speedometer, Trim, Options

Switches: Windshield Wipers, Windlass, Bilge Pump, Lights, Breaker,

Trim Tabs

## IV Systems Pg. 13

Fresh Water

Sea Water

Head/ Waste

AC/ Heat

Fuel/ Oil

Electrical (ac, dc, gen set)

After Market Accessories

## V Trailering and Launching Pg. 23

Classification and Capacity

Hitch

Load Distribution

Launching and Retrieving

## VI Operation and Performance Pg. 24

Loading

Fueling	
Starting	
Torque	
Trim	
Prop	
<b>VII Services and Care</b>	<b>Pg 29</b>
Fiberglass / Gel coat	
Marine growth	
Plexiglass	
Stainless Steel/ Aluminum	
Canvas	
Upholstery Vinyl, Fabric	
Corrosion Protection	
Winterization, Storage, Mooring	
<b>VIII Appendix</b>	<b>Pg 33</b>
Boat ID	
Trouble Shooting Chart	
Nautical Terms	
Specifications	
Wiring	

## **List of Illustrations**

Fig 1 helm	Pg 7
Fig 2 switch panel	Pg 10
Fig 3 trim tabs	Pg 12
Fig 4 fresh water systems	Pg 13
Fig 5 raw water system	Pg 14
Fig 6 electric head	Pg 15
Fig 7 air conditioner	Pg 16
Fig 8 fuel / oil systems	Pg. 17,18
Fig 9 a/c panel	Pg 19
Fig 10 genset	Pg 20
Fig 11 d/c panels	Pg. 21
Fig 12 battery switching	Pg 22
Fig 13 trim condition	Pg 28
Specifications / Dimensions	Pg 40
Through Locations	Pg 48
Wiring Diagrams	Pg 40

# Introduction

Congratulations! You are now the proud owner of a new Pro-Line sport fishing boat.

Welcome into the proud family of satisfied Pro-Line owners. Every expedition lets you enjoy the outstanding features designed into every boat we construct. Your new Pro-Line is more than just a boat, it's a lifestyle!

Pro-Line's commitment to the needs and wishes of the professional sport fisherman has resulted in a superior fishing craft, providing you with comfort, performance, security and fishability. All of our boats comply with U.S. Coast Guard (USCG) safety regulations, and are designed, and crafted in accordance with the National Marine Manufacturers Association (NMMA) and the American Boat and Yacht Council (ABYC) standards.

This manual (to be kept onboard your Pro-Line) is designed to provide you with information necessary for safe, efficient operation and care of your new Pro-Line. To maximize your enjoyment and safety, take the time now to carefully review the documentation in your owners pack and this manual, and really get to know your boat.

## Dealer's Duties

Your dealer's responsibilities include but are not limited to:

- \* Pre-delivery verification of proper rigging and operation
- \* Providing adequate orientation in general operation of your Pro-Line including explanation of specific safety considerations regarding the use of systems and components
- \* An explanation of owners packet literature and warranty registration cards for all separately warranted equipment and accessories.
- \* Explaining local and out of area service procedures during and out of warranty periods.

## Customer Responsibilities

- \* Be proficient in boat handling and safety - **THIS MANUAL IS NOT INTENDED TO PROVIDE COMPLETE TRAINING ON ALL ASPECTS OF GENERAL BOAT OPERATION.**
- \* Read and understand the limited warranty
- \* Read all literature and instructions and use and maintain all equipment as directed
- \* Examine the boat at time of delivery to ensure that all systems are functioning normally
- \* Learn about and operate boat in accordance with local, state and federal

laws, regulations and **registration** requirements

- \* The owner is legally responsible for all liabilities of operation - secure **insurance protection**.

## Safety

Your Pro-Line boat has been constructed with safety in mind, however the ultimate safety of you and your passengers is in your hands. Plan your trips carefully. Insure ample fuel supply and reserve. Tell someone where you are going and when you expect to return. Keep current charts onboard. Read and observe USCG boating safety circulars.

## Regulations

The USCG is the authority of all the waterways. State boating regulations are enforced by local authorities. You are subject to marine traffic laws and "Rules of the Road" for both federal and state waterways, and must submit to boarding if requested by proper authority.

There are many publications available from the Coast Guard concerning regulations and more. For additional information call the boating safety hot line at 1(800)368-5647.

## Equipment

USCG regulations require the following equipment while operating your boat:

- \* Fire extinguisher
- \* Personal Flotation Device (PFD) for each occupant
- \* One throwable PFD
- \* Sound signal device
- \* Navigational lights if operated at night
- \* Sight signal (flare- night, orange flag- day) when in coastal waters or great lakes.
- \* Anchor and sufficient line

In addition, here is a list of suggested equipment you should have aboard your Pro-Line:

- \* First aid kit and blankets
- \* Mooring lines and fenders
- \* Combination oar / boat hook
- \* Spare prop, nut & washer
- \* Spare fuses and bulbs
- \* Local charts and compass
- \* 2 way radio (with proper license)
- \* Floating key chain & spare keys
- \* Emergency food and water
- \* Sea anchor with line
- \* Bailing device
- \* Tool kit and lubricant
- \* Spare fasteners, hose clamps, plugs
- \* Binoculars or telescope
- \* Water proof flashlight
- \* EPIRB (emergency beacon)
- \* Navigation device
- \* Water proof matches or lighter

## Passenger Safety

You are responsible for the safety and conduct of your passengers, make sure

- \* You instruct passengers on proper use and location of PFD's, children and non swimmers should wear one at all times
- \* When underway each passenger is in a safe location, and knows to keep the boat balanced
- \* At least one other person knows how to operate the boat in case of emergency.
- \* They are aware of dangers of the prop, and the possibility of sudden maneuvers and jolts
- \* To turn the engine off and remove key when swimmers are near the prop or using the dive platform
- \* All keep away from lines under stress should they break and recoil

### Rules of the Road

Know and use the rules of the road, the information here is only a brief overview

For detailed information contact the USCG

Audible warning signals

- \* One short horn blast: starboard course change
- \* Two short horn blasts: port course change
- \* Three short horn blasts: astern operation
- \* Five horn blasts: doubt about previous signal, or danger
- \* One Five second blast every minute: for fog operation

When overtaking give- way vessel announces intention with horn blast(s) and waits for same response, then completes maneuver

When approaching head on both boats give way after giving appropriate horn blast. (preferable to starboard)

When crossing a vessel converging from starboard has right of way, port vessel gives way (both acknowledge with one short horn blast)

Know and observe navigational buoys and markers

Give way to craft under sail.

### Hazardous Conditions

Keep track of weather developments and avoid hazardous conditions if possible

When forced to operate your Pro-Line in storm conditions

- \* Wear PFD's
- \* Stow loose gear and equipment
- \* Place heavy items as low as possible
- \* Head for the easiest to reach safe location
- \* Reduce speed. If the boat leaves the water you're moving to fast
- \* If power fails tug a sea anchor off the bow (an empty ice chest in a pinch)

- Stay with boat if it capsizes, unless it is burning out of control.

## Alcohol

Don't drink and drive. If you have been drinking have someone drive who has not been drinking. Never operate a boat under the influence of drugs or alcohol.

## Carbon Monoxide

Be aware of and avoid conditions that can cause carbon monoxide poisoning (see USCG boating safety circular 77). Sources of carbon monoxide include any gas or diesel engine, any flame such as a charcoal grill, stove or heater. Carbon monoxide can accumulate to deadly levels in enclosed spaces. Always ventilate occupied areas of vessel with fresh clean air.

## Controls

Pro-Line Boats offer many different engine and drive unit choices, therefore the information in this manual is general in regards to engine and controls. Refer to the engine/ drive manuals in your owners packet for additional, specific information.

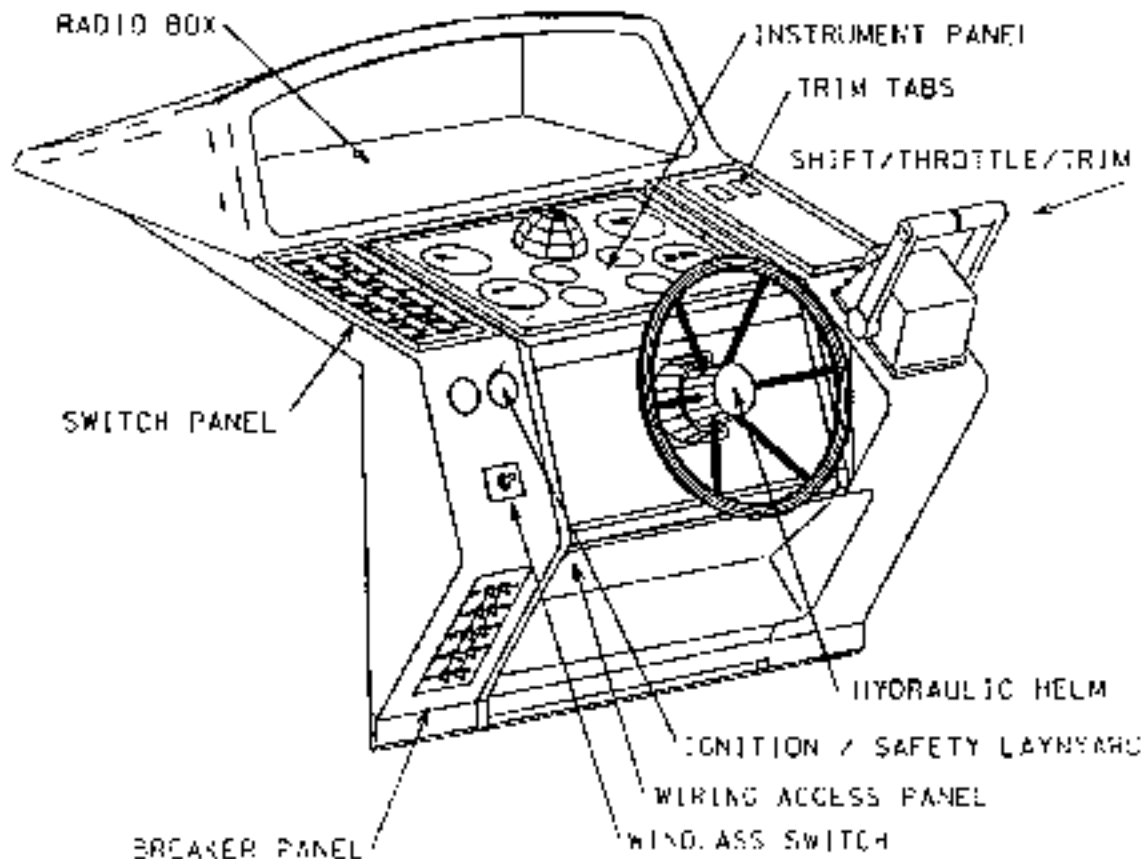

Fig. 1 Helm



## **Ignition**

The ignition switch has three positions, off, on, start. To start the engine, attach safety lanyard, turn the key clockwise against the spring pressure to the start position, as soon as the engine starts release clockwise pressure allowing spring tension to return switch to the on position. If the engine fails to start in 5 seconds of cranking allow the starter to cool 10 seconds and repeat.

For detailed instructions see engine manual

## **Choke**

The choke is only used to aid in starting a cold engine. Operation varies with manufacture, consult your engine manual

## **Safety Shut Down**

The Safety shut down switch shuts off the engine in case the operator is thrown from the boat. To ensure proper function always attach the lanyard securely to the operator.

## **Shift/ Throttle/ Trim**

Your Pro-line can be ordered with several different shift/ throttle systems. Refer to the owner's packet to find the manual pertaining to your particular installation.

## **Steering**

Your Pro-line is equipped with a self contained hydraulic steering system. When the steering wheel is turned the helm pump pumps fluid to the steering cylinder, causing the boat to turn.

Periodically check the fluid level and fill if necessary. Beware of adding too much fluid especially if the ambient temperature is cold because subsequent expansion could cause leaking or damage to your system (refer to manual in packet). Every 24 hours of operation check all nuts, caps, and hose fittings for tightness. Check that the hoses are not chafing, or kinking on sharp corners. Also check that hose ends are not damaged or distorted by the clamps.

The fluid should be changed yearly under normal conditions, twice yearly for heavy use.

If your steering does not operate properly first check for, drive entanglements, fluid level, hoses / fittings for leaks, and / or air in the system.

## **Instruments**

Your Pro-line's instrumentation will vary from model to model and engine to engine, therefore the following descriptions are general, refer to your engine manual for specifics.

### **Fuel Gauge**

Differences in temperature, humidity, speed and trim can affect the actual accuracy of this gauge in service. It is important to verify the fuel flow in gal/hr for your

boat and make note of your gauge position with respect to time for different RPM settings. No gauge can give 100% accuracy. If you notice unusually high or low fuel consumption, investigate further to see if the engine is using more fuel than normal.

#### **Oil Pressure**

This is a very important instrument, oil pressure is vital to engine life. Generally readings of 10-15 psi at idle and 15 to 25 psi at cruise are sufficient to protect your engine. If you notice abnormally low or high readings, check and correct oil level, if condition persists consult your dealer. If you lose oil pressure shut down the engine immediately, find and correct the problem before restarting engine, running your engine without oil pressure will result in serious and costly damage.

#### **Water Temperature**

The water temperature gauge indicates the internal water temperature of your engine. Your engine is equipped with a thermostat to quickly bring the engine up to its optimum operating temperature range of 150 to 170 degrees F. All outboard engines are also equipped with a audio alarm system indicating a overheat condition, if the gauge or alarm indicates a over heat condition immediately shut the engine off, lift the drive and inspect water intakes for obstructions such as aquatic vegetation or mud. After finding the source of the overheating, restart engine and confirm water flow, if water does not flow within five seconds shut the engine off.

#### **Volt**

The volt meter indicates battery voltage, normal reading is between 12 to 15.5 volts. A low reading indicates to heavy of a load or a dysfunction in the charging system. Too high of a voltage indicates a fault of the charging circuitry and continued operation will damage the battery.

#### **Tachometer**

The tachometer indicates the revolutions per minute (RPM) of your engine. Do not operate the engine beyond the limits stated in your engine manual. Abnormally low tach readings (for a given throttle setting) indicates loss of power, or a prop entangled with weeds or trash, check the prop first. A reading higher than normal indicates a ventilating or cavitating prop, or prop/drive damage.

#### **Speedometer**

The speedometer indicates the speed of your boat in Miles per Hour (MPH). The gauge operates by sensing water impact pressure from the pitot tube mounted on the transom (or integrated into the lower drive unit of the motor). If the gauge fails to give a reading suspect a blocked pickup.

#### **Trim**

The trim gauge indicates the in (down) and out (up) position of the drive unit in relation to the hull. (see *Trimming your boat* p 27,28 )

## Options

Optional instrumentation for your Pro-Line includes fish locator / depth finder, VHF radio, GPS / LORAN navigation aids, etc. Refer to the manuals supplied.

## Switches

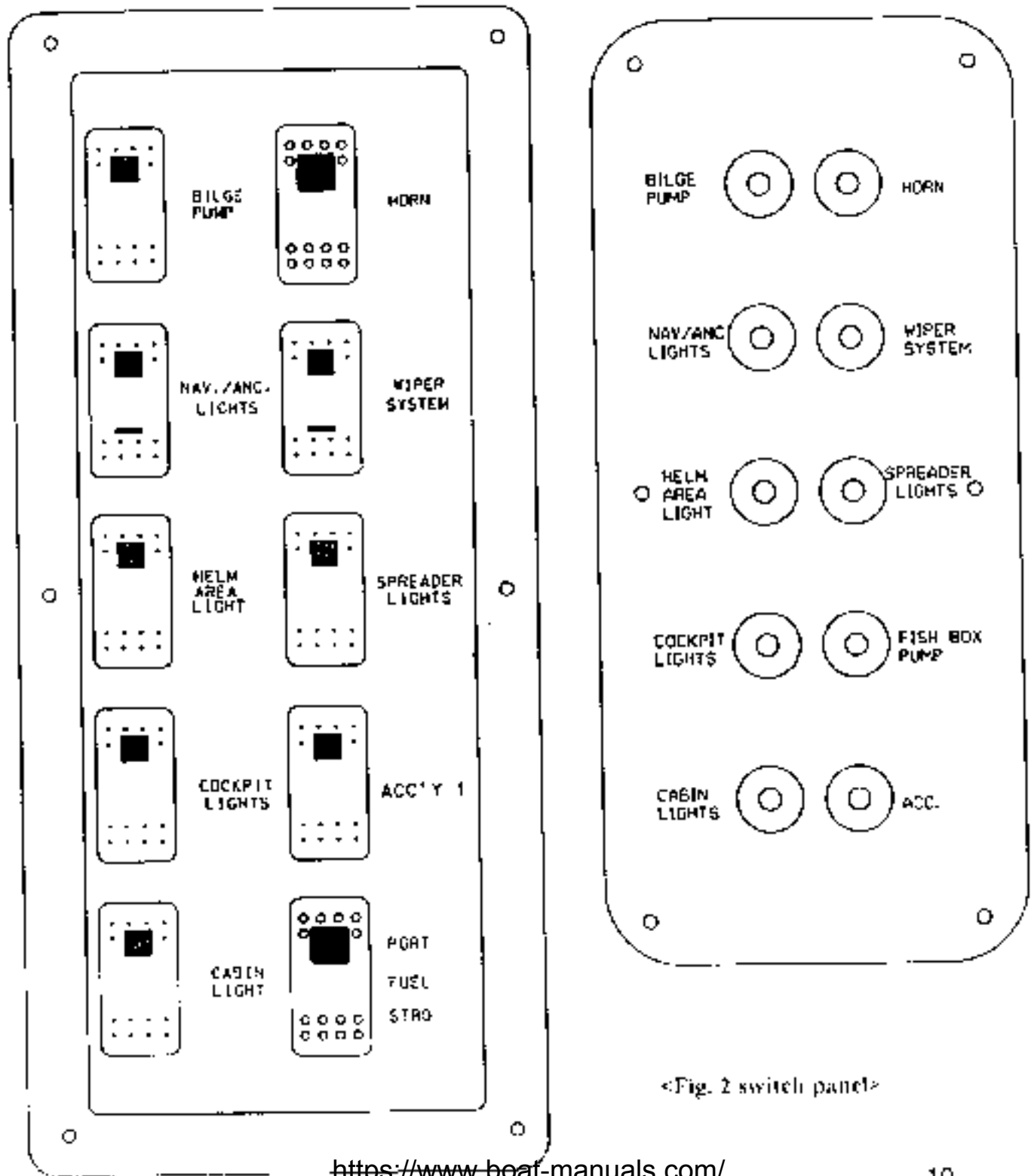

<Fig. 2 switch panel>

### **Windshield Wiper**

For operation in rain or adverse conditions, optional windshield wipers enhance visibility from the helm and therefore safety.

### **Windlass**

Refer to the windlass manual for operation of the optional windlass. The Windlass is protected by a 80A breaker located on the transom (O/B) or bulkhead breaker panel.

### **Bilge Pump**

Your Pro-Line is equipped with an automatic bilge pump system with a manual override. The pump is located at the aft end of the bilge at the keel. The automatic float switch is wired directly to the battery terminal through an in-line fuse. Keep the bilge area clean and free from debris that could clog ports. The helm switch overrides normal automatic operation. (Circuit breakers are located at the helm (and on the transom breaker box 2950 & 2700). Keep the battery that the bilge pump is attached to charged. If the battery is discharged and flooding occurs the boat could swamp, causing damage and possible loss of life or property.

### **Blower**

Pro-Line's equipped with an inboard mounted engine have a bilge blower to rid the bilge of explosive fumes. Always operate the blower a minimum of four minutes and check bilge for fumes before starting the engine. Operate the blower whenever engine is running and the boat is stopped (or operating at low speed). At speed, air blows through the bilge keeping fumes under control and blower operation is unnecessary.

### **Lights**

For operation at night your Pro-Line is equipped with navigation, and anchor lights to indicate your position to other boaters. While running after dark the nav. lights are required to be on and visible to other boaters, visually verify operation and lack of obstructions. Lights are also provided for the cockpit, bait-well, helm and cabin, as well as spreader lights.

### **Breaker Switches**

The wiring on your Pro-Line is protected by circuit breaker or fuse. If a device stops working first suspect the circuit breaker is tripped (or fuse blown).

A tripped breaker will protrude from its set position, indicating that the circuit has been overloaded. Turn off the device(s) on the circuit then reset the breaker by pushing in once. If the breaker does not reset or if it resets and then pops out again after the device is turned back on, then a short circuit exists or your device may be damaged, overloaded or faulty, correct the problem and then reset the breaker. If the breaker continues to pop and you are certain the device, switch and wiring are in good repair, either the breaker is too small for the load or is faulty, reduce the load, or replace the breaker.

## Trim Tabs

The optional trim tabs operate independently up or down to correct for differing conditions of wind or load.

Before the boat is underway, depress the bottom half of both switches until the tabs are fully elevated (bow up position) while underway and in open water, clear of other boaters, depress the top half of both switches in half second bursts to achieve the desired degree of bow down trim.

To correct a port list, give the top half of the starboard switch a series of bursts until the list is corrected. To avoid over trim, allow a few seconds between bursts to allow the boat to respond (if you over trim, simply give the over trimmed tab a burst or two in the opposite direction).

To trim the bow down, push the top half of both rocker switches in short bursts.

**Warning:** trim tabs can cause a dramatic change in the attitude and heading of your boat, adjust them only when in open water, clear of any obstructions, and then only in small increments.

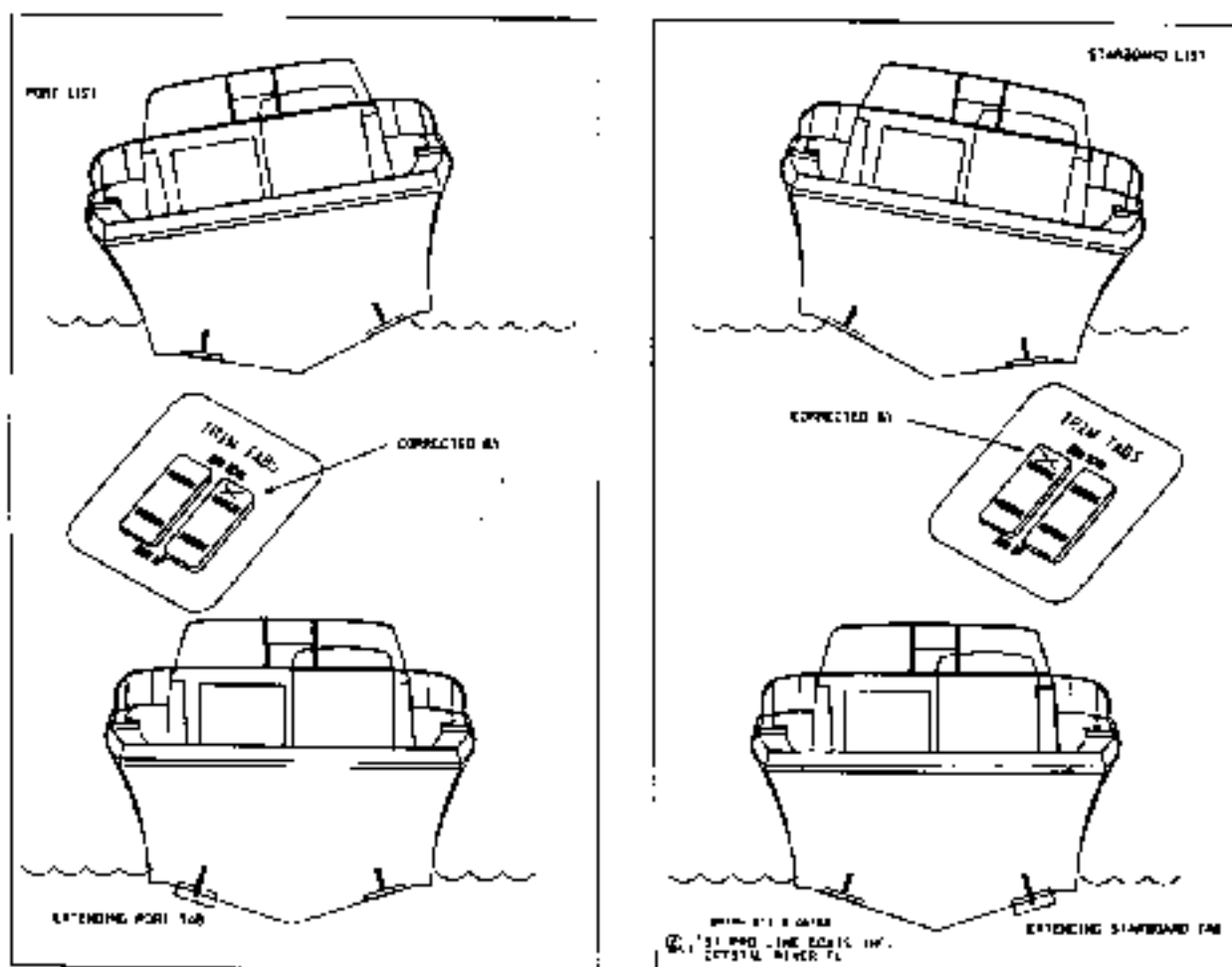

<Fig. 3 trim tabs>

# Systems

## Fresh Water System

The water pumps on your Pro-Line are controlled on demand by a drop in water pressure. The master switch located either at the helm or in the cabin switches the pumps unconditionally off. The switch should be kept off while not in use, or unattended. A dock side fitting is provided for heavy fresh water usage, the plumbing is not designed for sustained high pressure do not leave the dock side water hooked up while the boat is unattended or flooding may result.

The optional water heater is located under the steps to the fore deck. It is accessible by removing the ice box. Before operating the water heater make sure that all air is bled from the system by turning on the hot water faucets one at a time until water flows. Failure to purge the air could result in damage to the heating elements. After the air is purged top off the fresh water tank for full water capacity. Another fresh water tank supplies the transom sink and shower.

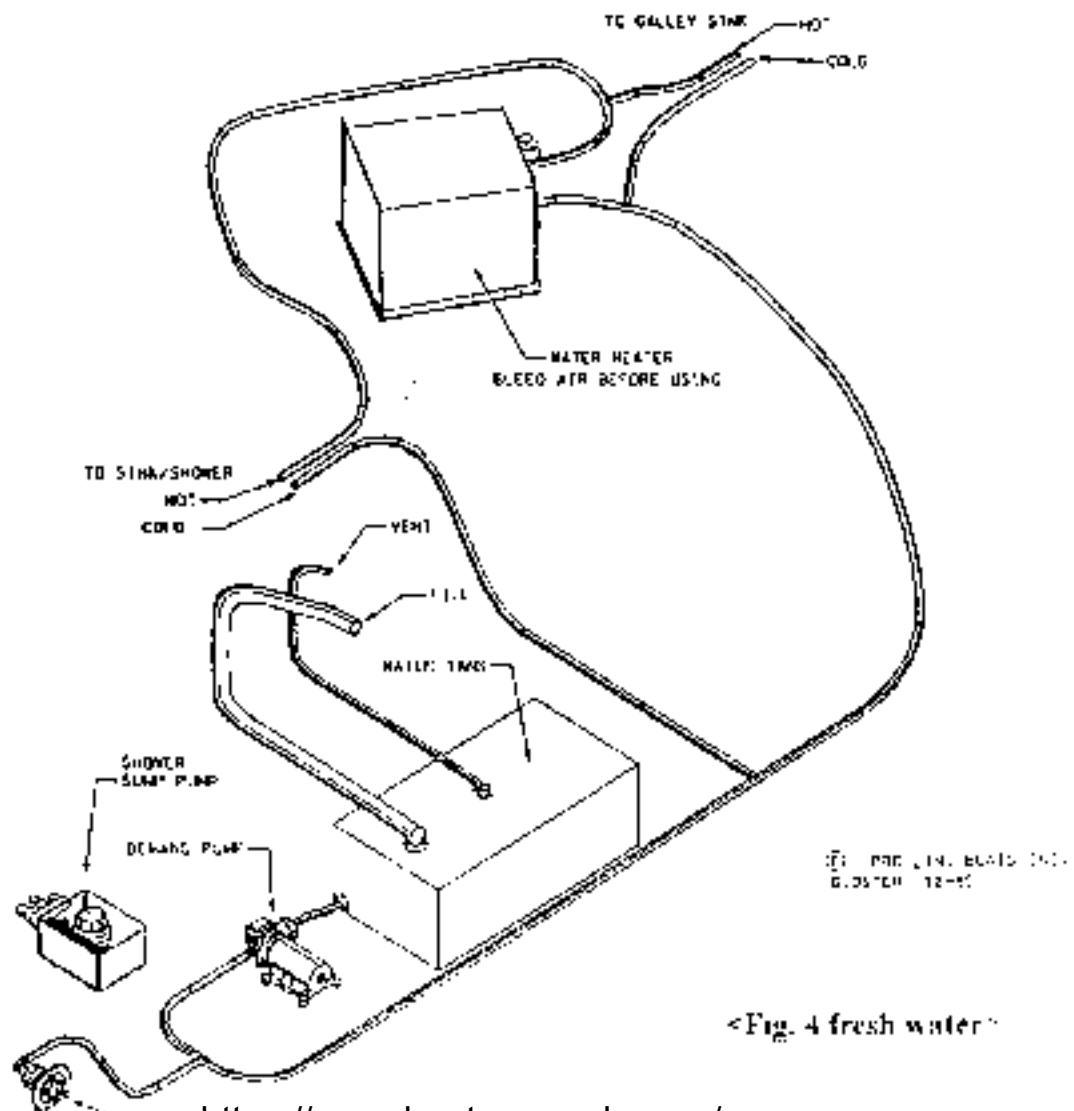

## Sea Water System

The bait-well/ wash down switch controls a demand pump. A valve located on or inside the transom hatch directs flow either to the wash down outlet or through the bait well. Seacocks on all below water line fittings should be closed when not in use.

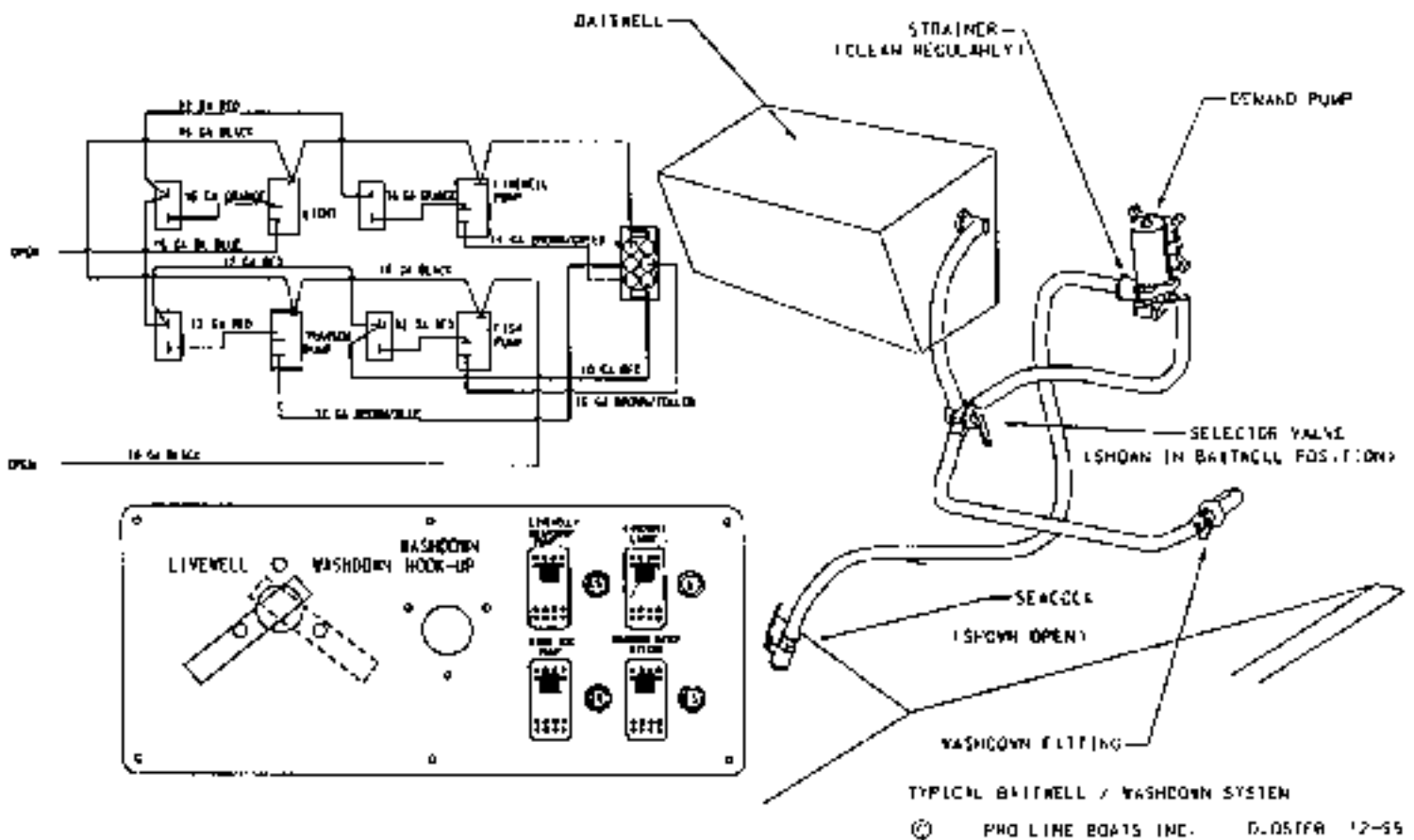

<Fig. 5 raw water>

## Head / Waste

If your Pro-Line is equipped with a portable or electric head refer to the manual supplied in your owner's packet

The electric head utilizes a macerator / waste pump and clean out fittings for dock side operation. A sea valve is provided for offshore operation. A raw water pump with an intake seacock is used for flushing.

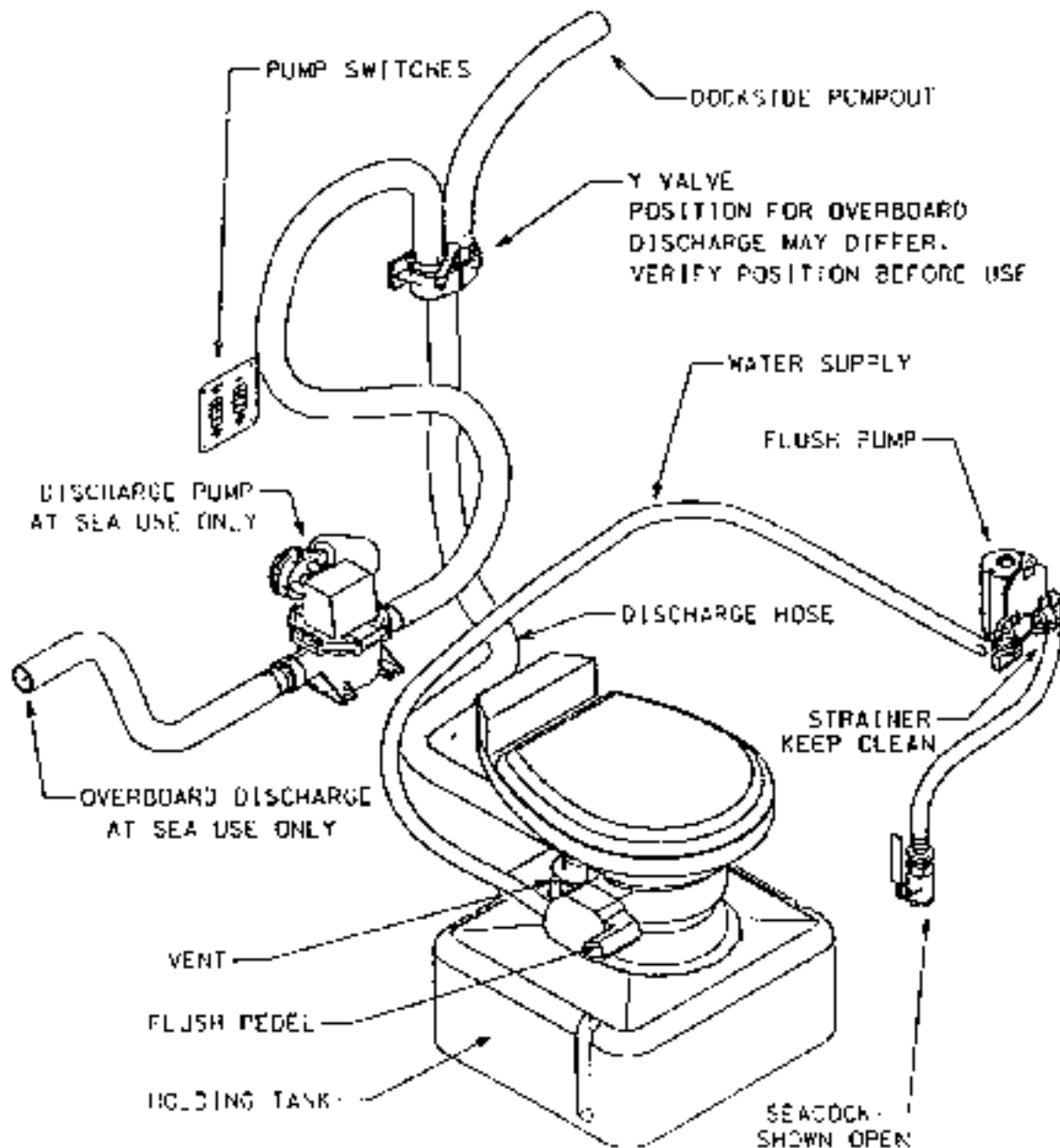

© PRO LINE BOATS INC 1995 BLOSTER

<Fig 6 electric head>



## Air conditioner

The optional air conditioner uses raw water for cooling. The seacock is located in the bilge. A strainer is located between the seacock and the cooling (raw water) pump. When the boat is put in the water the raw water pump must be primed by adding water to the strainer until the pump is full. Do not operate the unit if cooling water is not flowing or the pump will be damaged. If the unit fails to cool first suspect that the intake is blocked or the strainer clogged. make sure that the seacock is open when in use and closed when not in use. If the boat is removed from the water and the seacock is not closed the raw water pump will lose its prime.

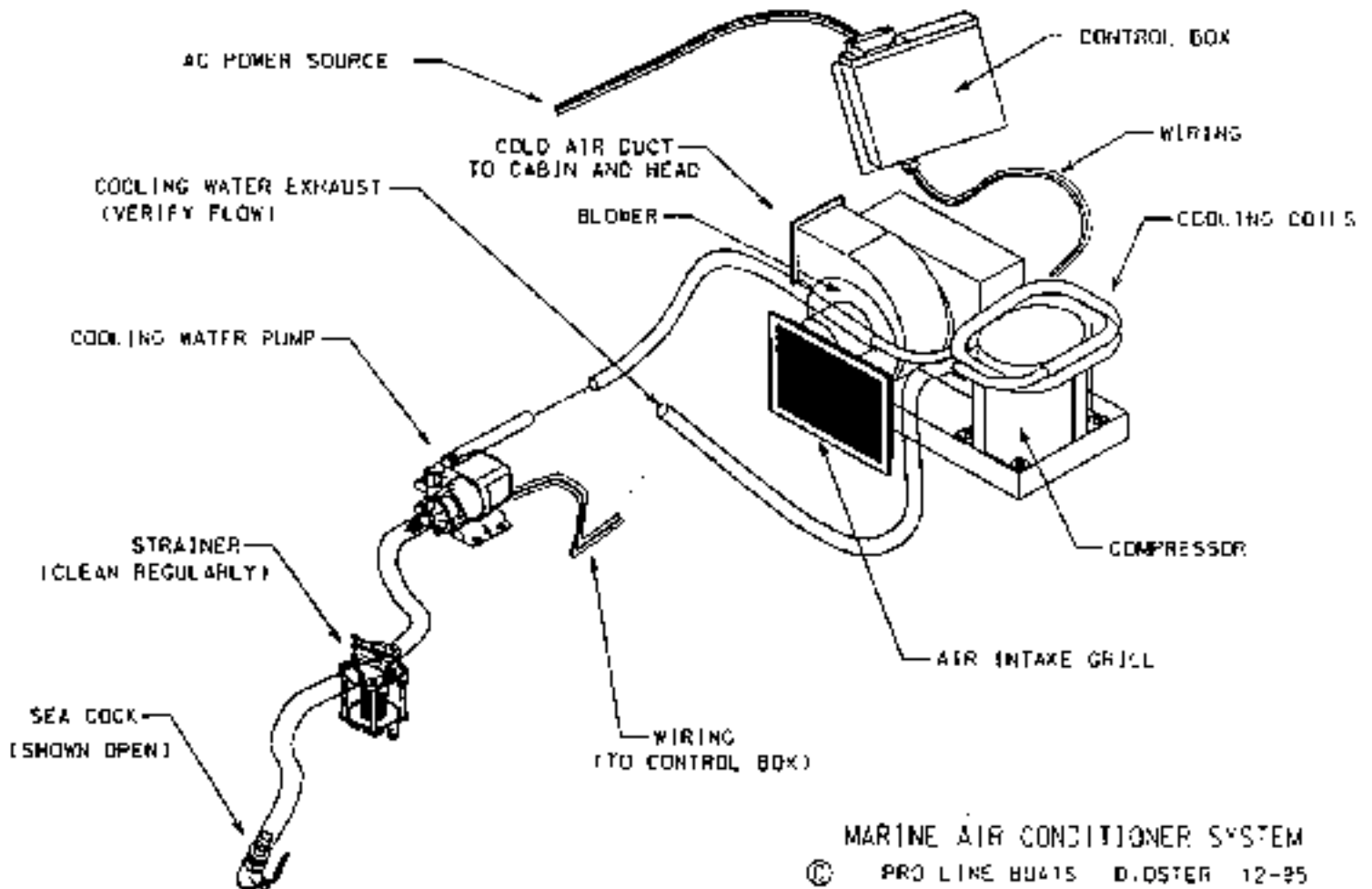

<Fig. 7 air conditioner>

## Fuel / Oil System

The fuel tank on your Pro-Line is made of aluminum with internal baffling to minimize sloshing. The tank is vented over-board, inspect the vent for obstructions regularly. 'Deck plate' access ports are placed over the hose connections and the sending unit. Inspect the hose connections on a regular basis and if you notice fuel odor or see fuel in the bilge.

The 2950 has dual tanks. The fuel selector valves should be positioned so that fuel is drawn from both tanks in an even manner to maintain a level attitude. Normal position for dual tank / twin engine installations is to draw fuel for starboard engine from the starboard tank (port engine from port tank). Use the both or opposite positions only in case of an engine failure.

**Caution:** On a diesel installation, fuel is returned to the tank, this return fuel is not switched by the selector, therefore to avoid a possible fuel spill never switch an engine to the opposite or both position if the tanks are more than half way full (see drawing). Watch your gauges, if you see one tanks level increasing check the fuel selector to make sure the proper engine is drawing from the proper tank.

Pro-Line boats equipped with oil injected outboard engines have on board oil tanks located in the port transom hatch. Ensure that the tanks are well stocked with the recommended 2 stroke oil - refer to your engine manual. It is imperative that the oil supply remain clean and uncontaminated by water or dirt. Check to make sure that the oil lines are free from leaks, kinks, and chafing.

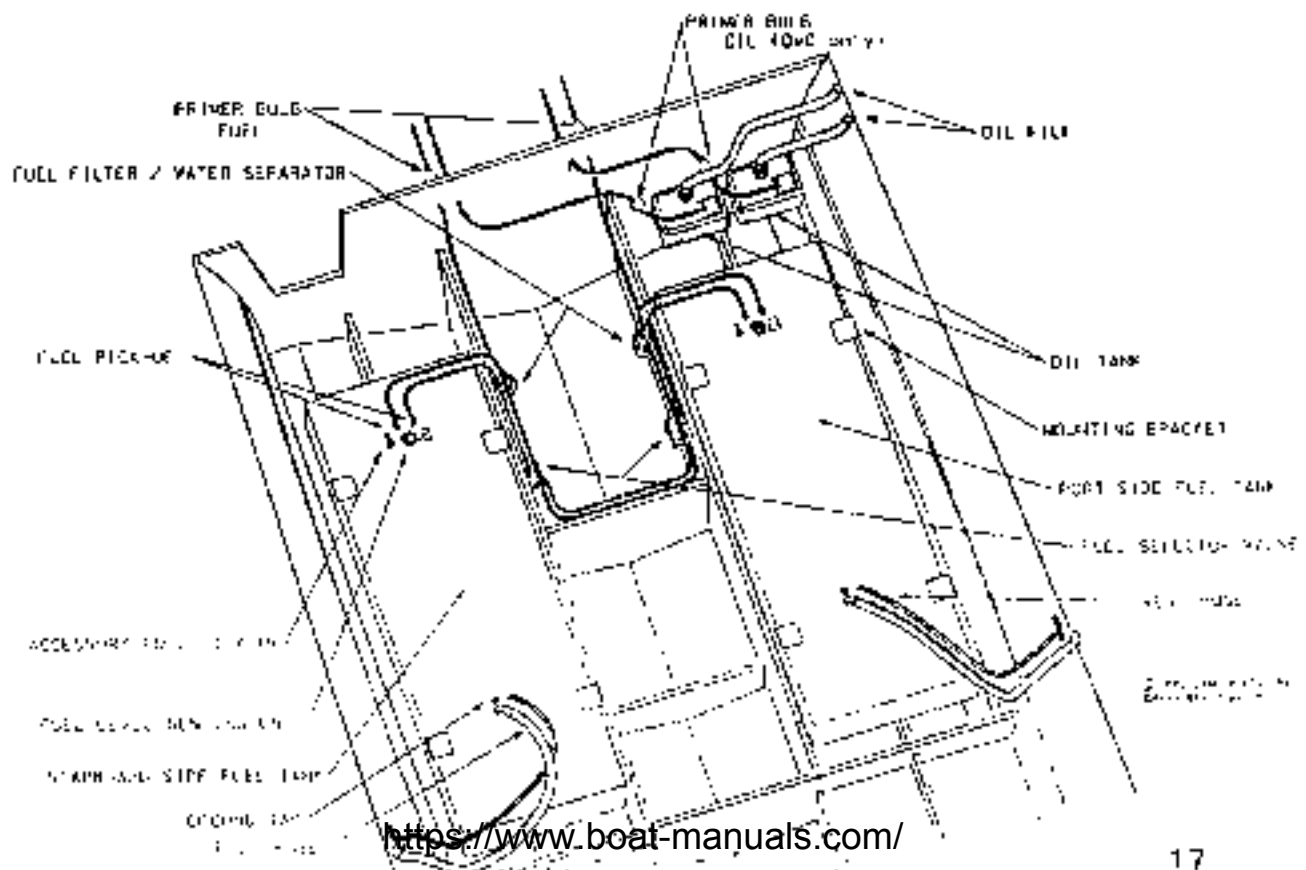

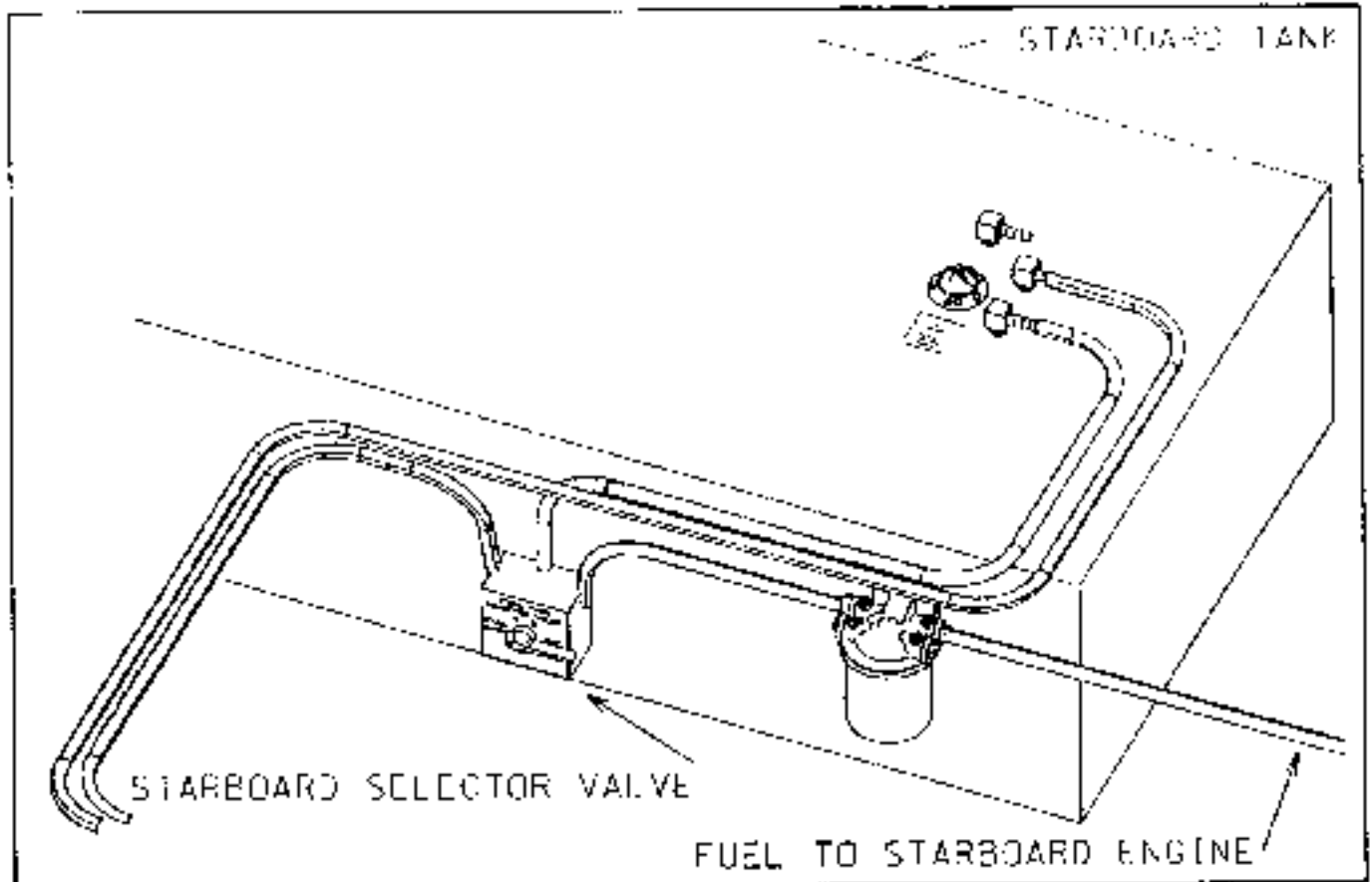

NOTE: FITTING LOCATION AND CONFIGURATION MAY VARY.

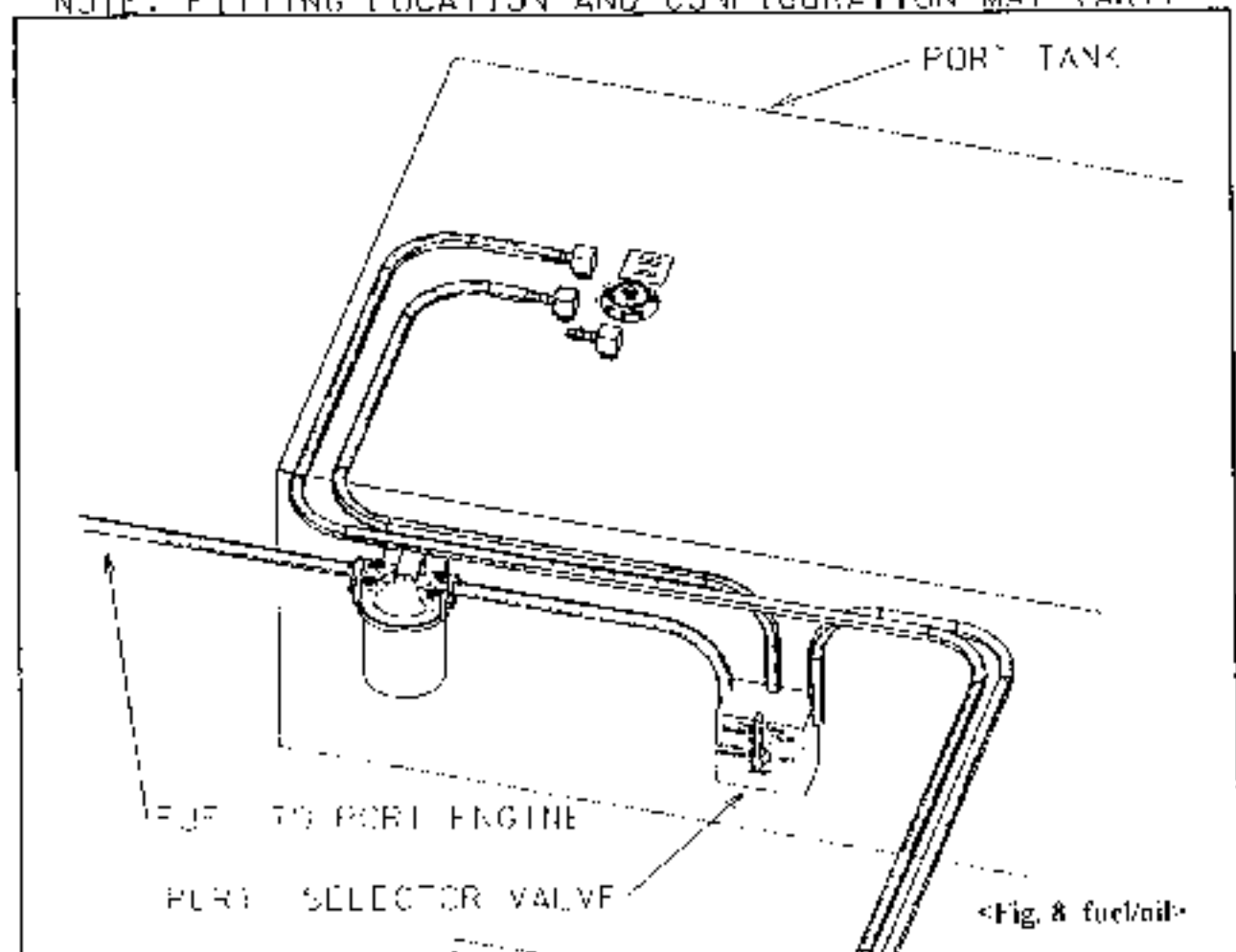

<Fig. 8 fuel/oil>

## Electrical Alternating Current

Shore power is used for the operation of AC devices like your air conditioner, microwave, battery charger, hot water heater and 110v outlets for other appliances. Shore power also operates your refrigerator (12v at sea). The panel is located in the cabin. If the reverse polarity light is on, unplug shore power and do not use it until this potentially dangerous situation is corrected.

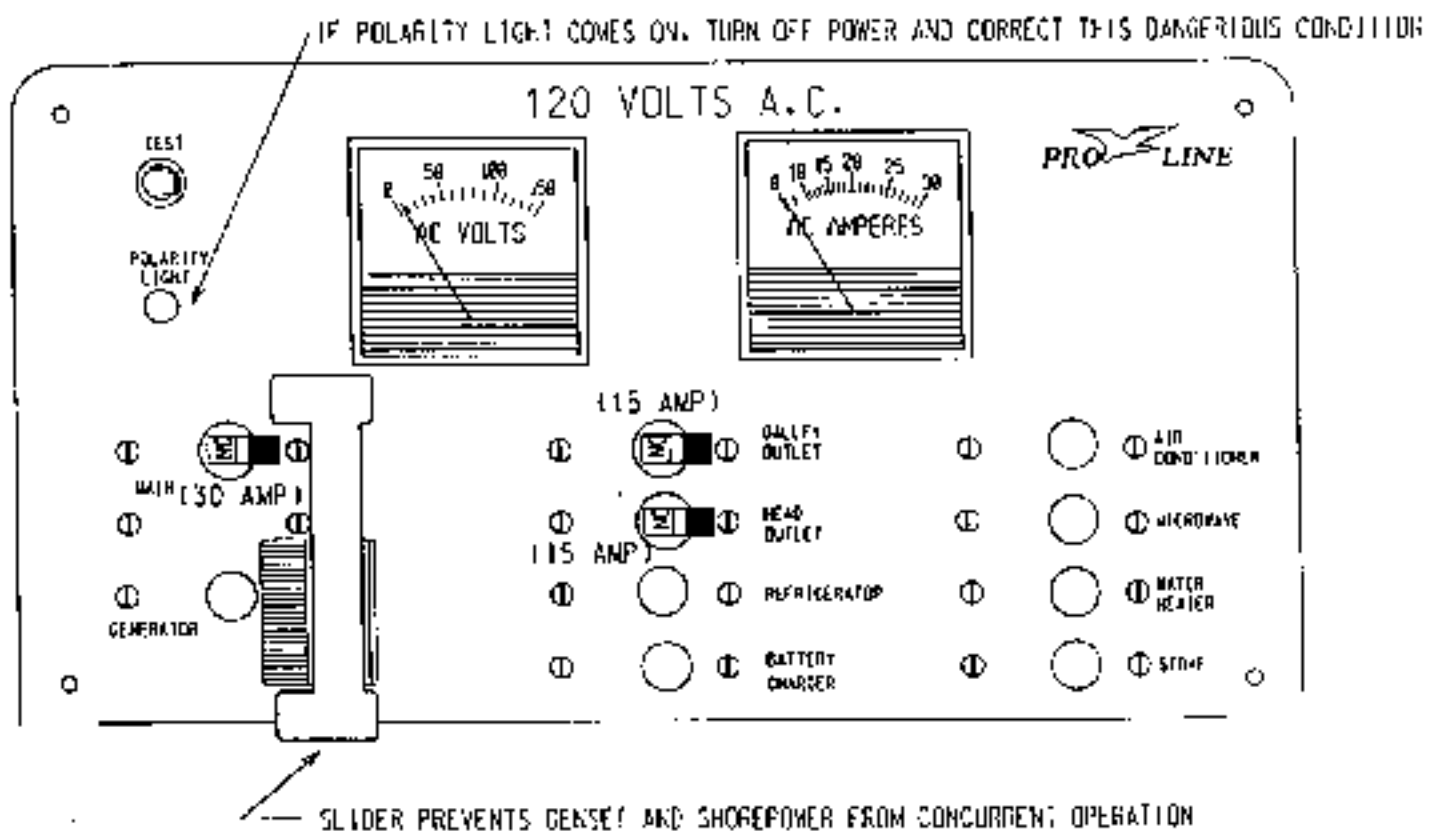

<Fig. 9 a.c. panel>

## Generator

If your Pro-Line is equipped with a generator, you can enjoy the use of your AC appliances while at sea. The generator energizes your AC electrical system by burning fuel from the fuel tank. Refer to the generator manual for maintenance requirements. It is imperative that the generator have cooling water while operating. Make sure the seacock is open and that cooling water is flowing from the exhaust port. Operation without cooling water could cause costly damage. Always shut the seacock when the genset is not in use. Before starting, shut the main breaker switch off to minimize the cranking load.

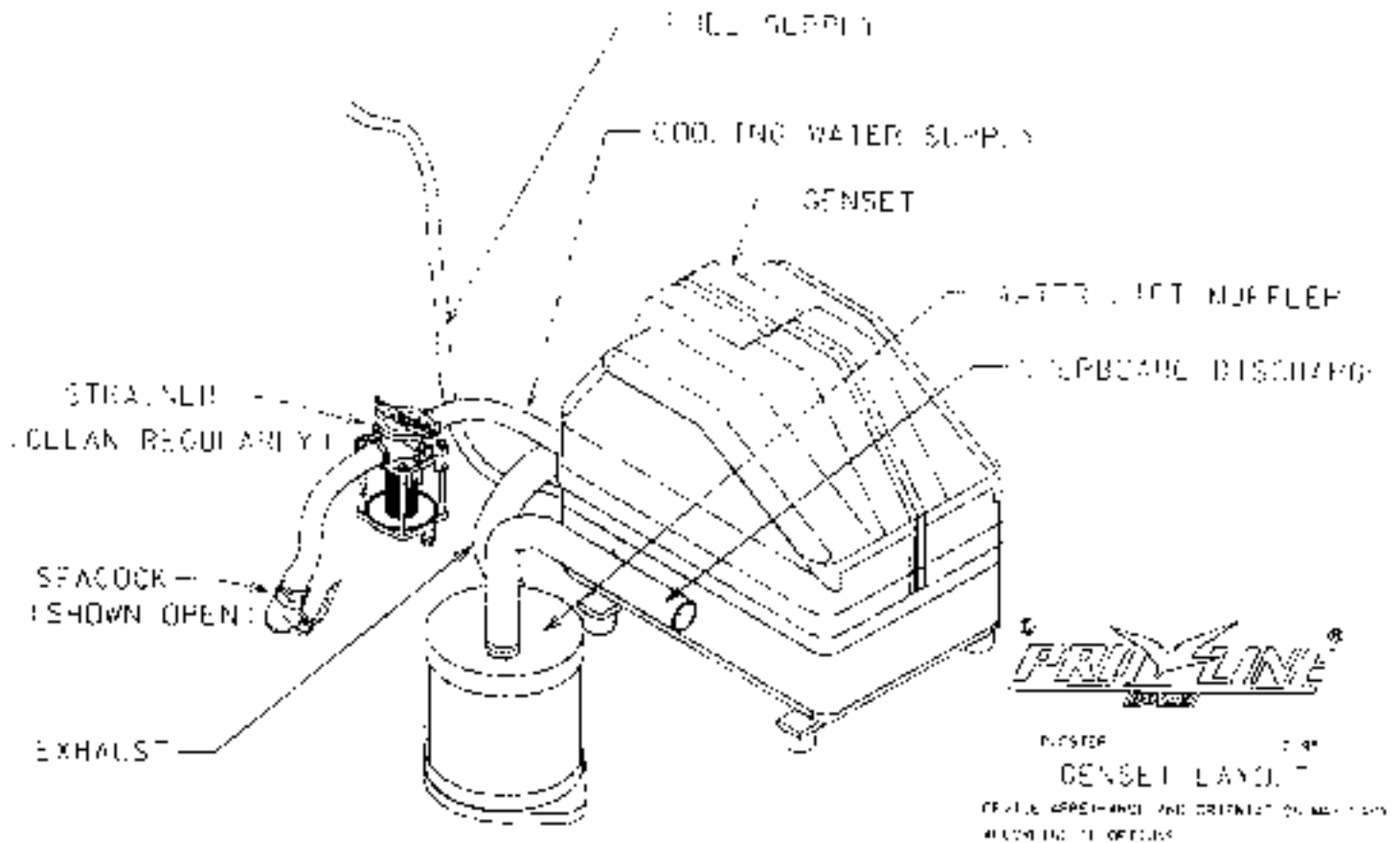
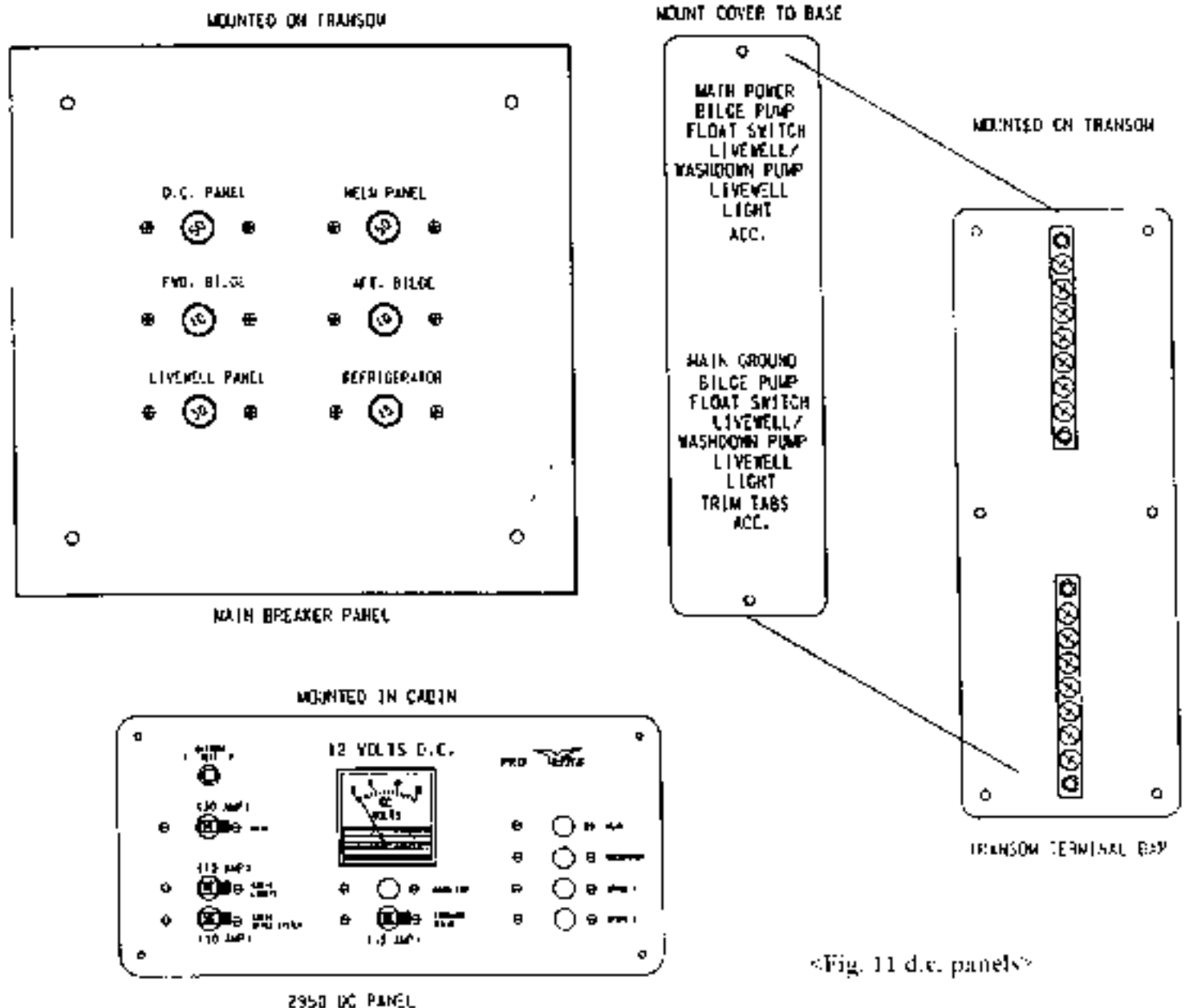

Fig. 10 genset

## Direct Current

12 volt direct current provides electrical power for all lighting, pumps, electronics, and DC devices. A main breaker panel is located on the transom. Battery selector switches are on the transom for battery isolation, parallel operation, and disconnect. **Caution:** To avoid possible alternator / battery damage on twin engine installations, ensure that the optional dual battery switches are never left so both engines are connected together (never leave a switch on 'both'). The preferred switch position is port engine to port battery, starboard to starboard.



<Fig. 11 d.c. panels>



## Aftermarket Accessories

Your Pro-Line electrical system was designed for factory tested and approved dealer installed optional accessories. Pro-Line makes no recommendations to the suitability of accessories that are not listed in the Pro-Line sales literature. Any unapproved modifications or additions to the standard or optional system are done at the owners risk and void the warranty. Unapproved modifications could cause risk of fire or failure of the electrical system.

## Trailer and Launching

Consult your trailer manufacture for specific information relating to your particular trailer. Pro-Line does not make or recommend the use of any particular trailer. Make sure the trailer you use is certified.

Consult your state authority for state regulations pertaining to trailering a boat. Use the following towing check list:

- \* Check brakes if equipped
- \* Check springs and under carriage for cracks, loose parts and fasteners
- \* Ensure tires are inflated to proper pressure, and in good condition.
- \* Check wheel bearings and lug nuts
- \* Verify light and signal operation
- \* Make sure boat is tied down from bow and stern eyes
- \* Stow bimini top and other items likely to blow off or out
- \* Carry a spare tire and tools for changing (spare bearing and race set for long trips)
- \* Securely brace O/B motors.
- \* Go slow over bumps
- \* Check tires and hubs often for excessive heat, service if required
- \* When backing have an assistant watch blind spots and guide with hand signals

## Capacity

The trailer you choose should be a proper match for your boat with regard to capacity and hull design. consult your dealer when making your selection. The tow vehicle must have sufficient towing capacity for the combined load of boat, trailer and accessories. Check the certification label on the forward port (left) side of your trailer to ensure that it has adequate gross vehicle weight rating (GVWR) for the combined boat and trailer.

## Hitch

Ensure that the hitch in the tow vehicle is rated for the GVW or greater, and that the ball size matches the trailer receiver.



## Load Distribution

Generally speaking the tongue weight should be from 5 to 10 % of the GVWR. Make certain that the hull is evenly supported along the length and width with no load concentrations. Make sure that the bottom of the transom is supported and not hanging past the end of the trailer. Load the boat so it is centered side to side, and straight on the supports.

## Launching and Retrieving

### Pre- Launch Check List-

- \* Install drain plug
- \* Remove covers and tie downs (leave bow winch strap in place)
- \* Place lines and fenders if needed
- \* Disconnect lights to avoid shorting
- \* Verify that safety equipment is aboard

### Launching-

- \* If possible use a lookout
- \* Back down the ramp until wheels are under water or the stern of the boat just starts to float (keeping perpendicular to the shore)
- \* Loosen bow strap, board the boat, lower the drive unit and operate the blower 4 min
- \* Start the engine and check the bilge for leaks
- \* Remove winch strap from bow eye
- \* Back boat off of trailer
- \* Dock the boat and park the tow vehicle.

### Retrieving-

- \* Back down the ramp so trailer is half submerged
- \* Carefully line up boat, slowly maneuvering with short bursts of power
- \* When the keel is centered and boat is just touching the trailer, winch (or smoothly apply power) until the boat eases to rest on the bow rest
- \* Secure the bow strap
- \* Haul the boat out of the water and park out of the way of others
- \* Remove the bilge plug
- \* Rinse off salt water if fresh water is available (or as soon as possible otherwise)
- \* Stow equipment and canvas, affix tie downs and covers
- \* Hook up trailer lights and verify operation

## Operation and Performance

### Loading

The capacity plate states the maximum persons and the maximum weight in

pounds for persons, engine and gear that the boat will safely accommodate under normal conditions. These load capacity ratings are computed using USCG formulas. For operation in rough and adverse conditions reduce the boats load to permit safe operation.

The performance of any boat is a function of the amount of load carried, great loads reduce performance. Depending upon conditions and what engine / hull combination you have selected, your boat may not be able to stay on plane when loaded to its maximum rated capacity.

When loading your Pro-Line always.

- \* Maintain a balance both port to starboard and bow to stern.
- \* Keep heavy items as low as possible.
- \* When boarding step (never jump) into the boat one at a time.
- \* Pass gear from the dock to someone in the boat, do not carry gear while boarding.
- \* Never allow passengers to rifle with feet hanging over the side of the boat.
- \* Do not allow passengers to sit or stand on top of the stern, or gunwales of the boat.

## Fueling

Due to the explosive nature of gasoline certain precautions must be observed when fueling.

### Before Fueling-

- \* Secure the boat to the dock with adequate moorings.
- \* Turn off engine and any equipment having brush type (spark producing) contacts.
- \* Close cabin, doors and hatches so fumes don't enter boat.
- \* Disembark all persons not necessary for the fueling operation.
- \* Prohibit all smoking and open flame on board and nearby.
- \* Have a fire extinguisher close by.

### While Fueling-

- \* Keep nozzle in contact with fill opening to minimize chance of sparks.
- \* Do not leave unattended.
- \* Do not spill fuel.
- \* Do not over fill, filling a tank until fuel is vented is dangerous. Allow room for expansion.

### After Fueling-

- \* Close till opening.
- \* Wipe up any spilled fuel. Dispose of rags on shore.
- \* Open cabin door, ventilate boat and run blower (stern drive & inboard).

- for a minimum of four minutes before starting
- \* Check for fumes in bilge, continue to ventilate if present
- \* Verify proper fuel selector valve position (dual tanks only)

## Starting

Follow the information in your engine manual if it deviates from the following instructions.

### Before Starting Engine-

- \* Ventilate all enclosed space, and run blower a minimum of four minutes
- \* Visually inspect bilge for raw fuel, smell for vapors
- \* Visually make sure propeller is clear of obstructions or swimmers
- \* Make sure engine cooling water intakes are submerged
- \* Lock helm seats to face straight forward

### For a Cold Engine-

- \* Pump the throttle two or three times to prime (stern drive only)
- \* Advance the throttle approximately 1/4 open (out of gear)
- \* Activate the choke while cranking
- \* Release the choke as engine smooths out

### For a Hot Engine-

- \* Leave the throttle closed and choke off.
- \* If engine fails to start in 5 seconds, partially open throttle (out of gear) and try again
- \* If flooded, keep throttle open for a few minutes and then crank. When engine starts close throttle smoothly as the engine clears to prevent over revving

After your engine starts make sure to observe a few basic rules to ensure that the engine is functioning properly.

- \* Verify oil pressure and water circulation
- \* Check the water temperature gauge for the first few minutes to make sure the engine is warming properly
- \* Check for leaks especially fuel, shut down and correct if found
- \* Follow the break-in procedures for your engine.
- \* After engine is warm and after the necessary break-in, drive the boat at full throttle for a few moments (if conditions permit) to verify engine is developing full RPM

## Torque

The twisting force that the engine applies to the prop lists the hull of your boat in the opposite direction the propeller is turning. For a large engine or light hull this list can be considerable. A listing hull has more drag on the side that is deeper in the water causing boat to turn in the direction of the list. The trim tab on your out

drive should be adjusted to counteract the torque steer for the load and speed the boat is most often operated at. Consult your engine manual for specific information on trim tab adjustment. Torque induced list can also be corrected by shifting the load in your boat. Twin engines, when counter rotating, cancel the torque and no correction is required.

## **Trim**

The power trim system allows the operator to raise and lower the drive unit or motor through out a infinite number of settings between its upper and lower limits. For every throttle setting there is a trim setting that will yield optimal speed, stability or maneuverability.

For most conditions the best all-round performance is obtained when the bow of the boat is slightly out of the water.

general trim down (or "in") characteristics are:

- \* Starting position for best acceleration to plane.
- \* Lowers bow in the water providing better stability and ride in rough water.
- \* Reduces boat speed and economy due to increased drag of hull and drive.
- \* More spray over bow.

General trim up (or "out") characteristics are:

- \* Raises the bow of the boat in the water, resulting in less hull in the water.
- \* Greater speed and economy for a given throttle setting.
- \* Greater maneuverability (provided prop does not ventilate during the maneuver).
- \* In excess, the reduced stability can lead to bouncing, porpoising and propeller ventilation.

In addition to providing ideal boat performance, the power trim enables the motor or drive unit to be raised (tilted up) for trailering, beaching, and launching.

The electric motor that drives the hydraulic pump is protected by a internal thermal circuit breaker that interrupts the power when overheated. Avoid continued pressure on the switch after the unit has reached the limits of travel (you can hear the difference in sound as the pump strains against the increased load).

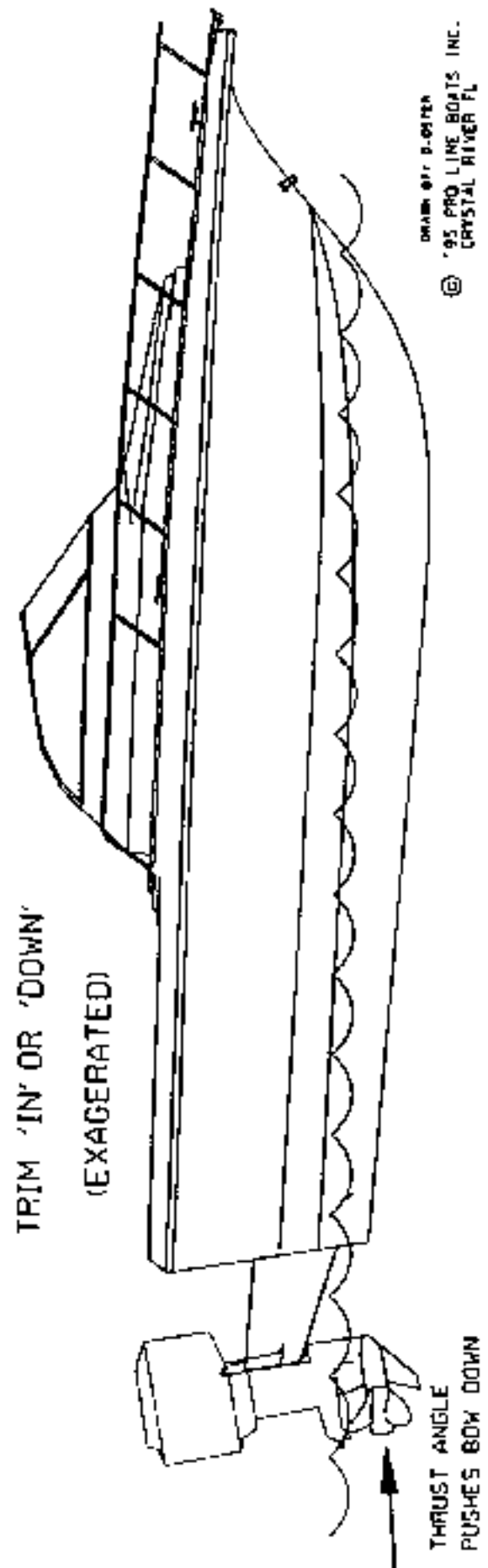
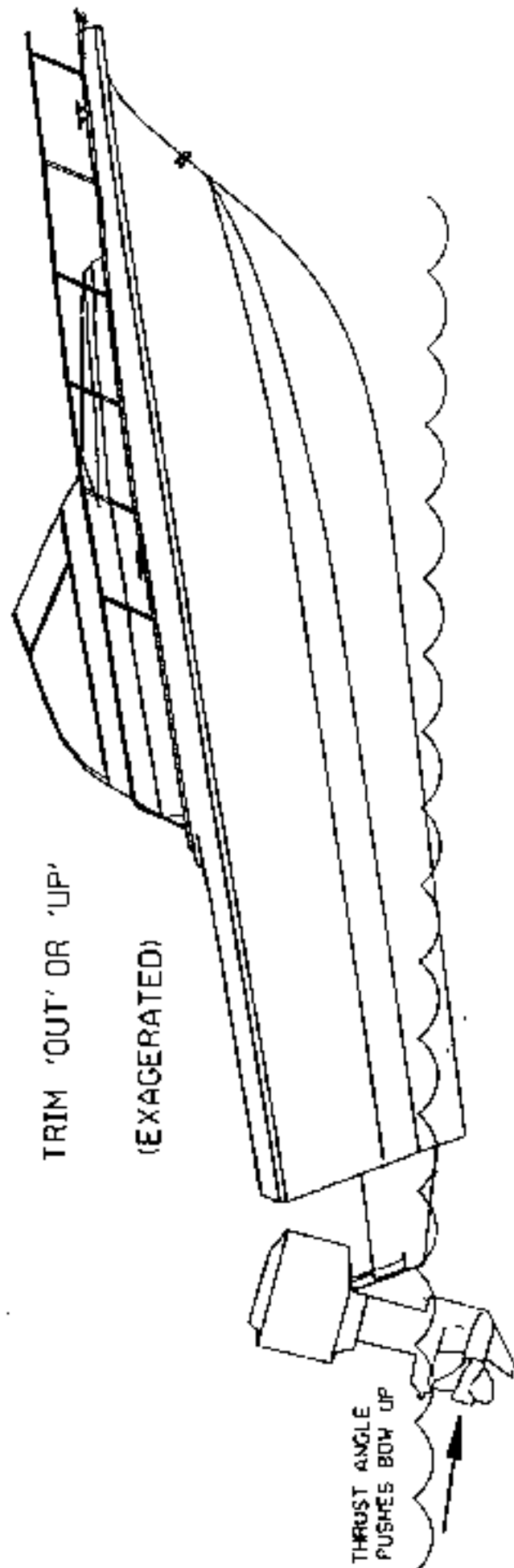

DRAWN BY: D. OSTER  
© '95 PRO LINE BOATS INC.  
CRYSTAL RIVER FL.

<Fig. 13 trim condition>

## Prop

If your Pro-Line was ordered with a factory installed engine it will have a propeller that has been performance tested to provide the best all-round performance for your engine /hull combination at sea level.

In some situations, it may be desirable to re-prop your Pro-Line to enhance desired performance needs. For instance:

- \* Decreasing pitch will enhance acceleration and power at high loads
- \* Increasing pitch will increase speed at light loads
- \* Decreasing diameter will compensate for loss of power at high altitudes
- \* Increasing diameter results in higher efficiency at low speeds at the expense of top speed and acceleration

When re-propping to a lower pitch or smaller diameter be sure not to over rev the engine at top speed, engine damage could result.

Operating your engine with a damaged prop will decrease top speed, increase fuel consumption and may introduce undesirable handling characteristics. The vibration caused by running a damaged prop could cause costly damage to your lower drive unit.

## Service and Care

To enjoy trouble free use of your Pro-Line follow the recommended procedures and instructions relating to the service and care of your boat. Failure to follow the following maintenance practices will result in shorter life of your equipment and may void your warranty.

Much of the installed equipment on your Pro-Line is separately warranted, follow the care instructions found in your owners packet to keep these warranties in force.

Your engine manual contains service information relating to your particular engine installation. Follow the provided recommendations for trouble free service, and to preserve your warranty.

### Fiberglass / Gel Coat

The gel coated fiber glass on your Pro-Line provides a smooth easy to clean and maintain surface. Regular cleaning and waxing will preserve the finish on your boat for many years to come.

Use a mild detergent and plenty of fresh clean water to swab down the exposed gelcoat of your boat, don't use harsh cleaners containing ammonia, chlorine or abrasives. Do not use acetone or any ketone solvents. Stubborn stains can be removed with alcohol or kerosene provided they are washed off immediately and completely with mild detergent and water.

Wax all gel coated surfaces a maximum of twice a year, more often if the boat is

stored in the sun. If due to neglect, the surface takes on a dull appearance that is not restorable by waxing, hand buff with a rubbing compound such as Dupont No. 7, or power buff with Mirror-Glaze No. 1 then wax.

Caution, when power buffing use care not to leave swirl marks or "burn" the surface. You may want to leave power buffing to a professional.

The gel coat on your Pro-Line is approximately 25 mil thick. Minor scratches and deep stains that do not penetrate the gel coat can be lightly wet sanded with 600 grit, buffed and waxed to remove.

If a deep gouge to the surface occurs that goes all the way through the gel coat into the fiberglass it must be repaired promptly to avoid further damage. Your dealer is best equipped to handle this repair and achieve good bonding and color match. There are many different gel coat repair kits on the market for this use however results obtained may not be satisfactory.

For damage to fiberglass that goes deeper than 1/16 inch see your Pro-Line dealer.

### **Marine Growth**

If marine growth is a problem, consult your dealer about an anti-fouling finish for the portions of the hull below the water line. When moored in salt or brackish water it is recommended that you haul the boat out and scrub the bottom every 30 days to prevent the acclimation of marine growth.

### **Windows and Hatches**

To clear acrylic, rinse with fresh water to remove as much grime as possible. Use your bare hand with lots of water so you can feel any grit and avoid grinding it in to the surface as you dislodge it. When all material that may scratch is gone, use a soft clean cloth with a non-abrasive mild detergent and clean fresh water. Rinse and blot dry with a clean dry chamois.

Grease and adhesives may be removed with kerosene, hexane or white gas (not gas you burn in your boat, car or lawnmower.)

Never use solvents like acetone, silicone spray, benzine, carbon tetrachloride, dry cleaning fluid, lacquer or paint thinner, or any chlorinated solvent, on acrylic, since they dissolve the material.

### **Stainless Steel / Aluminum**

Stainless steel is used on bow rail and deck fittings on your Pro-Line. Stainless is corrosion resistant but not corrosion proof. If used in contact with sulfides, chloride salts, or rusting metals, stainless will show rust spots, discolor or corrode. The grain structure of stainless, when modified by welding processes has increased susceptibility to micro-corrosion (invisible to the unaided eye) and embrittlement. Proper care will preserve the weld strength and beauty of your stainless.

- \* Always clean frequently with soap and water, most glass cleaners work.
- \* Always protect with a wax or oil film, especially around welds to guard

- against micro-corrosion cracking and rust spots
- \* Always remove rust spots as they appear with brass, silver or chrome cleaner
- \* Never use coarse abrasives like sandpaper or steel wool, as these can cause rusting
- \* Never clean with acids or bleaches
- \* Never permit contact with iron, steel or other metals which could cause rust or corrosion

## Canvas

**Cleaning:** Brush the canvas with a soft bristle brush and hose down at regular intervals to remove bird droppings, dust and dirt particles. It may be washed with a mild solution of natural soap in lukewarm water (less than 100 deg. F.) **DO NOT USE DETERGENTS**

For more stubborn stains soak the canvas in a solution of 4oz. non-chlorine bleach, 4oz. natural soap and one gallon warm water, for about 20 min. Rinse with cold water.

**Note:** If the water repellence is lost due to cleaning, apply a water repellent treatment as necessary.

The canvas may be washed in a automatic washing machine set on 'cold' using 2 cups non-chlorine bleach & cup natural soap. **DO NOT DRY IN A DRYER, LINE DRY ONLY** to prevent shrinkage. If water won't bead on dry surface, re-treat with water repellent.

**Storage:** Do not fold or store any canvas while wet. All canvas should be rolled or folded when dry and kept in a clean dry location.

## Upholstery

### Vinyl

An occasional wipe down with mild soap and water is all your interior and exterior vinyls need to remain in good condition for many years. We do not recommend the use of any special cleaners sealers or treatments for interior and exterior vinyls.

Refer to the provided brochure.

### Fabric

For all fabrics use dry cleaning fluid only.

## Corrosion Protection

If you moor your Pro-Line in salt water for extended periods make sure to check the transom mounted anti-corrosion anode often for operation. Check the electrical connections (green wire) on all metallic fittings with anode for conductivity with a ohm meter. Make sure the anode surface is exposed and not caked with corrosion and scale. If the anode is more than 50% eroded renew it. Your motor / drive unit has a sacrificial anode made of zinc to mitigate the effects



of corrosion causing, electrolysis. Maintain this anode in accordance with the maintenance schedule in your engine manual.

## **Winterization and Storage**

### **Pre-Storage Check List**

- \* Remove drain plug, keep bow high to drain any water accumulation
- \* Run a pint of RV antifreeze through bilge pump
- \* Drain all water from water systems and head, and pump an approved antifreeze through all pumps, valves, drains and lines
- \* Fill fuel tank and add a stabilizer such as 'STA-BIL' to the gasoline.
- \* Prepare the engine in accordance with manufactures recommendations found in your engine manual
- \* Treat metal parts with rust inhibitor
- \* Remove the battery and protect from freezing. Trickle charge overnight once a month
- \* Place under cover, if on a trailer loosen tie down straps, and unload the tires with blocks.

### **Fitting Out After Storage-**

- \* Check entire fuel system for loose fittings, leaks and damage
- \* Examine the exhaust system on stern drives for rust, loose fittings, and leaks (recheck after starting engine)
- \* Clean battery terminals, install battery(s), and coat terminals with deoxidizing agent
- \* Check all through hull fittings and hoses for obstructions, water tightness and condition
- \* Test navigation, anchor and other lights for operation
- \* Check wiring, terminal blocks and plugs for loose connections and corrosion
- \* Verify switch and equipment operation
- \* Check line condition and inspect anchor and rode.
- \* Install hull drain plug, clean out any debris from bilge and cockpit
- \* Remove antifreeze and flush water system

# Appendix

## Boat Identification Information

Owner: \_\_\_\_\_  
Home \_\_\_\_\_  
Port: \_\_\_\_\_  
Dealer: \_\_\_\_\_  
Boat Name: \_\_\_\_\_  
Registration No: \_\_\_\_\_  
Hull No: \_\_\_\_\_  
Boat  
model: \_\_\_\_\_ LOA: \_\_\_\_\_ Beam: \_\_\_\_\_ Draft: \_\_\_\_\_  
Vertical  
Clearance: \_\_\_\_\_ -Hull: \_\_\_\_\_ -Deck: \_\_\_\_\_ -Interior: \_\_\_\_\_  
Warranty Registration Date: \_\_\_\_\_  
Fuel Capacity Gal.: \_\_\_\_\_  
Ignition Key No: \_\_\_\_\_  
Radio Call Letters: \_\_\_\_\_ Bat. \_\_\_\_\_  
Engine Make & Model: \_\_\_\_\_ HP: \_\_\_\_\_  
Engine S/N: \_\_\_\_\_  
Drive  
S/N: \_\_\_\_\_  
Prop:  
Dia: \_\_\_\_\_ Pitch: \_\_\_\_\_ P/N: \_\_\_\_\_  
Trailer Make &  
Model: \_\_\_\_\_  
Trailer S/N: \_\_\_\_\_ GVWR: \_\_\_\_\_  
Insurance Company: \_\_\_\_\_  
Agent: \_\_\_\_\_  
Policy No.: \_\_\_\_\_ Phone No.: \_\_\_\_\_

## Trouble Shooting Chart

PROBLEM:	POSSIBLE CAUSE:
Low speed or fuel economy	<ul style="list-style-type: none"> <li>*Wrong propeller for load or craft type</li> <li>*Trim is in to far</li> <li>*Load is in far forward or too heavy, or seat has taken on water</li> <li>*Marine growth on hull. Lines or keel keel dragging</li> <li>*Fuel is stale or partially blocked, engine is worn, out of tune or under powered</li> <li>*Improper rigging, air intake or exhaust partially blocked</li> </ul>
Engine cranks but will not start	<ul style="list-style-type: none"> <li>*Out of fuel, filter is clogged, fuel line kinked, fuel vent plugged</li> <li>*Water in fuel</li> <li>*Engine problem (defect with fuel pump, blockage, etc.)</li> <li>*Safety shut down switch lamp not treated</li> </ul>
Engine will not crank	<ul style="list-style-type: none"> <li>*Drive is in gear (check operation of the throttle release).</li> <li>*Battery is weak or terminals corroded or loose</li> <li>*Engine or drive damage.</li> </ul>
Engine starts but won't go	<ul style="list-style-type: none"> <li>*Throttle release is engaged</li> <li>*Disconnected shaft linkage</li> <li>*Damaged prop. or lower drive unit</li> <li>*Entangled in lines or weeds, in Anchor is down</li> </ul>
Prop starts	<ul style="list-style-type: none"> <li>*Trim out too far, motor too high</li> <li>*Washed a prop</li> <li>*Bore holes, damage to hub</li> </ul>
Excessive vibration	<ul style="list-style-type: none"> <li>*Propeller, engine or drive unit damaged</li> <li>*Hull damage</li> </ul>
Head won't turn	<ul style="list-style-type: none"> <li>*Steering unit needs fluid or has trapped air, filter is Disconnected (helm tops)</li> <li>*Steering trunion or mechanism jammed (helm won't turn)</li> </ul>
Electrical problems (see wiring diagram)	<ul style="list-style-type: none"> <li>*Corroded wires, terminals, or plugs</li> <li>*Broken, loose or short circuited wires</li> <li>*Circuit breaker tripped</li> <li>*Defective switch, device or breaker</li> <li>*Inline fuse burnt out</li> <li>*Overloaded circuit</li> </ul>
Handling problems like: Porpoises Runs wet Hard ride List Overhang in turn Catches in turns	<ul style="list-style-type: none"> <li>*Trimmed out too far, damaged hull (cocker), trim tabs up, stem heavy.</li> <li>*Trimmed in too far, bow heavy, trim tabs down, overloaded for conditions</li> <li>*Stem heavy, trimmed in too far, going to fast for conditions.</li> <li>*Loaded to one side, trim tabs set wrong, trimmed to far in, fuel tanks uneven</li> <li>*Trimmed in too far, improperly located load, thruster adviced to far</li> <li>*Damaged hull (cock): stem heavy, trim tabs down</li> </ul>

## Nautical Terms

- Abram:** At 90 degrees to the center line of the boat, exactly to either side of the boat
- Abaft:** A point on a boat that is aft of another
- Aft:** Toward the rear of the boat
- Beam:** The widest part of the boat
- Bilge:** The lower interior of the hull
- Bow:** The fore part of a boat
- Bulkhead:** A vertical partition or reinforcement in a boat usually perpendicular to the keel
- Chine:** The juncture of the bottom and the side of the boat
- Check:** Deck fitting used to guide a line.
- Cleat:** Deck fitting used to secure a line to.
- Deck:** Upper structure of a boat which covers the hull
- Draft:** The distance the lowest part (usually the keel) of the boat projects into the water.
- Fathom:** A unit of measure equal to six feet
- Freeboard:** The height of the deck above the water line.
- Gunwale or Gunnel:** The juncture of the side of the cockpit, deck and hull
- Hatch:** An opening used for access to an interior space
- Head:** Toilet or toilet area in a boat
- Helms:** Steering wheel or console area of a boat
- Hull:** The basic structure of a boat, that provides flotation by displacing and excluding water.
- Keel:** The major lengthwise member of the hull, the lowest portion of the hull
- Knot:** A measure of speed in nautical miles per hour, equal to 1.15 MPH
- Lee:** The side sheltered from the wind.
- Port:** The left side of the boat when aboard the boat facing the bow
- Scupper:** Duct to drain water from the cockpit, usually with a check valve to sea water intrusion
- Sheer:** The juncture of the deck and the hull, generally covered by the rub rail
- Starboard:** The right side of the boat when aboard the boat facing the bow
- Stern:** The back of the boat
- Stern Drive:** Inboard /outboard I/O drive unit
- Stringer:** Lengthwise reinforcing members of the hull
- Transom:** Vertical part of the stern
- Wake:** Waves produced by a boat moving through the water
- Windward:** Toward the direction from which the wind is blowing

<b>Specifications:</b>	<b>2950</b>
Length over all	30'
Beam	10' 9"
Draft	22"
Freeboard	31"
Weight (hull only)	7500 lb
Fuel capacity I/O -O/B	200 g / 300 g
Max. Horsepower I/O -O/B	500 / 400

Specifications subject to change without notice





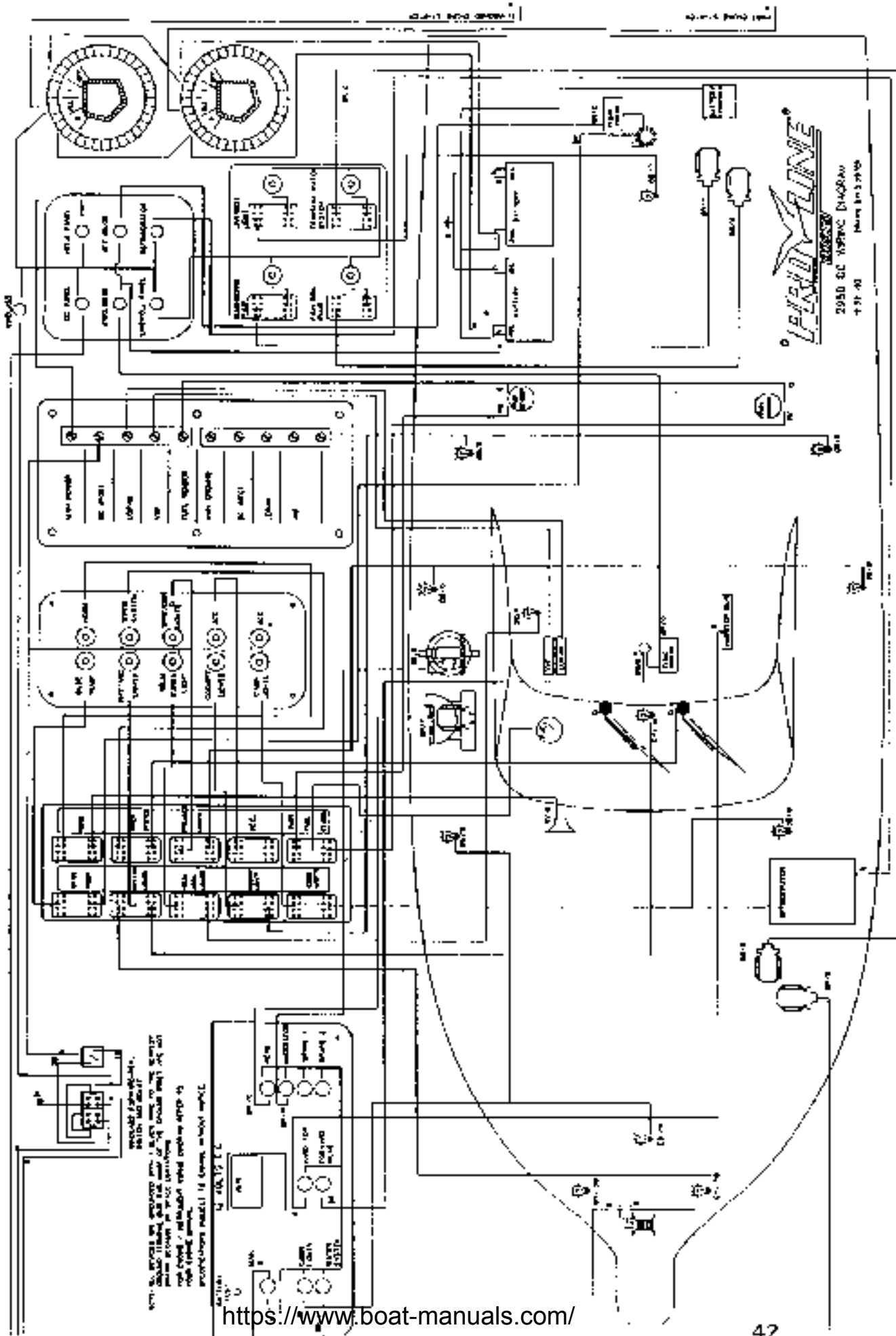

2. To check the engine, please refer to the engine manual for the correct procedure. The engine should be started and run for a few minutes before the battery is disconnected. The battery should be recharged after the engine is run.



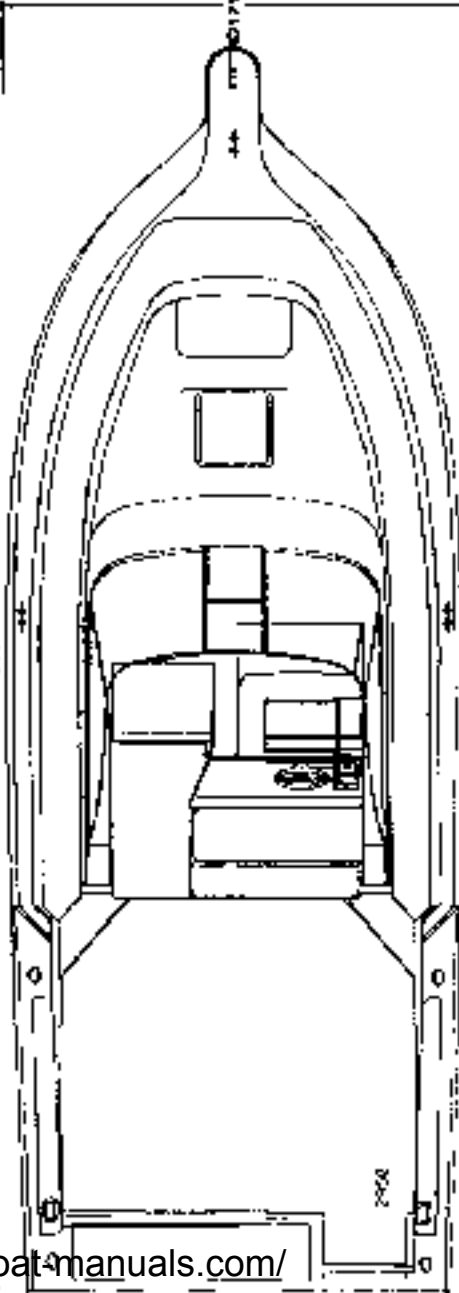
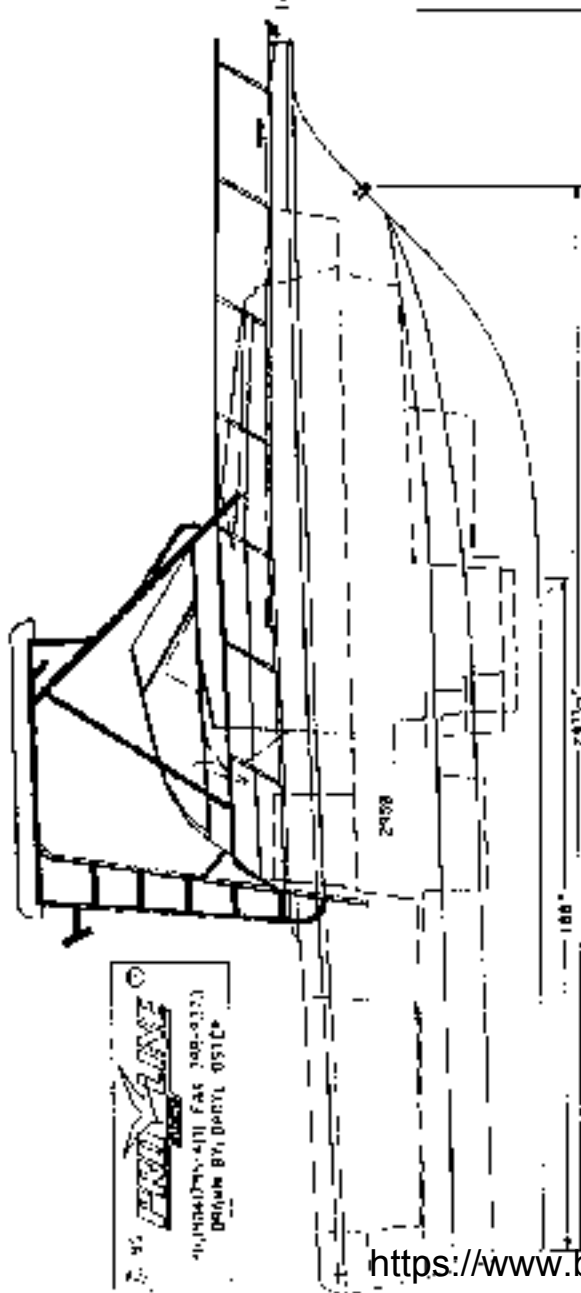
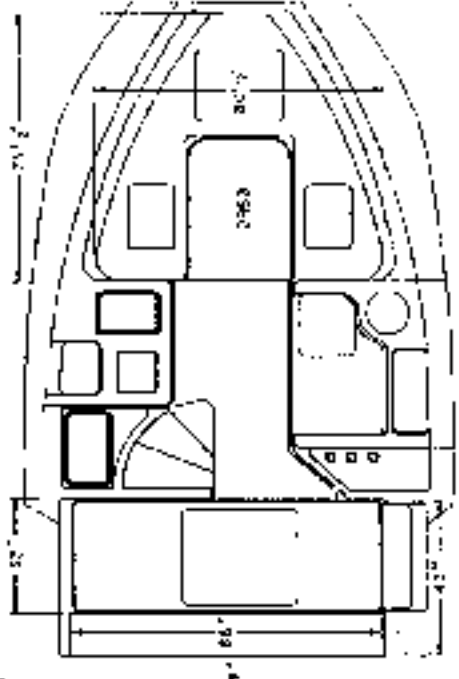
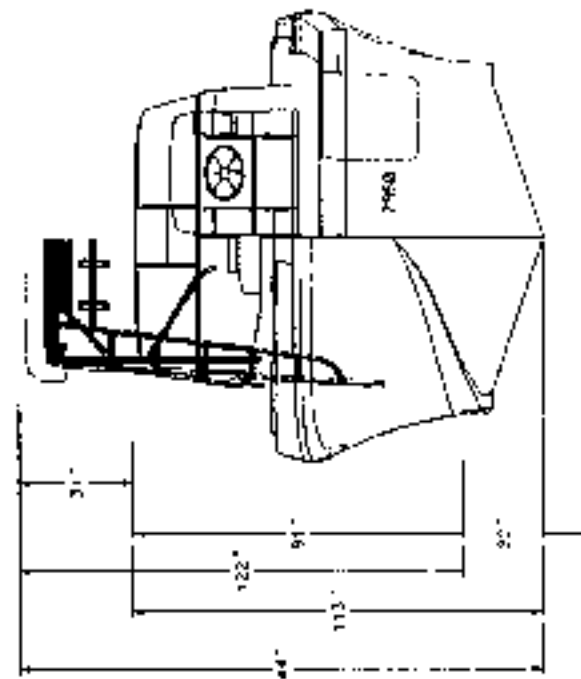

**FRONTRUNNER**  
 2008  
 20' x 8'6" x 5'11" (6.1m x 2.6m x 1.8m)  
 DECK: 8'6" (2.6m)

