



Owner's Manual

Pro-Line

29 Super Sport



Pro-Line Boats Inc., P.O. box 1348,
Crystal River, FL 34423. All rights reserved. Rev. 10-20-03
Specifications subject to change without notice. Actual boats may vary from drawings.

Table of Contents

- I. Introduction
 - Dealer / Customer responsibilities
 - Registration
 - Insurance
- II. Safety
 - Regulations
 - Equipment
 - Passenger safety
 - Rules of the road
 - Hazardous conditions
 - Alcohol
 - Carbon monoxide
 - Fire
 - Flooding
- III. Controls
 - Ignition
 - Choke
 - Lanyard Stop Switch
 - Shift / Throttle / Trim
 - Steering
 - Instruments
 - Switches
- IV. Systems
 - Fresh Water
 - Sea Water
 - Fuel / Oil
 - Head / Waste
 - Electrical
 - After Market Accessories
- V. Trailering and Launching
 - Capacity
 - Hitch
 - Load Distribution
 - Launching and Retrieving
- VI. Operation and Performance
 - Loading
 - Fueling
 - Starting
 - Trim / Tilt
 - Prop
- VII. Service and Care
 - Fiberglass / Gel coat
 - Marine growth
 - Windshield / Acrylics

- Stainless Steel / Aluminum
- Canvas
- Upholstery
- Corrosion Protection
- Winterization and Storage
- VIII. Appendix
 - Boat Identification Information
 - Trouble Shooting Chart
 - Nautical Terms
 - Specifications
 - Wiring Harness Drawing

Introduction

Congratulations! You are now the proud owner of a new Pro-Line *29 Super Sport* fishing boat.

Welcome into the proud family of satisfied Pro-Line owners. Every expedition lets you enjoy the outstanding features designed into every boat we construct. Your new Pro-Line is more than just a boat, it's a lifestyle.

Pro-Line's commitment to the needs and wishes of the professional sport fisherman has resulted in a superior fishing craft, providing you with comfort, performance, security and fishability. All of our boats comply with U.S. Coast Guard (USCG) safety regulations, and are designed and crafted in accordance with the National Marine Manufacturers Association (NMMA), American Boat and Yacht Council (ABYC) standards, and the optional Common European directive (CE).

This manual (to be kept onboard your Pro-Line) is designed to provide you with information necessary for safe, efficient operation and care of your new Pro-Line. Take the time now to carefully review the information in your owner's pack and this manual to maximize your enjoyment and safety as well as familiarize yourself with your new boat.

Dealer's Duties

Your dealer's responsibilities include but are not limited to:

- * Pre-delivery verification of proper rigging and operation.
- * Providing adequate orientation in general operation of your Pro-Line including explanation of specific safety considerations regarding the use of systems and components.
- * An explanation of owner's packet literature and warranty registration cards for all separately warranted equipment and accessories.
- * Explaining local and out of area service procedures during and after warranty periods.

Customer Responsibilities

- * Be proficient in boat handling and safety. **THIS MANUAL IS NOT INTENDED TO PROVIDE COMPLETE TRAINING ON ALL ASPECTS OF GENERAL BOAT OPERATION.**
- * Read and understand the limited warranty.
- * Read all literature and instructions as well as use and maintain all equipment as directed.
- * Examine the boat at time of delivery to insure that all systems are functioning properly.
- * Learn about and operate boat in accordance with local, state, and federal laws, regulations, and **registration** requirements.
- * The owner is legally responsible for all liabilities of operation. Secure **insurance protection.**

Safety

Your Pro-Line boat has been constructed with safety in mind. However, the ultimate safety of you and your passengers is in your hands. Plan your trips carefully. Insure ample fuel supply and a reserve. Tell someone where you are going and when you expect to return. Keep current charts onboard. Read USCG boating safety circulars and follow the safety guidelines.

Regulations

The USCG is the authority of all waterways. State boating regulations, are enforced by local authorities. You are subject to marine traffic laws and "Rules of the Road" for both federal and state waterways. Therefore, you must submit to boarding if requested by proper authority. There are many publications available from the Coast Guard concerning regulations. Call the Boating Safety Hot Line at (800)-368-5647 for additional information.

Equipment

USCG regulations require the following equipment while operating your boat:

- * Fire extinguisher
- * Personal Flotation Device (PFD) for each occupant
- * One throwable PFD
- * Sound signal device
- * Navigational lights if operated at night
- * Sight signal (flare - night, orange flag - day) when in coastal waters or great lakes.

In addition, here is a list of suggested equipment you should have aboard your Pro-Line:

- * First aid kit and blankets
- * Mooring lines and fenders
- * Combination oar / boat hook
- * Spare prop and hardware
- * Spare fuses and bulbs
- * Local charts and compass
- * 2 way radio
- * Floating key chain and spare keys
- * Emergency food and water
- * Sea anchor with line
- * Bailing device
- * Tool kit and lubricant
- * Spare fasteners, hose clamps, and plugs
- * Binoculars
- * Water proof flashlight
- * EPIRB (emergency beacon)
- * Navigation device
- * Water proof matches or lighter

Passenger Safety

You are responsible for the safety and conduct of your passengers. Make sure that:

- * You instruct passengers on proper use and location of PFD's. Children and non-swimmers should wear one at all times.
- * Each passenger is in a safe location when underway and knows to keep the boat balanced.
- * At least one other person knows how to operate the boat in case of emergency.
- * They are aware of prop dangers and the possibility of sudden maneuvers and jolts.

* The engine is turned off and the key is removed when swimmers are near the

prop or using the dive platform.

* All keep away from lines under stress should they break and recoil.

Rules of the Road

Know and use the rules of the road. The information here is only a brief overview. Contact the USCG for detailed information.

Audible warning signals:

- * One short horn blast: starboard course change.
- * Two short horn blasts: port course change.
- * Three short horn blasts: astern operation.
- * Five horn blasts: doubt about previous signal, or danger.
- * One, Five second, horn blast every minute: for fog operation

When overtaking, give-way vessel announces intention with horn blast(s) and waits for a response, then completes maneuver.

When approaching head-on, both boats give way after giving appropriate horn blast(s) (preferably to starboard).

When crossing, a vessel converging from starboard has the right-of-way. Port vessel gives way (both acknowledge with one short horn blast).

Know and observe navigational buoys and markers.

Give way to craft under sail.

Hazardous Conditions

Keep track of weather developments and avoid hazardous conditions if possible. When forced to operate your Pro-Line in storm conditions:

- * Wear PFD's
- * Stow loose gear and equipment.
- * Place heavy items as low as possible.
- * Head for the easiest to reach safe location.
- * Reduce speed. You are moving too fast if the boat leaves the water.
- * If power fails, rig a sea anchor off the bow (an empty ice chest in a pinch).
- * Stay with the boat if it capsizes unless it is burning out of control.

Alcohol

Don't drink and drive. If you have been drinking, have a designated driver who has not been drinking. Never operate a boat under the influence of drugs or alcohol.

Carbon Monoxide

Be aware of and avoid conditions that can cause carbon monoxide poisoning (see USCG boating safety circular 77). Sources of carbon monoxide include any gas or diesel engine, any flame such as a charcoal grill, stove, or heater. Carbon monoxide can accumulate to deadly levels in enclosed spaces. Always ventilate occupied areas of vessel with fresh clean air.

Fire

Be aware of and avoid conditions that can lead to accidental fire. Guard against and watch for fuel spills and leaks. Inspect wiring for damage or exposure that could lead to short circuits or arcing. Make sure those who smoke are careful to avoid accidental fire ignition. Don't allow smoking while fueling. Keep a USCG approved fire extinguisher on board at all times. Inspect the fire extinguisher regularly and learn how to properly use it (instruct others as well). Use water to fight a fire as a last resort after making

arrangements to abandon the boat if a fire should get out of control. Keep the following in mind if a fire is burning out of control and you must abandon the boat:

- * Abandon the boat into the wind to minimize burn risk from floating fuel.
- * Wear a PFD unless you must swim under burning fuel.
- * If swimming under burning fuel, throw a PFD outside of the burning area and swim under the burning fuel to it.

Flooding

Be aware of and avoid conditions that can cause your boat to flood with water.

Possible causes of flooding include: damage to hull or thru-hull fitting, waves washing into the boat, water entering cockpit due to improper loading, or failure to properly install drain plug. The boat will become flooded and may swamp, capsize, or sink if water enters the boat faster than the bilge pump can expel it.

Controls

Pro-Line Boats offers many different motor choices. Therefore, the information in this manual is general in regard to engines and controls. Refer to the engine manual in your owner's packet for additional specific information.

Ignition

The ignition switch has three positions: "OFF", "ON", and "START". To start the engine: attach safety lanyard and turn the key clockwise against the spring pressure to the start position. Once the engine starts, release clockwise pressure allowing spring tension to return switch to the "ON" position. Some engine models incorporate the choke into the ignition key switch. See the engine manual for specific details.

Choke

The choke is only used to aid in starting a cold engine. Choke operation varies with manufacturer. Consult your engine manual.

Lanyard Stop Switch

The safety Lanyard Stop Switch shuts off the engine in case the operator is thrown from the boat. Always attach the lanyard securely to the operator to insure proper functioning.

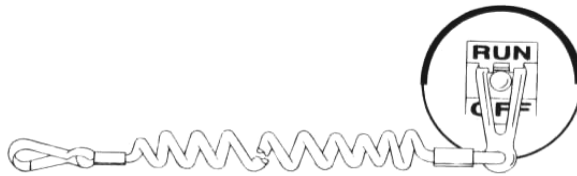

LANYARD STOP SWITCH

Shift/ Throttle/ Trim

Your Pro-Line can be ordered with different shift / throttle systems. Refer to the owner's packet to find the manual pertaining to your particular installation. Separate shift and throttle controls are available for each outboard motor. The throttle lever has three range positions: "Forward", "Neutral", and "Reverse". The shift function occurs in the first portion of the lever travel. After the transmission is shifted into gear, further movement of the lever advances the throttle. Push the throttle lever ahead to move forward and pull it back for reverse. Centralize the lever to the detent for neutral. The throttle lever is

equipped with a neutral safety switch to prevent the motor from starting in gear. Practice shifting a few times, without the engine running to develop a feel for the range and friction of the system. The initial short movement of the lever to engage the transmission should be made firmly to avoid causing gear clash. **CAUTION: Use care in shifting to avoid advancing the throttle more than intended.** Practice in a safe area away from obstacles until familiar with the feel of the throttle. The throttle can be operated independent of the transmission for starting. If attempting to start an engine this way, keep a hand on the throttle to pull it back as the engine clears to prevent over revving. The shift levers can be operated independently for precise maneuvering (twin engines at slow speed only). Refer to the engine / drive manuals in your owner's packet for specific information.

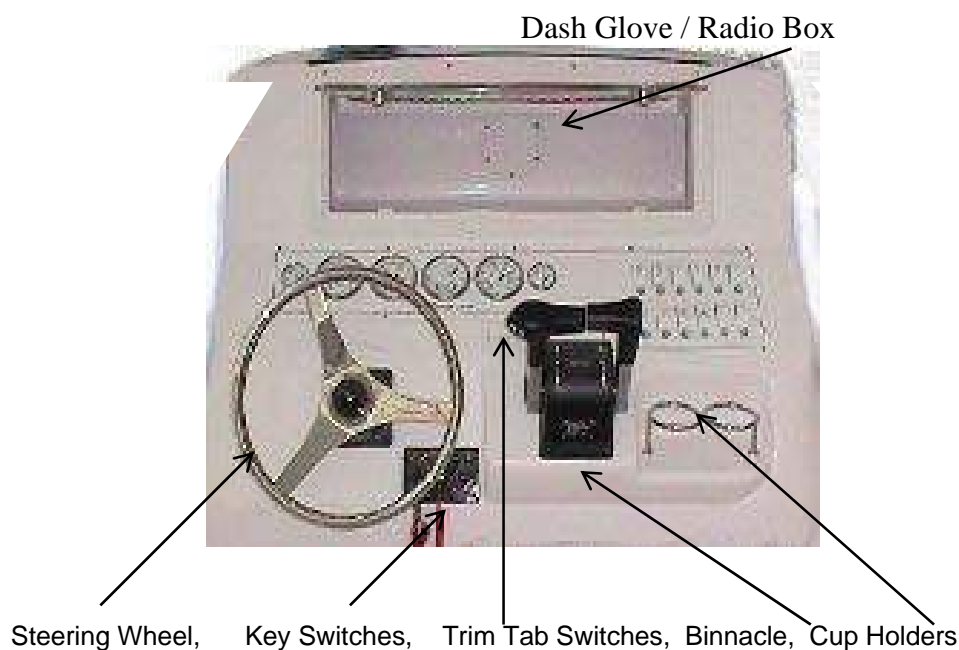

Steering

Your Pro-Line is equipped with a self contained hydraulic steering system. When the steering wheel is turned, the helm pump pumps fluid to the steering cylinder causing it to extend or retract. Periodically check the fluid level and fill if necessary. Beware of adding too much fluid, especially if the ambient temperature is cold because subsequent expansion could cause leaking or damage to your system (refer to manual in packet). Every 24 hours of operation check all nuts, caps, and hose fittings for tightness. Make sure the hoses are not chafing, or kinking on sharp corners. Also, check that hose ends are not damaged or distorted. The fluid should be changed annually under normal conditions and every six months during times of heavy usage. If your steering does not operate properly, first check for: drive entanglements, fluid level, hoses / fittings for leaks, and / or air in the system.

Instruments

Your Pro-Line's instrumentation will vary from model to model and engine to engine. Therefore, the following descriptions are general. Refer to your engine manual for specifics.

Fuel Gauge

Differences in temperature, humidity, speed, and trim can affect the actual accuracy of this gauge in service. It is important to verify the fuel flow in gal./hr. for your boat and make note of your gauge position with respect to time for different RPM settings. No gauge can give 100% accuracy. If you notice unusually high or low fuel consumption, investigate further to see if the engine is using more fuel than normal or the gauge has failed.

Temperature

The temperature gauge indicates the internal temperature of your engine. Your engine is equipped with a thermostat to quickly bring the engine up to its optimum operating temperature range. Outboard engines are also equipped with an audio alarm system indicating an overheat condition. Many times over heating may occur due to a blockage of the water intakes caused by aquatic vegetation or mud. Check the water intakes for blockage and see the engine manual for specific details.

Volt

The volt-meter indicates battery voltage. A low reading indicates too heavy of a load or a malfunction in the charging system. Too high of a voltage indicates a fault in the charging circuitry and continued operation will damage the battery. Refer to engine manual for specifications.

Tachometer

The tachometer indicates the revolutions per minute (RPM) of your engine. Do not operate the engine beyond the limits stated in your engine manual. Abnormally low tachometer readings (for a given throttle setting) indicates loss of power, or a prop entangled with weeds or trash. Check the prop first. A reading higher than normal may indicate a ventilating or cavitating prop as well as possible prop/drive damage.

Speedometer

The speedometer indicates the speed of your boat in Miles Per Hour (MPH) and Kilometers Per Hour (Km/H). The gauge operates by sensing water impact pressure from the pitot tube which is mounted on the transom (or integrated into the lower drive unit of the motor) depending upon the motor manufacture. Suspect a blocked pickup if the gauge fails to give a reading.

Trim

The trim gauge indicates the in (down) and out (up) position of the drive unit in relation to the hull.

Options

Optional instrumentation for your Pro-Line includes: fish locator / depth finder, VHF radio, GPS navigation aids, etc. Refer to the manuals supplied.

Switches

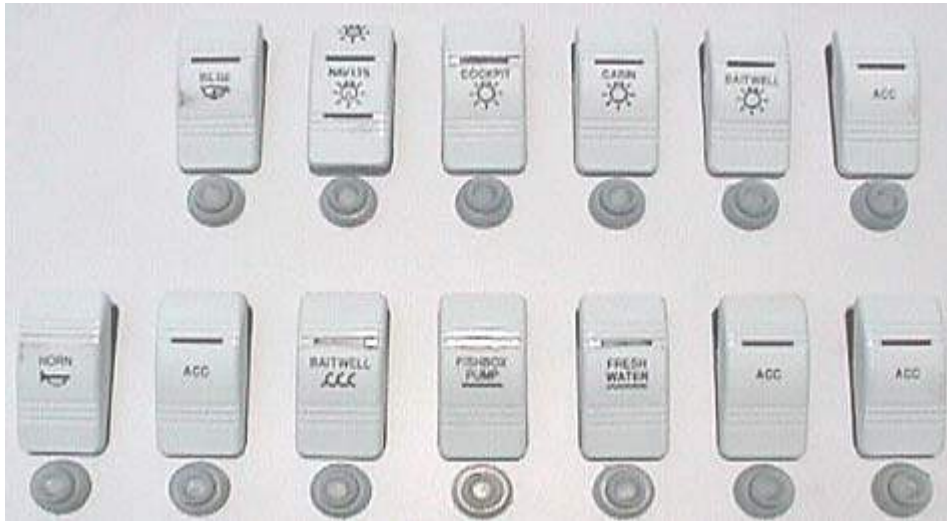

Front View of Switch Panel

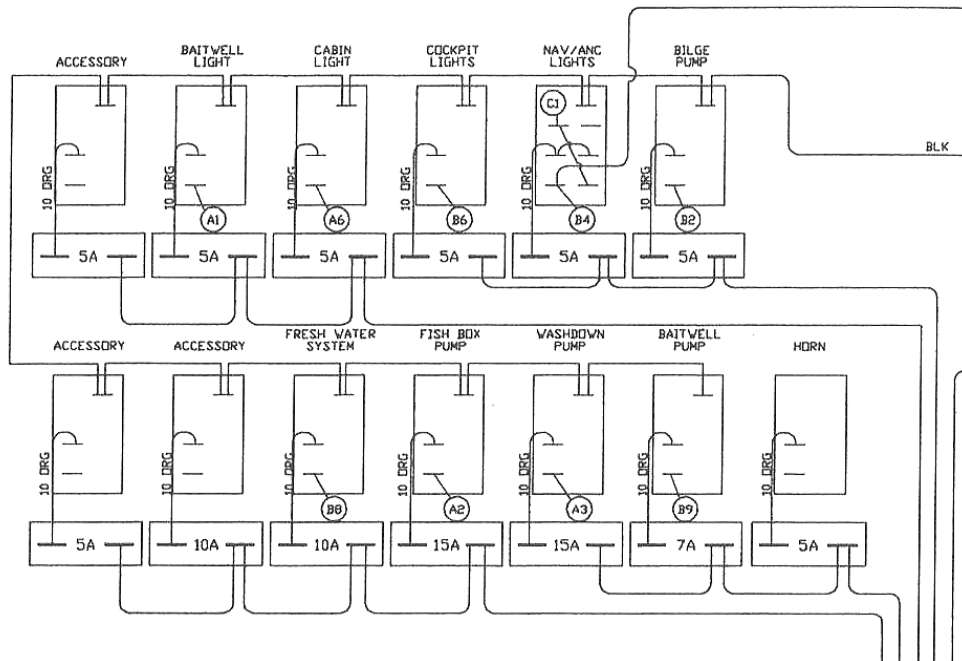

Back View of Switch Panel (wiring)

Bilge Pump

Your 29 Super Sport is equipped with an automatic bilge pump that has a manual switch override. The pump is located at the aft end of the bilge at the keel. The automatic float switch is wired directly to the battery terminal through an inline fuse. Keep the bilge area clean and free from debris that could clog ports or inhibit float movement. The helm switch overrides normal automatic operation. A circuit breaker for the pump is located at the helm below the switch. Keep the battery that provides power to the bilge pump

charged. If the battery is discharged and flooding occurs, the boat could swamp causing damage and possible loss of life or property.

Lights

Your Pro-Line is equipped with a variety of different lighting systems. The navigation and anchor lights are required to be used for operation at night or under low visibility conditions to indicate your position to other boaters. Visually verify operation of your Nav/Anc lights and insure the lights are free from obstructions. The dash instrument lights are turned on by the Nav/Anc light switch as well. Lights are also provided for the cockpit, baitwell, console compartment, helm-courtesy with optional t-top, and optional spreader lights. Spreader lights are operated by a switch incorporated into the helm-courtesy light which is located on the t-top. An optional remote spot light is also available and has a separate switch and control.

Accessory

These switches can be used for additional dealer installed accessories.

Windlass

The optional windlass is operated by a separate switch and is protected by an 80A breaker located below the switch. Refer to the windlass manual for operation and maintenance.

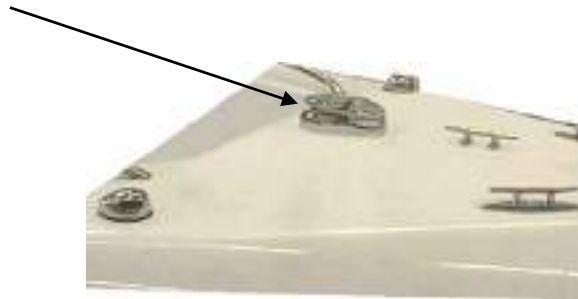

Trim Tabs

The trim tabs operate independently up or down to correct for differing conditions of wind or load. Refer to the owner's packet for specific information. The trim tab pump is located on the side of the aft port stringer near the transom. The pump is accessible through the port side transom / bilge hatch and should be maintained in accordance with the manufacturer's instructions.

Before the boat is underway, depress the bottom half of both switches until the tabs are fully elevated (bow up position). While underway and in open water clear of other boaters, depress the top half of the switches in half-second increments to achieve the desired degree of trim. To correct a starboard list, depress the top half of the port switch in small increments until the list is corrected. To avoid over trim, allow a few seconds between tab adjustments to allow the boat to respond (if you over trim simply give the over trimmed tab an adjustment in the opposite direction). Push the top half of both rocker switches in half-second increments to trim the bow down.

Warning: trim tabs can cause a dramatic change in the attitude and heading of your boat. Adjust them in small increments when in open water and clear of any obstructions.



Trim Tabs/Trim Tab Pump



Trim Tab Indicators

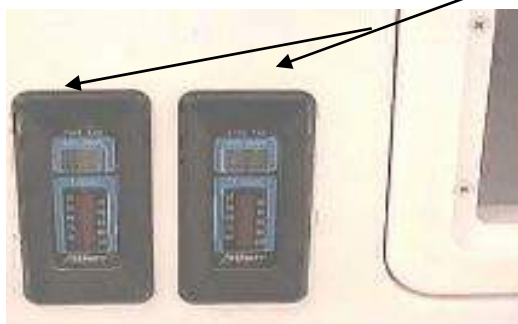

Circuit Breaker

The wiring on your *29 Super Sport* is protected by circuit breakers and/or fuses. In the event a device stops working, check to see if the circuit breaker is tripped or the fuse is blown. The main breaker is located on the aft port-side stringer and is accessible from the port transom / bilge hatch. Additional breakers / fuses for the bilge pump, trim tabs, etc. are located next to the main breaker and on the dash panel. A tripped breaker will protrude from its set position indicating that the circuit has been overloaded. Turn off the device(s) on the circuit then reset the breaker by pushing in once. If the breaker does not reset or if it resets and then trips again after the device is turned back on, then a short circuit exists or your device may be damaged, overloaded, or faulty. Correct the problem

and then reset the breaker. If the breaker continues to trip and you are certain the device, switch, and wiring are in good repair; then either the breaker is too small for the load, or is faulty. Reduce the load or replace the breaker.

Horn

The horn is used to signal, warn, or alert other boats or people on shore. Avoid any horn use without appropriate purpose.

Baitwell and Washdown

These switches energize the sea-water pumps (see Sea Water Systems section). Leave these switches off when not in use.

Fish Box Pump

This switch operates the pump to drain the fish boxes and should be left off when not in use.

Fresh Water

The fresh water switch activates the fresh water pump system (see Fresh Water Systems section). The switch should be left off when not in use.

Systems

Fresh Water System

The optional fresh water pump on your Pro-Line supplies water on demand when a drop in water pressure activates the pressure switch. The manual switch located at the helm energizes the pump. The switch should be kept off while not in use. Do not run the pump dry. The fresh water tank supplies the transom shower. The tank and pump are both accessible for maintenance or repair via the access bilge hatch located on the cockpit floor forward of the baitwell/transom seat. The fresh water tank fill is located just inboard of the transom sink.

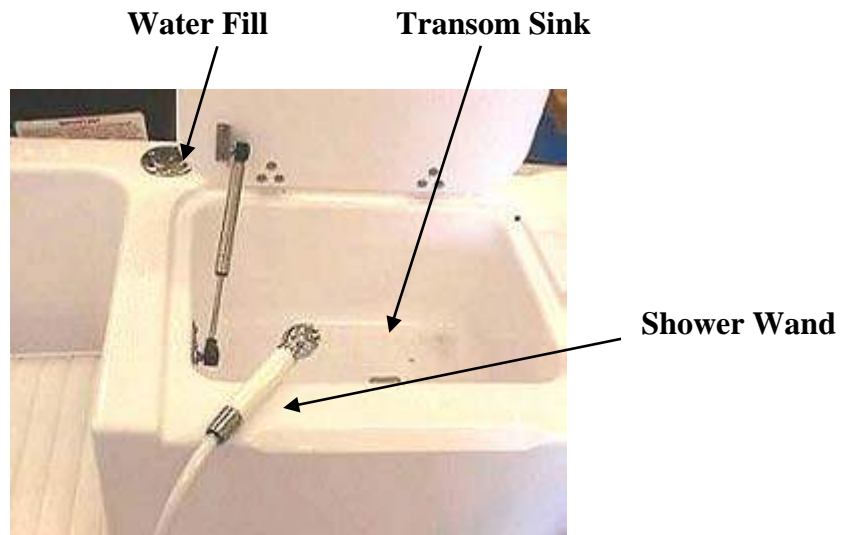

Sea Water Systems

The baitwell switch controls a pump mounted on a seacock in the bilge. An overflow tube is provided that is inserted into the drain to allow circulation to keep bait alive. The washdown pump is mounted in the bilge on the aft face of the aft fuel tank bulkhead. The pump is equipped with a pressure switch. Turn the main switches off if the pumps are not going to be used soon. Sea-water is taken in through a "T" fitting on the seacock and a strainer on the pump filters the sea-water. The filter must be cleaned as needed to avoid pump damage. The seacock should be closed when not in use.

Fuel / Oil System

The fuel tank on your Pro-Line is made of heavy gauge aluminum with internal baffling to minimize sloshing. The tank is vented overboard and the vent should be inspected for obstructions regularly. Deck plate access ports are placed over the hose connections and the sending unit. Inspect the hose connections on a regular basis. There may be a leak somewhere in the fuel system if you notice a fuel odor or see fuel in the bilge. Correct any fuel leaks before operating the vessel.

Fuel filter / water separator unit(s) are located in the starboard bilge area. There is one unit for each motor and the spin on cartridges should be renewed every season at a minimum. Fuel tanks that are not kept full accumulate water faster due to condensation. The cartridge(s) may need to be replaced more often depending upon usage and conditions or if motors begin to run rough. When replacing the filters / separators, coat the rubber seal with a film of grease or oil to help prevent sticking.

A primer bulb is used to prime the engine fuel pump with fuel. There is a primer bulb for each engine. Squeeze the bulb a few times until resistance is felt in order to prime. If no resistance develops and the fuel pump will not prime, you may be out of fuel, the primer bulb may be defective, or a leak may have developed allowing air into the system.

Pro-Line boats equipped with oil injected outboard engines have remote oil tanks located in the aft end of the bilge. The oil tank fills are located just above the motor well on the port side. Insure that the tanks are well stocked with the recommended two-stroke oil - refer to your engine manual. It is imperative the oil supply remain clean and uncontaminated by water or dirt. Check to make sure the oil lines are free from leaks, kinks, and chafing. Some motors use a primer bulb to initiate oil flow. Sometimes air may enter the system and require purging. Refer to your engine manual for specific instructions.

Fuel / Oil System

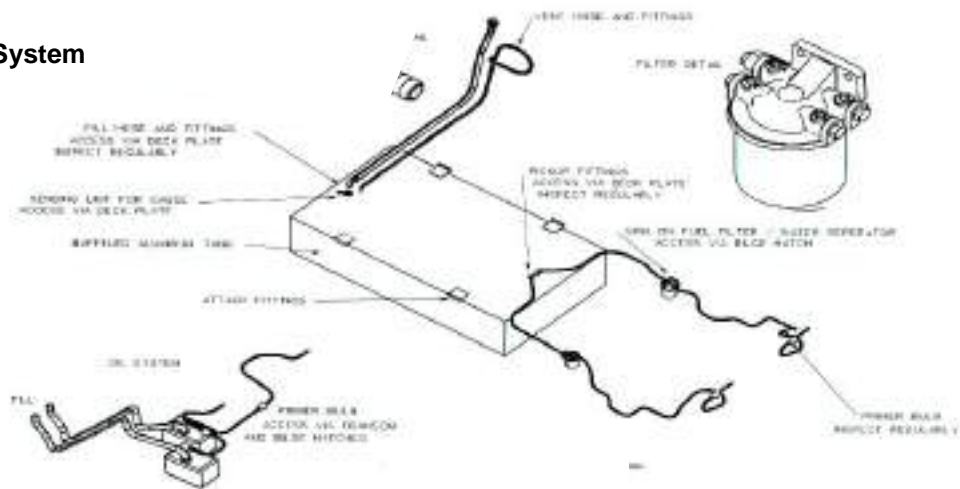

Head / Waste

The head / console compartment door is secured in the closed position with draw latches. Secure the door before operating the boat and make certain that no one is in the head compartment when latching the door closed. Your Pro-Line is equipped with a portable head. Refer to the manual supplied in your owner's packet. It is illegal to dump waste overboard in most locations. Be sure to check the law in your area.

Electrical

Direct Current

12-volt direct current provides electrical power for all lighting, pumps, electronics, and D/C devices. A main breaker is located in the battery switch box, located under the transom door walkway. Battery selector switches in the same switch box and are for battery isolation, parallel operation, and disconnect. The main helm terminal panel is accessed, by removing the aft wall panel, in the center console/head compartment.

Caution: To avoid possible alternator / battery damage on twin-engine installations, insure that the optional dual battery switches are never left so both engines are connected together (never leave a switch on "BOTH"). The preferred switch position is port engine to port battery, starboard to starboard.

Battery Switch box w/ Main Breaker located under transom door walkway.

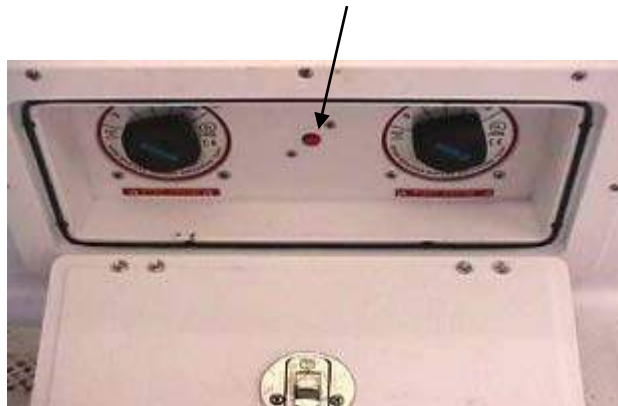

Please refer to Battery Switch Page in your manual to see proper positioning of Battery Switches.

After Market Accessories

Your Pro-Line's electrical system was designed for factory tested and approved dealer installed optional accessories. Pro-Line makes no recommendations to the suitability of accessories that are not listed in the Pro-Line sales literature. Any unapproved modifications or additions to the standard or optional system are done at the owner's risk and may void the warranty. Unapproved modifications could cause risk of fire or failure of the electrical system. A pull wire is installed in the optional t-top to facilitate installation of electronics. The wire is located on the starboard side, forward corner of the overhead electronics box. Use the factory supplied buss bar for connections. Make sure, the circuit is protected by fuse or breaker and the wire is properly sized for the load and length of run.

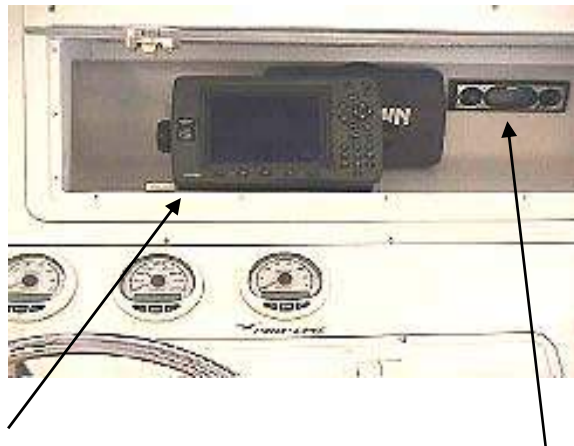

Optional Garmin Chartplotter / GPS

Optional Stereo

Trailer and Launching

Consult your trailer manufacturer for specific information relating to your particular trailer. Pro-Line does not make or recommend the use of any particular trailer. Make sure the trailer you use is certified. Consult your state authority for state regulations pertaining to trailering a boat.

Use the following towing check-list as a guideline:

- * Check brakes if equipped.
- * Check springs and under carriage for cracks, loose parts, and fasteners.
- * Insure tires are inflated to proper pressure and in good condition.
- * Check wheel bearings and lug nuts.
- * Verify light and signal operation.
- * Make sure boat is tied down from bow and stern eyes.
- * Stow Bimini top and all items likely to blow off or out of the boat.
- * Carry a spare tire and tools for changing (spare bearing and race set for long trips).

- * Securely brace O/B motors.
- * Go slow over bumps.
- * Check tires and hubs often for excessive heat. Service if required.
- Have an assistant watch blind spots and guide with signals when backing.

BACKING A TRAILER

Practice backing with a trailer *before* you get into a confined launch site. Get accustomed to using the trailer in an open area. Take someone with you who knows how to back a trailer. Backing a trailer works the opposite of backing a car. If the trailer needs to travel to the right, turn the steering wheel to the left and vice versa (Figure 6-3). Do not turn the wheel too far or oversteer. Turn the wheel gradually until you get the feel of safe backing.

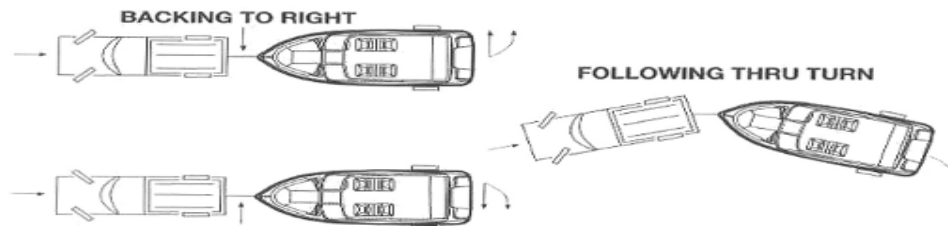

Capacity

The trailer you choose should be a proper match for your boat with regard to capacity and hull design. Consult your dealer when making your selection. The tow vehicle must have sufficient towing capacity for the combined load of boat, trailer and accessories. Check the certification label on the forward port (left) side of your trailer to insure it has adequate gross vehicle weight rating (GVWR) for the combined boat and trailer. The boat weight must include the weight of the empty basic hull, motors, full fuel and fresh water capacities, accessories, equipment, and provisions.

Hitch

Insure the hitch on the tow vehicle is rated for the gross total weight (GTW) or greater, and the ball size matches the trailer receiver.

Load Distribution

In general, the tongue weight should be from 5 to 10 % of the GVWR. Make certain the hull is evenly supported along the length and width of the trailer with no load concentrations. The bottom of the transom should be supported and not hanging past the end of the trailer. The bow must be supported as well. Load the boat so it is centered side to side, and straight on the supports. Rollers, if used, should only serve to guide the boat into position while in the water and not relied upon to support the weight of the boat. The improper use of rollers voids your warranty and could seriously damage your hull.

Launching and Retrieving

Pre - Launch Check List:

- * Install drain plug.
- * Remove covers and tie downs (leave bow winch strap in place).
- * Place lines and fenders if needed.
- * Disconnect lights to avoid shorting.
- * Verify safety equipment is aboard.

Launching:

- * If possible use a lookout.
- * Back down the ramp until wheels are underwater or the stern of the boat just starts to float (keeping perpendicular to the shore).
- * Loosen bow strap, board the boat, and lower the motor.
- * Start the motors and check the bilge for leaks.
- * Remove winch strap from bow eye.
- * Back boat off trailer.
- Dock the boat and park the tow vehicle. (see docking tie off below)

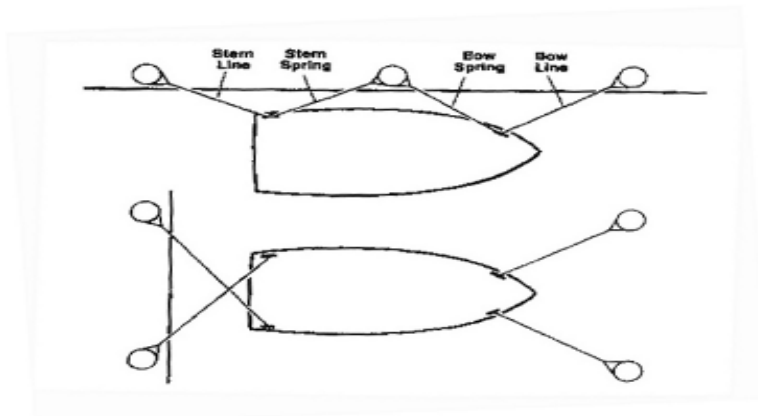

Retrieving:

- * Back down the ramp so trailer is half submerged.
- * Carefully line up boat, slowly maneuvering with short bursts of power.
- * When the keel is centered and boat is just touching the trailer, winch or smoothly apply power until the boat eases to the bow rest.
- * Secure the bow strap.
- * Haul the boat out of the water and park out of the way of others.
- * Remove the drain plug.
- * Rinse off salt water as soon as fresh water is available.
- * Stow equipment and canvas as well as affix tie downs and covers.
- * Hook up trailer lights and verify operation.

Operation and Performance

Loading

The performance of any boat is contingent upon the amount of load carried. Reduce the load to permit safe operation in rough and adverse conditions. Heavy loads reduce performance and increase fuel consumption. The positioning of load greatly affects the performance of your boat. If weight is placed too far aft, the boat may have difficulty getting on plane and ride rough. If the load is concentrated too far forward, the boat may “bow steer” or veer off to the side when entering a large wave at an angle as well as a reduction in top end speed. There is an optimum load location, which is generally near the center of the boat.

When loading your Pro-Line always:

- * Maintain a balance both port to starboard and bow to stern.
- * Keep heavy items as low as possible.
- * When boarding step (never jump) into the boat one at a time.
- * Pass gear from the dock to someone in the boat. Do not carry gear while boarding.
- * Never allow passengers to hang feet over the side of the boat.
- * Do not allow passengers to sit or stand on top of the stern or gunwales.
- * Do not overload the boat.

Fueling

Certain precautions must be observed when fueling due to the explosive nature of gasoline.

Before Fueling:

- * Secure the boat to the dock with adequate moorings.
- * Turn off engine and any equipment having spark-producing contacts.
- * Close console / head door and hatches so fumes do not enter boat.
- * Disembark all persons not necessary for the fueling operation.
- * Prohibit all smoking and open flames on board and nearby.
- * Have a fire extinguisher close by.

While Fueling:

- * Keep nozzle in contact with fill opening to minimize chance of sparks.
- * Do not leave unattended.
- * Do not over fill or spill fuel. Filling a tank until fuel is vented is dangerous.
- * Allow room for expansion.

After Fueling:

- * Close fill opening.
- * Wipe up any spilled fuel and dispose of rags on shore.
- * Open console / head door and hatches to ventilate boat.
- Check for fumes in bilge. Continue to ventilate if fumes are present.

Starting

Follow the information in your engine manual if it deviates from the following instructions.

Before Starting Engine:

- * Ventilate all enclosed spaces.
- * Visually inspect bilge for fuel and check for vapors.
- * Visually make sure propellers are clear of obstructions or swimmers.
- * Make sure engine cooling water intakes are submerged.
- * Attach safety stop switch lanyard.

Starting Engine:

Start the engine according to the instructions provided in your engine manual.

After Starting Engine:

After your engine starts, make sure to observe a few basic rules to insure the engine is functioning properly:

- * Verify engine cooling water circulation.
- * Check the temperature gauge for the first few minutes to make sure the engine is warming properly and not overheating.
- * Check for fuel, oil, and water leaks. Shut down and correct leaks if found.
- * Follow the break-in procedures for your engine(s).

Trim / Tilt

The power trim system allows the operator to raise and lower motors throughout an infinite number of settings between its upper and lower limits. There is a trim setting that will yield maximum speed, stability or maneuverability for every throttle setting. Refer to your engine manual for specific questions on trim / tilt.

For most conditions, the best all-round performance is obtained when the bow of the boat is slightly out of the water and all motors are trimmed to the same degree.

General trim down (or "in") characteristics are:

- * Starting position for best acceleration to plane.
- * Lowers bow, providing better stability and ride in rough water.
- * Reduces boat speed and economy due to increased drag of hull and drive.
- * More spray over bow.

General trim up (or "out") characteristics are:

- * Raises the bow of the boat out of the water resulting in less hull in the water.
- * Greater speed and economy for a given throttle setting.
- * Greater maneuverability (provided prop does not ventilate during the maneuver).
- * In excess, the reduced stability can lead to bouncing, porpoising and propeller ventilation.

In addition to providing ideal boat performance, the power-trim / tilt enables the motor or drive unit to be raised (tilted up) for trailering, beaching, and launching. Avoid operating the trim switch if travel of the motor is blocked or it has reached the limits of travel.

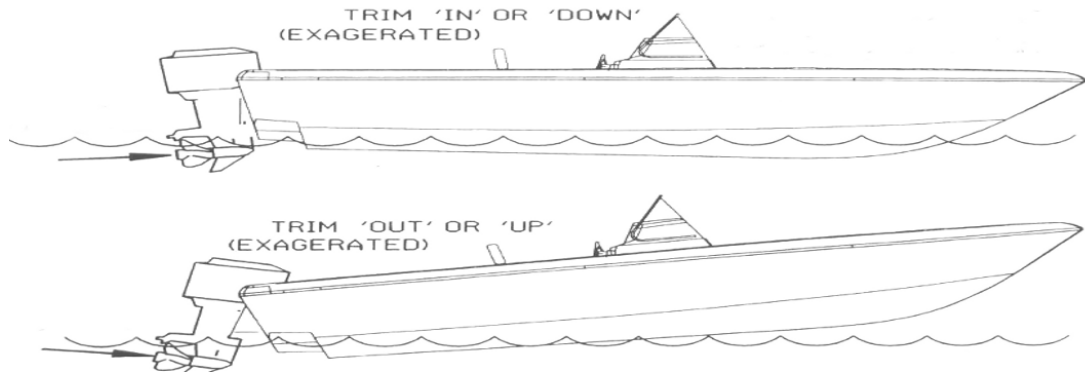

Trim Attitude

Prop

If your Pro-Line was ordered with a factory installed engine, it will have a propeller that has been performance tested to provide the best all-round performance for your engine / hull combination at sea level. In some situations, it may be desirable to re-prop your Pro-Line to enhance desired performance needs. For instance:

- * Decreasing pitch will enhance acceleration and power at high loads.
- * Increasing pitch will increase speed at light loads.
- * Decreasing diameter will compensate for loss of power at high altitudes.
- * Increasing diameter results in higher efficiency at low speeds at the expense of top end speed and acceleration.

Be sure not to over rev the engine when re-propping or engine damage could result. Operating your engine with a damaged prop will decrease performance, increase fuel consumption, and may introduce undesirable handling characteristics. The vibration caused by running a damaged prop could cause costly damage to your lower drive unit.

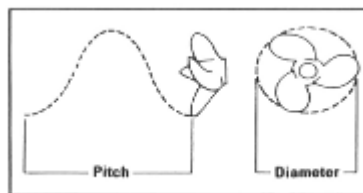

Service and Care

To enjoy trouble free use of your Pro-Line follow the recommended procedures and instructions relating to the service and care of your boat. Failure to follow the following maintenance practices will result in shorter life of your equipment and may void your warranty.

Much of the installed equipment on your Pro-Line is separately warranted. Follow the care instructions found in your owner's packet to keep these warranties in force.

Your engine manual contains service information relating to your particular engine installation. Follow the provided recommendations for trouble free service, and to preserve your warranty.

Fiberglass / Gel Coat

The gel-coated fiberglass on your Pro-Line provides a smooth, easy to clean, and maintain surface. Regular cleaning and waxing will preserve the finish on your boat for many years to come.

Use a mild detergent and plenty of fresh clean water to swab down the exposed gel coat of your boat. Do not use harsh cleaners containing ammonia, chlorine, or abrasives. Do not use acetone or any ketone solvents. Stubborn stains may be removed with alcohol or kerosene provided they are washed off immediately and completely with a mild detergent and water.

Wax all gel coated surfaces a minimum of twice a year, more often if the boat is stored in the sun. If due to neglect, the surface takes on a dull appearance that is not restorable by waxing, hand buff with a rubbing compound such as Dupont No. 7, or power buff with Mirror Glaze No. 1, then wax afterwards.

Caution: when power buffing use care not to leave swirl marks or "burn" the surface. You may want to leave power buffing to a professional.

The gel coat on your Pro-Line is approximately 2- mil thick. Minor scratches and deep stains that do not penetrate the gel coat can be lightly wet sanded with 600 grit, buffed and waxed to remove.

If a deep gouge to the surface occurs that goes through the gel coat into the fiberglass, it must be repaired promptly to avoid further damage. Your dealer is best equipped to handle this repair and achieve good bonding and color match. There are many different gel coat repair kits on the market for this use. However, results obtained may not be satisfactory.

See your Pro-Line dealer for fiberglass damage deeper than 1/16 inch.

Marine Growth

If marine growth is a problem, consult your dealer about an anti-fouling finish for the portions of the hull below the water line. When moored in salt or brackish water, it is recommended to scrub the bottom monthly to prevent the accumulation of marine growth.

Windshield / Acrylics

To clean acrylic, rinse with fresh water to remove as much grime as possible. Use bare hands with plenty of water so you can feel any grit and avoid grinding it into the surface as you dislodge it. When all material that may scratch the surface is removed, use a soft clean cloth with a non-abrasive mild detergent and fresh water. Rinse and blot dry with a

clean, dry chamois.

Grease and adhesives may be removed with kerosene, hexane or white gas (not gas you burn in your boat, car or lawnmower). Never use solvents such as acetone, silicone spray, benzene, carbon tetrachloride, dry cleaning fluid, lacquer or paint thinner, or any chlorinated solvent on acrylic since they may dissolve the material.

Stainless Steel / Aluminum

Stainless steel is used for bow rails and deck fittings on your Pro-Line. Stainless steel and aluminum are corrosion resistant but not corrosion proof. If used in contact with sulfides, chloride salts, or rusting metals, stainless will show rust spots, discolor or corrode. The grain structure of stainless and aluminum, when modified by welding processes, has increased susceptibility to micro-corrosion (invisible to the unaided eye) and cracking. Proper care will preserve the weld strength and beauty of your stainless and aluminum:

- * Always clean frequently with soap and water. Most glass cleaners work.
- * Always protect with a wax, especially around welds to guard against micro-corrosion, cracking, and rust spots.
- * Always remove rust and corrosion spots as they appear with a stainless steel or aluminum cleaner.
- * Never use coarse abrasives like sandpaper or steel wool, as these can cause rusting.
- * Never clean with acids or bleaches.
- * Never permit contact with iron, carbon steel, or other metals which could cause rust or corrosion.

Canvas

Cleaning: Brush the canvas with a soft bristle brush and hose down at regular intervals to remove bird droppings and dirt particles. It may be washed with a mild solution of natural soap in lukewarm water (less than 100 deg. F). **DO NOT USE DETERGENTS.** For stubborn stains soak the canvas in a solution of 4oz. non-chlorine bleach, 4oz. natural soap and one-gallon warm water for approximately 20 minutes. Rinse with cold water. **Note:** If the water repellence is lost due to cleaning, apply a water repellent treatment as necessary.

The canvas may be washed in an automatic washing machine with cold water using 2 cups non-chlorine bleach and 1 cup natural soap. **DO NOT DRY IN A DRYER. LINE DRY ONLY** to prevent shrinkage. If water will not bead on dry surface, re-treat with water repellent.

Storage: Do not fold or store any canvas while wet. All canvas should be rolled or folded when dry and kept in a clean dry location.

Upholstery

Vinyl

An occasional cleaning with mild soap and water is all that your interior and exterior vinyl needs to remain in good condition for many years. We do not recommend the use of any special cleaners, sealers, or treatments for interior and exterior vinyl. Refer to the provided brochure.

Fabric

Only use dry cleaning fluid for all fabrics.

Corrosion Protection

If you moor your Pro-Line in salt water for extended periods, be sure to check the transom mounted anti-corrosion anode often for operation. Check the electrical connections (green wire) on all metallic fittings with anode for conductivity with an ohm meter. Make sure the anode surface is exposed and not caked with corrosion and scale. Renew the anode if it is more than 50% eroded. Your motor / drive unit has a sacrificial zinc anode to mitigate the effects of electrolysis which causes corrosion. Maintain this anode in accordance with the maintenance schedule in your engine manual.

Winterization and Storage

- * Remove drain plug and keep bow high to drain any water accumulation.
- * Drain all water from water systems.
- * Fill fuel tank and add a stabilizer to the gasoline.
- * Prepare the engine in accordance with manufacturer's recommendations found in your engine manual.
- * Treat metal parts with rust inhibitor.
- * Remove the battery and protect from freezing. Trickle charge overnight once per month.
- * Place under cover. Loosen tie down straps and unload the tires with blocks if loaded on a trailer.

Fitting Out After Storage:

- * Check entire fuel system for loose fittings, leaks, and damage.
- * Clean battery terminals, install battery(s), and coat terminals with a deoxidizing agent.
- * Check all through hull fittings and hoses for obstructions, water tightness, and condition.
- * Test all lights for proper operation.
- * Check wiring, terminal blocks, and plugs for loose connections and corrosion.
- * Verify switch and equipment operation.
- * Check line condition. Inspect anchor and rope.
- * Clean out any debris from bilge and cockpit.
- * Flush water systems.
- * Install hull drain plug.
- * Purge air from sea-water strainers for air conditioner and generator cooling water after placing boat in the water.
- * Verify operation of equipment before leaving dock.

Appendix

Boat Identification Information

Owner: _____

Home Port: _____

Dealer: _____

Boat Name: _____

Registration No: _____

Hull No: _____

Boat model: _____ LOA: _____ Beam: _____ Draft: _____

Vertical Clearance: _____ -Hull: _____ -Deck: _____ -Interior: _____

Warranty Registration Date: _____

Fuel Capacity Gal.: _____

Ignition Key No: _____

Radio Call Letters: _____ Bat. _____

Engine Make & Model: _____ HP: _____

Engine S/N: _____

Drive S/N: _____

Prop: Dia: _____ Pitch: _____ P/N: _____

Trailer Make & Model: _____

Trailer S/N: _____ GVWR: _____

Insurance Company: _____

Agent: _____

Policy No.: _____ Phone No.: _____

Trouble Shooting Chart

PROBLEM:

POSSIBLE CAUSE:

Poor speed or fuel economy:

- *Wrong propeller for load or conditions.
- *Trim is in too far.
- *Load is too far forward or too heavy. Boat has taken on water.
- *Marine growth on hull. Line or anchor is dragging.
- *Fuel is stale or partially blocked. Engine is worn, out of tune or under powered.
- *Improper rigging. Air intake or exhaust is partially blocked.

Engine cranks but will not start:

- *Out of fuel. Filter is clogged. Fuel line kinked or fuel vent plugged.
- *Water in fuel.
- *Engine problem (electrical, fuel pump, blockage, etc.).
- *Safety shut off switch lanyard not installed.

Engine will not crank:

- *Drive is in gear (check operation of the throttle release).
- *Battery is weak. Terminals corroded or loose.
- *Engine or drive is damaged.

Engine runs but boat will not go:

- *Throttle release is engaged.
- *Disconnected shift linkage.
- *Damaged prop, or lower drive unit.
- *Entangled in lines or weeds. Anchor is down.

Prop cavitates:

- *Trim out too far. Motor is too high.
- *Weeds on prop.
- *Bow heavy, damage to hull.
- *Prop is damaged.

Excessive vibration:

- *Propeller, engine, or drive unit damaged.
- *Hull damaged.

Boat will not turn:

- *Steering unit needs fluid or has trapped air. Tiller is disconnected (helm turns).
- *Steering trunion or mechanism jammed (helm won't turn).

Electrical problems
(see wiring diagram)

- *Corroded wires, terminals, or plugs.
- *Broken, loose, or short circuited wires.
- *Circuit breaker tripped.
- *Defective switch, device, or breaker.
- *In-line fuse blown.
- *Overloaded circuit.

Handling problems like:

Porpoises

Runs wet

Hard ride

Lists

Overbank in turn

Catches in turns

- *Trimmed out too far, damaged hull (rocker), trim tabs up, stern heavy.
- *Trimmed in too far, bow heavy, trim tabs down, overloaded for conditions.
- *Stern heavy, trimmed out too far, going too fast for conditions.
- *Loaded to one side, trim tabs set wrong, trimmed too far in, fuel tanks uneven.
- *Trimmed in too far, improperly located load, throttle advanced too far.
- *Damaged hull (hook), stern heavy, trim tabs down.

Nautical Terms

Abeam: At 90 degrees to the center-line of the boat, exactly to either side of the boat.

Abaft: A point on a boat that is aft of another.

Aft: Toward the rear of the boat.

Beam: The widest part of the boat.

Bilge: The lower interior of the hull.

Bow: The fore part of a boat.

Bulkhead: A vertical partition or reinforcement in a boat usually perpendicular to the keel.

Chine: The juncture of the bottom and the side of the boat.

Chock: Deck fitting used to guide a line.

Cleat: Deck fitting used to secure a line to.

Deck: Upper structure of a boat that covers the hull.

Draft: The distance the lowest part (usually the keel) of the boat projects into the water.

Fathom: A unit of measure equal to six feet.

Freeboard: The height of the deck above the water line.

Gunwale or Gunnel: The Juncture of the side of the cockpit, deck and hull.

Hatch: An opening used for access to an interior space.

Head: Toilet or toilet area in a boat.

Helm: Steering wheel or console area of a boat.

Hull: The basic structure of a boat, that provides flotation by displacing and excluding water.

Keel: The major lengthwise member of the hull, the lowest portion of the hull.

Knot: A measure of speed in nautical miles per hour, equal to 1.15 MPH

Lee: The side sheltered from the wind.

Port: The left side of the boat when aboard the boat facing the bow.

Scupper: Duct to drain water from the cockpit, usually with a check valve to prevent sea water intrusion.

Sheer: The juncture of the deck and the hull, generally covered by the rub rail.

Starboard: The right side of the boat when aboard the boat facing the bow.

Stern: The back of the boat.

Stern Drive: Inboard /outboard I/O drive unit.

Stringer: Lengthwise reinforcing members of the hull.

Transom: Vertical part of the stern.

Wake: Waves produced by a boat moving through the water.

Windward: Toward the direction from which the wind is blowing.

29 Super Sport

SPECIFICATIONS

L.O.A.....	28'7" (8.71m)
BEAM.....	9'0" (2.74m)
DRAFT – HULL.....	21" (0.53m)
DEADRISE.....	228
WEIGHT – HULL.....	7194 lbs. (3263)
WEIGHT - TRAILER.....	9110 lbs (4132 kg)
FUEL CAPACITY.....	195 gal (738.15L)
COCKPIT AREA.....	101 sq. ft. (9.38m ²)
COCKPIT DEPTH.....	30" (.76m)
BRIDGE CLEARANCE.....	7'2" (2.19m)
W/TOP.....	8'8" (2.72m)
MAX. HP.....	500 hp (372.85kw)
BAITWELL CAPACITY.....	45 gal (170.4l)
FISHBOX CAPACITY.....	2@ 15 gals – 1@ 113gals
FRESHWATER CAPACITY.....	15 gal (58.6L)

