

HONDA[®]

MARINE

BF75A/90A

Owner's

Manual

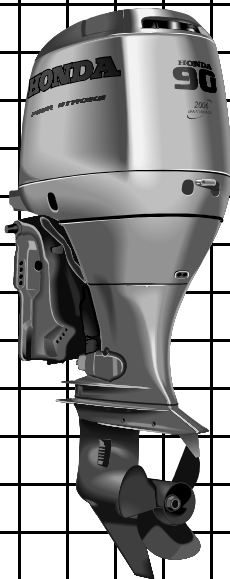



WARNING:



The engine exhaust from this product contains chemicals known to the State of California to cause cancer, birth defects or other reproductive harm.

Thank you for purchasing a Honda Outboard Motor.

This manual describes the operation and maintenance of the Honda BF 75A and BF 90A Outboard Motors.

All information in this publication is based on the latest product information available at the time of printing. Honda Motor Co., Ltd. reserves the right to make changes at any time without notice and without incurring any obligation.

No part of this publication may be reproduced without written permission.

This manual should be considered a permanent part of the Outboard Motor and it must stay with the Outboard Motor if resold.

SAFETY MESSAGES

Your safety and the safety of others are very important. We have provided important safety messages in this manual and on the outboard motor. Please read these messages carefully.

A safety message alerts you to potential hazards that can hurt you and others. Each safety message is preceded by a safety alert symbol ▲ and one of three words: DANGER, WARNING, or CAUTION.

These mean:

▲ DANGER You **WILL** be **KILLED** or **SERIOUSLY HURT** if you don't follow instructions.

▲ WARNING You **CAN** be **KILLED** or **SERIOUSLY HURT** if you don't follow instructions.

▲ CAUTION You **CAN** be **HURT** if you don't follow instructions.

Each message tells you what the hazard is, what can happen, and what you can do to avoid or reduce injury.

DAMAGE PREVENTION MESSAGES

You will also see other important messages that are preceded by the word NOTICE.

This word means:

NOTICE Your outboard motor or other property can be damaged if you don't follow instructions.

The purpose of these messages is to help prevent damage to your outboard motor, other property, or the environment.

HONDA MOTOR CO., LTD. 1995
ALL RIGHTS RESERVED

TYPES OF HONDA BF75A/90A OUTBOARD MOTORS

It may be necessary to refer to this chart for reference purposes when reading this manual.

Model	Type	Shaft Length		Tiller Handle	Remote Control	Power Trim/Tilt	Tachometer	Trimmeter
		L	X					
BF75A	LHT	●		●		●		●
	LRT	●			●	●		●
	XRT		●		●	●		●
BF90A	LHT	●		●		●		●
	LRT	●			●	●		●
	XRT		●		●	●		●

TYPE CODE (example)

L R T T=Power Trim/Tilt R=Remote Control H=Tiller Handle X=Extra Long Shaft L=Long Shaft

LEFT STERN BRACKET



PRODUCT IDENTIFICATION NUMBER

The Product Identification Number is stamped on a plate and attached to the left stern bracket.

Product identification number:

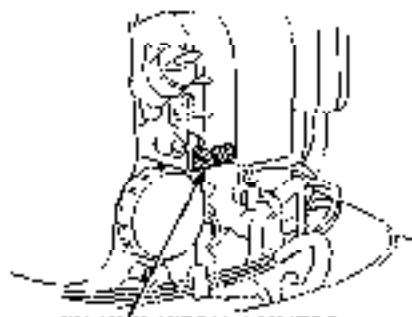

ENGINE SERIAL NUMBER

The Engine Serial Number is stamped on the cylinder block in the front of the engine.

Engine serial number:

Record the Product Identification Number (P.I.N.) and the Engine Serial Number for your reference. Refer to the Product Identification Number when ordering parts, and when making technical or warranty inquiries (see page 136).

CONTENTS

1. SAFETY			
SAFETY LABELS	6		
SAFETY INFORMATION	7		
2. COMPONENT IDENTIFICATION ..	8		
3. CONTROLS & INSTRUMENTS			
TILLER HANDLE TYPE			
Ignition Switch	14		
Gear Shift Lever	14		
Choke Knob	14		
Throttle Grip	15		
Throttle Opening Indicator	15		
Throttle Friction Knob	15		
Engine Stop Switch	16		
Emergency Stop Switch Lanyard ..	16		
Oil Pressure Indicator Light	17		
Overheat Indicator Light	17		
Power Trim/Tilt Switch	18		
Steering Friction Adjuster	18		
REMOTE CONTROL TYPE			
(SIDE-MOUNT TYPE)			
Remote Control Lever	19		
Neutral Release Lever	20		
Ignition Switch	20		
Emergency Stop Switch Lanyard ..	21		
Choke/Fast Idle Lever	22		
Manual Choke Knob	22		
Oil Pressure Indicator Light/Buzzer ..	23		
Overheat Indicator Light/Buzzer ..	23		
Power Trim/Tilt Switch	24		
		(PANEL-MOUNT TYPE)	
		Remote Control Lever	25
		Neutral Release Lever	26
		Ignition Switch	26
		Emergency Stop Switch Lanyard ..	27
		Throttle Button	28
		Choke Switch	28
		Manual Choke Knob	28
		Oil Pressure Indicator Light/Buzzer ..	29
		Overheat Indicator Light/Buzzer ..	29
		Power Trim/Tilt Switch	30
		(TOP-MOUNT TYPE)	
		Remote Control Lever	31
		Ignition Switch	32
		Emergency Stop Switch Lanyard ..	33
		Throttle Button	34
		Choke Switch	34
		Manual Choke Knob	34
		Oil Pressure Indicator Light/Buzzer ..	35
		Overheat Indicator Light/Buzzer ..	35
		Power Trim/Tilt Switch	36
		(remote control lever) ..	36
		Power Trim/Tilt Switch	36
		(control box console) ..	36
		COMMON	
		Power Tilt Switch (engine pan) ..	37
		Trim Meter	37
		Tachometer (optional equipment) ..	37
		Manual Relief Valve	38
		Tilt Lock Lever	39
		Trim Tab	39
		Anode Metal	40
		Cooling System Indicator	40
		Water Intakes	40
		Transom Angle Adjusting Rod ..	41
		Fuel Cap/Gauge/Vent Knob ..	42
		(optional fuel tank) ..	42
		Over-Rev Limiter	42
		Engine Cover Lock Lever	43
		Fuel Hose Connector	43
		4. PRE-OPERATION CHECKS	
		Engine Cover Removal/Installation ..	44
		Engine Oil	45
		Fuel Level (optional fuel tank) ..	46
		Fuel Recommendations	47
		Oxygenated Fuels	48
		Propeller and Cooler Pin Inspection ..	49
		Steering Friction Adjustment ..	50
		(TILLER HANDLE TYPE) ..	50
		Remote Control Friction ..	50
		Adjustment	50
		Engine Cover Lock Lever ..	51
		Adjustment	51
		Other Checks	
		• Stern bracket	52
		• Foot Kit	52
		• Anodes	52
		5. STARTING THE ENGINE	
		Optional Fuel Tank	53
		Fuel Line Connection	53

<p>STARTING THE ENGINE (TILLER HANDLE TYPE) .. 55</p> <p>STARTING THE ENGINE (REMOTE CONTROL TYPE) 60</p> <p style="padding-left: 20px;">(SIDE-MOUNT TYPE) 60</p> <p style="padding-left: 20px;">(PANEL-MOUNT TYPE) ... 63</p> <p style="padding-left: 20px;">(TOP-MOUNT TYPE)..... 66</p> <p>STARTING THE ENGINE (EMERGENCY STARTING). 69</p> <p>Troubleshooting Starting Problems , 74</p> <p>6. OPERATION</p> <p>Break-in Procedure..... 75</p> <p>TILLER HANDLE TYPE</p> <p style="padding-left: 20px;">Gear Shifting</p> <p style="padding-left: 20px;">Steering</p> <p style="padding-left: 20px;">Cruising</p> <p>REMOTE CONTROL TYPE (SIDE-MOUNT TYPE)</p> <p style="padding-left: 20px;">Gear Shifting</p> <p style="padding-left: 20px;">Cruising</p> <p>(PANEL-MOUNT TYPE)</p> <p style="padding-left: 20px;">Gear Shifting</p> <p style="padding-left: 20px;">Cruising</p> <p>(TOP-MOUNT TYPE)</p> <p style="padding-left: 20px;">Gear Shifting</p> <p style="padding-left: 20px;">Cruising</p> <p>POWER TRIM/TILT</p> <p style="padding-left: 20px;">Power Trim/Tilt System ...</p> <p style="padding-left: 20px;">Trim Meter</p> <p style="padding-left: 20px;">Power Tilt Switch (engine pan) ...</p>	<p style="padding-left: 20px;">Manual Relief Valve</p> <p style="padding-left: 20px;">Tilt Lock Lever.....</p> <p style="padding-left: 20px;">Trim Tab Adjustment</p> <p>MOTOR PROTECTION SYSTEM</p> <p style="padding-left: 20px;">Engine Oil Pressure and Overheat Warning System</p> <p style="padding-left: 20px;">Over-Rev Limiter</p> <p style="padding-left: 20px;">Ankle</p> <p style="padding-left: 20px;">Shallow Water Operation</p> <p style="padding-left: 20px;">High Altitude Operation</p> <p>7 STOPPING THE ENGINE</p> <p>TILLER HANDLE TYPE..... 95</p> <p>REMOTE CONTROL TYPE</p> <p style="padding-left: 20px;">(SIDE-MOUNT TYPE) 96</p> <p style="padding-left: 20px;">(PANEL-MOUNT TYPE) 97</p> <p style="padding-left: 20px;">(TOP-MOUNT TYPE)..... 98</p> <p>8. TRANSPORTING..... 99</p> <p>9 CLEANING AND FLUSHING 102</p> <p>10. MAINTENANCE 104</p> <p style="padding-left: 20px;">THE IMPORTANCE OF MAINTENANCE..... 104</p> <p style="padding-left: 20px;">MAINTENANCE SAFETY 104</p> <p>EMISSION CONTROL</p> <p style="padding-left: 20px;">SYSTEM INFORMATION ... 105</p> <p style="padding-left: 20px;">Tool Kit and Spare Parts ,</p> <p>MAINTENANCE SCHEDULE , 109</p> <p style="padding-left: 20px;">Engine Oil</p> <p style="padding-left: 20px;">Gear Oil</p> <p style="padding-left: 20px;">Spark Plugs</p> <p style="padding-left: 20px;">Battery (not included).....</p>	<p style="padding-left: 20px;">Lubrication</p> <p style="padding-left: 20px;">Engine Fuel Filter</p> <p style="padding-left: 20px;">Fuel Tank and Filter</p> <p style="padding-left: 20px;">Fuse Replacement</p> <p style="padding-left: 20px;">Propeller</p> <p style="padding-left: 20px;">Submerged Motor</p> <p>11. STORAGE 128</p> <p>12. TROUBLESHOOTING 132</p> <p>13. SPECIFICATIONS 134</p> <p>14. WARRANTY SERVICE 136</p> <p>15. INDEX..... 137</p> <p>16. WIRING DIAGRAM 141</p>
--	---	--

1. SAFETY

SAFETY LABELS

These labels are in the locations shown. They warn you of potential hazards that could seriously injure you. Read these labels carefully.

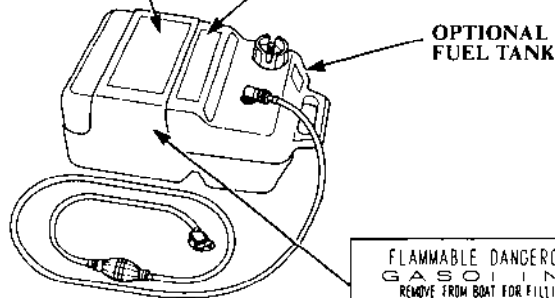
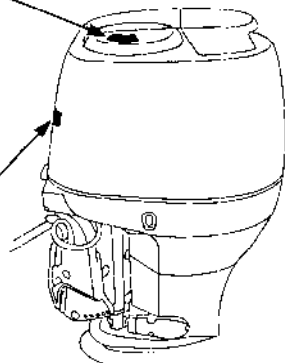
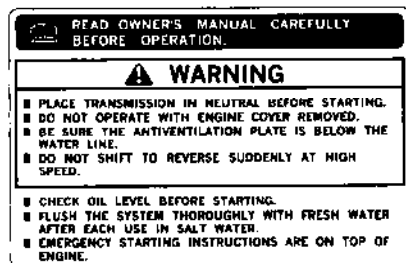
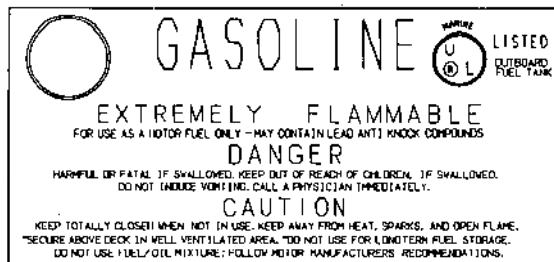

SAFETY INFORMATION

For your safety and the safety of others, pay special attention to these precautions.

Operator Responsibility

- Know how to stop the engine quickly in case of emergency. Understand the use of all controls.
- Do not exceed the boat manufacturer's power recommendation, and be sure that the outboard motor is properly mounted.
- Never permit anyone to operate the outboard motor without proper instruction.
- Stop the engine immediately if any one falls overboard.
- Do not run the engine while the boat is near anyone in the water.
- Attach the emergency stop switch lanyard securely to the operator.
- Do not remove the engine cover while the engine is running.

- Before operating the outboard motor, familiarize yourself with all laws and regulations relating to boating and the use of outboard motors.
- Do not attempt to modify the outboard motor.
- Always wear **PERSONAL FLOTATION DEVICE (PFD)** when on board.
- Do not remove any guards, labels, shields, covers or safety devices; they are installed for your safety.

Fire and Burn Hazards

Gasoline is extremely flammable, and gasoline vapor can explode. Use extreme care when handling gasoline.

- Remove any portable fuel tank from the boat for refueling.
- Refuel in a well-ventilated area with the engine stopped. Keep flames and sparks away, and do not smoke in the area.

- Refuel carefully to avoid spilling fuel. Avoid overfilling the fuel tank (there should be no fuel in the filler neck). After refueling, tighten the filler cap securely. If any fuel is spilled, make sure the area is dry before starting the engine.

2. COMPONENT IDENTIFICATION (TILLER HANDLE TYPE)

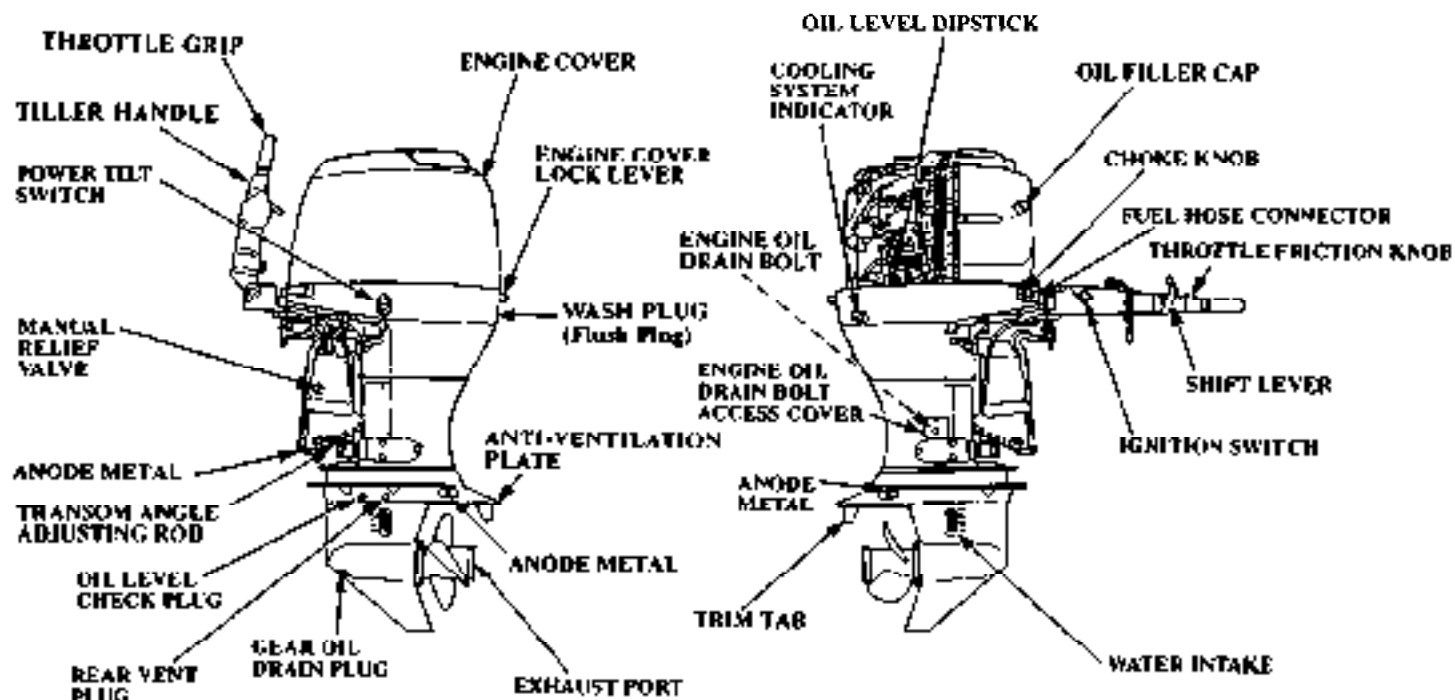

2. COMPONENT IDENTIFICATION (TILLER HANDLE TYPE)

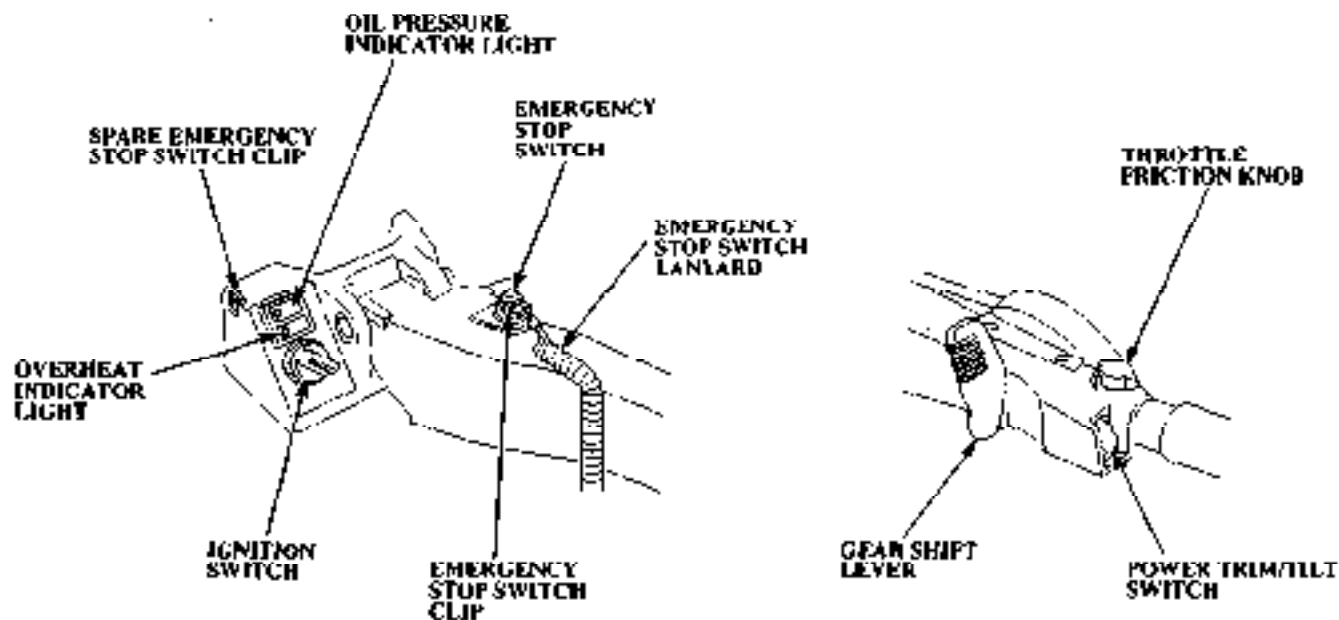

2. COMPONENT IDENTIFICATION (REMOTE CONTROL TYPE)

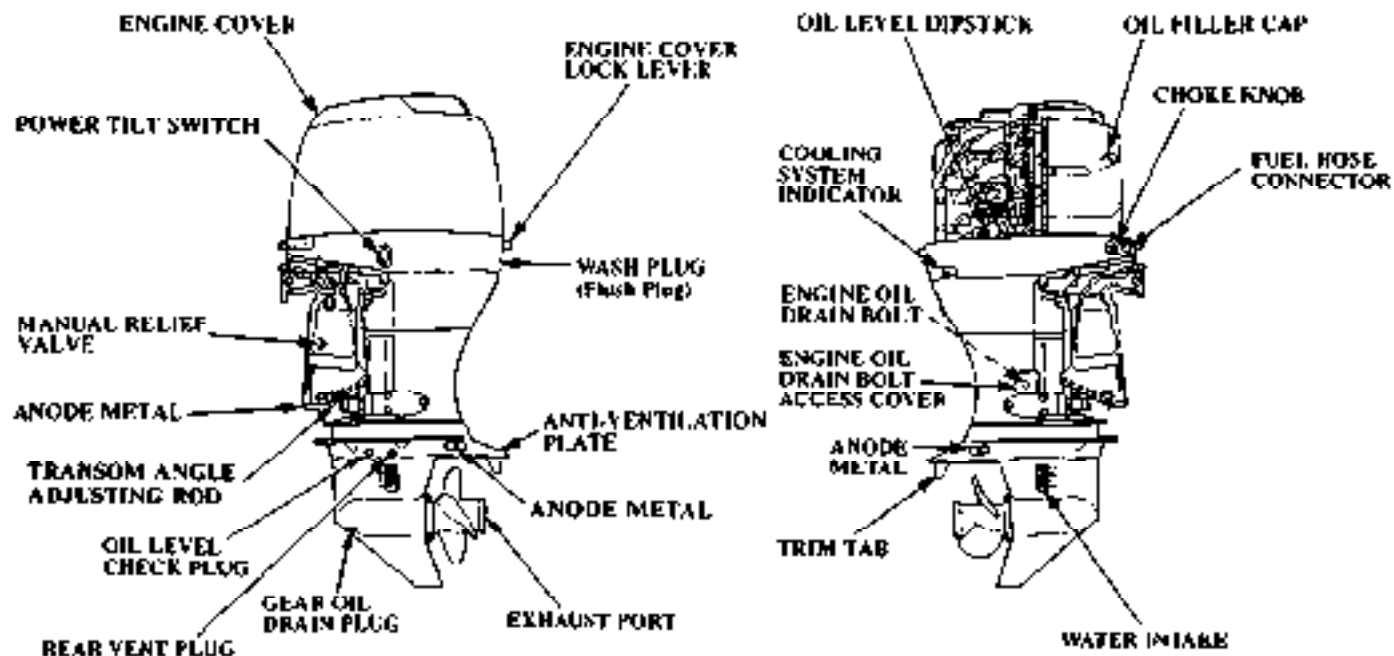

2. COMPONENT IDENTIFICATION (REMOTE CONTROL TYPE)

(SIDE-MOUNT REMOTE CONTROL)

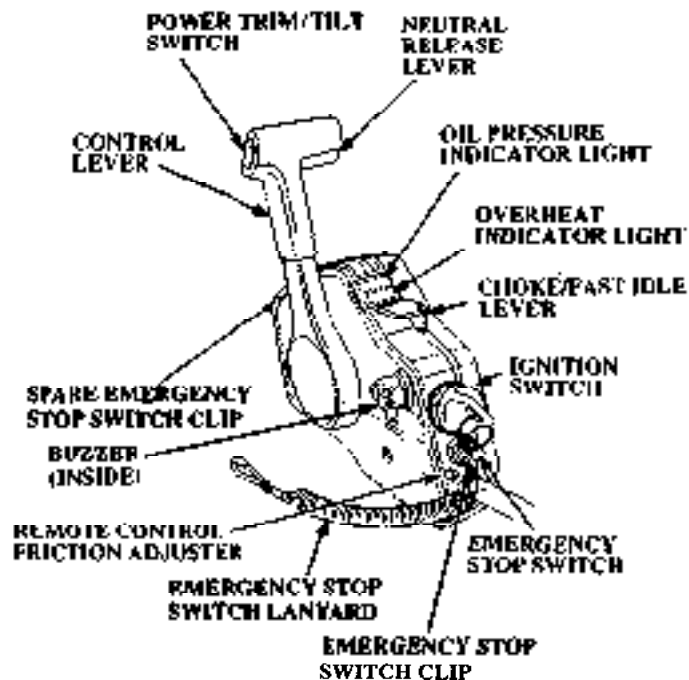

(PANEL-MOUNT REMOTE CONTROL)

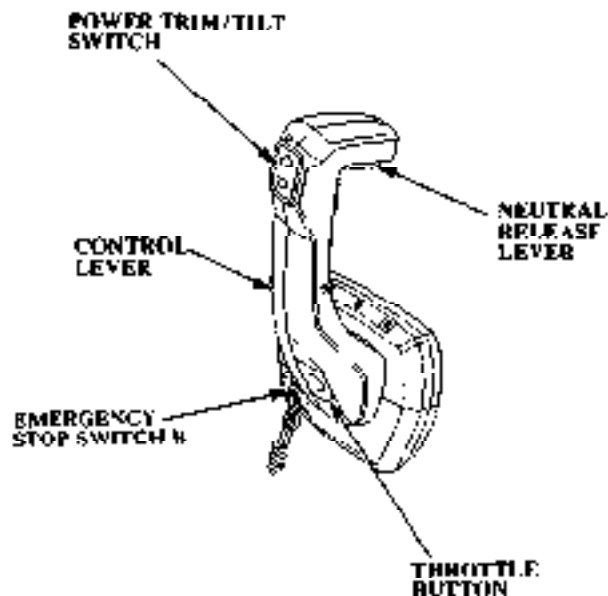

2. COMPONENT IDENTIFICATION (REMOTE CONTROL TYPE)

(SINGLE TOP-MOUNT
REMOTE CONTROL)

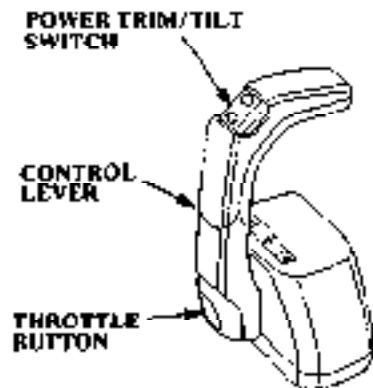

(DUAL TOP-MOUNT
REMOTE CONTROL)

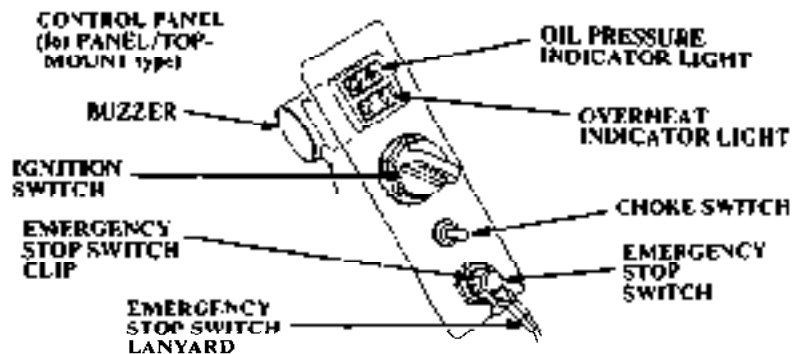
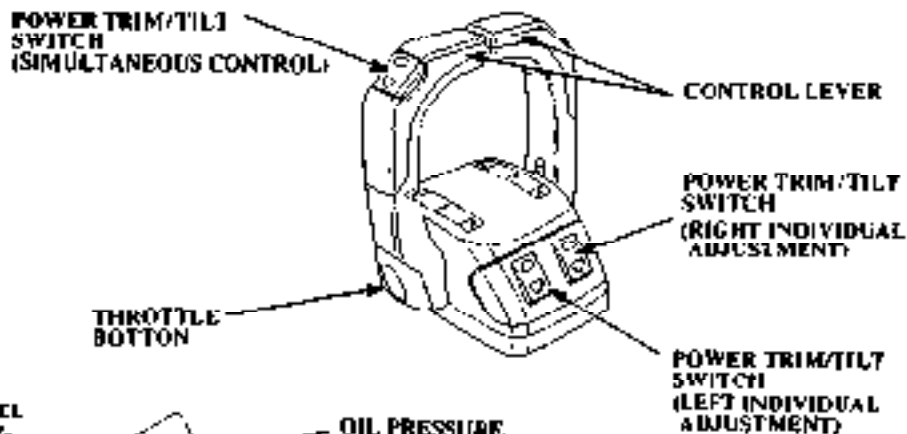

2. COMPONENT IDENTIFICATION (COMMON)

FUEL TANK (optional equipment)

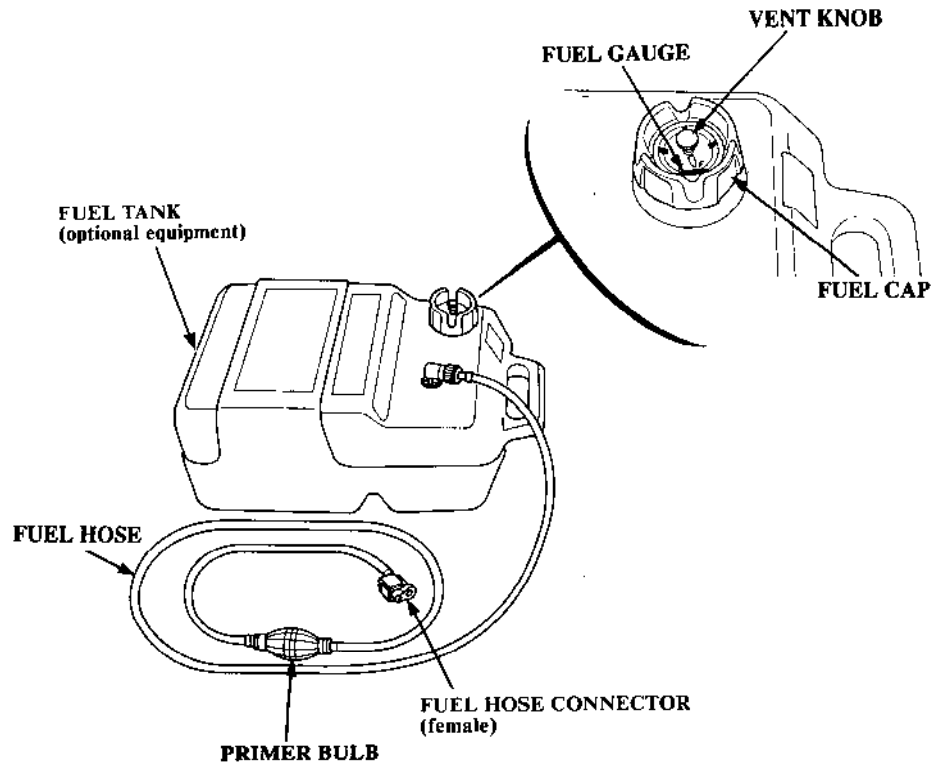

METER

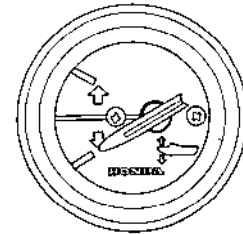

TRIM METER

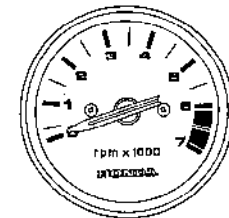

TACHOMETER (optional equipment)

3. CONTROLS (TILLER HANDLE TYPE)

Ignition Switch

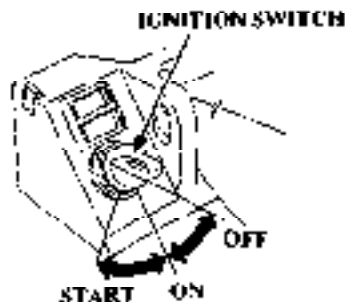

Move the gearshift lever to the N (neutral) position before starting. The engine will not start unless the gearshift lever is in the N (neutral) position.

Gear Shift Lever

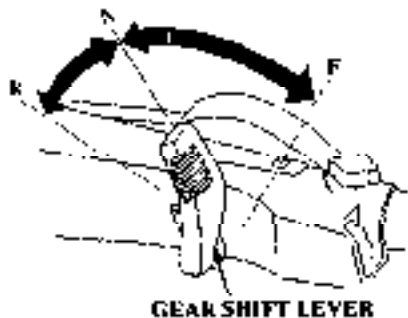

There are three gearshift lever positions.

F (forward): The boat moves forward.

N (neutral): The transmission gears are disengaged from the engine.

R (reverse): The boat reverses.

Choke Knob

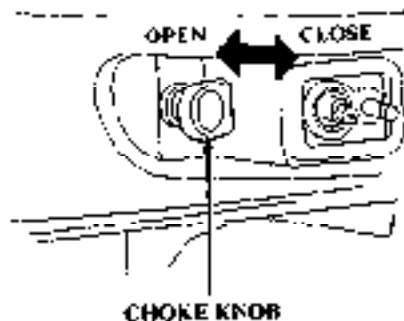

When the engine is cold, pull the choke knob. A rich fuel mixture is provided to the engine by pulling the choke knob.

3. CONTROLS (TILLER HANDLE TYPE)

Throttle Grip

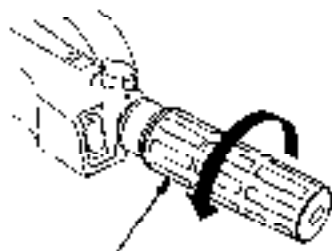

THROTTLE GRIP

Turn the grip clockwise or counter-clockwise to adjust the engine speed. Turning the grip in the direction shown by the arrow increases engine speed.

Throttle Opening Indicator

THROTTLE OPENING INDICATOR

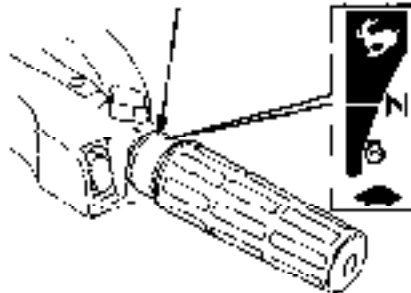

The curve on the grip label indicates throttle opening.

Throttle Friction Knob

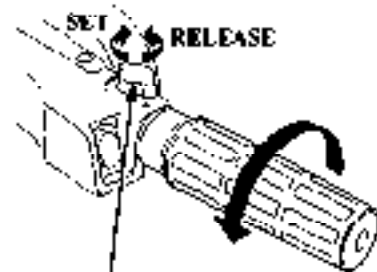

THROTTLE FRICTION KNOB

Use the throttle friction knob to set the throttle grip at a certain position while cruising. Turning the friction knob clockwise sets the throttle grip, and it is released by turning the friction knob counterclockwise.

3. CONTROLS (TILLER HANDLE TYPE)

Emergency Stop Switch

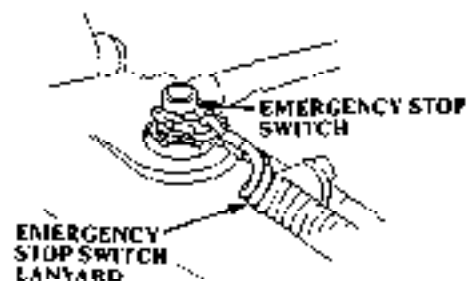

The emergency stop switch lanyard is provided to stop the engine immediately in the event the operator should fall overboard or away from the controls.

Emergency Stop Switch Lanyard

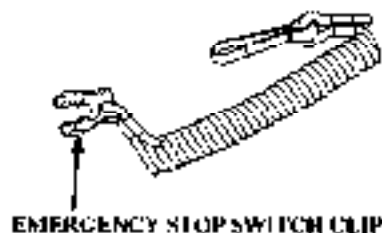

The emergency stop switch clip must be engaged with the emergency stop switch or the engine will not start. When the emergency stop switch clip becomes disengaged with the emergency stop switch, the engine will stop immediately.

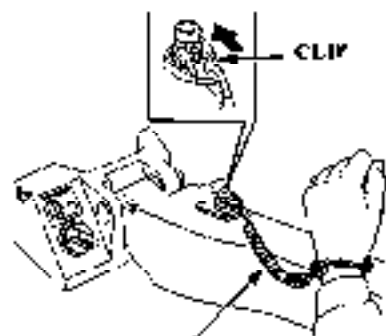

EMERGENCY STOP SWITCH LANYARD

Attach the emergency stop switch lanyard securely to the operator when operating the outboard motor.

3. CONTROLS (TILLER HANDLE TYPE)

SPARE EMERGENCY
STOP SWITCH CLIP



A spare emergency stop switch clip is provided near the ignition switch

Oil Pressure Indicator Light



(GREEN)

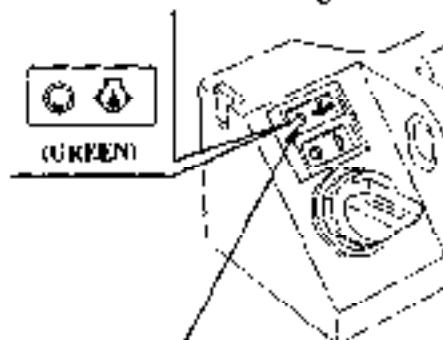

OIL PRESSURE INDICATOR LIGHT

The green oil pressure indicator light is normally ON when the outboard motor is running.

When the engine oil level is low or the engine lubrication system is faulty, the green oil pressure indicator light turns OFF and the engine speed decreases gradually.

Overheat Indicator Light



(RED)

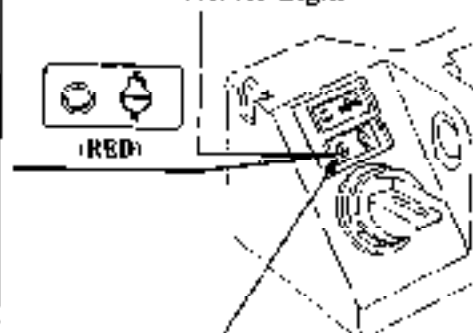

OVER HEAT INDICATOR LIGHT

When there is a cooling system problem, the red overheat indicator light turns ON and the engine speed decreases gradually.

3. CONTROLS (TILLER HANDLE TYPE)

Power Trim/Tilt Switch

Power Trim

Press the power trim/tilt switch on the tiller handle to adjust the motor trim angle from 0° to 20° to maintain proper boat trim. The power trim/tilt switch located on the tiller handle can be operated while the boat is under way or while stopped.

By using the power trim/tilt switch the operator can change the trim angle of the motor to achieve maximum boat acceleration, speed, stability and maintain optimum fuel consumption.

Power Tilt

Press the power trim/tilt switch on the tiller handle to adjust the motor tilt angle from 20° to 72°.

By using the power trim/tilt switch the operator can change the tilt angle of the motor for shallow water operation, beaching, launching from a trailer, or mooring.

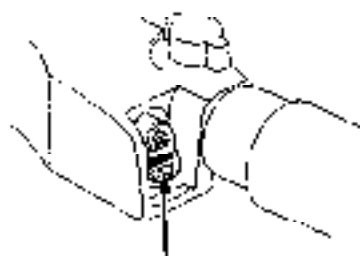

POWER
TRIM/TILT
SWITCH

NOTICE

Excessive trim/tilt angle during operation can cause the propeller to raise out of the water and cause propeller ventilation and engine over-revving. Excessive trim/tilt angle can also damage the water pump.

Steering Friction Adjuster

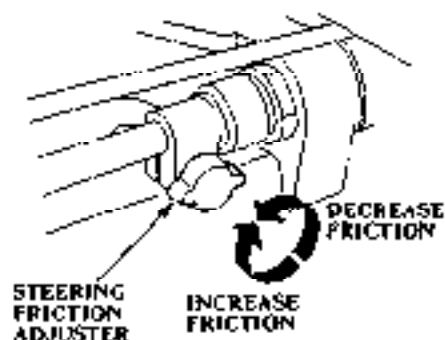

The steering friction adjuster adjusts the tightness of the steering movement.

3. CONTROLS (REMOTE CONTROL TYPE)

(SIDE-MOUNT TYPE) Remote Control Lever

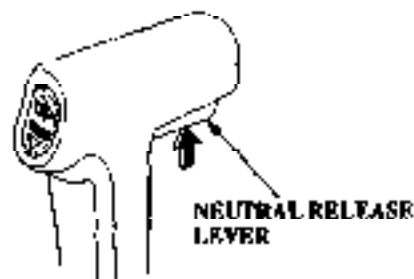

The remote control lever controls gear selection and throttle opening positions.

It is necessary to pull up the neutral release lever to operate the remote control lever.

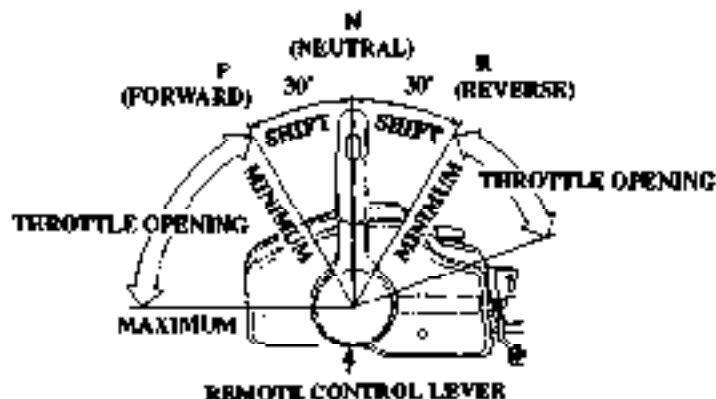

F (forward):

Moving the lever to the F position (approximately 30° from the N position) will engage the forward gear. Moving the lever farther into the F position will increase the throttle opening and the boat's forward speed.

N (neutral):

The engine idles and the transmission gears are disengaged.

R (reverse):

Moving the lever to the R position (approximately 30° from the N position) will engage the reverse gear. Moving the lever farther into the R position will increase the throttle opening and the boat's reverse speed.

3. CONTROLS (REMOTE CONTROL TYPE)

Neutral Release Lever

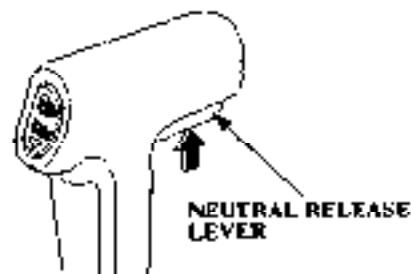

The neutral release lever is on the remote control lever to prevent an accidental gear engagement.

The remote control lever will not engage forward or reverse gear, unless the neutral release lever is pulled up.

Ignition Switch

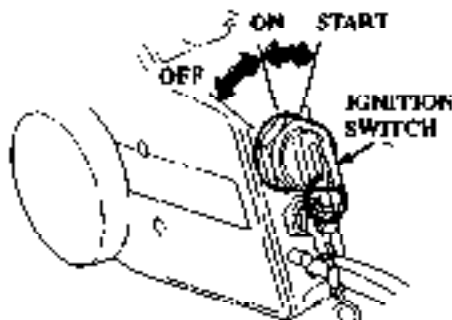

The remote control box is equipped with a key-type ignition switch. Key positions:

START

To activate the starter motor and start the engine (the remote control lever must be in the neutral position).

ON

To run the engine after starting (the battery will discharge if the key is left in this position with the engine not running).

OFF

To stop the engine (IGNITION OFF).

To prevent the battery from discharging, keep the key in the OFF position when the engine is not running.

3. CONTROLS (REMOTE CONTROL TYPE)

Emergency Stop Switch Lanyard

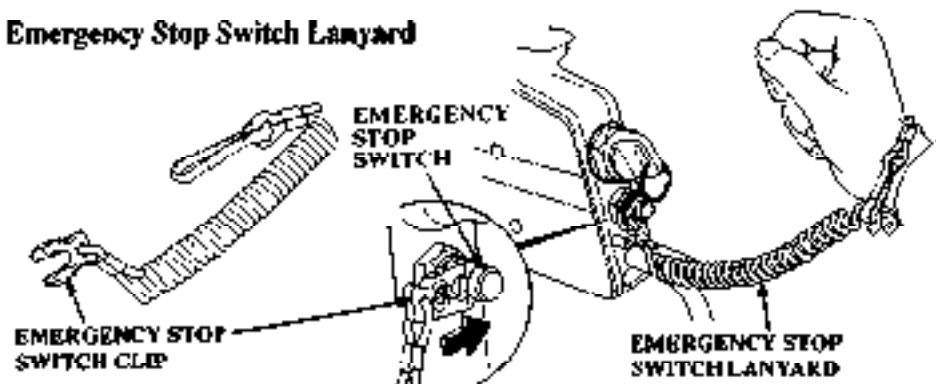

The emergency stop switch lanyard is provided to stop the engine immediately in the event the operator falls overboard or away from the controls.

The emergency stop switch clip must be engaged with the emergency stop switch, or the engine will not start. When the emergency stop switch clip becomes disengaged from the emergency stop switch, the engine will stop immediately.

The emergency engine stop switch should not be used to normally stop the engine. Use the ignition switch to normally stop the engine.

Attach the emergency stop switch lanyard securely to the operator when operating the outboard motor.

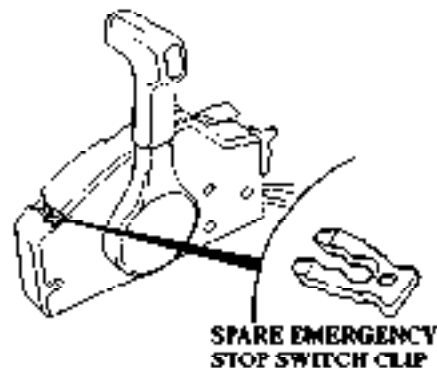

A spare emergency stop switch clip is provided on the remote control box.

3. CONTROLS (REMOTE CONTROL TYPE)

Choke/Fast Idle Lever

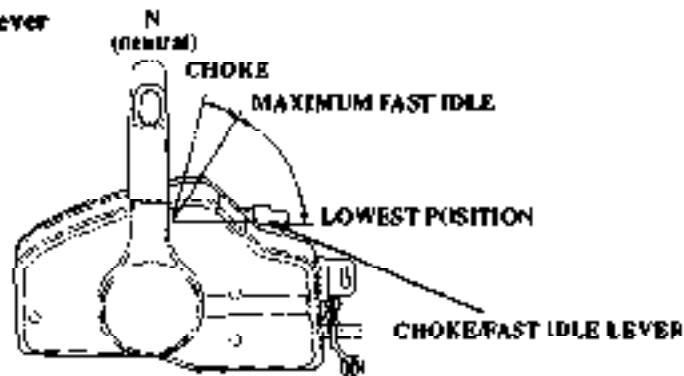

The choke/fast idle lever provides two functions:

1. Electric choke solenoid activation for easy engine start up.
2. Engine fast idle.

The choke/fast idle lever will not move unless the remote control lever is in the N (neutral) position. Conversely, the remote control lever will not move unless the choke/fast idle lever is in the lowest position.

Raise the choke/fast idle lever, and hold it all the way up to provide a rich fuel mixture and maximum fast idle.

Gradually lower the choke/fast idle lever to the lowest position to decrease the choke and fast idle

Manual Choke Knob

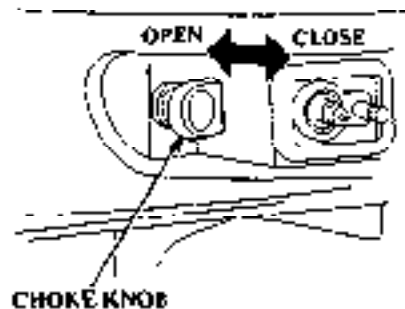

A manual choke knob is located on the right side of the motor, which can be used in the event the battery is discharged. Pull the manual choke knob, and a rich fuel mixture will be provided to the engine.

3. CONTROLS (REMOTE CONTROL TYPE)

Oil Pressure Indicator Light/Buzzer

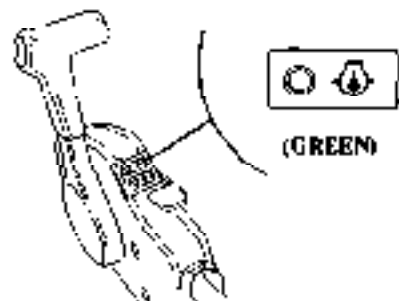

The green oil pressure indicator light turns **OFF** and the buzzer sounds when the oil level is low and/or the engine lubrication system is faulty. The engine speed slows down gradually.

Overheat Indicator Light/Buzzer

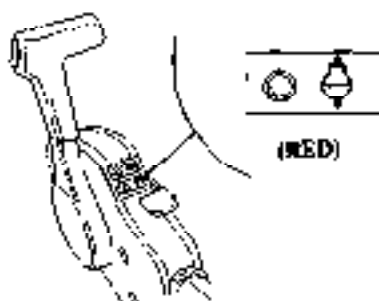

The red overheat indicator light turns **ON** and the buzzer sounds when there is a cooling system problem. The engine speed slows down gradually.

3. CONTROLS (REMOTE CONTROL TYPE)

Power Trim/Tilt Switch

Power Trim

Press the power trim/tilt switch on the remote control to adjust the motor trim angle from 0° to 20° to maintain proper boat trim. The power trim/tilt switch located on the remote control lever can be operated while the boat is under way or while stopped.

By using the power trim/tilt switch, the operator can change the trim angle of the motor to achieve maximum boat acceleration, speed, stability and maintain optimum fuel consumption.

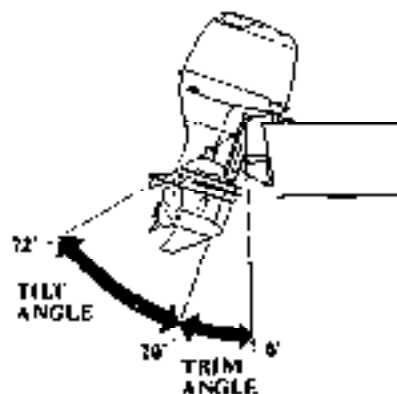

Power Tilt

Press the power trim/tilt switch on the remote control lever to adjust the motor tilt angle from 20° to 72°.

By using the power trim/tilt switch, the operator can change the tilt angle of the motor for shallow water operation, beaching, launching from a trailer, or mooring.

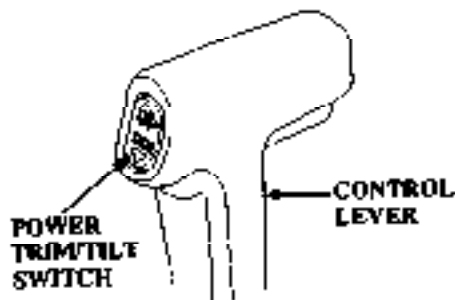

NOTICE

Excessive trim/tilt angle during operation can cause the propeller to raise out of the water and cause propeller ventilation and engine over-revving. Excessive trim/tilt angle can also damage the water pump.

3. CONTROLS (REMOTE CONTROL TYPE)

(PANEL-MOUNT TYPE) Remote Control Lever



The remote control lever controls gear selection and throttle opening positions.

It is necessary to pull up the neutral release lever to operate the remote control lever.

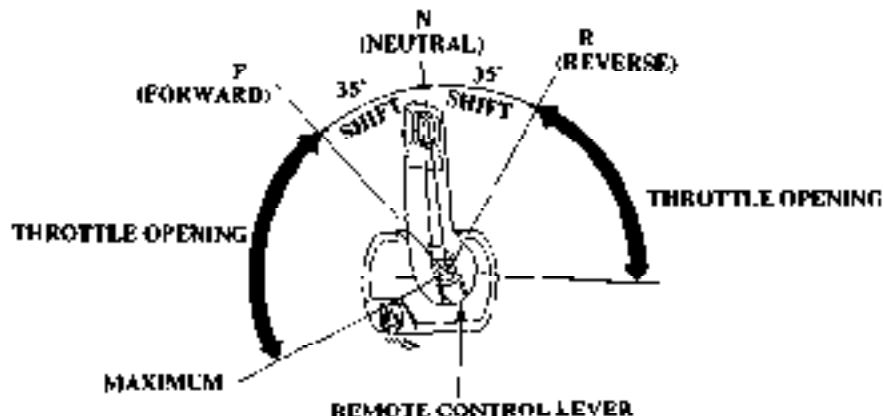

F (forward):

Moving the lever to the F position (approximately 35° from the N position) will engage the forward gear. Moving the lever farther into the F position will increase the throttle opening and the boat's forward speed.

N (neutral):

The engine idles and the transmission gears are disengaged.

R (reverse):

Moving the lever to R position (approximately 35° from the N position) will engage the reverse gear. Moving the lever farther into the R position will increase the throttle opening and the boat's reverse speed.

3. CONTROLS (REMOTE CONTROL TYPE)

Neutral Release Lever



The neutral release lever is on the remote control lever to prevent an accidental gear engagement.

The remote control lever will not engage forward or reverse gear, unless the neutral release lever is pulled up.

Ignition Switch

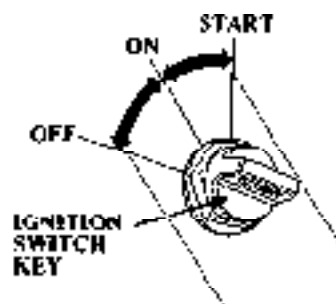

The switch panel is equipped with a key-type ignition switch.

Key positions:

START

To activate the stater motor and start the engine (the remote control lever must be in the neutral position).

ON

To run the engine after starting (the battery will discharge if the key is left in this position with the engine not running).

OFF

To stop the engine (IGNITION OFF).

To prevent the battery from discharging, keep the key in the OFF position when the engine is not running.

3. CONTROLS (REMOTE CONTROL TYPE)

Emergency Stop Switch Lanyard

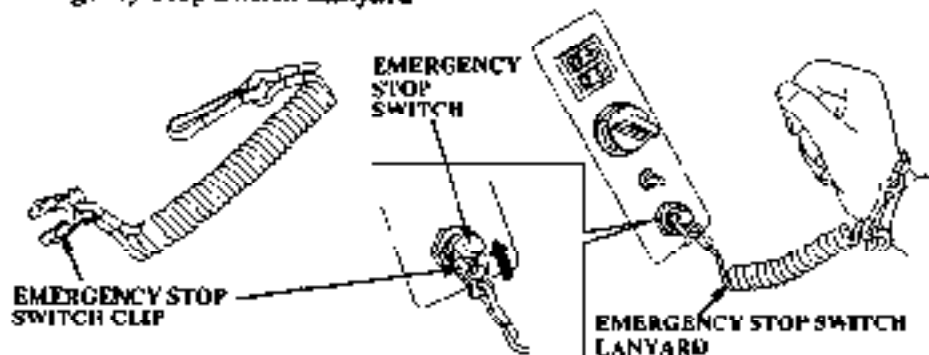

The emergency stop switch lanyard is provided to stop the engine immediately in the event the operator falls overboard or away from the controls.

The emergency stop switch clip must be engaged with the emergency stop switch, or the engine will not start. When the emergency stop switch clip becomes disengaged from the emergency stop switch, the engine will stop immediately.

The emergency engine stop switch should not be used to normally stop the engine. Use the ignition switch to normally stop the engine.

Attach the emergency stop switch lanyard securely to the operator when operating the outboard motor.



SPARE EMERGENCY STOP SWITCH CLIP

A spare emergency switch clip is provided in the tool bag.

3. CONTROLS (REMOTE CONTROL TYPE)

Throttle Button

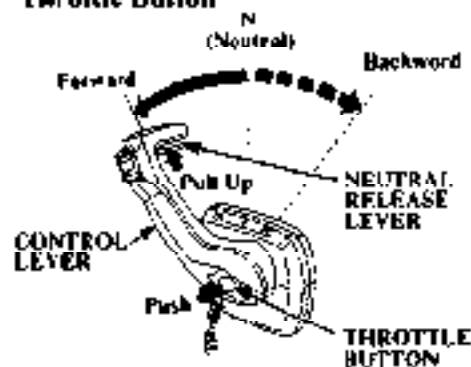

By moving the control lever forward or backward when the throttle button is pushed in, the throttle opening will be increased without engaging the gears.

It is necessary to position the control lever in N (neutral) to push in the throttle button.

Choke Switch

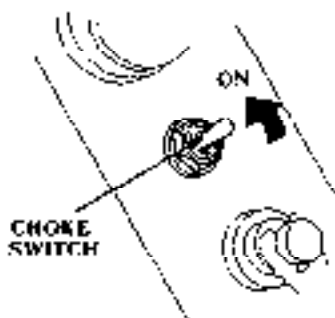

When the engine is cold, put the choke switch "ON". A rich fuel mixture will be provided to the engine.

Manual Choke Knob

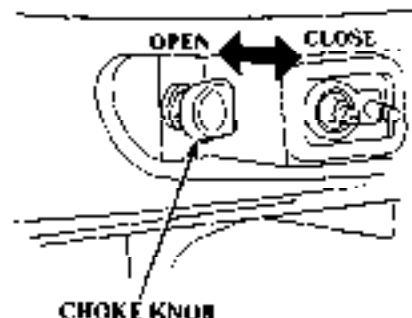

A manual choke knob is located on the right side of the motor, which can be used in the event the battery is discharged. Pull the manual choke knob, and a rich fuel mixture will be provided to the engine.

3. CONTROLS (REMOTE CONTROL TYPE)

Oil Pressure Indicator Light/Buzzer

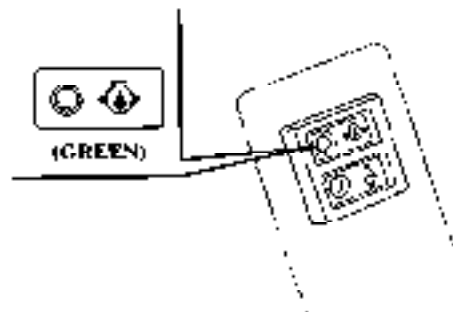

The green oil pressure indicator light turns OFF and the buzzer sounds when the oil level is low and/or the engine lubrication system is faulty. The engine speed slows down gradually.

Overheat Indicator Light/Buzzer

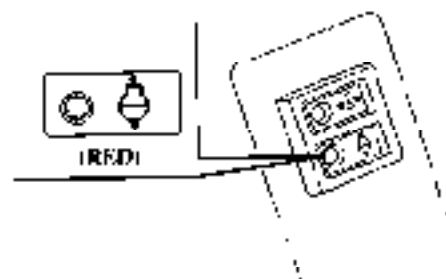

The red overheat indicator light turns ON and the buzzer sounds when there is a cooling system problem. The engine speed slows down gradually.

3. CONTROLS (REMOTE CONTROL)

Power Trim/Tilt Switch

Power Trim

Press the power trim/tilt switch on the remote control lever to adjust the motor trim angle from 0° to 20° to maintain proper boat trim. The power trim/tilt switch located on the remote control lever can be operated while the boat is under way or while stopped.

By using the power trim/tilt switch, the operator can change the trim angle of the motor to achieve maximum boat acceleration, speed, stability and maintain optimum fuel consumption.

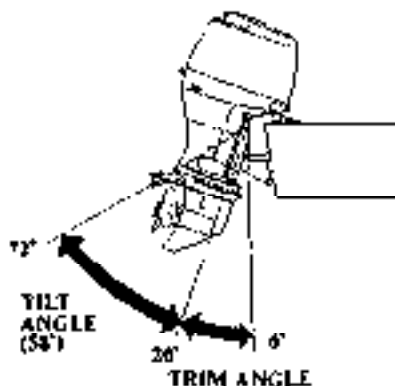

Power Tilt

Press the power trim/tilt switch on the remote control lever to adjust the motor tilt angle from 20° to 72°.

By using the power trim/tilt switch, the operator can change the tilt angle of the motor for shallow water operation, beaching, launching from a trailer, or mooring.

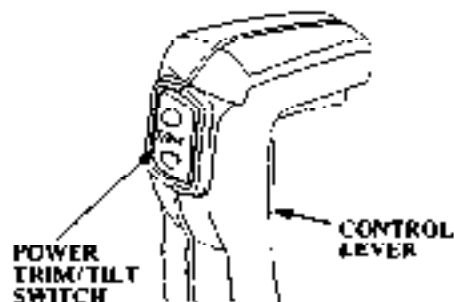

NOTICE

Excessive trim/tilt angle during operation can cause the propeller to raise out of the water and cause propeller ventilation and engine over-revving. Excessive trim/tilt angle can also damage the water pump.

3. CONTROLS (REMOTE CONTROL TYPE)

(TOP-MOUNT TYPE) Remote Control Lever

SINGLE TYPE

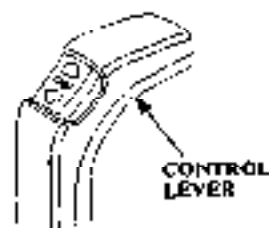

DUAL TYPE

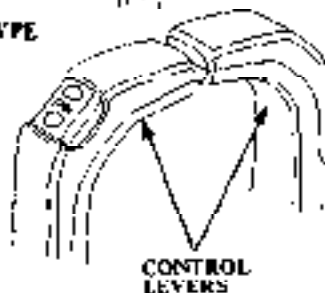

The remote control lever controls gear selection and throttle opening positions.

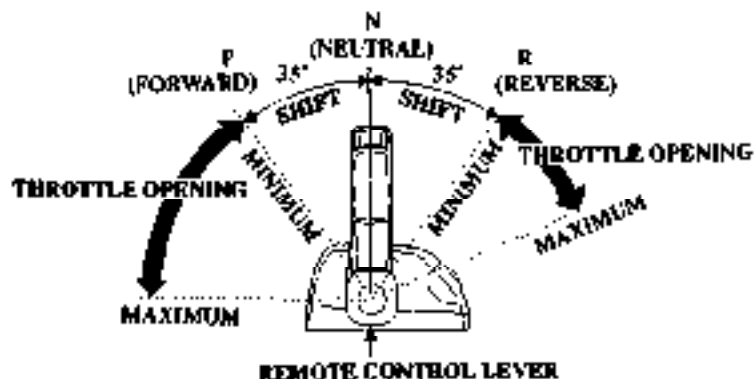

F (forward):

Moving the lever to the F position (approximately 35° from the N position) will engage the forward gear. Moving the lever farther into the F position will increase the throttle opening and the boat's forward speed.

N (neutral):

The engine idles and the transmission gears are disengaged.

R (reverse):

Moving the lever to the R position (approximately 35° from the N position) will engage the reverse gear. Moving the lever farther into the R position will increase the throttle opening and the boat's reverse speed.

3. CONTROLS (REMOTE CONTROL TYPE)

Ignition Switch

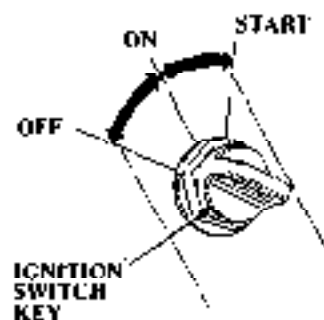

The switch panel is equipped with a key-type ignition switch.

Key positions:

START

To activate the starter motor and start the engine (the remote control lever must be in neutral position).

ON

To run the engine after starting (the battery will discharge if the key is left in this position with the engine not running).

OFF

To stop the engine (IGNITION OFF).

To prevent the battery from discharging, keep the key in the OFF position when the engine is not running.

3. CONTROLS (REMOTE CONTROL TYPE)

Emergency Stop Switch Lanyard

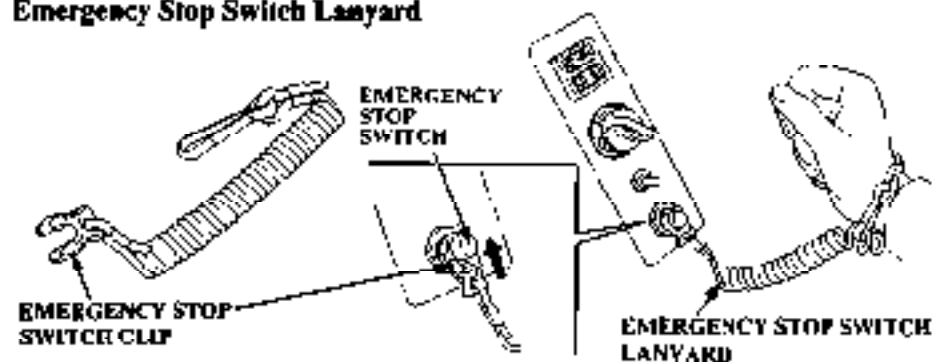

The emergency stop switch lanyard is provided to stop the engine immediately in the event the operator falls overboard or away from the controls.

The emergency stop switch clip must be engaged with the emergency stop switch, or the engine will not start. When the emergency stop switch clip becomes disengaged from the emergency stop switch, the engine will stop immediately.

The emergency engine stop switch should not be used to normally stop the engine. Use the ignition switch to normally stop the engine.

Attach the emergency stop switch lanyard securely to the operator when operating the outboard motor.



SPARE EMERGENCY STOP SWITCH CLIP

A spare emergency switch clip is provided in the tool bag.

3. CONTROLS (REMOTE CONTROL TYPE)

Throttle Button

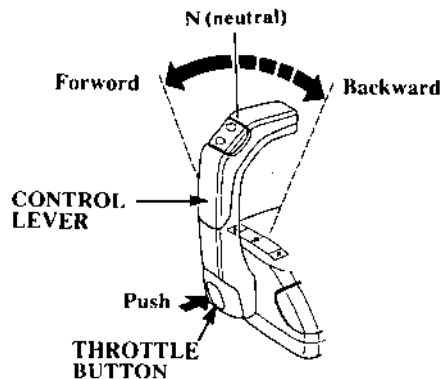

By moving the control lever forward or backward when the throttle button is pushed in, the throttle opening will be increased without engaging the gears.

It is necessary to position the control lever in N (neutral) to push in the throttle button.

Choke Switch

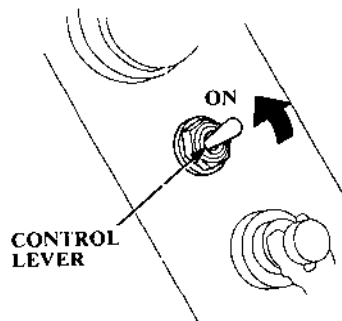

When the engine is cold, put the choke switch on. A rich fuel mixture will be provided to the engine.

Manual Choke Knob

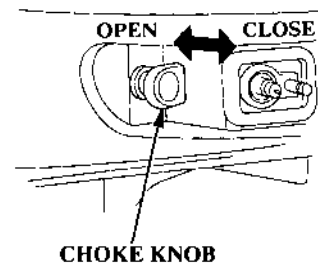

A manual choke knob is located on the right side of the motor, which can be used in the event the battery is discharged. Pull the manual choke knob, and a rich fuel mixture will be provided to the engine.

3. CONTROLS (REMOTE CONTROL TYPE)

Oil Pressure Indicator Light/Buzzer

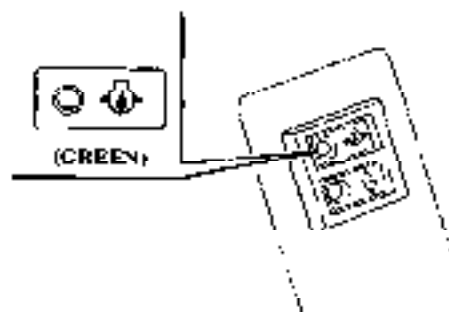

The green oil pressure indicator light turns OFF and the buzzer sounds when the oil level is low and/or the engine lubrication system is faulty. The engine speed slows down gradually.

Overheat Indicator Light/Buzzer

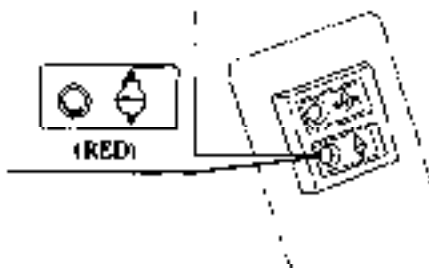

The red overheat indicator light turns ON and the buzzer sounds when there is a cooling system problem. The engine speed slows down gradually.

3. CONTROLS (REMOTE CONTROL TYPE)

Power Trim/Tilt Switch (remote control lever)

Power Trim

Press the power trim/tilt switch on the remote control lever to adjust the motor trim angle from 0° to 20° to maintain proper boat trim. The power trim/tilt switch located on the remote control lever can be operated while the boat is under way or while stopped.

By using the power trim/tilt switch, the operator can change the trim angle of the motor to achieve maximum boat acceleration, speed, stability and maintain optimum fuel consumption.

Power Tilt

Press the power trim/tilt switch on the remote control lever to adjust the motor tilt angle from 20° to 72°.

By using the power trim/tilt switch, the operator can change the tilt angle of the motor for shallow water operation, beaching, launching from a trailer, or mooring.

SINGLE TYPE

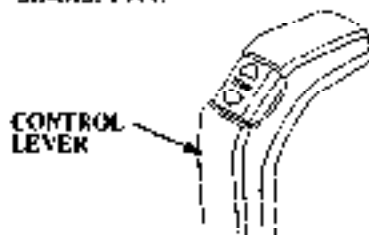

DUAL TYPE

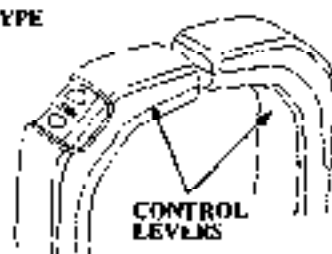

NOTICE

Excessive trim/tilt angle during operation can cause the propeller to raise out of the water and cause propeller ventilation and engine over-revving. Excessive trim/tilt angle can also damage the water pump.

Power Trim/Tilt Switch (control box console)

LEFT INDIVIDUAL ADJUSTMENT

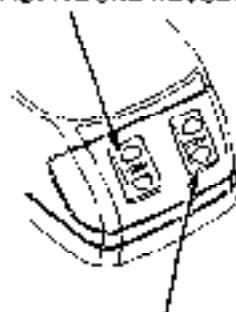

RIGHT INDIVIDUAL ADJUSTMENT

The right and left outboard motors can be adjusted separately with the switch on the console side.

Power Tilt Switch (engine pan)



POWER TILT SWITCH

The power tilt switch located on the engine pan is for tilting the motor for trailering, or performing outboard maintenance. This power tilt switch should only be operated with the boat stopped and engine off.

This switch can operate even when the ignition switch is OFF.

Trim Meter



TRIM METER

The trim meter has a range of 0° to 20° and indicates the trim angle of the outboard motor. Refer to the trim meter when using the power trim/tilt switch to achieve proper boat performance.

Tachometer (optional equipment)



TACHOMETER

The tachometer shows the approximate engine speed in revolutions per minute. Refer to the tachometer when using the power trim/tilt switch to achieve proper boat and engine performance.

3. CONTROLS (COMMON)

Manual Relief Valve

If the power trim/tilt switch will not tilt the outboard motor, the motor can be manually tilted up or down by opening the manual relief valve. To tilt the outboard motor manually, turn the manual valve under the left stern bracket no more than 1 or 2 turns counterclockwise using a screwdriver

After tilting the motor, turn the manual relief valve clockwise securely. The manual relief valve must be tightened securely before operating the motor, or the motor could tilt up when operating in reverse.

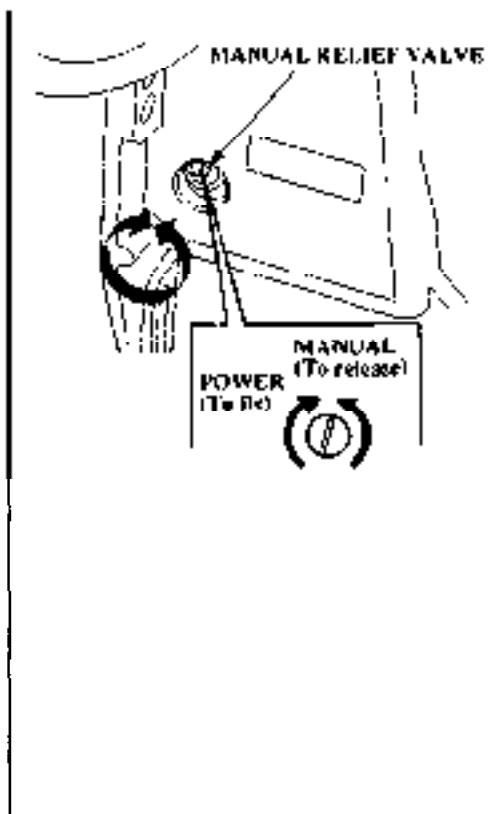

Tilt Lock Lever

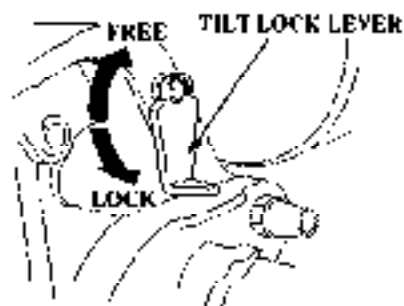

Use the tilt lock lever to hold the motor in the highest tilt position when the boat is moored for a long time.

Tilt the motor up as far as it will go, then move the tilt lock lever into the lock position and gently lower the motor.

NOTICE

Hitting piers or other boats when the motor is tilted can cause damage. Be especially careful to prevent the boat from bumping anything while the motor is tilted.

Trim Tab

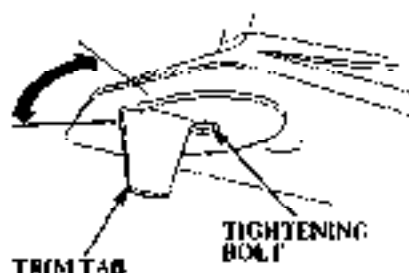

When making a turn, if an unequal amount of effort is required to turn the steering wheel or tiller handle right or left, adjust the trim tab so that an equal amount of effort is required.

Distribute the load evenly in the boat, and run the boat in straight course at full throttle. Slightly turn the steering wheel or tiller handle for both right and left turns to determine if an equal amount of effort is required. If adjustment is necessary, loosen the tightening bolt and turn the trim tab right or left. Make small adjustments at a time and retest. Incorrect trim tab adjustment can cause adverse steering. The trim tab also functions as an anode.

3. CONTROLS (COMMON)

Anode Metal

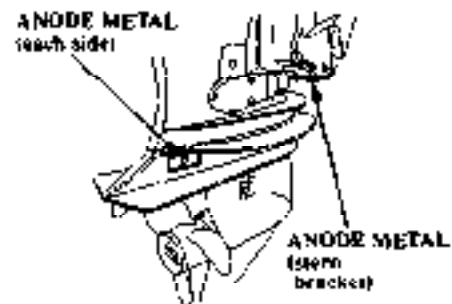

The anodes are made from a sacrificial material which helps to protect the outboard motor from corrosion.

NOTICE

Painting or coating the anodes will lead to rust and corrosion damage to the outboard motor.

Cooling System Indicator

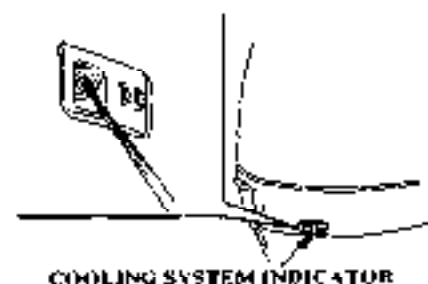

The cooling system is monitored here to make sure cooling water is circulating through the engine.

Water flowing out of the cooling system indicator shows that the cooling system is functioning normally.

Water Intakes

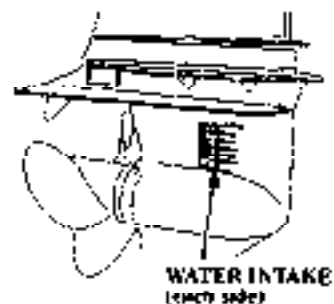

The engine cooling water is drawn into the water pump through these water intakes.

Transom Angle Adjusting Rod

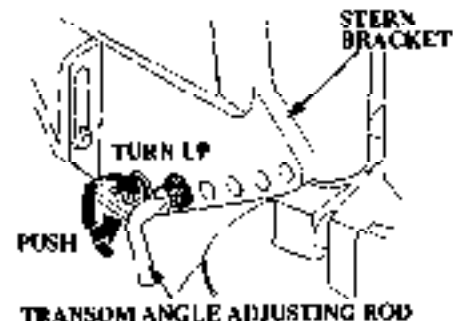

The transom angle adjusting rod is used to adjust the motor angle to achieve the correct boat trim. There are 5 adjustment holes located in the stern bracket.

Push in and turn the transom angle adjusting rod up to remove. To install, insert into the proper hole and turn down to lock. After installation, pull the transom angle adjusting rod outward to be sure it is locked in place.

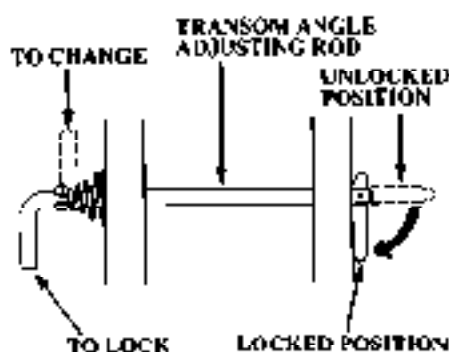

Start with the transom angle adjusting rod in the hole closest to the boat transom, lower the motor and operate the boat at full speed. If the bow is excessively low stop the boat. Tilt the motor up and raise the transom angle adjusting rod one more hole away from the transom and retest. The optimum boat trim is when the boat is parallel with the water. The transom angle adjusting rod stops the motor's forward movement.

The motor should never be operated with the transom angle adjusting rod removed.

3. CONTROLS (COMMON)

Fuel Cap/Gauge/Vent Knob
(optional fuel tank)

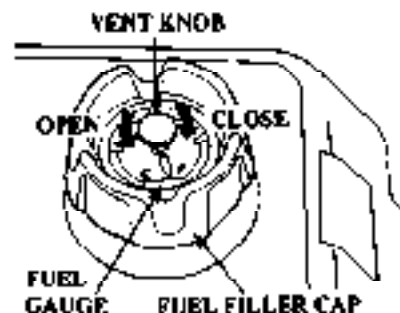

The fuel gauge is part of the fuel cap.

The fuel cap vent knob controls air entering and leaving the fuel tank. When refilling the fuel tank, turn the vent knob counterclockwise to the open position and remove the fuel cap.

Before transporting, storing or refilling the fuel tank, inspect the condition of the fuel cap gasket and replace if necessary.

Before transporting or storing the fuel tank, turn the vent knob fully clockwise to the closed position.

Anytime the fuel tank is in the boat with the vent knob closed, disconnect the fuel hose connector from the outboard motor (refer to page 53).

WARNING Gasoline is highly flammable and explosive, and you can be burned or seriously injured when handling fuel.

- Stop engine and keep heat, sparks, and flame away.
- Handle fuel only outdoors.
- Wipe up spills immediately.

Over-Rev Limiter

This outboard motor is equipped with an engine over-rev limiter which limits the maximum engine rpm. This over-rev limiter protects the engine from mechanical damage.

The over-rev limiter may be activated by putting the propeller in a light load condition or propeller ventilation. When the over-rev limiter is activated, the engine rpm will become unstable or erratic. Should this occur, reduce the throttle opening and wait for the engine rpm to stabilize, then increase the throttle opening.

On the power trim/tilt type motors, lower the trim angle on high speed turns to reduce the possibility of propeller ventilation.

If the over-rev limiter activates when trim/tilt angle is correct, stop the engine and check for mounting problems and propeller damage. If mounted improperly, fix it. If the propeller is damaged, replace it.

Engine Cover Lock Levers

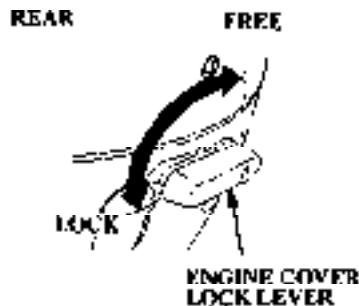
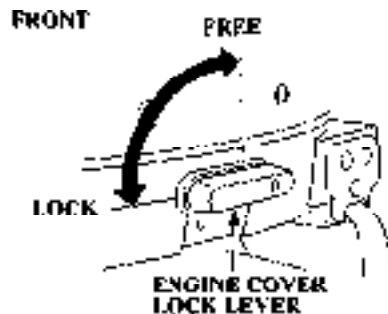

The engine cover lock levers are used to fasten the engine cover.

To open and remove the engine cover, turn the front and rear lock levers counterclockwise to the FREE position.

To fasten the engine cover, set the engine cover in position and turn the lock levers to the LOCK position.

Fuel Hose Connectors

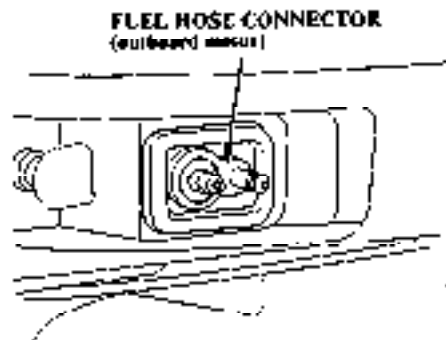

FUEL HOSE CONNECTOR
(optional, portable fuel tank)

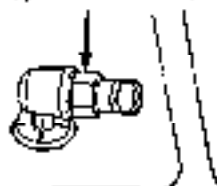

Refer to pages 53 - 54 for fuel hose connection.

4. PRE-OPERATION CHECKS

Engine Cover Removal/Installation

(FRONT)

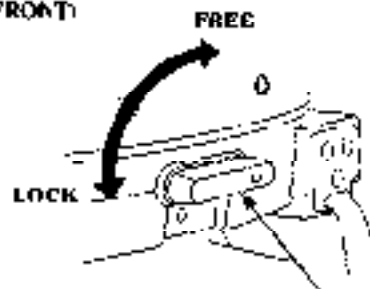

(REAR)



ENGINE COVER LOCK LEVER

To remove, turn the front and rear engine cover lock levers to the FREE position and remove the engine cover

To install, position the engine cover over the engine and turn the front and rear lock levers to the LOCK position

After installing the engine cover, inspect the engine cover fastening condition and adjust it if necessary (page 51)

4. PRE-OPERATION CHECKS

Engine Oil

Engine oil is a major factor affecting engine performance and service life.

NOTICE

Running the engine with insufficient oil can cause serious engine damage.

Recommended oil:SAE 10W-30 or 10W-40

Use 4-stroke motor oil that meets or exceeds the requirements for API service classification SG or SH. Always check the API SERVICE label on the oil container to be sure it includes the letters SG or SH.

NOTICE

Using nondetergent oil can shorten the engine's service life, and using 2-stroke oil can damage the engine.

Inspection

1. Position the outboard motor vertically, and remove the engine cover.
2. Remove the oil level dipstick and wipe with a clean rag.
3. Reinsert the dipstick all the way in, then pull it out and read the level. If the oil registers near or below the lower limit mark, remove the oil filler cap and fill to the upper limit mark with the recommended oil.

NOTICE

Do not overfill. Excessive oil can damage the engine.

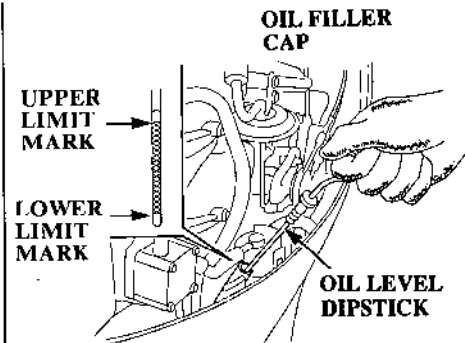

4. Reinstall the oil filler cap and tighten securely.
5. Install the engine cover and lock it securely.

When the engine oil is contaminated or discolored, replace with fresh engine oil (refer to page 111 for oil capacity, replacement interval and procedure).

4. PRE-OPERATION CHECKS

Fuel Level (optional fuel tank)

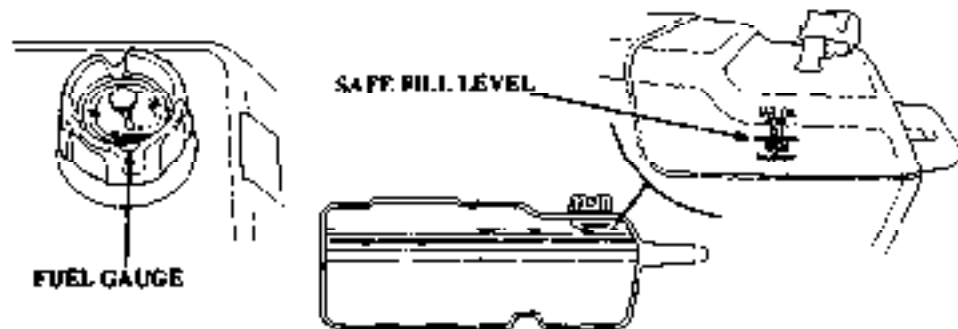

Check the fuel gauge and refill the tank to the **SAFE FILL** level mark if necessary.

Fuel tank capacity - 6.6 US gal. (25 lit.)

WARNING Gasoline is highly flammable and explosive, and you can be burned or seriously injured when handling fuel.

- Stop engine and keep heat, sparks, and flame away.
- Handle fuel only outdoors.
- Wipe up spills immediately.

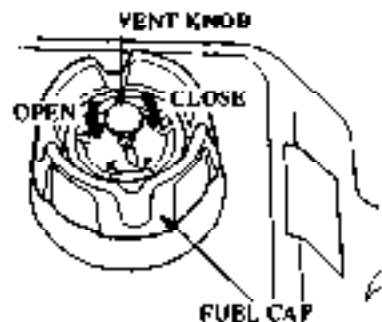

Refilling

Remove the fuel tank from the boat for refilling. Turn the vent knob counterclockwise to the open position and remove the fuel cap.

Refuel in a well-ventilated area. Fill the fuel tank up to the **SAFE FILL** level mark only. Inspect the condition of the fuel cap gasket and replace if necessary.

After refilling, install and tighten the fuel cap securely. Turn the vent knob clockwise to the closed position. Return the fuel tank to the boat.

Fuel Recommendations

Use unleaded gasoline with a pump-octane rating of 86 or higher.

These outboard motors are certified to operate on unleaded gasoline. Unleaded gasoline produces fewer engine and spark plug deposits and extends exhaust system life.

Never use stale or contaminated gasoline or an oil/gasoline mixture. Avoid getting dirt or water in the fuel tank.

Occasionally you may hear light "spark knock" or "pinging" (metallic rapping noise) while operating under heavy loads. This is no cause for concern.

If spark knock or pinging occurs at a steady engine speed, under normal load, change brands of gasoline. If spark knock or pinging persists, see an authorized Honda Marine dealer.

NOTICE

Running the engine with persistent spark knock or pinging can cause engine damage.

Running the engine with persistent spark knock or pinging is misuse, and the Distributor's Limited Warranty does not cover parts damaged by misuse.

4. PRE-OPERATION CHECKS

Oxygenated Fuels

Some conventional gasolines are being blended with alcohol or an ether compound. These gasolines are collectively referred to as oxygenated fuels. To meet clean air standards, some areas of the United States and Canada use oxygenated fuels to help reduce emissions.

If you use an oxygenated fuel, be sure it is unleaded and meets the minimum octane rating requirement.

Before using an oxygenated fuel, try to confirm the fuel's contents. Some states/provinces require this information to be posted on the pump.

The following are the EPA approved percentages of oxygenates:

ETHANOL — (ethyl or grain alcohol) 10% by volume
You may use gasoline containing up to 10% ethanol by volume. Gasoline containing ethanol may be marketed under the name "Gasohol".

MTBE — (Methyl Tertiary Butyl Ether) 15% by volume
You may use gasoline containing up to 15% MTBE by volume.

METHANOL — (methyl or wood alcohol) 5% by volume
You may use gasoline containing up to 5% methanol by volume, as long as it also contains solvents and corrosion inhibitors to protect the fuel system. Gasoline containing more than 5% methanol by volume may cause starting and/or performance problems. It may also damage metal, rubber, and plastic parts of your fuel system.

If you notice any undesirable operating symptoms, try another service station, or switch to another brand of gasoline.

Fuel system damage or performance problems resulting from the use of an oxygenated fuel containing more than the percentages of oxygenates mentioned above are not covered under warranty.

Propeller and Cotter Pin Inspection

WARNING The propeller blades are thin and sharp. Careless handling of the propeller can result in injury.

When checking the propeller:

- Remove the clip of the emergency stop switch to prevent an accidental starting of the engine.
- Wear heavy gloves when handling the propeller.

Propeller rotates rapidly while cruising. Before starting the engine, check the propeller blades for damage and deformation and replace if necessary.

We recommend carrying a spare propeller and fastening hardware aboard. If no spare propeller is available, return to the pier at low speed and replace.

Consult an authorized Honda outboard motor dealer for propeller selection.

COTTER PIN

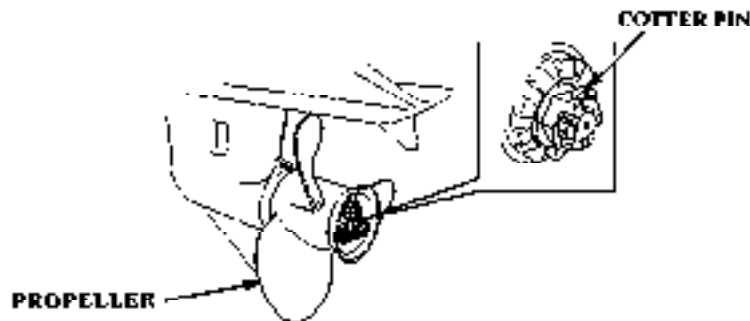

Engine speed varies according to propeller size and boat condition.

Use of the correct propeller assures powerful acceleration, high top speed, economy and cruising comfort, and it assures longer engine life as well.

Consult with your authorized Honda outboard motor dealer for proper propeller selection.

1. Check the propeller for damage, wear, or deformation.
2. Check whether the propeller is installed properly.
3. Check the cotter pin for damage. Replace whenever the propeller is faulty.

4. PRE-OPERATION CHECKS

Steering Friction Adjustment (Tiller handle Type)

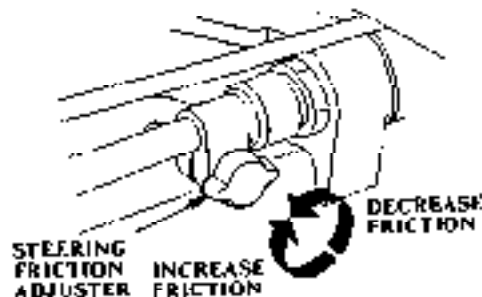

Operate the tiller handle right and left to check the tightness.

Adjust the steering friction adjuster so that a slight amount of drag is felt. The steering should move smoothly and freely.

Turning the steering friction adjuster knob to the right increases the drag and to the left decreases.

Remote Control Friction Adjustment

(SIDE-MOUNT TYPE)

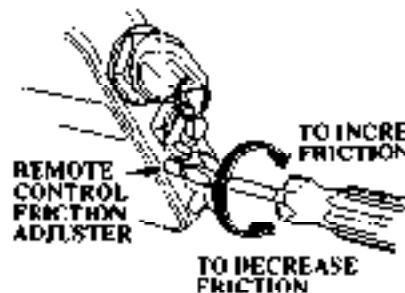

Move the remote control lever into forward and reverse gears, and check the amount of drag felt.

Adjust the remote control friction adjuster so that a slight amount of drag is felt. The remote control lever should move smoothly and freely.

(PANEL MOUNT TYPE)

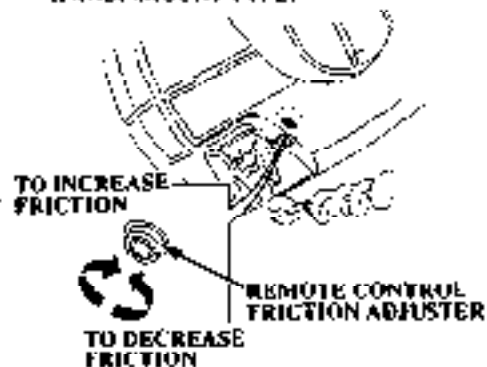

(TOP-MOUNT TYPE)

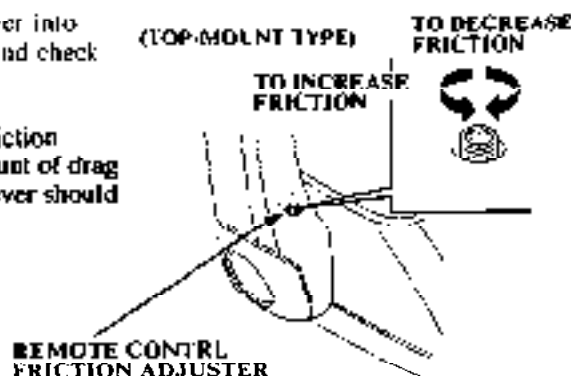

4. PRE-OPERATION CHECKS

Engine Cover Lock Lever Adjustment

If the engine cover becomes loose, it will shake and become noisy, and it may allow water to enter.

Inspect the engine cover fastening condition and adjust if necessary.

Inspection

1. Install the engine cover and fasten with the front and rear lock levers turned to LOCK position.
2. Inspect the clearance between the engine cover and the undercase at the points as shown.

The clearance should be within 0.19–0.23 in (4.8–5.8 mm).

Inspect front and rear end individually.

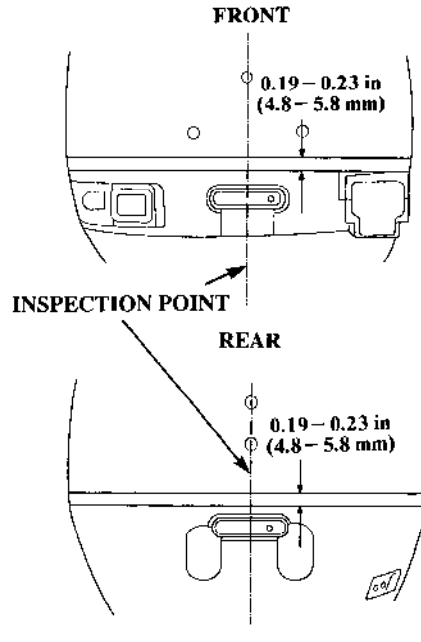

3. Adjust if the clearance is outside the specified range.

Adjustment

1. Remove the engine cover. Loosen each hook bracket retaining bolt and adjust the height of the brackets to gain the proper clearance.

Adjust front and rear end individually.

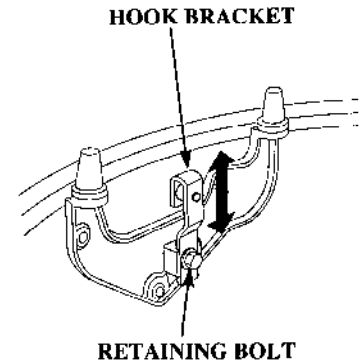

4. PRE-OPERATION CHECKS

2. After the adjustment, tighten the bolts securely and install the engine cover.

Reinspect the clearance and readjust if necessary.

Other Checks

Check the following items:

1. The fuel hose for kinking, collapsing or loose connections.
2. The stern bracket for damage and mounting bolts for proper torque
3. The tool kit contents. Compare your tool kit contents against the tool kit illustration in right column. Replace any missing items
4. The anodes for damage, looseness or excessive corrosion.

The anodes help to protect the outboard motor from corrosion any time they are exposed directly to the water.

Replace anodes when they are visibly reduced in size or crumble easily.

NOTICE Painting or coating the anodes will lead to rust and corrosion damage to the outboard motor.

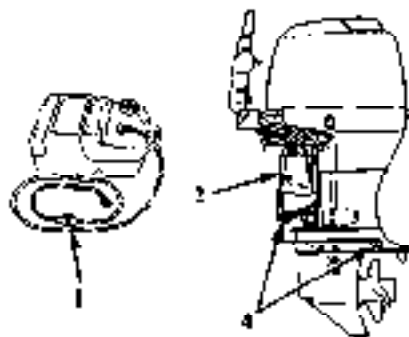

The following materials should be kept with the boat:

1. Owner's Manual
2. Tool Kit

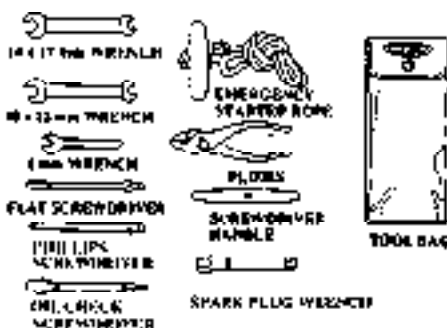

3. Spare emergency stop switch clip, engine oil, spark plug, propeller, plain washer, castle nut and cotter pin.
4. Required information regarding boating laws and regulations.

Optional Fuel Tank

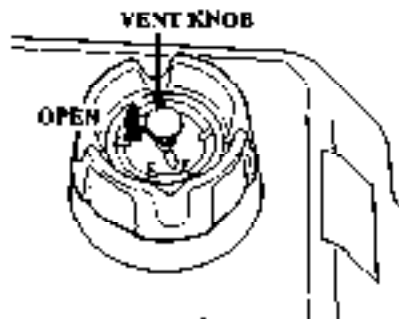

The fuel tank must be properly secured in the boat. This will protect the fuel tank from mechanical damage caused by the fuel tank shifting.

The fuel tank must be in a well ventilated area to reduce the chance of a gasoline vapor explosion. Avoid direct sunlight on the fuel tank.

Due to the fuel pump capacity, do not place the fuel tank more than 6 feet away from the motor or lower than 3 feet below the outboard end fuel hose connector.

1. Open the fuel tank vent by turning the vent knob at least 2 or 3 turns counterclockwise. Allow the air pressure inside the fuel tank to equalize with the outside air. With the vent open, air can enter the fuel tank to displace the fuel as the fuel level goes down.
2. Remove the fuel cap and inspect the condition of the fuel cap and gasket. Replace the fuel cap or gasket if they are cracked, damaged or leaking fuel.
3. Check the fuel level.

Fuel Line Connection

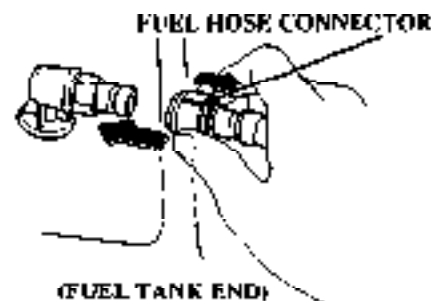

Inspect the fuel hose, and the O-ring seals in the fuel hose connectors. Replace the fuel hose, or fuel hose connectors if they are cracked, damaged or leaking fuel. Be sure the fuel hose is not kinked.

1. Connect the fuel hose connector to the fuel tank. Be sure the fuel hose connector is securely snapped in place.

5. STARTING THE ENGINE

FUEL HOSE CONNECTOR

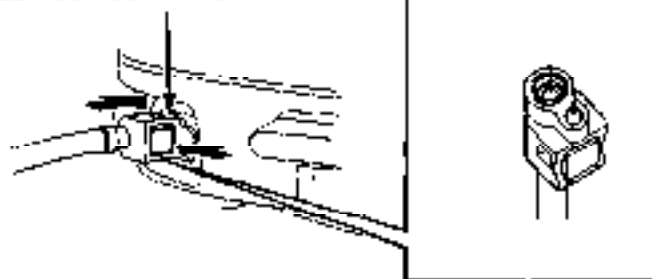

2. Connect the fuel hose connector to the outboard motor. Install the outboard end fuel hose connector with the clip toward the outside. Be sure the fuel hose connector is securely snapped in place.

NOTICE

If the outboard end fuel hose connector is forcibly installed in the reversed direction, the fuel hose connector O-ring seal can be damaged. A damaged O-ring seal can cause a fuel leak.

WARNING Gasoline is highly flammable and explosive, and you can be burned or seriously injured when handling fuel.

- Stop engine and keep heat, sparks, and flame away.
- Handle fuel only outdoors.
- Wipe up spills immediately.

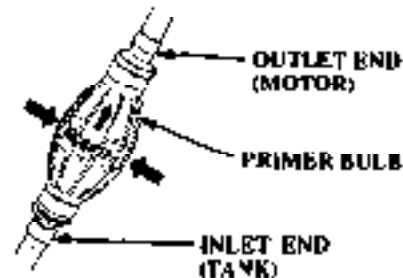

3. Hold the primer bulb so that the outlet end is higher than the inlet end. The arrow on the primer bulb points upward. Squeeze the primer bulb several times until it feels firm, indicating that fuel has reached the carburetors. Check for fuel leaks and repair any leaks before starting the engine.

Do not squeeze the primer bulb when the engine is running, because this could cause the carburetors to overflow.

5. STARTING THE ENGINE (TILLER HANDLE TYPE)

Ignition Switch

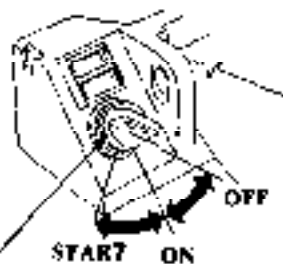

IGNITION SWITCH

Move the gearshift lever to the N (neutral) position before starting. The engine will not start unless the gearshift lever is in the N (neutral) position.

Shift Lever

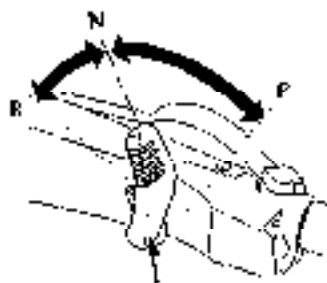

GEAR SHIFT LEVER

There are three gearshift lever positions.

F (forward): The boat moves forward.

N (neutral): The transmission gears are disengaged from the engine.

R (reverse): The boat reverses.

Choke Knob

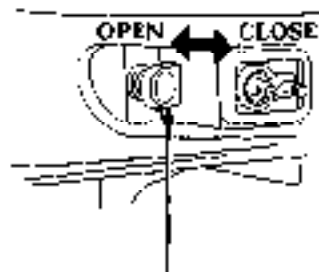

CHOKE KNOB

When the engine is cold, pull the choke knob. A rich fuel mixture is provided to the engine by pulling the choke knob.

5. STARTING THE ENGINE (TILLER HANDLE TYPE)



- 1 Engage the emergency stop switch clip (located at one end of the emergency stop switch lanyard) with the emergency stop switch.

Attach the other end of the emergency stop switch lanyard securely to the operator.

WARNING If the operator does not attach the emergency stop switch lanyard, and is thrown from his seat or out of the boat, the out-of-control boat can seriously injure the operator, passengers, or bystanders.

Always properly attach the lanyard before starting the engine.

The engine will not start unless the emergency stop switch clip is engaged with the emergency engine stop switch.

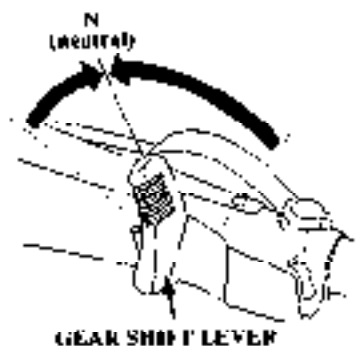

2. Move the gearshift lever to the N (neutral) position.

The engine will not start unless the gearshift lever is in the N (neutral) position.

5. STARTING THE ENGINE (TILLER HANDLE TYPE)

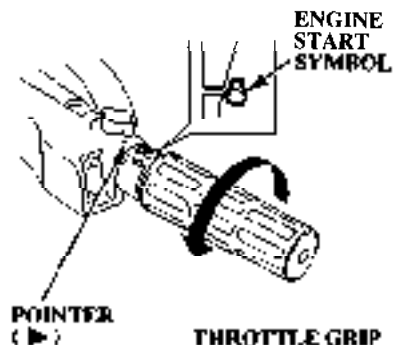

3. Align the engine start symbol "⊗" on the throttle grip with the pointer "▶" on the tiller handle.

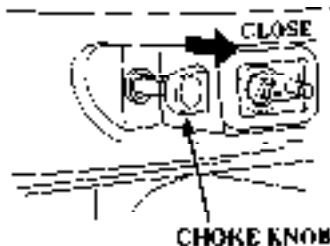

4. When the engine is cold or ambient temperature is low pull the choke knob.

5. Turn the ignition switch key to the START position, and release the key when the engine starts.

The starter motor consumes a large amount of current. Do not run it continuously for more than 5 seconds at a time. If the engine does not start within 5 seconds wait at least 10 seconds before using the starter motor again.

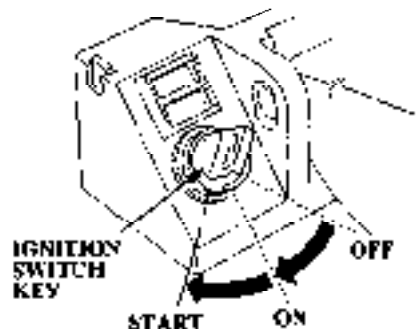

NOTICE

Do not turn the ignition switch key to the start position while the engine is running.

This can damage the starter motor and flywheel.

5. STARTING THE ENGINE (TILLER HANDLE TYPE)

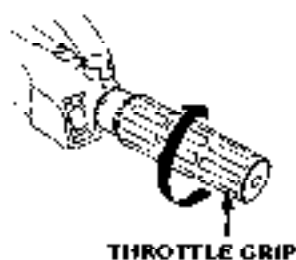
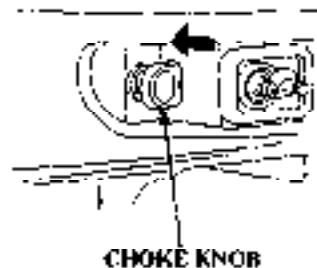

6. If it was necessary to use the choke knob to start the engine, slowly return it to its initial position. Turn the throttle grip in the SLOW direction to a position where the engine does not stall.
7. After the engine starts, verify that water is flowing through the cooling system by monitoring the cooling system indicator. The amount of water coming out of the cooling system indicator will vary due to thermostat operation. Stop the engine if water does not come out of the cooling system indicator or if you see steam.

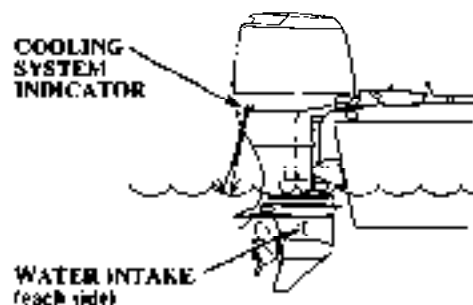

Check the water intake screens and the cooling system indicator discharge port, and if necessary remove any obstructions. If the problem continues, contact your closest authorized Honda Marine dealer.

NOTICE

- Running the outboard motor with an obstruction in the cooling system can damage the water pump and overheat the engine.
- The propeller must remain underwater. Running the outboard motor out of water will damage the water pump and overheat the engine.

5. STARTING THE ENGINE (TILLER HANDLE TYPE)

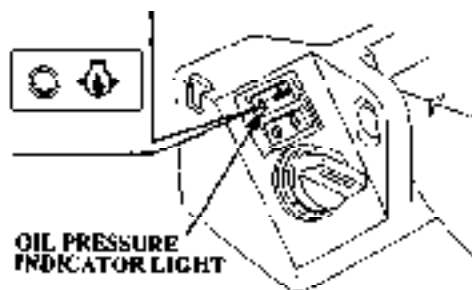

OIL PRESSURE
INDICATOR LIGHT

NORMAL: GREEN LIGHT ON
ABNORMAL: GREEN LIGHT
BLINKING OR OFF

8. With the engine running, check to see if the green engine oil pressure indicator light turns ON. Stop the engine if the oil pressure indicator light does not turn ON.

Check the engine oil level (see page 45). If the oil level is normal and the oil pressure indicator light does not turn ON, contact your closest authorized Honda Marine dealer.

9. Warm up the engine as follows:
Above 41°F (5°C) - run the engine for 2 or 3 minutes.
Below 41°F (5°C) - run the engine for at least 10 minutes at approximately 2,000 rpm.

Failure to completely warm up the engine will result in poor engine performance.

5. STARTING THE ENGINE (REMOTE CONTROL TYPE)

(SIDE-MOUNT TYPE)

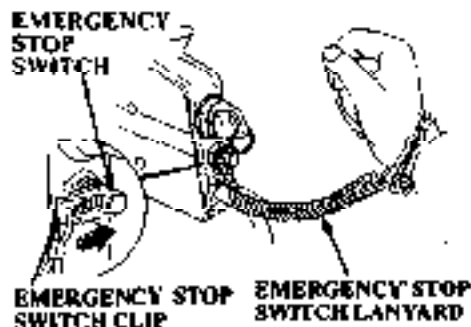

1. Engage the emergency stop switch clip (located at one end of the emergency stop switch lanyard) with the emergency stop switch.

Attach the other end of the emergency stop switch lanyard securely to the operator.

WARNING If the operator does not attach the emergency stop switch lanyard, and is thrown from his seat or out of the boat, the out-of-control boat can seriously injure the operator, passengers, or bystanders.

Always properly attach the lanyard before starting the engine.

The engine will not start unless the emergency stop switch clip is engaged with the emergency engine stop switch.

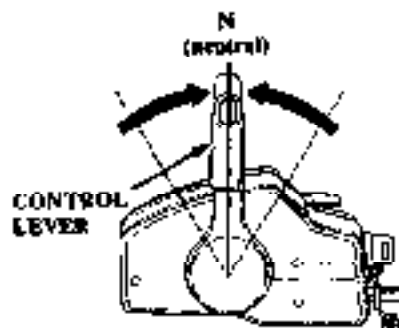

2. Move the control lever to the N (neutral) position.

The engine will not start unless the control lever is in the N (neutral) position.

5. STARTING THE ENGINE (REMOTE CONTROL TYPE)

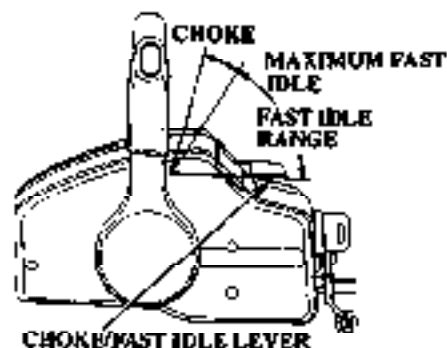

3. When the engine is cold or the ambient temperature is low, lift the choke/fast idle lever up fully. This will provide a rich fuel mixture.

When the engine is warm, it may be necessary to raise the choke/fast idle lever slightly. Hold it in this position.

The choke/fast idle lever will not move unless the control lever is in the N (neutral) position.

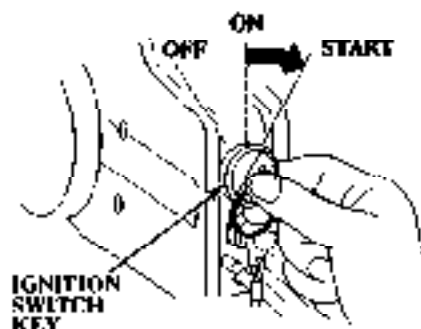

4. Holding the choke/fast idle lever in position, turn the ignition switch key to the START position, and release the key when the engine starts.

The starter motor consumes a large amount of current. Do not run it continuously for more than 5 seconds at a time.

If the engine does not start within 5 seconds, wait at least 10 seconds before using the starter motor again.

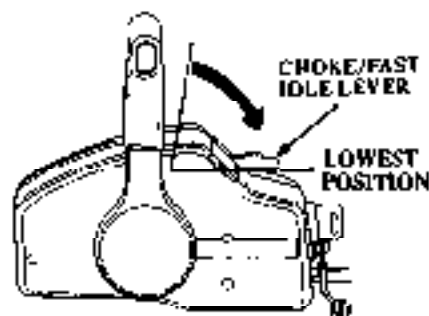

NOTICE

Do not turn the ignition switch key to the start position while the engine is running. This can damage the starter motor and flywheel.

5. After starting the engine, return the lever slowly to a position where the engine does not stall, and hold the lever in that position.

The control lever will not move unless the choke/fast idle lever is returned to the lowest position.

5. STARTING THE ENGINE (REMOTE CONTROL TYPE)

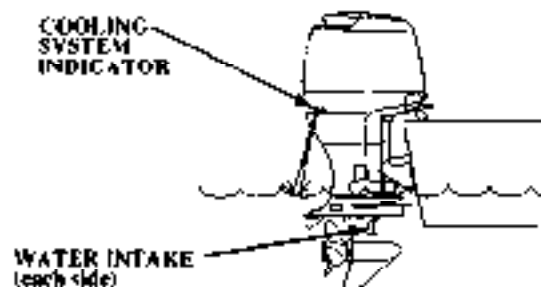

6. After the engine starts, verify water is flowing through the cooling system by monitoring the cooling system indicator. The amount of water coming out of the cooling system indicator will vary due to thermostat operation. Stop the engine if water does not come out of the cooling system indicator or if you see steam.

Check the water intake screens and the cooling system indicator discharge port, and if necessary remove any obstructions. If the problem continues, contact your closest authorized Honda Marine dealer.

NOTICE

- Running the outboard motor with an obstruction in the cooling system can damage the water pump and overheat the engine.
- The propeller must remain underwater. Running the outboard motor out of the water will damage the water pump and overheat the engine.

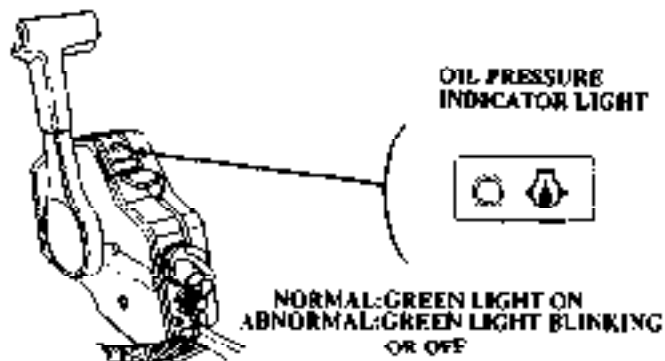

7. With the engine running, check to see if the green engine oil pressure indicator light turns ON. Stop the engine if the oil pressure indicator light does not turn ON. Check the engine oil level (see page 45). If the oil level is normal and the oil pressure indicator light does not turn ON, contact your closest authorized Honda Marine dealer.
8. Warm up the engine as follows:
Above 41°F (5°C) - run the engine for 2 or 3 minutes.
Below 41°F (5°C) - run the engine for at least 10 minutes at approximately 2,000 rpm.

Failure to completely warm up the engine will result in poor engine performance.

5. STARTING THE ENGINE (REMOTE CONTROL TYPE)

(PANEL-MOUNT TYPE)

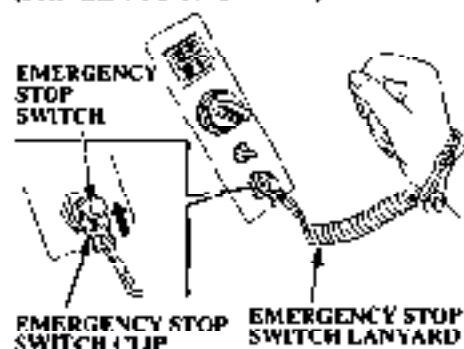

1. Engage the emergency stop switch clip (located at one end of the emergency stop switch lanyard) with the emergency stop switch.

Attach the other end of the emergency stop switch lanyard securely to the operator.

WARNING If the operator does not attach the emergency stop switch lanyard, and is thrown from his seat or out of the boat, the out-of-control boat can seriously injure the operator, passengers, or bystanders.

Always properly attach the lanyard before starting the engine.

The engine will not start unless the emergency stop switch clip is engaged with the emergency engine stop switch

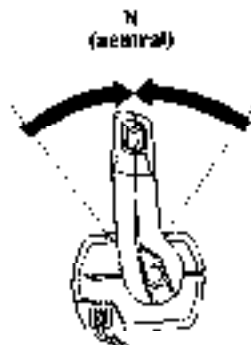

2. Move the control lever to the N (neutral) position.

The engine will not start unless the gears are not engaged.

5. STARTING THE ENGINE (REMOTE CONTROL TYPE)

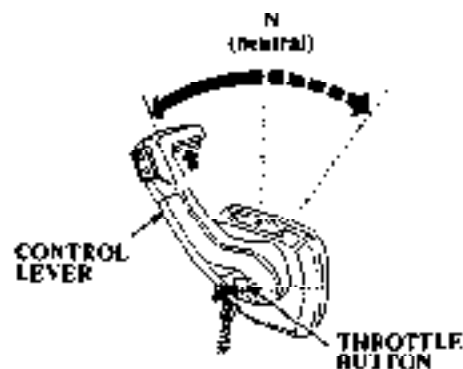

3. Move the control lever forward or backward pushing the throttle button to open the throttle slightly.
4. When the engine is cold or the ambient temperature is low, put on the choke switch. This will provide a rich fuel mixture.

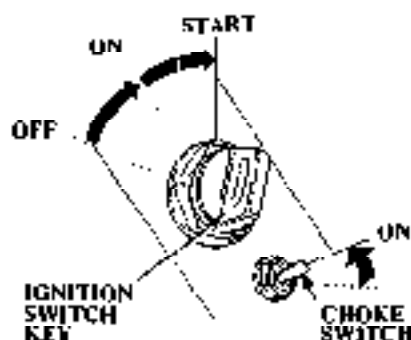

5. Holding the choke switch in position (ON), turn the ignition switch key to the START position and release the key when the engine starts.

The starter motor consumes a large amount of current. Do not run it continuously for more than 3 seconds at a time.

If the engine does not start within 5 seconds wait at least 10 seconds wait at least 10 seconds before using the starter motor again.

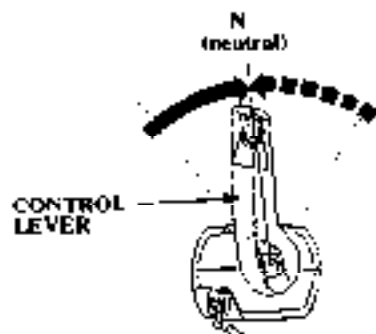

NOTICE

Do not turn the ignition switch key to the start position while the engine is running. This can damage the starter motor and flywheel.

6. After starting the engine, return the lever slowly to a position where the engine does not stall and hold the lever in that position.

The control lever will not shift the gears unless it is returned to the neutral position.

5. STARTING THE ENGINE (REMOTE CONTROL TYPE)

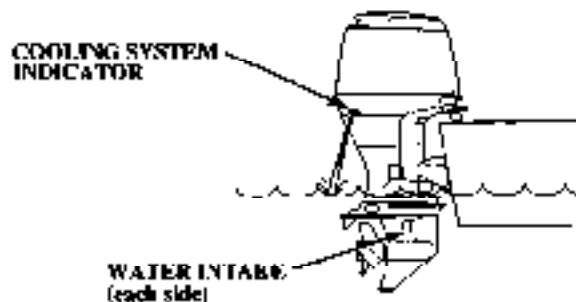

- 7 After the engine starts, verify water is flowing through the cooling system by monitoring the cooling system indicator. The amount of water coming out of the cooling system indicator will vary due to thermostat operation. Stop the engine if water does not come out of the cooling system indicator or if you see steam.

Check the water intake screens and the cooling system indicator discharge ports, and if necessary remove any obstructions. If the problem continues, contact your closest authorized Honda Marine dealer.

NOTICE

- Running the outboard motor with an obstruction in the cooling system can damage the water pump and overheat the engine.
- The propeller must remain underwater. Running the outboard motor out of the water will damage the water pump and overheat the engine.

OIL PRESSURE INDICATOR LIGHT

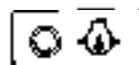

NORMAL: GREEN LIGHT ON
ABNORMAL: GREEN LIGHT BLINKING
OR OFF

- 8 With the engine running, check to see if the green engine oil pressure indicator light turns ON. Stop the engine if the oil pressure indicator light does not turn ON. Check the engine oil level (see page 45). If the oil level is normal and the oil pressure indicator light does not turn ON, contact your closest authorized Honda Marine dealer.
- 9 Warm up the engine as follows:
Above 41°F (5°C) - run the engine for 2 or 3 minutes.
Below 41°F (5°C) - run the engine for at least 10 minutes at approximately 2,000 rpm.

Failure to completely warm up the engine will result in poor engine performance.

5. STARTING THE ENGINE (REMOTE CONTROL TYPE)

(TOP-MOUNT TYPE)

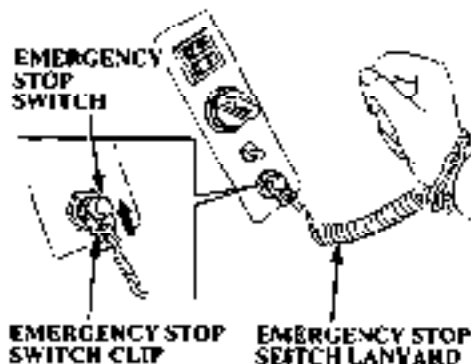

NOTICE The propeller must be lowered into the water. Running the outboard motor out of the water will damage the water pump and overheat the engine.

The following procedure is for starting a single engine equipped with a top-mount control.

For dual engines equipped with top-mount controls, follow the same steps for each engine.

1. Engage the emergency stop switch clip (located at one end of the emergency stop switch lanyard) with the emergency stop switch.

Attach the other end of the emergency stop switch lanyard securely to the operator.

WARNING If the operator does not attach the emergency stop switch lanyard, and is thrown from his seat or out of the boat, the out-of-control boat can seriously injure the operator, passengers, or bystanders.

Always properly attach the lanyard before starting the engine.

The engine will not start unless the emergency stop switch clip is engaged with the emergency engine stop switch.

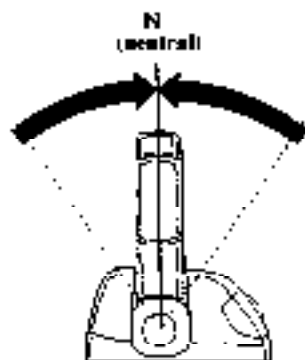

2. Move the control lever to the N (neutral) position.

The engine will not start unless it is in neutral.

5. STARTING THE ENGINE (REMOTE CONTROL TYPE)

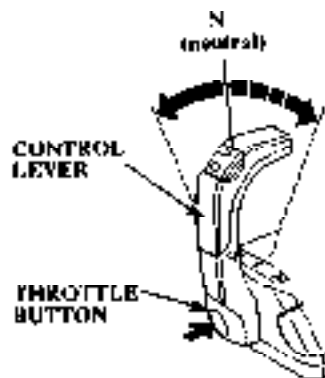

1. Move the control lever(s) forward or backward pushing the throttle button to open the throttle slightly.
4. When the engine is cold or the ambient temperature is low, use the choke switch to provide a rich fuel mixture.

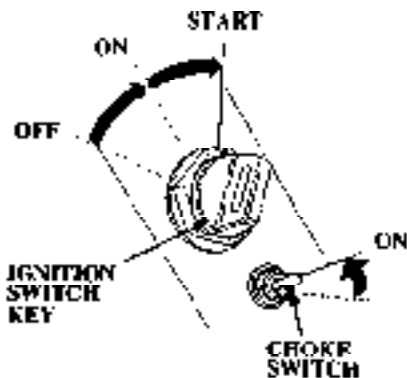

5. Holding the choke switch in the ON position, turn the ignition switch key to the START position and release the key when the engine starts.

The starter motor consumes a large amount of current. Do not run it continuously for more than 5 seconds at a time.

If the engine does not start within 5 seconds wait at least 10 seconds before using the starter motor again.

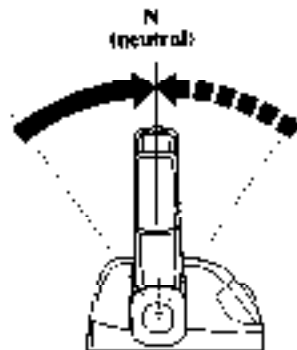

NOTICE

Do not turn the ignition switch key to the start position while the engine is running. This can damage the starter motor and flywheel.

6. After starting the engine, return the lever slowly to a position where the engine does not stall, and hold the lever in that position.

The control lever will not shift gears unless it is returned to the neutral position.

5. STARTING THE ENGINE (REMOTE CONTROL TYPE)

COOLING SYSTEM
INDICATOR

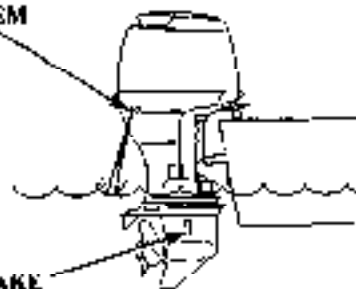

WATER INTAKE
(each side)

7. After the engine starts, verify water is flowing through the cooling system by monitoring the cooling system indicator. The amount of water coming out of the cooling system indicator will vary due to thermostat operation. Stop the engine if water does not come out of the cooling system indicator or if you see steam.

Check the water intake screens and the cooling system indicator discharge port, and if necessary remove any obstructions. If the problem continues, contact your closest authorized Honda Marine dealer.

NOTICE

- Running the outboard motor with an obstruction in the cooling system can damage the water pump and overheat the engine.
- The propeller must remain underwater. Running the outboard motor out of the water will damage the water pump and over the engine.

OIL PRESSURE
INDICATOR LIGHT

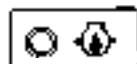

NORMAL: GREEN LIGHT ON
ABNORMAL: GREEN LIGHT BLINKING
OR OFF

8. With the engine running, check to see if the green engine oil pressure indicator light turns ON. Stop the engine if the oil pressure indicator light does not turn ON. Check the engine oil level (see page 45). If the oil level is normal and the oil pressure indicator light does not turn ON, contact your closest authorized Honda Marine dealer.
9. Warm up the engine as follows:
Above 41°F (5°C) - run the engine for 2 or 3 minutes.
Below 41°F (5°C) - run the engine for at least 10 minutes at approximately 2,000 rpm.

Failure to completely warm up the engine will result in poor engine performance.

5. STARTING THE ENGINE (EMERGENCY STARTING)

Emergency Starting

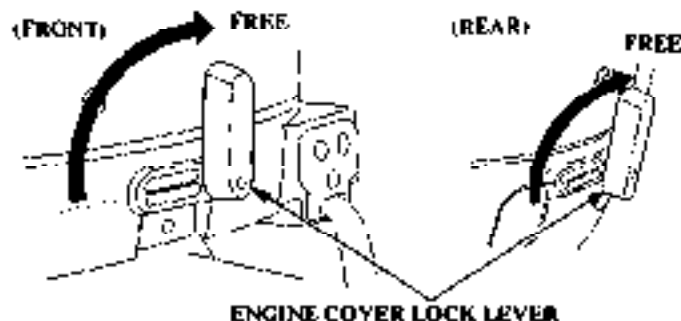

If the electric starting system will not start the engine, the engine can be started by using the emergency starter rope from the tool kit.

1. Turn the front and rear engine cover lock levers to the **FREE** position, then remove the engine cover.

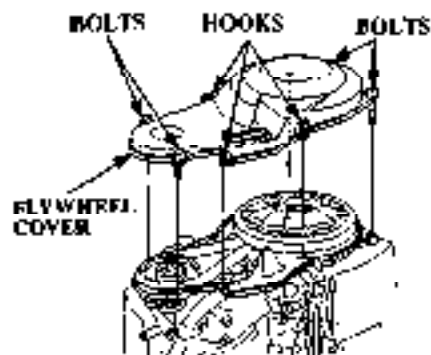

2. Loosen the four bolts and the three hooks, then remove the flywheel cover

5. STARTING THE ENGINE (EMERGENCY STARTING)

(TILLER HANDLE TYPE)

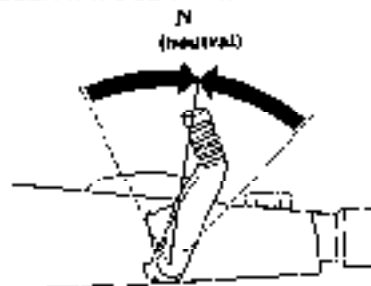

(REMOTE CONTROL TYPE)
SIDE-MOUNT

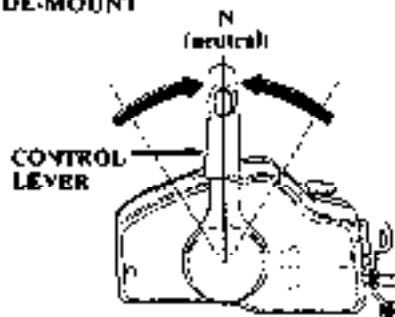

3. Depending on what type of outboard motor you have, move the shift lever or the control lever to the N (neutral) position.

PANEL-MOUNT

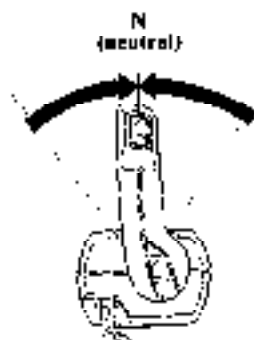

TOP-MOUNT

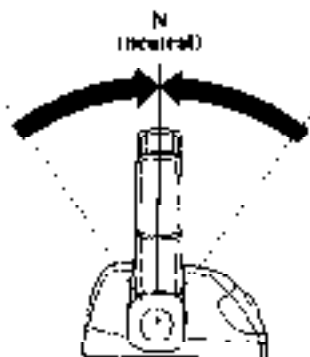

TILLER HANDLE TYPE

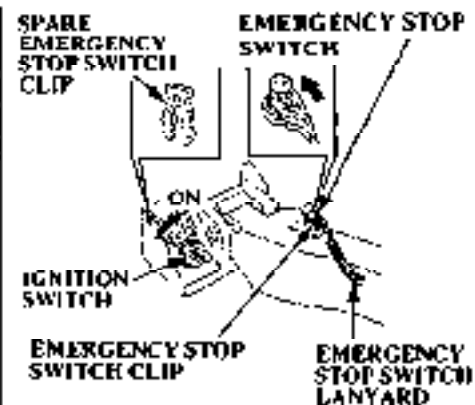

4. If your outboard motor is a tiller handle type, engage the emergency stop switch clip (located at one end of the emergency stop switch lanyard) with the emergency stop switch. Turn the ignition switch key to the ON position.

A spare emergency stop switch clip is provided near the ignition switch.

5. STARTING THE ENGINE (EMERGENCY STARTING)

SIDE-MOUNT TYPE

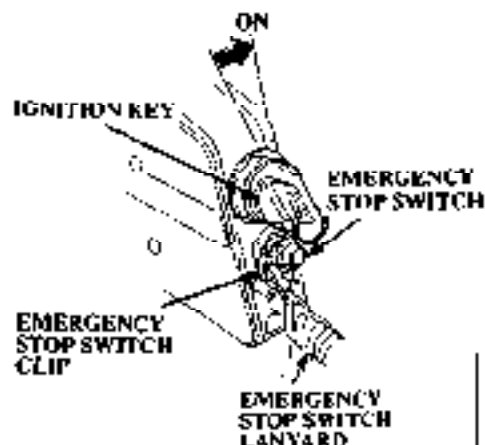

5. If your outboard motor is a remote control type, engage the emergency stop switch clip (located at one end of the emergency stop switch lanyard) with the emergency stop switch.

Turn the ignition switch key to the ON position.

PANEL-MOUNT TYPE, TOP MOUNT TYPE

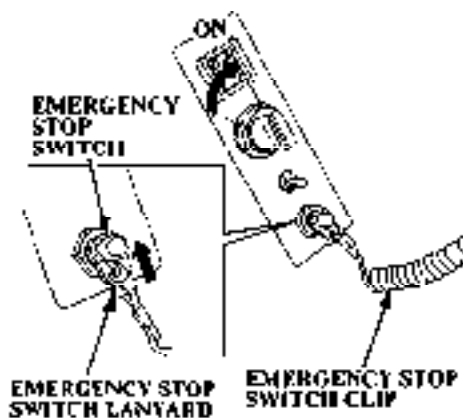

A spare emergency stop switch clip is provided on remote control box (side-mount type) or in the tool bag (panel-mount and top mount type)

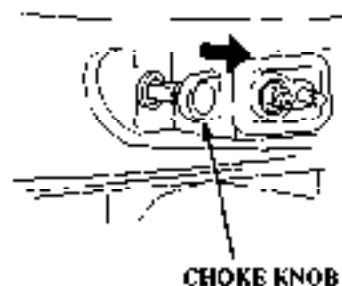

6. If the engine is cold or the ambient temperature is low, pull the manual choke knob located on the front of the outboard motor.

5. STARTING THE ENGINE (EMERGENCY STARTING)

(TILLER HANDLE TYPE)

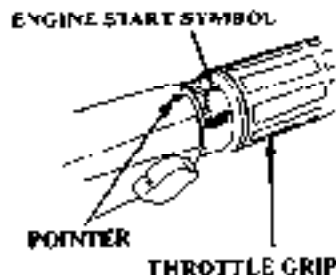

- 7 On the tiller handle type, align the engine start symbol "Q" on the throttle grip with the pointer "►" on the tiller handle.

On the side-mount remote control type, lift the choke/fast idle lever. The choke/fast idle lever will stay up only in the fast idle position.

(REMOTE CONTROL TYPE) SIDE-MOUNT

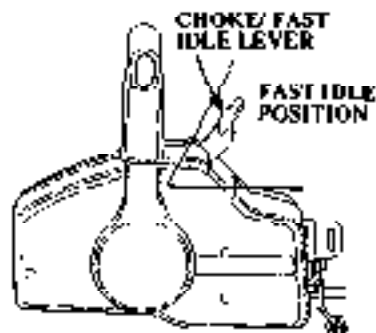

On the panel-mount and top-mount remote control type, move the control lever pushing the throttle button (not to engage the gear).

TOP-MOUNT

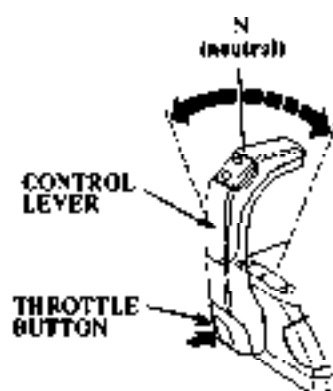

PANEL-MOUNT

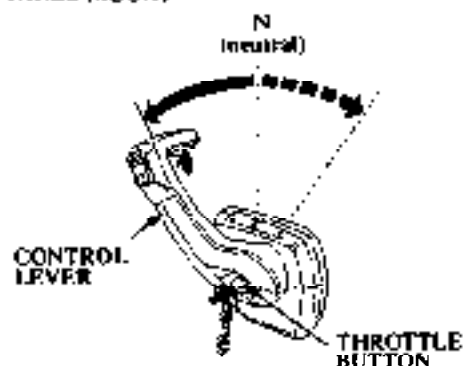

5. STARTING THE ENGINE (EMERGENCY STARTING)

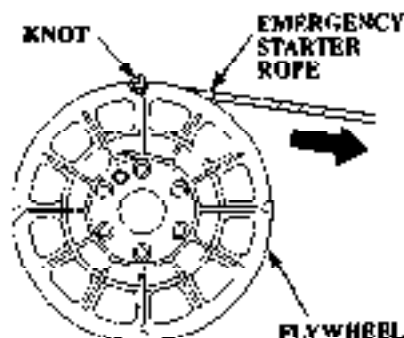

8. Set the emergency starter rope knot in the notch in the flywheel and wind the emergency starter rope counterclockwise around the flywheel.

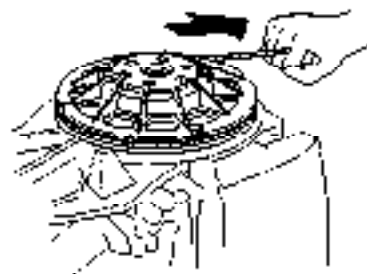

9. Pull the emergency starter rope lightly until resistance is felt, then pull briskly.

If the engine fails to start refer to Troubleshooting page 132.

10. If the manual choke was used to start the engine, slowly return it to its initial position.

11. Slowly return the throttle grip to the SLOW position, the choke/fast idle lever or shift lever to the lowest position where the engine does not stall.

WARNING Exposed moving parts can cause injury.

- Do not operate the outboard motor without the engine cover.
- + Use extreme care when installing the engine cover.

12. Leave the flywheel cover off and install the engine cover. Lock the engine cover latches.

Attach the emergency stop switch lanyard securely to the operator, and return to the closest boat landing. Contact your closest authorized Honda Marine dealer, and have the outboard motor and the electrical system checked.

5. STARTING THE ENGINE (TROUBLESHOOTING)

Troubleshooting Starting Problems

SYMPTOM	POSSIBLE CAUSE	REMEDY
Starter motor doesn't turn over.	<ol style="list-style-type: none">1. Shift lever not in neutral position.2. Blown fuse.3. Weak battery.	<ol style="list-style-type: none">1. Set shift lever in neutral position.2. Replace fuse (refer to page 124).3. Start by using starter rope (refer to page 69).
Starter motor turns over but engine will not start.	<ol style="list-style-type: none">1. Emergency stop switch clip is not engaged.2. Out of fuel.3. Vent knob not open.4. Primer bulb has not been squeezed.5. Engine flooded.	<ol style="list-style-type: none">1. Engage the emergency stop switch clip (refer to page 16, 21, 27 and 33).2. Supply fuel (refer to page 46).3. Open vent knob (refer to page 53).4. squeeze primer bulb to supply fuel (refer to page 54).5. Clean and dry spark plugs (refer to page 115).

Break-in Procedure

Break-in period 10 hours

Break-in operation allows the moving parts to wear-in evenly and thus ensures proper performance and longer outboard motor life.

Break-in your new outboard motor as follows:

First 15 minutes:

Run the engine at trolling speed. Use the minimum amount of throttle opening necessary to operate the boat at a safe trolling speed.

Next 45 minutes:

Run the engine up to a maximum of 2,000 to 3,000 rpm or 10% to 30% throttle opening.

Next 60 minutes:

Run the engine up to maximum of 4,000 to 5,000 rpm or 50% to 80% throttle opening. Short bursts

of full throttle are acceptable, but do not operate the engine continuously at full throttle.

Next 8 hours:

Avoid continuous full throttle operation (100% throttle opening). Do not run the engine at full throttle for more than 5 minutes at a time.

For boats that plane easily, bring the boat up on plane, then reduce the throttle opening to the specified break-in settings called out above.

6. OPERATION (TILLER HANDLE TYPE)

Gear Shifting

THROTTLE OPENING INDICATOR

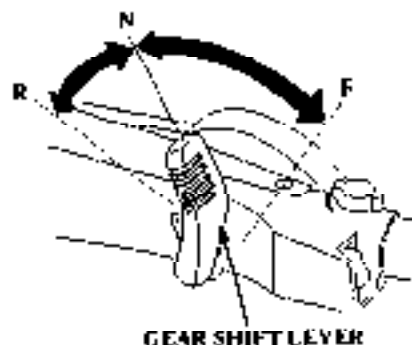
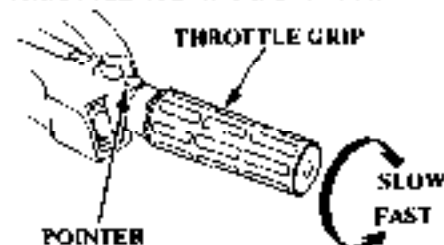

Gearshift lever has 3 positions: **FORWARD, NEUTRAL,** and **REVERSE.**

An indicator at the base of the gearshift lever aligns with the letters **F, N,** and **R** on the engine part.

1. Align the pointer on the tiller handle with the **SLOW** position on the throttle grip to decrease engine speed.

The throttle mechanism is designed to limit the throttle grip travel when operating in the **REVERSE** or **NEUTRAL** positions. The throttle grip can only be turned to the **FAST** position when operating in forward gear.

2. Move the gearshift lever to engage the desired gear.

Steering

RIGHT TURN



Move the tiller handle to the left.

LEFT TURN



Move the tiller handle to the right.

The tiller handle is moved in the opposite direction in which you want the boat to turn.

6. OPERATION (TILLER HANDLE TYPE)

Cruising

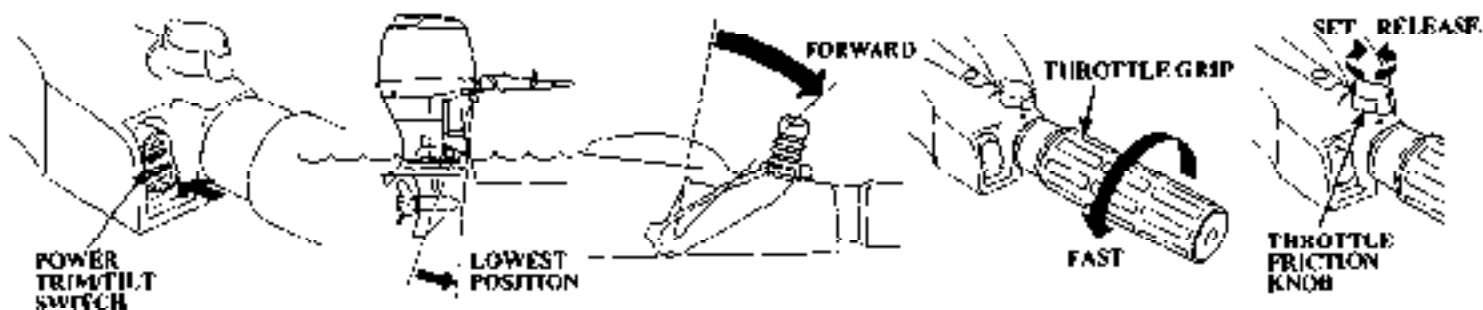

1. Press the DN portion of the power trim/tilt switch to tilt the motor to the lowest position.

2. With the gearshift lever in the F (forward) position, turn the throttle grip toward the FAST mark to increase speed. For optimum fuel economy, limit throttle opening to 80%.

When cruising at high throttle under rough water condition or large waves, the propeller may not remain fully in the water, and the engine speed could exceed the maximum speed range. Slow down to keep the propeller in the water.

boat by returning the throttle to the slow speed side.

3. To set the throttle as a steady speed, turn the throttle friction knob clockwise. To decrease friction for manual speed control, turn the friction knob counterclockwise. In an emergency, you can close the throttle without unscrewing the friction knob.

6. OPERATION (REMOTE CONTROL TYPE)

(SIDE-MOUNT TYPE)

Gear Shifting

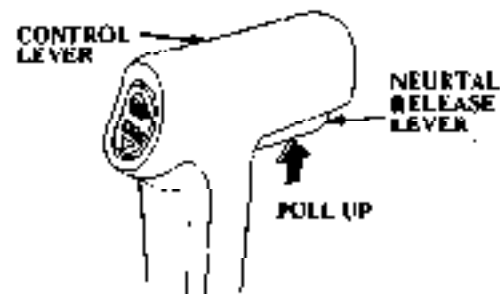

While pulling up the neutral release lever, move the control lever approximately 30° toward F (forward) or toward R (reverse) to engage the desired gear.

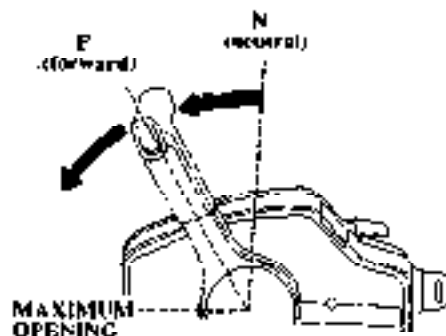

Moving the control lever farther forward or backward than 30° will increase throttle opening and boat speed.

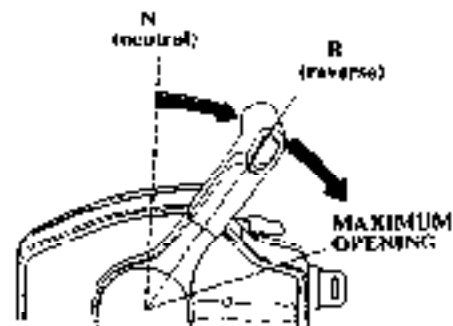

The control lever will not move unless the neutral release lever is pulled up, and the choke/last idle lever is in the lowest position.

6. OPERATION (REMOTE CONTROL TYPE)

Cruising

POWER TRIM/TILT SWITCH



1. Press the DN portion of the power trim/tilt switch to tilt the motor to the lowest position.

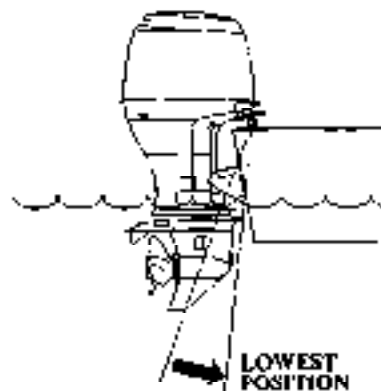

2. Move the control lever approximately 30° from N (neutral) toward F (forward) to engage the F (forward) gear.

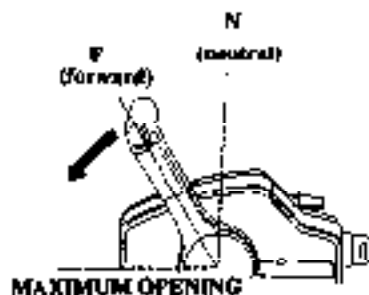

- Moving the control lever farther than 30° will increase the throttle opening and boat speed.
3. For optimum fuel economy, limit throttle opening to 80%.

When cruising at high throttle under rough water condition or large waves, the propeller may not remain fully in the water, and the engine speed could exceed the maximum speed range. Slow down to keep the propeller in the water.

6. OPERATION (REMOTE CONTROL TYPE)

(PANEL-MOUNT TYPE)

Gear Shifting

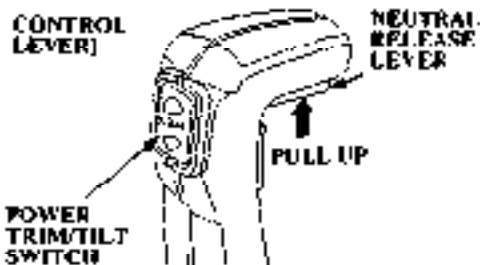

While pulling up the neutral release lever, move the control lever approximately 35° toward F (forward) or toward R (reverse) to engage the desired gear.

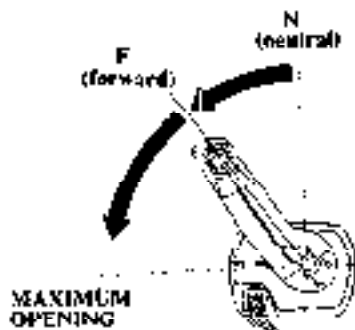

Moving the control lever further forward or backward than 35° will increase throttle opening and boat speed.

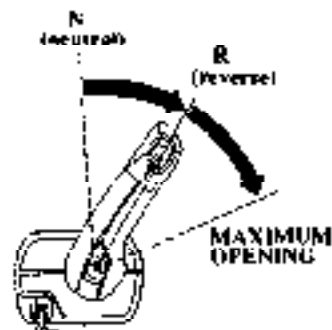

The control lever will not move unless the neutral release lever is pulled up.

6. OPERATION (REMOTE CONTROL TYPE)

Cruising

POWER TRIM/TILT SWITCH

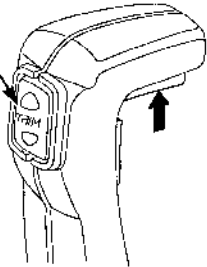

1. Press the DN portion of the power trim/tilt switch to tilt the motor to the lowest position.

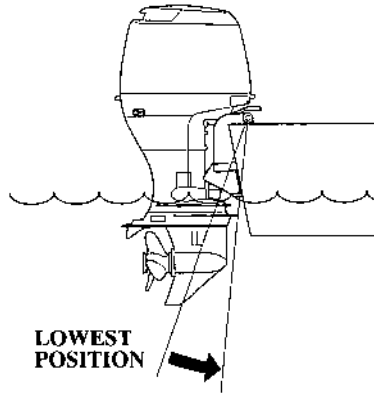

2. Move the control lever approximately 35° from N (neutral) toward F (forward) to engage the F (forward) gear.

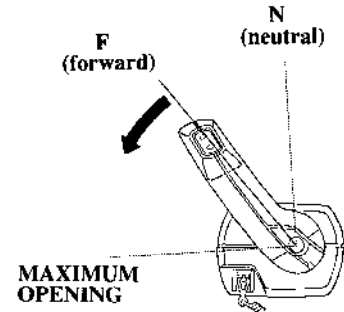

Moving the control lever farther than 35° will increase the throttle opening and boat speed.

3. For optimum fuel economy, limit throttle opening to 80%.

When cruising at high throttle under rough water condition or large waves, the propeller may not remain fully in the water, and the engine speed could exceed the maximum speed range. Slow down to keep the propeller in the water.

6. OPERATION (REMOTE CONTROL TYPE)

(TOP-MOUNT TYPE)

Gear Shifting

SINGLE TYPE

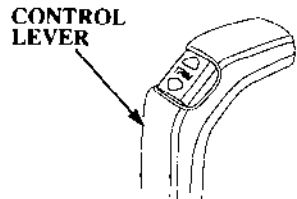

DUAL TYPE

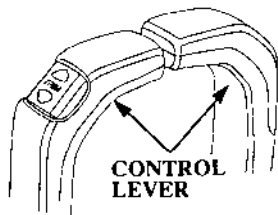

Move the control lever approximately 35° toward F (forward) or toward R (reverse) to engage the desired gear.

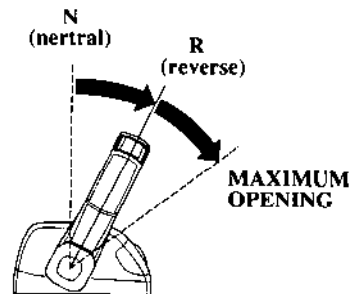
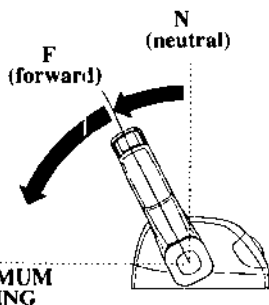

Moving the control lever farther forward or backward than 35° will increase throttle opening and boat speed.

The control lever will not move unless the neutral release lever is pulled up.

6. OPERATION (REMOTE CONTROL TYPE)

Cruising

SINGLE TYPE

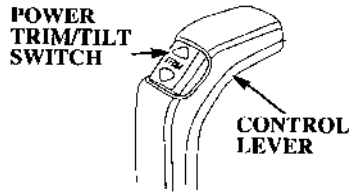

LEFT MOTOR TRIM/TILT SWITCH

RIGHT MOTOR TRIM/TILT SWITCH

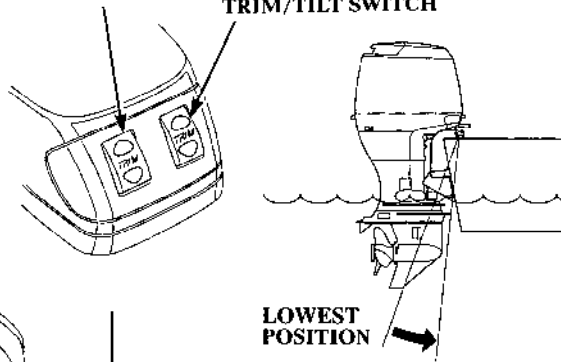

DUAL TYPE

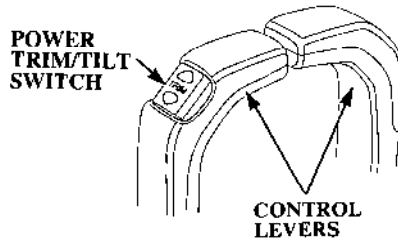

1. Press the DN portion of the power trim/tilt switch to tilt the motor to the lowest position.

If your boat is dual outboard motor type, adjust the trim angle of the right and left motors to be equal using the switches on the control box, as necessary.

2. Move the control lever approximately 35° from N (neutral) toward F (forward) to engage the F (forward) gear.

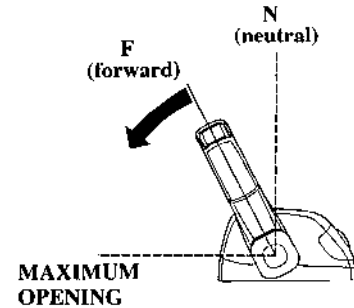

Moving the control lever farther than 35° will increase the throttle opening and boat speed.

3. For optimum fuel economy, limit throttle opening to 80%.

When cruising at high throttle under rough water condition or large waves, the propeller may not remain fully in the water, and the engine speed could exceed the maximum speed range. Slow down to keep the propeller in the water.

6. OPERATION (POWER TRIM/TILT)

Power Trim/Tilt System

The power trim/tilt system can adjust the motor angle while cruising, or the motor tilt angle while mooring. Motor trim angle adjustment is necessary to compensate for boat load or weight distribution, water conditions, propeller or engine condition.

The motor trim angle can be adjusted while accelerating or cruising to obtain the maximum boat speed, optimum boat stability, and fuel economy.

Under normal conditions, the boat will achieve optimum boat performance when the engine is running at maximum rpm and the ventilation plate is level with the water.

Press either the UP or DN portion of the power trim/tilt switch, and trim the motor to the best position for the cruising conditions.

The power trim/tilt system operates when the switch is pressed, and it stops when the switch is released.

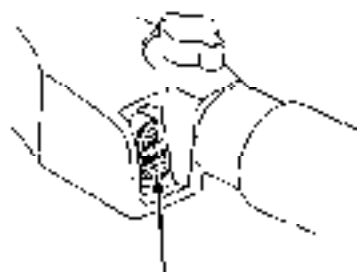

POWER TRIM/TILT SWITCH

POWER TRIM/TILT SWITCH



POWER TRIM/TILT SWITCH



POWER TRIM/TILT SWITCH



POWER TRIM/TILT SWITCH

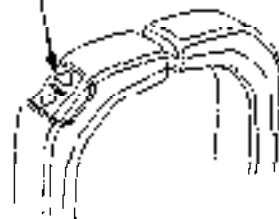

6. OPERATION (POWER TRIM/TILT)

NOTICE

Excessive trim/tilt angle during operation can cause the propeller to raise out of the water and cause propeller ventilation and engine over-revving. Excessive trim/tilt angle can also damage the water pump and overheat the engine.

To trim motor up slightly, press the UP portion momentarily.

To trim motor down slightly, press the DN portion momentarily.

Decrease the trim angle on high speed turns to reduce the possibility of propeller ventilation.

Improper motor trim angle can result in an unstable steering condition.

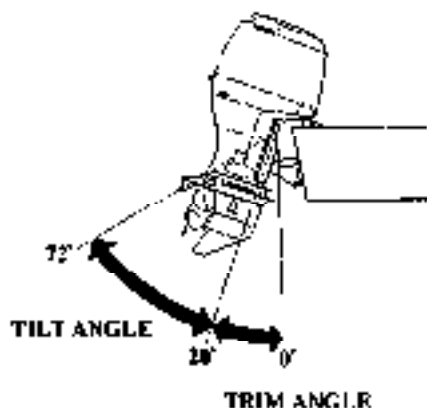

Dual-Mount Type Power Trim/Tilt Switches

LEFT INDIVIDUAL ADJUSTMENT

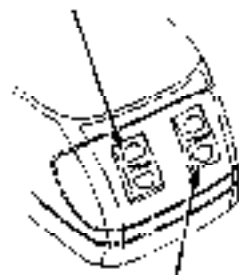

RIGHT INDIVIDUAL ADJUSTMENT

The right and left outboard motors can be adjusted separately with the individual adjustment switch on the console side.

6. OPERATION (POWER TRIM/TILT)

MOTOR TRIMMED TOO LOW

MOTOR TRIMMED TOO HIGH

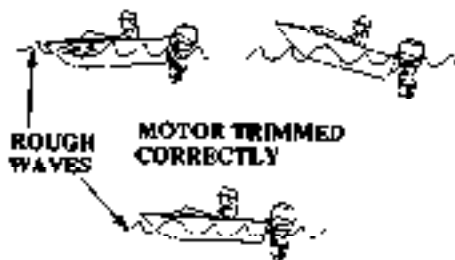

When cruising:

- (A) Into a high wind, trim the motor down slightly to level the bow and improve boat stability.
- (B) With a tail wind, trim the motor up slightly to raise the bow and improve boat stability.
- (C) Through rough waves, do not trim the motor too low or too high to avoid an unstable steering condition.

Trim Meter

The trim meter indicates the trim angle of the motor. Refer to the trim meter, and press the UP or DN portion of the power trim/tilt switch to adjust the motor trim angle to achieve good boat performance and stability.

BOW TOO LOW DUE TO
1. **LOAD IN THE FRONT**
2. **MOTOR TRIMMED TOO LOW**



With the motor trimmed low, the trim meter will read as shown. To raise the bow, increase the motor trim angle by pressing the UP portion of the power trim/tilt switch.



BOW TOO HIGH DUE TO
1. **LOAD IN THE REAR**
2. **MOTOR TRIMMED TOO HIGH**

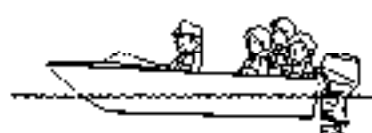

With the motor trimmed high, the trim meter will read as shown. To lower the bow, decrease the motor trim angle by pressing the DN portion of the power trim/tilt switch.



6. OPERATION (POWER TRIM/TILT)

Power Tilt Switch (Engine Pan)



POWER TILT SWITCH

The power tilt switch located on the engine pan is a convenience switch for tilting the motor for trailering, or performing outboard motor maintenance. This power tilt switch should only be operated when the boat is stopped and the engine is off.

Manual Relief Valve

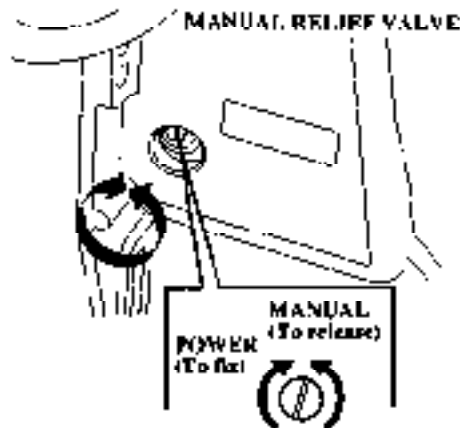

If the power trim/tilt switch will not tilt the outboard motor, the motor can be manually tilted up or down by operating the manual relief valve. To tilt the outboard motor manually, turn the manual relief valve under the left stem bracket no more than 1 or 2 turns counterclockwise, using a screwdriver.

After tilting the motor, turn the manual relief valve clockwise securely. The manual relief valve must be tightened securely before operating the motor, or the motor could tilt up when operating in reverse.

6. OPERATION (POWER TRIM/TILT)

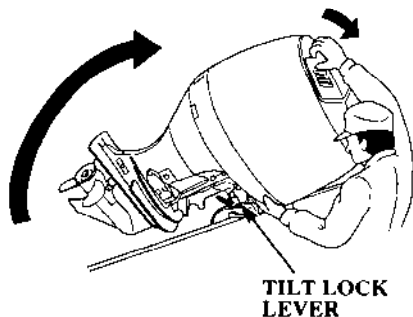

Tilt Lock Lever

Use the tilt lock lever when the boat is moored.

1. Tilt the motor up as far as it will go using the power trim/tilt switch.
2. Move the tilt lock lever to the LOCK position, and lower the outboard motor until the lock lever contacts the stern bracket (refer to page 39).

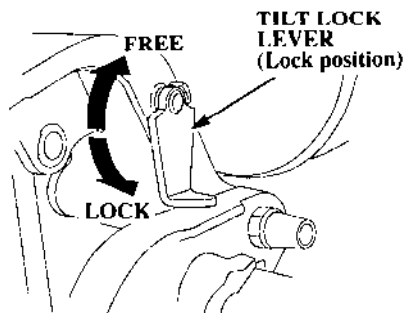

It may be necessary to lift the engine cover grip slightly to swing the tilt lock lever into the LOCK position.

3. To lower the motor, tilt the motor up slightly, move the tilt lock lever to the FREE position, and lower the motor to the desired position.

Trim Tab Adjustment

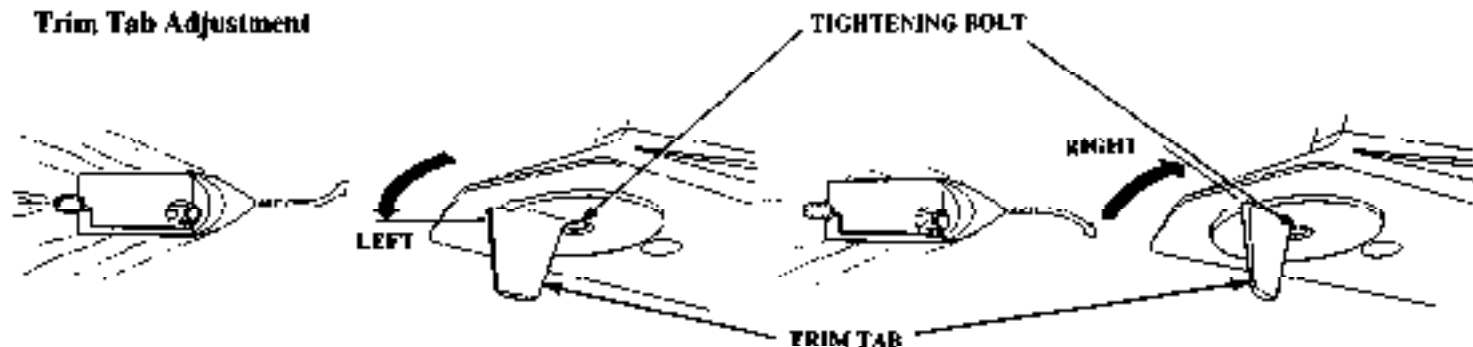

The trim tab is provided to adjust for "torque steer" which is a reaction of the propeller rotation or propeller torque. If during a high speed turn, an unequal amount of effort is required to turn the boat right or left, adjust the trim tab so that an equal amount of effort is required.

Distribute the load evenly in the boat, and run the boat in a straight course at full throttle. Slightly turn the steering wheel or tiller handle for both right and left turns to determine the amount of effort required.

If less effort is required to make left turns:
Loosen the trim tab tightening bolt, and turn the rear end of the trim tab toward the left. Tighten the bolt securely.

If less effort is required to make right turns:
Loosen the trim tab tightening bolt, and turn the rear end of the trim tab toward the right. Tighten the bolt securely.

Make small adjustments at a time and retest. Incorrect trim tab adjustment can cause adverse steering.

6. OPERATION (MOTOR PROTECTION SYSTEM)

Engine Oil Pressure and Overheat Warning System

If the engine oil pressure drops and/or the engine overheats, either or both warning systems could be activated. When activated, the engine speed will decrease gradually, the green oil pressure indicator light will turn OFF, and the red overheat indicator light will turn ON. A continuous buzzer will sound on the remote control type.

The engine speed can not be increased with a larger throttle opening until the malfunction is corrected. When the malfunction is corrected, the engine speed will increase gradually.

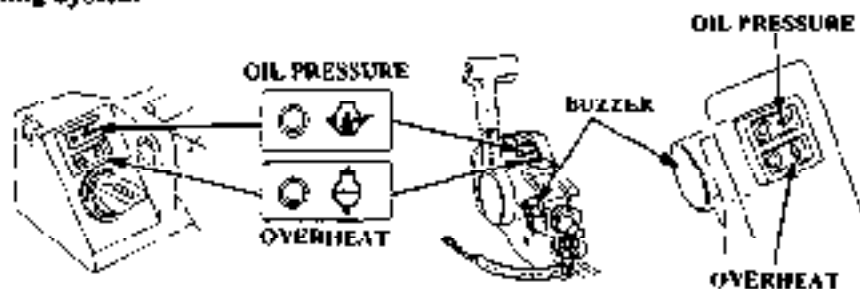

(TILLER HANDLE TYPE)

(REMOTE CONTROL TYPE)

Symptom \ System		Indicator light		Buzzer
		Oil pressure	Overheat	Remote control type
Normal		ON	OFF	—
Abnormal	Low oil pressure	OFF	OFF	Continuous
	Overheat	ON	ON	Continuous
	Low oil pressure/overheat	OFF	ON	Continuous

6. OPERATION (MOTOR PROTECTION SYSTEM)

When the oil pressure warning system is activated:

1. Stop the engine immediately and check the engine oil level (refer to page 45).
2. If the oil is up to the recommended level, restart the engine. If the oil pressure warning system stops after 30 seconds, the system is normal.

If the throttle was closed suddenly after cruising at full throttle, the engine speed may drop below the specified idle speed. This could cause the oil pressure warning system to activate momentarily.

3. If the oil pressure warning system stays activated after 30 seconds, return to the closest boat landing, and contact your closest authorized Honda Marine dealer.

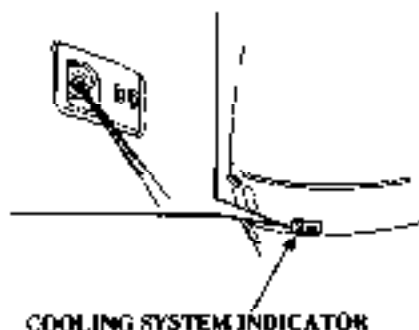

When the overheat warning system is activated:

1. Return the gearshift lever or control lever to the N (neutral) position immediately. Check to see if water is flowing out of the cooling system indicator.
2. If water is flowing out of the cooling system indicator, continue idling for 30 seconds. If the overheat warning system stops after 30 seconds, the system is normal.

If the engine is turned off after running at full throttle, the engine temperature may rise above normal. If the engine is restarted, shortly after being turned off, the overheat warning system could be activated momentarily.

3. If the overheat warning system stays activated, stop the engine. Tilt up the motor and check the water intakes for obstructions. If there are no obstructions at the water intakes, return to the closest boat landing, and contact your closest authorized Honda Marine dealer.

6. OPERATION (MOTOR PROTECTION SYSTEM)

Over-Rev Limiter

This outboard motor is equipped with an engine over-rev limiter which activates when the engine speed increases excessively. The over-rev limiter can be activated while cruising, tilting up the motor, or when ventilation occurs during a sharp turn.

When the over-rev limiter is activated:

1. Reduce the throttle opening immediately and check the trim angle.
2. If the trim angle is correct but the over-rev limiter stays activated, stop the engine, check the condition of the outboard motor, and check the propeller for damage. Correct or service as necessary.

Anodes

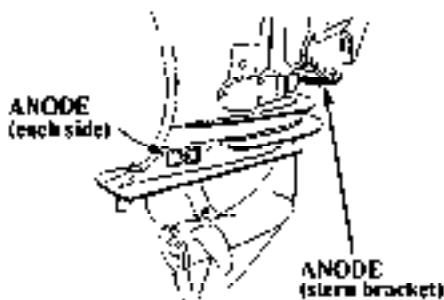

The anodes are a sacrificial material which helps to protect the outboard motor from corrosion.

NOTICE Painting or coating the anodes will lead to rust and corrosion damage to the outboard motor.

There are also 2 small sacrificial anodes in the water passages of the engine block.

Shallow Water Operation

NOTICE

Excessive trim/tilt angle during operation can cause the propeller to raise out of the water and cause propeller ventilation and engine over-revving. Excessive trim/tilt angle can also damage the water pump and overheat the engine.

When operating in shallow water, tilt the motor up to prevent the propeller and gear case from hitting the bottom. With the motor tilted up, operate the engine at low speed.

Monitor the cooling system indicator for water discharge. Be sure that the motor is not tilted so high that the water intakes are out of the water.

6. OPERATION

High Altitude Operation

At high altitude, the standard carburetor air-fuel mixture will be too rich. Performance will decrease, and fuel consumption will increase. A very rich mixture will also foul the spark plugs and cause hard starting.

High altitude performance can be improved by specific modifications to the carburetors. If you always operate your outboard at altitudes above 5,000 feet (1,500 meters), have an authorized Honda Marine dealer perform this carburetor modification.

Even with carburetor modification, engine horsepower will decrease about 3.5% for each 1,000 foot (300 meter) increase in altitude. The effect of altitude on horsepower will be greater than this if no carburetor modification is made.

NOTICE

When the carburetors have been modified for high altitude operation, the air-fuel mixture will be too lean for low altitude use. Operation at altitudes below 5,000 feet (1,500 meters) with modified carburetors may cause the engine to overheat and result in serious engine damage. For use at low altitudes, have an authorized Honda Marine dealer return the carburetors to original factory specifications if modified.

7. STOPPING THE ENGINE (TILLER HANDLE TYPE)

Emergency Engine Stop

EMERGENCY STOP SWITCH

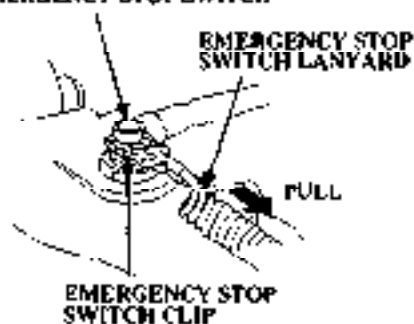

Disengage the emergency stop switch clip from the emergency stop switch by pulling the emergency stop switch lanyard.

It is a good idea to stop the engine with the emergency stop switch lanyard from time to time to be sure that the switch is operating properly.

Normal Engine Stop



THROTTLE GRIP

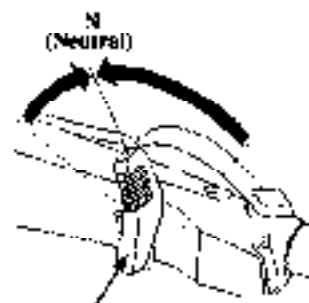

GEAR SHIFT LEVER

1. Turn the throttle grip to SLOW position, and move the gear shift lever to N (neutral).

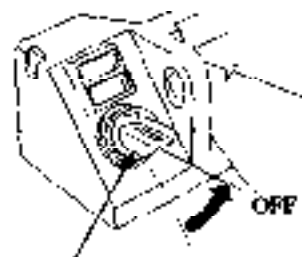

IGNITION SWITCH

2. Turn the ignition switch to the OFF position.
3. When the boat is not in use, remove and store the ignition switch key.

7. STOPPING THE ENGINE (REMOTE CONTROL TYPE)

(SIDE-MOUNT TYPE)

Emergency Engine Stop

EMERGENCY
STOP SWITCH

EMERGENCY STOP
SWITCH LANYARD

PULL

EMERGENCY STOP SWITCH CLIP

Disengage each emergency stop switch clip from the emergency stop switches by pulling the emergency stop switch lanyards.

It is a good idea to stop the engine with the emergency stop switch lanyard from time to time to be sure that the switch is operating properly.

Normal Engine Stop

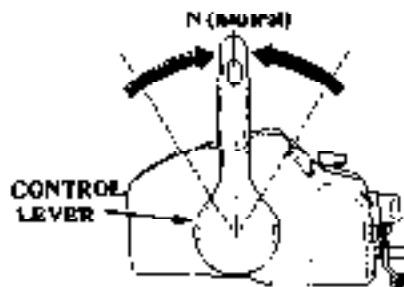

1. Move the control lever to the N (neutral) position, and turn the ignition key the OFF position

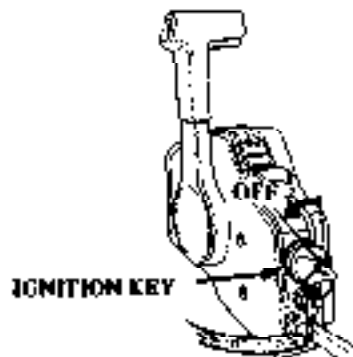

2. When the boat is not in use, remove and store the ignition keys.

7. STOPPING THE ENGINE (REMOTE CONTROL TYPE)

(PANEL-MOUNT TYPE)

Emergency Engine Stop

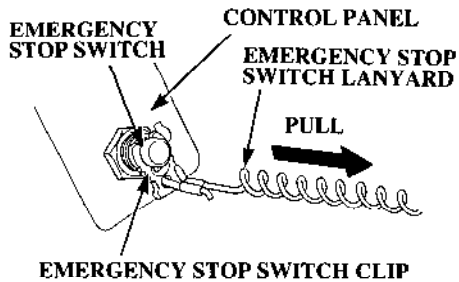

Disengage the emergency stop switch clip from the emergency stop switch by pulling the emergency stop switch lanyard.

It is a good idea to stop the engine with the emergency stop switch lanyard from time to time to be sure that the switch is operating properly.

Normal Engine Stop

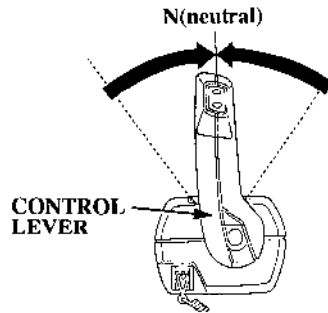

1. Move the control lever to the N (neutral) position, and turn the ignition key to the OFF position.

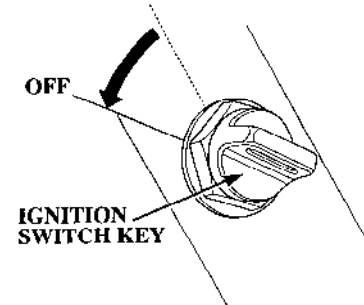

2. When the boat is not in use, remove and store the ignition key.

7. STOPPING THE ENGINE (REMOTE CONTROL TYPE)

(TOP-MOUNT TYPE)

Emergency Engine Stop

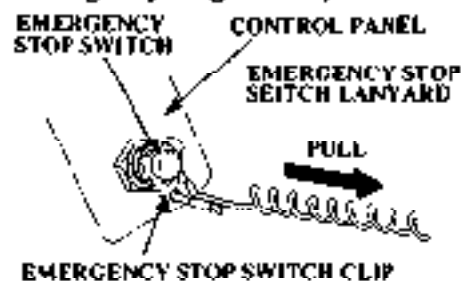

Disengage the emergency stop switch clip(s) from the emergency stop switch(es) by pulling the emergency stop switch lanyard(s).

It is a good idea to stop the engine(s) with the emergency stop switch lanyard(s) from time to time to be sure that the switch(es) is(are) operating properly.

Normal Engine Stop

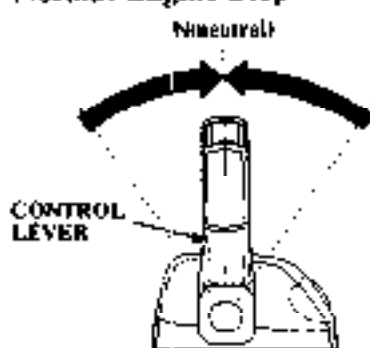

1. (SINGLE TOP-MOUNT TYPE)

Move the control lever to the N (neutral) position, and turn the ignition key OFF position.

(DUAL TOP-MOUNT TYPE)

Move both control levers simultaneously to the N (neutral) position, and turn each ignition key to the OFF position one by one.



2. When the boat is not in use, remove and store the ignition switch key(s).

Before transporting the outboard motor, always follow the carburetor drain procedure on page 128.

Close the fuel cap vent knob (refer to page 42).

Disconnect the fuel coupling from the outboard motor (refer to page 54).

Trailer

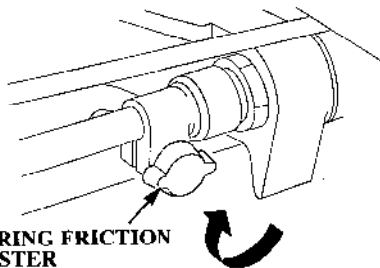

When trailering or transporting the boat with the motor attached, it is recommended that the motor remain in the normal run position.

(Tiller Handle Type)

Tighten the steering friction adjuster securely to stop the motor's side to side movement.

(Remote Control Type)

Use a motor support bar (refer to your motor support bar manufacturer's instructions) to stop the motor's side-to-side movement.

If there is insufficient road clearance with the motor in the normal run position, then trailer the motor in the tilted position using a motor support bar (refer to your motor support bar manufacturer's instructions) or remove the motor from the boat.

8. TRANSPORTING

Transporting on a vehicle

When transporting the outboard motor on a vehicle, perform following.

1. Remove the engine cover(see page 69).

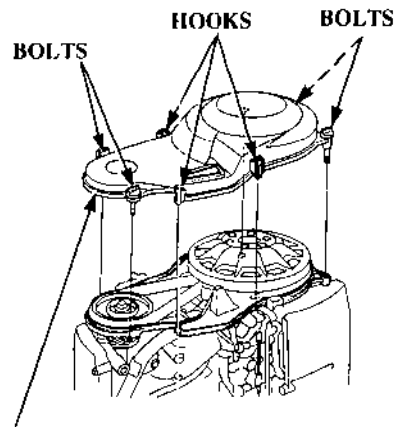

TIMING BELT COVER

2. Remove the four tightening bolts and the three hooks, then remove the timing belt cover.

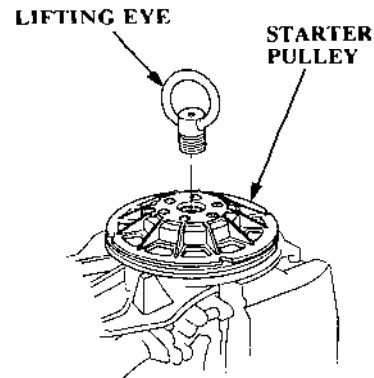

3. Install the lifting eye (optional part) in the center of the starter pulley and tighten securely.

⚠WARNING If the lifting eye is not securely installed in the starter pulley, the outboard motor could fall from the hoist, causing serious injury.

Be sure the lifting eye is securely installed before hoisting the outboard motor.

8. TRANSPORTING

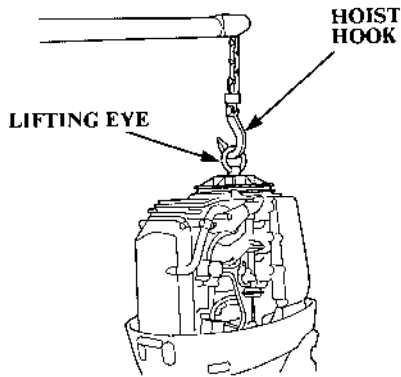

4. Hook the hoist hook to the lifting-eye, and lift the motor from the boat.

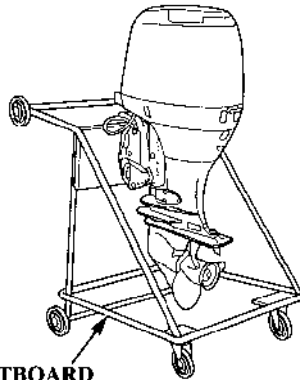

**OUTBOARD
MOTOR
STAND**

5. Place the motor on an outboard motor stand and secure with bolts and nuts.
6. Remove the lifting eye, and reinstall the timing belt cover and engine cover.

Horizontal Transport

Before removing the motor from the boat, drain the carburetors and engine oil. Follow the carburetor drain procedure on page 128.

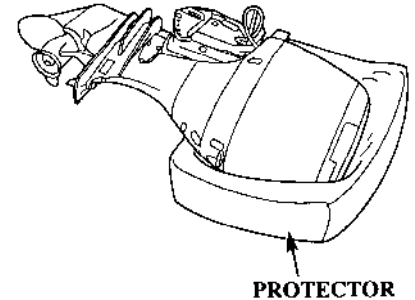

Always rest the motor on protectors and be sure to protect, it from impact and damage.

Always lay the motor carburetor side down.

9. CLEANING AND FLUSHING

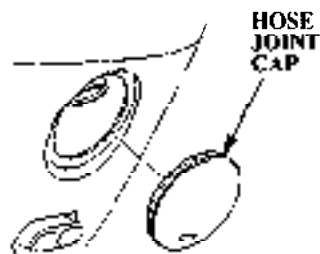

Thoroughly clean and flush the outboard motor with fresh water after operation in dirty or salty water.

Flushing with the Water Hose Joint

Do not run the engine during this flushing procedure. For safety, remove the emergency stop switch clip, so the engine cannot be started while you are standing near the propeller.

1. Remove the hose joint cap

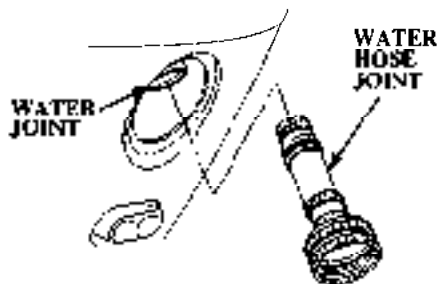

2. Install the water hose joint in the water joint.

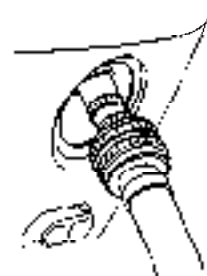

3. Connect a water hose to the water hose joint, and turn on the water supply.

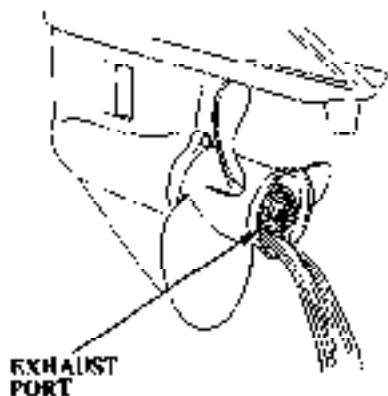

If using a headphone-type flush kit, temporarily cover the water intakes with duct tape.

4. Make sure that the water comes out from the exhaust port.
5. After flushing, remove the water hose joint and re-install the hose joint cap.

10. MAINTENANCE

THE IMPORTANCE OF MAINTENANCE

Good maintenance is essential for safe, economical, and trouble-free operation. It will also help reduce pollution.

WARNING Improper maintenance, or failure to correct a problem before operation, can cause a malfunction in which you can be seriously hurt or killed.

Always follow the inspection and maintenance recommendations and schedules in this owner's manual.

To help you properly care for your outboard motor, the following pages include a maintenance schedule, routine inspection procedures, and simple maintenance procedures using basic hand tools. Other service tasks that are more difficult, or require special tools, are best handled by

professionals and are normally performed by a Honda technician or other qualified mechanic.

The maintenance schedule applies to normal operating conditions. If you operate your outboard motor under unusual conditions, consult your servicing dealer for recommendations applicable to your individual needs and use.

Maintenance, replacement, or repair of the emission control devices and systems may be performed by any marine engine repair establishment or individual, using parts that are "certified" to EPA standards.

MAINTENANCE SAFETY

Some of the most important safety precautions follow. However, we cannot warn you of every conceivable hazard that can arise in performing maintenance. Only you can decide whether or not you should perform a given task.

WARNING Failure to properly follow maintenance instructions and precautions can cause you to be seriously hurt or killed.

Always follow the procedures and precautions in this owner's manual.

Safety Precautions

- **Make sure the engine is off before you begin any maintenance or repairs.** This will eliminate several potential hazards.
 - Carbon monoxide poisoning from engine exhaust.
Be sure there is adequate ventilation whenever you operate the engine.
 - Burns from hot parts.
Let the engine cool before touching.
 - Injury from moving parts.
Do not run the engine unless instructed to do so.
- Read the instructions before you begin, and make sure you have the tools and skills required.

- To reduce the possibility of fire or explosion, be careful when working around gasoline. Use only a non-flammable solvent, not gasoline to clean parts. Keep cigarettes, sparks, and flames away from all fuel-related parts.

Remember that an authorized Honda Marine dealer knows your outboard motor best and is fully equipped to maintain and repair it.

To ensure the best quality and reliability, use only new, genuine Honda parts or their equivalents for repair and replacement.

EMISSION CONTROL SYSTEM INFORMATION**Source of Emissions**

The combustion process produces carbon monoxide, oxides of nitrogen, and hydrocarbons. Control of hydrocarbons and oxides of nitrogen is very important because, under certain conditions, they react to form photochemical smog when subjected to sunlight.

Honda utilizes lean carburetor settings and other systems to reduce the emissions of oxides of nitrogen and hydrocarbons.

10. MAINTENANCE

The U.S. Clean Air Act

EPA regulations require all manufacturers to furnish written instructions describing the operation and maintenance of emission control systems.

The following instructions and procedures must be followed in order to keep the emissions from your Honda engine within the emission standards.

Tampering and Altering

Tampering with or altering the emission control system may increase emissions beyond the legal limit. Among those acts that constitute tampering are:

- Removal or alteration of any part of the intake, fuel, or exhaust systems.
- Alterations that would cause the engine to operate outside its design parameters.

Problems That May Affect Emissions

If you are aware of any of the following symptoms, have your engine inspected and repaired by your servicing dealer.

- Head starting or stalling after starting.
- Rough idle.
- Misfiring or backfiring under load.
- Afterburning (backfiring).
- Black exhaust smoke or high fuel consumption.

Replacement Parts

The emission control systems on your Honda engine were designed, built, and certified to conform with EPA emission regulations. We recommend the use of genuine Honda parts whenever you have maintenance done. These original-design replacement parts are manufactured to the same standards as the original parts, so you can be confident of their performance. The use of replacement parts that are not of the original design and quality may impair the effectiveness of your emission control system.

A manufacturer of an aftermarket part assumes the responsibility that the part will not adversely affect emission performance. The manufacturer or rebuilder of the part must certify that use of the part will not result in a failure of the engine to comply with emission regulations.

Maintenance

Follow the maintenance schedule on page 109. Remember that this schedule is based on the assumption that your machine will be used for its designed purpose. Sustained high-load or high-temperature operation, or use in unusually wet or dusty conditions, will require more frequent service.

10. MAINTENANCE

Tool Kit and Spare Parts

The following tools and spare parts are supplied with the outboard motor for maintenance, adjustment, and emergency repairs.

TOOL KIT

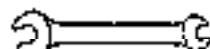

14 x 17 mm WRENCH

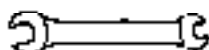

10 x 12 mm WRENCH

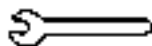

8 mm WRENCH



FLAT SCREWDRIVER



PHILLIPS SCREWDRIVER



OIL CHECK SCREWDRIVER



EMERGENCY
STARTER ROPE



PLIERS



SCREWDRIVER HANDLE



SPARK PLUG WRENCH



TOOL BAG

MAINTENANCE SCHEDULE

REGULAR SERVICE PERIOD (3)		ITEM	Perform at every indicated month or operating hour intervals, whichever comes first.	EACH USE	FIRST 20 HRS OR MONTH	EVERY 100 HRS OR 6 MONTHS	EVERY 200 HRS OR YEAR	EVERY 400 HRS OR 2 YEARS
●	Engine oil	Check level		○				
		Change			○	○		
	Gear case oil	Check level and check for water contamination				○		
		Change			○(2)		○(2)	
●	Engine oil filter	Change						○(2)
	Engine timing belt	Check-readjust					○(2)	
●	Carburetor linkage and idling speed	Check			○(2)	○(2)		
		Adjust			○(2)	○(2)		
●	Valve clearance	Check-readjust			○(2)		○(2)	
●	Spark plugs	Check-clean (Replace if necessary)			○		○	
	Propeller and cotter pin	Check		○				
		(Replace if necessary)				○		
	Lubrication	Grease			○(1)	○(1)		

10. MAINTENANCE

REGULAR SERVICE PERIOD (1)		EACH USE	FIRST 20 HRS OR MONTH	EVERY 100 HRS OR 6 MONTHS	EVERY 200 HRS OR YEAR	EVERY 400 HRS OR 2 YEARS
ITEM	Perform at every indicated month or operating hour intervals, whichever comes first.					
Fuel tank and tank filter	Clean				○	
Tank filter	(Replace if necessary)				○	
Fuel filter	Check			○		
	Change					○
● Thermostat	Check				○(2)	
● Fuel line	Check	○				○(2)
	(Replace if necessary)					
Battery cables	Check-tightness		○	○		
Bolts and Nuts	Check-tightness		○(2)	○(2)		

• Emission-related Items

- (1) Lubricate more frequently when used in salt water.
- (2) These items should be serviced by an authorized Honda Marine dealer, unless the owner has the proper tools and is mechanically proficient. See the Honda Shop Manual.
- (3) For professional commercial use, log hours of operation to determine proper maintenance intervals.

Engine Oil

Engine oil is a major factor affecting engine performance, service life, and emission.

Oil check interval:

Each use.

Oil change interval:

After the first 20 hours or 1 month, then every 100 hours or 6 months. (Refer to the maintenance schedule page 109).

Oil refill capacity:

4.2 US qt (4.0 lit)...When oil filter is not replaced

4.8 US qt (4.5 lit)...When oil filter is replaced

Recommended oil: SAE 10W-30 or 10W-40

Use 4-stroke motor oil that meets or exceeds the requirements for API service classification SG or SH. Always check the API SERVICE label on the oil container to be sure it includes the letters SG or SH.

NOTICE

Using nondetergent oil can shorten the engine's service life, and using 2-stroke oil can damage the engine.

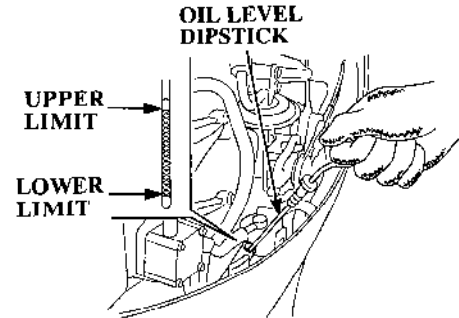

Engine Oil Check

Check the engine oil level positioning the outboard motor vertically.

1. Remove the engine cover.
2. Pull out the dipstick and wipe off.
3. Reinsert the dipstick and pull out again to check the level.

If the level is near the lower limit, refill up to upper limit. If the oil is dirty, replace it. If the oil is contaminated with water (it becomes white as milk), see your authorized Honda marine dealer.

10. MAINTENANCE

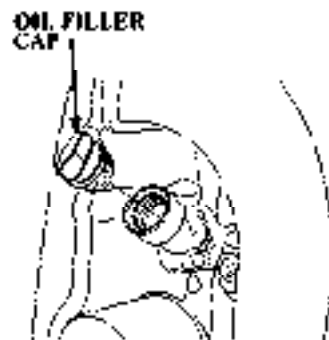

Engine Oil Replacement

Drain the oil while the engine is still warm to assure rapid and complete draining.

1. Position the outboard motor vertically, and remove the engine cover. Remove the oil filler cap.

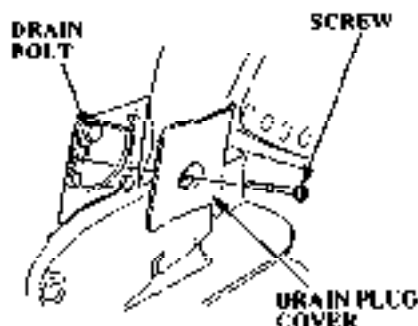

2. Loosen the drain plug cover screw using a flat blade screwdriver and remove the drain plug cover.

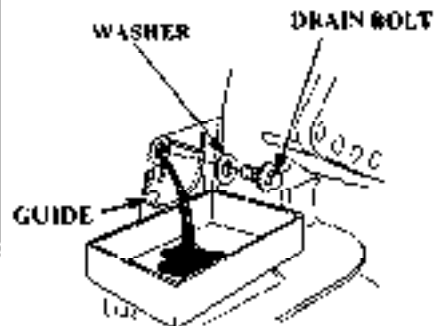

3. Place a suitable container under the guide. Remove the engine oil drain bolt and washer using a 12 mm wrench, and drain the engine oil.
4. Install a new sealing washer on the drain bolt and tighten the bolt securely.
5. Reinstall the drain plug cover.
6. Fill with the recommended engine oil.

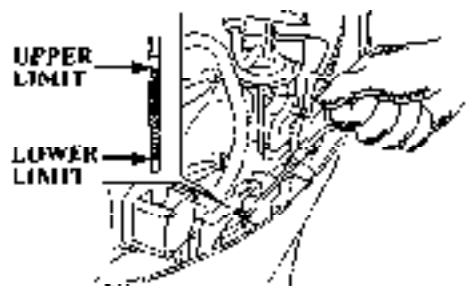

7. Inspect the engine oil level and refill to the upper limit mark on the oil level dipstick if necessary. Fill with the recommended oil.

NOTE: To avoid incorrect gauging of the engine oil level, inspect the oil level when the engine has cooled. The outboard motor needs to be in the vertical position.

8. Reinstall the oil filler cap and tighten securely.

Always wash your hands after handling used oil.

Also, please dispose of used motor oil in a manner that is compatible with the environment. We suggest you take it in a sealed container to your local service station reclamation center. Do not throw it in the trash, pour it on the ground down a drain, or into the water.

Gear Oil

Oil check interval:

Every 100 hours.

Oil change interval:

After the first 20 hours or 1 month, then every 200 hours or 6 months (Refer to the maintenance schedule page 109).

OIL CAPACITY:

33.8 fl oz (1,000 cc)

Recommended oil:

Quicksilver Gear Lube or Quicksilver Super Duty Lower Unit Lubricant or equivalent.

10. MAINTENANCE

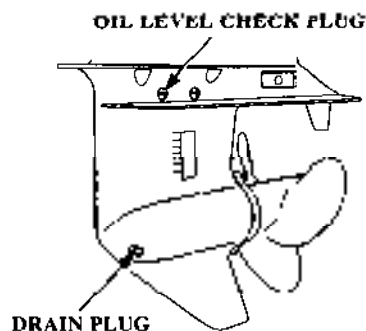

Gear Oil Level Check

- 1 Position the outboard motor vertically.
- 2 Remove the oil level check plug, and verify that oil flows from the oil level check hole. If no oil flows out, contact your closest authorized Honda Marine dealer.

The oil contaminated with water will be milky colored. If the oil appears abnormal, consult with your closest authorized Honda Marine dealer.

- 3 Install and tighten the oil level check plug securely.

Spark Plugs

To ensure proper engine operation, the spark plugs must be properly gapped and free of deposits.

Check-replace interval:

After the first 20 hours or 1 month then every 200 hours or 6 months (Refer to the maintenance schedule page 109).

Recommended spark plug:

DR7EA (NGK).

X22ESR-U (DENSO)

Use only the recommended spark plugs or equivalent.

NOTICE Spark plugs which have an improper heat range may cause engine damage.

1. Allow the engine to cool. The spark plugs will be hot if the engine has been running.
2. Remove the engine cover.



SPARK PLUG
WRENCH

17 mm WRENCH

3. Disconnect the spark plug caps from the spark plugs.
4. Use the spark plug wrench and 17 mm wrench supplied in the tool kit to remove the spark plugs.
5. Check the spark plugs. Replace the spark plugs if there is apparent wear, or if the insulators are cracked or chipped. Clean the spark plugs with a wire brush if they are to be reused.

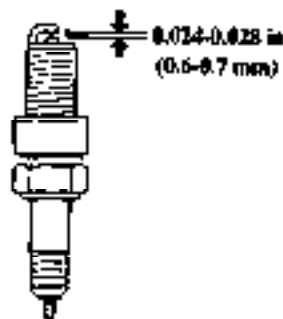

6. Measure the plug gaps with a spark plug gap gauge.

The gaps should be 0.024-0.028 in (0.6-0.7 mm). Correct as necessary by carefully bending the side electrode.

10. MAINTENANCE

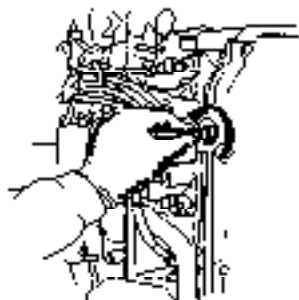

7. Thread the plugs in by hand to prevent cross threading.

8. After the spark plugs are seated, tighten with the spark plug wrench and 17 mm wrench from the tool kit to compress the washers.

If installing new spark plugs, tighten $1/2$ turn after the spark plugs seat to compress the washers. If reinstalling used spark plugs, tighten $1/8$ — $1/4$ turn after the spark plugs seat to compress the washers.

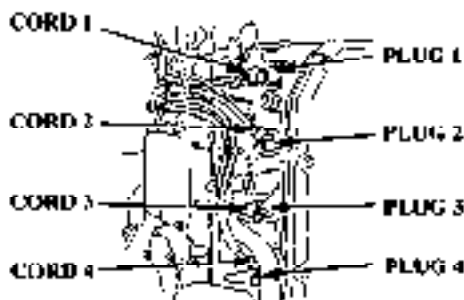

9. Reinstall the spark plug caps, matching the numbers on the cords with the cylinder numbers, as shown.

NOTICE

The spark plugs must be securely tightened. A loose spark plug can become very hot and may cause engine damage. Overtightening the spark plugs can damage the threads.

Battery (not included)

Minimum requirements
12V-70AH marine cranking battery.

Check the battery cables to be sure they are securely connected to the battery terminals. Tighten if necessary. If the battery terminals are corroded or if recharging is necessary, remove the battery from the boat to clean or recharge.

To protect the battery from mechanical damage and to prevent the battery from falling or tipping over, the battery must be:

- Installed in the correct size corrosion-resistant battery box.
 - Properly secured in the boat.
 - Secured in a location free from direct sunlight and water spray.
 - Secured away from the fuel tank to avoid potential sparks near the fuel tank.
1. Install the battery in the battery box.
 2. Connect the positive (+) battery cable first, then connect the negative (-) battery cable. Tighten the cable nuts securely.
 3. Coat the battery terminals and cable ends with marine anticorrosion grease.

4. Put the cover on the battery box, and secure the battery box to the boat.

10. MAINTENANCE

Lubrication

Lubrication interval:

After the first 20 hours or 1 month, then every 100 hours or 6 months.

(Refer to the maintenance schedule page 109).

Apply marine anticorrosion grease to the following parts

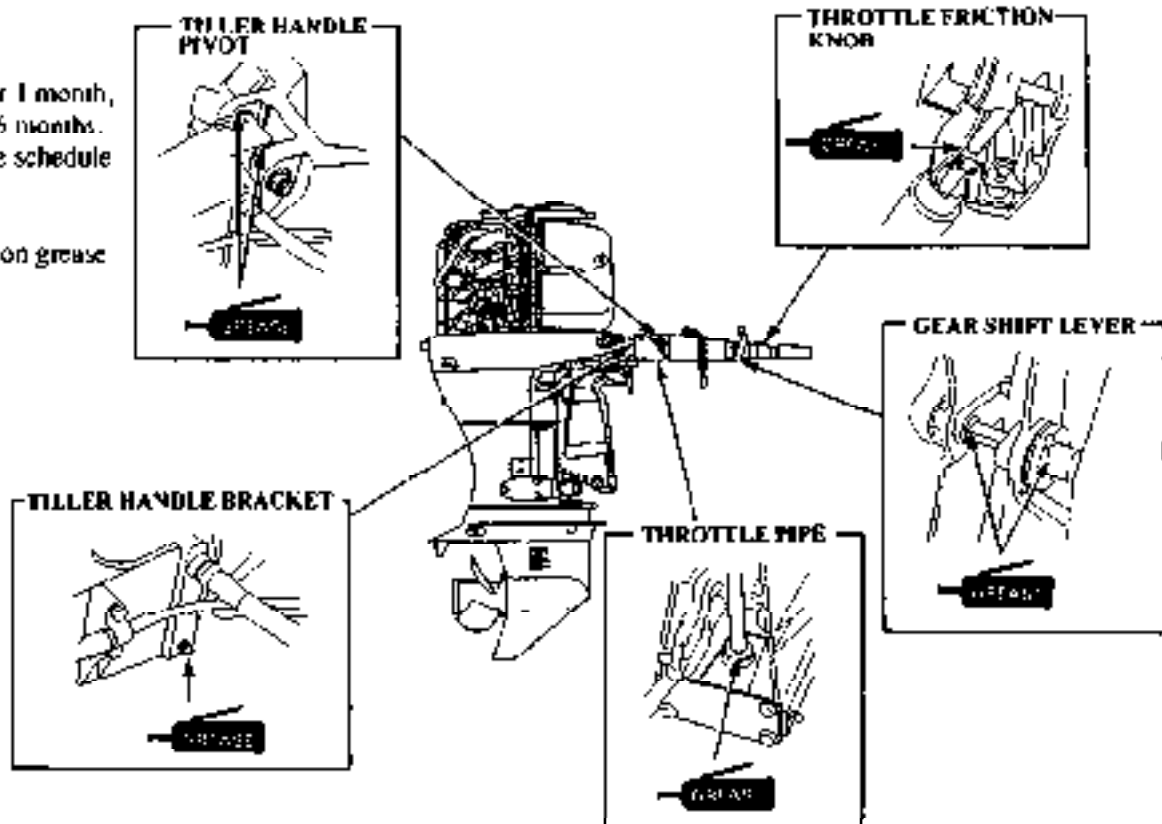

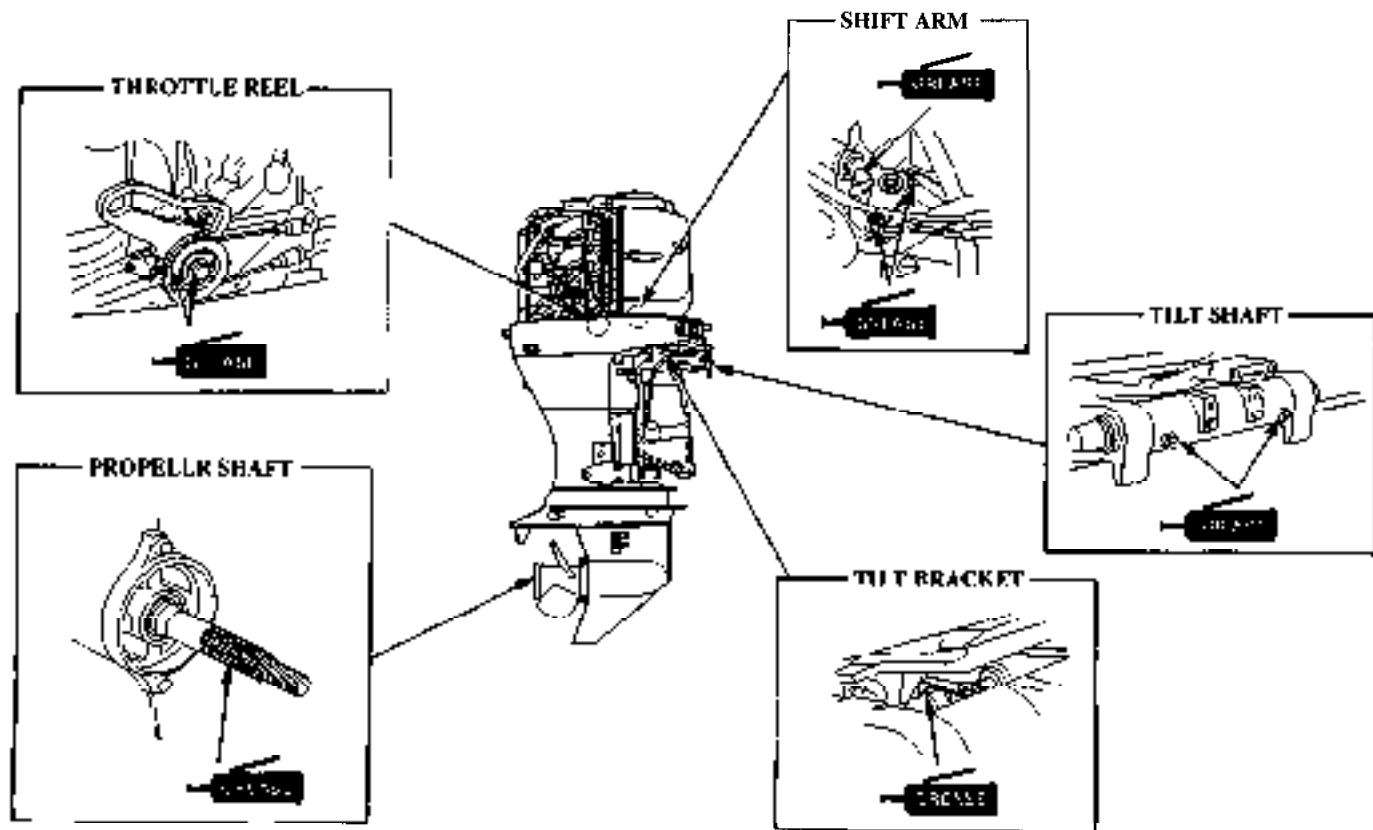

10. MAINTENANCE

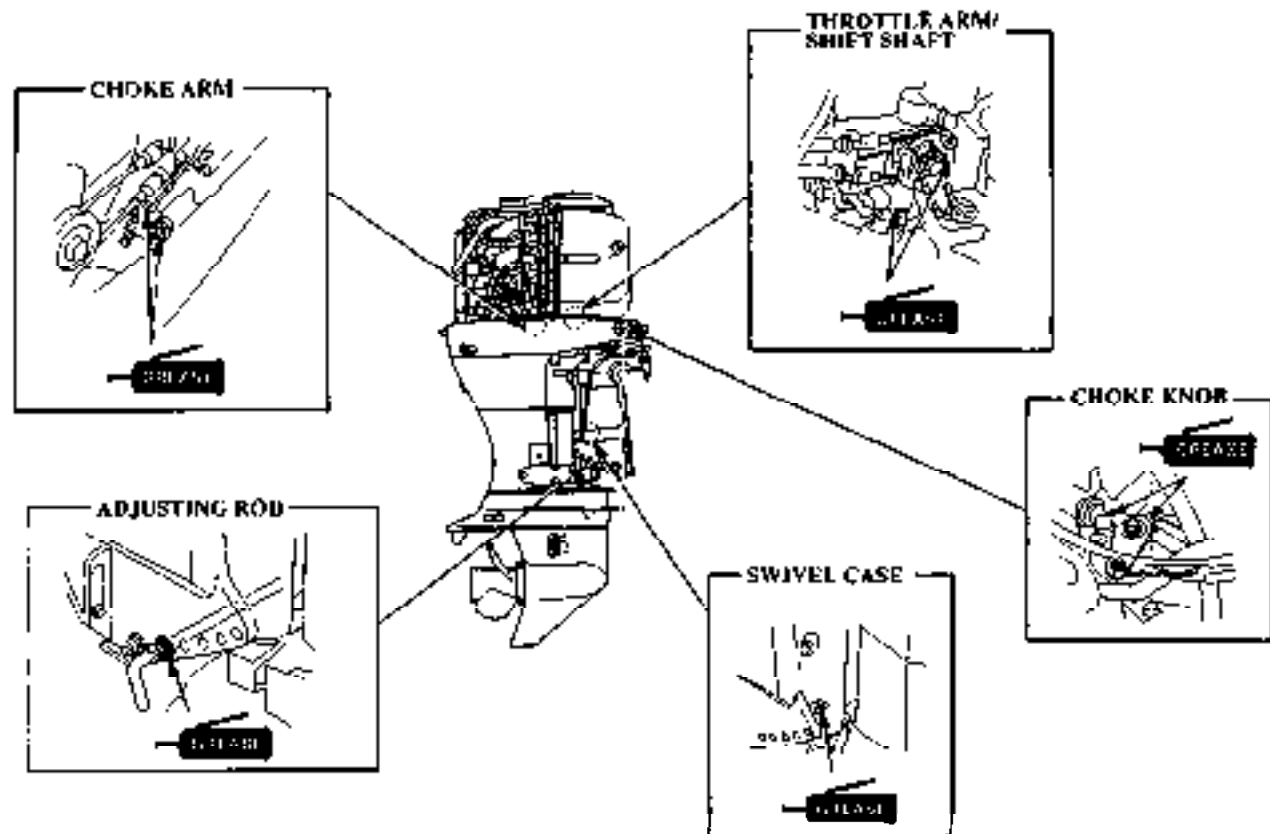

Engine Fuel Filter

FUEL PUMP

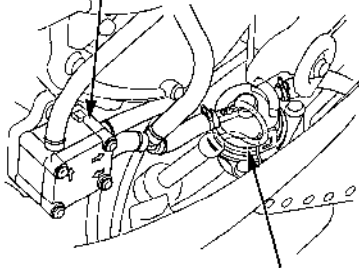

FUEL FILTER

The engine fuel filter is located under the engine cover between the fuel coupling and the fuel pump. Water or sediment accumulated in the fuel filter can cause loss of power or hard starting.

Check interval:

Every 100 hours or 6 months
(Refer to the maintenance schedule page 110).

Change interval:

Every 400 hours or 2 years
(Refer to the maintenance schedule page 110).

Always work in a well-ventilated area. Make sure that any fuel drained from the outboard motor is stored in an approved gasoline container. Be careful not to spill any fuel when replacing the filter. Spilled fuel or fuel vapor may ignite. If any fuel is spilled, make sure the area is dry before starting the engine.

⚠WARNING Gasoline is highly flammable and explosive, and you can be burned or seriously injured when handling fuel.

- Stop engine and keep heat, sparks, and flame away.
- Handle fuel only outdoors.
- Wipe up spills immediately.

CONNECTOR
FUEL HOSE

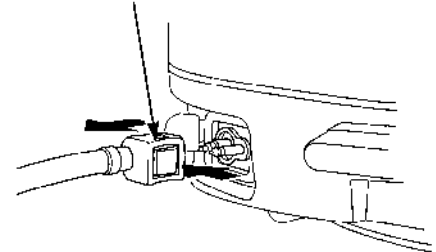

Check

1. Remove the engine cover and disconnect the fuel hose connector from the outboard motor.

10. MAINTENANCE

FUEL FILTER



SPRING RETAINER

2. Pull the spring retainer toward you, and raise the fuel filter.
3. Check the fuel filter for water accumulation or sediment. If no water or sediment are found, reinstall the fuel filter properly.

FUEL HOSES



FUEL HOSE CLIPS

Change

1. Remove the fuel filter.

Before removing the fuel filter, to prevent fuel leakage, place fuel hose clamps on the fuel hoses at each side of the fuel filter.

FUEL FILTER

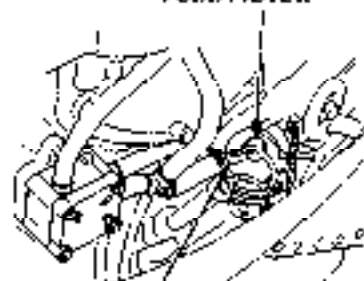

ARROW (Fuel Flow Direction)

2. Install the new fuel filter so the arrow on the fuel filter points toward the fuel pump.

Fuel flow will be reduced if the fuel filter is installed backward.

3. Connect the fuel hoses to the fuel filter securely with the hose clips. Remove the fuel hose clamps used to close the fuel hoses.

- Securely connect the fuel hose connector to the outboard motor page 52.
- Prime the engine using the primer bulb (refer to page 54). Check for fuel leaks.
Repair any fuel leaks if necessary.

If loss of power or hard starting are found to be caused by excessive water or sediment accumulation in the fuel filter, inspect the fuel tank.

Clean the fuel tank and tank filter if necessary. It may be necessary to drain the fuel tank completely and refill with fresh gasoline.

Fuel Tank and Filter (optional equipment)

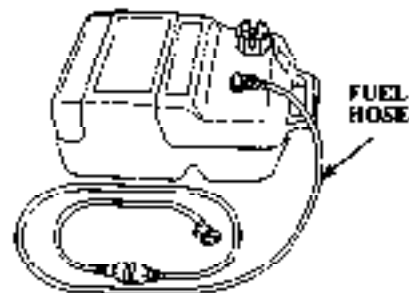

Cleaning Interval:

Every 200 hours (Refer to the maintenance schedule page 110).

Inspect the condition of the fuel cap gasket, fuel hose, and the O-ring seals in the fuel hose connectors. Replace the fuel cap gasket, hose, or fuel connectors if they are cracked, damaged or leaking fuel. Be sure the fuel hose is not kinked.

Fuel Tank Cleaning

- Disconnect the fuel hose from the fuel tank.

WARNING Gasoline is highly flammable and explosive, and you can be burned or seriously injured when handling fuel.

- Stop engine and keep heat, sparks, and flame away.
 - Handle fuel only outdoors.
 - Wipe up spills immediately.
- Empty the gasoline from the fuel tank into an approved gasoline container. Pour in a small quantity of fresh gasoline, and clean the tank thoroughly. Drain and dispose of the gasoline properly.

10. MAINTENANCE

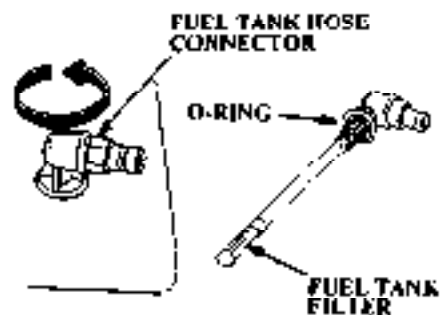

Fuel Tank Filter Cleaning/Replacement

1. Turn the fuel tank hose connector counterclockwise to remove the fuel tank filter.
2. Clean the fuel tank filter with non-flammable cleaner or solvent. Replace the fuel tank filter if necessary.
3. After cleaning or replacement, reinstall the fuel tank filter and fuel tank hose connector securely.

Fuse Replacement

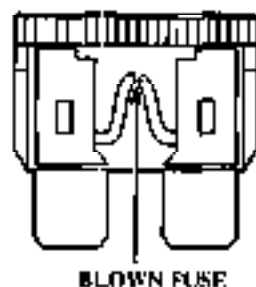

If the fuse is blown, running the engine will not charge the battery, and the electric starter will not work.

FUSE RATING : MAIN 30A
SUB 15A

NOTICE

Replacing a fuse with one that has a higher rating greatly increases the chances of damaging the electrical system.

If you do not have a replacement fuse with the proper rating for the circuit, install one with a lower rating.

MAIN FUSE

FUSE COVER

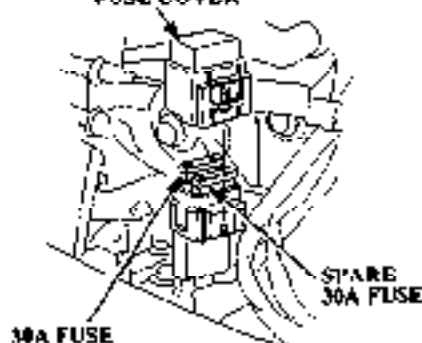

SUB FUSE

SPARE 15A FUSE

FUSE COVER



Replacement

1. Stop the engine.
2. Remove the engine cover.
3. Pull the blown fuse out of the clip.
4. Push a new fuse into the clip.

Spare fuses are located in each fuse holder. If the spare fuse is not available, the motor will need to be started with the pull starter rope (refer to the emergency start procedure page 69).

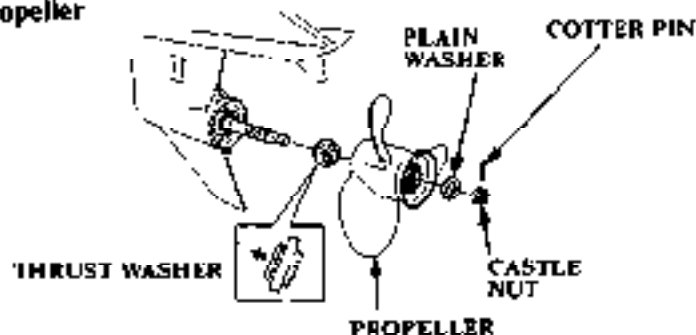
Propeller

If the propeller is damaged by striking a rock, or other obstacle, replace the propeller as follows.

⚠WARNING

- **When replacing, remove the engine switch key to prevent accidental engine starting.**
- **The propeller is thin and sharp. To protect your hands, wear the heavy gloves during replacement.**

Replacement

1. Remove the cotter pin then remove the 18.5 mm castle nut, 19 mm plain washer, propeller and thrust washer.
2. Install the new propeller in the reverse sequence to removal. Be sure to replace the cotter pin with new one.

NOTE:

- Install the thrust washer with the grooved side toward the gear case.
- Use a genuine Honda cotter pin and bend the pin ends as shown.

10. MAINTENANCE

Submerged Motor

A submerged motor must be serviced immediately after it is recovered from the water in order to minimize corrosion.

Immediately take the outboard motor to the closest authorized Honda Marine dealer or if you are far from a dealership, proceed as follows:

1. Remove the engine cover, and rinse the motor with fresh water to remove salt water, sand, mud, etc.
2. Drain the carburetors (Refer to Storage page 128).
3. Disengage the emergency stop switch clip from the emergency stop switch.
4. Remove the spark plugs

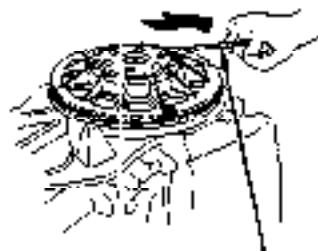

EMERGENCY STARTER ROPE

5. Remove the timing belt cover following the emergency starting procedure (refer to page 69), and remove the water from the cylinders by pulling the emergency starter rope several times.

If the engine was running when it submerged, there may be mechanical damage, such as bent connecting rods. If the engine binds when rotated with the emergency starter rope, do not proceed or attempt to run the engine until it has been repaired.

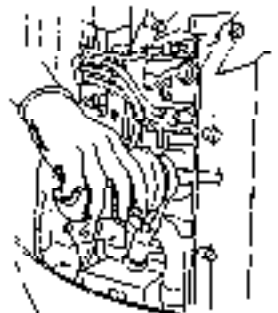

6. Change the engine oil (refer to page 111).
7. Put a teaspoon of engine oil into each spark plug hole to lubricate the inside of the cylinders. Then rotate the engine several times, using the emergency starter rope. Reinstall the spark plugs.

NOTICE

Running the outboard motor without sufficient cooling water will damage the water pump and overheat the engine.

8. Engage the emergency stop switch clip with the emergency stop switch, and attempt to start the engine (be sure the water level is at least 2 inches above the anti-ventilation plate)
 - If the engine fails to start, remove the spark plugs, clean and dry the electrodes, then re-install the spark plugs and attempt to start the engine again.
 - If the engine starts, and no mechanical damage is evident, continue to run the engine for a 1/2 hour or longer.
 - If there was water in the engine crankcase, or the drained used engine oil showed signs of water contamination, then a second engine oil change should be performed after running the engine for a 1/2 hour.
9. Take the outboard motor to your closest authorized Honda Marine dealer for inspection and service as soon as possible.

11. STORAGE

For longer service life of the outboard motor, have your outboard motor serviced by an authorized Honda Marine dealer before storage.

If you are unable to take the motor to your dealer, proceed as follows:

Draining the Carburetors

Be careful not to spill gasoline. Spilled gasoline or gasoline vapor may ignite. If any gasoline is spilled, make sure the area is dry before storing or transporting the motor. Do not smoke or allow flames or sparks where gasoline is drained or stored.

WARNING Gasoline is highly flammable and explosive, and you can be burned or seriously injured when handling fuel.

- Stop engine and keep heat, sparks, and flame away.
- Handle fuel only outdoors.
- Wipe up spills immediately.

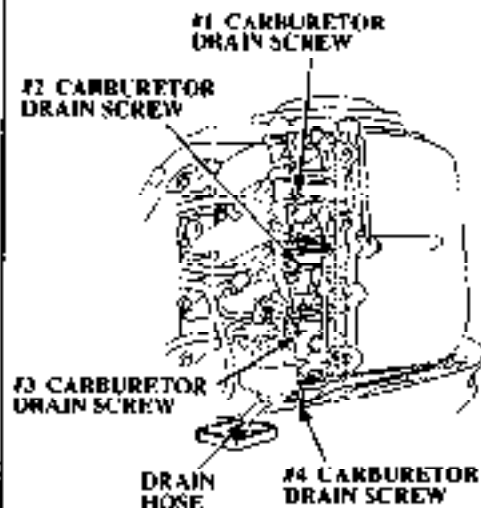

1. Remove the engine cover and disconnect the fuel hose connector.
2. Loosen the #4 carburetor drain screw to drain the fuel.

3. Remove the drain hose from the #4 carburetor, and reinstall it on the #3 carburetor to drain the fuel.
4. Drain the #2 and #1 carburetors in the same manner, using the #4 carburetor's drain hose.
5. After thoroughly drain the carburetors, tighten the drain screws securely.
6. Reinstall the drain hose on the #4 carburetor.

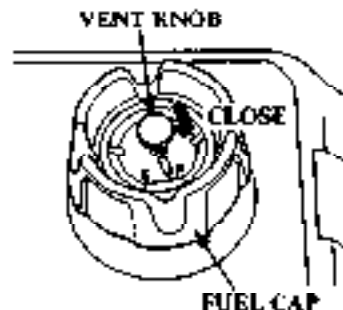
Fuel Tank (optional equipment)

1. Close the fuel cap vent knob.
2. Disconnect the fuel coupling from the outboard motor (refer to page 53)

Outboard Motor Position

Store the motor vertically, as shown above. Store the outboard motor in a well-ventilated area free from direct sunlight and humidity

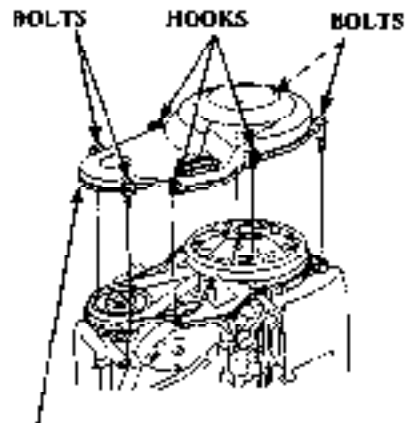
**TIMING BELT COVER****Vertical storage**

1. Remove the engine cover.
2. Loosen the four tightening bolts and unhook the three hooks, then remove the timing belt cover.

11. STORAGE

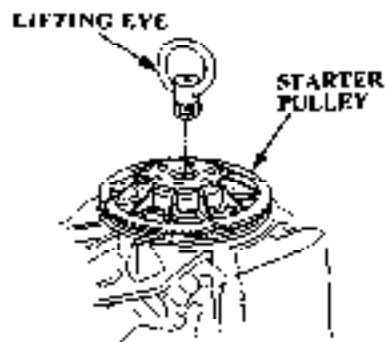

3. Install the lifting eye (optional part) onto the center of the starter pulley and tighten securely.

WARNING If the lifting eye is not securely installed in the starter pulley, the outboard motor could fall from the hoist, causing serious injury.

Be sure the lifting eye is securely installed before hoisting the outboard motor.

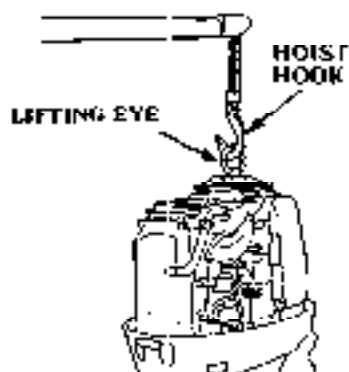

4. Hook the hoist hook to the lifting eye, and lift the motor from the boat.



5. Place the motor on an outboard motor stand and secure with bolts and nuts.
6. Remove the lifting eye and install the timing belt cover and engine cover.

Horizontal storage

Before removing the motor from the boat, drain the carburetors and engine oil. Follow the carburetor drain procedure on page 128.

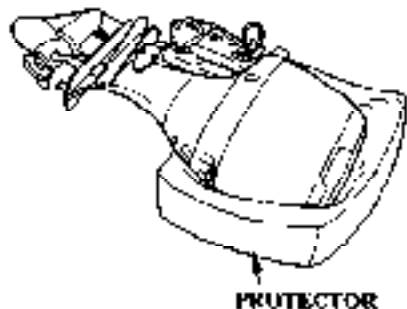

Always rest the motor on protectors, and be sure to protect it from impact and damage.

Always lay the motor carburetor side down.

12. TROUBLESHOOTING

(1) Engine does not start.

Fuel

• Fuel is not fed to carburetor.

- There is no gasoline in fuel tank.
- Vent knob is not open or vent clogged.
- Fuel filter is clogged.
- Fuel line is kinked
- Fuel line is connected improperly.
- Fuel pump is faulty.
- Primer bulb is faulty.
- Check valve in connector is faulty

• Fuel is fed to carburetor

- Excessive amount of fuel, overflow
- Carburetor is clogged.

Electrical

• Sparks across spark plug gap

- Insufficient sparks
- Normal sparks

- Spark plug gap is small.
- Weak starter motor rotation-weak battery.
- Recheck the fuel system.

• No sparks across spark plug gap

Spark plug is faulty.

- Contamination
- Incorrect gap
- Broken spark plug

Pulser coil is faulty.

Current leaks from high tension cord

C.D.I. unit is faulty.

Ignition coil is faulty

Wire harness is faulty.

Neutral switch is faulty.

Current leaks from engine stop switch cord.

Stop switch does not return satisfactorily

Spark plug is improperly installed

Spark plug cap is improperly installed.

Emergency stop switch clip is improperly installed.

Shift lever is not in N position.

(2) Engine starts but immediately stops. Engine sometimes stops while cruising.

Fuel

- No gasoline in fuel tank.
- There is gasoline in fuel tank

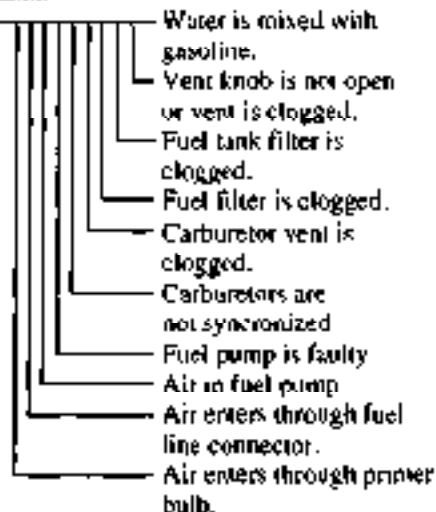

Engine overheats

- Normal sparking

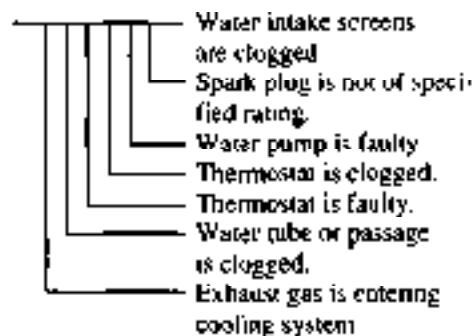

13. SPECIFICATIONS

MODEL	BF75A		
	BRAI		BRAI
Description Code	BRAI		BRAI
Type	LHT	LRT	XRT
Overall length	910 mm (35.8 in)	760 mm (29.9 in)	
Overall width	590 mm (23.2 in)	480 mm (18.9 in)	
Overall height	1,590 mm (62.6 in)		1,720 mm (67.7 in)
Transom height	537 mm (21.1 in)		664 mm (26.1 in)
Weight	179 kg (394 lb)	174 kg (383 lb)	179 kg (394 lb)
Rated power	55.9 kW (75 HP)		
Full throttle range	5,000 - 6,000 rpm		
Engine type	4-stroke OHC, in-line, 4-cylinder		
Displacement	1,590 cc (97.0 cu in)		
Spark plug gap	0.6-0.7 mm (0.024-0.028 in)		

Starter system	Electric starter
Ignition system	C.D.I.
Lubrication system	Trochoid pump pressure lubrication
Specified oil	Engine: API standard (SG, SH) SAE 10W-30/40 Gear case: API standard GL-4/S SAE 90 outboard motor gear oil
Oil refill capacity	Engine: 4.0 l (4.2 US qt) without oil filter change 4.5 l (4.8 US qt) with oil filter change Gear case: 1,000 cc (33.8 fl.oz.)
D.C. output	BLAG 12 V - 16 A
Cooling system	Water cooling with thermostat
Exhaust system	Thru hull
Spark plugs	DR7EA (NGK), X22ESR-U (DENSO)
Fuel pump	Diaphragm type
Fuel	Automotive gasoline (86 pump octane)
Gear change	Forward-Neutral-Reverse (dog type)
Steering angle	30° right and left
Transom angle	5 stages (8°, 12°, 16°, 20°, 24°)

13. SPECIFICATIONS

MODEL	BF90A		
Description Code	BBBL		BBBU
Type	LHT	LRT	XRT
Overall length	910 mm (35.8 in)	760 mm (29.9 in)	
Overall width	590 mm (23.2 in)	480 mm (18.9 in)	
Overall height	1,590 mm (62.6 in)		1,720 mm (67.7 in)
Transom height	537 mm (21.1 in)		664 mm (26.1 in)
Weight	179 kg (394 lb)	174 kg (383 lb)	179 kg (394 lb)
Rated power	67.1 kW (90 HP)		
Full throttle range	5,000 ~ 6,000 rpm		
Engine type	4-stroke OHC, in-line 4-cylinder		
Displacement	1,590 cc (97.0 cuin)		
Spark plug gap	0.6 - 0.7 mm (0.024 - 0.028 in)		

Starter system	Electric starter
Ignition system	C.D.I.
Lubrication system	Trochoid pump pressure lubrication
Specified oil	Engine: API standard (SG, SH) SAE 10W-30/40 Gear case: API standard GL-4/5 SAE 90 outboard motor gear oil
Oil refill capacity	Engine: 4.0 l (4.2 US qt) without oil filter change 4.5 l (4.8 US qt) with oil filter change Gear case: 1,000 cc (33.8 fl oz)
D.C. output	BLAG 12 V - 16 A
Cooling system	Water cooling with thermostat
Exhaust system	Thru-hub
Spark plugs	DR7EA (NGK), X22ESR-U (DENSO)
Fuel pump	Diaphragm type
Fuel	Automotive gasoline (86 pump octane)
Gear change	Forward-Neutral-Reverse (dog type)
Steering angle	30° right and left
Transom angle	5 stages (8°, 12°, 16°, 20°, 24°)

14. WARRANTY SERVICE

Warranty Service Information

Servicing dealership personnel are trained professionals. They should be able to answer any question you may have. If you encounter a problem that your dealer does not solve to your satisfaction, please discuss it with the dealership's management. The Service Manager or General Manager can help. Almost all problems are solved in this way.

If you are dissatisfied with the decision made by the dealership's management, contact the Honda Marine Customer Relations Office. You can write:

American Honda Motor Co., Inc.
Marine Division
Customer Relations Office
4475 River Green Parkway
Duluth, Georgia 30096-2565
Or telephone: (770) 497-6400

When you write or call, please give us this information:

- Model and serial numbers (see page 3)
- Name of the dealer who sold the outboard motor to you
- Name and address of the dealer who services our outboard motor
- Date of purchase
- Your name, address, and telephone number
- A detailed description of the problem

Current customer service contact information:

Your owner's manual was written to cover most of the questions you might ask about your Honda. Any questions not answered in the owner's manual can be answered by your Honda dealer. If your dealer doesn't have an immediate answer, they should be able to get it for you.

If you have a difference of opinion with your dealer, please remember that each dealership is independently owned and operated. That's why it's important to work to resolve any differences at the dealership level. If the service personnel are unable to assist you, please discuss your concerns with the dealer management such as the Service Manager or the dealership's owner.

If you need to contact American Honda regarding your experiences with your Honda product or with your dealer, please send your comments to the following address:

American Honda Motor Co., Inc.
Marine Division
Customer Relations Office
4900 Marconi Drive
Alpharetta, GA 30005-8847

Or telephone: (770) 497-6400 M-F, 8:30 am - 7:00 pm EST

When you write or call, please provide the following information:

- Your name, address and telephone number (complete with area code)
- Model and complete serial number
- Date of purchase
- Name and location of the selling dealer
- Name and location of the servicing dealer (if different)
- A detailed description of your concerns

<https://www.boat-manuals.com/>

Anode Metal	40	Stop Switch.....	16
PRE-OPERATION CHECK	44	Fuel	
MOTOR PROTECTION SYSTEM	90	Cap/Gauge/Vent/Knob (optional fuel tank)	42
Battery (not included)	116	Level	46
Break-in Procedure	75	Line Connection	53
Choke Knob	14	Optional Fuel Tank	53
Choke Switch	28, 34	Tank and Filter (optional fuel tank)	123
Choke/Fast Idle Lever	22	Fuel Recommendations	47
CLEANING AND FLUSHING	102	Fuse Replacement	124
COMPONENT IDENTIFICATION	8	Gear Oil	113
CONTROLS & INSTRUMENTS (common)	39	Gear Shifting	
CONTROLS		TILLER HANDLE TYPE	76
TILLER HANDLE TYPE	14	REMOTE CONTROL TYPE	78, 80, 82
REMOTE CONTROL TYPE	19	High Altitude Operation	94
Cooling System Indicator	40	Ignition Switch	
Cruising		TILLER HANDLE TYPE	14
TILLER HANDLE TYPE	77	REMOTE CONTROL TYPE	20, 26, 32
REMOTE CONTROL TYPE	79, 81, 83	Lubrication	118
Emergency Starting	69	MAINTENANCE	104
Emergency Stop Switch (anyard)		EMISSION CONTROL SYSTEM INFORMATION	105
TILLER HANDLE TYPE	16	MAINTENANCE SAFETY	104
REMOTE CONTROL TYPE	21, 27, 33	SCHEDULE	109
Engine Cover Removal/Installation	44	THE IMPORTANCE OF MAINTENANCE	104
Engine Fuel Filter	121	Manual	
Engine		Choke Knob	12, 28, 34
Oil		Relief Valve	
Level check	45	CONTROLS	38
Change	111	OPERATION	87
Pressure and Overheat Warning System	90	MOTOR PROTECTION SYSTEM	90
Over-Rev Limiter	42	Neutral Release Lever	20, 26

15. INDEX

Oil Pressure Indicator Light	17	(PANEL-MOUNT TYPE)	63
Oil Pressure Indicator Light/Buzzer	23, 29, 35	(SINGLE/DUAL TOP-MOUNT TYPE)	66
Other Checks	52	Steering	76
Over-Rev Limiter	92	Friction Adjustment	50
Overheat Indicator Light	17	Stern bracket	
Overheat Indicator Light/Buzzer	23, 29, 35	PRE-OPERATION CHECK	52
Oxygenated Fuels	48	STOPPING THE ENGINE	
Power Tilt Switch (Motor Pan)		TILLER HANDLE TYPE	95
CONTROLS	37	REMOTE CONTROL TYPE	
OPERATION	87	(SIDE-MOUNT TYPE)	96
Power Trim Tilt Switch	24	(PANEL-MOUNT TYPE)	97
(remote control lever)	24, 30, 36	(TOP-MOUNT TYPE)	98
(control box console)	36	STORAGE	128
PRE-OPERATION CHECKS	44	Submerged Motor	126
Propeller	125	Tachometer	37
Cotter pin	49	Throttle	
Remote Control		Friction Knob	15
Friction Adjustment	50	Grip	15
Lever	19, 25, 31	Opening Indicator	15
SAFETY	6	Tilt Lock Lever	
INFORMATION	7	CONTROLS	39
LABELS	6	OPERATION	88
Shallow Water Operation	93	Tilting motor	
Shift Lever	14	POWER TRIM/TILT	84
Spark Plug	115	Tool Kit	52
SPECIFICATIONS	134	Tool Kit and Spare Parts	108
STARTING THE ENGINE		Transom Angle Adjusting Rod	41
REMOTE CONTROL TYPE	55	TRANSPORTING	99
TILLER HANDLE TYPE		Trim Meter	
(SIDE-MOUNT TYPE)	60	Controls	37

Operation	86
Trim Tab	
Controls	39
Adjustment	89
TROUBLESHOOTING	132
Troubleshooting, Starting Problems	74
WARRANTY SERVICE	136
Water Intakes	41
WIRING DIAGRAM	141

<https://www.boat-manuals.com/>

TILLER HANDLE TYPE

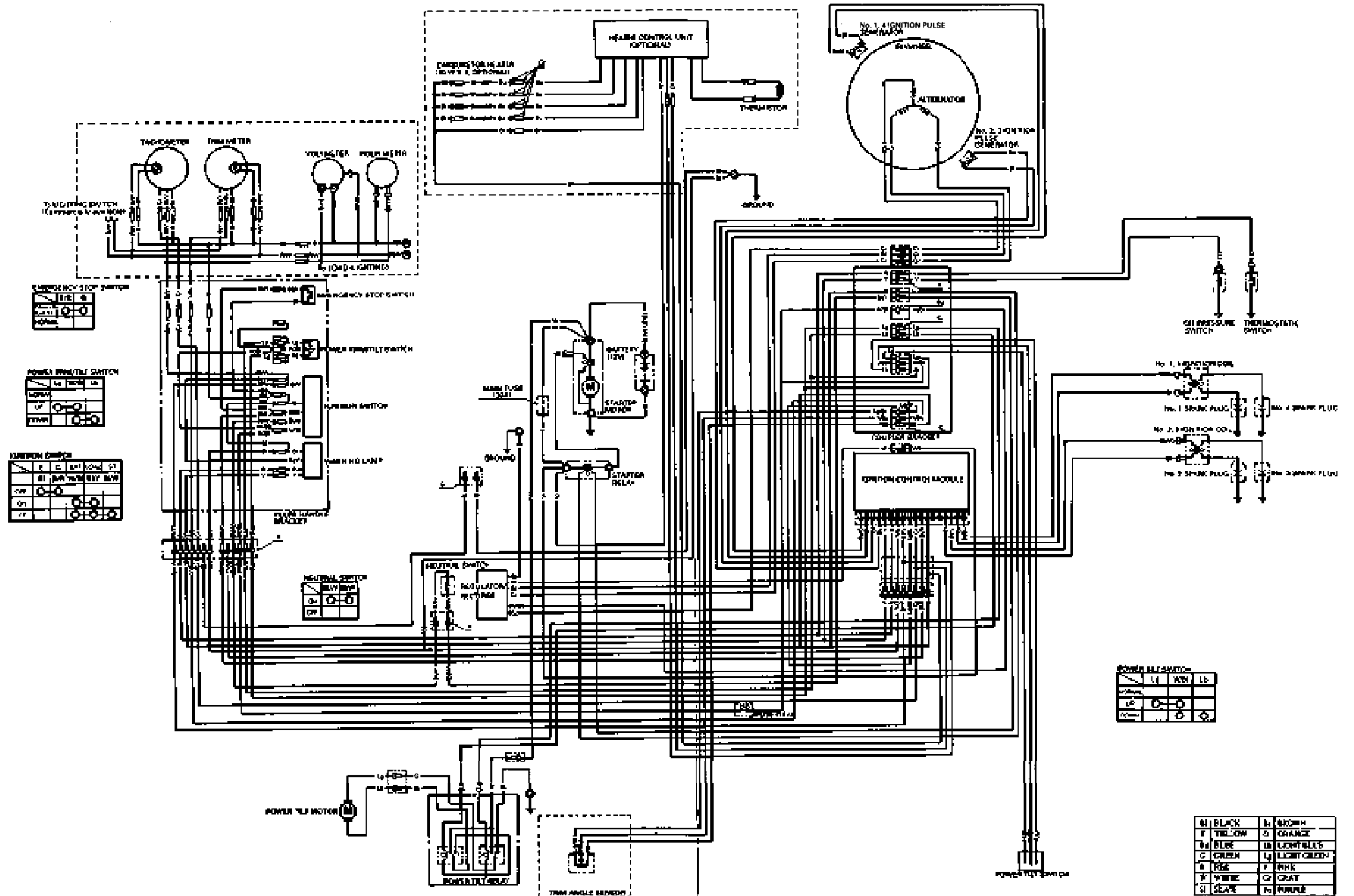

16. WIRING DIAGRAM

REMOTE CONTROL (SIDE-MOUNT TYPE)

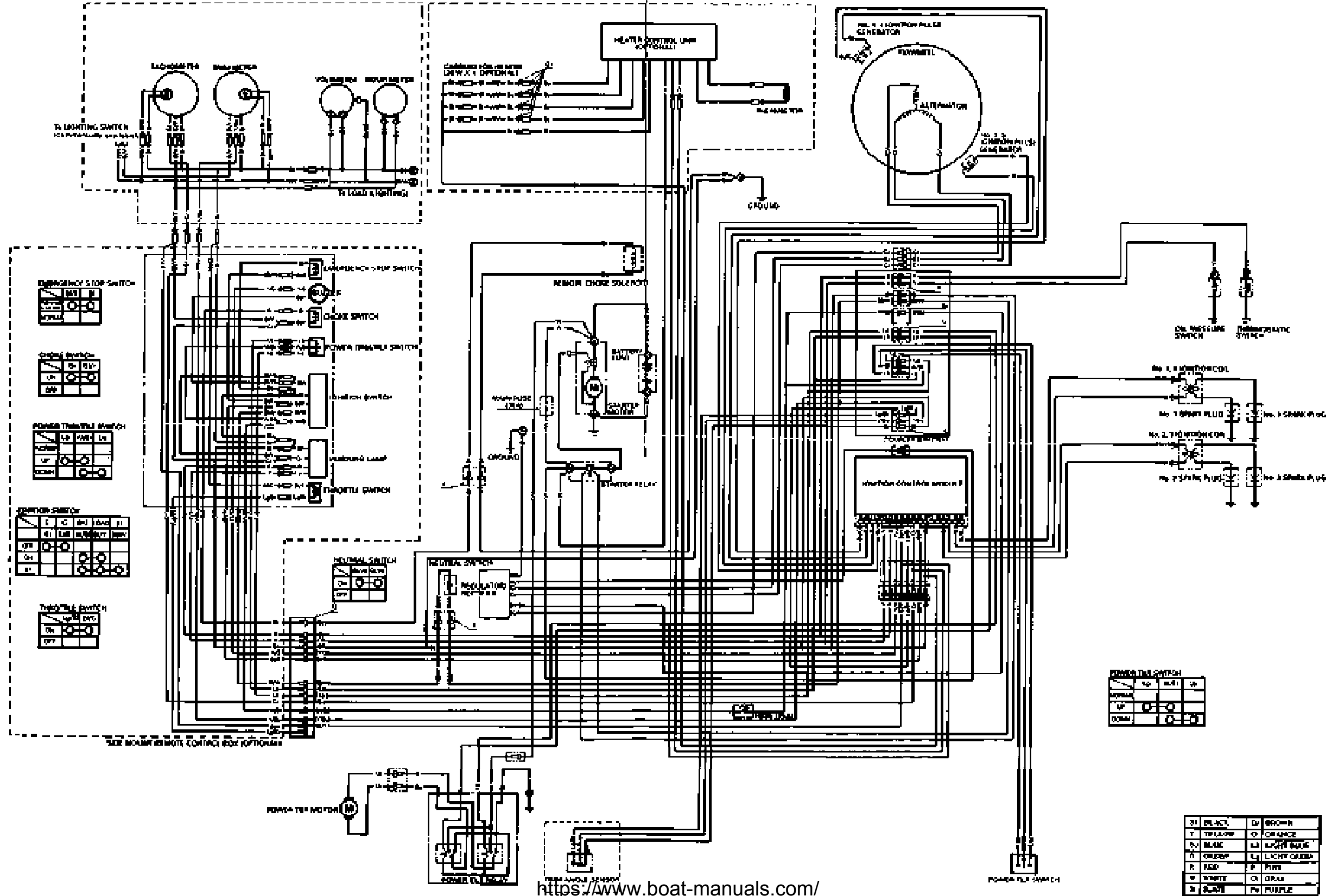

REMOTE CONTROL
(PANEL/TOP-MOUNT)

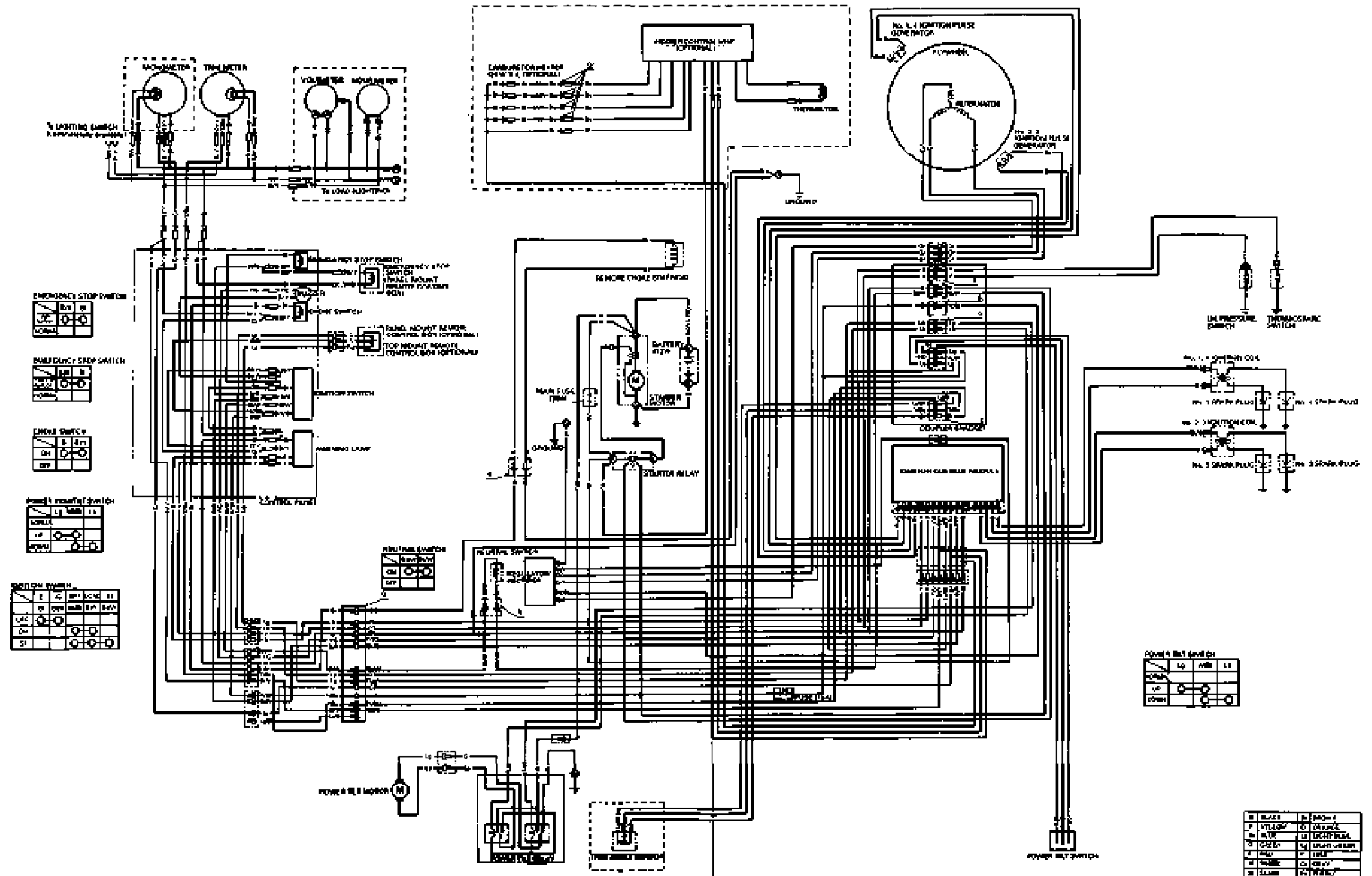

1	BLADE	10	STOP
2	W/STOP	11	START
3	STOP	12	START/STOP
4	START	13	STOP
5	START/STOP	14	STOP
6	STOP	15	STOP
7	STOP	16	STOP
8	STOP	17	STOP
9	STOP	18	STOP

<https://www.boat-manuals.com/>

HONDA

HONDA MOTOR CO., LTD. TOKYO, JAPAN

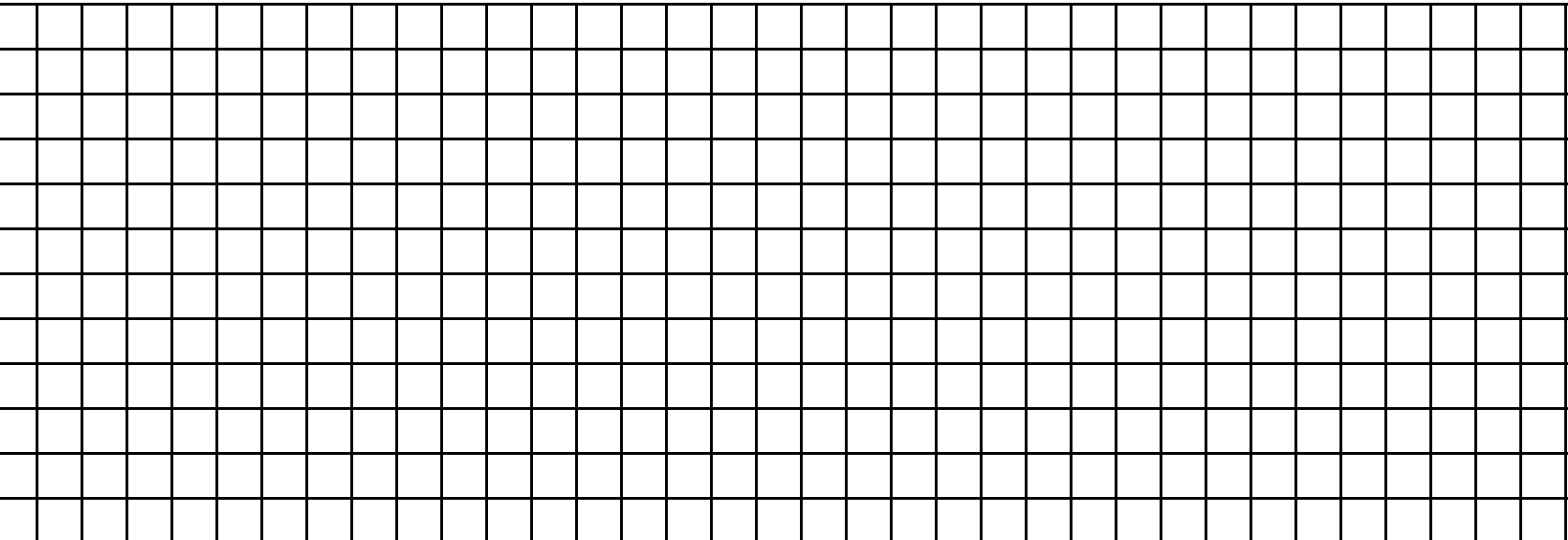

31ZW0602
00X31-ZW0-6020

<https://www.boat-manuals.com/>



200.2002.05
PRINTED IN U.S.A.